

WIRELESS, incorporating "Wireless Weekly," August 21, 1926.

WIRELESS



INCORPORATING
WIRELESS WEEKLY

2^D
WEEKLY

Special Neutrodyne Number.

Vol. VI] AUGUST 21, 1926. [No. 1

Special Articles by:

Prof. L. A. HAZELTINE
F.A.I.E.E., M.A.S.M.E., F.I.R.E.

JOHN SCOTT-TAGGART
F.Inst.P., A.M.I.E.E.

J. H. REYNER, B.Sc. (Hons.)
A.C.G.I., D.I.C., A.M.I.E.E.

**THREE COMPLETE
CONSTRUCTIONAL ARTICLES**

[Registered at the G.P.O. as a
Newspaper.]



Overcomes direct pick-up from your local station

A DIFFICULTY encountered in attempting distant reception in the near neighbourhood of the local station is direct pick-up. Even when using a tolerably selective circuit, it is found that interference continues to give trouble.

For this reason the selectivity of any ordinary receiver is somewhat limited. In "A Screened-Coil Single-Valve Set," described in the September issue of THE WIRELESS CONSTRUCTOR—now on sale—an attempt has been made to overcome the direct pick-up by the use of a screened coil for the actual tuning circuit. A self-contained wave-trap has also been included, with the result that some really selective results are possible with this receiver.

Helpful assistance in the successful building of this receiver may be obtained by using the FREE BLUE PRINT given in exchange for the Coupon contained in the same issue.



This back-of-panel photograph shows the placing of the various components, such as the Screened Coil, High-Frequency Choke and the Integral Wave-Trap. The design is one which will commend itself to many.

As you will see, by reading this list, the September issue of THE WIRELESS CONSTRUCTOR contains many other interesting articles:—

- A Three-Valve Set with One Control. By R. J. O'CONNELL
- Talks to Beginners—VI. By PERCY W. HARRIS, M.I.R.E., Editor
- A "Matchless" Crystal Set. By ROBERT H. TINGEY, M.I.R.E.
- Where the "X's" Come From. By J. H. REYNER, B.Sc. (Hons.), A.C.G.I., D.I.C., A.M.I.E.E.
- Points for the Short-Wave Operator. By A. V. D. HORT, B.A.
- A Screened-Coil Single-Valve Set. By W. H. FULLER
- Splendid News for the Home Constructor
- A Crystal Set for the Double Programmes. By A. S. CLARK
- Where Resistance Helps and Hinders. By C. P. ALLINSON, A.M.I.R.E.
- Professor Hazeltine and the "Elstree Six"
- Constructing a Receiver. By D. J. S. HART, B.Sc.
- Do You Use Grid Bias? By GEORGE T. KELSEY

The Wireless
Constructor
SEPTEMBER ISSUE
NOW ON SALE
PRICE SIXPENCE

The Wireless Constructor is obtainable from all Newsagents, Bookstalls and Booksellers, or direct from the Publishers, Radio Press, Ltd., Bush House, Strand, London, W.C.2. Subscription Rates, 8/6 per annum United Kingdom. 7/6 per annum Canada and Newfoundland, and Other Countries 8/6 per annum. Lesser periods pro rata.



FOR MODERN NEUTRODYNE CIRCUITS

IGRANIC RADIO DEVICES are designed and made by experts of vast experience with full knowledge of the requirements of modern circuits. The use of Igranic Radio Devices in *your* receivers is the surest way of obtaining the maximum efficiency of which they are capable.

Igranic Dual Condenser

Similar in general design to the single pattern which has been used so often in receivers described in the leading wireless journals that it has become known as "the choice of experts."

Igranic Dual Condensers, .0003 mfd., 22s. 6d.

Igranic Dual Condensers, .0005 mfd., 27s. 0d.

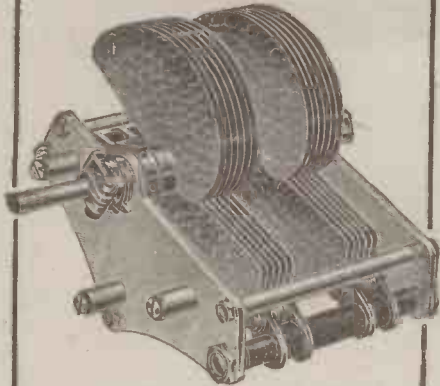

Igranic Dual Variable Condenser

Igranic Honeycomb H.F. Transformers

—with tapped primary—are particularly suitable for neutrodyne circuits. The method of winding results in a highly inductive coupling and low capacity between windings.

When used in neutralised circuits a range of 170—2180 metres is covered.

No. 1	...	Price 6s. 0d.	No. 3	...	Price 8s. 3d.
No. 2	...	Price 6s. 9d.	No. 4	...	Price 10s. 0d.



Igranic H.F. Transformer

Igranic Micro Condenser

A miniature variable condenser having stout brass vanes protected by a moulded cover (not shown in illustration). Hand capacity effects are rendered negligible by adequate spacing between vanes and control knob.

Maximum capacity .00004 mfd. with extremely small minimum. Single hole fixing.

Price, with Control Knob, 5s. 6d.

Price, with 1½" Indigraph Knob and Dial, 6s. 6d.

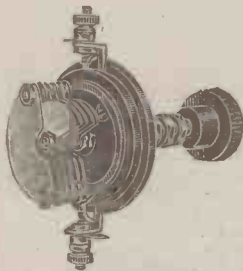

Igranic Micro Condenser

Igranic Vernier Balancing Condenser

Similar in general design to the Micro Condenser. Particularly suitable for balancing out small differences of capacity in two circuits tuned simultaneously with a dual condenser.

Prices as for the Micro Condenser.

SEND FOR LIST NO. S25.

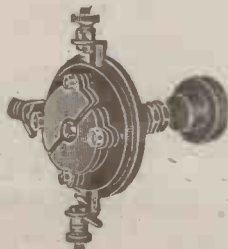

Igranic Vernier Balancing Condenser



149, QUEEN VICTORIA STREET, LONDON

WORKS: BEDFORD.

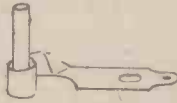

Valve sockets and springs are stamped in one piece. Thus there are no rivetted, soldered or clamped joints to work loose and cause microphonic noises.

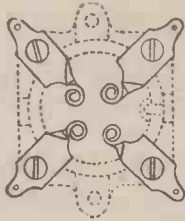

The four one-piece springs allow the valve to move in every direction, and absorb both lateral and vertical vibration.



Suitable stops control spring movement, making it easy to insert valves and without risk of damaging either the springs or the valves.

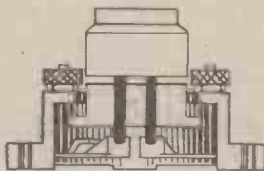

Valve legs, however far pushed home, cannot possibly foul base-board and thus destroy the springing.



Both terminal and soldering tags are provided for temporary or permanent connections.

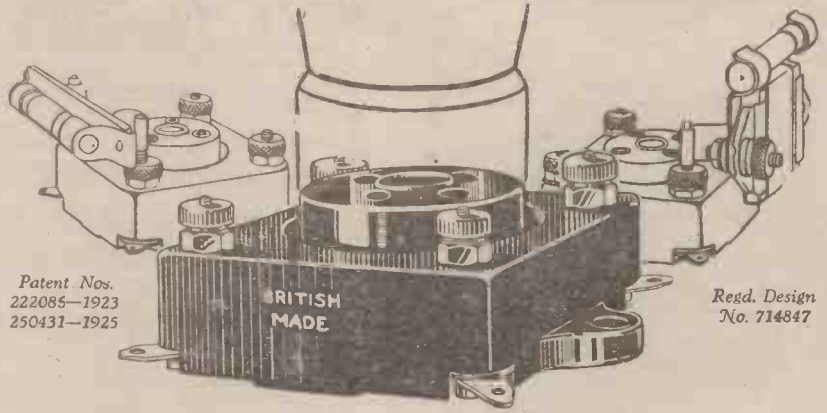

Patent Nos.
222085-1923
250431-1925

Regd. Design
No. 714847

Certified Sales.

44, Gresham Street,
E.C.2.

19-7-1926.

"We have examined the records of the Company and certify that during the ten months from 1st September, 1925, to 30th June, 1926, the Benjamin Electric Limited have manufactured and sold 351,455 Benjamin Clearer Tone Valve Holders."

(Signed) G. N. Read, Son, Cooke & Watson,
Chartered Accountants.

The explanation of this amazing popularity as compared with other valve holders lies in the five vital constructional features outlined on the left.

Benjamin Valve Holders are now offered either alone or with the following attachments. Constructors will instantly appreciate what an enormous saving of space and wiring these ingenious attachments mean.

Benjamin Clearer Tone Valve Holder	- - -	complete	2/9
Equipped with Dubilier Dumetohm Grid Leak	- - -	complete	5/3
With same Grid Leak and also Dubilier Grid Condenser (.0003) (series or parallel)	- - -	complete	7/-

From your Dealer or direct from the Manufacturers:

BENJAMIN

CLEARER TONE, ANTI-MICROPHONIC VALVE HOLDER

THE BENJAMIN ELECTRIC LIMITED

Brantwood Works, Tottenham, London, N.17

STAND N^o. 105 AT THE NATIONAL RADIO EXHIBITION

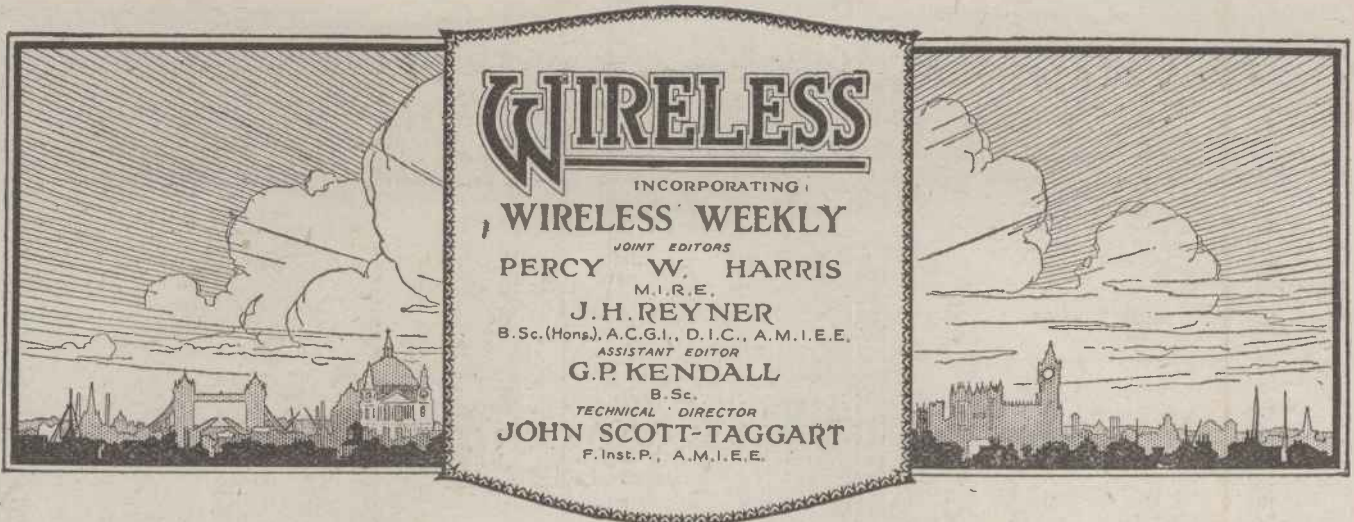

WIRELESS

INCORPORATING

WIRELESS WEEKLY

JOINT EDITORS

PERCY W. HARRIS

M.I.R.E.

J. H. REYNER

B.Sc. (Hons.), A.C.G.I., D.I.C., A.M.I.E.E.

ASSISTANT EDITOR

G.P. KENDALL

B.Sc.

TECHNICAL DIRECTOR

JOHN SCOTT-TAGGART

F. Inst. P., A.M.I.E.E.

THIS WEEK'S NOTES AND NEWS

A Suggestion

TO ALL WHOM IT MAY CONCERN, not forgetting those unfortunates blessed with oscillating neighbours. THIS is a special NEUTRODYNE number, and you will find full particulars within of three instruments of more than average efficiency which will get the distant stations *without* causing all the listeners in the immediate neighbourhood to tear their hair out in tufts. MORAL: If you live next to a Ham-Handed Henry, see that he buys this copy of WIRELESS.

The New Waves

AND now, having rid myself of that, we may proceed with the business. In case you do not already know the full details of the new B.B.C. wavelengths, which will come into operation on or about September 15, you will find them elsewhere in this issue.

A Long Contract

THE MARCONI CO. has, I see, recently added Bolivia to the already large field of its activities, and will, starting on October 1, control and operate the postal and wireless services of Bolivia for twenty-five years.

Three Opinions

WE cannot yet say whether the "physical jerkers" are to be satisfied by the B.B.C. At the present time it seems rather doubtful whether the scheme will be taken up, and public opinion seems very much divided on the subject. There are apparently three schools: Those who think it an excellent scheme; those who think that, if people are too

weak-minded to take exercise in the mornings without persuasion, they will not benefit by it; and those who positively refuse to get up early for "phiz-jerks" or anything else! I will not tell you to which class I belong. I am, however, rather inclined

"Controversial!"

I RATHER like the boldness of a correspondent in the daily Press who states that, since the Government does not allow the broadcasting of controversial matter of any kind, it will obviously prohibit the transmission of sermons, since there is certainly no subject more controversial than religion. Apparently even the Government overlooks these little points at times!

NAUEN

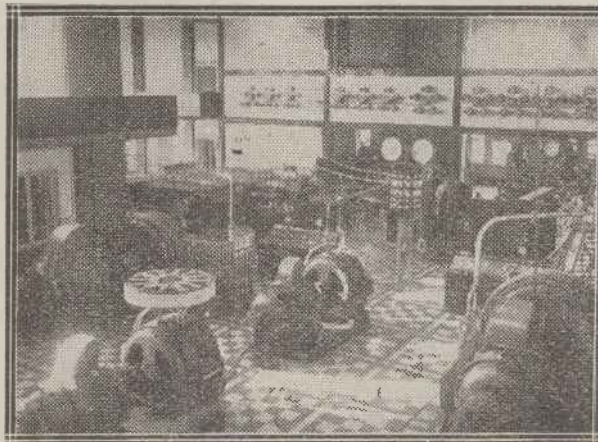

Our picture shows the giant power plant at the Nauen Station. The power to drive the generators at this station is obtained from an 800 h.p. motor.

The Smoke Nuisance

I HAVE recently seen an excellent suggestion in a contemporary, to the effect that the B.B.C. should from time to time broadcast little lectures on the absolute necessity of eliminating anything that is likely to increase the smoke nuisance in London. In New York, on account of the prohibition of the burning of soft coal in houses, factories, shops, etc., the atmosphere is clear. Why should London not be the same? And, also, what a treat it would be to be able to haul your aerial down after it had been up a month or so without looking like a sweep afterwards!

Microphone Faux Pas

THIS vexed question of pronunciation is still providing plenty of fun for the critics of the B.B.C., who are, of course, now more alert than ever when listening to the voices of the announcers. Several complain of the "wahrliss awkistrer," and another announces that he heard some one inflict "de-cor-ative" upon the microphone.

Something New

ON Friday, August 20, we shall hear a new turn from 2LO, when Mr. Zachray Tan will extract music from a
(Continued on next page.)

to share the opinion of the writer who considers that he gets enough exercise dodging buses in the one-way streets!

Lohengrin from Danzig

AN exceptionally interesting broadcast took place from Danzig on August 1, when a full performance of Lohengrin was given in the open-air, and parts of it were broadcast. Fifty microphones were used, and the music was S.B. from about ten stations. Several friends of mine picked up the transmission from Konigs-wusterhausen, but interference was rather bad at the time.

THIS WEEK'S NOTES AND NEWS

(Continued from previous page)

saw, a rubber balloon, and a guitar. The advantage of the first two turns is that we shall not be any the worse if our loud-speakers *do* suffer from distortion!

A Short Visit

WIRELESS has been responsible for shortening an American gentleman's holiday in England to 16 hours. Mr. Gardner T. Smith had come over here for a holiday, and two days after sailing received a radiogram asking him to return, as his business partner had met with an accident. He therefore had to come on to England in the full knowledge that he would have to return as soon as he reached his destination. He landed, came to London, slept for a few hours, and went back to Plymouth. He looks on the bright side of things, however, and says that the sea voyage did him good!

Risky!

THERE has been an idea "going the rounds" recently about a "radio clock" capable of controlling all the world's timepieces by signals sent out every minute. Those who grumble about the inconsistency of public clocks naturally jumped at the idea. What they overlooked, however, was that should this master clock go wrong, *all* the world's clocks would also go out of action, and no one would be any the wiser, since they would all be the same amount out!

A Wireless Exchange

MR. WALLACE MATON, of Hythe, Hants., on the edge of the New Forest, has been running a "wireless exchange" for some time. He has twenty subscribers, all of whom can, by inserting a plug in a socket, connect their loud-speakers to his receiver, thus obtaining the broadcast programmes "on tap." He also has an "alarm clock switch," which switches on his set at the hour when the programmes commence. All his subscribers have, of course, to hold B.B.C. licences, in addition to which they pay him 1s. 6d. per week.

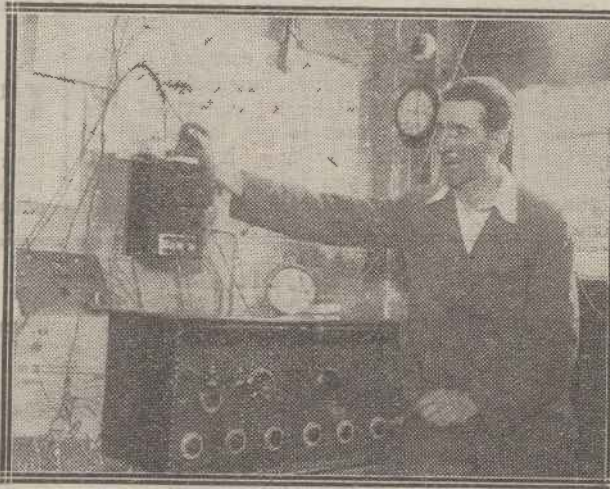

The Post Office authorities have ordered an immediate investigation into the legality of the "wireless exchange" which Mr. Wallace Maton, of Hythe, has established for the benefit of local residents.

Fishy Broadcasting

DID you know that a fishery bulletin is broadcast daily? There is a special arrangement between the B.B.C. and the Fishery Board for Scotland, and recently the Scottish trawler *City of Aberdeen* had failed to locate herring, but, on hearing the bulletin, hurried to a fresh ground, and immediately landed what was almost a record catch. There have, I hear, been many similar incidents.

Esperanto Aspirations

DR. FOURNIER D'ALBE, speaking at the Esperanto Congress in Edinburgh a week or so ago, said that he was convinced that Esperanto would be adopted by every large transmitting station as an auxiliary language before long, and that it would be universally used for the transmission of important news. It seems that just as the B.B.C. announcers have learnt to speak English, they will have to start learning Esperanto!

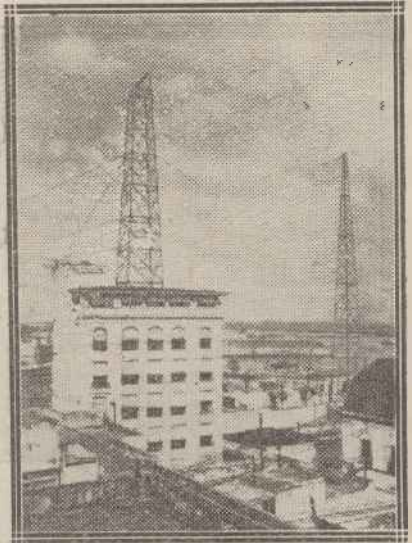

The transmitting aerial at WRAQ, San Juan, Porto Rico, which consists of three wires 90 feet long and 167 feet high.

Cross-Talk Again

A GAIN the problem of the accidental broadcasting of private telephone conversations has cropped up. A correspondent in a daily paper reports having a long portion of a private call broadcast, and advises those who are in the habit of making confidential trunk calls to avoid doing so when the lines are likely to be in use for broadcasting purposes. The trouble usually occurs through the accidental contact of two overhead wires, especially when they are in exposed positions. Moral: Lay all telephone wires underground!

The Latest

A "PRESS-BUTTON" wireless receiver is reported to have been made by Mr. M. A. Robinson, of Southampton. The rumour that a special button labelled "KDKA," and connected with the gramophone, has been provided is quite untrue.

Under Difficulties

I WAS rather amused to read that Miss Gertrude Ederle received a wireless message from her mother during her famous Channel swim. It had the effect of "spurring her on." She herself sent messages by means of the radio apparatus on the accompanying tug.

CALL-SIGN.

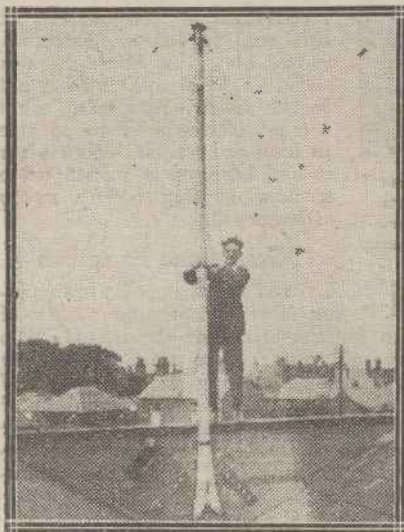

The programmes received on Mr. Maton's aerial are disseminated via land lines to the homes of his subscribers.

"The Wireless Constructor"

September Number

6d. Now On Sale 6d.

SELECTIVITY

Professor Hazeltine explains how Selectivity is obtained and why Multiple Circuits are needed

PRESERVING THE SIDEBANDS

In this exclusive article Professor L. A. HAZELTINE, Fellow A.I.E.E., Member A.S.M.E., Fellow I.R.E., gives a lucid exposition of the problem of the day. He explains how any desired degree of selectivity can be obtained and makes it clear that quality of reproduction is one of the chief limiting factors.



UNDER modern conditions, when any degree of sensitivity is readily attainable by a sufficient number of stages of amplification, the qualities to be considered primarily in a wireless broadcast receiver are selectivity and faithful reproduction. To some extent, these qualities are mutually antagonistic. Selectivity requires the exclusion of interference; faithful reproduction requires the inclusion of all components of the wave being received, and necessarily involves the simultaneous inclusion of a certain amount of interference that is electrically indistinguishable.

The Carrier Wave

Let us consider the characteristics of the electromagnetic waves emitted from wireless telephone broadcasting stations. When such a station is "on the air" but is not transmitting music or speech, as during a lull in the programme, there is radiated a wave of a single definite frequency (or wavelength, which is inversely proportional to frequency). This frequency is called the "carrier frequency." Now if the carrier wave is modulated by a pure musical tone, two new components will be radiated in addition, one at a higher frequency, the other at a lower frequency, each displaced from the carrier frequency by the frequency of the musical tone.

Sidebands

Since useful musical tones have frequencies up to about five thousand cycles per second, as do the components of speech, during a programme there will be present in the radiated wave components of all frequencies between two limits, one about five thousand cycles higher, the other about five thousand cycles lower, than the carrier frequency. These two frequency ranges are called the "sidebands." A properly operated broadcasting station emits waves at no other frequencies. Improperly operated stations may emit wider side bands or may emit harmonics (that is, multiples) of the normal carrier frequency, together with the corresponding side bands.

Limits of Selectivity

Selectivity is accomplished primarily by tuning. A tuned circuit will respond most readily to a certain frequency, but will also respond almost as well to frequencies very close to this resonant frequency. To preserve faithful reproduction, it is necessary to maintain a reasonably good response for frequencies up to five thousand cycles per second on each side of the carrier, for the reasons given above. It would be desirable to



A recent portrait of Professor L. A. Hazeltine.

have no response at more remote frequencies, but unfortunately this is not possible, the response falling only gradually. A single tuned circuit is therefore definitely limited in its selectivity by the necessity for faithful reproduction.

Deciding Factors

The breadth of the frequency band covered by a tuned circuit depends on the resistance. It just happens that with coils of convenient dimensions the resistance is such as to nicely cover the sidebands at wavelengths in the lower broadcasting range, say, 250 to 550 metres, while at such wavelengths as 1,600 metres the design must be such

as to introduce resistance that would otherwise be unnecessary. If reaction is employed, the effect is to lower the resistance and thereby to destroy faithful reproduction by cutting down the sidebands below the requisite five-thousand-cycle limit.

Cascade Circuits

To attain higher selectivity than is possible with a single tuned circuit, several tuned circuits may be employed in succession. They may be designed to preserve a suitable response for the sidebands and at the same time to give a more rapid falling off in response outside the sidebands. This effect is the better the greater the number of tuned circuits, three circuits being very commonly used and sometimes several more. For example, if with a single tuned circuit, an interfering station is cut down to one-tenth the strength it would have at resonance, then with two such tuned circuits it will be cut down to one hundredth, and with three such tuned circuits to one thousandth.

Coupling Methods

The successive tuned circuits may be coupled with one another electromagnetically or electrostatically, but the coupling must be very loose, otherwise the circuits will react appreciably with one another and will behave more like a single tuned circuit. A better plan is to couple the tuned circuits through valves, which at the same time serve to amplify the signal (that is, the music or speech) to be heard. To completely eliminate the reaction of one tuned circuit on another it is necessary to neutralise the natural electrostatic coupling of the vacuum tube, as is done in the Neutrodyne circuit.

The Spark Problem

We have so far considered selectivity from the point of view of cutting down interference from broadcasting stations having frequencies different from that of the station we wish to hear. A quite different problem is offered by interference from spark stations or from atmospheric and other sources of

(Continued on next page.)

Selectivity — continued

random interference. While spark stations have a certain nominal frequency (or wavelength), they actually radiate waves having components of all frequencies and thus come in the same class as random interference, particularly if their decrements are high. *The interference in such cases is primarily due to the same frequencies as are desired to be received from the broadcasting station which has been tuned in.*

If the receiver covers the sidebands of this broadcasting station, and no more, there is nothing which can be done to it to increase appreciably its selectivity against spark stations or random interference. Lower resistance will destroy the faithfulness of reproduction and more stages are of no avail. The interference must be eliminated at its source, or the power of the broadcasting station must be increased to drown out the interference.

Low-frequency Methods

In a wireless receiver designed to cover broadcasting stations having a wide range in wavelength, it is not generally possible to design the tuned circuits to have the most desirable resistance at all wavelengths. In such cases it is helpful to employ low-frequency amplifying stages arranged to cut off frequencies above 5,000 cycles per second and even to weaken components considerably below this limit. While this may somewhat impair faithfulness of reproduction, it will often give a more pleasing result by eliminating much of the hissing disturbances from atmospherics and other random interference.

Direct Pick-up

The above discussion relates to general methods. Special problems relating to selectivity often arise, of which two examples will be given, both in connection with interference from a very powerful or very nearby broadcasting station. First, in a tuned radio-frequency amplifier, there may be a direct pick-up of signal by the tuned circuit preceding the detector. Tuning the preceding stages will then not be effective in cutting out this

station. The remedy lies in shielding each stage, particularly the detector stage, to prevent direct pick-up. Secondly, in a reflex type of receiver, the reflexed valve may act as a detector and supply directly to its output low-frequency transformer. Tuning

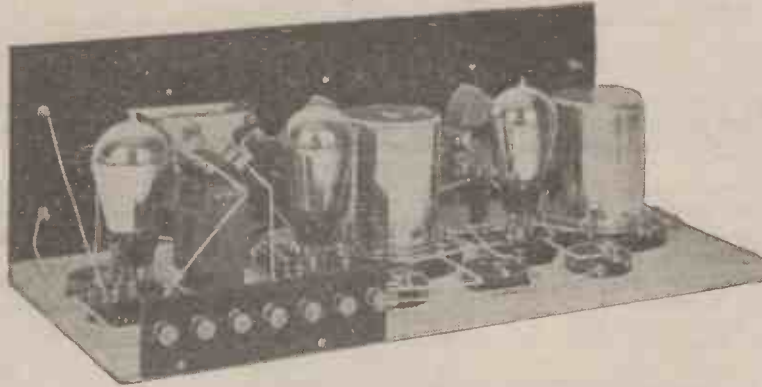

One of the problems of selectivity is the question of direct pick-up, and to eliminate it screened coils are used.

the subsequent stages will then not be effective. This is a limitation to reflex receivers in localities close to a broadcasting station.

Conclusions

Summing up, the type of wireless re-

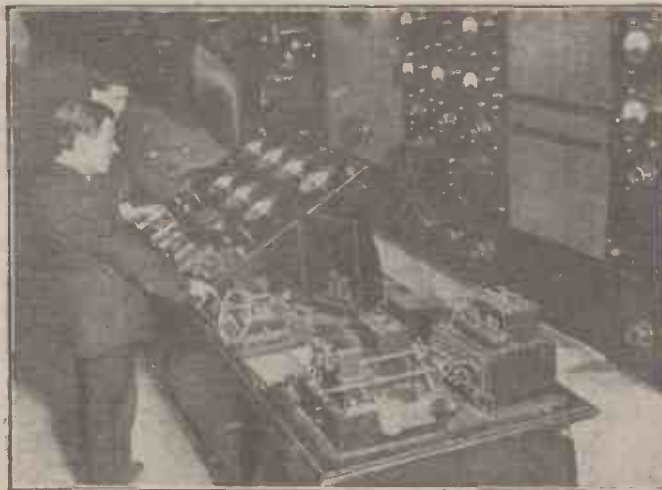

Special problems are associated with the design of the receiving circuits for the telephony transmissions of Rugby, in which only certain components of the normal carrier wave are radiated.

ceiver giving the highest degree of selectivity employs several stages of tuned high-frequency amplification, each stage being designed to barely cover the sidebands, and all undesired couplings between stages being eliminated or neutralized. (The elimination or neutralization of reactive couplings has, of course, the especial advantage, irrespective of selectivity, of preventing reaction and the consequent self-oscillation, the cause of the well-known

and distressing howls.) Supplemental features include the cutting off of relatively high frequencies in the low-frequency amplifier stages, the avoidance of reflex stages, and the use of shielding, when necessary. This is essentially a description of the Neutrodyne receiver.

Soldering Fine Wires

Probably all home constructors have been faced, at one time or another, with the problem of joining together two pieces of fine gauge copper wire, such as is used in barrel-type H.F. transformers, etc. This wire, which ranges in size from No. 34 to No. 40 S.W.G., cannot be soldered safely in the usual way, as there is considerable risk of injuring the wire.

The following method of soldering has proved successful in such cases:— Bare the two wires to be joined of insulation for about half an inch. Twist the bared ends together tightly, apply a little flux, and wrap a small piece of ordinary tinfoil round the joint. Apply a match to the tinfoil, which will melt and cover the joint neatly with solder. This makes a very strong and satisfactory joint.

A. P.

NEWS IN ADVERTISEMENTS

The Radio Service Co., in their advertisement elsewhere in this issue, announce that they are letting out Rotax H.T. and L.T. accumulators on hire, both on the weekly and fortnightly delivery system.

Messrs. Garnett, Whiteley & Co., Ltd., are advertising three new lines of their well-known "Lotus" products—the Lotus jack, the Lotus jack switch, and the Lotus plug.

The Bowyer-Lowe Co., Ltd., announce that with each set of Super-sonic transformers sold a free booklet describing the construction of a seven-valve superheterodyne will be presented.

SEND ALL YOUR QRA QUERIES TO US

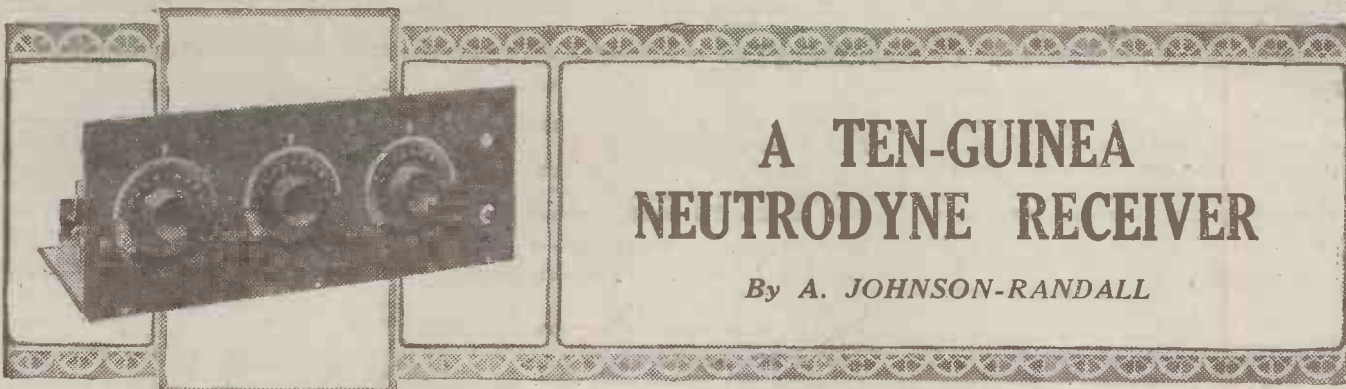

A TEN-GUINEA NEUTRODYNE RECEIVER

By A. JOHNSON-RANDALL

A four-valve neutralised receiver of very simple construction which can be built complete with falling-front cabinet for the sum of £10 10s.



WHETHER or not a wireless set shall be constructed is very frequently a matter of cost. A four-valve receiver for ten guineas is, as sets of this size go, a comparatively inexpensive proposition, and when in addition a handsome fall-front cabinet is included, together with two neutrodyne stages of high-frequency amplification, the *tout ensemble* becomes very attractive.

The set described in this article is selective and sensitive, and, moreover, is easy to build. As a matter of fact, the whole of the constructional work was completed in a couple of evenings.

Special Coils

The neutrodyne coils employed are similar to those used in the well-known "Fada" receiver, and are supplied as a "kit" complete with the neutrodyne condensers, or "neutrodrons," as they are called by the makers. The three coils are when purchased already secured to the variable condensers used to tune their secondary windings, and it is a simple matter to mount them on the panel owing to the fact that a template is supplied with the parts.

The Circuit

The circuit is as shown in Fig. 2 and follows standard practice, consisting of the two stages of neutrodyne H.F. amplification, a detector operating on the leaky-grid condenser method and one stage of transformer-coupled L.F. amplification. An "on-and-off" switch controls the filament supply to the valve, and no filament rheostats are used, one fixed resistor of suitable value controlling the voltage across the valve filaments. This incidentally cuts down the cost, simplifies the wiring, and does not reduce the efficiency of the set in any way, since British valves are not critical in these days.

The components required are as given in the list, and although the makers' names are given it must not be assumed that other components of good make are not suitable. Provided space on the baseboard permits, many

loop is the tapping point for the neutrodyne condensers, one side of each of these two condensers being joined to the tapping on the second and third "neutroformers." The tappings should, of course, be carefully scraped free from the insulating covering before the connections are made. The loop on the first "neutroformer" is not required.

Position of Valves

It will be noticed that two of the valve holders are placed between the "neutroformers," and it is necessary when placing these in position on the baseboard to make quite certain that sufficient space is allowed to permit the moving vanes of the variable condensers when these are rotated. In

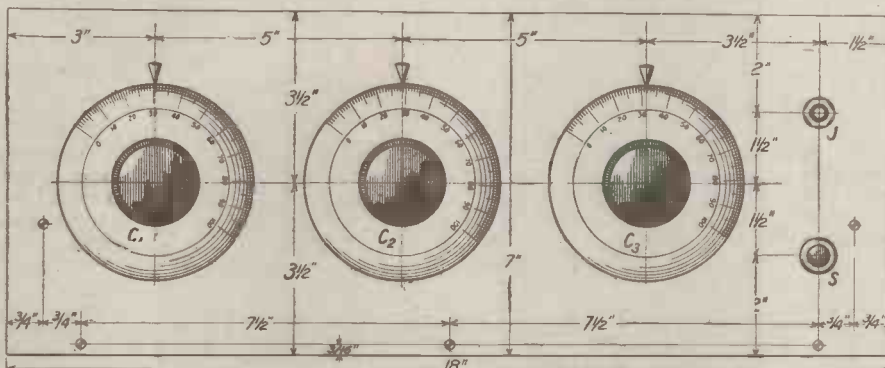

Fig. 1.—Your panel should be drilled in accordance with the dimensions given in this front-of-panel layout.

items can be replaced by equivalent types manufactured by other makers.

Construction

The lay-out of the set can be easily followed from the wiring and drilling diagrams, from which it will be seen that the "neutroformers" are staggered in relation to each other. The coils have to be mounted at an angle of 54.7 degrees to the horizontal, this angle being known as the critical angle, and any deviation will produce instability on certain portions of the wavelength range owing to interaction between the coils. Fortunately, the template supplied renders the mounting a simple procedure.

Neutrodyne Tapping

On all the "neutroformers" a small loop will be seen about two-thirds of the distance along the secondary (outside) winding. This

baseboard to make sufficient space is allowed to permit the valves to be used to clear the moving vanes of the variable condensers when these are rotated. In



The angle at which the coils are placed has a very important bearing upon the correct functioning of the receiver.

the set described there is ample clearance for valves such as the D.F.A.1, D.E.5, P.V.5, D.E., etc.

A Ten-Guinea Neutrodyne Receiver—continued from previous page.

Another point to note is that in choosing a fixed resistor it should be borne in mind that the resistance element has to carry the current for all the valves, and therefore must be of

the H.F. stages, these valves being of the low-impedance type.

To use a high anode voltage with such valves would mean a very heavy drain on the H.T. battery, hence it is

can be clamped under these in a very short time, the efficiency remaining the same as would be the case if the joints were soldered.

The single terminal strip is

WIRING INSTRUCTIONS

Join terminal A to top side of L1.
Join fixed plates of C1 to G of V1 and to one side of N.C.1.
Join A of V1 to top side of L3.
Join other side of L3 to H.T. + 1 and to lower side of L5, and to one side of C6.
Join fixed plates of C2 to G of V2, and thence to one side of N.C.2.
Join A of V2 to top side of L5.
Join fixed plates of C3 to one side of C4 and R2.
Join other side of C4 and R2 to G of V3.

Join A of V3 to O.P. of transformer, and to one side of C5.
Join O.S. of transformer to G of V4.
Join I.S. of transformer to G.B. — wander plug (flex lead).
Join A of V4 to lower contact of jack J.
Join upper contact of jack to H.T. + 2.
Join H.T. — to L.T. + and to one side of R1.
Join other side of R1 to F + contacts of V1 and V2 respectively, and thence to moving plates of C3, F + of V1, also to F + of V3 and V4.

Join lower side of L1 to terminal E, thence to L.T. —, and thence to one side of switch S.
Join remaining side of C6 to F — of V3, F — of V4, remaining side of switch S, F — of V2, F — of V1, and remaining side of C1 respectively. F — of V2 also to remaining side of C2, F — of V4 also to G.B. + wander plug (flex lead).
Join remaining side of N.C.1 to tap on L4.
Join remaining side of N.C.2 to tap on L6.
Join to I.P. of transformer T1, T2, remaining side of C5, and a piece of flex terminating in a wander plug (HT+3).

suitable dimensions in order to prevent undue heating. Most types at present on the market have a satisfactory factor of safety in this respect. With some, however, trouble might arise if bright emitter valves were used throughout.

H.T. Terminals

The high-tension tappings differ from those recommended in the "Fada" handbook inasmuch that a common lead supplies the two H.F. stages, another the detector, and a separate one goes to the anode of the low-frequency valve. In the "Fada" diagram a separate tapping is used for the detector valve and a common tapping supplies the H.F. valves and the L.F. valve.

The reason for the difference in the two circuits is as follows:—In America special detector valves are made which work extremely well on an anode voltage of 22½. A higher voltage than this would tend to reduce the efficiency. In addition to this the neutrodyne coils used work well with valves of the power type in

an advantage to use the separate tapping for the L.F. valve, thus enabling 120 volts to be used if desired.

Wiring-Up

The wiring can easily be followed

mounted on the top of the baseboard and not at the back edge, the object being to facilitate construction. The leads to the various terminals can be led through small holes in the back of the cabinet, one sufficing for the battery leads, which can be bunched together, and two others for the aerial and earth leads.

Testing

Having completed the wiring, place four valves in the sockets and connect a suitable accumulator to the L.T. + and — terminals. Place the "on and off" switch in the "on" position, and note that the valves light and that the switch does actually control the filaments. Now connect the H.T. leads to their terminals as marked, and with the L.T. battery disconnected, plug in the H.T. + plugs at, say, 6 volts. Note that the valve filaments should not light. All being well, join up the L.T. battery and connect aerial and earth.

(Continued on page 10.)

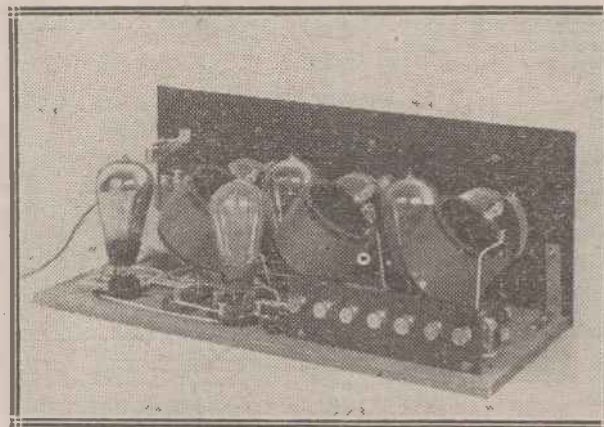

In this particular receiver a departure has been made from the conventional method of mounting the terminal strip.

from the wiring diagram, and no difficulty should be experienced here. The amount of soldering necessary is largely reduced by the terminals on the valve-holders, etc., since the wires

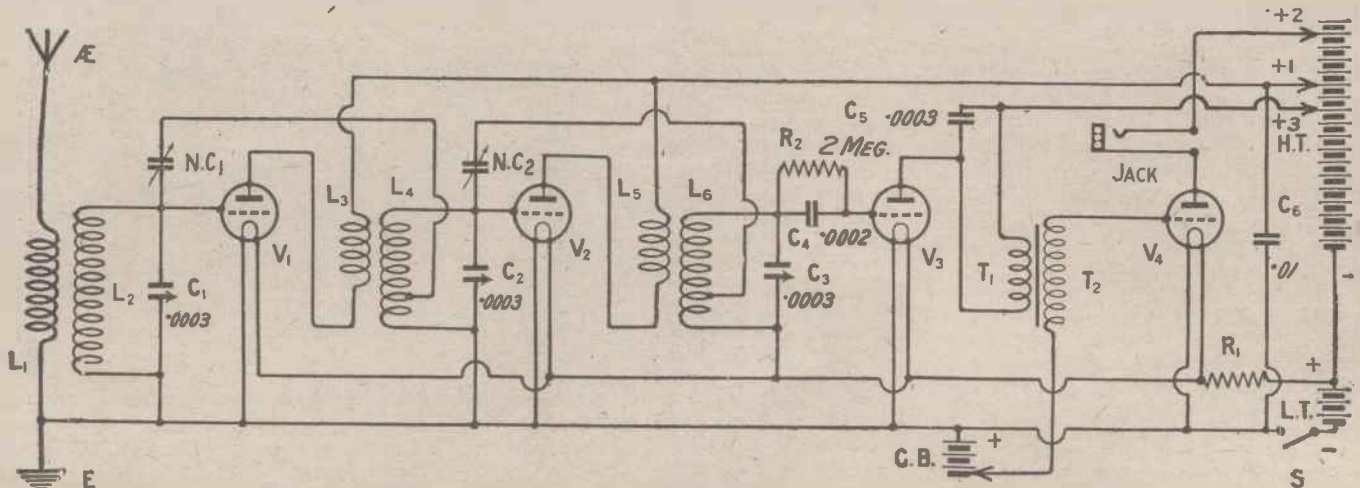
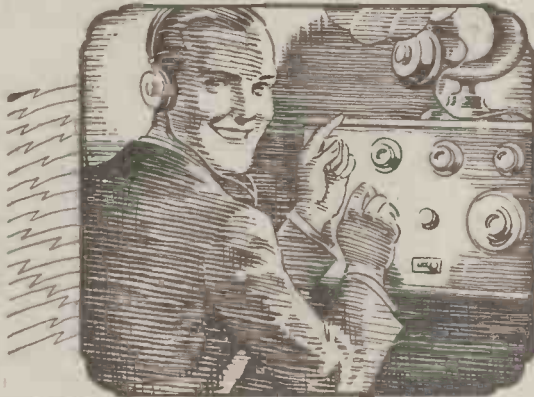

Fig. 2.—Two neutrodyne condensers are employed, and their positions in the circuit may be seen at N.C.1 and N.C.2. These condensers are supplied with the kit of special coils and condensers.



Regd.



Patents Pending
Action will be taken
against any person or
persons infringing our
rights.

The Secret of H·F EFFICIENCY

EXPERIMENTERS with experience of High Frequency Amplification are realising that the only satisfactory method of obtaining it, other than by the Supersonic Heterodyne, is to use multiple tuned circuits, and neutralise or balance out the valve capacities.

WHAT ARE THE ESSENTIALS OF THE PERFECT BALANCING CONDENSER?

1. High insulation resistance, so that no losses are added to the circuit.
2. High breakdown voltage, to eliminate risk of burnt-out valves and ruined high tension batteries.
3. Calibration to allow of re-setting to suitable values.
4. Precise adjustment, to enable the critical operation of balancing to be effectively and easily performed.
5. Ease and adaptability in fixing.

The unique design of the **MH** BALANCING CONDENSER, as here illustrated, enables all these advantages to be incorporated in a compact and highly finished unit at a moderate price.

Price 4/9 Each.

*Demand of your Dealer **MH** Components—
British, Best and Cheapest in the long run.*

NEW **MH** COMPONENTS OF EXTREME INTEREST

MH UNIMIC COIL

Its special base mounting is electrically and mechanically perfect, and allows of variable coupling.

Price 5/-
Base 2/6 extra.

MH DIMIC COIL, No. 1

Taken at the Middle frequency it has a resistance of 5.25 ohms at a frequency corresponding to 490 m., i.e. .026 ohms per uH.

Price 10/-
Base 2/6 extra.

MH SUPERSONIC BLOCK UNIT

Is the essential part of a Supersonic Heterodyne Receiver. With a few additions that you already possess, you will have a Super-Pet Receiver ready for reception in half-an-hour.

Price £6 - 6 - 0.
(Royalties Extra.)



Telephone:
SLOUGH
441-442

L.M^c MICHAEL LTD

Manufacturers of Wireless and Scientific Apparatus
WEXHAM ROAD, SLOUGH, BUCKS.

Telegrams:
Radiether
Slough



A Ten-Guinea Neutrodyne Receiver—continued from page 8.

Neutralising

You are now ready to neutralise the valve capacities, and the procedure is as follows:—Insert the telephone plug in its jack and rotate the three dials in step until a loud signal is heard—preferably outside broadcasting hours—and adjust the set for maximum volume. Now take the first H.F. valve from its socket and place a small piece of thin paper around the positive filament pin, so that when the valve is replaced in its holder the pin will not make contact with the socket, and will therefore not light.

Signals will, however, still be heard, although much fainter, and the dials should be readjusted until they once more become as loud as possible. With the aid of a long, thin stick, push the metal sleeve of the first neutrodyne condenser along the glass tube until a point occurs when the signals become practically inaudible, or, if possible, quite inaudible. The first H.F. valve will then be "balanced out."

Valves

For a set of this type the most suitable valves are those known as small-power valves, and these are made in

usually correct. For the detector valve the appropriate terminal is that on the L.F. transformer marked "I.P.," and to this about 30 volts should be applied for the first tests.

Condenser Connections

A few notes regarding the neutrodyne condensers will no doubt be of assistance to any who have slight trouble in neutralising different types of valves. The condensers have three soldering tags, one at each end and one in the centre. By connecting the two leads to the end tags of the neutralising condensers the minimum capacity becomes available.

Connecting one of the leads to the centre tag and the other lead to either one or the other of the end tags permits two further capacity ranges to be used. It is advisable to try these different connections when balancing out the valve capacities. In addition to this the bypass condenser C, is not always necessary, and constructors may find that the set works quite satisfactorily without it.

[Further operating notes and a detailed test report on this receiver will appear in our next issue.]

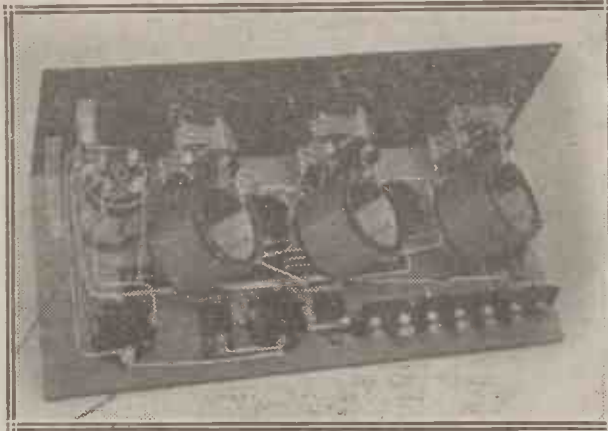

The fixed condenser across the L.F. transformer primary is in some cases optional.

various types suitable for 2-, 4- or 6-volt accumulators. The fixed resistor specified is for 6-volt .25 amp. valves, but the makers will supply any resistance required, hence all classes of valves can be used.

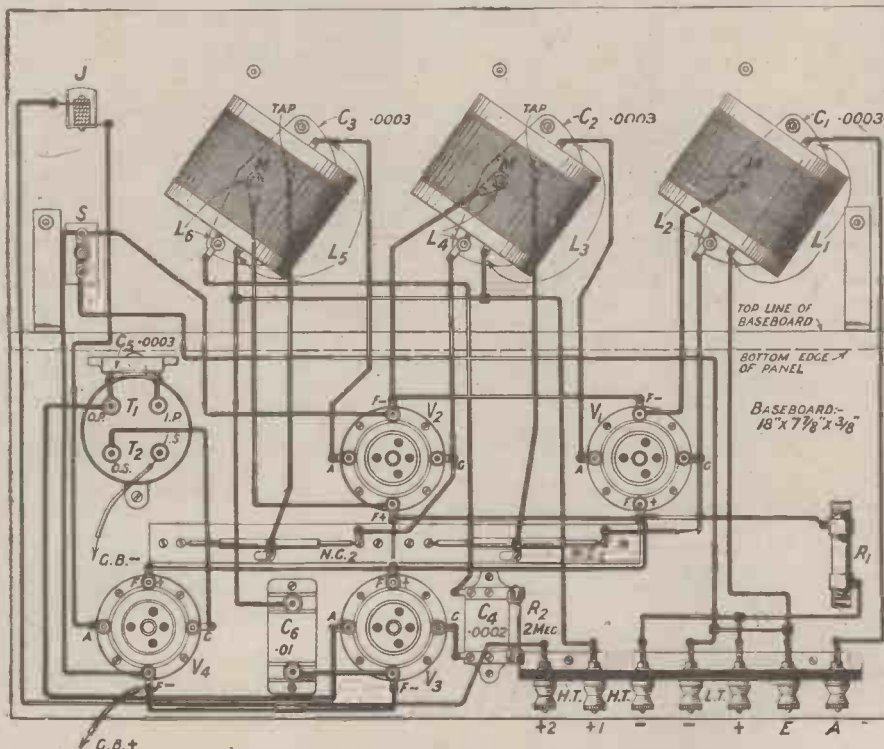

Fig. 3.—The "I.P." terminal of the L.F. transformer is used as the high-tension positive point for the detector valve.

Repeat this procedure for the second stage of H.F., removing the piece of paper from the filament leg of the first valve. The receiver is then neutralised and is ready for work.

The anode voltage for H.T. + 1 is a matter for experiment, but from 70-80 volts will give good results, and for the L.F. valve (H.T. + 2) 100-120 volts with about 7½ volts grid-bias is

"What you will need."

- One Cabinet with fall-front (Camco).
- One "Trolite" panel, 18" x 7" x 3/16" (F. A. Hughes & Co).
- One baseboard, 18" x 7 7/8" x 3/8" (Camco).
- One set of neutrodyne parts (Fada Radio).
- Four Lotus valve holders—anti-microphonic (Garnett, Whiteley & Co, Ltd).
- One fixed resistance and mount—Tempryte (Sydney S. Bird).
- (The resistance for valves of the 6 volt .25 amp. type should be .75 ohm).
- One .0002 fixed condenser and 2 meg-ohm leak (Dubilier).
- One .01 fixed condenser type (Dubilier).
- One .0003 fixed condenser (Dubilier).
- One Eureka concert grand L.F. transformer (Portable Utilities).
- One Jack—single circuit type (Bowler-Lowe Co., Ltd).
- One "on and off" switch (A. F. Bulgin & Co.).
- Three "Decko." dial indicators (A. F. Bulgin & Co.).
- One ebonite strip, 7" x 2".
- Seven terminals.
- Two angle brackets.
- Clazite wire for wiring up, and a set of Radio Press panel transfers.



I WAS in so much of a flutter with excitement that my feet somehow got tangled up as I dashed up the steps to Bumbleby Brown's front door,

that, in fact, instead of ringing the front door bell, I narrowly missed posting myself in his letter box. I should certainly have done so, but that he happened to be opening the door with a view to going out at the precise moment of my arrival. This being the case, I shot into the hall with something approaching the velocity of light, flinging the door open to its fullest extent in my passage, and wedging the hapless Bumbleby Brown between it and the knobbiest bits of the hat-stand.

Falling Soft

It was singularly fortunate for me that when what I call my face came to earth, as it did just inside the door, it alighted upon a delightfully soft mat, upon which I skimmed across the polished parquet floor, coming



“ . . . I shot into the hall with something approaching the velocity of light . . . ”

gently to rest just at the top of the back stairs. “Look here!” shouted Bumbleby Brown, “this is not Wembley. I simply will not have you Jack-and-Jilling all over my house. What on earth do you mean by it? And, meantime, perhaps you will come and hook me down from this hat peg.” I picked myself up as gracefully as possible in somewhat trying circumstances, and proceeded without further comment to the aid of my unfortunate friend, who was suspended between heaven and earth by the collar of his coat. Having effected the necessary disconnection, I led him

This week Wireless Wayfarer in co-operation with Bumbleby Brown devises a scheme whereby they can obtain a handsome income without doing anything so undignified as work

into his den, where, having installed myself in the most comfortable chair, I plunged at once in *medias res* by unfolding the object of my visit.

A Moving Thought

“Are you hard up?” I queried. Bumbleby Brown admitted that hard was not the word to use. Having sympathised, I explained that I was myself not quite stony, since I had that morning discovered a three-half-penny stamp in the pocket of an old coat; at the same time, I admitted that my financial position, despite the capital value thus represented, was not, strictly speaking, a strong one. “This being so,” I continued, “it is clearly up to you and me to make money with the greatest possible speed. Now, I have here an idea which, so far as I can see, has in it possibilities of a handsome income for both of us, without our being called upon to do anything so undignified as work.” Bumbleby Brown clasped my hand in silent emotion. “Go on,” he said, in a voice broken by sobs, “go on; you interest me strangely.”

The Project

“Look at this,” I cried, pulling the paper from my pocket, and thrusting it into his hand. “To one pair gent’s boots, soled and heeled —” he read out, rather wonderingly. “No, no,” I cried, snatching it from him and giving him another. “Do you wish to borrow from £5 to £50,000 on note of hand alone?” “Stop!” I yelled. “Must you always be reading the wrong paper?” I grabbed it and handed him another. “Private wireless exchange,” he intoned, solemnly. “Enterprising man enables subscribers to hear wireless concerts.” “At last,” I sighed. “Read on.” Bumbleby Brown continued. Some genius, said the cutting that I handed him, had conceived the brilliant idea of running a wireless exchange, and of connecting up his patrons by means

of special lines to the output terminals of his own receiving set. Each of the subscribers installed nothing more than a loud-speaker in his house, and when he wished to hear a broadcast programme all that he had to do was to plug-in.

Economy

“You and I,” I said, “will run a wireless exchange here in Little Puddleton. I have a five-valve set—or at least I will have when I have borrowed some coils from the General, a trio of condensers from the Admiral, a transformer from Puddleby, a low-frequency choke from Breadsnap, valves from Dippleswade, fixed condensers from Gubbworthy, rheostats from Snaggsby, terminals from Winklesworth, ebonite sufficient to make a panel from the Editor of the *Gazette*, and wire and things from Professor Goop. We will provide the whole of Little Puddleton with broadcast music, and the only work that we shall be called upon to do will be to turn a switch on when the programmes begin, and the same switch



“ . . . From £5 to £50,000 on note of hand . . . ”

off when they end.” “But,” objected Bumbleby Brown, “they have all got receiving sets.”

The Experts

“My dear sir,” said I, in pained surprise, “all Little Puddletonians are experts. Did you ever yet know an expert who had a set working? Whenever you go round to see one he is frightfully sorry, but he is just building a receiver, which will be finished in a couple of days; or he is improving his present set, which will be in action once more before so very long; or he has sent his accumulator

(Concluded on page 13.)

FADA Radio



“A Four-Valve Ten-Guinea NEUTRODYNE”

Here is the FADA Type 165-A
Neutrodyne Kit selected by Mr. A.
Johnson-Randall,

comprising:

- 3 FADA Neuroformers
- 2 FADA Neutrodons (Neutralizing Condensers)
- 3 FADA 4" Dials
- 1 Book of Instructions: "How to build a
FADA Neutrodyne"
- 1 Drilling Template.



Illustrated above is the
FADA Type 165-A Kit
Price . . . £5 0 0

Distance—Selectivity—Volume!

These are licensed Hazeltine Neutrodyne parts
manufactured to specifications personally drawn by

Professor L. A. HAZELTINE

F.A.I.E.E., M.E., F.I.R.E.



SEND COUPON for full information
and FREE COPY of "How to Build
a Hazeltine Neutrodyne Receiver."

SNIP OFF AND POST NOW

Please send me a free copy of your book "How to build a
Hazeltine Neutrodyne Receiver."

Name.....

Address.....

FADA RADIO LTD.,
31, KINGSWAY, LONDON, W.C.2.

Jottings by the Way—continued

to the charging station; or he really cannot let you hear what the set on the table will do, because he is not at all satisfied about the quality of its reproduction; or he has just made a slight alteration, which he has not had time to test; or he has, unfortunately, dug up his earth that very afternoon with a view to installing a new plate; or he is contemplating the erection of an entirely new aerial, and has meantime pulled down his old one. In any case, it is quite impossible for the friend of an expert, or for any member of his family, ever to hear such a thing as a broadcast programme."

Handicaps

"Golfers, you know, are never quite well. If you take on a man for a round, he explains his first fozzled drive by telling you that he has had no



"... Suffering from chronic indigestion ..."

sleep for a week. Then, when he misses a twelve-inch putt, he tells you that business worries have brought him to the verge of a nervous breakdown. Should he effect a perfectly marvellous approach shot at the ninth, he says, rather wearily, that it just shows how uncannily brilliant a man suffering from chronic indigestion can be at times. If you win, he confides in you that he is afflicted with practically every ailment known to Harley Street, while, if he just scrapes through, he will say that it was really not half a bad effort for a man suffering from an enlarged liver and a wooly heart. It is just the same with wireless experts, save that the ailments are confined in their case to their receiving sets, their own health—I say nothing of their manners—being of the rudest."

The Subscribers

"You imply, my friend," I continued, "that nobody in Little Puddleton would subscribe; I am quite sure that the wives and families of every member of the club will subscribe as one woman or child." After a little discussion we decided to put the idea to the test. Bumbleby Brown and I therefore went out to

sound possible subscribers. When we met on the following day we were both positively beaming. Our wildest expectations had been exceeded. Everyone had simply wept upon our necks. I am not fond of having my neck wept upon; a chilly proceeding during the English summer. But I can put up even with this if it is accompanied by the pouring into my pockets of coin of the realm. Anyhow, we had collected between us no less than forty-three subscribers, five of whom had paid cash down. Nothing remained but to construct the central receiving set and to run out wires to the abodes of our patrons. Both of these tasks were easily accomplished. A little intensive borrowing produced the required components, whilst for a small consideration young Edward Bugsnip undertook the job of laying the necessary lines. So rapidly did the work progress that within six weeks we were ready to bring into the homes of our subscribers something of the real joys of broadcasting.

The Opening Ceremony

It occurred to me that the opening of such a service should be marked by a certain amount of pomp and circumstance. We therefore arranged for our exchange to be opened by the Mayor, Mr. Spoooper, proprietor of the most go-ahead garage in the provinces and owner of "The Pride of Puddleton," the charabanc which can proudly claim that it has been in more ditches than any other in the kingdom. Mr. Spoooper in his opening speech really excelled himself, and our subscribers would, I think, have had a real treat but for the fact that Bumbleby Brown, who had been appointed chief engineer—I felt that organisation offered more scope for my abilities and demanded less hard work—announced when it was over that he had quite forgotten to switch on. Luckily, he had tact enough to tell me this in a whisper, and Mr. Spoooper in a moment of enthusiasm had parted with his subscription before we let him leave for his own home to learn the worst.

Back-Chat

Naturally, at such an exchange you have to have a control loud-speaker in order to be able to get an idea of the quality of the goods that you are delivering. We had borrowed this from the sub-editor-reporter-office boy-

chauffeur of the *Gazette*, who was fortunately away for his holiday when we went round to ask him for it. One need hardly say that when we switched on we discovered that there was a perfectly trifling fault which prevented us for the moment from giving our patrons the feast of music for which they were eagerly waiting. By means of the exchange microphone I explained in a few well-chosen words that too much must not be expected upon the very first evening. "Or any other, either!" roared the General's voice from our loud-speaker. We regret to have to record that the same loud-speaker instantly poured forth an outburst of unseemly laughter from the rest of our *clientèle*. This was something that we had not foreseen. It was quite impossible to switch them off without laboriously disconnecting about forty lines.

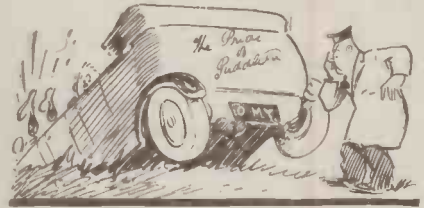

"... Owner of 'The Pride of Puddleton' ..."

A Horrid Situation

Whilst we were tracing the tiny fault—which eventually proved to be nothing worse than a few small errors in wiring, the grid-leak of the rectifier having been connected to H.T. + whilst the neutralising condensers were wired across the filament battery and the rheostats had somehow got into the grid circuits—a running commentary of the most ribald and uncalled-for kind upon the activities of Bumbleby Brown and myself was kept up from all over the district, evoking side-splitting laughter amongst all those who were connected to the exchange. I mean to say it is a perfectly rotten business that the loud-speaker won't stick to its own job. I mean to say that the loud-speaker simply ought not to be a loud-hearer. I mean to say that I don't see why it should also broadcast the perfectly private remarks of Bumbleby Brown and myself as well as the feeble remarks of our subscribers. We have not so far succeeded in giving our patrons a real wireless evening, but as I have pointed out to those who want their money back (a) Bumbleby Brown and I are experts, and (b) that you cannot squeeze water out of a stone.

WIRELESS WAYFARER.

**"THE WIRELESS
CONSTRUCTOR."
6d. SEPTEMBER ISSUE 6d.
NOW ON SALE**

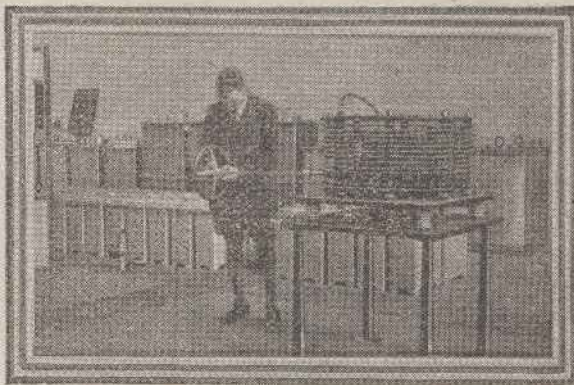

THE NEW EUROPEAN WAVELENGTH SCHEME

By Captain H. J. ROUND, M.C., M.I.E.E.

In this article Captain Round expresses his views on the proposed important wavelength changes announced from Geneva.

I HAVE just read Captain Eckersley's pronouncement in the *Radio Times* on the new wavelength scheme, and my only serious comment is that I wish he had let us into the secrets of the machinery to be used to carry out the scheme.

Reading between the lines one can see that a tremendous amount of diplomatic work has been done to get the wavelengths settled in the way that it has been done, and I know that the B.B.C. Chief Engineer has been the ringleader in devising the bold scheme now adopted.

The lists of main wavelengths and "sink" waves is in the main satisfactory. Any other arrangement would, no doubt, be equally criticisable, but the technical man would like to know the exact way in which the wavelength scheme is to be carried out.

Accurate Setting of Wavelengths

The new scheme depends, as all schemes must depend, upon every station doing its job properly—in other words, is everybody going to transmit on their proper wavelength all the time?

I know something about wavemeters, and the one critical question I would ask is: What provision has Geneva made to ensure that all European stations have an accurate, invariable wavelength standard?

They, no doubt, all have wavemeters, but most wavemeters have a habit of reading differently, and if provision has not been made for equalisation I can safely guarantee rapid production of grey hair for some of the schemers.

Before Mr. Arthur Burrows left for Geneva I suggested to him that international wavemeters, or wavelength standards for all stations were a starting point of any scheme, and since then the ideas of quartz crystal control have been developed by many.

The Personal Element

Even if each station is given an absolute standard there still remains

the personal elements of good faith and accurate observation at any station, and I think in this the national characteristics will show quite distinctly.

Systematic observations of wavelengths with reliable standards twice daily at every station are really necessary, unless the station can be fitted with a quartz crystal control; and if every station could be persuaded to send in to Geneva a duplicate copy

a large number of unimportant stations take the same wave is a really brilliant idea, and carried out faithfully it should succeed most of the time.

I take it that a relay station is not for distant working—the main station which it relays can be used for that purpose—therefore it does not matter whether it is jammed, providing that jamming does not take place inside the range it is designed for.

Only coming experience will show whether trouble will occur during much of the time, and I foresee that the choice of low waves for the "sink" waves will be a factor fighting against their proper working, because these shorter waves freak to great strengths much worse than the longer ones. I would have liked the sink waves to have been above 500 metres, and possibly 450 metres where ship jamming is a maximum.

A National Common Wavelength

As the general relay sinks are international there will be little chance for arranging for stations to be on exactly the same wave, and Captain Eckersley has very neatly dodged the difficulty by creating a national sink wave over which he will have complete control, as it is on one of the British exclusive waves.

The higher class sink system, undoubtedly the forerunner of others here in England, has a fine chance of success, because the B.B.C. has the power through its land lines of driving these sink stations absolutely on the same wavelength where interference is least, as no heterodyne note between carrier waves will be produced, and I believe the B.B.C. has already carried out extensive and successful experiments in this direction.

Returning again to the general relay sinks, I do not think I should like to have a main station within 10,000 cycles of that sink, and it would be interesting to know if the relay sink bands are wider than normal, because

(Continued on page 35.)

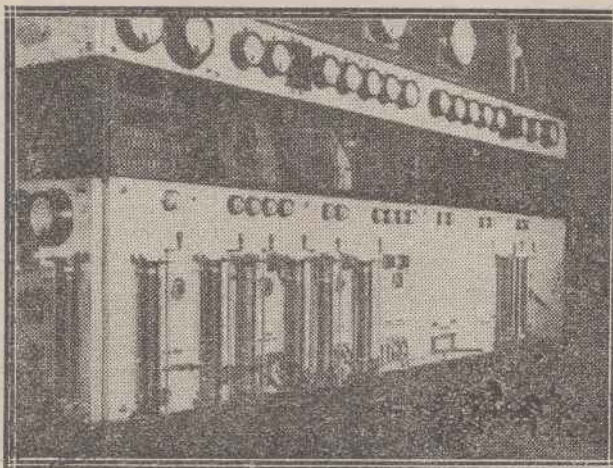

A view of some of the power control apparatus at the Eiffel Tower. Note the monster rheostats.

of its wavelength logs, any errors of observation or standard wavemeter variation would soon be spotted if the logs were used in conjunction with jamming reports. Deliberate faking would also soon be found out, but, of course, would take some careful diplomacy to stop. The making of the logs and the checking by Geneva would be a simple matter, and their chief use would be to teach station engineers a habit.

To get all European nations to agree to certain wavelengths, and to a limited number only for each, is certainly a feat, but cannot we be let into the secret of how even with the voluntary consent to Geneva's ruling the rules are going to be kept by the volunteers?

The "Sink" Wavelength

The sink wavelength scheme whereby

From my Armchair

BY EARL RUSSELL



In these columns Lord Russell expresses each week his own personal views on matters of interest to "Wireless" readers.

Power by Radio

I have to submit at intervals to the ministrations of a man who tells me things I ought to know. The other day he assured me that it would not be long before we should be able to transmit power by wireless waves. In vain I explained to him that to transmit enough power to kill a mouse ten yards off would be almost impossible, but that to transmit anything in the nature of several horse power for distances of a mile or more is quite impossible. He smiled pityingly and did not believe me, for he had read the opposite prediction in his favourite newspaper.

The lay mind is apt to counter all scientific arguments by the general statement that nothing is impossible, hence the temporary success of Grindell-Matthews and his Death Ray. The leading example of the transmission of power through the ether is, of course, sunlight, and so

stupendous is the source of energy that the amount which reaches us at our immense distance is really wonderful, although in itself small for every square yard upon which the rays fall. Yet the total of the chemical energy involved in vegetation is very large. Rash as it is to assert a general negative, I think it is fairly safe to say that no method we can employ and nothing resembling wireless waves or anything we now know about will ever suffice to carry through the ether any commercial amount of energy. In wireless reception and in all forms of wireless control the very minute amount of energy received is almost always amplified and increased by drawing on a local source of power.

H.T. Supply

I have at last permitted myself to buy 120 volts of accumulator H.T. supply in a rather attractive form, advertised lately, of Semi-Oil-filled. They are nice little cells, very difficult

to fill neatly with acid without a very sharp-lipped jug, and requiring a pipette or a fountain-pen filler to make adjustments in the height. My only criticism so far is that there is no mechanical separation between the plates, and therefore a possible risk of short circuit, although I think they are held sufficiently firmly in place to prevent this. I gave it a 36 hours' charge carefully, and have just started using it, with quite satisfactory results. The only thing is that just at present, being new to it, I continue to be terrified of a short circuit, which would indeed be a short circuit with accumulators behind it.

Comparisons

I got Manchester and San Sebastian last week when the other B.B.C. stations were on, and, indeed, Spain came in very nearly as strong as Bournemouth. They cannot do much more than that with the Elstree Six, except that they get a greater volume, but Mr. Harris need have no fear. I am not going to emulate the courageous example of Mr. X. and take a set down there with which to challenge competition. I have been reduced to a state of proper humility by the detailed and expert knowledge available, and I should be afraid of Mr. Reyner. It does look, though, as if they might be given a tip or two on how to keep their clever things safe from burglars, and I cannot understand why they have not called in Professor Goop.



FORMO
ANTENNA PURE L.T.A. COILS

A MONUMENT IN THE MARCH OF PROGRESS.
The Formo Shrouded Transformer is the universal favourite.

10/6 Made in Ratios 1-1, 1-2, 1-3, 1-4 and 1-5.
1-3 and 1-5 for First and Second Stages.

SEND FOR CATALOGUE AND DESCRIPTIVE LITERATURE OF COMPLETE FORMO RANGE.

THE FORMO COMPANY,
CROWN WORKS, CRICKLEWOOD, P.W.2.
Phone: Hamp. 1787.

Manchester: Mr. J. B. Levee, 23, Hartley Street, Levenshulme. Phone: Heaton Moor 476.

See page 17 for Formo S.L.F. Condenser.

Come and See the best Coil Holders!

At Stand No. 84 at the National Radio Exhibition you are invited to inspect for yourself the Coil Holders that are used in fully half the sets that are made—the "Lotus" Coil Holders. Their popularity with constructors everywhere is due to their unvarying good performance and the following unique features:—

MOVING BLOCK CANNOT FALL
Moves in same direction as knob, thus preventing confusion. Holds heaviest coil securely in any position. Dead accurate tuning possible because encased precision cut gears reduce speed by 8 to 1.

From all Radio Dealers

LOTUS
VERNIER
COIL HOLDERS

GARNETT, WHITELEY & CO., Ltd.,
Lotus Works, Broadgreen Road,
LIVERPOOL.

Makers of the new Lotus Buoyancy Valve Holder.

Two Types:
For outside panel mounting:
Three-way . . . 7/-
For inside board mounting:
With 6-in. handle:
Two-way . . . 8/-
Three-way . . . 12/6

Nickel-plated mouldings for the side blocks, knobs, and nickel-plating for the metal parts.

Makes short circuit impossible

The "Peerless" JUNIOR Rheostat

An OFF position is provided, while definite stops make short circuit impossible. Resistance element is immune from damage. Will safely carry current of two valves. Complete with nickelled dial and one-hole fixing. Three types: Size 1 1/4" diameter, 1 1/2" high, 6, 15 or 30 ohms. Price only **2/6**

From all dealers or direct:
THE BEDFORD ELECTRICAL & RADIO CO., LTD.,
22, Campbell Road, Bedford.

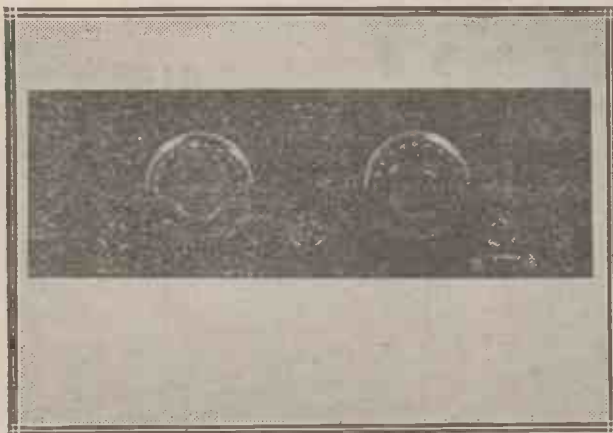

“DX ON THREE”

A SCREENED-COIL THREE-VALVE
NEUTRODYNE RECEIVER

By L. H. THOMAS



IN these days of the wide use of reaction there seems to be an idea current in some quarters to the effect that a set cannot be selective unless reac-

tion is used, and, conversely, that reaction is a sure cure for inselectivity as well as for many other minor ailments. The three-valve screened-coil set described in this article was built by the writer to attempt to show that quite an effective degree of selectivity can be obtained *without* the use of reaction, and at the same time with only one stage of H.F. amplification. In a way the absence of reaction is a very desirable feature, since one control is eliminated, and the operator can fix all his attention on the tuning of the two remaining circuits.

“Straight” Circuit

From the circuit diagram it will be seen at once that no freakish scheme has been employed for the set. On the contrary, it takes the form of an ordinary receiver of the “H.F.-D.-L.F.” type, the H.F. transformer having a centre-tapped primary winding for neutralising purposes.

The components required for the construction of an exact replica of the receiver described are as follows:—

— One ebonite panel, 21 in. by 7 in. by 3/16th in. (Camco).

— One cabinet to take above panel, and baseboard 21 in. by 9 in. by 3/8th in., and one pair of panel brackets (Camco).

— Two .0005 variable condensers (Igranic Electric Co., Ltd.).

— Two screens and two bases (Burne-Jones & Co.).

— One aerial coil and one H.F. trans-

former, as supplied for the “Magic Five” (Burne-Jones & Co.).

— Three “Clearer-Tone” valve-holders (Benjamin Electric, Ltd.).

— One neutralising condenser (L. McMichael, Ltd.).

— Three 6 ohm rheostats (C. A. Vandervell, Ltd.).

— One strip to take seven terminals.

— One strip to take two terminals.

— 1 L.F. choke (“Success,” Beard & Fitch, Ltd.).

— One .0003 fixed condenser, with clips (Dubilier Condenser Co.).

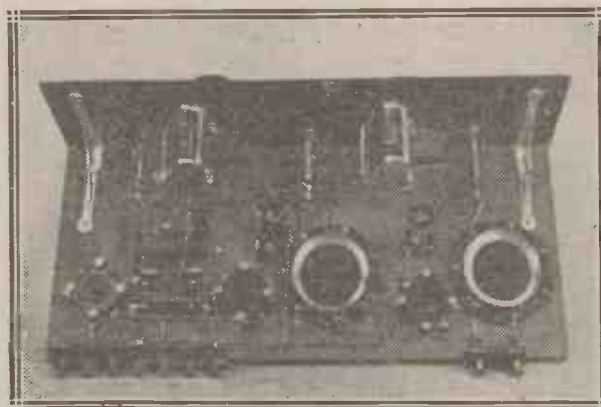

This plan view of the finished receiver will be helpful when laying out the components on the baseboard.

It is possible to eliminate the reaction control simply by compelling the H.F. valve to do its fair share of work, and to do this is really not a very difficult matter.

WHAT YOU WILL NEED

— One “Dumetohm” leak, 4 megohms (Dubilier Condenser Co.).

— One .005 fixed condenser, “clip-in” type, with base, and one .5 megohm leak, with base (L. McMichael, Ltd.).

— One .0005 fixed condenser (Igranic-Freshman).

— 11 brass terminals and wood screws, bolts, etc.

— Seven or eight lengths of “Glazite” for wiring.

— The total cost for the components listed above will be approximately £7.

— One .0003 fixed condenser, with clips (Dubilier Condenser Co.).

High Selectivity

Actually the selectivity is sufficiently high to make possible the reception (on 'phones) of Manchester and

Madrid while London is working, with only the very faintest trace of 2LO in the background. Cardiff can also be heard quite well, but the “background” from London is of the order of 33 per cent. All these results were obtained upon a moderate aerial about 6 miles distant from 2LO.

Easily Built

It will be seen from the front-of-panel drilling diagram and the photographs that the panel layout is of the simplest kind. It could, of course, be still further simplified by the substitution of fixed resistors for the variable rheostats used in the original set. The wiring-up of the set is also quite straightforward, and rather less care in the spacing of the components on the baseboard is necessary when screened coils are employed, on account of the relative absence of interaction between the tuned circuits.

The neutralising condenser has been placed on the baseboard because it was the writer's intention to set it to the correct value, and then “forget it.” It may, however, be made to perform the duty of a reaction control by “over-neutralising” the H.F. valve slightly, but the results were not im-

proved when the set was on test by any very appreciable amount; certainly not enough to justify the introduction of a third operating control.

(Continued on page 18.)

SAVE £ £ £ £ £ £ £ £ £ £ £ £ £ £ £

SAVE

CAN YOU AFFORD

TO

KEEP ON BUYING NOISY AND EXPENSIVE DRY H.T. BATTERIES ?

A "DUROS" H.T. MONOBLOCK ACCUMULATOR COSTS 8/- FOR EVERY 10 VOLTS, OR SEVENPENCE FARTHING A VOLT. WHEN IT IS DISCHARGED YOU DON'T HAVE TO GO TO THE EXPENSE OF A NEW H.T. BATTERY, JUST RUN IT ROUND TO YOUR DEALER AND HAVE IT CHARGED. IN A YEAR IT WILL HAVE MORE THAN SAVED ITS FIRST COST—

AND, ALL THE TIME YOU HAVE A SILENT H.T. BATTERY, NONE OF THOSE "X'S" AND OTHER PARASITIC NOISES.



Advt. A. F. A. Accumulators, Diana Place, N.W.1.

SAVE

£ £ £ £ £ £ £ £ £ £ £ £ £ £ £

THE TEN GUINEA HETERODYNE

IS BUILT ON

TROLITE

PANEL . DE . LUXE

EASILY WORKED—use acetone as adhesive, thus making a strong and neat joint without screws

EFFICIENT & ELEGANT



Supplied Ex Stock

Thickness $\frac{3}{16}$ " $\frac{1}{4}$ "

4 Finishes :
Polished Black
Polished Mahogany
Polished Walnut
Wavy Etched Black

A most attractive panel finish which does not show scratches or finger marks

PRICES	}	Polished Black ...	$\frac{3}{16}$ "	$\frac{1}{2}$ "	$\frac{1}{4}$ "	$\frac{3}{4}$ "	Sq. inch
		Mahogany, Walnut and Wavy	$\frac{3}{16}$ "	$\frac{3}{4}$ "	$\frac{1}{4}$ "	$\frac{1}{4}$ "	

IF YOUR LOCAL DEALER IS OUT OF STOCK, PLEASE INFORM US HIS NAME AND ADDRESS AT ONCE

F. A. HUGHES & CO., LIMITED
204-6, GT. PORTLAND STREET - - - LONDON, W.1.
Telephone ... Museum, 8630, -1-2
Telegrams—"Distancing, Wesdo, London."

FORMO
BY THE FORMO COMPANY

ULTRA LOW LOSS
Straight Line Frequency Condenser.

Cone bearings. Braced Vanes. Positive Collector. A real precision job.

Condenser only—
"0003 μ F, "0005 μ F ... 9/-
Condenser with plain dial.
Standard $\frac{1}{2}$ " dia. Shaft ... 10/6

Send for Catalogue and Descriptive Literature of Complete Formo Range.

THE FORMO COMPANY,
CROWN WORKS, CRICKLEWOOD, N.W.2.
Phone: Hamp. 1787.
Manchester: Mr. J. B. Levee, 23, Hartley Street, Levenshulme. Phone: Heaton Moor, 476.
See page 15 for Formo Transformer



for the

7 Valve SUPER-HETERODYNE SET



Owing to the excellent design and workmanship of the Bowyer-Lowe Super Heterodyne Transformers thousands of amateurs have built super-het sets using these components with perfect success.

Follow their example—Each set of Transformers is complete with instruction booklet, illustrating how to construct a Seven Valve Set. Every assistance will be given by us to those who are making a set to these instructions.

Set of Four Transformers ...	£4 0 0
Interchangeable Oscillator Couplers	
300-600 metres	1 0 0
Ditto 550-2000 "	1 0 0
Base for Same	0 4 0

Constructor's Kit containing principal components for building a Seven Valve Set, £10. Send for full particulars.

BOWYER-LOWE
TESTED RADIO APPARATUS

ANNOUNCEMENT BY THE BOWYER-LOWE CO. LTD. LETCHWORTH HERTS

2 volt, 3 amp. **You cannot buy a better Dull Emitter than Frelat**

Users by the thousand prove this! An owner of a one-valve set has logged 17 Foreign Stations with Frelat. Why then pay more than the Frelat price of 4s. 11d.? Frelat ensures better tone and greater volume and lasts much longer. If your Dealer cannot supply send P.O. 4s. 11d. (post free), or request delivery C.O.D. and send 6d. in stamps.

THE CONTINENTAL RADIO IMPORT CO., LTD.,
8, SPITAL SQUARE, LONDON, E.1



4/11 *Frelat*

"DX on Three"—continued

The Screened Coils

The designs of the aerial coil and the high-frequency transformer used in this set are exactly the same as those employed by Mr. J. H. Reyner in his "Magic Five," which was described in WIRELESS, Vol. 4, No. 1. The first coil consists of 90 turns of No. 30 D.S.C. wire, tapped at 10 and 15 turns. The special H.F. transformer has a secondary winding of 90 turns, and a primary winding of 25 turns with an exactly similar neutralising winding wound over it. The whole is fixed in the centre of the secondary winding.

Although the plug-and-socket mounting of the transformer and the aerial coil has been changed slightly since the description of the "Magic Five" was published, the back-of-panel diagram will make the method of connecting up the coil bases quite clear.

The Note Magnifier

It will be noticed that the choke-capacity system has been employed for the note-magnifier. This was done to enable the writer to use a high-impedance type valve to the best advantage in the detector socket, thus

tors. The one in use required a fairly high value grid-leak—4 megohms was the value actually used by the writer.

Assembly

It will be found easiest, when constructing this set, to wire up the components on the baseboard first. The panel should, however, be drilled and fixed first of all. After the components have been mounted on it, it may be removed again while some of the baseboard components are mounted and wired up. The only components upon the panel are the two variable condensers and three rheostats, with the two loud-speaker terminals in the bottom right-hand corner.

When wiring up the components on the baseboard, the best plan is to start with all the connections to the strip which carries the battery terminals.

note-magnifier should be wired up. This having been done, it is advisable to fix the panel and complete the

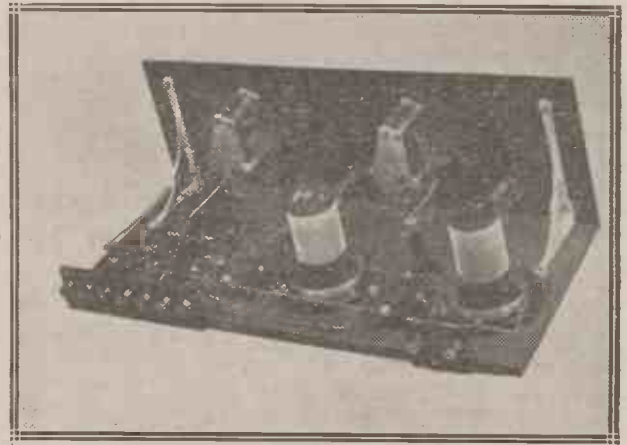

In this view of the finished receiver, the screens have been removed.

wiring, which will be found quite straightforward.

Final Tests

Before the receiver is connected up for its "trial trip" all the wiring should be very carefully tested out and

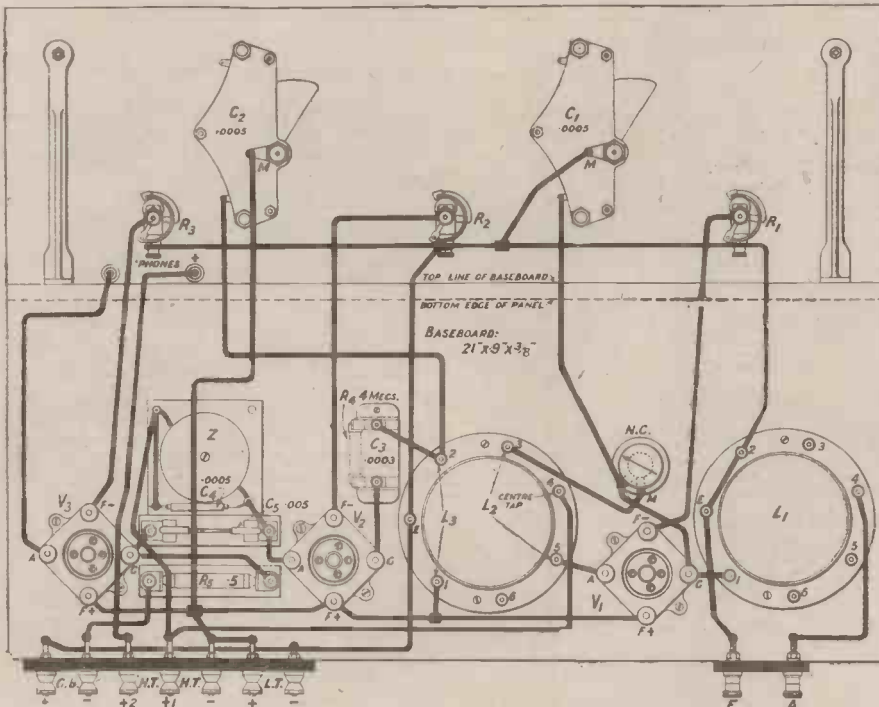

Fig. 1.—The terminals on the screened coils are numbered, and these markings correspond with those in the circuit diagrams.

reaping a double benefit, since these valves are not only excellent as choke-coupled amplifiers, but also are of more than average efficiency as detec

After this the connections to the L.F. choke, the fixed condenser across it, and the grid-condenser and leak by means of which it is coupled to the

WIRING INSTRUCTIONS

- Join terminal A to terminal 4 of L1.
- Join terminal 1 of L1 to G of V1 and to fixed plate of N.C., and thence to fixed plates of C1.
- Join A of V1 to terminal 5 of L2.
- Join terminal 4 of L2 to H.T. + 1, thence to one side of choke Z, and thence to one side of C4.
- Join terminal 3 of L2 to remaining side of N.C.
- Join terminal 2 of L3 to one side of C3 and R4, and also to fixed plates of C2.
- Join other side of C3 and R4 to G of V2.
- Join A of V2 to one side of C5 and thence to remaining side of choke Z and C4.
- Join other side of C5 to G of V3, and thence to one side of R5.
- Join other side of R5 to G.B.—
- Join H.T. + 2 to + telephone terminal.
- Join A of V3 to other telephone terminal.
- Join L.T.— to terminal E of L2 L3 coil base, thence to one side of R2, and thence to remaining side of C1.
- Same side of R2 also to one side of R3 and one side of R1, thence to terminal 2 and terminal E of L1, and thence to earth terminal.
- Join remaining sides of R1, R2, and R3 to F— contacts of V1, V2, and V3 respectively.
- The following points are joined together in the most convenient manner: H.T.—, L.T. +; remaining side of C2, F+ contacts of V1, V2, and V3, and terminal 1 of L3.
- Join L.T.— to G.B. +.

checked against the wiring diagram. The valves may then be placed in the appropriate holders and the low-tension battery connected up. Upon turning the rheostats towards the "all-out" position the valves should light up at the correct brilliancy, and should not show any change when about six or nine volts is connected across either of the pairs of H.T. terminals. Once it has been decided that everything is quite in order, the cor-

(Continued on next page.)

An Easily Operated Three-Valve Receiver

rect high-tension voltages may be connected up, and the aerial and earth attached to their terminals. The lead from the aerial may be taken to either

be correctly neutralised, and should remain quite stable and easy to handle over the entire tuning range.

Should it be found that for the local station the settings of the tuning condensers are not nearly the same, the aerial may be tried on the other tapping. Generally speaking, a long aerial will need to be connected to point "3" on the coil base, and one of less than average length to point "4."

probably be found that the neutralising condenser may be advanced a *very little* beyond the correct neutral position before the set will commence to oscillate.

Results

On test in South-East London, the receiver gave loud-speaker results at about 10.30 p.m. on some seven or eight stations, including the local. The best were Birmingham, Münster, Bournemouth, Radio-Toulouse and an unidentified German station working right at the bottom of the broadcast band.

These stations were, of course, not received at what one would call "full loud-speaker strength," but were quite enjoyable from the other side of a medium-sized room. 2LO was really too loud to be pleasant when tuned right in.

Points to Watch

Probably a few short notes on some special points noticed by the writer will be useful. In the first place, if the screens are removed the set will probably oscillate at once. This is mentioned in view of the letter of a constructor of the "Magic Five,"

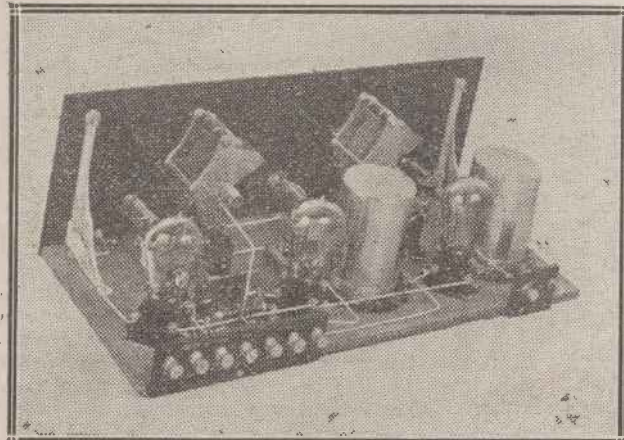

The strip on the left carries all the battery terminals, while that on the right is for aerial and earth connection.

of the tappings on the coil (i.e., either to terminal "3" or "4" on the base of the coil) for the first test.

Further Details

The writer found the ideal combination of valves to be as follows:—Two of the high-impedance (D.E.5b or D.F.A.4, etc.) type in the H.F. and detector sockets, and a power valve in the L.F. amplifier socket. Practically any variety of the high-impedance type will work well as the high-frequency amplifier and the detector, however. It is rather important that the L.F. valve should be of one of the types intended for power amplification. 60 v. H.T. was used for the H.F. valve, 45 v. for the detector, and 90-120 v. for the note magnifier.

The neutralising condenser should now be placed about one-third of the way in. It should first be unscrewed so that as much of the spindle as possible is showing, and then turned gently until about one-third of the latter has disappeared within the ebonite tube. (These remarks only apply to the particular make of neutralising condenser employed.) It will be advisable to listen on headphones at first. Insert the valves, connect up the batteries, aerial and earth, and rotate the two condensers, keeping the dials at approximately the same reading. The local station should come in very strongly in one position—2LO is received with both condensers at about 48 degrees, the dials reading from 0-100. Now switch off the H.F. valve and adjust the neutralising condenser until no sound of the local station is heard, at the same time altering the settings of the variable condensers slightly. When this point has been found, the receiver may be assumed to

The dials should now be rotated slowly and simultaneously. Since there is no reaction control, this will be quite simple to the ordinary two-handed person. The slight "mushy" noise that will be heard when the two

Searching for "DX"

there is no reaction control, this will be quite simple to the ordinary two-handed person. The slight "mushy" noise that will be heard when the two

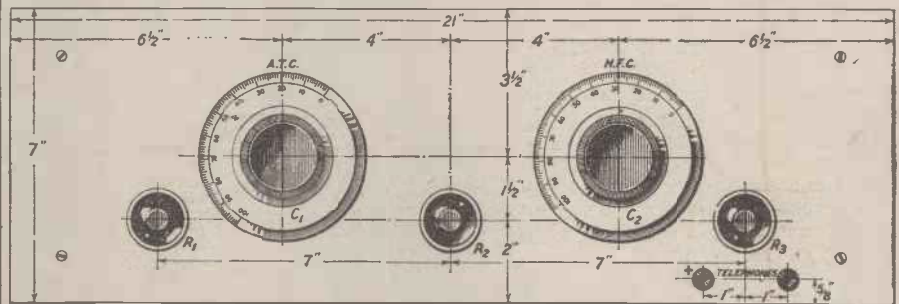

Fig. 2.—All drilling centres can be obtained from this dimensioned layout, providing similar components are used.

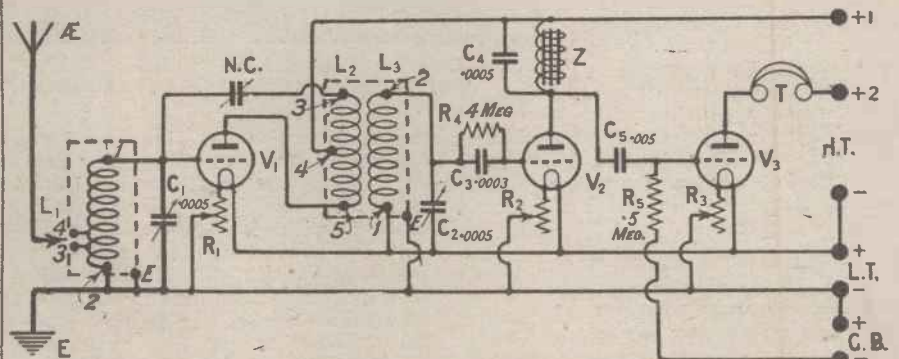

Fig. 3.—The dotted lines are intended to represent the screens, and, as will be seen, these are both connected to L.T.—

dials are roughly at the correct reading indicates that the receiver is correctly in tune. Various stations should now be heard, the receiver "running into" them, of course, with no sign of oscillation at all. It will

who complained that the set would not oscillate with the screens on, overlooking the fact that the set was not supposed to oscillate when correctly adjusted!

(Further practical notes next week.)

How the Neutrodyne System will Popularise Radio

By JOHN SCOTT-TAGGART,
F.Inst.P., A.M.I.E.E.

A special article outlining the great possibilities of an invention which has inaugurated a new epoch in receiver design.



THE Neutrodyne circuit is now nearly four years old, but it is only just coming into its own. There are many factors which have contributed to this apparent apathy on the part of the British public to take up an invention which will, I believe, have a permanent life.

Native Caution

The native caution of the average Britisher is probably more responsible than anything else for a lack of appreciation of something good. In America they take things up much more rapidly, and an inventor receives every encouragement. This is no doubt the reason why America has progressed so rapidly in radio matters. There is absolutely no reason why we in this country should not have taken the lead in world radio. As regards set designs we were at one time ahead of America. With their simple regenerative receivers American designers gave no thought to high-frequency amplification, whereas in this country we have practically always regarded a stage of high-frequency amplification as absolutely necessary. We lost, however, the lead in radio design, and it is only a matter of the last month or two in which we have achieved supremacy.

Intensive Research

We have been able to do this by the outcome of the intensive research work carried out at the Elstree Laboratories in Neutrodyne circuits, the elimination of parasitic oscillation in multi-stage high-frequency amplifiers and the use of screened coils.

The "Elstree Six" receiver marks a new epoch in receiver design, and this fact is brought home to us by the fact that the *Radio News*, the leading American radio journal, is by permission reproducing the article and

constructional details of the "Elstree Six." For America to be taught design from this British set is a very high tribute indeed.

A Fine Tribute

A further great tribute was paid by Professor Hazeltine, whose company, the Hazeltine Corporation of America, license the leading American radio manufacturers to make sets operating under the Hazeltine and Scott-Taggart Patents in America. Something like £7,000,000 worth of sets have

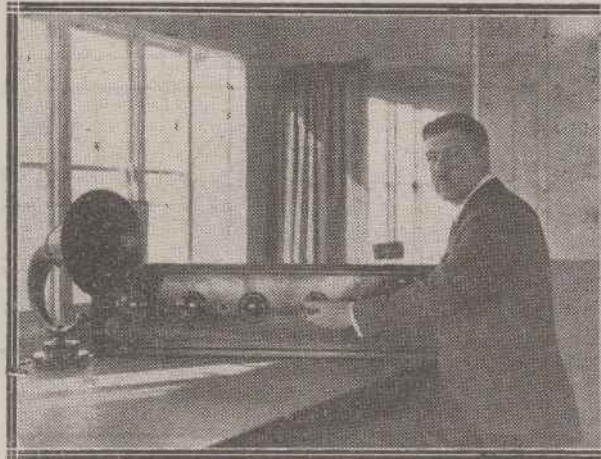

Professor Hazeltine and the "Elstree Six." "It is equal to the best I have heard in America."

been made under the Hazeltine Corporation licence, so that the Professor may be regarded as being competent to judge the results obtained with British and American receivers. At Elstree during his recent visit to England the "Elstree Six" was demonstrated to him, and he worked the receiver himself. His views on its capabilities were expressed in a few but very significant words. He said: "It is equal to the best I have heard in America."

Examples of Slowness

There is no doubt that we would have all been using Neutrodyne sets by now, had it not been for a certain slowness on the part of the British public to take up this receiver. When

in 1921 I first published the tuned anode with reaction circuit in my book, "Thermionic Tubes in Radio Telegraphy and Telephony," it was a very considerable time before this particular circuit achieved the national popularity which it ultimately did. The circuit was incorporated in dozens of designs, such as the "All Concert" and "Family 4-valve" receivers produced by Mr. Percy W. Harris.

When in June, 1923, I published details of my ST 100 receiver, nothing happened. There was no real popularity for this set for twelve months; instead, there was a great deal of criticism. Hundreds of people apparently could not get the set to work, due, incidentally, entirely to their own fault. Suddenly, however, it caught on, and a truly colossal number of these sets have been built up by experimenters in this country. The ST 100, however, only shows how slow the wireless public is to take up a new circuit.

A Period of Neglect

In June, 1923, I introduced to the British public the Neutrodyne method of reception, which I then called the "Bridge" method of high-frequency amplification. During nearly four years the invention has laid dormant as far as the broad public is concerned.

It has taken a set, the "Elstree Six," of outstanding merit, to bring home the real merits of the Neutrodyne. It must not be imagined, however, that a neutralised receiver is a sort of standard arrangement which will give equivalent results by whomsoever the receiver may be designed. The unique experience gained by us at Elstree has enabled us to turn out sets possessing very special features which did not figure in the original conception of the Neutrodyne.

Different circuits have been produced, dual condensers employed, screening, etc., etc. Although the plainest Neutrodyne receiver is a

(Continued on page 22.)

A GREAT STRIDE of progress is embodied in the perfection of a new all-British ebonite with a non-metallic leak-free polished surface by REDFERN'S, who have studied rubber manufacture for a quarter of a century. In EBONART utility is allied to beauty. The brilliant polish of EBONART resists condensation of moisture: it is absolutely without metallic influence, and is therefore non-conducting and adds immensely to the appearance of a Radio set. EBONART is sold in black and in a lovely mahogany shade.

[Made in panels from 6 in. x 6 in. to 24 in. x 12 in. in black polished surface and mahogany polished surface. Also in Black Fine S.B.]
 Matt, having great beauty of surface.

STANDARD SIZES.

"EBONART"

BLACK AND MAHOGANY.

Highly Polished Finish One Side

Inches.	Black. Each.	Mahogany. Each.
6 x 6 x 1/8	2/1	3/3
6 x 8 x 1/8	2/9	4/4
6 x 12 x 1/4	5/8	8/6
7 x 10 x 1/4	5/6	8/1
7 x 12 x 1/4	6/7	9/8
7 x 14 x 1/4	8/-	11/6
7 x 18 x 1/4	10/-	14/6
7 x 21 x 1/4	11/6	17/-
7 x 24 x 1/4	13/2	19/3
8 x 10 x 1/4	6/6	9/3
8 x 12 x 1/4	7/6	11/-
8 x 16 x 1/4	10/-	15/-
9 x 6 x 1/8	3/1	4/9
9 x 12 x 1/4	8/6	12/9
9 x 15 x 1/4	10/9	16/-
9 x 18 x 1/4	12/9	19/6
9 x 24 x 1/4	17/-	25/-
10 x 12 x 1/4	9/8	14/-
12 x 12 x 1/4	12/-	16/9

"EBONART"

Black Fine S.B. Matt Finish

Inches.	Each.
9 x 30 x 1/4	21/1
9 x 36 x 1/4	25/4

Made in England by Englishmen



REDFERN'S RUBBER WORKS, LTD.
 HYDE - - - - - Cheshire
 LONDON - - - - - 75 Newman Street, W.1

See these panels on Stand 94 (Ground Floor) at the National Exhibition, Olympia, commencing Sept. 4th.

How the Neutrodyne System will Popularise Radio—*continued*

great advance over the old methods of high-frequency amplification, yet, as I have just said, it has needed something more than, say, a 10 per cent. improvement in reception to popularise the Neutrodyne.

Achievements

When just over twelve months ago I established the Laboratories at Elstree, and gathered round me a staff of highly competent research engineers, it was my intention to try and solve the greatest problems which have faced broadcast reception. These problems are "selectivity without loss of signal strength," and "range." Some brilliant work has been carried out by Mr. J. H. Reyner in the direction of screened coils, and it is due entirely and solely to his work that we now have a standard screened coil on the market manufactured by different firms.

The problem now is to get the great mass of the British public to start constructing Neutrodyne receivers, and demonstrations are being given at Elstree and elsewhere in order to prove the great advances which we have accomplished. The average man looks somewhat askance at the introduction of new receivers, but in the case of the Neutrodyne there is no question of waiting and seeing. In America there is virtually only one receiver used—a 5-valve Neutrodyne. This set, made up by dozens of different manufacturers, has proved itself up to the hilt, and we in this country are now building receivers which are not only as good as the American design, but considerably better.

We are prepared to do all we can to show what our new designs will do, and will be pleased to receive suggestions from any readers. Never have we felt the same enthusiasm as we do at present, and our chief anxiety is to instil the same enthusiasm into our readers.

Shocks!

The wireless public must, however, be prepared to receive shocks. They must be prepared to hear that the ST 100 is, or should be, as dead as the Dodo. Other reflex receivers, such as the Twin Valve and the 3-valve Dual, are equally obsolete; not only have the methods of high-frequency amplification been revolutionised, but great advances have also been made at Elstree

in the direction of reflexing, and readers of WIRELESS have already been promised full details of the new "Elstreflex" circuits, which very shortly will be described in these

pages. Sets using the tuned anode with reaction circuit are now back numbers, and receivers such as the "All Concert," "Transatlantic Five," "Anglo-American Six," and other sets

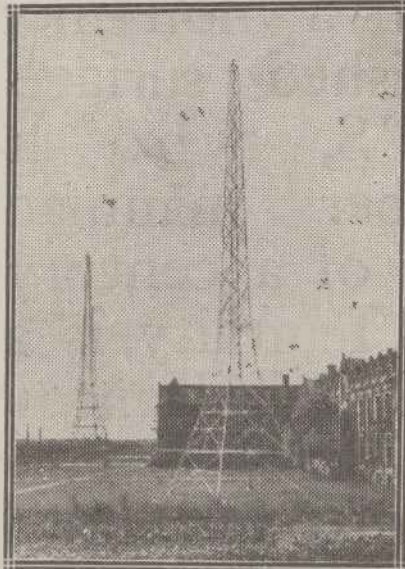

The aerial system of the station owned and operated by the Canadian National Railways at Moncton, N.B., Canada.

which have enjoyed, in their time, extraordinary and deserved popularity

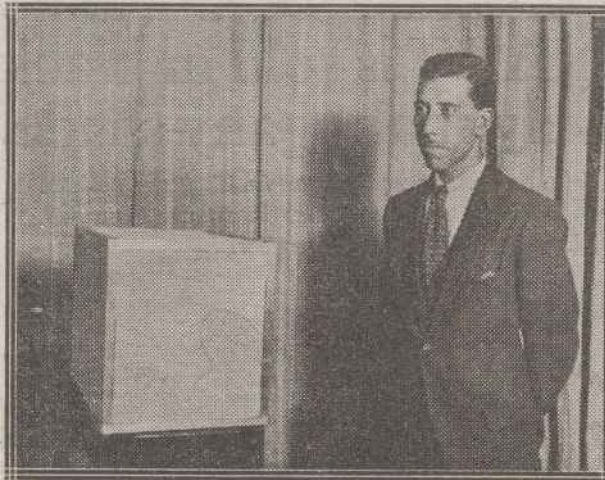

Sirdar Ikbal Ali Shah before the microphone at 2LO on the occasion of his recent talk on "A Pilgrimage to Mecca."

are now being condemned by the designers of the sets themselves.

The Logical Remedy

Radio Press are taking the very

logical step of trying to prevent these popular receivers from being built. It is a difficult task, because if a thoroughly good receiver, with a reputation perhaps of several years, is heard by a new listener, he will be tempted to build up that receiver. A mere announcement by a radio journal that much better receivers have since been designed will not deter him in many cases. He may have heard, say, an ST 100 set, and would rather have such a receiver than build one of the new sets which he has not heard. To try and prevent any obsolete sets from being built, even though they were excellent in their time, the Radio Press is stopping the supply of Envelopes and instructions for sets which they regard as no longer coming up to the standard of the new sets which are being published in their periodicals.

This scrapping of Envelopes, etc., involves a very heavy financial loss. One Envelope, the "3-valve Dual" has, in fact, only been issued a matter of some few months, yet we will be destroying thousands of these Envelopes for the sake of a principle. This particular set was put into Envelope form because of its very wide popularity when described in one of our periodicals. Now, however, we want to stop the set being built, because we know that the "Elstreflex" receivers are at least 100 per cent. better.

Straight Words

If you possess a receiver which is not of the Neutrodyne type please take my advice and scrap it. Some of the parts you will undoubtedly be able to use again, but to get the best results you will have to add one or two of the newer components which have been introduced. I strongly advise every reader of WIRELESS to refuse to build a set which is not neutralised in its high-frequency stages. Also I would like you to spread among your friends the same idea because every receiver which does not use this principle is a bad advertisement for what radio will do. Satisfaction with the local station is, unless you use a crystal or a single-valve receiver, a confession that your apparatus is out of date. Join now the throng of enthusiasts who are taking advantage of the new developments which we have made possible.

NEXT WEEK.

Special article by Mr. Reyner.

THE NEW B.B.C. WAVELENGTHS

How to alter your sets to deal with the new waves

It has now been definitely decided that the wavelengths of the majority of the B.B.C. stations will be altered on or about September 15 this year. The chief alteration is that one exclusive wavelength has been allotted for nearly all the British relay stations. Birmingham and Aberdeen will also share a common wavelength, at the top of the scale, as far as the British stations are concerned.

When these alterations come into force, Daventry is to be regarded as a stand-by for those in difficulty anywhere in the United Kingdom.

The B.B.C. state that the arrangements have been made so that the necessary alterations will apply to the minimum number of persons.

The new wavelengths are as follow:

Aberdeen and Birmingham, 491.8 m.; Glasgow, 405.4 m.; Manchester, 384.6 m.; London, 361.4 m.; Cardiff, 353 m.; Belfast, 326.1 m.; Newcastle, 312.5 m.; Bournemouth, 306.1 m.; Leeds (relay), 297 m.; Bradford (relay), 294.1 m.; all other relays, 288.5 m.

Altering Your Set

In most cases it is probable that no alteration to existing receivers to tune

to the revised wavelength of the local station will be needed. This applies particularly to the newer types of sets incorporating special coils which cover a wave-range of, say, 200 to 500 metres, with another unit for Daventry, but in the case of sets using plug-in coils and perhaps a plain parallel-tuned aerial circuit some slight modification may be required.

What May Be Needed

When plug-in coils are employed it may be necessary to use one size smaller in the various sockets of the tuned circuits in order to receive the relays on the new common wave.

Where parallel tuning is used in the aerial circuit there may be a little difficulty in getting down to this wave on a large aerial. In such cases three simple remedies are available, the first being to alter the wiring to give series tuning, the second to adopt one of the various tips which have been given for incorporating "aperiodic aerial" tuning, while the third and perhaps the simplest is to include a fixed condenser of .0001 in series in the aerial lead (outside the set).

THE WORLD'S SELECTED
COMPETA
RADIO PRODUCTS.

MINIATURE PANEL METERS

SPECIALLY designed for Radio Receivers, neat in appearance, accurate and easily fitted. Highly nickel plated. Our Trade Mark is the Guarantee.



VOLTMETERS.

0-3, 0-6 and 0-10 Volts Price 7/6 each

AMMETERS.

0-1, 0-3 and 0-6 Amps. Price 7/6 each

MILLI-AMMETERS.

0-20, 0-30 and 0-40 M.A. Price 10/6 each

COMBINED VOLTMETERS.

0-6 and 0-120 Volts Price 11/6 each

OBTAINABLE FROM ALL DEALERS.

A.F. BULGIN & CO
9-11, CURSITOR STREET
TEL HOLBORN 2072. CHANCERY LANE E.C.4. WORKS CHISWICK

WIRELESS.—Capable, trustworthy men with spare time who wish to substantially increase income required where we are not fully represented. Applicants must have practical knowledge of installation of Set and Aerial, be a householder or live with parents, and be able to give references; state age and experience. Address: Dept. 38, GENERAL RADIO COMPANY, LIMITED, Radio House, Regent Street, London, W.1.

WET H.T. BATTERIES

British made round or square Leclanche Glass Jars, 2 1/2 x 1 1/2 x 1 1/2, for wet H.T. Units. Waxed, 1/3 doz.; plain, 1/2 doz. Carriage and packing extra. Phones and Loud Speakers reconditioned, 4/6 & 5/-. The H.R.F. Co. 1, Cottrell Road, nr. Hackney Downs Station, London, E.8.

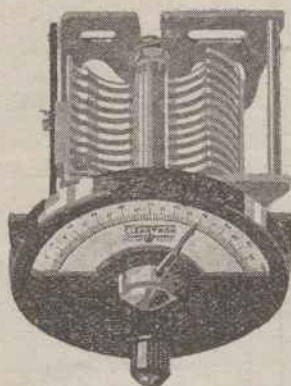

The Cleartron 'Di-Kast' Condenser fitted with Micro Station Selector Dial (precision movement) 10/6 extra.

THE DI-KAST CONDENSER

Both rotor and stator are die-cast in one piece. This means positive connexion, perfectly matched characteristics, and overcomes the contact resistance losses inseparable from all other assembled condensers. Specially designed vanes provide straight line reading, greater range, easy shortwave tuning and very low minimum capacity.

The Micro Station Selector—a newly designed dial precision movement—is so completely free from play or back-lash that more than ten different adjustments are possible between each degree.

and of course

CLEARTRON VALVES
—the new 1926-7 models with NEW filaments, INCREASED electronic emission, HIGHER vacuum and LONGER life. At standard prices everywhere.

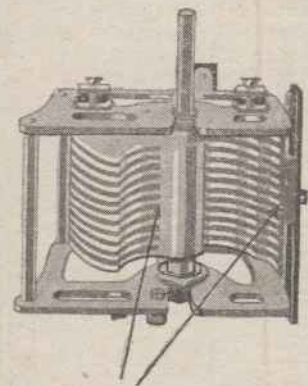

The famous Cleartron 'Di-Kast' Condenser from which, as both Rotor and Stator are die-cast in one piece, hitherto unattainable results are obtained.

'0002, '0003, '0005 10/6

CLEARTRON RADIO LIMITED

ONE CHARING CROSS, LONDON, S.W.1.
Telephone: Regent 2231-2.

(Works: Birmingham.)

Telegrams: "Cleartron, Westrand, London."

See us at Stands 135, 102 and 46



National Radio Exhibition

CT/56

BUILD A NEUTRODAPTER

By G. P. KENDALL, B.Sc.
Assistant Editor

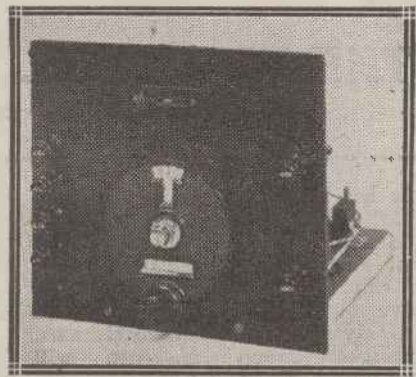

Take full advantage of the recent remarkable developments in neutralised receivers, with their special circuits, screened coils, and so on, it is no

doubt necessary to build a complete set from one of the published designs, but this is a step which we cannot all afford, and it is natural to wonder whether there is no alternative.

experience has been limited to the older types of sets. Such a unit, moreover, is a particularly valuable accessory when used in conjunction with the average insensitive "local" receiver, since it converts such a set into an instrument capable of pulling in the stations. After dark it would usually put Birmingham on the loud-speaker (it incorporates two L.F. valves in addition to the detector), and perhaps three or four Continental stations when full use was made of reaction and tuning performed with much care.

Possibilities of a Unit
As a matter of fact, as has just been stated, to get the full results of which the latest designs are capable one must build one of the new sets, and everyone who is prepared to face the necessary outlay is urged to do so. However, a considerable measure of participation in the benefits of the latest H.F. amplifying methods is possible for the man who is compelled to stick to his old detector and L.F. amplifying receiver, by adding a special H.F. unit in front of the existing set.

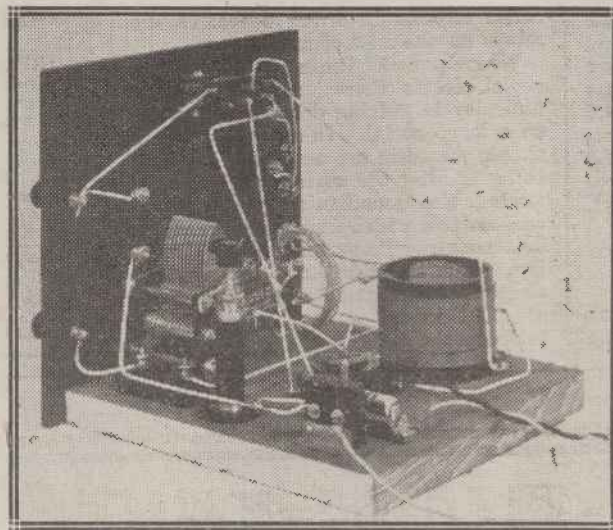

The neutralising condenser used in this unit is of the baseboard mounting type.

Receiver Capabilities

At about eight miles from 2LO that station came in "all over the dial" and made distant reception very difficult without the aid of a wave-trap. With a trap things were much easier, but even so the set was not capable of doing much in the way of "DX" by daylight; one had to wait until after dark before the distant stations started to come in.

The Result

On connecting the "Neutrodapter" in front of the set it was impossible to avoid a feeling of relief at the notable improvement in selectivity. The local station was now narrowed down to quite a reasonable band, so that it was possible to receive Bournemouth clear of 2LO and at quite good strength by daylight. Other stations which now came in by daylight were Dublin, New-

Use with Local Sets

It is not possible in this way to reap the full benefit of a well-thought-out and tested complete design, but such a unit can nevertheless be made to give

distant stations and giving quite a creditable performance in a long-range test.

Tests

To give an idea of the results obtainable with such a unit I will quote those produced by the "Neutrodapter," which forms the subject of this article. It has been used chiefly with a simple Reinartz receiver of a type designed to give loud signals on the local station, but no great degree of selectivity.

Without the "Neutrodapter" this receiver would, as a rule, bring in Birmingham at fair strength in daylight, and perhaps one or two German

castle, Hamburg, Brussels and Aberdeen, the last-named on 'phones only. (Continued on page 26.)

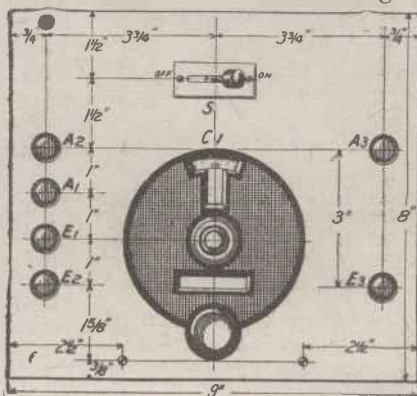

Fig. 1.—Simplicity is the keynote of the panel layout, as may be gathered from this drawing.

an improvement in selectivity and sensitivity which will be found sufficiently remarkable by those whose ex-

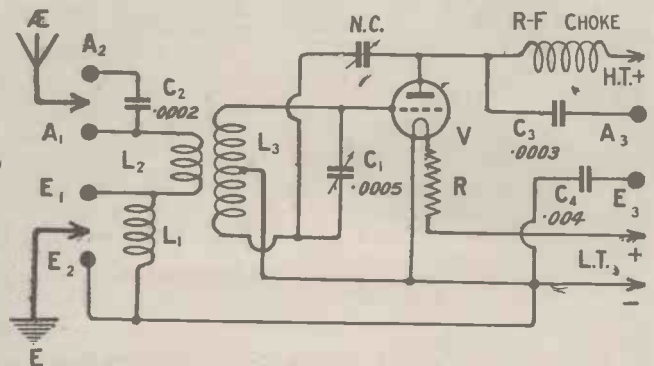

Fig. 2.—The simplified circuit arrangement upon which the final circuit shown in Fig. 4 was based.

castle, Hamburg, Brussels and Aberdeen, the last-named on 'phones only. (Continued on page 26.)

Figures to Remember



The Night Watchman.

"PAST eleven o'clock, and a starlight night. All's well." The cry of the night watchman giving that assurance of safety and well-being.

The old order changeth. Yesterday it was the individual, to-day it is the creative genius of man which bears the burden, but success is measured by the same standard, reliability.

Take the case of Broadcasting. The real pleasure of Radio depends on the degree of reliance you can place in your wireless set, or more particularly in your valves. Now Six-Sixty Valves ensure the maximum degree of reliance. They never let you down. They assure a wonderful purity of reception, and in addition to being remarkably economical, there are no valves on the market to-day that can boast of a longer life, because there are no valves that operate at a lower temperature.

Six-Sixty Valves are recommended by all the leading Wireless Journals of to-day.

For Perfection of Quality insist on SIX-SIXTY VALVES

Visit our Stand No. 38 at the National Wireless Exhibition, Olympia, September 4th-18th.



S.S.3 L.F.
(Green Disc).

Voltage - 3 volts
Consumption .06 amps.

PRICE 16/6

These prices do not apply in the Irish Free State.

Leaflet S.S. 1.7 gives full particulars. Your Dealer will be pleased to order Six-Sixty Valves for you if he is out of stock.



SIX-SIXTY VALVES
Better by Six times Sixty

The Electron Co., Ltd., Triumph House, 189, Regent Street, London, W.1. 12

APPOSITE ADAGES, No. 5.

'Don't Spoil the Ship'

Specify

DUBILIER
PRODUCTS

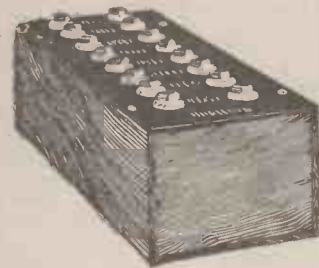

Have you entered for the Dubilicon Competition yet?

If not, write to us now for full particulars.

Cash Prize £200.

REGISTERED TRADE MARK

DUBILIER
CONDENSER CO (1925) LTD

ADVT. OF THE DUBILIER CONDENSER CO. (1925) LTD., DUCON WORKS, VICTORIA ROAD, N. ACTON, LONDON, W.3. Tel. Chiswick 2241-2-3.

E.P.S. 217

Build a Neutrodapter—(continued from page 24)

These stations, moreover, were heard with that steadiness and comparative freedom from mush and general stray interference which characterises a set of the selective type.

WHAT YOU WILL NEED.

One cabinet to take panel 9" x 8" x 1/4" and baseboard 9" deep (Peto-Scott Co., Ltd.).

One panel 9" x 8" x 1/4" (Peto-Scott Co., Ltd.).

One "Cylcon" plain type square law .0005 condenser (Sydney S. Bird & Sons).

One "Kilograd" vernier dial (Messrs. Rothermel).

One baseboard mounting type neutralising condenser (L. McMichael, Ltd.).

Three fixed condensers (type 610) .0002, .0033, .004 (Dubilier Condenser Co. Ltd.).

One "Utility" two-way change-over switch (Wilkins & Wright Ltd.).

One "Lotus" anti-vibratory valve holder (Garnett, Whiteley & Co. Ltd.).

One Amperite with clips, (Messrs. Rothermel).

Six "Belling-Lee" terminals, suitably marked.

One General Radio Co.'s Low-loss coupling coil, Type 277 D (Messrs. Claude Lyons).

One single-coil holder, baseboard mounting type (D. Burne-Jones, Ltd.).

Quantity of No. 20 d.c.c. wire, Glazite and flex.

Approximate Cost—£4.

The actual results which builders of the "Neutrodapter" will obtain will depend to some extent, of course, on the kind of receiver with which they use it, and in most cases will no doubt be considerably better than those I have quoted since these latter were obtained with a distinctly inferior set. I will return to this point in discussing the operation of the unit in greater detail next week.

The Circuit

A simplified version of the circuit employed in the Neutrodapter is given on these pages, omitting the switching arrangement with which we shall be dealing later. It will be seen that the aerial circuit consists essentially of the coupling coil L_2 , a series condenser C_2 , and a loading coil L_1 . Terminals are provided so that the series condenser and loading coil in question can be included in circuit or cut out as desired, and I have adopted this arrangement as the result of investigations which I have carried out in the past on the behaviour of the so-called aperiodic aerial circuit.

A centre-tapped coil is used in the grid circuit of the H.F. valve, the

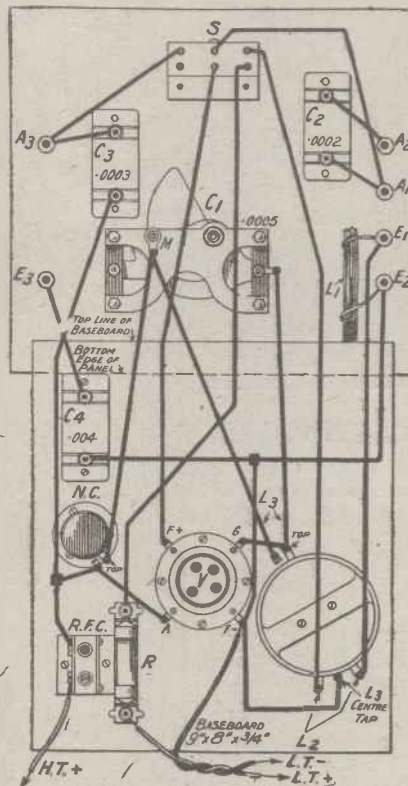

Fig. 3.—This drawing of the back of the receiver shows the panel in the same plane as the baseboard for reasons of clarity.

condenser in the manner which is now becoming familiar.

H.F. Coupling

In the anode circuit of the valve is a high-frequency choke, which serves to pass the amplified signals on to the

WIRING INSTRUCTIONS.

- Join A2 to one side of C2.
- Join A1 to other side of C2 and to top middle point on switch S.
- Join E2 to one side of L1 and to one side of C4. Join nearest point on latter wire to F - of V and thence to centre tapping of L3. Also join L.T. - flex lead to F - of V.
- Join E1 to remaining side of L1 and to one side of L2.
- Join other side of C4 to E3.
- Join A3 to one side of C3 and to top left-hand point of switch.
- Join other side of C3 to one side of H.F. choke, lower terminal of neutralising condenser, and A of valve holder respectively.
- Join L.T. + flex lead to one side of R.
- Join other side of R to bottom right hand point of switch.
- Join bottom middle point of switch to F + of V.
- Join G of valve holder to top side of L3 and thence to fixed plates of C1.
- Join other side of C1 to remaining side of N.C. and to remaining side of L3.
- Join top right-hand point of switch to remaining side of L2.
- Join H.T. + flex lead to remaining side of H.F. choke.

output terminals and to the first valve of the existing receiver by the "parallel feed" method. In this way the unit is rendered suitable for use with any type of receiver, regardless of the kind of tuning circuits which the latter incorporates.

The Choke

The H.F. choke is simply a plug-in coil of fair size, say a No. 200, and a socket is provided for its reception on the baseboard. This has been done because it was thought probable that most builders of the unit would already possess plug-in coils, but those who do not can, if desired, use a standard H.F. choke of any reputable make, since plenty of room is available on the baseboard.

Battery Leads

The batteries are connected to the unit by means of three flexible leads attached directly to suitable points on the baseboard, two being for low-tension supply and one for high-tension positive. No H.T. negative is needed, because it is assumed that common batteries will be

used for the receiving set and the unit. (Operating instructions and further details next week.)

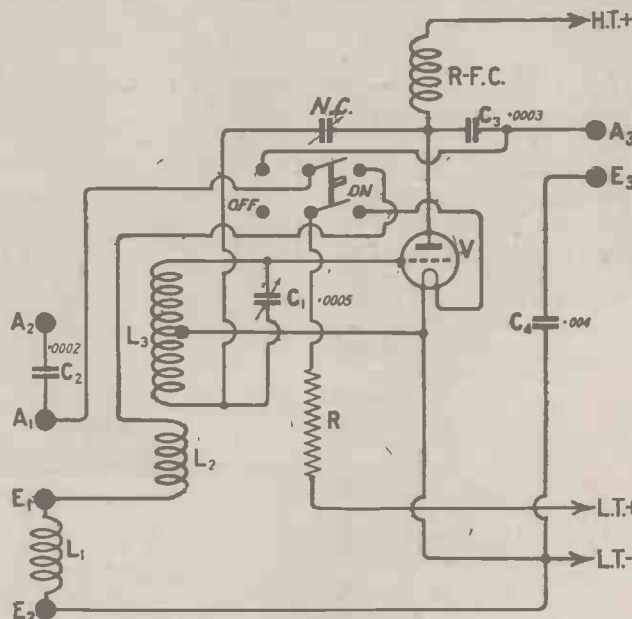
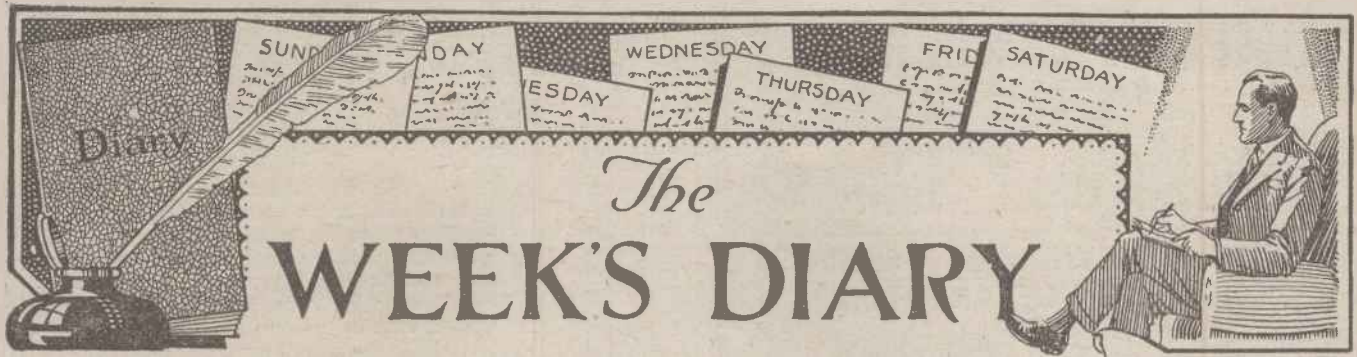

Fig. 4.—The final circuit arrangement upon which the present unit was designed. A switch is provided to cut it out of circuit when not required.

centre tapping being connected to filament, and one end of the tuned circuit being connected to the neutralising



I WAS very much surprised to read quite recently that there is a rumour current to the effect that the Eiffel Tower broadcasting service has been under the management of a Polish subject. This rumour stated that the person in question, by name Sacha Stavisky, is at present in gaol, and has applied to the Courts for a writ placing the broadcasting service under a sequestration order.

From what I know of the rigid military administration of the great French station it is difficult to see how this could be; no doubt most of my readers couple the names of "Eiffel Tower" and "General Ferrié" almost unconsciously. In view of this strict military control it certainly seems difficult to believe that there is any truth in the rumour.

* * *

I EXPECT the new wavelength arrangements have come as a surprise to many. We all realised that any alterations that were made would cause a slight amount of inconvenience to some sections of the community, and it certainly appears that the B.B.C. have managed to arrange things so as to cause a minimum of trouble. The chief fly in the ointment seems to be the common 491.8 metre wavelength for both Birmingham and Aberdeen. It will be rather a blow for the Southern listener who used to test out his set on Aberdeen, as the furthest British station. The B.B.C. had to resort to this device, however, in order to free the one exclusive wave of 288.5 metres on which most of the relay stations will work. Another point is that, unless both 51T and 2BD are crystal-controlled, a slight heterodyne is almost bound to occur from time to time, which is liable to cause annoyance. From the London listener's point of view, however, prospects are somewhat brighter, since a set of quite average selectivity should receive Newcastle (312.5 metres) and Bournemouth (306.1 metres) quite clear of London.

THE system on which Geneva worked in allotting the new wavelengths was really most interesting. The European stations are in future to be "spaced in frequencies," and not in wavelengths. By this means it will be definitely known beforehand that they cannot heterodyne one another, since there is to be the requisite space of 10 kilocycles between all the stations.

In the band allotted for broadcasting there is only room for 99 stations,

ONCE more I have found the Information Department sadly depressed on paying them a visit. This time they were dealing with a letter from a reader who had seen in the Press that wax could be "permanently electrified," and wished to know how he could use some of it for supplying high-tension to his receiver. Really, you know!

* * *

I UNDERSTAND that for three days during the Radio Exhibition the studios at Savoy Hill will be almost completely silent. All the broadcasts from Daventry and 2LO will take place in the "Aquarium" at Olympia, to which I alluded last week. After the first three days, September 4, 6 and 7, substantial portions of the programmes will still be performed at Olympia, and the remainder at the studios as usual. I do not think a demonstration of this kind can be praised too highly. It is most essential that the public should be brought into fairly close touch with the "men behind the voices" at frequent intervals, and demonstrations such as the coming one at Olympia do very much towards stimulating interest in broadcasting.

* * *

QUITE a fair percentage of London listeners must be affected by the good news that the overhead section of the Southern Electric Railway is to be converted to the three-rail system. I have listened-in quite often on a set working from an aerial within about fifty feet of the overhead wires of the present system, and the interference caused when a train passes by is considerably worse than any atmospheric that I have ever heard. Those unfortunates who are compelled to put up with this interference must possess their souls in patience for two years or so, for the noise caused by the trains on the third-rail system (using 600 volts D.C.) is very much less than that from the overhead
(Continued on page 29.)

AT BROOKLANDS

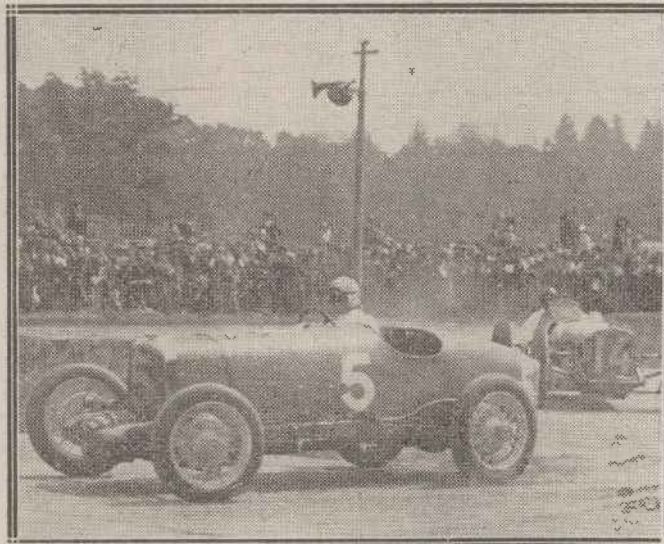

The Amplion public address system was used at the British Grand Prix race at Brooklands on August 7, the loud-speakers being distributed at points of vantage around the track.

and in Europe at present there are some 200 working. The problem of dividing two into one has been solved by allotting 83 "exclusive" waves, for one country only, and sixteen "common" waves, upon which any stations may work. Thus the B.B.C. main stations are all on exclusive waves, but to make this possible Aberdeen and Birmingham had to share one of them between them, and the relays are sharing another "exclusive" wave. Those that are not on this wave (288.5 metres) will occupy some of the "common" waves which may also be used by foreign stations.

SIMPLY WONDERFUL!

"The 'AF3' I have fitted is simply wonderful."
ENGINEER COMMANDER, R.N.

WONDERFULLY SIMPLE!

**YOUR RADIO WILL BE IMPROVED
SIMPLY BY SUBSTITUTING**



**British Made
AUDIO FREQUENCY
TRANSFORMERS
TYPE AF3
FOR THE OTHERS**

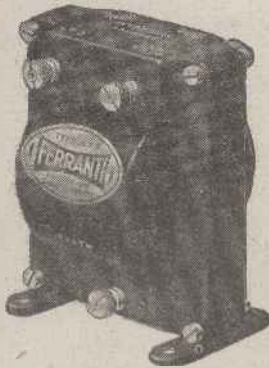

**No better Transformer is
available at any price.**

25/-

ASK YOUR DEALER FOR LEAFLET W-401.

**FERRANTI LTD., HOLLINWOOD,
LANCASHIRE.**

Chosen for use in the "Neutrodapter"

The .0005 Mfd. Cyldon Square Law Variable Condenser is a mechanically and electrically tested instrument of utmost precision, which when substituted for other makes has improved reception as much as 75%. The special Grounded Rotor enables you to tune in to *any* station smoothly and easily.

CYLDON

(pronounced Sil-don)

SQUARE LAW CONDENSER

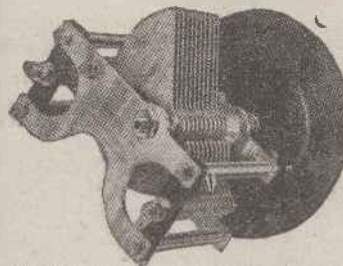

.0005 Square Law Model as illustrated 17/6 complete with comfortably large (4 in.) Knob Dial. Get particulars and prices of full range of these and of Cyldon Dual and S.I.F. Condensers from your dealer.

SYDNEY S. BIRD & SONS

"Cyldon" Works, Sarnesfield Road, Enfield Town, Middlesex.
Telephone: Enfield 672.

CAXTON 4-VALVE CABINET

Made for Sets, "As good as money can buy,"
"Harmony Four Receiver," "The Melody Three"

Special Cabinets made to Customer's measurements. Prices quoted.

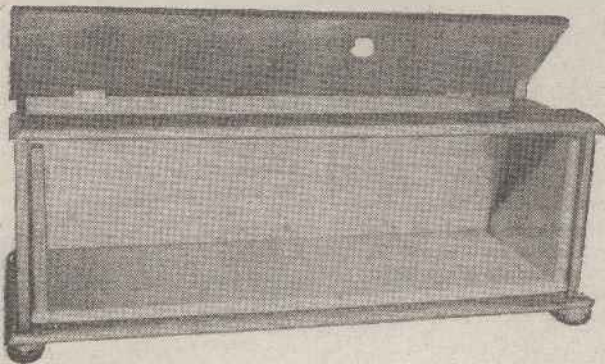

Cash with Order. Fumed Oak ...	£1 5 0
Dark or Jacobean Oak ...	£1 10 0
Real Mahogany ...	£1 14 0

Detachable 7" deep Base Board to mount 21" by 7" panel to slide out of Cabinet front.
Also supplied at 10/- extra with two beaded front doors placed 2 ins. in front of the enclosed panel.

Ebonite or Radion Panels Supplied and perfectly Fitted at low extra cost.

All Polished with the new enamel that gives a glass hard surface that cannot be soiled or scratched. **SENT FREE.**—Catalogue of standard Wireless Cabinets in various sizes and woods.

Packed and delivered free in U.K. No. c3

CAXTON WOOD TURNERY CO., Market Harborough

SUM IT UP

for yourself. The British Made Lustrulux '06 H.F. Det. or L.F. Valves cost 9/- each. The Lustrulux '34 Power Valve costs 11/-. You can get an ideal three-valve combination for 29/- and no valve calls for more than 2 volts!

Quite apart from the low initial cost, think of the current economy of arranging your accumulator cells in parallel—and the three valves together only call for '46 amps.

Quality and reproduction? Well, just try! Compare the Lustrulux with any valve you like, quite irrespective of cost. Your own good opinion will be confirmed by your most musically inclined friend.

Ask your dealer.

Lustrulux Valves also obtainable from LEWIS'S LTD., Liverpool and Manchester, and LUSTROLUX Ltd., West Bollington, Near MACCLESFIELD.

Send for Catalogue D.



LUSTROLUX

It will
Pay You
to see this
Exhibit!

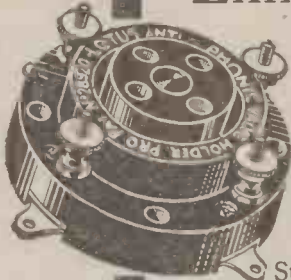

Visit
Stand No. 84
at the National
Radio Exhibition—see the
“Lotus” Valve
Holders and learn
just how and
why they excel
in absorbing
shock, protect-
ing the valves
and eliminating
all microphonic
noises.

Valve sockets and
springs locked to-
gether by a me-
chanical process,
making a definite
and permanent
connection.
Bakelite mouldings
nickel silver
springs and phos-
phor bronze valve
sockets, nickel
plated.

2/6 With
terminals

2/3 Without
terminals

Rigorous tests at
the factory en-
sure that
“Lotus” Valve
Holders will give
entire satisfac-
tion under any
conditions. That
is why you should
insist on them
for your set.

LOTUS

BUOYANCY

VALVE HOLDER

ANTI-MICROPHONIC

Made by the makers of the famous
Lotus Vernier Coil Holder.
GARNETT WHITELEY & CO., LTD.,
Lotus Works, Broadgreen Road, LIVERPOOL.

THE WEEK'S DIARY

(Continued from page 27)

wires. This is only natural—the present system has such a good aerial on which to transmit!

THE Post Office is at present pondering over the idea of Mr. Wallace Maton, of Hythe, Hants., who is supplying neighbours with the broadcast programmes for a small weekly subscription. Seeing that all his “subscribers” have B.B.C. licences, it is difficult to see that he is doing anything likely to contravene the terms of his licence, but the G.P.O. apparently thinks otherwise. It seems to me to be merely a rather wider application of the “room-to-room” system for loud-speakers working from one set.

* * *

HOW to amuse oneself on holiday during bad weather has hitherto been one of the stiffest problems with which we have been faced during the summer. Now, however, it is no problem at all! Nevertheless, I cannot help thinking that a holiday from wireless is a good thing now and then. Where the holiday-maker is able to listen to some station other than his usual “local,” the desired change is produced, however.

* * *

IF, when listening to amateur telephony on wavelengths of the order of two hundred metres, you hear a steady buzz or drone, you may take it on good authority that you are listening to the transmission of a face!

Mr. J. L. Baird, whose name is already well known in connection with television, has been granted two transmitting licences for television transmitters, and he is using powers of 250 watts. The two stations have been allotted the call-signs 2TV and 2TW, the former being in Upper St. Martin's Lane and the latter at Harrow-on-the-Hill. Television is, of course, still “in its infancy.” I don't mind using the horrid phrase in connection with the youngest branch of the radio art!

* * *

I HEAR on good authority that under the new B.B.C. rather a greater amount of controversial matter will be allowed to be broadcast, and it is just on the cards that the Children's Hour will be considerably modified. Several pernicious rumours are going the rounds at present, however, and my readers will be well advised to have their pinches of salt readily available.

WAVE-TRAP.

NEXT WEEK.

Complete operating details of the three instruments described this week will appear in our next issue, together with the feature “Short-Wave Notes and News,” which has unavoidably been held over from this issue owing to pressure on our space.

You need these
two LISSEN
parts in your
receiver



The LISSEN
FIELDLESS
COIL 10/-



The
LISSEN
Neutralising
Condenser 4/6

The Lissen Fieldless Coil is a highly efficient H.F. Transformer embodying all the improvements discovered by recent research in neutralised circuits. It has a negligible external field—does not interact with other circuits; centre tapped on both windings, and aperiodically coupled.

The Lissen Neutralising Condenser has an exact capacity range and absorbs no power.

Used together the Lissen Fieldless Coil and Neutralising Condenser bring success into any neutrodyne circuit.

LISSEN

LISSEN LIMITED,
18-22, Friars Lane,
Richmond, Surrey.

Managing Director—Thomas N. Cole.

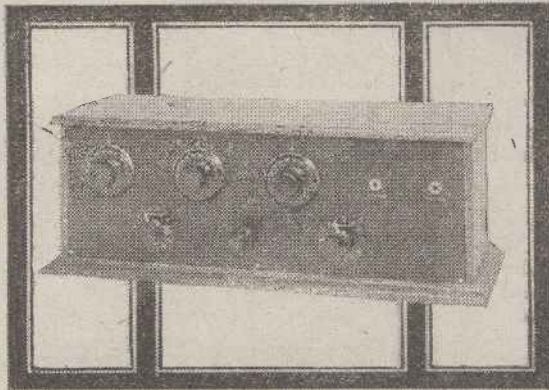

FAULTS IN NEUTRODYNE RECEIVERS

By JOHN UNDERDOWN

Preliminary adjustments and faults due to defective components occasionally puzzle the beginner. Much useful information on these subjects is here given.

MY experience largely goes to show that faults in neutrodyne sets may be divided into two categories: Firstly, the most common of all is failure to neutralise properly; and here it may be stated that generally the trouble is due to insufficient attention being paid to the author's instructions as to lay-out, etc., or lack of experience in handling any valve set; and secondly come faults due to minor faults in components.

From a crystal set to a multi-valve receiver is a large step to take, but is a leap often unhesitatingly taken, even by those noted for their sane judgment in business. By this I do not mean to indicate that the building of a multi-valve set, perhaps with several H.F. stages, is a proceeding which should be found difficult, even by the veriest novice, but it is to be advised that some experienced friend be called in when the preliminary tests are carried out. Alternatively, some little experience of handling valve receivers should be obtained by working a friend's set, since it is unlikely that the novice, who perhaps cannot tell the plate leg from the grid leg of a valve, will duplicate the results given in an author's test report at the beginning. Here an ounce of practical demonstration is worth pounds of theory.

Neutralising

Recently a number of cases have come to my notice where a reader has complained that the set will not neutralise and that the only station which can be obtained is the local, and this only with certain of the condensers not properly adjusted, as otherwise the set oscillates. In practically every case when the set has been tried it has been found quite satisfactory and a large number of stations have been received. A few words, therefore, on the subject of neutralising will not come amiss.

There are three types of neutrodyne sets with which most readers are

familiar, and these may be classified under the headings of the Cowper type, the "Elstree Six" type, and the type employing an H.F. transformer with a split primary winding, a typical example here being the "Magic Five." There are, of course, other systems of neutralising, but only these three, which will be most familiar to readers of WIRELESS, will be dealt with here.

The Cowper Arrangement

In the Cowper neutralising system the fundamental arrangement is that

of minimum capacity, whilst swinging the grid tuning condenser, the correct setting of the neutralising condenser will be obtained. When this condition of affairs is reached no clicks will be heard, however the grid tuning condenser is adjusted.

With a Cowper-type multi-H.F. receiver, however, I have discovered no rule-of-thumb method for neutralising, and here it is best generally to set the aerial tuning condenser at some given value, whilst screwing in the neutralising condensers by equal amounts and swinging the H.F. tuning condensers until a condition of affairs is reached where no clicks are heard upon these latter condensers being rotated fairly widely from the position of approximate tune. This sounds rather complicated, but actually in practice is not particularly difficult.

"Elstree Six" and "Magic Five" Types

With "Elstree Six" and "Magic Five" type receivers much simpler methods of neutralising are applicable. An approximate setting for the neutralising condensers for any given set is usually mentioned in the article for the particular valves with which the receiver has been tested, and if these condensers are so adjusted and the first valve extinguished upon its own filament resistance, or by removing a fixed resistor it will be found that the local station may be tuned in on the telephones. The first neutralising condenser should then be adjusted until the signals completely disappear or are reduced to minimum strength. This done, the first valve should be switched on and the second should be switched off on its filament resistance, and the process should be repeated, and so on until all the H.F. valves are neutralised. When this is carried out the set should be stable over the whole of the wavelength band covered by the coils, in conjunction with their condensers in the receiver. It should be emphasised here that it is essential for all tuning condensers

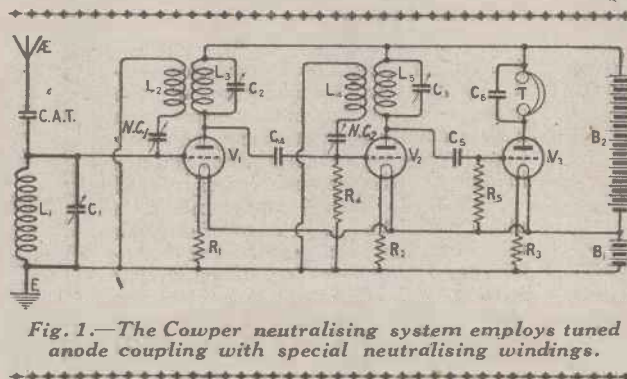

Fig. 1.—The Cowper neutralising system employs tuned anode coupling with special neutralising windings.

of a tuned-anode coupling, a further coil being coupled to the tuned-anode coil and connected in series with a very small condenser, between grid and filament of the valve concerned. The neutralising coil allows of a reversal of phase being obtained, and by suitably adjusting the neutralising condensers, for example, NC1 and NC2 of Fig. 1, voltages equal and opposite in sign to those due to the feed-back effect through the valve are obtained, which allow the desired neutralised condition to be obtained.

A Single H.F. Stage

With only a single H.F. stage neutralising is extremely simple, the anode tuning condenser being set at some intermediate value and the grid tuning condenser of the first valve being rotated. Clicks will be heard when the set goes into and out of oscillation, and by gradually increasing the capacity of the neutralising condenser, working from the position

Faults in Neutrodyne Receivers—continued

to be correctly adjusted for reception of the local station, which reading in such cases as the "Elstree-Six," for example, is readily obtainable from the article in question. But little

ting the balance obtained by the method given above, the set being more lively when this is done. With .06-ampere-type valves, however, neutralising may be somewhat more criti-

short lengths of insulated wire, such as Glazite, and connect one end of each piece respectively to the plate and to the grid of the valve concerned, after which the two wires may be

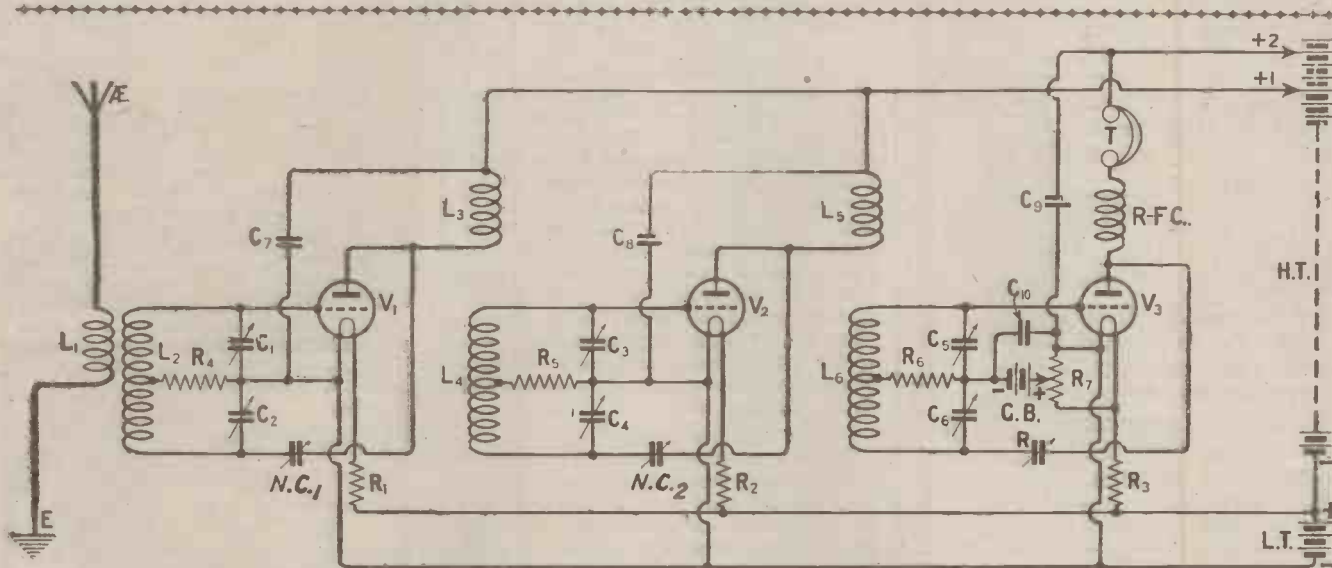

Fig. 2.—The "Elstree Six" method of stabilising is a marked advance on earlier methods.

difficulty should be experienced, however, if this information is not available.

Not Critical

With valves of the resistance-cou-

cal, and a tip worth knowing here is that the best adjustment of the neutralising condensers may be with the plates all out or towards the minimum capacity setting. With certain types of neutralising condensers, primarily

twisted together, the two free ends not being allowed to touch, as otherwise a short-circuit will occur. The two twisted wires will increase the capacity and make it easier to effect the desired balance.

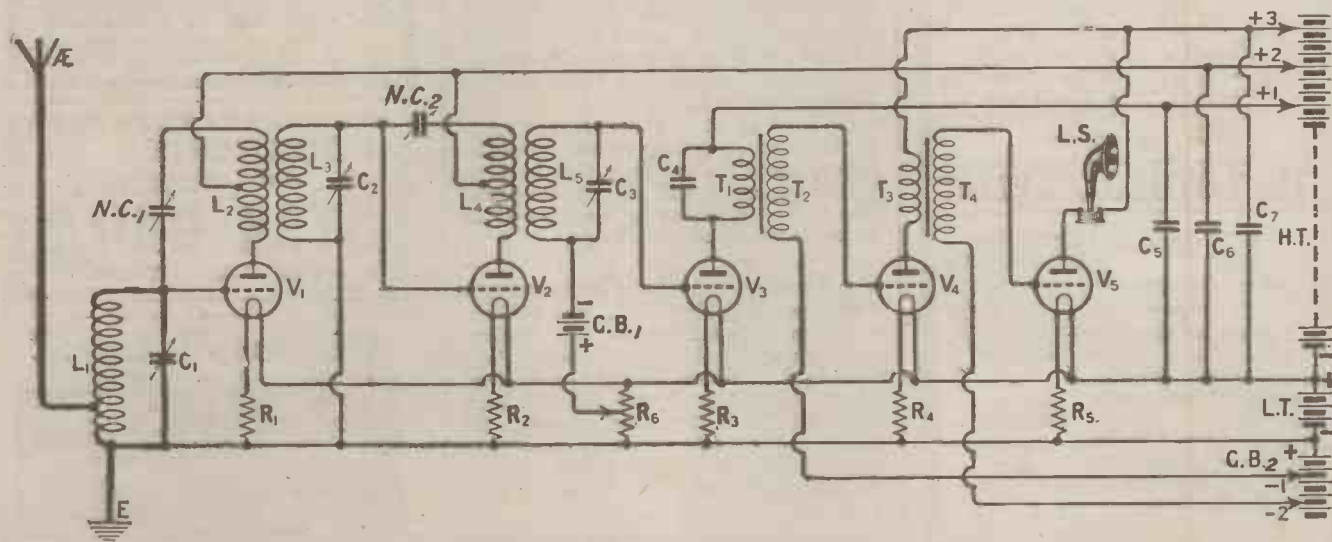

Fig. 3.—An excellent example of the split-coil method of neutralising is the "Magic Five" circuit.

ling 1/4-ampere type and certain H.F. valves it will be found that the neutralising setting is generally by no means critical, and some benefit may ensue in some cases by slightly upset-

designed for use with 1/4-ampere-type valves, it may even be desirable to increase the plate to grid capacity of .06-ampere valves, and this may be easily effected as follows: Take two

For Distant Listeners
 Listeners situated at some distance from a main station may not find the method of neutralising given above
(Continued on next page.)

Stand 84, Olympia Radio Exhibition

The name 'LOTUS' is your guarantee of sound results and solid satisfaction

The 'LOTUS' JACK

Designed to take up the least space, the depth back of panel being 1 1/4 in. Made from best Bakelite mouldings, with nickel silver springs and pure silver contacts. One-hole fixing. Soldering contacts can be brought into any position.

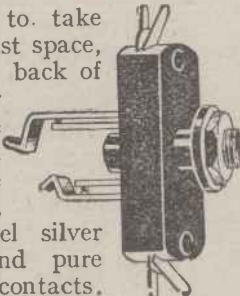

Prices No. 3, as illustrated 2/6 others from 2/- to 3/-

The 'LOTUS' JACK SWITCHES

This push-pull switch is designed to occupy the minimum space, being only 1 1/4 in. deep. Of the finest Bakelite, it has nickel silver springs and contacts of pure silver. Soldering contacts can be made to suit any wiring.

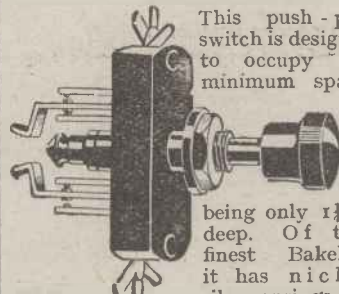

Prices No. 9, as illustrated 4/- others from 2/9

The 'LOTUS' JACK PLUG

Designed for use with Lotus jacks. Made from best Bakelite mouldings and nickel plated brass. To fix, the wires are placed in slots and gripped in position by a turn of the screw cams.



Price 2/-

Made by the makers of the famed 'LOTUS' Vernier Coil Holders and 'LOTUS' Buoyancy Valve Holders
Garnett, Whiteley & Co., Ltd.,
LOTUS Works
Broadgreen Road, Liverpool

NEUTRODYNE FAULTS

(Continued)

particularly helpful, and here the procedure to adopt is to disconnect the aerial and earth from the set and to set all tuning condensers in the position of approximate tune, which will generally be at similar readings with modern sets. It will then be found on swinging a condenser from the position of approximate tune that clicks will be heard in the telephones or loud-speaker at some distance upon either side of this point. The capacity of the neutralising condensers should be increased by approximately equal amounts, each tuning condenser being rotated backwards and forwards about the position of approximate tune, when it will be found that a setting will be obtained where no alteration of any condenser setting will allow clicks to be heard. The set is now approximately correctly neutralised, and may be connected to aerial and earth and worked in the normal way.

"Deadness"

In a number of cases with which I have come in contact recently, it has been found that the receiver appears to neutralise correctly, but only the local station is obtained at really good loud-speaker strength, and distant stations which should be heard well are only obtained at weak telephone strength. With the "Elstree Six" neutralising arrangements (Fig. 2) and and the "Magic Five" type arrangement (Fig. 3), the fault is often located in the primary or combined primary and neutralising coils. With the Fig. 2 circuit, the employment of unsuitable coils for primaries, namely, in the L3 and L5 positions, will account for lack of "liveliness." The correct direction of the windings of these coils is of great importance, and if the receiver fails to respond in the way it should do it is worth while trying the effect of reversing the leads to the coil blocks concerned. On the other hand, the set may fail to neutralise properly, and this is sometimes due to the insertion in these positions of coils which are too large.

□ □ □

An Opportunity for Constructors

Messrs. Selfridge, Ltd., are holding a Radio Competition, as our readers may know, the closing date being September 1. Prizes to the value of about £400 are offered for the best sets submitted by competitors, who must be bona-fide amateur constructors, and members of the R.S.G.B. or an affiliated society or of the Wireless League.

In addition to substantial cash prizes, over 100 consolation prizes are being offered, and Professor A. M. Low is providing a special prize for the best set submitted by a lady competitor. This competition is being run by the Selfridge Radio Society, and application forms may be obtained from the Secretary of that Society.

BRITISH MADE RADIO PRODUCTS

THE SECRET OF SUCCESS!

BALANCING or Neutralising Condenser, for Baseboard Mounting. Can be locked in position when adjusted.

Recommended by many technical journals, and used with success in the "Magic Five" and other circuits.

PRICE 3/- EACH.
New Large Pattern, PRICE 4/6 EACH.



Regd. No. 715459

OBTAINABLE FROM ALL DEALERS.

A.F. BULGIN & CO.
9-11, CURSITOR STREET
TEL HOLBORN 2077 CHANCERY LANE E.C.6, WORKS CHISWICK

Reception to Perfection

Perfect reception can only be certain if you have a Coil Holder in which the moving block cannot fall back

Stand No. 5, Olympia, Sept. 4-18.

No other Coil Holder combines this quality with so many other essential features as the PENTON Type "A."



The Only Perfect Coil Holder.

6/- of all good Radio Dealers, or post free direct from the Manufacturers:- THE PENTON ENGINEERING CO., 15, Cromer St., Gray's Inn Rd., London, W.C.1.

LOOK OUT FOR THE NEW STAR COILS AT THE EXHIBITION.

Valves Repaired AS GOOD AS NEW!!

HALF LIST PRICE (Except Weco, S.P.'s and low capacity types.) Minimum D.E. Current 0.15 amps when repaired. ALL BRIGHT & DULL EMITTERS Listed at less than 10/- Minimum charge 5/- VALCO LTD. Dept. W., Tabor Grove, Wimbledon, S.W.

GLASS JARS AND ZINCS FOR WET H.T. BATTERIES

Also Components for Pleated Paper Loud Speaker.

SPENCER'S STORES LTD., 4/5 Mason's Avenue Coleman Street, Lothbury, E.C.2 (Near Bank).

WHAT IS NEUTRALISING?

By J. H. REYNER, B.Sc. (Hons.), D.I.C., A.C.G.I.,
A.M.I.E.E., Joint Editor

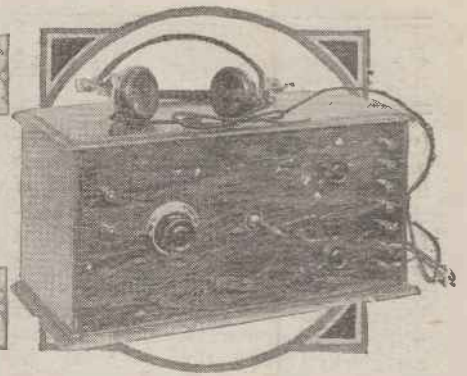

The use of "neutralising" or "neutrodyning" methods has opened up great possibilities, and it behoves every user of the new type of set to understand in a general way how they work.



PROBABLY every one of my readers has a fair idea of what is meant by neutralising in a high-frequency amplifier. An exact definition of the term, however, is not quite so straightforward. Probably most people, if they were asked definitely what neutralising was, would reply, "A method of preventing undesirable oscillations due to the valve capacity."

Negative Reaction

Is this really all that is meant, however? To take a simple case, it is possible to apply definite magnetic counter-reaction from the anode circuit back to the grid circuit of the valve. The circuit would be connected up in the usual manner but with the coils in the wrong direction, so that instead of producing oscillation it would tend to damp out any such tendency. This complies with the definition just given, namely, that it prevents undesirable oscillation, but it would hardly be considered as a neutralised circuit.

A Variable Effect

The principal disadvantage of such an arrangement as this lies in the fact that it would require constant adjustment for varying frequencies. As the condenser of the tuning circuit was varied from top to bottom of the scale, so the amount of counter-reaction required in order to stabilise the circuit would also require to be varied.

It is obviously an essential condition in a really neutralised circuit that the counter-reaction is such as to remain adjusted irrespective of the frequency of the currents which are being amplified.

Let us look into the matter a little more closely, therefore. What is the actual cause of oscillation in a valve amplifier? Consider the case shown in Fig. 1. We have here a certain signal applied across the grid and fila-

ment of a valve. The voltages produced by this signal cause similar but amplified currents to flow in the anode circuit of the valve. Normally these currents flow through the external output circuit of the valve, where they are made use of in some suitable manner depending upon the type of circuit adopted.

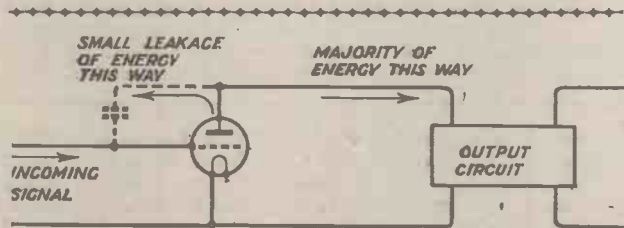

Fig. 1.—Mr. Reyner uses this simple schematic diagram to explain why neutralising is desirable.

Feed-back

The energy produced in the anode circuit, however, does not all pass through the proper channels where it is useful, but some of it filters back through the capacity of the valve itself, and so produces a voltage across the grid and filament of the valve.

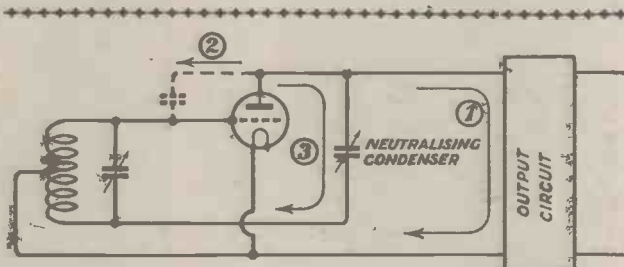

Fig. 2.—In this example it will be seen that the coil in the grid circuit of the valve is centre-tapped, the filament being connected to the centre point.

These two possible paths for the energy are illustrated in the figure. The majority is useful and results in the signals being handed on to the next stage of amplification, whatever it may be. The remaining small portion filters back through what is to all intents and purposes a leakage path (indicated by dotted lines), and it is this which gives rise to trouble.

Direction of Reaction

It is well known that if deliberate reaction is required in a valve, then the voltage produced in the grid circuit as a result of the reaction must be in the same direction as the voltages already existing there. The nett result will then be a progressive increase in the total voltage, as the reaction is increased, right up to a point where continuous oscillation results.

If we are to obtain oscillation through this capacity feed-back in the valve itself, then the same conditions must apply, and the voltages produced must be in the right direction. It does not follow that they are always in the appropriate direction or phase as it is called, but unfortunately in the majority of circuits which are satisfactory from other considerations, the direction of the capacity feed-back is such as to produce a marked reaction effect.

It is this reaction effect which we are up against in a high-frequency amplifier, and it is to prevent such undesirable oscillation that the various methods of neutralising are adopted.

Other Methods

Many readers will no doubt wonder why any method of neutralising is necessary, and whether the circuit could not be stabilised by some damping method such, for example, as the application of a small positive potential on the grid of the valve. This, however, is not satisfactory, because in a modern receiver we desire to eliminate all possible sources of damping in order to obtain the requisite selectivity and signal strength.

Incomplete Stability

There are also other objections to such a practice which cannot be discussed at length in a brief article. It will suffice to observe, however, that in a high-frequency amplifier the conditions are such that the capacity feed-back or reaction will take place

(Continued on next page.)

What is Neutralising?—continued

(with resulting oscillation in the amplifier) if any frequency, within wide limits, is fed into the input side of the amplifier. The oscillation, therefore, can occur at frequencies different from that to which the circuits are tuned, and even if the amplifier could be stabilised for the main frequency which was being received, it does not necessarily follow that it would be completely stable, and spurious oscillations might result.

True Neutralising

The only satisfactory solution, therefore, lies in definitely neutralising the effect of the valve capacity by some suitable means, and this is done by arranging to apply a counter-reaction which can be adjusted to be equal and opposite to that produced by the feed-back in the valve.

As was mentioned at the beginning of this article, ordinary magnetic reaction does not remain adjusted over the whole band of frequencies which are being received, and is therefore not satisfactory. Since the positive reaction which causes the oscillation is dependent on the passage of energy through a small condenser—that existing between the anode and grid of the valve—it follows that in order to obtain the most satisfactory neutralisation of this effect, we must arrange to produce our counter-reaction through another small condenser.

Two Methods

There are various methods by which this principle can be applied, but they divide themselves broadly into two classes. We have a certain voltage on the anode of the valve which causes oscillation as a result of currents passing through the valve itself to the grid, where further voltages are produced in the grid circuit in the same direction as those already existing there.

If we arrange to provide a parallel circuit so that currents can pass from the anode through a small condenser, and then through another coil or to some different point in the circuit, with the result that a negative reaction is applied, then by adjusting the value of the small neutralising condenser, as it is called, we can arrange to obtain a complete balance. Moreover, since the feed in both cases is through a small condenser and is controlled entirely by the value of this condenser, we can

obtain absolute balancing out, and a stable circuit results.

An Example

A circuit of this type is shown in Fig. 2. Here the grid circuit of the valve is centre-tapped, the filament being connected to this centre point. The top end of the circuit is connected to the grid, so that varying

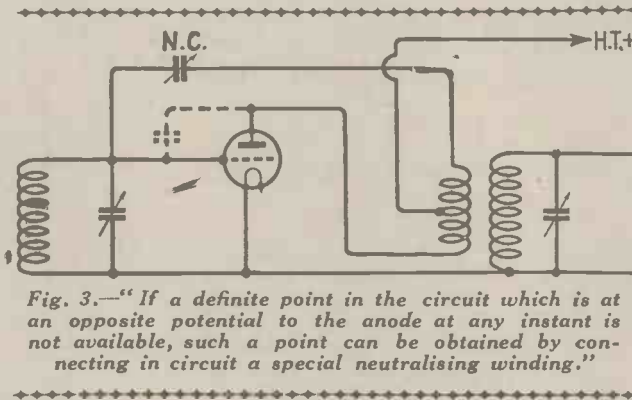

Fig. 3.—“If a definite point in the circuit which is at an opposite potential to the anode at any instant is not available, such a point can be obtained by connecting in circuit a special neutralising winding.”

voltages are applied across the grid and filament. The amplified voltages on the anode have then three paths. The first is the normal and legitimate path through to the output circuit of the valve. The second is the path through the valve capacity, which causes reaction, and the third is the

A Drawback

This method has one or two disadvantages, the principal one being that only half the full potential of the tuned circuit is applied across the grid and filament of the valve. An alternative method, therefore, is to find a point in the circuit which is at opposite potential to the anode of the valve at any instant, and to feed current from this point through a neutralising condenser back on to the grid. If a definite point in the circuit which is at an opposite potential is not available, we can obtain such a point by connecting in circuit a special neutralising winding, and a circuit of this type is shown in Fig. 3.

Here the primary winding of the transformer is provided with an extension which is similar to the primary winding proper, so that the potential at the end of this winding is equal and opposite to that on the anode of the valve preceding. This point is then connected through a small neutralising condenser back to the grid, and in this way the necessary counter-reaction is obtained.

Constant Adjustment

The point about both these circuits is that the counter-reaction or neutralising circuit is as nearly as possible identical with the internal circuit through the valve itself, so that once the balance point is correctly found it remains adjusted over a wide range of wavelengths. In fact, with a correctly proportioned circuit, even if the coils are changed for other ones covering a different wavelength range, or if various modifications are made to the circuit, apart from the actual neutralising portion, the circuit still remains perfectly stable. This, of course, is an ideal arrangement, and it is towards such an ideal that research work has been concentrated in the past and is still being pursued.

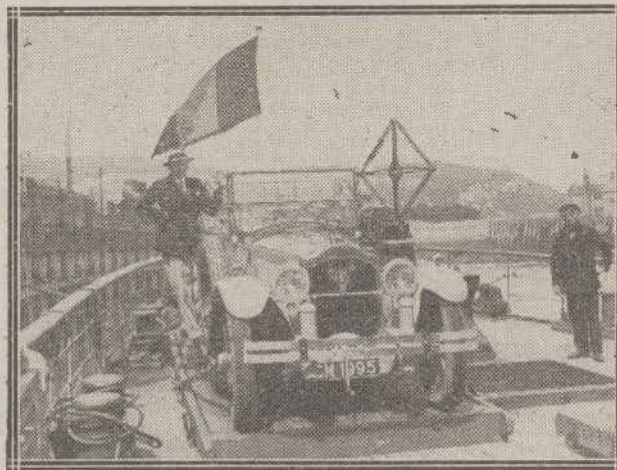

Capt. L. F. Plugge, the well-known contributor to “Wireless,” is making a radio test tour to Constantinople. Our picture shows Capt. Plugge leaving Dover with his specially equipped wireless motor-car.

path through the neutralising condenser which goes to the opposite end of the circuit from that connected to the grid. Obviously any energy which is received by this path will then affect the circuit in the opposite direction from that which passes through the valve itself, so that cancelling out is obtained and a stable circuit results.

In addition to the usual special constructional and general articles, our next issue will contain further helpful notes on each of the three instruments described this week. These will include detailed operating instructions, hints on getting the best from the set, and instructions for using the “Neutrodapter” with various types of sets.

Next Week

Build Your Own LOUDSPEAKER
 WITH A LISSENOVA OR BROWN A
 and our COMPONENTS. You can construct yourself a
 handsome CONE type, or PLEATED PAPER type
 LOUDSPEAKER in half an hour for less than it would
 cost you for the ordinary cheap horn type Loudspeaker.
 You will obtain VOLUME, CLARITY, and unsurpassed
 tonal quality. Prices, particulars and Diagrams
 for stamp. TRADE inquiries invited. Tell your dealer
Goodman's, 27, Farringdon St., E.C.4
Also obtainable from Spencer's Stores, 4-5, Mason's Ave., E.C.2

EARTH FAULTS ENDED
 Entirely new method of Earth-system efficiency. 20 per cent.
 to 200 per cent. increase guaranteed. Vastly superior to all
 metal sulphates. Ideal for all outdoor Earths. 2/6 complete,
 post 6d. Cash on delivery if desired. Particulars free.
J. W. MILLER, 68, Farringdon St., E.C.4.
 Phone: Central 1950. *Approved by Radio Association.*

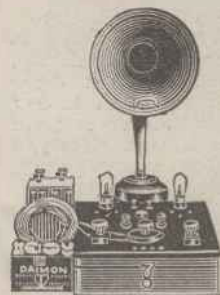

Sterling Receivers
 Sensational Offer!
 Having purchased a large
 number of Sterling 2-Valve
 Loud-Speaker Sets, we are
 offering them to the Public
 on unprecedented terms.
 A genuine Sterling 2-Valve
 Loud-Speaker Set complete,
 ready for immediate use
 with D.E. '06 Valves, H.T.
 & L.T. Accumulator Aerial
 Equipment, and one of our
 World-Famed De Luxe
 Excellence Loud Speakers.
 Price £15 15 0. Royalties
 paid. Terms—15/- deposit
 and 15 monthly payments
 of 20/-. Send for one of
 these Superb Sets at once
 as the number for sale is
 limited and, when sold,
 cannot be repeated under
 double the price.
Free Catalogue on Application.

The Wireless Distributing Co., Ltd. (Dept. W),
 WIRELESS HOUSE, STOKE NEWINGTON, N.16

COUPON.
QUESTIONS AND ANSWERS.
 This coupon must be accompanied by a
 P.O. for 2/6 for each question, and a stamped
 addressed envelope when sending queries to
 the Radio Press Information Dept. for a
 postal reply.
 "WIRELESS." Vol. V. No. 1.

Amateur Transmitting Notes
 ADDRESSES FOUND AND WANTED

QRA's Found

- G-5GZ: J. Geary, Landore, Swan-sea.
- G-6NZ: L. E. Newnham, 14, Silchester Road, Copnor, Portsmouth.
- DM: Militaire Française, Fort-d'Issy, Paris.
- PE-6YX: Flight-Sgt. Macey, Command HQ, Bir Salem, Palestine.
- D-7NR: J. Nissen Rahn, 15, Bispegade, Haderslev, Denmark.
- P-3GB: G. de Bianchi, Quinta da Paz, Funchal, Madeira.
- A-7LJ: L. R. Jensen, State School, Trowutta, Tasmania.
- A-5KN: S/W Station, Point Cook Air Force School, Victoria, Australia.
- TJ-CRJ: L. A. C. Rockall, R.A.F., W/T, Amman, Trans-Jordania.
- G-AKD: E. J. H. Moppett, Rhine Army Signals, B.A.O.R., Wiesbaden, Germany.
- G-5UH: C. Robinson, 357a, Bury New Road, near Broughton, Manchester.
- G-6ZD: Longstone Pharmacy, Seahouses, Northumberland.
- G-2OG: W. L. Williamson, Rawdon House, Grimsby Road, Cleethorpes.

- OCTN: Radio Mourillon, Toulon, France.
- G-6OT: H. A. Clark, 71, Station Road, Bedford.
- RA19: Tomsk University, Siberia.
- G-6OU: E. Willis, 9, Winchester Street, Bedford.
- PI-CD8: Bertram F. Bördero, Rival, Philippine Islands.
- G-5SS: Stretford and District Radio Society, The Cottage, Derby Farm, Derbyshire Lane, Stretford, Manchester.
- G-6JH: J. Hartley, Jr., 21, Plymouth Grove, Manchester.
- G-5CV: Ronald Harrison, c/o Morning Post, London.

WIRELESS, &c., in full swing, well established, freehold, good living and accommodation, £900 and s.a.v., selling urgent. Box A.44 this paper.

2-VALVE AMPLIFIER, 35/-
 1-Valve Amplifier, 20/-, as new: Valves, D.E. '06, 7/- each; smart Headphones, 8/6 pair; new 4-Volt Accumulator, celluloid case, 13/-; raw 60-Volt H.T. Battery, guaranteed, 7/-; 2-Valve All-Station Set, 24. Approval willingly.
R. Taylor, 57, Studley Rd., Stockwell, London.

Base Board Fitting Rheostat
Velvet Contact
 is the unequalled and outstanding quality of the new Etherplus† V.C. Rheostat. Neat and attractive pointer knob fits flush to engraved dial, over one hole fixing nut.

ETHERPLUS† BRITISH MADE

Panel Mounting	{ 6 ohms 15 .. 30 ..	Price 2/3 each.
Base Board Mounting	{ 6 ohms 15 .. 30 ..	Price 3/9 each.

From your dealer or direct from
M. & A. WOLFF,
 9-15, Whitecross Street, LONDON, E.C.1

ETHERPLUS†
 RADIO ACCESSORIES
 — ENSURE PERFECT RECEPTION

SUBSCRIPTION RATES

FOR RADIO PRESS JOURNALS.

MODERN WIRELESS

- 15/- per annum United Kingdom.
- 13/6 per annum Canada and Newfoundland.
- 15/- per annum Other Countries.
- Lesser periods than 12 months pro rata.*

THE WIRELESS CONSTRUCTOR

- 8/6 per annum United Kingdom.
- 7/6 per annum Canada and Newfoundland.
- 8/6 per annum Other Countries.
- Lesser periods than 12 months pro rata.*

WIRELESS

(Incorporating Wireless Weekly)

- 13/- per annum United Kingdom.
- 13/- per annum Canada and Newfoundland.
- 13/- per annum Other Countries.
- Lesser periods than 12 months pro rata.*

THE WIRELESS DEALER

(Available to the Trade only)
 7/6 per annum (10/- abroad).

N.B.—Business letter heading or trade card must be sent with subscription.

RADIO PRESS LIMITED,
 Bush House, Strand, London, W.C.2



BOOK SPACE EARLY!

Make your arrangements now for the Autumn Sales Campaign. All communications regarding advertising to be addressed to the Advertisement Manager:

WIRELESS, Bush House,
 Strand, London, W.C.2.



Research Work for the Industry

PROGRESSIVE improvement in design and the recommendation of standard dimensions for radio apparatus form an important part of the research work carried on by the Laboratories of THE WIRELESS DEALER.

Established to assist the Industry by the useful co-operation in the production of more efficient designs and new components, the Laboratories at Elstree have produced the Screened Coil. This type of coil is rapidly becoming popular, and its advantages are immediately appreciated by reason of the increased selectivity and stability that are obtained by its use.

Mr. J. H. REYNER, B.Sc. (Hons.), A.C.G.I., D.I.C., A.M.I.E.E., publishes in a detailed article, appearing in the July issue, the complete standard specification.

Advance manufacturing information of this kind becomes available to you every month by subscribing to THE WIRELESS DEALER. Make a point of keeping abreast of modern design by sending in your subscription to-day.

SUBSCRIPTION RATES:

7/6 per annum (abroad 10/-). Available to the Trade only. Trade card or business heading should accompany every subscription to the SALES MANAGER, Radio Press, Ltd., Bush House, Strand, London, W.C.2.

Selection from the Contents of the August Issue:

"Professor L. A. Hazeltine Visits Elstree"
 "The Wireless Dealer's Trade Luncheon"
 "Who Spends the Money?"

The Wireless Dealer
 AND MANUFACTURER

A Filament

that is tough enough
to support four valves
without breaking



Every feature of the wonderful P.M. Filament has a superiority all its own.

In this case you can judge the high mechanical strength of the P.M. Filament, particularly when you realise that an ordinary filament will barely support a single valve compared to the four possible with the P.M. filament.

This great difference in the strength is due to the special core of rare metal in the P.M. Filament, which is so tough that it can be tied in knots after 1,000 hours' life, and cannot be broken except by the very roughest handling. The P.M. Filament is set around 5 strong resilient hooks in such a way that it is free from tension or sag and cannot become displaced during the long life of the valve.

The multi-coating on the P.M. Filament core is prepared from an alloy of precious metals that secures a copious and powerful stream of electrons at a temperature so low that no sign of glow can be discerned.

The low current consumption of the P.M. Filament, only one-tenth ampere, will make your accumulator charges last seven times as long, reducing your recharging costs and journeys to one-seventh. The emission of the P.M. Filament is completely within the field of the grid and anode, despite the fact that this emission is up to 5½ times greater than that of an ordinary filament.

Finally, this vastly increased emission gives a wide range of power free from microphonic disturbances, and the P.M. Filament is so conservatively rated that it will stand a reasonable overload without fear of damage.

You will never really be satisfied until you have secured the valves with the P.M. Filament. There are many attempts to imitate its individual features, but all the advantages of the P.M. Filament can only be found in P.M. Valves:

ASK YOUR DEALER FOR P.M. VALVES. HE SELLS THEM BECAUSE THEY SATISFY.

For 4-volt accumulator or
3 dry cells
THE P.M.3 (General Purpose)
0.1 amp. 16/6
THE P.M.4 (Power) 0.1 amp. 22/6
For 6-volt accumulator or
4 dry cells
THE P.M.5 (General Purpose)
0.1 amp. 22/6
THE P.M.6 (Power) 0.1 amp. 22/6
For 2-volt accumulator
THE P.M.1 H.F. 0.1 amp. 15/6
THE P.M.1 L.F. 0.1 amp. 15/6
THE P.M.2 (Power) 0.15 amp. 18/6
These prices do not apply in Irish Free State

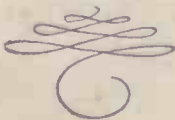

Mullard

THE MASTER VALVE

ADVT. THE MULLARD WIRELESS SERVICE CO., LTD., MULLARD HOUSE, DENMARK STREET, LONDON, W.C.2

Published by RADIO PRESS, LTD., Bush House, Strand, London, W.C.2, on Tuesday of each week, and printed for them by THE AVEGUE PRESS (L. Upcott Gill & Son, Ltd.), 55-57, Drury Lane, W.C.2. Address for Subscriptions and Editorial Communications:—Bush House, Strand, London, W.C.2. Address for Advertisements:—Advertisement Manager, WIRELESS, Bush House, Strand, London, W.C.2. Registered as a newspaper and for transmission by Canadian Magazine Post. Subscription rates:—13s. per annum, 6s. 6d. for six months, post free. Sole Agents for Australasia:—GORDON & GOTCH (Australasia), LTD. For Canada:—IMPERIAL NEWS, LTD. For South Africa:—CENTRAL NEWS AGENCY, LTD.