

Wireless Weekly

Vol 5. No. 24.

A.C. IN TRANSMISSION

By PERCY W. HARRIS.
M.I.R.E.



Burndept Components for convenient and reliable filament control

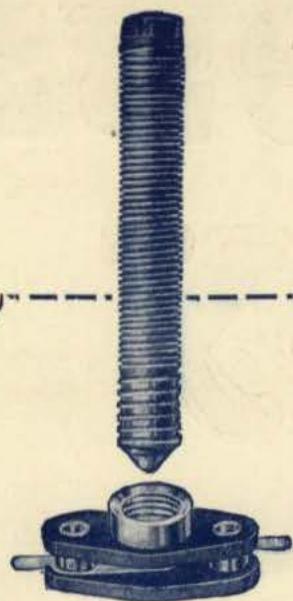

Fixed Resistors.

No.	Ohms.	Amps.	s. d.
721	.5	2	1 6
735	.75	2	1 6
722	1.5	2	1 6
723	2	1	1 6
724	3	1	1 6
725	5	.5	1 9
726	7.5	.5	1 9
727	10	.5	1 9
728	13	.5	1 9
729	20	.25	2 0
730	26	.25	2 0
736	40	.25	2 0
731	48	.25	2 0
732	55	.25	2 0

No. 718. Screw Holder on Ebonite Base, with instructions 1/6

No. 720. Brass Shorting Plugs, to fit Screw Holders, three in carton ... 1/6



The Dual Rheostat.

No. 222. Dual Rheostat, 5-30 ohms, for mounting on any panel, from $\frac{1}{8}$ " to $\frac{3}{8}$ " in thickness, with drilling template 7/6

THE Burndept Components for filament control deserve the attention of every constructor who wishes to equip the instruments he builds in the best possible way.

It is most convenient to have your set fitted with Burndept Fixed Resistors, which each consist of a definite amount of resistance wire wound on a fibre rod and are made in thirteen values from 0.3 to 55 ohms. They may be used in series with, or in place of a rheostat. When it is desired to use a new or different type of valve, one has only to insert the correct Resistor in the Screw Holder, no other alteration being necessary. Further particulars of Burndept Fixed Resistors will be sent on request.

A very useful component is the Burndept Dual Rheostat, which can be used to control either a bright- or a dull-emitter valve. The first half of the element is wound to a resistance of 25 ohms, and the second half, to a resistance of 5 ohms. The whole 30 ohms resistance is used to control a dull-emitter valve, and the 5 ohms resistance a bright valve. Contact is perfect and the movement of the brush practically noiseless owing to the special construction of the former on which the wire is wound.

*Purchase Burndept by its name—
substitutes are not the same.*

BURNDEPT

WIRELESS APPARATUS

BURNDEPT LTD., Aldine House, Bedford Street, Strand, London, W.C.2
Telephone: Gerrard 9072 Telegrams: "Burndept, Westrand, London."

LEEDS: 12, Basinghall Street (near City Square). BIRMINGHAM: Winchester House, Victoria Square.
NORTHAMPTON: 10, The Drapery. CARDIFF: 67, Queen Street.

Assistant Editor :
PERCY W. HARRIS,
 M.I.R.E.

Scientific Adviser :
Prof. G. W. O. HOWE,
 D.Sc., M.I.E.E.

Advisory Editors :
Prof. R. WHIDDINGTON,
 M.A., D.Sc.
Prof. C. L. FORTESCUE,
 M.A., M.I.E.E.

Wireless Weekly

Staff Editors :
E. H. CHAPMAN,
 M.A., D.Sc.
A. D. COWPER,
 M.Sc.
R. W. HALLOWS,
 M.A.
G. P. KENDALL,
 B.Sc.
STANLEY G. RATTEE,
 M.I.R.E.

Phone: City, 9911.



EDITED BY JOHN SCOTT-TAGGART,
 F.Inst.P., A.M.I.E.E.

Should Parliament be Broadcast?

ONCE more the question has been raised, this time in the House of Commons itself, by Capt. Ian Fraser, as to whether permission can be given for broadcasting the proceedings of our legislature. In particular, Capt. Fraser asked whether the House could be given the opportunity of deciding the desirability of giving permission to the British Broadcasting Company for the broadcasting of the forthcoming speech of the Chancellor of the Exchequer on the introduction of the Budget, and if they would consider the question of permitting certain proceedings of the House to be broadcast. The Prime Minister, in replying, answered the first part of the question in the negative, but considered the time had come when the whole question should be discussed, and for that purpose stated he was thinking of setting up a select committee of both Houses.

Whether or not such a committee can be truly representative of public opinion is open to doubt, but, in any case, it is well to consider some of the points arising when we discuss the broadcasting of speeches and debates. Comparatively few people have ever set foot inside the Houses of Parliament, and the parliamentary reports and news presented to us by the newspapers are very cleverly prepared so as to give us the gist of the news in a compact form. For this reason some people have gathered the impression that it should be possible for the B.B.C. to switch on to Westminster and give us, say,

half-an-hour or an hour of brilliant debate full of interest, and touching on a wide variety of important subjects. It is very easy to discover how erroneous such an impression can be by examining the volumes of Hansard, which give the verbatim reports of all parliamentary proceedings. These will show that many hours each week are filled up with speeches of no great importance, and that the

special broadcasting items some time beforehand, and it would take a more clever organiser than any we have yet met to predict a week or so in advance the particular subject to be discussed by our legislators. Then, again, there is the question of the time when important speeches are generally broadcast. Members of Parliament generally find that their constituents are most interested in question time, for during this period a number of interesting subjects are touched upon, and the replies are generally given by well-known ministers. Question time is from 2.45 to 3.45 p.m., which immediately indicates the impracticability of broadcasting this particular section of parliamentary procedure. Again, the most important speeches are generally delivered between 4 and 7 p.m., or after 10 p.m.; neither of these periods would be particularly suitable for broadcasting.

Finally, to deal with the first half of Capt. Fraser's question. Budget speeches are usually long and take anything from 1½ to 2 hours. Frequently the speech is completed about the time the city man leaves his office, and often before he gets into his train he is able to buy a paper with a full report.

It is highly probable that if at any time the proceedings of the House are broadcast, there will be great competition to make a speech during the broadcasting period. It would be only human nature for members to endeavour to impress their constituents at such a time.

CONTENTS

	Page
Making a Start in Transmission	876
Jottings By the Way	879
Random Technicalities	881
A Filter Circuit for Loud Speakers	883
A Useful Connecting Board	885
Improving Cheap and Old Variable Condensers	887
A Three-Valve Receiver with Series-Tuned-Anode	890
Reception Conditions Week by Week	895
A Handy Switch Unit	897
Correspondence	899
Apparatus We Have Tested	904
Information Department	907

breezy and interesting quarter-column reports that you may have read in the morning's paper may be a clever condensation of a speech lasting half-an-hour or even an hour.

Another point is that a large part of the proceedings of both Houses is of very little interest to the general public. In order that suitable announcements can be made it is necessary to arrange

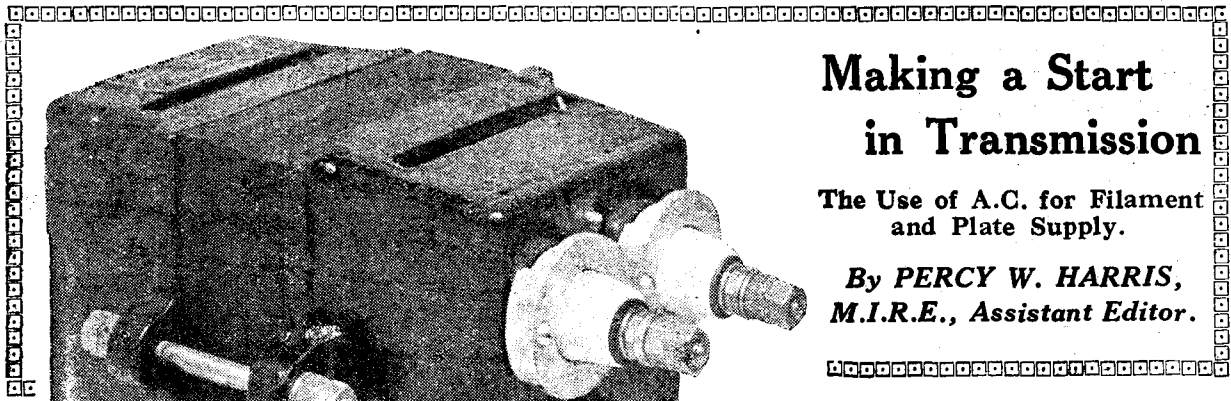

A filament lighting transformer with centre tapplings. Note the careful insulation.

Making a Start in Transmission

The Use of A.C. for Filament and Plate Supply.

By PERCY W. HARRIS, M.I.R.E., Assistant Editor.

A.C. Problems

Many readers have an alternating current supply in the house and are anxious to build a transmitter which will utilise this current for both filament lighting and plate supply. I have often heard it said that the man who has A.C. in the house is exceedingly lucky in so far as wireless transmission is concerned. A brief examination of the position will show that it is by no means

A FEW readers have recently written to me complaining that these articles on transmission are not appearing every week. In justice to myself I ought to explain that as the articles are based on practical experiments and are not merely a rehash of articles published elsewhere, they cannot be produced very rapidly. Furthermore, certain apparatus I had on order, or being constructed for me, and used in the tests, has only recently been delivered.

supply, with a L.S.5 dull-emitter power valve and an input of approximately 10 watts, I have already communicated with Belgium, Italy, Holland, Denmark, Sweden and Finland, the communications being in every case replies to calls from those countries. The distance from my station to Finland is well over a thousand miles, and signals were reported R6 by two stations there.

An Interesting Test

Readers of *Wireless Weekly* will remember that there appeared in the daily Press some weeks ago an account of communication by a British amateur with Mosul, Mesopotamia, when an important message was transmitted from that place to London via the British station. Hearing a CQ call from Mosul on the evening of March 19, I started up the generator and replied, thinking that possibly my signals might get through. Capt. Durrant of GHH immediately answered, and we inter-changed signals quite easily. I do not know the exact distance from Wimbledon to Mosul, but if you examine the map you will see that it is practically all overland and approximately 2,300 miles away.

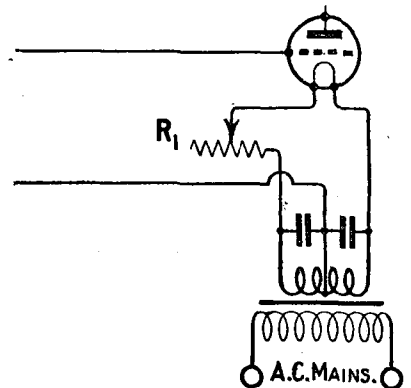

Fig. 2.—Incorrect balancing due to position of filament resistance.

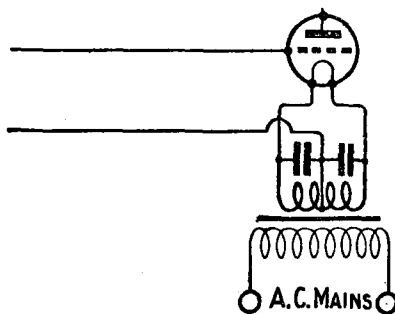

Fig. 1.—The filament transformer connections.

Before discussing the use of alternating current as a filament and plate supply of a wireless transmitter, I perhaps should mention that the transmitting set already described, without any modifications, using the M.L. anode converter as H.T.

a simple matter to construct a really efficient C.W. transmitter with A.C. supply. Furthermore, the expense is quite considerable. It may sound expensive to buy a twenty-pound motor generator to run from an accumulator so as to provide pure D.C. for your transmitter, but by the time you have purchased the necessary equipment to give a proper supply with A.C. you will not have spent less.

Filament Supply

The simplest problem is that of lighting the filaments by A.C. For this a step-down transformer is needed, the input side being, of course, wound to the voltage

In previous articles the construction of a transmitter using D.C. supply has been described. In this article the problem of using alternating current throughout is tackled

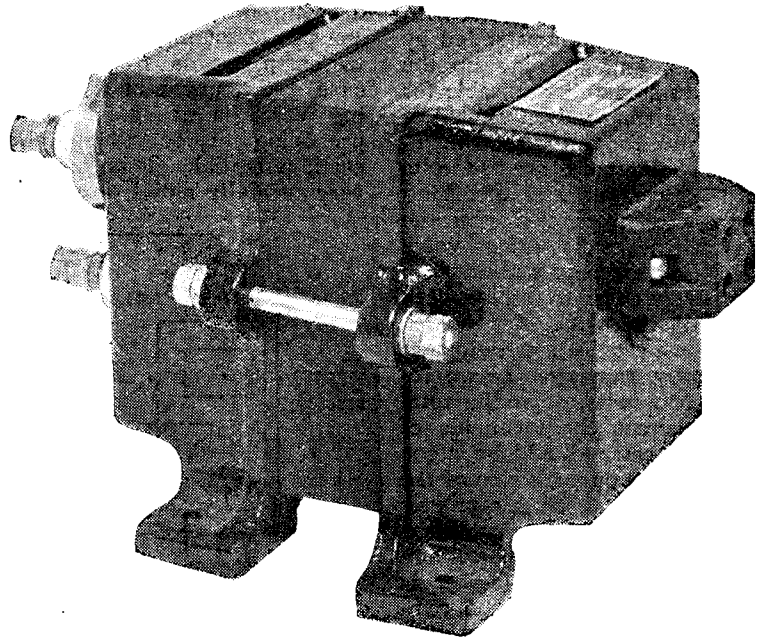

Rear view of the filament transformer. The H.T. transformer is similarly made.

and periodicity of the supply and the output giving the voltage to suit the filament of the valves. If you examine Fig. 1 you will see that the transformer there used has a centre tapping on the winding connected to the filament. The reason for this is that each end of the filament, when the A.C. supply is used, will become alternately positive and negative. If the

frequency of the supply. This would give a very annoying ripple. By making a centre tapping on the filament winding this trouble is eliminated. The condensers shown shunted across the filament can be of a value of .002 μ F, and serve to keep any radio-frequency current from passing through the windings of the transformer.

leg and both will be simultaneously varied. In this way it should be possible to preserve the balance. Suitable bobbins for this purpose are made by The Radio Communication Co., Ltd., for their Polar bobbin rheostats. They should be very easily adaptable by the transmitter.

Insulation

While the transformer used for lighting the transmitting valve filament needs no special insulation other than that suggested by the voltages used, the transformer used for lighting the fila-

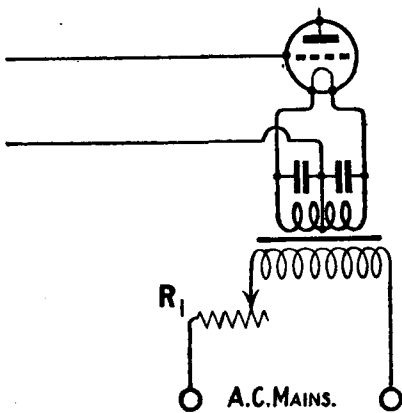

Fig. 3.—Correct placing of filament control rheostat.

Position of Filament Resistance

As this centre tapping is put there for the purpose of balancing, it is obvious that if we insert a filament resistance in one or other filament leg, the balance will be upset. For this reason it is generally considered desirable to place any variable resistance for controlling the filament voltage on the mains side, but, unfortunately, it is not easy to obtain a suitable filament resistance for this purpose. Many experimenters, however, get fairly satisfactory results by placing the filament resistance in the usual position. The current is certainly more easily controlled here. A method which I intend to apply, and which, to the best of my knowledge, has not so far been suggested, is to mount two filament resistance bobbins on a single shaft with separate contacts. There will then be a filament resistance in each filament

negative side of the high-tension supply were connected to either side of the filament permanently, the effect would be to provide a plate voltage relative to the negative end of the filament which would have superimposed on it a voltage change due to the variations of the A.C. supply to the filament. If, for example, we consider a plate voltage of 500 with the negative side of this supply connected to one end of the filament, then the voltage applied to the plate (considered in relation to the negative end of the filament) would vary between 500 and perhaps 506 (for a 6-volt filament) at the

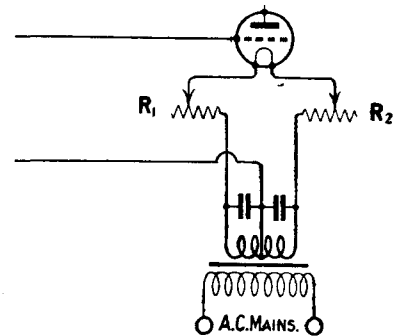

Fig. 4.—A suggestion for filament control.

ments of the rectifying valves is quite differently situated. This is a point which is often overlooked by the beginner in transmission. To understand the position clearly we must consider

Fig. 5 which shows how a rectified plate supply is obtained from an A.C. transformer fed by the mains, and stepping up the voltage to something suitable for the transmitting valves used. We will assume for the sake of argument that the mains are 240 volts and that we require something approaching 1,000 volts for the plate of the transmitting valve used. For efficient working we naturally require to utilise both halves of the A.C., for which purpose we require a transformer with centre tapping. If we require 1,000 volts, then the total voltage across the terminals of the transformer should be 2,000 or 1,000 volts on each side of the centre tapping. By examining the diagram you will see that each end of the high-voltage winding of the transformer is connected to a plate of a two-electrode rectifying valve. Such valves are manufactured commercially, and are obtainable from the Marconi Company and the Mullard Radio Valve Company.

Double Rectification

When the filaments are suitably heated current will pass one way between the plate and the filament, but not in the reverse direction. If now we take a wire from the common filament connection and another from the centre tapping of the transformer, we shall have the necessary positive and negative leads for supplying our transmitting valve. Each end of the transformer becomes alternately positive and negative, and when it is positive then current will pass between the plate of the valve and the filament, and through the common lead. When it becomes negative no current will pass, and thus we have a series of pulsations of current in one direction, there being one pulsation for each half cycle. Thus with a 50-cycle supply we shall get 100 pulsations of direct current, the connection to the filament being positive and that to the centre tapping of the transformer being negative.

An Important Point

We naturally light the filament of the rectifying valve by A.C. stepping the main voltage down to something suitable, and thus

you will see by examining the drawing that, by assuming that one side of the mains is connected to earth, as is frequently the case, the filament of the rectifying valve is at something approaching 1,000 volts above earth potential. This should be very carefully noted, for filament

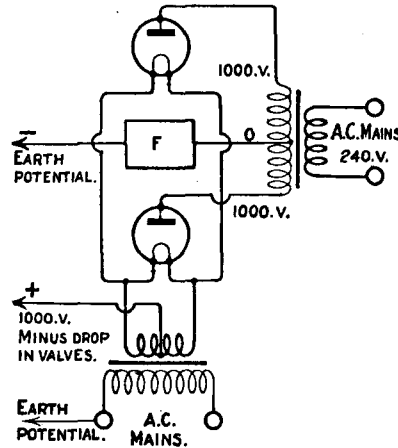

Fig. 5.—Showing necessity for good insulation on filament transformer for rectifying valves.

resistances and all the parts connected to the filament will be exceedingly dangerous to touch. Not only this, but the windings of the filament transformer used for the rectifying valve will have to be very highly insulated. The actual voltage available for the valve will be in the case just described 1,000 volts less a certain voltage lost in the valve itself. This will not be a very high

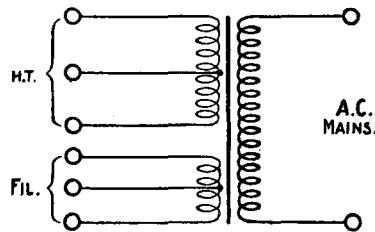

Fig. 6.—An arrangement sometimes used for economy.

percentage if suitable valves are used.

Filters

You will notice that in the leads from the centre tapping of the high-voltage transformer is a section marked F, this letter standing for "filter." If we are to obtain something approximating to our D.C. the ripple of

the supply must be smoothed out, and for this purpose we require a device known as a filter. The design of filters is a complex matter, and the perfect filter has yet to be designed, but something giving a close approximation to the ideal, so far as practical transmitting work is concerned, is not too difficult to devise. The trouble is that a filter suitable for one circuit may be totally unsuitable for another.

Telephony Filters

Thus, as will be explained when we come to deal with telephony, a filter which works excellently in a telephony circuit using choke control is totally unsuited to a circuit using grid control. For C.W. signalling the filter can be a relatively simple matter. Suitable transformers for transmission work are generally made to order. My own filament transformer illustrated at the head of this article was designed and built by the Zenith Manufacturing Company, of Willesden, for an input voltage of 220 (50 cycles) and an output voltage of 6. This company has also built for me on exactly similar lines, so far as the appearance is concerned, a high-voltage transformer giving 2,000 volts across the terminals of the secondary winding and with a central tap. A 1,000 volts supply is thus obtainable for the rectifying valve. Notice the careful insulation of the terminals on the filament transformer. The reason for this will be gathered by those who have followed the explanation just given. The cost of these transformers, by the way, was in the case of the filament transformers £2 15s., and the H.T. transformer £6 16s. Both will carry enough energy for a 100-watt transmitter if required.

The cost of equipment can be lessened by having one transformer with both plate supply and filament supply windings on the same core. Indeed, it is possible to obtain transformers which have three windings, one for the transmitting valve filament, one for the filament of the rectifying valve, and one for the plate supply. It is generally more satisfactory to have separate transformers, although they cost a little more.

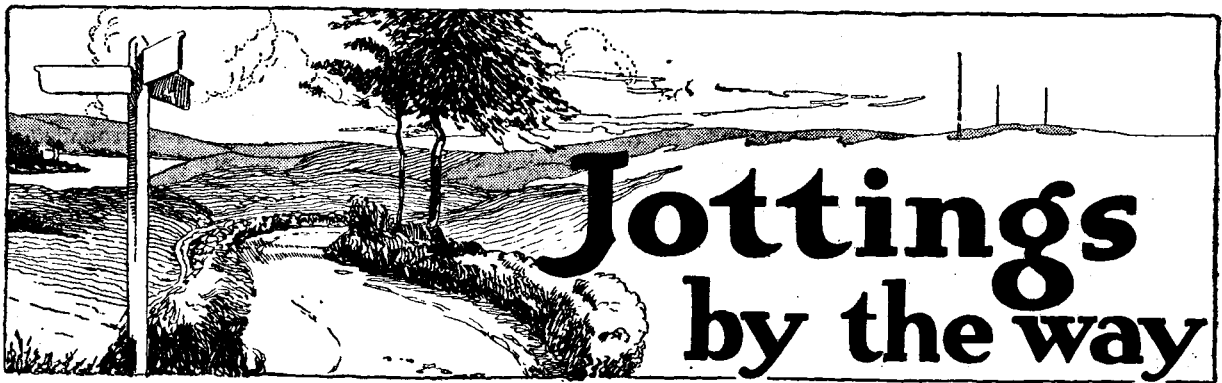

Professor Goop at Work

AS I entered Professor Goop's wireless den the other day I saw signs which told me that he was hard at it. Upon the table before him lay coils of wire, condensers, valves, terminals, batteries, and all the bits and pieces required for wireless experiments. He was bending over something when I came in, and as his back was towards me I slapped it with my usual hearty *bonhomie* in order to apprise him of my presence. I did not know that he was soldering; I had no intention whatever of driving his



... I slapped his back in my usual hearty way ...

nose into the contents of the tin of flux that was before him. All this I explained whilst the Professor was engaged in removing the unwanted adornment from his face. He took my handkerchief for the purpose, as he had not one of his own. This, I thought, was a little hard, as I had only just borrowed it from Poddleby. Still, *noblesse oblige*. A fellow like Poddleby would have been quite nasty over the flux incident.

Boys will be Boys

Not so the Professor. He merely beamed at me over his glasses, and said that boys would be boys. When you are just about to be forty this kind of thing is music in your ears. "Anyhow," I said, "the least I can do is to lend you a hand;

two heads are always better than one."

Convincing Proof

"On the contrary," smiled the Professor, "two heads are precisely the same as one. This I will demonstrate to you. The proof that 2 equals 1 is by no means original, but you, I am sure, will not have come across it, and certainly you will not be able to pick the obvious holes in it." Fearing that he had taken leave of his senses, I thought it best to humour him by begging him to proceed. Here is his proof:—

$$\begin{aligned} \text{Let } a &= b \\ \text{Then } a^2 &= b^2 \\ ab &= a^2 = b^2 \\ a^2 - b^2 &= a^2 - ab \\ (a + b)(a - b) &= a(a - b) \\ a + b &= a \\ 2a &= a \\ 2 &= 1 \end{aligned}$$

I have since proved this proposition to my bank manager. I suggested that as doubling obviously made no difference at all he should forthwith multiply by two the amount standing against my name in his books. He consented with alacrity, and handed me a little slip on which was pencilled "O/D £2 14s. 3d." Some people *are* so mercenary.

The New Idea

But to return to the Professor. I learnt that he had just been inspired with an idea for a wave-trap, but could not quite see how to work it out. Some of the greatest things arise from small causes. The Goop-Wayfarer Wave-trap, of which it need only be said that it has all others beaten by ten lengths and then some, came into being purely and simply owing to my chancing to smite the Professor on the back. My offer of help was accepted.

Epoch-making Discoveries

We collaborated. By this time you know the epoch-making nature of the inventions that are to be anticipated when our great brains are waving as one. I need hardly remind you of what the Goop-Wayfarer 761, the Milligoommeter, and the Rever-sodyne, to mention but a few of our efforts, have accomplished for the furtherance of wireless as a popular hobby. We have taken this noble science forward by leaps and bounds, leaving in our train an ever-growing queue of wireless widows.

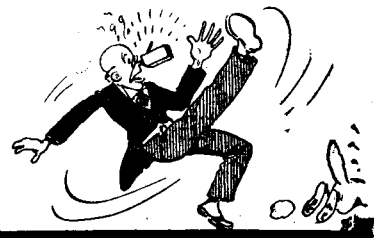

... He sustained a badly bruised nose ...

The Professor's Scheme

"This question of trapping waves," said the Professor, "has never been tackled properly. Let us think for a moment about trapping in general. What has mankind been endeavouring to trap with greater or less success ever since he left the tree-tops, took to wife-beating, and became civilised?" "Mice," I answered, after a moment's hard thought.

The Common Mouse-trap

"Exactly," beamed my colleague. "The common mouse-trap is a perfect example of man's ingenuity. Though it is unimposing in appearance and without mechanical complications, it delivers the goods each morning. Now what we require is

a wavetrapp upon the same general principles." We then fell to discussing the question in order to see whether we could not devise a means of giving the idea a practical form. The problem of the best bait to use was a difficult one, and it was only by dint of strenuous brain work and of unceasing experiments that we arrived at the solution.

The Theory

What does a wave-trap do? It mops up interfering signals. What is an interfering signal? One that you don't want; often it takes the form of a cornet solo from Manchester superimposed upon a snappy talk on Chest Protectors from Bournemouth or something like that. To devise an efficient means of trapping, it is first of all necessary to have an insight into the little ways of signals. The waves that you do want endeavour by every means in their power to avoid doing their lawful work. They do all that they can to escape without making the close acquaintance of your valves or your crystal. Interfering waves, on the other hand, behave in precisely the opposite way. To them the supremest of all delights is to dance upon the grids of valves or to go pushing and bustling through crystals, making all the noise that they can on their way. The only satisfactory method of dealing faithfully with oscillations of both types is to make use of low cunning.

The Bait

As interfering signals desire above all things to get busy with their victim's receiving gear, the obvious way of getting even with them is to allow them to encounter a crystal on their journey from the aerial. Thinking that they have arrived at the real scene of operations, they immediately begin to do their worst. The wanted oscillations, on the contrary, see the crystal, and give it the widest possible berth. They rush forward, believing fondly that they have escaped once more, only to find when it is too late to turn back that the path that they are following leads them straight into the receiver. A device designed upon these lines would, as you will readily

perceive, put it across both classes of signals with no mean success. It was these considerations that led us to adopt the crystal as our bait. We tried hundreds of different kinds, including Gottafrite, Glaxo, Merri-anbrite, Kruschen and Bonzolite. But we have found that there is nothing to touch as a wave-trap bait a carefully selected fragment of synthetic Nitinite.

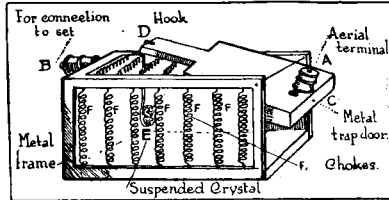

The Goop-Wayfarer Wave-trap

Practical Details

The finished trap, details of which are shown in the accompanying diagram, is easily constructed in the home workshop. The body of the trap consists of the metal frame, in which are mounted the trapdoor C and the chokes marked F. The aerial lead-in is attached to the terminal marked A, whilst to that seen at B is attached a wire running to the aerial terminal of the set. No other connections are necessary. The trap is set by mounting the suspended crystal E, and subsequently fixing the trapdoor in the open position with the aid of the hook D. The set is then tuned in the ordinary way, the trap needing no attention since it is entirely self-acting.



... Immersing the trap in a bucket of water ...

How it Works

Wanted oscillations observing the crystal pass through the metal frame of the trap and out at the terminal B. But interfering oscillations entering at A immediately scent the bait. They pass across the surface of the trapdoor, whence they travel *via*

the hook D to the crystal. Here they congregate, building up an ever-increasing mass of electrons until finally the trap door is sprung by their weight. Owing to their being now surrounded by chokes they are unable to escape. They therefore remain until the following morning, when they are drowned by immersing the trap in a bucket of water.

Results

The exhaustive tests which we have made show that the Goop-Wayfarer Wave-trap never fails to do what is claimed for it, provided that it is intelligently used. Unlike other traps it will stifle the mush of Northolt, and even atmospherics. A little practice is required in setting the trap, but this is merely a matter of time and patience. In the whole course of our experiments the Professor lost only two fingers, though I must admit that he also sustained a rather badly bruised nose on the occasion when he endeavoured to satisfy himself that the specimen of crystal in use as a bait was perfectly fresh.

Serving a Double Purpose

It should be noted that the Goop-Wayfarer Wave-trap may be employed to serve a double purpose. If the crystal is treated with cheese it becomes Tritigorgonzolite (HF2 L3 B4), which is just as attractive to mice as it is to unwanted signals. The wave-trap therefore, in addition to its usefulness as a signal-purifier, will rid the wireless table once and for all of those little pests which work such havoc with the insulation of our leads and are so apt to choose our spare inductances as resting-places.

WIRELESS WAYFARER.

APRIL

"Modern Wireless."

In this issue will be found full constructional details of how to make five different sets:-

- An Experimental Supersonic Receiver.
- The "General Purpose" Three-valve Receiver.
- A "Drawing-room" Two-valve Receiver.
- A Selective Single-valve Receiver.
- A Crystal Receiver.

In addition to these, full constructional details are given for the building of a "Split Secondary Tuner." Other articles of extreme interest are the Zurich Broadcasting Station, the Use of the Potentiometer, Eclipse and Radio Reception, etc. etc.

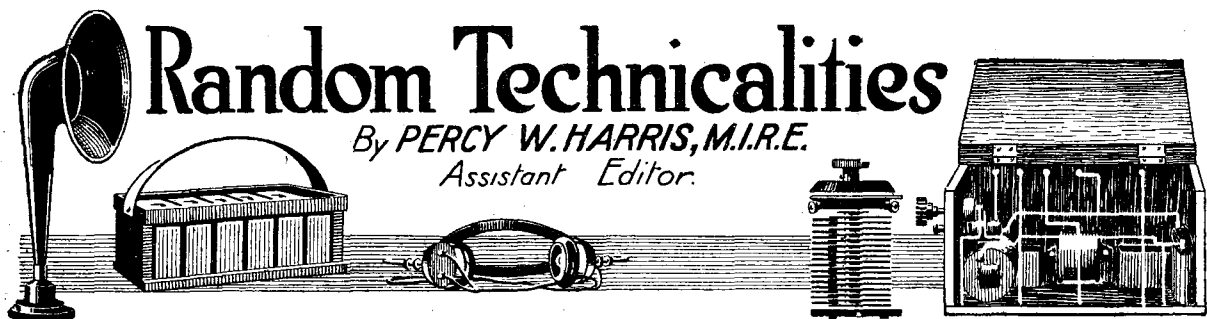

Random Technicalities

By *PERCY W. HARRIS, M.I.R.E.*
Assistant Editor.

AS you will have seen from the correspondence columns, two or three readers have written concerning the notes I gave recently regarding the effect of one set upon another and the strange increase of aerial current in my transmitter when the receiver in the house was suitably adjusted.

* * *

Once having discovered the effect of adjusting the receivers in the house when transmitting, I am now able to set them so as to give the maximum aerial current in the transmitter, with a result that I am obtaining an efficiency of transmission which exceeds my greatest expectations. Indeed, I am wondering whether gas pipes, electric light wires, and ether metal work in the house are not a very vital factor in reception, and it is possible they may explain why such totally different results are obtainable in different houses, whereas the aerials are very much the same in each case.

When both an indoor and an outdoor aerial are available it will sometimes be found that the indoor aerial can be used as an earth connection acting as a counterpoise. Readers who have both kinds of aerial are recommended to try this arrangement. The other evening when I was conducting some tests with FNWF in Stockholm, he told me that he was using an outdoor aerial with an indoor counterpoise! He was using an input power of 20 watts with a Mullard 0/20 valve fed from the 440 volts D.C. mains. His signal strength was good, although there was a certain amount of swinging. Personally, in spite of what has been written in so many quarters, I find a direct earth, efficiently designed, quite satisfactory. As soon as I can, I want to try some comparative tests with a counterpoise.

* * *

I have previously alluded in these columns to the lack of vision shown by many wireless

manufacturers. This is particularly the case of valve-holders. Anyone who has used the .06 amp. type of dull-emitter valve knows that whatever its advantages may be, it is most irritatingly microphonic—that is to say, a slight jar or vibration makes the valves ring in the most unpleasant fashion. The obvious thing to do is to mount these valves on some kind of shock-absorbing mounting. There are dozens of kinds of valves, hundreds of different makes of low-frequency inter-valve transformers, and—how many anti-vibration valve sockets? There ought to be dozens. The one or two that exist are much too dear for the ordinary man, yet the makers cannot possibly catch up with the demand for a long time to come.

* * *

There is also a great deal of room for experiment in the production of high-frequency inter-valve transformers. Two or three years ago a well-known experimenter in the north devised the disc type of plug-in transformers and was to the best of my knowledge the first to realise the value of using the ordinary valve sockets for the purpose. These transformers were demonstrated at a meeting of the Radio Society of Great Britain by Mr. Campbell Swinton, and were copied very extensively. Such transformers are now obtainable from a large number of firms, most of whom have copied one another. Later a firm introduced the barrel type of plug-in transformer, in which primary and secondary windings were alternative and staggered in relation to one another, so that the coupling in between the primary and secondary winding was looser than that obtainable with the original plug-in type, where one winding was directly super-imposed on another.



A section of the Exhibition recently held by the Schools Radio Society.

I think I may claim to be the first to popularise this type of transformer, and I have watched with interest how one firm after another has made a slavish copy of the original design.

* * *

Now there are dozens of possible ways of winding high-frequency transformers, and I am quite sure that any experimenter who has settled down to seriously consider the problem will produce something far better than either the disc or the barrel type. Sets using high-frequency amplification are becoming increasingly popular. Here is a wide field crying for investigation. A few hours before writing this article I received a further batch of plug-in transformers, from still another firm which has done nothing more than copy previous designs—gauge of wire, depth of slot, degree of staggering, every electrical feature has been reproduced with the fidelity of a Chinese artist.

* * *

Good as they are, these plug-in transformers seem to violate every low-loss principle we can think of. Double their efficiency, and you will effect a huge improvement in long-distance reception.

A Multi-Circuit Connector

THE problem which has presented itself to experimenters for some time past is an efficient multi-connector for use when wiring up experimental

diameter brass bar, and cut off several pieces $\frac{1}{8}$ in. long. Shoulder a $\frac{1}{4}$ in. of the piece down to a 4 B.A. clear diameter and then thread. Make a 4 B.A. tapping the other end to a depth of $\frac{1}{4}$ in., and finally cut a slot as shown to clear No. 18 or 22 gauge wire according to which it is desired to use for making connections.

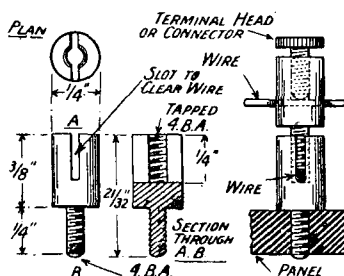

Constructional details of the connector.

Application

To put the multi-connectors in use, each component is equipped or mounted upon the panel with them. It will be seen that on inserting a wire in the slot of one connector it is firmly secured by the overhead connector or terminal. Where multi-connections are made from one point, the connectors are built up one upon the other, so that there is a different wiring plane in each case, thereby making crossings a simple matter. A further point in favour is that the wire holds each connector in a fixed position, no lock-nut therefore being required. The general appearance is also neat and business-like.

H. B.

circuits. The gadget must be quick to manipulate as well as practical.

The idea described in this article overcomes the usual difficulties which accompany several of such devices obtainable. Those who use receivers such as the "Omni" should find the idea extremely useful.

Details are shown in Fig. 1. First procure some $\frac{1}{4}$ -in. or $\frac{3}{8}$ -in.

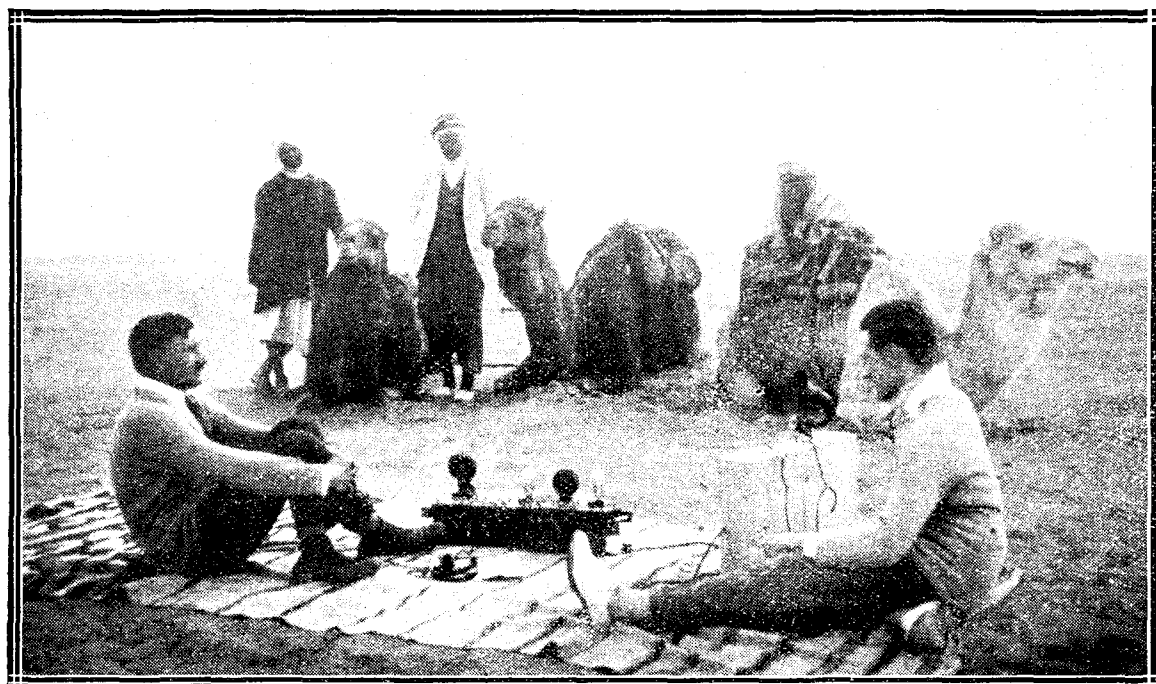

Our photograph shows a two-valve receiver made from Radio-Brix doing good work in the Sahara desert.

A Filter Circuit for Loud-Speakers

By A. JOHNSON-RANDALL.

An easily constructed unit particularly useful in cases in which loud-speakers have to deal with large inputs.

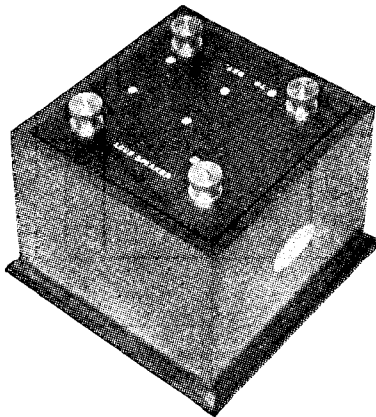

The filter circuit unit is of small dimensions.

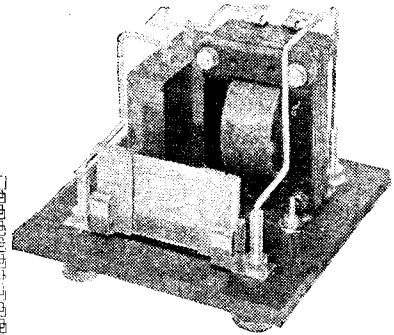

The components mounted beneath the panel.

windings of the instrument. There are two methods by which this may be accomplished, and they are as shown in Figs. 1 and 2. In the first case a resistance is connected in series in the plate circuit, and in the second case the resistance is replaced by a choke. The great disadvantage of the resistance method is that the H.T. value must be sufficient to maintain an effective

ohms, and for all practical purposes may be ignored. Referring to Fig. 2, the current variations in the anode circuit of the valve V_1 set up varying voltages across the choke which maintain the variations in current necessary to operate the loud-speaker which is shunted across the choke. No steady current will, however, pass through the windings owing to the $1 \mu F$ condenser, hence when no signals are being received no current is flowing in the shunt circuit at all.

FOR some reason or other the amateur has never properly appreciated the value of filter circuits. Time after time we see the delicate windings of a high-resistance loud-speaker placed directly in series in the plate circuit of the last valve with the steady anode current to that valve consequently flowing through them the whole time the set is in use. Now this steady anode current in cases where a power valve of low impedance is used in the last stage may be very considerable, and as the loud-speaker is operated not by the steady current but by the variations in current, all that is required is some method by which

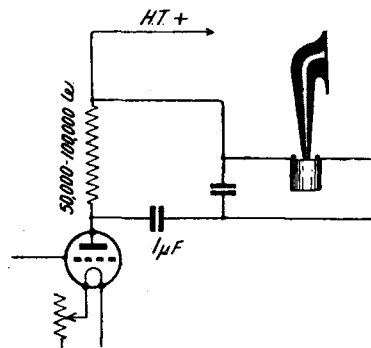
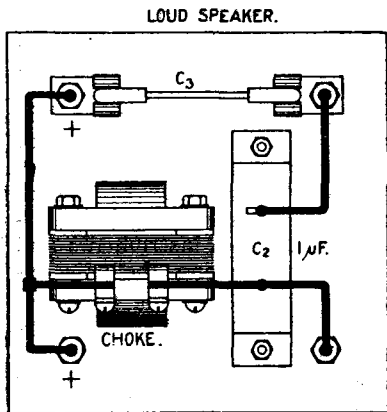

Fig. 1.—A simple filter circuit using a resistance.

applied potential on the plate of the valve in order to ensure efficient operation notwithstanding the drop in volts across the resistance itself. When a power valve is used and the value of the resistance is high this drop may be very considerable. It is necessary for the value of the resistance used to be high in order that the voltage variations across it should be sufficient to maintain the requisite current variations which operate the loud-speaker; hence it may be necessary to increase the H.T. value to between 200 and 300 volts, or by nearly 100 per cent. This has obvious disadvantages, and for this reason alone the choke method is more popular.

The Circuit Used

The unit about to be described is a simple arrangement utilising the choke method.



The wiring of the unit is extremely simple.

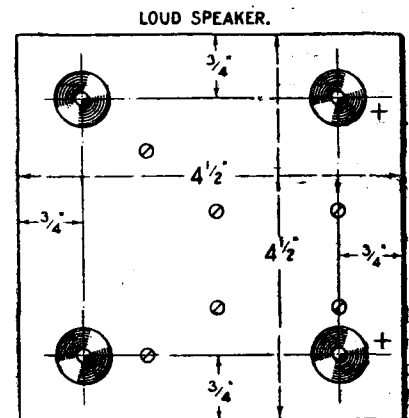

This figure gives the panel dimensions.

these fluctuations or impulses may be communicated to the loud-speaker without the steady current passing through the

The following components are required, but it is obviously not

The Choke Method

The resistance of a choke is very low as compared with an anode resistance of, say, 50,000

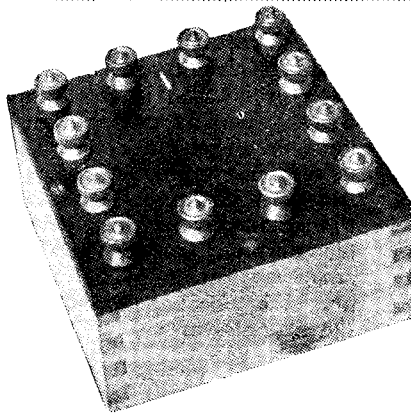

The terminal board mounted in its box.

A Useful Connecting Board

An easily constructed unit which both new and old experimenters will find of considerable assistance in the conducting of their experiments.

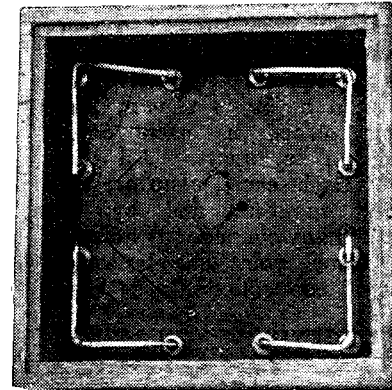

The connections beneath the panel are of the simplest.

WHEN trying out experimental circuits it is frequently found necessary to connect several wires under one terminal with serious "overcrowding" resulting. Further, when it is desired to change one connection, all the others fall out; certain wires which have no business to do so may touch, with disastrous results to valves, batteries or temper.

Construction

The little panel shown in the photograph was primarily designed for use as a "bridge" in making some resistances. By connecting the battery and galvanometer across the corner terminals respectively, as shown in the diagram (Fig. 2), four pairs of terminals are left to which the various resistances may be connected. It was desired to make a set of resistances, and as the writer had a resistance box the following procedure was adopted. A piece of 32 S.W.G. Eureka wire was obtained about 3 ft. long, and was stretched

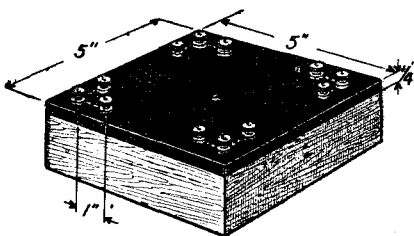

Fig. 1.—Dimensions of the panel.

between two nails on a wooden board, two leads being soldered to the ends. Across this the galvanometer shown at G in Fig. 3 was connected, while the two

ends were also connected together and to one side of a small battery.

Centre Point

The other side of the battery was connected to a short piece of copper wire, which was moved about near the centre of the resistance wire till a position was found where no reading was obtained on the galvanometer. This was the exact centre of the

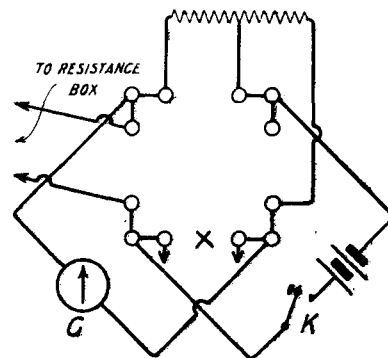

Fig. 2.—Illustrating the connections for measuring resistances.

resistance. A lead was soldered to this point, and carefully checked to see that the resistances of the two halves were still equal.

Connections

This resistance was then connected to the connecting board, as shown in Fig. 2, thus forming two of the arms of the bridge. The resistance box formed one of the other arms, and the resistance being made was connected at X. The resistances required were 1 ohm, 10 ohms, 100 ohms, and 1,000 ohms. Of these the two low value ones were wound with

copper wire, and the other two were wound with resistance wire.

It was first ascertained which way the needle of the galvanometer swung when the unknown resistance was too high, then, the resistance per 100 ft. of the wire being known, a length was measured off in excess of the resistance required. This was gradually reduced a little at a time, taking a reading every time till a point was reached when the galvanometer remained stationary with the resistance connected at X, the desired value included in the resistance box, and the key K closed. The unknown resistance X was now exactly equal to the value shown on the resistance box. The wire forming the resistance was now doubled back on itself and wound on to a little cardboard former, as shown in Fig. 3, so that it should be as nearly non-inductive as possible.

Damp-proof

The resistance was then dipped in molten wax to damp-proof it. The same procedure was followed in each case, and once a couple of resistances were made it was possible to get a 10 to 1 ratio by connecting these in the appro-

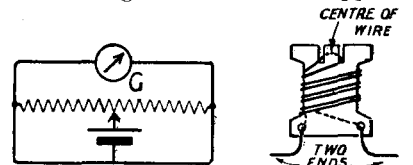

Fig. 3.—Showing how the zero point is found and how to wind the resistance on the former.

priate manner in place of the long single wire resistance.

The dimensions of the panel used are shown in the figure,

and owing to the lay-out mistakes in connecting up are practically impossible. A piece of ebonite 5 in. x 5 in. x $\frac{1}{4}$ in. was obtained and terminals mounted on it as shown, three being placed in each corner spaced 1 in. apart. All three terminals in each group are connected together, and by this means many connections going to the same point can be made. Single connections are easily

changed over without disturbing others. The panel was mounted on a wooden frame made of $\frac{3}{8}$ in. wood, which was just cut square and screwed, the frame being deep enough to clear the ends of the terminals.

This has been found a very handy little panel for other uses than bridge work, and as all the "bits and pieces" are to be found in the junk box its only cost was a matter of half an hour's time.

that the experimenter gets as good results, or nearly as good results, with the crystal detector out of circuit as when the detector is used in the ordinary way. This is due to the first valve acting as a detector, and it will be appreciated that the iron-core choke coil formed by the secondary of the iron-core transformer acts in much the same way as a gridleak, thus providing efficient rectification on the first valve.

Grid Choke Rectification

A Note

SEVERAL letters have been received by us in connection with my article on grid choke rectification. It would appear that several other investigators have used this method with success, and some claim patent protection.

It will consequently interest them, and also our readers, to note that the general principle of using a choke coil instead of a gridleak is outlined on pages 319 and 320 of the Admiralty Handbook of Wireless Telegraphy, 1920. The special circuits given in our article in question are, however, not described in this Admiralty Handbook.

Reflex Circuits

A very interesting sidelight on the whole question is the position of reflex circuits in which the secondary of an iron-core transformer is in the grid circuit of a high-frequency amplifying valve. It is well known that when a valve is near the oscillation point in a reflex circuit of this kind, there is always a great tendency towards buzzing, and I, and others, have given several explanations for this, but hitherto this new explanation has been ignored, although it explains the phenomena of buzzing in some cases.

Intermittent Oscillation

It is that the secondary of the transformer with its condenser acts as a leaky grid condenser, with the result that the intermittent oscillation effect takes place, just as it often takes place in the case of an oscillating valve where the reaction is

very tight, or where certain special values of grid condenser and grid leak are employed. In these cases the negative potential on the grid builds up to such a point that oscillation is stopped, the electrons on the grid then leaking away again, and oscillation recommencing. This process produces an audible note.

ST100

This leaky grid condenser rectification effect is often obtainable on the ST100 and other reflex circuits, the symptoms being

Buzzing

This trouble would theoretically be eliminated by giving the grid of a valve a negative grid bias, and in actual practice this often reduces the tendency towards this form of buzzing, and also lessens the rectification effect of the first valve.

Grid Bias

It should, of course, be remembered that any grid bias on the grid of the first valve should be accompanied by a suitable adjustment of filament current and anode voltage, otherwise, rectification due to bends in the anode current curve will be produced.

JOHN SCOTT-TAGGART.

The Cathedral of Notre Dame

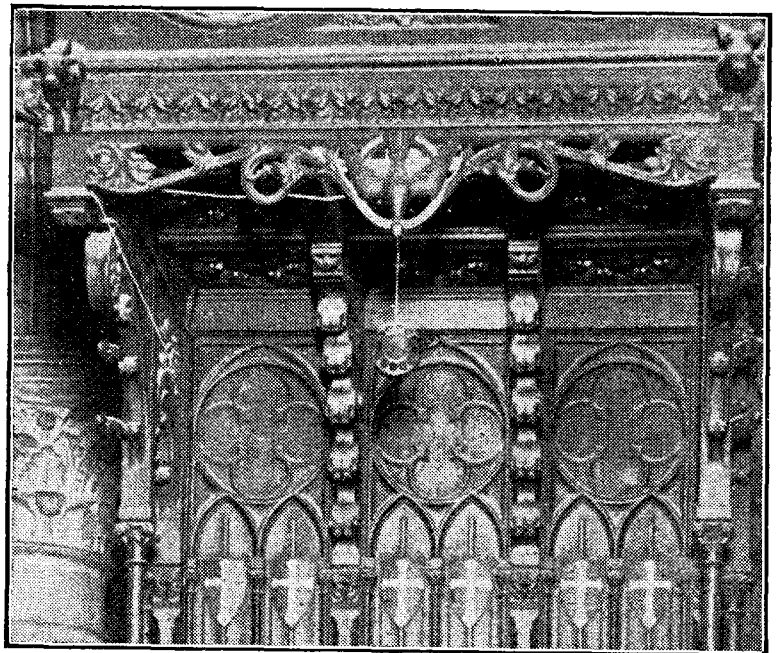

Our photograph shows the microphone which has been installed above the pulpit at the Notre Dame, Paris.

Improving Cheap or Old Variable Condensers

By R. W. HALLOWS.

How many have purchased cheap variable condensers and regretted it? That it is not necessary to discard specimens of proved deficiency, however, is indicated in the following article, in which various methods of improvement are described.

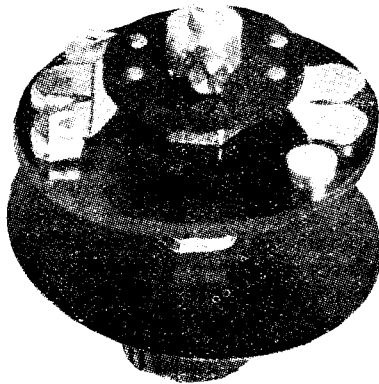

A useful switch for series or parallel connections.

TIME was when the only variable condensers manufactured were very expensive instruments made with the greatest precision. I have one before me as I write, for which in 1919 I paid no less than £5! At that time this was not at all an out of the way figure for a good variable condenser with a capacity of .001 μ F, and I do not think that there was a single pattern of the same capacity available at much less than half this amount of money. Then came a great change. The growing popularity of wireless as a hobby induced manufacturers of all kinds to turn their attention to the output of components. Competition became fierce and prices dropped rapidly. The question of efficiency did not receive the consideration that it deserved, and constructors were content to fit their receiving sets with almost

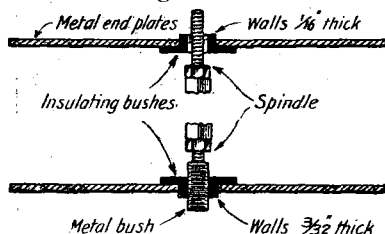

Fig. 1.—Illustrating the insulation often provided between the fixed and moving vanes.

anything provided with fixed and moving plates which looked like a variable condenser. The state of affairs persisted for some time and then people began to give really close attention to the various questions affecting the efficiency of condensers. So long as

the reception of our own broadcasting stations was all that was desired very fair results could be obtained with condensers that were only moderately good; but when telephony from the United States was heard for the first time in this country every real enthusiast desired to be able to pick up the American stations on favourable evenings. Broadcasting stations were inaugurated all over the Continent of Europe so that those who could not manage the trans-Atlantic ranges of 3,000 miles or more had yet plenty of opportunities of testing the long distance qualities of their receiving sets. But perhaps the greatest event of all from the condenser point of view was the coming of short-wave transmissions from America, from the Continent, and from amateurs. Everyone desired to be able to pick up these signals—and there is nothing to equal the ultra-short waves for showing up unsatisfactory variable condensers.

Discarded Condensers

There must be thousands of wireless folk who have upon their shelves varying numbers of condensers which have been discarded owing to their being defective in some way. Such is certainly my own case, and as I have been spending some time recently in giving these old servants a new lease of usefulness, an account of the methods by means of which they were rescued from the scrapbox may be of use to many readers. Those who happen to have condensers not of the best design in use on their receiving sets will find that the hints given in this article will help them very greatly to effect a considerable improvement in their results. Let us take, in the first place, the question of metal end pieces. Condensers constructed in this way may be thoroughly efficient if very great care has

been given to their design. Fig. 1 shows a sectional diagram of a cheap condenser which I pulled to pieces recently. The spindle carrying the moving plates passes through insulating bushes fixed into both top and bottom end pieces, which are of aluminium $\frac{1}{8}$ in. thick. The "walls" of the upper bush are $\frac{1}{16}$ in. thick, whilst those of the lower are about $\frac{3}{32}$ in. Now as the fixed plates are in direct electrical contact with the metal end pieces this means that between the spindle

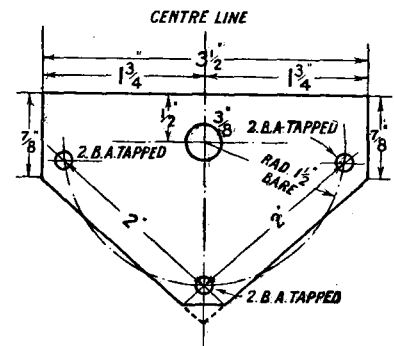

Fig. 2.—Ebonite top end plates may be constructed as shown above. The measurements given may be modified if necessary.

carrying the moving plates, and the end plates in contact with the fixed, we have a thin layer of material with a high dielectric coefficient and a low factor of efficiency. As compared with air the dielectric constant of ebonite is a little over 2; this means that the capacity between the spindle and the end pieces is, owing to the presence of the bushes, rather more than double what it would be if the two were separated by air. But the dielectric efficiency of ebonite, by which is meant its power of preventing losses is only about 70 per cent. of that of air. To make matters worse the bushes in the condenser under description, like many of those of cheap make, were made not of good ebonite but of some

form of moulded composition with very poor insulating properties. In a condenser of this kind the losses will be large—and it must be remembered that the higher the frequency the more serious will they be. As a matter of fact this condenser was completely useless below 150 metres. Further, the minimum capacity will be high, so that the tuning range when it is used with a fixed inductance will be very limited. To show what can be done by a few simple alterations I may say that this particular condenser is now working most satisfactorily on a short-wave set. This result was brought about chiefly by scrapping the metal end pieces and replacing them with ebonite.

Ebonite End Plates

Fig. 2 shows the layout of a top end-plate cut from a piece of ebonite measuring $3\frac{1}{2}$ in. by $3\frac{1}{2}$ in. The centre line is first of

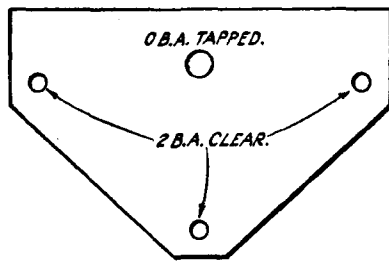

Fig. 3.—The bottom end plate should be constructed in a similar manner to the top end except as regards sizes of holes.

all marked with a scribe, as shown in the diagram, and the plate is then cut out and trimmed up. All the corners may be rounded off if desired. On the centre line $\frac{1}{2}$ in. from the front edge make a punch mark, and using this as centre describe a semi-circle with a radius of slightly under $1\frac{1}{2}$ in. At the point where the circumference cuts the centre line make a second punch mark, and from this measure chords 2 in. in length punch marking at the points where the straight lines cut the circumference. Make the central hole with a $\frac{3}{8}$ in. drill and the other three with a No. 26 drill.

The Bottom Plate

Tap these latter 2B.A. The bottom plate (Fig. 3) is made to precisely the same dimensions, but the drilling is different. The central hole has to be

tapped oB.A. If you have not a tap of this size available you will probably be able to find some friend who has, or you can get the job done at a garage or cycle shop.

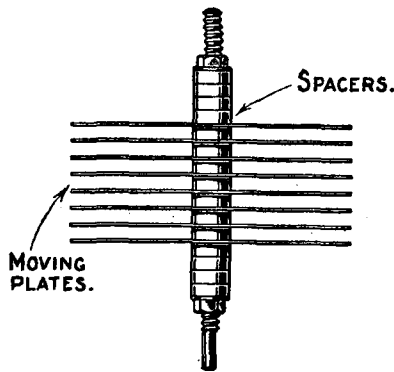

Fig. 4.—The insertion of extra spacing washers allows plates to be discarded, thus providing a lower capacity.

Before assembling the condenser with its new end pieces consider the question of its maximum capacity. In the early days of wireless it was fashionable to fit to receiving sets an A.T.C. with a maximum capacity of .001 μ F and a closed circuit condenser of .0005 μ F. Except for fairly long wave work these capacities are too big. The suitable sizes for ordinary reception are from .0004 to .0005 μ F for the A.T.C. and .0002 or .0003 μ F for the secondary condenser. If the condenser under reconstruction has too large a maximum capacity for your present requirements it is quite an easy matter to reduce it.

Decreasing the Capacity

The average variable condenser with a reputed maximum capacity of .001 μ F has 25 fixed and 24 moving plates—the exact number

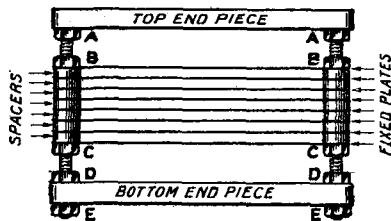

Fig. 5.—Manner of reassembling the fixed plates. The usual third support is omitted in the figure for clearness.

depends partly upon the thickness of the spacing washers. If you desire to halve this you should reassemble leaving out 12 fixed and 12 moving plates. We can-

not usually reduce the total depth of the condenser from top to bottom since the spindle cannot be shortened unless the workshop boasts a lathe. It is, of course, possible to buy ready-made spindles with square portions of varying lengths; but there is really no need either to shorten the spindle or to buy a new one. Fig. 4 shows a simple way out of the difficulty. In this figure a spindle designed to carry twelve plates is shown with only eight mounted upon it. The plates are brought approximately to the middle of the spindle by using suitable numbers of spacer washers above and below them.

Reassembling Fixed Plates

And now for the fixed plates. We shall find in the first place that new pillars are brought owing to the fact that the ebonite end pieces are very much thicker

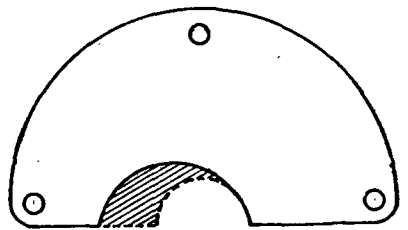

Fig. 6.—By cutting the fixed plates in the manner indicated, a square-law effect is obtained.

than the discarded metal ones. These should be cut from 2B.A. studding, care being taken to see that the piece used is perfectly straight, and to be on the safe side they should be made, in the first instance, $\frac{1}{2}$ in. longer than the old ones. Any surplus can be cut off with a hacksaw after the condenser has been assembled. Screw the pillars into the top end piece and lock them with the nuts A A in Fig. 5. In the central hole of the top end piece place a $\frac{3}{8}$ in. brass bush, such as can be bought from almost any wireless shop for a penny. On to the pillars run the nuts B B (Fig. 5) and put on the first fixed plate.

Adjusting the Plates

Now insert the spindle into the bush and you will get some idea of the distance from the top end piece at which the first fixed plate must be set. Do not bother to get it exactly, just obtain a rough idea and adjust the nuts B B accordingly. Put on the remaining fixed plates with spacer

washers between them, and when all are in place screw on the nuts C C.

Final Adjustments

Into the oB.A. hole in the bottom end piece screw the metal seating for the end of the spindle taken from the bush of the discarded metal plate. Insert the spindle into the top plate. Put on the nuts D D, then the bottom piece, and lastly the nuts E E. By means of the nuts B B and C C you can now raise or lower the fixed plates upon the pillars until the spindle goes properly home. It should be centred up by getting the bottom end piece properly level with the aid of the nuts D D and E E. When this has been done fine adjustment of the fixed plates must be made by the nuts above and below them. Lastly, the plates must be clamped tightly.

Another Improvement

Before the fixed plates are assembled you may, if you feel so disposed, improve the shape of your fixed plates by cutting a piece from each, in the way shown in Fig. 6. This will not give you a genuine square law effect unless you are lucky enough to strike the exact curve required, but it will improve the usefulness of the condenser by enabling you to obtain finer adjustments on the lower part of its scale. The best way of making this cut is as follows. Make a template of cardboard or of metal of the shape which you desire the plates to assume when they have been cut.

Cutting Out

Clamp all the fixed plates together by passing 2B.A. screws through the holes in them, and with the template and the scriber mark on both the outer plates the line of the cut that has to be made. Put the plates into the vice, screw them up tightly, and with a jeweller's hacksaw take out the greater part of the undesired metal. Finish up with an old D file—do not use a new one for aluminium clogs up files and renders them rapidly useless for cutting harder metals.

Uncertain Contact

If you assemble your condenser in the ordinary way, using a spiral

spring washer between the top end of the spindle and the brass bush in the end piece, the odds are that you will find when you come to use it that the contact between the spindle and the terminal to which the lead running to it from the inductance is attached is of

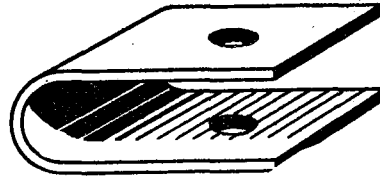

Fig. 7.—A piece of springy metal bent to a suitable shape replaces a spring washer with advantage.

rather a "chancy" kind. It may be excellent for a day or two, but at the end of that time as likely as not clicks or scraping noises will be heard at certain settings of the condenser. By far the best type of spring washer is that shown in Fig. 7. This is very easily made in the workshop. Take a piece of springy sheet metal about $\frac{3}{8}$ in. in width and bend it round a small piece of wood $\frac{1}{8}$ in. thick. Drill a 2B.A. clearance hole right through and remove the wood.

Removing All Doubt

Trim up any rough edges with a fine file. A suggested method for absolute contact is that shown in Fig. 8. A short piece of 4B.A. studding is inserted through a clearance hole in the lower end piece and is locked

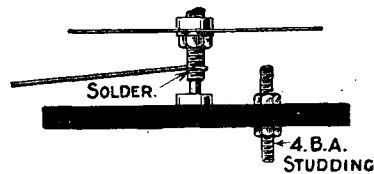

Fig. 8.—Illustrating the first process in making a pigtail connection for the moving vanes of a condenser.

by means of two nuts. Next a strip of copper foil $\frac{3}{8}$ in. in length and rather less than $\frac{1}{8}$ in. wide is cut out. One end of this is soldered to the spindle, as shown in the drawing, and the knob is then turned in a clockwise direction so as to wind on the copper strip tightly. When allowed to uncoil a little it will assume the shape of a watch spring, and the

free end is soldered to the 4B.A. studding. We have thus an absolutely positive contact between the spindle and the studding, and if the external lead is soldered on to the latter there need be no fear that clicks or scratching noises due to uncertain contact will occur. With a spring connection of this kind it is essential that the movement of the moving plates should be confined to a turn of 180 degrees, for otherwise the copper strip may be broken or wrenched off. If, therefore, you wish to be quite on the safe side you may make a stop by drilling a small hole through the spindle and inserting into it a piece of stiff wire which will engage with a stop pin set in the bottom end piece.

Worth While

These are the main improvements that can be effected in the home workshop in variable condensers whose design was originally defective. None of the jobs suggested takes long to carry out, and it is well worth while to do so, for by a little trouble a poor condenser can be so improved that it becomes quite a useful member of your wireless outfit, and even a very bad one indeed may be made to render good service.

The Eiffel Tower and "Wireless Weekly"

THE importance attached to the publication by *Wireless Weekly* of the programmes of Continental and American broadcasting stations, is clearly indicated by the announcements broadcast from the famous Eiffel Tower Station on Sunday, March 22. During the programme the following announcement in English and in French was made:—

"We have a special message for our British listeners. We have made arrangements with the interesting periodical *Wireless Weekly* for the exclusive publication of our programmes, and we advise those listeners interested to buy this weekly paper, on sale every Wednesday."

The announcement was repeated on Sunday, March 29.

Valve Receiver Tuned-Anode

HARTY, B.Sc.

Methods of obtaining stability is the interesting arrangement. A. D. Cowper, M.Sc. and mode coupling, this being never described below.

connected as shown in series with the anode of the high-frequency valve V₁ and the grid condenser of the detector valve

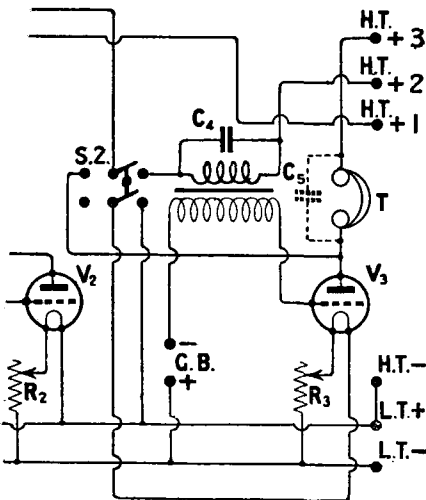

The chief feature is the unconventional anode coil L2.

V₂, and is tuned by the variable condenser C₂ of .0003 μ F maximum capacity. A radio-choke coil L₄ is provided, for which a No. 250 plug-in coil or a Gambrell F may be used. Reaction is obtained by coupling to the aerial coil a small coil L₃ correctly connected in the anode circuit of the detector valve.

Receiving the Long Waves

For long-wave reception a single-pole, single throw switch S₁ is connected, so that resistance coupling may be employed by changing over the switch,

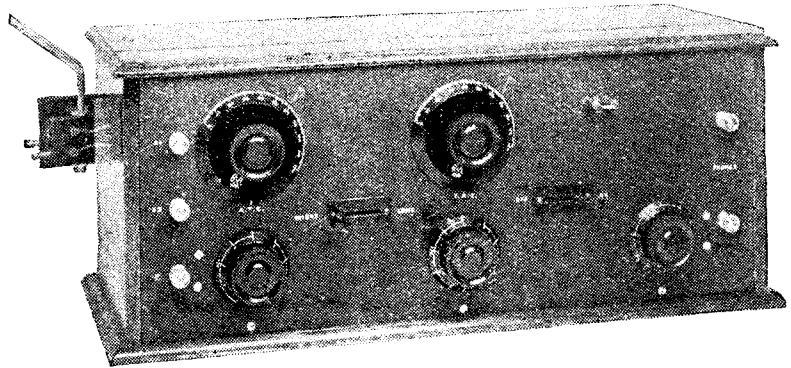

With the coils removed, a clearer conception of the layout is obtained.

removing the coil L₂, and inserting a shorting plug. When changing over from the short to the long wavelengths, it will be found necessary to reverse the connections to the reaction coil, assuming that they were correctly connected to give the desired reaction effect on the shorter wavelengths when using the series-tuned-anode arrangement.

Switching Out the Last Valve

For the purpose of cutting out the note-magnifying valve, a double-pole, double-throw switch S₂ is connected in circuit as shown. By this means the telephones are connected either in the anode circuit of the detector valve or the last valve, and with

the switch in the position for using two valves only, the filament circuit of the last valve is automatically broken. Allowance is made for separate high tension on each valve, and this arrangement will be discussed later on under the operation of the receiver.

Shunting the H.T. Battery

It will be noted that no fixed condensers are shunted across the high-tension battery; these are not included in the set, as it is often more convenient to make up a special unit for this purpose so that it may be used in conjunction with any receiver. In any case, it is good practice to provide fixed condensers of, say, 2 μ F across each portion of the

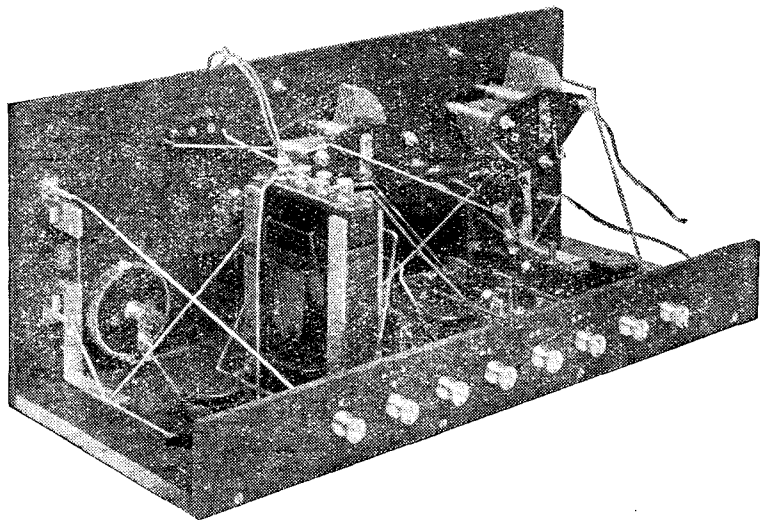

The wiring appears much simpler upon obtaining a closer view. The method of securing the telephone condenser clips is clearly shown.

high-tension battery, that is, between each tapping and high-tension negative.

Selective Reception

While only a direct-coupled aerial circuit is used, the selectivity possible with this receiver is such that the author has been able to listen to Manchester (on 375 metres) at about eight miles from 2LO (on 365 metres) with practically no interference from the latter, the tuning being extremely sharp.

Design Adopted

The general design of the receiver may be seen from the

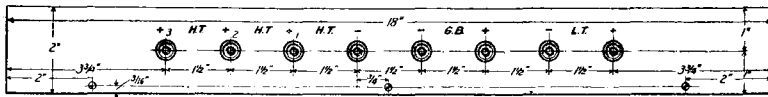

This diagram should be followed when constructing the terminal strip for the battery connections.

photographs; a vertical panel and loose baseboard arrangement with a terminal strip for battery connections at the rear has been adopted. The whole is arranged to slide into the cabinet, the back of which is cut away at the bottom to receive the terminal strip. The terminals seen on the left of the panel are for aerial and earth connections, while those on the right are for the telephones or loud-speaker, the "positive" tag of which is connected to the upper terminal.

It will be seen that plug-in coils are used for the inductances, the two-way coil holder attached to the cabinet on the left being for the aerial and the reaction coils. It is important

in a circuit of this type to have the aerial and the anode coils arranged well apart so as to avoid or minimise any coupling between them, and for this reason the anode coil is mounted on the panel on the right-hand side, so that it is at right angles to the aerial coil. The radio-choke coil is suitably disposed inside the cabinet.

The filament resistances used are of the dual type, thus permitting either bright or dull emitter valves to be used. The three control knobs and dials for these are seen along the bottom of the panel. The two condenser dials, that on the left for

aerial tuning and on the right for anode tuning, and the two switches, one between the condenser dials being for the change over to resistance coupling for long wavelengths, while the one further to the right serves to cut out the last valve, complete the panel layout. The remainder of the components are mounted on the baseboard so that the valves are enclosed within the cabinet when the set is in use, access to the inside being given by the hinged lid.

Component List

As to the components required, the following is a complete list, together with the names of the manufacturers of those actually used.

Strict adherence to the particular components specified is not, of course, necessary, and any similar components of good make may be substituted.

1 ebonite panel, 18 x 7 x 1/4 in., guaranteed free from surface leakage (that used is "Paragon").

1 ebonite terminal strip, 18 x 2 x 1/4 in. ("Paragon").

3 dual-type rheostats (McMichael).

1 two-way coil holder (Burne-Jones).

1 coil socket for panel mounting with shorting plug (Woodhall).

1 coil socket for baseboard mounting (Burne-Jones).

1 .0005 μF variable square law condenser (Bowyer-Lowe).

1 .0003 μF variable square law condenser (Bowyer-Lowe).

1 S.P.D.T. switch, lever type (Utility).

1 D.P.D.T. switch, lever type (Utility).

1 low-frequency transformer (Grelco, by Grafton Electric Co., ratio 4:1).

1 grid-leak (2 MΩ) and grid condenser (.0003 μF), mounted (McMichael).

1 .002 μF fixed condenser, clip-in type, mounted (McMichael).

1 clip-in condenser with clips (McMichael). (This is placed across the output terminals, and the best value should be determined by experiment.)

1 anode resistance 100,000 ohms (McMichael).

3 antiphonic valve holders (Burndept).

13 terminals.

One packet Radio Press panel transfers.

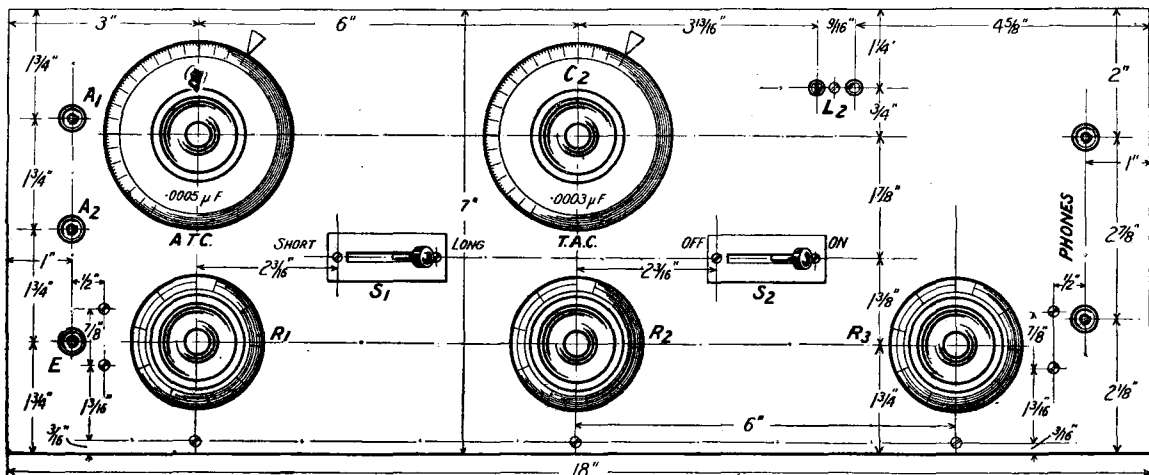

All necessary dimensions are given in this figure, which should be followed carefully when drilling the panel.

Square section tinned wire for wiring.

A suitable cabinet (Camco).

Some brass screws and two angle brackets for securing the panel to the baseboard are also required.

Drilling the Panel

The first operation in the construction of the receiver is the marking out and drilling of the panel. If the latter is of guaranteed ebonite this may be proceeded with at once and the positions for the drilling centres carefully marked out on the back of the panel in accordance with the drilling diagram. If the variable condensers are of the same type as those in the actual set the drilling templates supplied with them should be used to determine the positions for the holes required for fixing.

Cutting Slots

In the case of the switches the metal plates may be used as tem-

plates according to the maker's instructions. The slots in the panel through which the switch levers have to pass are conveniently made by drilling two suitable sized holes at what are to be the ends of each slot and using an ordinary hand fret-saw to cut away the unwanted ebonite; if this method is not favoured a series of holes may be drilled closely together along the length of the slot and the surplus ebonite removed with the aid of an old pocket knife and a thin file.

To find the positions for the holes for the two fixing screws for the rheostats the best plan is probably to drill the centre clearance holes, then place the rheostats in position and use them as templates. The holes are then drilled in the panel and tapped to take the 4 B.A. fixing screws, or, if desired, clearance holes may be drilled and their fixing nuts used on the front of the panel.

Mounting the Parts

If a little care is taken no difficulty should be experienced in these operations, and when all the holes have been drilled (including the countersunk holes for the wood screws to secure the panel to the baseboard, and those for fixing the angle brackets) the various components should be mounted. The clips take a fixed condenser across the output terminals, and are clamped tightly under the fixing nuts of the latter, as will be seen from the photographs.

Attention should next be given to the mounting of the remainder of the components on the baseboard. The disposition of these may be gathered from the wiring diagram and from the photographs. The terminal strip is then marked out, drilled, and the terminals mounted on it; this strip is attached to the rear of the baseboard with the aid of four 1/2-in. wood-screws.

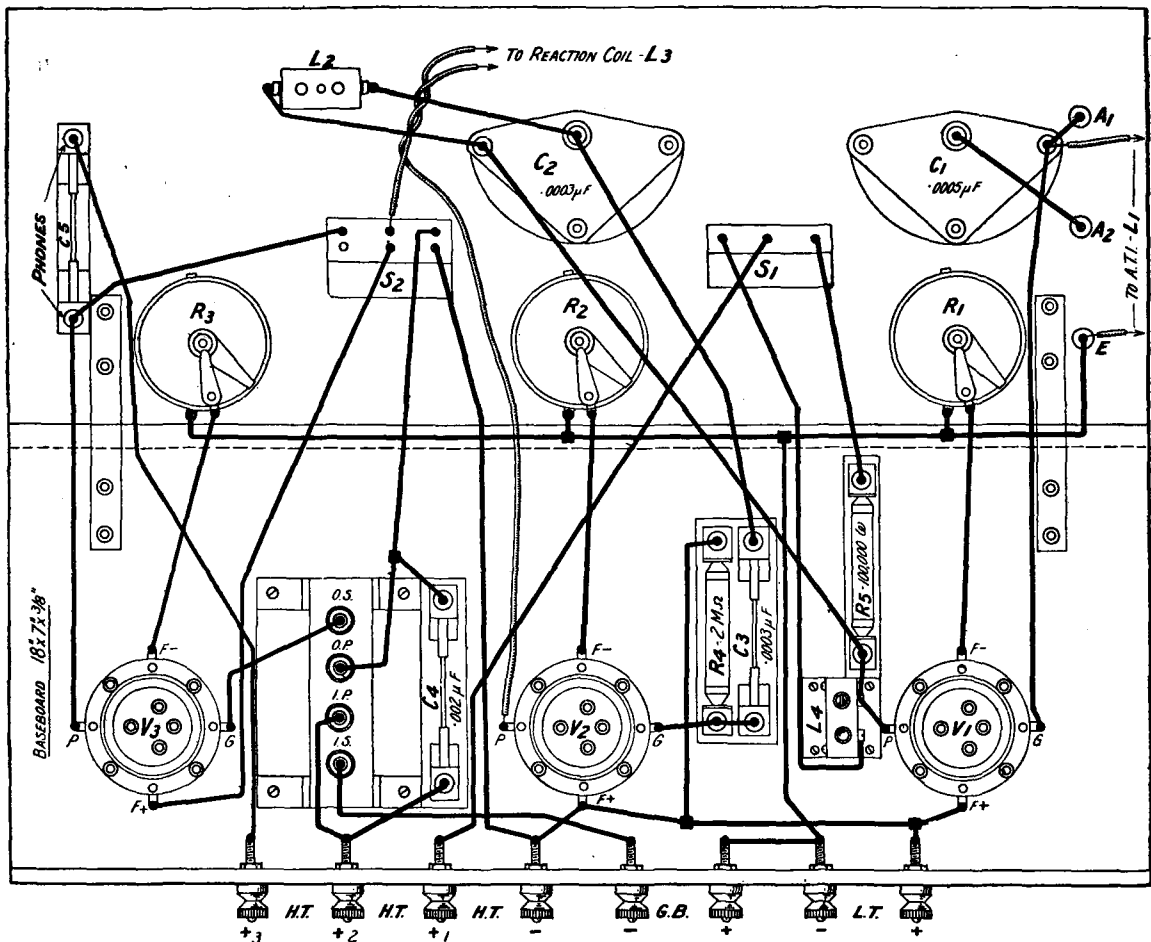

The drilling diagram. The leads on the actual receiver are in most cases much shorter than they appear here. Blueprint No. 109 B is obtainable, price 1s. 6d. post free.

Wiring

All is now ready for the wiring-up of the receiver. This should present little difficulty if the wiring diagram is consulted in conjunction with the photographs. The first operation should be to make the connection between the earth terminal and the filament resistances. This is done before securing the panel to the baseboard, and here it may be mentioned that the soldering tags on the filament resistances for this connection are so bent as to allow for ample clearance between this wire and the baseboard when the panel is subsequently secured in position. With the panel secured the remainder of the wiring may be carried out.

Methods of Tuning

When the receiver has been completed and the wiring checked to make certain that this is correct, the necessary connections may be made to try the set out. For a preliminary test cut out the last valve by switching the double-pole switch over to the left. For parallel tuning the aerial is connected to the terminal marked A₁, earth to E, while A₂ and E are joined with a connecting link.

Suggested values for the coils for the lower broadcast band are No. 35, Gambrell A, or the equivalent for the aerial, No. 50 or a B for the anode inductance, and a No. 250 or F for the radio-choke. For the higher wavelength B.B.C. and Continental stations a No. 50 or B in the aerial and a No. 75 or C for the anode may be used. For series tuning the aerial is connected to A₂, earth to E, and A₁ left unconnected. The most suitable coils for reception of a given station are best determined by trial.

Reaction Coil

For reaction only a small coil is required on the 250- to 600-metre band, and a Gambrell "a/2" or "a" has been found to give very smooth control, and only a small effect on the tuning when the coupling was varied. First tune in the local station by varying the two condensers simultaneously until each circuit is tuned to resonance and the station is heard at maximum strength. Then bring the reaction coil gradually nearer to the aerial coil and ob-

serve whether the set begins to oscillate. This test should be made carefully so as to cause a minimum amount of interference.

Obtaining Reaction

If the set cannot be made to oscillate reverse the leads to the reaction coil. To facilitate reversing these leads they should be provided with Clix plugs, the two leads from the reaction coil-holder being taken to two Clix sockets mounted on a short strip of ebonite fixed with small angle brackets to the inside of the cabinet on the left. Final adjustments should be made of the filament temperatures and of the H.T. voltages applied to the first two valves so as to secure the best operating conditions. It will be noted that when only two valves are used the detector valve receives its high-tension supply from the tapping marked HT + 3. Thus the tapping HT + 1 for the first valve should be adjusted and left, then with two valves in operation the best position for the HT + 3 tapping is found. The HT + 2 tapping is given this same value, so that when the third valve is switched on the H.T. voltage on the detector valve remains sensibly the same, and all that is necessary then is to plug-in the HT + 3 tapping at the correct voltage for the last valve. On switching back to two valves the HT + 3 tapping is plugged-in at the former value. This may sound complicated, but in actual practice is a simple operation, and is very quickly done. The filament resistance for the last valve is adjusted and left set, as also is the grid-bias.

Valves

As far as valves are concerned ordinary general purpose valves may be used, either bright or dull-emitters, but for the third valve the use of a small-power valve of the B₄ or B₆ type is recommended. A point to notice when changing over to resistance coupling for long wavelengths is that a higher voltage should be applied to the HT + 1 tapping to allow for the drop across the resistance.

Careful Tuning Required

After a little practice the handling of the receiver will be found to be comparatively easy, and once the local station has been

tuned in searching is best carried by slowly rotating the dials so as to keep the two circuits in resonance. Here it may be mentioned that unless each circuit is accurately tuned to the wavelength it is desired to receive nothing will be heard except possibly the local station, which in the majority of cases it should be possible to eliminate when the final tuning has been made.

Results

The actual receiver when tested on a good outside aerial at about eight miles from 2LO gave very satisfactory results. All of the B.B.C. stations, with the exception of Cardiff, and most of the Continental stations were received very well, many of them justifying the use of a loud-speaker when using three valves, in particular Brussels, Zurich, Munster, Ecole Superieure, Belfast, Eiffel Tower, Glasgow, Bournemouth and Birmingham. In some cases fading was experienced, and on other occasions interference from "mush" and "X's" spoil the quality of the reception. The local station and 5XX are, of course, received at excellent loud-speaker strength.

Shortly after midnight one Sunday a church service was heard on two valves. This proved to be from WGY, but reception, on the whole, was marred by atmospherics. Later on WBZ was received at much better strength as conditions seemed to have improved, and speech and music were received at good strength on the 'phones using two valves. For a short period moderate loud-speaker reception was possible using three valves, but after a time the station faded away, and was barely audible on the head-'phones.

Super-Heterodyne enthusiasts should not miss the important article by

Mr. G. P. KENDALL, B.Sc., in the April issue of

"Modern Wireless,"

OUT on APRIL 3rd

Reception Conditions Week by Week

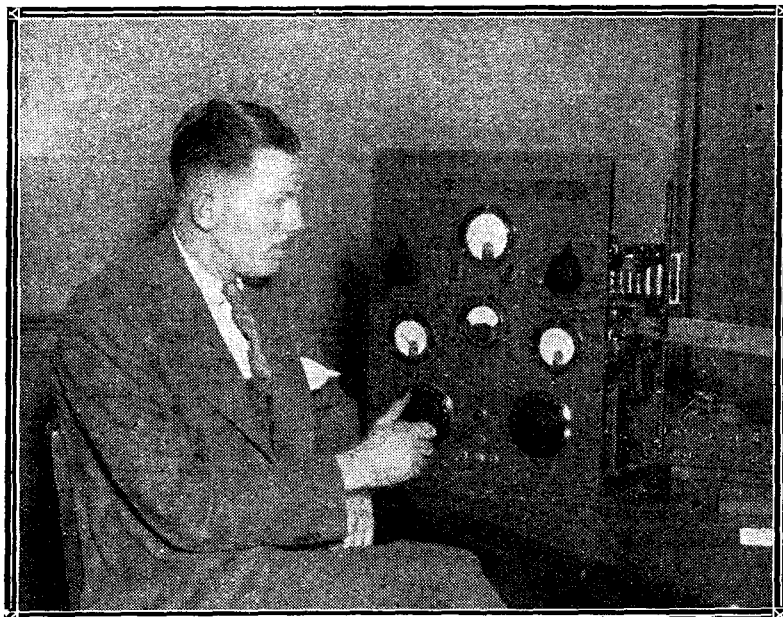

Mr. Theodore Ostman, U2OM, with his 50-watt transmitter, which won first prize at the fifth Annual Radio Exhibition, New York.

By W. K. ALFORD.

Review of reception for week ending March 22.

THE reception conditions this week are again characterized by the monotonous and exceptionally heavy "X's" and "mush" which frequently attain intensity usually associated with midsummer. To the average listener these conditions have to be accepted as a more or less inevitable blemish on his broadcast enjoyment, but as time goes on, and people begin to "think" radio, there is undoubtedly a feeling of surprise that, in all the great achievements in radio during recent times, very little appears to have been done in the direction of bringing some means of "X" elimination within the reach of the average listener.

Atmospherics

It may be stated definitely and without fear of contradiction that no greater problem confronts the radio engineer than the elimination of atmospherics. A tremendous amount of work has been done, as the matter is of far greater importance in connection with commercial radio services than in the broadcast services, and, although the work of the Marconi Company in this country, of Weagant and McCaa in America, has brought the solu-

tion very much nearer, yet the means employed are not at all adaptable to the average broadcast receiver.

High Speed Morse

Perhaps the greatest damage which "atmospherics" cause when insufficiently eliminated is in the reception of high-speed automatic transmissions in Morse at the rate of 150 or more words per minute. At these speeds a heavy crackle of "atmospherics" may very easily blot out several consecutive words, or so disfigure the "tape" as to make the message unintelligible.

The aim of all the researches in the matter is to raise what is called the Signal/Static ratio ("Static" being another accepted term for "atmospherics" or "X's").

The latest figures of the efforts of Dr. Gelen McCaa in America claim that under a given set of conditions this ratio of audibility was increased from 1/2.4 (static stronger than signal) to 246/1 when using his apparatus. These figures are remarkable, and although it is not possible to go into details of the apparatus and methods involved it may be

stated that the whole idea is very much less complicated than many of the previous attempts at solving the problem. There is, however, a simple means of partially overcoming the trouble, which is within the reach of everybody possessing a receiver having a stage of H.F. amplification. The H.F. valve is made to act as a "limiter"; in other words, it responds more readily to the desired signal than to the stronger "atmospherics," and this condition is brought about by dimming the H.F. valve to the correct degree and then retuning the set. Very many people are aware of this useful feature, though few know quite what is happening.

The New 2LO

Much interest has been attached to the testing of the new London broadcasting station, and the method employed in the later tests of switching over from the old to the new station has considerably assisted everybody in making comparisons.

Differences in Reception

At 35 miles I find that very little difference is noticeable in actual "aural" reception with a three-valve receiver, although a micro-ammeter used to show the rectified current through an ordinary crystal receiver gives just over two microamperes more for the new station than the old. The parasitic noises over the longer land-line from the studio appear to have been very successfully eliminated, and the transmissions fully maintain the excellent standard of the old station.

B.B.C. Conference

Regarding the recent conference of representatives of the broadcasting companies of Western Europe, it is to be hoped

that some agreement was arrived at to prevent the overcrowding on the broadcast band, which is so rapidly approaching a serious magnitude.

Wavelengths

Whether the shifting of the wavelength of three British stations (notified recently, but eventually cancelled) in favour of a Norwegian station was due in any measure to this conference one cannot say, but it is to be hoped that an all-round "reshuffle" of wavelengths was not suggested or upheld, otherwise we shall be embarrassed by this

sort of thing whenever a new station comes on the scene. After all, one would expect that a certain proprietary condition would exist in regard to wavelength for stations which have been working for a long time, and the British listening public have had the unfortunate experience of one attempt at "reshuffling" which raised such a storm of opposition.

It is to be hoped that the deliberations of the above-mentioned conference will be made public, as they most assuredly should be.

cells. Also a volt meter used for testing them should have a high resistance or else the same will apply. If a large condenser is placed across your H.T. battery make sure that the insulation is good, a condenser of the type generally used for this purpose has been known to pass quite a reasonable current.

Dust

Keep dust away from the top of your H.T. battery; it provides a leakage path, especially in damp weather, that helps to run down the battery, and also may help to spoil the silent background that is so desirable a feature for the reception of distant transmissions.

A High-Tension Battery from Flash-Lamp Cells

THERE seems to be a pretty general complaint nowadays that high-tension batteries are not what they used to be. Batteries are used for a few months, after which there seems to be a lamentable absence of volts in them. Many amateurs are now making up their own

melted paraffin wax. This will not only make the unit into a solid block but will also help to seal the cells and prevent evaporation. If desired, of course, it may be placed in a wooden case. Tappings can easily be taken by using spring clips instead of wander plugs, and these make an excellent positive contact.

A Soldering Hint

THE chief difficulty when soldering is to keep the iron really clean and the solder running properly. Now the flux usually used by tinsmiths is "killed spirits," but this is quite unsuitable for actual use on wireless work. It has the property, however, of keeping the iron perfectly clean and makes the solder run well. The writer, therefore, always has a pot of this flux on hand, in which the iron is dipped every time it is taken off the gas, while the paste flux is used actually on the job. By this means soldering becomes not only easier but quicker, and the iron is always kept bright. At the same time the use of killed spirits is quite a good indicator as to the heat of the iron. The best heat to work at is when the iron makes a kind of whistling noise when it is dipped in, though if it spits and sizzles loudly it will do.

To make "killed spirits" obtain two or three pennyworth of spirits of salt from your local oilshop, together with a pennyworth of zinc nails. Put the spirits in an old jam pot and drop the nails in. Place it outside on the window ledge till it ceases to effervesce. What is left of the zinc nails should be left in the solution, and it is now ready for use.

C. P. A.

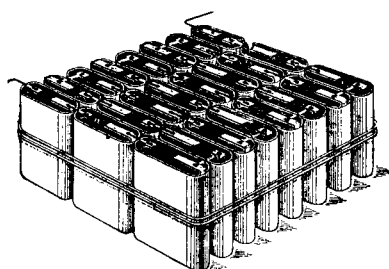

The assembled battery.

H.T. units from flash-lamp cells, and one method of doing this is shown herewith. Say a 100-volt battery is required, two dozen flash-lamp cells will be needed; these will give a total voltage of approximately 108. They can be made up in a block three cells wide by eight deep, placed so that negative and positive contacts are next to each other, as indicated in the sketch. These are then connected together as shown by short lengths of wire.

Connecting Up

Square tinned wire will be found very useful for doing this, and when the unit is completed it can be tied together with string and dipped for a moment into

Dead Cells

With this type of H.T. battery it is a simple matter to remove dead cells and replace them by new ones. The battery will thus be kept up to the mark, and faulty cells that may be creating a high internal resistance in the battery or causing noisy operation of the set are easily removed.

A warning here will not be out of place. Do not buy cheap Continental batteries, though they may look good and give a full reading when new; most of them run down rapidly, and

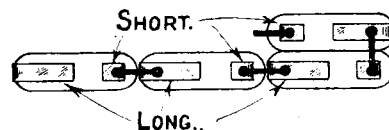

How the cells should be connected.

though cheap to buy will prove expensive in the end.

Testing

When testing a high-tension battery or single cells do not use a flash-lamp bulb. The current taken is unduly heavy and will materially shorten the life of the

A Handy Switching Unit

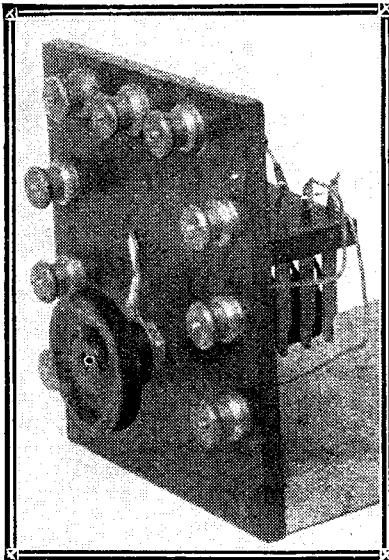

The switch is both compact and easily made.

WHEN comparing out different pieces of apparatus it is extremely useful to have some form of two or three pole double-throw switch handy which is provided with good-sized terminals to which connections can be made. The writer having need of such a switch promptly looked through the "junk box" and found an old three-pole "Utility" switch that was not in use. This was mounted up on a piece of ebonite, as shown in the drawing, and nine terminals fitted, three along the top edge, and three along each of the sides, either set of

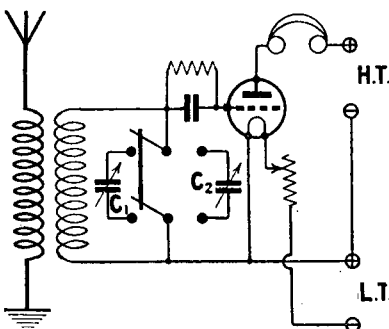

Fig. 1.—The arrangement for comparing two variable condensers.

which could be connected in turn to the three middle terminals. This, therefore, constituted a

A useful switch may be used for a variety of purposes and calls for very little skill in construction.

three-pole two-way switch. The wiring up is quite straight forward, the three centre contacts of the switch were connected to the top row of terminals, and

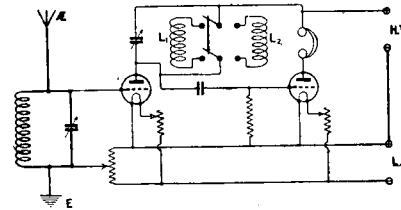

Fig. 1a.—The connections when comparing two anode coils.

those on each side of the switch to the three terminals near to them. The ebonite panel was then mounted on a little wooden base by means of a couple of screws along the lower edge of the ebonite.

Uses

This switch has many uses, and a few of them are shown

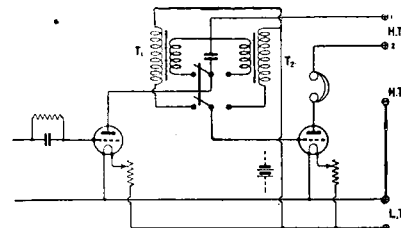
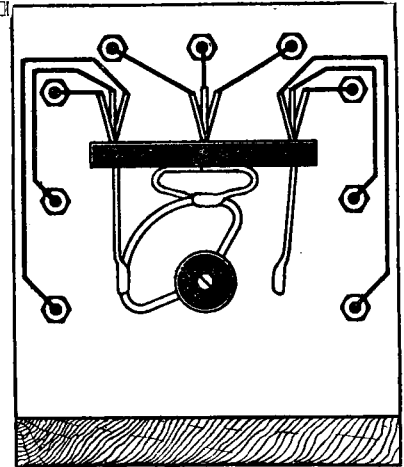

Fig. 2.—When comparing transformers the above connections are used.

here. Fig. 1 shows how it can be used to compare two variable condensers in a receiving circuit.

Comparing Components

If the value of one is known an approximate value can be found for the other one. In a similar manner two coils can be compared, for instance, in a tuned anode circuit by connecting the anode of the valve and the H.T. + to two of the centre contacts of the switch, and the two coils to be compared to the two corresponding contacts on either side. The tuning range of the two coils can be compared, as well as their efficiency, etc.



The connections behind the panel may be followed from this drawing.

Fig. 2 shows how it can be used to compare two intervalve transformers. A double-pole double-throw switch is an absolute necessity if comparative readings of any value are to be obtained, as the amount of time elapsing between the disconnecting of one transformer and the connecting up of another is quite sufficient to falsify any observations made, for not only is the ear unable to retain the exact volume and quality for comparison, but also the strength and character of the received signal may have altered considerably.

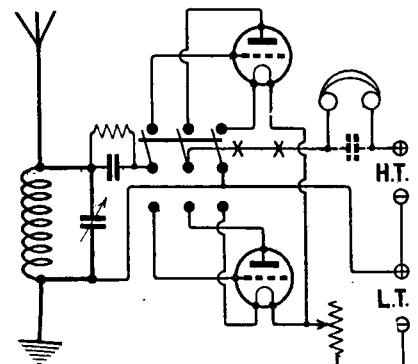

Fig. 3.—Showing how two valves may be compared.

Comparing Valves

Fig. 3 shows how two valves may be compared in any given circuit, and, if desired, a reaction

coil may be placed in series between the points marked with a cross and coupled to the aerial coil. In this case a condenser will be required across the

'phones of approximately .001 μ F capacity, no doubt many other uses will be found for this useful little component by the experimenter in his workshop.

monly used in wireless telegraphy in such a way as injuriously to interfere with the working of authorised wireless telegraphic stations.

Wireless Telegraphy and Signalling Bill

THE Council of the Institution of Electrical Engineers have addressed a letter to the Postmaster-General in which it is pointed out that in the Council's opinion some of the provisions of the Bill are of far-reaching importance, and unless modified will prove a hindrance not only to wireless telegraphy and radio science, but also to electrical and physical research and to the progress of electrical science generally.

The Council urge that it should be made clear that the words "any apparatus for wireless telegraphy" do not apply to such apparatus except in connection with wireless telegraphy, inasmuch as many pieces of apparatus, such as condensers, crystal detectors, valves, etc., are now in common use in physical laboratories and by electricians generally for quite other purposes than wireless telegraphy.

The Council strongly recommend that all regulations made by the Postmaster-General under Clause 3 of the Bill should, before being placed before Parliament, have been previously submitted to a statutory Advisory Technical Committee for their consideration, such a Committee to be representative "inter alia" of the Royal Society, the Institution of Electrical Engineers, and the Radio Society of Great Britain.

Clause 7 of the Bill which applies the provisions of the Bill to the use of etheric waves for the transmission of energy, might greatly interfere in directions quite outside its object, namely, to prevent interference with wireless telegraphy. It is suggested that for this clause a new one be substituted, rendering liable to penalties anyone using electro-magnetic radiations of the radio frequencies com-

ST140 in South Africa

SIR,—I herewith wish to let you know the results which I am at present obtaining with the ST140 ("More Practical Valve Circuits"). On various occasions I have tried numerous four-valve circuits, but have never obtained the results I do now with this wonderful ST140. These are the results: Cape Town, distance approximately 950 miles, loud-speaker strength; Durban, 450 miles, loud-speaker strength. KDKA, Pittsburgh, on three valves, is received at comfortable 'phone strength any time from 1.15 a.m. till 2.15 a.m., and on Sunday mornings from 3.30 a.m. till 6 a.m.; the distance is 8,000 miles, which I think is really wonderful reception at this distance.

Wishing your excellent papers, *Wireless Weekly*, *Modern Wireless* and *The Wireless Constructor* every success.—Yours faithfully,

TOMMY H. CARSON.

Johannesburg,
South Africa.

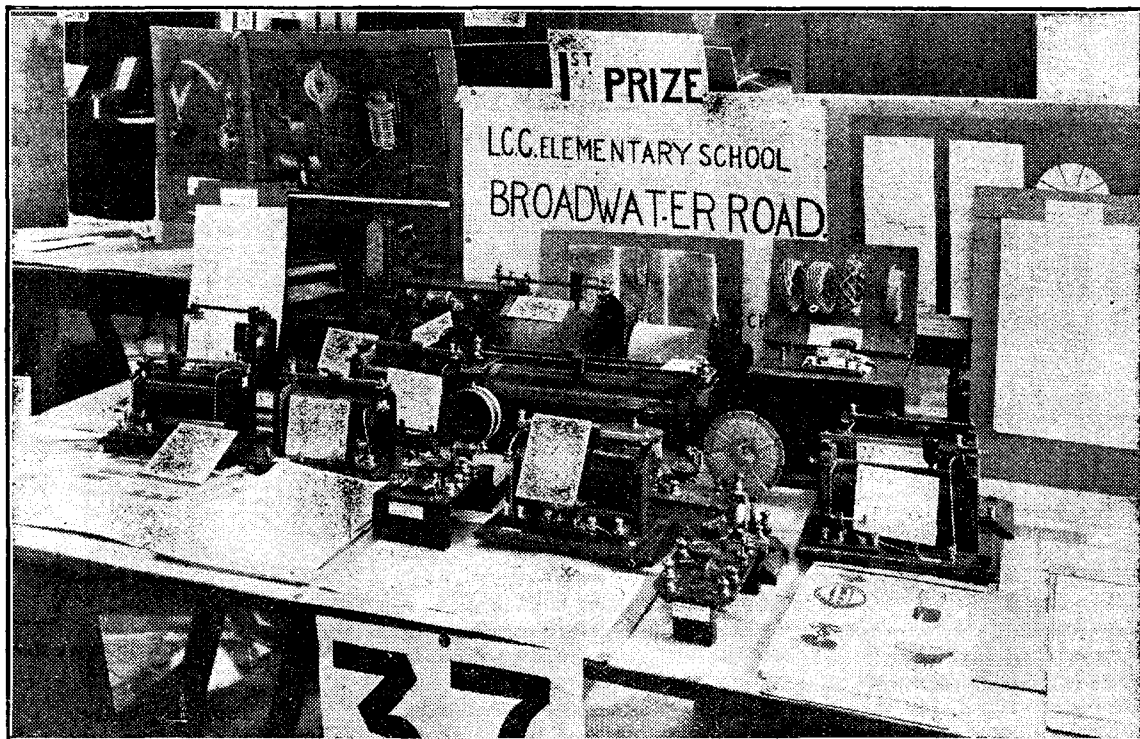

Our photograph shows the prize winning exhibit at the Schools Wireless Exhibition which was reported upon in our last issue.

Correspondence



"THE FOREIGN RADIO TIMES"

SIR,—I should like to express my great appreciation of *Wireless Weekly* and also *The Wireless Constructor*. In the former I consider *The Foreign Radio Times* is an excellent feature, but personally I would like Hilversum to be included.

If it is impossible to publish the complete programmes for the ensuing week, and if the various foreign stations included in your list have regular fixed times for their transmissions, it might perhaps be of value to listeners to have the times of the transmissions given (for the following week) even if details of programmes were not available.

I must say I thought the list which you published recently, giving a note of all the times through the day and a note of the foreign transmissions occurring at each time, was very excellent, as with that, at any time one wished, one could see at a glance what stations were transmitting.

I might mention that I have recently made up the "Simplicity" Three-Valve Set (Envelope No. 3 by G. P. Kendall, B.Sc.), which is a great success, and am now busy on the construction of the A.B.C. Wavetrap, described in Envelope No. 6 by the same author.—Yours faithfully,

WALTER G. BUCKELL.
London, E.C.3.

SIR,—I notice with interest your innovation, *The Foreign Radio Times*.

In my opinion it would be far more useful if you were to publish it as an *entirely separate* periodical. It could then be more complete and contain programmes for the whole week, published a few days before the first programme, for the benefit of readers abroad.

In this way it would not encroach on your space, which I would not like to see done, as in my opinion *Wireless Weekly* is far the best of your three periodicals.

Might I add that the set I use out here is the original "Transatlantic Three" described by Mr. Percy W. Harris in November, 1923, *Modern Wireless* with which

Chelmsford is audible all over a medium-sized room on a small Brown loud-speaker without any L.F. valves, the distance being about 1,000 miles!—Yours faithfully,

H. C. GRANT WATSON.
Lisbon, Portugal.

a far larger public than it does as a supplement to *Wireless Weekly*.

I wish it all the success it deserves.—Yours faithfully,
I. A. W.

London, S.W.6.

SIR,—I think the supplement that you are now publishing in *Wireless Weekly* supplies a definite need of the amateur wireless enthusiasts. I have found it of great use this week-end trying to get Continental stations on the wavelengths you have given and thus saved much time in experimenting.

I note that you are only giving programmes for five days, and wonder whether a full week may be given shortly, and also the programmes for Spain—Radio-Iberica.—Yours faithfully,

D. M. HUGHES.
Romford.

A READER'S COLLECTION

SIR,—I hope the photograph enclosed will me of interest to you and your readers. My wife sprang a surprise on me by having them photographed quite unknown to me, because she was of an opinion I should like to see my family altogether, and where the money goes; of course, that is just like a woman. Well, Mr. Editor, now we have the photograph I will endeavour to explain to you what is on show. You will notice I have, to my mind, two improved cabinets which give a pleasing appearance, and also offer protection to the valves; one is on the right, a finished two-valve, with dull-emitters, and on the left, unfinished, waiting for a circuit, is of the sloping type with a fender on top. The finished sets are the ST100, made according to Mr. Percy W. Harris's description, in background; two-valve by Stanley G. Rattee; one-valve—i.e., Simpson, and amplifying crystal set, all of *Modern Wireless*; in addition the "Simplicity," which has left for a holiday. They have all turned out top-hole, and work a loud-speaker 23 miles from 2LO. The cabinets, I might mention, are made of teak.—Yours faithfully,

W. W. FIGGINS.
Brentwood.

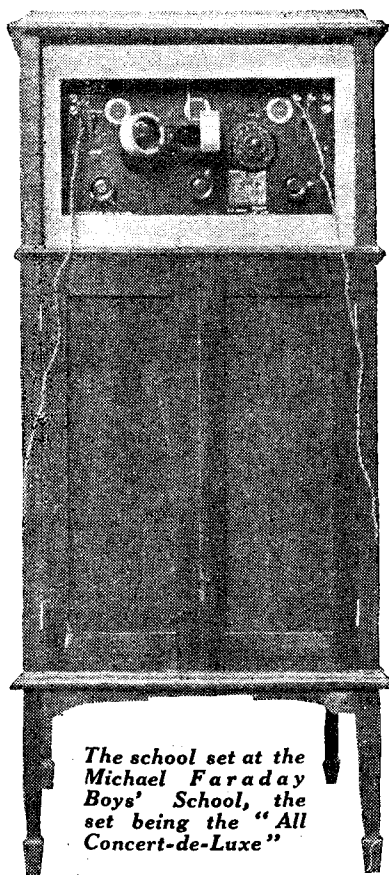

The school set at the Michael Faraday Boys' School, the set being the "All Concert-de-Luxe"

SIR,—May I congratulate you on your excellent new supplement, *The Foreign Radio Times*, now appearing in *Wireless Weekly*.

It must be a boon to thousands of listeners-in, who before found a difficulty in identifying the programmes from the various foreign stations.

May I suggest that in the near future it is published as a separate journal on the same lines and at the same price as *The Radio Times*, for as such I am sure it would reach

THE RESISTOFLEX RECEIVER

SIR,—I enclose two photographs of the Resistoflex receiver, and I must say the reception and purity of tone, as well as the volume are marvellous. Previously I have experimented with the ST34, but to my way of thinking the Resistoflex is far and away above that.

Considering we are 30 miles from aLO, it renders with the purity of an unamplified crystal, and is quite easy to tune.—Yours faithfully,

ERNEST WATTS.

East Grinstead.

A SINGLE-VALVE RECEIVER FOR KDKA

SIR,—I feel I must write and tell you of the excellent results I am obtaining with the KDKA single-valve receiver described by Mr. Stanley G. Rattee in the last number of *Modern Wireless*.

I have long been interested in short-wave reception, but since my

I took the remainder of the wire over from the coils and fixed it round the top of the wooden partition of my cubicle by the aid of drawing-pins. This was to function (or not!) as the aerial. I made an earth connection by winding a piece of bare wire round the hot-water pipes, and concealed the set under my bed. From 9 p.m. to 10 p.m. I picked up several French and other amateurs, one particularly being quite loud. At 11.15 sharp I tuned in KDKA quite easily, and followed the whole of his dinner concert. He was not what one might call loud, but perfectly distinct; I could follow every word he said, and the music was quite clear, especially a piece from "Die Meistersinger." Since then I have not had another opportunity of testing the set, but all should go well after such an eminently satisfactory "maiden voyage."

Incidentally, the valve used was a Cossor P1, which is nearly two years' old, and had only about

1924). Having constructed the set, I had excellent results as far as the first three valves, but on switching over to L.S. nothing came through. On entirely retuning on

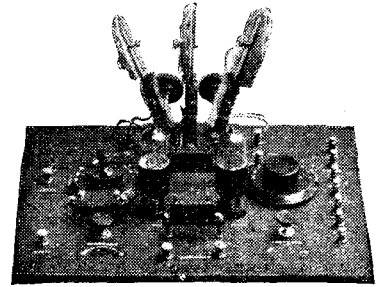

The "Resistoflex" made by Mr. Watts

both condensers or potentiometer, results were obtained for about 5-10 seconds, after which the set choked up and the trouble could only be remedied by switching off for a few moments.

Eventually the trouble was put right by changing the 80,000 ohms anode resistances for ones of 100,000. I have now got a set which I consider unsurpassed for all-round efficiency, and I think that thanks are due to Mr. Harris on the design. I am using the specified components except for a Burndept potentiometer in place of the Igranic and a Burndept switch for the Utility. The following are the stations I have received at my home on the Eastern edge of the New Forest, 18 miles from 6BM. These are all on a large Amplion loud-speaker: 6BM, London, Chelmsford, Cardiff, Manchester, Belfast, Newcastle, Birmingham, Radio-Paris, PTT, Petit Parisien, Madrid, Hilversum, Hamburg, Frankfurt, Leipzig, Nuremberg.

WBZ was recently brought in on 'phones connected to L.S. terminals and using five valves. Music, followed by Harvard and Yale baseball results. Quite loud and clear, but jammed by dreadful morse from Niton, I.W. I am

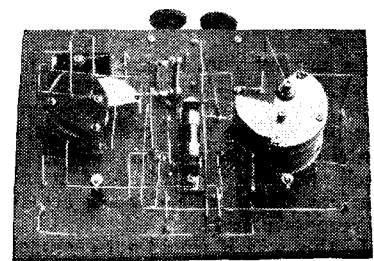

An underside of panel view of Mr. Watts' receiver

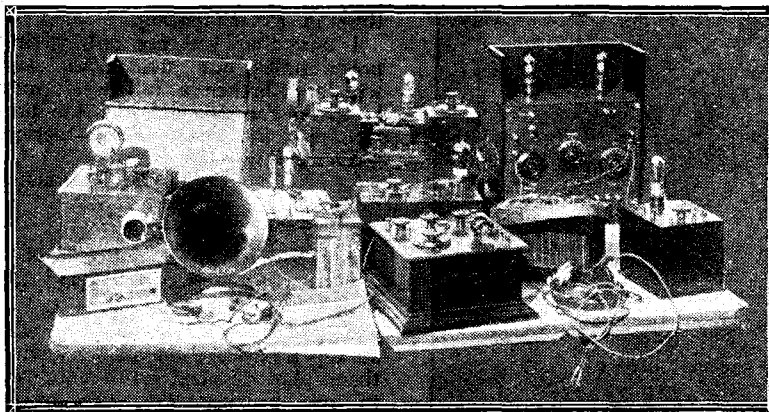

An interesting collection of Radio Press sets made by Mr. Figgins.

purse is not too well-lined, I have been unable to find a cheap enough design. However, when I estimated that this set would not cost me more than 12s. 6d., I decided to make it straight away. All I had to buy was some ebonite, a grid-leak and condenser, a .0001 mfd. condenser, and a .05 mfd. Mansbridge condenser. I stripped an old .0005 mfd. variable condenser of some of its plates, to bring its capacity down to the required value.

I then put the set together, exactly as described in *Modern Wireless*, being extremely careful to keep the panel free from flux by putting paper underneath all the connections when soldering.

The Mansbridge condenser, which is to shunt the H.T. and L.T., has not yet arrived, and I do not know what difference to expect in results when it is fitted. The only other difference to the specification is that of 18-gauge wire for the coils instead of 16-gauge.

As soon as I had the set ready

18 volts potential applied to the plate. Wishing you the best of success with your most excellent journals.—Yours faithfully,

"SCHOOLBOY."

SIR,—The receiver described by Mr. Stanley Rattee in your current issue of *Modern Wireless* is easy to build and highly efficient. KDKA on 68 metres is received, as stated by Mr. Rattee, at loud telephone strength with perfect clearness and free from atmospherics.

Thank you.—Yours faithfully,
CECIL E. BANBURY (Major).
Marden Hill, Hertford.

THE TRANSATLANTIC V.

SIR,—Knowing that you like to hear of results obtained by readers of Radio Press sets, I am writing to let you know my results with the Transatlantic V, by Mr. Percy Harris (*Modern Wireless*, June,

using two Cossor H.F. plain top, Cossor detector and two Marconi D.E.5B. Hoping this letter may interest your readers (I myself am a regular reader of your three

periodicals), and wishing you the best of luck.—Yours faithfully,
Winchester. H. C. HAMILTON.

[The first 80,000 ohms resistances were obviously faulty, as very little difference should be noted in making the change.—Ed.]

AN IMPROVED TWO-VALVE RECEIVER

SIR,—I have built the Improved Two-Valve Receiver described by Stanley G. Rattee in *Modern Wireless* of January, and can easily tune in Radio-Paris, 6BM, 5WA, 5NO, School of Posts, Paris, and Swansea. I might mention that I am delighted with the set.—Yours faithfully,

E. T. SMART.

Kidwelly.

AUTO-COUPLING

SIR,—Mr. Kendall's recent articles on the efficiency of coils have been very interesting and instructive, especially that in *Wireless Weekly*, March 4, giving the results obtained with the auto-coupled circuit.

May I suggest this hardly went far enough! And I crave for more for this reason. Stress seems always to be laid on "Selectivity," which for the valve user is essential, but is not so necessary for the crystal user. For him the maxi-

mum phone strength from the local station is the chief aim.

It seems to me, admittedly a

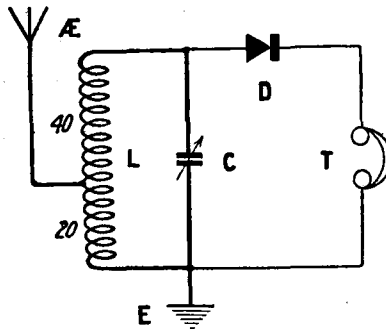

Fig. 1.—The first circuit used by Mr. Warren.

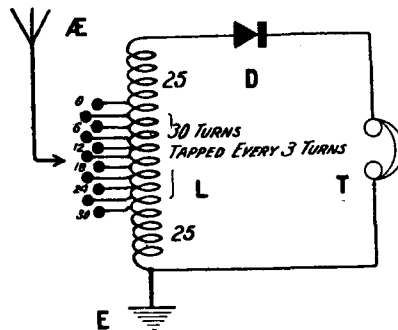

Fig 2.—The second arrangement tried by Mr. Warren.

novice among novices, that the signal strength lost on the "24" tapping on the above circuit could possibly have been regained and perhaps exceeded by extending the top end of the coil without the inclusion of the condenser.

I am led to think this because some time ago I constructed a crystal set (from *Wireless Weekly*) made with a "Harris" X former and 16 gauge wire, three slots of 20 turns each, and found it functioned best as in Fig. 1. Up to then it was the best I have constructed or tried. Recently, however, at the request of a friend, I made up a cheap set and cut out the condenser as in Fig. 2.

To my complete surprise, this gave a slightly better signal strength than the X coil set, using identical detector, phones, aerial and earth.

It seems to me, therefore, that further experiment is required, and unfortunately I do not possess the measuring instruments, or I think I should experiment with the circuit of Fig. 3.

Possibly you will be able to say "no good" at once; on the other hand, if you do try it, something may be found out.

Thanking you for these excellent articles from which I have benefited tremendously.—Yours faithfully,
H. W. WARREN.

The COLVERN BRINGS IN THE DISTANT STATIONS

Fit a Colvern
Independent
Vernier

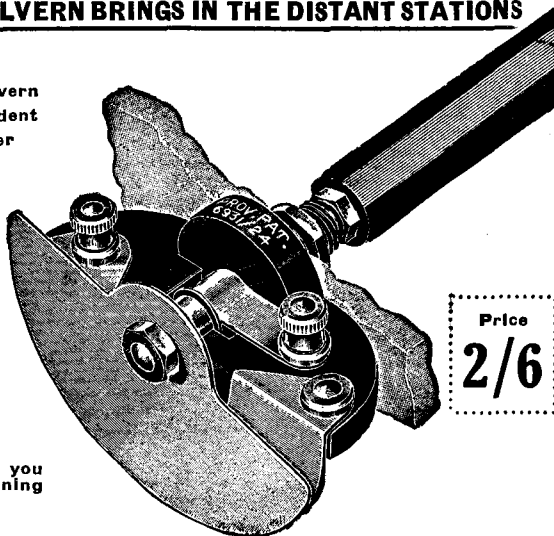

Price
2/6

It gives you
Fine Tuning

for very accurate H.F. work

Users of H.F. Receivers appreciate how extremely difficult it is to bring circuits into resonance. The large tuning condenser which permits only a comparatively large variation of capacity tends to make the accurate balancing of circuits a matter of chance. It is quite simple when searching for Distance Signals to pass over the correct dial reading, but if you use a low maximum capacity condenser which gives you very fine tuning, it will come as a pleasant surprise just how easily you can tune in weak signals.

Fine tuning control reduces the search for distant stations to extreme simplicity. Use the Colvern only across reaction, fit one in parallel with your large tuning condensers and you will demonstrate how extremely sensitive your set is to fine control. Remember that a vernier should not be in association with the main condenser.

Fit an independent vernier; your dealers sell them. The Colvern.

COLLISON'S PRECISION SREW CO. LTD. Macdonald Rd., Walthamstow, London, E.17. Tel.: Walthamstow 632.

Barclays

THE PANEL DE LUXE

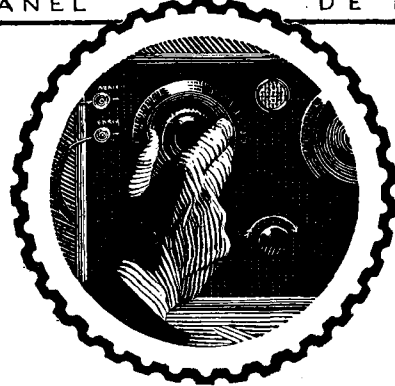

THE advantage that a Radion Panel confers on a Receiving Set is much more than merely adding a gold case to a watch. Rather, is it comparable to the addition of that delicate compensating balance wheel mechanism which ensures split-second accuracy. If you aim at 100 per cent. efficiency for your Set you'll naturally start with a Radion Panel. With dials to match.

Radion is available in 2x different sizes in black and mahogany. Radion can also be supplied in any special size. Black 1d. per square inch, mahogany 1½d. per square inch.

RADION

American Hard Rubber Company (Britain) Ltd.
Head Office: 13a Fore Street, London, E.C. 2
Depots: 120 Wellington Street, Glasgow. 1
116 Snow Hill, Birmingham.
Irish Agents: 8 Corporation Street, Belfast

Gilbert Ad. 263x.

NOTE: Where it is intended that the tuner shall be permanently adjusted to one wavelength it is, no doubt, desirable to omit the tuning condenser altogether, and use a finely adjustable inductance, so that the maximum p.d. may be obtained to operate the valve or crystal. Practical considerations, however, usually demand that it shall be possible to cover a wide band of wavelengths easily, and therefore a tuning condenser is used. We hope to publish further results of simple tests on these circuits at an early date.—ED.

A CHALLENGE

SIR,—As one of many of your Belfast readers who were interested in Mr. S. A. Booth's challenge to Mr. Haddick in your issue of February 25, I and others should be very glad to know from either of these gentlemen whether the test has been carried out or not, and if so, with what result.

Surely if Mr. Haddick's claim is correct, he will have no hesitation in accepting Mr. Booth's challenge, thus benefiting the Hospitals Wireless Fund to the extent of 20s.

My own personal opinion is that Mr. Haddick has a rather strong imagination, or perhaps he has only been rehearsing a vivid dream. Of course, if the test has been carried

out with success it is up to Mr. Booth as a sportsman to report the result.—Yours faithfully,
T. H. HOUSTON.
Belfast.

A READER'S EXPERIENCE ON SHORT WAVES

SIR,—In your issue of *Wireless Weekly*, No. 21, Vol. 5, it is stated

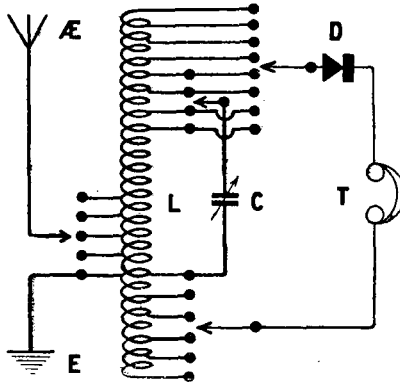



Fig. 3.—The circuit suggested by Mr. Warren.

that the famous Reinartz, working in conjunction with other experimenters in America, had discovered that very short waves, below 30 metres, would not travel in the dark. I do not propose to contradict this statement, as I am not

sufficiently expert in radio to pit my knowledge against that of such experimenters as John Reinartz, but I would like you to know the following: About four or five weeks ago, whilst experimenting on what I thought was 20 metres, I picked up faint, clear music, and I repeatedly heard the call-sign WGY. The music was remarkably pure and free from distortion, atmospherics were almost inaudible, and the reception was entirely free from the noise which has recently made itself troublesome on the 40-90 metre band. I informed my radio friends that I had heard a very low harmonic of WGY on about 20 metres! Your issue, No. 19, Vol. 5, surprised me when it stated WGY had been down on 15 metres, but I did not communicate with you as I thought it would not be of sufficient interest in view of recent amateur short-wave successes. I now feel that it may interest you.

The circuit used was that of the "Low-loss Tuner," by Mr. Percy W. Harris, but was panel-mounted and only one valve used. The valve was a Myers bright-emitter, and I find it the best for short-wave working. Coils used were one 3-in. turn in aerial primary, three turns aerial secondary and five turns reaction. The condenser was .0003 μ F and of cheap make. I was not using extension handles, and the slightest

Don't leave it to chance
make your set **SELECTIVE**—use

"Tangent" Tuning Coils

The Unshrouded Coil with the guaranteed **LOW SELF CAPACITY**.

Figs. below are taken from N.P.L. Report, copy sent on request.

Coil No. - -	25	35	50	75	100	150	200	250
Self Capacity in Micro-Microfarads	8	9	25	31	22	16	22	22
Price - - -	4/3	4/3	4/3	4/6	5/-	6/-	7/-	7/6

COMPLETE { 4 Concert Coils (W/L 250 to 1180)—16/- the set.
SETS { 11 Concert Coils (W/L 250 to 9500)—67/- the set.

Obtainable from all good dealers—
:: any difficulty—write us. ::

GENT & Co LTD (Est. 1872.)
Manufacturing Electrical Engineers
**FARADAY WORKS,
LEICESTER**



**UNSHROUDED
EFFICIENCY**



RIGID AS A MOTOR WHEEL.

movement of my hands upset the tuning, which was exceedingly fine. I held the station for about twenty minutes with varying success, and then, on attempting to "step it up," I lost it completely. The time was between 2 a.m. and 3 a.m., G.M.T., but I forget the actual date, as I did not take note of it because I believed it was merely an harmonic. My aerial is about 35 ft. long, single, and is about 40 ft. high at free end.

Although I have not since heard WGY on this wave, I am of the opinion that it is rather soon to settle definitely anything about very short waves, as their behaviour is very erratic.

It may also interest you to know that, using the same coils, I have heard WIZ clearing traffic by morse to LPZ (Buenos Aires), and I have written to the United States Naval Research Laboratory at Washington (NKF), for whom I am "logging," to ascertain his (WIZ's) position and wavelength. He comes in very strong with and without aerial and earth.

I would like to thank you for the "Low-loss Tuner," as it converted me to short-wave working. I would strongly recommend it to those who have not yet tried working short waves, as, apart from morse, KDKA comes in with a

roar. I have arranged low-capacity coil-holders and can use the set for any wavelength.—Yours faithfully,
PAUL MARSHALL.

Dublin.

GRID-CHOKE RECTIFICATION

SIR,—I have read with interest your article in March 11 issue of *Wireless Weekly* under the subject of Grid-Choke Rectification.

I beg to inform you that some months ago a patent was taken out by me covering this means of rectification, and as I am about to take out complete letters patent, you will be helping me if you could inform me whether this method has been previously used and/or patented.

I have been experimenting for the past 12 months with this particular circuit (Fig. 8 in your article) and have gone into the most exhaustive comparisons with the leaky grid rectification, and have found that, given proper values to inductances, capacities, etc., this method is infinitely more efficient than the old one.

Results obtained so far are as follows: Local Liverpool station, five miles away, full loud-speaker strength, using 60 volts H.T., B.T.H. B5 valve. Manchester, 35 miles away, good loud-speaker strength. Four German stations,

Brussels and Bournemouth clearly audible over room 15 ft. square, and America on every occasion the test was made.

Should you be able to give me any information as to previous investigations of this particular circuit, I shall be very greatly obliged.

Thanking you.—Yours faithfully,
PHILIP W. LACE.

Spital, Cheshire.

P.S.—Should you be interested further, I am quite willing to give you particulars as to values of capacities, inductances, etc., to obtain the best results from this very interesting circuit.

[Please do so. See my note elsewhere as to originality of the choke in place of the leak.—Ed.]

SINGLE-VALVE RECEIVER FOR KDKA

SIR,—I have constructed the single-valve receiver for KDKA, by Mr. Stanley G. Rantee in the current issue of *Modern Wireless*, and have found it a great success. I have used it four nights and have successfully heard KDKA's transmission 11.15 p.m. to 12 midnight. The absence of mush and X's is truly remarkable, and fading is only slight.

Thanking you.—Yours faithfully,
W. HAYNES.
Portsmouth.



"Father used to say that headphones hurt his ears"

"Now, it is quite a different story. He has fitted 'KUMFI' De Luxe Ear Pads to the 'phones, and all that Father can find time to say is... SH'... SH'... SH'!!!"

The new "KUMFI" De Luxe antiseptic Ear Pad is a soft, velvety pad that just covers the ear piece of the headphone, and entirely prevents that uncomfortable pressure on the ears and enables you to listen-in for hours without discomfort. In addition, it shuts out exterior noises, and prevents moisture collecting on the diaphragms. Each pad is antiseptic and self-adhesive, and can be fixed or removed without the slightest difficulty—no heating or damping is needed.

'KUMFI' De Luxe EAR PAD

the only scientifically prepared pad—can be had from Wireless Dealers, or POST FREE from the makers on receipt of 1/3.

A. de ST. DALMAS & CO., LTD., LEICESTER.

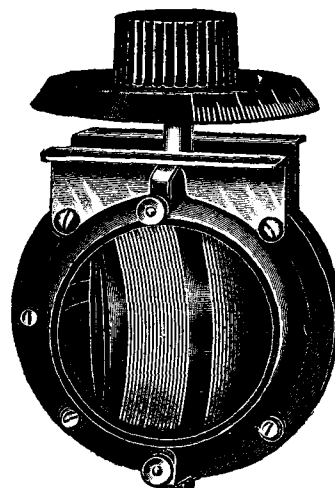
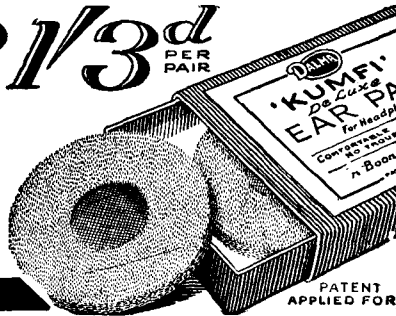

Low in cost —but high in efficiency

In the H. type Igranic Variometer you have an instrument to please not only by its highly selective tuning when used in aerial, secondary, tuned anode, rejector or selector circuits, but also in its very low cost of 10/-. The approximate wave-length is 150-600 metres when used with a P.M.G. standard aerial.

Ask your dealer about it.
Write for List Y52.

IGRANIC Radio Devices include:
Honeycomb Duolateral Coils, Fixed Condensers, Variable Condensers, Filament Rheostats, Interval Transformers, Variometers, Vario-couplers, Bi-plug Coil Holders, Tri-plug Coil Holders, Battery Potentiometers, Vernier Friction Pencils, Electric Soldering Irons, etc., etc.
All carry the IGRANIC guarantee.



149, Queen Victoria Street, London.

Works: BEDFORD.

Branches: BIRMINGHAM, CARDIFF, GLASGOW, LEEDS, MANCHESTER, NEWCASTLE.

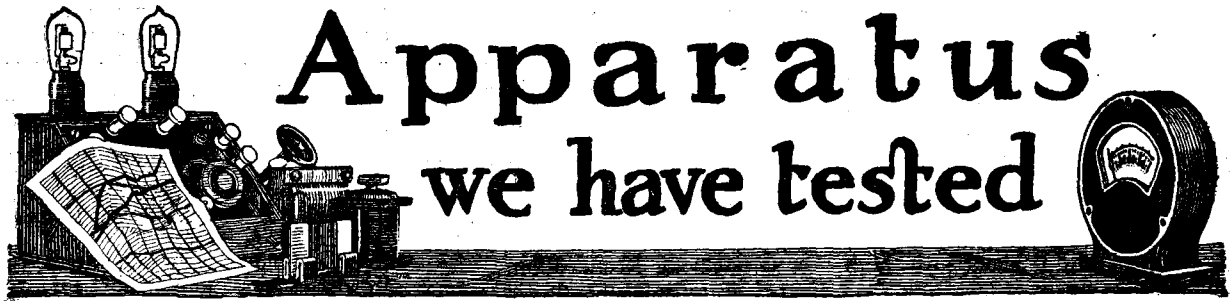

Conducted by A. D. COWPER, M.Sc., Staff Editor.

"R.G." Strip Coil

Messrs. Faulkner & Co. have submitted a set of plug-in tuning inductances, from the customary No. 25 to the No. 200, for our trial. These are of a very interesting type, in which a genuine effort has been made to produce a coil of really low high-frequency resistance by the use of copper strip, spaced laterally as well as insulated between layers by paper dielectric, and wound in the form of flat spirals. The result is certainly a coil of unusually low resistance, small reaction-demand, and good selectivity, in the lower members of the series. But the writer did not expect, from first principles, and from an elementary consideration of the usual distribution of high-frequency currents in adjacent conductors (especially when

in the form of strips with successive layers wound closely together in spiral form), that such an arrangement would show a materially decreased resistance below that of e.g. No. 22 or 20 S.W.G. wire properly air-spaced, so as not to crowd the major portion of the current flowing to a minute portion of the outer skin at the outer edges of the spiral (as undoubtedly must occur here). Actual comparison showed that this *a priori* reasoning was sound; the coils did not exhibit any lower resistance than a coil of the type indicated, though both reaction-demands and selectivity were considerably more favourable than in the average fine-wire commercial coil. As usual, there was less difference noticeable in the larger coils and at lower frequencies, where H.F. re-

sistance is so much less serious a phenomenon.

It is evident that great care must be taken with these coils to keep them very dry on account of the heavy dielectric losses in the mass of paper insulation if any damp penetrates the latter.

The tuning range, on trial, with a P.M.G. aerial and .0005 μ F (actual) tuning-condenser in parallel, together with inevitable casual panel and distributed capacities, was found to be:—No. 25, 1,160-900 kilocycles; No. 35, 1,040-770 kc.; No. 40, 860-600 kc.; No. 50, 680-480 kc.; No. 60, 500-410 kc.; No. 75, 400-325 kc.; No. 100, 375-230 kc.; No. 150, 260-172 kc.; No. 200, 204-130 kc.; covering therefore the range of wavelengths for practical reception from 260 to 2,300 metres



Now—make that Super-Heterodyne this better, BRITISH way

These new Transformer Units for Super-Heterodyne Circuits are the latest Bowyer-Lowe contribution to wireless progress. They are built expressly for use with British Valves, which have less internal capacity and more stability than foreign makes, so that it has been possible to increase the transformer amplification and yet obtain greater purity of signals and quieter functioning than has previously been possible.

On test a six-valve set fitted with these transformers gave greater amplification and selectivity than a seven-valve instrument with foreign transformer units.

The Bowyer-Lowe Units work at approximately 150 k.c. and pass sufficient side bands to prevent all distortion.

Every set is individually tested and matched at the same peak frequency so that an unequivocal guarantee of performance can be given. To eliminate all chance of short-circuiting, every transformer is tested at 500 volts between windings.

The complete set consists of an Input Filter Transformer with the primary tuned by a .0005 M.F. fixed condenser, and three Inter-stage Transformers. A matching number is fixed to all transformers and the condenser so that purchasers may assure themselves that they are buying a perfectly uniform set.

The Transformer Cases are of Polished Grade "A" Ebonite, all terminals being clearly marked. Wiring diagrams and layout are supplied with each set. Ample

supplies are available and should be ordered direct if not obtainable locally.

Price £4:0:0
the Set of Four.

OSCILLATOR COUPLER

In addition to the Super-Heterodyne Transformers we have introduced an Oscillator Coupler Unit to cover the broadcast band with a .0005 Variable Condenser. The coupler comprises grid and plate coils, together with coupling or pick-up coil and is fitted in an Ebonite Case uniform in size and shape with the Transformers, except that it has six terminals. **Price £1:0:0**

Complete Series

including 1 Input Filter, 3 Inter-stage Transformers with .0005 Dubilier Fixed Condenser, and 1 Oscillator Coupler, all matched and guaranteed. Price 25

Bowyer-Lowe Tested Intermediate Wavelength H.F. TRANSFORMERS

BOWYER-LOWE CO. LTD. RADIO WORKS LETCHWORTH

with adequate overlap, and giving good choice of reaction-coil at all points. On account of the low H.F. resistance of the short-wave coils, a smaller size than usual of reaction-coil could be sometimes chosen, particularly when using a series tuning condenser. Similarly, the No. 25 coil would oscillate on an aerial with which no oscillation at all could be obtained with the ordinary type of coil. With a .0003 μ F tuning-condenser and casual capacities alone, as in a secondary grid coil or tuned-anode, the No. 60 amply covered the whole short-wave broadcast belt from 580 to 1,130 kc.; the No. 75 with a .0002 μ F covered about the same belt, from 570 to 940 kc., and can, therefore, be used in this position for other than the short-wave relays. 5XX and Radio-Paris came in very well on the No. 200 with No. 150 reaction and direct coupling.

The coils are well made and highly finished. The coil base is of a ceramic material, and is rather brittle; care should be taken not to attempt to force the plug in an ill-fitting holder. Provided that it is kept very dry, we have no hesitation in recommending, from our tests, this interesting type of coil, which represents a distinct step in advance towards a really low-loss plug-in inductance.

Back-of-Panel Coil-Holder

A new pattern of two-coil-holder for mounting behind the panel made by the Grafton Electric Co., which has been already noticed in these columns, has been submitted for our comment. In this later pattern (which is similarly of the one-hole-fixing variety) an extension sleeve has been fitted to the central column which carries the fixed coil-holder and the co-axial spindle on which the moving coil-holder rotates. Both coils are thus carried well away from the back of the panel, the nearer fixed coil having a clearance of some 1½ in., and hand-capacity effects are very much reduced. Otherwise the instrument is of similar design and finish to that already reported on.

Hewetson Crystal Detectors

We have received from Messrs. Hewetson, Son & Co. some samples of crystal detectors of the conventional cat-whisker and galena type, the one pattern for panel-mounting in a vertical position, the other of horizontal arrangement already fitted on a small insulating base and provided with micrometer adjustment. Both have the essential parts of the mechanism enclosed in glass tubes.

The vertical type is on a circular base just over 1¼ in. diameter, to be secured on the panel by means

of a back-nut on a substantial brass column and by a screw which also holds the crystal-cup and provides the electrical connection to the latter. It stands about 3 in. high overall. The usual universal joint and sliding adjustment is provided at the top for the whisker-holder; the universal joint is tightened by means of a large milled head nut which, when removed, allows of the dismantling of the instrument and of free access to the crystal cup. The crystal is to be held by an annular screw-cap or cover, which has an aperture of less than ¼ in. diameter. This appears to be on the small side, since so small a surface of crystal is exposed for the exploration of the whisker, which will very soon wear the sensitive spot in the nightly setting. On trial, the holder worked freely and without shake; the whisker was observed to be of a favourable type and fineness.

The horizontal type has again the usual sliding and universal ball-and-socket movements; but the crystal holder (of the same type as in the other instrument) has an independent fine adjustment in the form of a small longitudinal movement given by a micrometer screw, and controlled by a second insulated knob on the opposite end from the whisker-holder. The whole springs

HAWK

MAXIMUM

Efficiency

—

Strength

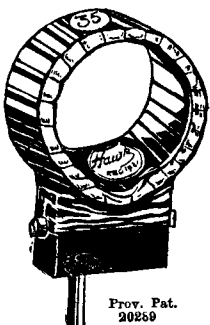

Prov. Pat. 20259

COILS

MINIMUM

Capacity

Damping Effects

Resistance

WATERPROOF

Coil	Wave Length using .001 Variable Condenser in Parallel		PRICE.
	MAXIMUM	MINIMUM	
13	—	—	2/-
25	395	190	2/4
30	435	240	2/4
35	515	360	2/6
40	680	370	2/8
50	835	485	3/-
75	1250	600	3/4
100	1820	815	3/10
150	2300	960	4/8
200	3100	1870	5/4
250	3750	2200	5/8
300	4500	2300	6/-
400	4950	2500	6/6

Sold by all Wireless Dealers

Sole Manufacturers:

The Hawk Coil Co.,

ST. MARY'S ROAD,
SURBITON, SURREY.

Another Guaranteed **BRETWOOD** Speciality

is our improved

ANODE RESISTANCE



(Patent No. 224,295)

which gives accurate readings consistently from 10,000 ohms to over 100,000 ohms. This BRETWOOD Component is particularly suited for the ST100 circuit (*Modern Wireless*), the super-sensitive circuit (*Popular Wireless*), and for resistance coupling, etc.

It is constructed on the same principles that have made BRETWOOD Components famous, and, of course, it carries the BRETWOOD Guarantee. Price 3s. Postage 3d.

BRETWOOD LTD.,

12-18, London Mews, Maple Street,
London, W.

All Bretwood specialities are obtainable from most Wireless Dealers.

BRETWOOD ANTI-CAPACITY SWITCH

Bretwood Specialities are known throughout the wireless world to be the last word in scientific achievement, and constructors will welcome news of a further Bretwood Product, an Anti-Capacity Switch, the principal features of which include:—

- Absolute freedom from capacity effects—Perfect Contact—
- Workmanlike finish and neatness of appearance—Simple single hole fixing and Easy to make wiring connections. Special spring loaded balls in the base make the Bretwood Switch wonderfully smooth in action and ensure clean and perfect electrical contact at all times.
- It is confidently offered to wireless constructors as the Anti-Capacity Switch *par excellence*, and of course it carries the famous Bretwood Guarantee.

5/-

Postage 3d.

BRETWOOD

GUARANTEED

BRETWOOD GRID LEAK.
Patent No. 224,295.
Used and recommended everywhere.
Price 3/- Postage 3d.

BRETWOOD PATENT VALVE HOLDER
Fix this efficient component and get maximum results. Positively no leakage or capacity effects. Perfect contact. Can be mounted on front or back of panel.
Price 1/9 Postage 3d.



Barclays 974.

out of place for dismantling and renewal of the crystal, etc. It is provided with two substantial terminals on the insulating base. The latter is nearly 4 in. long by 1½ in. wide, and can be used on the table for experimental work. On trial, the fine adjustment device was found to give excellent critical setting of the whisker, with the necessary light pressure from the springy whisker fitted. We should have liked again to have seen a larger crystal cup fitted for regular use.

A Knob and Scale-Fixing Device

Most experimenters have experienced from time to time the annoying habit that knobs and scales show of working loose on their spindles, when trust is perforce placed in the jamming action produced by screwing the knob hard down on to a lock-nut on the other side of the scale. Very few knobs and scales are fitted with proper substantial set-screws to obviate this difficulty, and when so fitted there is a tendency to injure the thread of the spindle, and also to make fine adjustment of the zero of the scale a matter of some precariousness. To overcome this difficulty Messrs. Grafton Electric Co. have recently brought out a simple locking device fitted to a finely finished knob and bevel scale of the usual type, and for application to the ordinary No. 2 B.A. con-

denser spindle. This device, which we have had an opportunity of putting to a severe test, has a small conical split sleeve, operating after the manner of an ordinary draw-in drill or brace-chuck, by being pulled up into the conical central bore of the bevel scale (provided for this purpose with a substantial boss), by means of a wide bore nut mounted in the knob itself, and which screws over the end of this sleeve. When applied on either a smooth or screwed spindle of the corresponding size the split sleeve grips the spindle firmly, when the scale is held stationary and the knob screwed down hard, and this without turning the spindle itself. Accordingly the knob and scale can be secured firmly without disturbing the setting of the instrument, and the scale set to zero with equal ease. There is not the same tendency to loosen other nuts and fittings on the same spindle (especially on a variometer spindle in the home-made variety) as with the older device of jamming lock-nuts. We can strongly recommend this simple and effective device.

Audio Choke

From Messrs. Grafton Electric Co. we have received a sample of their audio-frequency choke for filter circuits and for choke-capacity coupling in general, etc. This is uniform in size and build with the large new

patterns of L.F. transformers of the same make recently reported on in these columns, the only apparent difference being that there are but two terminals in the place of four. The same generous and well designed magnetic circuit is used, and the makers claim that there are no less than 30,000 turns of wire on this choke-coil.

Tested practically in choke-capacity coupling, it was immediately apparent that the high inductance provided, together with the generous iron core, gave sufficient impedance over the whole of the available audio-frequency range, so that there was no distortion noticeable at all traceable to the choke. With an efficient transformer-coupled three-valve circuit in the outer suburbs, using this choke-coil in the usual type of filter-circuit across the loud-speaker, on the extremely critical test of Paderewski's piano recital from 2LO, magnificent rendering was given over the whole piano range, from the high runs in the treble to the thunderous bass, at an intensity which taxed the capacities of a small power valve with ample H.T. voltage and 8 volts grid bias.

We can strongly recommend this large, finely finished instrument for such purposes, and as an insurance against breakdowns in the fine windings of telephones and loud-speakers when heavy anode current is used.

WIRELESS BATTERY SERVICE

(DEPARTMENT)

BATTERIES LOANED FREE

Charges for service only. Service comprises: Charging accumulator, free delivery and collection. Payments to be made one quarter in advance. 4 volt 80/40 amp. 6 volt 60/30 amp.

Fortnightly exchange (4 volt only) ... 15/- per quarter.
Weekly exchange (4 or 6 volt) ... 18/9 " "
Weekly " " " 2 Batteries 31/3 " "

Service within 15 miles of Charing Cross.

AUTO MECHANICAL RECTIFIERS LTD.,

Wireless Battery Service Dept.,

91, TABERNACLE STREET, E.C.2.

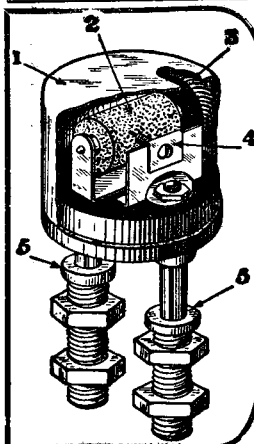

Don't tickle the Crystal—use

Harlie
FOOL-PROOF
DETECTOR

Provisional Patent 26731/24.

Continuous reception in any position at all times, owing to the special design of both crystal and catwhisker, being always in contact.

GUARANTEED TONE—VOLUME—PURITY
SOME NOVEL FEATURES:—

1. Nickel plated detachable dust proof cover.
2. Special "Harlie" super sensitive crystal.
3. Ebonite wheel for rotating crystal. No fumbling about adjusting, just turn the wheel—simplicity itself.
4. Catwhisker on slider for covering whole surface of crystal. Shock-proof.
5. Nickel plated sockets for panel mounting. Obtainable from all dealers or direct from patentees and manufacturers.

PRICE COMPLETE 5/6

Generous Trade Terms. Telephone: Clissold 293.
HARLIE BROS., 163 DALSTON LANE
HACKNEY, LONDON, E.8.

Quality
RADIO

COMPONENTS
for Back of Panel Mounting

2-COIL HOLDER
with plug terminals
for reversing re-
action. Price 8/6,
post 3d.

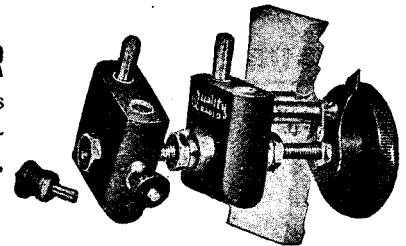

Anti-Capacity
VALVE HOLDER
with red insulated bush
to plate socket. Price 2/-,
post 2d.

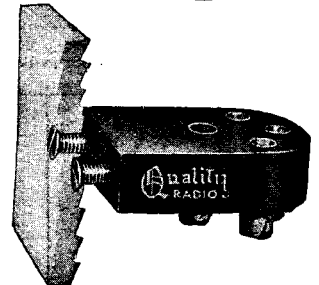

Quality
RADIO
BASKET
COIL HOLDER
Price 1/3, post 2d.



If your dealer cannot supply, we send post free if you mention his name and address.

GOSWELL ENGINEERING CO., LTD.
12a, PENTONVILLE ROAD, LONDON, N.1.
Liberal Trade Terms. LIST FREE. Phone: North 3051.

Information Department

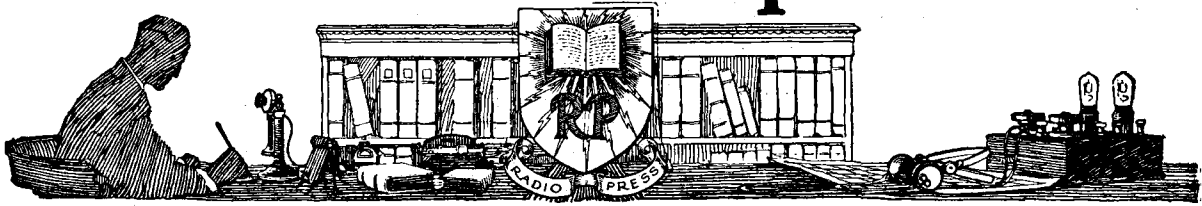

SUPPLIED BY RADIO PRESS SERVICE DEPT., LTD.

D. M. B. (RICHMOND) has built a two-valve and crystal reflex receiver employing a form of the Grimes circuit, in which both the valves act in a dual capacity, so that two stages of high-frequency amplification are provided and two stages of note magnification. He finds the set extremely unstable, the main trouble being self-oscillation at high frequency. He asks for any suggestions for stabilising this receiver, and suggests that he should insert a potentiometer to control the grid potential of the two valves.

The method suggested by our correspondent is not one which we would recommend, because it involves the placing of a positive bias upon the grids of the valves, which

is most undesirable from the point of view of distortionless low-frequency amplification. Better results would probably be obtained by the use of the conventional arrangement of a variable high resistance connected across one or more of the tuning circuits. For example, a variable anode resistance might be connected directly between the aerial and earth terminals, and if this does not give a suitable degree of control another might be connected across one of the tuned inter-valve couplings.

T. M. E. (DROITWICH) has been informed that instead of using an earthing switch as a protection against lightning, he can quite easily make for himself an earth arrester spark gap, and asks our

opinion with regard to the efficacy of such a device.

The earth arrester spark gap was originally used as a means of dispensing with a change-over switch from a combined transmitting and receiving installation, the apparatus consisting of an exceedingly short spark gap placed in series in the earth lead, across which the strong transmitting current jumped in a series of sparks. The received signals, however, were, of course, unable to jump this gap, and so passed through the receiving apparatus which was connected in parallel with the gap. Such an arrangement is a decidedly difficult one to arrange in a really efficient manner, since in most cases the earth arrester gap itself forms a condenser of

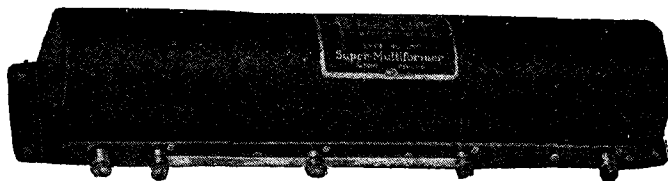

The PRECISE SUPER MULTI FORMER

One Instrument Which Does the Work of Four.

Replaces all long wave transformers in any type or modification of the Superheterodyne circuit. This instrument has met with the unanimous approval of noted radio experts and is already demanded by the public which is rapidly learning of its superiority over the conventional type of Superheterodyne transformer. It cuts in half the time and eliminates all trouble in building a Superheterodyne and insures the builder of successful results due to the short connections that are required from the instrument to the respective valve sockets thus preventing the experimenter from unconsciously causing undesirable coupling between circuits.

Price £4 17 6.

Fully illustrated constructional booklet including full size drawing on building the McLaughlin Super Heterodyne ... 5/-

N.B. All our products are fully tested and guaranteed by our Principal, C. G. Vokes, A.M.I.Mech.E., etc.

C. G. VOKES & COMPANY, 38, Conduit St., Regent St.,
Telephone: Gerrard 4693. W.1.

Wireless Gramophone Loud Speaker.

The Dulce-Tone

is a Link between Your Wireless Set and the Gramophone.

The Dulce Tone is NOT AN ATTACHMENT. It is used simply by placing the needle of the gramophone on the vibrating reed of the Dulce Tone. It does not require the removal or change of any part of the machine. Dulce Tone can be used and then laid aside as easily as a record—in fact, the operation is virtually the same. Hence, it does not reduce the use or availability of the gramophone for the playing of records.

Price £2 10 0.

FREE GIFT

To all purchasers of either of the components advertised, sending the name and address of their local dealer, we will forward post free a dainty nickel-plated match box holder and ash receiver for car or home use, sold in the Motor Trade at 7/6 each.

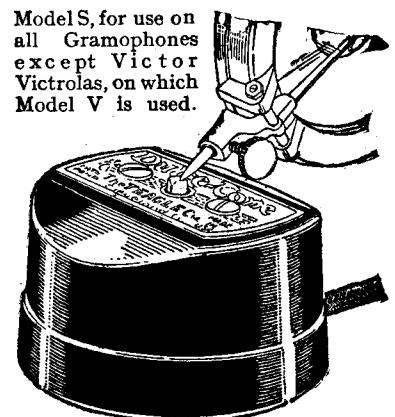

quite considerable capacity with its attendant losses. It is, no doubt, feasible to make such an appliance reasonably efficient, but its difficulty from the point of view of the amateur constructor does not seem to us to justify the trouble involved. Somewhat similar devices are upon the market, and may be purchased at quite reasonable prices, but they do not, of course, completely isolate the receiving apparatus from the aerial itself in a way that a double-pole change-over switch does.

H. A. (TRURO) asks for general advice for the construction of a complete receiving equipment to give him reliable signals from Chelmsford, with the minimum of interference from shipping. He states that his experience shows that a frame aerial will be practically essential, and he is prepared to build quite a large one.

We fear that our correspondent will find that a rather large number of valves will be needed to give him anything like good signal strength from a frame aerial in Cornwall, since we have had numerous reports that in the Truro area 5XX is extremely weak, an easier station to receive being Radio-Paris. The frame may be of 8 ft. diameter, with twenty turns of wire of a

gauge not less than No. 18. The spacing between turns should not be less than $\frac{3}{8}$ in., and the usual attention should be devoted to the careful insulation of the winding. Since our correspondent informs us that he has achieved a reasonable amount of success by means of a high-frequency amplifier containing three stages of resistance capacity coupling, following upon a special ultra-selective tuner, we think that the same amplifier might be used with the frame aerial, although the amplifier itself does not assist the actual selectivity of the frame. Three high-frequency valves should be adequate with the addition of two stages of low-frequency for loud-speaker work.

H. R. H. N. (N. 16) asks what is meant by an "artificial" aerial. He also wishes suggestions for experimental transmission work.

An "artificial aerial" is a combination of inductance, capacity, and resistance, giving the same general electrical effects as an ordinary aerial, but so disposed that it does not appreciably radiate energy. Such arrangements are useful in experimenting with transmitting circuits, but it must be understood when using them that it is impossible to estimate such values as range of the set, quality of modulation, etc. The

following are lines of research suitable for experiment in transmission. (1) The best arrangement of wiring and earth connections. (2) Methods of reducing loss at the leading-in insulator. (3) Various forms of counterpoise with and without an earth connection at the same time. (4) Circuits which are not affected in their oscillation frequency by variation in aerial resistance, height, etc., due to swaying in the wind. (5) Short-wave transmission below 200 metres with a view to finding best radiation methods.

B. L. T. (LLANELLY) experiences difficulty in obtaining a critical adjustment of reaction.

Your set appears to be suffering from a trouble known as overlap, for which you should apply the usual remedies. These are as follows:—Try different makes of valves for the rectifier, and vary the plate voltage and filament current of the high frequency and rectifying valves separately. You might also try varying the value of the grid-leak. The "howls" which you have heard are, of course, quite normal in such a receiver, but yours appears to be somewhat uncontrollable. We think that when you have corrected this difficulty you will be able to tune in other broadcasting stations.

RADIO PRESS ENVELOPE NUMBER 8. Price 1/6

HOW TO MAKE A ONE VALVE REFLEX RECEIVER

By HERBERT K. SIMPSON
EVERY POSSIBLE DETAIL GIVEN

LIST OF PARTS

1. 1000 ohm Resistor

2. 100 ohm Resistor

3. 10 ohm Resistor

4. 1000 ohm Resistor

5. 100 ohm Resistor

6. 10 ohm Resistor

7. 1000 ohm Resistor

8. 100 ohm Resistor

9. 10 ohm Resistor

10. 1000 ohm Resistor

11. 100 ohm Resistor

12. 10 ohm Resistor

13. 1000 ohm Resistor

14. 100 ohm Resistor

15. 10 ohm Resistor

16. 1000 ohm Resistor

17. 100 ohm Resistor

18. 10 ohm Resistor

19. 1000 ohm Resistor

20. 100 ohm Resistor

21. 10 ohm Resistor

22. 1000 ohm Resistor

23. 100 ohm Resistor

24. 10 ohm Resistor

25. 1000 ohm Resistor

26. 100 ohm Resistor

27. 10 ohm Resistor

28. 1000 ohm Resistor

29. 100 ohm Resistor

30. 10 ohm Resistor

31. 1000 ohm Resistor

32. 100 ohm Resistor

33. 10 ohm Resistor

34. 1000 ohm Resistor

35. 100 ohm Resistor

36. 10 ohm Resistor

37. 1000 ohm Resistor

38. 100 ohm Resistor

39. 10 ohm Resistor

40. 1000 ohm Resistor

41. 100 ohm Resistor

42. 10 ohm Resistor

43. 1000 ohm Resistor

44. 100 ohm Resistor

45. 10 ohm Resistor

46. 1000 ohm Resistor

47. 100 ohm Resistor

48. 10 ohm Resistor

49. 1000 ohm Resistor

50. 100 ohm Resistor

51. 10 ohm Resistor

52. 1000 ohm Resistor

53. 100 ohm Resistor

54. 10 ohm Resistor

55. 1000 ohm Resistor

56. 100 ohm Resistor

57. 10 ohm Resistor

58. 1000 ohm Resistor

59. 100 ohm Resistor

60. 10 ohm Resistor

61. 1000 ohm Resistor

62. 100 ohm Resistor

63. 10 ohm Resistor

64. 1000 ohm Resistor

65. 100 ohm Resistor

66. 10 ohm Resistor

67. 1000 ohm Resistor

68. 100 ohm Resistor

69. 10 ohm Resistor

70. 1000 ohm Resistor

71. 100 ohm Resistor

72. 10 ohm Resistor

73. 1000 ohm Resistor

74. 100 ohm Resistor

75. 10 ohm Resistor

76. 1000 ohm Resistor

77. 100 ohm Resistor

78. 10 ohm Resistor

79. 1000 ohm Resistor

80. 100 ohm Resistor

81. 10 ohm Resistor

82. 1000 ohm Resistor

83. 100 ohm Resistor

84. 10 ohm Resistor

85. 1000 ohm Resistor

86. 100 ohm Resistor

87. 10 ohm Resistor

88. 1000 ohm Resistor

89. 100 ohm Resistor

90. 10 ohm Resistor

91. 1000 ohm Resistor

92. 100 ohm Resistor

93. 10 ohm Resistor

94. 1000 ohm Resistor

95. 100 ohm Resistor

96. 10 ohm Resistor

97. 1000 ohm Resistor

98. 100 ohm Resistor

99. 10 ohm Resistor

100. 1000 ohm Resistor

THIS ENVELOPE CONTAINS

1. Full and elaborate sheets of instructions

2. Two full-size blue prints

3. Three sheets of photographs on art paper

4. A sheet of working drawings

ASK FOR THIS FROM RADIO PRESS ENVELOPES

Radio Press Ltd
BUSH HOUSE, STRAND, W.C.2.

ALL THE INSTRUCTION NEEDED TO MAKE THIS

ONE VALVE REFLEX RECEIVER

IS CONTAINED IN OUR ENVELOPE NO 8



RADIO PRESS ENVELOPE No. S. 8.

HOW TO MAKE A ONE VALVE REFLEX RECEIVER

By Herbert K. Simpson

1/6 NET. (Post free 1/9)

This envelope contains full and elaborate sheets of instructions, two full-size blue prints, three sheets of photographs on art paper and a sheet of working drawings. An ideal one valve set for working a loud-speaker up to 10 miles from a broadcasting station. Strong 'phone signals are obtainable from many stations.

Obtainable from all Newsagents, Bookstalls, local Wireless Dealers or direct from the Publishers. When ordering direct be sure and quote Envelope No. S. 8.

RADIO PRESS, LTD, Bush House, Strand, W.C.2.

908



APRIL ISSUE
ON SALE
TO-DAY

1/-
Monthly

A SELECTION FROM CONTENTS

HOW TO MAKE:

- An Experimenter's Supersonic Receiver.
G. P. Kendall, B.Sc.
- A General Purpose Three-Valve Receiver.
By A. Johnson-Randall.
- A Drawing-Room Two-Valve Receiver.
By John Underdown.
- A Simple Selective Set.
By A. D. Cowper, M.Sc.
- A Crystal Set for Comparative Tests.
By A. S. Clark.
- A Split Secondary Tuner.
By John W. Barber.
- The Zurich Broadcasting Station.
By Capt. Plugge, B.Sc.
- Using the Potentiometer.
By R. W. Hallows, M.A.
- Trouble Corner.
In Passing.
- Regular Transmissions from Continental
and American Broadcasting Stations.
By Capt. Plugge, B.Sc.

WHAT are the latest improvements in Radio; how far has so-and-so invention been developed and how will it affect or influence listeners-in?

What new circuits have been devised; what additional benefits are to be derived from their adoption? What is a suitable set for me to build next, or how can I make use of my components? All these, and many other questions of an analogous character, are fully dealt with in the Splendid New Issue of "MODERN WIRELESS" now on sale throughout the country. This, your favourite journal, excels itself by its fearless originality and exceptional brilliance displayed in the current number, which includes articles from writers whose names are household words. These experts contribute a really interesting, instructive and powerful work for the general benefit of the Radio public.

All experimenters will appreciate a serious endeavour on the part of G. P. Kendall, B.Sc., to assist their entry into the field of superheterodyne reception, which is very little known to most British enthusiasts. The article is entitled "An Experimenter's Supersonic Receiver," and the set, which is described in full detail, is thoroughly practical and effective. It is especially designed to facilitate general experimental work on the superheterodyne, and is used by the author himself for this purpose.

Readers desiring to construct a useful set without delving unduly into the intricacies of wireless technique have been fully provided for by A. D. COWPER, M.Sc., who describes "A Simple Selective Set." This receiver, as its name implies, ensures selectivity, and its construction should be well within the capabilities of the modest enthusiast.

In addition to this, there is an interesting article by PERCY W. HARRIS, M.I.R.E. (Assistant Editor) giving most valuable advice to those who, owing to lack of information on some minor points, have hitherto hesitated to step into the field of constructors and experimenters.

That other grades of our readers have been suitably provided for will readily be seen from a brief glance at the Contents selection.

If you contemplate a new receiver, or an addition to your existing set; if you wish to augment your knowledge of wireless or test a new circuit, "MODERN WIRELESS" will show you how, and, moreover, in the most interesting and economical manner. Buy your copy to-day. It is as good as a course of Wireless. 1/- per copy.

MODERN WIRELESS

Edited by JOHN SCOTT-TAGGART, F.Inst.P., A.M.I.E.E.

for Sunny days are near — and Radio is here

Sterling radio has a place in outdoor life, for everywhere on sunny days it is ready to provide the constant charm of music, song and speech. On the river, in the garden, by the sea—what prospects of happy pleasures it opens up for spring and summer!

Convenient apparatus giving perfect results will enhance the enjoyment of broadcast reception—that is why the Sterling way is the sunny way in radio.

Test the truth of this claim where you will, for Sterling products have a world-wide reputation for unflinching efficiency and convenient simplicity. Dealers everywhere are ready to demonstrate.

Sterling publication No. 364c gives full particulars of Sterling Radio apparatus. Ask your dealer for a copy.



The STERLING "DINKIE" Loud Speaker

The little fellow with the loud voice. A loud speaker without equal in its class. Small in size but big in volume—small in price but big in value. "Dinkie" reproduces clearly, loudly and in perfect tone all that is broadcast. In brown tinted finish. PRICE **30/-**



The STERLING "BABY" Loud Speaker

The most popular entertainer in the world, giving ample volume for all usual requirements and a reproduction that is consistently faithful and pleasing in tone. In black or brown tinted finish. PRICE **55/-**



THE STERLING "ANODION-ONE"

A highly efficient one-valve receiver giving splendid results often at considerable distances under favourable conditions. The tuning units available for this set cover a wave-band of 275-7600 metres. With B.B.C. coil, but without accessories. PRICE **£7:7:0**



STERLING RADIO

FOR THE SUNNY DAYS SO NEAR

at your
Radio Dealers



Advt. of STERLING TELEPHONE AND ELECTRIC CO., LTD.
210-212, Tottenham Court Road, London, W.1
Works: DAGENHAM, ESSEX

Printed for the Proprietors, RADIO PRESS, LTD., Bush House, Aldwych, W.C.2, by THE AVENUE PRESS (L. Upcott Gill & Son, Ltd.), 55-57, Drury Lane, London W.C.2. Published on Wednesday of each week at 3, Bolt Court, Fleet Street, London, E.C.4. Address for Subscriptions and Editorial Communications:—Bush House, Strand, London, W.C. Advertisement Managers:—BARCLAYS ADVERTISING LTD., Bush House, Strand, London, W.C.2. Registered as a newspaper and for transmission by Canadian Magazine Post. Subscription rates:—32/6 per annum, 16/3 for six months, post free. Sole Agents for Australasia:—GORDON & GOTCH (Australasia), LTD. For Canada:—IMPERIAL NEWS LTD. For South Africa:—CENTRAL NEWS AGENCY, LTD. For Japan:—SALE & FRAZER, LTD.

Wireless Weekly

Vol. 6. No. 1



Burndept lead again!

A Short Wave Receiver for 50-150 metres

THE Ethophone Short Wave Receiver has been produced in order that anyone who can handle an ordinary broadcast set can receive ultra short wave transmissions with ease and certainty. The use of short waves is decidedly on the increase, and as ordinary receivers are not quite suitable for such wave-lengths the introduction of an instrument specially designed for the purpose will be welcomed. The instrument has a wave-length range of 50-150

metres, covering amateur radio telegraphy stations and KDKA, the renowned Pittsburg broadcast station which transmits nightly on 64 metres. Any evening anywhere in Great Britain, it is easy to log dozens of American amateur stations, and, after 11.30 p.m., KDKA will be received at full telephone strength, and at loud speaker strength when a one or two valve amplifier is used. The new Ethophone model will be found all that can be desired by the most experienced amateur. It is quite simple to operate, the controls being four in number—two tuning condensers, a special vernier condenser so arranged that tuning in a 60 metre station is as easy as tuning in a 400 metre station on an ordinary set, and a reaction control. A single switch controls the lighting of the two valves—detector and low frequency amplifier—and gives two separate wave-length ranges of 50-100 and 80-150 metres. No plug-in coils are required. The panel of the Ethophone Short Wave Receiver is free from untidy wires, as all terminals are placed conveniently at the back of the cabinet. This receiver matches the Ethophone Power

Amplifier (Mark IV) with which it forms a four valve short wave receiver of enormous range and power.

Write for particulars of this new Burndept instrument.

Ethophone Short Wave Receiver (No. 1540), 50-150 metres, without valves or batteries **£17 10s. 0d.**

Marconi Licence, £1 5s.

Ethophone Power Amplifier, Mark IV (No. 1520), two-valve type, without valves or batteries **£22 0s. 0d.**

Marconi Licence, £1 5s.

Purchase Burndept by its name—substitutes are not the same.



-CUT HERE-

To BURNDEPT LTD., Aldine House,
Bedford Street, Strand, London, W.C.2.

Please send me Publication No. 69,
giving full particulars of the new
Ethophone Short Wave Receiver.

NAME.....

ADDRESS.....

DATE..... "Wireless Weekly," 8/4/25.

BURNDEPT

WIRELESS APPARATUS

BURNDEPT LTD., Aldine House, Bedford St., Strand, London, W.C.2.

Telephone: Gerrard 9072. Telegrams: Burndept, Westrand, London.

LEEDS: 12, Basinghall Street (near City Square).

CARDIFF: 67, Queen Street. NORTHAMPTON: 10, The Drapery.

BIRMINGHAM: Winchester House, Victoria Square.

Assistant Editor :
PERCY W. HARRIS,
 M.I.R.E.

Scientific Adviser :
Prof. G. W. O. HOWE,
 D.Sc., M.I.E.E.

Advisory Editors :
Prof. R. WHIDDINGTON,
 M.A., D.Sc.
Prof. C. L. FORTESCUE,
 M.A., M.I.E.E.

Wireless Weekly

Phone: City, 9911.

Staff Editors :
E. H. CHAPMAN,
 M.A., D.Sc.
A. D. COWPER,
 M.Sc.
R. W. HALLOWS,
 M.A.
G. P. KENDALL,
 B.Sc.
STANLEY G. RATTEE,
 M.I.R.E.



EDITED BY JOHN SCOTT-TAGGART,
 F.Inst.P., A.M.I.E.E.

Summer-time Radio

NOW that broadcasting is no longer a novelty, but has settled down as a regular and much appreciated ingredient of our daily life, it is well to consider whether an effort should not be made to place summer-time radio on a proper footing. Mere statements that "this will be a radio summer!" or pretty pictures depicting dances on lawns will not carry us very far. The public as a whole must be educated up to the important advantages of radio as a summer-time amusement.

So far, the public has not evinced any special interest in portable sets, although we believe that last year some of the best known commercial makes sold very well, and the Radio Press portable designs were made up in considerable numbers. In the main, however, the broadcast listener prefers to use his wireless at home, and if he has a set using telephones, then the warm weather will soon bring home to him the inconvenience of wearing headphones in the dining-room when the rest of the family are sitting in the garden.

There are at present on the market a number of excellent loud-speakers, which, used with suitable receiving gear give a reproduction which pleases the most fastidious. Most loud-speaker manufacturers advertise their products in such a way as to appeal to the more experienced listener. The beginner with a crystal set glances at the advertise-

ment, and says to himself: "That is no good for me. My set will not work a loud-speaker." There are still thousands of people who do not realise that the attachment of a two-valve amplifier to a crystal set will, in the great majority of cases, give full loud-speaker strength and admirable quality.

Of course, the B.B.C. must do their part. For the summer

wondering where to go for their holidays. The town authorities at the great seaside resorts are nowadays fully alive to the importance of publicity. Why not run a series of evening talks explaining the advantages and facilities of the various watering places? On one evening, for example, we might have a twenty minutes talk on the merits of Brighton, while on another evening a speaker connected with some resort in North Wales might explain the charms of his particular locality. There should not be the slightest difficulty in obtaining the right speakers. Again, this year thousands of new motorists will be on the road. There might be a weekly talk from each of the main stations on suitable trips in the locality for half-days and weekends, the state of the roads, and other such matters.

Finally, there will be this year still more dances in the open air, to the music distributed from loud-speakers. Cannot the Savoy Band be persuaded to give us a few new tunes? We believe the British Broadcasting Co. pay quite a considerable fee for the privilege of broadcasting these bands, and this fee, of course, comes from funds contributed by the public, and the public is getting just a little tired of the present well-worn tunes.

CONTENTS

	Page
Wireless at the Boat Race	2
Reception Conditions Week by Week ..	6
How to Charge Accumulators	7
Some Notes on Low-Frequency Amplification	10
Jottings by the Way	14
Some Experiments with Aerial Coupling Methods	16
How to Fix a Window-pane Lead-in ..	21
An Ultra-Short-Wave Valve Mounting	23
Radio Notes and News	24
Correspondence	25
Apparatus We Have Tested	30
Information Department	33

period there should be a thorough revision of the lecture programmes to make them suitable for the time of the year. Important items should, we think, be placed towards the end of the programme as in the early hours of the evening most people are likely to miss them.

At this time of the year hundreds of thousands of people are

Wireless at the Boat Race.

By E. REDPATH.

“**T**HE Oxford boat is sinking!”

By this brief but dramatic statement from three loud-speakers, the hundreds of spectators in the Cambridge enclosure at Dukes Meadows were informed of the unfortunate end of Oxford’s hope of victory in the race.

M.L. Etona

The words were actually spoken by our representative on board the motor-launch *Etona*, following the competing crews, and, by means of a low-power short-wave transmitter on the launch and a temporary receiving station with loud-speaker equipment in the enclosure, every incident, from the “toss for position” to the time when the

Cambridge boat passed the winning post, was faithfully reported.

Although wireless telegraphy has been employed previously on similar occasions—the last two races being reported by means of

80-metre spark transmission—this was the first time the spectators heard the spoken words of an actual eye-witness of the race from start to finish. Judging by the cheers which greeted the various announcements, the method was successful and appreciated.

The Arrangements

The complete arrangements were undertaken by Radio Press, Ltd., in co-operation with Burndept, Ltd., at the request of Mr. H. E. Morrison, the President of the Cambridge Boating Club, who, owing to ill-health, resigned in the early stages of the crew’s training. Mr. Morrison himself contributed largely to the success of the radio undertaking by facilitating arrangements and personally assisting in the several preliminary tests. He will be seen at the wheel of the launch in the above photograph.

The Technical Aspect

Apart from the practical or utility side of the matter in which radio telephony may be regarded merely as a means to a certain end, the technical aspect is interesting, and the writer purposes giving a brief description of the apparatus employed, together with an account of the tests made and the incidental

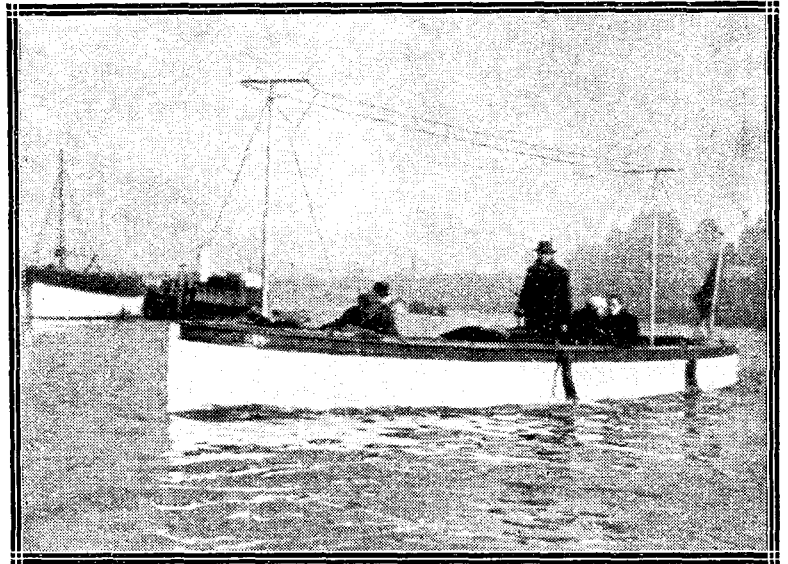

The wireless launch which followed the competing boats.



The receiving apparatus installed in the van at the Cambridge enclosure.

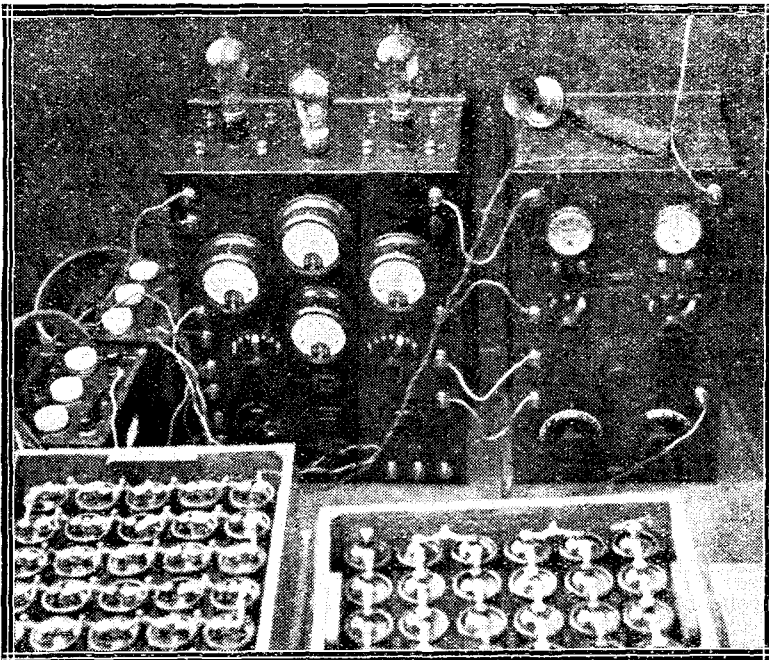

The transmitting apparatus and batteries on the launch.

How the progress of this historic event was reported by radio telephony for the first time.

indicate plate and grid currents to the valves and filament voltmeter, being fitted to the left-hand unit, whilst the tuning, reaction and modulation adjustments with high-frequency ammeters to indicate the currents in the aerial and closed oscillatory circuit are in the right-hand unit. (See photo of transmitter on this page.)

Call-Sign

Special permission for both stations was, of course, obtained

difficulties encountered and overcome.

The technical organisation and responsibility for the success of the undertaking was in the hands of Capt. R. Tingey, Chief of the Radio Press Service Department, assisted by the present writer. All the apparatus used was supplied by Burndept, Ltd., who courteously arranged that we also had the valuable assistance of two members of their experimental staff—Mr. J. H. D. Ridley (who will be remembered in connection with long-distance transmission and reception) and Mr. S. Hills.

The Transmitting Station

The small motor-launch did not afford many facilities in the way of aerial erection, but, as will be seen from the photograph, we managed a small but serviceable two-wire aerial attached to spreaders and suspended between two light wooden masts, each about 9 ft. high.

The Aerial

The two wires were joined in the usual "V" to a single wire down-lead connected to the aerial terminal of the transmitter. It was subsequently found necessary to add an external aerial - tuning inductance,

and during the race a peculiar incident occurred in which this inductance figured largely; but of this more anon.

The earth connection was made to the frame of the launch engine. An alternative "earth," consisting of a coil of bare copper wire trailing in the water over the side of the launch, was also tried, but did not prove any advantage.

The Transmitter

The transmitter itself consisted of two separate but interconnected units; the oscillator valve, control valve (each a Mullard 0.40) and sub-control or speech amplifying valve (D.E. 5), together with millie meters to

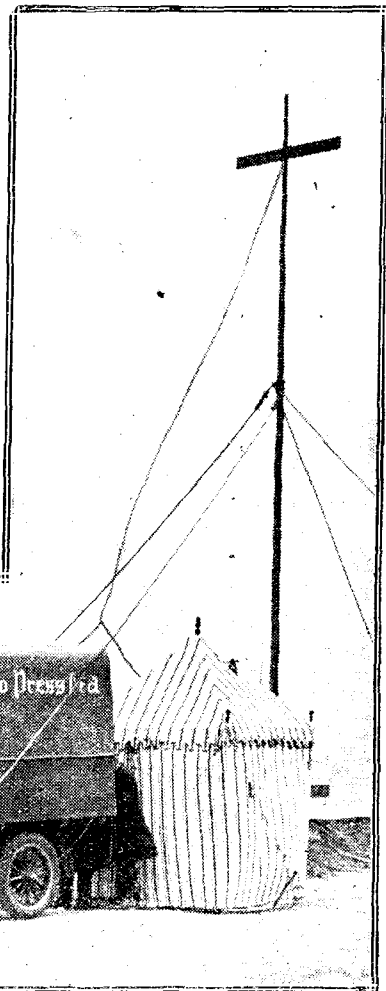

A general view of the receiving station and signal mast.

from the Post Office authorities, and the call-sign 2CU was allotted to the transmitter. That many local amateurs searched for and found the transmission was clearly shown by the "chirps" of oscillating receiving sets heard at the receiving station. With the exception of one offender, however, who interrupted once or twice, we were pleased to find that, during the whole of the race period, receiving sets in the vicinity were kept under proper control. For this sporty conduct, our thanks to those concerned.

The Receiving Station

The Radio Press delivery van formed a suitable shelter for the receiving apparatus, which consisted of a newly designed short-wave receiver and power amplifier—both by Burndept, Ltd.—

operating three Ethovox loud-speakers.

The receiver, which includes a detector valve (D.E.3B) and low-frequency amplifying valve (D.E.3), is capable of tuning-in wavelengths from 50 to 150 metres, and, in conjunction with a single-wire aerial from the van to the crossbar of the signal mast shown in our photograph, gave excellent reception, the two-valve power amplifier with D.E.5 valves being readily switched on when full loud-speaker strength was required. The receiver unit alone on a six-foot vertical aerial wire and usual earth connection will bring in KDKA quite readily.

The Earth

The "earth" consisted of about 20 feet of bare copper wire placed beneath newly laid loose

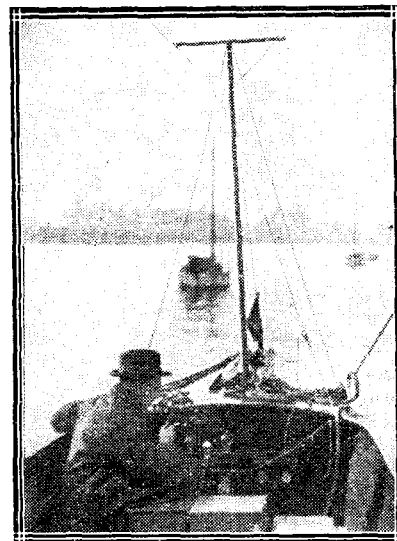

The writer on the launch during the trial run.



Capt. R. Tingey testing the transmitter. Note the aerial inductance referred to in the article.

turf alongside the van. For the actual race period the three loud-speakers were placed at some little distance from the van, one being inside a marquee about 40 yards from the receiver, a second being suspended from one of the guy ropes of the signal mast, whilst the third loud-speaker stood on top of the van. This gave a satisfactory distribution of sound over the whole enclosure, speech being clearly audible at about 35 yards from each loud-speaker.

Preliminary Trials

In order to ensure success, several tests were made. In the first place, the receiving apparatus was temporarily installed in the Leander Club House and a short transmission made from the launch in the river, followed by a full-course test, with Capt. Tingey operating the receiver in the Club House and the writer transmitting from the launch.

In addition to slight trouble with the microphone (readily rectified on conclusion of the run), difficulties occurred apparently due to (a) engine vibration of the complete transmitter; (b) engine noise entering the microphone, and (c) magneto "click."

Further trial and examination eliminated the first-named trouble. The second was overcome by inserting a wad of cotton wool into the mouthpiece of the microphone, but the magneto noise was never completely cut out, and was apparent during the final

transmission, but not to an extent which interfered with reception.

A peculiar effect was noted during the run. As the launch passed beneath any of the bridges, the reading of the aerial ammeter dropped slightly and, at the receiver, speech volume decreased considerably, the effect being that of shutting and re-opening the doors of a cabinet gramophone.

Having made the small but necessary improvements on the launch, the van receiving station was set up in its proper position in the Cambridge enclosure, and a further full-course test at speed indicated that everything was in working order.

The Race

Making an early start on the day of the race, the van receiving station was erected, the loud-speakers placed in position, and tests were made with the launch in the river at Putney. Shortly the spectators commenced to assemble, and the many questions asked showed the interest which the van and its equipment evoked.

Tests

Half-hourly tests were continued up to 2.30, and at 2.45 the loud-speakers were switched on; a preliminary announcement

was made from the van by means of a local microphone, after which announcements were made by wireless from the launch as events at Putney required.

The rule that each boat must abide by its own accidents; the result of the toss; the launching of the boats; were announced in turn, and then "They're off," which called forth a cheer.

State of Water

Indicative of the state of the water is the fact that no sooner had the wireless launch got under way than a quantity of water was shipped which drenched the transmitter and operators, and the separate aerial tuning inductance already referred to had to be carefully dried during the actual transmission. As this

kind of thing cannot be done with impunity on a wavelength of 113 metres (!), the speech was temporarily broken and had to be relayed to the loud-speakers via the local microphone in the van.

Following the statement that Cambridge were well away and leading by 2½ lengths came the announcement which commences this article and, of course, after that the excitement of the race was unfortunately gone.

Altogether the wireless undertaking was a distinct success. Possibly its utility was emphasised owing to the mishap to the Oxford boat, as it afforded the only means of informing the anxious spectators "what had happened to Oxford."

A Simple Dial Indicator

A POINT which is often ignored in the assembly of receivers is the mounting upon the panel of an indicator, whereby the position of the variable condenser dial may be easily and accurately read.

A neat device for this purpose is now on the market, but those who desire to make one will find

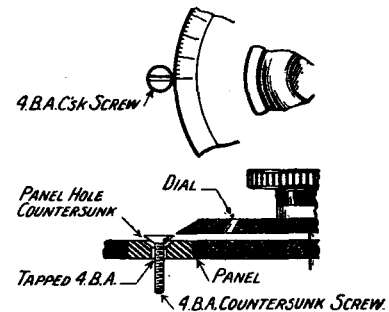

Constructional and explanatory details of the indicator.

the idea shown in Fig. 1 simple and efficient.

All that is necessary is to tap a 4 B.A. hole in the panel at a distance from the variable condenser spindle hole, equal to the radius of the condenser dial plus half the diameter of the head of the 4 B.A. countersunk screw-head. The tapped hole is then countersunk to a depth equal to the depth of the head of the screw. Whatever the distance of the underside of the condenser dial from the surface of the panel, the screw may be adjusted to suit, as shown. The slot in the head of the screw acts as a reading line in conjunction with the scale of degrees on the panel. The head of the screw may be treated with black enamel to make the slot stand out clearly if desired.

H. B.

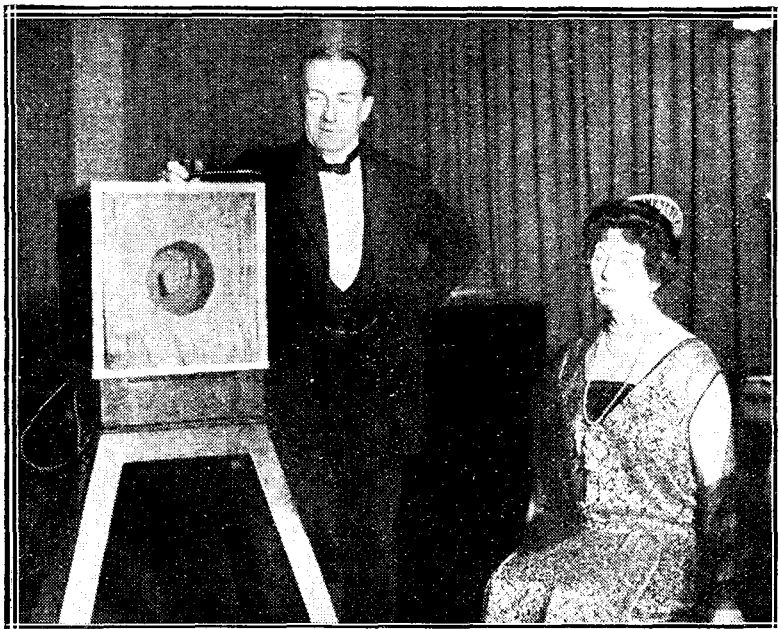

Mr. and Mrs. Baldwin on the occasion when the Premier broadcast from 2LO on behalf of funds in aid of a club for working girls. Mr. Baldwin paid a visit to the van receiving station on Boat Race day.

Reception Conditions Week by Week

By W. K. ALFORD.

Review of reception for week ending March 29.

THERE is every indication that the stable and good conditions existing during the winter months have now come to an end, and from now on we may expect that really interesting long-distance reception will be very spasmodic, although undoubtedly there will be much speculation as to what will happen during the summer to the ultra short wavelengths which travel better in daylight than darkness. KDKA, East Pittsburgh, whose strength seems to have been on the increase since the beginning of the year, with less of his periodic fading, is now showing distinctly the coming of summer conditions (speaking, of course, from the radio standpoint) in the form of very accentuated fading, and great distortion due to that very technical phenomena known as "night effect."

Signal Strength and Interference

Even our own broadcasting stations, when received at distances over 200 miles, are beginning to show distinct "swaying" characteristics. Glasgow, received at about 30 miles from London, at Camberley, was particularly noticeable in this respect, although, as he is very often partially submerged in a welter of "mush," which is constantly changing its intensity, it is somewhat difficult to reconcile how much of the phenomenon is definitely attributable to the signal and how much due to the changing interference.

Experiments on Fading

During the winter of a year ago the writer was endeavouring to measure, as a comparative figure, the maximum and minimum strength of distant telephony stations when fading was present. Although the quantitative results were not of very great value, it was definitely established that whenever fading

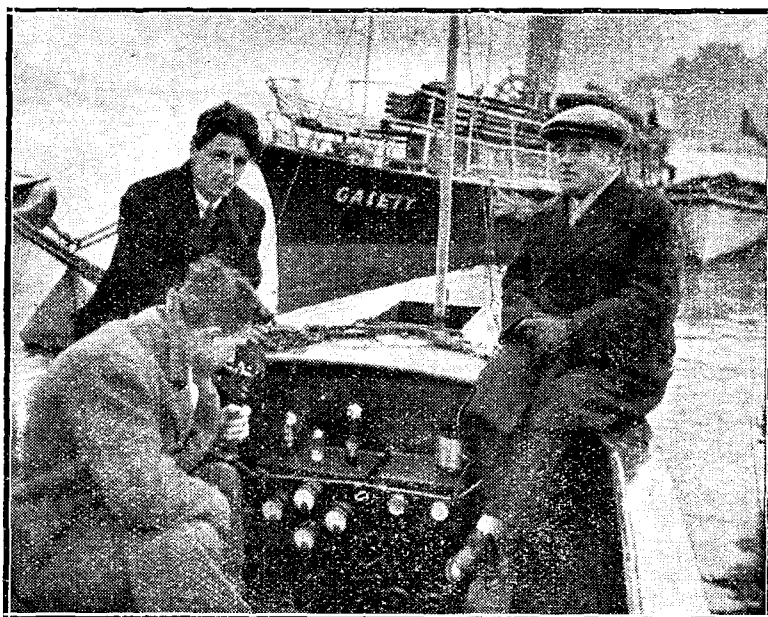

The transmitter used for reporting upon the progress of the Boat Race. Capt. R. Tingey, of the Radio Press Service Department, may be seen on the left, in the dark overcoat.

takes place, the observed "bearing" of that station from the receiving station changed by an amount considerably in excess of the errors which existed in the direction-finding system employed. I have discussed this matter with many people, and the general comment is that this phenomena is more or less to be expected, but it would be very interesting to know whether any experimenters with fairly large "loop" aerials have noticed the same phenomena.

Overcrowding

A week or two ago I commented at some length on the overcrowding which was rapidly assuming alarming "dimensions" on the 300 to 500 metre broadcast band. On further investigation as to the number of stations audible near London on this band I recognised 37 different stations mostly easily readable on the receiver used, and the majority were crowded together on the lower end of the band. It appeared quite striking that the smaller stations of "relay" class should be so much stronger in proportion to their size as compared with the so-called "main" stations. The small stations in Germany

are particularly noticeable in this respect, but it should be understood that the power rating is different to that adopted in this country, being the number of watts delivered into the aerial. Thus a 250-watt German station puts 250 watts into the aerial, but a British station of the same nominal rating only about 100, the efficiency of input to output being probably of the order of 50 per cent.

At the time of writing, a great number of people are grumbling at the B.B.C. on account of the unfortunate breakdown of Chelmsford on the night of March 28. A very sincere apology was made by Capt. Eckersley, and his remarks were worthy of consideration by all those whose listening-in suffered by the occurrence. It should be remembered that Chelmsford is the most powerful broadcasting station in the world, and it is a remarkable thing that Chelmsford should have been able to supply almost as regular transmissions as the smaller stations while its engineers have been virtually using the station for research work on the hitherto practically unexplored field of high-power telephony transmission.

How to Charge Accumulators

By C. P. ALLINSON.

The problem of accumulator charging is ever present and the following article gives a solution to those readers who are so fortunate as to have a D.C. lighting system for the house supply.

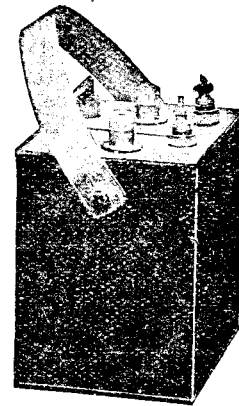
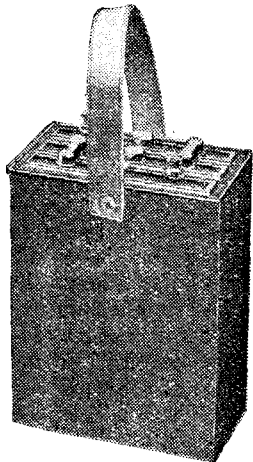

THE amateur living in a house where the electricity supply is direct current is fortunate indeed, for he is then more easily able to charge his own accumulators. The methods to be here described are only suitable for use with direct current supply, and should your mains provide you with alternating current other means must be employed. In order to ascertain what your supply is the electricity meter should be examined, and it will either be found stamped on

decide what method to employ. There are two chief methods that may be used in charging accumulators from the mains. One of these is to make up a charging board bearing three or four lampholders in which lamps may be inserted, thus regulating the amount of current passed through the accumulator.

A Charging Board

The appearance of such a board is shown in Fig. 1, and it will be seen that to it is attached a

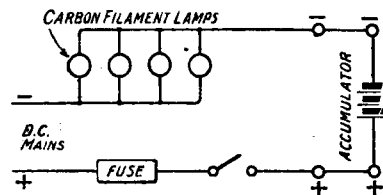

Fig. 2.—The circuit of the charging board illustrated in the previous figure.

length of flex and an adaptor plug. This plug is placed in an ordinary lampholder in place of the lamp, thus connecting the board to the mains, a switch and fuse also being placed in the circuit. The materials required can be obtained from the nearest electrician and will be: 1 imitation teak block (12 in. x 12 in. will be found a useful size), three or four batten lampholders, the number depending on the size of the accumulator to be charged, 1 fuse box, 1 tumbler switch, 4 terminals, a length of flex, and an adaptor plug.

The Fuse Wire

The layout shown in the sketch and the wiring diagram in Fig. 3 may be carefully followed. It will be found necessary to drill holes in the block to allow the connections to lampholders, etc., to be made, for

which insulated wire should be used. On consulting the circuit diagram, a further guide to wiring up this board will be found. The fuse wire used should be able to carry about 5 amps., which will give ample protection in the event of a short occurring while yet allowing as much current to be passed as will be necessary to charge most accumulators.

Testing the Unit

Having completed the construction of this unit, it should

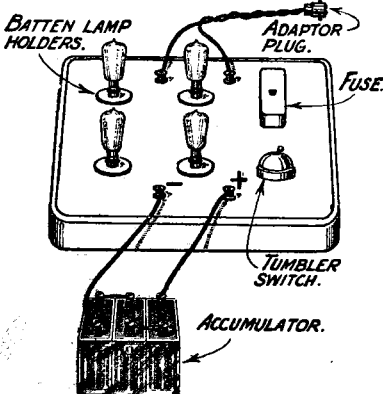

Fig. 1 shows a suitable arrangement for the charging board.

the case or else engraved on a metal plate which bears other particulars.

Methods to Use

Having ascertained that the supply is direct current (generally called D.C.), it remains to

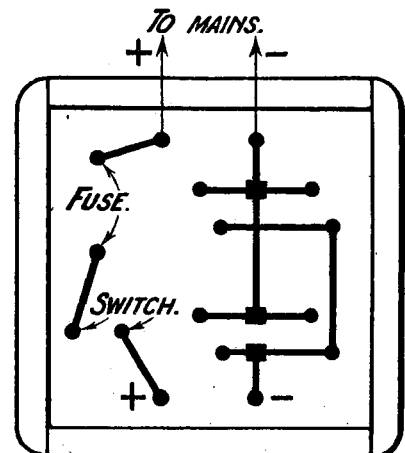

Fig. 3.—The wiring of the charging board should be carried out with insulated wire.

next be tested. Proceed as follows: Insert the adaptor in a lampholder with the current turned off, insert a lamp in one of the lampholders on the board, short the two output terminals

with a piece of wire, and switch on the current to the board. Switch on the tumbler switch on the board, and if the lamp lights all is well. See that it lights in all the holders, and if it does so the board is ready for use. The next thing to do is to determine the polarity of the output terminals, and this may be done with a pole finder. The simplest method, perhaps, is one that involves no more than a cup of water and a pinch of salt. Put the salt in the water and with the current switched off insert two pieces of wire into the water, these wires being connected to the two output terminals. They should be fairly close together in the water but not actually touching. Now insert a lamp in one of the holders and switch on the current. A large number of bubbles will be seen to form on one of the wires. This is the negative pole. The two bare ends of the wires should not be handled while the current is on or a severe shock may be received.

Avoiding Shocks

In order to avoid any possible risk of shock, you should find out whether the positive or negative of your mains is earthed. In most D.C. systems it is the negative, and if this is so you should connect the charging board to the mains so that the positive lead goes to the terminal which is connected to the switch. Then with the switch in the "off" position you are not likely to get a shock owing to an accidental short to earth, as the negative lead, which is not broken, is already at earth potential.

If the adaptor plug is reversed in the lamp holder, the current to the board will also be reversed.

An Economical Method

The other method of charging an accumulator from D.C. mains is to link it in with the house lights. This is by far the most economical method (providing that you can get at the main house fuse, as distinct from the company's main fuse, which is sealed), as it uses exactly no extra current. What does happen, however, is that the house lights are dimmed just a trifle while an accumulator is on charge. The difference is, however, hardly noticeable, and is only perceived at the moment the

battery is switched in, when a slight drop in brightness is noticed.

Precautions

The circuit is that shown in Fig. 4, and is shown pictorially in Fig. 5. The two leads to the board are taken from one of the fuses as shown in Fig. 5. A B is the fuse wire, which is removed, the two leads to the

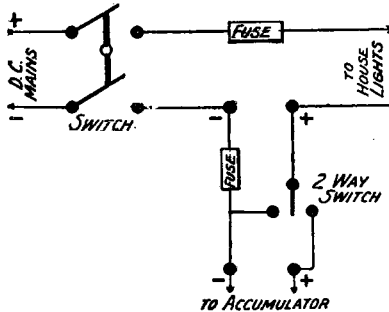

Fig. 4 shows the circuit when the accumulator is linked in with the house lights.

board being taken from the two terminals to which it is connected. Here, again, care should be taken as to the polarity of the leads. Supposing that the negative is earthed, the leads should be taken from that fuse where the lead nearest to the main switch is negative. Then an accidental short to earth of the positive lead on the charging board will not blow the main fuses.

Mounting the Components

The components necessary to construct this board are: 1 imitation teak block (6 in. square will

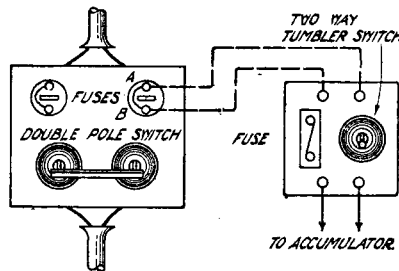

Fig. 5.—A pictorial representation of the Fig. 4 circuit.

be large enough), a fuse box, 1 two-way tumbler switch, some flex, some 7/22 insulated cable, and 4 terminals. The switch and fuse box are mounted on the board, small holes being drilled as before to allow the leads to come through and make the necessary connections to these and the terminals. A glance at

the wiring diagram in Fig. 6 should make these quite clear. The position in which the switch shorts the two input terminals to the board through the fuse, which should be sufficiently heavy to pass all the house-lighting current, should be marked "off" and the other "on charge." Place the switch in the "off" position, switch off the main switch, and connect the two leads to the terminals in the main fuse box, using the 7/22 insulated cable. The fuse wire is of course removed, and the leads should have the polarity shown in the circuit and wiring diagrams, this being the correct scheme of connections to employ when the negative pole of the supply mains is earthed. There will then be no risk of shock when handling the output terminals when connecting or disconnecting an accumulator. Mark the correct polarity of the output terminals, for with this method of charging, as the board is always left connected, the sign of the terminals will always be the same. With the switch in the "off" position, the main switch may again be closed and the board is ready to do its work.

Connections to Accumulator

When connecting an accumulator which is to be charged, the positive terminal of the battery should be connected to positive of the output terminals and negative to negative. If the connections are wrongly made the accumulator will become discharged instead of charged.

Charging Rate

We may now consider the question of the charging rate. With charging board No. 1 constructed, we may vary the amount of current passed by inserting a larger or smaller number of lamps into circuit, and also by employing lamps of higher or lower wattage. Assuming that the voltage of the mains is 240, an approximate guide to the current taken by various lamps is as follows: A 30-c.p. carbon filament lamp takes just a fraction over 1/2 amp., a 100-watt metal filament lamp takes .4 amp. and other wattage lamps in proportion. If a very heavy charging current is required the old-fashioned radiator bulbs may be used, these bulbs taking over an ampere apiece.

House Lights

With charging board No. 2 the charging current will depend on the number of lights on in the house. There is little risk that the current passed will be too heavy even for a comparatively small accumulator, as with the

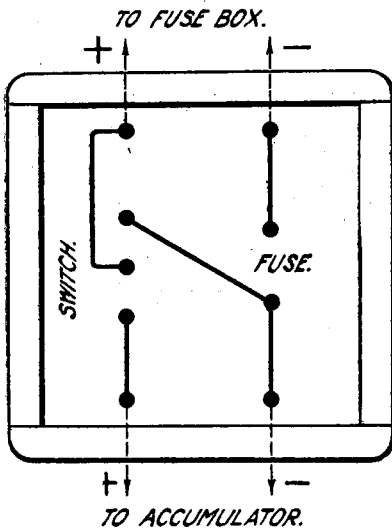

Fig. 6.—The connections when utilising the house lighting.

present low-consumption metal filament lamps the usual amount passed by the house lights seldom exceeds 2 amperes.

There is no harm, however, in giving an accumulator a long, slow charge; it is a rapid charge which causes accumulators to deteriorate. As long as the maximum rate given by the makers is not exceeded the actual charging rate is not usually very important. There is one exception, however, and that is with regard to the first charge of an accumulator. Here the figures given should be more strictly adhered to.

Service

In order to get the best service and longest life out of accumulators they should be carefully looked after. One of the most important points is to see that they are not allowed to discharge below a certain point. A reliable voltmeter should be obtained and used, and the voltage of the cells (i.e., the single cells) should not be allowed to drop below 1.8 volts. Where dull emitters are used it is an easy matter to run an accumulator too low, as these valves will frequently function far below their normal rating, and there is no warning, as there is in the case of bright emitters by

a falling off in signal strength, that the accumulator is run down.

The electrolyte or acid in the cells should also be kept up to the correct level, that is, $\frac{1}{8}$ in. to $\frac{1}{4}$ in. above the top of the plates. A certain amount of water is lost by evaporation, and this must be replaced periodically with distilled water; tap water should not be used. If, however, some of the acid gets spilt it should be replaced by dilute sulphuric acid of the correct specific gravity.

Charging should be carried on till all the cells gas freely, and the acid almost becomes a milky colour due to the large numbers of small bubbles present. The terminals should be smeared with vaseline so as to protect them from the acid, for once they start corroding it is usually a difficult matter to stop.

Sulphating

Accumulators should never be left standing in a discharged condition as they will be liable to sulphate. When this occurs a white deposit will be seen on the plates, and owing to the fact that lead sulphate is insoluble either in water or sulphuric acid, it is difficult to cure this trouble short of taking the accumulator to pieces and scraping the plates. If only slight traces of sulphating have appeared it can sometimes be cured by giving the accumulator a very slow charge, then

emptying the acid out and filling the cells with distilled water. The terminals should now be shorted and the accumulator left to stand for 48 hours. It is then filled with fresh acid and the process repeated if necessary three or four times.

When mixing acid care should be taken to add the acid to the water, and not *vice versa*, otherwise the intense heat generated may cause the acid practically to explode with risk of serious injury. If acid gets spilt on the clothes ammonia should immediately be poured on so as to neutralise the acid; failing ammonia, bicarbonate of soda may be supplied till the fizzing stops.

Acid

The specific gravity of the acid should be tested periodically by means of a hydrometer. The most convenient type is the bulb hydrometer, which draws up acid into a glass tube which contains some form of indicator. The specific gravity can then be read off and more acid or more water added according to the reading obtained. With a fully charged accumulator the acid should have a density of 1.220 unless the maker gives other figures.

The cells should be examined occasionally to see if there is any sediment at the bottom below the plates.

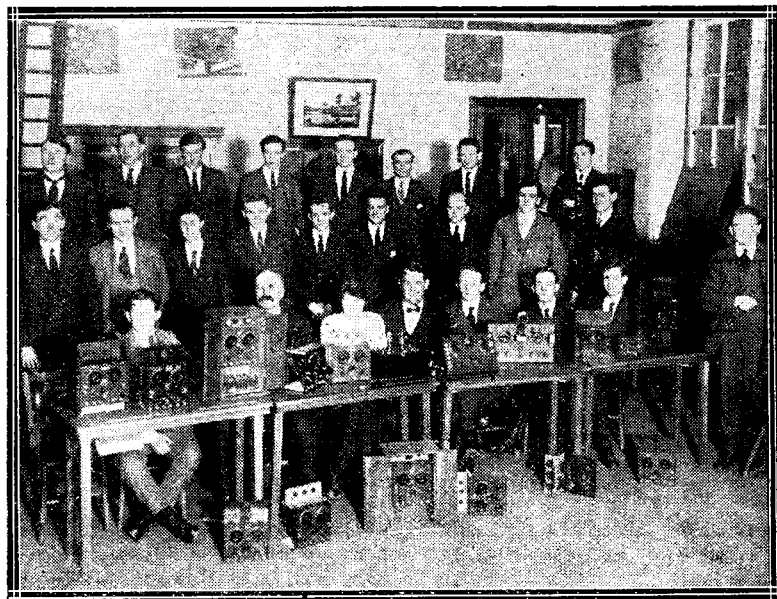

During the session just ended the Breconshire Education Authority has held wireless classes at Ystradgynlais, Swansea. Our photograph shows a practical class with some of the apparatus used, several Radio Press designs being apparent.

Some Notes on Low-Frequency Amplification

By A. JOHNSON-RANDALL.

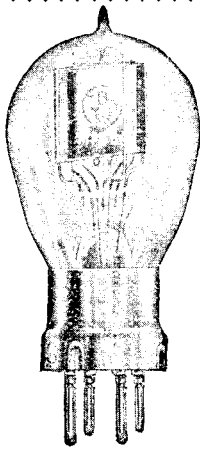

The B.T.H. B4 valve, a small power valve of the dull-emitter type.

ONE of the most serious problems that the amateur has to contend with is that of magnifying signals in such a manner that the output from the telephones or loud-speaker will be a faithful reproduction of the original signals transmitted from the broadcasting station.

There are two methods by which signals may be magnified. One of these is termed high-frequency amplification and the other low-frequency amplification.

Amplification of Signals

High-frequency or radio-frequency amplification is simply the amplification of signals at their fundamental frequency, and low or audio-frequency amplification is the magnification of signals after rectification, or, in

an undistorted reproduction of the original, as, for instance, it is in cases where crystal rectification is employed, or in a stable valve receiver in which reaction is applied in an intelligent manner.

Three Methods

In considering low-frequency amplification we have the choice of three methods.

- i. Transformer coupling.
- ii. Choke-capacity coupling.
- iii. Resistance-capacity coupling.

The most popular of these is, without doubt, the first method, in which the valves are coupled by means of iron-core transformers, the chief reason being probably the high amplification obtained per stage.

L.F. Transformer Design

The problem of transformer design is a very difficult one, but manufacturers have now realised that the magnifying of Morse signals is a very different matter to that of amplifying speech and music, and there are now several very efficient transformers on the market. To be efficient a trans-

a minimum, and the insulation resistance between windings and between windings and core must be high. Unfortunately, as we increase the number of turns so we increase the distributed capacity of the windings, and at the same time the bulk of the instrument. To prevent breakdown, wire of a substantial gauge must be used, and the turns must be very carefully wound to prevent actual movement in the field and consequent breakage through chafing. The use of thick wire, again, means an increase in bulk,

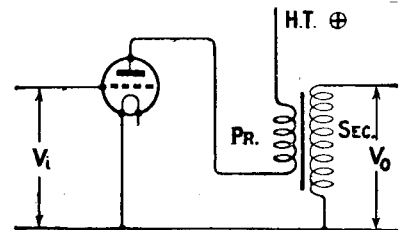

Fig. 2 illustrates the significance of the voltage amplification factor V_o/V_i

hence it will be seen that to keep the size of the transformer within reasonable limits the design must necessarily be a compromise. The theoretical amplification of a transformer is usually measured as the voltage amplification of the transformer plus the valve; that is, the ratio V_o/V_i where V_o is the voltage across the secondary, which is applied to the grid of the following valve, and V_i is the input voltage between grid and filament of the preceding valve, as shown in Fig. 2.

Amplification Curves

For a transformer of first-class design a good average figure is 30, and for faithful reproduction there should be no variation in this value at different frequencies; in other words, our curve of V_o/V_i plotted against frequency must be a straight line parallel to the frequency axis. The impedance of the valve will affect the shape of this curve, and with

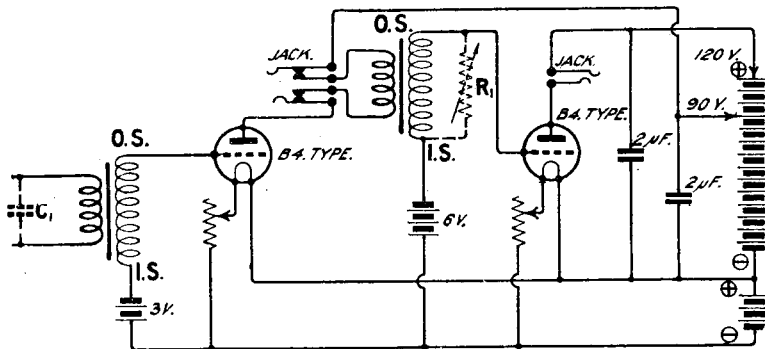

Fig. 1.—A two-stage transformer-coupled amplifier circuit suitable for use where large volume is required.

other words, the method by which the volume of the audible signals is increased.

In this article I shall deal briefly with the latter method, and I shall assume that the actual input at the terminals of the amplifier is

former must have a very large number of turns in the primary winding, and this is particularly the case when the preceding valve has a high impedance. The iron core must be sufficiently large to ensure that the iron losses are

An article, dealing with some aspects of low-frequency amplification, which will be found particularly valuable to those who desire pure reproduction.



The Mullard D.F.A.A. valve, a type of valve suitable for resistance amplification.

a transformer of unknown characteristics it is often possible to improve quality by changing the type of valve used. Makers of good instruments will supply curves of their transformers obtained with valves of known characteristics, and it is therefore possible with a little thought to design an amplifier using this method of coupling that is capable of giving exceedingly good reproduction. Even with the best transformers, and with valves of suitable impedance, good reproduction will not be possible unless the valves used are capable of handling the input energy, and

and which should at all times be as small as is consistent with efficient reaction control. Quality may often be improved by shunting a fixed resistance R_1 of $.5 M \Omega$ across the secondary of the second transformer, and by making the resistance variable between, say, 100,000 and 500,000 ohms a convenient control of volume is obtained. A condenser is not shown across either of the jacks, as this should be treated as a separate tone control unit for best results, and its value is dependent upon the type of loud-speaker used.

L =inductance of the coil in Henries.

Referring to the theoretical diagram, the voltage amplification will be equal to $\frac{V_o}{V_i} = M$.

If μ =voltage amplification factor of the valve used.

R_a =impedance of the valve, then,

$$M = \frac{V_o}{V_i} = \frac{\mu Z}{\sqrt{R_a^2 + Z^2}}$$

neglecting the resistance of the choke.

Let us now take a few values to show how M varies with Z .

Let $\mu=10$ (for good R type valve μ is between 8 and 10), and $R_a=30,000$ (this is about right for an R valve), then taking Z as 10,000 ohms we have

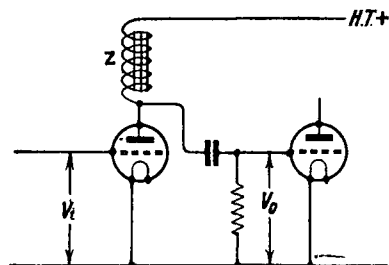

Fig. 3 illustrates the choke-capacity method of coupling.

unless they are operated at the correct point on their characteristic by the application of the proper negative grid bias for the value of H.T. voltage specified by the maker. A good form of amplifier circuit suitable for loud-speaker work in large rooms is shown in Fig. 1. The first transformer should be one specially designed for use in the first stage immediately following the detector valve, and its primary should have a high impedance, particularly if the detector valve is of the R type. The method of connecting the O.S. to grid, as shown, is not necessarily the correct one in all cases, and it is wise to try the effect of reversing the windings.

Tone and Volume Control

The condenser C_1 will not be necessary in cases where a telephone shunt condenser is already employed in the existing receiver,

Choke-Capacity Coupling

The second method of amplifying audible signals is by means of choke-capacity coupling. Provided the choke has a sufficiently high impedance very good reproduction may be obtained, but the amplification is not so great as with transformer coupling, and is slightly better than that obtainable with resistance coupling using ordinary valves.

Fig. 3 shows a simple theoretical diagram illustrating choke

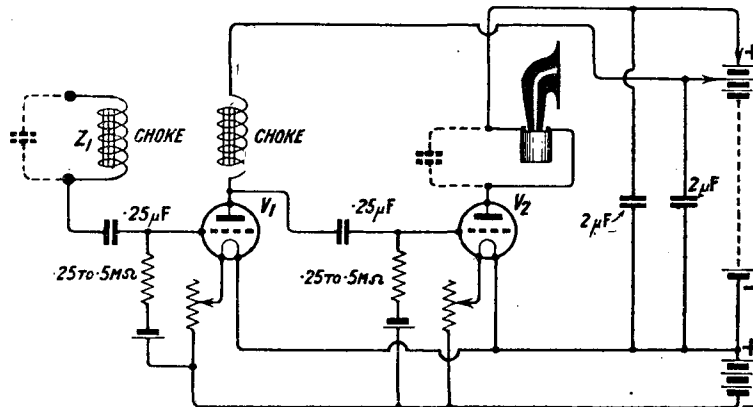

Fig. 4.—A typical choke amplifier circuit. The best values for the condensers shown dotted should be determined by experiment.

coupling. Now the impedance Z in ohms of an inductance is given by the expression

$$Z = 2\pi fL \text{ ohms,}$$

(assuming pure inductance).

where f =frequency in cycles, and

$$M = \frac{10 \times 10,000}{\sqrt{(30,000)^2 + (10,000)^2}} = 3 \text{ approx.}$$

If we take Z as 60,000 ohms we get :

$$M = \frac{10 \times 60,000}{\sqrt{(30,000)^2 + (60,000)^2}} = 9 \text{ approx.}$$

Hence by increasing our impedance to 60,000 ohms or twice that of the valve, we have multiplied M by three. We can therefore obtain, by using an impedance of the above value, a theoretical voltage amplification of $\frac{1}{3}$ that of the valve itself. This is the lowest value we can use with safety, as with lower values than this our amplification frequency characteristic curve would be irregular owing to the amplification of some frequencies more than others.

Inductance of the Choke

In the equation $Z = 2\pi fL$ knowing Z we can now determine L.

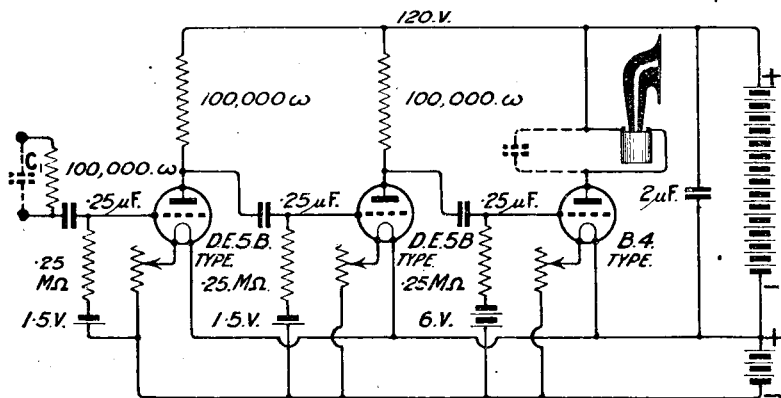

Fig. 5.—An amplifier circuit embodying resistance coupling. Suitable values are indicated where possible.

If $Z = 2\pi fL$ and, assuming $f = 200 \sim$, then,

$$L = \frac{Z}{2\pi f} = \frac{60,000}{2 \times 3.14 \times 200} = \text{approx. } 48 \text{ Henries.}$$

The smallest value for our choke will therefore be about 50 henries, and using this value we shall obtain good amplification and little distortion. As we increase the impedance beyond the value given, the voltage amplification will only increase very slowly, but, from the point of view of purity alone, it is advisable to use the largest possible value, always taking into consideration R_a , the plate-filament impedance of the valve.

Values of Components

A typical choke amplifier circuit is shown in Fig. 4. The values of the coupling condensers should be about $.25 \mu F$, and of the grid-leak resistances from $.25-$

$.5 \text{ M}\Omega$. The latter value is usually quite satisfactory, and gives slightly better signal strength. Any valves may be used, and the H.T. voltage and grid-bias should be adjusted in accordance with the maker's instructions. In the case of the choke Z , in some receivers a small fixed by-pass condenser will be connected across the existing telephone terminals. Upon adding a choke amplifier, this value should be decreased to about $.0001 \mu F$, or to the smallest value that will give adequate reaction control. The use of a larger condenser will tend to cut down the higher speech frequencies and distortion will result, and for the same reason the self-capacity of the choke itself should be as small as possible.

$= 100,000 \times \frac{I}{1,000} = 100 \text{ volts,}$ which is the total voltage drop across R when the steady anode current is $i \text{ m/a}$. If the value of

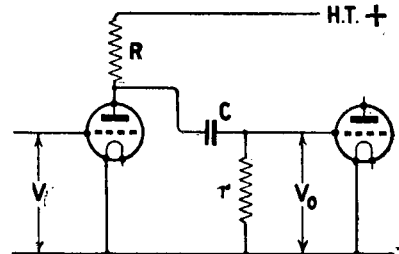

Fig. 6 shows the connections for resistance-coupling.

R is decreased then M, which is equal to $\frac{V_0}{V_1}$, will be smaller, so that, although we may decrease our voltage drop by making R smaller, we shall at the same time decrease M, as will be shown.

Theoretical Considerations

Now for a change in V_1 of one volt we shall obtain a change in voltage in the anode circuit of $V_1 \times \mu$, where as before $\mu =$ voltage amplification factor of the valve. The current I_a in the anode circuit as the result of V_1 is $\frac{V_1 \times \mu}{R_a + R}$, where $R_a =$ plate-filament impedance of the valve. But the voltage across $R = I_a \times R = \frac{V_1 \times \mu \times R}{R_a + R} = V_0$, provided C is made sufficiently large.

Since
$$V_0 = \frac{V_1 \times \mu \times R}{R_a + R}$$

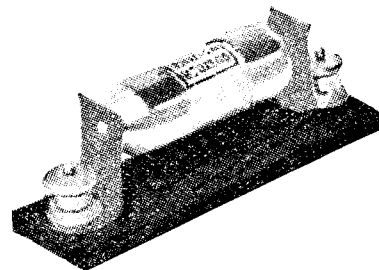

A well-known form of anode resistance.

$$\frac{V_0}{V_1} = \frac{\mu R}{R_a + R} = M.$$

Taking $\mu = 10$ and $R_a = 30,000$ ohms as in the case of the choke amplifier, and R the external resistance in the plate circuit as $50,000$, we have

$$M = \frac{10 \times 50,000}{30,000 + 50,000} = 6.25$$

Again, taking R as 100,000 ohms, we see that

$$M = \frac{10 \times 100,000}{30,000 + 100,000} = 7.7$$

Therefore by increasing R we increase M , and when R is infinity $M = \mu$.

It will be seen that the amplification obtained with resistance coupling is not quite so great as that obtained with choke coupling using the same valve, but fortunately it is now possible to procure valves specially designed for resistance amplification such as those of the D.E.5B type which have a $\mu = 20$, and a plate-filament impedance of about 30,000 ohms.

Substituting these figures in our equation, and taking R as 120,000, we get

$$M = \frac{20 \times 120,000}{30,000 + 120,000} = 16$$

a very good value, and one which in practice gives excellent results.

Practical Details

With this type of valve a suitable H.T. value is 120 volts with about 1.5 volts grid-bias. The method of coupling the plate of one valve to the grid of the succeeding valve is by means of a condenser C as in choke-capacity

coupling, the function of this condenser being merely to act as a "stopping" condenser, that is to prevent the steady plate voltage from acting directly on the grid, while at the same time communicating to it the voltages set up across R as the result of a variation of V_i . The value of this condenser is not critical, but it is essential that the voltage V_o should be as near as possible equal to that across R for all frequencies, and for this purpose the reactance $\frac{1}{2\pi fC}$, where $C =$ capacity of the condenser in Farads should be small. It has been found that a very suitable value is .25 μF , but in many cases values as low as .01 μF may be used without noticeable effect upon signals. The grid-leak resistance should be kept low, say .5 to .25 $M\Omega$, and this will be found very advantageous in cases where the insulation of the condenser C is not perfect. Let us suppose that the effective applied potential at the plate of the valve is 100 volts, and that C has a resistance of 50 $M\Omega$ and $r = 2 M\Omega$. Then in these circumstances a positive potential of

$\frac{2}{52} \times 100 = 3.8$ volts will be applied to the grid of the succeeding valve.

If $r = .25 M\Omega$ the positive potential due to the defective insulation of C will only be half a volt. It will therefore be seen that in the second case the behaviour of the valve will not be affected so seriously as it would be in the first case. Fig. 5 shows a typical amplifier circuit employing resistance coupling. Owing to their high μ and general suitability for this class of amplifier valves of the D.E.5B or similar type are indicated, while in the last stage a small power valve of the B4 type will handle all the energy necessary for good loud-speaking. A common plate potential of 120 volts will give good results with the proper grid-bias. It is essential that C_r should be small, and .0001 μF will in nearly every case be found sufficiently large for effective reaction control. If a condenser is already shunted across the existing telephone terminals in the set, C_r will not, of course, be necessary, but the above remarks regarding the value of this shunt condenser still apply.

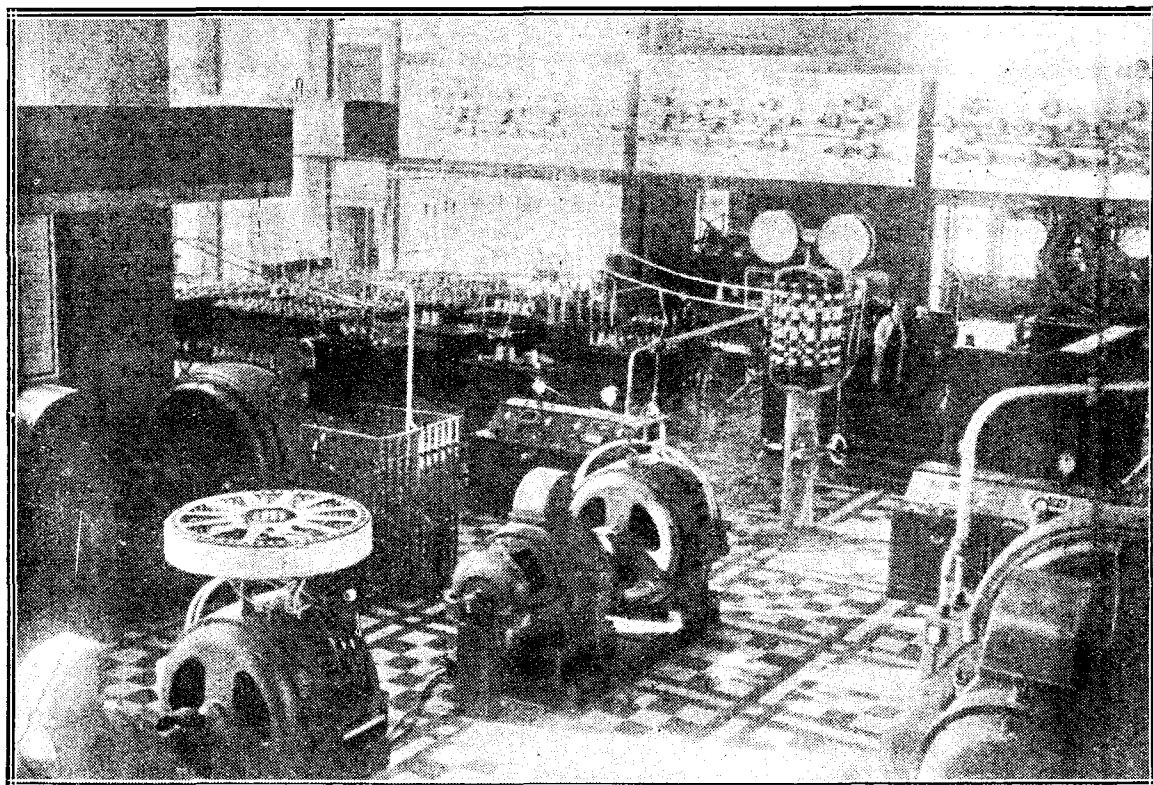

Our photograph shows the engine room at the well-known Nauen Station.

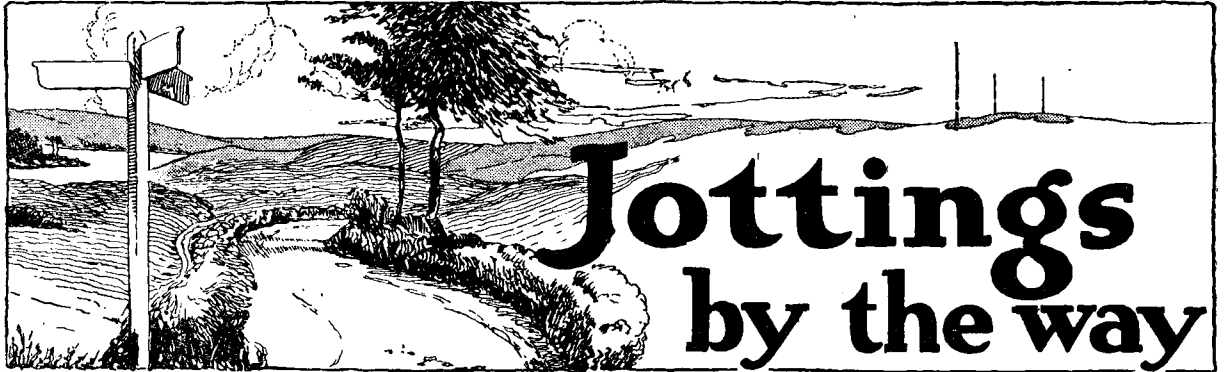

Jottings by the way

Tragic

*'Midst a concert, a hubby of
Bosham
Removed all his valves for to
wash 'em,
His missis cried " Jack,
If you don't put 'em back,
I'll fetch a coke hammer and
squash 'em."*

THAT beautiful little poem sums up in five short but pregnant lines the story of a tragedy which is taking place everywhere in the once happy homes of England. Women, you see, have no real soul for wire-

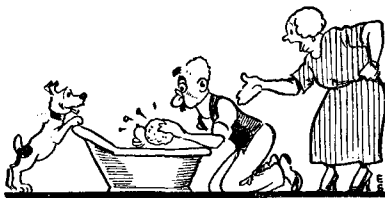

... Removed all his valves for to wash 'em ...

less. They simply want to hear the music that pours from the spout of the loud-speaker. The fact that this music comes from Madrid, or Rome, or Kbel, or some other distant place with an unpronounceable name, means nothing whatever to them. Also they hate interruptions. Suppose, I mean, that having tuned in London you observe, whilst a sonata, or some other form of noise is in full swing, that you are using an aerial coil of too small a size. Your whole soul is revolted, for you perceive at once that you are breaking one of the cardinal rules by employing too much parallel capacity. It does not matter in the least that music is coming in perfectly well. You would as soon be seen using an A.T.I. of this kind as you would wearing shepherd's plaid trousers

with evening dress, or a bowler hat to surmount tennis flannels. These things simply are not done.

A Problem

It is here that we come upon a problem, which besides making wireless extremely difficult for such purists as you and myself, is threatening to shatter the domestic peace of all kinds of households. X. has observed that his A.T.I. is incorrect. Obviously he cannot go on using it. Mrs. X., on the other hand, is listening entranced to the strains of Pittapattaski's *Suite in A Flat* for seven trombones, two steam whistles, and a klaxon horn. X. cannot bear the sight of the offending inductance, whilst Mrs. X. will probably foam at the mouth and bite pieces out of the hearthrug if the music ceases for a moment. What is X. to do? Frankly, I do not know.

Expensive

One solution is for him to set his jaw firmly and to carry on with the alteration, having first stopped his ears with pieces of felt extracted from a valve box. This, however, comes expensive in hearthrugs. If Mrs. X. is using headphones instead of listening to the loud-speaker it is just possible to solve the problem by the exercise of a little skill. X. should flick out one of the high-tension wander plugs, replace it and remove it again, taking great care that she does not see. As she tears the 'phones from her ears he should then explain, going, if possible, a little pale, that the set has been struck by lightning and that it will take him a few minutes to set matters right. Provided that the high-tension battery is big enough, his better half will probably swallow this statement without any difficulty. In any

case, she will be too stunned to offer any effective resistance.

Worse and Worse

Though I confess that I cannot myself find a satisfactory solution for the loud-speaker part of it anyhow, the first problem that I have set you is a comparatively easy one as compared with the next. Having left poor X. guessing we will now worry Y. for a while. Y. is what we may call, in the beautiful language of America, a "DX Bug." Like X. he has tuned in some nearby broadcasting station which is performing an apparently endless

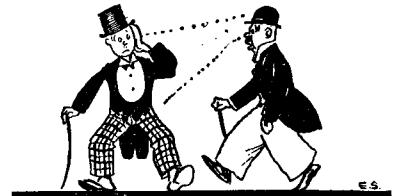

... These things simply are not done ...

piece. Like him, too, he possesses a wife who adores this kind of thing. In the midst of the piece he suddenly remembers that a new Czecho-Slovakian station opened on that particular evening, and on referring to his watch he sees that its initial transmission will end in five minutes. What is poor Y. to do?

Speed Work

Here I confess myself completely beaten, and I think that the odds are that he will not hear Czecho-Slovakia. Then there is Z., who has a perfectly understandable passion for logging the greatest number of stations in the shortest possible time. On the word go he twiddles rapidly, and gives you two bars from 2LO. This is followed by someone clearing his throat in Manchester, two or three syllables from Bournemouth

and the first "peep" of the time signal from Newcastle. He gives similar snatches from Glasgow, Belfast, Birmingham, and Aberdeen, and then goes abroad, beginning with a word or two from Brussels and running through the gamut of the French, German, Spanish and Italian stations. All this is sheer joy to him, but Mrs. Z. winces visibly at every flight that he makes. If she hears half a dozen notes of a song from Breslau it is sure to be just the thing that she most wants to hear, and it does not console her in the least to hear a violin in Rome five or six seconds later.

A Menace to Wireless

All this, I think, constitutes a very grave menace to the progress of the wireless experimenter. Different men try different expedients. Poddleby, for example, devotes the earlier part of each evening to what he vulgarly calls "tripe." That is, he tunes in 2LO, and, leaving Mrs. Poddleby enraptured, goes to a distant part of the house where he

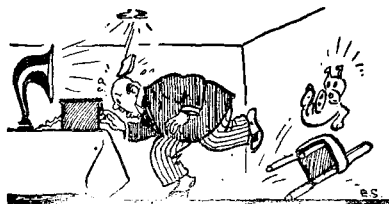

... Mrs. Poddleby knocks on the bedroom floor ...

busies himself with soldering jobs and things of that kind. At about ten o'clock he tells Mrs. Poddleby that she is looking tired, and sometimes succeeds in getting her to retire. As soon as this has been achieved out comes his wavemeter and off he goes on tour, via the ether, to distant places. You might think that this arrangement would work perfectly. It would, I think, if Poddleby would use headphones.

Bald-headed Results

Being bald-headed he finds the pressure of the bands most uncomfortable, and therefore makes a practice of listening always by means of the loud-speaker. As his set is a fairly large one the wavemeter naturally produces a certain amount of noise from it, when tuning to the desired wavelength has been accomplished.

Rappings

He has usually not been at work for more than a quarter of

an hour when Mrs. Poddleby knocks on the floor with the heel of a slipper, and on his running upstairs, informs him that she cannot sleep on account of the din that he is kicking up. He therefore lays the wavemeter aside and does his searching without it. So far so good. But you, who have brought in foreign stations, know what it is. You no sooner get hold of Barcelona than you must needs perform prodigies of tuning to bring him up to full loud-speaker strength.

Temptation

This produces more raps on the floor, and makes matters extremely difficult. Poddleby, of course, cuts out his last note magnifier and promises not to do it again, but when he gets hold of another station the old instinct exerts itself, and despite the loss of the note magnifier the loud-speaker is soon doing itself pretty proud, whilst the slipper is once more at work.

To the Rescue

I was pondering these things very deeply in my mind (having myself on the previous night provoked as many raps as would have satisfied even the most confirmed table turner) as I walked up to visit Professor Goop to see whether by laying our heads together we could not arrive at some solution of the most pressing problem of the day. The first laying together of our heads nearly made stretcher cases of both of us. The Professor himself answered my ring at his door, and upon entering I tripped over little Bingo, dropping my hat on the floor. The Professor, who is renowned for his old-world courtliness, stooped down to pick it up. I did the same thing at the same moment, with the result that our craniums (or crania, if you prefer it so) came into violent contact. When we had recovered a little I told the Professor about X. and Y. and Z. and Poddleby and myself, and he told me about himself. After a little thought the Professor's face suddenly lit up. "What is wanted," he said, "and what you and I must busy ourselves about devising is a simple silencer." "My good friend," I cried, "many brains even greater than ours have set themselves the task of silencing women and have

failed dismally. Think of Socrates and the rest. Do not let us follow in their footsteps." The Professor explained that what he meant was not a wife silencer but a set silencer.

The Loud-speaker Silencer

And so it is that we are now at work upon one of the greatest of the great inventions that we have given to an astonished world. This is the loud-speaker silencer, which we believe will make matters plain sailing for all wireless enthusiasts in days to come. It is certain to have an enormous sale, for it will be a very great help indeed to picking up weak and distant transmissions. Just imagine the conversation of your fellow wireless men in a few months' time. "I got WGY perfectly at three o'clock this morning." "Could you hear what he was saying?" "No, of course not; I was using a silencer." Besides conducting to domestic peace the silencer is guaranteed so to muffle call-signs, that it is the easiest thing in the world to mistake, for ex-

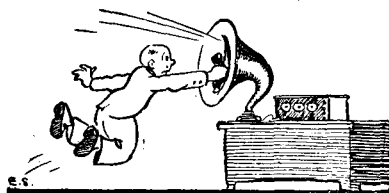

... Silencing the loud-speaker ...

ample, 2ZY for WBZ. When using it there is not the slightest need to stretch your conscience, as, if I know anything of you, you have done pretty frequently in the past. The device is not yet perfect, though we are unceasingly at work upon it. Shortly I hope to give you full particulars, but meanwhile you will find an old sock rammed down the throat of the loud-speaker wonderfully effective.

WIRELESS WAYFARER

An Informal Meeting of the R.S.G.B. will be held at the Institution of Electrical Engineers, Savoy Place, Victoria Embankment, W.C.2, at 6 p.m., April 8, when Mr. E. C. Atkinson, M.A., will give an address upon "Home-made Components and Sets"

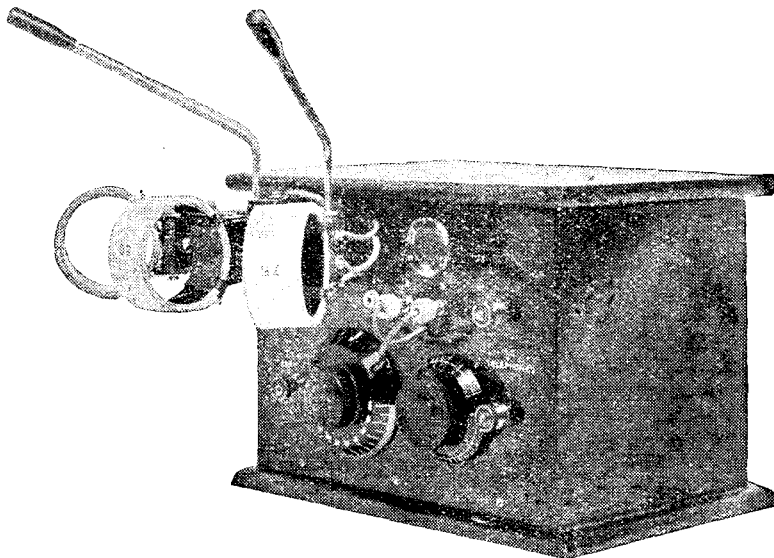

This compact little set permits comparative tests to be made with three different forms of aerial coupling.



Observation of the wavelengths used by the B.B.C. and of those stations given in *The Foreign Radio Times*, indicates that for successful reception—that is, reception free from interference—more and more attention must be paid to the increasing of the selective properties of receiving sets, and when one counts the number of transmitting stations which work between the wavelength band of 300-500 metres, it seems almost incredible that we are still content in the majority of cases to use the single tuned aerial circuit with its well-known absence of selectivity.

Interference

When confronted with any particular interference elimination problem, there is always to be decided the means whereby the elimination may be effected, and ruling out the possibility of wave-traps in that the question to be decided is one of general improvement in selectivity of the receiver to permit any given station to be selected, to the exclusion of others, rather than the cutting out of a local station, then the adoption of some form of

loose-coupling or semi-a-periodic arrangement is advocated.

Probably the most commonly used is the ordinary loose-coupled method, in which both aerial and closed circuits are tuned, but there are, without doubt, certain disadvantages with this form of coupling, which go to make the tuning of distant stations a rather tedious business.

Split Secondary Tuning

To overcome these defects "split secondary" tuning may be used, and the advantages and disadvantages attendant upon

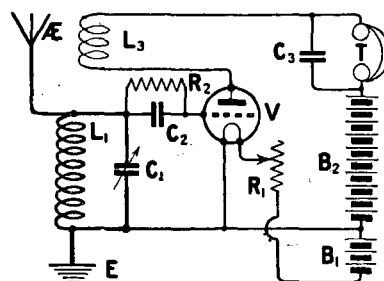

Fig. 1.—With the plugs inserted in sockets 1 and 2, direct coupling results as above.

these two methods were explained by me in an article upon "Split Secondary Tuning" in the February 18 issue.

Another arrangement by which selectivity may be obtained is

Some Experiments in Aerial Coupling

Direct and Semi-Periodic

By STANLEY G. RATT

With the number of broadcast stations almost monthly increasing, the elimination and the methods suited to personal requirements are becoming more and more engaging.

that known as semi-a-periodic aerial tuning, which has much to commend it, in that it is considerably easier to handle than either the ordinary loose-coupling or "split secondary" arrangements

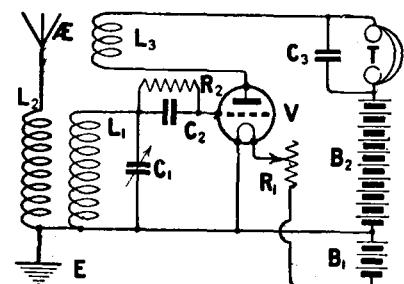

Fig. 2.—The positions of the plugs as seen in the first photograph give semi-a-periodic aerial coupling.

at the same time giving quite good signal strength and selectivity with only one circuit to tune, as will be seen upon looking at Fig. 2. Though this arrangement will be found easier to handle than the two methods previously mentioned it is still lacking that simplicity given by direct coupling, and for that reason auto-coupling, though little used, has only to be experimented with for its advantages to be appreciated.

Auto-Coupling

In this connection readers will remember that Mr. G. P. Kendall, in the March 4 issue, published certain data relative to auto-coupling, at the same time

Experiments with Tuning Methods

Indie Methods Compared.

By E. E. M.I.R.E., Staff Editor.

Broadcasting stations increasing the problem of interference and the need of aerial coupling best experiments are subjects of interest.

explaining its advantages over the more usual form of coupling.

Those readers who are victims to interference, and who do not quite know which form of coup-

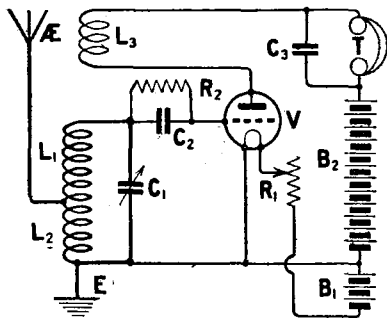
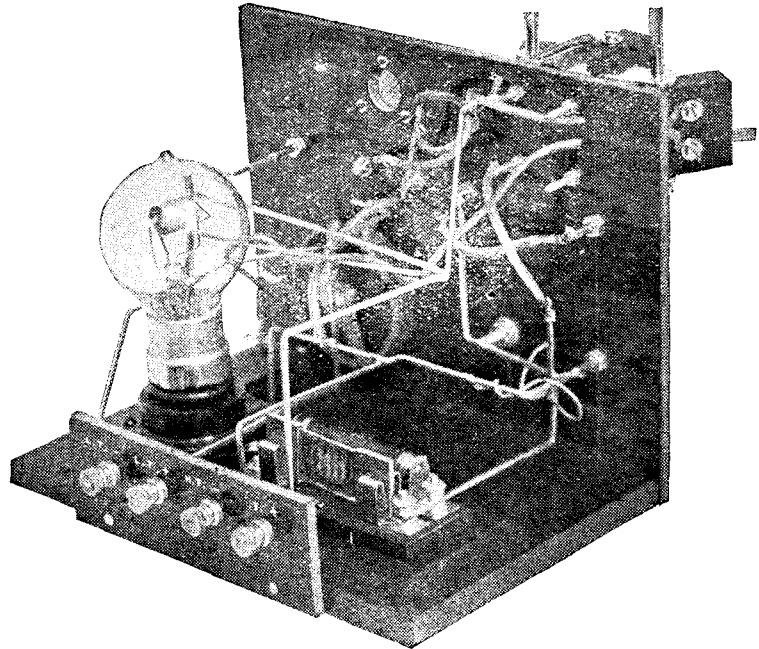

Fig. 3.—Auto-coupling as shown is obtained with the aerial plug in socket 2 and earth plug in 3.

ling to adopt to bring about their freedom, will find in the receiver illustrated a means whereby they may make quick comparative tests between the ordinary direct-coupling and semi-a-periodic aerial and auto-coupling, using the ordinary plug-in coils.

Conditions

In the experiments conducted, details of which are given below, the aerial used was a full size aerial, 50 ft. high, at Clapham, S.W., somewhere about 3 miles from 2LO, and the station chosen as the objective was Cardiff on 351 metres, a station always difficult to receive upon this aerial. In the first test a No. 35 coil for aerial tuning with a No. 50 for reaction, were used



A view of the wiring of the receiver, which also shows how simple is the constructional work.

with direct coupling, and it was found that 2LO was audible at good strength practically all round the condenser scale, making the tuning of any other station without interference a physical impossibility while using the 35 coil. During an interval of 2LO, Cardiff was tuned in at a strength consistent with a

The next experiment involved the use of semi-a-periodic aerial coupling and with a No. 35 as L2 (see Fig. 2), a No. 50 as L1, with another No. 50 as L3, the tuning of Cardiff was again tried.

Loose Coupling

It was found that by tuning to 2LO and separating L2 and L1 by about 75 degrees, 2LO was still fairly well audible without the use of any reaction. As any attempt at loosening the coupling between L2 and L1 still further merely made the set oscillate, the tuning of Cardiff was tried with the coils as indicated, and though 5WA was audible the very weak signals were still jammed by 2LO's transmission. At this stage the No. 35 coil was changed for a No. 25, and the coupling tightened a little, with the result that though tuning was considerably sharper and reaction adjustments always upset coupling adjustment, the tuning of 5WA, without interference from 2LO, was accomplished, but only with extreme difficulty and patient operation, any loosening of aerial coupling causing the set to oscillate, and any variation of reaction

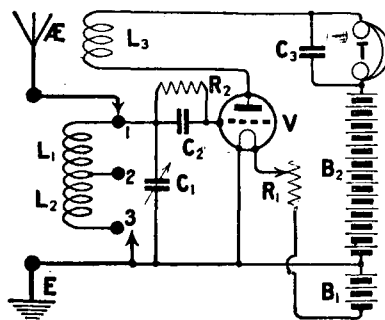

Fig. 4.—The circuit of the receiver. Three distinct forms of tuning are obtained with the aid of the sockets 1, 2 and 3.

single valve receiver, but was completely lost when 2LO resumed its transmission. The reception of the Manchester station also suffered in the same way.

disturbing the adjustment of coupling with consequent interference from 2LO. Though with other aerials in districts not so

L2 with a proportionate increase in the size of L1 reduced signal strength quite audibly. Similarly, the substitution of home-

it is not suggested that they will prove to be the best on any aerial other than that upon which these experiments were conducted, and for that reason various coils should be tried both for the auto-coupled arrangement and semi-aperiodic coupling until the most suitable values are found. After half an hour's experimenting it will be quickly realised that for the particular aerial in use there is a definite value for the coil L2 in both cases, for a compromise of signal strength and selectivity, the same remarks applying also to the coupling between L1 and L2. It may be said, however, that the smaller the value of L2 the higher the selectivity of the receiver, and consequently the harder is the set to tune.

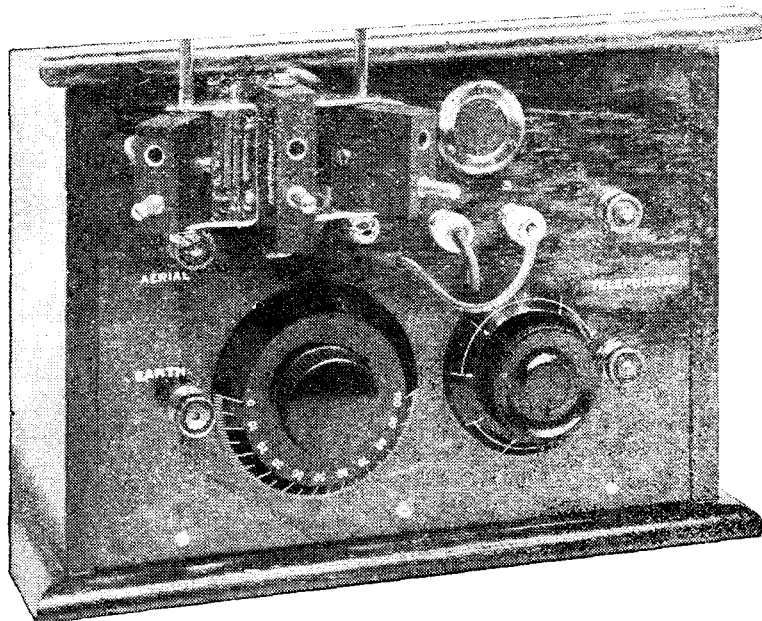

With the coils removed, this close-up photograph shows the panel arrangement in detail.

near to 2LO the behaviour of this same circuit is all that could be desired, when used in conjunction with the good low resistance aerial referred to the tuning of any station other than London with the coils as given was a task calling for considerable experience and untiring patience.

Another Method

A third experiment was made, this time using auto-coupling, with a view to tuning 5WA under the same conditions, and once the best sizes of coils were found the operation of the set, with the complete elimination of 2LO, was a comparatively easy business, comparing very favourably with the simplicity of the direct coupled method of tuning 5WA during intervals of 2LO.

Degree of Coupling

As indicated by Mr. Kendall, the fact that there is a defined optimum value for the aerial coupling turns was most marked, and after a number of coil changes, with L2 and L1 at right angles to each other, it was found that a suitable value for L1 was a Gambrell A used with a No. 35 as L2, or, if the coupling was tightened somewhat a Gambrell "a" could be used for L1. Any reduction in the size of coil

made coils smaller than an A also gave poor results.

It must be remembered by readers that though these coil sizes are given, and may be tried,

Three Forms of Tuning

The advantage offered by the little set illustrated is that the three different forms of coupling mentioned may be tried by simply changing the position of two Clix connections and inserting suitable coils in the three-way coil-holder.

Looking at the photographs showing the front of the panel, the left hand coil socket is for the reaction coil L3, whilst the centre and right hand sockets are for the L1 and L2 coils respectively.

The aerial and earth terminals may be seen on the left of the panel, whilst the telephone terminals may be seen on the right,

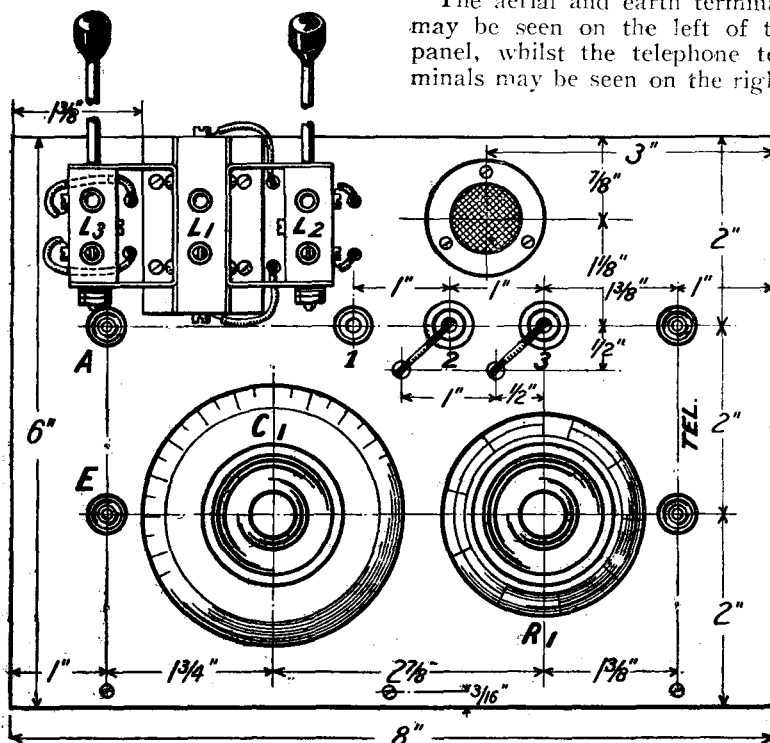

All necessary dimensions are included in this diagram, which should be followed during the drilling operations.

the battery terminals being fitted to a separate panel secured to the back edge of the baseboard.

To the right of the three-way coil-holder and above the filament rheostat will be noticed three Clix adaptors, numbered 1, 2, 3, whilst in 2 and 3 are two Clix "plugs," the plug on the left and in socket 2 being connected to the earth, whilst the other in the socket numbered 3 is connected to the aerial. Upon looking

at the circuit diagram it will be seen that these Clix adaptors are again indicated by 1, 2, 3, whilst the two Clix "plugs" are represented by arrow heads; it will be noticed from the circuit diagram that if we connect the aerial to 1 and the earth to 2 the circuit becomes the direct-coupled arrangement shown in Fig. 1. If, or the other hand, we connect the aerial to 3 and the earth to 2 we have the semi-aperiodic arrange-

ment given in Fig. 2. Similarly, by connecting the aerial to 2 and the earth to 3 we convert the circuit into one employing auto-coupling.

Components

For the benefit of those readers who wish to build this little set the following are the materials and components required, all of which are easily procurable from wireless dealers:—

One three-way coil-holder (that illustrated in the photograph is a Magnum).

One ebonite panel measuring 6 in. by 8 in. by 3/16 in. (that in the original set is a Radion mahoganite panel).

One strip of ebonite 4 in. by 1 3/8 in. by 1/4 in.

One dual rheostat (McMichael).

One grid leak (2 megohms) and condenser (0.0003 μF) unit (McMichael).

One fixed condenser, 0.0001 μF capacity (Dubilier).

Eight terminals (the four used on the front panel are oxy-copper finished to match the mahoganite panel, and supplied by Grafton Electric).

One box and baseboard (Camco).

One variable condenser, 0.0005 μF (in the original set the condenser used is a "Dial-o-densifier," supplied by Portable Utilities).

One valve holder (that in the photographs is a Burndept anti-phonetic holder).

Three Clix adaptors and two Clix plugs (Autoveyors).

One set of Radio Press panel transfers.

One valve window (Grafton Electric).

The Panel

All necessary details for drilling the panel are given in the illustration showing the layout, and after mounting the components in accordance with the photographs given, the panel should be secured to the baseboard in the manner shown in the photographs by means of three wood screws. The terminal strip with terminals mounted should be fitted to the baseboard on the opposite side, then the grid leak and condenser unit and valve-holder should be mounted upon the baseboard. The actual wiring up of the receiver, and the manner of connecting the coil sockets may be clearly followed

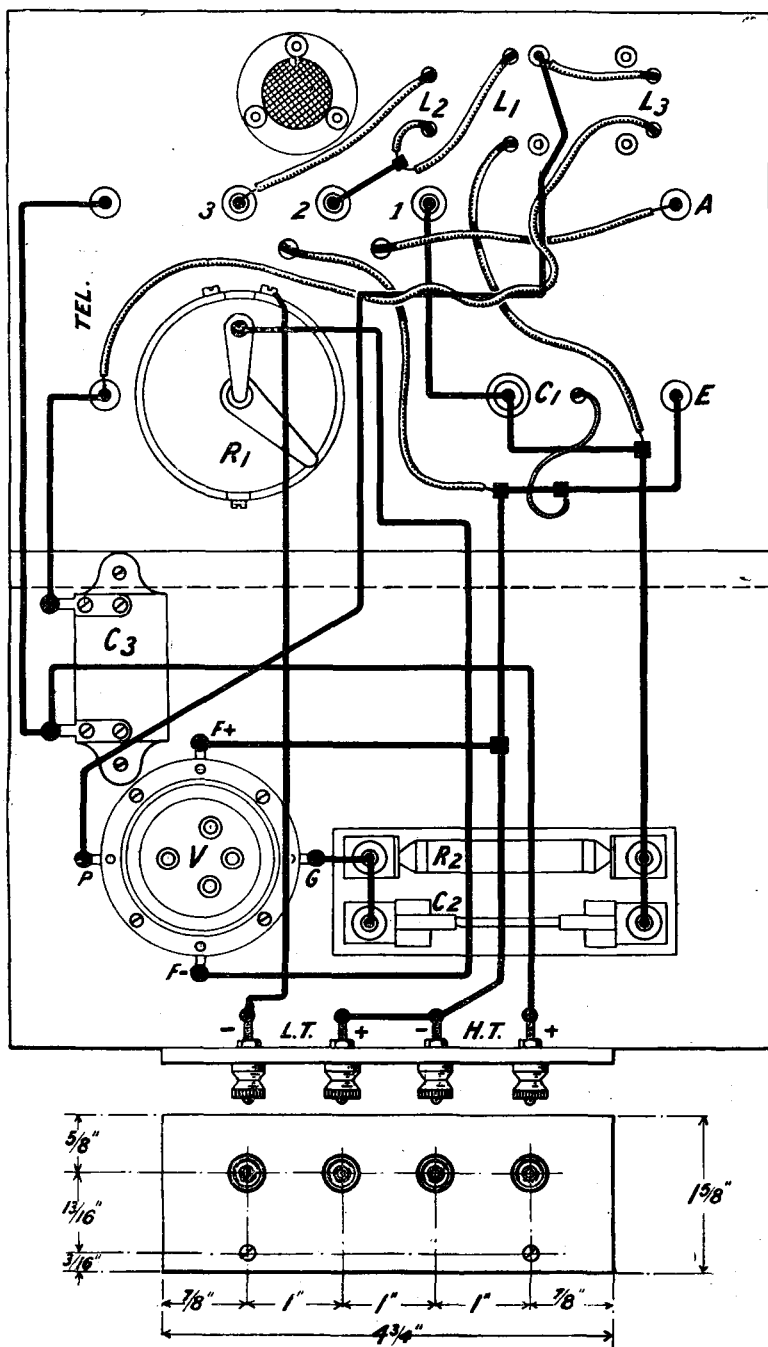

This diagram of the wiring of the set should be followed with care. The dimensioned drawing included in the diagram shows how the battery terminals are arranged.

from the photographs showing the back of the panel, and also from the practical illustrations of the wiring scheme in general.

Operating with Direct-Coupling

The simplest manner in which the receiver may be used is to

For the reception of 5XX or Radio-Paris, L₁ should be a No. 150 coil with a No. 200 for reaction.

Tuning

With suitable coils chosen for the wavelength desired the opera-

An examination of Fig. 3 will show that the aerial coil is now L₂, whilst the secondary coil is L₁ tuned by the condenser C₁, L₃, as before, being the reaction coil.

Coil sizes for use with this arrangement are, in the case of L₂, best found by experiment, using for the shorter B.B.C. wavelengths Nos. 25, 35 or 50; for Chelmsford and Radio-Paris a No. 150 coil should be employed. The secondary coil should, in the case of wavelengths up to 400 metres, be a No. 50 or 75, with a No. 50 for reaction. For wavelengths up to 500 metres the secondary coil will be a No. 75, with reaction as before. For the reception of 5XX or Radio-Paris the secondary coil will be a No. 200 or 250, with a No. 150 or 200 for reaction.

Using a suitable combination of coils, set L₃ at right angles to L₁ and L₂ near to L₁, and tune with the condenser C₁ until signals are heard at their loudest; if no signals are heard at all vary the coupling between L₁ and L₂ either one way or the other, at the same time tuning upon the condenser until the best results are obtained.

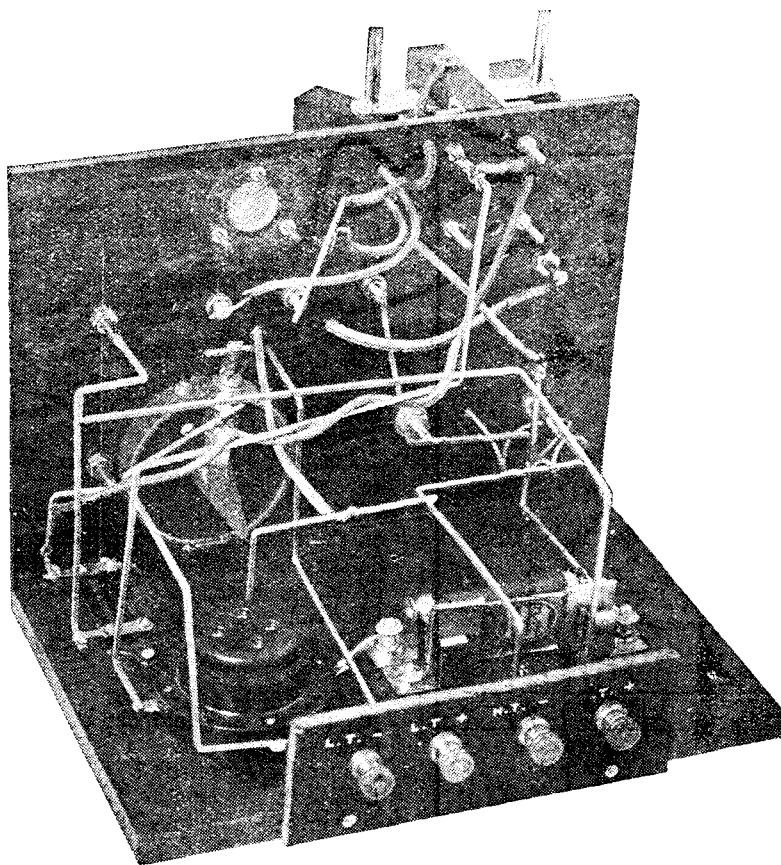

A very clear conception of the wiring may be gathered from this photograph, while the relative positions of the components on the baseboard may also be seen.

employ direct coupling, in which case turn the filament resistance to the "off" position, and after the aerial, earth, batteries, telephones, and valve have been added, the Clix connected to the aerial terminal is inserted in socket 1, and the Clix connected to the earth terminal is connected to socket 2, thus making L₁ the aerial inductance and L₃ the reaction coil; the coil socket L₂ may be neglected for the time being.

In order to tune to the B.B.C. stations using wavelengths up to 400 metres a No. 25 or 35 coil should be used for L₁ (depending upon the aerial), and a No. 50 for reaction; for wavelengths above 400 metres and below 500 metres a No. 50 coil should be used for L₁, with a No. 75 for reaction.

tion of the receiver is the same as any ordinary straight circuit single valve set employing reaction, and in view of the common use of this circuit the actual procedure of how to tune such an arrangement is not dealt with. Should the reader, however, be unfamiliar with how best to go about things then it is suggested that he read the article written by me for the February issue of the *Wireless Constructor*, where the subject is dealt with at some length.

Semi-Aperiodic Aerial Coupling

For this arrangement of coupling the terminal connections remain the same, whilst the plug which is now in socket 1 is moved to socket 3, and the plug in socket 2 remains where it is.

Reaction

With signals tuned to their loudest in this way bring the reaction coil nearer to L₁, at the same time making slight adjustment upon the variable condenser.

When using this method of coupling, in the majority of cases, selectivity is obtained by keeping the size of L₂ as small as pos-

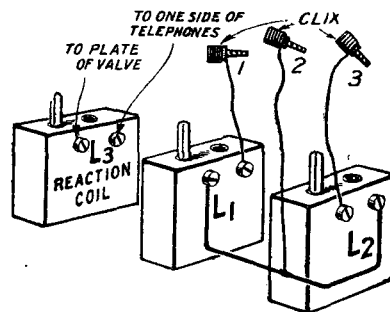

Showing the connections to the 3-coil holder. The Clix marked 1, 2 and 3 represent the adaptors fitted to the panel and numbered similarly.

sible and the distance between L₁ and L₂ as great as the strength of the wanted signals will allow.

(To be concluded.)

How to Fix a Window-Pane Lead-in

By JOHN W. BARBER.

A descriptive article upon how a hole may be drilled in a common window pane for the fixing of a suitable insulator.



THE question of a suitable lead-in insulator is one which confronts the wireless man at some time or other, be he either a "broadcast listener" (commonly abbreviated to B.C.L.), or be he one of the transmitting brotherhood, and the answers to the question, as given in different cases, vary tremendously. In one case we may find an ebonite tube coming in through a hole in the window frame, carrying a brass rod

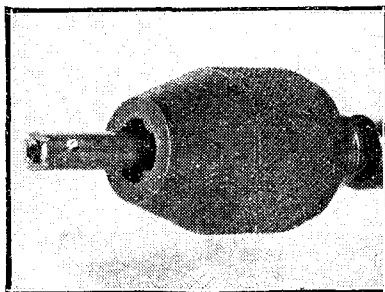

The necessary drill.

threaded at each end, connection being made by means of terminals screwed on to the rod, while in another the lead-in consists of a length of heavy rubber-covered cable brought in through the top of the window, which must therefore be kept a little way open—often a disadvantage in winter-time.

A Flexible Lead-in

Another form of lead-in insulator which has been evolved, and which has an appeal to those who do not desire to drill holes in the woodwork of a window frame, consists of a strip of copper, perhaps one inch wide, covered each side by a strip of some insulating material. Two terminals are provided, one at each end, for connections, and the insulator is placed at the bottom of the frame, and the window closed down upon it. As

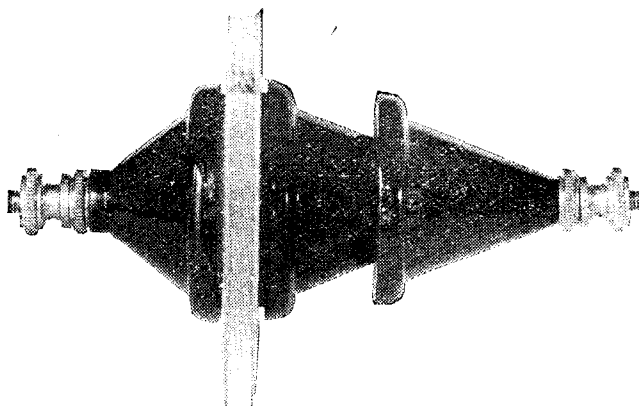

Illustrating the insulator in position.

the total thickness of the insulator is not more than $\frac{1}{8}$ in., the window is not prevented from shutting satisfactorily.

Window Insulators

None of these schemes, however, appealed to me, and I endeavoured to find some simple method of making an efficient job of it, when the idea struck me of bringing the lead-in through the centre of the window-pane. This was many months ago, and until recently I had been trying to find an easy way to drill a hole through the glass without removing the pane. The solution was the advent of the Silvertown window-pane insulator, which is seen in the photographs accompanying this article. These excellent accessories are sold complete with the neces-

of all, a piece of wood must be procured, and a $\frac{1}{4}$ -in. hole is drilled in it, in such a position that when the wood is rested against the window frame the hole in the wood is in register with the desired position of the hole in the glass. When the actual drilling through the glass is in progress, by far the most satisfactory way is to get someone to hold the wood in position, as there is then no tendency for the drill point to cause the wood to wander. The carborundum powder supplied is then mixed up with a little turpentine, the paste being then fed to the copper drill, which is fixed in the hand-drill in the usual manner.

Drilling

The point of the drill is passed through the hole in the wood, and

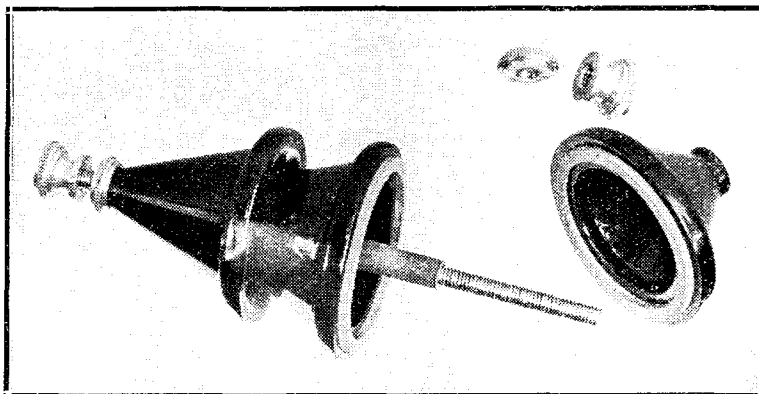

The parts which go to make the complete insulator.

sary drill and grinding powder, and may be fixed in a very short time as described later. First

the handle of the drill is turned, feeding the point from time to time with fresh paste. No pres-

sure must be put upon the drill, especially when the hole is nearing completion, as if this rule is ignored there is a possibility of damage occurring. The process of drilling in my case took about ten minutes, but in no circumstances should this operation be hurried.

Fitting

The insulator itself is then dismantled, as seen in the third photograph, and the rod is placed through the hole in the glass, with the skirted portion on the outside in such a manner that the rubber-covered portion of the central rod is through the hole. The cone-shaped portion removed previously is now replaced, and the terminal collar screwed on and

tightened up. Do not be afraid to tighten this up, as its effect is to bring the two portions of the insulator together, and as these are faced with a rubber ring no damage will result. Finally the terminal lead is replaced, and the lead wires joined up.

In cases where the window consists of two portions, opening vertically, it is advisable to have the insulator near the bottom of the lower half, in order not to interfere with the opening of the window.

This type of insulator will be found very efficient, inasmuch as advantage is taken of the high insulating properties of glass, while the skirted portion ensures that some portion of the insulator will be always dry.

tions shown, and the top coil may be swung away from the lower one, thus giving a good control of coupling. The coils may conveniently be of the basket type—wound on cardboard formers, i.e., five or seven slots are cut radially in the piece

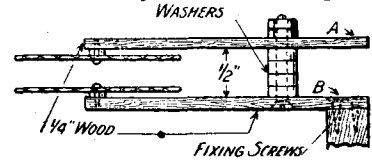

Illustrating the principle of the two-coil holder.

of circular cardboard from the circumference to about 1/2 in. from the centre and the wire wound in and out of these. Approximately the same number of turns as required on an ordinary plug-in coil plus about 15 per cent. will give the same wavelength range when tuned with a variable condenser. It is, however, an easy matter to add or take away a few turns in order to get the right wavelength.

A. S. C.

An Emergency Two-Coil Holder

VERY often the need is found for a tuner which can be made quickly and easily, and that shown in the diagram will fulfil such requirements. Apart from some odd pieces of wood and cardboard and a few screws, the only thing required is some insulated wire to wind the coils.

Construction

The diagram will make the construction quite clear: A and B are two pieces of 1/4-in. wood

about 2 in. by 6 in., the lower piece being screwed to the bench or other convenient support, and the other piece fixed to it by means of a 4 B.A. countersunk bolt, which moves easily in a hole drilled in A, and has two fixing nuts locked on it. Washers are used to give a clearance of about 1/2 in. between the two pieces of wood.

Coils

The two coils are screwed to the pieces of wood in the posi-

The Hale-Lyle Radio System

Readers of *Wireless Weekly* will be interested to learn that Radio Press, Ltd., have arranged, in conjunction with the patentees, to give public demonstrations of the Hale-Lyle system, which aroused so much interest in this month's *Wireless Constructor*. The system can be heard in operation any day during broadcasting hours at Baltic House, Leadenhall Street, E.C., by any reader producing a copy of *Wireless Weekly*, *Modern Wireless*, or *The Wireless Constructor*.

Radio Press Motor Club

The inaugural meeting of Radio Press Motor Club took place on Tuesday, March 31, in the company's offices at Bush House. This club has been formed as one more branch of Radio Press social activities, and has as its object the organisation of outings, etc., for those of the company's staff who own motor vehicles. With an initial membership of nearly a score, and promises of many further enrolments in the near future, the club is anticipating a very successful season.



The studio at CNRA, Moncton, New Brunswick, Canada. The bell shown in the photograph is characteristic of all C.N.R. stations. It is a standard locomotive bell at present in use, and is rung at the opening of the programme.

An Ultra-Short-Wave Valve Mounting

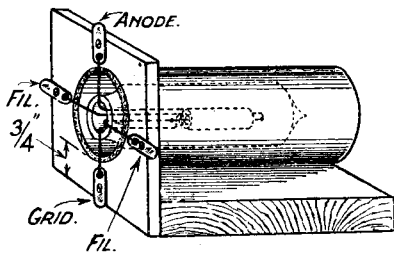

Fig. 1 shows the complete short-wave valve mounting.

A constructional article on some forms of valve mountings particularly useful for reception on the short wavelengths.

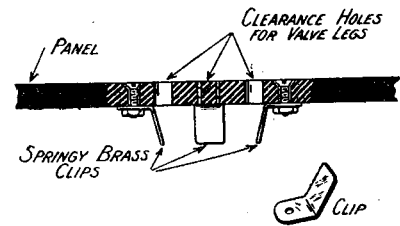

Fig. 3.—The contacts in this case are made by brass springs.

IT was desired to mount up a valve specially for the reception of very short waves, and to do this it was intended to take off the cap. Now came the question of mounting the denuded valve in a suitable manner. The following method was finally adopted:—

A piece of cardboard tube about $\frac{3}{4}$ in. greater in diameter than the valve and about 1 in. longer was obtained. The base of the valve was next removed.

Removing the Valve Cap

This was done by unsoldering the wires where they are soldered on to the valve legs and straightening them out; next the cap was gently warmed in the flame from a methylated spirit lamp till the cement with which the cap was fixed became soft. The cap was now pulled off by rotating it gently backwards and forwards and pulling at the same time.

Protecting the Valve

The valve was next wrapped in cotton wool and placed inside the cardboard tube so that the end with the leads just protruded. A hole of the same diameter as the outside of the cardboard tube was cut in a piece of $\frac{1}{4}$ -in. ebonite, so that one edge of the hole was $\frac{3}{4}$ in. away from one edge of the ebonite. Next four copper strips were cut $\frac{3}{4}$ in. long x $\frac{1}{4}$ in. wide, gauge 22 copper sheet being used.

Connections

These were drilled through the centre with a 6 B.A. clearance hole and mounted opposite each other as shown in the figure. The cardboard tube with the valve inside it was next fitted into the hole in the ebonite and the ebon-

ite was fixed to a small wooden base $\frac{3}{4}$ in. thick with a couple of screws, and a small screw was driven through the far end of the cardboard tube into the base, thus fixing it in position. The leads from the valve were next soldered to the respective lugs, the other sides of which were tinned for connections to be soldered on.

Short Grid Lead

The grid lead was placed at the bottom so that a very short lead could be obtained from the grid condenser to the grid of the valve.

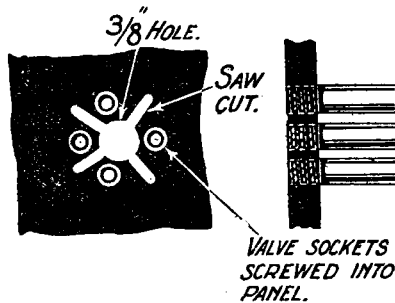

Figs. 2a and b illustrate two forms of anti-capacity panel mountings.

The completed mounting is shown in the figure and proved most successful in use.

Anti-Capacity Valve Holders

If it is not desired to take such drastic measures as removing the base or cap of the valve, the valve may just be mounted inside the tube and leads soldered direct to the valve legs, or else some anti-capacity valve mounting may be used.

The First Method

One method is to drill four holes into the panel or valve shelf correctly spaced and tap them out with the right thread so that four

valve pins can be screwed direct into the ebonite. A hole can now be drilled in the centre and four cuts made with a hack-saw blade between the legs as shown in Fig. 2. The hole should be about $\frac{3}{4}$ in. in diameter; this will not weaken the ebonite to any appreciable extent. Another method is to drill four holes with a 4 B.A. clearance drill and mount four pieces of springy brass, as shown in the figure, so that they press against the valve legs when the valve is inserted.

A Further Suggestion

A third method is to cut a thread on the top end of four valve sockets and screw them into the panel; they can then be screwed in so that they do not quite come up to the surface of the panel, and so also form a safety holder. The usual threaded legs can be cut off so as to reduce the total amount of metal, and leads soldered on direct. The appearance of this holder is as shown in Fig. 2b.

With all these valve-holders the sockets used should be as thin as possible, and those with 6 B.A. threaded legs are to be preferred.

OUR NEXT ISSUE.

In next week's "Wireless Weekly," Mr. G. P. Kendall, B.Sc., will contribute a further article upon the subject of "Auto-Coupling." Another article of interest to the experimenter will come from the pen of Mr. Percy W. Harris, M.I.R.E., the subject being, "Which is the Best L.F. Transformer?"

RADIO NOTES AND NEWS.

Some brief news concerning what is happening in the wireless world.

ON the occasion of the visit to this country of American wireless amateurs in April, it has been decided to give in their honour a dinner which will be held in London under the auspices of the Transmitter and Relay Section of the Radio Society of Great Britain. The function will take place on April

24, and those members of the T. & R. Section of the Radio Society of Great Britain who are desirous of attending are invited to send their names to the Hon. Secretary, T. & R. Section, the Radio Society of Great Britain, 53, Victoria Street, S.W.1, without delay. Tickets will probably be 12s. 6d. each.

His Majesty's Postmaster-General recently received a deputation from the Radio Association on the subject of the proposed wireless legislation. The deputation, which was headed by Lt.-Col. L'Estrange Malone, consisted of Prof. A. M. Low, D.Sc., and Messrs. Douet, H. J. Hinks, and R. R. Pecorini.

In replying to the various points raised, Sir William Mitchell Thompson agreed that sympathetic consideration should be given to the Association's suggestion for a reduction of the penalties for listeners-in.

The Association's Fellowship, acquired by examination, together with the degrees of other scientific bodies, would be taken into consideration when the grant of an experimenter's licence was under review. The subject of interference from power stations, etc., was also raised, and Sir William expressed the hope that the Post Office would be able to come to some satisfactory working arrangement with the authorities concerned.

The Post Office do not wish to treat the broadcast service as a substantial source of revenue to the State, and will give every consideration to the possibility of reducing the licence fee as the number of licences increases.

* * *

The British Horological Institute announces that a debate will be held at the Institute, 35, Northampton Square, London, E.C., on Wednesday evening, April 22, at 6.30 p.m., on the subject of Wireless Time Signals and the most desirable type of transmission code from the point of view of the watch, clock and chronometer manufacturers in the British Isles.

The debate will be open to members of the Institute. Others interested in this important subject will also be welcome.



Our photograph shows M. Trocme at the Eiffel Tower reading out the weather forecast, which is given daily from that station.

Correspondence

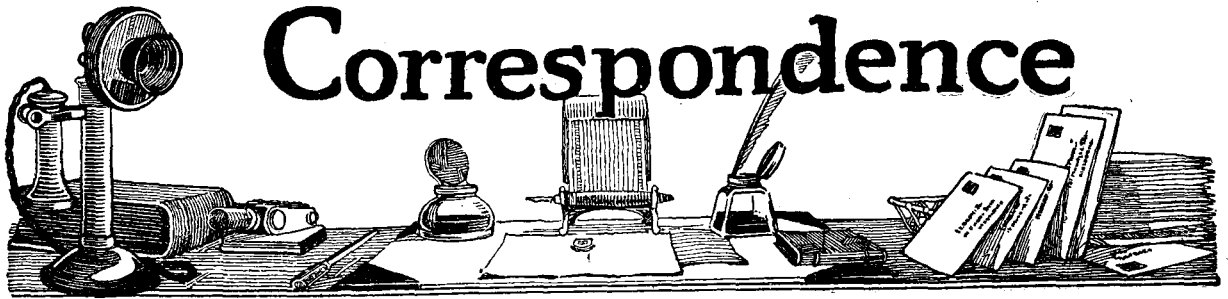

THE FOREIGN RADIO TIMES

SIR,—Many thanks for including in *Wireless Weekly* details of the Continental programmes. This is a feature which I and my friends appreciate very much. May I suggest that, as you have a limited space at your disposal for *The Foreign Radio Times*, you eliminate from the list those stations from which a regular reception cannot be guaranteed. I would suggest that you delete Rome and the American stations and include Brussels, Hilversum, Madrid, and Frankfurt. I sincerely hope that you will continue to include *The Foreign Radio Times* in *Wireless Weekly*.

I should like to take this opportunity to thank Mr. Percy W. Harris for designing the "Transatlantic V." The purity of reproduction by this receiver is excellent. I can "tune in" practically all the Continental stations, most of them on the loud-speaker. I listen regularly to Vienna, Zurich, Voxhaus, Munich, l'Ecole Superieure, Petit Parisien, Radio Paris, Brussels and Madrid.

I have recently added Mr. John Scott-Taggart's method of aerial trap-tuning to my set, and find its inclusion a great advantage. It is, however, absolutely essential for efficient tuning by this method to use a vernier condenser. I find that a station can be tuned in and out by the vernier alone; also, the loss in signal strength is very slight. I use an ebonite low-loss former with five turns in the aerial and fifty in the trap circuit using No. 36 d.c.c.

I have also been successful in making some H.F. transformers as described by Mr. Donald Straker in *Wireless Weekly* for December 10 and 17. I have found a considerable increase in signal strength, showing a marked superiority over bought transformers I used previously. I tried a step-up ratio with success, giving 38 turns in each winding of the primary and 60 in each of the secondary, using No. 36 d.s.c. A simple method of winding is first to file each slot V-shape, then tap the centre of one end of the former to take a valve leg. The former can then be held in the chuck of a hand drill, which is placed in a vice. The bobbin of

wire is placed in line with the slots and the winding can be carried on very rapidly, one former only taking from 10 to 15 minutes.

The best of luck to all your publications.—Yours faithfully,

J. H. BORRILL.

Grimsby.

SIR,—I am writing to say how much I appreciate your new feature, *The Foreign Radio Times*. I think there are many who will be glad to have the detailed foreign programmes, and shall be pleased when

When on to Italy you've got,
And say "what's all this tommie rot!"

Can it be news? or is it rhymes?"
Consult *The Foreign Radio Times*.

This supplement the "F. R. T."
Is in the *Wireless Weekly*. . . .
Don't worry who sang so and so,
'Twill tell you all you want to know.

When tuned on Eiffel Tower Paree,
You hear an unknown melody.
Don't argue with your family,
Consult the handy "F. R. T."

NORA WILDE.

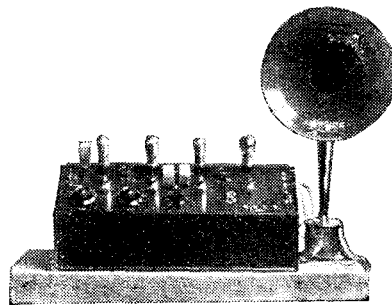

Mr. Hunt's Four-Valve Family Set.

the whole week's programme is given. Could it not be published separately?—Yours faithfully,

THOMAS WALKER.

London, W.9.

SIR,—Allow me to congratulate you on your supplement to *Wireless Weekly*, *The Foreign Radio Times*, which is a great help in identification of foreign stations. Hoping that you will include WBZ, KDKA and Hilversum as regular features.—Yours faithfully,

F. ROBINSON.

Stockton-on-Tees.

TO THE "F.R.T."

SIR,—Just a few verses in tribute to your new venture in *Wireless Weekly*.

It is what many of us have been long on the look-out for, myself included.—Yours faithfully,

NORA WILDE.

Brighton.

ENVELOPE NO. 2

SIR,—The keen interest which you have shown from time to time in your readers' work has prompted me to send you a photograph of my set.

With the "Four-Valve Family" Receiver, using three B.T.H. B5's, and in the last stage a B4, with a grid bias of 6 volts, I have swept the British broadcasting and a large quantity of foreign stations.

With a tapped H.T. I use 50 volts on the first two valves; that is, the "H.F." and "detector," 60 volts on the first "L.F." stage and 120 volts on the last stage.

A variable leak across the secondary winding of the last transformer has turned my loud-speaker results into perfect reproduction. The cabinet contains the necessary batteries, thereby making a set, which you can use without being a nuisance to everyone else on account of the battery leads and batteries taking up so much more room.

Wishing *Wireless Weekly*, *Modern Wireless*, and *The Wireless Constructor* every success, I am—Yours faithfully,

VIVIAN B. HUNT.

Stratford-on-Avon.

THE "ALL-CONCERT" RECEIVER

SIR,—May I be allowed to compliment you upon the efficiency of the "All-Concert" receiver.

As one who has tried several three-valve circuits, including

"supers," I can honestly say, that for simplicity, freedom from noises and sweetness of tone, I have not found anything to beat it. Furthermore, the first night that I tried it, I received WGY, New York, quite clearly, and that on about 30 to 40 volts H.T. Since then, which is only about a month ago, I have received WGY five times, WBZ once, and KDKA once; in fact, each time I have tried to get them I have been successful, with the exception of one occasion, when conditions were particularly bad.

I can, of course, tune in any station in the British Isles and France.

Incidentally, I may say that I get Liverpool and Manchester (which is approximately 40 miles away), and Chelmsford on a big loud-speaker with sufficient volume to be heard all over the house. Of course, it is only fair to say that I use a power valve, as the L.F. amplifier, with separate H.T. and grid bias.

One very good point about this circuit I find is the selectivity; I am able to cut Liverpool clean out on 315 metres and tune-in to Leeds-Bradford on 310 metres, without any wave-trap.

In wiring up, I followed the advice very carefully with regard to the grid leads, keeping them extremely short, and I attribute much of the efficiency of my set to that fact.

Trusting that the above remarks have been of interest, I am—Yours faithfully,

J. MARSH.

Southport.

SINGLE-VALVE RECEIVER FOR KDKA

SIR,—With regard to the "Single Valve Receiver for KDKA" described by Mr. Stanley G. Rattee in the March issue of *Modern Wireless*, allow me to say what a good little set this is.

The first night I tried it I switched on about 11.30 p.m., and within one minute I was listening to the orchestra at KDKA. I tried again the next night, and was equally successful, being able to tune-in to KDKA immediately.

On both nights there was almost a complete absence of atmospherics, but a great deal of fading. Conditions were far from ideal for long-distance reception; in fact, I was unable to receive any American broadcasting at all on an "All-Concert De Luxe" Receiver that has received America on the loud-speaker previously.

I would like to say for the benefit of other listeners that KDKA closes down from 12.15 to 1.30 a.m. (G.M.T.).

Thanking you for this splendid little set.—Yours faithfully,

JAMES A. TURNOUGH.

Rochdale.

SIR,—I understand you are interested in hearing reports of the performance of sets designed in your papers, and I feel that very great credit is due to Mr. Rattee for

his short-wave receiver for KDKA in March *Modern Wireless*.

I made this single-valve set up one afternoon and was able the same night to tune in KDKA within a minute of switching on. Since then it is possible to hear very clear speech and music during the American dinner hour, with some fading at times.

By coupling up this set to a 2 L.F. amplifier one can easily hear the voice in a fair-sized room on a loud-speaker.

Having been a constant reader of your papers since the very beginning, I am particularly keen on the set in question, which is the first I have assembled exactly to schedule so far as lay-out is concerned, and thoroughly agree that it pays to follow this point exactly and probably to adhere to the specified components, if identical results are to be obtained to those in the original set.

I tuned in WGY testing recently about 1 a.m. and got a violin solo and orchestral accompaniment quite well.

I have also had successful results with experimental sets of ST100, ST34, ST75, ST150, and am now working a 2 H.F., D. and 1 or 2 L.F. as desired, using the T.A.T. scheme. This has produced some most satisfactory results on the loud-speaker, some European stations coming in at times full strength. WBZ on two nights in succession was quite good, though reception was somewhat difficult owing to mush from some C.W. and spark stations.

With many thanks for your assistance, and whilst looking forward to future articles on really

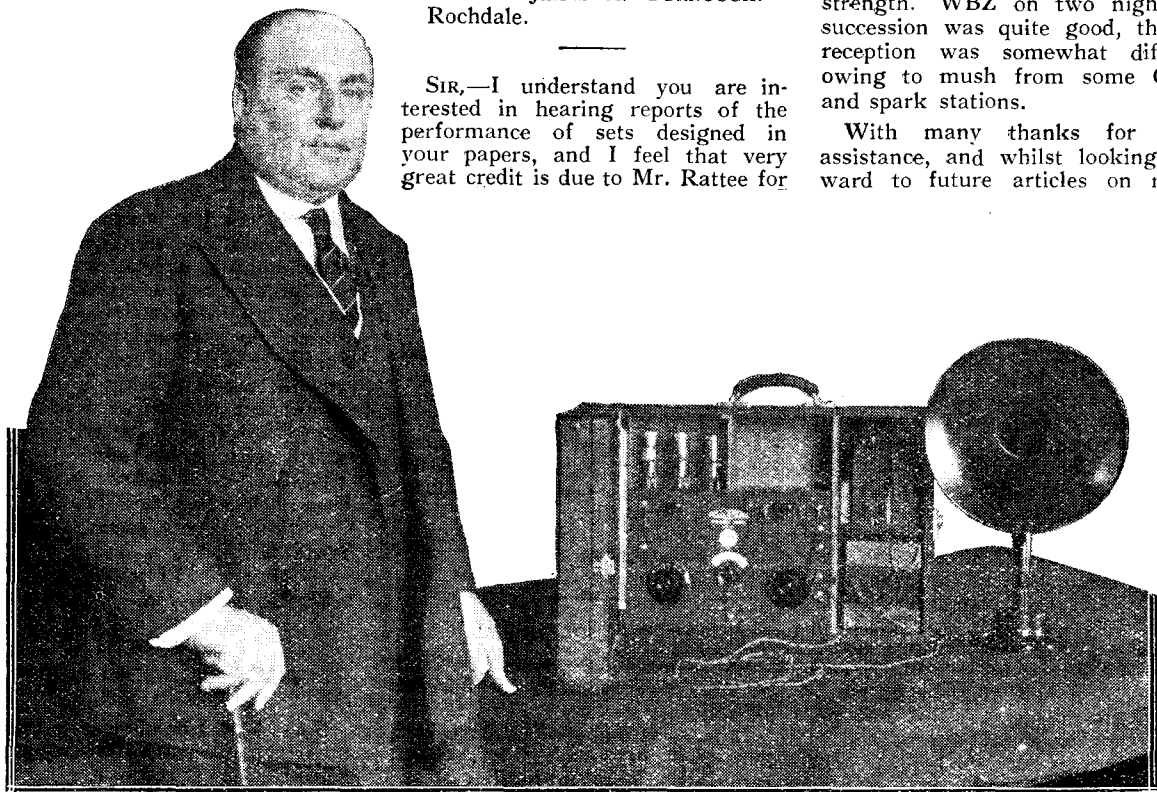

The Hon. Sir Arthur Stanley, who was Chairman at the mass meeting of the Wireless League.

short-wave work, offering you my congratulations.—Yours faithfully,

RICHARD B. GARRARD.

Boxmoor, Herts.

P.S.—Aerial is now single wire, hand-drawn 7/22 copper, 30 ft. average height and P.M.G. length, in a valley, but well insulated at both ends.

A LOW-LOSS TUNER FOR SHORT WAVES

SIR,—After reading the article on a "Low Loss Tuner for Short Waves," by Mr. Percy W. Harris, I decided to construct same as described in November 19, 1924, issue.

I used an American Tool Co.'s condenser, as no Sterlings were available, Phillips' and "Cossor" valves as det. and L.F. respectively. The "Phillip's," I might state, requires no grid-leak. The wire used in coil construction was 14 gauge, d.c.c.

I tried the set out in the evening, and was able to receive two New Zealanders (amateurs) about 7 p.m. while still daylight (the sun had only just gone down). I closed down at 7.30 p.m. and started again at 8.30 p.m. Two Victorian amateurs were then heard till I closed down at 9 p.m.

Unfortunately, the construction of this receiver was finished 24 hours too late for the test transmissions from KDKA, Pittsburgh, but I have no doubt that this station would have been heard if I had finished building the receiver in time.

Trusting the above is of interest to you, and wishing *Wireless Weekly* every future success.—Yours faithfully,

ESMOND A. TURNER.

Victoria Park, W. Australia.

AN AUSTRALIAN READER'S RESULTS

SIR,—It may interest you to have a letter of appreciation from a South Australian amateur who has been making up various circuits which have been published in your excellent magazines. After trying several simple circuits I tried the ST100, and got excellent results with the headphones, but distances are so great out here that a bigger set is absolutely necessary. Adelaide is 250 miles, Melbourne about 450, Sydney about 650, and Perth 1,200. Since then I have made up the circuit published in *Modern Wireless*. The ST100 with an extra stage of high frequency, and although at the time of writing it is the middle of summer, I get Sydney at full loud-speaker strength,

hearing the reports of the Test Match, which report would not have reached us here until a week later, as we only have one mail per week.

When in Adelaide I found that the electric tram lines and alternating current produced a very bad interfering hum which made the set unworkable, so introducing C.A.T. was tried, with the result that it made the set practically noiseless as regards the interference from the above.

As soon as I get the chance I am going to try the T.A.T. method of H.F. amplification. Out here it is extremely hard to get all the different parts needed, so I have had to make a great many myself, and in this connection have found the weekly paper, *Wireless Weekly*, invaluable.



Wishing your periodicals all the luck.—Yours faithfully,

A. S. HAWKER.

Port Augusta,
West Australia.

SELECTIVITY

SIR,—It may be interesting to you to know of some results I have obtained after reading the article on selectivity by Mr. G. P. Kendall. I had in use the "Long-Distance Single Valve Receiver," which I constructed from an article by Mr.

For Sharp Tuning and
Fine Selectivity use

"Tangent" Tuning Coils

The Unshrouded Coil with a guaranteed LOW SELF CAPACITY.

Coil No. - -	25	35	50	75	100	150	200	250
Self Capacity in Micro-Microfarads	8	9	25	31	22	16	22	22
Price - - -	4/3	4/3	4/3	4/6	5/-	6/-	7/-	7/6

A copy of the N.P.L. Report sent on application.

COMPLETE SETS { 4 Concert Coils (W/L 250 to 1180)—16/- the set.
 { 11 Concert Coils (W/L 250 to 2500)—67/- the set.

Obtainable from all good dealers—any difficulty, write us

GENT & Co LTD (Est. 1872.)
Manufacturing Electrical Engineers
FARADAY WORKS.
LEICESTER

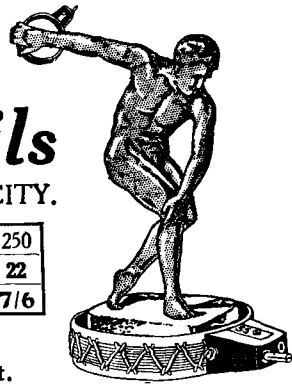

UNSHROUDED EFFICIENCY



RIGID AS A MOTOR WHEEL.

John W. Barber in the Christmas Number of *Modern Wireless*. The results I obtained were extremely good, but, due to my lack of skill, I think, I could never make a success of the loose-coupling. After reading Mr. Kendall's article I made a special tuner. I first wound a 60-turn coil on a 3½-in. cardboard cylinder, tapped every 10 turns with "Clix," then a plain 75-turn coil mounted to slide in and out of first coil. Using the tapped coil for aerial and plain coil for reaction, I connected up and commenced turning the condenser. The result surprised me. At almost every degree a fresh station seemed to come in. London, my nearest station, came in with more strength than I have ever heard before, then Bournemouth, Newcastle and Aberdeen, all at decent 'phone strength. Glasgow also came in, but faded away. For these I used 40 turns, with the aerial plugged in on the twentieth. By using 50 turns I was able to get Belfast and another station I was unable to get the call sign of. I also during the evening got at least five different foreign stations, all at readable 'phone strength. I do not pretend these results are very marvellous; probably much better results have been obtained with a single valve, but as I know nothing about wireless except what I learn

from *Wireless Weekly*, *Modern Wireless* and *The Wireless Constructor* and handbooks, I think the fact that they were obtained, and obtained easily, first trial, makes it well worth the experiment, especially as the tuner costs considerably less than plug-in coils.

Wishing your papers every success.—Yours faithfully,

H. WALLIS.

Horley.

A DOUBLE CIRCUIT NEUTRO-DYNE RECEIVER

SIR,—Re the "Double Circuit Neutrodyne" 2-valve set described by John Underdown in November, 1924, *Modern Wireless*, I constructed this set shortly after seeing it, and have had excellent results from it.

At the beginning I had rather a difficulty with regard to the loose-coupling, but soon acquired the art. So far I have had the following stations, all at good phone strength, and speech was clearly understood: 5SC, 5NO, 2EH, 6BM, 2ZY, 6LV, Belfast, 5WA, Brussels (SBR), Ecole Supérieur, Hamburg, Breslau, Madrid, 5SA, 5UU, and the Liverpool Harbour Board conversing with the Crosby and Formby Lightships. I think this is a very good record indeed for a two-valve set.

I am situated nine miles north of Liverpool Station and my aerial is 25 ft. high, 75 ft. long and 25 ft. lead in.

It does not actually work a loud-speaker, although speech can be heard about 6 ft. away. Liverpool Station can be heard without aerial or earth, and louder than a crystal set. For long range I think this set is the best possible for two valves.

Wishing *Wireless Weekly*, *Modern Wireless* and *The Wireless Constructor* every success.—Yours faithfully,

J. ERIC BEYES.

Liverpool.

AN AERIAL HINT

SIR,—In your "Information Department" in March 18 issue of your paper, we notice a query from "A. S. O." (Tonbridge) who is having difficulty with the stretching and contracting of his aerial halyards in fine and wet weather.

Perhaps the following simple hint may be found useful by "A. S. O." and other readers who are troubled in the same manner. We do it ourselves, and customers of ours who have done it are quite pleased. Now for the hint:—

Attach to the loose end of the halyard a weight of, say, 3-5 lbs.,

Quality RADIO

ELECTRIC SOLDERING SET.

Works from any wireless accumulator.

Complete, as illustrated, with full instructions.

5/6

Postage 3d.

No gas, fire or lamp needed. Always ready, no waste; a joint is made in a few seconds. The soldering bit being of carbon it requires no cleaning or tinning.

If your dealer cannot supply, we send post free if you mention his name and address.

GOSWELL ENGINEERING CO., LTD.,
12a, PENTONVILLE ROAD, LONDON, N.1.

Liberal Trade Terms. LIST FREE. 'Phone: North 3051.

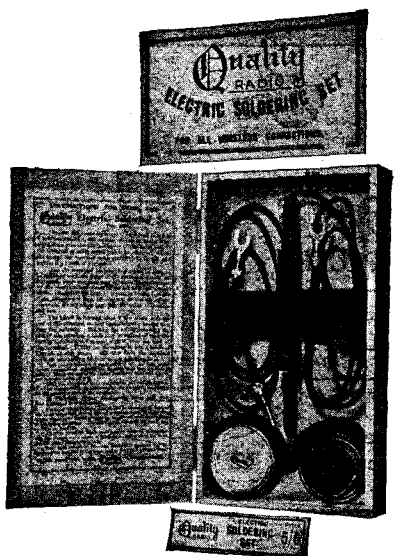

COMPONENTS for PERMANENT RELIABILITY

Finston Fixed & Variable Square Law Condensers & Variometers
The Finston Fixed Condenser is the only "one hole" fixing condenser on the market and is guaranteed within 5% of stated capacity; no wax is used, therefore climatic conditions have no ill effects upon them. Buy one. Test one. It will prove our statements and thoroughly satisfy you.

If your dealer cannot supply Finston Components, send your order to us together with his name and address, please!

LIGHTING SUPPLIES CO., 2, FINSBURY AVE., LONDON, E.C.2.

Barclays 1000

BROKEN VALVES MADE EQUAL TO NEW IN FIVE DAYS.

Guaranteed to give Satisfaction or Money Returned.

BRIGHT EMITTERS 6/6 (Money should be enclosed with valves.)
FOUR ELECTRODE 8/-

Send to:—ECLAT ELECTRIC MANFG. CO. LTD.,

Spencer Works,

SPENCER HILL ROAD, WIMBLEDON, S.W.19.

this will keep the halyard tight under all circumstances; in wet weather when the rope contracts it pulls the weight up a little way, and in fine weather when the rope lengthens the weight pulls it down, with the result the aerial is always taut, and there is not so much "fading" in reception.

The writer attached the weight to his halyard about 6 ft. from the ground, and it consists of an old 7-lb. paint-tin with a wire handle; the tin is filled with sand, but water or anything else would do. The tin is secured to the halyard by some twine, which can easily be cut or undone whenever I want the halyard clear to run through the pulley at the top of the pole, to examine the aerial, etc. It is not, of course, necessary to put a weight at the "lead in" end of the aerial.

Re suitable halyards:—My experience of galvanised rope for halyards is that they are a nuisance; they are very awkward to use in case you want to drop your aerial, and they soon rust away. I find good, half-inch rope good enough for most aerials; and for preserving it, get a stiff brush and some reliable brand of wood preservative, and rub the preservative well into the rope. This is much less "messy" than melting tar, and whereas it is often difficult to get good tarred rope, you can get wood

preservatives at any good paint or ironmonger's shop. And if the pole itself has not already been painted a coat or two of preservative before it is erected will treble its "life."

Trusting that the above hints may be useful to you and your readers. —Yours faithfully,

FAIRFIELD MFG. Co.

Liverpool.

amplification of any description whatever being used either before or after rectification.

Using a 100 ft. "loft" aerial at Ilford, 2LO gives quite good results, whilst Channel and shipping stations come in very well. The earth is in this case on the water main. —Yours faithfully,

F. C. A. F.

Ilford.

A CRYSTAL SET

SIR,—Having recently constructed the crystal set as described by Mr. P. W. Harris in the issue of *Modern Wireless* for September last, I think that the following excellent results obtained may be of some interest to your readers.

The undermentioned Morse stations on 600 metres were received, after dark, whilst lying in the Firth of Forth, the receiver being used in conjunction with a small ship's aerial:—Gibraltar, Oporto, Santander, Finsterre, Bordeaux, Genoa, Cape Sperone (Sardinia), Soller (Majorca), Gothenburg, Copenhagen and Hangö (Finland), in addition, of course, to most of the nearer Continental Morse stations—on the broadcast wavelengths Edinburgh, Glasgow, Dundee and Aberdeen gave good results.

All the above stations were received direct on the crystal, no

THE R.S.G.B. AND THE W. T. AND SIGNALLING BILL

The following is a copy of a letter which the Society has sent to the P.M.G. :—

WIRELESS TELEGRAPHY AND SIGNALLING BILL.

DEAR SIR,—I have the honour to inform you that the Council of the Radio Society of Great Britain have considered the provisions of the above Bill, which is now before Parliament, and desire to submit to you a Memorandum upon the Bill. At present the Memorandum is being considered by the representatives of the Affiliated Wireless Societies throughout the country, but it will be forwarded to you at the earliest possible moment.—I am, Sir, your obedient servant,

(Signed) H. A. Rock,
For Hon. Secretary.



A new way- to build a better Super-Heterodyne

Complete Series

The complete set of Bowyer-Lowe Intermediate Wavelength H.F. Transformers comprises: 1 Input Filter Transformer, with a .0005 Dubilier Fixed Condenser for tuning the primary, and 3 Interstage Transformers. Each set is matched and sold complete in boxes with Full Instructions for Making a Seven-Valve Super-Heterodyne Receiver, at the exceptionally low price of

£4

A special Oscillator Coupler Unit, uniform in size and shape with the Transformers, to cover the broadcast band with a .0005 Variable Condenser is also supplied at the cost of £1.

The Series of Transformers with Oscillator Coupler included costs

£5

Given free with every set of Bowyer-Lowe Super-Heterodyne Transformers are complete instructions, wiring diagram, and progressive assembly photographs from which any wireless amateur can make a Seven-Valve Super-Heterodyne Receiver of the latest design.

With these Transformers a Six-Valve Super-Heterodyne gave better results than a Seven-Valve instrument with foreign Transformers, because the new Bowyer-Lowe Unit is built expressly for use with British Valves which

have less internal capacity and more stability than foreign transformers make allowance for.

Bowyer-Lowe Super-Heterodyne Transformer Units are all matched in complete series so that each set is guaranteed to function perfectly at the same peak frequency. A matched .0005 Fixed Condenser is supplied with every set. To eliminate all chance of short-circuiting every transformer is tested at 500 volts between windings. Each transformer is fitted in a case of Grade "A" Ebonite.

Although the Bowyer-Lowe Units cost less than those of foreign makes, they give results surprising in their purity and quiet functioning no less than in their range and selectivity. The complete set, used according to the free instructions given, will enable you to build a Super-Heterodyne Receiver of finer performance than any you have seen. No type of receiver is so interesting to make and use. Start building yours on the Bowyer-Lowe plan to-day.

Bowyer-Lowe Tested Intermediate Wavelength H.F. TRANSFORMERS

BOWYER-LOWE CO. LTD. LETCHWORTH.

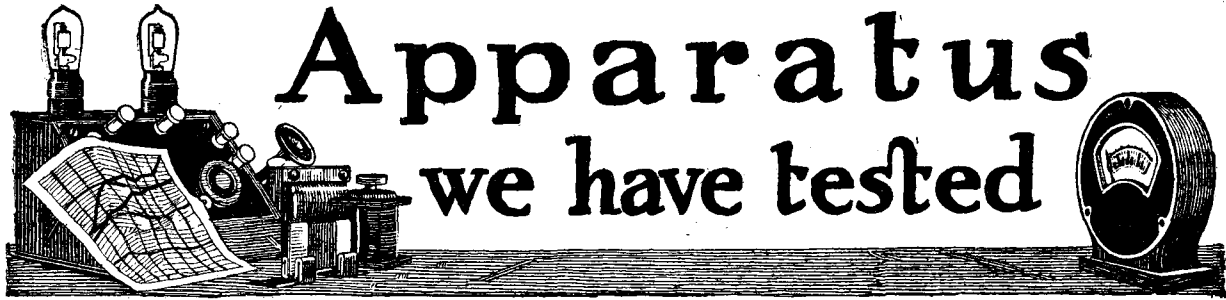

Apparatus we have tested

Conducted by A. D. COWPER, M.Sc., Staff Editor.

Brackets for Transatlantic Four Receiver

Messrs. "A. V." Wireless Company have submitted for our inspection a sample of the strong iron brackets they are supplying for use in the well-known "Transatlantic Four" Receiver designed by Mr. Harris; the purpose of these is to carry the strip of ebonite on which are mounted the valves and transformers at the rear of the set. These brackets are to be affixed directly to the panel by suitable bolts, and the makers claim that this not only facilitates the wiring-up of the receiver but also holds the front panel very securely at right angles to the base-board. A slight rearrangement of the transformers and blocking condensers is then necessitated. The brackets are of substantial

build, finished neatly in black enamel, and drilled for the necessary holes for screws and bolts; the price is also moderate. We understand that similar brackets are supplied by the same firm for other types of vertical panel receivers.

The "Radiotester"

Messrs. The British & Colonial Industries Association, Ltd., have submitted for our inspection and trial an ingenious little instrument having for its purpose the facilitation of the process of testing for faults and so on, in the complex electrical circuits which make up a modern radio receiver. This "Radiotester" consists of a small case, measuring 4 in. by 2½, which is carried by an elastic strap on the wrist of the operator; in the case

is enclosed an ordinary 4½ volt flash-lamp battery. A lamp-bulb is arranged on the upper side to indicate the completion of the circuit; two telephone terminals are provided for connecting up the headphones in certain tests; also a couple of flex connections, 2 ft. in length, carrying sharp-pointed electrodes, one of these being double-ended. Insulating sleeves are provided for these electrodes for protection when not actually in use. In order to maintain the sharp points a slip of emery-paper is affixed to the side of the box. The needle-sharp points can thus be used even on ordinary insulated wire, readily penetrating the insulating covering.

One of the contact points on the double-ended electrode makes con-



Get this Pilot's Chart!

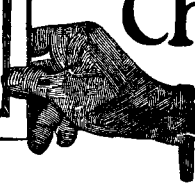

THIS 32-page Booklet contains illustrations and specifications of more than 30 different Receiving Sets that can be built at home by anyone—no matter how inexperienced. Send for it to-day and read how little you need pay for a first-class Receiver such as the famous S.T. 100 or the Transatlantic V. No one need be without a good Valve Receiver on account of expense when Pilot Sets for home constructors cost so little.

3d

Typical Pilot Receivers shown in the Pilot Chart

All Concert De Luxe.
S.T. 100.
All Britain.
Family 4-Valve.
Transatlantic V. 7 Valve T.A.T.
Anglo-American Six.
Etc., etc., etc.

CATALOGUE

Peto-Scott's 48-page Catalogue of Components. Largest mail order Catalogue in the industry. Fully illustrated. Post free

3d

PETO-SCOTT Co. Ltd.

Registered Offices, Mail Order & Showroom;
77, City Road, London, E.C.1

Branches:
LONDON—62, High Holborn, W.C.1.
WALTHAMSTOW—280, Wood Street.
PLYMOUTH—4, Bank of England Place.
LIVERPOOL—4, Manchester Street.
CARDIFF—21, Queen St.

HAWK COILS

MAXIMUM

MINIMUM

Efficiency

Capacity
Damping Effects

Strength

Resistance

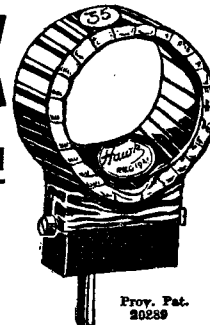

Prov. Pat. 20289

Prices below

WATERPROOF

Coil	Wave Length using '001 Variable Condenser in Parallel		PRICE.
	MAXIMUM	MINIMUM	
18	—	190	2/-
25	395	240	2/4
30	435	300	2/4
35	515	370	2/6
40	680	485	2/8
50	835	600	3/-
75	1250	815	3/10
100	1820	980	4/8
150	2300	1870	5/4
200	3100	2200	5/8
250	3750	2300	6/-
300	4500	2500	6/6
400	4950	—	—

Sold by all Wireless Dealers

Sole Manufacturers:

The Hawk Coil Co., ST. MARY'S ROAD, SURBITON, SURREY.

nection with the lamp (and 'phones if in use) *via* the enclosed cell; the other cuts out the cell, as when testing L.T. grid-bias, and tapped H.T. batteries which provide an external E.M.F.

It is evident that a very varied list of practical tests can be carried out with this equipment, with the minimum of trouble and time expended. There is no need to stop for the purpose of affixing leads, connecting up a spare cell, looking out some kind of current indicator, etc., when a fault develops and a systematic search must be undertaken to locate it in a receiver. The telephone is sensitive enough to indicate leaks and short circuits even of great resistance, and to give some indication with condensers of moderate size when these are in order. A comprehensive pamphlet is enclosed in the case which will instruct the less experienced as to the many possibilities of this simple and effective testing outfit, which we can thoroughly recommend. The price is very reasonable.

An Electric Soldering Set

At first sight it would appear as if an attempt to operate an electric arc, as a source of heat in soldering operations, from the ordinary small 4- or 6-volt L.T. accumulator, was

at least inviting catastrophies, though such experiments might have the approval of charging stations. However, in actual trial, this bold venture proves to be not only practicable, but actually to simplify the business of soldering connections in a radio set so much that it might also be claimed to make it a pleasure. Messrs. Goswell Engineering Co., Ltd., have sent for trial samples of a small, very inexpensive equipment packed in a neat wooden box with supplies of flux and solder, etc., all complete, which enables the operation to be performed with only a moderate sized 4- or 6-volt accumulator for "power-station." The pseudo-arc (it is not a genuine persistent arc, as there are not the 40 volts or so available to maintain it in air) is struck between a carbon electrode and the work. The former is secured in a convenient holder, with flex connection to be put on the negative terminal of the L.T. accumulator. The positive pole of the accumulator is connected by another flex to the wire or terminal to be soldered. By gently stroking or light tapping of the work with the negative electrode an intermittent arc is obtained, sufficient together with the development of enough local heat by the resistance of the bad contacts made here, to heat the metal above the compara-

tively low melting-point of common solder. A touch of fluxite and the application of the stick of solder will then give an easily-produced, clean, sound joint, if the work is reasonably clean already. There is but little lost heat; time is enormously economised; the work is kept clean, and is actually heated in a partly reducing atmosphere (for the arcs emit a certain amount of carbon monoxide through the consumption of the carbon); there is no mess, and no equipment is needed beyond the usual accumulator of a valve set and this small box, 8 in. by 4½ in., which contains all the necessary material. Preliminary tinning of wires, etc., is done with delightful ease, it was found, in a small carbon crucible that is connected to the positive pole for this purpose. Using a four-volt accumulator, it was found in extensive tests that the average current demand (during the few seconds of actual heating of a junction, etc.) was 4 amperes, rising momentarily to 8 amperes if too close contact was made and held, or if the carbon electrode was dipped in the molten solder on a joint. The resistance of the electrodes and leads prevents too great a rush of current. At the same time it is evident that the equipment should not be used on very small accumulators, such as the ten ampere-hour type, except,

WIRELESS BATTERY SERVICE

(DEPARTMENT)

BATTERIES LOANED FREE

Charges for service only. Service comprises: Charging accumulator, free delivery and collection. Payments to be made one quarter in advance. 4 volt 80/40 amp. 6 volt 60/30 amp.

Fortnightly exchange (4 volt only) ... 15/- per quarter.
Weekly exchange (4 or 6 volt) ... 18/9 " "
Weekly " " " 2 Batteries 31/3 " "

Service within 15 miles of Charing Cross.

AUTO MECHANICAL RECTIFIERS LTD.,

Wireless Battery Service Dept.,

91, TABERNACLE STREET, E.C.2.

NEW VALVES FOR OLD!

Whenever your valves burn out or filaments are damaged in any way, send them to us and we will repair them equal to new. Perfect reception is guaranteed with our repaired valves, which are returned to you

WITHIN SEVEN DAYS

D.E '06, 12/6. D.E 2v. '25 to '3 amp., 10/6

Price List for Power Valves on application.

Liberal discount to Wireless Agents. Terms on application.

The North London Valve Repairing Co.

22½, Cazenove Road, Stoke Newington, N.16.

WE ARE ALWAYS AT YOUR SERVICE.

PRICE
6/6
Post FREE
(Bright
Emitters)



Another Guaranteed
BRETWOOD Speciality
is our improved
ANODE RESISTANCE

which gives accurate readings consistently from 10,000 ohms to over 100,000 ohms. This BRETWOOD Component is particularly suited for the STroo circuit (*Modern Wireless*), the Super-Sensitive circuit (*Popular Wireless*), and for resistance coupling, etc.

It is constructed on the same principles that have made BRETWOOD Components famous, and, of course, it carries the BRETWOOD Guarantee. Price 3s. Postage 3d.

BRETWOOD GRID LEAK

Patent No. 224,295/23.

Used and recommended everywhere.

Price 3/- Postage 3d.

BRETWOOD Patent VALVE HOLDER.

Fix this efficient component and get maximum results. Positively no leakage or capacity effects. Perfect contact. Can be mounted on front or back of panel.

Price 1/9 Postage 3d.

BRETWOOD ANTI-CAPACITY SWITCH

Constructors will welcome news of a further Bretwood Product, an Anti-Capacity Switch, the principal features of which include—

Absolute freedom from capacity effects—Perfect Contact—Workmanlike finish and neatness of appearance—Simple single hole fixing and Easy to make wiring connections. Special spring loaded balls in the base make the Bretwood Switch wonderfully smooth in action and ensure clean and perfect electrical contact at all times. It is confidently offered to wireless constructors as the Anti-Capacity Switch *par excellence*, and of course it carries the famous Bretwood Guarantee.

PRICE
5/-
Postage 3d.

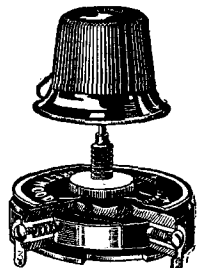

BRETWOOD LTD.,

12-18, London Mews, Maple St., London, W.

All Bretwood specialities are obtainable from most Wireless Dealers

perhaps, in an emergency. A large accumulator such as is used for multi-valve sets with bright-emitter valves would not be affected by this current demand, and several joints could be made for a consumption of current equal to that of an hour's normal listening. For hasty repairs when away from the home work-

shop the outfit should be invaluable. We can strongly recommend the set provided that too small a battery be not used with it, and feel assured that if electrical soldering were widely practised there would be less general aversion to this method of making really sound, permanent electrical connections.

Queries

The Query Department is now re-opened to accept readers' queries. Readers are advised that a charge of 2s. 6d. is made per question, and a stamped, addressed envelope should be enclosed.

Charged Snow

ON Sunday afternoon, March 22, on coming in after a slight fall of snow, I was surprised to hear a series of clicks emanating from the corner of the room, where a two-valve set was located. Thinking it was the accumulator gassing, I lifted the vents, but the noise persisted and seemed to come from within the set itself. I touched the aerial terminal—the one on the aerial side of the constant aerial tuning condenser—and received a sufficient shock to make me jump. This occurred some time after the fall of snow

and when to all appearances the day was a fine spring day. Removing the aerial and touching it on the earth terminal, it was found possible to get a series of sparks and shocks if the aerial was touched. I then fitted a "Static Arrester"—a neat little adjustable gap—between the C.A.T. terminal and earth, and found after a further slight fall of snow that by adjusting the gap a spark 1-16 in. long could be obtained, and that by gradually decreasing the gap the rate of sparking increased until, when almost touching, a noise from the

loud-speaker like the firing of a multi-cylinder petrol engine resulted.

A similar charging of the aerial took place after several slight falls of snow, but when this latter turned to sleet the phenomenon ceased.

J. U.

The Wireless Constructor.

A Free Blueprint of a Three-Valve PORTABLE RECEIVER,

By PERCY W. HARRIS, M.I.R.E. Will be GIVEN AWAY in the MAY ISSUE.

ON SALE APRIL 15.

"VARIC" Air Spaced Variometer

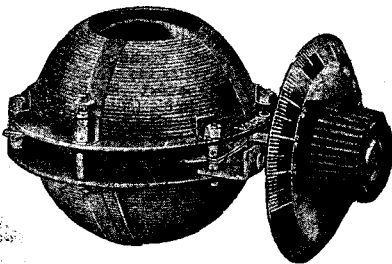

Panel Mounting
Type S.P. . . 10/-
Wavelength 250 650 Metres.
Table or Panel Mounting
Type S.T. . . 12/6
250-650 Metres.
Type L.T. . . 15/-
580-2,300 Metres.

The result of extensive experiment and research, the "Varic" Variometer is designed on scientific principles, combining maximum mutual inductance with absolute minimum self capacity. No mouldings are used, the coils being self-supporting and wound with a very heavy gauge wire, thus keeping down High Frequency Resistance.

The "Varic" Variometer has bearings of unique design, forming perfect electrical contact between Stator and Rotor, whilst ensuring that the Rotor "Stays Set."

In short, the "Varic" Variometer has been constructed to give High Efficiency, Low Self Capacity, Sharp Tuning, Big Signal Strength.

VARIC LTD. CASTLE HILL, BEDFORD

'Phone: Bedford 879,

THE PANEL DE LUXE

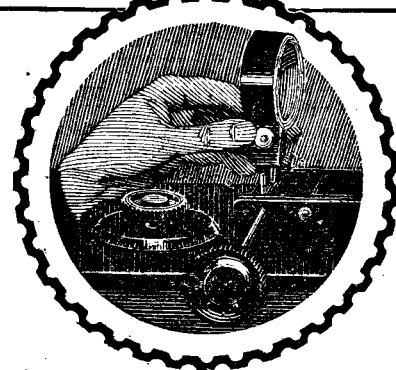

THE real wireless enthusiast goes over his Set inch by inch. Shortening a connection here—replacing an inefficient component there, he knows that success depends on the most careful attention to seemingly insignificant details. Such men are now standardising on Radion as the panel material de luxe.

Radion is available in 21 different sizes in black and mahogany. Radion can also be supplied in any special size. Black 1d. per square inch, mahogany 1½d. per square inch.

RADION

American Hard Rubber Company (Britain) Ltd.

Head Office: 13a Fore Street, London, E.C. 2. Depots: 120 Wellington Street, Glasgow. 116 Snow Hill, Birmingham. Irish Agents: 8 Corporation Street, Belfast.

Information Department

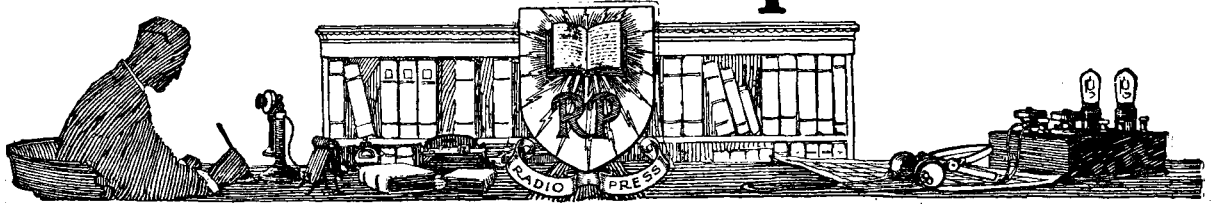

SUPPLIED BY RADIO PRESS SERVICE DEPT., LTD.

J. Q. R. (ROMFORD) has built a three-valve receiver consisting of H.F. amplifier, detector, and L.F. amplifier, the high-frequency valve being coupled to the detector by means of a large variometer, providing a tuned anode circuit. In the anode of the detector valve there is another large variometer which it is intended shall provide reaction effects, and our correspondent finds it impossible to stop the set from oscillating and asks for our advice.

Our correspondent's circuit diagram shows that the connection from the lower end of the tuned aerial circuit goes to the L.T. negative terminal, the filament rheostat being connected in the negative

lead. No potentiometer is provided, and there is thus no means of preventing the set from oscillating when the first variometer brings the anode of the high frequency valve into tune with the aerial circuit. Such circuits will often oscillate quite freely upon aerials of reasonably low resistance, even when no second variometer is provided in the anode circuit of the detector valve for the express purpose of producing reaction. This assumes, of course, that the variometer is sufficiently large to tune to the desired wavelength without the aid of a parallel condenser, and our correspondent informs us that he has obtained a sufficiently large instrument of American manufacture. In such a circuit some means of controlling the degree of reaction

is most essential, and we would suggest that a potentiometer be introduced to control the grid potential of the first valve. Alternatively, the second variometer might be replaced by an ordinary reaction coil coupled to the aerial tuning inductance, so that reversed reaction might be employed if desired.

L. U. J. (BRENTFORD) finds that whenever he lifts the cat-whisker off his crystal detector he hears a steady buzzing noise, and he inquires whether this is normal. He is using a simple form of crystal set.

The buzz in question arises from induction effects from alternating current mains, and is quite a normal symptom in a crystal receiver. So long as the cat-whisker is pressing

The Wireless Constructor

EDITED BY PERCY W. HARRIS

6^d

MONTHLY

Creating a Market

The "WIRELESS CONSTRUCTOR" has amply fulfilled its mission in Wireless. A new demand has been created from a large section of the public not previously catered for. This is amply proved by the fact that the "Wireless Constructor" has a circulation greater than that of all non-Radio Press wireless publications added together. It is, therefore, only pointing out the obvious to claim that your advertisement should also be included in its columns.

Next issue closes for press April 18th.
For rates write Advertisement Managers:

Barclays Advertising, Ltd.,
Advertising Consultants & Contractors,
Bush House, Strand, London, W.C.2
Telephone: City 9911 (Extn. 9).

L.F. INTERVALVE TRANSFORMERS. THE RENOWN

Is made in any ratio you desire and, if you require an Intervalve Transformer for general work, we see to it that you get an Instrument that is soundly constructed, and is really designed for the work it has to do.

With its large initial diameter of bobbin, its good hefty soft iron core, its infinity insulation resistance, its great number of turns, you have an instrument that will give perfect transference of energy, with the highest amplification that it is possible to combine with that perfect ability, to produce in constant strength, over the whole of audible range. In fact in the "Renown" you have an Intervalve Transformer that will help you to attain a more distortionless reproduction by the loud speaker, than any other transformer preferred to you to-day. Furthermore: You may prove it for yourself. You are given the opportunity of returning it to us within 14 days, after having tested it against ANY other.

Ratios 5 : 4 : 3 : 2 to 1. Price 8/4 Post Free.

We are still repairing ANY MAKE of Intervalve Transformer with our efficiency equal to new guarantee for 5/- Post Free. Delivery 3 days.

TRANSFORMER REPAIR CO., Hay Street, PORTSMOUTH.

WIRELESS VALVES

Guaranteed Osrams "C" Type, R.A.F. Surplus,
The cheapest high-frequency valve on the market and
the most satisfactory as a detector and amplifier.

Adaptor for same 1/- each.

**5/- each, 4 for 19/-, postage paid, at
Buyers' Risk.**

J. MARTIN BLAIR,
Amberley House, Norfolk St., Strand, London, W.C.2
Phone. Central 4253.

Barclays 969.

SEND A SUBSCRIPTION

for your favourite wireless journals. Promptly delivered, post free.

Modern Wireless	Wireless Weekly	The Wireless Constructor
Twelve months 15/-	Twelve months 32/6	Twelve months 8/6
Six months 7/6	Six months 16/3	Six months 4/8

RADIO PRESS Ltd. (Dept. S.), Bush House, Strand, London, W.C.2.

upon the crystal the telephone circuit is virtually short-circuited by the tuning inductance, so far as low-frequency currents are concerned. It seems that when the cat-whisker is lifted the low-frequency induction currents find a pass through the windings of the telephones and through the capacity of the body of the operator, and thus produced a buzz.

M. R. L. (BRISTOL) asks for information with regard to the low-frequency side of his 4-valve receiver. When using only one stage of L.F. amplification signal strength and quality are good. On switching in the second L.F. valve, however, very little increase in signal strength is obtained, and bad distortion is noticed which cannot be removed by any adjustment of grid bias or high tension voltage. If, however, he turns down the filament of the first L.F. valve there is a soft "plop" and the quality and volume of signals improved. Different valves have been tried without effecting a cure, and the placing of a milliammeter in the plate circuit of the first L.F. valve shows that there is a sudden change in anode current when the "plop" occurs.

The trouble of which you complain is due to low-frequency oscillation occurring when the second stage of the low-frequency amplification is switched in. This is showing itself, however, in an unusual form, as usually this form of oscillation is accompanied by a high-pitched whistle. As you are using a common H.T. positive lead for the two stages of L.F. amplification we would advise you to place a fixed condenser of 2 μ F capacity across this and the H.T. negative leads. The two L.F. transformers should be placed well apart with their cores at right-angles. The effect should also be tried of connecting the two cores together, and connecting them either to earth or L.T. negative or H.T. positive. Further means of effecting a cure may be found in reversing either one or the other of the windings of the first L.F. transformer, and you should also try connecting various resistances across the secondary of the transformer. The value of this resistance may be between 100,000 ohms and half a megohm, as high a value as possible being preferably employed, as otherwise a loss in signal strength may result.

H. C. (BLOOMSBURY) has a 2-valve set, H.F. and detector,

which has suddenly ceased to function. 2LO is now barely audible, and changing over the valves makes no difference to the results. On changing the valves back the grid-leak was accidentally short circuited, and it was noticed that the filament of the detector valve then burnt very brightly.

The fact that short-circuiting the grid-leak causes the filament of the valve to burn more brightly shows that this filament is lying on the grid of the valve. As your grid-leak is connected to L.T. positive when this component is shorted, that portion of the filament between its point of contact with the grid and the positive lead is also shorted, and the rest of the filament therefore burns more brightly. It may be possible to make the valve serviceable again in the following manner. Determine at what point the filament is making contact with the grid. Remove the valve from its socket, and hold it with this point uppermost. Light the filament by means of two leads taken from the accumulator and tap the bulb of the valve smartly. In this manner you may succeed in separating the filament from the grid and put the valve back again into use.

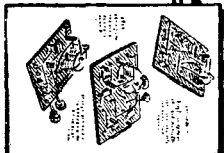
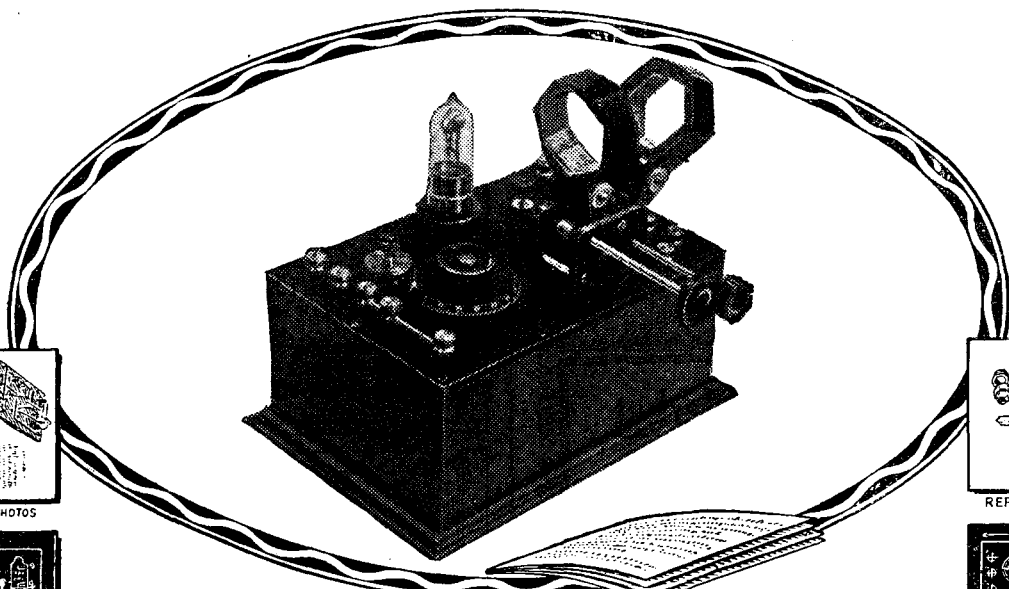

REPRODUCTIONS OF PHOTOS

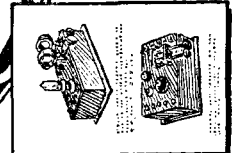

REPRODUCTIONS OF PHOTOS

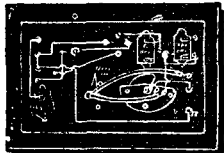

BLUE PRINT

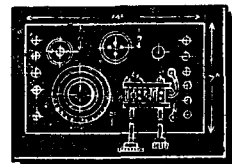

BLUE PRINT

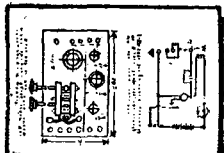

WORKING DRAWING

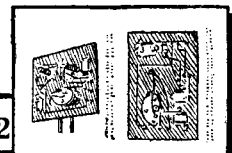

REPRODUCTIONS OF PHOTOS

ENVELOPE No 9 CONTAINS ALL THE NECESSARY INSTRUCTIONS WITH WORKING DRAWINGS, BLUE PRINTS &C, FOR MAKING THE ABOVE.

SINGLE VALVE SET

This set has been designed by Herbert K. Simpson, and numerous letters have been received by us testifying to its excellent range and power. Ask for Radio Press Envelope No. S9. Price 1/6 or post free 1/9

RADIO PRESS Ltd., Bush House, Strand, London, W.C.2

Whatever the Circuit—

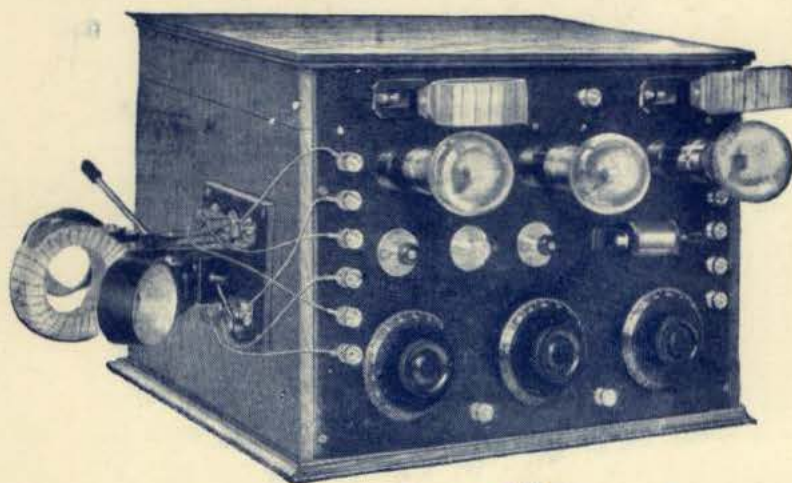

the Omni is the Set

A LABORATORY in a single cabinet. These few words sum up the Omni Receiver, full constructional details of which appear in the Radio Press Envelope No. S5.

The Omni Receiver was designed by John Scott-Taggart, F.Inst.P., A.M.I.E.E., to enable the really keen experimenter to have a cabinet wireless receiver which could be wired up to almost any circuit in a very short time—the set, however, always retaining its neat outward appearance.

The raising of the hinged lid of the cabinet discloses a panel on which have been mounted 50 well-spaced terminals, and that is the key to what has hitherto been considered an impracticable problem. The various components are mounted behind the front panel, and, generally speaking, the connections of each component are taken to the terminal panel. After the Omni Receiver has been completed, it is possible and an easy matter for any wireless enthusiast to try out and compare practically any new circuit, or variations in old circuits, by simply raising the lid of the cabinet and connecting up. It is advisable to use rubber covered flex for the purpose.

Every terminal on the panel under the lid of the cabinet is numbered, and a key is supplied. Using the numbered key it is an easy matter for the experimenter or even beginner to wire up and test the following 12 circuits, given in the envelope:—Crystal, Crystal and 1 L.F., Crystal and 2 L.F., 1 H.F. Crystal and 1 L.F., H.F. Crystal and 2 L.F., Detector and 1 L.F., Detector and 2 L.F.,

Single Valve Reflex ST 34, ST 45, ST 75, ST 100. It is simply a matter of connecting terminals 51-50, 51-28, 50-42, etc. From time to time new keyed circuits will appear in the Radio Press publications, principally *Wireless Weekly*. No wireless enthusiast should be without an Omni Receiver, the Receiver you can wire at will, always ready for future experiments.

The Radio Press Envelope No. S5 contains full constructional details, Blue-prints, Photographs, Diagrams, Key charts, a transfer of key numbers for the terminal panel, together with useful hints and tips for the constructor and many pages of interesting information, experiments, etc., showing the enormous advantages and possibilities opened out to owners of the Omni Receiver. Obtainable from all Newsagents, Bookstalls, local Wireless Dealers or direct from the Publishers. When ordering direct be sure and quote Envelope No. S5.



Always ready for the Future

Radio Press, Ltd.

BUSH HOUSE, STRAND, LONDON, W.C.2.

Barclays



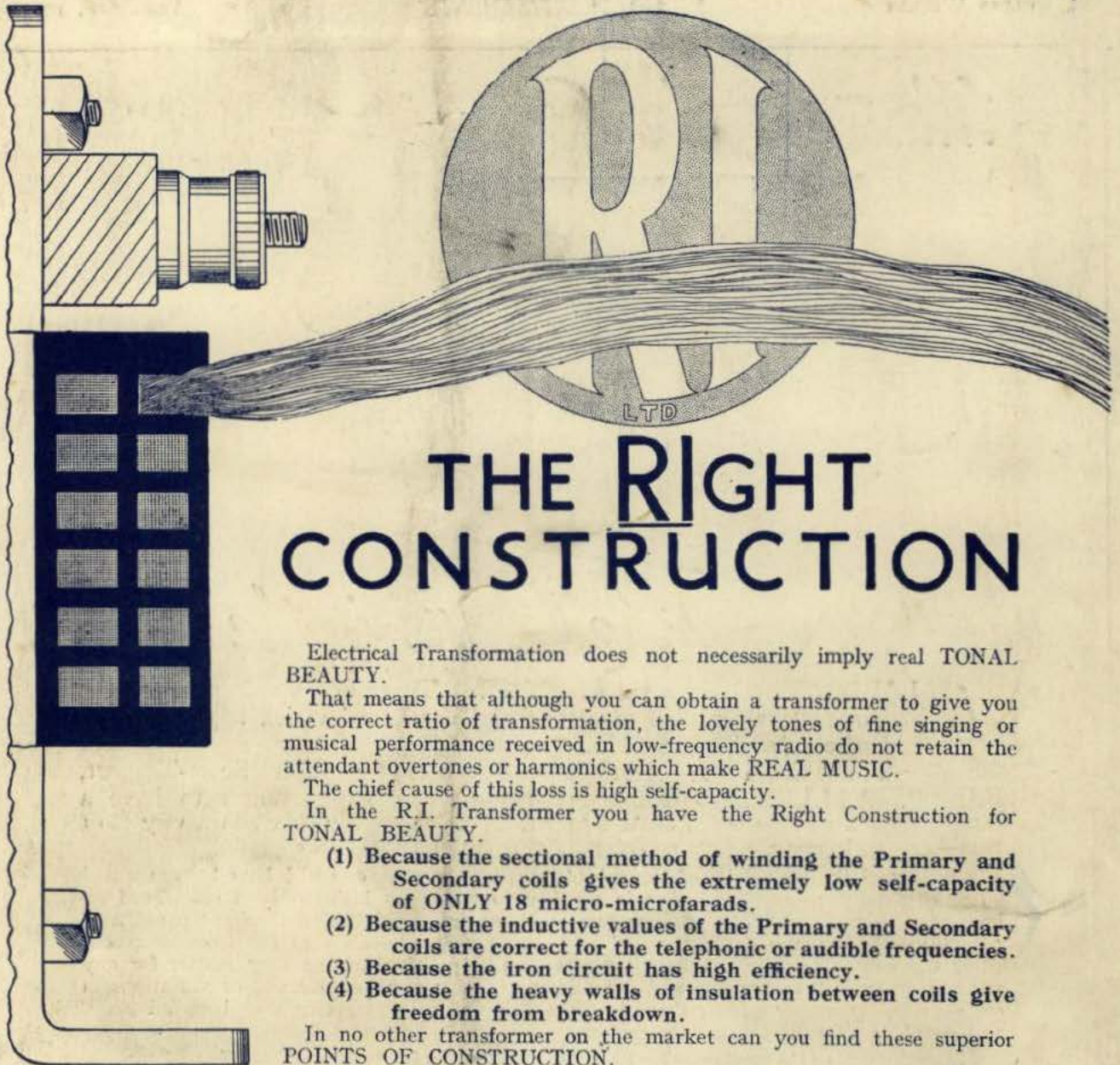

THE RIGHT CONSTRUCTION

Electrical Transformation does not necessarily imply real TONAL BEAUTY.

That means that although you can obtain a transformer to give you the correct ratio of transformation, the lovely tones of fine singing or musical performance received in low-frequency radio do not retain the attendant overtones or harmonics which make REAL MUSIC.

The chief cause of this loss is high self-capacity.

In the R.I. Transformer you have the Right Construction for TONAL BEAUTY.

- (1) Because the sectional method of winding the Primary and Secondary coils gives the extremely low self-capacity of ONLY 18 micro-microfarads.
- (2) Because the inductive values of the Primary and Secondary coils are correct for the telephonic or audible frequencies.
- (3) Because the iron circuit has high efficiency.
- (4) Because the heavy walls of insulation between coils give freedom from breakdown.

In no other transformer on the market can you find these superior POINTS OF CONSTRUCTION.

For the man who wants REAL RADIO MUSIC there is only one transformer worth buying.

THE R.I. TRANSFORMER

PRICE 25/-

Write for the New R.I. Catalogue.

12 HYDE ST OXFORD ST LONDON W.C.1

Contractors to the Admiralty and all Government Departments.

Wireless Weekly

Vol. 6. No. 2

WHICH IS THE BEST
L.F. TRANSFORMER?

By PERCY W. HARRIS, M.I.R.E.



Burndept Components for convenient and reliable filament control

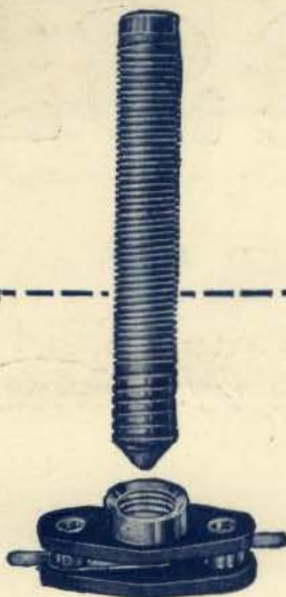

Fixed Resistors.

No.	Ohms.	Amps.	s. d.
721	.3	2	1 6
735	.75	2	1 6
722	1.5	2	1 6
723	2	1	1 6
724	3	1	1 6
725	5	.5	1 9
726	7.5	.5	1 9
727	10	.5	1 9
728	13	.5	1 9
729	20	.25	2 0
730	26	.25	2 0
736	40	.25	2 0
731	48	.25	2 0
732	55	.25	2 0

No. 718. Screw Holder, on Ebonite Base, with instructions 1/6

No. 720. Brass Shorting Plugs, to fit Screw Holders, three in carton ... 1/6

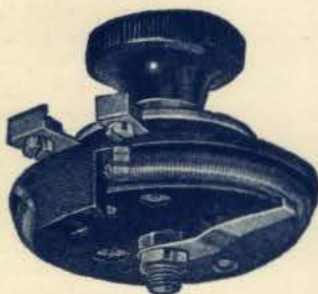

The Dual Rheostat.

No. 222. Dual Rheostat, 5-30 ohms, for mounting on any panel, from $\frac{1}{8}$ " to $\frac{3}{4}$ " in thickness, with drilling template 7/6

THE Burndept Components for filament control deserve the attention of every constructor who wishes to equip the instruments he builds in the best possible way.

It is most convenient to have your set fitted with Burndept Fixed Resistors, which each consist of a definite amount of resistance wire wound on a fibre rod and are made in thirteen values from 0.3 to 55 ohms. They may be used in series with, or in place of a rheostat. When it is desired to use a new or different type of valve, one has only to insert the correct Resistor in the Screw Holder, no other alteration being necessary. Further particulars of Burndept Fixed Resistors will be sent on request.

A very useful component is the Burndept Dual Rheostat, which can be used to control either a bright- or a dull-emitter valve. The first half of the element is wound to a resistance of 25 ohms, and the second half, to a resistance of 5 ohms. The whole 30 ohms resistance is used to control a dull-emitter valve, and the 5 ohms resistance a bright valve. Contact is perfect and the movement of the brush practically noiseless owing to the special construction of the former on which the wire is wound.

*Purchase Burndept by its name—
substitutes are not the same*

BURNDEPT

WIRELESS APPARATUS

BURNDEPT LTD., Aldine House, Bedford Street, Strand, London, W.C.2
Telephone : Gerrard 9072 Telegrams : "Burndept, Westrand, London."

LEEDS : 12, Basinghall Street (near City Square). BIRMINGHAM : Winchester House, Victoria Square.
NORTHAMPTON : 10, The Drapery. NEWCASTLE : 17, Lisle Street. CARDIFF : 67, Queen Street.

Assistant Editor :
PERCY W. HARRIS,
 M.I.R.E.

Scientific Adviser :
 Prof. G. W. O. HOWE,
 D.Sc., M.I.E.E.

Advisory Editors :
 Prof. R. WHIDDINGTON,
 M.A., D.Sc.
 Prof. C. L. FORTESCUE,
 M.A., M.I.E.E.

Wireless Weekly

Phone: City, 9911.

Staff Editors :

E. H. CHAPMAN,
 M.A., D.Sc.

A. D. COWPER,
 M.Sc.

R. W. HALLOWS,
 M.A.

G. P. KENDALL,
 B.Sc.

STANLEY G. RATTEE,
 M.I.R.E.



Another Step Ahead

LAST summer Radio Press, Limited, took the bold step of transferring its offices from the quiet, old - world premises previously occupied in Devereux Court, Strand, to spacious and up-to-date apartments in Bush House, the finest office building in this country. The offices in Devereux Court were the second suite to be occupied by the firm, its previous accommodation in Norfolk Street having proved totally inadequate within a few months of the Company's formation. The change to Bush House seemed, as indeed it was, a bold step, and many people questioned the wisdom of taking premises which at the time seemed unnecessarily large. Confidence, however, has always been the watchword of the Radio Press organisation—confidence in itself, confidence in the future of the great industry with which it is associated, and in which it has played such an important part, and last but not least, confidence steadily

but surely built up in the minds of the public who know by experience that Radio Press and Reliability are synonymous. Those who have watched the growth of this

out—large additional accommodation on the second floor will be taken to house the steadily increasing editorial staff, leaving the existing premises for the sales branch of the business, which, owing to the great success of *Wireless Weekly*, *Modern Wireless*, *The Wireless Constructor* and the Radio Press books, envelopes, and other publications, now requires a very large portion of the present offices.

The many new readers of *Wireless Weekly* may not all be acquainted with the policy of Radio Press, Ltd. It is, of course, to give accurate, reliable and up-to-date information on every aspect of the art. To do so requires the highly competent editorial staff for which Radio Press, Ltd., is world famous. Its position as the largest wireless publishing house in the world has only been attained by paying the most careful attention to its readers' interests, thus building up the confidence in which it is universally held.

CONTENTS	
	Page
The Wireless Chain of the C.N.R.	26
Reception Conditions Week by Week	33
Jottings by the Way	39
Two Useful Accessories for the Experimenter	42
A Useful Application of the Weston Relay	43
Some Further Measurements with Auto-Coupled Circuits	46
Some Experiments with Aerial Coupling Methods	51
Which is the Best L.F. Transformer?	52
A Cabinet Crystal Receiver	57
Correspondence	61
Apparatus We Have Tested	66
Information Department	69

great wireless publishing house will learn with interest that the existing offices occupied by Radio Press at Bush House have now proved inadequate for their needs, and that within a few weeks—just as soon as the necessary structural alterations can be carried

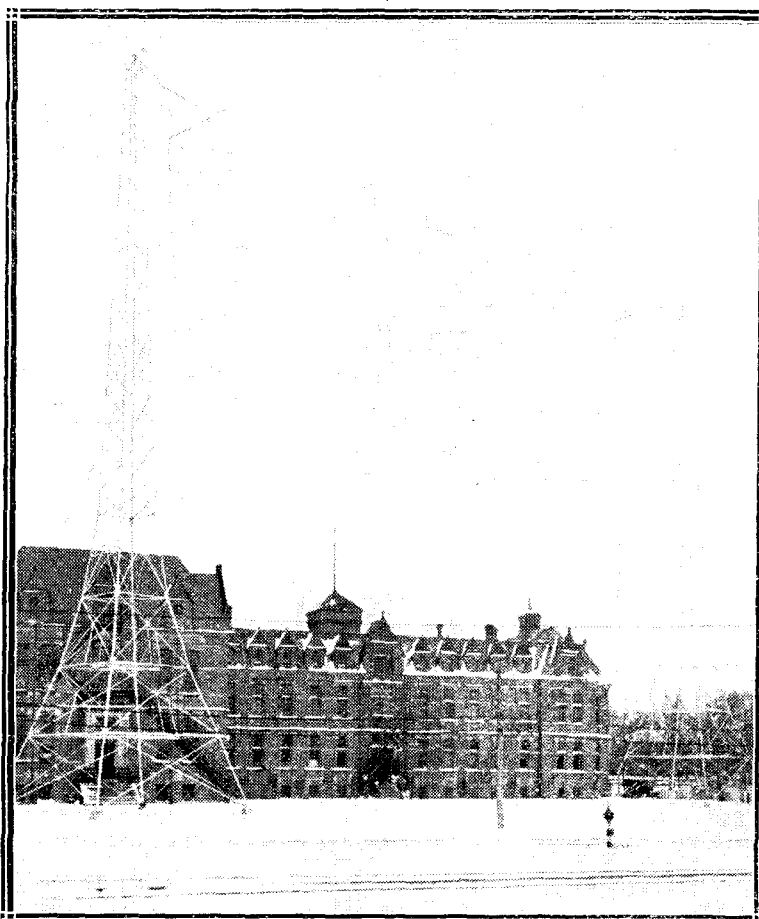

The aerial at CNRA, this station being the most easterly of all wireless broadcasting stations in North America.

The Wireless Chain of the C.N.R.

By Capt. L. F. PLUGGE,
B.Sc., F.R.Ae.S., F.R.Met.S.

ing throughout Canada. These stations do not broadcast daily, but as a rule something like twice a week, which somehow corresponds to the position of the trans-continental trains. The call-signs allotted to these stations have been distributed in a very consistent manner. These call-signs are of four letters, all of them beginning with CNR, which stands for "Canadian National Railways," followed by a letter which is the first letter of the town in which the station is situated: thus we get CNRO for Ottawa; CNRW for Winnipeg; CNRM for Montreal. There is one exception to this, however, namely Moncton, and this call-sign is CNRA, to avoid confusion with Montreal. The wavelengths of the stations vary between 313 and 517 metres. Most stations transmit on a power of 500 watts, but there is one which uses 750 watts and two 1 kw.

Control

Plans are now under consideration by officials of the

THE Canadian National Railways was the first, and is still, I believe, the only railway system in the world to adopt radio as part of their regular service of transportation. A chain of broadcasting stations radiating information and entertainment north, south, east and west across the continent of North America has been established by them with powerful links in Montreal, Moncton, Ottawa, Toronto, Winnipeg, Regina, Saskatoon, Edmonton and Calgary.

First Transmissions

The first wireless transmissions from a station to a moving train were successfully carried out under the direction of Sir Ernest Rutherford on October 13, 1902. Sir Ernest was then Professor of Physics at McGill University, Montreal. Now, in 1925 the Canadian National Railways was

the first transportation system to establish wireless as a definite part of the service to be rendered to the public. The Canadian National Railways have at present some nine stations work-



Listening in while travelling on a trans-continental train of the C.N.R. A view of the interior of a library observation car.

Some brief particulars concerning the Canadian National Railway Wireless Scheme which allows reception of broadcasting for the entertainment of trans-Canadian passengers.

Department of Marine and Fisheries, which department has control of wireless and radio in Canada, for a standardisation of wavelength by cities, and changes have already been made during this month to the Montreal and Toronto stations, which have been respectively changed from 435 metres to 410 and from 356 to 350 metres.

Below is given a table of the stations of the wireless chain, showing the call signs, wavelengths, etc., and also the time prevailing in the various towns at midnight Greenwich Mean Time.

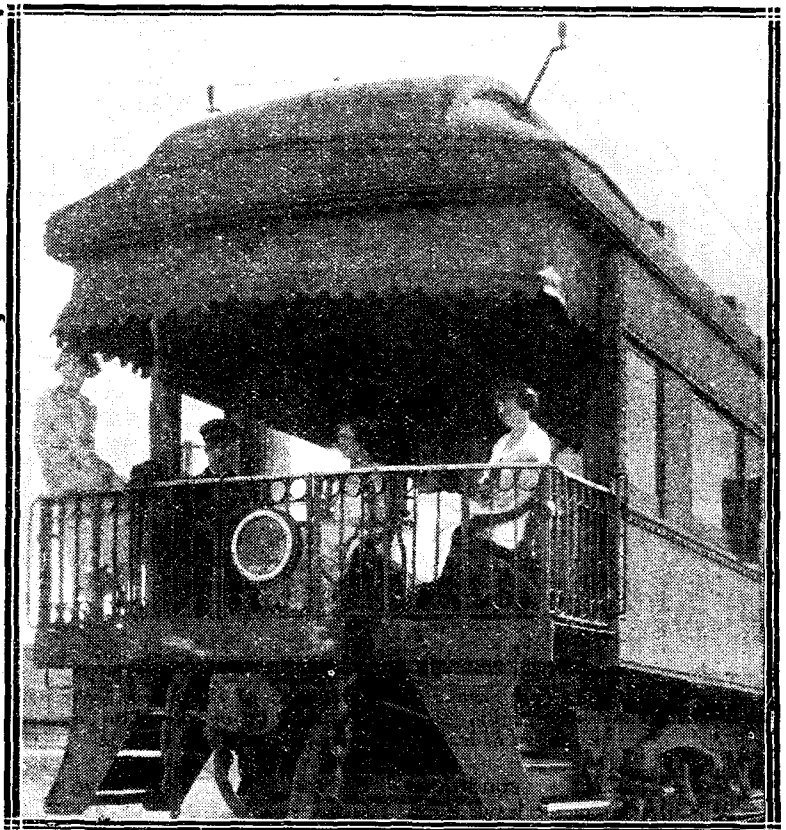

This photograph of a C.N.R. observation car shows the aerial system used

Station.	Call Sign.	Wave length.	Power used.	Time prevailing at midnight GMT.
		Metres.	Watts.	P.M.
Montreal, Quebec, Canada	CNRM	410	1,000	7.0
Moncton, New Brunswick, Canada ..	CNRA	313	750	8.0
Ottawa, Ontario, Canada	CNRO	435	500	7.0
Toronto, Ontario, Canada	CNRT	350	500	7.0
Winnipeg, Ontario, Canada	CNRW	450	500	6.0
Regina, Saskatchewan, Canada ..	CNRR	420	500	5.0
Saskatoon, Saskatchewan, Canada ..	CNRS	400	500	5.0
Edmonton, Alberta, Canada	CNRE	517	500	5.0
Calgary, Alberta, Canada	CNRC	430	1,000	5.0

Moncton, New Brunswick, Canada, is the most easterly of the Canadian National Railways radio chain, and the most easterly of all wireless stations in North America. The difference between Moncton and British time is only four hours.

Time Difference

This is the smallest difference between any American time and our own. All trans-continental trains of the C.N.R. and other principal trains are equipped with wireless receiving sets by means of which entertainment for passengers is provided when the train is in motion or at a standstill at a station. Reception on such trains is very clear, covering a wide range. The aeriels used consist of a seven-strand double wire placed on the roof of the library-observation cars. The sets operate either a loud-speaker or headphones according to the requirement of passengers. The transmitting gear used throughout the wireless chain is the well-known Western Electric Standard Transmitting Equipment.

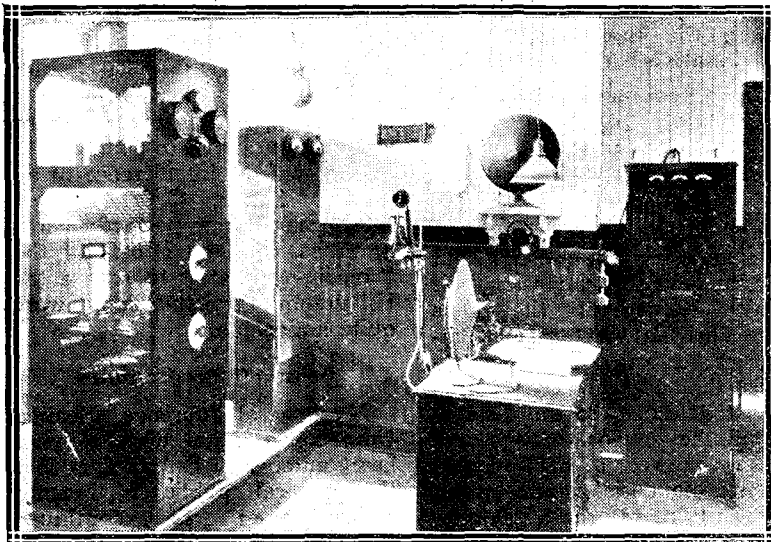

The power control room at CNRA. This station uses a Western Electric Standard 750 watts transmitting panel, which may be seen on the left.

Reception Conditions Week by Week

By W. K. ALFORD.

Review of reception for week ending April 5.



Steady progress is being made in the erection of the new high-power Post Office station at Rugby. The photograph above shows an engineer engaged in testing the aerial insulators.

RECEPTION conditions during the week have been particularly interesting, chiefly on account of the rapid changes which have taken place. Early in the week conditions were very unfavourable indeed, but on Wednesday night an extraordinary change took place, giving an efficiency of reception equalling that of any night during the winter period. A perfect "bedlam" of stations on the broadcast band appeared at much greater strength than has been noticed for a considerable time, and later in the evening I discovered a rather interesting phenomenon which very rarely occurs.

Some Interesting Results

I happened to be in communication with several American amateur stations who were coming in at far above normal strength, and in every case they reported that signals from Europe were much worse than usual, showing that reception (and transmission) may be well above normal in one direction and well below in the opposite direction, other conditions being the same, and it is quite safe to state that the American listeners do not suffer to anything like the same extent from "mush" interference as we do over here, as

the radio authorities have apparently realised that "arc" and high-power spark stations are quite obsolete. It is to be hoped that the controlling forces in this country will do the same.

The New London Station

Considerable interest and discussion is attached to the opening of the new London station of the B.B.C., who have apparently raised a "mare's nest" in the form of drastic complaints from listeners in S.E. London, who state that they can hardly hear the transmissions, whereas to the very great majority of listeners the improvement over the old station is quite marked.

Obtaining Symmetrical Radiation

The official statement of the B.B.C. that it is impossible to create a symmetrical radiation from a transmitting station situated in the heart of a great city is quite beyond question, but I cannot help thinking that their technical excuse that the masts of the new station were oscillating is rather too novel for a station of that power. It has been stated that owing to the disposition of the station houses and masts on the roof of the building, the resulting aerial would be too long and therefore a sloping aerial was to be tried which extended from the hut to the top of

the nearer mast. A more asymmetric arrangement could not well be conceived, especially as it is directly above a steel-structured building. What form of aerial is being used now I cannot say, but one would think that, first and foremost, the B.B.C. would have laid their plans for a reasonably symmetrical radiating system.

The Test Transmissions

The comparative testing of the "old" and "new" stations has been followed with considerable interest by a large community, but I have never heard any reference to the relative powers used.

Presumably they were, or ought to have been, the same, but the new station is generally thought to be 3 kw. as against $1\frac{1}{2}$ kw. for the "old" station. I am sure that some statement from the B.B.C. on this point would be of considerable interest to people who have followed the tests.

Relaying the Hilversum Station

On Thursday night, April 2, an interesting re-transmission of Hilversum was given by 5XX. Although probably of an experimental nature, the net result could not altogether be called a success. Quite uncontrollable circumstances had to be met with in the form of interference of all kinds. Spark, C.W. and X interference grew perfectly fierce at times, and the efforts of the "receiving" staff to retune the Hilversum transmission were quite noticeable.

"Stunt" Programmes

My general inference, gleaned from conversation with a very large number of listeners, is that the general public is getting rather tired of continued "stunts" of doubtful success on the part of the B.B.C.

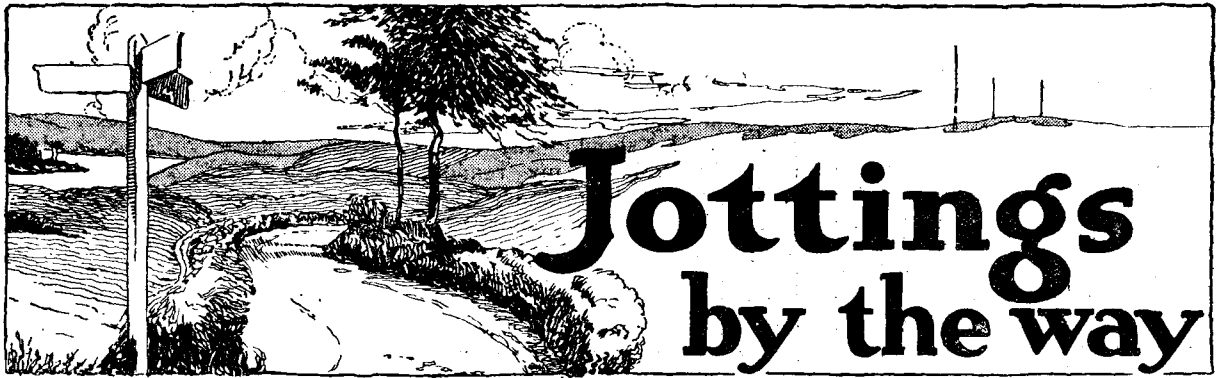

Jottings by the way

Signs and Portents



As I was riding slowly home today, covered about a foot thick in snow, many thoughts ran through what I am pleased to call my mind. I wondered why Armstrong Supers hiss like serpents, and why some people stick up sausage aerials. I pondered over the great question of hysteresis losses in condensers, asking myself whether there was any connection between hysteresis and hysterics. And then as a snowflake about the size of a pocket handkerchief fell across both my eyes, rendering me temporarily blind, a sudden great and cheering thought came to me. The



... His face works horribly as in the movie close-up ...

summer, the glad summer, was at hand. Before long nightingales would be singing in every sylvan glade, pausing every now and then to ask one another whether it was not about time for Captain Chuckersley or his accomplices to turn up with the microphone. Before long atmospherics, those heaven-sent blessings, would come to one's aid whenever the set refused to work before an audience of critical friends. In but a little time one would be able to lie in a hammock cursing the horrible distur-

tion of the loud-speaker bellowing upon one's next-door neighbour's lawn. And from loud-speakers out of doors my thoughts flashed in a moment to portable sets.

A Mystery

At this season of the year numbers of those who write help-

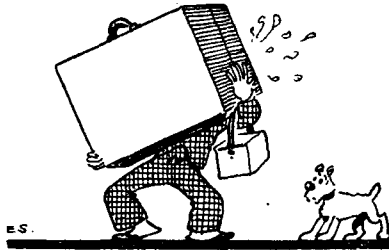

... You stagger along ...

ful articles give you the fullest instructions for making portable wireless receiving sets. I have often wondered what sort of a man it is that makes up and uses one of these things. Frankly I do not know, for I have yet to meet him. I think, however, that he must be the wireless equivalent of the dope fiend, the jazz maniac, and other horrible people that one meets at the pictures and in the more lurid type of novels. I picture such a man starting out upon life's thorny path full of youth and

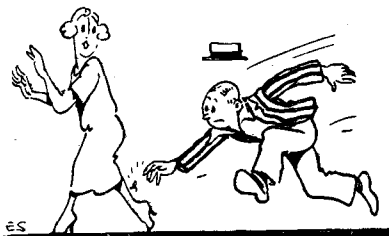

... A picnic gnaw is easily acquired ...

health and cheerful animal spirits. All goes well with him until one day a friend asks him round to hear some wireless. He

goes. He listens. He realises that at last he has found the thing for which his soul was thirsting. Next day, though he feels that he ought not to call again so soon, he returns to the friend's house and demands more wireless. In a month's time broadcasting has become the only thing that makes life worth living. It does not suffice him to switch on after dinner and to listen for a couple of hours. He must have broadcasting morning, noon and night. The craving has mastered him.

A Sad Case

He can just manage to get through his work at the office so long as he can have broadcasting at lunch-time and again during the afternoon. If he is forced to

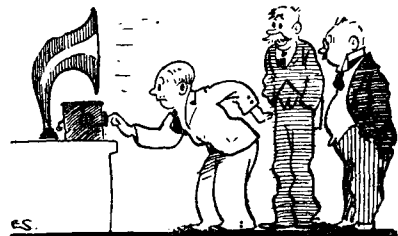

... You hastily alter the tuning ...

take a journey by rail or car his case is terrible. His face works horribly—you have seen this kind of thing in the movie close-ups. His hands are hot; his lips, which he bites continually, are parched and feverish. There is only one thing that can help him to preserve his peace of mind; he must have a portable set, so that, like the fellow in the nursery rhyme, he shall have music wherever he goes. So he builds one, fitting it into an attaché case or a cabin trunk or a hatbox. I do not suppose for a moment that it ever works, but so long as his fingers can find knobs to twiddle, his heart is buoyed up with hope, and

- 3.45 a.m.—The Book Shelf.** An intimate peep into the home life of famous authors.
- 4.0 a.m.—Programme,** presented by the "Los Angeles Examiner."
- 5.0 a.m.—The Sunshine Girls Trio and Don S. Smith (Tenor),** in semi-classical and popular numbers.
- 6.0 a.m.—The Packard Radio Club,** including Dorothy Cleveland, Way Watts, and Barney Weber.

SUNDAY, APRIL 19th

FRANCE.

PARIS.—Station: Eiffel Tower.—FL.
Wavelength: 2,650 metres—5 kw.

6.0 p.m.—Concert.

Artists: Dr. Vachet, M. Louis de Serres, Mlle. Estrabat Eytmin (Pianist), M. Paul de Lignis (Bass), and Mlle. Pascal (Vocalist).

1. Medical Talk. Dr. Vachet.
2. Choir of Maids (Wagner). Mlle. Eytmin.
3. Song from "Tristram and Isolde" (Wagner). Mlle. Pascal.
4. The Count Ory (Rossini). M. Paul de Lignis.
5. Theme and Variations (Chevallard). Mlle. Eytmin.
6. The Beautiful Lady of the Mill (Schubert). Mlle. Pascal.
7. (a) Song for John (Chizat), (b) The Old Purse (Chizat). M. Paul Lignis.
8. Ballad (Chopin). Mlle. Eytmin.
9. The Pleasant Hours (de Serres), The End of Love (de Serres). Mlle. Pascal, accompanied by the Composer.

6.55 p.m.—News Bulletin and Weather Forecast.

7.10 p.m.—End of Transmission.

PARIS.—Station: Radio-Paris.—SFR.
Wavelength: 1,750 metres—8 kw.

11.45 a.m.—Concert, by M. Roland Lenoir.

12.45 p.m.—News Bulletin and Close Down.

3.30 p.m.—News Bulletin, Sporting Results, and Close Down.

NOTE.—The Concert is temporarily suspended.

7.15 p.m.—Esperanto Lesson, by Doctor Corret. **Lecture** by Doctor Frumusan, "The Skin and Hair."

7.30 p.m.—Sporting Results.

7.45 p.m.—Jazz Music by Mario Cazes and his Orchestra of the Chateau Caucasiens.

9.30 p.m.—Close Down.

GERMANY.

HAMBURG.—Station: Nordische Rundfunk.—AG (Norag).
Wavelength: 395 metres—1.5 kw.

1.15 p.m.—Musical Programme by the Orchestras of Bremen and Hanover.

6.0 p.m.—Concert.

1. In the Spring (Grieg). The Station Orchestra.
2. Mazurka—Violon Solo (Wienawsky). Hans Tack.
3. Serenade—Trumpet Solo (Bohme). Fritz Peters.
4. Viennese Children (Strauss). The Station Orchestra.
5. Andante in D—Flute Solo (Mozart) Hans Bauer.
6. Heyre Kati—Violon Solo (Hubay). Hans Rosenlocher.
7. Concert No. 2—Cello Solo (Julius de Sweet). Heinrich Ritter.
8. Hungarian Dance (Gungl).

7.15 p.m.—English Lesson.
Hans Bredow School.

8.0 p.m.—Operette in Three Acts: "The Dollar Princess." A. M. Willener and F. Grundbaum. Music by Leo Fall.

Personnae: John Couder (Bernhard Jacks.htat), Alice, his daughter (Erna Lange), Dick, his nephew (Max Pratsch), Daisy Gray, his niece (Isa Roland), Fredy Wehrburg (Fred Schneider), Hans (Franz Burg), Olga Labinaka, Singer (Else Walther), Tom, Couder's Brother (Curt Rodeck), Miss Thompson (Edith Scholz), James (Hans Freundt), Bill, Chauffeur (Fritz Heimlich).

Act I and II take place in New York at the home of Couders.

Act III takes place at the house of Wehrburg in Aliceville (Canada).

10.30 p.m.—News Bulletin given partly in English.

Dance Music by the Station Orchestra

KONIGSBERG.—Station: Ostmarken Rundfunk.—AG.

Wavelength: 463 metres—1.5 kw.

4.0 p.m.—Concert by the Station Orchestra.

6.30 p.m.—Address: "The Practice of Auto-Suggestion." Herr Hans Braun.

7.0 p.m.—Orchestral Selections.

Artists: Walter Kelch and Max Aschner (Vocalist).

1. "The Midsummer's Night Dream" (Mendelssohn).
2. "Don Juan" (Mozart).
3. Song of Leporello from "Don Juan" (Mozart). Max Aschner.
4. "The Poacher" (Lortzing).
5. Song of Barcolous from "The Poacher" (Lortzing). Max Aschner.
6. Selection (Smetana).
7. The Merry Wives (Nicolai).
8. Song of Falstaff from "The Merry Wives of Windsor" (Nicolai). Max Aschner.
9. "The Barber of Seville" (Mozart).
10. Song of Bartolo from "The Barber of Seville" (Mozart).
11. Selection (von Weber).

AMERICA.

United States.

NEW YORK (Schenectady).—Station General Electric.—WGY.
Wavelength: 379.5 metres.

11.30 p.m.—Madison Ave. Reformed Church, Albany.

12.45 a.m. (Monday, 20th).—Waldorf-Astoria Hotel (New York) Orchestra. Joseph Knecht (Conductor).

PITTSBURGH.—Station: Westinghouse Electric.—KDKA.

Wavelength: 309 and 68 metres.

11.30 p.m.—Dinner Concert by the Pittsburgh Athletic Association. Orchestra under the Direction of Gregorio Scalzo

12.30 a.m. (Monday, 20th).—Services of the Calvary Episcopal Church, Pittsburgh, Rev. E. J. Van Etten, Pastor.

ZION, ILLINOIS.—Station: Zion.—WCBD. Wavelength: 344.6 metres.

1.0 a.m. (Monday, 20th).—A Musical Programme will be given by the Mixed Quartet, assisted by the following performers:

Miss Sweeney and Mrs. Crow (Soprano and Contralto), Mrs. Ruth Pihl (Soprano), Mr. Chester Bagg (Baritone), Messrs. Dunn & Stewart (Euphonium and Cornet), Mr. Paul Stewart (Cornet), Mr. Wm. C. Dunn (Euphonium), Mr. L. J. Hire (Viola), Miss Bessie Wiedman (Piano), Mrs. Mary Bagg (Reader).

MONDAY, APRIL 20th

FRANCE.

PARIS.—Station: Eiffel Tower.—FL.
Wavelength: 2,650 metres—5 kw.

6.0 p.m.—Concert.

Artists: M. Maurice Gouineau, Mlle. Marcelle Richard Waldy, Mlle. Louise Carmel, Mlle. Marguerite Papin (Pianist), M. Jean Hazart, M. Marc David, M. Renoult, and M. Omer Letorey.

1. Roundelays of Villon (Hazart). M. Marc David.
2. Melodie (David). M. Hazart.
3. Melodie (David). Mlle. Marcelle Richard Waldy.
4. The Three Clerks (David). M. Hazart.
5. The Happy Isle (Debussy). Mlle. Marguerite Papin.
6. I Do Not Remember (Bernheim); Song from "Tosca" (Puccini). Mlle. Louise Carmel.
7. Song of the Harvesters (Letorey). M. Marc David and M. Hazart.
8. Beside the Sea (Letorey). M. David and the Composer.
9. Song of the Pardon of Ploermcl. Mlle. Marcelle Richard Waldy.

5.55 p.m.—News Bulletin and Weather Forecast.

6.10 p.m.—End of Transmission.

Two Useful Accessories for the Experimenter

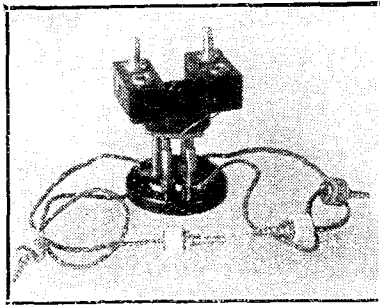

The photograph shows the two units fitted together.

Those who experiment with high-frequency transformers will find this article of practical interest.

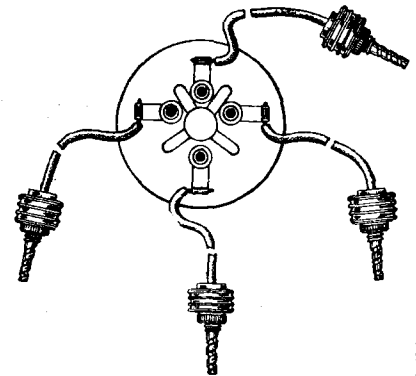

Connections to the valve-holder are clearly shown here.

THE lack of standardisation with H.F. transformer connections often is found to cause the experimenter a considerable amount of trouble where an assortment of various types is available. Any comparison is a somewhat difficult matter if connections have to be unsoldered and changed over before any idea as to the relative merits can be obtained, and is often impossible aurally, as unless there is an outstanding difference the ear cannot distinguish variations in volume over the period taken to change from one H.F. transformer to another.

Simplifying Change-Over

It is also an advantage with a given set to be able to use any type of H.F. transformer where a number of the same type are not available for various wavelength ranges. A simple arrangement which facilitates trial and change-over without any re-soldering is that of using a valve-holder with four flexible connections terminated by Clix or similar type plugs, which may be inserted into the sockets on the panel which take the H.F. transformer.

Type of Holder Required

A type of valve-holder with a flat base is to be preferred, since this will stand upright when carrying the transformer, and for this purpose a "Magnum" type has been found handy. In carrying out experiments with transformers in ordinary and in neutrodyne methods of coupling, I

have found that when using a transformer with primary and secondary wound in the same slot it is important to get magnetic and capacitive couplings working in co-operation for the former method, and that for the latter method this type is often not to be advised, since for neutrodyne stabilisation magnetic coupling is essential with minimum capacitive coupling. Using barrel-type transformers with ordinary H.F. working, the connections are of a less critical nature, and this kind work well

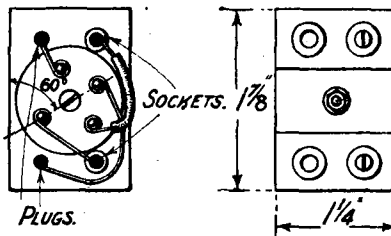

Fig. 1.—The method of connecting the coil-holders to the valve legs.

in the Cowper type of neutrodyne circuits. In these latter the relation between windings is of vital importance, and the use of the unit previously mentioned will be appreciated.

Use of Plug-in Coils

A further plug-in unit, to use two plug-in coils in place of an H.F. transformer, is also found to be a useful adjunct when an extra efficient transformer is required, or an ordinary transformer is not to hand, or when the effect on selectivity of varying the ratio of the windings is

to be tried. As will be seen from the photograph, this consists of two plug and socket coil blocks mounted on a thin ebonite platform, which is secured in turn to the four-pin base removed from a burnt-out valve. Mounted as shown by means of a 6 B.A. screw or nut, an efficient transformer results when suitable coils are used.

The spacing between coil-blocks will, of course, depend on the type of coil to be used, and can be obtained by placing the coils side by side and leaving about 3-16 in. clearance between. When wired to replace most barrel types of transformers, the connections are as shown in the diagram of Fig. 1.

Minimising Undesired Coupling.

Should two units of this type be used it is an advantage to arrange to get the axis of the coils staggered at an angle of 60 deg. to avoid as far as possible inter-action effects, and this may be done by arranging the plate and grid pins on a line at 60 deg. to the side of the ebonite platform. For this latter a thin piece of ebonite suffices admirably, $\frac{1}{4}$ in. being ample thickness. The size in individual cases is determined by the size of the coil-blocks and spacing between coils.

J. U.

"The Wireless Constructor"

A Free Blueprint of a Three-Valve Portable Receiver, by Percy W. Harris, M.I.R.E., will be found in the May Issue ON SALE TO-DAY.

A Useful Application of the Weston Relay

By H. WARWICK.

Those readers who use long telephone extension leads to various parts of the house will find the remote control unit described below particularly useful. When connected correctly to a valve set this unit will switch off the latter completely upon disconnecting one of the telephone leads.

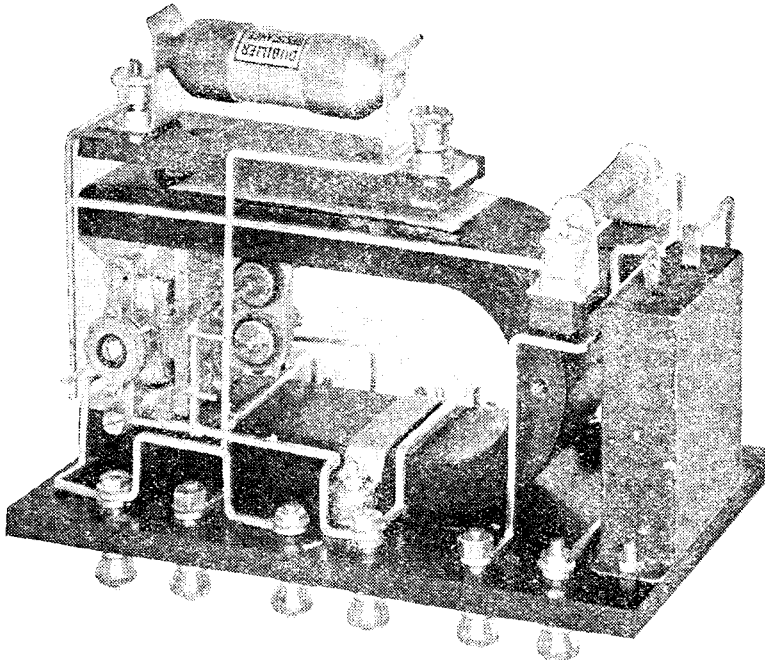

The Weston Relay, with the accessories required, fits very compactly to the back of a small ebonite panel.

By means of screws the pressure on the bearing may be adjusted. The metal former is wound with a layer of extremely fine silk-covered copper wire, and the ends are connected to two separate hairsprings, which are connected to different parts (D and E) of the frame, to which external connections may be attached. The springs, besides furnishing a convenient conducting path for the current, also serve the purpose of always restoring the moving parts to their original position. Attached to the other side of the former is the pointer or contacting arm, and also a further hair-spring, which may be adjusted to place the pointer in any required position initially. This spring also provides a path for the current travelling in the circuit of which the arm forms a part (shown at

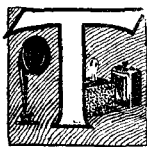

THE instrument to be described may be used in a variety of interesting ways as a time and current saving device when employed to control wireless receiving sets.

At the present time quite the most common form of relay in everyday use is the thermionic valve, and no other device has yet appeared to oust it from its

Relays of the moving coil type have, however, been neglected except in so far as they have been used in conjunction with recording apparatus, and this has been within the scope of but few amateurs.

Working Parts

The Weston is one of the best-known of relays, and since these may now be obtained at absurdly low prices (the one illustrated cost 10s. 6d.) from ex-Government surplus stores, unused, and in perfect order, one will be described, and it may be taken as typical of moving coil instruments. The whole working parts are housed between the poles of a powerful permanent magnet. Between the poles, and so arranged as to leave only a very narrow space, is a rectangular iron block which is rigidly fixed, its purpose being to increase the flux density of the magnetic lines of force in the neighbourhood. Two metal strips are screwed one on each side of the magnet, and these carry bearings for a metal former, which is of such a shape as to pass between the aforementioned iron block and the pole pieces.

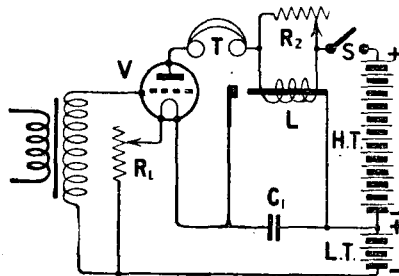

Fig. 1.—Breaking the anode circuit automatically switches off the filament current by virtue of the relay.

deserved popularity. The microphone amplifier has, to a certain extent, been used, but its inherent defects and limitations have been sufficient deterrents to strictly limit its employment.



The instrument completed and enclosed in a cabinet is of pleasing and symmetrical appearance.

C). On a level, and in line with the contacting arm, are placed two adjustable platinum-tipped screws, one on each side, so that contact may be made when the former, pointer, etc., are in the correct position. (These screws are connected at A and B.)

Action of Instrument

The manner in which the device operates is as follows:—

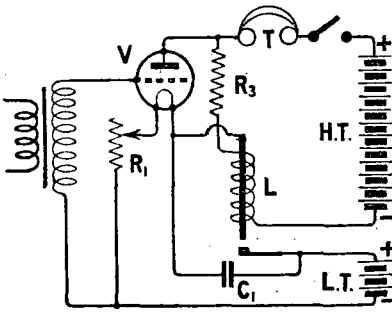
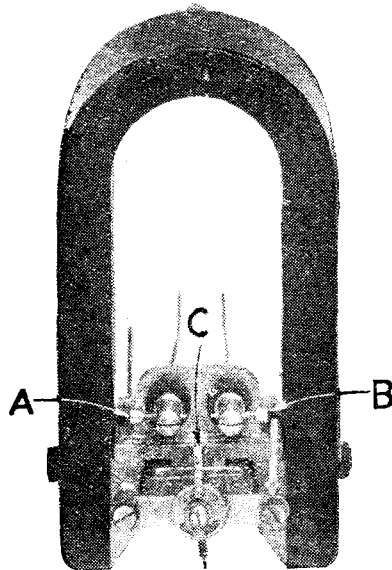

Fig. 2.—Using this circuit arrangement, closing the switch completes both anode and filament circuits.

Current may be passed through the windings placed on the former, thus creating a magnetic field which varies in intensity according to the amount of flow. In the normal position, when the needle is pointing upwards, and, momentarily, when current is switched on, the lines of force are at right angles to those due to the magnet. Now this coil may be considered to act in the same way as a magnet, the positions of whose poles would be above and below the coil, the polarity being decided by the



Two adjustable screws are seen at A and B, while C is the moving arm.

direction of current flow. The tendency of these two is for them to move so that the N pole of the one approaches the S pole of the other, and vice versa, besides which there is opposition between the two N poles and the two S poles.

Owing to the fact that the former is pivoted it will move, and the contacting arm may be made to move so as to perform a variety of functions by simply varying the critical position of the arm by the spring previously referred to, and reversing the current.

Supposing the two contacting screws be called A and B and the contacting arm C, then the following table shows the variations possible:—

Initial Contact.	Contacts Made or Broken.
—	C made to A.
—	C made to B.
C to A	Contact Broken.
C to B	Contact Broken.
C to A	C to A Broken, C to B Made.
C to B	C to B Broken, C to A Made.

Employment of Relay

The Weston Relay is made so delicately that it will function—that is, move the contacting arm so as to make or break a circuit upon the extremely minute current of 50 micro-amps. flowing through the windings; and, as a matter of fact, it may be adjusted so as to indicate currents of a considerably low value. From this it will be seen that only a portion even of the current passed through the plate circuit of a single valve will operate the device. Let us now examine Fig. 1. The circuit shown is a modified single-valve note-magnifier, the additions to the usual arrangement being a relay L indicated as a winding and two contacting points.

Breaking the Filament Circuit

It will be observed that these two contacts are in the filament circuit of the valve, and the relay is arranged so that the filament circuit is complete only when plate current is flowing. Thus the plate current is made to keep the filament circuit complete.

Let us firstly suppose that the whole is in operation, and then

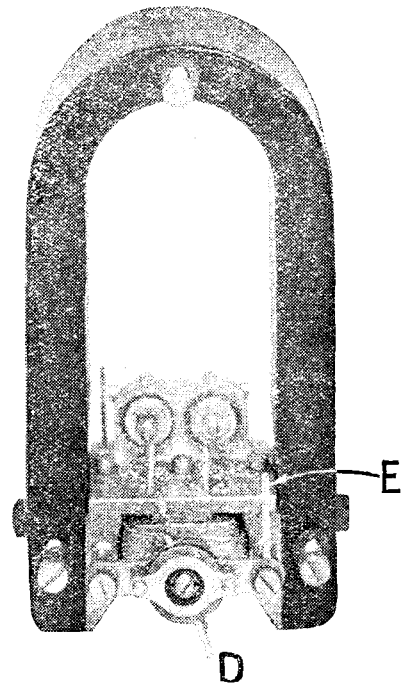

On this side of the relay two hair-springs are connected to the points D and E.

one of the telephone leads is removed. This is equivalent to opening a switch S. What will happen? Plate current will cease to flow, contact in the filament circuit will be broken, the filament current will die out, and the set will be out of action. This then provides an extremely simple and useful method of switching off, for no matter at what distance from the set are the telephones or loud-speaker situated, just the removal of one lead will effectually stop the set working.

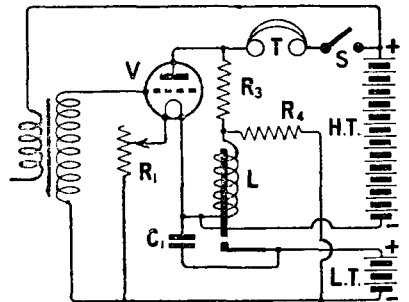

Fig. 3.—The above circuit arrangement is particularly reliable.

This should appeal to those whose sets are in an upper storey while headsets are in use in the basement.

There is one other point, however, which should be noted. If the valve in question is a power valve, or even a bright emitter only, the plate current may be

too high for the delicate windings of the instrument to carry. In this case it may be shunted by an ordinary filament resistance of from 0-10 ohms resistance, and regulated to such a position that the relay will just operate with certainty.

A disadvantage of this arrangement is that it is impossible to switch the set on again by re-completing the plate circuit by connecting the head-phones, since no plate current can flow until the filament is alight.

A Refinement

The following schemes have been devised to allow for this. If Fig. 2 be examined it will be noticed that the relay is not now in the plate circuit of the valve, but is placed, together with a high resistance and the telephones, in parallel with the high-tension battery. When this circuit is complete, as when the head-phones are connected, the contacts are held by the current flowing in the relay windings, the filament circuit is completed, the valve lights, plate current flows, and the set functions. The reverse happens when one connection of the head-phones is removed.

Value of Resistance

The value of the resistance R₃ depends upon the value of H.T. used, but the following values are satisfactory, being so arranged as to allow a current of very approximately 200 micro-amps. to flow, a current so high being used to ensure absolutely certain contact in the filament circuit.

H.T. Voltage.	Value of R ₃ in Ohms.
40-60	250,000
60-80	350,000
80-100	450,000
100-120	$\frac{1}{2}$ megohm.

A Further Improvement

In this arrangement there is one fault which has occasionally troubled the writer, and that is a tendency to stick together of the two relay contacts when the current is switched off from the winding. A method of eliminating this possible difficulty is here described, and with this refinement the resulting arrangement may be considered as reliable as most wireless apparatus in action. The addition is shown in Fig. 3,

and consists of a further high-resistance R₄ wired as shown, and whose value will be decided later.

When the relay is contacting a circuit will be completed through accumulator, R₄ and the relay, and its effect is arranged to break contact—that is to say, it is opposite to the effect of the current which flows in circuit in which R₃ is included. Now if this new circuit be made to pass a suitable current, say 60 micro-amps., it will not be sufficient to nullify the effect of the 200 micro-amps. flowing in the opposite direction, but on removing the 200 micro-amps., if the contacts stick, this 60 micro-amps. will be sufficient to force them apart.

Obtaining Correct Current

Suitable values of R₄, to allow approximately 60 micro-amps. to flow, are as follows:—

Voltage of Accumulator.	Value of R ₄ in Ohms.
2	30,000
4	60,000
6	90,000

The switch S₁ in all the diagrams when open is equivalent to the removal of a head-phone connection.

Limits of Safety

A further point which arose was whether the small area of the contacts was sufficient to pass effectively and silently enough, current to supply the needs of a number of valves. Some time was therefore spent in attempting to determine this, and the conclusion was reached that 2 amps. was a safe maximum value, and large enough for most purposes. A three-valve set employing bright-emitter valves would be amply catered for (3 × .65 amps. = 1.95 amps.). A four-valve set with two bright valves and two dull emitting power valves would take about 1.8 amps. ((2 × .65) + (2 × .25) amps.). Using dull emitting valves up to 30 taking .06 amps. each could be used.

Compactness

When this arrangement had been evolved, and made to work as a unit with ease and certainty, it was decided that it was worth a cabinet, and so the instrument seen in the photographs was constructed.

At a glance it may be seen that the whole may be enclosed in an extremely small compass behind the panel, only the terminals appearing on the outside. No alterations need be made to an existing set, the instrument being simply connected between the battery and telephone terminals of the set and the batteries and telephones themselves.

Disposition of Parts

If viewed from the rear of panel (see photograph), the relay will be located in the centre of the panel with the condenser fixed at the extreme top. Above the relay may be seen the high resistance R₃ held in position by the stiff wire used for the connections. The same method of fixing is resorted to in the case of the resistance R₄. Terminals to set appear on the right, while those for the batteries and phones are upon the left.

The front of the panel presents an extremely neat appearance, particularly when ensconced in a shapely well-made cabinet.

Furthermore, with the interval refinements properly adjusted, it is difficult to see any way in which results not in keeping with the appearance can fail to be obtained by even the veriest tyro.

In next week's issue will be given full constructional details of how to build the unit described and illustrated.

A Cabinet Single-Valve Receiver

SIR,—I am writing to inform you of the capabilities of the Single-Valve Receiver described in *The Wireless Constructor* for December by Percy W. Harris. Using an outdoor aerial of three wires 3 ft. apart and about 30 ft. long and 30 ft. high, I have received the following stations: London, Chelmsford, Bournemouth, Birmingham, Manchester, Belfast, Newcastle, Aberdeen, Glasgow, Radiola-Paris, Petit Parisien, Berlin, besides several other Continental stations. I have also heard messages being sent out (in speech) by the airmen on the cross-Channel services.

I might mention that on Sunday, March 29, 10.45 to 11 o'clock p.m., I heard the election results being broadcast from Berlin very clearly.

Wishing your journals every success.—Yours faithfully,

E. A. MORLING.
Wimbledon, S.W.

Some Further Measurements with Auto-Coupled Circuits

By G. P. KENDALL, B.Sc.,

Staff Editor.

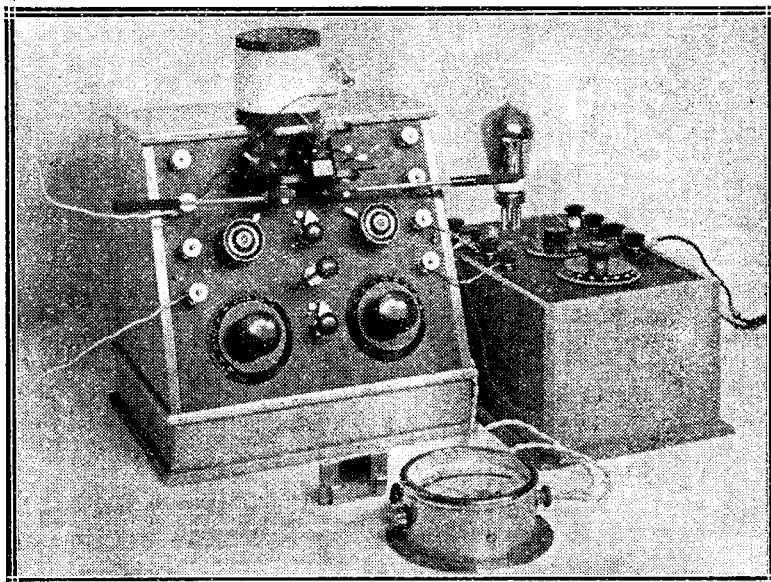

The complete apparatus used for the measurements discussed in this contribution.

It may be remembered that some few weeks ago I described some simple tests on an auto-coupled circuit of the simple type illustrated in Fig. 1, using a form of the Moullin voltmeter arrangement for the measurement of signal strength. In this contribution I showed that with the particular coil under consideration upon my own aerial, selectivity increased as the number of turns included in the aerial circuit decreased, while signal strength was greatest when a certain definite number of turns were so included, falling off upon either side of this particular tapping point. Furthermore, it appeared that signal strength with this arrangement was decidedly good as compared with the more conventional single circuit tuner.

Varied Opinion

I have heard extremely conflicting reports from trustworthy experimenters regarding the results obtained with this circuit, some stating that it gave greatly increased selectivity, and improved the signals when this arrangement was inserted in a standard tuner, others reporting

that although the circuit certainly gave them selectivity, signals fell off so badly that it was not for them a practical arrangement, and therefore it seemed to me that a considerable amount of further experiment was necessary to locate, if pos-

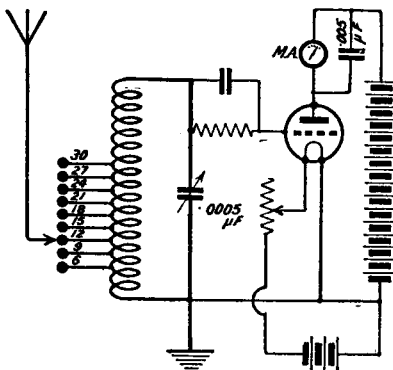

Fig. 1.— The shunting condenser across the milliammeter is essential in many cases. This condenser may be seen in the photograph above.

sible, the cause of the discrepancy, more particularly in regard to signal strength. The variation of selectivity with the number of turns included in the aerial circuit appears to be a matter of universal experience, and, furthermore, it seems to be reasonable that selectivity should increase as the coupling turns

are decreased in number, by analogy with the ordinary loose coupled circuit.

Objects of the Present Experiments

The point which therefore seemed to require elucidation was connected with the actual number of turns included in the aerial circuit for the production of greatest signal strength, and the correct number of turns upon different aerials. At the same time, it was desired to determine the ratio of the maximum signal strength obtainable with the auto-coupled arrangement to that obtained with an ordinary single circuit tuning system upon the particular aerial and earth under test.

It was thought that the correct number of aerial turns might vary in some relation to the actual size of the aerial (in the electrical sense), according to the number of wires composing the aerial, and so on, and therefore I obtained details of the numerous aerials owned by different colleagues on the Radio Press staff, and decided to carry out tests upon my own aerial, and those of Mr. Percy W. Harris, Mr. D. J. S. Hartt and that of a friend in St. John's Wood, since these seemed to promise a good selection of different types.

Conditions of the Experiment

The circuit shown in Fig. 1 was used and this will be recognised as the usual one which I have used for the series of experiments described in these articles, the shunting condenser across the milliammeter being a point to be duly noted by those who intend to carry out similar work. This is a desirable precaution with any milliammeter, and quite an indispensable one with mine, which is capable of making a single-valve circuit oscillate quite freely when the

In view of the interest created by the article published in our March 4 issue, Mr. Kendall gives in the following article some further observations and measurements resulting from experiments conducted upon different aerials.

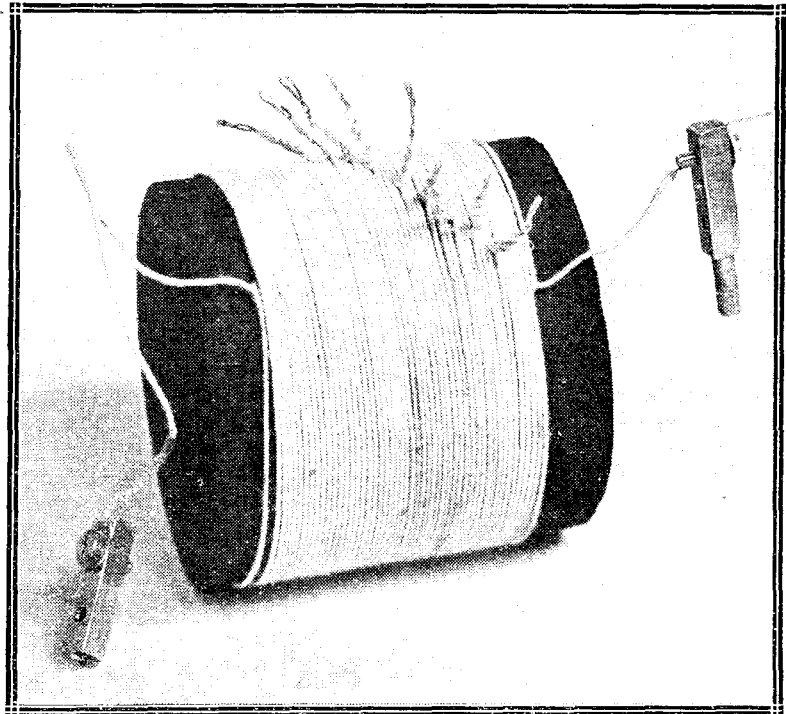

The coil was provided with separate pin and socket connectors to eliminate the possibility of plug losses.

tuning condenser is in the series position. The value of this condenser is quite unimportant, so long as it is so large as to prevent the milliammeter windings from functioning as a circuit tuned more or less to the broadcast wavelengths.

A Special Coil

A special coil was wound for the experiment, consisting of a single layer of No. 22 d.c.c., 50 turns in all, upon a 3-in. diameter ebonite tube. Tappings were made at 6, 9, 12, 15, and so on, up to 30 turns, and the coil was arranged so that it could be inserted in the socket of a standard tuner which I employ a good deal for these measurements. This tuner is illustrated in one of the photographs which accompany this article, and it will be seen that the coil stands on the top of the box, its two ends terminating in a coil pin and socket, these being inserted in the usual secondary socket of the coil holder. The lower end of the secondary circuit is then earthed by means of one of the small switches upon the tuner, and the aerial is connected by means of a wandering lead to the various tapping points upon the coil.

The Measuring Unit

Connected to the tuner is the useful measuring unit, which I described not very long ago in this journal, the usual batteries and milliammeter being provided. The valve used for these measurements was a DE5.B., which I find to give conveniently large readings with an anode voltage of about 80 to 90 volts. These conditions were repeated upon each aerial which was tested, the whole outfit being taken from one to another.

The First Aerial Tested

I commenced, naturally, with my own aerial, and a few words of description will be necessary before the results obtained can be interpreted. My object was to provide a very large aerial for this first test both electrically

for an experimental aerial. It should be explained that aerials of electrical dimensions as great as this are quite often encountered where the legal limits of 100 ft. of wire have not been exceeded, the large electrical size being the result of the proximity of earth connecting bodies, and so on. This aerial is of the single wire variety, and represents something of a mystery, since, although it would appear to be capable of giving good signals, they are, in actual fact, distinctly poor. The locality in which it is erected appears to be somewhat of a dead spot, but I believe that in addition there is some serious source of inefficiency in the aerial itself, which has so far defied detection.

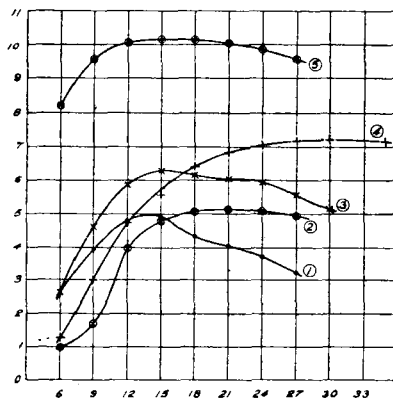

Fig. 2.—These curves summarise the results obtained on five different aerials. Turns in the aerial circuit are plotted horizontally and signal strength vertically.

The Lead-in

It will be observed that the down lead is brought down fairly close to the house in order to obtain access to the front window which supports the leading-in tube, and it should be explained that this down lead is some 6 ft. away from the wall. This in itself would appear to be a considerable source of loss, but the down lead has been tried as an experiment through one of the windows at the back of the house, and no perceptible difference in signals

and as regarding its physical dimensions, and a length of 20-ft. was added to the further end of the horizontal span. The dimensions shown in Fig. 3 were therefore obtained, and it will be seen that this represents somewhere about the extreme limits

resulted. Abundant insulators are provided of various types and the wire is the usual 7/22 copper. The earth lead is only some 6-ft. long, and goes straight out through the lower edge of the window frame to a copper tube 6 ft. long and 1 in. in diameter, driven straight down into moist clay, the resulting earth connection being, apparently, of quite low resistance.

Results on the Author's Aerial

When considering the results obtained on my aerial, therefore, it must be remembered that this aerial represents a type of large-sized and rather inefficient

evening. The result was a suspiciously low signal strength reading upon my aerial, but I do not think that the shape of the curve was affected. This curve is No. 1 in the diagram which summarises the results of all these tests, and it will be observed that it rises sharply to a peak located somewhere between the twelfth and fifteenth turns, these being the number of turns included in the aerial circuit, and then falls off not quite so steeply as the number of turns in the aerial circuit is increased. The irregularity of the slope between 15 and 27 is noteworthy and at first was thought to be due to experimental errors, but

Comparative Tests

To obtain an idea of the relative signal strength given by the auto-coupled circuit and by the single circuit type, the whole coil was placed in the aerial circuit with the tuning condenser in series, and a signal strength reading obtained in this way. The coil was a little small to obtain the greatest possible signal strength with this arrangement, but this effect was not so pronounced as to be worth taking into account seriously, a rough idea only being required. This method of comparison was used upon all the aerials tested. In my own case it was found that if the signals given on the

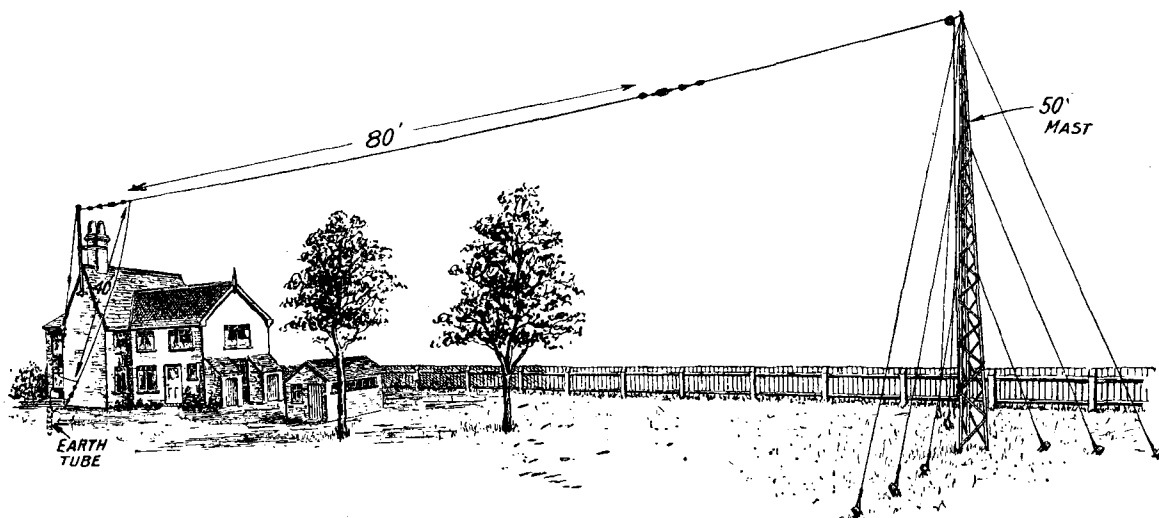

Fig. 3.—Mr. Kendall's aerial is of the single-wire inverted-L type.

system, since it has always behaved in a way that suggests that its high frequency resistance was decidedly high. The signal strength figures usually obtained with the coil in question, which has been in use for some time, are in the neighbourhood of 5 to 6 upon the scale which I employ, but when the actual curve was plotted a signal strength reading in the neighbourhood of only 4 to 5 was obtained, this being more or less constant for the whole evening, unquestionably as the result of the pernicious activities of the oscillating neighbour of whom I have spoken in somewhat bitter terms on more than one occasion in these articles. On this particular night he apparently settled down to one particular setting of his reaction coil and left it so adjusted for the whole

since the same form was obtained upon other aerials, it is evidently the result of some peculiarity of the circuit or of the coil itself.

Signal Strength

It will be seen that the actual maximum signal strength will be obtained with a tapping taken from the 13th or 14th turn, and in the case of this aerial it is evidently only necessary to locate the correct tapping point with some accuracy if anything like good results are to be obtained. From the point of view of signal strength the tapping at the 13th or 14th turn would be chosen, but if it was desired to obtain at the same time an increase in selectivity, with only a small loss of signal strength, perhaps the 11th or 12th turn would be chosen.

ordinary single circuit arrangements were taken as 100, the auto-coupled circuit gave 118. It should perhaps be explained at this point that the signals given by the auto-coupled arrangement were compared with the maximum obtainable with the direct coupled system, that is to say, that on all the aerials it was ascertained whether parallel or series tuning condenser gave the best results, and the best value was compared with that of the auto-coupled system. It may be interesting to note that upon all the aerials tested the series arrangement gives the best results.

An Aerial of Medium Size

My next test was made upon the aerial of Mr. Harris, and the outstanding features of this system will be seen in Fig. 5.

The earth lead is 12 ft. long and makes connection to a system of buried wires, which is believed to form a very low resistance oscillatory system. This aerial is believed to be of reasonably low resistance and good efficiency and to be located in quite a good spot for reception, while, regarding it as a transmitting aerial, it would also appear to be of high efficiency.

Tapping Points

The results obtained are expressed in curve No. 3, and it will be seen that we have again the sharp rise to a maximum and then a gradual falling off. It is noteworthy that the maximum in this case is apparently obtained actually upon the 15th turn, and that the falling off is not nearly so rapid above this value as it was in the case of my own aerial. The irregularity of the form of the curve above the 15th tapping is again to be noted, and it will be seen that it coincides fairly closely with the irregularity already noted in connection with my own aerial, the effect being a sort of secondary peak which is not fully developed, appearing at almost exactly the same point on the curve as in the previous test. It was further observed that as Mr. Harris's aerial is considerably smaller in electrical dimensions, it was

circuit have been exceeded, while one of low resistance is less critical as to the correct number of turns, the falling off past the optimum point being more gradual than in the case of a poor aerial, as exemplified in these two cases, and therefore it is an easier matter to find the correct number of turns. Whether this conclusion is borne

well away from the wall of the house. The leading-in arrangement is good, and the earth lead is extremely short, not exceeding 6 feet, and terminating in a buried metal plate of generous dimensions.

Aerial Turns

The readings obtained at so short a distance from 2LO are

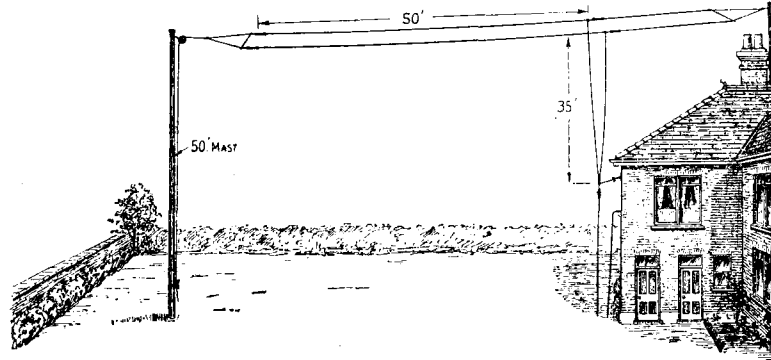

Fig. 5.—The twin aerial used by Mr. Harris. The earth consists of a buried wire system.

out or not by further experiments will be seen when we come to consider the other aerials.

The ratio of the signal strength obtained with the auto-coupled circuit to that given by a direct-coupled system was 115 to 100.

A Very Low-Resistance Aerial

The first two aerials tested are both between 8 and 9 miles from

naturally very large, and the curve which resulted upon their being plotted against the tapplings upon which they were obtained will be seen in No. 5. It should be observed that the maximum is obtained upon the 15th turn, and this coincides with the result obtained upon Mr. Harris's aerial, and it is interesting to note that the condenser readings upon these two aerials with a given coil are exactly the same, suggesting that the two aerials are similar in their electrical dimensions.

It will be observed that the falling off in strength as the number of turns in the aerial circuit is increased above 15 is very gradual in this case, which appears to confirm the suggestion that where the aerial circuit is of very low resistance the number of turns is in fact less critical. The ratio of auto-coupled circuit signals to direct-coupled was in this case only 101 to 100.

An Indoor Aerial

At the same address in St. John's Wood an indoor aerial was also available, of rather large size, and the tests were repeated upon this system, the original earth being used. Curve No. 2 was obtained in this case, and it will be seen that the form agrees in a general way with that given by the outdoor aerial,

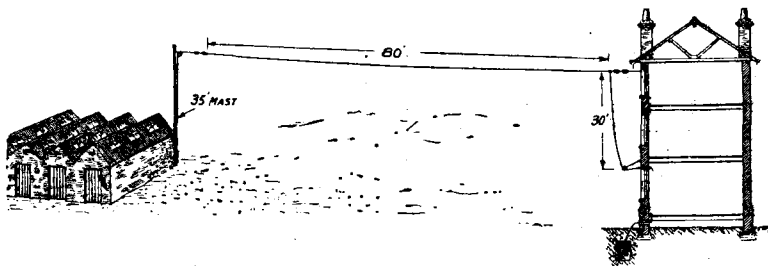

Fig. 4.—The aerial which gave curve No. 5. (Fig. 2.)

possible to obtain a reading when the aerial tapping was taken from the 30th turn, the effect of this in the case of a larger aerial being to make it impossible to tune down to the desired wavelength.

Good and Poor Aerials

As a result of these two tests alone it might be inferred that an aerial of poor efficiency results in a sharp falling off in signal strength when the critical number of turns in the aerial

2LO, and the next to be investigated was at St. John's Wood, a distance of not more than three miles, this aerial belonging to a friend not upon the Radio Press staff. This aerial has always struck me as being of particularly low resistance, since sets oscillate upon it with only a small reaction coil, and it gives decidedly good signals for its height and size. It consists of copper ribbon well insulated, and relatively clear of buildings and trees, the down lead being stayed

except that the peak was found upon the 21st turn instead of upon the 15th. The top of the curve was again fairly flat, and the suggestion thereby given that this indoor aerial is of low resistance is confirmed by the fact that sets appear to oscillate quite easily upon it.

Results Observed

The ratio of auto-coupled to direct circuit signal strength with the indoor aerial was somewhat different from all those previously tested, since the two figures were exactly equal, indicating that the auto-coupled arrangement is of no benefit in this case, except from the point of view of the

estimate of signal strength, since one never knows when the offender is going to give his reaction coil another tweak. For example, upon the evening when I made the measurements which are now under consideration, for something like 10 minutes or a quarter of an hour, 2LO was giving maximum readings of between 4 and 5 upon the scale adopted, and I had plotted about half the curve, when suddenly the milliammeter needle began to flicker violently and continued to do so for some two or three minutes. It then steadied down again to an entirely new reading of the order of 6 or 7, which I believe to be an entirely fictitious

small one electrically, by comparison with the curve given by the other small aerial tested, namely, the indoor aerial represented by curve No. 2. It will be seen that at the 30th turn tapping the curve was still rising, and therefore a further tapping point was hastily prepared at the 35th turn, and a reading obtained at this point. This showed that the correct position for the aerial tapping was somewhere in the neighbourhood of the 30th turn, and it will be seen that the top of the curve is extremely flat.

Upon this aerial also, there was exceedingly little difference in the signal strength obtained with the auto-coupled arrangement, as compared with the more usual single circuit tuning system. The ratio was actually 103 for the auto-coupled circuit to 100 for the direct coupled.

As regards signal strength, it would seem from these tests, and also from the experience of a number of other experimenters, that where the aerial and earth are of rather poor quality, or perhaps one should say, are of only average efficiency, the auto-coupled arrangement, when a reasonably good coil is used, will lead to an increase in signal strength, provided that the aerial tapping is correctly adjusted, while, in the case of a really low resistance aerial and earth, little or no increase will be observed. Thus it may be said that this arrangement is well worth adopting upon a poor aerial, but the aerial tapping must be adjusted correctly to suit that particular aerial and the wavelength being received. Upon a good aerial, on the other hand, the improvement in signal strength may be negligible, and the only reason for adopting this arrangement is the increase in selectivity which is thereby obtained. In such cases the tapping point need not be adjusted very accurately. To secure the very best results from the point of view of selectivity, however, adjustment is needed even here, to ensure that one is working with the lowest number of coupling turns compatible with a reasonable signal strength.

I have not taken into account in these considerations differences in design of the coil itself,

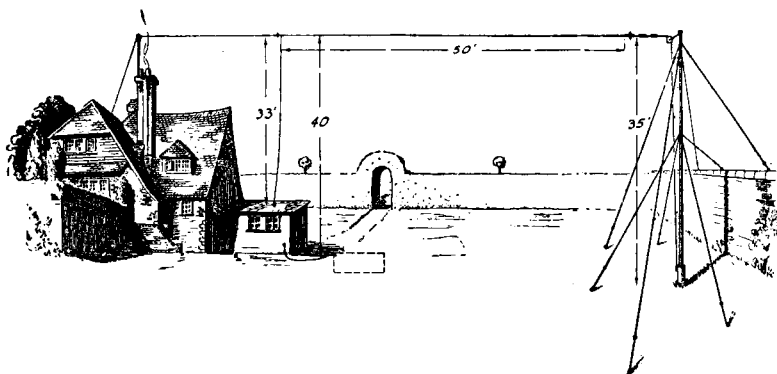

Fig. 6.—This diagram gives the electrical conditions of Mr. Hartt's aerial.

increase in selectivity which it has conferred in every case which I have yet met.

An Unusually Small Aerial

The last aerial upon which I carried out tests was that belonging to Mr. D. J. S. Hartt, and the dimensions and principal features of this are given in Fig. 6. It will be observed that its dimensions are on the small side, and in actual fact, it behaves much as though it were even smaller. For example, when using the coil which I have already described, with the aerial tuning condenser in series, it was impossible to tune up to the wavelength of 2LO, although the series condenser was of .00075 μ F capacity.

I found that Mr. Hartt suffers from the same trouble as myself, in that he is so unfortunate as to have a neighbour who is in the habit of oscillating for hours at a time upon 2LO, which makes it extremely difficult to get a proper

one, resulting from the radiation from a neighbouring aerial. It is to be observed in passing, that in my own case at any rate, it is quite possible for the neighbouring oscillator to increase the apparent signal strength considerably, while at other times the effect is a reduction to something like half the true strength. Much depends upon whether the criminal in question succeeds in getting his set, which he apparently keeps continually in the oscillating condition, accurately adjusted to the silent point of 2LO's carrier wave.

The Curve

It should be borne in mind, therefore, when considering curve No. 4, that it is probably much too high to represent the true state of affairs upon this aerial, and that at least one of the points is probably slightly displaced. The shape of the curve, however, is very much what one would expect after realising that the aerial is an exceedingly

(Continued on page 68.)

Some Experiments with Aerial Coupling Methods

By **STANLEY G. RATTEE, M.I.R.E., Staff Editor.**

Below will be found some further remarks relating to auto-coupling, together with some particulars concerning results obtained in the reception of distant stations.

(Concluded from Vol. 6, No. 1, page 20.)

Auto-Coupling

WITH this method of coupling the terminal connections again remain the same, but the plugs which are now in sockets 2 and 3 are made to change positions, that is, aerial to 2 and earth to 3. It will be seen upon examining Fig. 4 (see last issue) that this alteration results in the circuit given in Fig. 3, which illustrates the principle of auto-coupling.

Coil Sizes

In so far as coil sizes are concerned, these are largely a matter for experiment, for they will vary to some extent with every aerial the set is connected to, but in a general way it may be said that the smaller the coil L2 the higher the selectivity and the sharper the tuning. Various coils should be tried, however. On the aerial referred to earlier in this article the best general results were obtained when L2 was a No. 30 Lissen coil, L1 a No. 35 of the same make, and a No. 50 for reaction; using this combination good signals were received without interference, from Newcastle, Bournemouth, and Hamburg, whilst with a No. 35 as L2 and Gambrell A as L1, with a No. 35 as reaction, Cardiff, Manchester, and Brussels were also received while London was working.

Chelmsford

The reception of Chelmsford or Radio-Paris was not attempted with this form of tuning, as excellent results were obtained from both these stations using semi-aperiodic aerial coupling. When using this form of tuning the two coils L1 and L2 should be set at right angles to each other, and after really satisfactory results have been found the varying of

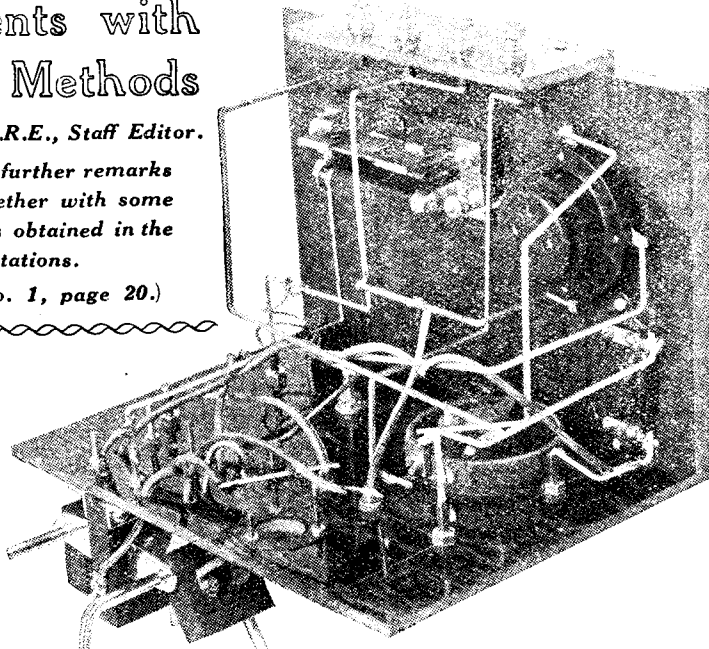

The above is a back of panel photograph of the single-valve set described in our last issue, and concerning which some further results are now given.

the coupling may be tried, though I think that in the majority of cases the best results will be obtained when the coils are situated at right angles to each other.

General Observations

Another point which must be remembered by the operator is that as in the two previous methods of coupling, any alteration in the adjustment of the reaction coil necessitates further adjustments being made to the variable condenser C1.

In so far as these experiments indicate, it would seem that of the three coupling methods tried, the auto-coupled arrangement is by far the best, giving the selectivity of the semi-aperiodic method without that tendency towards self-oscillation. With this coupling the added advantage of simple tuning is given with the fact that the varying of reaction coupling does not upset the remainder of the adjustments to such a large degree as in the case of semi-aperiodic tuning.

Short Waves

In addition to the stations given above, the reception of the short-wave amateur transmitters was also attempted. For the reception of these wavelengths

direct coupling was employed with a Gambrell a 2 as L1, a Gambrell A as reaction (L3), L2, of course, not being used.

On the outside of the a 2 coil was wound edgewise five turns of No. 16 d.c.c. wire, and the aerial and earth, instead of being connected to the terminals provided, were connected one to each end of this coil.

Using the set in this manner resulted in quite good reception of many amateurs upon the 70-100 metres band. From these remarks it must not be assumed that the receiver is advocated as being capable of receiving KDKA, though such reception may possibly be accomplished on good nights; the receiver is, however, not designed for this work.

Reception upon the amateur wavelengths was good, and the control of reaction, though somewhat "floppy," was manageable, a condition which would probably be remedied by using a second a 2 for the reaction coil.

Should any reader care to forward results of tests with this little set, together with a list of those stations he has managed to receive, the information would be of considerable interest, and would be appreciated.

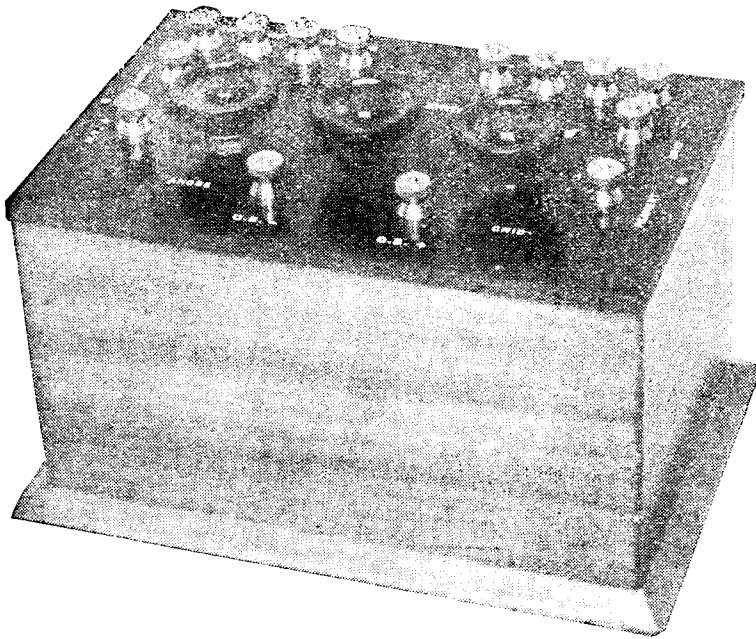

By means of this simple instrument, low-frequency transformers may be tested and compared for quality and signal strength.

IF you turn over the advertisement pages of any wireless periodical, you will be confronted at every turn with an appeal to buy this or that make of low-frequency intervalve transformer, each maker claiming wonderful amplification, complete freedom from distortion, and, of course, a number of special merits not possessed by any rival instrument. After you have read about twenty such advertisements you may well be pardoned certain scepticism about any, or all, of the claims, and a feeling of bewilderment as to which you really should buy.

No Best Make

You will see at the head of this article that I have put the question "Which is the best low-frequency transformer?" because it is one which every expert is called upon to answer every day. To save you the trouble of glancing at the end of the article at once, I think it only fair to state that I have not the slightest intention of telling you that Smith's or Brown's or Robinson's is the best, but I do

hope to show you how impossible it is to claim that any one make is the best in all conceivable circumstances.

The Use of a Transformer

Quite a number of people have an erroneous idea about low-frequency transformers before they try to make a choice. We shall save ourselves a lot of trouble if we look upon this useful instrument merely as a link between stages, depending for its efficiency on how well it carries out this linking process. Sometimes it may be a link between a crystal or other form of detector and a valve, but always at least one valve is connected to its terminals. We must also consider for a moment a few fundamental points regarding valve amplification. If a valve is connected to a tuned circuit in which currents are set up by signals arriving from some broadcasting station, the high-frequency oscillations in this tuned circuit will be applied to the valve at its grid and filament.

Effect of Signal Currents

The pulsations will cause changes in the difference of poten-

Which is the Frequency T

By **PERCY W. HARRIS, M**

In this article, which deals with frequency transformers, Mr. Harris describes the construction of an apparatus by which they may be tested and compared for quality and signal strength.

tial between the grid and the filament and these differences of potential will modify the flow of electrons between the filament and the anode of the valve. The anode, as we know, is connected to a suitable high tension battery, and the circuit from anode to filament outside of the valve is made through either a pair of telephones, a loud speaker, or some

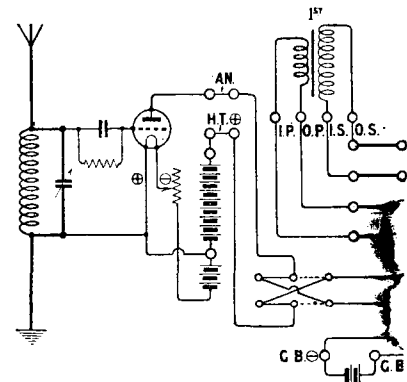

The above theoretical diagram shows the circuit in readiness for comparing transformers.

form of link for passing on the energy to a succeeding valve.

Now, changes of grid voltage will bring about fluctuations in anode current. Somehow or other we want to apply to the grid of the next valve a faithful reproduction, in an amplified form, of the oscillations in the first tuned circuit. Now the valve is a potential operated device, whereas in the output circuit of the valve from which

The Best Low-Transformer?

I.I.R.E., Assistant Editor.

With the question of low-angle, Mr. [Name] and use of simple testing tests can be carried [Name] of trouble.

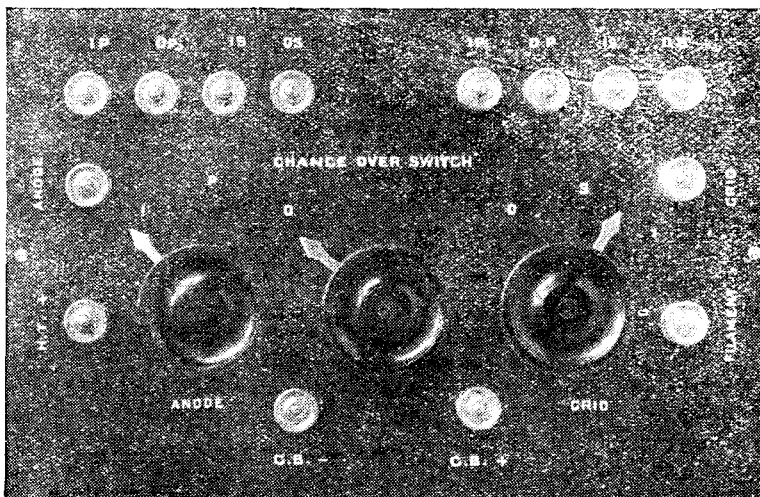

The panel lay-out is extremely simple. The connections are clearly indicated.

we desire to pass on signals, there are current fluctuations. How can we convert these current fluctuations into potential changes which will affect the grid of the next valve?

Methods of Transfer

One method is to pass the anode current through a high resistance. Variations of cur-

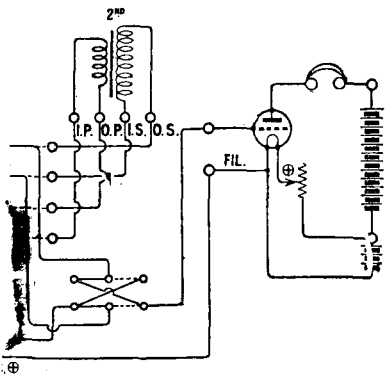

the connections when the instrument transformers after a valve detector.

rent through this resistance will bring about variations of potential at its end, so by tapping off the next valve across this resistance (being careful to insulate the grid of the next valve from the steady direct-current pressure of the H.T. battery by means of a stopping condenser) we can bring about the necessary fluctuations. This method is called resistance-capacity coupling. A similar effect can be produced by utilising

the differences of potential which occur when a choke coil is substituted for the resistance. This is called choke coupling. A still further method, and that with which we shall deal more in detail in this article, consists in using a transformer. Here the plate current is passed through a primary winding of an iron core transformer, the secondary winding of which is connected to the grid and filament of the next valve. Variations of current in the primary winding caused by variations of plate current in the valve connected to it, will set up differences of potential across the secondary winding of the transformer, and these are applied to the next valve in the manner desired.

Complications

Now this sounds very simple, but actually in practice there are many complicating factors. To get the best results we must arrange the impedance of the primary winding to suit the valve or detector with which it is connected. This means in practice that it must have a fairly high impedance for the average valve.

Now here is the first complicating factor. The high impedance of the thousands of turns of wire round the iron core will

tend to resist any change of current in the circuit and considerable differences of potential will be set up across the ends of the winding. On the other hand, for transformer action we desire a maximum of current fluctuations in this winding. If possible too, we want to get a voltage step-up in the secondary winding, and, to obtain this, most manufacturers aim at giving a step-up turn-ratio, the secondary, for example, having perhaps four or five times the number of turns in the primary. This secondary winding, too, would tend to resist current changes, but as there is practically no load on the secondary, we shall obtain what we desire, *i.e.*, voltage changes across the secondary coil.

Effect of Capacity

Between the primary and the secondary windings there exists a certain capacity (often quite large), so that in addition to the transformer action we get a choke-coupling action, the differences of potential across the ends of the primary winding being applied to the grid of the next valve, via the capacity formed by the two windings. For this reason it is often possible to get good signals when one end of the secondary winding (that normally connected to the filament)

is disconnected. When matters are arranged to the best advantage, we get a combination of the two effects (transformer and choke coupling) both acting in harmony. It is probably for this reason that better results are obtained when, for example, the OS is connected to the grid and IS to the filament. In some transformers, the other connection (i.e., IS to grid and OS to filament) works better. Some advantage can often be found by reversing the primary windings, joining IP instead of OP, for example, to the anode of the previous valve. Usually, in practice, there is less effect in reversing the primary winding than in reversing the secondary winding. Sometimes when interaction occurs between two stages of low-frequency amplification, this can be checked by reversing one or other of the windings, thus breaking an undesirable chain.

Turns Ratio

It might appear that the greater the ratio between the two windings, the better the effect obtainable, but in practice it is found that the ratio of turns is not so important as it first

appears. Personally, in choosing a transformer for a special purpose I pay no regard to the ratio of turns and determine its suitability simply by test. To carry out these tests I designed some months ago the piece of apparatus illustrated in this article. It is very easy to construct and I think should prove of great value to wireless societies, wireless dealers, and to experimenters generally. I do not think such a device has been described before, nor do I know of any other instrument on these lines. Regular readers will remember that I referred to it some months ago in my "Random Technicalities."

Advantages of the Instrument

Prior to designing and making this instrument, I had been in the habit of comparing transformers by wiring one in circuit, listening to signals, disconnecting it and reconnecting another instrument. This involved a great waste of time when several transformers were being compared, and it is not easy to memorise results for comparison purposes. Indeed, it often happened that before I had time to

change over to the second transformer the tune or song stopped, and another quite different item was being broadcast. It then became apparent to me that if I could make some kind of quick switching arrangement, it would be very helpful, as I could then rapidly switch from a transformer, with the qualities of which I was well acquainted, to the new instrument to be tried.

Three Switches

Further consideration showed that it would be a great advantage to have switches to reverse the IP and OP connections as well as the IS and OS. This made in all three switches, two for reversing the connections of the primary and secondary windings respectively, and one to make a complete change over from one transformer to another. The finished instrument is illustrated in this article, and a complete outfit in operation will be seen in the cover design. As full wiring particulars are given together with a proper circuit diagram, I need not go into constructional details. The three switches are of the well-known "Utility" make, one being a

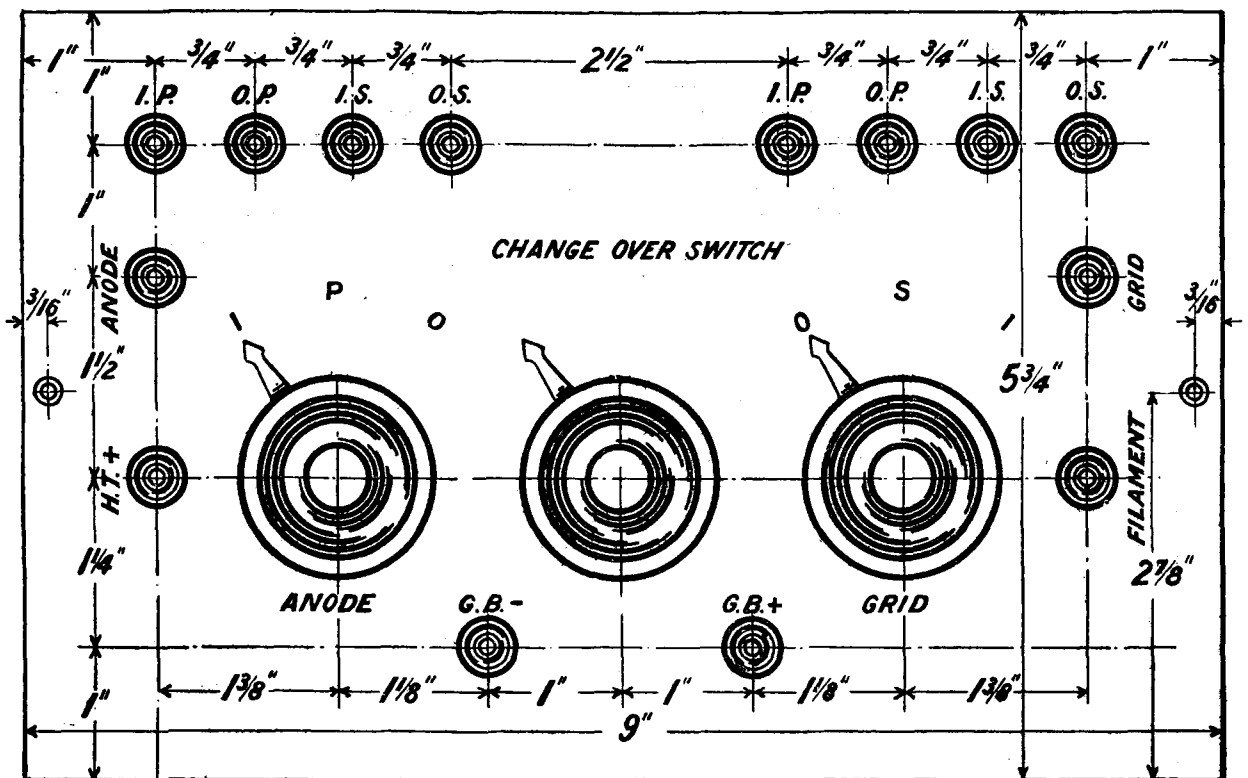

The drilling diagram. The dimensions may be varied to suit the convenience of the builder.

four-pole two-way switch, and the other two being double-pole two-way switches. As these switches are mounted by the one-hole mounting method, there is very little work to be done other than wiring up. Fourteen terminals and a certain amount of square wire for wiring up are needed, and any suitable box can be used. You will notice the terminals are clearly marked.

Terminal Markings

We have two terminals on the left-hand side which are joined respectively to the anode and the positive H.T. of the valve detector, if such is used, or to the two telephone terminals of a crystal set, if we desire to make comparisons following a crystal detector. Transformers may also be tested in the second-stage position. On the opposite side of the panel are two terminals for connection to the grid and the filament of the amplifying valve, while in front is a pair of terminals for suitable grid bias to be applied to the grid of this valve. At the back of the instrument are eight terminals marked IP, OP, IS and OS, on each set of four. The left-hand set of

four terminals is joined to a transformer well known to the experimenter. The instrument to be compared goes to the other set of four terminals.

Using the Instrument

When the pointer of the four-pole change-over switch is to the left then the standard transformer will be in circuit, when it is to the right the instrument to be tested will be substituted. The first step is to switch on to the transformer to be tested, and after suitable regulation of the filament and plate voltage has been made, the IP, OP connections should be reversed, and then the IS and OS reversed, to see which ways the transformer works best. Note carefully the best connections. Now change over to your standard transformer and find which way round this works best. Remember that whichever setting of the two switches is made on one transformer, this setting will remain on the other when the change over is made, so that if the two transformers work differently you should simply change the connections to your standard transformer so that when you change

over from one to the other both transformers are correctly joined up. This may sometimes involve connecting the OS terminal of the standard transformer to the IS terminal on the testing board and IP to OP similarly. When this has been done you will be able to listen upon either transformer merely by changing over the switch and with both transformers correctly connected to the valve. The wiring could, of course, be made to retain the standard connections permanently, but for my own purposes I prefer the arrangement given.

Correct Grid Bias

Grid bias, of course, should be carefully attended to, and the grid bias for a given valve should be the same on either transformer. I have not found that with a particular valve a grid bias that is correct with one transformer is incorrect for another, although some advertisements might lead you to think this is so. The correct grid bias can be found by examining the characteristic curve of the valve for the particular plate voltage you use.

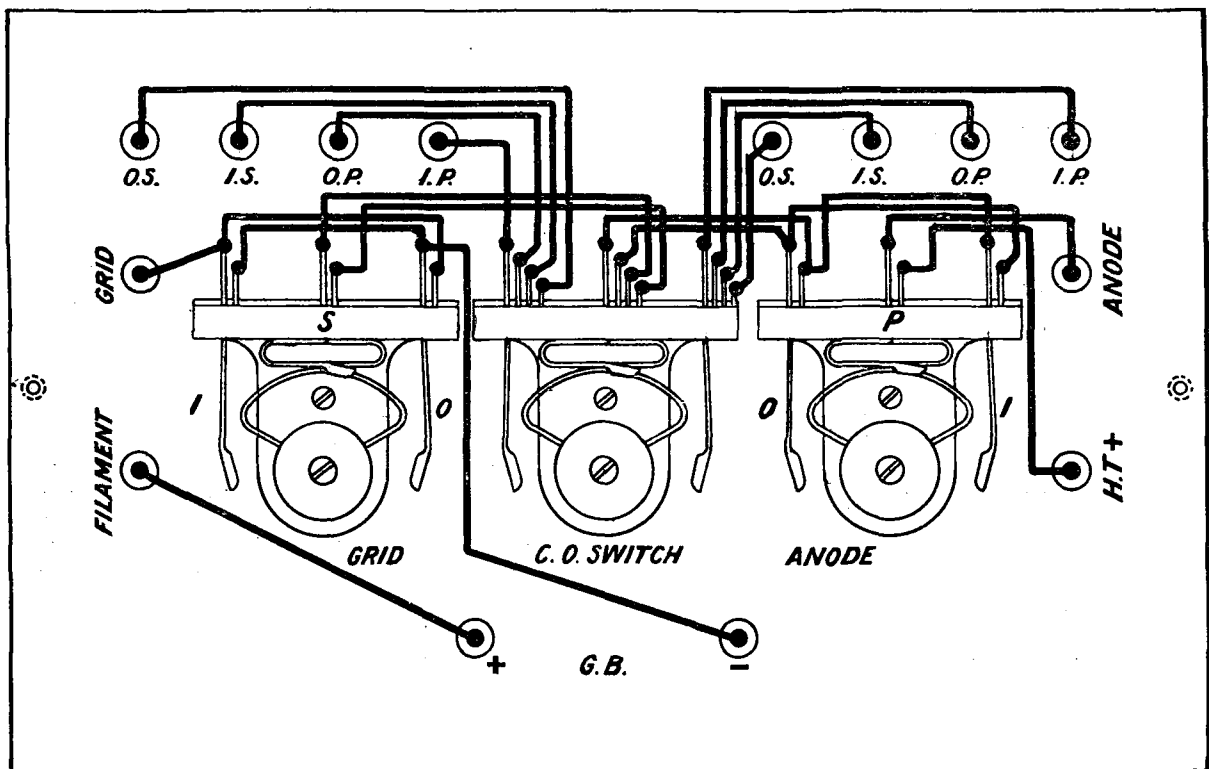

The above diagram should render the wiring process a simple matter if this is undertaken systematically. Note that the soldering tags of the switches are drawn of different lengths in order to indicate their connections clearly.

Classification

Now let us imagine you are using any of the well known general purposes valves as detector preceding this unit, and that you are following it with a suitable L.F. valve. You may

get very accurate comparison by ear, and the result is most illuminating. One transformer stood out above all others in strength, but the quality was distinctly "woolly" and unpleasant. This is the transformer I should

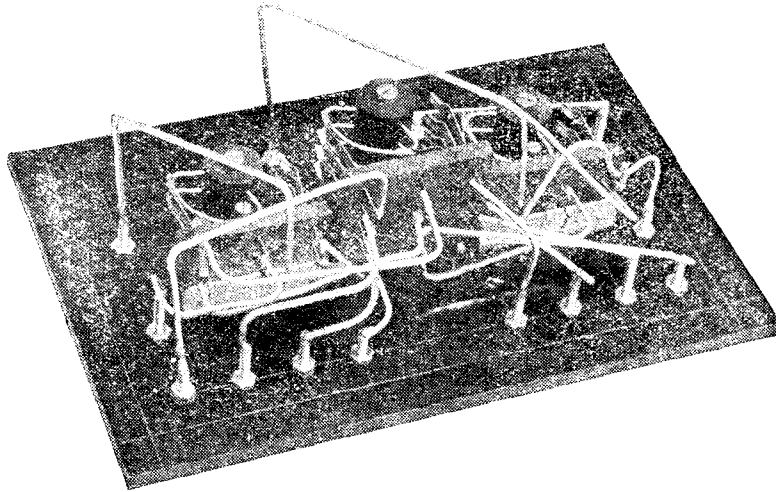

In order to obtain neat wiring this back of panel photograph should be consulted in conjunction with the wiring diagram.

choose as your standard a transformer of good make with which you are well acquainted and you may then proceed to grade the various transformers in your possession, in order of merit. There are several ways of classifying them, and it is not a bad plan to make several classifications. For example, you may keep a notebook and rule it in columns, the first column being for signal strength regardless of quality, the second for purity of reproduction regardless of strength, and the third for overall efficiency, having regard to both strength and purity. In making the tests it is well to choose some piece of music played by instruments with many fine overtones and wide scale variations. If you confine your tests to, say, the news bulletin or a lecture by some eminent speaker, you will not be able to make fair comparisons.

Ease of Selection

I suppose I tested about twenty transformers in this way as soon as the instrument was completed, and it did not take me long to pick out of this twenty, one or two which were of outstanding merits and which served as standards for the time being. When you can change over in a moment from one to another you

pick if my reproduction needed to be confined to, say, telegraphic signals, for then strength is of much greater importance than purity of note. I was soon able to place these transformers in order of merit.

Changing the Detector

The next experiment consisted of repeating the tests, not with a valve, but with a crystal detector, and I found that the order of merit was entirely different. Transformers which had given little amplification with the valve detector showed up extremely well with the crystal. The transformers which were the best on the valve were a long way behind others when tested with a crystal detector. Then again, when I changed over from the crystal to a certain dull-emitter, the transformers had to be placed in still another order. It was soon evident that placing the transformers in order of merit for one valve was no indication of the order of merit for another type of valve, nor for use with a crystal detector. Some transformers prove to be very susceptible to valve changes, whilst others seem to work quite well with any valve. Then again, some transformers have a type of distortion which seems to counteract other

distortion in some loud speakers, so that we can say that one transformer suits a particular loud-speaker quite well, whilst another does not. There is a great deal of importance in suiting valves, transformers, and loud-speakers. There is on the market one well-known type of power amplifier and loud-speaker equipment which, until a year or two ago, was not sold in separate units. To buy the loud-speaker it was necessary also to buy the power amplifier. The amplifier and the loud-speaker together are beautifully balanced and give admirable reproduction, and no doubt the manufacturers had this in mind in refusing to supply the loud-speaker without a suitable amplifier. One of the most valuable lessons you will learn from tests carried out with this apparatus is that relatively cheap intervalve transformers work excellently following crystal detectors, probably because the cheap transformers usually have low impedance primary windings which happen to suit the relatively low impedance of a crystal detector. I think, too, the experiment will show you that it is not wise to place too much reliance upon turn ratios, and the fact that one transformer has a ratio of 5 to 1, whereas another has 3 to 1, or even 1 to 1, often has little bearing on the amplification obtained.

Worth Making Up

I hope you will not think I have misled you in the title of this article. You will now understand, and can confirm, if you carry out the experiments described, that one cannot say that any one transformer is the "best." I have purposely avoided any reference to price here. If you are doing much experimental work it will pay you to make up the testing unit shown, and if you can persuade your friends to bring all their transformers round you will spend a very interesting evening trying them.

OUT TO-DAY.
The Wireless Constructor
 PRICE 6d. EVERYWHERE.

A Cabinet Crystal Receiver

By H. BRAMFORD.

Full constructional details will be found in this article for the building of a useful and compact crystal set

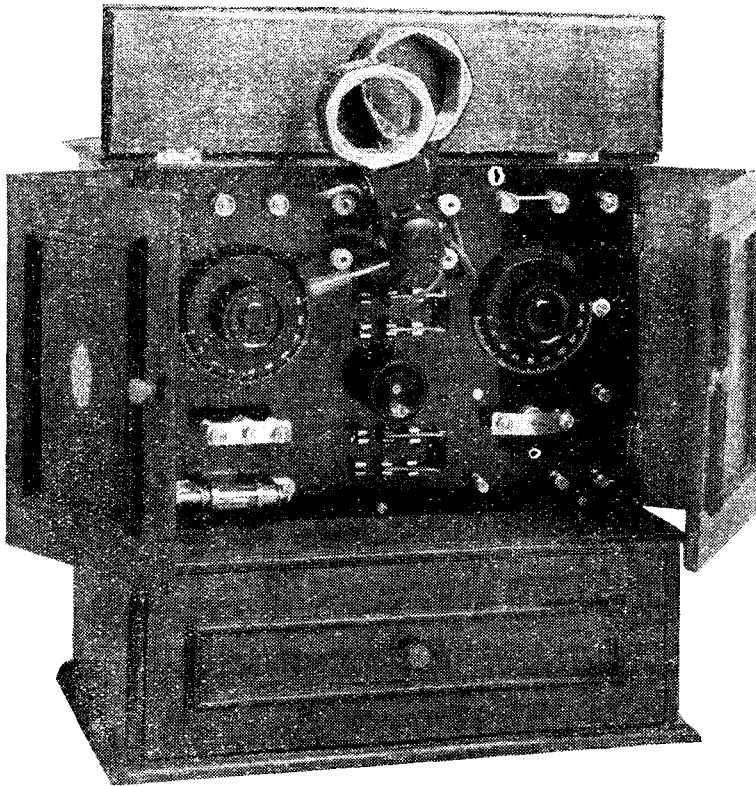

The receiver is totally enclosed in a home-constructed cabinet.

coil holder; alternatively, two way coil holder (Burne-Jones).

Six nickel W.O. terminals.

Four nickel telephone terminals.

Four clix plugs and sockets.

Two 4½-volt flashlamp batteries.

Crystals : Galena, zincite, bor-nite, carborundum.

Wood for box : ¾-in. thick × 9 in. wide.

Panel Drilling

The panel is drilled in accordance with the details shown in Fig. 2, full dimensions being given. The sizes of the various holes are as follows :—Terminals, 4 B.A. clearance; clix plugs, 3/16 in.; variable condensers and potentiometer; single hole mounting; drill to clear bush; panel switches, 6 B.A.; fixed condenser clips, 4 B.A.; two-way coil holder, 2 B.A.; detectors, 4 B.A.

The Coil Holder

Before attempting to assemble the components upon the panel, the coil holder, unless purchased,



ALTHOUGH the receiver described in this article is elaborate in detail, it should prove well worth the trouble and expense of construction, especially for those who require a selective receiver.

Crystal receivers very often give better results if their construction is of a simple nature, certain losses being unavoidable where intricate wiring or switches are employed. On the other hand, a very simple type of receiver employing, say, a plug-in coil tuned by means of a variable condenser, is not, as a rule, very selective. The design of the crystal receiver described in this article provides for all requirements that may be likely, and though more complicated than most crystal receivers, the design has yet been kept as simple as possible.

Materials Required

Ebonite panel measuring 12 × 8 × 3/16 in.

One variable condenser .001 μF capacity (K. Raymond).

One variable condenser .0005 μF capacity (K. Raymond).

One fixed condenser .0005 μF capacity (McMichael).

One fixed condenser .0003 μF capacity (McMichael).

One potentiometer, 600 ohms. (Shipton).

One crystal detector (Service).

One perikon detector—home construction.

One carborundum detector—home construction.

Two miniature D.P.D.T. switches (K. Raymond).

Two coil plugs for two way

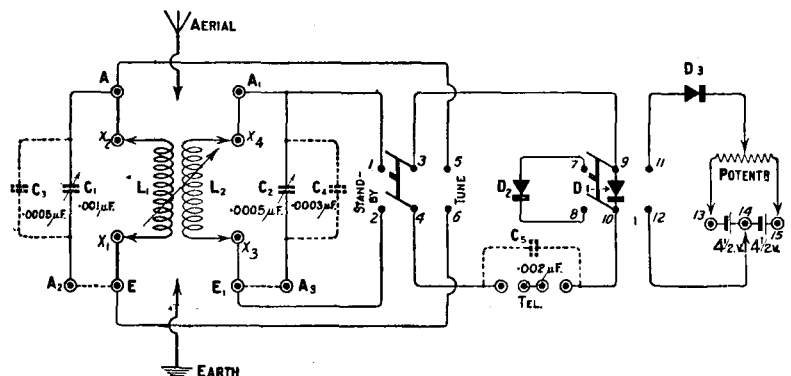

Fig. 1.—The circuit arrangements in theoretical form.

should first be constructed. Alternatively, a suitable type is recommended in the list of materials required. Details of the coil holder seen in the photograph are given in Fig. 3. It is so constructed as to be adaptable for use either with basket, any type of duo-lateral, or hank-wound plug-in coils. This is a considerable advantage, as many prefer basket coils which are both efficient and cheap. The method of construction is made quite clear in the diagram. The coil holder nearest to the panel is fixed, the other being the moving one. The fixed socket is spaced from the panel by a distance piece, consisting of a short length of ebonite tube, while the moving socket is separated from the fixed socket by means of a spring. By rotating an ebonite knob, L₂ is brought nearer to or farther from L₁, as desired. The extension handle shown provides a radial movement to L₂. Each of the coil holders is provided with two flexible leads, the ends of each being equipped with clip plugs.

Detectors

Having constructed and mounted upon the panel the two-way coil holder, the detectors must next be made. The object of employing the use of three separate detectors, viz.—catwhisker, perikon and carborundum, is to give the operator ample choice. It is also convenient for the purpose of com-

paring results. The three detectors are so arranged for this purpose, and each is brought into operation at will by means of a double pole, double throw, miniature panel switch. With the switch off the catwhisker detector is employed; with the switch down in clips 7 and 8, the perikon detector is employed; and with the switch down in clips 11 and 12 the carborundum detector is used. Therefore, both the perikon and the carborundum, once adjusted and the best position found for the potentiometer area, may remain set, without interfering with the cat-

whisker, which, however, should be lifted from its crystal when either of the first two is used. This is a considerable advantage, as if the catwhisker detector does not on any special occasion prove satisfactory, either of the others may immediately be resorted to.

Perikon Detector

The construction of the Perikon detector is clearly shown in Fig. 5. Two short lengths of 4 B.A. rod are mounted upon the panel in the position indicated in Fig. 2 (D₂). Centrally between the two rods is mounted a crystal cup of the "Easyfix," or any other suitable type. Each of the 4 B.A. rods is equipped with a spring made from steel wire. These springs are easily made by winding the wire upon a 2 B.A. rod. A piece of strip brass which holds the upper cup is cut and drilled to the dimensions given in the diagram. With the upper cup secured to this piece as shown, the whole is assembled by passing it over the 4 B.A. rods, pressure being applied to the crystals by means of the two 4 B.A. terminal heads, as shown. The crystals used with this detector are Zincite and Bornite.

Carborundum Detector

The carborundum detector is made as shown in Fig. 6. As will be seen from the diagram, the construction is much the

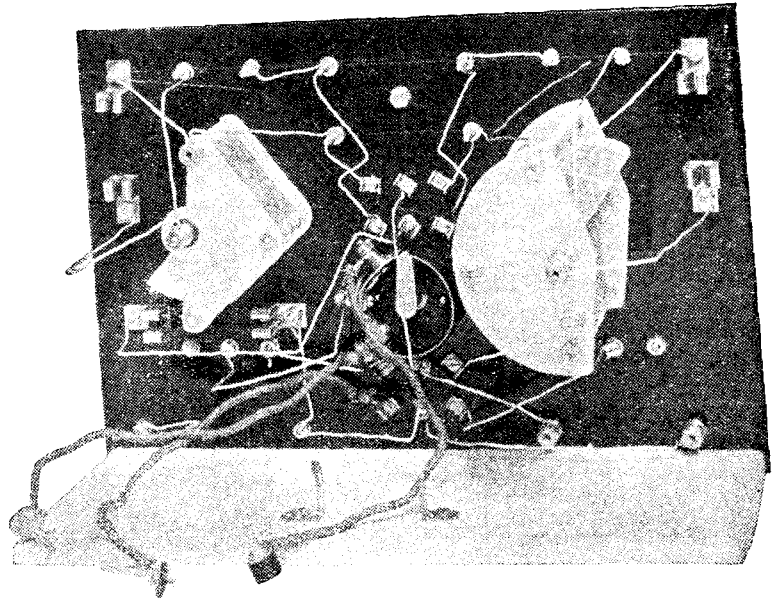

A back of panel photograph showing the wiring. The batteries are fixed between the clips mounted upon the base-board.

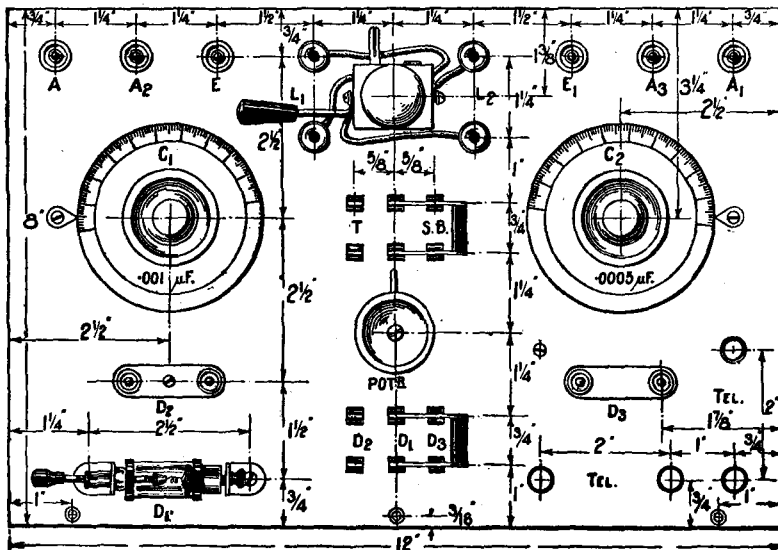

Fig. 2.—Drilling dimensions may be understood from this drawing.

same as that of the Perikon detector. In this case, however, only one cup is required which contains a carborundum crystal. The tension bar is made from springy steel instead of brass, and two holes are drilled as shown instead of three.

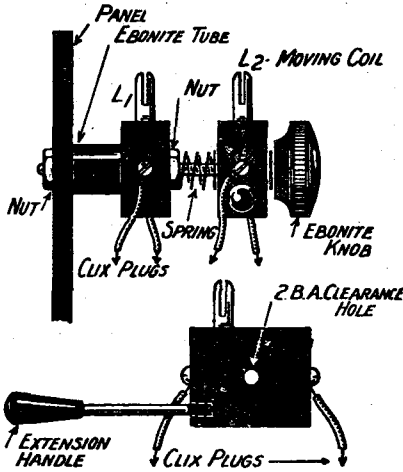

Fig. 3.—Details of the coil-holder.

Assembly

Having already mounted upon the panel the two-way coil-holder and the three detectors, the other components may now be assembled. The two variable condensers are first mounted, followed by the potentiometer. Next the two D.P.D.T. switches may be assembled. Terminal A mounted upon the panel also secures a fixed condenser clip on the underside, as shown in Fig. 4. Terminal A₁ is also similarly mounted. Terminals A₂, A₃, E, and E₁ are mounted in the usual manner. Four Clix sockets, marked X₁, X₂, X₃ and X₄ are mounted as shown. The four telephone terminals are mounted, one of which secures a fixed condenser clip on the underside of the panel, as seen in Fig. 4. The two condenser dial indicators shown in Fig. 2 are made from celluloid, the securing screws acting in each case as a means of holding fixed condenser clips on the underside of the panel.

Wiring

The various connections are made as shown in Fig. 4. Terminal A connects to X₂, the fixed vanes of C₁, and to point 5 of the tune-stand-by switch. A₂ connects to the other clip of C₃ and the moving vanes of C₁. Terminal E connects X₁ and

point 6 of the switch. Terminal A₁ connects X₄, the fixed vanes of C₂ and point 1 of the switch. Terminal A₃ connects the other clip of C₄ and the moving vanes of C₂. Terminal E₁ connects X₃ and point 2 of the switch. Points 1 and 2 of the switch indicate the "stand-by" side, and points 5 and 6 the "tune" side. Point 3 of the switch connects point 9 of the detector switch and also the crystal side of D₁. Point 4 of the tune-stand-by switch connects to 'phones. The other side of the 'phones connects to the other clip of C₅, point 10 of the detector switch, and the catwhisker side of D₁. The two 'phone terminals in the corner of the panel are also connected.

Connections

Point 7 of the detector switch is connected to one side of D₂ (Perikon), and point 8 to the other side of D₂. Point 11 connects one side of D₃ (carborundum). The other side of D₃ is connected to the switch arm of the potentiometer. One side of the potentiometer winding connects to the negative side of one of the batteries (13). The positive of this battery is joined to the negative of the other battery, the positive side of the second battery (15) being connected to the other side of the potentiometer winding. Points 13 and 15 are wander plug con-

nections, flexible leads being used. Point 12 of the detector switch is equipped with a flexible lead and plug which makes contact with point 14 of the batteries in Fig. 1.

Box

Details of the box construction are shown in Fig. 7. The dimensions given are cutting sizes. The wood and finish are

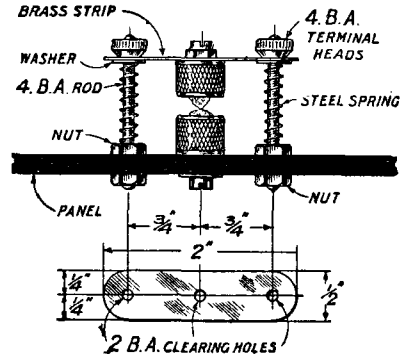

Fig. 5.—The construction of the Perikon detector.

left to the choice of the constructor. The two panel doors and a portion of the top are hinged, so as to give easy access to the receiver when in use, thereby making aerial and earth connections easy. The lower part of the cabinet may be used to store 'phones, crystals, coils, fixed condensers, etc. A better appearance may be given to the cabinet by glueing on to the hinged doors some 3/8-in. beading of any suitable design.

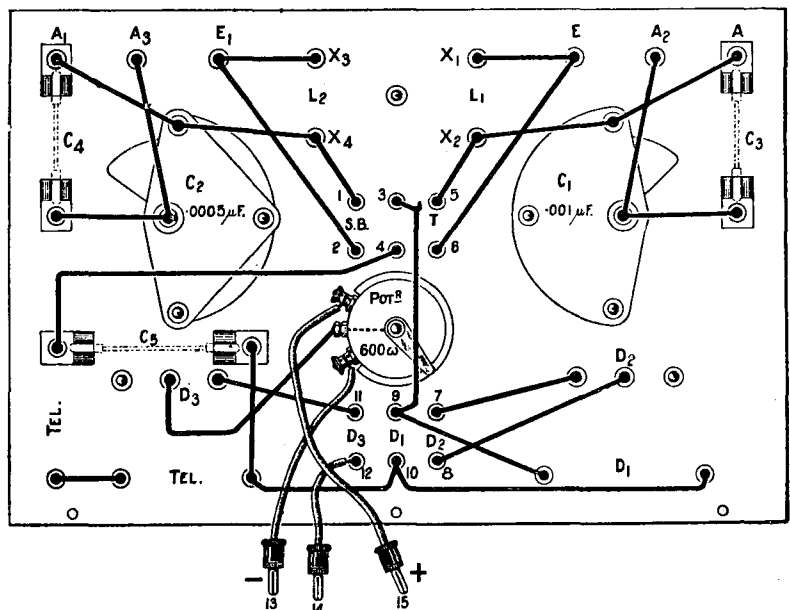

Fig. 4.—The wiring of the receiver may be followed from this practical drawing.

Circuit

The theoretical circuit diagram is shown in Fig. 1. Where loose coupling is employed L1 (fixed) is plugged into the socket connected to X1 and X2, and L2 (moving) into that connected to X3 and X4. To use C1 in series connect the aerial to terminal A2. To use C1 in parallel connect the aerial to A and join terminals A2 and E by means of a link. The clip-in condenser C3 provides added capacity to C1, thus

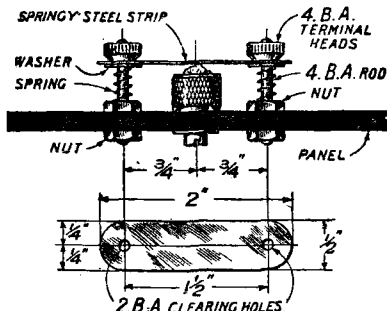

Fig. 6.—The carborundum detector.

making the actual capacity up to .0015 or .0013 μ F, according to which fixed condenser is used.

The earth is connected to E.

Direct Coupling

For direct coupling L1 may be used with the panel switch down on the "tune" side. Alternatively L2 may be used by connecting the aerial to terminal A1 and the earth to E1, the panel switch being down on the "stand-by" side. The variable condenser C2 is placed in series or in parallel, like C1, the aerial being connected to A3 for series, and to A1 for parallel, with A3 and E1 connected by means of a link. The condenser C4, of the clip-in type, may be used to increase the tuning capacity, if this is required. Provision is made for shunting a fixed condenser across the telephones if desired; this may be of the clip-in variety, and is indicated at C5 in the wiring diagram.

Tuning Arrangements

The actual choice of tuning arrangements is as follows:—Loose coupling with C1 in series with the aerial coil, and C2 in parallel with the secondary coil, or both C1 and C2 in parallel with L1 and L2 respectively. Direct coupling with C1 or C2 in series, or, alternatively, C1 or C2 in parallel.

Telephone Connections

When using one pair of telephones, the two terminals across which the second pair would be connected, should be joined together by means of a piece of wire. When using two pairs of phones these are connected, one pair to each set of terminals indicated, the shorting wire having been previously removed.

Results

The receiver was tested at a distance of $4\frac{1}{2}$ miles from 2LO and 30 miles from the Chelmsford station 5XX, the aerial employed being of the twin type, 40 ft. in length and 28 ft. high.

2LO was tuned in first of all with direct aerial coupling, good signals being obtained with a No. 35 coil in the aerial socket with parallel tuning. The Galena detector was employed during this and all subsequent tests upon 2LO's transmission. Series tuning with a No. 60 coil gave noticeably louder signals.

Upon changing to the loose coupled method of tuning, a further improvement in signal strength was observed, series tuning being retained in the aerial circuit.

Chelmsford

Chelmsford was next tuned in, home wound coils being

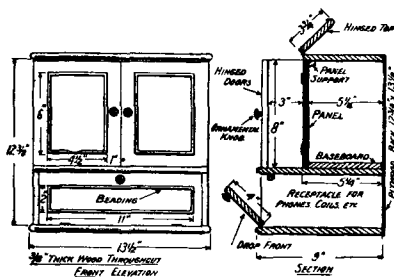

Fig. 7.—Details of the cabinet.

employed for the reception of this station. Using direct aerial coupling with a No. 200 coil and the tuning condenser (in parallel position) adjusted to its minimum capacity, good strength was obtained with the carborundum detector in use. Loose coupling produced apparently similar results.

Loose-Coupling

Since the loose-coupling arrangement gave very good

results from 2LO, the effect of replacing the phones with a small loud-speaker was tried. Although the programme could hardly be enjoyed in this manner, an indication of the signal strength may be gathered from the fact that speech could be read at a distance of 3 ft. from the loud-speaker mouth.

Finally, do not be sure that you are obtaining best results possible until you have experimented well with the various methods of tuning.

Quick Battery Connector

TROUBLE is often experienced in making efficient battery connections quickly, where a potentiometer or grid-bias battery is used.

A simple way of overcoming the difficulty is shown below. All that is necessary is to bend the battery tags over a piece of

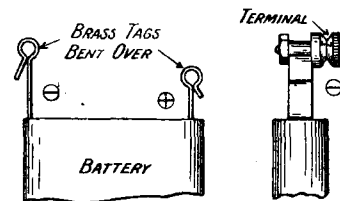

Illustrating the connector applied to the battery.

4 B.A. rod, and pinch tightly with a pair of pliers. When the rod is withdrawn the tags will take the shape shown in the left-hand diagram. The long tag is marked negative and the short one positive. Next secure a terminal to each of the tags as shown, when it will be found that the securing nut on being tightened up makes a rock-firm connection. The battery may then be connected to the panel component by means of a lead passing from the component to the battery terminal. For quick "on" and "off" connection the lead should be equipped with a spade terminal at the battery end.

H. B.

All readers interested in Supersonic receivers should not fail to read the current issue of "Modern Wireless." Buy your copy to-day.

Correspondence

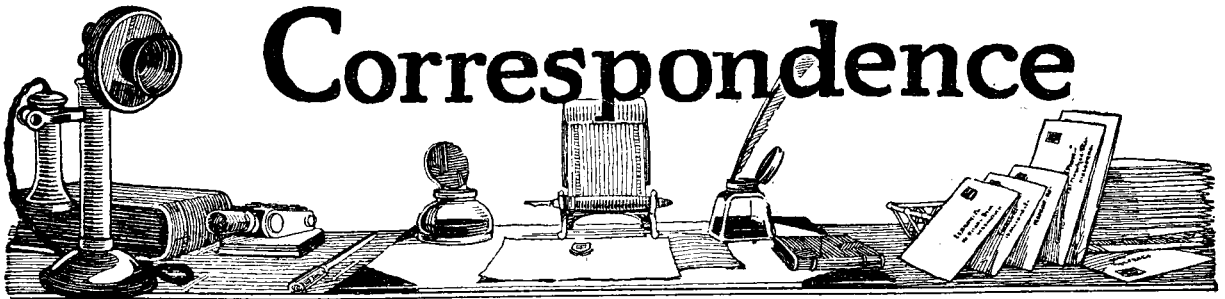

'THE FOREIGN RADIO TIMES'

SIR,—I should like to congratulate you on the general excellence of your paper, and in particular on the special prominence you are giving to foreign stations and foreign time-tables, in which you are doing valuable pioneer work.

Anything of this kind which is of international interest must be of corresponding international value. I have found it of special interest in the reception of foreign languages.

I am sure many of your readers would be glad if you could include other stations in your list. For example, I should personally be very interested in Rome, Barcelona, etc.

Wishing your efforts much success.—Yours faithfully,

A. L. MINNS.

Brighton.

SIR,—May I congratulate you on the new feature which is appearing in your paper—*The Foreign Radio Times*.

The Continental programmes have been wanted by listeners for a long time. A friend of mine who is always experimenting in "getting" stations outside the British Isles is most enthusiastic about it.

Would it be possible for you to give the morning transmissions of

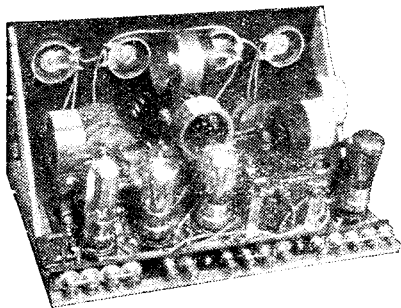

The home-built 4-valve T.A.T. receiver made by our correspondent "B. A."

the German stations as well as the evening ones?

Wishing your paper every success.—Yours faithfully,

(Miss) K. CREIGHTON.

Swinton.

SIR,—Congratulations on your new and excellent supplement to *Wireless Weekly*, namely, *The Foreign Radio Times*. I consider it fills a long-felt want, and trust it will meet with all the success it deserves.

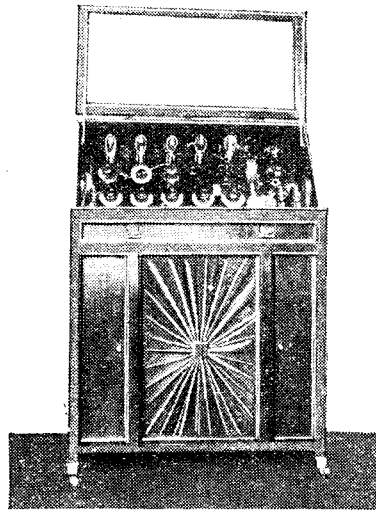

A Transatlantic V, by "Amateur." The loud speaker is situated behind the centre panel of the lower half of the cabinet.

I should like to suggest that the programmes from Madrid be included.—Yours faithfully,

JAMES WATSON.

Mitcham, S.W.17.

SIR,—Allow me to congratulate you on your new feature in *Wireless Weekly*, namely, the *Foreign Radio Times*. I only wish space permitted you to give more stations and also programmes for the whole week.

I also think that you might omit the American stations in favour of some of the European stations.

I also want to congratulate you on the wonderful crystal-valve circuit with reaction (described by Mr. John Scott-Taggart) published in the March number of *The Wireless Constructor*. I have made up one or two for friends, and the results are excellent.

Your publications are far in advance of other wireless periodicals, both in information and clearness of illustrations and type.—Yours faithfully,

F. D. V. GOODALL.

Teddington.

THE FOUR-VALVE T.A.T. RECEIVER

SIR,—I note that you ask constructors to give results of the four-valve T.A.T. receiver described in the Christmas number of *Modern Wireless*. I have just finished constructing this set, but have adapted the components to make a cabinet set. I enclose two photos which perhaps will interest you. From external appearances I think you will agree that it makes a very neat and compact receiver. You will note that all main terminals are out of the way at the back, and only the headphone terminals on the panel. After thoroughly testing all connections I got good results, and it was striking how one could get stations without any or with practically no interference from those operating on wavelengths near that of the station being received.

I got London at full loud-speaker strength, also Newcastle, Glasgow, Belfast, and Aberdeen were good 'phone strength, but am hoping by better tuning, to improve on these.

London was clear, and there was no interference from Leeds, which is very nearly the same wavelength.

The signals seem very clear, and there is no suggestion of distortion "crackling" in the L.S. or of certain notes "clashing." I am truly delighted with the results.

On a subsequent evening, after trying for different stations, I got the following results:—

London, Leeds, Manchester, New-

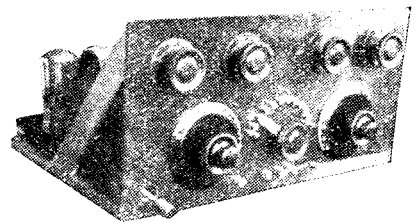

The front of panel view of the 4-valve T.A.T., by "B. A."

castle, Glasgow and Belfast at full loud-speaker strength, i.e., as loud as one could wish to listen to.

Birmingham, Bournemouth, Aberdeen and Chelmsford at medium loud-speaker strength, i.e., easy to

listen to without strain to make out words, etc.

On this occasion a German station (unidentified) was also received at full 'phone strength. Tuning was very critical in many cases, but I managed by careful manipulation to bring signals up to the strengths given.

I hope these few remarks will be of interest, in spite of their somewhat amateurish nature.—Yours faithfully,

Ilkley.

B. A.

THE TRANSATLANTIC V

SIR,—I, the undersigned, have the pleasure of sending a photograph of the Transatlantic V, described in *Modern Wireless*, June, 1924, by Mr. Percy W. Harris, and I compliment him upon such a splendid receiver

I constructed panel and cabinet myself. I find that different stations require different H.T. for H.F. and L.F.

My loud-speaker, a "Revo," is screened behind centre panel, which is made of black satin; the cabinet is of oak. Accumulator and H.T. are at the back of cabinet.

Again many thanks to *Modern Wireless* and *Wireless Weekly*.—Yours faithfully,

Plymouth.

AMATEUR.

SCHOOLS RADIO SOCIETY

SIR,—I take this opportunity to thank you for the interest you have shown in the Schools Radio Exhibition; such valuable assistance will do much to foster the growth of "Wireless in Schools."

Appended is the report issued by the judges in connection with the award for the exhibit of the greatest merit.—Yours faithfully,

REGINALD J. HIBBERD.

Hon. Sec., Schools Radio Society.
Dorking.

The list given below represents the order of merit in connection with the Schools Radio Exhibition. We have taken into consideration, in making our awards, the number of exhibits from each school, the number and quality of drawings, the standard of workmanship, points of originality and application to general education. For future guidance we take this opportunity of expressing our views that the recent Exhibition has been of great value inasmuch as it has clearly shown that the interest in wireless science amongst boys is undoubtedly considerable. At present there does not seem to be, on the whole, very much originality of design indicated, and it is under this heading that we think there is scope in the future.

Again, probably the greatest educational value of the study of wireless principles and the construction of apparatus lies in the methods of

application to other branches of science and knowledge.

With two outstanding exceptions (Broadwater Road School, Tooting, and St. Paul's, Dorking), there appears to be very little indication that any attention is given in schools to this last-mentioned point. On the other hand, the workmanship in many cases was of quite a high order, as were also the drawings, and as these are of important educational and commercial value, there can be no question as to the justification for schools giving time and facilities to the boys in connection with the theory and practical application of wireless science.

The first three schools on the list were: 1st, Broadwater Road School, Tooting, 67 marks; 2nd, L.C.C. Beaufoy Technical Institute, 53 marks; 3rd, St. Paul's School, Dorking, 52 marks.

The prize of five guineas given by J. H. Reeves, Esq., M.A., M.B.E., was presented to the winning school by Dr. Eccles at a meeting of the R.S.G.B. held at the Institute of Electrical Engineers on Wednesday, March 25, 1925.

(Signed) L. F. FOGARTY,
G. G. BLAKE,
MAURICE CHILD,
Judges.

THE ANGLO-AMERICAN SIX

SIR,—I am writing to say how pleased I am with the "Anglo-

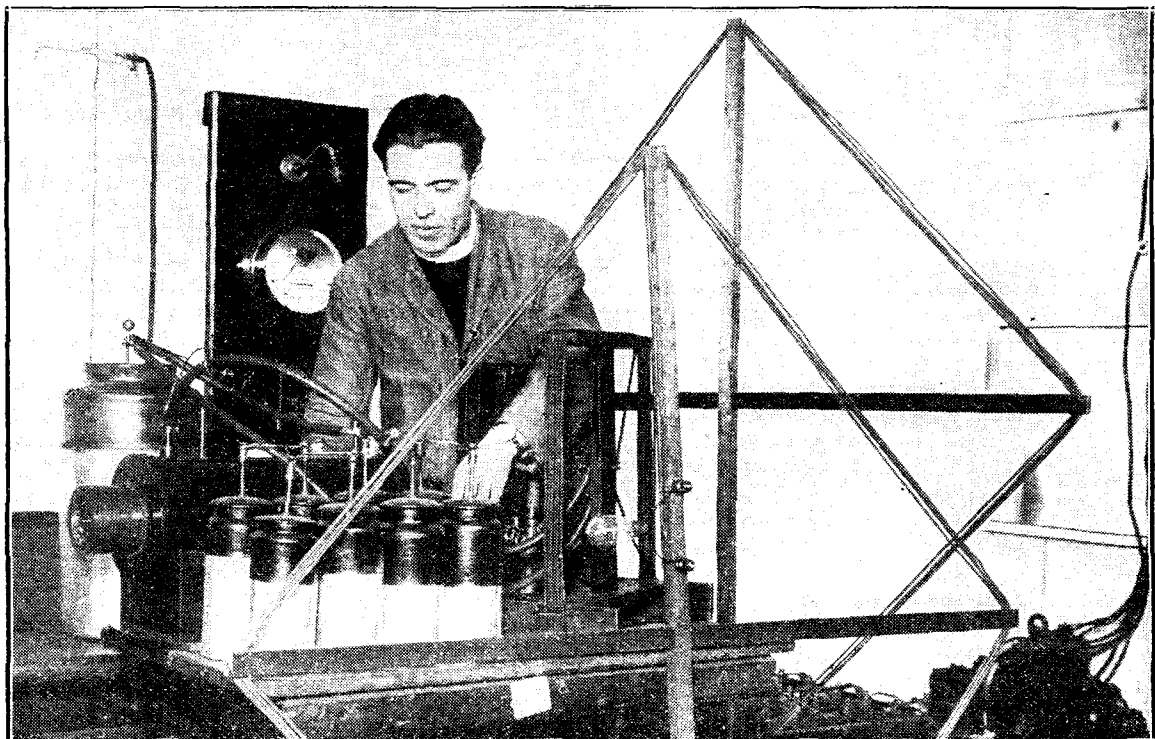

Rev. Maurice T. Beckett, O.B.E., hon. chaplain to the Forces, is a very keen wireless enthusiast, and may be here seen conducting some of his experiments.

American Six," described by Mr. Harris in *The Wireless Constructor* for January, which I have just completed. Here in Birmingham I have received all the B.B.C. main stations and most of the relay. Such is the power of this set that it will work the loud-speaker quietly with the H.F. and detector valves only on such distant stations as Newcastle and Glasgow. Now, as regards selectivity, it is possible using a wave-trap to cut out 5IT working on 475 metres 3 miles away and receive Frankfurt on 470 metres without a trace of the local station. Wishing you the success you deserve.—Yours faithfully,

RALPH CROWDER.

Birmingham.

"WHAT CONSTITUTES A GOOD AERIAL?"

SIR,—It is at least some poor consolation to have Mr. Percy W. Harris in "Random Technicalities" of March 11 agree that "reception conditions depend more on the locality than on the actual disposition of the aerial wires." Here in southern Spain the quality of reception is entirely dependent on the amount of interference from atmospherics. In my efforts to tune out atmospherics I have tried something like a dozen different aerials from 50 to 150 ft., single and double, in four different orientations relative to

the set, bare and insulated wire, indoor and outdoor, and from 20 to 50 ft. high, with as many different forms of earth and counterpoise. With all these multiple combinations I have not only not succeeded in getting rid of atmospherics, but there is practically no difference in strength of signals or range, whether my aerial has been north or south, 50 ft. or 150 ft. long, or 20 ft. or 50 ft. high. The term one so often sees in the technical journals, "with a good aerial," seems, therefore, to have no application to a geographical position such as this, 200 miles from the nearest broadcasting station. Sometimes, but not always, I get relief from atmospherics by using no earth lead, but even then there is no appreciable difference in strength of signals. Distance may "tone-down" incoming impulses. I certainly get stronger signals for Radio Iberica (200 miles) and Rome (700 miles) than from Bournemouth (800 miles), but only slightly stronger, and the difference in strength is in no way in relation to the distance. Moreover, my range is no greater with an aerial of 150 ft., 50 ft. high, than with one of 50 and 25 ft. high. It is still another problem!

As regards atmospherics, the local weather seems to be the dominating factor. A storm in the English Channel or Bay of Biscay, for

example, does not affect our reception of Bournemouth, but a local barometric depression makes it impossible to hear anything from anywhere.—Yours faithfully,

GEORGE L. BOAG.

Aguilas (Murcia), Spain.

INDIGNATION

SIR,—I have read with indignation the letter of H. C. I. Grenside in the March 25 issue of your most excellent paper. Having had the opportunity of discussing every point of the broadcast programmes, etc., I would like to point out that only one listener out of one hundred cares to listen to the Continental stations, and that here in the Vale of Aylesbury, which is about 38 miles from 2LO, the increase of power means a great deal to our average listener. It is impossible to get anything like good loud-speaker reproduction here on less than three-valves, and I am quite safe in stating that the large majority in the whole of this district would appreciate an increase of 2LO's power to 5KW.

If your correspondent would remember that there are listeners who pay a broadcast fee other than those who reside in Highgate he would be, perhaps, not quite so selfish and egotistical in his views.

Personally, I should like to suggest that Mr. Grenside constructs a

For making all Wireless Connections use the

Quality RADIO ELECTRIC SOLDERING SET.

Works from any wireless accumulator.

Complete, as illustrated, with full instructions.

5/6

Postage 3d.

No gas, fire or lamp needed. Always ready, no waste; a joint is made in a few seconds. The soldering bit being of carbon, it requires no cleaning or tinning.

If your dealer cannot supply, we send post free if you mention his name and address.

GOSWELL ENGINEERING CO., LTD.,
12a, PENTONVILLE ROAD, LONDON, N.1.

Liberal Trade Terms.

LIST FREE.

'Phone: North 3051.

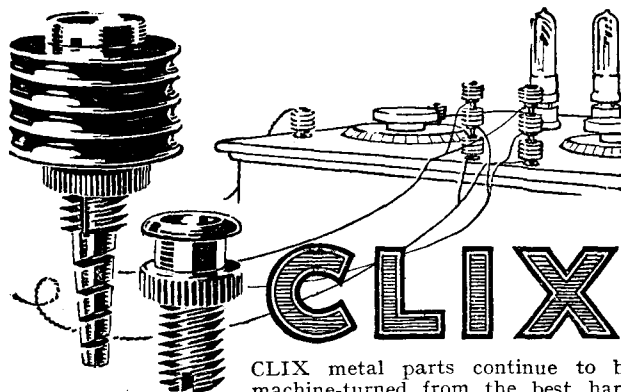
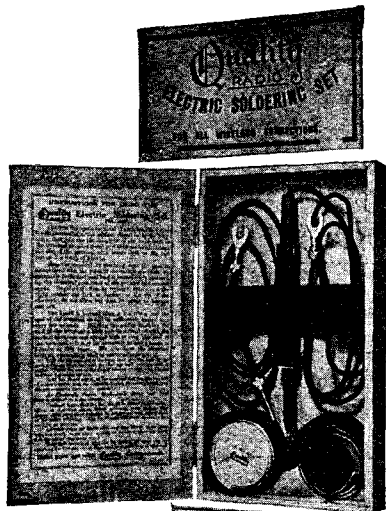

CLIX metal parts continue to be machine-turned from the best hard brass rod, but a special nickel-bathing process is now employed to increase CLIX high standard of efficiency, workmanship and finish.

The new skin of special nickel-silver alloy of high electrical conductivity ensures in CLIX a perfect fitting connection with a high frequency resistance of practically zero. This fact, in conjunction with the large area of contact surface provided with the minimum of capacitive metal in both plug and socket portions, gives CLIX its supremacy over every other form of plug, switch or terminal.

Solder all connections!
Where you can't, use CLIX!

Retail Prices of the New

CLIX

- CLIX with Locknut 2d.
- CLIX Adapter with Locknut 2d.
- CLIX Insulators (6 colours) 1d. each.
- CLIX Bushes (6 colours) 1d. pair.

AUTOVEYORS LTD., 84 VICTORIA STREET, LONDON S.W.1

wave-trap to assist the operation of his set, thereby allowing him to continue with his Continental reception.—Yours faithfully,

ALAN T. CHAPMAN.

Aylesbury.

[What have *The Foreign Radio Times* readers got to say?—ED.]

A SINGLE-VALVE RECEIVER FOR KDKA

SIR,—May I add my congratulations to those of the many readers of *Modern Wireless* who have built the "Single-Valve Receiver for KDKA" described by Mr. Stanley G. Rattee in the March issue.

This circuit really has solved the problem of long-distance reception on short waves. The dream of the wireless enthusiast has come true at last, namely, to be able to invite friends in any evening and get KDKA as easily as one would tune in any other station. Using a note magnifier, music can be heard comfortably loud on the loud-speaker, while on the phones the strength almost equals single-valve reception of the local station, with its remarkable purity of tone, while the absence of self-oscillation is a delight. I have extended still further the "extension handles" which I had purchased, making

them 16in. long, thus entirely eliminating hand-capacity effects. The valve I am using is a metal .06 type with 54 volts H.T., and a dull-emitter power valve for note magnifier with 114 volts H.T. and 3 volts G.B. The aerial consists of three lengths of 30 ft. in parallel, at a height 22 ft. (screened), though personally I do not think screening makes any appreciable difference, since I get pretty well all the European stations on this aerial. The earth is a rainwater pipe which goes direct to earth outside my window and several feet below the ground. This, by the way, is the most efficient earth I have found for all reception.

These, and the fact that I followed Mr. Rattee's lay-out to the letter no doubt accounts for the pleasing results obtained. This set can be built by any amateur with assured results, and can be built for permanence.—Yours faithfully,

ROBERT J. NICHOLS.

Eltham, S.E.9.

AERIAL INTERACTION



SIR,—The remarks under "Random Technicalities" in your March 4 and 11 issues, anent the interaction between transmitters and receivers, I would like to offer the results of a few experiments con-

ducted by 2OZ. and myself in the same direction. I make a practice of checking off transmission by means of a O-V-O receiver connected to an indoor aerial, and several weeks ago it was noticed that the aerial ammeter needle varied with the setting of the receiver A.T.C. In fact, another H.W.A. placed between the indoor aerial and earth showed a reading of .05A while the key was down, and, as far as can be remembered, .3 in aerial.

Since reading the above-mentioned remarks we have covered the ground again, giving the following results with a constant input to transmitter:—

	Reading of H.W.A.
(1) Indoor aerial earthed29
(2) Receiver tuned to transmitter32
(3) Receiver with coils removed (no other alteration)18
(4) With series cond. shorted the parallel condenser moving from .0001 to .001 (Polar)27 to .17
(5) As No. 4 with addition of .006 in parallel28

The receiver is fitted with both

For Closest Selectivity and Sharpest Tuning use

"Tangent" Tuning Coils

The Coil with the extraordinary LOW SELF CAPACITY.

See the figs.—then try the coils! they're it!

Coil No. - -	25	35	50	75	100	150	200	250
Self Capacity in Micro-Microfarads	8	9	25	31	22	16	22	22
Price - - -	4/3	4/3	4/3	4/6	5/-	6/-	7/-	7/6

COMPLETE SETS { 4 Concert Coils (W/L 250 to 1180)—16/- the set.
11 Concert Coils (W/L 250 to 9500)—67/- the set.

Obtainable from all good dealers—
:: any difficulty—write us. ::

GENT & Co LTD (Est. 1872.)
Manufacturing Electrical Engineers
FARADAY WORKS, LEICESTER

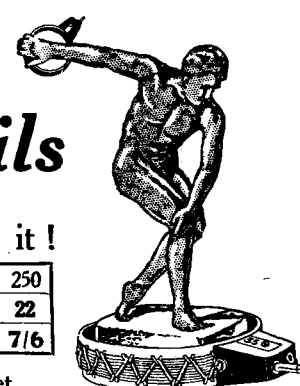

UNSHROUDED EFFICIENCY



RIGID AS A MOTOR WHEEL.

series and parallel condensers, the series one having a shorting switch. Adjusting the series condenser made no difference. The transmitting-aerial is at right angles to the in-door aerial, and is about 22 ft. above it.

2OZ, in working, had noticed variations in signal strength though neither of us connected it with the above circumstances. We hope to test this out in the near future as to the bearing, if any, on distant reception.

It would be interesting to know if others have also investigated this matter at all.—Yours faithfully,
"5YR."

A LOW-LOSS TUNER FOR SHORT WAVES

SIR,—Permit me a word of thanks and appreciation of the "Low-Loss Tuner" for short waves, by Percy W. Harris. KDKA has been received here at good phone strength every time the station has been tuned, and I have never as yet failed to tune in the station when required.

Using a power amplifier (small) with this receiver on Saturday, March 28, signals at 11.15 p.m., G.M.T., were of good strength (L.S.3) on a large B.T.H. speaker. Later, about 1.30 a.m., G.M.T., the

"Studio Concert," as it was announced, was received at such strength that the receiver and amplifier had to be detuned so as not to disturb others in the house. I switched off finally at 2.45. I must say this is the best I have received this station, and considering the time of year, I think it good.

Wishing your journals every success.—Yours faithfully,

HARRY C. COVE.

Ealing, W.

DRY CELLS AS L.T.

SIR,—I have just read an article by Mr. Harris in *Wireless Weekly* in which he condemns the use of dry cells for supplying L.T. current to D.E. valves, and the conclusions which he draws are so different to my own experience that I should like to put before you the other side of the question.

Sixteen months ago I bought a 2-valve set fitted with Marconi D.E.3's, and purchased a Siemens battery to light the filaments. This cost me 9s., and it supplied the current to the two valves for ten months running on an average from two to three hours nightly. I then added a 2-valve amplifier and loud-speaker, and purchased two other batteries of the same

type, one for each pair of valves. These have now been running for six months, and I have only recently changed over to the 4½-volt tapping, so that they are still good for some months. During the whole of this period my results have been consistently good, and even when the set has been run for five hours at a stretch the drop in voltage is quite negligible. The set is ready for use at any moment without the risk of having an accumulator which has run down, and I do not require to send an accumulator to be recharged every month or so.

The doctrine which you preach in all your articles about purchasing reliable components appears to be particularly true with regard to dry cells. I seem to have struck the genuine article and would not change to an accumulator on any consideration. Admittedly dry cells do not last for ever, but, from what I have seen, the same is true of accumulators.

I do not know, of course, to what type of battery Mr. Harris was referring, but can state with confidence that from experience over an extended period the Siemens battery more than fulfils the makers' claim and gives absolute satisfaction.—Yours faithfully,

DRY CELL.

Melrose.

Learn FREE—how to make this better Super-Heterodyne

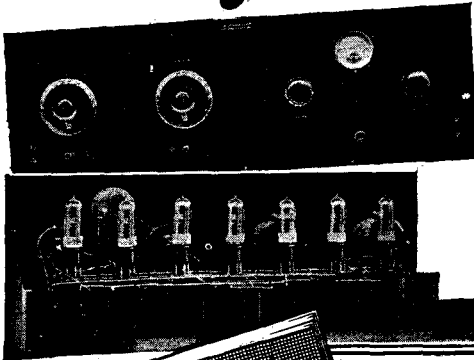

IT is within the power of every amateur to make a successful Super-Heterodyne Set now that Bowyer-Lowe Intermediate Transformer Units are available.

These Units are built for use with British Valves, and have less internal capacity and more stability than foreign units, so that high efficiency and quiet functioning are obtained with increased selectivity and power. Complete instructions for building a remarkably simple and effective Seven Valve Receiver are given with every set.

Bowyer-Lowe Super-Heterodyne Transformer Units are all matched in complete series, each guaranteed to function at a uniform peak frequency. Each set is tested at 500 volts between windings to eliminate all chance of short circuiting. The transformers are contained in cases of Grade "A" Ebonite, and sold in complete sets of four (Dubilier Fixed Condenser '0005 included) at £4 the set. A special Oscillator Coupler Unit, uniform with the transformers in size and shape to cover the broadcast band with a '0005 Variable Condenser, is also made, and costs £1.

COMPLETE SERIES, comprised of 1 Input Filter and 3 Interstage Transformers with Dubilier '0005 Fixed Condenser for tuning primary of Filter. Each set individually matched and sold in boxes with Instruction Booklet for making 7-Valve Receiver shown.

Price £4

The set as above, but with Oscillator Coupler Unit, £5

Ample supplies. Order direct or from your dealer.



How to Build a Better Super Heterodyne

This book given FREE with every complete set

Progressive wiring photographs, circuit diagram, list of parts and complete instructions for making this 7-Valve Super-Heterodyne Receiver are given FREE with every set of Bowyer-Lowe Super-Heterodyne Transformers. Start work on it to-day.

The booklet may be had separately. Price 6d.

Bowyer-Lowe INTERMEDIATE WAVELENGTH H.F. TRANSFORMERS

BOWYER-LOWE, C^o L^{td} LETCHWORTH





Apparatus we have tested

Conducted by A. D. COWPER, M.Sc., Staff Editor.

"Dulce-Tone" Gramophone Attachment

Messrs. C. G. Vokes have submitted for trial a sample of their "Dulce-Tone" gramophone attachment, for converting an existing gramophone into a radio loud-speaker without any structural alterations whatever. The Model S Type submitted consists of a small case, similar to a single ear-phone, resting on a felt base; this is simply placed on the turn-table of the gramophone, and connected by its flexible leads to the ordinary 'phone or loud-speaker terminals of the receiver. The needle of the gramophone sound-box is then rested in a slot in the end of a reed, which projects through the top of the small case and rocks on a spring mount-

ing in the base. This is free to vibrate between the poles of a permanent magnet, and is surrounded by the usual fine coil of wire; the audio-frequency current sets this in motion by controlling its magnetic polarity, thereby actuating the diaphragm mechanism of the gramophone, the trumpet attached to the latter giving the necessary "attack" on a large volume of air for loud reproduction. The D.C. resistance of the windings was but 1,000 ohms on measurement, which suggests that the instrument would operate better in conjunction with a low-impedance small-power, or American type of receiving valve than with the R type of high impedance.

On trial with .06 type of D.E. valves, and with power amplifica-

tion (D.E.5 valves), it was noticeable that the sensitiveness was less than with conventional types of modern loud-speakers, but that the quality of the tone, making use of the excellent audio system developed in the course of many years' experience by the makers of high-class gramophones was excellent. For those who possess powerful sets and wish to utilise a high-class cabinet type of gramophone occasionally without inviting a great deal of trouble in switching from records to radio and *vice versa*, this instrument should have a strong appeal. Some very interesting experiments can be carried out also with its aid in the direction of unconventional types of loud-speaker. Thus a common domestic poker, a sheet of

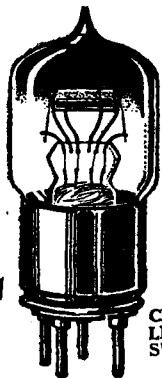

The Valve

that opens for you a road of unending possibilities! The C. & S. DULL EMITTER. We are receiving every day unsolicited testimonials from delighted users

praising its CLEAR MUSICAL TONE, LONG LIFE, LOW CURRENT CONSUMPTION, and RELIABILITY.

THE

C. & S. Dull Emitter

2 v. 0.2 amp. (227) which received NEW ZEALAND on a single 12/- valve costs you only (Also made 0.06 amp. (227L), 15/-).

GET YOURS NOW!

Special dry batteries for these valves—

227 .. 7/6 each
227L .. 5/- each

CRAIK & SMITH (Desk D)

Allen Street, Goswell Road, E.C.1. Phone: Clerkenwell 7346



HAWK COILS

MAXIMUM

Efficiency

Strength



Prov. Pat. 29269

WATERPROOF

MINIMUM

Capacity
Damping Effects
Resistance

Prices below

Coil	Wave Length using .001 Variable Condenser in Parallel		PRICE.
	MAXIMUM	MINIMUM	
13	—	—	2/-
25	395	190	2/4
30	435	240	2/4
35	515	360	2/8
40	680	370	2/8
50	835	485	3/-
75	1250	600	3/4
100	1820	815	3/10
150	2300	980	4/8
200	3100	1870	5/4
250	3750	2200	5/8
300	4500	2300	6/-
400	4950	2500	6/6

Sold by all Wireless Dealers

Sole Manufacturers:

The Hawk Coil Co., ST. MARY'S ROAD, SURBITON, SURREY.

cardboard, a stiff paper pleated fan, a sheet of ply-wood, etc., in turn gave results of varying quality and loudness when one end was simply rested in or thrust into the operating slot of the reed; the inertia of the remainder sufficed to determine an intense vibration of the lower part. A little experimenting in that direction, made possible by this convenient reed type of receiver, may produce results of surprising fidelity and elegance. We can certainly recommend the device.

A Quick-Release Terminal

From A. Butler come a number of samples of a type of quick-release terminal which will be of considerable utility in connection with experimental circuits of the table-top order, or even for semi-permanent wiring with large tinned wire. These are similar to a large valve-leg socket just over $\frac{3}{8}$ in. high, and with a No. 4 B.A. back-stud. A slanting slot is cut in the side of the barrel and a shouldered plunger, pushed upwards by an internal spring, slides within the barrel. By pressing on the projecting, rounded end, this plunger can be depressed so far that the shoulder on it comes below the diagonal slot; the end of a wire can then be nipped in the slot between the upper end of this and the plunger shoulder. Good electrical contact is

thus made, but the wire can be released in a moment by pressing again on the plunger. The slot is nearly $\frac{1}{8}$ in. wide, so that more than one wire or alternatively a thick tinned bus-bar can be accommodated.

The fittings were well finished, and operated with ease and certainty. They can well be recommended for the purposes indicated.

Ediswan Variometer

Messrs. Edison Swan Electric Co., Ltd., have sent for trial a sample of their variometer, Type W.L. 439. This is of the one-hole fixing type so popular now, one hole $\frac{3}{8}$ in. diameter being needed in the panel. The rotor windings are on a spherical moulded composition former; the stator windings on the inside of a cylinder of bakelite. Substantial metal bearings are mounted on the former for the centre spindle, and a spring washer ensures good contact and smooth action. Convenient terminals provide, in conjunction with metal bridges, an easy change over from the series to the parallel connection of rotor and stator, and a good quality knob and bevel dial are supplied with the instrument. The finish and workmanship are generally what one would expect in an Ediswan product.

The range is given by the makers

as from 277 to 634 m. in series, and 205 to 359 in parallel arrangement, with a standard P.M.G. aerial. This is presumably taken as of .00025 μ F capacity; on what is often taken as a P.M.G. aerial mean capacity of .0003 μ F. the writer determined the range as from 1,040 to 430 kilocycles and 1,420 to 870 kilocycles respectively, giving a total range therefore of from 210 to just under 700 metres wavelength.

In crystal reception the signal-strength observed (in series arrangement) on 2L.O at 13 miles was excellent. With the improved arrangement possible with efficient inductances of a tapping for the crystal midway in the inductance (i.e., at the spindle) the signal-strength was 23 micro-amperes compared with 25 micro-amperes with the standard low-loss air-core tapped inductance, an exceedingly high ratio for a commercial tuning-device. Accordingly, we can well recommend this neat and convenient little instrument.

Rubber Ear-Caps

The "H'Ear-Easy" rubber ear-pads or caps for fitting to existing ear-phones have been brought to our notice by Messrs. J. C. Scott & Co. These, which are made in three sizes to fit any make of headphone, form large cups which fit completely over the ears when in use, resting on



EVERYBODY NEEDS
the **RADIO BEAD**

Every radio enthusiast is troubled by the twisting and kinking of the flex leads of his headphones, loudspeaker, or batteries and the consequent damage resulting in inferior reception. But now there is a remedy—

THE RADIO BEAD
is a simple accessory which clamps on to your flex leads (no disconnecting necessary) and enables you to instantly remove kinks and prevent their recurrence. Light in weight and small in cost, it prevents that frequent and often unknown cause of loss of signal strength which is so difficult to trace.

Approved by leading radio experts.
SATISFACTION GUARANTEED.
ESSENTIAL TO YOU. GET ONE NOW.
Obtainable from all dealers.
Trade enquiries invited.

WIN PATENTS, Bridgeway House, Hammersmith, London, W.6.
Tel.: Elverside 3483.

1/- EACH

Prov. Pat. No. 11016 2A.

Barolays 1023.

THE PANEL DE LUXE

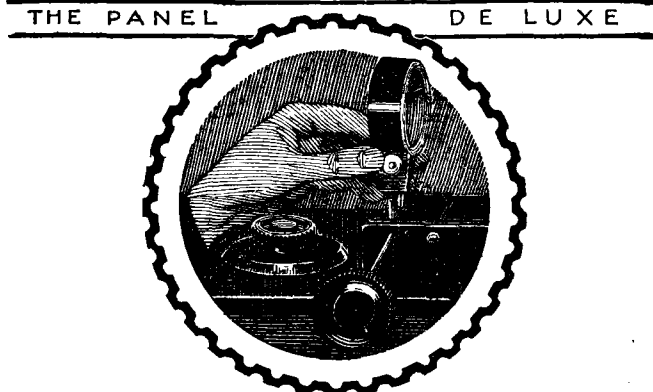

THE real wireless enthusiast goes over his Set inch by inch. Shortening a connection here—replacing an inefficient component there, he knows that success depends on the most careful attention to seemingly insignificant details. Such men are now standardising on Radion as the panel material de luxe.

Radion is available in 21 different sizes in black and mahoganite. Radion can also be supplied in any special size. Black 1d. per square inch, mahoganite 1½d. per square inch.

RADION

American Hard Rubber Company (Britain) Ltd.
Head Office: 13a Fore Street, London, E.C. 2
Depots: 120 Wellington Street, Glasgow, 116 Snow Hill, Birmingham.
Irish Agents: 8 Corporation Street, Belfast.

Gilbert Ad. 2691

BROKEN VALVES MADE EQUAL TO NEW IN FIVE DAYS.

Guaranteed to give Satisfaction or Money Returned.

BRIGHT EMITTERS 6/6 (Money should be enclosed with valves.)
FOUR ELECTRODE 8/-

Send to:—ECLAT ELECTRIC MANFG. Co. LTD.,
Spencer Works,
SPENCER HILL ROAD, WIMBLEDON, S.W.19.

the sides of the head; they are maintained in position on the receivers by a thickened flange.

On trial these were found to exclude to a great extent unwanted external noises, even with the head-band fitting deliberately loosened so as to give tolerable comfort over extended periods of listening. The fitting is not air-tight, however, so that the common difficulty of condensed perspiration is largely avoided.

Whilst not adding to the appearance either of the head-set or of its wearer, this provides some palliative to the torture experienced by many when they attempt to listen to a lengthy programme with ill-fitting 'phones tightly clamped on, so that nothing may be missed of the transmission. For tuning-in a loud-speaker set in a noisy room they also offer advantages, whilst the caps are more secure on the receivers than is the case with some pads offered.

are increased up to a certain point, beyond which the signal strength remains fairly constant, only falling off very slightly, and therefore in these cases it would seem that no very great pains need be taken to find the correct tapping point. Unless the extreme of selectivity is required, some 12 or 15 turns, according to the size of the aerial, may be regarded as a satisfactory number. Upon aerials of fairly high resistance, on the other hand, the curve possesses a definite peak, and it is worth while taking the trouble to find this for any given station which one desires to receive. Upon these aerials, therefore, it would probably be an advantage to provide a means of varying the tapping point according to the wavelength to be received, since it must not be forgotten that all my tests were done upon the wavelength of 2LO, and wherever the tapping point is found to be at all critical, it may be necessary to adjust it to one position for the lower half of the broadcast band, and to another for the upper half of the band.

SOME FURTHER MEASUREMENTS WITH AUTO-COUPLED CIRCUITS.

(Concluded from page 50).

and it is probable that there are a number of factors here that will modify the results somewhat, particularly as regards the exact location of the correct tapping point for a given set of conditions. The actual resistance of the coil itself would seem to effect this, and I fear that the only advice which can be given is to wind the coil with a variety of tapping points, and adjust the connection to suit the particular conditions.

Conclusion

Upon the basis of these few aerials, which I am quite prepared to admit, are not sufficiently numerous to justify one in speaking very positively, it would appear that upon a large aerial only a relatively small number of turns require to be included in the aerial circuit for coupling, and *vice versa*. Further, a low resistance aerial and earth system results in a rapid rise of signal strength as the coupling turns



"Father used to say that headphones hurt his ears"

"Now, it is quite a different story. He has fitted 'KUMFI' De Luxe Ear Pads to the 'phones, and all that Father can find time to say is ... SH' ... SH' ... SH' !!!"

The new "KUMFI" De Luxe antiseptic Ear Pad is a soft, velvety pad that just covers the ear piece of the headphone, and entirely prevents that uncomfortable pressure on the ears and enables you to listen-in for hours without discomfort. In addition, it shuts out exterior noises, and prevents moisture collecting on the diaphragms. Each pad is antiseptic and self-adhesive, and can be fixed or removed without the slightest difficulty—no heating or damping is needed.

'KUMFI' De Luxe EAR PAD

the only scientifically prepared pad—can be had from Wireless Dealers, or POST FREE from the makers on receipt of 1/3.

A. de ST. DALMAS & CO., LTD., LEICESTER.

Ⓔ5

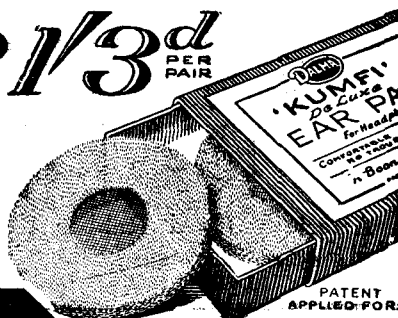

PATENT APPLIED FOR.

For the TROPADYNE

Builders of this very efficient type of Super-Heterodyne Receiver must recognise that they cannot hope for successful work without the Colvern General Purpose Vernier fitted in parallel with the Oscillator Condenser. Tuning at this point of the receiver is exceptionally sharp. So exceedingly sharp that one can pass over a station.

A peculiar plop indicates the reception of a carrier wave; the actual telephony lies in the centre. The comparatively large .0005 tuning condenser specified will pass over the station. Unless a Colvern Low Maximum is fitted in parallel with the Oscillator Condenser your Tropadyne will not function anywhere approach- ing efficiency.

The theoretical capacity of an integral vernier is considerably increased by the mutual capacity between the main vanes and the vernier. It is patent that the vernier is thus deprived of its intrinsic value—that of permitting comparatively larger physical movement for a minute variation in capacity.

Builders of the Tropadyne must take a leave from the book of those who have done considerable experiments with this receiver. Tuning is so exceptionally sharp that it is more easily handled and operates most efficiently by using the Colvern General Purpose Independent Vernier.

It gives you fine tuning

!

THE COLVERN

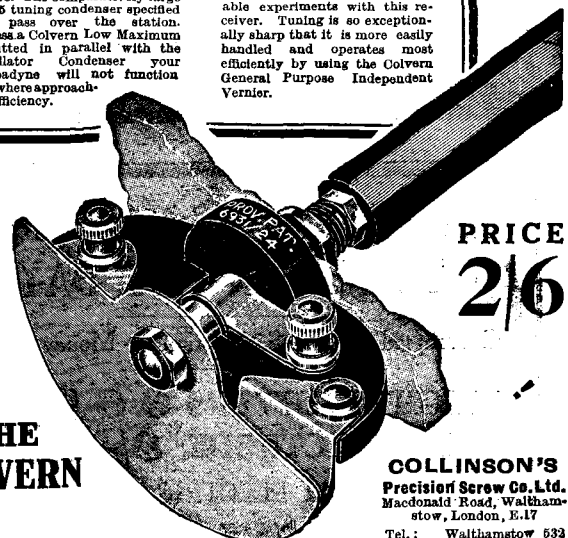

PRICE 2/6

COLLINSON'S Precision Screw Co. Ltd. Macdonald Road, Walthamstow, London, E.17

Tel.: Walthamstow 533

Barclays 1001

Information Department

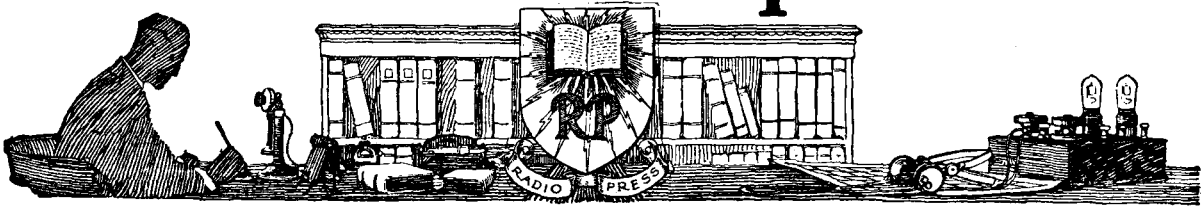

SUPPLIED BY RADIO PRESS SERVICE DEPT., LTD.

H.A.U. (HATFIELD) states that he believes that two components in his set are defective, viz., the aerial tuning condenser, and the second low-frequency intervalve transformer, the receiver being of the four-valve type. He asks us to give him some simple tests for these components, involving no instruments other than a milliammeter and a pair of telephones, in order that he may check his suspicions.

Our correspondent does not make it quite clear what type of fault he suspects in the variable condenser, and we will therefore indicate how the two most likely ones may be identified. The fact that the set in question works in an indifferent

manner would seem to suggest that the most likely fault is that of poor insulation between the fixed and moving plates, and we will deal with testing for this fault first. The first test to be applied should be the ordinary one with a pair of telephones and a single dry cell, and it should be carried out as follows: Connect one tag of the telephones to one terminal of the dry cell, fasten the other tag of the phones under a terminal of the variable condenser, and touch the other terminal of the variable condenser with a lead from the other terminal of the dry cell. An exceedingly faint click should be heard upon touching the terminal, and a still fainter one upon removing the wire. In a really good condenser this

second click may be nearly absent. It is best to carry out this test with the moving vanes turned to the minimum capacity position.

If anything resembling a real click is heard upon breaking the circuit, it is to be assumed that the insulation of the condenser is not very good, and the testing voltage should be raised to, say, 20 or 30 volts, and if quite a strong click is now heard, it may be interesting to insert the milliammeter in the place of the telephones, and note whether any perceptible reading can be obtained.

It should perhaps be added that for all these tests all wiring should be removed from the variable condenser, in order that the issue may not be confused by leakages at

"HENDRY" QUICK GRIP TERMINALS

Make a good set perfect

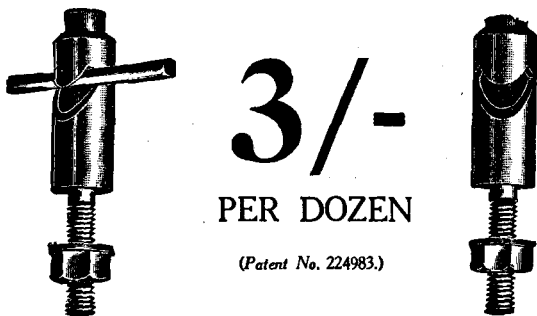

3/-
PER DOZEN

(Patent No. 224983.)

The "Hendry" Quick Grip Terminals give perfect and instantaneous contact

Simply push down top and insert wire in patent grip, it will securely grip wire at any point. These terminals, which are highly lacquered and pleasing in appearance, were used in the Crystal Set described in April issue of "Modern Wireless" (see page 348).

Obtainable from all dealers.

THE TRADE ARE INVITED TO APPLY FOR TERMS AND SAMPLES

Sole Distributor:—
ARTHUR BUTLER, 219, Forest Rd., Walthamstow, E.17
Phone: Walthamstow 1255.



Another Guaranteed BRETWOOD Speciality is our improved ANODE RESISTANCE

which gives accurate readings consistently from 10,000 ohms to over 100,000 ohms. This BRETWOOD Component is particularly suited for the ST100 circuit (Modern Wireless), the Super-Sensitive circuit (Popular Wireless), and for resistance coupling, etc.

It is constructed on the same principles that have made BRETWOOD Components famous, and, of course, it carries the BRETWOOD Guarantee. Price 3s. Postage 3d.

BRETWOOD GRID LEAK

Patent No. 224,295/23.

Used and recommended everywhere.

Price 3/- Postage 3d.

BRETWOOD Patent VALVE HOLDER.

Fix this efficient component and get maximum results. Positively no leakage or capacity effects. Perfect contact. Can be mounted on front or back of panel.

Price 1/9 Postage 3d.

BRETWOOD ANTI-CAPACITY SWITCH

Constructors will welcome news of a further Bretwood Product, an Anti-Capacity Switch, the principal features of which include:—

Absolute freedom from capacity effects—Perfect Contact—Workmanlike finish and neatness of appearance—Simple single hole fixing and Easy to make wiring connections. Special spring loaded balls in the base make the Bretwood Switch wonderfully smooth in action and ensure clean and perfect electrical contact at all times. It is confidently offered to wireless constructors as the Anti-Capacity Switch par excellence, and of course it carries the famous Bretwood Guarantee. Postage 3d.

PRICE 5/-

BRETWOOD LTD.

12-18, London Mews, Maple St., London, W.

All Bretwood specialities are obtainable from most Wireless Dealers.

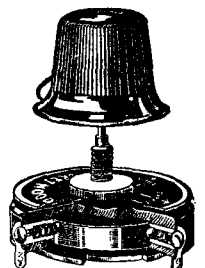

other points in the set. The test for a broken connection or defective contact between the actual terminals of the condenser and the fixed and moving vanes, however, may be carried out with the wiring in place. The telephones and a single dry cell will suffice for any test required here, and the procedure is to attach one telephone tag to one of the terminals of the condenser and the other tag to one of the terminals of the dry cell. A lead from the other side of the dry cell should then be touched upon the moving plates themselves, or the fixed plates, according to the terminal being tested. A good click should, of course, be obtained, and the test should then be repeated upon the other terminal of the condenser. It is not likely that a fault will be discovered here, but it is not altogether impossible.

To carry out really decisive tests upon a low-frequency transformer is not a very easy matter, but some indication can be obtained with the aid of the telephone and dry cell test previously mentioned. Our correspondent states that in his case, on switching in the last valve signals disappear entirely. It would therefore appear that there is some quite serious fault in his transformer, which would be revealed by

the simple test in question. (He has tried the effect of substituting a different transformer, which removes the trouble.) Quite a good click should be heard through the primary winding when tested with the phones and dry cell, and a click of considerably reduced intensity through the secondary winding. There should be practically no audible click between the secondary and primary or between either of the windings and the iron core. It is to be noted that when testing for a leak to the core the best method is to scrape off with a knife a little of the enamel, or whatever protection is present upon the core preferably at the edge of the laminations. This should be done upon both sides of the core, since in a good transformer it is usually found that the various laminations are insulated from one another. In those types in which the clamping bolts pass through the core itself it will usually be sufficient to make the tests upon one of the metal feet of the transformer.

It is to be noted that even where a break exists in one of the windings, a faint click will still be heard as a result of the charging of the condenser formed by the two halves of the winding. When testing a

suspected transformer, therefore, it is as well to have a sound one (of the same make if possible) at hand for purposes of comparison.

G.M.E. (GREENOCK) possesses a low-resistance (120 ohms.) loud-speaker which he uses in conjunction with a telephone transformer of 10:1 ratio, and he has been led to suspect that either the loud-speaker or the transformer is defective. He finds that reproduction is decidedly harsh and tinny unless he uses a shunting condenser of large capacity across the loud-speaker itself, whereupon it becomes somewhat muffled.

Our reader mentions the make of both loud-speaker and transformer, and these are both known to us as being of satisfactory quality, and it seems probable that the trouble will be removed by a proper adjustment of the shunting condenser.

It is often found when a transformer is used that good results cannot be obtained by placing the condenser across the loud-speaker itself, since muffling results when the capacity is made large enough to remove tinniness. If the condenser is placed across the primary, however, the trouble will probably be removed, and the more conventional capacity of .004 μ F—0.006 μ F will probably suffice.

WIRELESS BATTERY SERVICE

(DEPARTMENT)

BATTERIES LOANED FREE

Charges for service only. Service comprises: Charging accumulator, free delivery and collection. Payments to be made one quarter in advance. 4 volt 80/40 amp. 6 volt 60/30 amp.

Fortnightly exchange (4 volt only) ... 15/- per quarter.
Weekly exchange (4 or 6 volt) ... 18/9 " "
Weekly " " " 2 Batteries 31/3 " "

Service within 15 miles of Charing Cross.

AUTO MECHANICAL RECTIFIERS LTD.,
Wireless Battery Service Dept.,
91, TABERNACLE STREET, E.C.2.

NEW VALVES FOR OLD!

PRICE
6/6
Post FREE
(Bright
Emitters)

Whenever your valves burn out or filaments are damaged in any way, send them to us and we will repair them equal to new. Perfect reception is guaranteed with our repaired valves, which are returned to you

WITHIN SEVEN DAYS

D.E '06, 12/6. D.E 2v. '25 to '3 amp., 10/6

Price List for Power Valves on application.

Liberal discount to Wireless Agents, Terms on application.

The North London Valve Repairing Co.

22 1/2, Cazenove Road, Stoke Newington, N.16.

WE ARE ALWAYS AT YOUR SERVICE.

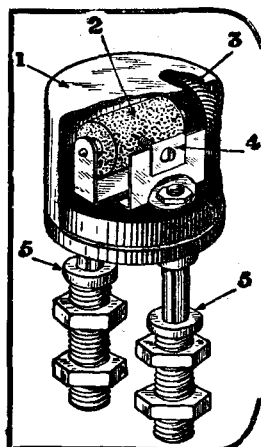

Don't tickle the Crystal—use

Harlie

FOOL-PROOF
DETECTOR

Provisional Patent 26791/24.

Continuous reception in any position at all times, owing to the special design of both crystal and catwhisker, being always in contact.

GUARANTEED TONE—VOLUME—PURITY
SOME NOVEL FEATURES:—

1. Nickel plated detachable dust proof cover.
2. Special "Harlie" super sensitive crystal.
3. Ekonite wheel for rotating crystal. No fumbling about adjusting, just turn the wheel—simplicity itself.
4. Catwhisker on slider for covering whole surface of crystal. Shock-proof.
5. Nickel plated sockets for panel mounting.

Obtainable from all dealers or direct from patentees and manufacturers. **PRICE COMPLETE 5/6**

Generous Trade Terms. Telephone: Clissold 293.
HARLIE BROS., 183 DALSTON LANE
HACKNEY, LONDON, E.8.

Barclay's 985

L.F. INTERVALVE TRANSFORMERS

The guaranteed "RENOWN" means:—The perfect intervalve transformer giving perfect service, with perfect maintenance. It is more worthy of your consideration than any other.

GUARANTEE—Test this intervalve transformer against any other and if you do not find it equally as efficient in every respect, or better, return it to us within 14 days, and we will refund cash immediately.

Should this transformer ever break down, return the materials to us intact with 2/9, plus 6d. postage, and we guarantee to replace the instrument by return of post.

Ratios 5 : 4 : 3 : 2 to 1. **PRICE 8/4 Post Free.**

We repair any make of intervalve transformer for 4/6, plus 5d. postage.

The TRANSFORMER REPAIR CO., Hay St., PORTSMOUTH.

ANOTHER NEW RADIO PRESS PUBLICATION



TAKING THE TROUBLE OUT OF RADIO

THAT is the object of this, the latest Radio Press Book (Series No. 24). We know what it is to have a fault in the radio receiver that obstinately refuses to reveal itself. An evening wasted in futile trouble-hunting, a good programme missed and perhaps family and friends disappointed. Yet a word or two of expert advice would probably have enabled you to speedily remedy the defect, and this is what the new addition to the Radio Press publications actually does.

Entitled "Wireless Faults and How to Find Them," and written by R. W. Hallows, M.A., Staff Editor of "Modern Wireless," it is so complete in its scope that there are few faults likely to occur in a radio set that cannot be easily traced with the aid of the valuable advice which it contains. This makes it a book that should be in the hands of every radio enthusiast. The book is clearly written and illustrated throughout so that even the veriest beginner in radio will be able to understand it. Get a copy at once and stop all that trouble and waste of time in fault-hunting. *Here is a brief description of the book's contents:* Opening with instructions for making a very effective yet inexpensive little appliance which is used in conjunction with a pair of telephones for testing the set and its components, the author proceeds to deal with the testing of every radio part likely to cause faults, and gives complete series of tests for all types of receivers from crystal to multi-valve sets. Special attention is given to the testing of reflex circuits.

*When purchasing ask for Radio Press Series No. 24,
"Wireless Faults and How to Find Them."*

**NO WIRELESS
ENTHUSIAST CAN
AFFORD TO BE
WITHOUT THIS
BOOK**

On Sale Everywhere

Publishing Date, April 16

1/6

Or Post Free, 1/8

from (Dept. S), Radio
Press, Ltd., Bush House,
Strand, London, W.C.2

Expert advice just when you need it

Radio Press, Ltd.
BUSH HOUSE : STRAND : LONDON : W.C.2



Sunshine!

I shall be there.

Give me sunshine but give me radio too! My "Dinkie" Loud Speaker carries on its good work of entertaining in spring and summer days with just the same charm, clarity and volume that made the winter evenings so bright for thousands upon thousands. Small in size—handy to move about. Big and true in volume—so easy and pleasing to hear anywhere. "Little but loud" sums "Dinkie" up. There is one other great point about "Dinkie"—its price, 30/-.

The Sterling "Dinkie" Loud Speaker is supplied in a brown tinted finish, complete with flexible cord. Dimensions: height overall, 13 in.; diameter of flare, 7 in.; diameter of base, 4 in.

At your radio dealer

30/-

STERLING DINKIE LOUD SPEAKER

and if it's wet — "Dinkie" never minds the rain; for indoors, on verandah or in pavilion it is ready to entertain with all that is broadcast. Says "Dinkie" in any weather — *I'll be there still!*



Advt. of **STERLING TELEPHONE AND ELECTRIC CO., LTD.**

Manufacturers of Telephones and Radio Apparatus, etc

210-212, Tottenham Court Road, London, W.1

Works: DAGENHAM, ESSEX

Printed for the Proprietors, RADIO PRESS, LTD., Bush House, Aldwych, W.C.2, by THE AVENUE PRESS (L. Upcott Gill & Son, Ltd.), 55-57, Drury Lane, London W.C.2. Published on Wednesday of each week at 3, Bolt Court, Fleet Street, London, E.C.4. Address for Subscriptions and Editorial Communications:—Bush House, Strand, London, W.C. Advertisement Managers:—BARCLAYS ADVERTISING LTD., Bush House, Strand, London, W.C.2 Registered as a newspaper and for transmission by Canadian Magazine Post. Subscription rates:—32/6 per annum, 16/3 for six months post free. Sole Agents for Australasia:—GORDON & GOTCH (Australasia), LTD. For Canada:—IMPERIAL NEWS LTD For South Africa:—CENTRAL NEWS AGENCY, LTD For Japan:—SALE & FRAZER, LTD.

Wireless Weekly

Vol. 6. No. 3.



A Neutrodyne Receiver

WITH TWO HIGH-FREQUENCY STAGES

By JOHN W. BARBER



Short wave reception simplified

The new Ethophone Short Wave Receiver



Ethophone Short Wave Receiver (No. 1540), 50-150 metres. In mahogany cabinet, without valves or batteries, **£17 10s.**
Marconi Licence, £1 5s.

Ethophone Power Amplifier, Mark IV (No. 1520), two-valve type, in mahogany cabinet, without valves or batteries, **£22.**
Marconi Licence, £1 5s.

THE reception of short wave transmissions with ease and certainty is now made possible by the introduction of the Ethophone Short Wave Receiver, a notable addition to the Burndept range. This new Ethophone can be operated by anyone who can handle an ordinary broadcast set, and is all that can be desired by experienced amateurs. The wave-length range of 50-150 metres covers amateur radio telegraphy stations and KDKA, the renowned Pittsburg broadcast station. Any evening it is easy to receive American amateur stations, and after 11.30 p.m. KDKA will be received at full telephone strength, whilst the addition of a one or two valve amplifier will give loud speaker reception of that station. A single switch controls the lighting of the valves—detector and low-frequency amplifier—and gives two wave-length ranges of 50-100 and 80-150 metres. No plug-in coils are required. There are four controls—two tuning condensers, a special vernier condenser so arranged that tuning-in a 60-metre station is as easy as tuning-in a 400-metre station on an ordinary set, and a reaction control. The Ethophone Short Wave Receiver matches the Ethophone Power Amplifier (Mark IV) with which it forms a four-valve short wave receiver of enormous range and power. Send the coupon for Publication No. 69, which gives full particulars.

---CUT HERE---

To BURNDDEPT WIRELESS LTD.,
Aldine House, Bedford St., Strand, London, W.C.2
Please send me Publication No. 69, giving full particulars of the new Ethophone Short Wave Receiver.

NAME.....

ADDRESS.....

Date..... Wireless Weekly, 22-4-'25

BURNDDEPT
WIRELESS LIMITED

Aldine House, Bedford Street, Strand, London, W.C.2.

Telephone : Gerrard 9072. Telegrams : Burndept, Westrand, London.

LEEDS : 12, Basinghall Street. CARDIFF : 67, Queen Street.
BIRMINGHAM : Winchester House, Victoria Square.
NORTHAMPTON : 10, The Drapery. NEWCASTLE : 17, Lisle Street.

Assistant Editor :
PERCY W. HARRIS,
M.I.R.E.

Scientific Adviser :
Prof. G. W. O. HOWE,
D.Sc., M.I.E.E.

Advisory Editors :
Prof. R. WHIDDINGTON,
M.A., D.Sc.
Prof. C. L. FORTESCUE,
M.A., M.I.E.E.

Wireless Weekly

Phone: City, 9911.

Staff Editors :

E. H. CHAPMAN,
M.A., D.Sc.

A. D. COWPER,
M.Sc.

R. W. HALLOWS,
M.A.

G. P. KENDALL,
B.Sc.

STANLEY G. RATTEE,
M.I.R.E.

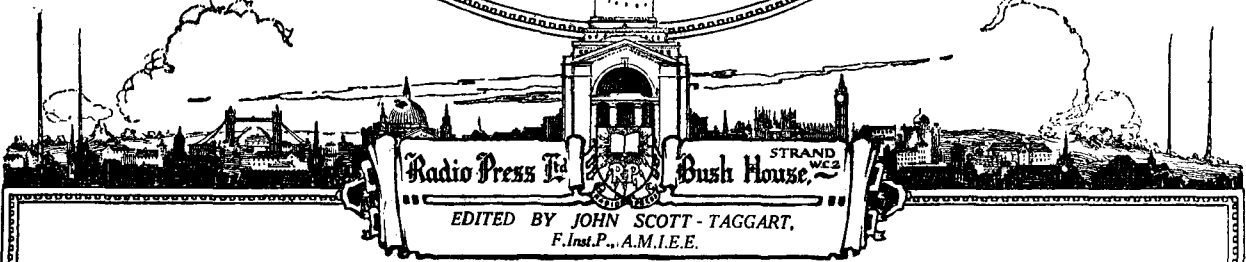

International Wireless

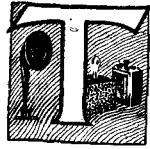

THE appointment of Mr. Arthur R. Burrows, until recently Director of Programmes of the British Broadcasting Company as Director of the newly-formed International wireless bureau in Geneva Switzerland, is a step of considerable importance, and marks a distinct advance in international wireless relations. One of the chief objects in the formation of this bureau is the satisfactory adjustment of wavelengths between different broadcasting stations so as to avoid the annoying overlapping and interference which has already manifested itself on several occasions. It is but a short time ago since there were barely half a dozen broadcasting stations operating simultaneously in Europe, whereas at the present time a really sensitive receiver will bring in a perfect babel of sounds. Without some kind of international agreement it is hopeless to expect amicable working, and for this reason the new bureau should be welcomed by all who are genuinely interested in the art.

The organisation and administration of the new bureau will present many difficulties. For example, it is by no means easy to establish a basis on which the judgment of "interference" shall be formed. What standard

of selectivity in receivers shall be assumed when judging whether one station interferes with another? So far, the British Broadcasting Company have attached great importance to the crystal user, and only in very rare cases is such a listener likely

The greatest trouble, of course, arises from the operation of stations which are so close together in wavelength that the two carrier waves produce a beat note between them, thus giving an annoying whistle which no tuning apparatus will eliminate, as it is a modulation of one carrier wave by another. Listeners equipped with sensitive apparatus are well acquainted with this phenomenon, which can only be entirely removed by slight readjustment of either of the wavelengths concerned.

So far, few details of this bureau have been published. For instance, it would be interesting to know how the various countries are represented in voting power. Will, for example, a country having a large number of low-power stations have a higher voting representation than another with a few medium or high-power stations excellently organised and conducted? Again, we in England, separated from other countries by an appreciable distance, are not so likely to be worried with interference as a country of small area immediately adjacent to others with powerful stations.

It will thus be seen that Mr. Burrows will have much to do and many problems to face. Readers of *Wireless Weekly* will, we are sure, join with us in wishing him all success in his new post.

CONTENTS

	Page
H.F. Resistance in Tuning Circuits	72
How to Make a Telephone Switch-Board	75
Locating an Obscure Fault	76
A Useful H.T. and L.T. Unit	77
Random Technicalities	79
Transatlantic Wireless Telephony	80
Jottings By The Way	81
Reception Conditions Week by Week	83
An Auto Coupled Three-Valve Neutrodyne Receiver	84
A Basket Weave Coil Former	89
Correspondence	91

to be interfered with by a foreign station. On the other hand, a user of a superheterodyne (provided he is manipulating a satisfactorily designed instrument) can afford to laugh at those who speak seriously of interference between stations separated by, say, 5 metres. The average valve set user will, however, be badly interfered with in such circumstances.



Showing some of the instruments used in making resistance measurements in the laboratory.

High-Frequency Resistance in Tuning Circuits

By SYLVAN HARRIS.

It will be found that the actual resistance of a coil added to the circuit depends somewhat on the coil's position in the circuit with respect to other apparatus. This does not refer to coupling effects through magnetic or electrostatic fields, which may result from having the apparatus too close together, but refers to the actual diagram of connections. This will be brought out clearly as we proceed. In many cases the particular piece of apparatus may act as if its resistance is higher than it really is, thus giving rise to the expression "apparent" resistance.

NEARLY all experimenters are by this time aware of the disadvantages that may come in operating radio receivers when there is excess resistance in the receiver, but it is doubtful if their attention has been called to the many ways in which resistance can affect the operation of the set.

In considering the losses in circuits which are tuned, as is usual in radio work, the formula $P=I^2R$ always comes to mind, for this equation enables us to calculate the loss of power in the circuit when the current in it and its resistance are known. In other words, suppose a current of 10 amperes is flowing in a circuit which has resistance of half an ohm (0.5 ohm). The power loss in the circuit will then be $P=0.5 \times 10^2$ or 50 watts.

Power

The amount of power used in radio receivers never approaches this value, but is generally expressed in microwatts, or millionths of a watt. Some conception of the magnitude of the watt may be obtained by remembering that 746 watts are equivalent to one horsepower.

In radio receivers, where we are dealing with such minute quantities of power, it is very essential that every bit of this power be utilised, for the loss of a small amount of it may represent a considerable portion of the

total power coming into the aerial from the transmitting station.

Design

The proper design of radio apparatus, directed by the ideas

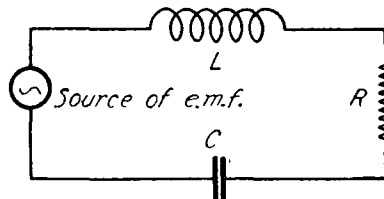

Fig. 1.—A simple series circuit consisting of an inductance, resistance and capacity in series with a source of E.M.F.

of efficiency and economy, requires the reduction of all losses to the least amount possible, and for this reason it is well to obtain an understanding of the various ways in which resistance in a circuit acts, and also as to what factors contribute to the resistance.

H.F. Values

In making a study of this, it must be remembered that the values to be used in the formula given above are the high-frequency values, which are in existence when the receiver is operated. R is the high-frequency resistance, and furthermore, the frequency at which the measurements are made must be specified, for the resistance changes with the frequency.

Series Circuit

To begin the discussion, let us consider a simple series circuit, as shown in Fig. 1, consisting of a coil and a condenser connected in series with a source of energy. This source of energy may be any generator of high-frequency current. Both the coil and condenser have resistance, so, to simplify matters, we have assumed all this resistance to be concentrated into the resistor marked R.

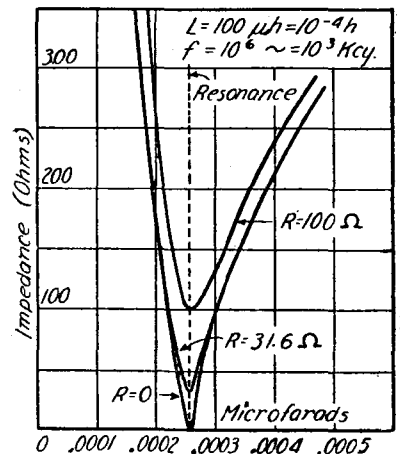

Fig. 2.—Showing how the impedance of a simple series circuit changes with the setting of a tuning condenser. These curves are for 300 metres.

The current in this circuit is obtained by dividing the voltage

In this valuable article our contributor discusses several effects which have an important bearing on set design, and which are often overlooked by professional and amateur alike.

of the generator by the impedance of the circuit. This impedance is given by the formula

$$Z = \sqrt{R^2 + \left(0.00628fL - \frac{159.2}{fC}\right)^2} \quad (1)$$

in which f is the frequency in kilocycles, L is the inductance in microhenries, C is the capacity in microfarads, R is the resistance in ohms, and Z is the impedance in ohms. This formula is not given to mystify the reader, but it is presented because our discussion uses this formula as its basis.

Curves

If we have a certain signal coming into the aerial, impressing a certain voltage on the tuned circuit pictured in Fig. 1, by means of formula No. 1, we may learn how the current changes in the circuit as the condenser setting is changed, or, as the circuit is brought into resonance.

Fig. 2 shows three curves plotted from this formula, assuming the coil to have an inductance of 100 microhenries and the con-

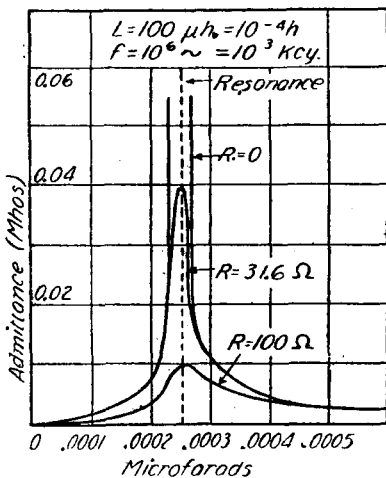

Fig. 3.—Showing the variation in current in a single series circuit as the setting of the condenser is changed. The wavelength is constant.

denser to have a capacity of 0.0005 μ F. One curve is for the

theoretical condition of no resistance in the circuit, and the others for the same circuit with resistance added.

As the condenser is turned round from zero setting, the curve continuously drops. This means that the impedance of the circuit is decreasing, and the current consequently will increase. (See Fig. 3.) When the circuit is exactly tuned to the incoming frequency or wavelength, the impedance of the circuit is a minimum and the current a maximum. The curve for the circuit of zero resistance drops all the way to zero impedance.

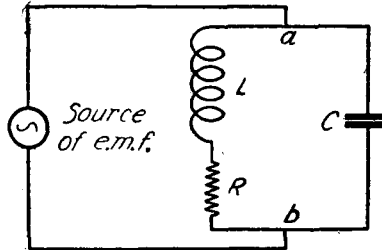

Fig. 4.—A simple parallel circuit connected in series with an E.M.F.

If it were possible to have a circuit of zero resistance, the current existing in the circuit when resonance is attained would be enormous, even with small impressed voltages.

When there is resistance in the circuit, however, the impedance cannot drop any lower than the value of that resistance. This is the lowest point of the upper curves in Fig. 2. Besides this, the curves do not come to as sharp a point as the lowest curve.

Admittance

These same curves are plotted in Fig. 3, but here, instead of using the impedance as the vertical scale, we have used the admittance, which is the reciprocal of the impedance (or admittance = $1 \div$ impedance). This gives a graphical idea of how the current varies in the circuit as the

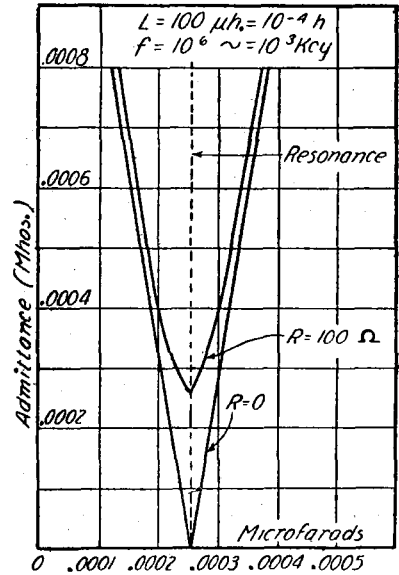

Fig. 5.—Showing how the current varies with a parallel tuned circuit. Compare this figure with Fig. 2.

condenser is turned. The current is small for the greater part, but as resonance is approached, it mounts to relatively high values.

The curves for the circuit with resistance do not go nearly as high as that for the circuit with no resistance, which theoretically would have no topmost point. Furthermore, the greater the resistance, the flatter will be the curve, so that it will be difficult to tell exactly where the peak of the curve is. This is the reason for broad tuning, and illustrates clearly an important reason why resistance ought to be kept out of tuning circuits.

The series circuit we have been discussing is the same as the aerial circuit consisting of the aerial capacity in series with the inductance of the tuning coil. It is also the same as the secondary circuit (or nearly so), which has likewise a coil and condenser in series. The electromotive force in each case is regarded as in series with the rest of the circuit, although in the secondary it originates in the windings of the coil.

Parallel Circuits

The reverse conditions are found in the case of parallel or shunt circuits, such as we have in wave-traps or filters. Fig 4 shows such a circuit, in which a coil and condenser are connected in parallel and the combination

connected in series with the source of energy. The formula for this case is rather complicated, and will not be given here, but in Fig. 5 are shown curves plotted from it. The two curves shown are for a circuit like Fig. 4, with and without resistance. These are to be interpreted the same as the curves of Fig. 2. It will be noted, however, that in Fig. 2 for the series connection the impedance is zero at resonance, while in Fig. 5 the admittance is zero at resonance. This means that when tuned to resonance the series circuit will permit a maximum of current to pass through it, while the parallel circuit permits a minimum of current to pass.

When there is resistance in the circuit the series circuit does not permit as much current to pass as it should, and the parallel circuit does not cut the current down as much as it should. Moreover, in both cases, it is difficult to find the maximum or minimum points, with the result that the tuning is broad.

Resistance Affects Frequency

There is another effect present in tuned circuits which has considerable resistance that is generally overlooked, and that is, in parallel circuits the presence of the resistance causes the natural frequency or wavelength of the circuit to be different from that which would be calculated from the usual formula:—

$$f = \frac{159.2}{\sqrt{LC}} \quad (2)$$

in which f is the frequency in kilocycles, L is the inductance in microhenries, and C is the capacity in microfarads. The exact formula is

$$f = 159.2 \sqrt{\frac{1}{LC} - \frac{R^2}{L^2}} \quad (3)$$

in which R is the resistance of the coil, and the other symbols are as above. Thus, if we have a coil of 100 microhenries, and our condenser is set to 0.000253 μF, if the circuit had no resistance, it would be tuned to a frequency of 1,000 kilocycles (300 metres) as calculated by equation (2). If, however, our circuit had a resistance of 100 ohms, its frequency, as determined by equation (3), would be 988 kilocycles (304 metres). To tune the circuit to

exactly 1,000 kilocycles we would have to use a trifle more of our condenser.

Of course, this change of wavelength is not serious, for we can always make the necessary adjustment by tuning the condenser; in fact, we do it automatically, but it is interesting to know how many things resistance can do in a tuned circuit.

Small Condenser

If, in Fig. 4, the capacity C should be relatively small as compared with the inductance L and resistance R of the coil, we have the ordinary conditions for a coil

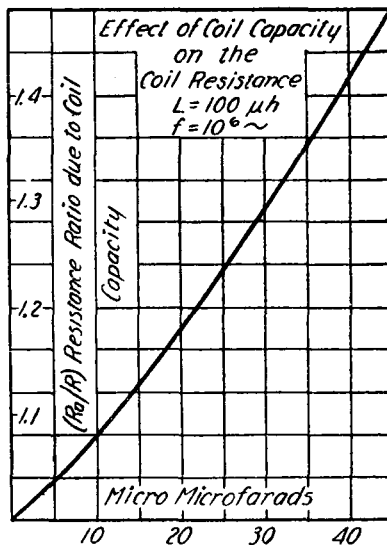

Fig. 5a.—Curve showing the effect of coil capacity on the resistance of single layer coils.

with distributed capacity. The mere fact that there is a small capacity in shunt with the inductance of the coil causes the coil to act as if its resistance is higher than it really is.

The joining of several pieces of apparatus in parallel, as in Fig. 4, causes their resistances and reactances to be parallel, and if we regard the whole combination to be one piece of apparatus, it is obvious that its resistance and reactance as measured between the points a and b will be different from those of the separate pieces of apparatus.

Apparent Resistance

In other words, suppose we have a coil with a certain inductance, resistance and capacity. The resistance of this coil measured between its terminals will be greater than its true

resistance, because the resistance of the coil is associated with the other things, viz., the coil capacity and inductance. The measured resistance, reactance or inductance of the coil is called the *apparent* resistance, reactance or inductance, as distinguished from the true values which exist when the coil has only one of these three properties.

Coil Capacity

This point is brought out in Fig. 5a, in which the effect of coil capacity on the resistance of the coil is shown graphically. This curve has been calculated for a frequency of 1,000 kilocycles (300 metres). The horizontal axis gives the capacity of the coil in micromicrofarads, while the vertical axis shows how many times the true high-frequency resistance of the coil has been increased by the capacity. In other words, the vertical axis is the ratio of the high-frequency resistance of the coil to its high-frequency resistance neglecting the coil capacity. It is to be noted, however, that even for such abnormally high coil capacities as 50 micromicrofarads, the ratio of apparent resistance to true high-frequency resistance is small compared with corresponding ratios due to skin-effect only. The latter may run as high as 50 or 60, depending on the size of wire and the spacing of the turns of the coil.

BACK NUMBERS.

Will readers who have copies of the undermentioned journals available, and not required for binding, kindly communicate with our Sales Manager:—

“Modern Wireless,”
Vol. 2, No. 7
(April, 1924).

“Modern Wireless,”
Vol. 3, No. 4
(Sept., 1924).

“Wireless Weekly,”
Vol. 2, No. 19
(Nov. 21st, 1923).

“Wireless Weekly,”
Vol. 3, No. 5
(Jan. 9th, 1924).

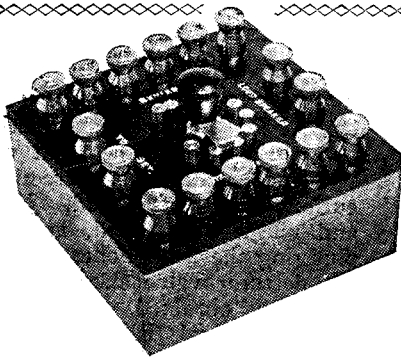

The completed telephone board is both neat and compact.

How to Make a Telephone Switchboard

By A. S. CLARK.

A useful little unit which is very easily made and permits a number of telephones to be used either in series or in parallel.

WHERE one, two, or three pairs of telephones are used for listening to broadcast programmes it is always an advantage to have a distributing board. The telephone board about to be described has a switch which enables one, two, or three pairs of telephones, or a loud-speaker, to be switched into circuit, and when using two or three pairs they may either be in series or in parallel, according to which side of the distributing board they are connected.

Construction

The construction is very simple, and the components required are given here:—

One ebonite panel, 4½ in. by 4½ in. by ¼ in.

Sixteen terminals. (These may be of any type which the constructor desires.)

One Bowyer - Lowe stud-switch. (Only eight of the contact studs provided are used.)

One packet of Radio Press panel transfers.

One suitable box to hold the panel.

The disposition of the components is easily seen from the photograph of the completed instrument. No drilling diagram is given, as the dimensions of the lay-out are not important. A drilling template will be found for the switch on its containing box. It is necessary that the switch arm has two laminations, in order to get the desired results, and these are spaced out as described further on and shown in the photograph.

Place six terminals along the left-hand side of the panel and six along the right, two at the back, and two in the front, and the switch in the centre. When

these parts are fitted to the panel, wiring may be commenced.

Wiring

This is done in accordance with the diagram of Fig. 1, care being taken to see that the wiring does not touch at any point where it should not. When finished the wiring should

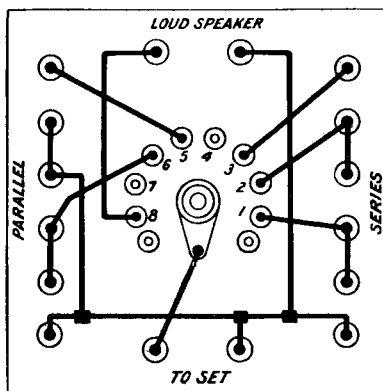

Fig. 1.—The wiring is simple, carried out from this diagram.

look quite neat if the wire used is square section tinned copper. The two laminations of the switch arm are separated, so that when one is on a certain stud, the other is making contact with the next stud. Having placed them in this position they should be tightened up by screwing down the insulated knob.

Panel transfers are used to indicate the connections to the terminals, and the construction is completed, although, if desired, the panel may be screwed down by means of two or four wood screws.

Connections

The two terminals marked "To Set" are left connected, and the loud-speaker is placed across the terminals marked for it. If the telephones are to be

used in parallel they are connected to the right-hand terminals, and if in series to those on the left-hand side. If so desired, and the required number of telephones are available, six pairs may be permanently connected up.

If only two pairs of telephones are to be used they may be connected to the four front terminals on the left-hand side if they are to be used in series. When they are to be used in parallel one pair is connected to the two right middle terminals and the other pair to the two right front. When using one pair of 'phones one tag of the second pair should be disconnected. This changing over of connections is required only when two pairs of telephones are available. This disconnecting is unavoidable when such a simple switching device is employed, and will not be found a very great inconvenience.

Positions of Switch Arm

In the following table, showing the correct position of the switch arm for certain telephone combinations, the studs are num-

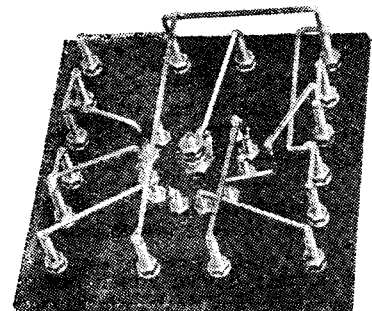

The wiring of the unit is very easy as will be seen from this photograph.

bered from left to right, looking at the top side of the switch. The switch is considered to be on stud one, when the left

lamination is on this stud, and so on for all studs:—

would be inclined to topple over. Another point is that it is

Position of Switch-arm.	Pairs of telephones in use.	How connected.
1	S_1	Straight across output.
2	S_1 and S_2	In Series.
3	S_1 , S_2 and S_3	In Series.
4	P_3	Straight across output.
5	P_1 , P_2 and P_3	In Parallel.
6	P_1 and P_2	In Parallel.
7	Loud Speaker	Straight across output.

The manner in which the connections in this table come about may easily be followed from the diagram of Fig. 2. The uses of this little panel will be quite obvious to the serious experimenter and to those listeners who desire convenient manipulation of their headsets.

The Containing Box

It is unnecessary to make a deep containing box for this distributing board, and a fairly shallow one will in most cases be found more suitable. The one shown in the photograph of the completed board at the beginning of this article was 1½ in. deep, and was found to keep quite steady in spite of various tugs from the telephone leads. A deeper box

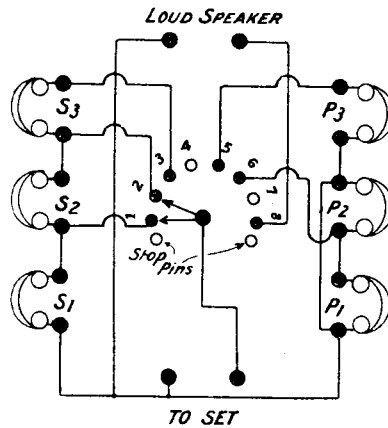
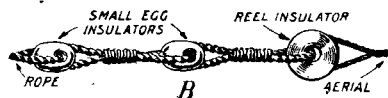

Fig. 2.—A diagram showing how the various 'phones are connected.

entirely unnecessary to have a bottom to it, and this considerably simplifies construction.

the two egg insulators, having first been passed along the rope, and is then secured tightly at the rope end by a wire binding. The insulation of the aerial during a shower of rain is now maintained through the inner tubing keeping two of the insulators perfectly dry.



Possible leakage may occur here when insulators are wet.

The inclusion of the third insulator might be questioned. The reason is that after a time various insects may find their way into the inner tubing, and there set up home with a possibility of causing a short circuit. Unfortunately, their entrance cannot be barred by binding the free end of the tubing, for by so doing we should defeat the object we have in view. Occasional cleaning, however, will find repayment in the knowledge that your aerial is always safe as regards insulation.

Locating an Obscure Fault

AFTER a long examination of a friend's set that was not functioning correctly a curious fault was found. Jacks and plugs were used, and on plugging the headphones in after the detector valve excellent signals were obtained. Not only was the local B.B.C. station coming in at good strength, but distant transmissions were also tuned in at varying strengths. On removing the 'phones from their jack, and thereby switching in a couple of stages of L.F. amplification, signals were barely audible, and what was audible seemed distorted.

Transformers were tested for shorts or disconnections, condensers for shorts, the wiring for continuity, and so on, but all the usual tests produced no result. All the components came out with flying colours. It was therefore decided to put a milliammeter in the plate circuits of each of the valves in turn. The headphones were put in the detector jack with the milliammeter in series with the H.T. lead, and excellent reception was obtained, a normal current being indicated by the meter. On removing the 'phones, however, and switching in the amplifying valves, the milliammeter needle dropped to zero, showing definitely that there was a disconnection in the plate circuit of the detector valve. As everything but the jack had been tested, it was obvious that the fault was there, and an examination of this showed that the springy arm which should have made contact with the inside leaf did not do so when the plug was withdrawn. A touch with a small pair of pliers soon put this right, and no further trouble was experienced.

C. P. A.

All-Weather Aerial Insulation

MANY aerials, while very well insulated during dry weather, tend to develop leakage during a spell of rain or snow due to the latter partially shorting the insulators. Even when three or four insulators are used to insulate one end of a single wire, it is doubtful whether they are absolutely leak-proof when wet.

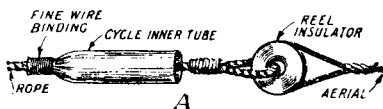

Showing how the inner tube fits over the egg insulators.

A simple device which ensures all-weather insulation is seen in the illustration at A. B shows the first step, two small egg insulators and one reel type being arranged in the manner indicated. A suitable length of old cycle inner tubing is now drawn over

Obituary

We regret to have to record the death of Mr. Godfrey Charles Isaacs, until recently Managing Director of Marconi's Wireless Telegraph Company and the Marconi International Marine Communication Company, Ltd., which took place on Friday, April 17th.

A Useful H.T. and L.T. Unit

By C. P. ALLINSON.

An easily-made unit which may be used with multi-valve receivers for the successful smoothing out of H.T. noises, at the same time giving a master control of the L.T. supply.

ANY readers may not realise that a H.T. battery can develop a high internal resistance that may set up all kinds of curious symptoms in a receiver. It is one of the most frequent causes of a low-frequency howl developing and also makes the set noisy in operation. Even when new, the current taken from the high-tension battery may not be absolutely steady, and though not audible on nearby transmissions, the searcher for distant stations may find a noisy background that makes long-distance work difficult.

H.T. Condenser

In order to smooth out any irregularities in the H.T. supply a $2 \mu\text{F}$ fixed condenser of the Mansbridge type is usually connected across the H.T. battery, but actually one of these condensers should be shunted across each H.T. tapping.

The unit shown in the photographs was accordingly made to incorporate these condensers as part of the H.T. battery, and not as part of the set, and a couple of refinements have been added. Three H.T. tappings

that heavy leads have been used for taking tappings from the H.T. battery, and these, instead of ending in the usual wander plugs, are terminated by spring clips. This is owing to the fact that the writer uses a H.T. battery made up from flash-lamp cells and these clips are by far the most convenient means of making connection to the soldered connections that have been employed. Incidentally it was found that with the more usual commercial type of H.T. battery

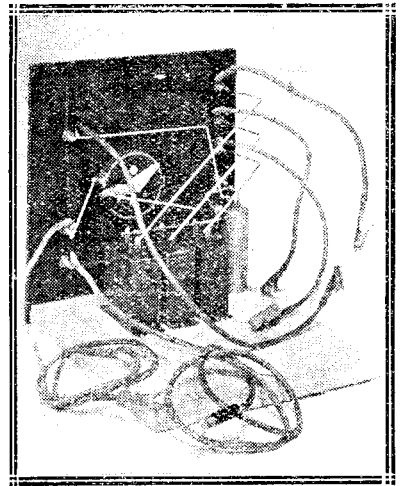

The back of the unit showing the simple wiring necessary.

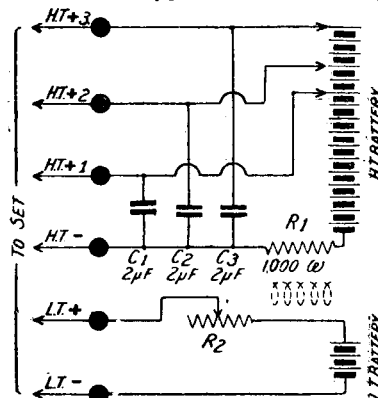

Fig. 1.—The circuit diagram of the unit.

the sockets stood up enough for the clips to grip them firmly.

In order to eliminate the risk of a valve being accidentally burnt out owing to a short occurring at any time, a limiting resistance has been included in the H.T.—lead. The value of this resistance, which is actually a small ex W.D. choke, such as can be bought in Farringdon Road, or at any of the firms specialising in disposals goods, is 1,000 ohms, so that at 60 volts, say, the current passed on dead short would only be 60 milliamps, which is not enough to injure even a .06 type of valve. This choke further appears to have a smoothing effect on the H.T. current, and when the unit was used with a battery that was unpleasantly noisy the dead silent background

obtained made the writer look for a disconnection in the H.T. circuit. Everything was correct, however, as was speedily proved when the announcer was heard.

Master Switch

The writer has further always been in favour of some form of master L.T. switch, by means of which the set can be left adjusted and turned off without touching the receiver itself. The usual form of snap switch, with its sudden make and break, is not good for the life of valves, and therefore it was decided to use a resistance as master control. This is of the dual type which allows a receiver with 6 ohm filament resistances to be used with dull emitters, the current being cut down to a suitable value by means of the master rheostat.

Components

Fig. 1 shows the circuit diagram of the unit, and particular notice should be taken of the position of the resistance, or choke, which must be connected on the battery side of the point where the bypass condensers are connected to the H.T.—lead. The two L.T. leads have been fitted with spade tags with coloured shanks to obviate mistakes being made in connecting up and can be as long as is required to reach the accumulator.

The following components will be needed to construct this unit,

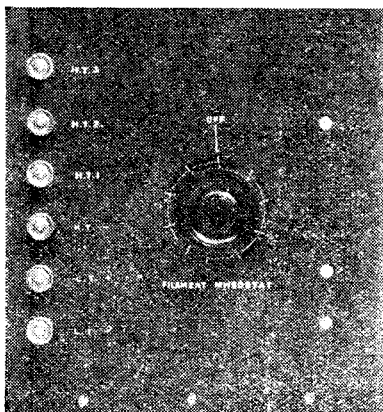

The front of the panel showing the master switch.

are allowed for, as this is the usual number required. The view taken from the back shows

and if reliable ones are obtained, it is not necessary to use just that make mentioned.

One piece of ebonite, 8 in. by $7\frac{1}{2}$ in. by $\frac{1}{4}$ in.

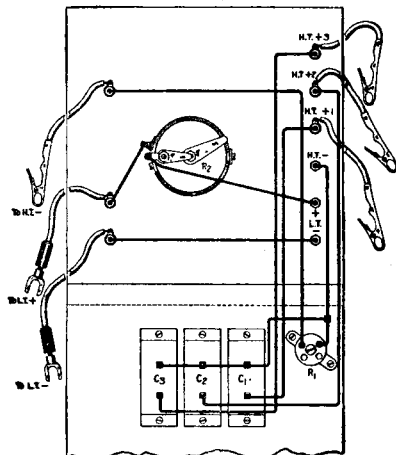

Fig. 2.—The wiring of the unit may be followed from this figure.

Three 2 μ F Mansbridge type condensers (T.C.C.).

One dual filament resistance (McMichael).

Six nickel terminals (Burne-Jones).

Four clips or wander plugs (Burndept spring clips have been used).

One choke or resistance of about 1,000 ohms.

Two spade tags, which may have coloured shanks (Gibson).

A length of heavy rubber covered flex.

A piece of wood to suit requirements.

One set Radio Press panel transfers.

Construction

The construction is perfectly straightforward and needs no comments, the reader being able to suit his own arrangements as regards the layout. With the unit here described a fairly deep base board was used so that the H.T. battery could be stood on it and the whole enclosed in a cabinet if desired. The wiring diagram shown in Fig. 2 will assist in making the connections correctly, while the use of panel transfers gives a finished appearance to the unit.

The writer has no hesitation in recommending the construction of this unit, and considers the time and trouble taken in its construction (about half an hour) have been more than repaid by the results obtained.

Useful Angle Brackets

THE wireless constructor may frequently find himself faced with the need of special little brackets, either to support certain components or a valve shelf behind the panel, and may have some difficulty in obtaining anything like a suitable brass bracket from his local ironmonger. A quick and easy way of making any size of brass bracket that will be really strong, and will support components of quite considerable weight, is by means of a piece of angle brass. Obtain the length necessary to make the brackets you require, in $\frac{1}{2}$ in. x $\frac{1}{2}$ in. x $\frac{1}{16}$ in. angle brass; measure off the length necessary to make one bracket and cut it off. Next mark off the point where the bend is to be, and cut through one face of the angle brass. This can now be bent at the point where the cut has been made, and the overlapping portions sweated up

solid. A set-square will be useful here to make sure that the two arms of the bracket are at right angles. Holes can now be

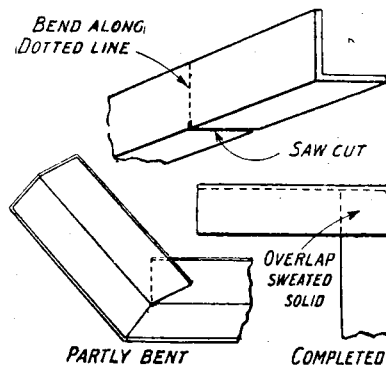

Constructional details of the brackets.

drilled as required to fix the bracket to the panel and component, or shelf, and the completed job will be found to be perfectly rigid and strong.

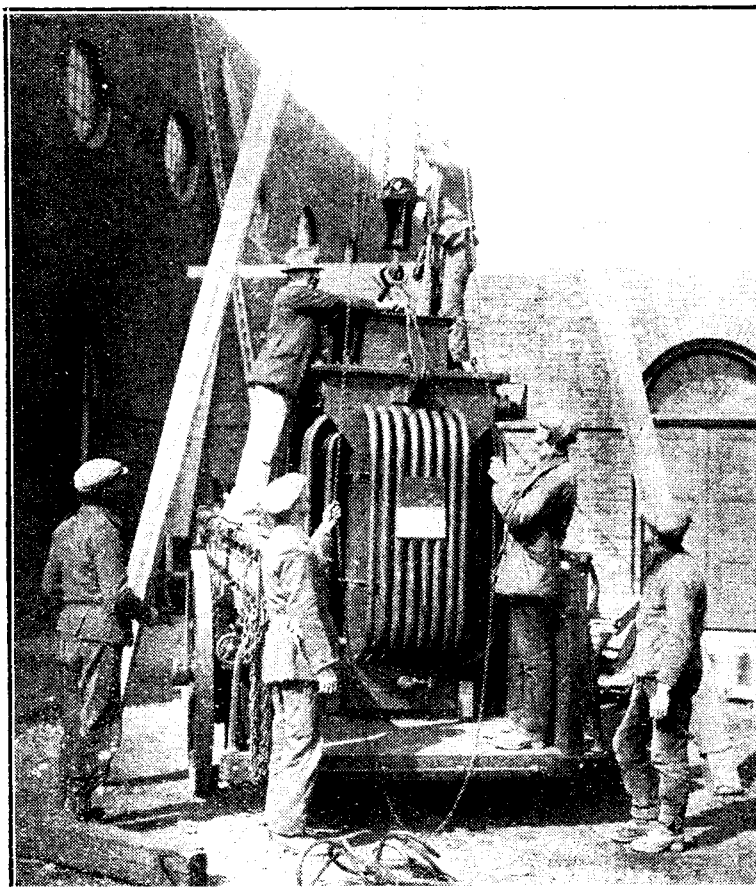

Workmen unloading a four-ton transformer at Hillmorton for the new station at Rugby.

Random Technicalities

By **PERCY W. HARRIS, M.I.R.E.**
Assistant Editor.



I WONDER how many experimenters keep a proper notebook, or for that matter any notebook at all, of the experiments they carry out from day to day? Very few, I should imagine. The transmitting experimenter is, of course, bound by the conditions of his licence to keep a log book, and this, to some extent, gets him into the habit of making proper records. But even he is apt to be rather neglectful in this direction, and as a consequence much valuable information is lost and many experiments needlessly duplicated.

The habit of making technical notes was acquired by some of us at school or college, but others have never made any serious attempt to keep records and find any effort in this direction very tedious. The initial difficulty, however, is soon overcome, and should be faced by every man who calls himself a genuine experimenter. Once the habit is acquired the effort is

forgotten, or is at least unnoticed.

Particularly in transmission, I consider that adequate records are essential. Very frequently when one is signalling to a particular station some other station at a great distance may overhear a remark and subsequently communicate with you to this effect.

whatever, and had come to the conclusion that there was some defect in the transmitter, when, after a few days, I received a card from a couple of hundred miles away reporting that the sender had overheard me calling another station at a given time, which coincided with my log. The circuit arrangement I was using

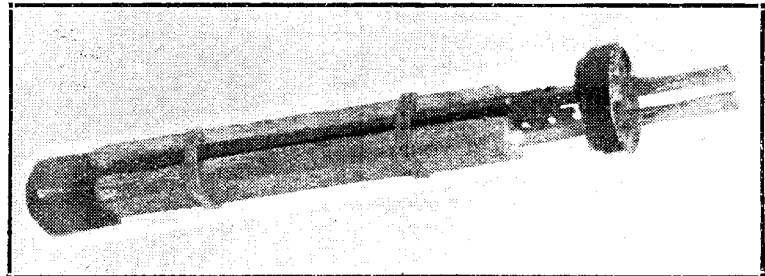

A unit of the new C.A.V. high tension accumulator.

I have had several most interesting QSL cards from the north of England when I have been working on very low power to someone but a few miles away, when I imagined my signals were not carrying. One night, indeed, I succeeded in raising no one

that evening was not one that I am generally subject to operating, and but for this report I should have been inclined to think that the particular arrangement was inefficient.

* * *

In reception, too, it is very valuable to record weather conditions. These may not indicate anything at the moment, but an examination of perhaps six months' record may subsequently show that a particular type of weather accompanies good receiving conditions in your locality. Signal strength measurements are a far more difficult problem, and I have yet to find any method, other than ones most elaborate, which is really satisfactory. On strong signals it is, of course, possible to use instruments which will give a visual indication, but when you are near enough to a transmitting station to obtain a visual record of signal strength, you are not likely to experience the fading which occurs at much greater distances,

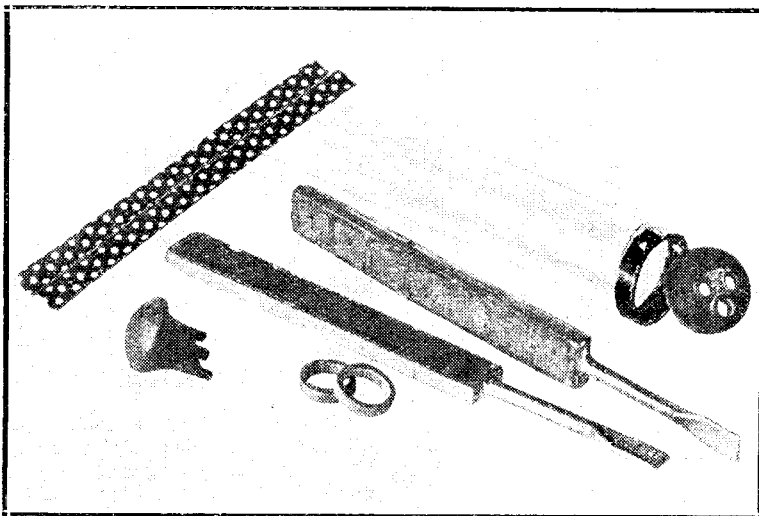

The parts removed from the glass tube. Several ingenious ideas are incorporated.

and which it is important to observe.

There are one or two records which you will find it very helpful to make, even if your receiver is operated purely for broadcast reception on the local station. You should, for example, make a note of the date when you put each valve into service, and if you can manage to do it, I would recommend you to make a note each day of the length of time your set is in operation.

* * *

This may seem a rather annoying procedure, but in practice the wireless set is generally switched on at some particular hour and left on for an hour or two at a time. If every time the on-and-off switch is operated a note is made on, for example, a washable tablet nearby, records can be compiled which will show the life of your valve, the number of hours' service obtained from your accumulator (a very useful check on whether or not your local garage charges your accumulators properly!) and the life of your high-tension battery. With regard to the time your accumulator will last, this record should be made in conjunction with an ammeter reading. In a given set you can ascertain once and for all the total current consumption by putting in circuit a suitable ammeter. A milliammeter should also be used to record the total anode current consumption.

* * *

The filament voltmeter is an instrument of great value, for by its use you can decide once and for all the best position of your filament resistance for a given valve. If, for example, you have a valve which is rated by the makers at 3.5 volts on the filament and you are using a 6-volt accumulator, you can measure the voltage on the filament by connecting one lead of the voltmeter to one filament leg and the other to the other leg. This must be done while the valve is in the socket and the current flowing. It is no use measuring the voltage across the socket without the valve in place. The best way is to get a friend to help you in this measurement, and

while you hold the voltmeter leads against the filament legs, your friend should gradually turn the knob of the filament resistance until the voltmeter gives the correct reading. A mark can then be made on your

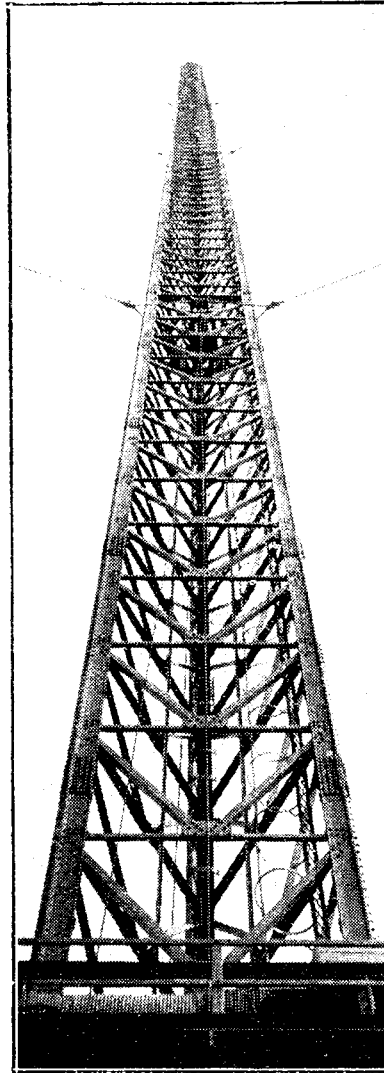

One of the giant masts erected to support the aerial of the high-power wireless station at Rugby. An impression of the great height may be obtained by placing the eye near the foot of this column and looking from the base of the mast upwards. Stay wires may be seen at intervals, arranged at constant angles.

panel, where the pointer or indication of the filament resistance comes. By adjusting your valves in this fashion you get double or treble the life out of them. Otherwise you may be burning the filament much too brightly.

The Type W4 Receiver

SIR,—Wishing to build a new set I was looking through the back numbers of *Wireless Weekly* to find a set that would meet with my requirements and which I could build with the components already in my possession. I came across the Type W4 Receiver described by Mr. Herbert K. Simpson in Vol. 3, No. 18, April 9, 1924. I have built this set and get really excellent results on it.

2LO, 5IT, 5NO, Radio-Belgique, Radiola and two or three German stations which I have not yet been able to identify come in well on the loud-speaker, while I receive all other B.B.C. main and relay, most Continental, WBZ, KDKA and WGY all with good strength on the 'phones.—Yours faithfully,

PATRICK MACDOWELL.

London, S.W.7.

Transatlantic Wireless Telephony

The Postmaster-General makes the following announcement:—

Statements have recently appeared in the Press on the subject of Transatlantic wireless telephony, to the effect that two-way telephonic communication has already been established between England and America by means of a new and secret system. The Postmaster-General desires it to be understood that this is not the case. The experiments so far made are a continuation of those announced to the Press in May, 1924.

Following the first successful reception of speech by wireless telephone from America in January, 1923, the Postmaster-General appointed a Committee under the chairmanship of Admiral of the Fleet Sir Henry Jackson to investigate the possibility of establishing a commercial telephone service between England and America. Under the supervision of this Committee special receiving stations were established in this country and a series of experiments and observations on the reception of speech from America have since been in progress, in conjunction with the American Telephone and Telegraph Company, the Radio Corporation of America, and the Western Electric Company.

Similar experiments on the transmission of speech to America have not been, and cannot be, undertaken until the Post Office transmitting station at Rugby, where experimental telephone plant is being installed, has been completed.

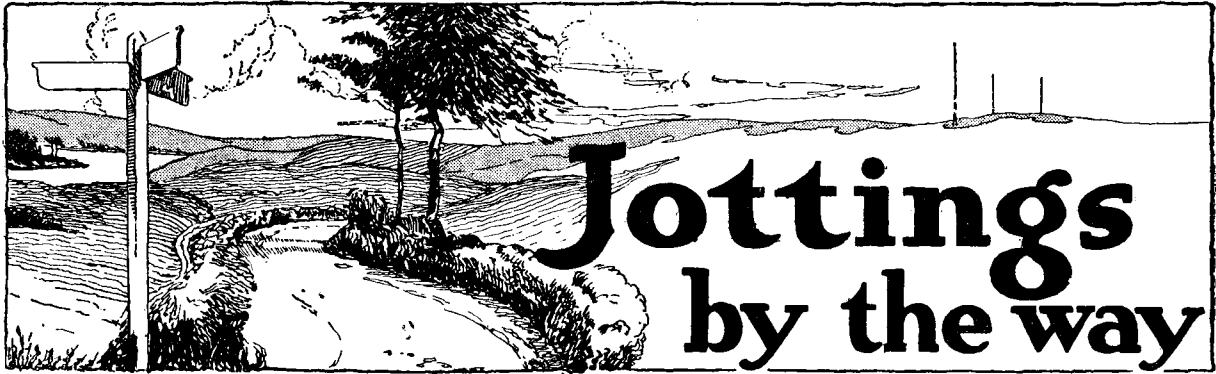

Jottings by the way

Persistence

"Is that you?" said Poddleby's voice as I picked up the telephone receiver. "Number engaged," I replied in a squeaky voice with great presence of mind, for I knew what was coming. I hung up the receiver and settled down to work once more in the armchair. Next minute that beastly bell went again. Poddleby once more. "I say, how about that transformer of mine that you promised to return?" he shouted. "Speak up," I called.

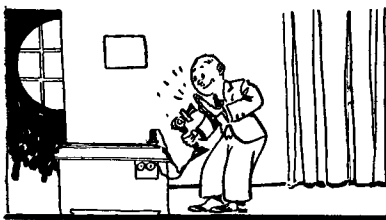

. . . I smacked the microphone . . .

"Who's that? Do you want me? No, I can't hear a word." Poddleby was getting pretty ratty at the other end of the line by this time, so just to cool him off a little I smacked the microphone quite hard three times with my open hand, joggled the lever thing up and down and rang the bell violently. I was not bothered further by the telephone, but in less than half an hour there was a ring at the front door bell and my handmaiden announced that Mr. Poddleby wished to see me. "Tell Mr. Poddleby," I said, "that I am far too busy to see anyone; that I am ill in bed with influenza and that I have gone up to London to attend the funeral of an aunt." That, one would think,

would have choked most people off, but if you imagine that it had any effect on my visitor, then all I can say is that you don't know Poddleby.

The Sick-room Violated

The fellow simply burst into my room. I had barely time before his entry to seize the table cover and drape it closely round my neck or to assume the correct facial expression for a victim of the fashionable malady. Poddleby also appeared to be suffering, for I noticed that his right ear was plugged with a large tuft of cotton wool. I inquired sympathetically whether he was suffering from earache, to which he replied that if he had broken an ear drum he supposed that he must blame himself for being rash enough to telephone to a goggle-eyed, putty-brained, mule-eared idiot. Though the description by no means fits, I gathered that he was referring to me.

Couéism

I told him I was far too unwell to listen to vulgar abuse, but all that he did was to yank off my tablecloth, and to tell me that there was nothing on earth the matter with me. "If," I said, "you are practising Couéism, I cannot congratulate you upon your bedside manner. Further"—and here I removed the plug of cotton wool deftly from his ear—"you also are shamming, so let us cry quits." It looked for a moment as if Poddleby was going to show fight, but as he was unarmed, whilst I had quickly seized the tongs, with which I prodded him gently in the waistcoat, he appeared to come to a quick decision that the omens were not propitious for a battle. I was glad of this, for I hate bloodshed, especially as I

have just had a new hearthrug installed. Poddleby is a squashy kind of fellow, who might make an awful mess if I were thoroughly roused and set about him properly.

A Wise Plan

"Talking of transformers. . .," said Poddleby. "We were not," I replied hastily, "nor have I any intention that we should. In fact, I never talk of transformers on Wednesday; that is my day for rheostats. You, Poddleby, are an unmethodical kind of creature; your mind is not tidy or orderly like mine. Probably you discuss high-tension batteries, and grid-



. . . I assumed the correct facial expression . . .

leaks, and condensers, and aerials, and earths practically all in the same sentence. I, on the other hand, like to get things properly sorted out. For this reason I have a time table, to which I stick. On Sunday I deal with batteries; Monday is my day for valves; Tuesday—Tuesday, mark you—is set apart for transformers. On Wednesday (and I would remind you that to-day is Wednesday) the filament resistance is my topic. I must therefore decline to discuss any component but rheostats.

A Man of Principles

"I have none of yours in the house, and if you want to talk about transformers you must call again next Tuesday, when, by

the way, I shall have started upon my journey to Wales. I propose to stay there three weeks, which means that I am prepared to debate the whole question with you fully upon the Tuesday after the Tuesday after the Tuesday after next." Any respectable man would have understood at once and have held his peace. When, for instance, I find that a fellow has hard-and-fast principles, I will not raise a finger to induce him to deviate from them. Poddleby, however, is apt to be a little obtuse at times. I think that he would have said quite a lot about transformers, despite the day of the week, if I had not suddenly remembered that he was building a super-heterodyne receiving set of vast size.

The Red Herring

In certain circumstances there is nothing like a red herring, provided always that the circumstances are such that you are not compelled to devour it. The only use that I have found for red herrings—and, believe me, it is an excellent one—is to draw them across trails. At first sight you may fail to see any similarity between an umpteen valve super-heterodyne and a bloater, but I can assure you that in this case the super-heterodyne proved to be the most effective and the most heaven-sent red herring that I have ever known in the course of my long and checkered career.

For this Relief

As I uttered these magic words Poddleby dropped the nasty frown which was disfiguring his moon-like face and assumed a smile which suited it (and me) far better. Though my rules are strict I have my conscience well under control, and anyhow the super-heterodyne does contain heaps and heaps of rheostats. No other receiving set, in fact, has anything like the number. Therefore it seemed to me that I could with all propriety continue the subject whose opening had seemed so propitious. One leading question, and Poddleby was well away. "How," I asked, "have you arranged the circuit of your oscillator valve?" I did not in the least wish to know, but I felt that it would be a relief to Poddleby to tell me. I therefore

sank back into my armchair, explaining to him that I always listen better with my eyes closed, especially when handsome men are speaking. "If," I said, "I watch a really good looking fellow as he is talking I cannot concentrate upon his words. Having received in my young days a sound classical education, I find that his features naturally conjure up the magic names of

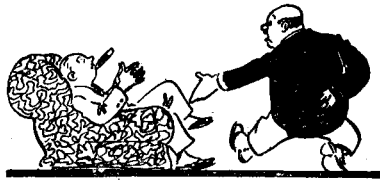

. . . Poddleby walked up and down . . .

Pheidias and Myro and chaps of that kind. When, for example, you, Poddleby, thought of leaping at my throat a few moments ago your attitude was distinctly reminiscent of that of the Discobolus. Allow me to close my eyes, and I can forget for the moment your fatal beauty, giving my whole attention to what you have to say."

Poddleby Talks

I settled down comfortably. Poddleby did not. He stood upon my new hearthrug with his muddy boots and talked and talked and talked. At intervals I said "yes," or "no," or "quite," or "oh?" or "really," or "my hat!" These exclamations appeared to fill the bill, for

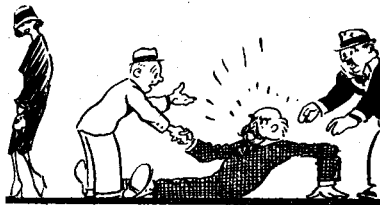

. . . I tried to explain . . .

Poddleby went on like a siphon whose lever has been pressed. Do not ask me to tell you what he was talking about. I hadn't the slightest idea, nor probably had he, but it seemed to please him to do it. In fact I think that he would have gone on talking until further notice had I not suddenly sprung to my feet and suggested that we should adjourn to the wireless club and ask Snaggsby's opinion upon the last

point that he had raised. What that point was is more than I can say, but it appears that there was one, for Poddleby accepted my suggestion at once. The result, anyhow, was that we presently found ourselves walking down the High Street with Poddleby still talking nineteen to the dozen. Force of habit compelled me to close my eyes, which was a little unfortunate, for I am not a practised somnambulist. The fact that I presently barged into General Blood Thunderby was due entirely to Poddleby, as I tried to explain to the warrior, what time I was helping him to his feet. When I had talked quite a lot and had observed that the General's eyebrows were mounting higher and higher, I finished by saying that explanations were difficult, since it was a hard world. Our respected president blurted out that it was also a hard pavement, and that in any case it was I and not Poddleby (as I would have had him believe) who had come into collision with him.

Once Again.

It looked for a moment rather as if I were in for it, since the General, who has a hobnailed liver, produced by many years' service in the East, can be distinctly pointed at times in his remarks. This would have been most unfortunate, since the High Street was at the moment crowded with the elite of Little Puddleton, and I would have hated to see the warrior make an exhibition of himself. Fortunately my nimble wits suggested once more the idea of the Superedherringodyne.

A Fortunate Meeting

"This," I said, "is a most fortunate meeting, for Poddleby has just raised a point which I am quite unable to deal with. You, sir (the word sir is a wonderful oiler of troubled water—or livers), will no doubt be able to supply the information that he requires, a task which is quite beyond my poor powers." I left the General and Poddleby hard at it in the midst of the High Street. It was Tuesday, I admit, but Poddleby had forced me to break my rules. I felt justified, therefore, in going home to see what I could do with that transformer of his.

Reception Conditions Week by Week

By W. K. ALFORD.

Review of reception for week ended April 12.

THE sudden approach of weather of truly summer nature has had the expected effect on reception generally, and is characterised at the moment with very heavy atmospherics in the form of sharp cracks and intermittent rattles. It has been noticed that some of the discharges were sufficient to bring about a momentary paralysis of the receiver, and during the worst periods of really heavy discharges "fading" was particularly marked, even at comparatively short distances. The Glasgow station of the B.B.C. was particularly affected in the London area, and several of the small-powered Continental stations faded practically into inaudibility, and gave excellent examples of the "periodic" nature of the phenomenon.

Atmospherics

It may be said that, when atmospheric disturbances are particularly heavy and temporary paralysis of the receiver is taking place, the method known as "bottom bend" rectification is distinctly better than the almost universal "cumulative" method employing a grid-leak and condenser. The former method, curiously enough, is very little

used in this country, presumably on account of the few valves which are available for the purpose, but the advantage gained in efficient rectification, combined with great silence, is very marked over the latter method.

The new London station of the B.B.C. has now settled down to its regular duties, and there is no doubt that the "promised improvement during the next month" is surely taking place. The improvement is generally admitted to be considerable in nearly all districts, except in a

S.E. direction from London, where the inhabitants are supposed to be making "the slight adjustments to their sets," as recommended by the B.B.C.

Kilowatts

Considerable comment has arisen over the publication in a section of the Press of the B.B.C.'s idea of a Broadcasting Elysium. The basic motto seems to be "kilowatts and plenty of them." This is all very well till every station in Europe adopts the same motto and the affair simply becomes a battle of Capital. In addition, every fair-minded listener will agree that after all the ether was not created solely for fireside amusement, and one is bound to think that the B.B.C. in their enthusiasm do allow themselves to be carried away by an exalted sense of their own importance, which is possibly explained by their close association (chiefly financial) with the Post Office.

It is interesting to note that in the forthcoming Bill dealing with the Wireless Telegraphy Act it does not mention the position of private Broadcasting Services and their relation to the listening public. Such stations are bound to come into existence in time, when the present monopoly comes to an end.



A spectacular crash occurred when the war-time wireless masts at Inglewood, Cal., were razed recently, and our photograph shows the mast immediately after the fall.

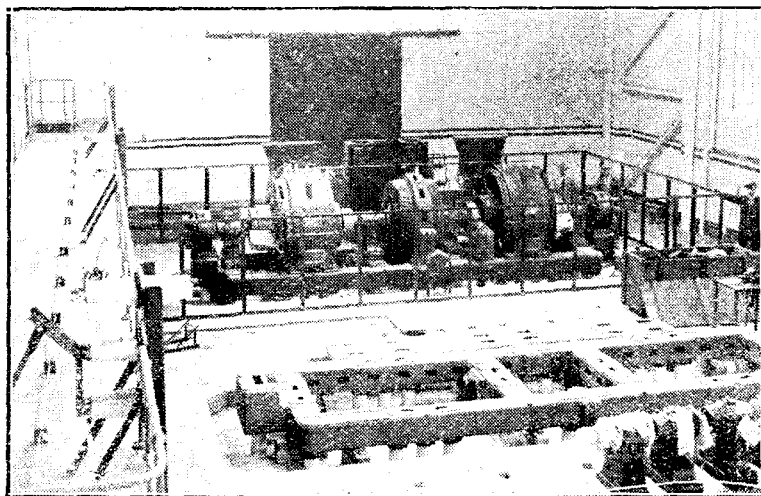

A general view of the interior of the power-house at Rugby. The machine in the background is a 500-Kilowatt generator.

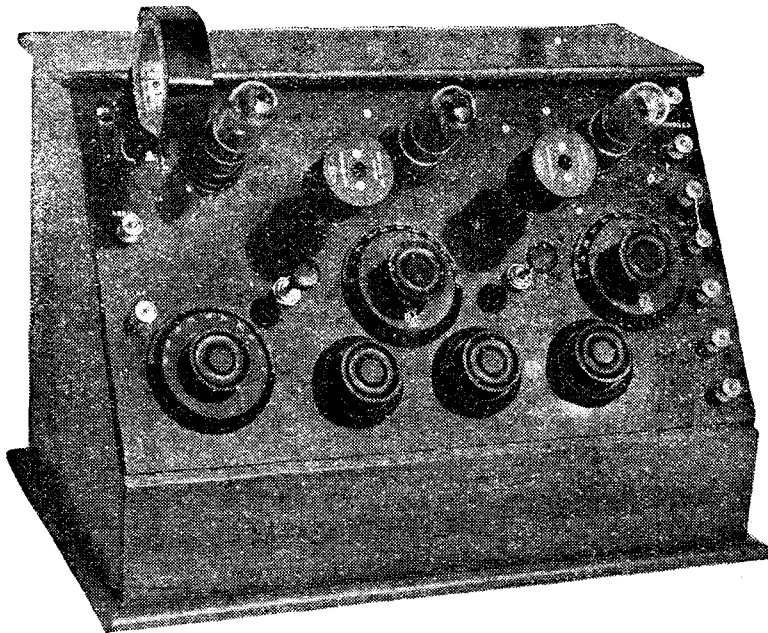

For broadcast wavelengths the aerial is joined to one of the tapings on the "X" coil.

WIRELESS as a hobby has various forms of appeal depending largely upon the temperament of the experimenter. In some cases it is simply desired to install a receiver to give loud-speaker results from the local station, no interest being shown in transmissions from stations at a greater distance, whilst again a receiver may be required which will bring in the more distant stations at reasonable strength, at the same

time still being capable of receiving the local station with sufficient volume to operate a loud-speaker. Again, the experimenter may require a receiver which will be capable of bringing in all the British and Continental stations on telephone receivers, the operation of a loud-speaker not being required.

Distant Phone Reception

When a receiver is required only for this latter purpose,

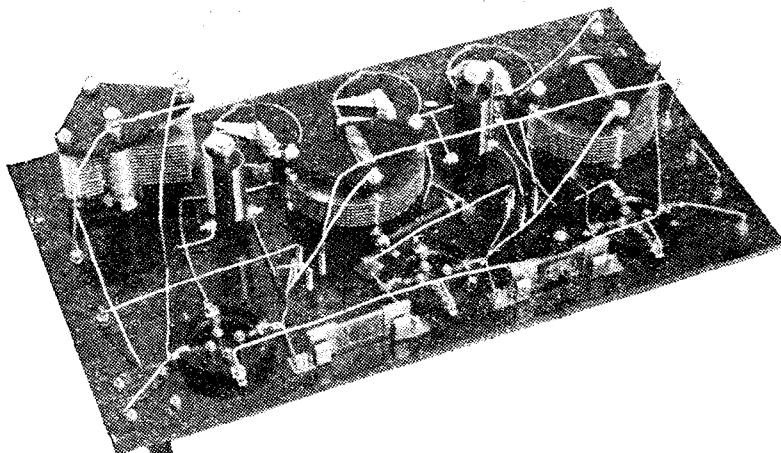

This view clearly shows the mounting of the grid condensers and leaks.

An Auto-Coupled Neutrodyne

By JOHN W

Full constructional details of building of a highly efficient stages of high-frequency selective a

several factors have to be taken into account. It is possible, given a good location and a good night, to receive most of the British main stations on a single-valve receiver, but to be more sure of reception under varying conditions, both of geographical situation and of atmospheric con-

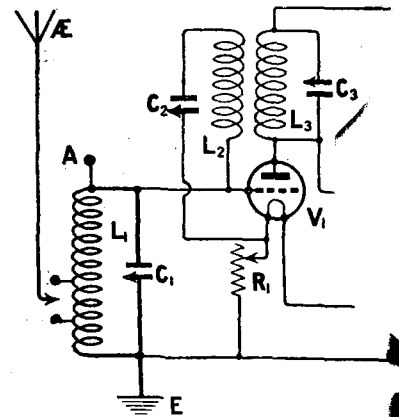

Fig. 1.—The circuit arrangement. The grid condensers are indicated.

ditions, a receiver employing stages of high-frequency amplification must be considered essential.

Methods Available

Considering the question of high-frequency amplification, the experimenter has several methods at his disposal. A single high-frequency valve may, for example, be coupled to the detector valve either by means of the tuned anode or the tuned transformer systems, these being only two

ed Three-Valve e Receiver

V. BARBER.

s are here given for the
nt receiver, employing two
mplification together with
al tuning.

methods suitable for the relatively short waves used in broadcasting. The resistance-capacity method of high-frequency amplification is not considered here, as it is in its present state not altogether suitable for wavelengths below 1,000 metres. When one considers the addition of a second

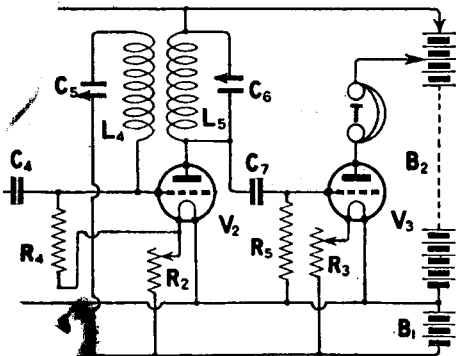

The moving plates of the variable indicated by arrows.

high-frequency valve, the problem becomes a little more complicated, as, in general, a receiver employing two stages of high-frequency amplification by either of the two methods enumerated, if carefully designed with low-loss inductances and so forth, will be so unstable as to render its operation impossible. If the receiver is stabilised by means of a potentiometer, a certain amount of efficiency must inevitably be sacrificed, and one must look around for another method

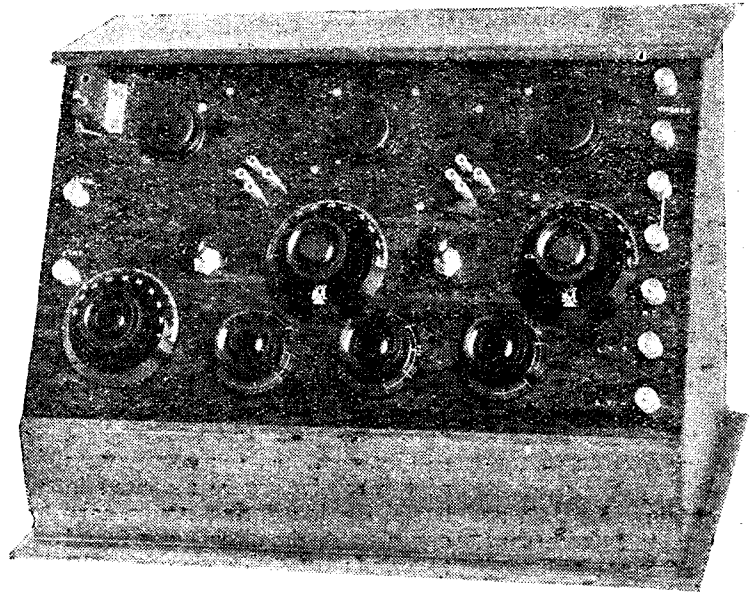

The essential controls are readily to hand.

by means of which efficiency will not be sacrificed to so great an extent. In the receiver to be described the Cowper Neutrodyne method of stabilisation has been employed, and the modification suggested by Mr. Percy W. Harris, in which a plug-in transformer with suitably-adjusted windings for the neutrodyne circuit employed, has been adopted.

Cabinets

In the writer's opinion the most convenient form of mount-

ing for such a receiver is the sloping front or desk type, and a cabinet of this type has been used. The appearance of the finished receiver can be gathered from the photographs which accompany this article. On the left of the panel is seen the aerial tuning condenser, or rather the variable condenser tuning the secondary circuit, the aerial being aperiodically coupled to the main secondary coil. Above the filament resistances, which are arranged at the bottom of

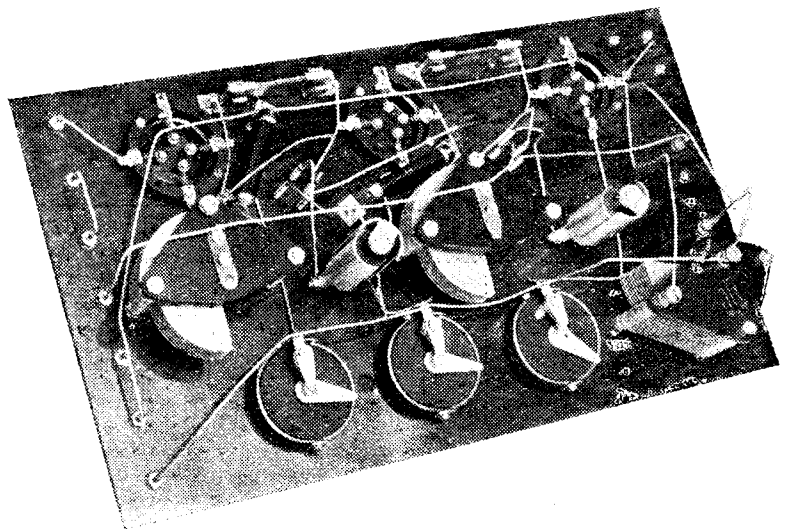

A further back view showing the positions of the neutrodyne condensers.

the panel, will be seen the dials of the two anode tuning condensers, while to the left of these will be seen the knobs for the respective neutrodyne condensers. The valves are mounted in anti-vibratory sockets in order that dull emitter valves may be used without microphonic noises causing trouble.

The Circuit Diagram

The grid circuit of the first high-frequency valve is tuned by the circuit $L_1 C_1$, and the aerial is connected to either of the tappings shown on the left of this coil, which is a commercial coil made by Lissen, Ltd., and known as the "Lissenagon X" coil. By means of this arrangement of aerial coupling great selectivity is obtainable, while at the same time the necessary tuning controls are not rendered more complicated. The form of coil mentioned is tapped at 6 and 10 turns from the earth end, and the aerial may be joined to either of these tappings, which are brought out to terminals on the ends of ebonite lugs on the side of the coil mount. Stronger signals will in most cases be obtained with the aerial connected to the tenth turn tapping, but selectivity will be greater when the aerial is joined to the sixth turn tapping. The connections of the neutrodyne windings and con-

densers should be carefully noticed. It will be seen that the moving plate of the neutrodyne condenser C_2 is connected directly to the filament of the valve, that is, above the filament resistance, while in the case of the second neutrodyne condenser its moving plate is connected to the negative of the low-tension battery. The grid leak of the second valve is also connected directly to the filament and not to the low-tension negative.

Difficulties

These connections were found necessary after considerable experiment and gave the best results. When the components of the receiver were mounted in board fashion during preliminary experiment, the circuit was found to work quite well with the neutrodyne condensers both connected to the negative end of the filaments and the grid leak connected to the negative L.T., and when the receiver was mounted upon the panel in complete form these connections were made. Upon attempting to neutralise the receiver, however, considerable trouble was experienced, it being found that the receiver would neutralise at certain positions, but any small alterations of the controls upset the adjustment entirely. Upon examination, the

first source of trouble was found to be situated in the first valve holder, owing to the fact that the grid socket was not making proper contact with the leg of the valve, due to the presence of some black deposit in the socket.

The Real Trouble

Upon a further trial the receiver was found to be a little more manageable, but was still not as it should be. The first neutrodyne condenser was then joined direct to the negative leg of the filament, and the grid leak joined to the filament of the second valve. This effected a slight improvement, but it was found that at a certain adjustment of the variable condensers C_3 and C_6 across the tuned anode coils respectively, the neutralising adjustments were once again upset. This very puzzling fault was eventually traced to the condenser C_6 , when it was discovered that at one point only during the rotation of the moving vanes one of the latter, though not actually touching the fixed vanes, was virtually doing so in that a certain amount of dust afforded the contact. The removal of this dust completely eliminated the trouble, and the receiver was then quite as it should be.

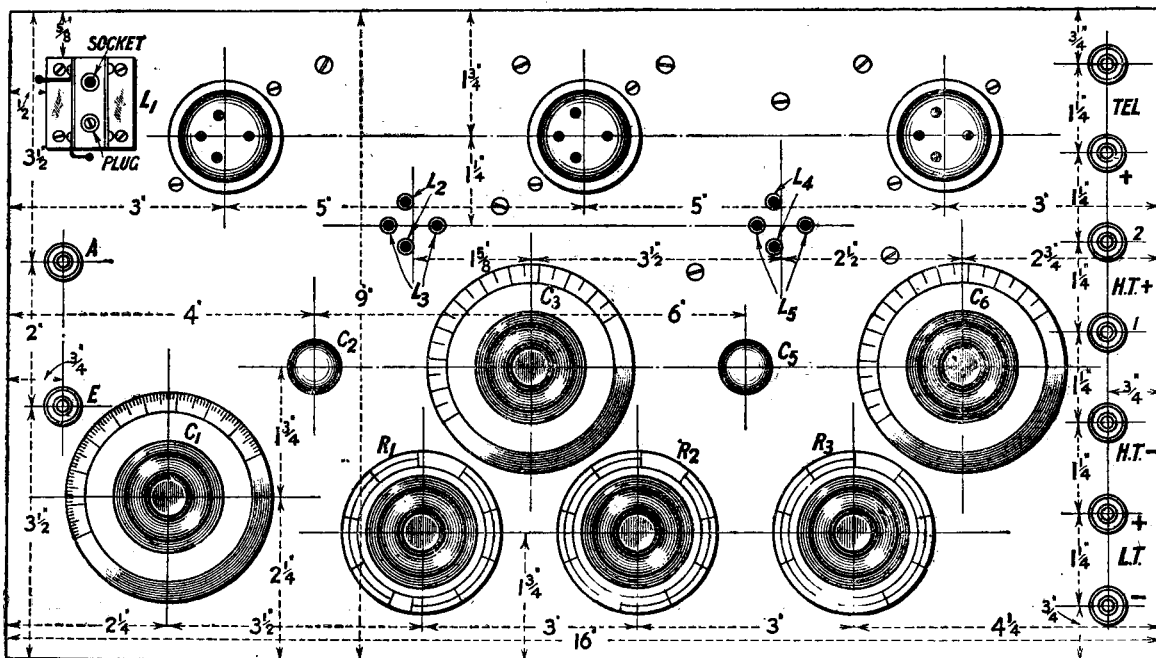

Fig. 2.—The drilling diagram, showing the layout of the controls. Full size blueprint, No. 114a, may be obtained, price 1s. 6d. post free.

List of Components

For the benefit of those readers who may wish to duplicate this receiver, the list of components used is given below. It must be understood, however, that the information given as to makers' names is only intended to serve as a guide, and if other good components are used there will be no difficulty in duplicating the results obtained.

One panel, $16 \times 9 \times \frac{3}{16}$ ths or $\frac{1}{4}$ in. (Radion Mahoganyite).

One variable condenser .0005 μ F (Jackson Bros.).

Two variable condensers .0003 μ F (Bowyer-Lowe).

Three dual filament resistances, one-hole fixing type (McMichael, Ltd.).

Three "Antiphonic" valve-holders (Burndept, Ltd.).

Two clip-in condensers .0003 μ F, and two 2-megohm grid-leaks, both with clips (McMichael, Ltd.).

Eight valve legs.

Nine terminals.

One coil socket for panel mounting (Burne Jones, Ltd.).

Two micrometer condensers, "Polar" (Radio Communication Co., Ltd.).

One Lissenagon X coil (Lissen, Ltd.).

Two plug-in "Neutra-Formers" (Peto-Scott, Ltd.).

Suitable cabinet (Carrington Manufacturing Co.).

One set Radio Press panel transfers.

Notes on Construction

The usual constructional details are given in the two drawings showing the drilling and the wiring of the receiver, and no difficulty is anticipated in these respects. In wiring it is important to mention that the plug of the coil socket must be connected to earth in order that the tappings on the Lissen X coil shall be on the earth side. Particular care must be taken with the soldering, as it has been found that a badly-soldered joint will cause an immense amount of trouble in such a receiver.

Neutralising

When completed the receiver is joined up to the necessary batteries but not to aerial or earth. A No. 50 plug-in coil is put into the aerial socket and the filaments of the valves turned on.

The aerial and anode condensers are set to a low value and the neutrodyne condensers adjusted until the receiver ceases to oscillate when the anode condensers are moved a little toward the maximum position. It will probably be found that as these condensers are moved the set bursts into oscillation again, and the neutrodyne condensers should be adjusted again. By

careful adjustment it will be possible to set the neutrodyne condensers to such a position that no oscillation takes place on any wavelength to which the three circuits are tuned. The aerial condenser is then rotated and further adjustments made if necessary. These instructions sound somewhat complicated, but in actual practice it will be found a fairly easy matter if carefully carried out. Neutralisation must be effected before going any further, or the correct results will not be obtained.

Using the Receiver

When properly neutralised, the receiver may be put into operation by replacing the plug-in coil with the Lissenagon X coil, joining the aerial to the sixth-turn tapping and the earth to terminal E.

It will then be possible to tune the receiver in the ordinary way to the various stations simply by movement of the three dials, and if the neutrodyne transformers are matched, the anode condensers will have approximately the same setting. The receiver will be found very selective in handling, and it has been possible by careful tuning at $4\frac{1}{2}$ miles from the London station to eliminate that station and receive Bournemouth without the use of a wave-trap. In those cases where reac-

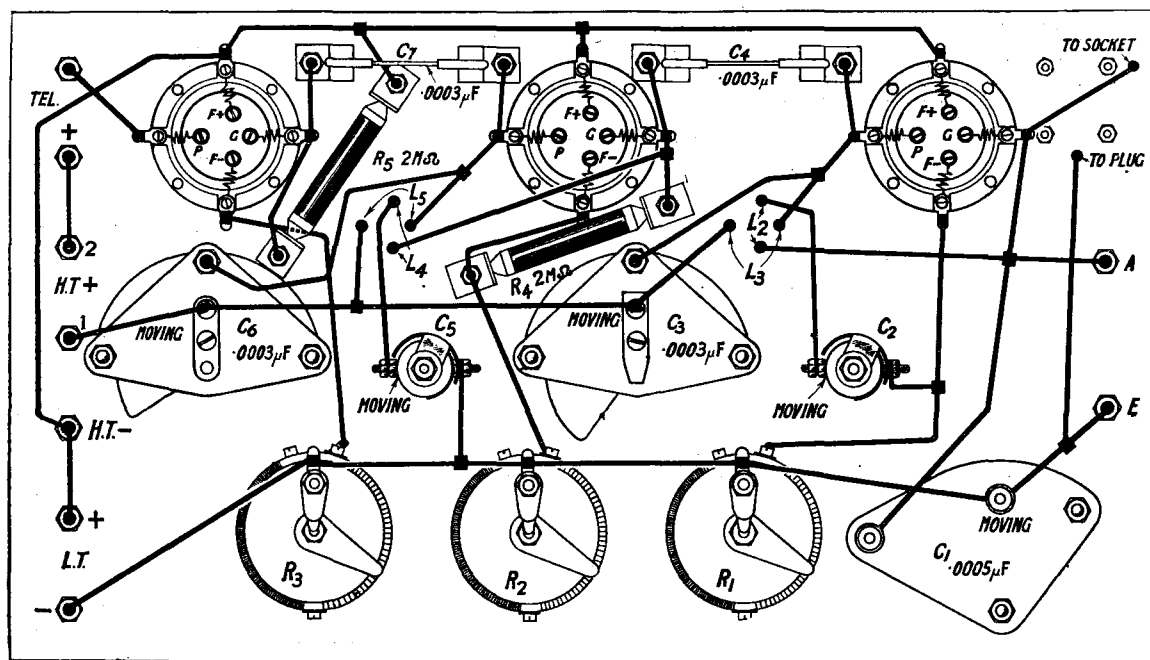

Fig. 3.—The wiring diagram. The process of wiring will be found simple if this diagram is used in conjunction with the back-of-panel photographs. Blueprint No. 114b.

tion is desired, this may be obtained by slight variation of the adjustment of the neutrodyne condenser C₂, though, generally speaking, with the receiver working normally, reaction will not be necessary.

Results

On an indifferent aerial in S.E. London, good headphone signals have been obtained from all the main B.B.C. stations with the exception of Manchester and Cardiff, the former station only being heard on very rare occasions, while the latter is seldom received without the use of a split-secondary circuit owing to interference from London. Of the relay stations, Dundee and Liverpool were heard during a

short test one evening, while L'Ecole Supérieure comes in at a strength which is rather too much for comfortable headphone reception.

On a good aerial in an unscreened position (the reverse of the conditions obtaining in the writer's case) even better results will be obtainable, and the writer will be very pleased to hear from any reader who makes this receiver.

In conclusion, I do not recommend a beginner to attempt to use this receiver, which is more suitable for the man who has had some little experience in operating, but where such experience is to hand, the set will provide many interesting hours of "station-logging."

RADIO NOTES AND NEWS

It is hoped to arrange for the broadcasting of the King's speech in the Stadium at Wembley at the opening of the British Empire Exhibition on May 9. The arrangements will probably be on the same lines as last year; that is to say, there will be a microphone over the Royal dais with loud-speakers distributed round the Stadium for the benefit of those present, while the speech will also be broadcast to all stations of the British Broadcasting Company.

* * *

Of especial interest to the amateur wireless world is the ex-

perimental station which has recently appeared upon the scene in Paris. It is that of the Ecole Centrale des Arts et Manufactures. Under the call letters 8 DK, it makes regular experiments in transmission on a wavelength of 300 metres, with a power of 250 watts. Like all stations of the fourth class in France, it transmits between midnight and 10 a.m. and 1 and 4 p.m.

The transmissions are naturally extremely variable in quality, both in telegraphy and telephony. The station was especially installed for the instruction of the

students in the science and practice of radio, and it rarely has the same arrangement of circuit for two days in succession.

The aerial, which is erected over the school, is in the form of a hexagonal prism, with six wires 70 metres long.

* * *

The monthly meeting of the Paddington and District Branch of the Radio Association will take place on Wednesday, April 22, at the usual place, viz., "The Manor House," Westbourne Terrace North, Paddington, W.2, at 8 p.m.

The principal feature on this occasion will be a lecture on "Grid Trap Circuits for Short-Wave Work," by Mr. A. Turner (2XO), who is President of the Branch. This bids to be an extremely instructive evening, and all who are interested in "wireless" in the locality are invited to come along. Mr. Turner needs no introduction, and this will be a unique opportunity for hearing at first hand his experiences on short-wave work.

The Morse class, conducted by an "old hand," has proved a most attractive part of the weekly meetings, and will be held prior to the lecture mentioned above. Following Mr. Turner's talk, there will be the usual "queries" —when faulty sets can be put right or other troubles cleared up.

All are welcome, and there is no charge for admission. Full particulars of the Branch and its objects can be obtained from the Hon. Secretary, Mr. H. J. Wood, 5, Senior Street, Paddington, W.2.

* * *

An ordinary meeting of the Radio Society of Great Britain will be held at the Institution of Electrical Engineers, Savoy Place, W.C.2. at 6 p.m., on Wednesday, April 22, when Mr. G. G. Blake, M.I.E.E., A.Inst.P., will deliver a lecture and demonstration entitled, "Communication on Wavelengths other than those in general use." Tea at 5.30 p.m.

□

A Useful Application of the Weston Relay.

We deeply regret that owing to pressure upon our space the conclusion of this article is held over until next week.

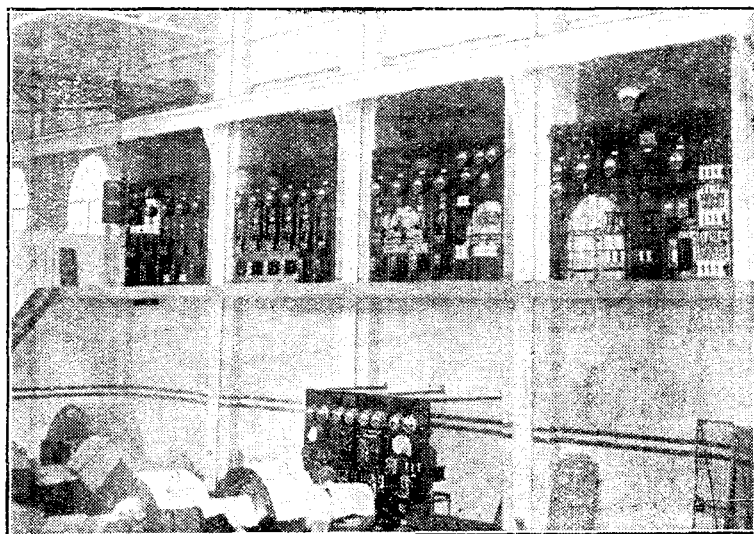

The giant switchboard at the new Government high-power station at Hillmorton, Rugby.

A Basket-Weave Coil Former

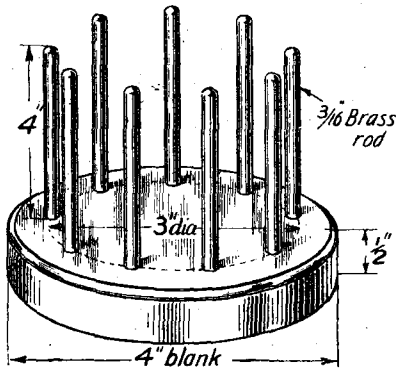

Fig. 1.—Illustrating the base and arrangement of the spokes.

Those readers who are interested in the construction of home-made coils will find in this article how to build a former for winding a low-loss basket coil which is self-supporting.

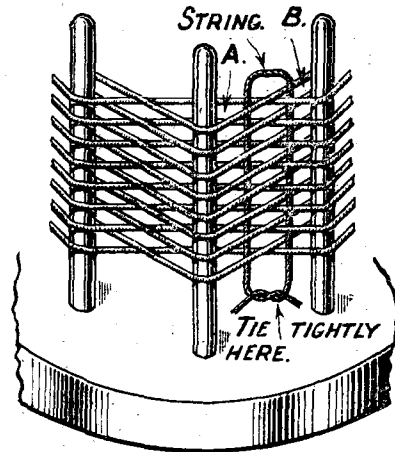
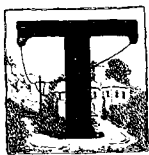

Fig. 3.—The coil is self-supporting and secured with string.



HE basket weave method of winding coils is becoming increasingly popular with the amateur who makes his own coils, especially for short-wave work where a coil should be practically self-supporting so as to include a minimum of dielectric in its field.

Construction

The writer, requiring a coil of this description for a Tropadyne adaptor that was described in *Wireless Weekly* for November 26, 1924, made up a special former for the job, which has since come in exceedingly useful whenever a coil has been wanted.

It should be mentioned here that the former described needs a 2 and a 4B.A. tap and die and the appropriate drills for its construction, but for the benefit of those who do not possess these tools an alternative method will be given at the end of this article.

The Base

The base is made of 1/2-in. brass, a blank 4 in. in diameter being obtained from one of the large metal merchants, though it could probably have been only 3/8 in. or 1/4 in. thick without detriment to the finished former—which is shown in Fig. 1. The centre of the blank was found and a 3-in. circle scribed on one surface. This circle was divided into nine equal parts and

a centre punch mark made at each division line. The division of the circumference into any number of equal parts is easily done by multiplying the diameter by 22/7 and dividing the resulting figure by the number of divisions required. This figure will not be quite accurate, but any

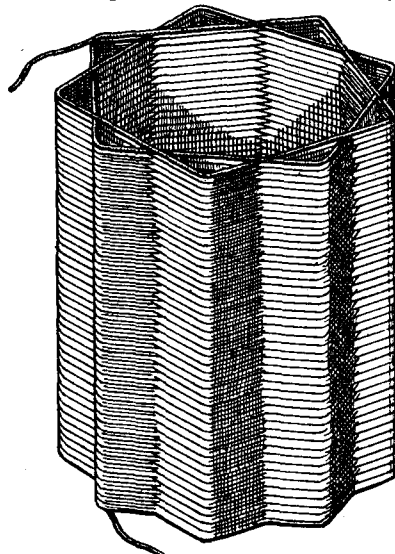

Fig. 2.—The appearance of a single-weave coil wound on the former described.

slight inaccuracy can easily be corrected by "trial and error."

Brass Rods

A hole was drilled at each of the punch marks, a 2B.A. tapping drill being used. After this the holes were tapped out 2B.A., and the complete base was filed dead smooth and

polished with sand paper. The top edge had a groove cut in it on a friend's lathe just to finish it off, and a coat of lacquer applied.

Next a length of 3/16 brass rod was obtained, and nine 4-in. lengths were cut from it. One end of each of these lengths was rounded off with a file, and a little over 1/4 in. of the other end was screwed with a 2B.A. die. It was now merely necessary to screw the rods into place to be able to make basket-weave coils. The single-weave coil is the most usual, and is shown in Fig. 2, but double- and triple-weave coils can be made if desired and form interesting variations from an experimental point of view, as well as allowing more turns of wire to be accommodated on a winding of a fixed length.

Special Chokes

It was also intended to wind special chokes for fifteen-metre reception; these, of course, need to be much smaller than those usually used, and another circle was scribed inside the first one but only 1 in. in diameter. This was divided into seven parts, and 4B.A. tapping holes were drilled, and the pegs were made, of course, from 4B.A. rod. These pegs were made only 2 in. long, but the same amount was screwed at one end of each. The chokes made on this former consisted of 30 turns of 24 S.W.G. d.c.c. copper wire.

Supporting the Coil

The method of making these basket-weave coils self-supporting is shown in Fig. 3. First lift the coil so as to leave a space of $\frac{1}{2}$ in. to 1 in. between the bottom of the coil and the base of the former. This can be done with a strip of metal bevelled off at one end so as to insert it between the base and the bottom turn, or by means of a special lifting plate shown in Fig. 5. Next a piece of thin string or twine is slipped down the space as shown at A on one side of where the wires cross between the pegs and the other end slipped down the space B on the other side. The ends of the twine are now tightly tied so as to pull the winding together and then knotted. After all the crossings have thus been tied, it will be found that the coil can be slipped off the former as a whole and will be quite self-supporting.

Mounting

There are various methods of mounting these coils, but what is probably the simplest is shown in Fig. 4. A is a piece of wood

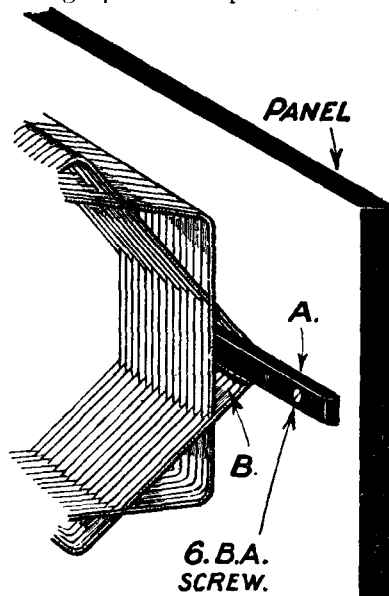

Fig. 4.—A suggested method by which the coil may be mounted.

or ebonite cut down so as just to slip into one of the spaces of the coil as at B. About $\frac{1}{2}$ in. is allowed at either end by which the piece of wood or ebonite can be fixed either to the panel, some instrument, or the base board of the receiver.

Coils made on this former will be found to be very efficient and

give a good tuning range on account of their low self-capacity, while for low-loss tuners they are undoubtedly one of the best types to use on short-wave work.

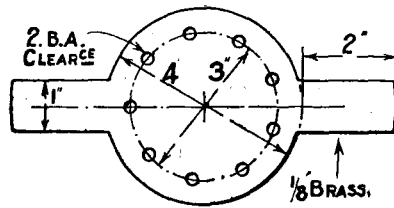

Fig. 5.—Details of the metal lifting plate.

An Alternative Method

If the constructor does not happen to have the necessary tools for drilling and tapping the base and threading the ends of the brass pegs, another means of

making the former is as follows: Drill the nine holes required in an inch-thick hardwood base with a drill which is a trifle smaller than the brass rod used for the pegs, and having cut these, drive them into the holes with a hammer so that they are quite firm. As long as fairly light gauge wire is used in winding the coils, and undue tension is not put on the wire while winding, this will prove quite a satisfactory alternative. If too great a tension is applied to the wire the tops of the pegs will be pulled out of the vertical, and not only will the coil be conical, but after several have been wound the pegs will tend to become loose in their holes.

C. P. A.

Tapping Made-up H.T. Batteries

THERE are very few valve sets which do not require occasional adjustment of the high-tension voltage applied to the anodes of the valves, and probably the best way to select the desired voltage from a battery is by means of the conventional wander-plug and sockets, the latter being permanently connected to various voltage points on the battery. The usual high-tension wireless battery is tapped every three volts in this manner, the number of sockets depending, of course, upon the size of the battery.

Flash-lamp Batteries

But what of those convenient and cheap high-tension batteries made up from a number of flash-lamp refills? Normally, there is no convenient means of selecting any particular voltage desired, although a multi-point rotary switch has been utilised occasionally. But the man who can solder may make use of the sockets from an old high-tension battery of the commercial type in a very effective manner, and for no cost whatever.

Sockets

The easiest way of getting at the sockets is to break the old battery to pieces. It will then be found that the sockets are secured by solder to brass caps, which are in turn clamped over the heads of carbon rods occupying the centres of the cells. Since it is easy to

break off a piece of the carbon rod while attempting to remove the socket alone, it is a good plan to effect the latter operation with the aid of a soldering iron.

After removing the desired number of sockets it remains only to solder them to suitable points

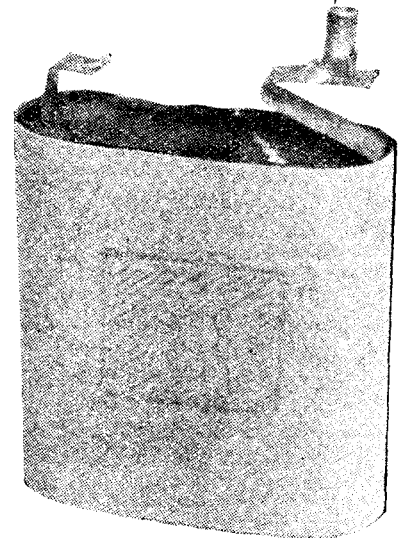

Showing how the socket may be secured to the battery.

on the made-up battery. The illustration shows a socket soldered in position on a negative tag, a hot iron and a little flux resulting in a very strong joint. The actual situations of the sockets on the battery tags must naturally depend upon the manner in which the batteries are joined to each other.

C. E. L.

Correspondence

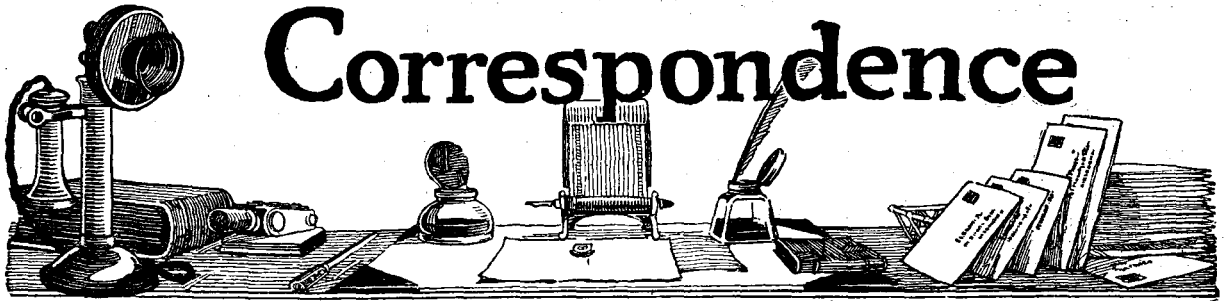

" THE FOREIGN RADIO TIMES "

SIR,—I have been taking *Wireless Weekly* for some time now, and I write to say how much I appreciate the new supplement containing the Continental broadcasting programmes. The need for these to be brought before the public has existed for some time, and it is very interesting for those who, like myself, have long-range sets.

Your paper appears to be the only one in the field with detailed foreign programmes, and this should go far to making your paper a still greater success.—Yours faithfully,

ARTHUR B. WILLIAMS.

Worcester.

SIR,—I think it would be a most excellent idea to bring out the *Foreign Radio Times* as a separate paper. There must be many listeners like myself (a stay-at-home mother) who do not care to afford a sixpenny paper containing articles which they are not able to understand, but who would be very glad to take in one at a lower price for just the Continental programmes, with also perhaps some reading about the artists, stations or countries.

Wishing you still further success.
—Yours faithfully,

AMY WILDE.

Brighton.

SIR,—Being a constant reader of *Wireless Weekly*, I have noticed several letters published *re* foreign programmes.

Imagine what a boon wireless is in a military station, and naturally the interest taken in wireless amongst the soldiers is enormous. Everyone greatly looks forward to the foreign wireless concerts, and the opinion is often expressed that we could do with even more foreign station programmes. I am sure they would be greatly appreciated by all, as all people interested in the welfare of the nation realise, wireless is a splendid education. I am speaking with regard to literature and language and the foreign opinions obtained on various subjects.

If it had not been for your paper we should not have had the pleasure of first-hand knowledge of these foreign time tables.

I think every credit is yours for being first in the field with such, and I also think the publication of

such an interesting paper as yours an absolute necessity.

Wishing your papers every success in the future.—Yours faithfully,
E. C. MARKS,

Corpl., 17/21st Lancers.

Tidworth.

THE 3-VALVE DUAL RECEIVER

SIR,—Although the three-valve dual circuit is nearly twelve months old (published in April, 1924, *Modern Wireless*), I am pleased to inform you of the results I have obtained. On the speaker I have heard all B.B.C. main stations with the exception of Aberdeen. Newcastle, Bournemouth and Manchester come in splendid, sometimes with more volume than 2LO. Several foreign stations come in well, especially Petit Parisien.

On Saturday morning, February 28, at about five past one, I heard a man talking in English about the Allies, Germany and her reparations, and when he gave his call-sign, to my surprise it was WGY.—Yours faithfully,

WILFRID E. KING.

Chatham.

[A Simplified Three-Valve Dual Receiver was published in the March issue of *Modern Wireless*.—Ed.]

SOMETHING USEFUL!!

SIR,—As a reader of Radio Press publications, the enclosed advertisement from a Newcastle newspaper struck me as rather "good." You may possibly think it sufficiently so to publish for the amusement of other readers. A course of "Radio Press" would probably convert the set and him!—Yours faithfully,

JOHN C. HOLDEN.

Newcastle-on-Tyne.

"Exchange 4-Valve Wireless Set, Coils, Accumulator, Loud Speaker and 'Phones, for something useful.—Write Box —."

ENVELOPE No. 4

SIR,—Having recently finished making the "All-Concert De Luxe Receiver," I thought perhaps the following particulars would be of interest to you.

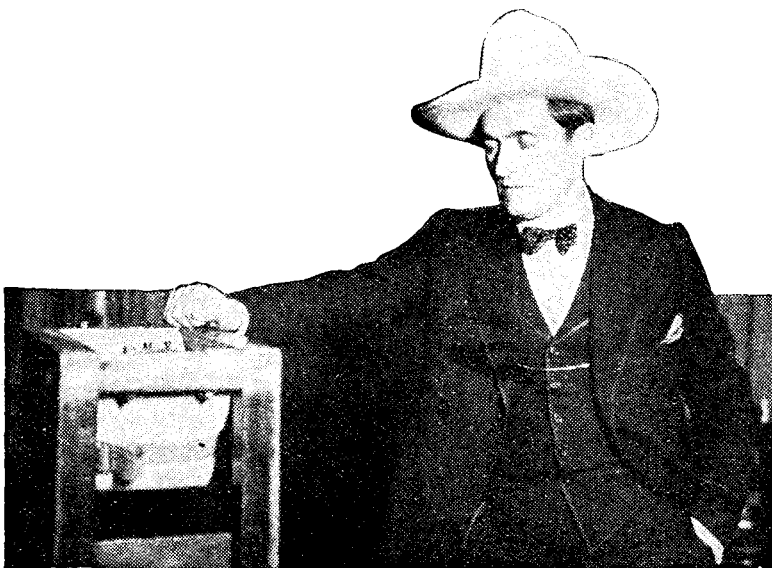

The American film star Tom Mix before the microphone at 2LO, from which station he was heard by millions of British listeners.

Aerial, height about 60 ft., length 98 ft., location West Cumberland. Stations received: *Belfast, *London, *Glasgow, *Bournemouth, *Birmingham, Edinburgh, Aberdeen, Manchester, *Chelmsford, *Berlin, *Newcastle. All the above on loud-speaker strength (those marked with asterisk being very loud).

We are greatly bothered here during the week with disturbances on the loud-speaker from the very large electrical plant at the United Steel Works, the voltage of this plant being something like 100,000 volts. On Sundays there is none of this, as the plant is not used.

Trusting these particulars will be of use to you.—Yours faithfully,
 ERNEST LOCKHART,
 Ex-Telegraphist, R.N.
 Workington.

AN IMPROVED TWO-VALVE RECEIVER

SIR.—Allow me to say how very pleased I am with my two-valve set, this being the one described in *Modern Wireless*, Vol. III, No. 8, January, 1925, "An Improved Two-Valve Set," by Mr. Stanley G. Rattee. I do not propose to go into details beyond the fact that, provided one adheres to the instructions of the Staff Editor with regard to the making of this set, it affords plenty of selectivity, and leaves nothing to be desired regarding appearance. Testing my set on Friday, March 20, 1925, I heard the following B.B.C. stations: (Stoke, "Oh, no!"), Manchester, Birmingham, Bournemouth, Glasgow, London. On Sunday, March 22, I heard Dundee. On Monday, March 23, I heard a voice saying, "Anne Thursfield singing from the Aberdeen station"; this was said after the announcer had spoken with regard to what she was singing. Having very little time at my disposal this particular night, I was compelled to close down. Other stations I have heard are Liverpool, Nottingham and a foreign station. I do not know who this is, but should very much like to, for I get him good strength. When he announces he comes out with a good "Allow," plenty of emphasis on the "Al."

I must admit this is the best two-valve set I have made up, and intend to stick to it. I have also made up the Simple Loose-Coupled Crystal Receiver described in *The Wireless Constructor* for April, 1925. Have no complaints to make. Concluding, allow me to wish you every success, and let's have more of these fine circuits.—Yours faithfully,

A RADIO PRESSER.

Longport, Staffs.

P.S.—This set works loud-speaker very well from our relay station,

6ST, and will work it from 2ZY, though weaker. Speech, etc., is quite plain from the latter station.

"THE LOW-LOSS TUNER FOR SHORT WAVES" IN S. AFRICA

SIR.—Mr. Harris will probably be glad to hear that his "Low-loss

TRANSATLANTIC IV

SIR,—I have made a few alterations to my Transatlantic IV, described by Mr. Percy W. Harris in *Modern Wireless* for November, 1924, which I think may interest you and some of the readers of your ever-interesting wireless periodicals.

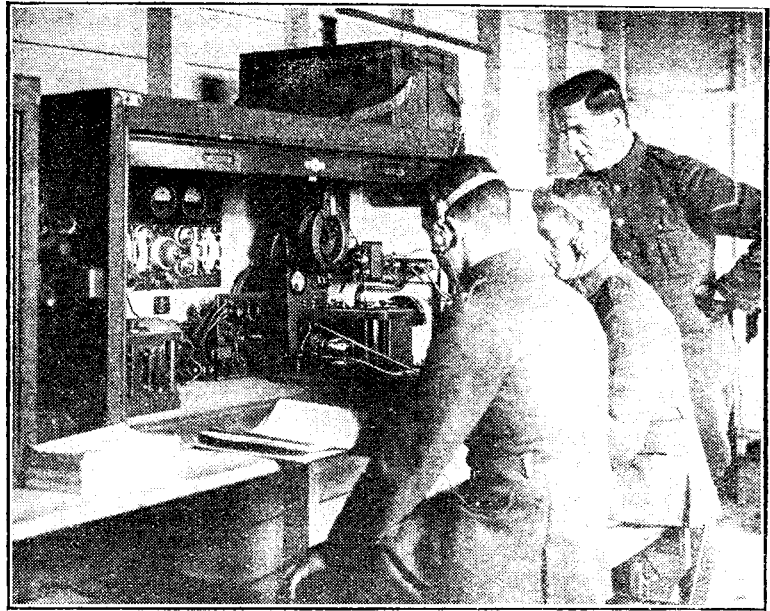

The 120 watts Army training station at Maresfield where wireless operators are prepared for the Royal Corps of Signals. This station works with a similar station at Chatham.

Tuner for Short Waves," as published in *Wireless Weekly*, No. 5, of November 19 last, has made good out here. I built it to the diagrams, but used 20 S.W.G. wire instead of 16, as I had none of the latter on hand, putting in the same turns as specified. As Mr. Harris says, it is not a thing of beauty, but it is the goods every time. The same evening I tuned in KDKA and heard a good part of his programme, but the following evening I made a night of it and put a stage of L.F. behind the set and woke up the house with KDKA's orchestra playing "The Marseillaise," and with the exception of items weak through fading, had a splendid reception.

I had been waiting to find a low wave outfit that would reach out for DX, and have, thanks to Mr. Harris, got what I have been waiting for and, as I said before, it is the goods. I have also logged several American amateurs, including ANE, Govt. Lab. Station at Bandoeng, Java, DE, India. As Pittsburgh is approximately 8,000 miles from this dorp, it speaks well for its properties. Heartiest congratulations to yourself and success to *Wireless Weekly*.—Yours faithfully,

W. H. RHOADES.

Johannesburg, S. Africa.

My first alteration was to add the wave-trap described by Mr. Harris in *The Wireless Constructor* for March, 1925. With the trap in use with Transatlantic IV I found I was able to tune in Cardiff and Manchester without the slightest sound of London. In doing this I got a little loss in strength, so my next alteration was to add another stage of L.F., which has improved the set so much that I must tell you all about it.

I have received all of the main B.B.C. stations and the following relays: Sheffield, Stoke-on-Trent, Nottingham, Hull, Leeds, Bradford and Liverpool on a small indoor cage aerial on loud-speaker at very loud strength, also all the remaining relays on loud-speaker, using outside aerial, at moderate strength. Many Continental stations have been received on indoor aerial, too.

Wishing Mr. P. Harris and all Radio Press books every success.—Yours faithfully,

CHAS. A. BAXTER.

Waterbeach.

5XX HEARD IN SWITZERLAND ON A CRYSTAL RECEIVER

SIR,—You will probably be interested to learn that I have succeeded in listening to 5XX on a crystal set.

I am building the Transatlantic IV Receiver described by Mr. Percy Harris in the November, 1924, issue of *Modern Wireless*, and as I am waiting for some component parts to arrive, I made a little crystal set, so that I could listen to Lausanne. I first made a coil for Lausanne only and enclosed it in a box, but as I heard quite a lot of Morse, I altered the set to take plug-in basket coils, which I wound with No. 22 d.c.c. wire.

On Saturday, February 28, I tried to tune in to Radio-Paris, but instead of Radio I got 5XX. I just heard the tail-end of a lecture, and after that I heard the opera "Samson and Delilah." Later on came the news bulletin, giving the result of the Scotland v. Ireland Rugby match, news about the German President, the Rio explosion, the Prince in the hunting field, etc. I have forgotten the name of the announcer, but his voice was easily recognisable. It was the same pleasant voice which I heard so often in London. Afterwards came the Savoy Bands, and although statics and a 15,000-volt railway line nearby upset things now and then, I could hear very clearly, but, of course, it was necessary for everybody in the room to keep quiet and I had some hectic moments searching for a sensitive spot with the cat whisker.

I used a Neutron crystal, Burn-dept detector, Polar .001 condenser and a home-made basket coil. Every connection was soldered.

The aerial is rather good, about 65 ft. high at the free end and about 60 ft. at the lead-in end. It is unscreened at both ends, has two-reel type and a large Silvertown insulators at each end. The wire is 7/22 stranded and enamelled copper. The aerial is of the inverted L type, single wire, 125 ft. long, not counting the lead-in, which is about 45 to 50 ft. long. The lead-in end of the aerial is pointing north-west, which is about the direction of London. The earth wire goes from the first floor to a water pipe in the garden directly underneath the aerial, but it is not yet soldered, and at the time of receiving 5XX it was simply twisted around the pipe.

Now, in case somebody says that this was a freak result, due to re-radiation from a valve set, let me say at once that it was nothing of the sort. The nearest valve set is about half-a-mile away. Reception conditions in this part of the world appear to be exceptionally good, as is indicated by the results referred to, and any chance of re-radiation effect is ruled out by the fact that there is no valve set in the immediate neighbourhood, the nearest being several miles away. I also received London and Paris again

lately, but London was not so good as before. It sounded like the usual Sunday night service from St. Martin's, and the choir was quite distinct. I could not get 5XX while Lausanne was transmitting, because I could hear Lausanne at 850 metres, 1,700 metres and 2,550 metres. This is a nuisance, and I hope it will not happen when I use the valve set.

I got Radio-Paris one evening at six o'clock, but as there was daylight, I could hear only very faintly.—Yours faithfully,

G. HOFER.

Vevey La Tour, Switzerland.

THE FAMILY FOUR-VALVE RECEIVER

SIR,—I have just completed the Family Four-Valve Receiver and followed Mr. Percy W. Harris's instructions as given in Radio Press Envelope No. 2.

I had previously made up a two-valve set, which was my first attempt at wireless, and this was successful, but the four-valve set is a wonderful instrument. I simply started it from instructions given, and followed out every detail with the exception of the panel, which I made from a piece of ebonite 24 in. by 10 in., and not wood as in instructions. I did not have one failure whatever, and as soon as I

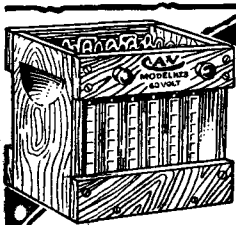

Experience Tells!

The superiority of secondary H.T. cells over the low capacity dry types is now more widely recognised. The crackling noises due

to chemical action in the dry batteries are eliminated, and they give a consistent discharge over a long period.

60 Volt H.T. ACCUMULATOR £3.

Write for catalogue of C.A.V. Wireless Accumulators, Loud Speakers and Transformers.



NEW VALVES FOR OLD!

Whenever your valves burn out or filaments are damaged in any way, send them to us and we will repair them equal to new. Perfect reception is guaranteed with our repaired valves, which are returned to you

WITHIN SEVEN DAYS

D.E '06, 12/6. D.E 2v. '25 to '3 amp., 10/6
Price List for Power Valves on application.

Liberal discount to Wireless Agents. Terms on application.

The North London Valve Repairing Co.

22½, Cazenove Road, Stoke Newington, N.16.
WE ARE ALWAYS AT YOUR SERVICE.

PRICE
6/6
Post FREE
(Bright Emitters)

BOWYER-LOWE TESTED PARTS

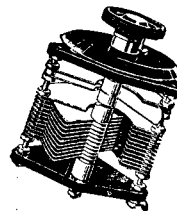

SELECTIVE

Designed with moving plates smaller than those in ordinary condensers, the Bowyer-Lowe Square Law Condenser has lowest losses yet obtained. Richer music, greater wavelength range and selectivity are given to any set in which it is installed. Test it in the instrument you are making. Ask for it by name at your dealer's or order direct.

Bowyer-Lowe SQUARE LAW CONDENSERS

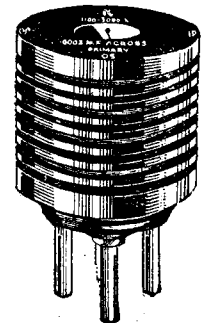

MATCHED H.F. TRANSFORMERS

Every one in a range matches every other perfectly. All terminals clearly marked. All ranges from 150 to 3000 metres supplied. These transformers cost less. They give better service because the matching guarantee means extra care in manufacture. All ranges same price. Order direct 7/- or from your dealer.

HOW TO MAKE A SEVEN VALVE SUPER HET.

Circuit diagrams, progressive wiring photographs and full instructions for building a new Super Heterodyne Receiver with all English components and Bowyer-Lowe INTERMEDIATE WAVELENGTH TRANSFORMERS. Send for this book, or get it from your dealer to-day. Price **6d.**

MAKE SUCCESSFUL SETS

Bowyer-Lowe Co. Ltd. Radio Works, Letchworth

had the last connection complete I was anxious to try it. I received 2LO right away and can get practically any station. Paris on the loud-speaker is perfect. I am so delighted with the results that I take the first opportunity to write you a few lines. Anyone else who wants to possess a good four-valve set should construct one of these.—Yours faithfully,
Sutton Coldfield. E. FRANCE.

AN EFFICIENT SINGLE-VALVE RECEIVER

SIR,—I am writing to tell you of the excellent results I get from the single valve set described by Herbert K. Simpson in the June, 1924, number of *Modern Wireless*. I use the set here off a "Ducon" plug in a wall socket and a short earth to an old gas pipe. The valve used is a D.E.3 with a 4-volt accumulator. The condenser is a Sterling Square Law with vernier, the latter being a great help. The set otherwise is exactly built to the original specification, and the results are as follows: Brussels just readable on one valve, excellent with one-stage L.F.; Liverpool slightly better than above; London weak; Manchester of course very loud, and with one-stage L.F. works a Pathé loud-speaker; Newcastle, the same as Liverpool; Birmingham, quite

O.K. on one-stage L.F.; Chelmsford, not so good as one would expect; Radiola, just readable.

Now, with a set of this kind I consider this performance rather wonderful. I have not tried the set on an outdoor aerial yet. On all the stations mentioned above I do not get a whisper from 2ZY, though it is only two miles away.—Yours faithfully,

R. A. GROSVENOR.

Pendleton.

THE ALL-CONCERT RECEIVER

SIR,—I am writing to thank you for the splendid results I am getting from my "All Concert" described in "Twelve Tested Wireless Sets," by Mr. Percy W. Harris.

It is made up from the best of parts, and, considering I am only 15 and have only been at radio for a year, I think the following are good results:—6BM, 2LO, 5XX, 5NO, 5SC, and 5WA, all on a "Baby Sterling" all over the house; 5WA faint, SFR, PTT and Petit Parisien good L.S. strength. Radiofonica and Frankfurt faint L.S. Valves, H.F. Cossor, Detector Mullard, L.F. Marconi, 60 volts H.T.; aerial 25 ft. high, 52 ft. long; single wire, badly screened, and long lead to earth.—Yours faithfully,

C. LIVERMORE.

Southsea, Hants.

A FIVE-VALVE SUPER-HETERO-DYNE RECEIVER

SIR,—I am writing re results with the above set (*Wireless Weekly*, December 24, 1924). I have added an intermediate stage on the long-wave side, making a six-valve set. The results are wonderful, not so much as regards volume, but selectivity. The local station 2ZY (one mile away) can be tuned out and 2LO tuned in. When I say tuned out I mean he is minus, not a faint background of him, as is the case in a normal selective set. I am not going to compile a list of stations received to date, but I have heard all B.B.C. (including relay), most of Continental and, last but not least, KDKA on 68 metres. I have also received 88F1 on speech around 100 metres (11 p.m., March 29, 1925).

I am writing chiefly on account of the short-wave reception, as I think you will be interested. KDKA, by the way, is regular, but he is getting weaker every night. I use a short indoor aerial coupled to a low-loss coil for the short waves, and a 30-in. frame for 300-600 band. I have been a reader of your papers for about two years, and think they are the best of their kind.—Yours faithfully,

A REGULAR READER.

Hulme.



Do it now—

MAKE YOUR SET SELECTIVE by using

"Tangent" Tuning Coils

Scientific users of Tuning Coils will tell you they always employ "The Tangent."
Note the Self Capacity figures—then try the Coils.

Coil No. - -	25	35	50	75	100	150	200	250
Self Capacity in Micro-Microfarads	8	9	25	31	22	16	22	22
Price, each -	4/3	4/3	4/3	4/6	5/-	6/-	7/-	7/6

COMPLETE SETS { 4 Concert Coils (W/L 250 to 1180)—16/- the set.
11 Concert Coils (W/L 250 to 9500)—67/- the set.

All good dealers stock them—
: any difficulty write us. :



UNSHROUDED EFFICIENCY



RIGID AS A MOTOR WHEEL.

GENT & Co LTD (Est. 1872.)
Manufacturing Electrical Engineers
**FARADAY WORKS,
LEICESTER**

London: 25, Victoria St., S.W.1
Newcastle/Tyne: Tangent House, Blackett St.



A Wireless Magazine compiled by Experts

THE WIRELESS CONSTRUCTOR, as everyone knows, is the leading magazine of its kind in wireless and it has done more to popularise this ever-growing hobby than any other journal or institution. The original circuits, the varied and compact sets, the economical methods of assembling, the numerous hints and tips on operating, etc., and the confidence of the public in Radio Press, Ltd., are all great factors in explanation of the huge sale of over a quarter of a million copies per month. Among this vast number of readers, there is included a big representation of all grades of enthusiasts and no one would feel out of his depth when perusing a copy.

It is ideal for the beginner, the listener-in, the amateur, the experimenter and even the expert.

Percy W. Harris, M.I.R.E., the well-known constructional expert of Radio Press, Ltd., contributes an interesting article describing a "THREE-VALVE PORTABLE SET" to the Great New Issue of "THE WIRELESS CONSTRUCTOR." NOW ON SALE EVERYWHERE.

This receiver will bring in all main B.C. Stations on an average G.P.O. Aerial, while on the smallest outdoor Aerial, or even a frame will give you the nearest station splendidly. It is of great interest to all builders of sets and a Free Blue Print of the wiring is enclosed with every copy.

A Small Selection from CONTENTS.

HOW TO MAKE :
A THREE-VALVE PORTABLE SET.

By Percy W. Harris, M.I.R.E.

A TWO-VALVE RECEIVER FOR DISTANT RECEPTION

By John W. Barber.

A SIMPLE SET FOR THE INVALID.

By Stanley G. Ratten, M.I.R.E.

A MIDGET SINGLE-VALVE RECEIVER. *By A. S. Clark.*

SECRETS OF LONG DISTANCE WORKING.

By Percy W. Harris, M.I.R.E.

STRANGE INSTRUMENTS BEFORE THE MICROPHONE. *By "Carrier-Wave."*

NOTES ON FRAME AERIALS. A TALK ABOUT CAT-WHISKERS.

CARBORUNDUM AS A WIRELESS CRYSTAL.

Hundreds of Practical Hints and Tips for the beginner.

*Build with Minimum Cost and Maximum Efficiency
by buying a copy of the current issue of:—*

FREE BLUE
PRINT WITH
EVERY COPY.

The Wireless Constructor

NOW
ON SALE
EVERYWHERE.



Tone—not merely clear and accurate tone, but tone that has the full richness and depth of quality distinguishable by the master musician in his own instrument.

Volume and distance are easy to the majority of transformers, but the power of **perfect reproduction** is practically unknown. A note is reproduced technically correct—correct because it remains the same note that was transmitted—in other words, its pitch is correct, but it is a thin, poor specimen of the real thing; it is, in fact, a mere imitation that has lost all the intimate personality of the instrument and its master, for the secret of musical architecture lies in the attendant delicate overtones.

If you wish to test the difference these overtones make, replace your present transformer by an R.I.; immediately you will identify the character of your tone—rich, sweet, resonant and free from all blurring background noises.

Perfect and full in quality, the very reality of the producer appeals to you, and the reason is so easy to understand. *The R.I. transformer is built with interleaving sections designed to give maximum amplification and yet to control that energy in just the right sort of way to keep the self-capacity down so that it will not injure those beautiful overtones that create the sense of fine music.*

And again remember the **R.I. Transformer prevents interaction**; three side by side work perfectly and preserve the smooth running of your receiver, producing no radiation whatever.

These are the points that are worth considering if you want better reproduction.



Free booklet on request.



The R.I. Transformer

25/-

12 HYDE ST! NEW OXFORD ST! LONDON W.C.1.

Contractors to the Admiralty and all Government Departments.

Printed for the Proprietors, RADIO PRESS, LTD., Bush House, Aldwych, W.C.2, by THE AVENUE PRESS (L. Upcott Gill & Son, Ltd.), 55-57, Drury Lane, London W.C.2. Published on Wednesday of each week at 3, Bolt Court, Fleet Street, London, E.C.4. Address for Subscriptions and Editorial Communications:—Bush House, Strand, London, W.C. Advertisement Managers:—BARCLAYS ADVERTISING LTD., Bush House, Strand, London, W.C.2. Registered as a newspaper and for transmission by Canadian Magazine Post. Subscription rates:—32/6 per annum, 16/3 for six months post free. Sole Agents for Australasia:—GORDON & GOTCH (Australasia), LTD. For Canada:—IMPERIAL NEWS LTD. For South Africa:—CENTRAL NEWS AGENCY, LTD. For Japan:—SALE & PRAZAR, LTD.

Wireless Weekly

Vol. 6. No. 4.



The Rome Station Described



Choose one of these loud speakers

*you will surely be satisfied
with the ETHOVOX or
the BURNDIPT JUNIOR*



*The
Ethovox.*

BOTH the Ethovox and the Burndept Junior are good loud speakers—which of them you will choose will be influenced only by your requirements and your means. Go to the nearest Burndept Agent and ask him to let you hear them in operation.

The Ethovox is known all over the world as a loud speaker capable of giving great volume without distortion. It has a beautiful, deep, mellow tone and reproduces music and speech perfectly. In appearance it is very pleasing, the swan-neck and flair being gracefully curved and coloured a rich mahogany shade. The diaphragm is adjustable. Height, 26 inches.

No. 203 (120 ohms resistance) or **No. 204** (2,000 ohms resistance), **£5.**

The Burndept Junior is sweet-toned and gives quite sufficient volume of sound for ordinary domestic requirements. It costs little more than the price of two pairs of good headphones. The adjustable diaphragm is of the "floating" pattern. The Burndept Junior has a neat black crystalline finish and is 19 inches in height.

No. 331 (2,000 ohms resistance) **£2 15s.**



*The
Burndept
Junior*

BURNDIPT

WIRELESS LIMITED

Aldine House, Bedford Street, Strand, London, W.C.2.

Telephone: Gerrard 9072.

LEEDS: 12, Basinghall Street.

BIRMINGHAM: Winchester House, Victoria Square.

NORTHAMPTON: 10, The Drapery.

Telegrams: Burndept, Westrand, London.

CARDIFF: 67, Queen Street.

NEWCASTLE: 17, Lisle Street.

Assistant Editor :
Percy W. Harris,
 M.I.R.E.
Scientific Advisor :
Prof. G. W. O. Howe,
 D.Sc., M.I.E.E.
Advisory Editors :
Prof. R. Whiddington,
 M.A., D.Sc.
Prof. C. L. Fortescue,
 M.A., M.I.E.E.

Wireless Weekly

Phone: City, 9911.

Staff Editors :
E. H. Chapman,
 M.A., D.Sc.
A. D. Cowper,
 M.Sc.
R. W. Hallows,
 M.A.
G. P. Kendall,
 B.Sc.
Stanley G. Rattee,
 M.I.R.E.

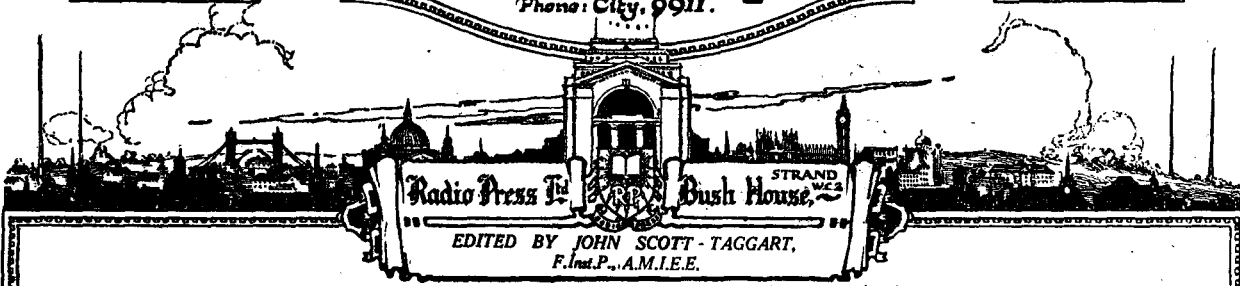

Mr. Godfrey Isaacs

ON Friday, April 17, just as the reconditioned airship R33 was returning safely to her moorings after a thrilling struggle with the elements, demonstrating once again the inestimable value of wireless, there passed away one who, though neither scientist nor technician, had an influence equalled by few other people on the development of the great art of radio communication. Godfrey Charles Isaacs, brother of Lord Reading, and one of the nine children of a fruit and ship broker in London, accepted in 1910 the invitation of Mr. Marconi to become Managing Director of Marconi's Wireless Telegraph Co., Ltd., at a time when sound business organisation of the firm was badly needed. This position he held until November last. At the time of his joining, although the capital of the Company had been increased on several occasions, not a penny of dividend had been paid. The subsequent success of the Company is too well known to need comment, and although opinions may differ as to the wisdom of the Company's policy in certain matters during Mr. Isaacs' tenure of office, none will deny that the success of the organisation was largely due to the remarkable vision, enthu-

siasm and real hard work of the Managing Director himself. A knowledge of the technique of wireless telegraphy and telephony has long ceased to be the monopoly of any one company. After all, the possession of technical knowledge and the proper utilisation of it are two separate and distinct affairs. In the early

less companies, the promoters basing all their hopes upon the technical knowledge possessed by one or two people, forgetting that in the business world such knowledge unaided is useless. Sound organisation and skilled administration are as vital in a wireless company as in any other business. A recent proof of the success which will attend adequate attention to such matters is given by the success of the Burndept share issue. Begun a few years ago as a side-line to another business, and aiming to supply sound apparatus to the few enthusiasts who were then making a hobby of wireless telegraphy, the company rapidly adapted itself to the new conditions of broadcasting and succeeded in building up the confidence of the public so that when further capital was needed the issue was immediately over-subscribed. To gain public confidence should be the first aim of every wireless company, and this confidence cannot be built up by exaggerated claims or flamboyant statements. A good product or products, adequately and persistently advertised, the maintenance of the quality and a courteous service to the customer are essential contributing factors. Given these, success is practically assured.

CONTENTS.

	Page
Editorial	95
Stazione di Roma	96
The International Amateur Radio Conference	98
Reception Conditions Week by Week	100
Jottings By The Way	101
A Useful Application of the Weston Relay	103
Test Your Own Valves	104
Low-Loss Inductances	109
A New Receiver for Modern Conditions	110
H.F. Transformer Efficiency	115
Correspondence	123
Apparatus We Have Tested	129
Information Department	131

days, with limited experience of the art, the commercial application of wireless was practically confined to the one company, but this period has long since passed, and a wealth of technical information is available to all who care to seek for it.

In the past many attempts have been made to launch wire-

STAZIONE di ROMA

By
Frank H. Sharman

*A short account of the famous
Italian station and its studio.*

BRROADCASTING in Italy is at present running none too smoothly. Last August a company was formed in Rome under the name of "Unione Radiofonica Italiana," with a capital of 1.4 million Lire. In December this company was given the exclusive right of broadcasting to extend over a period of six years.

For each station that is now erected the Unione Radiofonica Italiana (U.R.I.) has to pay 15,000 Lire per annum to the Government. As is usually the case where a monopoly is concerned, prices are high, and the Italians have every reason to be dissatisfied with the licensing regulations. The Rome broadcasting station officially started transmitting on October 6, 1924, and other stations are likely to be erected at Palermo, Milano and Naples. "1RO," Rome, is

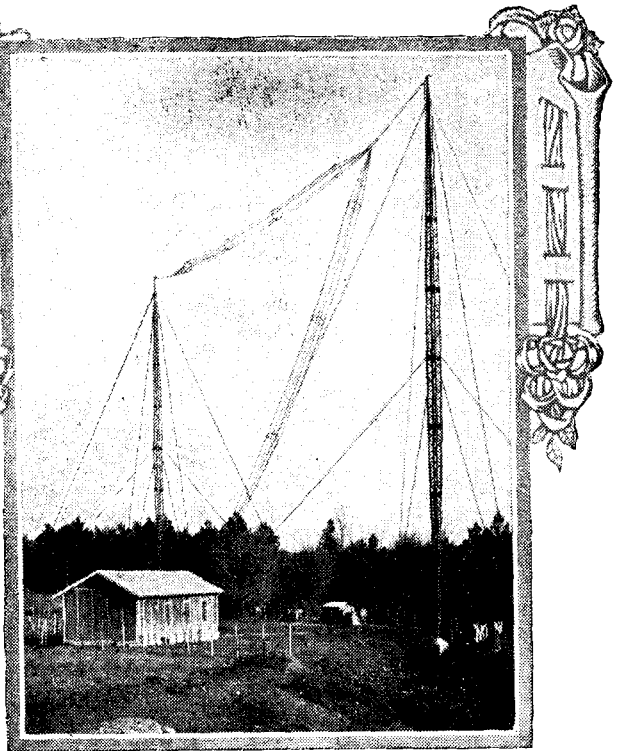

The slender masts at the Rome station are 120 feet in height.

a type "Q" Marconi station, similar to those at London and Brussels. The wavelength was at first 422 metres, but owing to interference from Berlin (then transmitting on 430 metres) and also from the Glasgow station on 420 metres, this wavelength was changed to 425 metres, the present one. The power is obtained from a 6-kw. 300-cycle alternator, giving 500 volts, 15 amperes. This voltage is transformed up to

20,000 volts and rectified, which supplies 10,000 volts high-tension for the anodes. The energy in the aerial is about 2 kw, with 107 amperes. The aerial, as can be seen from the photograph, is of the inverted "L" cage type. It is a 4-wire cage of 3ft. diameter.

The Aerial

This is suspended between two wooden lattice masts 120 ft. high, 150 ft. apart. Underneath the aerial the transmitting shed is seen, the roof of this being 17 ft. high. Parts of the transmitter are seen in the photographs. The earthing system consists of 36 strands of copper wire 2 mm. thick, buried in the ground underneath the aerial.

The Earthing System

These are spread out in all directions in a radius of 150 ft. To each of these strands is soldered a galvanised metal sheet, 18 sq. ft. in area, buried vertically in the ground in a semi-circle of 50 ft. radius. The aerial and transmitter are situated at San Filippo, which is two miles away from the studio, this site being chosen on account of freedom from metallic masses. The studio

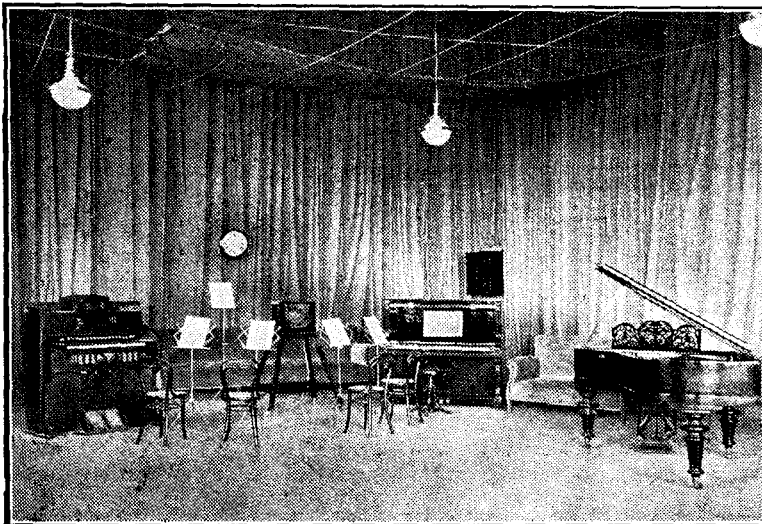

The large and handsomely decorated studio from which many British listeners are entertained throughout the year.

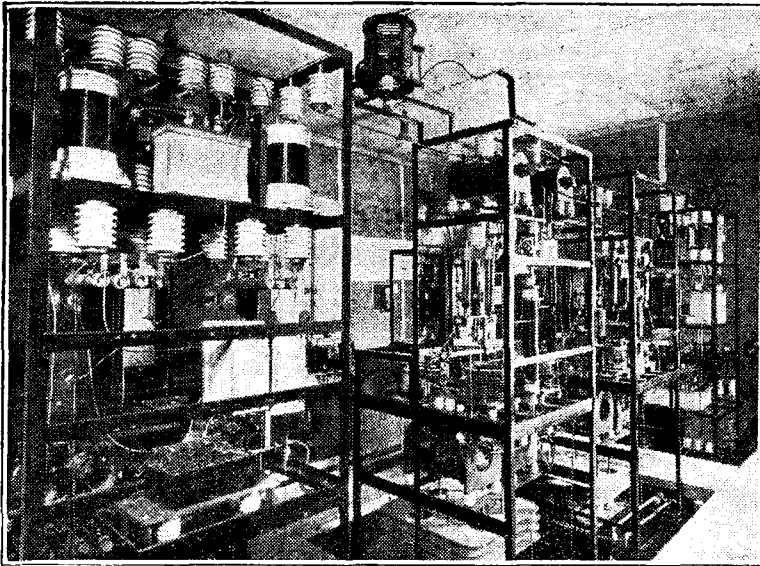

A part of the transmitting plant at the Rome station which readers will recognise as being of Marconi design.

is in Rome via Maria Cristina, and is joined to the transmitter by three special telephone lines, one joining the microphone to the transmitter, one in case of emergency, and the third for telephone communication. The studio has an area of 980 sq. ft. and is carefully draped to give the most natural tone to the concerts. A Round microphone is used, mounted on a stand fitted with wheels, so that any part of the studio can be reached at will.

The Studio

The microphone can be seen in the photograph. The amplifier, of which a photograph is also shown, consists of three panels. On the right-hand panel a long pencil-like extension handle is seen. This is a potentiometer, by the means of which the modulation is controlled. The left-hand panel contains the microphone transformer. Marconi valves are used throughout. Above these panels another piece of apparatus is seen. This is a special amplifier for use when broadcasting from theatres, etc. The engineer in charge of the control room keeps in touch with those in the studio by means of a glass window connecting the two rooms.

Results

The range of this station is very great, and is well known to all British DX enthusiasts. It is regularly heard "strong and clear" by an American amateur

at Marshall, Texas, U.S.A., owning a Neutrodyne set. Madame Tetrzini sang from the station in December, and reports of having heard her were received from all over Italy, Central Europe, England and America.

Call Sign

The call sign of the station is "Stazione di Roma, Unione Radiofonica Italiana." Usually a lady does the announcing, which gives a clue to the station to those readers who cannot follow Italian.

The programme at present stands as follows:—

- 15.45.—Children's hour.
- 16.15.—Orchestra of the Hotel de Russie.
- 16.40.—Exchange and news.
- 16.45.—Dance music.
- 19.30.—Concert and weather.
- 21.15.—News and exchange.
- 21.30.—Dance music.
- 22.00.—Close down.

The above times are G.M.T. in Continental style, e.g., 15.45 = 3.45 p.m., and are corrected up to February 23, 1925.

"Radio Orario"

The Unione Radiofonica Italiana has an official organ as does the British Broadcasting Co. The name of this weekly paper is *Radio Orario*, and it contains the programmes of all the chief European stations. Reports from all readers tuning in this station would be appreciated, and should be addressed to Unione Radiofonica Italiana, Via Maria Cristina 5, Rome.

The May issue of "Modern Wireless" will contain full details of "How to Make a Nine-Valve Supersonic Heterodyne Receiver," by John Scott-Taggart, F. Inst.P., A.M.I.E.E. This remarkable receiver is the result of many months of experiment and will receive both B.B.C. and Continental stations on a small frame aerial.

**Out on May 1st. Price 1/-.
ORDER YOUR COPY NOW.**

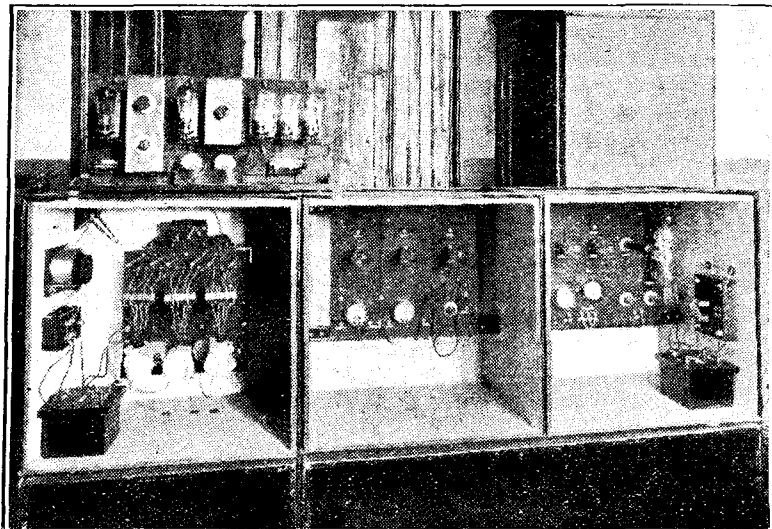

A photograph of the amplifying apparatus. The special amplifier used when broadcasting from theatres or public halls is seen in the top left-hand corner.

The International Amateur Radio Conference

Special Report to "Wireless Weekly."

By G. H. RAMSDEN (6BR).

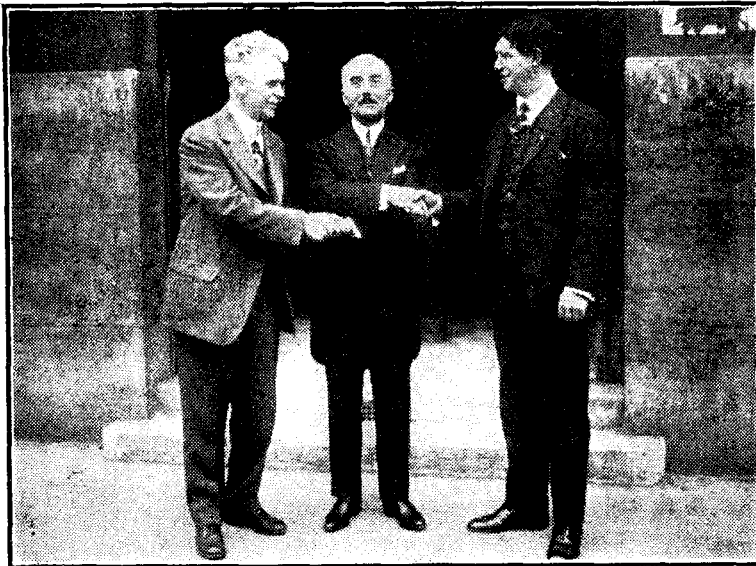

Reading left to right:—Messrs. Hiram P. Maxim, E. Belin, and G. Marcuse, the American, French, and British delegates respectively.



THE first international amateur radio conference, held in Paris from April 14 to April 18, 1925, marks a stage of vast importance in the progress of amateur radio. It was, therefore, gratifying to find an enthusiastic band of English experimenters, led by the official delegate of the Radio Society of Great Britain, Mr. Gerald Marcuse, assembled in the Faculté des Sciences on the opening day.

The President

By unanimous assent Mr. Belin (France) was elected President of the Congress, and Mr. Hiram P. Maxim (President of the American Radio Relay League) and Mr. Marcuse, vice-presidents. General Ferrié, of Eiffel Tower fame, opened the conference and pronounced in his speech a conviction which we all feel; namely, that the development of amateur radio will be a potent aid to world peace, fostering international friendship and mutual understanding.

The President then introduced the five questions which were to form the business of the conference. These were:—

- (I) The organisation of an International Union of Radio Amateurs.

- (II) The organisation of international tests and of amateur two-way working.
- (III) The allocation of amateur wavelengths for inter-continental communication.
- (IV) International language.

- (V) Call Sign books and national prefix letters.

The method of debate was determined by vote. It was decided that committees should be appointed to discuss each question, every country sending one representative to each committee. Reports of the work done by these committees were to be read before the full Congress and their resolutions adopted, with or without amendments, according to vote.

The I.A.R.U.

The formation of an International Amateur Radio Union was the proposal of the A.R.R.L., and Mr. Maxim, as American delegate on the committee which considered the question, read the articles agreed upon to the Congress. After a brief discussion these were adopted and the Union came into being. Its objects are stated to be:—

"The promotion and co-ordi-

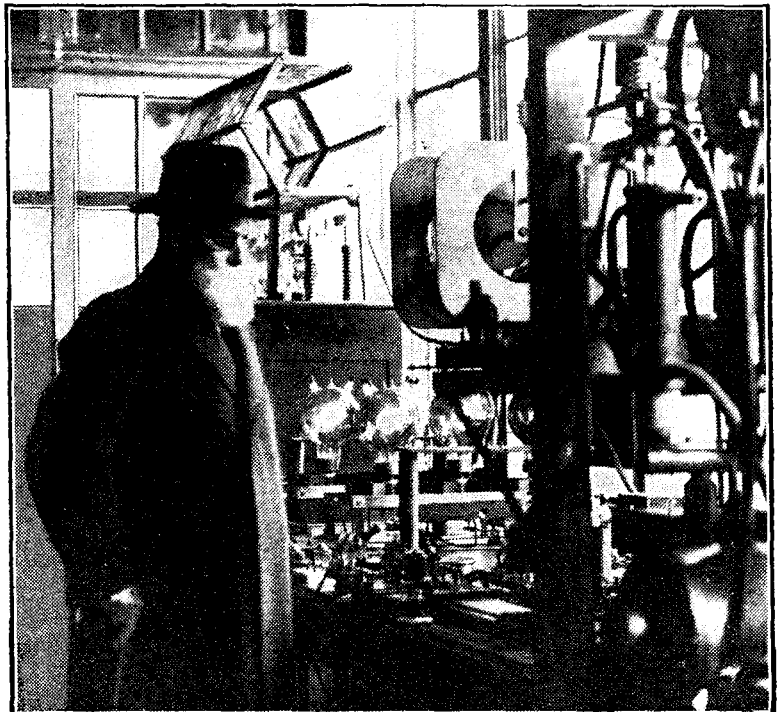

One of the outings of the Conference was a visit to the transmitting room of the Eiffel Tower Station.

A special report upon the proceedings of the International Amateur Radio Conference which was held in Paris from April 14 to 18.



Delegates making an inspection of M. Belin's private station at Malmaison.

nation of free two-way communication between the amateurs of the various countries of the world; the advancement of the radio art; the representation of two-way amateur communication interests in international communication conferences; the encouragement of international fraternalism; and the promotion of such additional activities as may be allied thereto."

All amateurs interested in these objects may become members on the payment of an annual subscription of one dollar. Provisionally, the headquarters of the Union have been allocated at the offices of the A.R.R.L., and the official organ will be "QST" until such a time as finances permit the production of an independent publication.

International President

Mr. Maxim was selected by the Union as international president, and Mr. Marcuse as vice-president.

Questions two and five were referred to the I.A.R.U. for

settlement when that organization should be in a position to consider them. It was recommended that an international list of amateur call-signs should be published and monthly supplements and correction sheets issued.

For the time being the national prefix letters adopted by the Berne Convention of 1912 will be used by transmitting amateurs.

Amateur Wavelengths

The resolutions regarding the allocation of amateur wavelengths for inter-continental working were excellent in themselves. But, though fully approved by the Congress, they must depend upon the govern-

ments concerned for their efficacy. The following wave bands were allotted:—

Metres.	Metres.	
120-115	43 & 41.5	Newfoundland & Canada.
115-95	75-70 & 47-43	Europe.
85-75	41.5-37.3	U.S.A.
95-85	37.3-35	The rest of the world.

All waves above 120 and below 35 metres are open to all transmitters.

On the last day of the conference the question of an international language was considered, and, as might be expected with such a cosmopolitan gathering, gave rise to the keenest contention. The committee had unanimously agreed upon Esperanto for radio use in preference to other natural and artificial tongues, but the cause of English found an able champion in Mr. Ryan (5BV), who pointed out that English and jargon English was already established as a conversational medium among the world's transmitters: The Swedish delegate also objected on the grounds of impracticability for telegraphy and the difficulty of acquisition in his own country where English was well known. It remained for Dr. Pierre Corret to turn the tables by a compromising speech in which he reminded the Congress that the A.R.R.L. had provisionally adopted Esperanto in spite of its defects, as the only international language able to supply a pressing need.

(Concluded on page 108)

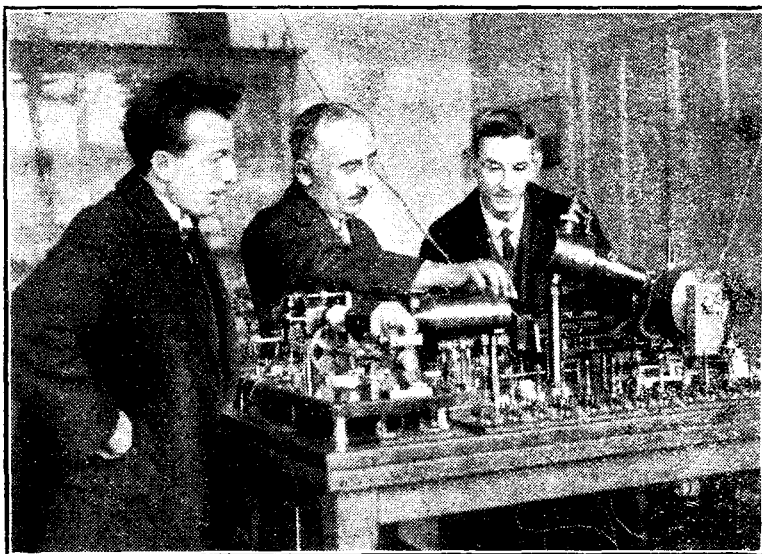

M. Belin explaining the working of his tele-photography apparatus, a description of which was given in "Modern Wireless," Sept., 1923.

Reception Conditions Week by Week

By W. K. ALFORD.

Review of reception for week ended April 19.

THE general conditions for reception are becoming uniformly and gradually worse with the approach of the summer months, and there is little hope of respite from the very heavy "X" storms which have been particularly prevalent during the recent period of high winds. The effect of high winds in producing bad atmospherics is not recognised by most people who associate "X's" primarily with thunderstorms, but a very high state of electrification of the atmosphere is often reached during high winds, especially if rain is falling at the same time.

Weak Signals

There is very little enjoyment to be got from listening to weak and distant stations under these conditions, and during the last week most people could only get reasonable satisfaction by listening to the local broadcasting station.

A large number of people in the London area who possess apparatus of a type which gives good results on distant stations are feeling the effect of the higher-powered London station which, in a large number of cases, now precludes the reception of Bournemouth or Manchester, which could be received quite satisfactorily under the old conditions. The vast majority of listeners are, however, highly delighted with the new station, and the minority must needs give in. This brings us to the growing outcry for a second London station, but it is to be hoped that before any serious suggestions are made in this direction full consideration will be given to the possibility of over-congestion of the broadcast wavelengths which has been discussed previously in these columns. The daily Press are the chief agitators in the matter, and their reports are compiled without the least foresight by persons who apparently



Mr. Hiram Percy Maxim, who was unanimously elected President of the International Amateur Radio Union during the Paris Conference.

have only recently taken up the Radio science as a source of "copy."

The New 2LO Station

I have heard from several technical people in the London area that the new station is overmodulating its transmissions, with a consequent deterioration of the quality. I am situated too far away to give a definite opinion on the subject, but I say without fear of contradiction that the present standard of quality has not reached that of the old station, although the strength of the transmission has, and is, increasing. In this matter the B.B.C. is without doubt considering the vast number of "crystal" users whose sets call for a certain amount of over-modulation as distinct from more powerful valve sets.

20 Metres

The attention of everybody interested in the advancement of the Radio science is being focussed on the extraordinary things which are being done on ultra-short wavelengths of 20 metres and less. It is now possible to communicate with stations in America in broad daylight with powers of 100 watts and less, and the strength of several of the

Americans is quite astounding, particularly IXAM and NKF, the latter station being particularly useful for experimenters over here, as he gives his wavelength almost invariably with each transmission. As a further guide for experimental people who may be interested in reception on these wavelengths, it may be stated that the harmonics of several of the B.B.C. stations can be picked up quite easily. These harmonics occur at $\frac{1}{2}$, $\frac{1}{3}$, $\frac{1}{4}$, etc., of the fundamental wavelength of the station, and therefore act as a most useful guide as to "where you are."

It is rather a humorous fact that the wavelength of a Ford car is in the vicinity of twenty metres; in other words, the ignition system can be heard nearly 100 yards away!

I expect quite a large number of readers listened to the messages passing to and from the R33 while on her runaway trip. Her signals were very strong during the whole period, but were much cut about by atmospherics. It was particularly interesting to hear the reports of her position from time to time, culminating in her final statement—"Making for home."

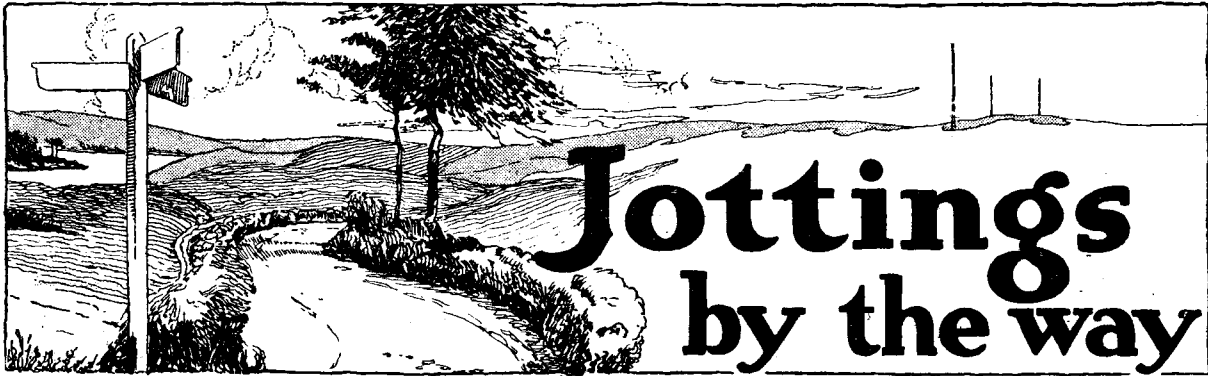

To the Rescue

For some little time I had been roticing an announcement that the Inquiry Department was so snowed under with work that it would be impossible for it to deal for the present with any fresh problems. At first this little notice struck no responsive chord in me at all. I merely read it, said to myself, "Dear, dear," and thought no more about it. Then quite suddenly a thought came to my mind. "By Jove!" I said to myself, "those fellows in the Inquiry Department must be overworked! The best thing that I can do is to go to the office and lend them a helping hand."

A Noble Idea

This was such a noble idea that I made it my daily good resolution for three weeks. Then one fair morn, when spring-cleaning fever had descended upon my household, I sent a wire, "Buck up! Help is coming," and after a hasty breakfast, dashed to the station, which I reached just in time to catch the 12.50. I always maintain that there is nothing like an early start. On

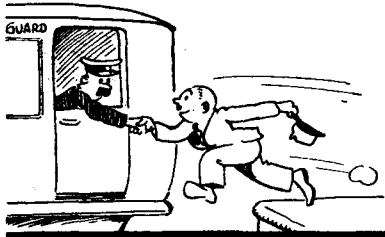

I just caught the 12.50

reaching London I remembered that I required a new gridleak, and when I had done the round of the wireless shops, I felt that it was of no use going to the office that day, so sending another cheering wire I returned home. The next day I awoke filled with

the determination to render personal service. I duly reached the office, and walking into the Inquiry Department announced that I had arrived.

Really, you know, some people have curious ways of showing

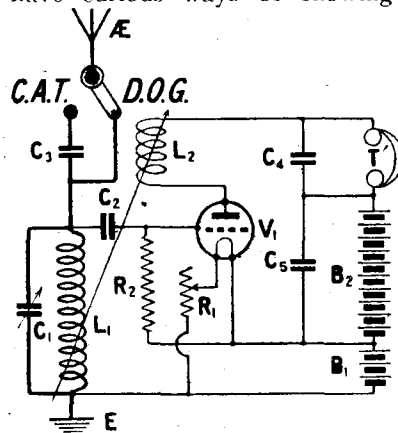

Fig. 1.—A circuit incorporating the C.A.T. and the "Direct on Grid" methods of tuning.

their gratitude. Though I hardly expected the overworked staff to rise as one man and fling its combined arms round my neck, I did look for a pretty warm welcome.

Blessed is he . . .

And did I get it? All that happened was that one fellow looked up and said, "Get out. We're busy." I did not get out. Instead, assuming my most winning smile, I advanced towards him with outstretched hand and remarked: "My poor fellow, you are overwrought. Your nerves are all on edge. You are not at all yourself. I do not take offence. Nay, I forgive you freely. But cheer up; your cares are ended, for I have come to lighten your burden. In other words, heave me over a pile of your queries and they shall be answered as they should be by no less a person than myself." The chap simply grunted, indi-

cated a chair, and hurled a pile of letters in my direction. I sat down without further ado and got to work, observing with a sigh of resignation that all postal orders had been removed. Sheer jealousy has made the Inquiry Department refuse to print my answers under the usual heading. I therefore score off these people by giving them in my own columns. Are you ready? Go!

Acid Stains

PERCY W., OF WOLVERHAMPTON, asks to be told how to remove acid stains from a carpet. Naughty boy, Percy; you have been throwing the accumulator at the cat again. As a matter of fact, it is impossible to remove acid stains from the carpet, though it is quite simple to remove the carpet from the stains. To do this, drive tinnacks into the floor through the stained patches, then cut round them with a sharp knife, and lift the carpet. If you do not care about this rather drastic method, make up the following solution:—

- Beer . . . 1 part.
- More beer . . . 2 parts.

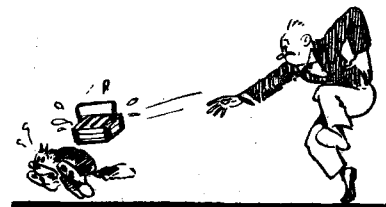

Naughty boy, Percy!

Provide yourself with a stiff brush, pour the solution into a bucket, take up a position upon the carpet and put on a busy look. When the coast is clear, drink the solution and send the carpet to the cleaners.

A C.A.T. Query

HORACE HOBBLEFORTH, OF BERMONDSEY, asks whether he

can use C.A.T. with a single-valve set. Certainly. We do not recommend C.A.T. for use with crystal sets, since whisker problems may arise (see reply to BEAVER); but with the single valve set it is excellent, enabling the set to be used upon any aerial that is fit to be called an aerial without altering the calibration (if any). Though the present writer hates blowing his own trumpet, he cannot refrain from mentioning the great advantages of the Goop-Wayfarer D.O.G. modification of the C.A.T. system (see Fig. 1). C.A.T. stands, as you know, for Constant Aerial Tuning. The letters D.O.G. are short for Direct On Grid. The great advantage of using both the C.A.T. and D.O.G. is that it gives you two entirely different calibrations for the set, and so provides endless amusement in moments which would otherwise be dull. Again, if a sceptical friend calls round to hear the set, you can always tune in Birmingham or some other near-by station using D.O.G., and then inform him that it is Rome or Belfast. If he looks as though he did not believe you, all you have to do is to show him your C.A.T. calibration table.

A Set from Odds and Ends

"I have a piece of crystal and a single telephone earpiece," writes "PERSEVERING" from SCARBOROUGH. "Can I construct a crystal receiver from these components without buying anything else?" You have set us an easy problem. The writer has frequently made a five-valve set (without buying anything) from nothing more elaborate than a gridleak. Success depends entirely upon your power of winning the confidence of your friends. You can easily acquire the correct facial expressions for the purpose by constant attendance at the movies. Having perfected yourself in this department, call upon friend after friend, borrowing here a variable condenser, there a fixed, here a detector, there a coil. The writer frequently finds it best to do his borrowing while the backs of so-called friends are turned. The panel for the set may be rather a problem, but you can make quite a good one from a slate borrowed from your next-door neighbour's roof. Slate is

easy to drill, though it is inadvisable to use one's own tools for the purpose, since it is apt to diminish their cutting power. You will doubtless be able to find some friend who possesses a No. 26 drill. Having acquired your components and the necessary slate, visit some friend or acquaintance who is an enthusiastic



Whiskers provide many problems in wireless

constructor. If you talk to him properly and display the right amount of helplessness, eagerness and distress, he will probably stick the things together for you and do the wiring. The writer once had an umpteen valve super-heterodyne wired up for him by collecting a number of friends and suggesting a soldering competition.

A Novel Problem

"I am a crystal enthusiast," writes "BEAVER" from WIGAN, "but though I have been getting very good results, I am very much worried at the present time by the whisker problem." It used to worry us, too, a good deal at one time. Long experience has shown that the problem is best solved with the help of a safety razor. Whiskers are seldom satisfactory, for they are



A small hatchet is a very useful tool

so apt to get caught up by the moving plates of one's variable condenser. The writer had a friend once who had his turned a bright emerald green by inadvertently allowing them to dangle in the electrolyte whilst he was engaged in examining his accumulator. He was never the same man again. Other whisker problems are furnished by the squiggly things in the detector and the whiskers which grow

upon the jokes made by entertainers and concert-party funny men. Taken as a whole, whiskers provide many of the greatest difficulties in wireless at the present time.

A Trans-Atlantic Query

"My neighbour," writes G. WASHINGTON, from IPSWICH, "tells me that he gets WGY every night on a crystal. Why cannot I do the same thing?" Your name, in the first place, is against you. Had it been Ananias the thing would have been simplicity itself. We believe that your neighbour's success annoys you more than your own lack of success. A former G. Washington, who achieved a certain measure of notoriety, did excellent work with a small hatchet. His objective was an apple tree. Surely you have a wood-chopper about the place, and do not you think that your neighbour's mast is asking for it? Just think it over, George. We are quite sure that if you do the nuisance will shortly be abated. If you do not possess a chopper, another method is to sandbag the neighbour, or, again, you may set fire to his house. These, however, are perhaps rather violent methods, and we hesitate to advocate them, since we have always held that the wireless man is above all things a perfect gentleman.

WIRELESS WAYFARER.

THE R.33

A Post Office Warning

The Postmaster - General's attention has been called to the fact that during the recent flight of the R.33 communication between the airship and the Croydon and Pulham aerodromes was seriously impeded by oscillation from wireless receiving sets.

The consequences which might result from interference with communication with aircraft in danger are very grave and the Postmaster-General warns the owners of wireless receiving sets that the use of reaction to such an extent as to cause interference is an offence which directly contravenes one of the conditions of their wireless licences, and renders the licence subject to withdrawal.

A USEFUL APPLICATION OF THE WESTON RELAY

By H. WARWICK.

Details are here given of how to construct the remote control unit described in our April 15 issue.

The Circuit

This has been dealt with before, but only in conjunction with a receiving set and batteries. Fig. 1 shows these separated, the left half of the diagram indicating the connections to the last valve of a receiver, and the right half the additional connection of the distant control unit.

List of Components

The following were used, but values may vary as indicated previously.

One Weston Relay (ex-Government Disposals Stores).

One high-resistance. (Several of different makes were tried and found to be satisfactory.)

One high-resistance, 50,000 ohms.

One piece of ebonite, 6 in. x 4 in. x $\frac{1}{4}$ in. (American Hard Rubber Co.)

One dozen terminals.

One fixed condenser, .25 μ F (T.C.C.).

One cabinet to take panel 6 in. x 4 in. and 4 in. in depth (Carrington Manufacturing Co., Ltd.).

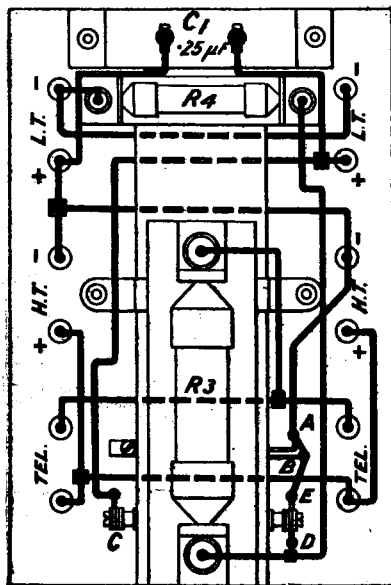

This figure should be followed closely in order to ensure correct functioning of the instrument.

One packet Radio Press panel transfers.

Assembly of Components

On the outer sides and near the poles of the magnet forming the outer portion of the relay are two screws, one on either side. In the normal course of events these would effectually prevent the relay from being placed flat against the panel. It was not found difficult, with the aid of a

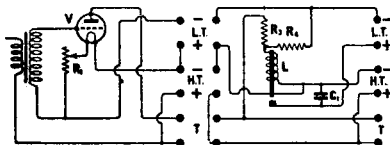

Fig. 1. — Theoretical diagram of connections between the receiver and unit.

large diameter drill with a flat nose to make a hole of sufficient depth, even with $\frac{1}{4}$ -in. thick ebonite to accommodate the heads. The actual holding device consists of a strip of springy brass placed across the magnet and held in position by two countersunk screws taken through the panel. The resistances are held by stiff wire in the positions shown.

Wiring

If the above method is adopted for mounting the resistance units, wire of a heavy gauge must be used to hold them in position. No. 16 gauge square tinned copper wire will serve admirably for this purpose.

As to the actual connections, every care has been taken by the aid of photographs and diagrams to make them as clear as possible, and no great difficulty should be experienced in wiring up the unit.

Testing of Instrument

Battery connections should first be made to the terminals on the right of the panel, and then connecting links should be made between all terminals on the left to their respective terminals on the receiver.

Lastly, the head-phones or

loud-speaker should be attached, when, if the filament resistances of the valves are in an "on" position and the H.T. battery plugged in, the set should begin to function.

If failure results it is probably due to the too great spacing of the contacts. This may be rectified by means of the adjustable screw. It will be found that the contacts will have to be very close indeed to obtain completely satisfactory working. When switching on has been accomplished successfully it may be found that although signals are being received they are much weaker than usual. This will be immediately and completely rectified by reversing the connections between telephone terminals on set and those on control unit.

Next try switching "off." Should trouble be experienced the probability is that the contacts are sticking, and a lower value of R_4 should be tried. If it is found that a much lower value must be used, R_3 will have to be decreased or the H.T. voltage increased.

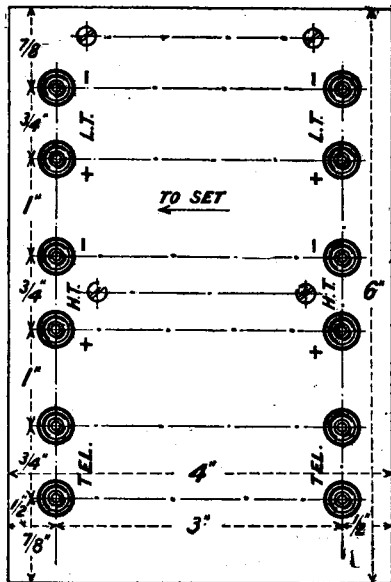

The ebonite panel is drilled to the dimensions shown above.

Test Your Own Valves

How Characteristic Curves May be Prepared at Home.

By **PERCY W. HARRIS,**
M.I.R.E.,
Assistant Editor.

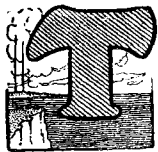

THE man who attempts to obtain efficient reproduction of wireless speech and music without at the same time having a knowledge of the characteristics of the valves he is using, is in much the same position as a man who strives to select a key from a bunch in the darkness. To the uninitiated the terms "characteristic curve" may seem formidable, but in reality it is a form of chart which can be understood by almost everyone after a few minutes' study. Fortunately, a number of valve makers now issue curves for their valves, and the preparation of such a curve for yourself is quite a simple matter, provided you have a few pieces of apparatus. These are

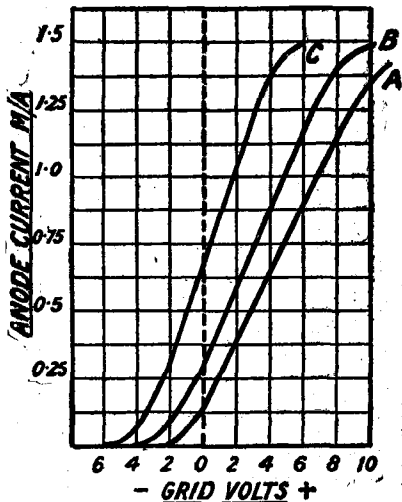
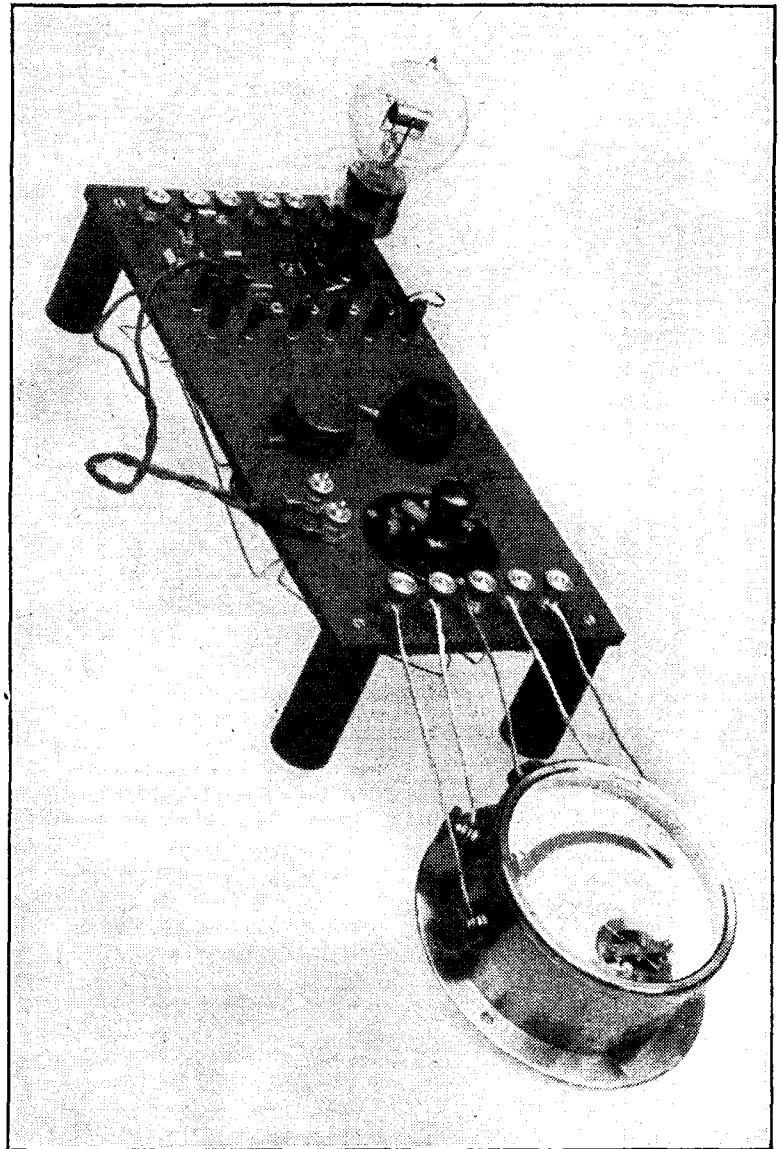

Fig. 1.—The curves for a well-known general-purpose valve.

not expensive, nor is the process of plotting a characteristic curve a lengthy or intricate matter. The purpose of this article is to show how, with the simplest apparatus, accurate curves may



The author's valve-testing board for plotting characteristic curves.

be drawn and valuable data obtained upon any valve you happen to possess at the moment.

A Typical Curve

Let us first consider a typical characteristic curve and what it means. Fig. 1 shows a curve as issued by the makers for a well-known "general-purpose" valve. This requires about 3.8 volts on the filament and works quite well with 20 volts on the anode, although higher voltages give better results. Three characteristic curves, marked respectively A, B and C, are illustrated; curve A is for 20 volts, curve B for 30 volts and curve C for 50 volts on the anode respectively.

Now let us consider Fig. 2, which shows a two-valve receiver with one stage of high-frequency coupled by the tuned-anode method to a detector valve. We will imagine that the valve in question is used as the high-frequency amplifier, or the first of the two in the receiver shown. We will also assume for the moment that a 50-volt high-tension supply is being used.

Anode Current

Now if the anode of a valve is made positive with respect to the filament, in certain circumstances a current will flow between the filament and the plate, the circuit being completed through the high-tension battery. If we keep

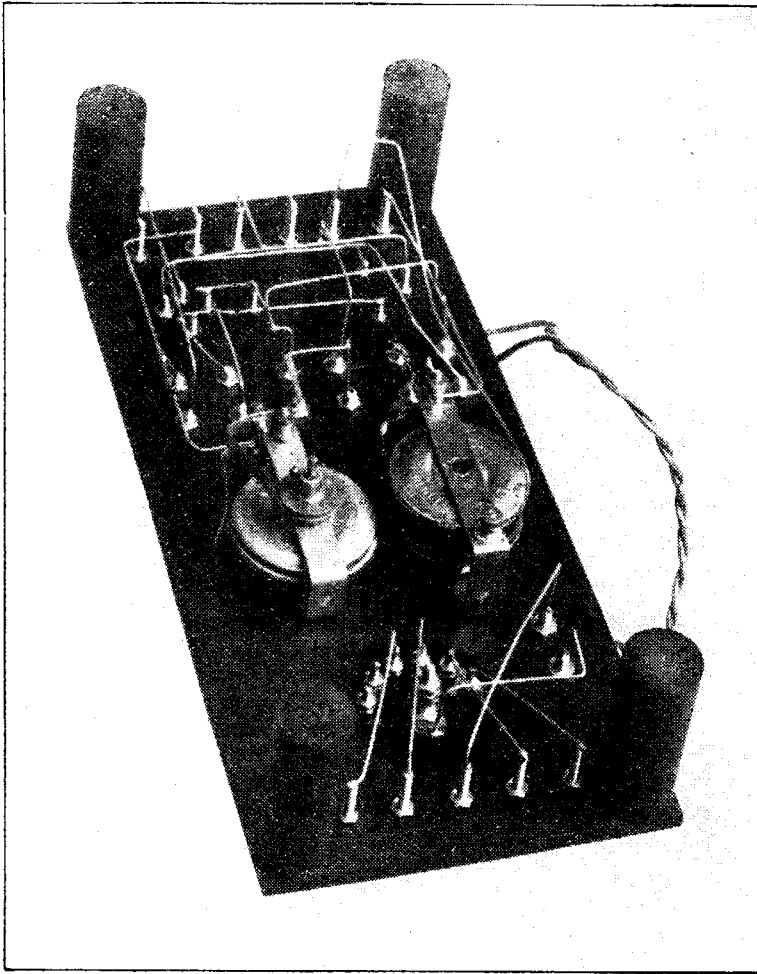

The back of panel, showing its simplicity.

the grid of the valve discussed at the same voltage as the negative end of the filament, which we will call zero, then with 50 volts supply we shall have a plate current of about .6 of a milli-ampere. If we make the grid positive with respect to the filament negative leg, then we shall increase the flow of current between the anode and the filament, and if we make it more negative, then the current will decrease.

Stopping the Anode Current

The current will continue to decrease as we make the grid more negative until a point is reached, when the grid is so negative that the current between anode and filament ceases entirely. The degree of negative bias on the grid required to stop completely the flow of current in the anode circuit, varies in different valves and with the same valve varies with anode voltage. To obtain undistorted reproduction, equal fluctuation of voltage on the grid above and below the

normal must bring about equal fluctuation of current in the anode circuit above and below the normal. If, for example, our grid voltage varies by 2 volts on each side of the normal, then the

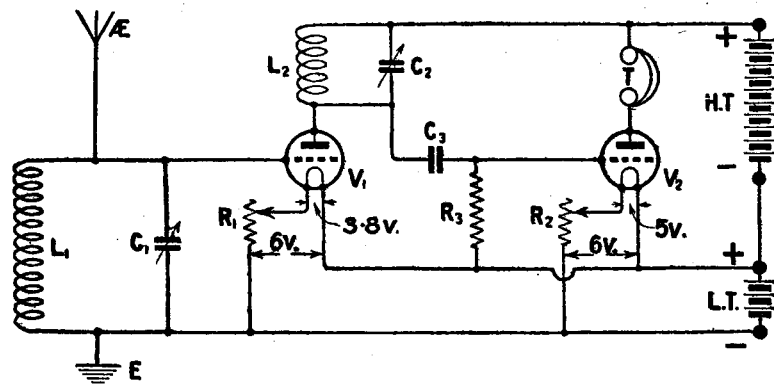

Fig. 2.—A typical two-valve receiver, showing the effect of filament resistances.

anode current should increase and decrease in equal proportion about the normal value. If a decrease of, say, 2 volts on the grid oversteps the mark at which

through the inductance L_1 to the negative side of the filament battery. In the negative L.T. lead of the first valve is the resistance R_1 , which is

In this article an outline is given of the simplest methods of obtaining the data necessary to plot characteristic curves without the aid of elaborate or expensive apparatus.

the anode current stops, then we are bound to obtain distortion in the anode circuit. Faithful amplification can only be obtained when we are working on the straight portion of the characteristic curve.

What We Want to Know

It will thus be seen that among the matters we require to know about a valve is the grid voltage at which the anode current ceases, and the length of the curve. If we draw a chart along the bottom of which is marked grid voltage, and make vertical readings for anode current in milliamperes, we can plot a curve showing the relation of grid voltage to anode current for each anode voltage used. If we combine two or three such curves on one sheet we can make some interesting comparisons. Fig. 1 is such a collection of curves.

Now let us return to Fig. 2. Here it will be seen that the grid of V_1 is connected

introduced for the purpose of cutting down the voltage applied to the filament of the first valve, which, as we know, must be 3.8. As a 6-volt battery is used, the voltage must be brought down by 2.2 volts, which represents the drop in voltage across the resistance R1. As, now, the grid of the first valve is connected to the negative side of the battery, and not to the negative filament of the valve, it will be 2.2 volts more negative than the negative end of the filament, and thus we are able to say that there is a negative bias of 2.2 volts on the grid of the first valve. We have already assumed that we are using 50 volts on the anode. Let us now examine the characteristic curve C (which is that for 50 volts), looking along the bottom line until we come to 2.2 volts. If we take the vertical line corresponding to 2.2 volts we shall see that the plate current is approximately .25 of a milli-ampere, and that the voltage can be dropped about another 2 before we get off the fairly-straight portion of the curve. On the other side (i.e., with a reduction of the negative bias and after zero point has been reached the impressing of a positive bias), we can place quite an appreciable positive charge (about 4 volts) on the grid before we get off the upper straight portion. It will thus be seen that as the valve is connected in Fig. 2 we shall have a negative grid bias of just over 2 volts, and shall still be working well on the straight portion of the characteristic curve, provided our voltage fluctuations do not exceed about 2 volts.



The Mullard D.3 valve.

Now suppose we drop the voltage to 30 on the anode. We now see that at 2.2 volts the anode current will have ceased, and if the grid becomes yet more

negative the anode current still remains at zero, while if it becomes positive, or if the negative



The B.T.H. B5 valve.

charge is decreasing, then there will be a growth in the anode current from zero up to a point depending upon the value of the grid voltage. Fluctuations either

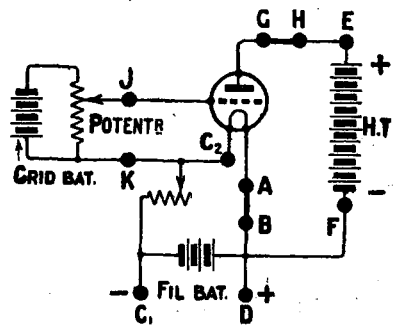

Fig. 3.—Terminals used in the valve measurements.

side of the working point will not give faithful reproduction in the anode circuit.

Grid Bias

It will thus be seen that if we have different characteristic curves for different voltages we can obtain valuable information as to working our valves. We can see the amount of grid bias advisable with various voltages and the length of the characteristic curve. This will show us whether or not considerable voltage fluctuations on the grid will still give faithful reproduction in the anode current. Still examining Fig. 2, let us look at the second valve V2. Here we are assuming that we have a valve requiring 5 volts on the filament, there being a drop in voltage of 1 volt in the filament resistance. The normal grid voltage, in this case, however, will not be 1 volt negative, for

it will be seen that the grid-leak is connected to the positive leg of the valve, which, of course, is 5 volts more positive than the negative end of the valve. There will, therefore, be a positive voltage of 5 on the grid. If the grid-leak were connected to the negative leg of the valve, the normal grid voltage would be zero, while if it were connected to the negative pole of the L.T. battery, then it would have a negative bias of 1 volt. It may be mentioned in passing that, in the case of a detector valve, connecting the grid-leak as shown, usually gives the best results, for rectification is often helped by the grid current which flows when the grid is made positive.

Apparatus Needed

It will now be apparent to every reader that the instruments required for plotting characteristic curves of valves are:—

1. A filament voltmeter.
2. A milliammeter to measure the anode current, and
3. Means of ascertaining the voltage of our plate supply.

Fortunately, it is possible to obtain combined instruments which can be used with various scales for volts and milliamperes. I have made considerable use of a combined voltmeter and milliammeter with 5 terminals, enabling the following scale to be used:—

- o to 2 volts.
- o to 20 volts.
- o to 10 milliamps.
- o to 100 milliamps.



The Mullard D.06 valve.

I obtained it second-hand from Mr. Leslie Dixon, and I believe he still has several available. Many good makes are obtainable, new, but good second-hand instruments can be obtained and

save the experimenter a good deal of money.

A Testing Board

The two photographs accompanying this article show a testing board I made up for the purpose of utilising this instrument for drawing a characteristic curve. There are 5 terminals along the bottom of this board corresponding to the 5 terminals on the combined voltmeter and ammeter, while a switch enables various terminals to be connected at will. The board carries a filament resistance, a potentiometer, two kinds of valve sockets for the tubular, and four pin type of valves respectively, and a number of Gibson sockets so that flexible leads can be plugged in to given filament voltage, anode voltage, filament current, anode current, and grid voltage. The purpose

of the potentiometer was to vary the grid voltage so that readings could be taken of the anode current for the whole range of grid voltages. The general scheme of connections is shown in Fig. 3. Terminals A and B are kept short-circuited unless it was desired to measure the filament current, whereupon the short-circuiting link is withdrawn and the ammeter placed in circuit there.

Suitable Meters

The combined instrument alone serves for some valves, while the bright emitters and valves using more than 100 milliamperes filament current, require an ammeter with higher reading. A voltmeter connected across terminals C1 and D gives the filament battery voltage, while across C2 and D a reading of the filament voltage is obtained.

Similarly, the value of the anode or high-tension battery can be obtained with a suitable voltmeter by connecting this instrument across E and F, while G and H, normally short-circuited, can be opened for the insertion of a milliammeter for measuring

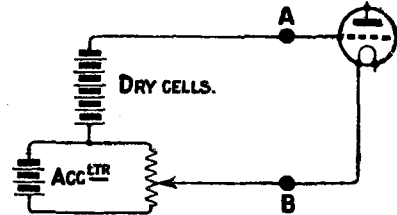

Fig. 4.—Use of accumulator and dry cells for grid bias.

the anode current. J and K enable a measurement of the grid voltage to be obtained, progressive variations of grid voltage being obtainable by moving the slider of the potentiometer from one side to the other.

Important Points

Here are a few important practical points which might, at first, be overlooked:—

1. Do not use small-size batteries of the flash-lamp type across the potentiometer to enable you to obtain grid voltage changes. The resistance of such a potentiometer is relatively low and will draw from the grid battery too large a current for small cells. A far better plan is to use either large dry cells of the electric bell variety, or preferably an accumulator in series with small dry cells as shown in Fig. 4. A progressive six-volt variation of grid voltage can be obtained by moving the slider from one end of the potentiometer to the other, while steps of 6 volts can be taken by plugging into different dry cell plugs. In this way the dry cells are not required to give any current for the potentiometer, and quite small cells will do, such as the ordinary tapped H.T. units. The accumulator, for its part, will suffice to give the necessary P.D. across the potentiometer winding, and its voltage will remain constant under the load.

2. To measure the grid voltage use a good voltmeter of high resistance, such as the instrument illustrated. If you use a low-resistance voltmeter, such as are sold for testing accu-

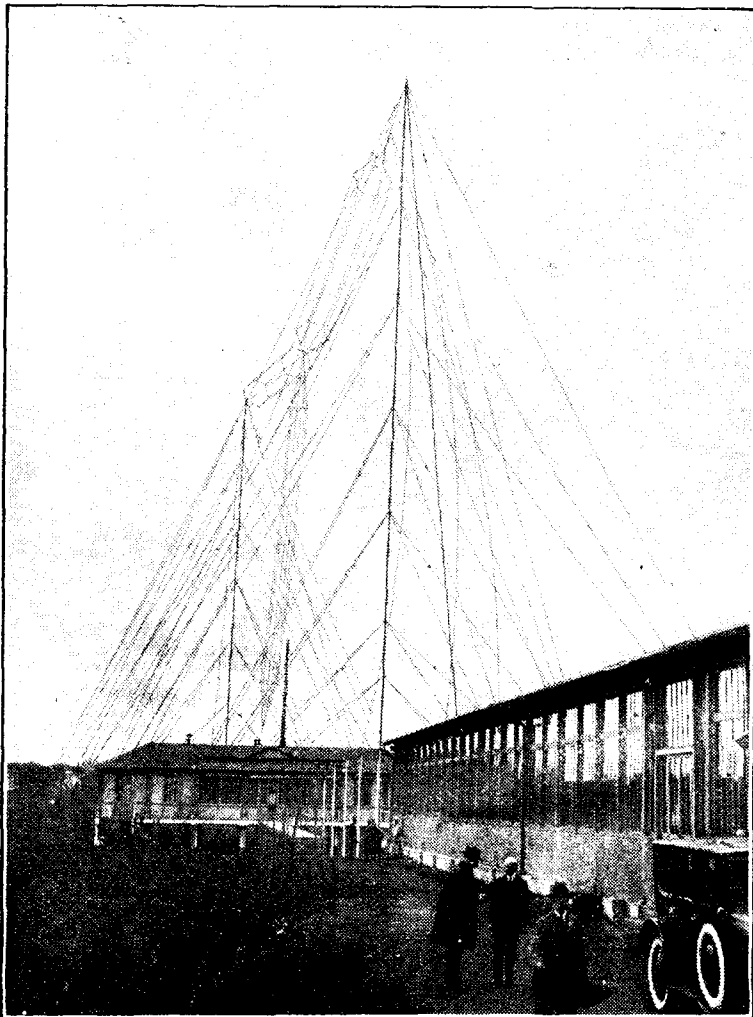

The lofty masts and elaborate aerial system at M. E. Belin's private station at Malmaison.

mulators, these windings will, in themselves, draw considerable current from the grid battery and upset the readings.

3. When obtaining figures to plot the characteristic curve, be sure to connect the grid battery across the grid and negative filament leg of the valve, not across the grid and negative lead to the battery, with the filament resistance in the circuit. If you follow the latter procedure you will find that every variation of the filament resistance will alter the voltage on the grid and upset your calculations.

4. Use a higher resistance voltmeter for measuring the voltage of your plate supply. Low-resistance voltmeters will give you quite false readings and they will, in themselves,

take a lot of current from the high-tension battery.

As Fig. 4 is shown, a varying negative grid bias can be placed on the grid of the valve. In this way we can plot the negative side of the characteristic curve. To plot the positive we must reverse the connections A and B.

Plot as many points as you can, and this will enable you to make a more accurate curve. Particularly in soft valves there are often slight but important irregularities in the curve which you may miss if you take only a few readings and join these up.

Be sure to maintain your filament voltage at the correct figure throughout the whole of the test, or you will be badly misled.

The International Amateur Radio Conference
(Concluded from page 99)

Before the President dismissed the conference an amusing incident occurred when Mr. K. B. Warner, Secretary of the A.R.R.L., was presented with a large cottage loaf gaily decked with the colours of all nations, as compensation for his prolonged labours which, according to rumour, had prevented his taking sufficient nourishment during the preceding days.

Exhaustive details of the Paris Conference will be available in book form at an early date.

No résumé, however, would be complete without some reference to the delightful series of distractions organised by the authorities. These included visits to the great stations at the Eiffel Tower and at Saint Assise, and a visit to M. Belin's experimental laboratory at Malmaison.

A Safety Device

A SIMPLE device for preventing the shorting of H.T. or L.T. battery leads is shown in the accompanying diagram. The leads are equipped with spade or pin terminals, or plugs, in the usual

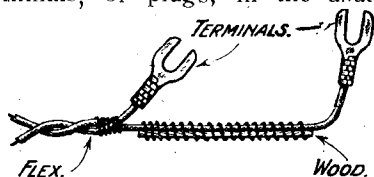

Illustrating the connector.

manner, one lead finishing about 3 in. short of the other. A strip of wood or ebonite is then bound to the longer lead, as shown, thus preventing all possibility of the metal tags accidentally touching.

H. B.

Temporary Connections

A SIMPLE way of making temporary connections to terminals or valve legs is shown in the accompanying

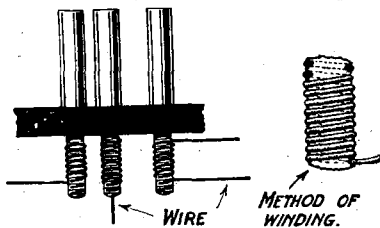

Showing how the connections are made.

□ □ □
diagram. Where two connections are made to one point the bare wire is wound as shown on the plate socket in the diagram.

H. B.

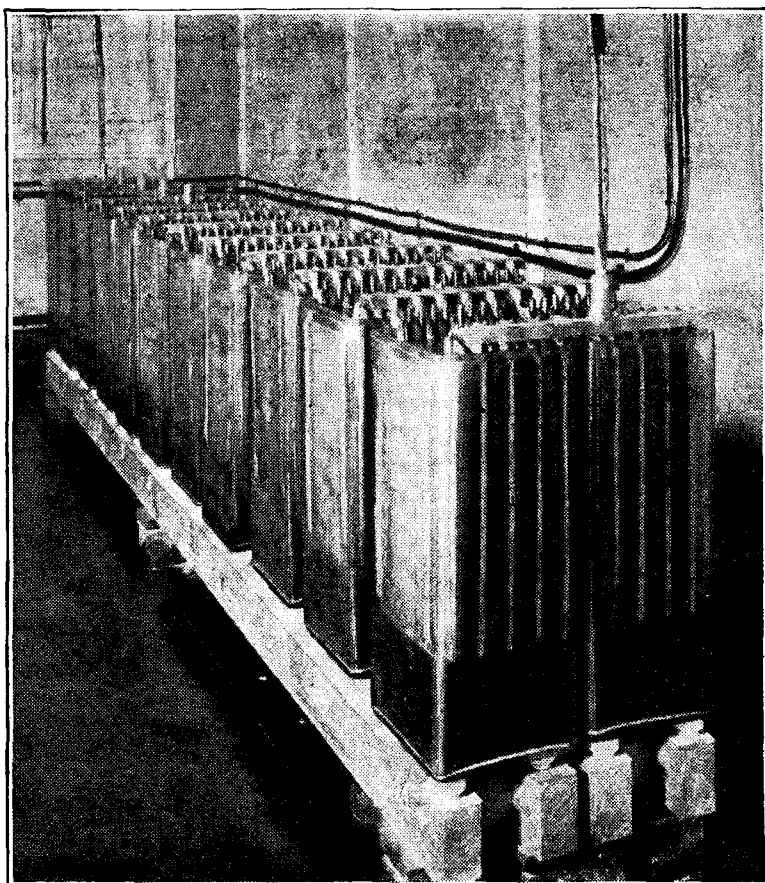

A battery of large accumulators which are used at the Rome station. Batteries similar to this are used at the main B.B.C. stations.

LOW-LOSS INDUCTANCES

By

A. D. COWPER, M.Sc.,
Staff Editor.

In view of the interest in short wave work and the number of articles we have published, Mr. Cowper's remarks on this subject should not be missed.



GOOD deal of work has been published recently, in an accessible form for the radio experimenter, on the subject of high-frequency resistances in tuning inductances, and the bearing of this on efficient coil design. It is a subject that has badly needed ventilating for some time, in relation to the broadcast frequencies, as very little appeared to be known on the subject up to a recent period, amongst experimenters and professional designers of receiving apparatus alike. A very interesting popular account of the whole topic of resistance in wireless circuits was given by Prof. C. L. Fortescue before the Radio

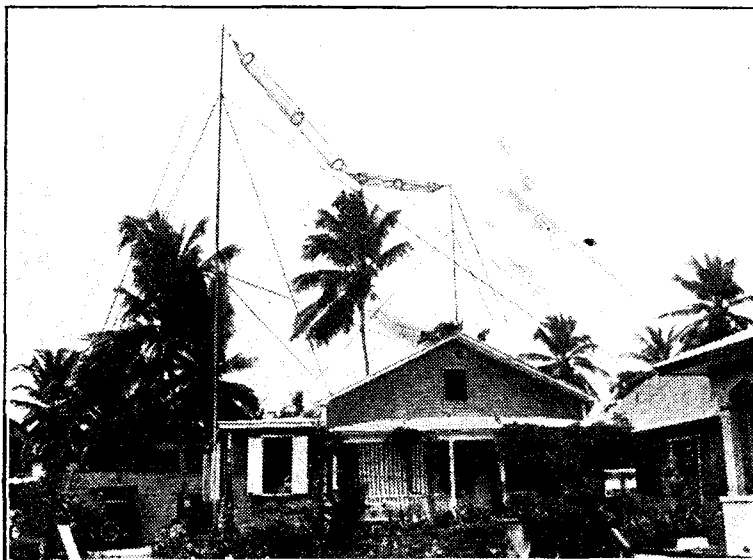

The aerial and masts at the amateur station belonging to Mr. J. Augusty, Santures, Porto Rico.

Kendall has also published the results of measurements on multi-layer coils by the Moullin voltmeter method, without the use of reaction, in *Wireless Weekly*, Vol. 5, No. 17 (February 11, 1925), together with some later observations in this field.

Optimum Signal Strength

Careful experimenters have long observed that the optimum signal-strength in crystal receivers, on a given aerial and transmission, and with tuning-capacities of similar order, is generally given when inductances wound with a generous gauge of wire are used, e.g., with No. 18 or even No. 15 d.c.c. wire. In routine testing of large numbers of various types of crystal-tuning devices, by the method of measuring the whole rectified wave at optimum setting by a microammeter in series with the 'phones or a similar high resistance, it was almost invariably observed that the fine-wire inductances gave a poor result, so much so that it was almost always possible to tell with a glance at the windings and general design what quantitative performance the particular tuner would show on actual test. For example, No. 24 or 26 wire would

give from 60 to 85 per cent. of the signal-strength given by the standard thick-wire variometer, of No. 15 or 16 wire, enamel-insulated and air-spaced. Careful quantitative comparison showed that No. 18 wire appeared to represent about the optimum gauge; whilst the usual bugbear of distributed capacity seemed, when put to a quantitative test, to be quite irrelevant.

A Hank Coil

A simple "hank" coil of No. 18 d.c.c. gave by repeated and most careful measurement the same optimum signal-strength as the best air-spaced coil of No. 15; and was markedly better than any commercial device or plug-in coil compared with it. A simple type of crystal-set with two such hank coils as a primitive variometer, described by the writer in *Modern Wireless* (December, 1923), gave this optimum signal-strength, and has proved most successful in the hands of very many home-constructors.

Apparent Resistance

However, certain curious observations on the apparent re-
(Continued on page 119.)

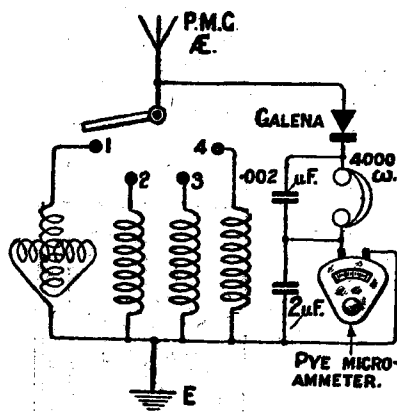
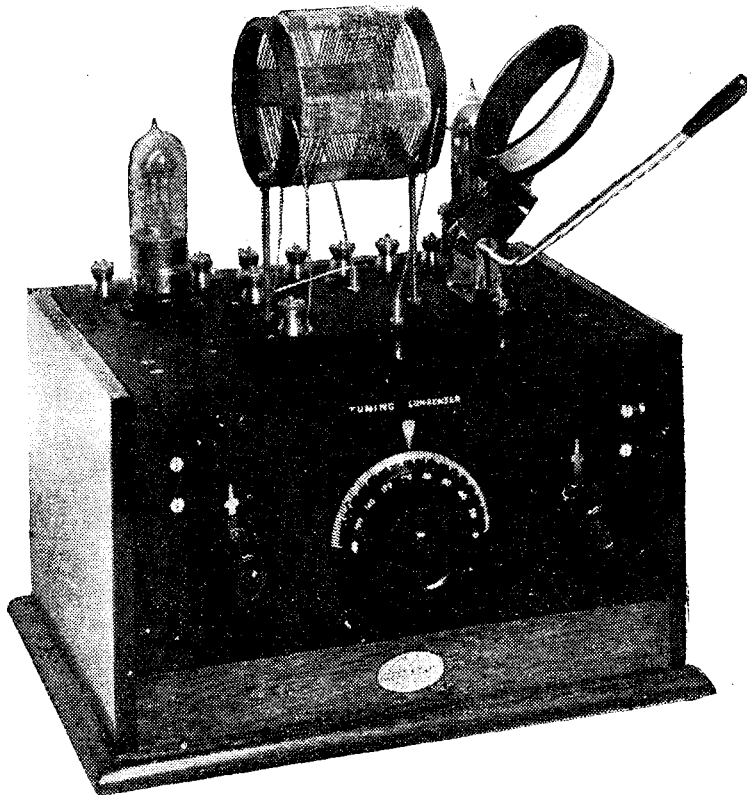

Fig. 1.—A standard type of circuit for the measurement of relative efficiency of tuning inductances in crystal reception.

Society of Great Britain on February 25, 1925, which would well repay close study, and some systematic measurements were given in an article by Sylvan Harris, in *Wireless Weekly*, Vol. 5, No. 14 (January 21, 1925). Mr. G. P.



The receiver is here seen with the low-loss coils for short wave reception.



THE radio amateur who takes an active interest in the progress of the art is not nowadays concerned solely with what is happening on the broadcast and higher band of wavelengths, for with the more extensive use of very short wavelengths, the efficiency of which has been so often proved by the numerous long-distance records recently established, a new field of activity has been opened.

Short-Waves

Since, however, the majority of receivers designed for use on the broadcast band of wavelengths and on the long waves are not adaptable for efficient reception on the short waves down to about 50 metres, it is usually necessary for this latter purpose to employ an entirely separate receiver of special design which will cover a limited band of wavelengths only. This involves the keeping in commission of two receivers if it is

desired to embrace the whole range of wavelengths from, say, 50 metres up to the very long wavelengths used by some of the Continental stations.

Modern Requirements

It is the purpose of this article to describe a single receiver which effectively combines the functions of a short-wave receiver and a broadcast and long-wave set in a very simple manner, and which gives a tuning range of from 50 metres upwards.

From the simplified circuit diagram shown in Fig. 1 (a) it will be seen that a simple two-valve circuit is employed consisting of a detector valve and one stage of low-frequency amplification, while the tuning circuit consists of a "semi-a-periodic" aerial coupled to a tuned secondary circuit with reaction applied to the latter from the plate circuit of the detector valve. This arrangement is used on both the short

A New Rectifier ... Modern

Low-loss design for s

By D. J. S. H

An easily-built receiver
wavelengths from

range, direct coupling may be employed. Thus simple and rapid tuning is possible on any wavelength within the range.

The Aerial Condenser

For the purposes of this receiver a dual tuning condenser, each section of which gives a maximum capacity of .0003 μ F, is employed in conjunction with

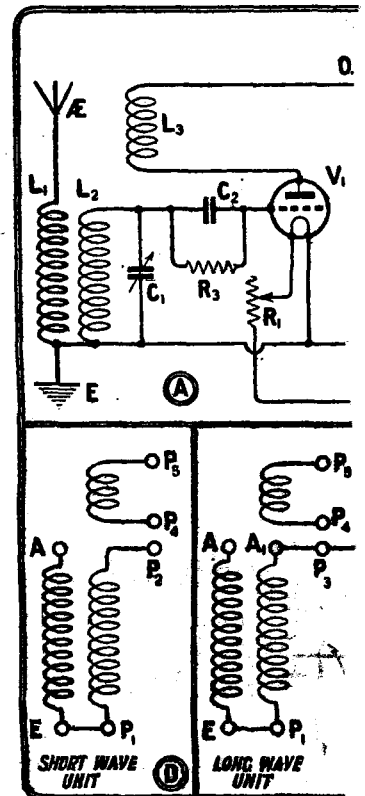

Fig. 1 shows at A a simplified circuit and C and D indicate how the ph coil units and the panel

Receiver for... 1 Conditions

Short and long waves.

MARTT, B.Sc.

which may be used upon
50 metres upwards.

two plug-in units, one carrying a three-way coil holder, and the other the special short-wave coils, which will be dealt with later.

For the short waves only one section of the dual condenser is used for tuning, and on the higher wavelengths the two sections are used in parallel. The manner in which the dual variable condenser and the coil units are connected

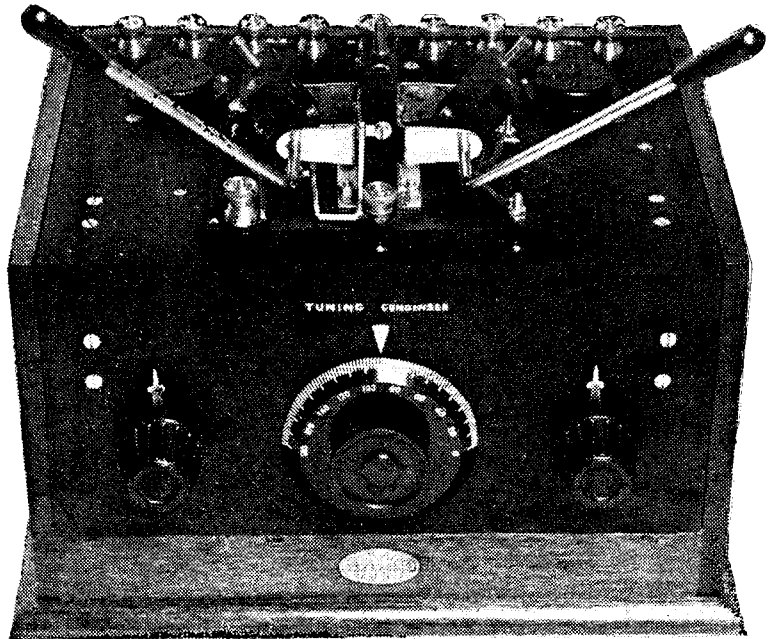

The arrangement of the panel may be seen from this photograph, which also shows the three-way coil-holder unit for B.B.C. and longer wavelengths.

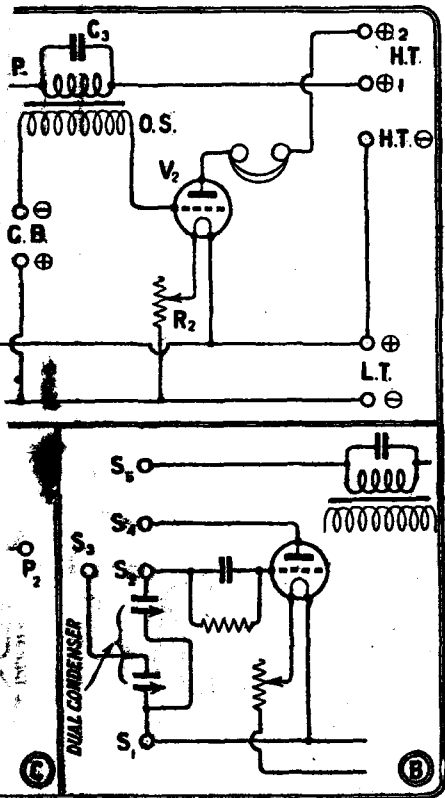

Fixed circuit diagram of the set, whilst B, plug and socket connections on the two are arranged. S=socket, P=plug.

up is such that the operation of plugging-in the short-wave unit connects one half of the dual condenser across the secondary coil and give the circuit shown in Fig. 1 (a), with C1 having a value of .0003 μ F. Similarly, with the second coil unit plugged-in for use on the higher wavelength range we have the two halves of the dual condenser connected in parallel across the coil, giving the same circuit with a value for C1 of .0006 μ F, and also the option of direct coupling.

Thus it will be noted that the mere action of changing the units automatically changes the value of the condenser C1. Reference to the various connections will be made later.

Design

In designing the receiver the main points to be considered were to obtain a layout in which the wiring was kept as short as possible, yet at the same time allowing the tuning controls to be placed in a convenient and accessible position where they could be operated with comfort. As will be seen from the photographs, two

panels secured at right angles by means of angle brackets are used. On the small vertical panel in the front the dual tuning condenser and filament resistances are mounted, while the valves and terminals for battery and telephone connections are arranged at the back of the horizontal panel. Terminals are provided for separate H.T. tapplings for the two valves, and for grid-bias on the note-magnifier. The panels measure 10 x 7½ in. and 10 x 4½ in., and it will be quite satisfactory to cut these from a standard 12 x 10 in. panel.

Coil Units

Each of the coil units is mounted on a piece of ebonite measuring 5 x 3 in., and each has two terminals on the left for aerial and earth connections, that in the front being for the aerial in both cases. The unit on which the three-coil holder is mounted has five plugs which engage with five corresponding sockets on the front of the horizontal panel when the unit is plugged in. The diagrams (b) and (c) in Fig. 1, in which these plugs and sockets are

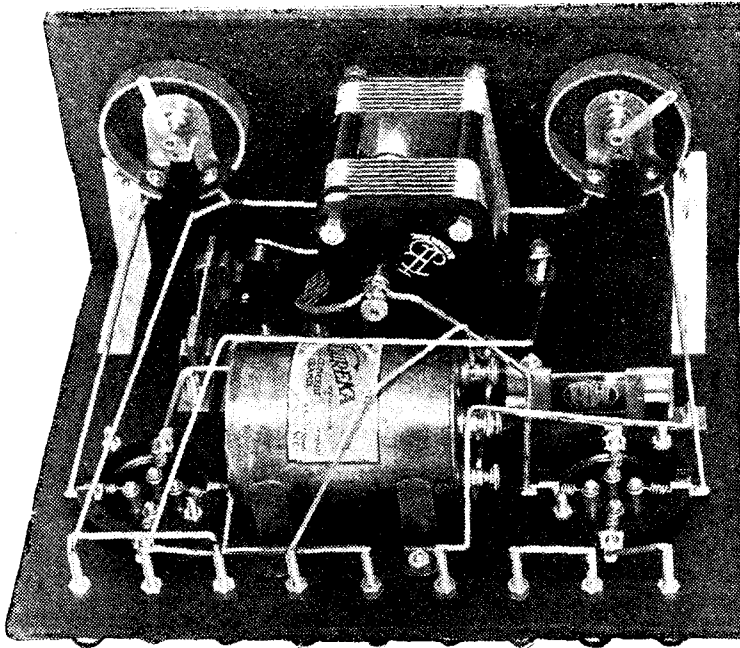

A back of panel photograph with the upper panel in the foreground.

Ten coil sockets and pins for panel mounting (Bowyer-Lowe). (Four of the sockets are not actually used.)

Two filament resistances. (Those used are Royal 35-ohm resistances for dull-emitter valves, Rothermell, Ltd.)

One grid-leak (2 mΩ) and grid condenser (.0003 μF) unit (McMichael).

One .0003 fixed condenser with clips (McMichael).

One three-way coil-holder (Burne-Jones).

One single moving-coil mounting (Burne-Jones).

Fourteen terminals.

One skeleton ebonite former and a 3/4-in. length of 3-in. diameter ebonite tube (Burne-Jones).

One packet Radio Press panel transfers.

Square wire, two suitable brass angle brackets, some 18-gauge bare copper wire, and a small quantity No. 22 d.c.c. wire.

No great difficulty should be

lettered and numbered 1 to 5 to correspond, show how the connections are made. Notice that socket S1 is connected to the moving plates of the dual condenser, which are all on one spindle and electrically connected, and that plug P1 is connected to the earth terminal.

Short Wave Unit

On the short-wave unit there are only four plugs, and the manner in which the connections are made to give the desired circuit when the unit is plugged in may be seen by reference to diagrams (b) and (d) in Fig. 1.

Components

The following is a list of the components used in the construction of the receiver, together with the names of the manufacturers, and it should be remembered that if other components are used it will be advisable to make sure that there is sufficient clearance in which to mount them.

One suitable cabinet (Carrington Mfg. Co.).

Two panels, one 10 in. x 7 1/2 in. x 1/4 in. and one 10 in. x 4 1/2 in. x 1/4 in. (Paragon).

Two pieces ebonite, 5 in. x 3 in. x 1/4 in. (Paragon).

One dual square-law condenser, each half .0003 μF (Jackson Bros.).

One L.F. transformer (Eureka, Portable Utilities, Ltd.).

Two "Anti-phonics" valve-

holders (Burndept Wireless, Ltd.).

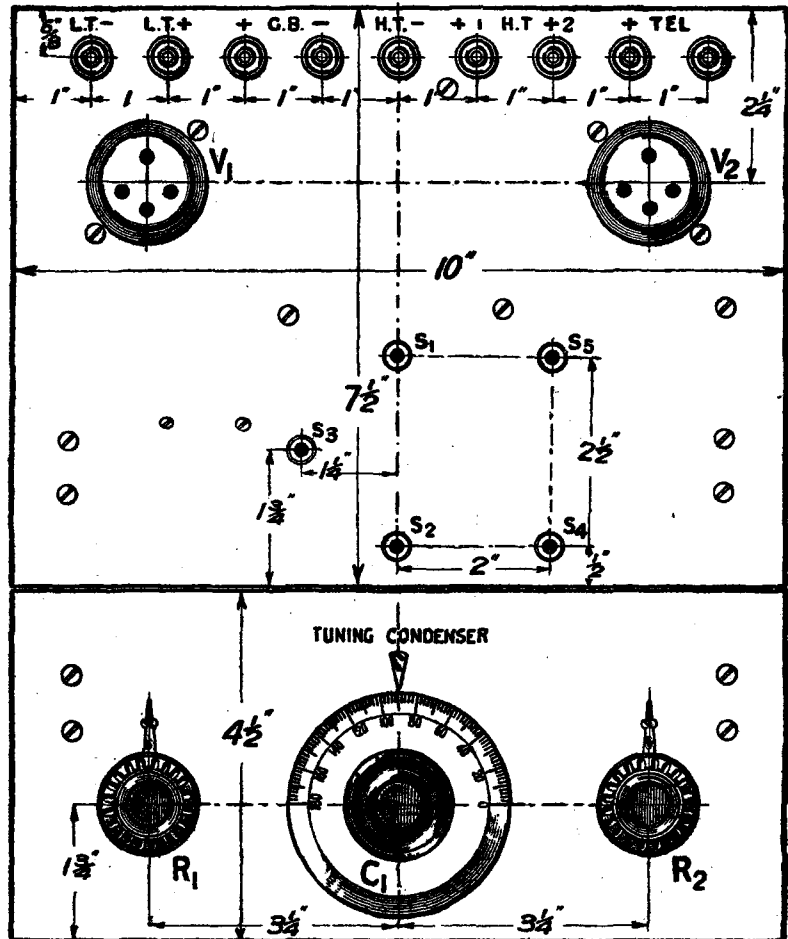

Constructional details such as drilling dimensions should be taken from this drawing. Blueprint No. 115A.

experienced over the construction of the set, and the first operation should be to mark out and drill the two panels in accordance with the drilling diagram, not forgetting suitable holes for the fixing screws for the two angle brackets. The large circular holes to accommodate the valve-holders may be made with the aid of an ordinary hand fretsaw, or with an expanding bit, if this is available. Particular care should of course be taken in marking out and drilling the holes for the five sockets.

Wiring

When the components have been mounted on the two panels the wiring may be carried out and no great difficulty is anticipated here if as much of the wiring as is possible is done before fixing the two panels together. A study of the back of panel photographs in conjunction with the wiring diagram will be helpful here.

When this part of the receiver

has been completed attention should next be turned to making the coil units. Drilling and wiring diagrams are given for each of these, and here again care should be exercised in drilling the holes for the plugs in order to secure a good yet easy fit in the sockets on the panel when the units are complete. The unit carrying the three-coil holder is quite straightforward in construction, and the points to remember are that the shanks of the aerial and the earth terminals on the left are cut short and the terminals secured with thin 4 B.A. nuts, and that a washer and terminal head are placed on the shank of the centre plug in the front for the purpose of connecting the aerial for direct coupling. Soldering-tags are placed under the terminals and between the fixing nuts of the plugs to facilitate connections to the coil-holder.

The special inductance for the short-wave unit seen in the

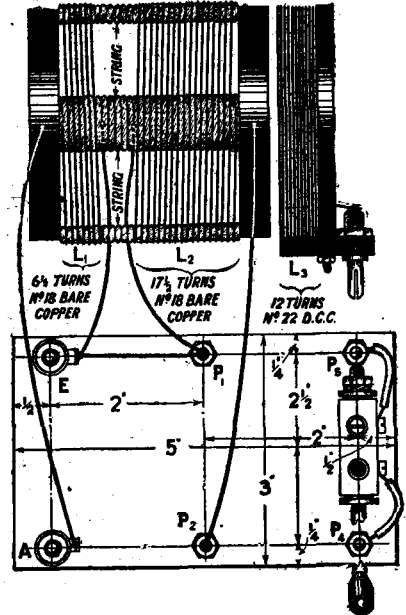

Details of the short-wave coils, dimensions of the ebonite base being included in this figure.

photograph is wound as follows:—

Some fairly thick twine of good quality, previously well dried, is wound round the four strips of the skeleton former in such a manner that each strip is covered completely with the same number of turns of twine, thus forming a "grooved" surface on each of the four strips on which an air-spaced bare wire inductance can be wound, the spacing between the wires being determined by the thickness of the twine, which in the actual coil is such that 34 turns of it are wound on each strip. The twine is secured temporarily, and is then wound along one strip, crossed over to the next, wound back over that, and so on, the end being securely knotted to the beginning when the operation is complete. The twine is then treated with a weak solution of shellac in methylated spirit, and dried thoroughly.

Turn Numbers

Turn numbers for the coils are $6\frac{1}{2}$ turns for the primary and $17\frac{1}{2}$ turns for the secondary, the reason for the half turns being that the ends of the coils are terminated at opposite sides of the former, short lengths of wire being left for connecting purposes. The ends are best secured by threading the wire through two small holes drilled in each

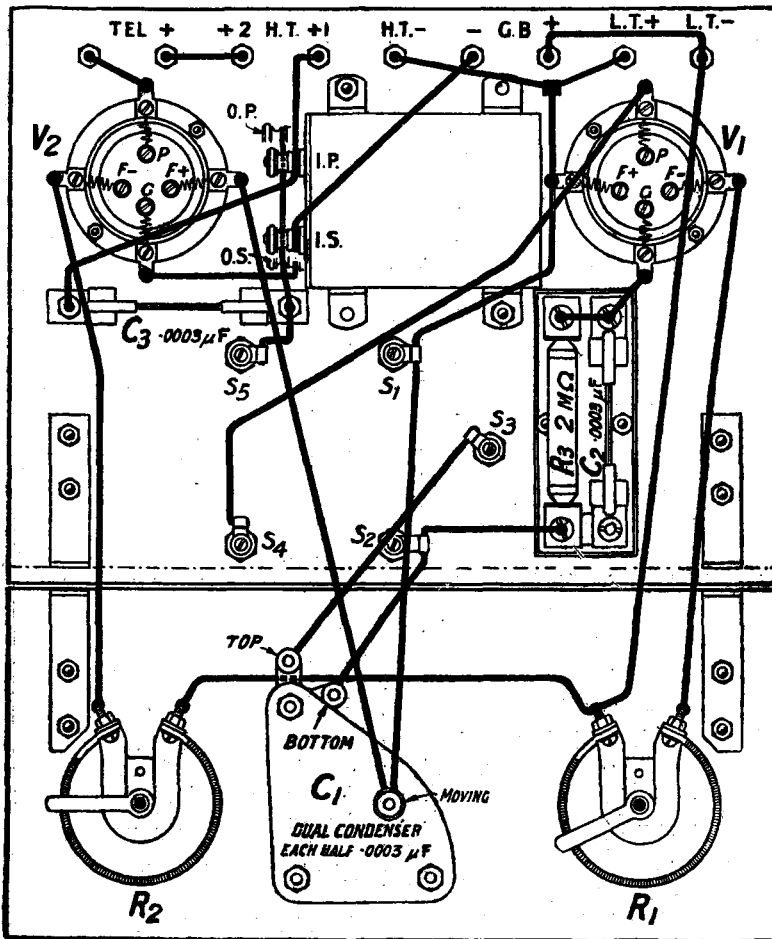

The wiring of the receiver may be easily followed from this diagram. Blueprint No. 115B.

H.F. Transformer Efficiency

A Useful Instrument for Comparative Tests.

By **STANLEY G. RATTEE, M.I.R.E.,**
Staff Editor.

Full constructional details are here given for the building of an instrument which will be of considerable utility to the experimenter.

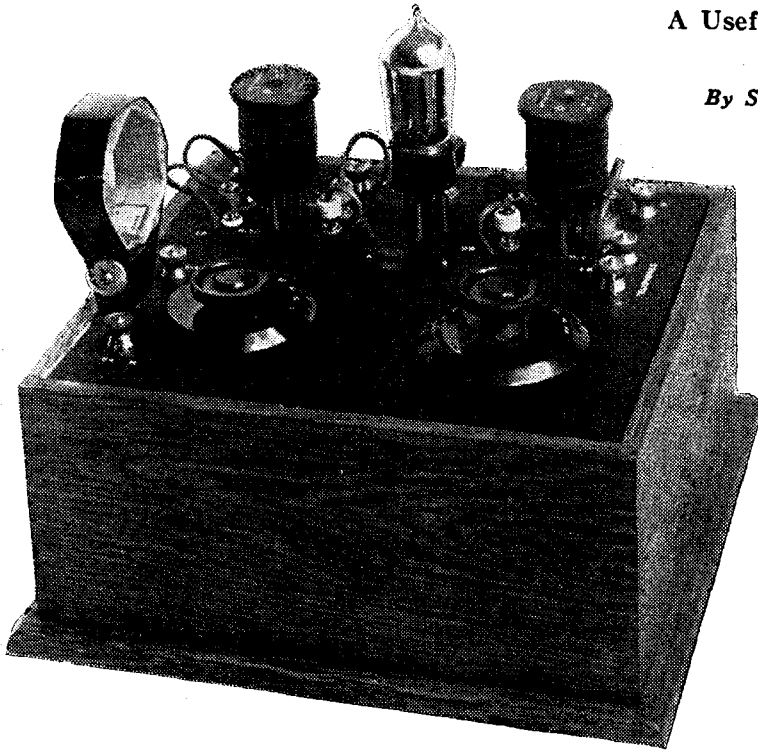

The instrument includes all the necessary aerial tuning arrangements in addition to the testing circuit.

existing between the various commercially-made transformers with regard to amplification. A further use to which the unit may be put is the matching-up of transformers for use in two or more high-frequency stages in a receiver, in a manner to be described later. The plug-in coil seen in the first photograph constitutes the aerial tuning inductance tuned by the variable condenser on the left. The two transformers under test are plugged into their sockets, as shown, the right-hand variable condenser being connected across the secondary winding of whichever transformer is in circuit; the rapid change from one to the other is effected by the switch situated in the centre of the panel. In regard to the departure from the more usual practice of tuning the primary winding, the reason for such departure is



It has often occurred to the writer how useful would be an instrument by which comparative tests of various makes of high-frequency transformers could be made in such a way that by the rapid movement of a switch one transformer could be changed for another. With this object in view, the design of such an instrument was attempted, and bearing in mind the absence of consistency in H.F. transformer connections facilities also were made for the quick change-over of connections, such as IP or OP to H.T. positive and IS or OS to grid.

The Unit

The apparatus resulting from these deliberations is shown in the first photograph, and in order that the instrument may be complete, aerial tuning, together with the high-frequency valve, are both incorporated in the unit. By means of a four-pole utility

switch the connections from one transformer to the other may be made at will, whilst by changing the positions of the Clix the best arrangement of the actual trans-

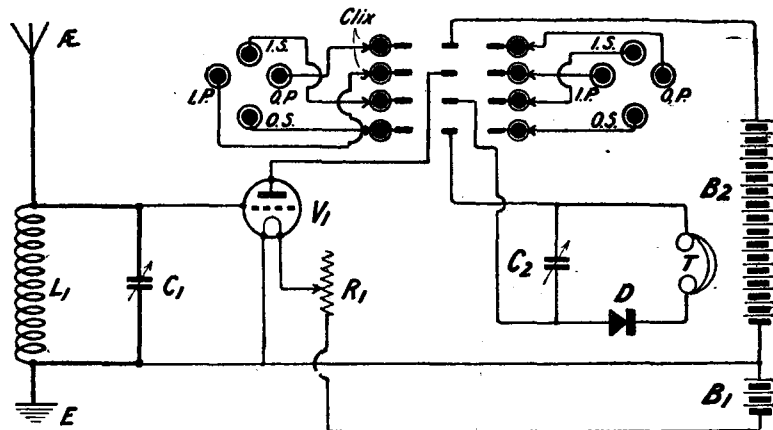

The circuit used in the instrument. Note the connections to the 12-point switch and the Clix adapters.

former connections may be found quickly and without difficulty.

Using this compact little instrument it is rather surprising to find the difference of efficiency

that when the secondary is tuned some slight increase in stability is obtained, and to make doubly sure that undesirable oscillation will not take place, the positive

One permanent crystal detector (Radio Instruments).

Set of Radio Press panel transfers.

Eight Clix adaptors (Autoveyors, Ltd.).

Eight Clix plugs (Autoveyors, Ltd.).

Two indicators (Decko).

One coil socket, or socket and pin for panel mounting.

Wiring the Instrument

The layout of the panel should, for reasons of balancing the transformer connections, be carried out with some thought, and for that reason the illustration showing the drilling dimensions of the panel should be consulted before the construction of the unit is attempted. With the layout given the mounting of the components is both easy and straightforward, giving easy access for wiring with even a fairly large soldering-iron. The wiring in the case of the

original unit is carried in the main by means of square tinned wire, but for the connections to the switch Glazite wire is used to permit the shortest connections to be made without the fear of possible short circuits resulting during use. From the sockets which hold the high-frequency transformers connections are taken to Clix plugs by means of rubber-covered flexible wire brought out through holes drilled in the panel, as seen in the first photograph.

How to Use the Unit

To make use of the unit for comparative tests between, say, two makes of transformers covering the broadcasting wavelength band, a suitable coil is chosen for aerial tuning, and the two transformers are plugged into the sockets provided. With the switch thrown to the right, the left-hand transformer is in circuit, and after the crystal, valve, and

aerial and ~~transformer~~ condensers have been attended to, with signals resulting, the best arrangement of connections for the transformer should be found by means of the Clix. With the loudest signals obtained in this way the reading on the transformer condenser scale should be noted and the switch thrown to the left. In this way the right-hand transformer is brought into circuit instead of the one previously used, and though the aerial tuning condenser need not be touched, some slight adjustment of the transformer condenser may be called for before the loudest signals are obtained, upon which the changing of the connections by means of the Clix on the right-hand side of the panel should be also tried. When these instructions have been carried out the best connections for both transformers will have been found and

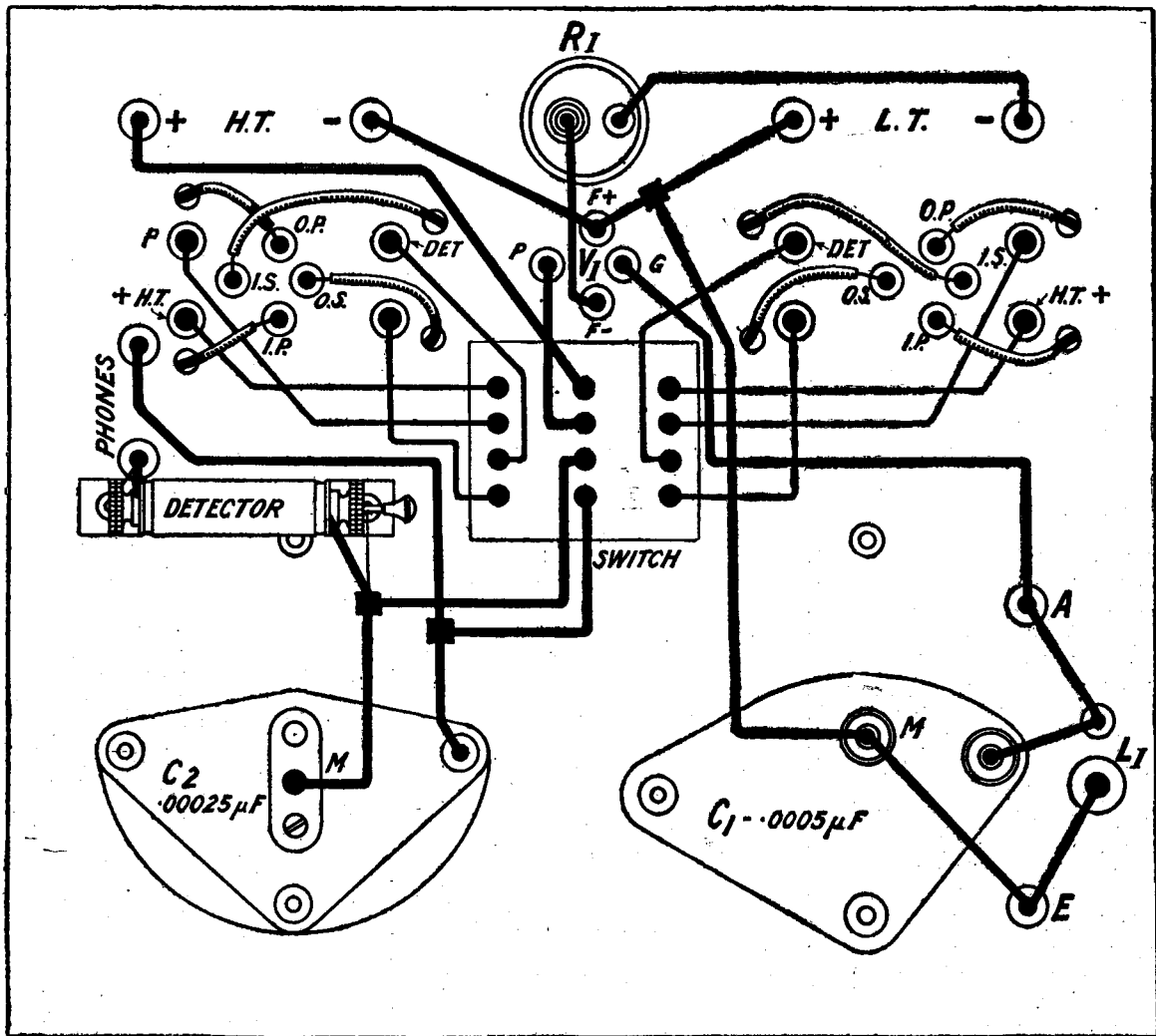

A practical wiring diagram, in which the values are included in addition to the markings for the Clix connectors.

the reading upon the transformer condenser scale should be noted.

Changing Transformers

Knowing the best positions upon the condenser for both transformers it is therefore a simple matter to change from first one transformer to the other by throwing over the switch, at

high-frequency transformer coupling tuned by a dual condenser, and in such cases as these it becomes imperative that the two transformers are matched or else nothing like the maximum efficiency is obtained.

To employ the unit successfully in the testing of matched transformers the operation is much the

Wavelength Range

Another use to which the unit may be put is that of arriving at the wavelength ranges covered by various transformers, whether purchased or home-made, and from an experimental point of view some very interesting data can be collected within a short time.

Weak Signals

Whenever making any of the tests suggested it is recommended that such tests should always be made upon weak signals, otherwise the tuning upon the high-frequency tuning condenser will not be sufficiently sharp to give a true reading.

Probably the easiest way in which to obtain the desired signal strength is to tune to the local station for the best results, and then before making comparative tests detune with the aerial tuning condenser.

In this way really sharp tuning can be obtained upon the high-frequency tuning condenser, in spite of the fact that a crystal detector is employed, and when the signal strength is reduced sufficiently in the manner indicated in the last paragraph the tuning of the high frequency transformer becomes as critical as may be desired.

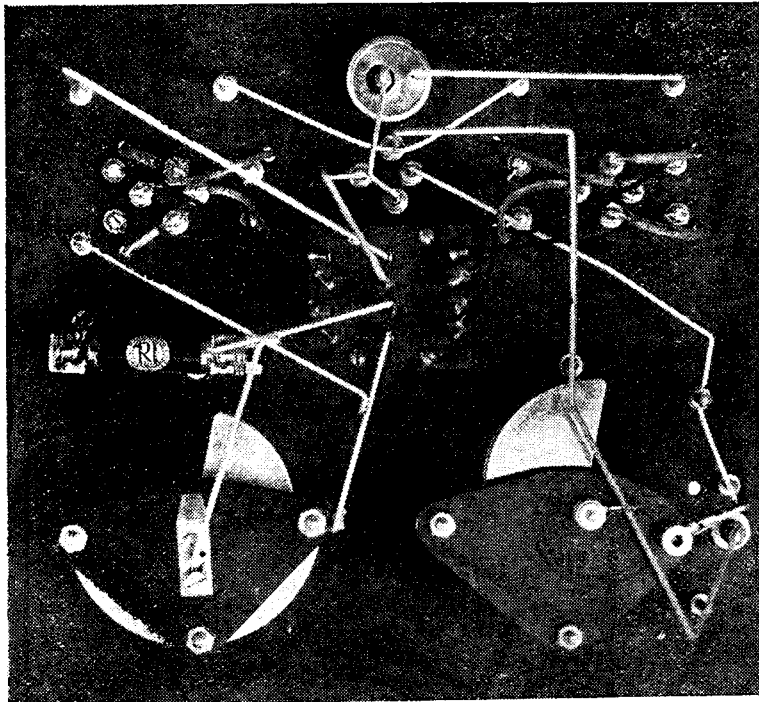

In wiring up the unit this back-of-panel photograph should be consulted in conjunction with the wiring diagram.

the same time setting the condenser to the required position, thereby obtaining a speedy comparison of results obtained with the two particular transformers under test.

Testing

When making these comparisons it will be found more satisfactory to make them upon stations whose signals are relatively weak, and since no deliberate reaction is incorporated in the unit the finding of weak signals should not be difficult! It must also be remembered that the adjustments of the valve and crystal should not be interfered with between the testing of one transformer and the other, otherwise the comparison will not only be unfair but will probably give a false understanding of things; the same remarks also apply to aerial tuning.

Test for Matched Transformers

Quite a number of receivers nowadays include two stages of

same as when making comparative tests, with the exception that when the condenser readings have been taken for both transformers and duly noted, the positions of the transformers are reversed, that is, they are made to change positions. If the transformers are matched the readings of the condenser will be the same, that is, the left-hand transformer will tune the same as before, and similarly the right-hand one will do the same.

Method Employed

If for any reason it is desired to match three or more transformers then the changing of either one in the unit for the third should not make any difference in the readings of the condenser. In this way quite a number of transformers can be tested for matching purposes with the minimum possible trouble and the assurance that the matching is accurate as determined by the condenser reading.

A NEW BOOK.

A most interesting little book just published as an addition to the Radio Press Series is "Wireless Faults and How to Find Them" (R.P. Series No. 24, 1s. 6d., or post free 1s. 8d.), by R. W. Hallows, M.A., staff editor.

The book is a most comprehensive guide to the art of fault finding, and it is difficult to see how the most stubborn of concealed faults could evade for long anyone who has read it and who puts into practice the extremely simple but searching tests which the author describes.

Separate chapters deal most thoroughly with the testing of all the more important classes of components, and with crystal sets, single valve, multi-valve and reflex receivers, in such a way that it becomes a perfectly simple matter gradually to narrow down the location of a fault until it is finally discovered in a particular component or section of wiring.

Altogether, a book which should prove indispensable to novice and experienced constructor alike.

Low Loss Inductances
(Concluded from page 109)

sistance of tuning-inductances of more compact form, e.g., duo-lateral coils wound with No. 18

when crowded close to another turn of the same coil in a multi-layer, or compactly-wound inductance in general. This is due to the "skin effect," whereby oscillating currents of high frequency in any case only pene-

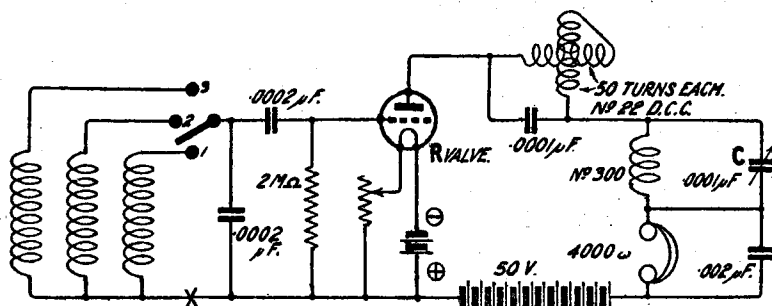

Fig. 2.—A circuit for the comparison of H.F. losses in tuning inductances. Note the variable condenser C.

d.c.c., or even with three No. 22 d.c.c. wires in parallel, in an endeavour to produce a short-wave inductance of minimum resistance, have for some time caused the writer (amongst others) to suspect that the problem was not so simple as it seemed at first sight; the fact that very thick wire, such as No. 12 bare copper, did not give any improvement over No. 18, rather the reverse, when used for a crystal-tuning inductance, also suggested the presence of other factors. The observations and calculations given in the articles mentioned above have made clear what this principal disturbing factor is: the enormous increase in the H.F. resistance of a wire

trate a very small fraction of a millimeter into the surface of the wire; when close to another conductor also carrying an oscillating current the distribution of the current is still further distorted, so that in a multi-layer inductance an incredibly small portion of the metal of the wire is really effective in carrying the current. The resistance accordingly increases beyond all measure. It is already six times or more greater than the D.C. resistance in a wire of medium gauge isolated in space, for the broadcast frequencies. Measurements given here on commercial types of multi-layer plug-in inductances show that the actual increase is many times this.

Multi-Layer Coils

Hence it becomes intelligible that a No. 20 and a No. 28 wire wound in a certain type of multi-layer coil for short wavelengths show but little difference in effective resistance, the No. 20 actually being more "crowded," relatively, on the same former than the No. 28, when mechanically-controlled air-spacing is used. Also that with d.c.c. wire spaced automatically merely by the thickness of the insulation and by the difficulty of winding the thicker wire really neatly and in close turns, the thick wire will actually score, within limits; this is shown by measurements given here, for single-layer or flat basket-coils. In fact, the obvious deduction, which clears up the whole problem of the relative efficiency of thick- versus thin-wire inductances, is that it is a matter of spacing and effective

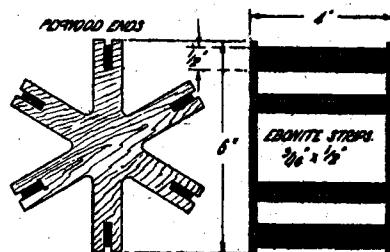

Fig. 3.—Details of the low-loss coil former.

utilisation of the larger surface-area of the thick wire—which cannot be easily achieved in the usual compact multi-layer coil.

Distributed Capacity

Ignoring the largely irrelevant point of small distributed capacities, the question then becomes chiefly one of making the most of a narrow thread of external surface on the wire used, and of cutting down dielectric losses in the finished coil to a minimum.

Aspect-Ratio

The papers quoted indicate that an "aspect-ratio" (diameter/length) for a single-layer coil is not necessarily 2.46 for optimum resistance: inductance-value ratio (as with D.C. or with the lower frequencies) on these short broadcast waves; but that a ratio nearer unity is required. As evidently only the single-layer inductance can be considered for an ultra-low-loss coil, and a winding space of some inches is required for a secondary-tuning-

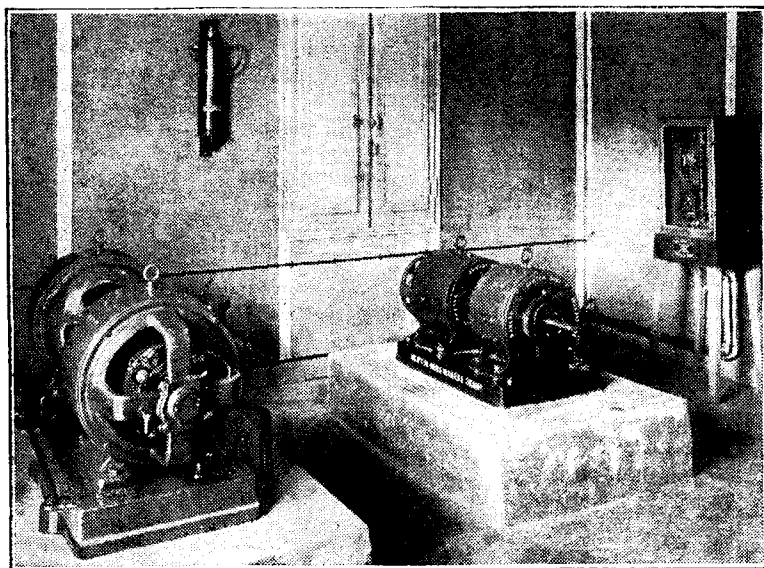

Our photograph shows the generators at the Rome station. Further pictures of this station appear elsewhere.

inductance to be used with a small tuning capacity, say, .0001 or .0002 μF , the largest convenient size for practical use was taken as a starting-point, i.e., 6 in. diameter; and low-loss formers of the modern type were constructed of these dimensions: 6 in. diameter, with 4 in. maximum winding length, of six strips of 3/16 in. ebonite, about 1/8 in. wide, mounted in slots (by the aid of Chatterton's cement) in ply-wood star-shaped former-ends, as indicated in Fig. 3. Then the practical problem to be elucidated was the determination of the gauge, insulation, and distribution of wire on this standard low-loss former, which gave the lowest effective H.F. resistance under practical working conditions: for a crystal-tuning inductance, and for a secondary valve-tuning inductance, on a broadcast frequency of approximately 820 kilocycles (i.e., 2LO's wavelength of 365 m.).

Crystal Reception

In crystal reception, theoretical deductions had long ago indicated that the determining factor was rather the severe damping by the crystal than any reasonable H.F. resistance of the tuning-inductance. Hence the old school of long-wave radio-telegraphy engineers was inclined to scoff at efficiency in crystal-tuning inductances, even when actual measurements were educed to support the thick-wire coils; and as a result tuning-inductances of high H.F. resistance and dielectric losses, giving from 40 to 60 per cent. only of the available signal-strength in broadcast reception, have become common.

A Circuit

With the circuit indicated in Fig. 1 (the standard type of practical comparison circuit for testing tuning inductances, crystals, etc.), the relative efficiency of such poor inductances in comparison with a standard low-loss variometer can be measured on a low-resistance P.M.G. aerial within a score or so of miles from a broadcast centre; earth, lead-in, and all connections being made of as high efficiency and low resistance as possible. A good tuner should give thus, with sensitive galena and unscreened P.M.G. aerial, some 20 microamperes at

a dozen miles, and up to four (or more) at 30 miles, from a 1 1/2 kw. station and under average good conditions.

The standard variometer in all these tests was a fairly low-loss one of No. 18 d.c.c. wound in slots in skeleton versions of the Harris X-former, a 4 in. square stator having a 3 in. square rotor pivoted within it. This tunes on a P.M.G. aerial over the usual broadcast belt, but suffers from the inevitable defect of variometers in possessing too much wire for its inductance value on the lower range, thus offering greater resistance than a simple coil.

Comparison of Coils

Comparing this standard with low-loss coils wound with different gauges of wire, turns close side by side, No. 32 d.c.c. gave slightly less than the standard (on 2LO's wave at about 13 miles); No. 26 gave the same as the standard; Nos. 24, 22, 20, 18 and 14 d.c.c. gave a slight improvement (of the order of 5 per cent., and therefore quite indistinguishable aurally); Litz gave the same signal-strength; whilst No. 18 or No. 15 enamel-insulated wire gave an improvement of the same small order. The best observed result was with No. 15 enamel-insulated wire, bowed alternately inwards and outwards between the supporting strips to simulate a cylindrical basket, but the figures were only 28 and 27 microamperes respectively. It is

evident, then, that once the gross losses due to crowding the wire in a multi-layer coil, and to heavy dielectric absorption, have been eliminated, the heavy damping of the crystal swamps any differences in H.F. resistances in these low-loss types of inductances, down to about No. 24 gauge d.c.c. wire. The smaller number of turns needed with the closer-wound finer gauges of wire to reach the requisite inductance assists considerably to favour the

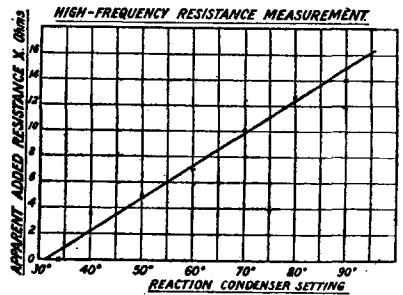
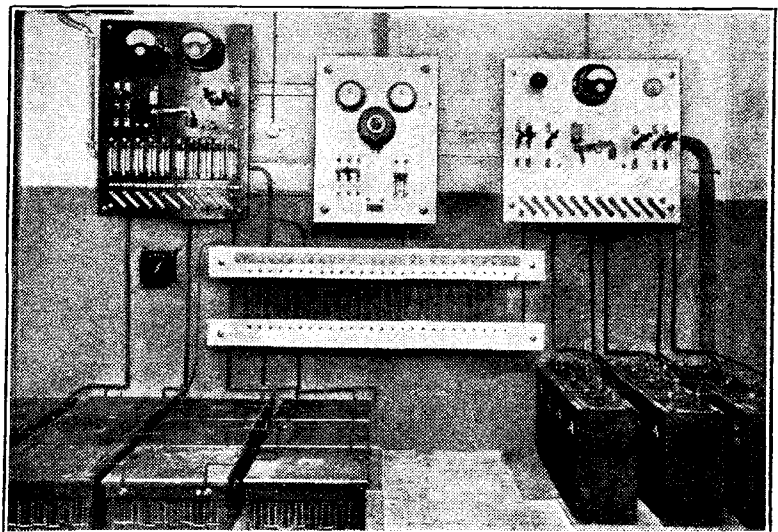

Fig. 4.—A curve plotted from measurements made with the Fig. 2 circuit.

latter; thus the No. 26 coil had but 22 turns as against 29 for the No. 14 gauge. (The turns were adjusted by trial until the coil tuned exactly to the required wavelength. Fine adjustment was made by opening or closing up the end turn or two.) The single-wire aerial used had a capacity of nearly exactly .0002 μF .

Valve Circuits

Turning now to valve-tuning inductances, where the heavy damping resistance-effect is absent, the relative H.F. resist-



This photograph shows the switchboard and charging plant at the Rome station.

ances could be readily compared by the method indicated in Fig. 2, devised some time ago by the writer, and regularly practised in routine tests on tuning-inductances, condensers, etc. This depends on the determination of the setting of a reaction-controlling condenser, which will just permit self-oscillation of a standard hard R valve, of M about 10, with 50 volts H.T. and a steady plate-current of 1 milli-ampere when not oscillating, reaction being produced by electrostatic coupling *via* the valve capacities, a low-resistance plate-variometer being used, tuning sharply on a fixed small condenser (.0001 μ F) across it. The expedient of a radio-choke in the plate circuit bridged by a small variable condenser, described some time ago by the writer for ordinary reaction control in reception, gives a quantitative controlled variation of this reaction-effect, by adjusting the H.F. potential-drop across certain parts of the anode circuit.

Measurements

By introducing a known variable non-inductive resistance at the point X in the grid-circuit, in conjunction with a low-loss tuning inductance, noting the reaction-condenser settings for different value of this which just produce oscillation; and then measuring the value of X in the usual way on the Wheatstone bridge with D.C., the order of the resistance-increase corresponding to different settings of C can be found. The H.F. resistance of the ordinary carbon-compression filament-resistance (which was used for X) is not necessarily identical with the D.C. value, on account of the skin-effect (even though this may be looked upon as a number of roughly parallel small conducting threads, with resistances at every contact between the graphite particles, which make up the conducting chains in the resistance-medium); but the relative value and order only are required here. The graph indicates how closely linear the relationship between reaction - condenser-setting and added resistance in the grid-circuit is in practice; about $\frac{1}{4}$ ohm per degree of condenser being the "apparent" resistance value. This approxi-

mate method can be strongly recommended to amateur experimenters, who do not possess much laboratory equipment: a carbon filament resistance, a variometer, a No. 250 or 300 coil, a fixed .0001 μ F condenser, and a 5-plate variable condenser with proportionate scale, and an ordinary valve-panel, are all that are needed for comparative observations of a roughly quantitative character. The plate variometer is critically tuned, with a constant tuning capacity in the grid-circuit, and the condenser C is then decreased in value (following up slightly with the variometer to retain critical tuning here) until the circuit will just not oscillate or *vice versa*. The difference in reading with

shows in an unmistakable manner the lowered H.F. resistance of the thick-wire coils, when properly spaced especially. Litz wire comes out the poorest, on a low-loss former; No. 15 enamel-covered wire closely wound is inferior to No. 18 d.c.c. spaced by its cotton insulation, and is only equal to No. 20 d.c.c. if bowed inwards and outwards between supports basket-coil fashion. No. 18 d.c.c. appeared to be better than the enamel-covered wire; but on separating the enamel-covered wire so that it wound only 13 or 14 to the inch, the minimum resistance of all was observed: so that this represents a practical optimum.

Basket Coils

Even though favoured by low tuning-capacity, a basket-coil of No. 20 on a skeleton former which gives most excellent results in actual reception showed marked inferiority to these low-loss forms. (Col. 11.) Yet in comparison with an exactly similar basket-coil wound with No. 22 d.c.c. wire, or with a conventional type of solenoid wound with No. 20 d.c.c. on a three-inch wax-impregnated cardboard former, its superiority was manifest. The greater spacing given by the clumsy thick d.c.c. wire comes into obvious play here. One of the most favourable types of commercial multi-layer plug-in coils, carefully spaced and of an unusually generous gauge of wire, gave for the No. 50 size a H.F. resistance far above the worst of these (Col. 1); another familiar multi-layer type of crowded thin wire was of too high a resistance to measure at all in this manner, the "apparent" resistance value corresponding to well over 20 ohms. This is in exact accordance with the properties of such plug-in inductances when used in practical short-wave reception: the flat tuning, and large reaction-coupling required for attaining sensitive reception.

Table

In connection with the table it must be noted that the valve operating conditions varied slightly from test to test; results in any one column are comparable, but not from one column to another. The relative values only were required, in any case.



At the conclusion of the Amateur Radio Congress the Secretary, Mr. Warner, was presented by the French Delegates with a ham roll decorated with the colours of all nations represented at the Congress. Each day of the Congress Mr. Warner never took lunch, but carried on his work only partaking of a few sandwiches.

two inductances of the same value but of different construction then gives a measure of the difference in their H.F. resistance.

Various Coils

In this way a number of different tuning inductances were measured, all on 365 metres, and in most cases with the standard tuning-capacity of .0002 μ F (with a low-loss tuning condenser). A few coils already at hand were measured at the same frequency with the particular tuning capacities required to reach this; these are not strictly comparable, as with smaller tuning capacity the losses are less and self-oscillation takes place the more readily. The table of results

The practical conclusion from these experiments is that:—

(a) For crystal reception a low-loss former of the type indicated, with a single-layer winding, has already cut down losses so far that little practical gain is obtained above No. 24 gauge d.c.c. wire, with ordinary parallel tuning.

(b) For valve-reception, with small tuning capacities, the minimum resistance is obtained with No. 18 enamel-covered wire spaced about 13-14 to the inch.

All for the broadcast range of around 300 to 400 metres, and probably up to 500 m. or so and on a 6 in. diameter low-loss former. These results probably will require revision for the higher frequencies, where stouter wire and more generous air-spacing appear to be indicated.

Results

The actual results achieved in reception on a O-V-1 or O-V-2 transformer-coupled receiver with a tuning-inductance following this design, with Reinartz reaction, and aperiodic aerial coupling, are so remarkable that the writer hesitates to publish them. An outside aerial becomes, e.g., a positive embarrassment, at short ranges, and good distances can be covered with comfort and enjoyment on an earth-lead, or no aerial or earth at all. It is quite a new world of reception that offers itself to the experimenter: I can only heartily recommend this virgin field to the enthusiastic listener who is willing to take a little trouble in fine tuning.

HIGH-FREQUENCY RESISTANCES.

Reaction-Condenser Settings for bare Oscillation : $\lambda = 365$ m.
Tuning Capacity : .0002 μ F.

	I.	II.	III.	IV.	V.	VI.
Standard Variometer. No. 18 d.c.c.	86	86	—	—	—	—
Low-Loss Inductances.						
6 in. former, Litz	52	—	—	—	—	—
No. 24 d.c.c.	50	—	—	—	—	—
No. 22 d.c.c.	—	35	—	—	—	—
No. 20 d.c.c.	—	30	58	—	—	—
No. 18 d.c.c.	37	—	53	72	72	—
No. 18, enamel close-wound	—	—	—	90	—	—
Do. do. open	—	—	—	70	—	—
No. 15, enamel	40	—	—	—	—	—
No. 15, bowed	—	30	58	—	80	—
Other Types.						
Basket-coil, No. 20 d.c.c.	75	—	—	—	—	—
Large basket-coil on skeleton former, with .00007 μ F, No. 20 d.c.c.	—	70	—	—	—	34
Do. do. No. 22, d.c.c.	—	—	—	—	—	62
Single-layer coil on 3 in. waxed cardboard former, with .0001 μ F, No. 20 d.c.c.	—	—	—	—	—	50
Good type of commercial plug-in coil, No. 50. (?) No. 22 d.c.c.	98	—	—	—	—	—

Envelope No. 5

SIR,—In Envelope No. 5 you ask anyone making the "Omni Receiver" to send in a report on same. I give mine with pleasure. It was just the set I was looking for. I have had it in operation a month up to date, and during that time I have tried the following four circuits: One-valve Reflex, ST100, H.F., D., L.F. and detector and two L.F. Each one was wired up in less than 10 minutes, and the results obtained equalled in volume and range a set that had been made for the circuit. From start to finish, including making of the cabinet, it took a week, my spare

time being about three hours a night. But it was a week well spent. All my friends are greatly interested, and lose no time in hearing a new circuit. Six months ago I was quite content to make crystal sets. Then I started reading *Wireless Weekly*, *Modern Wireless*, and when *The Wireless Constructor* made its appearance I became a regular reader of that also. I have made several valve sets since, all with the help of your books. There is no doubt about the Radio Press leading. I think that any experimenter who is a regular reader of your papers is missing his way in not making the "Omni." The only critical point to watch is the coils, and once you get the right com-

OBITUARY

MR. GODFREY ISAACS, brother of Lord Reading, whose death was announced in our last issue, resigned last November the office of managing director of the Marconi Company, which he had held since 1910. His illness was short, and his death, at the age of 58, was undoubtedly hastened by overwork. In addition to outstanding financial ability, he possessed an astonishing energy and industry, which he devoted with un-



Mr. Godfrey C. Isaacs.

remitting enthusiasm to the affairs of the company. The period of his service has been one of great development in wireless, and it is hardly too much to say that the company owes as great a debt to Mr. Isaacs on the business side as it does to Mr. Marconi on the scientific side. It may be that Mr. Isaacs's methods were not always exempt from criticism, and both during the famous Marconi "scandals" and in various litigation he had to face severe, if not always well-informed, comment. But he will be long remembered as a man of remarkable gifts and boundless enthusiasm for the new science with which he had linked his commercial fortunes.

bination for the circuit being used it will practically knock your head off with the volume if you keep the phones on. I have also just completed the "Wavemeter," by Mr. Harris, in the February number of *Modern Wireless*, and that, together with the Omni, should take some beating.—Yours faithfully,
Stockport. W. WHITE.

Correspondence

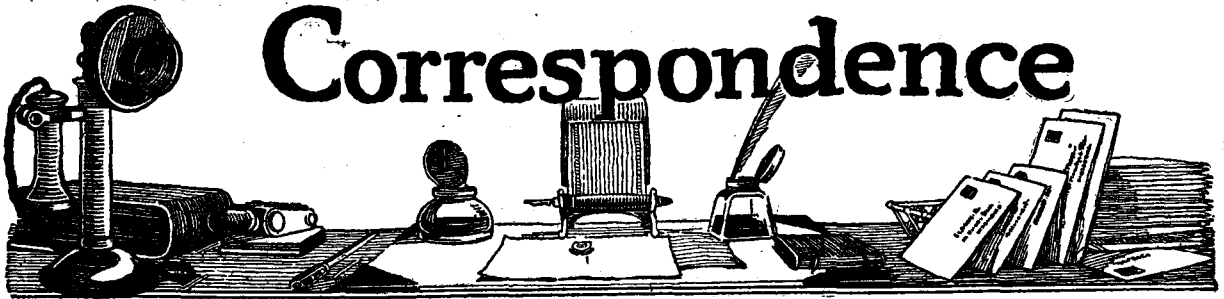

"THE FOREIGN RADIO TIMES."

SIR,—Your new publication, *The Foreign Radio Times*, as a supplement to *Wireless Weekly* supplies a long-felt want to all who are interested in this subject. While it is a good step in the right direction, it would be still more interesting if other stations could be included, such as Rome, Stockholm, Madrid, etc.

You are to be congratulated on your enterprise. You were the pioneer in publishing, firstly, foreign time tables, and now the detailed programmes, which give a greatly added interest in wireless generally, and especially in long-distance reception.

The programmes published enable me to identify stations received, but hitherto unidentified, and to tune in to many others. As a regular reader of *Wireless Weekly*, I think the new feature has added greater interest to an already popular publication.—Yours faithfully,

Bristol.

J. R. C.

SIR,—Although I have taken in your three journals since their commencement, I have rarely found a

assure you, is in no way derogatory to the usual excellent standard of your papers, which I find more and more interesting and instructive.

With regard to recent correspondence upon the subject, I should be sorry to see the *Foreign Radio Times* made a feature distinct from *Wireless Weekly*, and think the inclusion of the American stations less useful than detailed programmes of Madrid, Brussels and Munster, which latter comes in best of the German stations.—Yours faithfully,

R. F. K. GOLDSMITH.

Dorset.

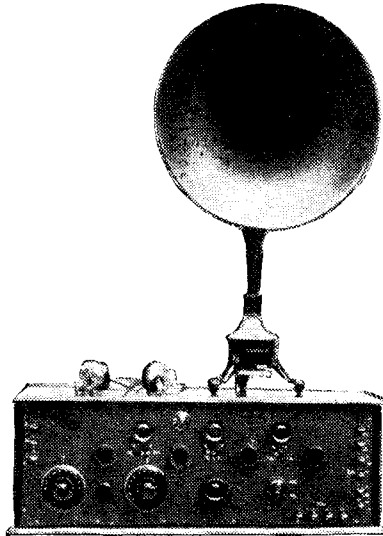

A four-valve family receiver as made by Mr. Wiggins.

more useful feature than the *Foreign Radio Times*. This statement, I

APPRECIATION

SIR,—Once again I have to thank the Radio Press for their designs and helpful periodicals. A few notes on my second effort at construction may be of interest. A three-valve set, using the Reinartz design of Mr. Stanley G. Rattee (*Wireless Weekly*, March 25) for the first stage, transformer-coupled for the second and resistance-capacity coupled for the last, the whole arranged behind the panel



Some well-known faces. A group of British delegates to the International Amateur Radio Conference, a report upon which appears earlier in this issue.

with telephone jacks for one, two or three valves, as in Mr. Rattee's three-valve set in *Wireless Weekly* of March 4. The coil-holder, together with a plug and a socket for the aerial and earth leads, is mounted on an ebonite strip on one side of the cabinet. A small ebonite block on the other side has a flush mounted valve-holder. Rubber covered flex connections run from the coils, aerial and earth to five terminals on the back of the

Foreign Radio Times, I hope now to enjoy many of the foreign programmes.

Again wishing you continued success.—Yours faithfully,

G. M. PART.

Tunbridge Wells.

ENVELOPE NO. 2.

SIR,—I have enclosed photographs of a four-valve family receiver from your No. 2 Envelope. I have

including some of the relays, four French, three German, Madrid, Brussels and Hilversum, so that the set may be regarded as reasonably efficient, but I am not going to pretend that I would take an armchair and sit down for the evening with any of those stations other than 5XX and occasionally 2LO, except under exceptional conditions. I am going to suggest a numerical scale on the following lines. (This may be a hardy annual, but I am comparatively fresh to radio.)

Strength 0.—Very weak; music just audible.

Strength 1.—Weak; music and speech audible, but latter not distinguishable.

Strength 2.—Moderate; speech distinguishable, but not loud enough for continuous enjoyment.

Strength 3.—Comfortable strength.

Strength 4.—Loud—"the gramophone in the small room" effect.

Strength 5.—Too loud without detuning.

Applying this to my own set results as follows under normal conditions of reception:—

5XX	4
2LO	3
Radio-Paris	2-3
Madrid, Petit Parisien, Hilversum, Bournemouth, Newcastle	2
The rest	0-1

(The position of Bournemouth above is peculiar, due possibly to local conditions, but it always comes in badly, and usually distorted in addition.)

I certainly feel that some such scale as the above would give a better idea of performance than the phrases "The local station was received at excellent strength," while "XYZ and ABC were quite audible in the phones." Would the

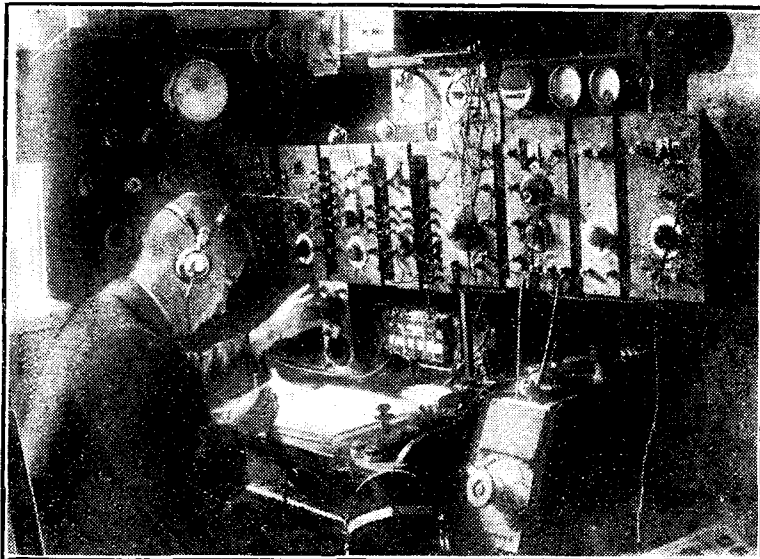

Mr. Walter Sherratt, who has established wireless communication with Reikjavik, Iceland, is, we believe, the first amateur to accomplish this feat.

panel. Likewise flex connections run from the valve-holder to terminals on the baseboard.

My various batteries being kept together, the leads are braided together and fitted to an old H.F. transformer former, which plugs into the valve-holder. By this means the unskilled members of the household (including myself) cannot very well connect up the batteries wrongly. The flex connections to terminals behind the panel enable one to remove "all the works" if necessary without much trouble and at the same time secure a "clean" front panel with only the condensers, rheostats and jack sockets on it.

As regards performance, I am very pleased with it, now that I have mastered the coupling of the coils; the Reinartz reaction is delightful. Situated some 35 miles south of London, 470 ft. high, 2LO comes in almost unpleasantly loud on the outdoor aerial (75 ft. long, single wire, 20 ft. lead-in and about 30 ft. high) on one valve. Very pleasant phone strength is obtained (also on one valve) with 25 ft. of No. 26 d.c.c. wire hung round the ceiling. Bournemouth, Manchester, Newcastle, Madrid and Petit Parisien all come in well, particularly the last. Thanks to your

only made the necessary alterations to have valves and tuning coils inside, as I wanted these parts out of the way of being damaged. I am highly delighted with the receiver, and consider it all that can be desired. I am now making the three-valve All-Concert de Luxe, No. 4 Envelope, and must congratulate Radio Press on such perfect designs.—Yours faithfully,

EDWIN O. WIGGINS.

Smethwick, Staffs.

SIGNAL STRENGTH STANDARDS

SIR,—I have observed lately several letters on the subject of loud-speaker strength, and venture to suggest that the question of phone strength requires equal ventilation and revision. While appreciating that individual tastes differ and also that freedom from distortion and interference and the "background of pure silence" have a not inconsiderable bearing, I feel that something better than the present vague generalisation is possible. It may make my ideas clearer if I take the case of a single-valve receiver in constant use here some 35 miles south of London. Now, at various times I have received most of the B.B.C. stations,

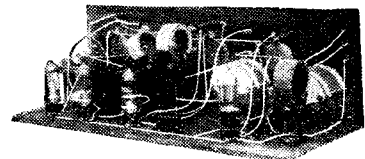

A back of panel view of Mr. Wiggins' receiver.

tester have liked a whole evening, or even half an hour, of XYZ?

The average listener wants an evening's entertainment, not a DX hunt in the "Forest of Morse," though the latter is occasionally entertaining as a diversion, and I feel that some such scale as that indicated would give a better idea of the capabilities of a set than the usual remarks in test reports about the "local station being received at fair strength" or merely that "several of the B.B.C. stations were received without difficulty." The conservatism of Radio Press test reports is excellent, but cannot

we get a more quantitative basis for estimating performance?—Yours faithfully,

G. M. PART.

Tunbridge Wells.

APPRECIATION

SIR,—Having been a regular reader of *The Wireless Constructor*, and having made up two sets described therein, I thought I should like to express my appreciation of Mr. Percy W. Harris's receivers. I built up first his "Single Valve," as described in the December number. I did this while waiting for some parts for a larger set, and found it very efficient, and since then I have built his "Three Valve" as given in the April *Constructor*, and I am exceedingly pleased with the results. I can pick up all the B.B.C. stations on the loud-speaker without touching 'phones for tuning in, and many foreign stations as well. Hilversum came in beautifully on Sunday, March 29, on the loud-speaker, and Cardiff also was very good in the evening. The set is extremely simple to operate, and English stations come in so easily that it is no trouble to pick out the one you want.

Thanking you.—Yours faithfully,
P. J. JACKSON.
Lowestoft.

A CANADIAN READER'S VIEWS ON EUROPEAN CHAOS (?)

SIR,—I am pleased to find *Wireless Weekly*, *Modern Wireless* and *The Wireless Constructor* on sale in bookstores in this city, and I bought a copy of *Wireless Weekly* recently and was a good deal interested in the article, "The International Aspect of Broadcasting." It seems to me that in order to save broadcasting in Europe from chaos it is absolutely necessary to call an International Conference to settle the matter of wavelengths and of international broadcasting difficulties, and I have understood from the American Press that such a conference is to meet next autumn sometime. Such a conference ought to find no more difficulty in settling the question of wavelength interference in Europe than we have on this side in the U.S. and Canada with our 200 and more broadcasting stations. It is just a case of harmonious agreement for the benefit of all.

Kingston, Ont.

H. ROBERTS.

6HC.

SIR,—I would be very much obliged if you could give publicity to the following short paragraph:—

The name and address of 6HC is as follows: H. Cooper, "Morning Dawn," Burnt Ash Lane, Bromley, Kent.

Apparently my address is unknown to many amateurs, and I understand that several have reports for me, but do not know where to send them.—Yours faithfully,

H. COOPER.

Bromley.

AERIAL CURRENT VARIATIONS

SIR,—With reference to one or two of your articles, "Random Technicalities," and particularly to your remarks regarding aerial peculiarities and apparent increases in transmitter aerial current when a second aerial in the neighbourhood is in sympathetic tune, I may add that Mr. W. Bakewell and myself co-jointly run a wireless station in a common room, as we both have all the necessary permits. We have several aerials, earths and other ornamentations.

On Sunday mornings when working on the 400 metre band on telephony we not only found all you state (to be our experience), but also that when a 95 ft. single L receiving aerial is in use for reception that if this aerial is switched through to the set whilst we hail

HAWK COILS

MAXIMUM EFFICIENCY STRENGTH **MINIMUM CAPACITY DAMPING EFFECTS RESISTANCE**



Prov. Pat. 20289

WATERPROOF

Prices below

Coil	Wave Length using .001 Variable Condenser in Parallel		PRICE.
	MAXIMUM	MINIMUM	
18	—	—	2/-
25	895	190	2/4
30	435	240	2/6
35	515	360	2/6
40	680	370	2/8
50	835	485	3/-
75	1250	600	3/4
100	1820	815	3/10
150	2900	960	4/8
200	3100	1870	5/6
250	3750	2200	5/8
300	4500	2360	6/-
400	4950	2500	6/6

Sold by all Wireless Dealers

Sole Manufacturers:

The Hawk Coil Co., ST. MARY'S ROAD, SURBITON, SURREY.

Some change their value many times in a few hours

Constant resistance is the primary and most essential feature of a variable grid leak. Truly, some types change their value many times in a few hours. The adjustment of the grid leak value in some circuits is fairly critical and the composition of the material providing the resistance should not be subject to change by any varying conditions of the atmosphere or by the application of voltage if results are to be reproduced. In buying any variable grid leak you build endless trouble into your sets. But by purchasing a WatMel Variable Grid Leak you incorporate Detector Valve Control of the highest efficiency. Its resistance value is constant.

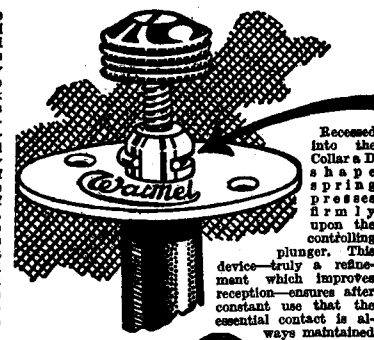

Recessed into the Collar a D shape spring presses firmly upon the controlling plunger. This device—truly a refinement which improves reception—ensures after constant use that the essential contact is always maintained electrically good.



All goods of our manufacture bear this mark. It is your only guarantee.

5 to '5 Megohms .. 2/6
50,000 to 100,000 Ohms 3/6
When at your dealers SEE THE TRADE MARK.

If you are troubled with poor results pay particular attention to the working of the Detector Valve. Reduce the H.T. voltage consistent with good volume and incorporate a WATMEL Variable Grid Leak.



ON EVERY GRID LEAK BEWARE OF IMITATIONS

Send P.C. for Descriptive Folder.

The WATMEL WIRELESS CO. LTD.
332a, Goswell Road, LONDON, E.C.1

Telephone CLERKENWELL, 7990

someone on the transmitter, and that on its own aerial (a 45-ft. twin), the transmitter does not reach at all, although, as you say, the current in the aerial increases. We took this matter up with a local amateur; he is not three miles from us, and we found that when the receiving aerial was in sympathetic tune with our transmitting aerial, he could not pick us up on a 6 H.F. Marconi receiver. On cutting out the receiving aerial and not touching the transmitter, our telephony range was 70 miles. Hence we always use a cut-out D.P. switch on the receiving aeriels and earths. This is indeed a nasty knock for any enthusiastic transmitter, particularly he who worships "aerial amps."

Regarding Exide wet H.T. battery, type BK, such as you describe, we have some 400 volts of this make, and 300 volts are *not* of the type where the single plates at the end of each row simply sit on the top of the container, but are fastened down with a lead nut on to a pin that is fitted right through the top ring of the container into the container proper.

This method has certain disadvantages, but the later type is much better, and the oil supplied by "Exides" for floating on the cells is excellent, saves all acid spraying and creeping, and is worth recom-

mending. Once having got the containers dead clean and dry and filled with new acid with $\frac{1}{4}$ in. layer of their oil, all worry disappears. The type BK stands up well even to transmitting; regularly we discharge at 60 and 70 milliamps, and they are in excellent condition after 18 months' use, and that is covering two wireless winters. We have also got 120-volt Hart wet H.T. battery, very excellent, too.—Yours faithfully,

C. W. ASHTON, 5CW.
Stoke-on-Trent, Staffs.

MR. HADDICK'S CLAIM

SIR,—I should esteem it a favour if you would grant me a little space in your valuable columns to inform Mr. Houston and others that I have received no communication whatever from Mr. Haddick in regard to the challenge I made him through the columns of *Wireless Weekly* dated February 25, 1925. Due to this fact I am now thoroughly convinced of the inaccuracy of Mr. Haddick's claim, viz., to get any station without interference from 2BE on the circuit mentioned.

Thanking you in anticipation.—
Yours faithfully,

SAMUEL A. BOOTH.
Belfast.

A LONG-RANGE TWO-VALVE RECEIVER

SIR,—I have been a subscriber to *The Wireless Constructor* since No. 1 came out, and admire the paper and its "get-up," etc., very much.

Graduating through several crystal receivers and a one-valve reaction set (with which, by the way, I once tuned in America), I have achieved my desire to date, i.e., a long-range two-valve set.

I suppose you are continually being overwhelmed by congratulations on Radio Press sets, but I thought I would like to add my little quota of thanks. *The Wireless Constructor* has not yet published a straight H.F. and Detector circuit, has it? I wanted one, and a chum lent me *Wireless Weekly*, dated September 17, 1924. Therein was a long-range receiver, described by Mr. John Underdown.

I built this set, using the best materials I could afford, Cossor valves, Sterling square law condensers, Polar coil-holder and Igranite coils, etc. The results have astonished me.

My aerial is 70 ft. long, and averages about 20 ft. high.

During the two months I have been using this set I could get any

Quality RADIO DUPLEX BASKET COILS.



The most efficient inductance coil made for short waves, mounted on standard plugs. No wax or varnish used.

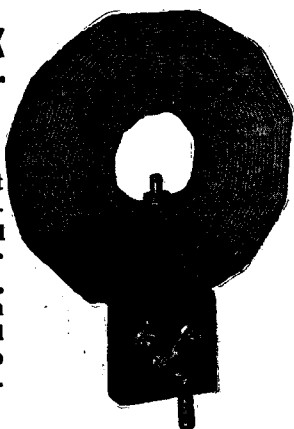

Number	Mounted	Mounted with Reaction Reverse Switch	Unmounted.	Number
25	1 6	3 0	0 9	25
35	1 9	3 3	1 0	35
50	2 0	3 6	1 3	50
75	2 3	3 9	1 9	75
100	2 9	4 3	2 3	100
150	3 0	4 6	2 6	150
175	3 6	5 0	2 9	175
200	3 9	5 3	3 0	200

Postage: 3d. each. Set of eight coils post free.

If your dealer cannot supply we send post free if you mention his name and address.

GOSWELL ENGINEERING CO., LTD.

12a, PENTONVILLE ROAD, LONDON, N.1.

Liberal Trade Terms.

LIST FREE.

Phone: North 3051.

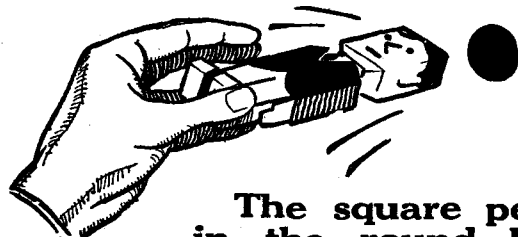

The square peg in the round hole

Everywhere you find them, these unhappy square pegs. Often, indeed, you must have been conscious of occupying their uneasy situation yourself. And oftener still their rank incompetence must have harassed and perplexed you.

In one thing at least in this life they need have no place. You can banish them for ever from your radio set (where commonly their name is legion) by using the CLIX Plugsocket and Adapter.

The plug of one CLIX smoothly slips into the socket of the next CLIX or CLIX Adapter—and there is firmly held, with full surface contact. That's the CLIX secret. Simple? But it's withheld from every kind of switch, plug or terminal but CLIX.

Retail Prices of the new CLIX:

- CLIX with Locknut, 3d.
- CLIX Adapter with Locknut, 2d.
- CLIX Insulators, 6 colours, 1d. each.
- CLIX Bushes, 6 colours, 1d. pair.



The Electro-Link with 159 Uses

AUTOVEYORS LTD., 84 Victoria St., LONDON, S.W.

B.B.C. station at will, on almost any evening, and on most evenings they all came in well. Aberdeen is inclined to be rather indistinct at times, and usually is accompanied by lots of Morse. German and French stations come in more strongly than our own!

Last Sunday morning, early (2 a.m.) I tuned in three American stations—two unidentified and the other was Springfield, Mass.

I should very much like to know why it is that the "Jerry" stations and Bournemouth and Manchester and sometimes Newcastle are quite as loud as London.

In spite of very careful tuning I cannot get London any louder than Manchester or Bournemouth, and not nearly so clear!

Chelmsford, of course, comes in loud, but Chelmsford will come in on anything.

By the way, I hung an ordinary galvanised washing bath up in the room and soldered a lead to it which I carried to aerial terminal of set. Both Chelmsford and London came in on this, 5XX being quite loud. I can also get 5XX without any aerial or earth at all.

Next year I intend to build an "All Concert" set—at present funds do not permit.—Yours faithfully,

J. J. MARKWELL.

Framlingham.

[A receiver embodying such a circuit was described in *The Wireless Constructor* for May.—Ed.]

THE TWIN-VALVE RECEIVER IN SOUTH AFRICA.

SIR,—You will, no doubt, be pleased to learn of the following results obtained with the Twin-valve set made by myself from instructions given in *The Wireless Constructor* for January, 1925, by Mr. John Scott-Taggart, F.Inst.P., A.M.I.E.E. As you are probably aware, our chief trouble out here is the prevalence of X's, but nevertheless, the results obtained are really remarkable.

sen's fairy tales, but they can be verified by several independent witnesses.

Your interesting paper is a boon to us out on the backveldt, and I look forward to its receipt every month. With best wishes for the success of Radio Press.—Yours faithfully,

H. G. H.

Bethlehem, O.F.S.,
South Africa.



A NEW SOCIETY.

SIR,—You may probably think the following information of interest to a few of your readers, if so, will you kindly have same inserted in *Wireless Weekly*.

Station and Wavelength.	Distance.	Aerial Condenser.	Condenser H.F. Transformer.	Reaction.	Result.
	Miles.			Reversed.	
Capetown 375	695	98	46	35	Fair L.S.
Durban 400	200	110	54	35	Good L.S. results.
Johannesburg 450	165	125	68	35	Good L.S. results

Within five minutes of connecting up the set for the first time I was successful in picking up JB, and the other two stations came very easily. The results read as though they emanated from Hans Ander-

A society has been formed for wireless enthusiasts in the Eastern District of London named the Tower Hamlets Radio Society. All interested are requested to call or write to the Hon. Secretary, F.

STOP!

this is the Coil you're looking for!

The Self-Capacity of

The "Tangent"

is extraordinary low (see figures below)—RESULT—Closest Selectivity

Coil No. - -	25	35	50	75	100	150	200	250
Self Capacity in Micro-Microfarads	8	9	25	31	22	16	22	22
Price, each -	4/3	4/3	4/3	4/6	5/-	6/-	7/-	7/6

COMPLETE { 4 Concert Coils (W/L 250 to 1180)—16/- the set.
SETS { 11 Concert Coils (W/L 250 to 9500)—67/- the set.

All good dealers stock them—
: any difficulty write us. :

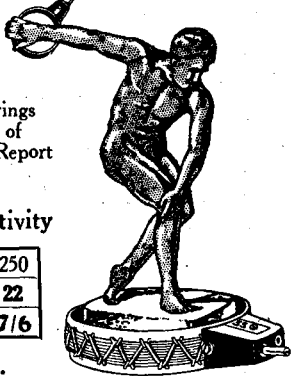

GENT & Co LTD

(Est. 1872.)
Manufacturing Electrical Engineers
FARADAY WORKS,
LEICESTER





RIGID AS A MOTOR WHEEL.

London : 25, Victoria St., S.W.1
Newcastle/Tyne : Tangent House, Blckett St.

Goodman, 47, St. Paul's Road, Bow, E.3.

This society has been formed, further, to a suggestion of the Radio Society of Great Britain, to whom we are applying for affiliation.

Thanking you in anticipation.—
Yours faithfully,

F. GOODMAN.

London, E.

20-METRE TRANSMISSIONS.

SIR,—We would be very grateful if you would announce to your readers that the Radiogiornale transmitting station in Bellagio; Lake Como, Italy, sends out every Sunday, at 3 p.m. G.M.T. on 20 metres and at 4 p.m. G.M.T. on 40 metres. Input power 30 watts approx. QSL will be welcomed.

With best regards.—Yours faithfully,

IL RADIOGIORNALE.
Milano, Viale Maino 9.

CORRODED ACCUMULATOR TERMINALS

SIR,—I am sending you the most valuable hint I know of in connection with accumulators, and trust it will be useful to your readers.

For many years I have been at a loss to discover how to free corroded battery terminals, and found this

out by accident. Wishing to make a connection to a badly corroded terminal, I decided to solder the wire to the terminal. Imagine my surprise when the terminal came absolutely loose as soon as the iron made it hot. The ease with which terminals can be freed in this manner has to be seen to be believed.—Yours faithfully,

C. BAXTER.

Birmingham.

THE J.B. STATION.

SIR,—I have pleasure in sending you herewith a few details of our Johannesburg broadcasting station, JB, for the benefit of your readers.

JB was officially opened on July 1, 1924, after two weeks' experimenting. The complete station is housed on Messrs. Stuttaford's buildings in the centre of the town, this building being the highest and most convenient. The studio is on the third floor and the transmitting instruments on the top (ninth floor).

JB is equipped with a 500-watt Western Electric installation, which has proved to be very efficient. The wavelength in use is 450 metres, making it possible for standard B.B.C. sets to be used.

The studio is well equipped and laid out, and it has been said by several visitors that it is one of the best studios to be seen anywhere.

Very good results have been obtained at long distances on JB, though, owing to the climate, atmospherics are troublesome. Normally JB is received in Cape Town (800 miles) on four valves, i.e., 1 H.F., D., 2 L.F., and Durban (350 miles) on three valves, i.e., 1 H.F., D., 1 L.F. However, at times Cape Town amateurs have received JB using a detector valve with reaction. An amateur in Nairobi, British East Africa (about 1,700 miles), has heard JB on his four-valve set (Family Four-Valve; Radio Press Envelope No. 2).

Of the three South African broadcasting stations (JB, Johannesburg; Durban and Cape Town), Johannesburg is by far the most popular, both in quality of transmission and programmes. The latter include market reports, stock and share market, weather reports, time signal at 9 p.m., and each week-day JB works for seven hours with varied programmes. On Saturdays until 11 p.m. dance music, and Sundays from 8.45 p.m. to 10.30 p.m. Sunday evening concert.

JB's Station Orchestra has the pick of the South African musical talent, and the combination would be hard to beat.—Yours faithfully,

R. N. LENNARD.

Johannesburg, South Africa.

COLVERN Tuning Condensers BRING IN DISTANT STATIONS

For the TROPADYNE

Builders of this very efficient type of Super-Heterodyne Receiver must recognize that they cannot hope for successful work without the Colvern General Purpose Vernier fitted in parallel with the Oscillator Condenser. Tuning is so exceedingly sharp that one can pass over a station. A peculiar click indicates the reception of a carrier wave; the actual telephony lies in the centre. Unless a Colvern Low Maximum is fitted in parallel with the Oscillator Condenser your Tropadyne cannot function anywhere approaching efficiency.

The theoretical capacity of an integral vernier is considerably increased by the mutual capacity between the main vanes and the vernier. The vernier is thus deprived of permitting a comparatively larger physical movement for a minute variation in capacity. Tuning on the oscillator is so exceptionally sharp that it operates most efficiently by using the Colvern General Purpose Independent Vernier. It is obtainable from all dealers.

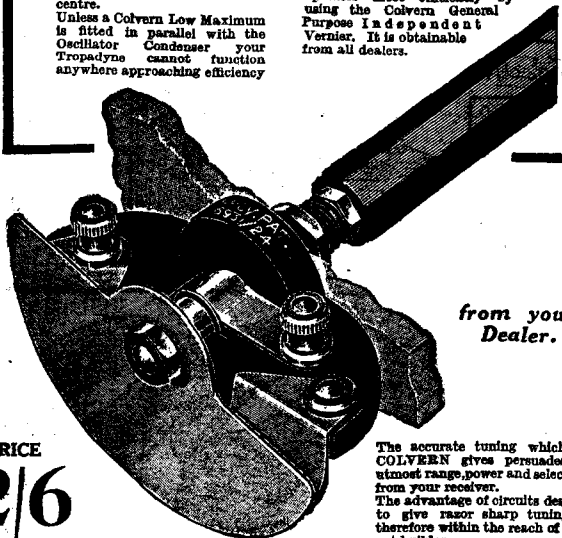

from your Dealer.

PRICE
2/6

The accurate tuning which the COLVERN gives persuades the utmost range, power and selectivity from your receiver. The advantage of circuits designed to give razor sharp tuning are therefore within the reach of every set builder.

COLLISON'S PRECISION SCREW Co., Ltd. Macdonald Road, Walthamstow, London, E.17. Tel.: Walthamstow 533

Barclays 1101

QUALITY AND EFFICIENCY.

THE ONLY PERFECT INSULATED

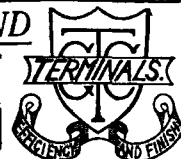

HAVING RELIABLE CONTACTS.

ASK YOUR DEALER FOR THEM.

LOOK FOR THE NAME AND PATENT NO.

GIBSON PATENT TERMINALS

SUPPLIED WITH RED OR BLACK SLEEVES.



SEVEN OTHER TYPES.



Sockets 4d. each.

SLIDING CONTACT.

No. 5. 1/3 each.

THE GIBSON TERMINAL COMPANY,
Denmark Road, Ealing, London, W.13.

Phone —
EALING 65.

BROKEN VALVES MADE EQUAL TO NEW IN FIVE DAYS.

Guaranteed to give Satisfaction or Money Returned.

Bright Emitters 6/6 each (Money should be enclosed)
Four Electrode 8/- each with valves.)

Send to:—ECLAT ELECTRIC MANFG. Co. LTD.,

Spencer Works,

SPENCER HILL ROAD, WIMBLEDON, S.W.19.



Conducted by A. D. COWPER, M.Sc., Staff Editor.

Anti-Vibro Valve-Holder

From Messrs. Phipps & Read come samples of an anti-vibration valve-holder, made actually of fairly soft rubber, for which, in addition, a lowered casual capacity is claimed. The valve-leg sockets are mounted in a disc of rubber 1 1/4 in. in diameter and about 1/4 in. thick, one socket (the plate socket) being enamelled bright red as a precaution against accidental short-circuits. Four No. 4 B.A. holes are required in the panel, through which the back-studs of the sockets pass; the disc itself acts as a drilling jig for this operation. Small soft rubber sleeves are then placed on the legs and ebonite back-nuts over them; connections to the studs are to be made by soldering.

On actually mounting a holder, as described, on a small panel, it was found that this was quite a simple operation; with a D.E. valve of notorious microphonic nature inserted in this and included in an ordinary reception circuit, a greatly diminished sensitiveness to ordinary jars and vibration was immediately noticed, quite a sharp rap on the panel or table giving but a slight ring in the phones in place of the usual booming sound. The valve oscillated with ease. Although the legs were a fairly tight fit in the holes in the panel, the whole mounting was so flexible that considerable care had to be taken not to insert the valve in the wrong orientation; the red colour of the anode socket is a wise precaution here.

The insulation-resistance from grid to anode and from grid to filament was satisfactorily high in the case of two out of three sockets examined; the third showed 100 megohms from grid to filament sockets, and 200 elsewhere. This is not low enough to cause much trouble in practice, though it were preferably somewhat higher. The capacities from grid to both filament-sockets connected together, and from grid to plate-socket, after eliminating leads, etc., came out at 3.1 and 1.3 μF respectively, as compared with similar figures for a conventional solid ebonite socket of 3.5 and 1.4 μF respectively, showing a small, but generally inappreciable diminution in casual capacities in the favour of these sockets.

This PAD makes all the difference in the world

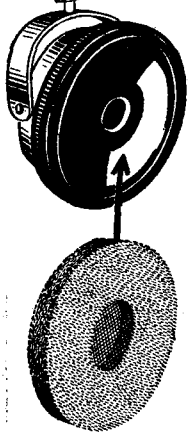

The "Kumfi" de Luxe Ear Pad is a veritable boon to listeners. Instead of the hard surface of the headphone ear-pieces pressing continuously on your ears, you have instead a soft, luxurious pad that relieves pressure and prevents all discomfort. The "Kumfi" de Luxe Ear Pad is the only scientifically prepared pad. It is hygienic and absorbent, and shuts out exterior noises. Try a pair and add greatly to your comfort; they are easy to fix and easy to remove.

'KUMFI' De Luxe EAR PAD

1/3d per pair
Sold by Wireless Dealers, or post free from the makers, on receipt of 1s. 3d.
A. De ST. DALMAS & CO., Limited, LEICESTER.

Patent applied for.

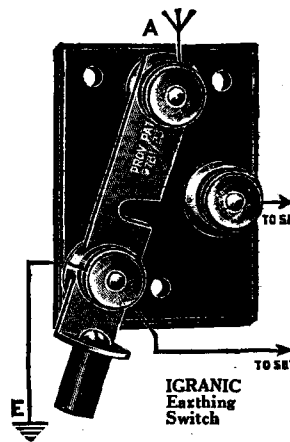
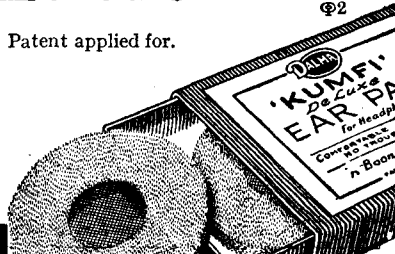

Protect your set from static charges

It is only natural for your aerial to accumulate a heavy static charge—especially when lightning is about—and for the safety of your set when not in use you should fit the Igranic Earthing Switch. You will thus protect the more delicate component parts by preventing the accumulated charge from discharging through the receiver. At the same time you will protect your home from fire, as it is possible for sparks due to the discharge, to ignite inflammable material if near at hand. The Igranic Earthing Switch is of an improved type having spring switch contacts ensuring perfect electrical conductivity. Price, mounted on solid ebonite base. 3/-

Ask your dealer about it.

Write for List Y54.

IGRANIC RADIO DEVICES
includes

Honeycomb Duolateral Coils, Fixed and Variable Condensers, Filament Rheostats, Intervolve Transformers, Variometers, Variocouplers, Bi-plug Coil Holders, Tri-plug Coil Holders, Battery Potentiometers, Vernier Friction Pencils, Electric Soldering Irons, etc., etc. All carry the IGRANIC guarantee.



149, QUEEN VICTORIA ST., LONDON, Works: BEDFORD.

BIRMINGHAM LEEDS BRANCHES: CARDIFF MANCHESTER GLASGOW NEWCASTLE

Aerial Masts

We have had an opportunity of trying in a practical manner the type of tubular steel aerial masts supplied by Messrs. John & James Laker Co. These are made up of handy sections of very light, large diameter steel tubing, the sections being connected together by a strong wooden plug inserted in the ends, and by bolts. Rings for stays at proper intervals are provided and a cap for the pulley. The base rests in a metal fitting to be secured on a substantial wood base-board; but no special foundations, cement pillars or "tabernacle" are needed, beyond a firmly-rammed patch of ground. The stays are properly relied upon for withstanding the strains, and for securing them long iron stakes, equipped with split rings, are provided for driving into the ground. The whole mast, even if of considerable height, takes down and packs into a comparatively small bundle for transport, the smaller parts being sent packed inside the hollow spars. Insulators for the stay-wires, the wires themselves, and a "non-jam" pulley are provided with the mast, but not halliards, nor aerial insulators.

Two 40-ft. masts of this type, on trial, were unpacked and put together, and the twelve stays, each cut to length, affixed, and the

stakes, etc., arranged, by one man in just over a day's work. The whole 40-ft. mast, when lying on the ground, could be lifted by one hand. Actual erection of the two masts took four men and two intelligent helpers (to stand by the guyropes, etc.) just two hours. A 25-ft. ladder was used, as suggested by the makers, roped to the one mast for this purpose; the other mast was hauled up by the stays from first-floor windows, as it happened to be near the house. The operation was performed with considerable ease, although there was a high wind blowing at the time. The finished masts had a very graceful, efficient appearance, with the slender centre pole and symmetrical stay-wires, and were, if anything, an ornament to the garden rather than the reverse.

We can strongly recommend these businesslike but graceful masts. A variety of sizes are supplied, up to the lofty type favoured by the amateur transmitter.

Regal Variable Condensers

Messrs. Regal Radio Components Co. have submitted samples of their 32-plate and 16-plate variable condensers, of the snail-cam or "square-law" type. These have metal frames, with large insulating bushes

but $\frac{1}{4}$ in. thick and over 1 in. diameter, giving accordingly much lower losses than the customary absurdly small, thick bushes fitted in many types of metal-frame variable condensers, when in use on the shorter waves. The usual one-hole fixing device is provided, and substantial, easily accessible terminals. Spring washers give good electrical contact to the moving plates, and render the action of the condenser smooth and certain. On test, the maximum capacity of the larger instrument was about .00065 μ F, minimum 25 μ F; the smaller had .00017 μ F maximum and no less than 18 μ F minimum. The relatively high minimum capacity is explained by the slight engagement of the plates even in the zero position, and could readily be avoided by a slight change in design. The insulation-resistance was excellent when the instrument was kept dry; on breathing on the condenser it sank to only 10 megohms, slowly recovering to 200 megohms. Naturally, any insulation will suffer with moisture; the experiment indicates the necessity of maintaining the relatively small surfaces of the insulating bushes at their best, by keeping the whole very dry. Free oscillation was obtained in very high frequencies with these instruments when in normal condition.

THE ACDIC BATTERY CHARGER

(M. A. CODD'S PATENTS.)

Charges your Batteries from the Alternating Current Mains.

This is the economy Transformer which reduces mains' pressure to that of the cells to be charged, without the use of wasteful lamps and resistances. Cells are insulated from the mains; therefore there is no risk of shock. Gives 3-cycle Rectification 3 Amps.

For 6-Volt Cells

£4-10

For 12-Volt Cells

£4-15-0

This is the patented Electrolytic Cell containing a carbon and aluminium plate which rectifies the current. There are no bulbs, commutators or buzzers to go wrong; it will not let you down. It only requires occasionally a new aluminium plate at the cost of a few pence.

Write for List to:—

THE SOLUS ELECTRICAL CO.,

Tel.: MUSEUM 2829. 100, Judd St., W.C.1.

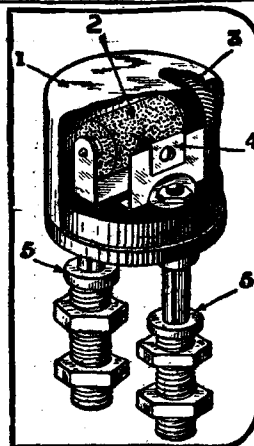

Don't tickle the Crystal—use the

Harlie
FOOL-PROOF
DETECTOR

Provisional Patent 26791/2A.

Continuous reception in any position at all times, owing to the special design of both crystal and catwhisker, being always in contact.

GUARANTEED TONE—VOLUME—PURITY

SOME NOVEL FEATURES:—

1. Nickel plated detachable dust proof cover.
2. Special "Harlie" super sensitive crystal.
3. Revolve wheel for rotating crystal. No fumbling about adjusting, just turn the wheel—simplicity itself.
4. Catwhisker on slider for covering whole surface of crystal. Shock-proof.
5. Nickel plated sockets for panel mounting.

Obtainable from all dealers or direct from patentees and manufacturers. **PRICE COMPLETE 5/6**
Generous Trade Terms. Telephone: Chisold 293.

HARLIE BROS., 183 DALSTON LANE HACKNEY, LONDON, E.8.

Barclays 1076.

Improve Your Loud Speaker

by fitting a "SCIENTIFIC" NON-METALLIC LOUD SPEAKER HORN. Being non-resonant and distortionless they give perfect reproduction and full amplification of volume. Finish—an attractive dull bronze.

	Ht.	Flare	PRICE
SMALL SWAN-NECK	15"	8 1/2"	5/9
SWAN-NECK with petal flare	18"	10"	7/9
SMALL WESTERN pattern	19"	11"	7/9
MEDIUM WESTERN pattern	22"	12"	8/9
do. with petal flare	22"	12"	9/9
LARGE WESTERN pattern	24"	15"	11/9
CURVED HORN, specially designed for Amplion Juniors	—	15"	11/0
LARGE SWAN-NECK, as illustrated, exceptionally loud	24"	15"	14/0
do. with petal flare	24"	15"	15/9

Post, packing and crate—1/9 extra.

SCIENTIFIC SUPPLY STORES—
86, NEWINGTON GREENWAY, LONDON, S.E.1. Phone: Epp 4177.
Branches: 128, Wellington Observatory, S.E.1.; 7 St. George's Circus, S.E.1.; 16, Massello St., Charing Cross Rd., W.1.; 207, Edgware Rd., W.2.; 84, Church Rd., Upper Norwood, S.E.20.



995471

Information Department

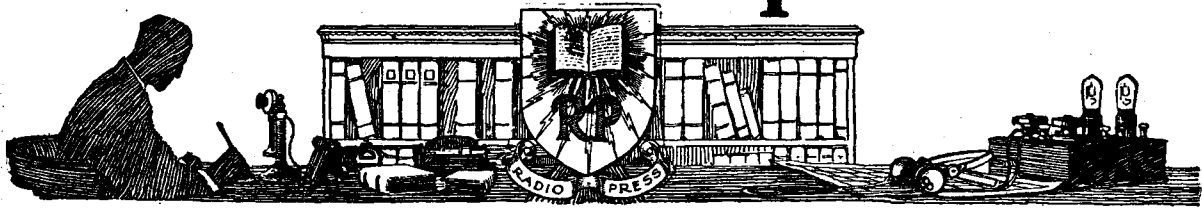

SUPPLIED BY RADIO PRESS SERVICE DEPT., LTD.

N. T. C. (SOUTHAMPTON) has been told that he is liable to injure his high tension battery by the use of a voltmeter for testing purposes which does not provide a sufficiently high resistance, and asks our opinion as to the minimum safe resistance for such a voltmeter, stating that he uses this instrument a good deal in carrying out certain experimental work which demands that he frequently checks his anode voltage.

The answer to such a question must depend to a considerable extent upon the nature of the high tension battery, and if our correspondent is aiming at extreme constancy we think he will be well advised to instal an accumulator high

tension battery, since it is now possible to obtain really satisfactory batteries of this nature at quite reasonable prices. Assuming a high tension pressure of 100 volts, it will be seen that if the voltmeter has a resistance of only 1,000 ohms it will draw a current of 100 milliamps from the battery, which, of course, is much too heavy a load for the ordinary dry cell type. Bearing this relation in mind, it is an easy matter to decide upon the resistance of the voltmeter for any given high tension battery. Thus, if it is decided that the maximum current permissible is 10 milliamps, the voltmeter must have a resistance of 10,000 ohms. The maximum permissible load for a dry cell battery will depend upon the actual size of the cells of which it is com-

posed, but 10 to 15 milliamps is to be regarded as the absolute maximum in most cases. In the case of an accumulator battery, reference should be made to the makers, but it will generally be found that a somewhat larger current may be drawn for purposes of test.

P.L.C. (BORDEAUX) has constructed the Anglo-American Six receiver described by Mr. Harris and wishes to try this set on a frame aerial. He wishes to use a four-foot frame for the B.B.C. stations, and also for Chelmsford and Radio-Paris. He also desires to know how to introduce reaction when using a frame aerial.

For the reception of the B.B.C. stations, and also for that of Radio-Paris, etc., it will be necessary to

ARE YOU SAFE ?

Can you leave your set with the **ABSOLUTE CERTAINTY** that no lightning, however bad, can possibly injure it ? Do not rely on any device which does not entirely isolate apparatus, and which makes a direct circuit from aerial to earth.

Prov.
Patent
No.
4326.



THE "AVON" SWITCH

AND COMBINED LEAD-IN

satisfies all these requirements—it is neat and unobtrusive, and so easily fitted.

SWITCH IS OUTSIDE—where it ought to be.
OPERATES FROM INSIDE—where you ought to be.
Just a turn of the knob and "SAFETY."

Made in three sizes, 8"—4/6; 10"—4/9; 12"—5/-

At all reputable dealers. If any difficulty post free from

H. C. DAVIS, Victoria Rd., BIDFORD-ON-AVON, Warwickshire.

RADIO MEN, ATTENTION!!

Have you ever considered the importance of perfect soldered joints ? Half of your troubles are due to these bad joints ! If you want perfection try

ZENITH SUPERFLUX

You will be amazed how easy efficient soldering is with "Superflux."

ZENITH SUPERFLUX guarantees perfection.

Sold by all wireless retailers and ironmongers at 1/-.

Manufactured by

THE ZENITH SUPERFLUX CO.
78, Commercial Road - Southampton.

THE PANEL DE LUXE I



A RADION PANEL—with its sleek polished surface—is a joy to behold. But the wireless enthusiast knows that its advantages are more than "skin deep." Its superior insulation qualities are even more important than its handsome appearance. In every way it proves itself the "panel de luxe."

Radion is available in 27 different sizes in black and mahogany. Radion can also be supplied in any special size. Black 1d. per square inch, mahogany 1 1/2d. per square inch.

RADION

Trade Mark

American Hard Rubber Company (Britain) Ltd.

Head Office: 13a Fore Street, London, E.C. 2
Depots: 120 Wellington Street, Glasgow. 1
116 Saow Hill, Birmingham.
Irish Agents: 8, Corporation Street, Belfast.

G.A. 2767.

construct two frames, one for the 300 to 500-metre band and the other for Radio-Paris. For the B.B.C. band the number of turns necessary will be eight, whilst $\frac{1}{2}$ in. spacing should be used between these. For 5XX and Radio-Paris we would advise that 25 turns be used, and that the spacing, between these should be made $\frac{3}{16}$ th of an inch. The gauge of wire is not critical, but we would advise that 18 gauge or above be used. A parallel tuning condenser of .0005 μ F will be satisfactory with these two frames.

It is seldom necessary to introduce reaction when using a set of the type our correspondent mentions. All the reaction effects necessary can quite well be obtained by slightly upsetting the adjustment of the Neutrodyne condensers. In some cases, however, where it is desired to introduce magnetic reaction into the frame circuit this may conveniently be done by placing a small coil in series with the grid side of the frame, and between the end of this and the upper end of the parallel tuning condenser, which goes to the grid of the first valve. Coupled to this a coil in the plate circuit of the detector valve may be used to obtain the necessary reaction effects.

J.U. (RAYNES PARK) has a detector and one low-frequency set using reaction, but finds it extremely

difficult to make the set oscillate, and cannot get rid of London all over the condenser scale of the aerial tuning condenser. He states that his earth connection is 20 feet away from the set and is made to a buried bath in very dry soil. To make the set oscillate he finds it necessary to use a much larger size of coil than is normally used. Reaction control is then far from smooth and easy.

From the particulars our correspondent gives we should be inclined to at once suspect his earth connection, since it is a considerable distance away from the set and would seem to be buried in dry soil, which often makes but a poor earth connection. As an experiment to locate definitely the cause of the trouble we would advise our correspondent to remove his normal earth connection, and in place of this connect to the earth terminal of the set a length of insulated wire which may be stretched under the aerial to act as a counterpoise. This should be taken the full length of the aerial if possible, and preferably 6 ft. from the ground, and well insulated. If with this arrangement tuning is found to be sharpened, selectivity very much improved and reaction demands very much less great, it is certainly the earth which is the cause of the trouble, and we would advise that means be taken

to remedy this or a counterpoise be used permanently. Where it is impossible to carry a counterpoise underneath the aerial a satisfactory arrangement is often to connect a length of insulated wire from the earth terminal of the set and take this through the house on the floor. Although not nearly so good, of course, as the outdoor counterpoise, in many cases this will be found a great improvement on the ordinary earth where it is difficult to get a good one. This arrangement can be made quite inconspicuous by taking it round the skirting of the room or under the carpet. A second experiment which should be tried to decide the point is to dig down to the buried bath and pour several buckets of water round it, until the soil is thoroughly soaked. A great improvement in results would then confirm that the cause of the trouble had been diagnosed correctly.

"A Basket-Weave Coil Former"

With reference to the article under this heading in our last issue, we are given to understand that Mr. J. P. Pragnall holds a patent covering coils wound on the particular type of former described.

**WHEN YOU BUY A VALVE HOLDER
BE SURE IT'S AN
"APEX"**

ANTI-CAPACITY VALVE HOLDER

(Patent pending)

Specially designed for back of Panel Mounting.

**1/6
each**

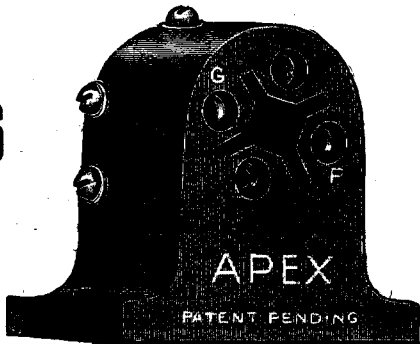

**1/6
each**

Note the rigid construction and the unique air space which gives a very low capacity between the valve legs.

BASEBOARD TYPE NOW READY.

APEX ELECTRICAL SUPPLY CO.

59, Old Hall Street, LIVERPOOL.

Phone: BANK 5295.

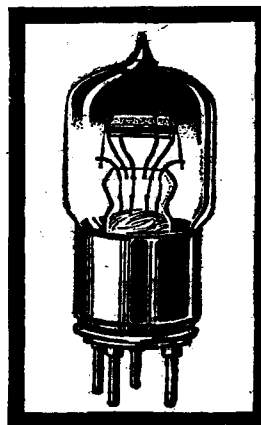

**There is
no doubt—**

It is a proven fact that the **C. & S. DULL EMITTER** does give **INCREASED AMPLIFICATION, CLEAR MUSICAL RECEPTION, has a LONG LIFE and a LOW CURRENT CONSUMPTION.**

It is the valve you are looking for! Ask your dealer for one to-day, and prove for yourself its capabilities. Refuse imitations. Look for our trade mark on the orange box.

The C. & S. Dull Emitter 2 v. 0.2 amp. (227) which received New Zealand on a single valve ... **12/-**

(Also made 0.06a (227L) 15/-)

Special dry batteries for these valves:—
227 .. 7/6 each. 227L .. 5/- each

Write direct if you cannot obtain locally, and we will mail you per return.

CRAIK & SMITH (Desk D)
Allen Street, Goswell Road, London, E.C.1.

Phone: Clerkenwell 7346.



An ANNOUNCEMENT



IN every field of life, in every branch of industry, there is almost always one individual or one firm standing out above the rest. In the wireless publishing business we have no exception—the words "RADIO PRESS" spring to the lips of novice and expert alike, as the obvious source to go to for wireless literature, whether books or periodicals.

The three great British papers, "Modern Wireless," "Wireless Weekly" and "The Wireless Constructor," have the words "Radio Press Ltd." indelibly stamped on every copy because these words mean more than an indication that these periodicals are owned and issued by that great publishing house—they stand for reliability, confidence, accuracy, enterprise, sound technique, fearless criticism where necessary, brilliant editorship, keenness, a whole-hearted love for the work which turns out week by week and month by month the papers which reach almost every corner of the earth.

Is it any wonder, then, the Radio Press announce a more than doubling of their rent? In other words, that they have taken another huge floor area in Bush House, that loftiest and finest example of business architecture standing at the foot of Kingsway, and between that thoroughfare and the Strand.

The great new editorial and managerial offices will leave about 5,000 square feet entirely to the vastly developing sales and publishing departments.

This new step is a proof that "A Radio Press paper is a Radio Press success." If a periodical is issued by the Radio Press, it is a brilliant success in its own field. That is why everyone interested looks to the Radio Press for the best in wireless literature.

Radio Press, Ltd.,

Bush House, Strand, W.C.2

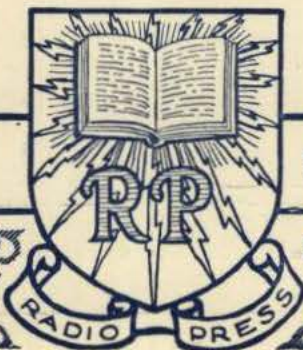



Get the right set— that's the point

Never try to get more out of your receiving set than the manufacturers state it will perform. So many radioists hug vain hopes of "getting the world on one valve" and so lay up for themselves a store of disappointment.

All Sterling Receivers will perform exactly what is claimed for them. Under favourable conditions often more than is claimed, but, given a good aerial, never less than is stated.

Sterling Receivers, whether one, two, three or four valve, have the widest possible range, maximum efficiency, and a certainty of performance. If you want long distance, plus selectivity, plus volume, plus appearance—then this latest model Sterling "4-valve" will give you years of unflinching service. The details of this high powered set are given opposite.

The most efficient all-purpose receiver extant—the arrangement of the circuit gives the utmost efficiency and results in selectivity, range, volume and quality.

Normally it will receive transmissions on wave-lengths from 300-500 metres, but is adaptable up to 5,000 metres, or may be tuned to wave-lengths of 40-275 metres—an exclusive Sterling feature.

Under favourable conditions the majority of the transmissions from the main B.B.C. Stations, as well as some Continental ones, can be received on a loud speaker. Its loud speaker reproduction of the local station is sheer perfection.

PRICE (exclusive of accessories) **£26**
Royalties, extra, £2:10:0 All accessories extra.

At your radio dealer's

There was once a man who built unto himself a one-valve wonder of many wires. He listened for the world and heard but little.



There was once a man who built unto himself a one-valve set. Content with local broadcast, he heard!



There was once a man who bought unto himself a Sterling "4-valve" set, desiring to hear other countries and the B.B.C. He was everlastingly happy.



Advertisement of **STERLING TELEPHONE & ELECTRIC CO., LTD.**

Manufacturers of Telephones & Radio Apparatus, etc.

210-212, TOTTENHAM COURT ROAD, LONDON, W.1

Works: DAGENHAM, ESSEX

Printed for the Proprietors, RADIO PRESS, LTD., Bush House, Aldwych, W.C.2., by THE AVENUE PRESS (L. Upcott Gill & Son, Ltd.), 55-57, Drury Lane, London W.C.2. Published on Wednesday of each week at 3, Bolt Court, Fleet Street, London, E.C.4. Address for Subscriptions and Editorial Communications:—Bush House, Strand, London, W.C. Advertisement Managers:—BARCLAYS ADVERTISING LTD., Bush House, Strand, London, W.C.2. Registered as a newspaper and for transmission by Canadian Magazine Post. Subscription rates:—32/6 per annum, 16/3 for six months post free. Sole Agents for Australasia:—GORDON & GOTCH (Australasia), LTD. For Canada:—IMPERIAL NEWS LTD. For South Africa:—CENTRAL NEWS AGENCY, LTD. For Japan:—SALE & FRAZER, LTD.