

Wireless Weekly

Vol. 5.
No. 6

CONTENTS

Special Illustrated Description of "Ecole Superieure" Station (Exclusive).

A Short - Wave Adaptor for Existing Sets.

A Self-Contained Three Valve Receiver.

What is the Best Weather for Wireless? Supersonic Heterodyne Reception in Theory and Practice, Valve Notes, Jottings by the Way, Apparatus We Have Tested, Correspondence, Information Department, etc., etc.

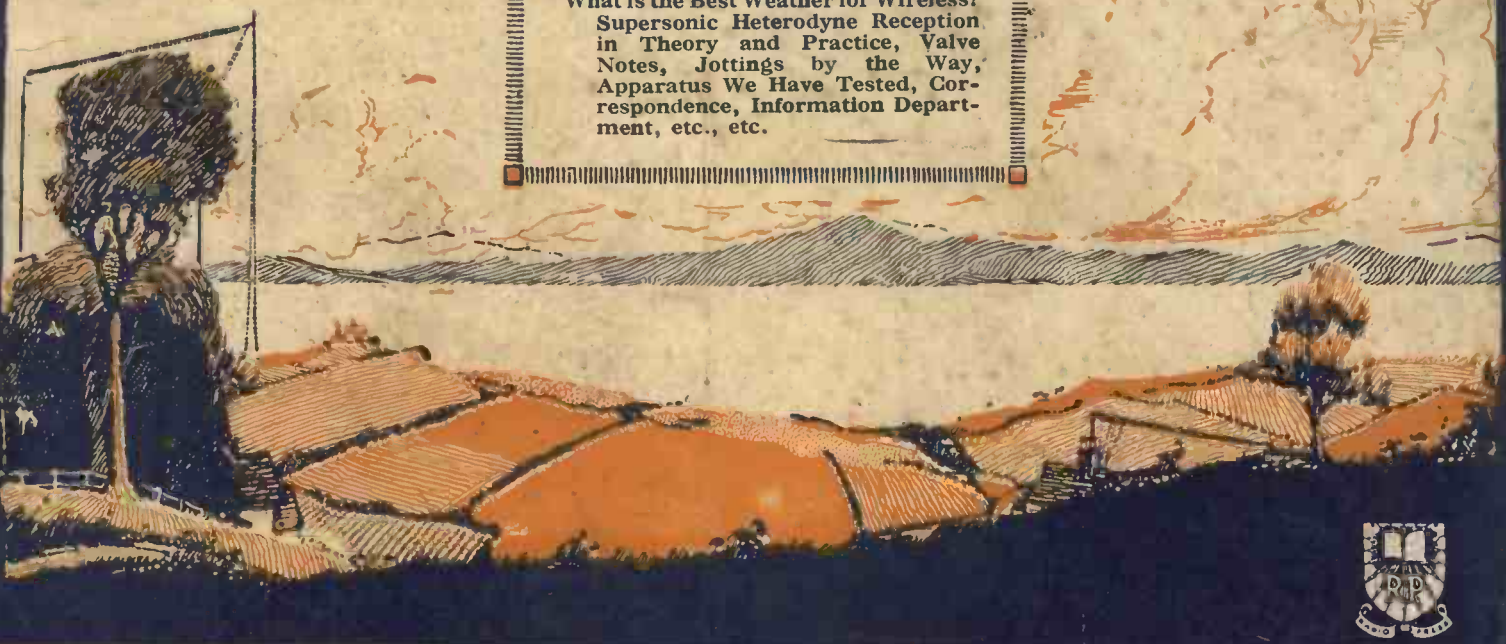

Free Photogravure Supplement

*Listen
Daddy!*

BURNDIPT
WIRELESS APPARATUS

BURNDIPT LTD., Aldine House, Bedford Street, Strand, London, W.C.2.



Wireless Weekly

Radio Press, Ltd.

BUSH HOUSE, STRAND, W.C.2.
Tel.—City 9911.

EDITED BY JOHN SCOTT-TAGGART, F.Inst.P.,
A.M.I.E.E.

Assistant Editor:
PERCY W. HARRIS.

Scientific Adviser:
Prof. G. W. O. HOWE,
D.Sc., M.I.E.E.

Advisory Editors:
Prof. R. WHIDDINGTON,
M.A., D.Sc.
Prof. C. I. FORTESCUE,
M.A., M.I.E.E.

Staff Editors:

E. H. CHAPMAN,
M.A., D.Sc.
A. D. COWPER,
M.Sc.
R. W. HALLOWS,
M.A.
G. P. KENDALL,
B.Sc.
S. G. RATTEE,
Member I.R.E.

Vol. 5, No. 6

NOVEMBER 26, 1924.

Price 6d. net.

More About the First Million

LAST week we commented upon the fact that the number of licences already issued amounts to practically a million. This is not a sudden boom figure—the licence holders have been steadily increasing in numbers for many months. A great new industry has grown up in this country, giving employment to thousands of skilled and semi-skilled men, yet the most superficial observer can see that the industry as a whole is very badly organised. Of ready-made sets of excellent design there are many, and it may be said that as a whole they are efficient, the prices charged being quite reasonable, having regard to the material and labour entailed. Yet it must never be forgotten that for every man who buys a ready-made set there are hundreds who buy component parts, and it is in regard to the “component” market that such general dissatisfaction exists.

In the three Radio Press periodical publications, *Wireless Weekly*, *Modern Wireless*, and *The Wireless Constructor*, we are continuously publishing designs from which the home constructor can build his own receivers. Throughout we use parts of standard design. Why is there such difficulty in regard to supplies?

There is no real excuse. It is quite obvious that there has been for some months, and there will continue to be for a very long period, a steady and insistent demand for all those parts necessary to build up an efficient wireless set. Had there been a sudden boom there would be some excuse for manufacturers being behind in their deliveries, but for several months-past

it has been most difficult to obtain delivery of certain makes of plug-in transformers of standard design, square-law condensers, combined filament resistances for bright- or dull-emitter valves, ebonite panels, and other much needed parts. There is plenty of room in the industry for small and enterprising firms who will seriously consider experimenters' requirements and not simply rush into production with components which are

Some business men are under the impression that the sole requirements for success in the wireless industry are big capital and large engineering plant, whereas the primary needs are of foresight, sympathy with the experimenter, and sound common-sense. A number of firms who started a year or two ago with but a few pounds' capital have now built up splendid businesses, simply by making a close study of amateur requirements, while others with the advantages of engineering equipment and plenty of capital have made a failure in the same direction. Radio Press, Ltd., has always been, and always will be, ready to give advice to manufacturers who wish to know what are the real needs of the industry.

Undoubtedly a certain amount of the trouble arises from the short-sighted attitude adopted by a few of the manufacturers. Having large works fully occupied, they seem to take a pride in telling people how many orders they had to refuse last week and how they can supply only a portion of each order. The gratification arising out of these statements will be short lived, as a potential customer who is unable to obtain satisfaction from a firm now is not likely to return on another occasion. Ultimately the business will gravitate towards those companies who are prepared to “go all out” to supply the steady demand which exists. Pride comes before a fall, and the undoubted excellent quality of some makes of component does not justify the manufacturers in treating would-be customers in an arbitrary manner.

CONTENTS

	Page
A Short Wave Adaptor for Existing Sets	194
Jottings by the Way	197
Supersonic Heterodyne Reception in Theory and Practice	199
Wireless at the White City	202
The Resistoflex Circuit on the Omni Receiver	205
What is the Best Weather for Wireless?	207
Valve Notes	209
A Self-Contained Three-Valve Receiver	211
Some Interesting Photographs	216
The “Ecole Supérieure” Broadcasting Station	218
Correspondence	225
Apparatus We Have Tested	227
Information Department	229

already easily obtainable. It has always been a mystery to us why so many of the larger manufacturing firms, when deciding to take up wireless manufacturing, start at once with a new inter-valve transformer. Many of these instruments made by firms well known in other branches of the electrical industry are by no means well designed, and the production of a satisfactory inter-valve transformer needs much research and experience.

A Short-Wave Adaptor for an Existing Receiver

By J. L. CASSELL.

The increasing popularity of broadcasting on wavelengths of 100 metres and below has prompted many designs of short-wave receivers. Our contributor is an American and we have not tested the method ourselves. We think, however, that British experimenters will like to try the arrangement.

FOR the past two years much has been said and written concerning the experiments with short waves, those waves which lie below the broadcast and amateur bands. However, most of the stories concerning the great distances and ease of communication made available by the use of this new field, told of much special apparatus and great technical questions involved. After reading a few such reports, the ordinary amateur relegated the subject to the scientist and went again to more pertinent problems dealing with questions nearer his heart concerning the efficiency and the distortion in his loud-speaker.

Many of the largest broadcast stations in America, such as WGY, KDKA and KFKX are now using short waves with regularity, and it only remains for the amateur to construct a set or an attachment for his present set which will enable him to receive these wave bands in order to get into the forefront of wireless experimental work.

The Principle Involved

Advantage is taken of the Super-Heterodyne principle. Essentially, the apparatus is a short-wave tuner with an oscillator. The incoming signal, which, for example, may be of a 60-metre wavelength, is picked up by the tuner, passed on to the oscillator and heterodyned to a higher wavelength of about 350 metres which may be easily picked up by the ordinary tuner. Thus every set can be easily made into a Super-Heterodyne receiver.

The addition of the short-wave oscillator valve increases the range of the set since it acts as an amplifier. Also, the receiving set proper may be worked at its most efficient point.

Still another advantage is gained through the adoption of the Tropadyne principle in the short-wave tuning unit. By using the standard Super-Heterodyne circuit the short-wave adaptor would require two valves. In this case only one valve is required.

The heart of the apparatus is embodied in the variable condensers. Several tests were made with the adaptor before the present design was evolved, but

frame to eliminate body capacity was used. With this type of condenser, the adaptor works admirably.

Of course, the ordinary type may be used for the tuner circuit if its capacity is reduced. Usually four plates have to be taken from the ordinary .00025 condenser to make it serve for short-wave work. The condenser selected must have low losses, or the efficiency of the adaptor will be reduced to a low point.

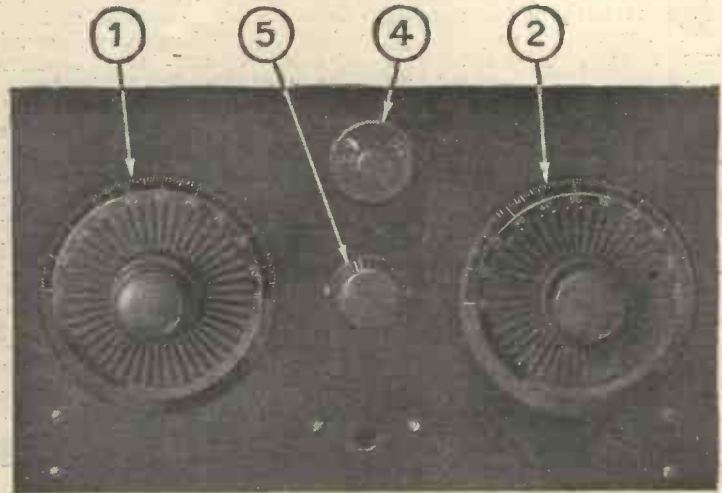

Fig. 1.—The completed adaptor. The figures are (1) tuning condenser, (2) oscillator condenser, (4) switch, and (5) variable grid leak.

due to the design usually employed in the manufacture of commercial condensers, the scheme was found to be impracticable. It was necessary with their use to cut out a number of plates in order to tune down to the short waves. And in this particular case, since neither side of the oscillator circuit may be earthed, the body capacity of the operator was so great that it was practically impossible to tune in a station.

A low loss condenser, C₂, having a straight line wavelength curve and separately earthed

Figs. 1 and 2 are photographs of the completed unit, and Fig. 3 is the wiring diagram. In constructing the adaptor, the first point is to wind the low loss coils. Fig. 4 is a drawing of the winding former. A piece of 1-in. soft wood may be used for the former base. Over this the template is pasted and nails or pins driven in as indicated. If nails are used the heads will have to be sawn off before being driven into the wood so that the completed coil will slip off the former. The coils will have a mean diameter of 3 in.

No. 18 S.W.G. d.c.c. wire is used throughout in making the coils. Four are necessary. The first consists of six turns. Begin at any pin on the former and wind the wire in front of one pin and behind the next. On account of the odd number of pins, each turn will be staggered over the next. Besides the six-turn coil, one of 10 turns and two of 21 turns will be necessary. In the centre turn of one of the 21-turn coils at the opposite side from the beginning of the coil a tap is taken. This is exactly at $10\frac{1}{2}$ turns. The windings are securely bound with twine before being taken from the former

The Tuning Circuit

The six-turn coil L_1 and the 21-turn coil L_2 are fastened together with three glass tubes 2 in. long, as shown in Fig. 5, and form the primary and secondary of the tuning circuit. Very little insulating substance should be used in supporting the coils as insulating substances increase losses. The primary and secondary are spaced $\frac{1}{4}$ in. apart. The 21-turn coil, L_3 , with the tap in the centre, and the 10-turn coil, L_4 , are mounted together with three more pieces of glass tubing and serve as the oscillator circuit.

The apparatus is mounted on a 7 by 12 in. panel. Instead of the usual sub-base, brass strips were used, as seen in the photographs of the set. The extra bracing strips shown will be found necessary for the stability of the set, as the least vibration

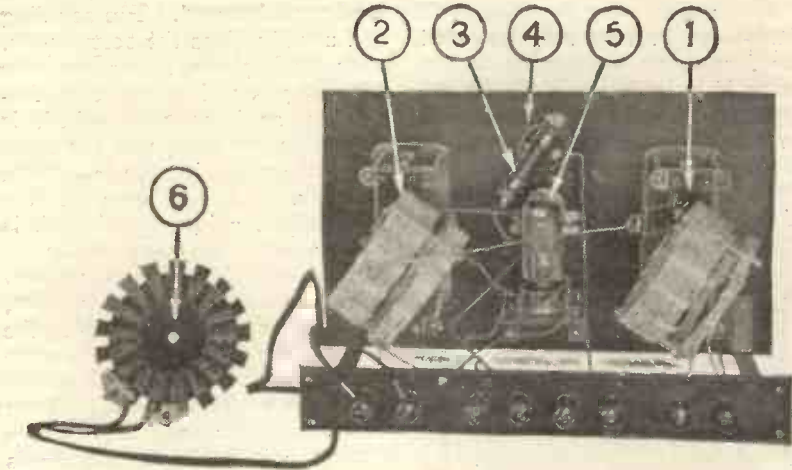

Fig. 2.—Rear view of the complete instrument. Note how the coils are staggered.

will detune it. An insulating strip of ebonite, $1\frac{1}{2}$ by 11 in. to carry the eight terminals is mounted at the back of the two bottom strips.

Shock-proof Valve Socket

The socket is of the panel mounting type and has a shock-absorbing attachment. This latter feature is not absolutely necessary, but is desirable since, working at the high frequencies for which the adaptor is designed, stability is both elusive and of the greatest importance. A .06 type of valve is used because of its low internal capacity. In making the connections to the socket flexible wire is used. Bus bar is suitable for the remainder of the set, but since its stiffness might pass on a measure of outside vibration, its use is prohibited in the socket leads.

For laying out the panel, mark a centre line on the panel and drill the centre holes for the condenser shafts on this line. The condensers are spaced 7 in. apart. The variable resistance and filament control switch may be placed conveniently. The lay-out depicted in the illustrations is good and may as well be followed.

Method of Mounting the Coils

If care is taken the coils may be attached directly to the rear of the condensers as shown. This is by far the best method and should be followed. The heavy wire of which the coils are wound is sufficient to support them and the advantage of short leads is gained, which advantage is extremely important in short-wave work. No appreciable losses are incurred by mounting the coils close to the condensers because of the small amount of metal used in their construction. The coils are mounted at an angle of approximately 60 degrees so as to minimise the coupling between them. They are placed so that the condenser plates are not in their magnetic field.

The variable resistance, R_1 , having a range from one-half to 5 megohms, is of the commercial carbon compression type. The rheostat in the filament circuit is used to obviate switching on and off suddenly, thus endangering the life of the valve.

The brass supporting strips and braces are also earthed. The leads from the condenser frame and the supporting strips are taken to the earth terminal and attached.

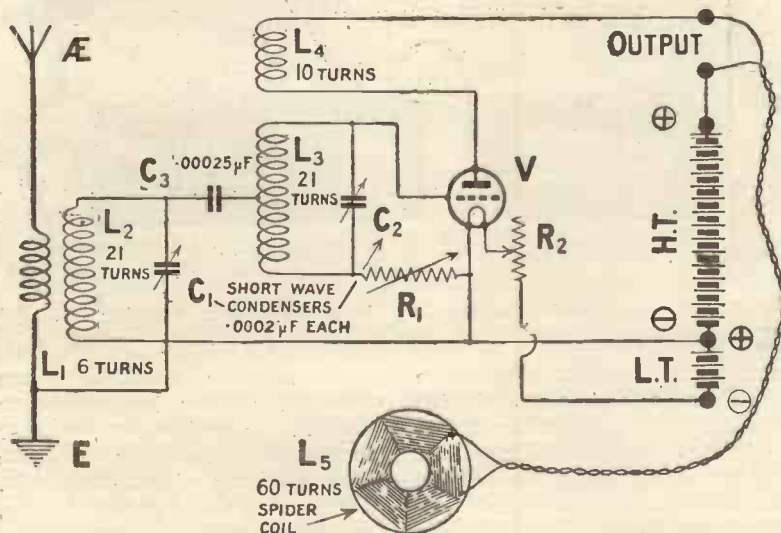

Fig. 3.—The circuit arrangement. The tropadyne principle is used for heterodyning the incoming signals.

Three dry cells or a 4½-volt flash-lamp battery may be used for furnishing the supply to the valve if it is of the D.E. or .06 type; 40-80 volts will be required on the plate. When the set is ready for operation, a test will have to be made for oscillation. If the grid leak is screwed out to maximum the set will squeal.

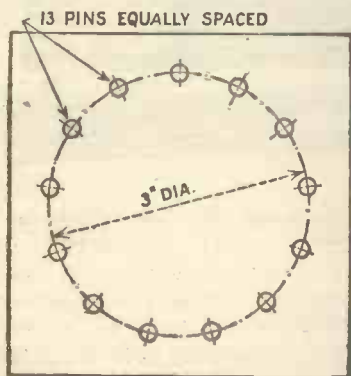

Fig. 4.—How to drill the former for winding the coils.

Before tuning in a station, the leak should be turned down until the squeal stops. The set can be easily tested by connecting the 'phones to the output terminals and leaving out the coupling coil described below.

The coupling method for attaching the heterodyning apparatus to the set will depend upon the set and its peculiarities. In the diagram a coupling coil is used. The coil is nothing less than a 60-turn spider-web coil, L5, connected to the output terminals with a 2-ft. length of telephone cord. This cord is for the purpose of obtaining the proper capacity for by-passing the short-wave oscillation. Any other lead may be used so long as the necessary capacity is given. However, the wire mentioned is probably the easiest obtainable and will serve the purpose admirably.

Coupling to the Receiver

The coupling coil is placed in the maximum inductive relation to the first inductance in the set. See Fig. 6. Other connections are optional. The coupling coil may be disconnected and the leads taken directly to the aerial and earth terminals on the set, if there is no series condenser in the circuit, or to the top and bottom lead of the inductance. In each case, the 2-foot capacity

lead must be used. The coupling coil usually gives the best results.

In tuning the apparatus, the receiving or intermediate frequency, as it may be called, is selected with an eye to the most efficient point in the standard receiver. In the case of the Neutrodyne a low wavelength is chosen, since by principle the set works best below 360 metres. After the coupling coil is in place, adjust the three dials of the Neutrodyne to about the same setting in the neighbourhood of about 20 or 30 degrees. Turn the condensers of the heterodyning unit until the station is brought in and then readjust the three dials of the Neutrodyne for loudest reception. Following this, the oscillator is again tuned and then the process is repeated until the Neutrodyne end of the apparatus is in as perfect tune as possible. The Neutrodyne is never touched after being once brought into perfect resonance. All short-wave stations are brought in with the heterodyning unit alone.

Employing Reaction

In the case of a regenerative receiver, the coupling coil is put in place, as above, in maximum coupling to the secondary of the tuner. If there is a tuned primary circuit, it is perhaps best to

the set may be oscillating so that the squeal of the received station's carrier wave can be heard. Reaction is then reduced until the set is just off the oscillation point. When very carefully adjusted for signal strength and clarity, re-adjustments are unnecessary.

The procedure in other sets is practically the same. The system works very well when used in connection with a standard Super-Heterodyne. The writer obtained excellent results with this arrangement. It is interesting to note that the short-wave signal

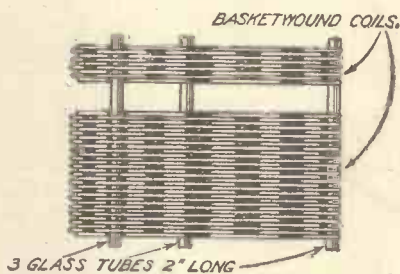

Fig. 5.—The finished staggered coil

of about 60 metres was first heterodyned to about 350 metres, amplified by reaction and heterodyned again to about 6,000 metres and amplified again by regeneration, detected and then amplified at audio-frequency.

In closing, it might be well to reiterate a few warnings as to the disposition and choosing of ap-

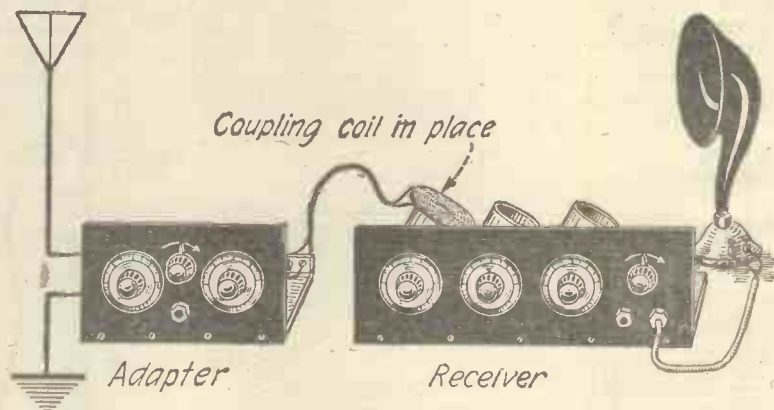
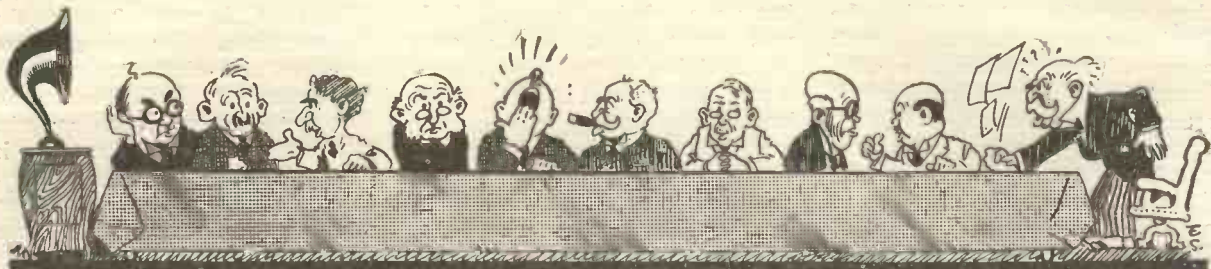

Fig. 6.—The method of coupling the adapter to an existing set.

remove it. Then the short-wave signal is heterodyned with the secondary at any wave the operator may desire. The most efficient setting would probably be somewhere about the centre of the condenser. While the preliminary tuning with the oscillator is taking place, the regenera-

paratus. The condensers are chosen for their low minimum capacity, as well as for the other reasons stated. Their minimum is less than 2.5 micromicrofarads. When used with the above coils, an approximate wavelength range of 50 to 150 metres was obtained. (Concluded on page 210.)



JOTTINGS BY THE WAY *By Wireless Wayfarer*

Of course, one can never be really dull at Little Puddleton, though there are moments when an attack of the liver or an untraceable wireless fault make one feel a little below par. It is at such times particularly that I welcome the cheerful letters which reach me from readers. About half of them write just to say "cheerio," and the other half want to know who Wireless Wayfarer is. One ingenious soul has worked me out on the most approved Sherlock Holmes lines. It appears that he has kept a list of the members of the Staff whose legs I have pulled in these pages from time to time. "You have poked fun," he writes, "at A

in wireless should remember the fact that he possessed a family at all. It was this writer or somebody else who called my attention to a statement appearing in several papers which has very much intrigued me. Speaking at the World Power Conference in London, Mr. E. W. Rice, chairman of the board of directors of the General Electric Co., drew attention to the minuteness of the power received by our aerials. He quoted the wonderful words of Dr. Whitney, who has calculated that the energy expended by one fly in crawling a single inch up a window pane would be sufficient to operate a wireless set for a quarter of a century. My friends, is not this a beautiful and noble thought? It made such an impression upon me that I hurried round to talk to Professor Goop about it at once.

zoomed like a young aeroplane over his flower beds. With his eye firmly fixed on the fly, he did not notice me, and as mine was also fixed upon the object of his pursuit, I did not see that he was coming until he had crashed into me and sent me sprawling upon my back. He explained that you cannot experiment upon a fly until you have caught a fly to experiment upon. This seemed quite true. At that moment I felt a violent blow upon the side of the head, and heard him shout, "Stand still. I have just got the big fellow which settled on your cheek." The fact that I had a black eye did not really matter in the least



An Omni, a wife and three kids.

and B, and C and X and Y. This leaves Z. Therefore, my dear Watson, you must be Z." Sorry though I was to disappoint this amateur sleuthhound, I had to write to tell him that I was not. As a matter of absolute fact, I have had a gibe at myself on several occasions, and quite enjoy doing it, for I think that I need taking down a peg or two every now and then. Another writer is a real wireless enthusiast, to whom I take off my hat and bow gracefully. "It may interest you," says he, "to know that I am the proud possessor of an 'Omni,' a wife and three kids. Alas! that the order should read thus." Not at all, not at all; I am merely a little surprised that one so immersed

Practical Experiments

The Professor is not the kind of man to take for granted the statements of any other scientist, no matter how eminent he may be. You will not be surprised, then, when I tell you that when I broke the news to him he was inclined to be a little sceptical. But when he had listened for two or three hours to my expressions of wonder and astonishment, of admiration and surprise, he decided that the matter was at least worth investigating. He bade me return upon the following afternoon, so as to help him with the practical experiments which he proposed to make. When I reported for duty at the appointed hour, I found the Professor rushing round his garden with a butterfly net in one hand and a cocoa tin in the other. He was engaged as I entered in chasing a large bluebottle which



Sent me sprawling on my back.

so long as the Professor had the bluebottle. He proceeded to transfer the insect to the tin, but in doing so liberated accidentally all his other captives. It was plain that the Professor was not a first-class hand at the gentle art of fly catching. I proceeded, therefore, to instruct him in the way in which it should be done.

I Take a Hand

I took him into the house, and made him sit down comfortably before his table. Professor Goop is the proud possessor of a bald and shiny top to his domed cranium. This is used habitually as a settling place by wandering flies, but as they always skid with all six legs at once they remove themselves as soon as

they have alighted. Bidding the Professor to sit quite still, I took a pat of butter from the sideboard, and gently smeared it over the bald spot. This, besides acting as a lure, also provided a firm foothold for the little creatures, who began to arrive in large numbers. When I first conceived this plan I was, owing to slight mental confusion, thinking of kittens rather than of flies. If you remember, the one way of making an infant cat settle down in your home is to butter its feet. But, anyhow, the inspiration was a good one, for once the flies had thoroughly buttered their feet, it was easy to catch them and to transfer them to a suitable receptacle for their safe keeping. By the end of the afternoon we had a fine stock of flies, and the Professor proposed that we should really get down to the practical work upon the following day.

What is a Fly Power?

The first thing we had to determine was the exact amount of energy that can be exerted by a given fly. Here we met with a certain amount of difficulty, for we found that some members



Gently smeared it over the bald spot.

of our stud were much more energetic than others. Marmaduke, for example, when harnessed to a minute dynamo made by the Professor, had an output of 1.0062 microwatts normally, and this could be increased considerably by placing a piece of sugar just beyond his reach. On the other hand, neither Alonzo nor Anastasia ever registered a larger microwattage than .580r.

By the end of the morning we had obtained some really interesting results, and were able to calculate the average. This was all right so far as it went, but I pointed out to the Professor that what we had to discover was the work done by a fly in crawling, not over a table,

but up a window pane. This was most difficult, for even Marmaduke, our prize specimen, would insist on crawling down instead of crawling up whenever we tried to obtain measurements. However, this little difficulty was overcome eventually by my again treating the Professor's head, this time with treacle, and induced him to stand upon the step ladder with the aforesaid head bent downwards until it was a few inches above the insect under test. I, meantime, was taking readings, a process which I found a little difficult owing to the illegibility of the Professor's figures upon the scales. I think, however, I must have made a mistake when, after a sudden burst of energy on his part, I credited Alonzo with 2.4 kilowatts. We decided that this reading should be regarded as abnormal, and took no account of it in our subsequent calculations. I do not myself feel at all sure that it was not correct, for, between you and me, Alonzo is a regular lad for treacle.

Future Developments

I am not going to divulge to you at the present moment the full results of these experiments, though I think that if I apply to them the epithet "epoch making" I shall not be guilty of any exaggeration. You remember the Goop-Wayfarer No. 761 circuit, which probably caused more stir in the ether than anything that has ever been designed? (We do, anyhow, for we had our ether properly stirred by it.—ED.) Well, I think I can promise you in the Goop - Wayfarer Musciflex (musca, dear reader, is what the old Romans called their flies; I have heard them called much worse things than that in England) something in comparison with which the Goop-Wayfarer No. 761 will look like an 1895 Pant-hard beside a 1924 Rolls Royce. I am not going to give away too much for the moment. I will just tell you enough to whet your appetite. The fly already exerts a much greater influence than is recognised upon wireless reception. When are atmospheric at their worst? In the summer time. When are

flies at their worst? In the summer time. Put two and two together, and what conclusion do we come to? Half the trouble that we experience during the warmer portions of the year is due to flies. The Goop-Wayfarer Automatic Aerial Swatter is going to revolutionise summer time reception. So much for that. But what of the winter? There are no flies with us in the winter time; in fact, many of our best brains have long been exercised in a vain attempt to discover where they go to at that season. Now, why should fly activity shorten our range and reduce our signal strength in the summer? Simply and solely because the current generated by their wanderings over the aerial wires is several degrees out of phase with that of incoming signals. The whole secret lies in training your flies, so that what we have called the musciwatts (this has nothing to do with mosquitoes) have a phase curve which is precisely in step with that of the received signals. I am afraid that I am getting a little deep; but all real wireless enthusiasts will be able to follow me, whilst the others do not



A few inches above the insect.

matter. The difficulty is that the muscivolts and the musciamps show a very heavy lag, and it is only by the most intensive training of these little insects that one can obtain real success. The Professor and I have solved the secret of, so to speak, making flies eat out of one's hand (or off the top of one's head), and we are now able to apply the energy so that it comes in at exactly the right moment like the jazz band drum. I would like to draw you a vector diagram to illustrate this, but, as I am quite sure that you would not understand it, I refrain, for I hate being over the heads of my readers.

WIRELESS WAYFARER.

Supersonic Heterodyne Reception in Theory and Practice

By JOHN SCOTT-TAGGART, F.Inst.P., A.M.I.E.E.

Part VI.

COMING now to actual supersonic heterodyne receiving circuits, we have a first example in Fig. 20. In this circuit a frame aerial L_1 is shown, a local oscillator V_1 being connected up in the immediate proximity of the loop. The local oscillator V_1 may take many forms, but that illustrated shows the use of an aperiodic grid coil L_5 coupled to the tuned anode circuit $L_4 C_5$, the direction of the coupling, of course, being such as to produce self-oscillation of the valve V_1 .

The Oscillator

The oscillator, which may conveniently be in the form of a separate box, as shown in Fig. 21, induces the local oscillations into the frame aerial circuit, which is also the grid circuit of the valve. Supersonic beats are produced, these are rectified by the valve V_2 , producing currents in the anode circuit L_2 having a frequency which may be readily adjusted to, say, 50,000, corresponding to a wavelength of 6,000 metres, and these currents are then passed on to the grid circuit $L_3 C_3$ of the second valve, this grid circuit being tuned to a wavelength of 6,000 metres to correspond to the beat frequency. The second valve V_3 acts as a detector, and telephones are connected in the anode circuit of the valve, as would be expected.

Frame Aerial Reception

This simple circuit may be used to demonstrate several very important facts in connection with supersonic heterodyne receivers.

In the first place, it will be seen that a frame aerial is used. This frame aerial will usually be found in most supersonic heterodyne receivers, but there is really no particular reason why such an aerial should be employed. The fact is that a frame

aerial, of course, is more selective than an outdoor aerial, because it may be rotated so as to cut out interference due to directive atmospheric and signals from undesired stations. Then, again, the sensitiveness of the supersonic heterodyne receiver is so great that signals may be received on a loop owing to the number of stages of amplification and the great advantages due to polarising, which have already been explained. It must not, however, be thought that supersonic heterodyne reception necessitates the use of a frame aerial; an outdoor aerial will give louder results with a supersonic receiver than a frame aerial, unless the receiver is "saturated" in the latter case, i.e., that sufficiently strong signals are already being obtained.

Radiation May Occur

Of course, in many cases, an outdoor aerial is not convenient, as in the case of portable sets, and here the supersonic heterodyne receiver is undoubtedly a

great advantage over other types.

Another consideration which governs the use of a frame aerial is the question of radiation, due to the fact that there is an oscillating valve inducing currents into the receiver circuit, and therefore into the aerial circuit.

Interference

If an outdoor aerial were employed and a local oscillator were caused to induce oscillations into the aerial, any adjustment of this local oscillator might lead to very serious consequences in the case of neighbours. The experimenter in supersonic heterodyne reception is liable to become a very serious nuisance to his friends, who will soon become his enemies, unless the local oscillations are either induced into a frame aerial or into a circuit on the other side of the first valve. Even with a frame aerial I have found that interference will be caused to immediate neighbours in many cases. Of course, if the local oscillator is set to a fre-

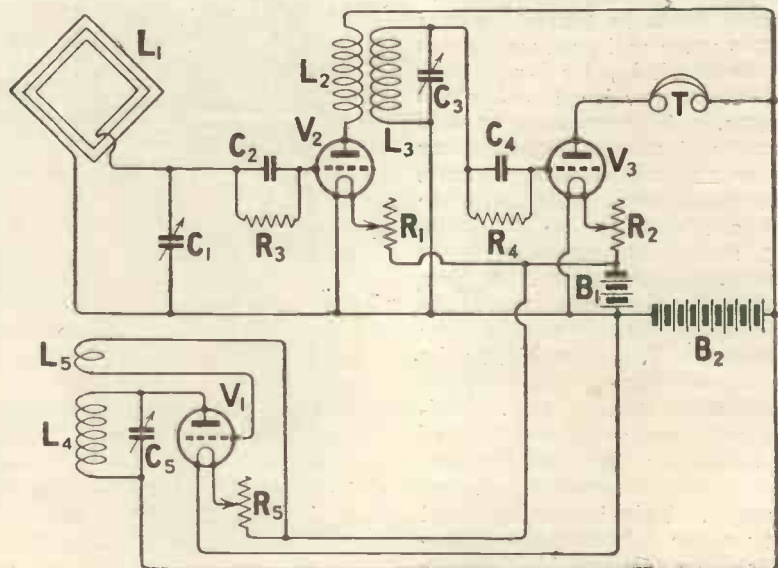

Fig. 20.—A practical supersonic circuit.

quency 50,000 different from that of the incoming signal, not much trouble would be experienced by neighbours tuned in to the incoming signal; but, on the other hand, when tuning in a super-sonic heterodyne receiver, the local oscillator wavelength will be varying and will cut across the carrier wave of a station to be

Operating a Simple Super-Heterodyne Receiver

It is first of all important to see that the oscillator V₁ is working properly. If another valve circuit is made up, or an ordinary receiver used, so that it is oscillating, but not connected to the aerial, a beat note howl may be obtained by suitable ad-

latter is actually generating continuous oscillations.

Another test to see whether the valve V₁ is oscillating is to put telephones in the anode circuit and to touch a point on the high-frequency side of the grid-circuit, e.g., the grid pin itself, with a slightly moistened finger. A good plonk should be heard on touching the grid and when removing the finger.

Ratio of Signal to Oscillations

If the coupling between L₅ and L₄ is variable, a certain point in the coupling is reached where the valve will begin to oscillate and the plonk begins to be heard. Another test is to have the telephones in the anode-circuit shunted by a fixed condenser, of course, of, say, .002 μF and to bring the reaction coil up to the coil L₄ until the plonk is heard; this indicates that the valve has begun to oscillate. On moving the coil L₅ further from L₄ the valve will stop oscillating. Another test would be to include a delicate galvanometer in the grid-circuit, and this galvanometer will show a decided reading when the valve starts oscillating, but probably only a small reading when the valve is not oscillating.

One of the first points which will be noticed when working the Fig. 20 circuit is that the signal

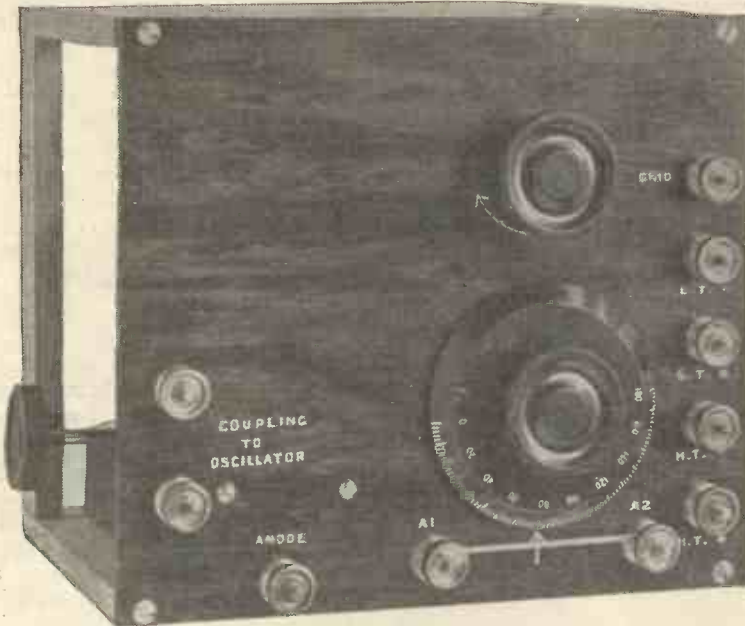

Fig. 21a.—Front view of local oscillator.

received, this, of course, producing serious interference with neighbouring sets.

The First Valve

The first valve acts as a detector, and the new 50,000 frequency currents produced by the rectification of the 50,000 frequency beats in the grid-circuit of the valve will produce signals in the circuit L₃ C₃ corresponding to a wavelength of 6,000 metres. The currents on this wavelength vary in the same way as the original incoming currents and would be similar to those sent out from, say, a broadcasting station radiating on 6,000 metres. These currents are then rectified by the second valve, the detector currents operating the telephones T. The circuit L₃ C₃ is, of course, tuned to the 6,000-metre station in the ordinary way, and any adjustment of the condenser C₃ round the best point should reduce signal strength. This is the essential test to see whether the super-heterodyne principle is in operation.

justment of the condenser C₄ of the oscillator V₁, provided the

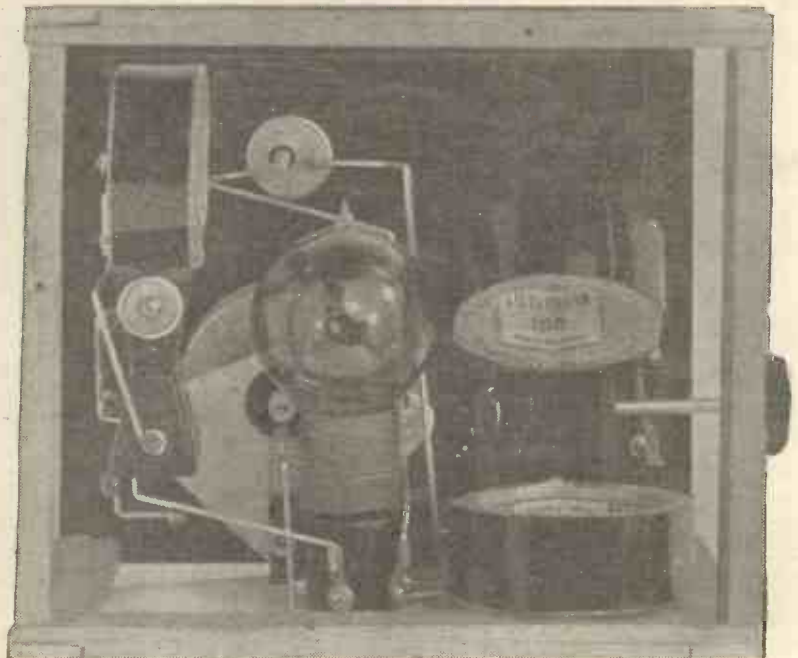

Fig. 21b.—Local oscillator viewed from the back, showing its compact construction.

strength will depend largely on the position of the oscillator unit. Here, obviously, we are getting a demonstration of the principle that the incoming signal and the induced current in the receiving circuit from the oscillator should bear a certain relationship. The actual relationship is not critical, but, on the other hand, it is very important to see that the oscillations induced into the receiving circuit are not too weak.

Oscillator gives two readings

It will be noticed that when the circuit $L_3 C_3$ is adjusted to a certain wavelength, say, 6,000 metres, it will be possible to receive signals on the telephones at two positions of the condenser C_5 of the oscillator without altering the tuning of the receiving circuit $L_1 C_1$.

The reason there are two points on the condenser C_5 where maximum signal strength is obtained, is due to the fact that the beat frequency of 50,000, corresponding to 6,000 metres, may be obtained when the local oscillator is producing oscillations having a frequency of either 50,000 above or 50,000 below the frequency of the incoming signals.

Tuning the Receiver

Another point which has already been briefly discussed is that an alteration in the tuning of $L_1 C_1$ will vary the extent to which the receiver circuit has induced in it the local oscillations. The ideal state of affairs is to have the circuit $L_1 C_1$ tuned exactly to the incoming signals and to force into the receiving circuit oscillations from the local oscillator V_1 . If, however, sufficiently strong oscillations cannot be induced into the circuit $L_1 C_1$, the experimenter is more than likely to find that by a slight detuning of $L_1 C_1$ a compromise is obtained between the incoming signals and the local oscillations. By tuning $L_1 C_1$ a little nearer to the frequency of the local oscillator it will be clear that stronger oscillations will be induced into the receiver circuit, although the incoming currents will also be weakened.

The experimenter with super-sonic heterodyne receivers must therefore be prepared to have

some of the effects masked by this difficulty of the tuning of the receiver circuit affecting the amount of induced current from the oscillator.

Coupling the Oscillator

This brings me to the consideration of a practical circuit in which means are provided for feeding the high-frequency currents into the grid-circuit of the

receivers, enables a much tighter coupling to be obtained.

Sometimes the coil L_6 is shunted by a variable condenser, which we will call C_6 , so that the circuit $L_6 C_6$ is tuned to the same frequency as the local oscillator. This arrangement is rarely used, and, if employed, it will be found that the variable condensers C_1 and C_6 cannot readily be operated independently

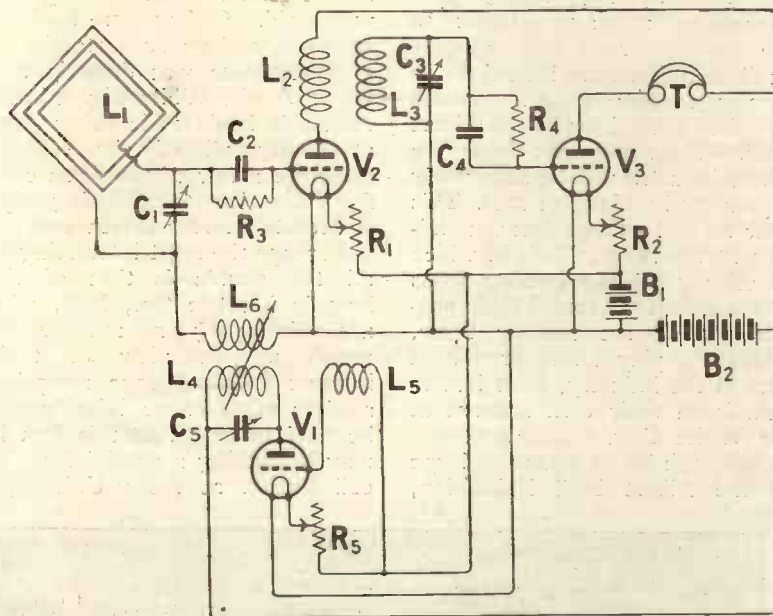

Fig. 22.—This shows one method of coupling the oscillator to grid of V_2 .

receiver circuit in such a way as to avoid the necessity for detuning the aerial circuit to get an adequate amount of local current in the receiver circuit.

In Fig. 22 it will be seen that an inductance coil L_6 is included in the grid-circuit of the first valve V_2 of the receiver, and that this coil is coupled, preferably variably, to the anode inductance L_4 of the local oscillator valve V_1 . The coil L_6 , being outside the main receiver circuit $L_1 C_1$, and being more or less aperiodic, it is possible to feed into the grid-circuit currents having a different frequency than that to which the circuit $L_1 C_1$ is tuned.

A stronger current can therefore be induced into the receiver circuit; but the experimenter will find that the tuning of the circuit $L_1 C_1$ will still affect the strength of the oscillations induced into the grid-circuit by the valve V_1 . This method, however, which is very commonly employed in super-sonic heterodyne

of the other, i.e., the tuning of the circuit $L_6 C_6$ will modify the tuning of the incoming signal, and this, of course, seriously complicates the operating of the set.

(To be continued.)

Special Christmas Number of "Modern Wireless"

The December issue will contain, among others, the following interesting articles:

THE SUPERSONIC HETERODYNE. MAKING A 4-VALVE T.A.T. RECEIVER.

Both by John Scott-Taggart, F.Inst.P., A.M.I.E.E.

A REINARTZ RECEIVER FOR PLUG-IN COILS.

RECEPTION ON THE ULTRA-SHORT WAVES.

OUT NOVEMBER 29th
PRICE . . . 1/6

Wireless at the White City

Some Notes on the British Wireless Exhibition.

THE second wireless exhibition held this year—that at the White City—contains much of interest to the constructor as well as many exhibits which were looked for in vain by visitors to the All-British Wireless Exhibition at the Albert Hall. Next year we hope the whole industry will be adequately represented under one roof. This year we had a magnificent exhibition at the Albert Hall, in which practically all the leading firms in the industry showed their products, while the smaller firms, who really play a very prominent part in the industry, have had to exhibit on their own account at the White City.

Although by no means so large as the Albert Hall Exhibition,

the White City show has attracted big attendances. At the Albert Hall Exhibition no goods were sold. Orders were booked, however, and we understand that good business was done in this way. At the White City a brisk cash sale business is being done at nearly all of the stands, although a few of the firms confine themselves to exhibiting only.

Plug-in coils for short waves

Perhaps the most interesting of all the stands is that of the Igranic Electric Co., Ltd., who are displaying a number of novelties. In view of their interest in short-wave reception, readers of *Wireless Weekly* will be glad to hear that this firm is now marketing a special form of coil known as the "Unitune,"

consisting of a specially wound honeycomb coil, two windings being used, one for aperiodic aerial circuits, and the other for the secondary. The coil is mounted on the standard plug, and can be fitted at once to any existing direct-coupled receiver. Aerial and earth connections, however, are made to separate terminals on the side of the plug so that the sockets which previously were used for the aerial coil now hold what is the secondary coil. The smallest of these coils tunes to 75 metres without difficulty, while another coil is suitable for the broadcast band, giving a greatly enhanced selectivity.

Two other important novelties are the new Igranic variable



This photograph shows Professor A. M. Low (centre), who opened the Wireless Exhibition, watching the process of coil winding.

grid leak and the new Igranic potentiometer. The grid leak, which is continuously variable from about $\frac{1}{2}$ to 5 megohms, is made to attach to the panel with an indicating dial in front, the leak itself being held some distance away from the panel to avoid hand capacity effects. The contact of the leak runs over a special graphite compound in the form of a semi-circular rod of square section. The potentiometer is similarly constructed, a graphite compound being used. Its particular virtue is its very high resistance (somewhere in the neighbourhood of 30,000 ohms). In this way the steady current through the potentiometer will not exhaust dry batteries so rapidly as is the case with the ordinary 300 or 400 ohm potentiometer.

Efficient Variometers

The same company have produced a new line of variometers, in which practically all the solid dielectric used in previous models

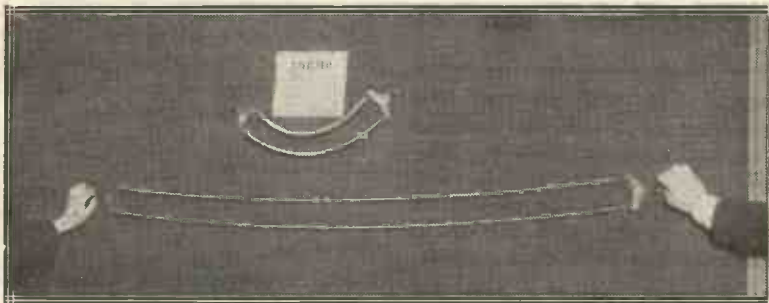

The Formo portable aerial.

has been removed, both rotor and stator being almost self-supporting. This removal of solid dielectric from the field is an important step forward, and much higher efficiency should be obtained.

Messrs. Reed and Morris are showing a number of interesting components, including a dual rheostat of unconventional type for bright and dull emitters, and a back-of-panel valve socket, to which is attached a piece of ebonite with clips for the grid leak. This firm is also showing an anti-capacity and anti-vibration valve socket of new design.

Panels

The new material "Radion," marketed by the American Hard Rubber Co., is also well displayed. This material is obtainable in both the black and

mahogany finish, which gives it a very handsome effect. We notice that two well-known Radio Press sets, viz., the "Transatlantic Five" and the "All-Concert de Luxe," are being used

Electric. A feature of these sets is that valves are built inside the sets, and all connections are made through the back, thus leaving the front panel free of any obtrusive wires. Non-reversible plugs and sockets are used for battery connections, and it is impossible to plug in the high-tension battery to the low-tension socket.

A High-tension Accumulator

The new Oldham wireless accumulator is well displayed, and we noted with interest a high-tension accumulator made by this firm with sockets to enable various voltages to be tapped off. This firm is making a special study of the requirements of the wireless man, and has produced a very good accu-



A contrast in crystals!

to exhibit the handsome appearance of sets made with these panels.

The "Penton" and the "Louden" valves, test reports on which have already appeared in these pages, are being exhibited. Portable Utilities, Ltd., are showing the well-known Eureka transformers and the new "Gravity" detector, while Neutron, Ltd., Gran-Goldman, Ltd., Tungstalite, Ltd., and a number of other firms, are showing special wireless crystals. One of the biggest stands in the show, and certainly one of the most interesting, is that of the City Accumulator Co., who are showing a number of sets, and particularly their portable receivers.

Some very well-made receiving sets are being shown by Abgar

mulator for the purpose. The India Rubber Gutta Percha Telegraph Works' well-known Silver-town components are attracting much interest, and on the stand of J. B. Mulholland, Gambrell coils, Myers valves, and the new



On the Telegraph Condenser Company's stand. The condenser shown is tested to 30,000 volts.

Allison loud-speakers are leading exhibits. The great attention now being paid to neutrodyne sets has prompted Messrs. Gambrell to place on the market a very simply-made and easily-mounted neutrodyne condenser, which is also shown on Messrs. Mulholland's stand. Several types of variable grid leaks are displayed in the exhibition, these components being shown by the Igranic people, Messrs. Reed & Morris, Radio Improvements, Ltd. (the Bretwood), and the Watmel Co.

Inventions

A certain space at the exhibition has been given over to the display of inventions and sets sent in by competitors, and prizes are being awarded. As usual, we saw many attempts to put a wireless set into some kind of container not suitable for it. For example, wireless sets are built into books, which seems to us about as logical as making a book look like a wireless set.



The largest crystal and "cup" at the Exhibition!

However, such attempts amuse many people, and are good exercises in ingenuity.

In spite of the absence of many of the well-known firms, the ex-

hibition is certainly very interesting, and is a good indication of the popularity of home construction among every class of the community.

□ □ □

Radio Notes and News

Work on Belgian Station Continues

The new Belgian broadcasting station at Ruysselede is being gradually constructed, and the second mast has just been erected. It is visible at a distance of 19 miles. This station will be one of the greatest on the Continent when completed, and it will be ready for operation in 1925. No broadcasting is scheduled to begin until 1926, however, because of delays in the delivery of materials. The Ruysselede station will be used chiefly for communication with Belgian colonies, but it is possible that local broadcasting will be carried out as well.

U.S. Government Sanctions Radio Power Increases

The U.S. Government will allow experimental increases in the power of broadcasting stations, beginning at 1,500 watts and increasing gradually in 500 watts steps until a maximum of 5,000 watts is reached. Super-power stations of 25 to 50 kilowatts will not be authorised, however, due to the marked disapproval of many amateurs, and the Government will take steps to check the power in-

creases and will prevent the blanketing of low-power stations by the more powerful ones. The radio amateurs themselves will be the judges of the effects of increased power, and the radio section invites critical comment.

Patent Suit Won by U.S. Inventor

Dr. James H. Rogers, a Washington, D.C., inventor, has won a patent suit of three years in the Court of Appeals, which reversed three decisions of the Patent Office unfavourable to the inventor. The invention is a submarine radio device perfected before the war and used in the war by the United States Navy.

Licences for German Patents to be issued in U.S.A.

Following the announcement of the ruling that the U.S. Navy Department had authority to issue licences to manufacturers desirous of using German radio patents confiscated at the outbreak of war, officials report that the assigning of licences has already been started in response to applications which have been filed. Among the patents to be licensed is the Reflex Circuit, invented by Wilhelm Schloemilch

and Otto Von Bruk, which is understood to have been used in the super-heterodyne receiving set. All licences issued will be issued as non-exclusive, non-transferable, and revocable, and agreements will be effective until January 1, 1933, or extended throughout the life of the patents.

Berlin Erects "Eiffel Tower" for Radio

The construction of an "Eiffel Tower" in Berlin for a wireless transmission station was begun recently, and it is to have a total height of 418 feet. The Paris tower is 975 feet high. There will be a restaurant on the first platform of the Berlin structure, 146 feet above ground. At 406 feet will be a platform open to sightseers, reached by an elevator.

Speaker Indicates Growth of Radio in Germany

The inauguration of the powerful Munster radio station was held on October 10 last, and Dr. Bredow, Secretary of State, made an inaugural speech, in which he said that there were 250,000 private radio sets in Germany, and that the number was increasing at the rate of 2,000 weekly.

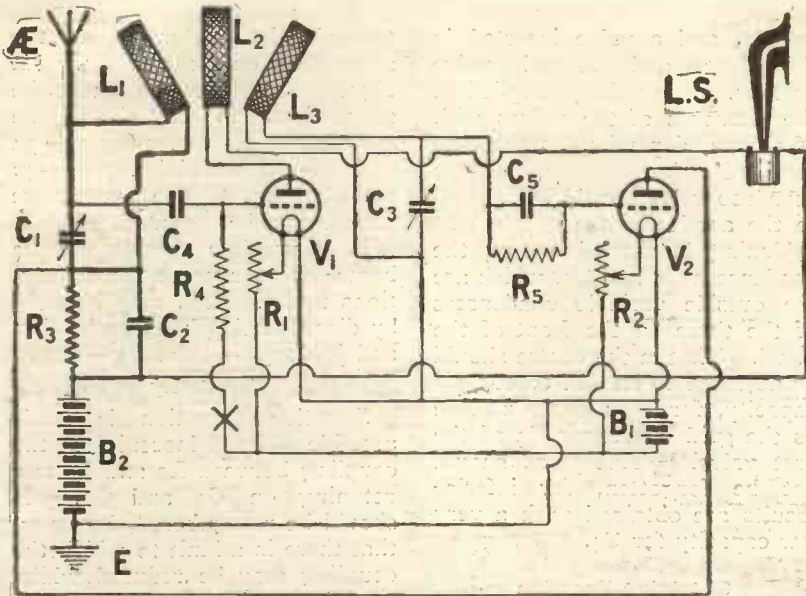

Fig. 1.—A slightly modified form of the Resistoflex circuit which may be wired up on the Omni receiver.

The Resistoflex Circuit on the Omni Receiver

READERS of our new monthly journal, *The Wireless Constructor*, will have seen in the first two issues the detailed description of a highly-successful two valve-receiver, employing the "Resistoflex" circuit, by John Scott-Taggart, F.Inst.P. The actual circuit used is that recommended by the same author in his article "The Resistoflex Circuit" in the October number of *Modern Wireless*. The first valve acts both as a high-frequency and low-frequency amplifier, the usual iron-core transformer employed in such circuits being replaced by a resistance. The circuit, with a few minor modifications, is reproduced in Fig. 1. Briefly, the action of the circuit is as follows:—

The incoming oscillations are tuned by the aerial coil L1 and variable condenser C1 of 0.0005 μ F capacity and are applied to the grid of V1 through the condenser C4 of 0.0005 μ F capacity. The resultant amplified high-frequency currents in the anode circuit of V1 are transferred by means of the two coils L2 and L3 to the grid circuit of the second valve V2. L3 is tuned to the required frequency by C3 of 0.0005 μ F, while L2 is left untuned. The valve V2 detects the H.F. currents by virtue of the grid leak and condenser R5 C5, their respective values being 2 megohms and 0.0003 μ F. The low-frequency

current pulsations in the anode circuit of V2 set up low-frequency potentials across the resistance R3, whose value may be 100,000 ohms. This resistance is in the grid circuit of V1, and the fluctuating potentials across it are communicated to the grid of the valve via the aerial coil L1 and condenser C4. The amplified currents in the anode circuit of V1 then pass through the telephones, or the loud-speaker LS and produce sound.

At the point X a small battery may be inserted to apply negative bias to the grid of V1.

may not equal those obtained on the receiver described in *The Wireless Constructor*, owing to modifications, an idea as to its capabilities and virtues may be obtained.

The following is the list of connections for wiring up the circuit on the terminal board:—

51—34	25—23
42—36	31—24
36—3	1—2
11—44	9—10
44—24	10—19
32—52	19—5
34—18	27—13
33—34	13—14
41—42	40—32
26—12	6—36
26—35	43—48
4—17	2—40

Connections

The circuit may be wired up in a very short time on the Omni receiver, and although results

Coils to Use

The aerial coil L1 may be a No. 50 for the British broadcast

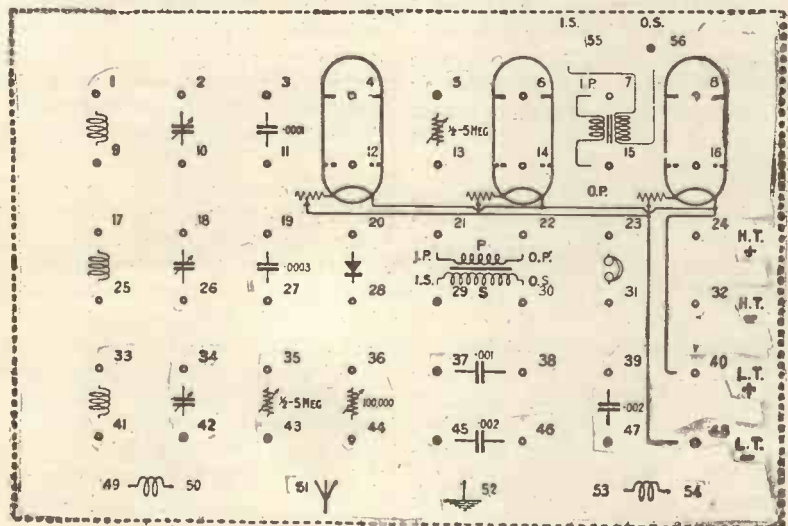

Fig. 2.—The terminal board.

wavelengths below 420 metres, while for those above this wavelength a No. 75 should be used. L2 may be a No. 75 for the broadcast wavelengths, so also may L3. For the reception of Chelmsford L1 may be a No. 150 coil, L2 and L3 each No. 200.

The three coils are placed in the sockets of the three coil holder on the left hand side of the receiver. The aerial coil L1 is placed in the front moving socket, the anode coil L2 in the centre fixed socket, and the secondary coil L3 in the rear moving socket. The three coils arranged in this manner comprise what is known as "Tri-coil" coupling, which was fully explained by Mr. Scott-Taggart in the September, 1924 issue of *Modern Wireless*. With this arrangement selective reception is possible, and fine control of reaction is obtained.

Operating the Receiver

Having inserted the correct coils, the batteries, telephones, aerial and earth should be connected to their respective ter-

minals, and a valve inserted in the first and second valve sockets. The voltage applied to the filaments of the valves will, of course, depend upon the type used. For best results, not less than 100 volts should be applied to the anodes of the valves.

Tuning is carried out on the condensers C1 and C3, which are the outside variable condensers of the three on the front of the panel. That in the centre should be adjusted to its full 0.0005 μ F capacity, for it is being utilised as the grid condenser C4 of the first valve. This point should not be forgotten, for inferior results are obtained with a very low capacity for C4.

Obtaining Reaction

Reaction is obtained by coupling L1 to L2, so these two coils should be kept well apart when first tuning, to prevent any possibility of causing interference. L2 and L3 should be coupled closely and tuning carried out on C1 and C3 until the required signals are obtained. L1 may now be brought slowly

towards L2, retuning at the same time on C1 and C3. If signals do not become louder the connections to L1 should be reversed by disconnecting 33-34 and 41-42 and joining 33-42 and 41-34. The procedure should now be repeated.

It is possible that it will be beneficial to reverse the connections to L3. This may be tried by disconnecting 1-2 and 9-10 and joining 1-10 and 9-2.

Selectivity

Selective reception is made possible by loosening the coupling between L2 and L3 and retuning on C1 and C3. It should be remembered, however, that there is a limit to which the coupling may be reduced whilst retaining the same signal strength, for the amount of energy transferred from L2 to L3 depends upon the coupling between them. It must also be remembered that patience is required to tune in a distant station to the exclusion of one near-by, and very careful adjustment of the condensers and coils.

Tool Outfits for the Wireless Experimenter

SEVERAL American manufacturers have found it well worth their while to put on the market small handy kits of tools designed to meet the needs of the wireless man; but so far as I know, only a few British makers have taken up the idea. One of the most compact outfits that I have seen contains only five main items—a soldering iron, a centre punch, a hammer, a special pair of pliers and a spiral ratchet screwdriver. Small as this list may seem, the kit nevertheless contains practically everything required for doing simple wireless jobs. The secret of its efficiency lies in the pliers and the screwdriver.

The former are made on the same lines as those used by milliners. At their tips the jaws are rounded off so that they may be used for making loops in wire. For the rest of their length they are flat, with a width of about 5/16 in. Side cutters of good quality steel are provided. With a tool of this kind

there are very few ordinary wireless jobs demanding the use of pliers than cannot be done.

The spiral ratchet screwdriver can be applied to a great many uses in addition to that for which it was originally designed. In the American tool kit it is supplied with three screwdriver bits of different sizes, a countersink, two box spanners and drills of various gauges. It thus becomes a spanner and a hand-drill in addition to being a screwdriver.

If I were making up a suitable tool kit for the British amateur who does only small constructional work, the list would be as follows: A soldering iron of adequate size, hand-drill with 1/4-in. and 3/8-in. drills in the inch fraction sizes, and Nos. 34, 26 and 12 in the Morse sizes; two screwdrivers, one small and one large; a pair of good quality milliner's pliers, a centre punch, a light hammer, a jeweller's hacksaw, a scribe, three files, a small setsquare and a counter-

sink to fit the chuck of the breast drill. The whole outfit could be sold quite cheaply, and I am quite sure that there would be a ready market for it. R. W. H.

Adapting Telephone Leads to Plain Terminals

WHILE several constructors favour the telephone type of terminal, the plain terminal is in many cases more useful, especially in the building up of unit receivers.

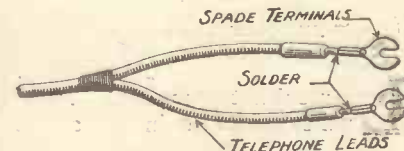

Spade terminals are soldered to the ends of the telephone tags as shown.

The existing tag-ends on the telephone leads are not, however, adaptable to the latter type of terminals, but this difficulty is easily overcome by the method shown in the diagram. All that is necessary is to solder a spade terminal to the end of each of the telephone leads.

What is the Best Wireless Weather?

By M. J. CAVENEY (Canadian 3GG)

An interesting article dealing with the effects of the rise and decline of the barometer readings on radio reception. The tests covered a period of two years, and enough data was collected to form definite conclusions. Note that the observations are all Canadian. Similar tests in this country would be valuable.

(Continued from p. 157)

BEGINNING on July 25, 1922, a series of good nights terminated with the barometer showing D30. After a week of bad static the glass climbed on an R38 on August 4. Remarkable DX was accomplished until August 6, when the good air was spoiled by a D42 and restored on August 7 by an R35. Another favourable run of reception ended with a D62 on August 17, 1922, but the following day an R38 repaired the damage, and the glass settled steady, giving us two splendid nights on August 19 and 20, only to desert us again when a D60 appeared on August 21 disturbing things temporarily for a night until an R51 came along and handed us a brace of radio nights worth staying home for.

Steady Barometer

On Aug. 24 we find a D55 and poor reception, and on August 25 good work being done on the receiver with an R70. Also, the barometer took a vacation and rested on a practically "flat" curve similar to H in Fig. 1 for a period of five days, during which time the air was first-class all through, yet it is certainly interesting to find a D43 again putting a stop to such ideal conditions on September 1, giving only indifferent reception for the next two days. As usual, an R75 cleared things up again for us, but a D65 next day undid the good work, the latter eventually giving way to an R53 again on September 5, which pacified us until September 7, when a D38 served up such a very poor quality of reception for four nights straight, that we were extremely thankful for the slow climb on an R18 to patch up our tattered air again on September 11, 1922.

An Unusual Occurrence

While I am around this date, let me tell you of an unusual occurrence on September 13. This particular night was really a

wonderful one for radio and the glass was passing through a relatively high position, climbing at the rate of 65 degrees, the pressure registering 30.25 in., but the barometer evidently felt youthful and vigorous that night, for it went on climbing to an abnormally high position seldom attained here, namely, 30.5 in. For a period of four days after that "Super" night of September 13 when the glass climbed out of sight, the air was simply "dead" and it took three more days before the barometer got over its foolish notions and slid down to a rational level when our reception materially improved on September 20.

A Sharp Rise

This phenomenon was duplicated more recently on April 26 this year, when the barometer curve almost ran over the top of the pressure chart, soaring to an altitude of 30.65 in. at 12 noon that day. The reception that night was exasperating, to say the least, yet at midnight the glass relented and was seen to be tumbling headlong the following

day, passing through a normal zone of 30.15 on April 27, the night of which was exhilaratingly crammed with lilting jazz. To quote each instance in detail would take up too much space; but in very many instances we find the reception curve rising and falling in direct sympathy with the barometer curve. The first two ideal weeks of January, 1923, succumbed finally to a savage attack of the barometer, which, after being passive for those two weeks, ran amuck. On January 16 it dived violently, and rose again—then plunged again early on January 20. That was enough. Our long spell of lovely reception while the glass was steady suffered terribly under such treatment, wilting almost completely from that time on, and was at a critically low ebb on January 26, when a long looked for R45 just arrived in time with an antidote for our disgust of radio in general, and on January 29 we were back on full fare, dining royally on plump DX reception again.

I am simply repeating the story



Capt. Ian Fraser, M.P., the President of the Transmitter and Relay Section of the Radio Society of Great Britain. Although blind, he is an enthusiastic amateur, having made his own transmitting and receiving sets.

with a change of dates when I refer to February 23, 1923. Here again, a lightning-like D86 scattered a splendid succession of good nights and practically left us desolate for five or six days. Coming further and picking at random we find September 14, 15, 16 and 17, 1923, delivering superb radio, but a D78 put an end to it all until the 20th of the month, when an R65 was exceedingly welcome.

Rippling over the months for the benefit of our newcomers who only got into the game this year with their logs, let us go to January 25 of this year (1924) and see how poor the stations were and fading very bad. Well, a nasty D76 set in on the day before and the glass had fallen remarkably low on the 25th with a frightful blizzard here. On January 26 an R70 arrived, continuing through the 27th, on the night of which your logs will undoubtedly prove unique for startling DX records.

Effects of Rapid Decline

More recently still, let us pause at the first week in July, 1924, so as to select a difference in seasons.

Here we watched the barometer ambling along for several

days on a comparatively "flat" curve, nice and steady in a fair weather zone. Radio reception was very good during the whole of this period, but on July 7 the break came. The glass fell away rapidly and was in a "bad low" next day, reaching its worst on the night of July 9.

Thousands of logs of radio amateurs will show that the signals from the Canadian Polar ship *Arctic* (call VDM) which had been roaring in for several days, then fell away to a weak whine on July 11. Turning back now to July 10 on their log books, these amateurs will find that their transmitters put over some nice DX (if they were working) for the time of the year, but on the night of July 11 that strange magic which flung their signals into distant states had vanished and on the whole reception was jotted down as very poor.

Present Evidence

The *Arctic* was wonderful in volume when the glass was steady or rising—wheezy and swinging when the glass was falling, and back to her usual trumpet note on the 14th when the glass rose again, although the ship was considerably further away.

The evidence up to now tries to show the rising or steady barometer as our best friend, and the falling or erratic barometer our worst enemy, but there are exceptions, of course; in fact, there are instances which will cause one to ponder before coming to a conclusion on anything. A log of transmissions from this station shows that while the bulk of my DX was accomplished during the periods of the rising or steady glass, yet I was only able to reach the West Coast (2,500 miles distant) and to England once in a period of four months with 20 watts of C.W.

Then one morning I worked the West Coast three times inside the hour on 15 watts C.W. while the barometer was falling rapidly.

We will carry confusion further by relating that my average range on the 'phone (10 watts) was 800 miles, easily conversing for hours at a range of 600 miles, and many reports from ranges of 1,000 to 1,200 miles of good reception, yet on both occasions when I have been notified that my voice has been heard plainly 1,300 miles South, the barometer was falling here.

(To be concluded.)



Mr. Godfrey Isaacs, the retiring Managing Director of the Marconi Company, in his office at Marconi House; Ill-health is the cause of his retirement.



Valve Notes

By

JOHN SCOTT-TAGGART,

F.Inst.P., A.M.I.E.E.

More About Condenser End Plates

CONSIDERABLE interest seems to have been taken in my comments on condenser end plates, and the undesirable smallness of some of the ebonite bushes in many types of variable condenser. The losses in these bushes become very appreciable when receiving the ultra short waves of the order of 75 metres.

It is, however, to be noted that in certain variable condensers the losses have been very greatly minimised by avoiding a concentration of the electric field in the dielectric of the bushes. This has been done by removing the bushes from the strongest field, the concentrated field acting through air alone. While serving as insulators and mechanical supports, they are not actually in the concentrated part of the field, and have only the outer edge of such field passing through them.

Reducing the Losses

In other designs of variable condenser, losses are minimised by separating the metal end plates from the fixed plates by a substantial amount of insulating material. Most condensers, however, have their metal end plates actually in electrical contact with the fixed plates.

The variable condensers with ebonite end plates have usually the lowest losses, but it must be remembered that it is little use having a wide space at one point between the two sides of the condenser if they are brought very close together at another with insulating material between them. The losses in a variable condenser become particularly noticeable when the condenser is on its lower values. With the condenser full out, for example,

practically the whole of the high-frequency currents passing through it (for it always has a certain minimum capacity) will pass through "the dielectric of the bushes." Most of the field is now concentrated at this point, and whereas, under ordinary conditions, a valve receiver would oscillate most readily on the lower values of the variable condenser, when receiving short wavelengths with a

Only the detector part of the super heterodyne is shown, and it will be seen that the idea is that the valve acts both as a detector and oscillator. There is nothing new in this idea, of course, in itself, but it is found, apparently, that it is possible to use the valve as an oscillator without detuning the receiving circuit. This is supposed to be done by having a tuned circuit L₃ C₃ tuned to the local fre-

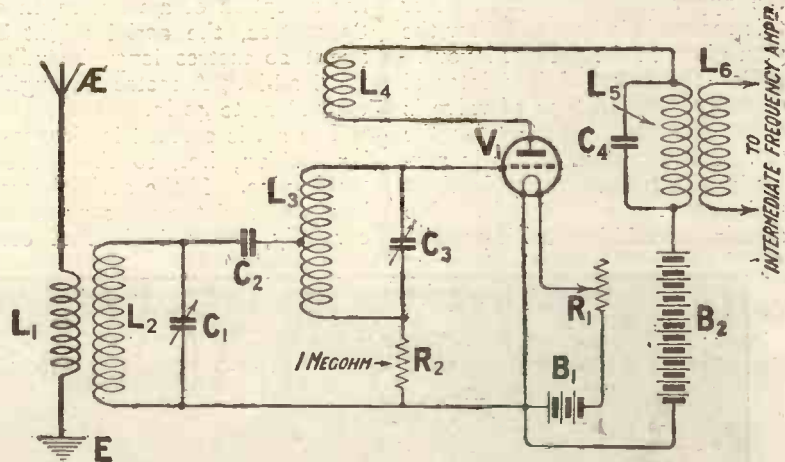

Fig. 1.—The Tropadyne circuit. The valve acts both as a detector and oscillator.

condenser which is not efficient, the losses will mount up to such an extent that it may be impossible to get the valve to oscillate at all.

The Tropadyne Circuit

As a writer said the other day, the Americans are inclined to give a fancy name, usually ending in dyne or flex to almost any combination of valves which is not exactly what someone else has previously done.

Supersonic heterodyne receivers are not without their dynes and flexes. The name Tropadyne has been given to the kind of circuit shown in Fig. 1.

quency while the circuit L₂ C₁ remains tuned to the incoming wavelength. The condenser C₂ is a .0005 μF condenser, the connection being taken to the middle of the coil L₃. The long-wave output produced by the rectification of the supersonic beats by the valve (it will be noticed that there is a grid leak R₂, while C₂ serves presumably also as a grid condenser) is passed out *via* the transformer L₅ L₆ to the intermediate frequency amplifier, which, of course, will be followed by a detector, and probably some low-frequency amplification stages.

I have not tried the particular

arrangement at the time of writing.

Super-Heterodyne Coupling

I saw the other day a very neat little coupling arrangement for use with a supersonic heterodyne receiver. An ordinary plug-in transformer L_1 L_2 (shown in Fig. 2) was used for the oscillator of a valve receiver, one of the windings being tuned. Around this transformer was an ebonite tube T , on which was wound about eight turns of wire, the ends being connected to brass strips fixed to the panel by ter-

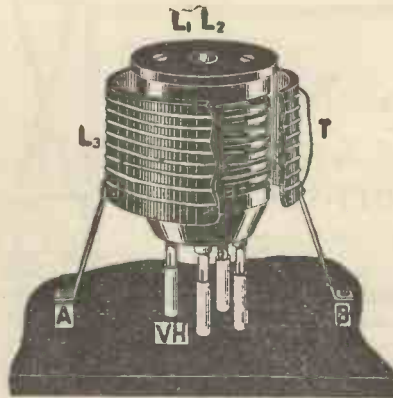

Fig. 2.—A useful coupling device for super-heterodyne receivers

minals A and B. These brass strips act as conductors, going to the coil wound on the tube T , which coil is consequently coupled to the transformer L_1 L_2 , which may be put in or withdrawn without affecting the rest of the apparatus. The transformer, of course, fits into the usual valve holder $V.H.$ The winding on T , which usually consists of only a few turns, is included, usually, in the grid circuit of the first detector valve of the supersonic receiver.

A Short-Wave Adaptor for an Existing Receiver

(Concluded from page 106)

The leads must all be kept as short as possible and as direct to the terminals as the position of the apparatus will permit. For this reason it is best to follow the plan given in the present layout.

For the sake of low internal capacity, the .06 type of valve is about the most suitable for the set. Its low capacity fits in perfectly with the other specifications and demands of the unit. No sleeving should be used if practi-

able and the design allows perfect protection for the wiring and valve without its employment.

Preliminary tests showed that an indoor aerial 10 or 15 ft. long gave best results. Possibly, the aerial length should be about one quarter of the wavelength to be received. For instance, for the reception of a wavelength of 80 metres, the aerial might be about 20 metres long, including the lead-in. A metre is roughly equivalent to 40 in.

The set is earthed in the regular fashion, i.e., to the nearest water pipe. If the aerial is well insulated and the set constructed carefully, when it is first con-

nected it will work, and there will be no lack of short-wave signals on the air with which the enterprising builder may plunge himself into this, the newest field of radio research.

The condenser C_1 should have a very small minimum capacity, and be the best obtainable, and the rotating plates should be connected to the earth-side, thus minimising body capacity effects when tuning. A condenser with ebonite end plates is preferable, although there are a few condensers with metal end plates that are quite suitable, as the spindle insulating bush is of a large diameter.



The B.B.C. Birthday Night. The staff of the British Broadcasting Company outside the Institute of Electrical Engineers, 2, Savoy Hill is just around the corner.



Fig. 1.—The batteries are carried in the cabinet beneath the apparatus.

A Self-Contained Three-Valve Receiver

By HERBERT K. SIMPSON

Embodying the tri-coil method this instrument has the advantage of self-contained batteries.

circuits in which three coils, in a three-coil holder, are utilised to obtain maximum selectivity. In the present receiver, a circuit of this nature is employed, and a stage of resistance-coupled note-magnification added to increase the strength of the detected signals. The advantages of resistance coupling are many, the chief of these being the absence of the distortion prevalent in low-frequency amplifiers employing cheap transformers. To many, therefore, the receiver should prove ideal, possessing range and selectivity, and giving very pure reproduction with fair volume, the latter depending upon the distance from the station being received.

FOR long-distance reception it is well known that a receiver possessing a certain amount of selectivity is essential if interference from a near-by broadcasting station or spark station is to be eliminated. The large amount of broadcasting and

commercial transmission carried on every day in the British Isles calls for considerable care in the selection of a circuit to be used for distant reception.

In a recent issue of *Modern Wireless*, Mr. John Scott-Taggart described a number of "tri-coil"

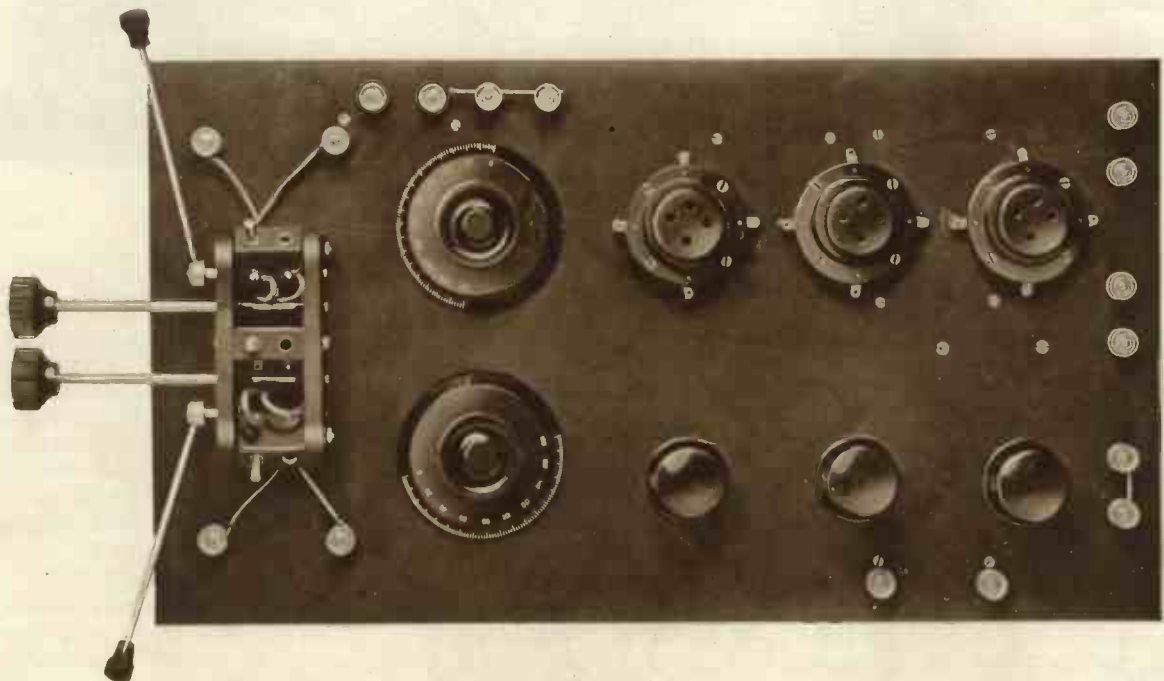

Fig. 2.—A plan view photograph of the receiver, with coils and valves removed.

A photograph of the finished instrument is seen in Fig. 1, and it will be noticed that the cabinet is of unusual size. This is to enable the H.T. and L.T. batteries to be placed inside the cabinet when dull-emitter valves are used; the receiver thus becoming quite complete in itself, with no necessity for trailing wires and ugly batteries to mar the appearance of the room in which the set is installed.

The three coils are seen mounted in the three-coil holder on the left of the panel, the two outside coils being tuned by the two variable condensers to the right of the coil holder. At the back of

The three valves in their respective holders are conspicuous on the right-hand rear portion of the panel, while the three knobs to the front of the valves are those controlling the filament rheostats.

The Master Switch

A rheostat knob may also be seen on the front side of the cabinet, its purpose being to save switching off each of the other rheostats when the receiver is not in use. The same purpose, of course, might be achieved by means of an ordinary two-way switch, or by simply disconnecting the lead to the L.T. battery. It is inadvisable,

The Circuit of the Receiver

A diagram of the circuit is given in Fig. 6. The condenser C.A.T. has the usual capacity of $.0001 \mu\text{F}$, and is placed in series with the aerial when it is desired to use constant aerial tuning. The aerial is tuned by the coil L1, and the variable condenser C1 of $.0005 \mu\text{F}$, the latter being placed either in parallel or series with the aerial coil.

The first valve V1 acts as a high-frequency amplifier, the amplified currents being communicated to the grid of the detector valve, V2, by means of the two coils L2 and L3 which comprise an H.F. transformer. The latter coil

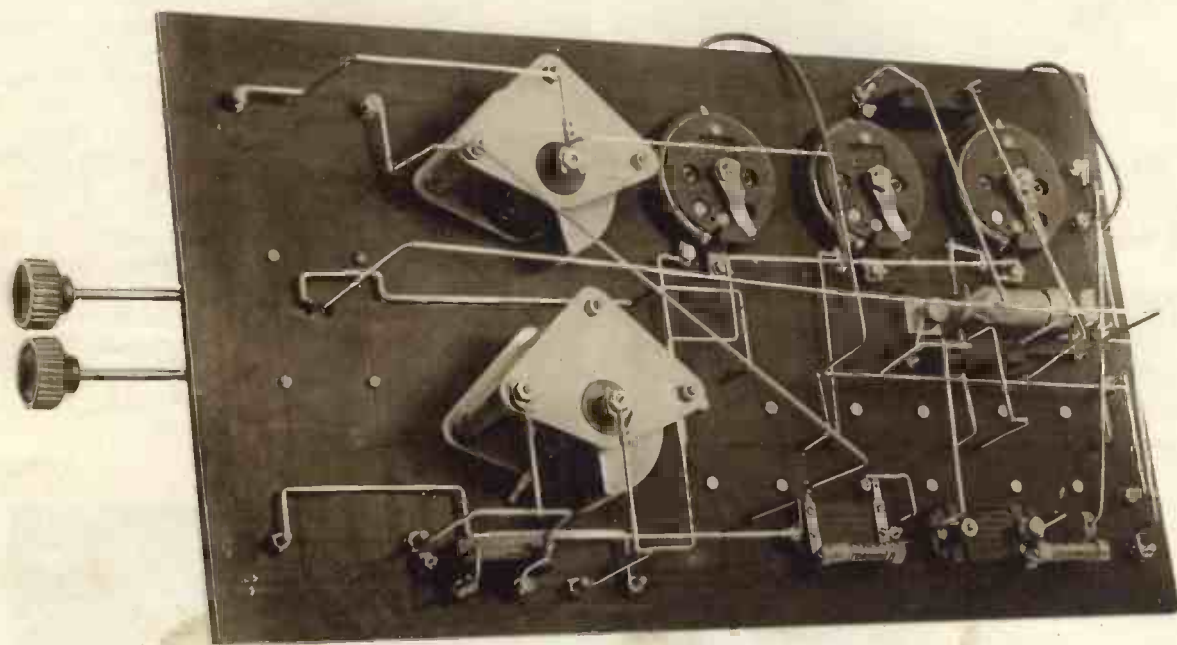

Fig. 3.—The back-of-panel wiring is quite simple in layout.

the panel are seen four terminals by means of which the usual forms of aerial tuning may be tried; namely, constant aerial tuning, ordinary parallel tuning, and series aerial tuning. Reading from the left, these are A, B, C, and E.

Battery Connections

The battery terminals are on the right of the panel, and reading from the back are H.T.+, H.T.—, L.T.+, L.T.—, G.B.+, and G.B.—. The two terminals on the front of the panel are those to which the telephones are connected.

however, to light up or switch off the valves too frequently, for this shortens their lives appreciably. The use of a rheostat prevents this, for when connected in one of the L.T. battery leads, the current allowed through the valve filaments may be slowly varied from a negligible amount (so far as danger due to sudden switching is concerned) to the correct amount of current as determined by the other rheostats. This point should become quite clear upon referring to the circuit diagram.

is tuned by the variable condenser C3 of $.0003 \mu\text{F}$ capacity. C2 and R5 are the usual gridleak and condenser, their values being respectively $.0003 \mu\text{F}$ and 2 megohms.

In the plate circuit of the second valve is the non-inductive resistance R6 shunted by C4 of $.0003 \mu\text{F}$. C5 is the low-frequency coupling condenser of $.01 \mu\text{F}$ capacity, while R7 is a gridleak having the conventional resistance of 2 megohms. The low-frequency potentials across R6 result in amplified currents in the plate circuit of the note-magnifying valve

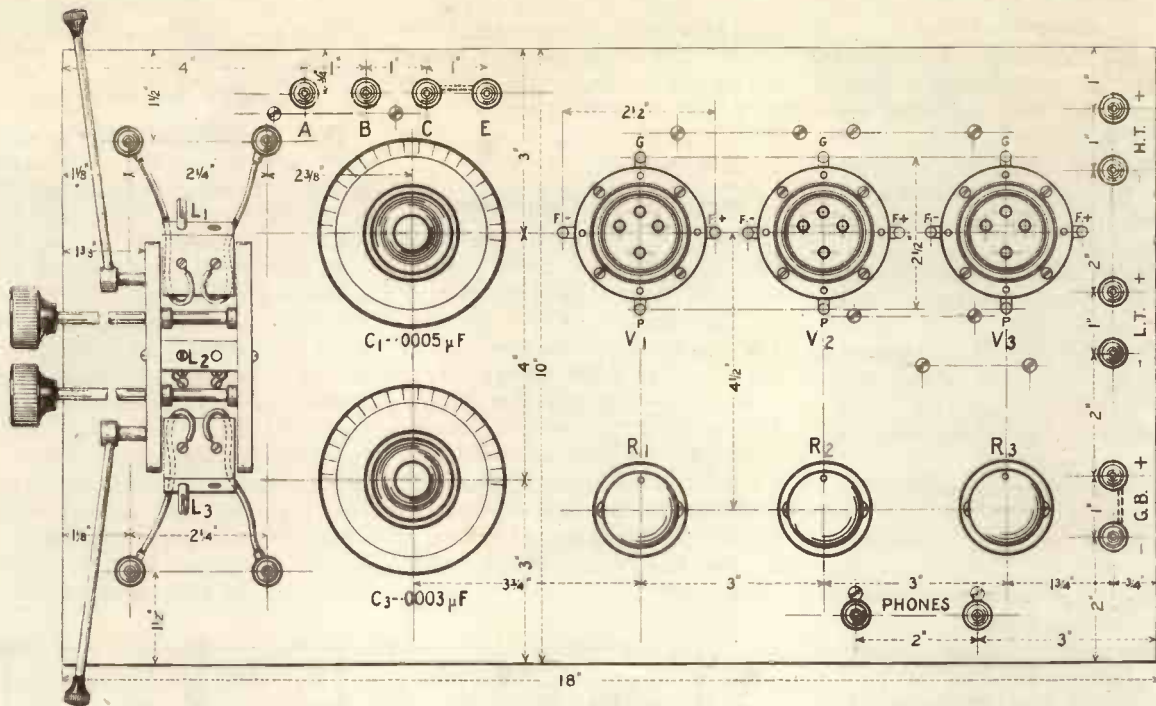

Fig. 4.—Drilling and engraving diagram to scale. Blueprint No. 74A.

V₃, in which is included the telephones T shunted by the condenser C₆ of .004 μF.

Negative bias is applied to the grid of the last valve by means of the battery B₃, which is connected between the negative terminal of the filament battery and the lower end of R₇.

Use of the Master Rheostat
R₄ is the master rheostat to which previous reference has been made. By placing the slider (represented by an arrow-head) at the extreme left of the resistance, the negative terminal of the L.T. battery is virtually connected direct to the rheostats

R₁, R₂, and R₃, and those latter may then be adjusted individually to give the valves their correct degrees of filament brilliancy. To switch off it is merely necessary to turn the knob of R₄ slowly to the "off" position. This dims the filaments before the current is finally switched off, resulting in less strain.

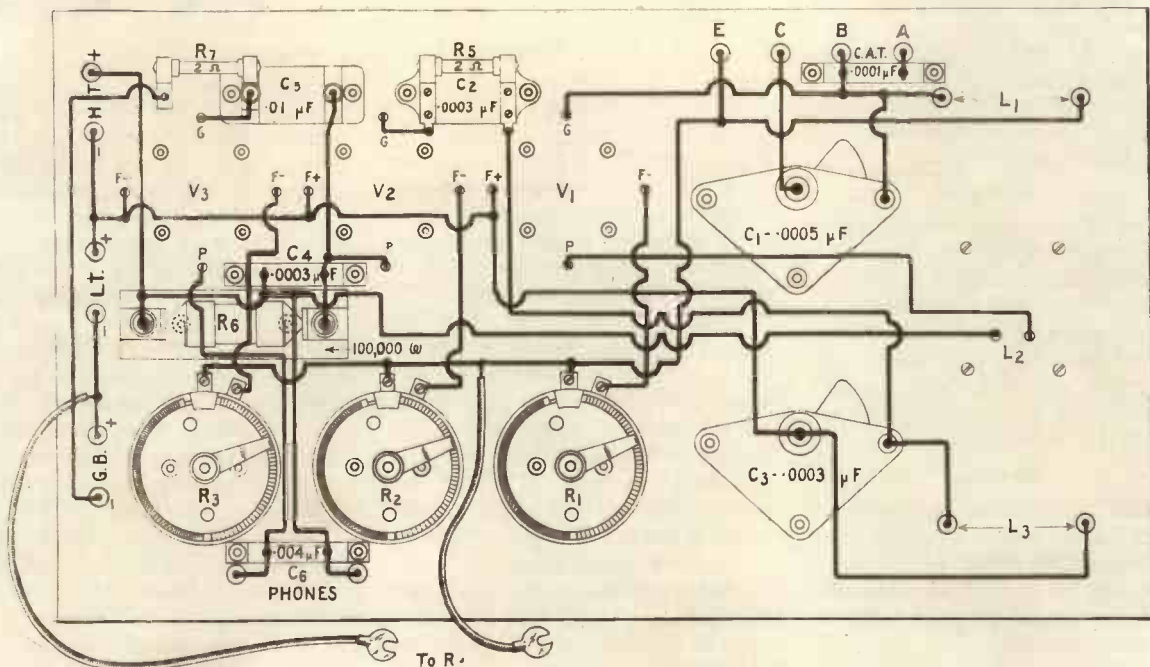

Fig. 5.—Practical wiring diagram. Blueprint No. 74B.

This and the above blueprint can be obtained from Radio Press, Ltd., price 1/6 each, post free.

Component List

In the following list of components, the names of the manufacturers have been included since this is desirable to many. If the constructor does not intend to copy the set exactly, care should be taken in selecting components of good quality.

- Ebonite panel, 18 in. by 10 in. by $\frac{1}{4}$ in. (Paragon; Peter Curtis, Ltd.).
- Cabinet of suitable dimensions.
- Vernier three-coil holder (Goswell Engineering Co., Ltd.).
- 3 valve holders (Burndept, Ltd., "Antiphonic").
- 3 dual filament rheostats (Burndept, Ltd.).
- 1 master rheostat (Burndept, Ltd.).
- 1 .0005 μ F variable condenser (Jackson Bros.).
- 1 .0003 μ F variable condenser (Jackson Bros.).
- 1 .0001 μ F fixed condenser (Dubilier).
- 2 .0003 μ F fixed condensers (Dubilier). One of these should be fitted with clips for gridleak.
- 1 .004 μ F fixed condenser (Dubilier).
- 1 .01 μ F fixed condenser (Dubilier).
- 1 mounted 100,000 ohm resistance (Dubilier).
- 2 2-megohm gridleaks and one pair of clips (Dubilier).
- 16 4BA terminals.
- Quantity of tinned square copper for wiring.
- 2 doz. 6BA screws and nuts.
- A short length of rubber-covered flex is also required.

The Panel

One of the most difficult faults to detect in a wireless receiver is poor insulation, and it is now unnecessary to risk this trouble by purchasing unguaranteed ebonite. If such ebonite is purchased, however, the shiny surface on each side should be removed with the aid of fine emery cloth.

Drilling

This is carried out in accordance with Fig. 4, and to save time it is recommended that all holes of one size be drilled in succession without regard to their positions on the panel.

The valve holders may be mounted as shown in the photographs or they may be fixed with

their four contacts underneath the panel. The latter method necessitates the drilling of a hole of an inch and a half diameter, but some may prefer the valve holder mounted thus.

Mounting the Components

The photographs of the back and front of the panel should allow no doubts upon this part of the construction of the receiver. The fixed condensers are secured by means of 6BA screws which pass right through the panel. This method will be found easier than that in which the condensers are held in position by the stiff wire used for the connections. It will be found convenient to mount the coil holder last of all, owing to its size.

of the coil holder as shown in Fig. 2.

The Cabinet

If it is intended by the constructor to use an accumulator for filament heating, it will not be advisable to place this inside the receiver, although, of course, the high-tension battery may be enclosed in this manner. The size of the cabinet, therefore, depends upon the inclusion or exclusion of the L.T. battery. The cabinet shown in Fig. 1 has been designed to take both H.T. and L.T. batteries (the latter being a dry battery used in conjunction with D.E.3 valves), and the following measurements are given for the benefit of those who desire to construct the cabinet themselves.

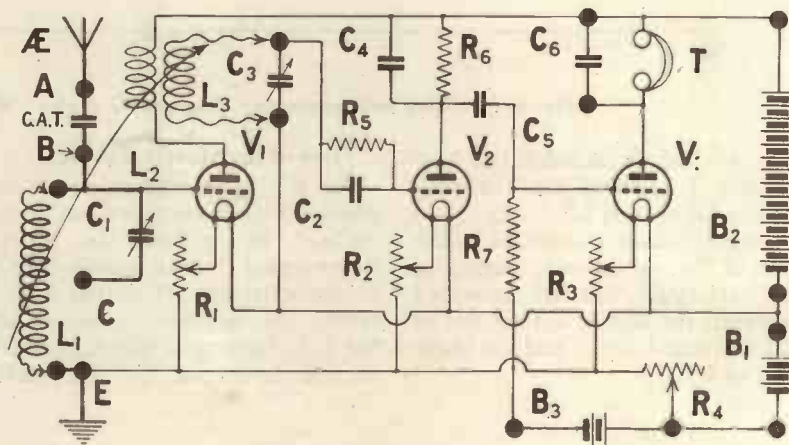

Fig. 6.—Theoretical diagram.

Wiring

The wiring diagram is given in Fig. 5 and the connections may seem at first somewhat complicated. Actually, however, very little difficulty should be experienced providing the useful art of soldering has been acquired.

It will be observed that the connections to the terminals of the valve holders pass through the panel and soldering is carried out on the front of the panel. Care should be taken to avoid allowing the soldering-iron to touch the panel, for if this occurs the appearance will be spoiled.

Flexible Leads

Two rubber-covered leads are soldered as shown, and are taken later to the terminals of the master rheostat.

Four rubber-covered leads are connected to the moving sockets

- 2 sides 10 in. by 10 in. by $\frac{1}{4}$ in.
- 2 sides 18 $\frac{1}{4}$ in. by 10 in. by $\frac{1}{4}$ in.
- Base, 19 $\frac{1}{4}$ in. by 11 $\frac{1}{4}$ in. by $\frac{1}{4}$ in.

Supports are arranged inside the cabinet to bring the ebonite panel flush with the surface.

It will be seen in Fig. 1 that part of the front side is hinged at the base so that about two thirds of the side (no definite measurements need be followed) opens to admit inspection of the batteries. On the remaining fixed piece the master rheostat is fitted with its two terminals near the lower edge, in the position shown in Fig. 1. The wiring of the receiver is completed by joining the two rubber-covered leads from the panel to the terminals on the rheostat.

Six holes are drilled in the right-hand side of the cabinet immediately below the battery terminals, to allow connections

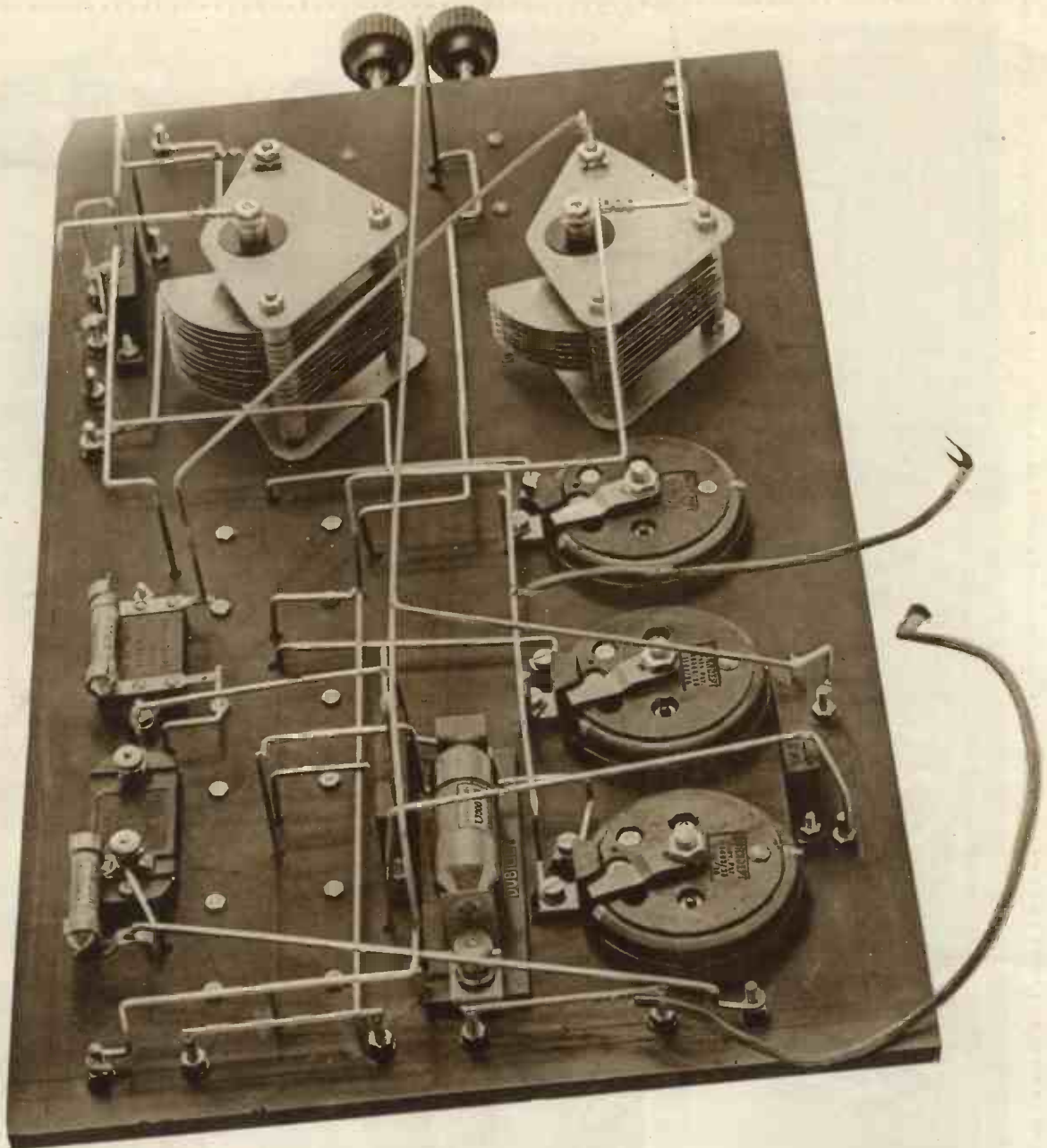

Fig. 7.—This large picture in perspective shows the wiring details clearly.

between the latter and the batteries inside the cabinet.

The cabinet described is quite suitable in cases where the L.T. battery is to be kept outside, though the 10-inch depth becomes unnecessary. The cabinet may be modified to suit the particular requirements of the constructor.

Operating the Receiver

If there are any doubts as to the correct size of coil to use for the particular aerial to which the set is to be connected, constant aerial tuning should be tried. The

aerial is connected to terminal A, the earth lead to E, and C and E joined together with a piece of wire. The master rheostat should be adjusted to the "full on" position (zero resistance) and the other three to the "off" positions. The H.T. and L.T. batteries may now be connected to their respective terminals, while the terminals G.B.— and G.B.+ may for the time being be connected together.

The three sockets of the coil holder are marked in Fig. 4. For the broadcast wave-lengths below

420 metres a No. 50 coil will be required in the aerial socket, while for those above this wave-length, a No. 75 will be suitable. The primary coil L₂ of the H.F. transformers L₂L₃, may be a No. 50 or 75 coil, and is plugged into the centre socket of the coil holder. Nos. 50 and 75 should also be tried for the secondary coil L₃.

The valves may now be inserted and the filaments adjusted to the correct brilliancy by means of the three rheostats on the panel.

(Continued in later pages)

Operating the direction-finding apparatus in the Niton station. Very great accuracy in obtaining bearings is possible with modern apparatus.



A new wireless directional station on the southernmost point of the Isle of Wight, at Niton, will be in operation before winter fogs become a menace to ships constantly using the Channel. The new station at Niton will be able to communicate with ships in any of the Channel waters, and will enable them to find the exact spot over which they are steaming. A five-shilling fee is charged for each direction. On the left: Leading-in wires of the D.F. aerial.

On the right: Transmitting the observed direction to an enquiring ship.



Erecting the giant Radio Press aerial on the roof of Bush House, Strand, the new offices of Radio Press, Ltd.

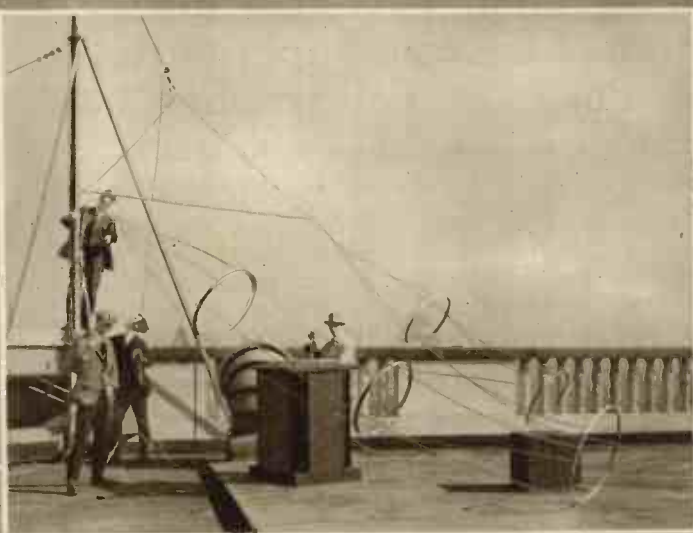

Above: In the Manchester Broadcasting Station.

Below: The broadcasting transmitter used by the Deutsche Radio Club, Berlin. It is a 50-watt set, operating on a wave-length of 250 metres, and has a 60-mile range.



The French Broadcasting Station of L'Ecole Superieure des Postes et Telegraphes

By Capt. L. F. Plugge, B.Sc., F.R.Ae.S., F.R.Met.S.

THE premises of the broadcasting station of L'Ecole Superieure des Postes et Telegraphes are in the Rue de Grenelle, Paris. Owing to the installation being in the centre of Paris, and also the fact that the station had to be erected in the college building itself, it was not found practicable to install the gear to the best possible advantage. Nevertheless, taking into account the low power used, results shown within the last three years have been remarkable. The station is regularly heard within a radius of 1,200 miles, and its transmissions are received over the whole of France, the North of Africa (Algeria, Tunis, and Morocco), in the whole Peninsula of Iberia, Italy, Switzerland, Belgium, Holland, British Isles, and Scandinavia, where excellent receptions are reported; among others, one on a frame aerial at Stockholm.

Power Used

The power used is 500 watts in the aerial, and transmission takes place on a wave-length of 450 metres. The modulation used is the well-known choke control

system, and the transmitting gear is of the Western Electric type. It is made up on a metallic frame, supporting at the lower part the filters and terminals required for the plate circuit current, the valve lighting current, and the modulating circuits connected to the microphonic amplifiers. Immediately above the inductances and capacities of the oscillating circuits are placed those of the aerial circuit and the controls used to bring the grids, plates, and filaments of the oscillator and modulator valves to the potentials required.

Above these are the oscillator and modulator valves. The microphone current, suitably amplified by means of a resistance coupled amplifier, goes to the primary of a transformer, the secondary of which is connected to the grid circuit of a 50-watt valve. The valve again amplifies the current before it is applied to the grids of the modulator valves.



Fig. 1.—The control switchboard for the generator system.

The oscillator valves—two in parallel—are fixed on the same shelf as the modulator valves. Both the oscillator and modulator valves are Western Electric type. Each valve has a platinum filament covered with some rare metal oxides. These oxides are of the radio-active type and are intended to increase the electronic emission from the filament.

Potentials applied to the valves are respectively, 1,600 volts on

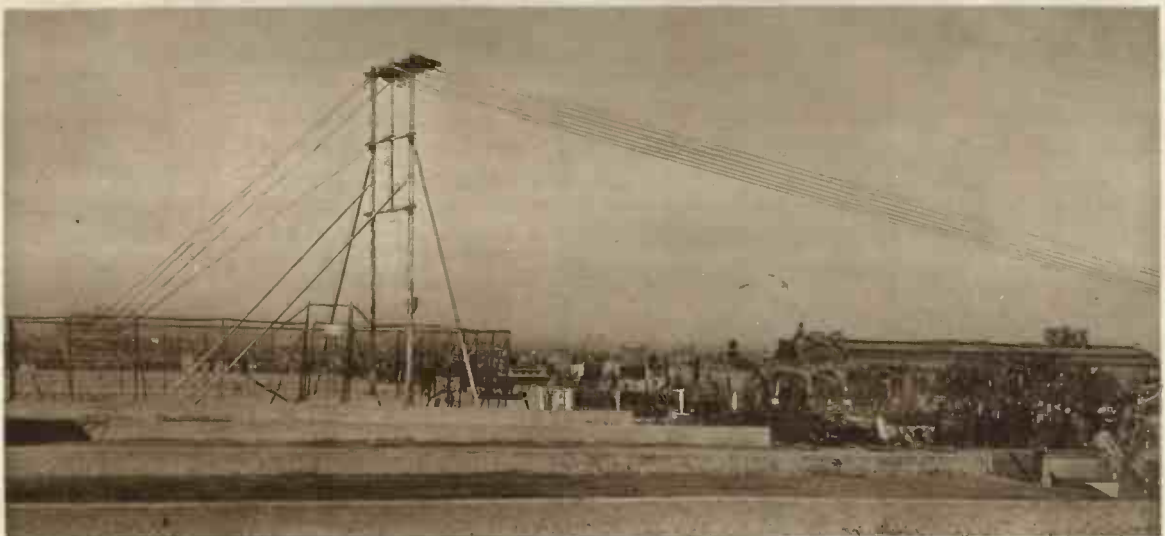

Fig. 2.—The aerial, erected on the college roof, is of unusual design.



Fig. 3.—The interior of the college studio from which transmissions are sometimes arranged.

the plates and 14.5 volts on the filaments.

The Aerial

The aerial is erected on the roof of the college. It is composed of seven parallel copper wires arranged horizontally. The lead-in is taken at one-third from the near end. The mean height of the aerial from the ground is 30 metres approximately, and its span covers 97 metres.

The fundamental wave-length of this aerial is 510 metres. A condenser fitted at the base of the aerial, and in series with it, permits this natural wave-length to be brought down to 450 metres.

The aerial current is normally of 6 amps. The high tension on the two valves in Fig. 5 is supplied through the iron core choke L.

Current is supplied by high tension and low tension generators installed in the basement of the building. They are divided into two main groups: Group A consists of a monophase current motor 110 volts, 42 periods, driving a high tension dynamo generating 2,000 volts, 2 amps, and a low tension dynamo generating 18 volts, 50 amps, all three coupled to the same shaft.

Filament Lighting

The latter dynamo supplies the current required to light the filaments of the valves and also to excite the field coils of the high tension dynamo. The second group, or Group B, consists of another monophase motor 110

volts, 42 periods, driving, by means of a belt, a dynamo generating 110 volts, 40 amps DC. This dynamo feeds a DC motor which drives the high tension and low tension dynamos of this group which are similar to those of Group A, and also charges a battery of accumulators. This battery has a rating of 120 volts, 100 amp-hours, and can be used as an additional stand-by to work the whole station for a short time in case of complete breakdown of the other two plants.

The starting and controlling of these groups of generators is arranged from a switchboard shown in the photograph. The high tension currents are controlled by means of a double throw-over switch. This switch is worked at a distance by means of a rod. The low tension current double-pole switch, and the high tension



Fig. 4.—The amplifying apparatus for use in concert halls and theatres.

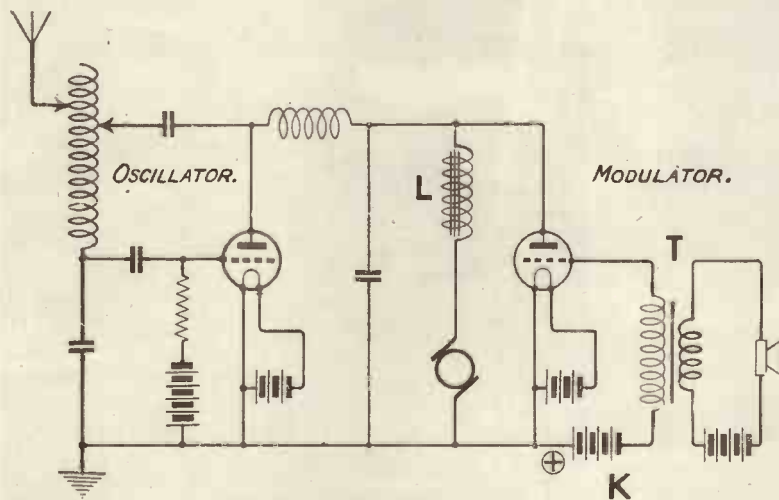

Fig. 5.—A simplified circuit diagram, showing the modulating system.

and low tension fuses are also fitted on the board.

Before reaching the transmitting set, the supply is received on the switchboard seen on Fig. 8. This switchboard is also fitted with the high tension and low tension voltmeters and ammeters and the necessary switches, fuses, etc.

Rheostats controlling the fields of the generators are also placed here together with a main switch which controls the field current of the high tension generator. This switch is for use in case of serious mishap. A quick release, short circuiting the cut-out coil of the starting rheostats, also permits of an emergency control of the whole system. The microphone which is intended to intercept the sound waves has been carefully studied. Since it is possible to increase the microphone current variation by amplification, the sensitiveness of the microphone is not the most important factor to be considered. What is most necessary is that the quality should be very pure and

the microphone itself should not introduce any distortion in the circuit. All acoustic frequencies that reach the vibrating membrane should be equally reproduced.

The Microphone

The instrument used at the Ecole Superieure's studio is composed of a metal diaphragm strained in order to make its natural frequency of vibration higher than the highest musical note likely to be transmitted. The diaphragm is held very close to a rigid metallic plate. This produces damping owing to the thin layer of air which exists between the diaphragm and the supporting plate. Two microphone buttons are placed on either side of the diaphragm. In this manner distortion arising in one is balanced by the distortion occurring in the other. This differential mounting



Fig. 6.—A special amplifying unit which is used for outside broadcasts.

million. This amplification can still be considerably increased if necessary.

The College Studio

A studio has been built at the college for use on the rare occasions when transmissions are arranged from there.



Fig. 7.—The microphone installed permanently at the Academie Francaise.

has been extensively used in this country and in America.

Since the most common distortion of sound occurring in microphones is due to the mouthpieces, no mouthpiece is used. The sound waves are sifted as it were, through a fine metallic gauze, the mesh of which had to be experimentally determined. In this way shouts, for instance, reach the diaphragm slightly attenuated, but, at the same time, the pitch of the notes and quality of timbre are respected without causing natural vibration of the microphone membrane. In order to guard the microphone from any ground vibration or vibrations due to its supports, the microphone gear is suspended in a metallic cage by means of a set of springs specially designed for the purpose.

The energy supplied by such a microphone is of the order of 10^{-8} watts (one hundred-millionth of a watt). By means of a suitable amplifier this power is increased to one-hundredth of a watt corresponding to an amplification of the order of one



Fig. 8.—The control switchboard for the transmitter is seen on the left of this photograph.

Light signals permit the correction of the position of the microphone in regard to the artistes or the instruments in the studio. A red lamp placed at the foot of the microphone indicates to the artistes if the switch is connected or not. The room is draped to avoid unnecessary echo. The station possesses two pianos—one concert grand and one upright grand.

Concerts given from outside the station are transmitted by means of the ordinary telephone lines which reach the station by a special switchboard arranged for this purpose.

By means of one of the plugs on the right shown on Fig. 9, the operator connects the microphone amplifier to the line which serves the concert hall.

A special amplifier is arranged in the concert hall or theatre building. When this instrument is used, the amplifier at the station is tuned down in order not to amplify the parasite noises on the line. By a special arrangement it is possible to talk along the circuit used, while transmission is going on.

Special Transmissions

In the case of special transmissions such as those of Roubaix, Geneva, and at Anatole France's funeral, a special amplifier, as shown in the photograph, was used.

A special circuit keeps the operator in continuous communication with the sending station, so that any immediate and necessary alteration at either end can be carried out with the least possible delay.

Finally, simultaneous transmissions of the Eiffel Tower and Petit Parisien have been many times effected. For these the necessary switching on the switchboard was made at the main station in order to feed the microphone current to the land lines joining this station to the others, in a similar manner to that adopted in this country.

These circuits have to be adjusted to offer equal ohmic resistance.

Listeners in this country who have been used to "outside" broadcast for several years, are, perhaps, not aware that this kind of transmission is a more recent development in France. Such transmissions were inaugurated in France by the Ecole Superieure station on January 31, 1923—nine days after its opening.

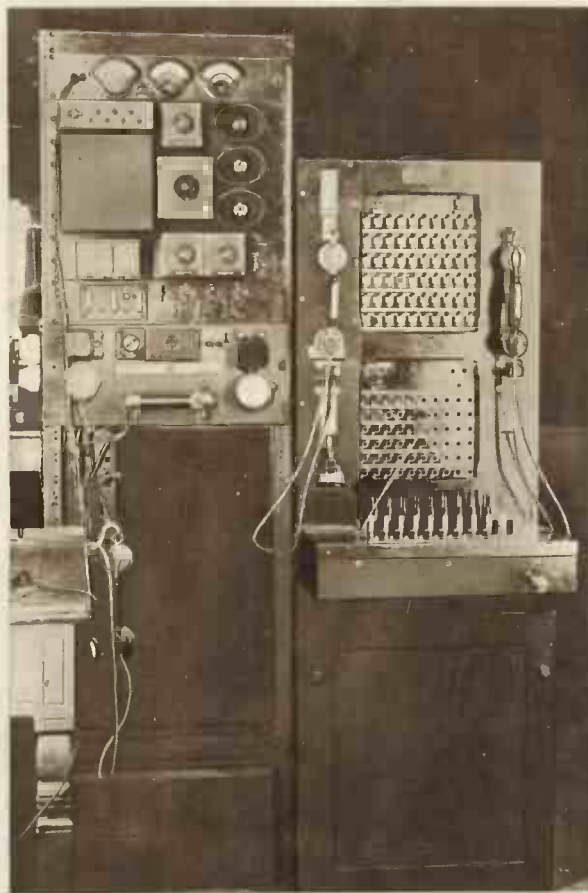

Fig. 9.—By the aid of this switchboard land-line connections with many concert halls and theatres may be established.

On January 31, 1923, the concert transmitted was given at the Salle Gaveau, and it was transmitted by the station, to the great joy of the French amateurs, to whom it was a real innovation. Later, concerts from other halls were transmitted, among these the Salle Pleyel, Salle de Conservatoire, and the Salle des Agriculteurs.

It was on February 28, 1923, that the first outside transmission of importance was made, when the meeting held in the grand amphitheatre of the Sorbonne (Paris University) on the occasion of the centenary of Renan (one of the

French classic poets of the sixteenth century) was broadcast by this station, the President of the Republic being in the chair. On February 27, 1923 the first transmission of a theatrical performance met with the greatest success and gave the French radio industry a considerable lift up. On that day the station of the Ecole Superieure transmitted the dress rehearsal of the "Mastersingers,"

of Wagner, given at the National Opera. That evening has remained imperishable in the memories of all French listeners. On March 3, the performance of "The Magic Flute," by Mozart, was also transmitted in its entirety from the National Opera, with considerable success. The transmission of theatrical performances met with enthusiasm among French listeners, as was confirmed by the numerous letters which reached the station. In a similar manner theatrical performances from the "Trianon Lyrique" de la "Gaité Lyrique" were successfully transmitted later.

Transmissions of a high literary value were given in a course of lectures given at the Sorbonne, by Professor Hazard and Professor Sagnac. The first lecture took place on February 17, 1923. Each year a course of lectures on French literature is transmitted in this way in its entirety by the Ecole Superieure. In the scientific world the epoch making lectures delivered in the amphitheatre of Physics of the Sorbonne by the eminent Professors Lorentz, Stoemer, Knudsen, and also Lord Rayleigh, on the occasion of the fiftieth anniversary of the French Society of Physics, were transmitted in December, 1923.

CONTINUED ON A
SUBSEQUENT PAGE.

A Self-Contained Three-Valve Receiver

By **HERBERT K. SIMPSON.**

(Concluded from page 215.)

The master rheostat should never be used for this purpose; it should always be right "on" or "off."

Tuning

Tuning is carried out by adjustment of the two variable condensers, and by varying the coupling between L₁, L₂, and L₃. Reaction is obtained by coupling L₁ to L₂, but care should be taken to prevent the receiver oscillating. If no reaction effect is obtained upon placing L₁ close to L₂, the leads to the former should be reversed with the aid of the two terminals provided. L₃ will generally be kept close to L₂, though for maximum selectivity different degrees of coupling should be tried. The effect of reversing the leads to this coil should also be tried. A change in the position of either of the two outside

coils necessitates readjustment of each of the variable condensers.

Loudest signals and maximum selectivity are obtained with the receiver just off oscillation point, but the danger of interfering with other listeners should always be kept in mind when making tuning adjustments in this neighbourhood.

Grid Bias

The use of negative grid bias may be found to improve the quality of the received signals. A dry battery capable of variation between three and fifteen volts is desirable. The link between G.B. + and G.B. - should be taken out, and the - terminal of the battery connected to G.B. - and the + terminal to G.B. +. Different voltages should be tried, together with an increase in the H.T. voltage. If the grid battery proves beneficial

it may be placed inside the cabinet with the other batteries.

Series and Parallel Tuning

Ordinary parallel tuning without the constant aerial tuning condenser is employed by joining the aerial to B instead of A. Nos. 25, 35, and 50 coils should now be tried in the aerial socket.

Series tuning is obtained by taking out the link between C and E, and connecting the aerial to C. It is probable that a larger coil will be required than that which proved suitable with parallel tuning.

The receiver has not been designed for any specific purpose, but should prove popular with the average listener.

Readers are reminded that the fee charged by Radio Press, Ltd., for answering technical queries is 2s. 6d. per question. As a highly technical staff is devoting its whole time to replying to these queries, it is impossible to answer any query which is unaccompanied by a remittance.

GO ONE BETTER THAN THE OTHER FELLOW

The valve repays! By fitting ordinary valves to your receiver you build inefficiently. Valve pins and Sockets introduce short distance paralysis. Capacity—the paralyzing factor in every valve—is increased, depriving your receiver of the power to bring in distant signals.

In the MYERS the grid and anode leads are brought out at opposite ends. Bunched Electrode leads in the ordinary valve are the cause of your receiver's failure to give either distance or power. The wide separation of the grid and anode leads leaves those elements to function without unwanted capacity effects, which react—shortening the effective range of your set.

MYERS are expressly designed for the long-distance receiver. This design, logically, gives added power. Free of the inter-electrode capacity of ordinary valves you can go one better than the other fellow. Simply mounted—Myers may be adapted to existing panel design—your next set should be constructed for MYERS—they enable you to go one better.

Myers Valves

PRACTICALLY UNBREAKABLE

YOU WILL FIND

Put the World on your Dial.

MADE IN TWO TYPES

Universal, 12/6
4 volts .6 amp.
Dry Battery, 21/-
2½ volts .25 amp.



Most dealers stock MYERS. If you cannot obtain them at your local dealer's send direct to the nearest agent:

LONDON—The Dull Emitter Valve Co., 83, Pelham St., South Kensington, S.W.7 (Kensington 3331).

MANCHESTER—R. Davis & Sons, Wireless Depot, Bilberry Street.

LIVERPOOL—Apex Electrical Supply Co., 59, Old Hall St.

GLASGOW—Milligan's Wireless Co., 50, Sauchiehall St.

YORKSHIRE—H. Wadsworth Sellers, Standard Buildings, Leeds.

SOUTHERN COUNTIES—D.E.D.A., 4, Tennis Road, Hove.

Or direct to us. Your set deserves them.

The French Broadcasting Station of L'Ecole Superieure des Postes et Telegraphes

(Concluded from page 222.)

Finally, events presenting a special interest have also been transmitted. In a similar way listeners were able to hear the speeches delivered at the League of Nations, at Geneva, by Mr. MacDonald, M. Herriot, M. Theunis, M. Benes, M. Salandra, etc., Prime Ministers, and Ministers of the various countries represented at the League; also the speeches given on the occasion of the unveiling of the statue of Marechal Gallieni, the French general, famous for his army of taxi-cabs which are reputed to have saved Paris in 1914; and, more recently, the speeches delivered at the funeral of Anatole France.

Owing to this station's wavelength of 450 metres, it has been among the Continental stations the best known to British ama-

teurs. It is unfortunate that the power used is kept so low. The German stations using three times that power are beginning to reach England with greater strength.

For these reasons there is little doubt that the number of listeners in this country tuning in the Ecole Superieure is decreasing. This is much to be regretted, as the Ecole Superieure has for some time been in the foreground among Continental stations for the international value of their outside broadcasts. Many of us owe our gratitude to this station for many a pleasant evening, and our thanks should go to the chief engineer, Monsieur Chanton, under whose direction these transmissions have been so ably conducted.

A Long-Range Two-Valve Receiver

SIR,—I have recently constructed a set similar to the one described by Mr. Underdown, which is known as the "Long-range Two-valve Set," and can receive all the B.B.C. main stations and Edinburgh (relay) and numerous Continental ones.

Several nights during the last week or two signals were received from WDD, a Westinghouse station which broadcasts from an hotel. They gave the time as 6.28 p.m., our time being 1.30 a.m. This station is a little above Edinburgh's wavelength.

I have also picked up the carrier waves of other American stations. I should be obliged if you could let me have the address of the WDD station.

The valves used were Marconi Osram D.E.R. dull emitters. All the above stations were received on an indoor aerial.—Yours faithfully,
JOHN HUTTON.

Falkirk, N.B.

[The station our correspondent refers to is undoubtedly WBZ (the Z being always pronounced "Zee"), the Westinghouse Electric Co.'s station at Springfield, Mass.—Ed.]

HAWK COILS

MAXIMUM

MINIMUM

Efficiency

Capacity

Strength

Damping Effects

Resistance

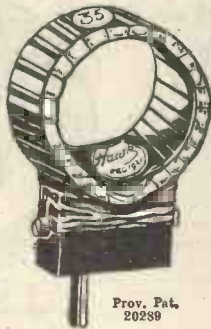

Prov. Pat. 20289

WATERPROOF

Prices below

Coil No.	Wave Length using '001 Variable Condenser in Parallel		PRICE.
	MAXIMUM	MINIMUM	
13	—	—	2/-
25	305	190	2/4
30	435	240	2/4
35	515	360	2/6
40	680	370	2/8
50	835	485	3/-
75	1250	600	3/4
100	1820	815	3/10
150	2300	960	4/8
200	3100	1870	5/4
250	3750	2200	5/8
300	4500	2300	6/-
400	4950	2500	6/8

Sold by all Wireless Dealers

Sole Manufacturers:

The Hawk Coil Co., 39, PENRHYN RD., Kingston-on-Thames

ANTI-CAPACITY SWITCH

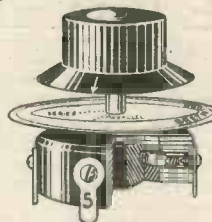

We have pleasure in presenting another first-class specialty, which is the outcome of the famous BRETWOOD ANTI-CAPACITY VALVE HOLDER, which has gained such popularity among the wireless public on account of its scientific design and smart appearance. The Bretwood Switch is constructed on similar lines and we claim that it is, like the Valve Holder, absolutely free from capacity effects, and we feel confident that this component will meet with the most exacting requirements of the present-day experimenter. One of the principal features of the Bretwood Switch is its beautifully smooth action, made possible by the

spring-loaded balls, and the wiping or rolling motion of the Phosphor-Bronze balls always ensures clean and perfect electrical contact.

Features—1. Absolute freedom from capacity. 2. Perfect contact. Price 5/-
3. Sweet and smooth action. 4. Practically no wear and tear. 5. First-class finish and neat in appearance. 6. Easy to fix (one-hole fixing). 7. Very easy to make wire connections. 8. Like our other components it is fully guaranteed. 9. For value offered the price is postage moderate. 3d.



Patent Pending
Price 3/-
Postage 3d.

It's the LEAK that Counts

The Bretwood Grid Leak (Guaranteed) tunes a carrier wave from the silent point up. The Bretwood is recognised by highest experts and experimenters as the only variable and reliable Grid Leak.

THE BRETWOOD PATENT VALVE HOLDER.

Eliminate poor reception by adopting this scientifically designed Valve Holder, and obtain 100 per cent. efficiency. Easy to fix. No capacity. No leakage. Always perfect contact. No soldering. Can be mounted on front or back of panel.

Price 1/9 Postage 3d.

VISIT OUR STAND, SECTION I, BRITISH WIRELESS EXHIBITION.

RADIO IMPROVEMENTS LTD.,
12-18, London Mews, Maple St., LONDON, W.
ALL BRETWOOD SPECIALITIES ARE OBTAINABLE FROM MOST WIRELESS DEALERS.

Correspondence



FILLING HOLES IN EBONITE

SIR,—No really satisfactory method of filling up holes in ebonite panels exists. Is no ebonite manufacturer sufficiently enterprising to turn out flat-topped ebonite plugs same size and shape as 2, 4, and 6 BA nuts and also $\frac{3}{8}$ in. diameter? With a little Chatterton's compound these could be inserted so as to be practically invisible, and the experimenter need not be so chary of trying different components on his panel.

Perhaps the publication of this letter in *Wireless Weekly* will again, as it has so often in the past, achieve the desired result.—Yours faithfully,

D. R. WHITE.

Prenton.

GRAMOPHONES AND WIRELESS

SIR,—I had thought that correspondence *re* the relative merits of gramophones and loud-speakers had been dropped, but the letter in the November 12 issue of *Wireless Weekly* contains so many fallacies that I cannot let it pass unanswered.

In the first place the controversy is not, as Mr. Hallows appears to imagine, between gramophones and wireless but between the quality of reproduction by loud-speakers and by gramophones. He takes as an example the transmissions relayed by wireless from the Old Vic. These were admittedly a great success, but the fallacy lies in the fact that from the time the music entered the microphone in the

theatre, until it was reproduced in the homes of the listeners the sound impulses were never reconverted into actual sound. If the music had been received at 2LO and reproduced on a loud-speaker, the sound from the loud-speaker in turn entering the microphone for re-transmission, I think that the results would have been greatly inferior to what they actually were.

The only time I have heard a loud-speaker before the microphone was when Captain Eckersley showed us how to tune in, while Mr. Palmer was speaking into the microphone of a small transmitter in the room below. At its best it was very difficult indeed to tell what Mr. Palmer was saying, whereas the gramophone before the microphone is at least passable. Of

The "Mars Aerial" gives "really extraordinary" results

Read this interesting testimony.

Mr. W. T. AKED, A.M.I.Mech.F., A.M.I.A.E., Call Sign 5 DC, Devonshire Road, St. Annes-on-the-Sea, Lancs., writes:—

"I have during the week-end made a preliminary test of your patent aerial, and must say, at once, that the results achieved are really extraordinary. Your aerial, in my opinion, is without doubt, the most efficient I have ever tested, and without exaggerating, I may safely quote 30 per cent. increase in volume, that is from a reception point of view.

With regard to the transmitting side, I can only go by the reports I receive from various amateurs and listeners-in, and yesterday two Stations reported my transmissions approximately 30/50 per cent stronger in volume.

We claim that—
 COMPARED WITH 7/22'S THE 'MARS' HAS 80% GREATER SURFACE AREA. GIVES 50% GREATER EFFICIENCY WHEN USED FOR RECEPTION. 90% GREATER EFFICIENCY WHEN USED FOR TRANSMISSION.

Figures for Experts

Surface areas: 7/22's, $\frac{1}{2}$ The 'Mars', $1\frac{1}{2}$. Tensile strength, 70 lbs. Weight, 9 ozs. Can be obtained in 100' to 600' lengths in multiple of 50'.

Please get your 'Mars' Aerial locally—leading dealers in most towns now stock. In case of difficulty send P.O. for 9/6 to us, and we will supply 100 ft. as quickly as possible.



9/6
100 ft.

MARS AERIAL

E. & W. G. MAKINSON LTD.
 Sole Manufacturers and Patentees,
 Wellington Works, Wellfield Rd., Preston.

GET FINE TUNING it means signal strength

To secure maximum signal strength requires something more than good components and a well-designed set. The best is only obtained from your sets when, besides skilful tuning, you have the means provided whereby skill may be rewarded with exceptional results.



PRICE
2/6

While the potential signal strength of any receiver may be good, large tuning condensers fail to balance circuits into resonance, so that the receiver cannot function at its best. With the use of large tuning condensers—since they do not allow delicate movement—tuning is never accurate. The advantages of circuits with razor-sharp tuning are therefore never used to their utmost capacity. But really accurate and delicate tuning is at once within the reach of every experimenter if fine tuning devices are incorporated. Do not use a vernier in association with the large condenser. Fit an independent vernier—it gives finer tuning. The COLVERN (max. cap. .00014 mfd.) will make your tuning razor-sharp, enable you to build selective receivers and will demonstrate that your set is more sensitive to perfect balance than you have yet experienced. Remember—the COLVERN.

If your local dealer does not stock the COLVERN TUNING CONDENSER, kindly send his name and address when ordering.

COLLINSON'S PRECISION SCREW CO., LTD.
 Macdonald Rd., Walthamstow, London, E.17. Tel.: WAL. 532.

Barclays 345.

course, no one would prefer the broadcasting of gramophone records to the broadcasting of an actual performance.

From what I can gather from Mr. Hallows' letter he says that the fact that listeners prefer a real orchestra to gramophone records proves that the loud-speaker must be better than a gramophone, which is absurd.

With reference to the complaint against the scratch of a gramophone needle, this is at least constant, and becomes unnoticed in time. Now, situated as I am, at a considerable distance from a broadcasting station, I use the ST100 circuit to get loud-speaking. This gives me very good results indeed, but I find the variable interference by atmospherics, Morse, and howling is much more annoying than the scratch of a gramophone.—
Yours faithfully,

N. LILLEY.

Leek, Staffs.

P.S.—I was unable to hear the loud-speaker demonstrations at the Albert Hall Exhibition, but I have heard the loud-speakers at Wembley, and was far from pleased by them. I got much more enjoyment from the H.M.V. stand in the Palace of Industry.—N. L.

A SINGLE-VALVE RECEIVER FOR DULL EMITTER VALVES

SIR,—I have constructed the single-valve receiver designed by Mr. S. G. Rattee, and described in your issue of October 15, 1924. You will, I am sure, be pleased to hear of the excellent results I have obtained with this set.

In the main I have followed the design, but have departed from it in one or two minor matters. The valve used was an Ediswan A.R.; my aerial is badly screened, only 20 ft. high and 60 ft. long, 3 miles from Sheffield relay station.

My first "try-out" was on October 23, when I had roughly finished the wiring in order to give it a preliminary test before the stations closed down. In the short time at my disposal I tuned in Sheffield, Manchester and Newcastle. The following evening I completed the wiring and "logged" the stations shown in the list. The last on the list was not identified, as the speech was too weak.

Station.	Strength.	Remarks.
Sheffield.	Excellent.	
Nottingham.	Good.	
Cardiff.	Fair.	
Leeds.	Good.	
Manchester.	Very good.	
Birmingham.	Fair.	
Foreign?	Faint.	
Newcastle.	Rather faint.	
Bournemouth.	Fair.	
Stoke-on-Trent.	Faint.	Sheffield closed down.
London.	Good.	
Aberdeen.	Fair.	
?	Faint.	All B.B.C. stations closed down. Faded.

The following evening (Saturday) I repeated most of the above, but the relay stations all having the same programmes could not definitely be confirmed.

I had made the set for a friend and last Saturday tested it on his aerial (a good one) and tuned in nine different stations in a very short time.

These results I think are excellent. I found the tuning very critical, and the reaction to require very careful handling on stations other than the local relay station.

Yours faithfully,
D. MANTERFIELD.
Sheffield.

**STAND
57**

**The White City
Radio Exhibition**

— Nov. 15th to 29th —

**STAND
57**

ABGAR

Single Valve Receiver.

A Complete Set including 1 D.E. Valve, dry cells, 1 60-volt high-tension battery, 1 pair of telephones, 1 aerial equipment, 1 set of coils for B.B.C. and Paris wavelengths. A splendid selective set built to a standard of perfection at a price within your reach. **The Price is £8 10s.**

Write for particulars of our other sets and components.

TRADERS AND FACTORS SHOULD WRITE FOR PARTICULARS OF OUR AGENCY AND DISTRIBUTING POSITIONS.

ALL OUR RECEIVERS CARRY OUR GUARANTEE AGAINST FAULTY WORKMANSHIP.



Reg. Trade Mark.

Mr. D. GLOVER,
23, Collings Park, Plymouth,
and of Calcutta,

writes:—
I have consistently received several American broadcast Concerts, particularly W.B.Z. Boston, K.D.K.A., E. Pittsburg and W.J.Z., Schenectady, N.Y.

The two former Stations were distinctly audible on the loud speaker using only three valves.

Mr. Glover owns and uses a Standard ABGAR receiver.

Write for Catalogue and further information to:—

ABGAR ELECTRICS

(Dept. R).

39/40, St. Andrew Street, Plymouth, Devon

Giving your dealer's name and address.

REDSPOT

Guaranteed Radio Components.

A complete range of high class accessories for the home Constructor who requires the best components at reasonable prices. The range includes:

Coil Holders, Potentiometers Rheostats for D.E or R type valves, including our dual rheostat. No-capacity valve holders and switches together with laboratory and standard condensers.

ENQUIRIES FROM OVERSEAS BUYERS INVITED.

ALL OUR REDSPOT COMPONENTS ARE GUARANTEED AGAINST DEFECTS IN WORKMANSHIP.



Apparatus we have tested

Conducted by A. D. COWPER, M.Sc., Staff Editor.

"Cecil" Cat's Whisker

A specimen of the "Cecil" cat's whisker, supplied in a small box, has been submitted by H. C. Hunt. This consists of a wire (an alloy) of fairly stout gauge, wound into a small, stiff spiral, and with a flattened and sharpened end. On practical trial in reception, in comparison with other types of cat's whisker on more than one good synthetic galena crystal, it was found appreciably difficult to get a good setting, and the sensitive spots found were rapidly destroyed by the unduly rigid whisker. The quantitative measurement of resulting signal-strength showed, also, no improvement over the standard when an optimum setting had been obtained. It is hard to see, there-

fore, how the much-overworked term "super" can be applied to this accessory, and the justification of the price asked for it.

"Ampliflytone" Aerial Outfit

From Messrs. United Manufacturers & Agency, Ltd., we have received a sample of their "Ampliflytone" aerial outfit, a cardboard box containing a 100-ft. roll of thin copper tape $\frac{1}{4}$ in. wide, insulators, rubber-covered lead-in, and sleeves for fastening the ends of the tape. This tape, when tested in direct comparison under identical conditions, gave with a low-resistance standard crystal tuner on a distant transmission a signal strength which was, by direct measurement,

slightly superior to that with a stranded aerial-wire; in valve reception not the slightest quantitative difference could be detected when reaction was used. This was in agreement with results previously observed and measured by the writer with ribbon aerials. By casual observation no difference is noticeable in either case.

Provided that the extra wind-resistance is provided for, this outfit provides a convenient and low-resistance aerial-equipment, appreciably easier to erect than standard stranded wire.

"F.A.R." L.F. Intervalve Transformer

A L.F. intervalve transformer of French origin is the "F.A.R.," a

Choose and Use—

"Tangent" Tuning Coils

—and thus ensure low self-capacity



"No second-rate effects will satisfy the intelligent purchaser for whom 'Tangent' fittings are designed."

Ask for Leaflet 107

Sizes	
Coil No.	Price
25	4/3
35	4/3
50	4/3
75	4/6
100	5/-
150	6/-
200	7/-
250	7/6
300	8/-
400	9/-
500	10/-

Unshrouded Efficiency

In order to obtain satisfaction

you must have a tuning coil that is **STRONG and SELECTIVE yet HIGHLY EFFICIENT**

SELF-CAPACITY has been reduced to a minimum owing to the fact that the impregnated cord not only passes between the layers and thus provides air spacing, but also firmly braces up the whole coil so that no empire cloth or shellac is required

Ask your dealer—Take no substitute for "TANGENT"

Rigid as a Motor Wheel

GENT & CO. LTD. Faraday Works, **LEICESTER.** Established 1872.
Manufacturing Electrical Engineers.

London: 25, Victoria St., S.W.1.

Newcastle-on-Tyne: Tangent House, Blackett St.

Complete set of 4 Concert Coils (Nos. 25 to 75), 16/- the set.
Complete set of 11 Concert Coils (Nos. 25 to 500), £3 7s. the set.

specimen of the 5 to 1 ratio type of which has been submitted for test by the British agent, Maurice Bobin. The instrument is of medium size, with enclosed windings, and has the four neat terminals arranged at the top and clearly marked. On test, it operated noiselessly, and showed good insulation; in comparison with other instruments this one gave a good build-up of signals and a tone that was above the average of moderate-priced transformers.

Safety Wander-Plug

The possibility of destroying the filaments of the valves in a receiver by accidentally short-circuiting the H.T. battery through them is almost entirely removed by putting a high resistance permanently in circuit with the battery, which allows the few milliamperes of normal plate current to pass without serious voltage drop, but prevents the passage of sufficient current to do the damage to the filaments even when an almost complete short-circuit is made. At the same time, the H.T. battery is preserved from an untimely end due to such accidental short-circuits even where the filaments are not endangered.

Messrs. Radi-Arc Electrical Co., Ltd., have sent for our trial a sample of a wander-plug that incorporates a high resistance, which is thus permanently and automatically put in series with the H.T. battery, and provides the protection indicated. This is a neat, somewhat elongated version of the ordinary red-coloured wander-plug, with a milled-head nut for wire-connection, the length over all being about 2 1/4 in. The appearance is quite attractive. On test, the enclosed resistance came out at about 500 ohms, and both an ordinary R valve and a .06 type of dull-emitter were deliberately short-circuited, as to the filament, across a high-tension battery of nearly 100 volts with this wander-plug in use, with complete impunity. With dull-emitters, however, a considerably higher resistance would be indicated, as with a high value of H.T. and a new battery in good condition it would be possible to exceed their safe current for a brief time, with only 500 ohms in circuit. In actual reception, using a 2 µF condenser across the H.T. battery, a valve oscillated freely, and reception was quite silent. It is advisable to use a large blocking condenser as indicated, particularly in a many-valve set, with this device. With this

proviso we can certainly recommend this safety plug for general use.

A Two-Coil Holder

A two-coil holder for mounting on the top of the panel or side of cabinet of simple but substantial design, has been submitted for our examination by Messrs. Burne-Jones & Co., Ltd. In this, the fixed coil is mounted on a stout ebonite plate which is secured on the panel, etc., by screws through two plated metal angle-pieces. A bracket carries, at a distance of about 1 1/2 in., a horizontal axle controlled by a 3in. extension spindle carrying a large knob. On this axle rotates the moving coil-plug with a range of coupling through over 100 degrees of arc. A spiral friction-spring, with adjusting nut, at the further end of this axle renders the motion sufficiently stiff, so that the larger and heavier sizes of plug-in coils can be used, though with coils above about No. 200 it would be better to mount the holder in a vertical position.

On trial, the insulation was found excellent and the mechanism worked smoothly, a sufficiently fine control over reaction being obtained for ordinary purposes with the broadcast range of coils in use. The finish and workmanship are of a high order.

The ST100
—the most popular
2-Valve Receiver

IN spite of all the new "dynes" and "supers" that have been produced during the last 18 months, the ST100 still remains the most popular Set for Broadcast reception. To the sceptic its volume is amazing—in fact, it is often necessary to detune it within 3 or 4 miles from a Broadcast Station, because so few Loud Speakers can cope with the volume. For long-distance work it is unique—from any position in the country all the B.B.C. Stations can be received at good headphone strength. Is any more required from a Set? Descriptive Folder of all Peto-Scott Pilot Receivers sent free of charge. Catalogue (48 pages fully illustrated), of components, 3d., post free.

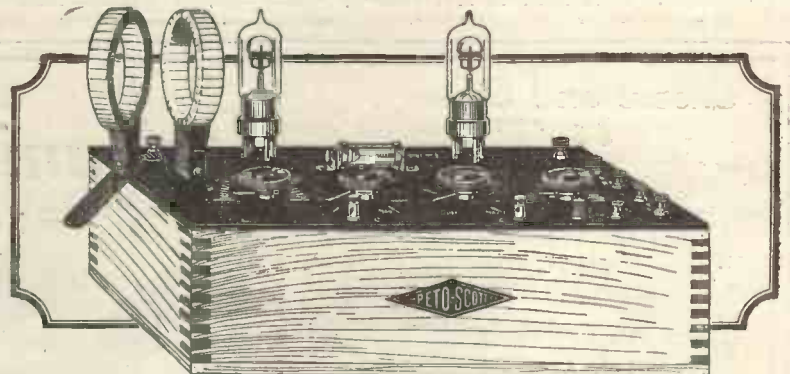

A square law Dual Condenser

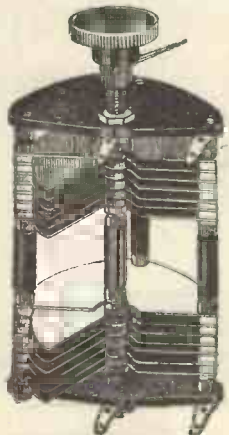

For the Transatlantic V and other Receivers using two stages of High Frequency, a dual condenser is essential for tuning the two H.F. Transformers simultaneously. Here is a square law Dual Condenser to match up with the square law condenser you will use for your aerial tuning. Handsomely finished with solid ebonite end plates and one-hole fixing to panel. Fitted with engraved dial or knob and brass pointer. Each half has a capacity of .0003 mfd. **15/6**

Build your own ST100 and we will guarantee you successful results.

Because the ST100 is a Reflex Set it is imperative that the lay-out of the Set—the disposition of its components and the wiring should be correct. The safest way of ensuring this is to build up a Peto-Scott ST100. If the instructions we give are followed exactly you are ensured of success from the commencement. Further, we will back this statement with the following guarantee:

If after building the Set from our kit of Components it does not work satisfactorily, return it to us for testing. It will be put into thorough working order, and should the defect be due to a mistake on the part of the constructor only a nominal charge will be made. If it is due to some defective component, the part will be replaced entirely free of charge.

Thus, the Peto-Scott way will enable you to obtain the finest 2-Valve Reflex at the cost of the materials alone.

Complete kit of all components, including drilled and engraved panel, and all transformers, variable condensers, etc. (but without coils and valves) and including full instructions for assembly (Marconi Royalties paid) **£4 17 6**
Polished Cabinet extra **7 6**
Finished Instrument, aerial tested and Marconi Royalty paid **£8 5 0**

Peto-Scott Co. Ltd., 77 CITY ROAD, LONDON, E.C.1

Head Offices, Mail Order Department and Showrooms—
Branches:—LONDON—62, High Holborn, W.O.1. PLYMOUTH—4, Bank of England Place. LIVERPOOL—4, Manchester Street, CARDIFF—94, Queen Street, WALTHAMSTOW—230, Wood Street. Gilbert Ad. 1833

Information Department



SUPPLIED BY RADIO PRESS SERVICE DEPT., LTD.

J. Q. C. (BRADFORD) is using a super-heterodyne receiver and enquires as to the possibilities of causing interference with such a circuit.

The circuit diagram accompanying J. Q. C.'s letter shows that he is using an arrangement in which the first detector valve is connected directly to the secondary circuit of the tuner. The local oscillator is also coupled to the secondary circuit. With such a receiver a certain amount of interference is bound to occur when stations are being tuned-in. Such interference will be less serious than that produced by a self-oscillating receiver, since the currents induced in the tuned circuits by the local oscillator are not as a rule very strong, and it is usually

considered that when once the desired station has been tuned-in, all interference ceases. When properly adjusted the oscillator is set to a frequency which will produce, when combined with the incoming signals, "beats" corresponding to a wavelength of the order of 3,000 metres. This means that the frequency of the local oscillations is widely different from that of the signals, and no audible interference will normally result from any radiation which may occur. Cases have been observed, however, in which curious effects were undoubtedly produced by such a set at short distances, even when correctly adjusted. To reduce the risk of causing annoyance, it is usual to interpose a high-frequency valve between the tuner and the

first detector, and to couple the oscillator to the anode circuit of this H.F. valve.

S. E. P. (WOKING) is much troubled by interference from 5XX when endeavouring to receive Radio-Paris and enquires as to remedies.

In the first place, critically examine your aerial circuit, and note whether its efficiency can be increased. Poor insulation, a long earth lead (especially if the wire used is too thin), a bad earth, poor joints, and a down-lead which runs close to walls, iron spouting, etc., are among the possible causes of unduly flat tuning. Tuning coils should not be overlooked (consult "Tuning Coils and How to Wind Them," Radio Press, Ltd., 1s. 8d., post free) as possible sources of

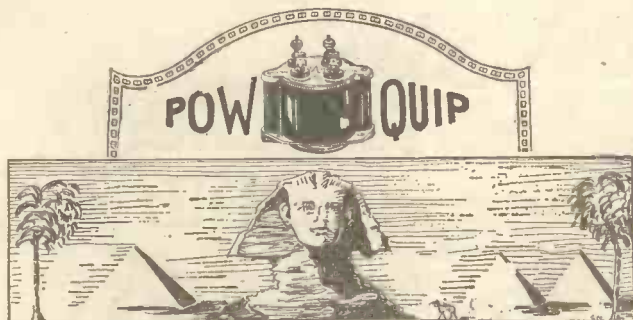

They stand the Test of Time.

This can be truly said of every "Powquip" Low-frequency Transformer that leaves our Works, for the following reasons:—

- They are*
- Built from the soundest designs.
- Made from the best materials.
- Solidly constructed.
- Of the best workmanship.
- Fully tested before and after assembling.
- Tested electrically, magnetically and on standard aerial.
- Fully shrouded.
- Guaranteed 12 months.

Open Type 14/6 each. Shrouded type 18/-

The **POWER EQUIPMENT COMPANY LIMITED**

KINGSBURY WORKS, THE HYDE HENDON, N.W. 9.

Safety first - in Panels

TO be sure that your panel is free from conductivity is to take a big step towards ensuring the efficiency of your sets.

Bowyer-Lowe Panels are made from P.O. Grade "A" Ebonite which we guarantee to be entirely free from metal. It may be used without rubbing down. Our polished and engraved panels have won a fine reputation for perfection of polish, neatness of engraving and accuracy of drilling.

PRICES: Semi Matt Surface 3/4d. per sq. inch. Hand polished one side and all edges 1d. per sq. inch. Drilled and engraved for any Radio Press Set (except OMNI top) and polished one side and all edges 1 1/4d. per sq. inch.

Bowyer-Lowe Tested Ebonite

Sold by Good Dealers in sealed packages. Every sheet bears our Trade Mark on reverse side. Order direct if unobtainable locally

Bowyer-Lowe Co. Ltd.
Letchworth.

trouble, and if after attending to these points it is still impossible to separate the stations, adopt either a loose-coupled tuner or a "type D" wave-trap (see *Wireless Weekly* for August 13, 1924).

U. S. C. (CIRENCESTER) asks for the best method of inserting a key in his transmitting circuit for the transmission of Morse signals.

Our correspondent's circuit is a fairly standard one employing choke control for telephony transmission, and we suggest the placing of the key in the grid circuit in such a way that when it is depressed the usual connection from the lower end of the grid circuit to the filament is completed, whereas when it is raised this connection is broken.

This is a common method of keying, which gives moderately clean-cut signals. The sharpness of the signals can be improved, in the case of the majority of the smaller transmitting valves, by so arranging a battery of dry cells that when the key is raised a high negative potential is communicated via the "back stop" of the key to the grid. The connections are as follows: Take the lead from the lower end of the grid circuit to the arm of the key, and the one from the filament circuit to the

front stop. The negative terminal of the dry battery (100 volts or more, depending upon the valve and the conditions under which it is working) is to be connected to the back stop of the key, and its positive to the filament. The best results will then be obtained with a fairly small "drop" or play on the key, but care must be taken not to screw the key right down, lest the dry battery be short-circuited. This method is used in commercial practice.

J. E. R. (BEDFORD) enquires as to the efficiency or otherwise of copper wire enamelled and then double cotton covered, for the winding of tuning coils.

Such wire can be obtained with a certain amount of difficulty at the present time, and at first sight it would appear to possess great advantages for use in the construction of low-loss inductances. It is very doubtful if such is actually the case, however. It is true that the enamel provides the necessary insulation, the cotton serving merely to space the turns apart, so that it need not be impregnated against damp to maintain the insulation of the coil. Nevertheless, if the cotton is not protected against damp it will absorb moisture at times, with a

consequent serious increase in the capacity of the coil (remember that the dielectric constant of water is exceedingly high), the only real advantage of this wire being that this harmful increase in capacity is not accompanied by a reduction in insulation.

P. R. W. (FRIZINGHALL) wishes us to recommend a three-valve receiver of a very high order of selectivity and possessing reasonable sensitiveness. The set is to be used fairly close to the Bradford relay station, and is intended for the 300-500 metre wave band only.

A Reinartz receiver with a stage of H.F. amplification strikes us as suitable, and the necessary instructions with full details will be found in "Twelve Tested Wireless Sets," by Percy W. Harris (Radio Press, Ltd., 2s. 8d. post free). Such an instrument requires a certain amount of operative skill to obtain the best results, but is capable of an extremely good performance.

Will Mr. A. H. McHenry kindly send his address to Messrs. F. J. Fletcher, of Halifax, in order that they may send him the goods he ordered?

FIT THE NEW

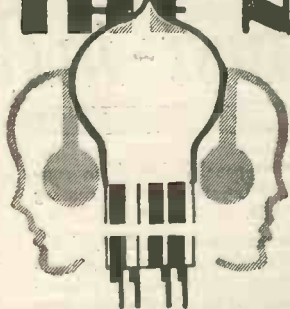

**RAIDION
G.P.
VALVE
AND SIMPLIFY RECEPTION**

Here's an economical bright emitter general purpose valve with amplification factor of 9. filament 3.5 to 4 volt, .48 amp. Anode 30 to 90. Use it in any part of your set. Let us send you free and post free the curve for this valve. Just a P.C. will do.

RADIONS LTD., BOLLINGTON, MACCLESFIELD.

From Dealers **10/-** or direct.

The Valve knocked out!

'CONCITE' CRYSTAL

Registered No. 44946.

Recommended for use with Reflex and Dual Amplification Circuits

Obtainable from:

Wholesale:—
CONRADI & BRAUN,
52, Theobalds Road,
London, W.C.

Retail:—
PAYNE & HORNSBY,
Newcastle, Leeds, Nottingham, Belfast, N. & S. Shields, Sunderland and of all Wireless Dealers

IN SEALED TUBES



CRYSTAL & SILVER WHISKER COMPLETE

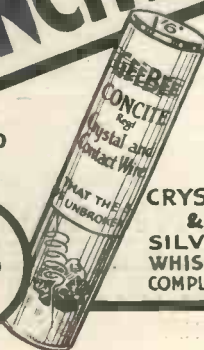



The Distinguishing Quality

THE distinguishing quality of any really fine instrument is its tone and therefore this must apply to your Radio Receiving apparatus, Amplifiers and Loud Speakers, otherwise the delights of listening-in are non-existent.

Western Electric Loud Speaking Equipments are renowned for

clear distortionless reproduction, in fact the tone is so wonderfully natural that you can hear every inflexion and every delicate gradation of tone. Ask for a special demonstration and hear these wonderful instruments yourself, it will be a revelation to you.

Western Electric Company Limited.

Connaught House, Aldwych, W.C.2.

CENTRAL 7345 (9 lines).

Branches: Birmingham, Leeds, Glasgow, Newcastle, Cardiff, Manchester, Southampton, Liverpool, and Dublin.

It will pay you always to watch WIRELESS WEEKLY Advertisements.

Tune the Table-Talker with the "Matched Tone" Headphones



The Brandes Family Series.

YOUNG Bill is decidedly quiet. This most unusual phenomenon is duly commented upon. Mother says that it looks as though wireless has provided a remedy for which she has been looking

for years. Previously the whole house was aware of his presence by a piercing whistle or a cracked and tuneless rendering of an all too popular melody. A gentle trot from room to room characterised his movements and occasionally a shrill college yell. Now there are endless experiments which occupy his time. But if only he would cease to impress on us the technical advantages of Brandes Products. Technicalities don't interest us because we believe our own ears. The reception given by the *Table-Talker* was vigorous yet pleasant and beautifully natural—we might be right in the Studio.

Ask your Dealer for Brandes.

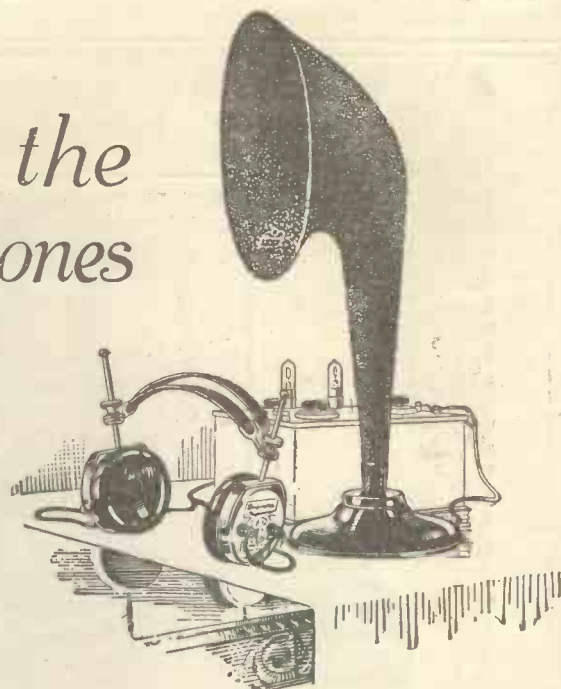
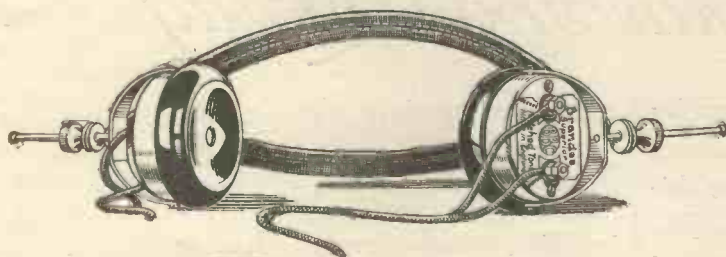

All Brandes products carry our official money-back guarantee, enabling you to return them within ten days if dissatisfied. This practically constitutes a free trial.

The "Matched Tone" feature was embodied as the distinctive characteristic of Brandes' Headphones in 1908, and means that both your ears hear exactly the same sound at the same instant—and you learn a new beauty of tone. They are tested and re-tested for just this one vital point, and in addition their strength, long-wearing comfort and reliable efficiency make them undoubtedly superior. **25/-**

The *Table-Talker* is a Brandes quality product at a moderate price. The non-resonant, specially constructed horn is matched to the unit so that the air resistance produced will exactly balance the mechanical power of the diaphragm. This means beautiful sound-balance and remarkable tone qualities. It is twenty-one inches high, has a self-adjusting diaphragm and is finished a **42/-** shade of neutral brown.

British Manufacture (B.B.C. Stamped).

Brandes

Result of
16 Years
Experience

The name to know in Radio

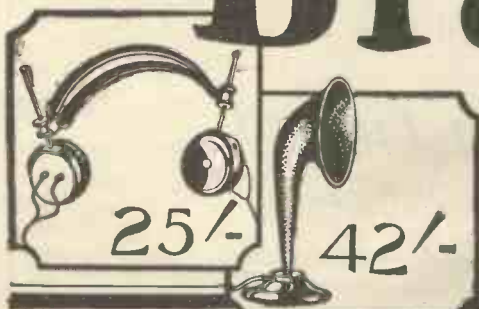

It will pay you always to watch WIRELESS WEEKLY Advertisements.

LISSENIUM



THE CONSTRUCTION OF AN L.F. AMPLIFIER USING LISSEN CHOKES

The LISSEN Choke is different to any other choke. There is no sharply defined resonant peak anywhere in the band of audible frequencies. It is a highly efficient Choke—two important characteristics are its uniform impedance on all audible frequencies and its high inductance value—the first characteristic resulting in perfectly pure amplification, and the second ensuring that a maximum signal voltage is transferred from the plate of the one valve to the grid of the succeeding valve.

THE OBJECT OF USING LISSEN L.F. CHOKES—

The difficulty in ordinary use of employing more than three stages of L.F. transformers is well known. An interesting experiment therefore would be to see how many stages of LISSEN Chokes can be successfully employed and to what extent it would be possible to build up a volume of perfectly pure sound.

THE L.F. AMPLIFIER USING LISSEN CHOKES—

This is comparatively quite simple. The connections are as follows :—

One terminal of the LISSEN CHOKE is connected to the plate of the preceding valve, the other terminal to the H.T. Battery. A Fixed Condenser of .01 capacity is connected between the plate of the preceding valve and the grid of the L.F. valve, and a Grid Leak (preferably the LISSEN Variable Grid Leak) is connected between the grid of the L.F. Valve and the L.T. negative. Grid cells should be introduced between the Grid Leak and L.T. negative if they are found necessary. Each succeeding stage is connected in the same manner

PRICE

10/-

Also Try Adding a LISSEN Choke to your last Transformer

LISSEN LIMITED

30-32, Woodger Rd., Goldhawk Rd., Shepherd's Bush, W.12

Telephones : *Riverside* 3380
3381
3382
1072

Telegrams:
"LISSENIUM
LONDON."

PARTS THAT PULL TOGETHER—BUILD WITH THEM

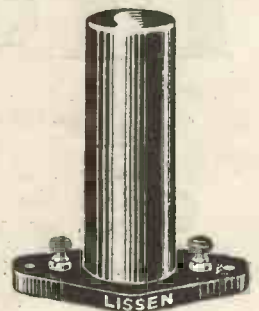

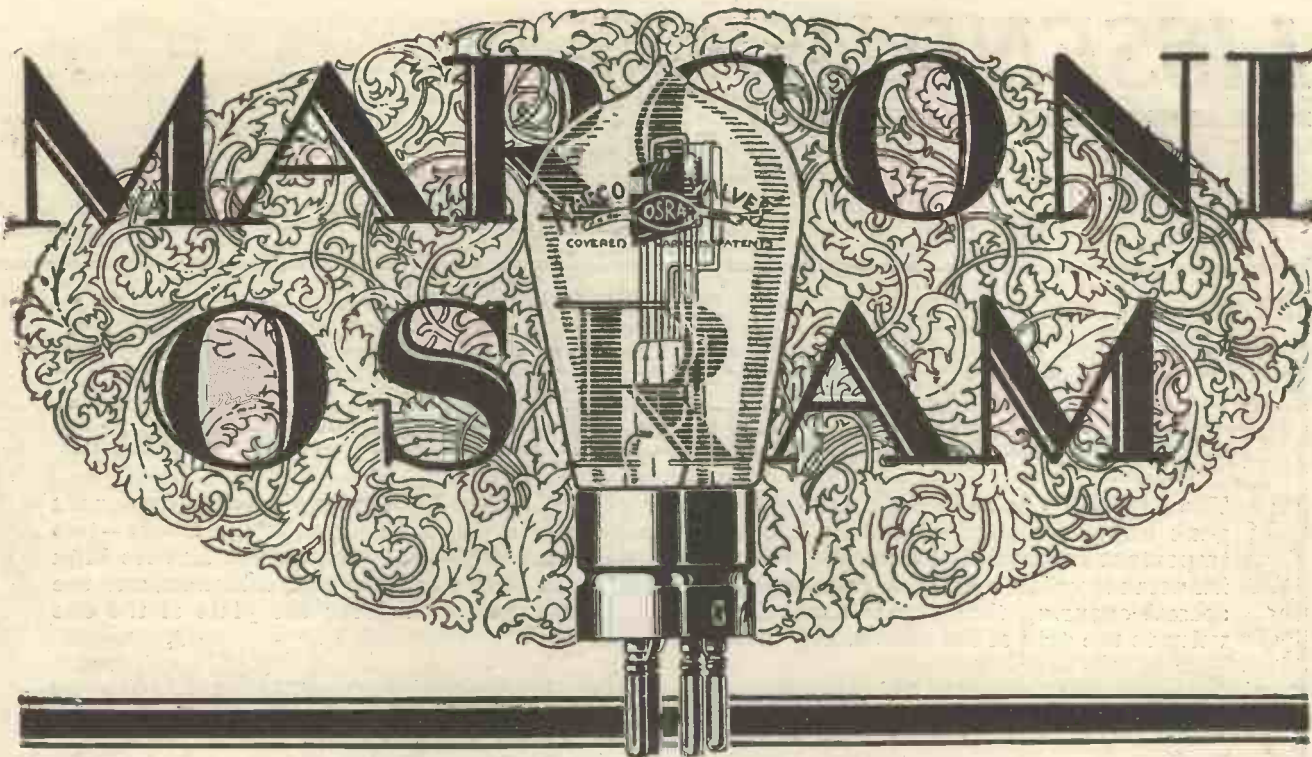

The two great names behind the Valve in the Purple Box

Since the first days of wireless the name MARCONI has been identified with every forward achievement. That unique knowledge has been added to the vast experience of the OSRAM manufacturing organisation. To these combined efforts in research and valve production is largely due the present-day development of wireless as a pastime for the million.

MARCONI VALVES

MADE AT THE OSRAM LAMP WORKS

Sold by Wireless and Electrical Dealers, Stores, etc.

Read the authoritative wireless work, *The Book of MOV*. Get a copy from your Dealer, or write to the M.O. Valve Co., Ltd., Brook Green, Hammersmith, London, W.6.



Get the Valve in the Purple Box!



How does it magnify?

AS a matter of fact, it *doesn't* although most people think of it in that way. The wireless valve is a valve in the truest sense of the word; just as much as the throttle on an engine. It is there to regulate the supply of energy from your H.T. battery in obedience to impulses from the aerial. The energy so regulated transforms the feeble current picked up from the ether into sounds

which are audible in your loud speaker.

Ediswan valves perform the delicate function of current control with a notable absence of distortion, a complete silence of operation and a marked economy in filament consumption and length of service.

Ediswan Valves will bring the best out of your wireless set—get some on the way home and enjoy better programmes from to-night onwards. All dealers sell them.

THE EDISON SWAN ELECTRIC CO. LTD.
QUEEN VICTORIA ST., LONDON, E.C.4

EDISWAN VALVES

The first valve ever made, was produced in the Ediswan laboratory

An interesting study of early wireless history may be made at the Science Museum, South Kensington, London, where the complete series of Dr. Fleming's experimental valves can be seen.



Good reception at minimum expense and without trouble is the aim of all. Complete satisfaction will result from using an M.H. Receiver as employed in every quarter of the Globe owing to their reliability, ease of operation and moderate cost.

TWO-VALVE BROADCAST RECEIVER

An excellent and highly efficient set suitable for all reception purposes is now offered to the public, and the home in which one of these is installed will be able to thoroughly enjoy the excellent entertainments supplied by not only British Broadcasting Stations, but also those of our Continental neighbours.



The general appearance of the set is compact and pleasing. All Fittings are lacquered, the panel is of highly polished ebonite and all controls are clearly engraved. The containing cabinet is of polished mahogany, highly finished.

PRICE £15. Marconi Royalty 25s.

L.M. MICHAEL LTD

IN CONJUNCTION WITH B. HESKETH LTD

Radio Corner, 179, Strand, London, W.C.2

Barclays 362

It will pay you always to watch WIRELESS WEEKLY Advertisements.

BATTERY PROTECTION

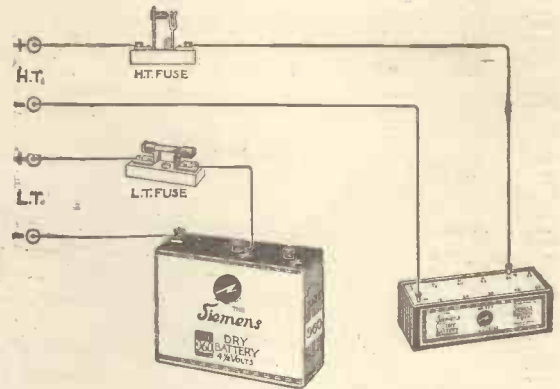

"In commercial installations it is the invariable practice to ensure that any electric battery installed is adequately protected by suitable devices which will immediately break the battery circuit in the event of an excessive discharge taking place. Unfortunately, this precaution is one which is seldom observed by the Wireless Amateur and, until he is confronted with a useless battery, the need for such protective devices is not sufficiently realised. The provision of suitable fuses is quite a simple matter and the initial cost of them comparatively small. On pages 19 and 20 of this Catalogue we illustrate and describe our Fuse Q.2875 for protecting the filament (L.T.) battery and Fuse Q.2890 for protecting the anode (H.T.) battery. When ordering the L.T. Fuse Q.2875 it is desirable to specify the maximum current which the fuse will be called upon to carry safely.

"The fuses are mounted on porcelain bases which may be affixed to any convenient woodwork. The fuses should preferably be inserted in the positive connecting lead from the respective batteries to the receiving set; but in cases where separate tappings are taken from the H.T. battery, the fuse for this battery may be connected in the negative lead.

"A suitable wiring diagram is shown above."

Extract from our Catalogue 595, a copy of which will be sent on application.

Advertisement of Siemens Brothers & Co., Ltd.,
Woolwich, S.E.18.

Trans-atlantic and other short wave reception calls for Igranic control

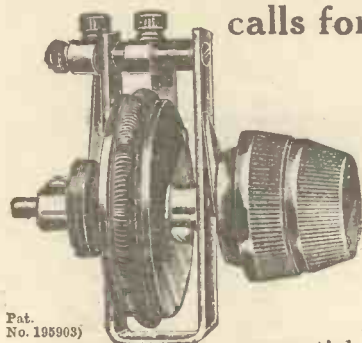

Pat. No. 195903)

IGRANIC Filament Rheostat (Vernier Type).
The perfect "control" for Dull Emitter Valves operated by 2-volt battery and Bright Emitter Valves with 4 or 6 volt battery. Supplied with 4, 6, 8, or 10 ohms resistance. Price, with fixing screws and drilling template 7/- for panel mounting

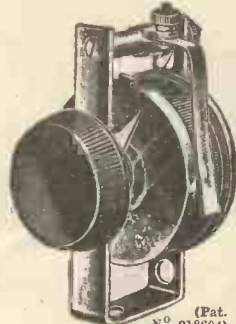

(Pat. N.º 218604)

IGRANIC Filament Rheostat for Dull Emitter Valves.
This 30-ohm type rheostat has been designed for controlling all types of Dull Emitter Valves. Suitable for controlling up to four valves according to the type of valve used. Current carrying capacity 0.4 amp. Price, with screws and drilling template 7/- for panel mounting



(Pat. No. 223981)

IGRANIC Auxiliary Rheostat for Dull Emitter Valves (25 ohms).
For joining in series with existing rheostats to obtain additional resistance for the control of Dull Emitter Valves. A hole is provided at one end to pass over the terminal of the rheostat, and at the other end is fitted an adjustable clip with terminal. Any value of additional resistance up to 25 ohms may therefore be obtained. Easy to fit. No further control required. Price 1/3

Owing to the very small wave-band occupied by the short wave length transmission of the Trans-atlantic stations KDKA and WGY and amateur experimentalists, extremely accurate tuning is essential, particularly in the aerial circuit. Short wave reception therefore calls for use of the most precise instruments. Because Igranic engineers, specialists in electrical control devices for many years, now give their wealth of experience to the building of wireless "control" devices — you should look for this mark :



upon the components you build into your receiver.

Igranic Radio Devices include

- Honeycomb Coils
- Filament Rheostats
- Intervall Transformers
- Variometers
- Vario Couplers
- Bi-plug Coil Holders
- Tri-plug Coil Holders
- Battery Potentiometers
- Vernier Friction Pencils
- Electric Soldering Irons etc., etc.

All carry a six months' guarantee.

All reputable dealers carry stocks.

Write for List Y42.

IGRANIC ELECTRIC CO., LTD.,
149, Queen Victoria Street, London.

Works : BEDFORD.

Branches at :
BRADFORD CARDIFF BIRMINGHAM
GLASGOW MANCHESTER NEWCASTLE



Fellows Coils. For all purposes. Standard non-reversible pin contacts, 4/8 to 10/-



Switch Arms. As illustrated 2/6 each.



Filament Resistances 5 ohms for Panel or Cabinet Mounting. 3/-

Fellows' components



Low Frequency Intervall Transformer. Accurate and distortionless 20/- each.



The Fellotone. For varying and improving the tone of a Loud Speaker, 15/- complete for 2,000 and 4,000 ohms Speakers only.



Variable Condensers For Panel Mounting. Highly finished with Ebonite bevelled dial as illustrated.

Variable Condensers Capacities 0-00006 to 0-001 mfd. Prices 6/8 to 20/-.

Whether you are constructing a set to last you five years, or just wiring up a "freak" experimental circuit for the evening you cannot afford to use anything but the best and most reliable components.

In many cases the best is also the cheapest and you are sure to find that the wide range of Fellows components will suit both your set and your purse.

The Fellotone condenser will improve Loud Speaker reproduction considerably and the Intervall transformer is really distortionless. In fact, switch arms, filament resistances or variable condensers, they are one and all true examples of the well-known Fellows policy of

Quality Apparatus at Low Cost.

Stands 1 and 22, British Wireless Exhibition, White City.



B.T.H. Headphones

WE couldn't improve the technical qualities of B.T.H. Headphones. They were and are perfect in tone, clarity and volume. We have, however, embodied a great many constructional improvements in the latest pattern, which make it the most comfortable and convenient instrument of its kind. Here are some of the more important features of the new B.T.H. Headphones:—

Weight, with cord, only 9½ ozs.

No hair-catching projections.

No "scissors" movement of headbands.

Adjustable to any head by a single movement, without the manipulation of screws or nuts.

No screws or nuts employed in construction, and therefore nothing to work loose.

Minimum number of separate parts.

Body of ear-piece made of non-resonating material.

Diaphragm rigidly clamped around periphery between surfaces of non-resonating material.

Permanent magnets are really permanent and are not affected by lapse of time or external changes of polarity.

B.T.H. Headphones are unequalled for sensitiveness, volume, comfort and appearance.

Price 25/ per pair

(4000 ohms.)

*Obtainable from all
Electricians & Radio Dealers*

Advertisement of The British Thomson-Houston Co. Ltd.
Crown House, Aldwych, London, W.C.2



It will pay you always to watch WIRELESS WEEKLY Advertisements.

Do this for increased Volume and Clarity



JUST take out your last L.F. stage valve and insert a Mullard D.F.A. MASTER VALVE. You will be delighted with the immediate increase in volume and clarity from your loud speaker. The special construction of these Master Valves gives powerful and pure amplification and yet requires *LESS* current than your present valves.

If you use a 4-volt battery

ASK FOR A MULLARD D.F.A.0 - - Price 30/-

If you use a 6-volt battery

ASK FOR A MULLARD D.F.A.1 - - Price 35/-

Leaflet V.A.3 gives full technical information. Obtainable from all wireless stores, electricians, ironmongers, etc. Avoid accidents to your valves by using the Mullard Safety Disc, free on request from your dealer. Send us his name and address if you cannot get what you want.

Mullard

THE • MASTER • VALVE

Advt.—The Mullard Radio Valve Co. Ltd. (W.W.) Nightingale Works, Nightingale Lane, Balham, S.W.12

It will pay you always to watch WIRELESS WEEKLY Advertisements.

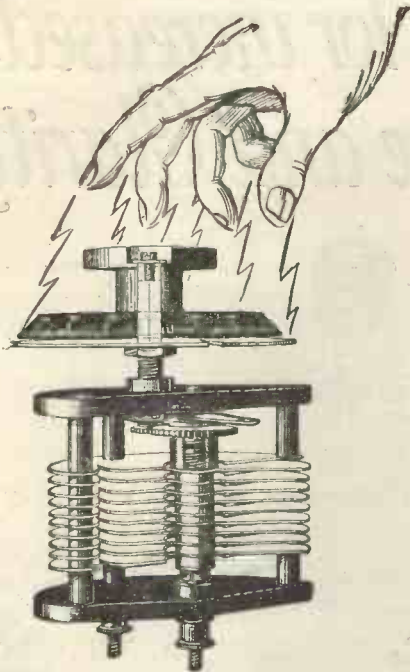

FINE TUNING

There are three main reasons why the "Fulstop" variable condenser gives fine tuning. First, as it is a square law condenser, the stations are spaced evenly round the dial with wide gaps between each station; second, because the dial is geared two to one to the moving plates and the dial turns completely round to move the plates 180°; and third, because with the "Fulstop" all hand capacity effects are completely eliminated.

The "Fulstop" variable condenser is the only one which actually guarantees the abolition of hand capacity.

Read what "Modern Wireless" says:

"We can strongly recommend this type of geared condenser for careful tuning and for use in situations where hand capacity effects are troublesome." October, 1924.

Prices { .001 13/6 .0003 10/3
 .0005 11/3 .0002 9/6

Protected throughout the World.

Stocked by most Wireless Dealers, but if you have any difficulty send direct to

J. H. NAYLOR Ltd. Central Brass Works, WIGAN.



It will pay you always to watch WIRELESS WEEKLY Advertisements.

THE NEW "DEXTRAUDION"

DULL EMITTER

PRICE 21/-

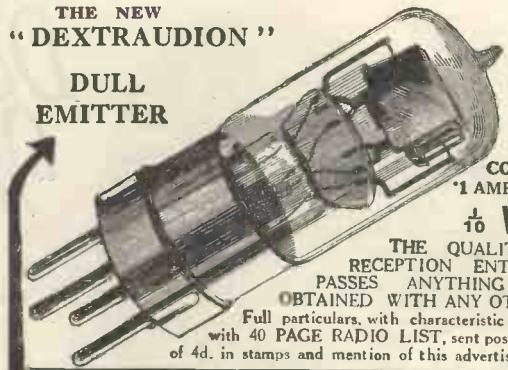

MAXIMUM CONSUMPTION 1 AMP. AT 1 VOLT.

1/2 WATT!

THE QUALITY OF THE RECEPTION ENTIRELY SURPASSES ANYTHING HITHERTO OBTAINED WITH ANY OTHER VALVE.

Full particulars, with characteristic curves, together with 40 PAGE RADIO LIST, sent post free on receipt of 4d. in stamps and mention of this advertisement.

ECONOMIC LTD. Head Office: 10, FITZROY SQUARE, LONDON, W.1. Showrooms: 303, EUSTON RD. N.W.1

REGENERATION IN THE DETECTOR CIRCUIT.

The damping effect of a grid leak having the wrong value is an experience which has to be tried to be fully understood. Damping in circuits where Detector Valve Regeneration is employed does actually destroy, or rather counteracts, the gain in signal strength secured by regeneration.

Ability to adjust grid leak resistance to just the correct proportion for the full employment of regeneration is only possible with a VARIABLE GRID LEAK. By working the detector valve on the correct portion of the curve for perfect rectification—AND HERE A VARIABLE GRID LEAK IS INDISPENSABLE—the detector valve may be sufficiently controlled to give maximum signals without any possibility of the rectifier tipping the set into self-oscillation. CHOOSE ALWAYS A WATMEL. IT GIVES DELICATE CONTROL. BUT BE SURE YOU FIT A



are now fitted with a spring contact on the control ensuring good electrical connection.

All goods of our manufacture bear this mark. It is your only guarantee

IMPORTANT NOTICE to intending purchasers



Patent 206098

5 to 5 Megohms ... 2/6
 50,000 to 100,000 Ohms. 3/6
 Other Resistances to suit any circuit.

Send P.C. for Descriptive Folder. SEE THE TRADE MARK

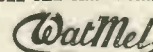

ON EVERY GRID LEAK. BEWARE OF IMITATIONS.

The Watmel Wireless Co. wish to notify the trade and public that their Variable Grid Leak Patent Application No. 206098 was contested in the Comptroller's Court, and on Appeal; in both instances the Patent Grant was upheld and costs awarded.

It is the aim of this Company to protect traders', customers', and also its own interests by securing Patent protection for the novelties in its specialities, as it is these novelties, invented by experts and exhaustively tested, which are the Hall Mark of all Watmel Products.

THE WATMEL WIRELESS CO. 332a, Goswell Road, London, E.C.1.

Telephone - - - - - CLERKENWELL 7990.

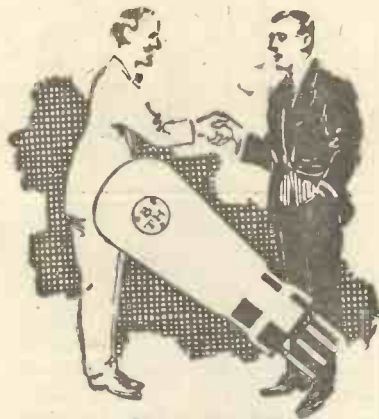

Where Expert & Amateur agree

GENERAL PURPOSE VALVES:

Type R. ... 12/6 each

Filament Voltage.....4 volts
 Filament Current.....0.7 amp.
 Maximum plate voltage...100 volts
 Plate resistance.....27,000 ohms.

Type B 3 ... 21/- each

Filament voltage.....1.8 volts
 Filament current.....0.35 amp.
 Maximum plate voltage...80 volts
 Plate resistance.....27,000 ohms.

*Type B5. ... 25/- each

Filament voltage.....2.8-3 volts
 Filament current...0.06 amp. (at 3 v.)
 Maximum plate voltage...80 volts
 Plate resistance.....17,000 ohms.

POWER AMPLIFYING VALVES:

Type B4. ... 35/- each

Filament voltage 5-6 volts
 Filament current...0.25 amp. (at 6v.)
 Maximum plate voltage...120 volts
 Plate resistance 6,000 ohms.

*Type B6 ... 35/- each

Filament voltage.....3 volts
 Filament current.....0.12 amp.
 Maximum plate voltage...120 volts
 Plate resistance 9,000 ohms.

*Type B 7 ... 37/6 each

Filament voltage.....6 volts
 Filament current.....0.06 amp.
 Maximum plate voltage...120 volts
 Plate resistance 9,000 ohms.

*For use with Dry Cells



The test reports of experts in the technical journals, and the verbal and epistolary comments of amateurs all over the country, alike testify to the marked superiority of B.T.H. Valves. The three B.T.H. "general purpose" valves give better results in any position in the circuit than many valves designed and recommended for a single function only; while the three "power" valves are unequalled for L.F. amplification.

USE B.T.H. VALVES AND GET
 "EXPERT" RESULTS.

From all Electricians and Radio Dealers

B.T.H. RADIO VALVES

Advertisement of The British Thomson Houston Co. Ltd.

215

It will pay you always to watch WIRELESS WEEKLY Advertisements.

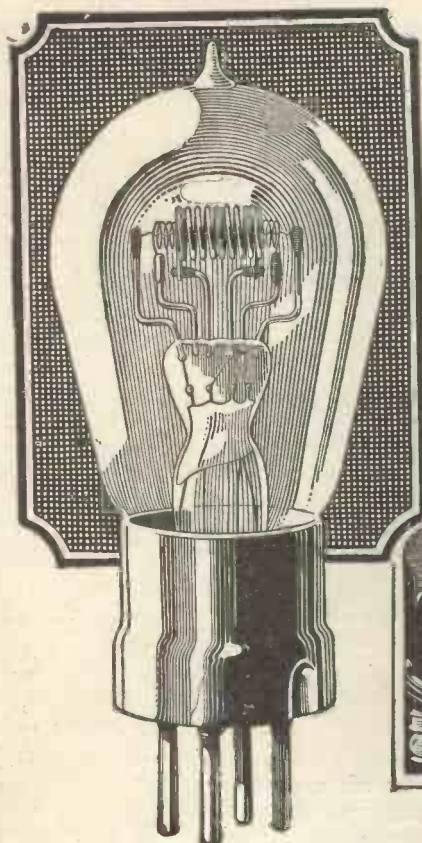

Louden



The Secret

10/-

Magicians and Sorcerers had their "Secrets of Healing" and "Secrets of Success," which they would dispense for a consideration, but in these less romantic times success is more apt to be won on sheer merit.

Take the case of the Louden Valve. Four months ago it was unheard of—to-day there are thousands of enthusiastic "slaves of the lamp" who will never go back to the old type of valve.

Why? Well, because however you consider the Louden Valve it is a sound investment.

It costs only ten shillings. It takes so little current that your accumulators will last twice as long as they do with ordinary

bright filament valves, and in spite of the fact that the anode is "full of holes" volume is, if anything, above the normal, showing that a full use is made of the electron stream.

It is the *unwanted* charges that escape through the turns of the anode, and strangely enough this is precisely what we intend to happen.

It gives a silver clear reproduction which is the delight of all who have heard it, and the life of the filament is exceptionally long.

So naturally the Louden is outstripping all other valves in popularity.

There is no secret—only merit.

Louden
VALVES



The Plain Louden for Detecting and Low Frequency Amplifying.

The Blue Louden for H.F. Amplification.

Filament Volts ... 4.8-5

Filament Amps... 0.4

Anode Volts ... 40-80

FELLOWS
WIRELESS

Manufactured throughout in Great Britain.

All Loudens are silver clear and free from mush. The current consumption is very low and the life long.

Louden Valves - Silver Clear



21/-

TRUE MUSIC : MINOR :

"An infinite capacity for taking pains" is still our motto, and never was it better illustrated than in the TrueMusic Minor.

This wonderful little instrument gives ample volume and perfect articulation for all ordinary purposes. Its sensitiveness can be judged from the fact that excellent results have been obtained 6 miles from 2LO on a crystal set.

No illustration can do justice to its appearance. The whole of the outside—horn and base—is finished in nigger brown, and the inside of the horn (which is of copper) is sand-blasted. The wonderfully rich and warm effect of the brown and copper must be seen, to be appreciated.

The TrueMusic Minor is the Loud Speaker for every home.

You can get yours from the nearest dealer. If you have any difficulty write to us direct.

LOUD SPEAKERS

TrueMusic Minor	£1 1 0
TrueMusic Junior	2 10 0
TrueMusic Standard	5 0 0
TrueMusic Concert Grand	6 10 0
T.M.C. Clear as Crystal Headphones	1 2 6

T M C

The Telephone Manufacturing Co., Ltd., Hollingsworth Works, West Dulwich, S.E.21.

E.P.S. 205

It will pay you always to watch WIRELESS WEEKLY Advertisements.

Wireless Weekly Small Advertisements.

3-VALVE DUAL, CABINET SET, complete with Valves, Coils, Brown L.S., Brown Phones and Batteries. £25.—Box A26, Barclays, Bush House, Strand, W.C.2.

HEADPHONE REPAIRS.—Rewound, remagnetised, readjusted. Lowest prices quoted on receipt of telephones. Delivery three days. Est. 26 years.—Varley Magnet Co., London, S.E.18.

TELEPHONE RECEIVERS and Loud Speakers Rewound, 2,000 ohms, 3/6.—A Roberts & Co., 42, Bedford Hill, Balham, S.W.12.

BATY Condenser, High Max., Low Min., High insulation, Min. weight, 5/3 post free. Coil to match, 230/4,000 metres, 6/9 post free. Combined space 4"x1", weight 2 oz. Suitable for all circuits. Technical reprints giving circuits, 1/3 post free. Ernest L. Baty, Luton.

PARTNER or Director required for Involute Helical Inductor Cylinder Generators and Motors, D.C. (Self-commutated) and A.C. Adapted for press tool mass products, suitable all sizes and purposes. Patented in all countries. Great opportunity to obtain large or controlling interest (£5,000 upwards) in British Patent as affecting aircraft and wireless, for which large orders are promised. Invaluable first hand knowledge and experience could be acquired.—Reply to Box A22, "Wireless Weekly," Barclays, Bush House, Strand, W.C.2.

AGENTS Wanted. Wireless valve repair business. Deal with the actual repairers. Lowest trade terms. All types repaired. A hard vacuum guaranteed. Also old valves bought for cash, 6d. each. Cossors 1/- each. M. & G., 60, Churchfield Road, Acton, W.3. Telephone Chiswick 2681

THIS  MEANS IMPROVED **ATHOL** COIL INSULATION

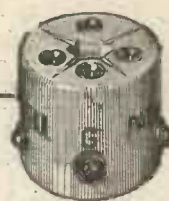

REVERSIBLE VALVE HOLDER
The only single hole fixing holder that fits any set.

1/3 each

For mounting front or back of panels, or on base boards.

We will send goods post free if you mention dealer's name



PORCELAIN COIL MOUNT

With the perfect plug. Will fit any coil.

1/- each

LISTS FREE.

ATHOL ENGINEERING CO.

Cornet Street, Hr. BROUGHTON, Manchester

EL-BE UTILITIES

The "MIKROTUNE" MAKES TUNING SIMPLE & CERTAIN

Reversible Coil-holder.

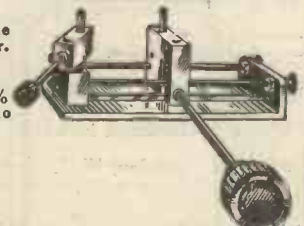

Adds 50% value to any set.

12/6

Coils under minutest control. A Perfect VARIOMETER

Send us the name of your Dealer and we will arrange a demonstration for you.
LEIGH BROS. 37, Sidmouth St., Gray's Inn Rd., LONDON, W.C.1
Telephone: MUSEUM 4192.

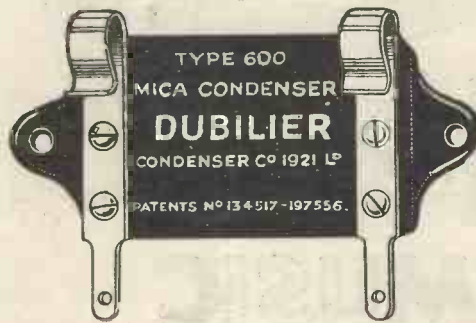

Type 600—For all purposes in connection with receiving apparatus. With or without clips for grid leak.
 0.0001-0.0009 mfd. 2/6 each.
 0.001-0.006 mfd. 3/- each.

Type 600a—As Type 600 but for vertical pane mounting.
 0.0001-0.0009 mfd. 2/6 each.
 0.001-0.006 mfd. 3/- each.

DUBILIER GUARANTEE.

Your only safeguard lies in purchasing the products which carry the guarantee of a firm with a reputation to maintain.

All Dubilier fixed condensers are guaranteed to be within 15% of their stated capacity, and where desired they can be manufactured and guaranteed within still closer limits. The type 600 illustrated here, and the type 600a are practically universal amongst manufacturers of complete sets, whilst experienced home constructors continually assure us that they can feel complete confidence in the working of their sets when—and only when—they have fitted Dubilier Condensers. See that they are in your set as well.



Ducon Works,
 Goldhawk Road,
 London, W.12.

DUBILIER
 CONDENSER CO. LTD

Telephone:
 Riverside 1084
 Telegrams:
 Hivolcon, Phona,
 London.



DUBILIER PRODUCTS

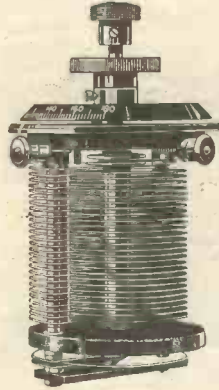

Maximum Capacity.	Price		
	£	s.	d.
0.0003 mfd. ...	0	17	6
0.0005 „ ...	1	0	0
0.0007 „ ...	1	2	6
0.001 „ ...	1	5	0

Ebonite boxes can be supplied at an extra cost of 7/6, 10/- and 12/- according to capacity, Calibration Charts can be supplied at an extra charge of 10/6. All capacities except 0.0003 mfd. can be supplied with Vernier for 2/6 extra.

DECEPTIVE SIMPLICITY.

The apparently simple things in life are frequently the most difficult to achieve.

Riding a bicycle looks easy—until you come to try it for the first time.

There is little apparent difference between the ordinary variable condenser of unknown make and the Vanicon, but when you examine a Vanicon closely several things will strike you.

The plates are accurately and evenly spaced, they are stiff, and will not touch one another.

The spindle turns freely but does not work up and down, causing unexpected variations in capacity, and a fixed pointer is provided just below the dial. The moving plates are joined to their terminal positively by means of a phosphor-bronze strip—not by an uncertain “rubbing contact,” thus good electrical contact is assured *always*.

In fact the Vanicon abounds in instances where our twelve years' experience enables us to offer you a product which has no equal on the market, whatever the price.

Ducon Works,
Goldhawk Road,
London, W.12.

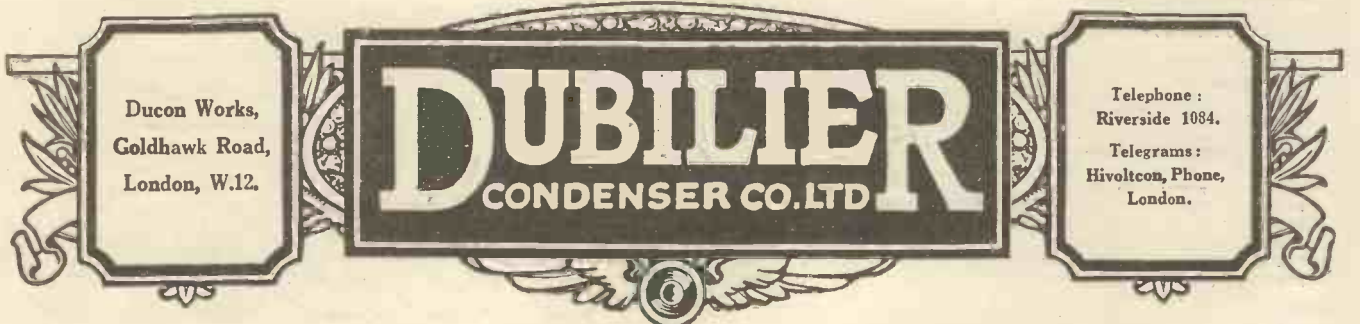

DUBILIER

CONDENSER CO. LTD

Telephone :
Riverside 1084.
Telegrams :
Hivolcon, Phone,
London.

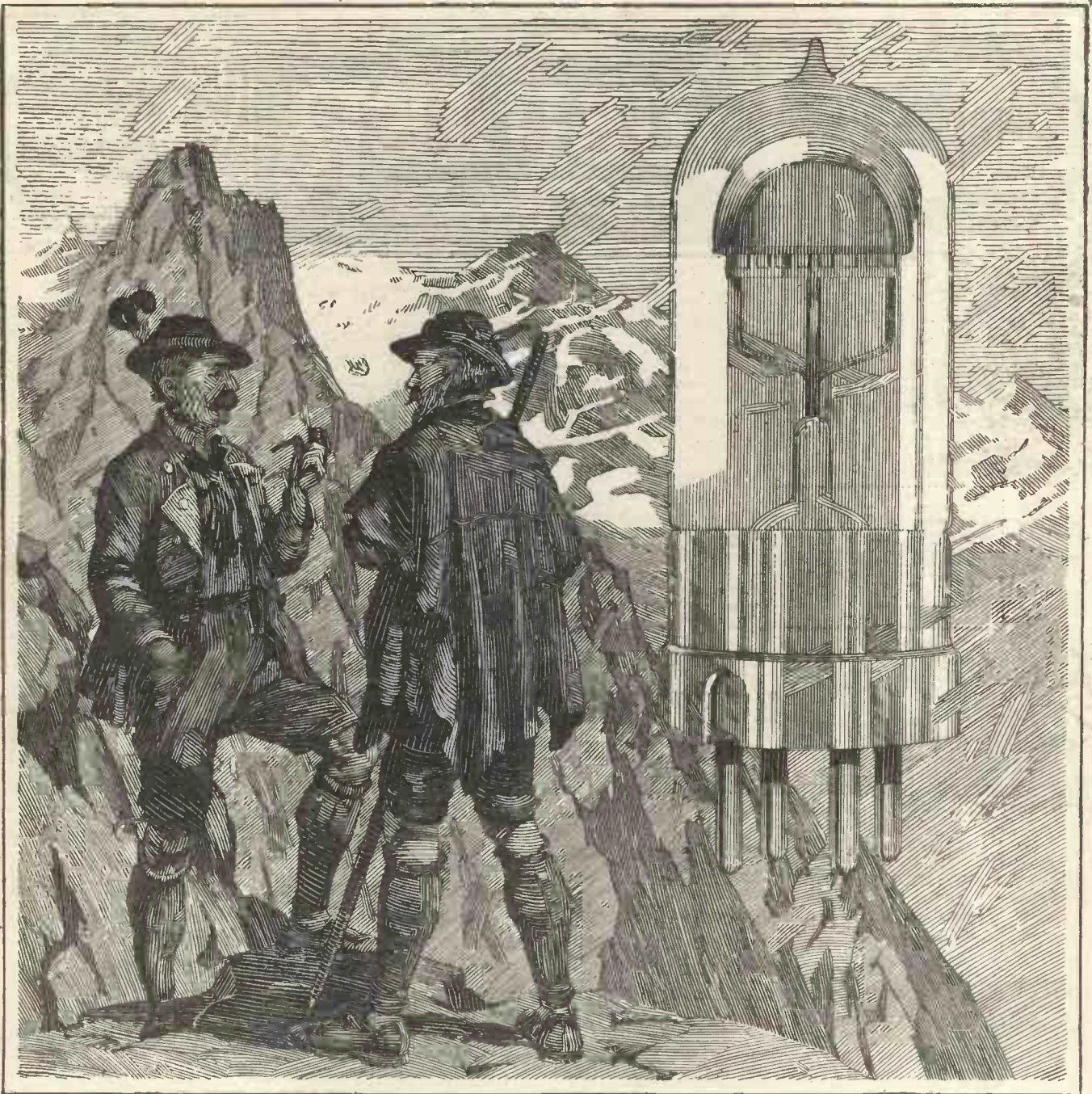

Continental Broadcasting Series No. 3

Broadcasting from Switzerland.

Although using comparatively little power as yet, there are three Swiss Stations that can be readily heard in this country—Zurich, Lausanne, and Geneva. The Broadcasting Station at Zurich transmitting on 650 metres is responsible for an excellent concert programme commencing at 7.15 every evening. Why not tune in? Don't forget to use a Cossor P.2 as the high-frequency amplifying valve.

Cossor

Gilbert Ad. 1825

It will pay you always to watch WIRELESS WEEKLY Advertisements.

That "urge" for distance!

—with the correct valves

WE all know the man who, making his debut as a motor cyclist, declares that he only wants a machine for pottering around the lanes. But see him a few months later really bitten by the germ of motor cycling. His only regret is that his machine is not fast enough.

And so it is with wireless. The man who buys or builds his Crystal Set to-day is the long-distance enthusiast of to-morrow. Sooner or later we all get this tremendous urge for distance. No matter how good the local broadcasting station, we must seek means of tuning it out so that we may pick up a note or two from some station a few thousand miles away.

But with improved designs in Receiving Sets, increased knowledge and better H.F. Valves, long distance reception has changed considerably within the last year or so.

Then, the man who received W G Y was considered an expert; to-day, the man who cannot receive K D K A on two valves is clearly a novice.

After all, long distance reception is more or less a combination of three things: (1) The possession of a Receiver using at least one stage of high-frequency amplification. (2) The patience to learn accurate tuning and (3) The correct type of Valves.

Assuming that you can conform to 1 and 2, all that stands between you and the regular reception of other European Stations as far distant as Zurich, for example, is a Valve definitely designed for high-frequency amplification.

The first, and still the country's accepted standard, was the Cossor P.2, the Valve with the red top. This Valve, incorporating all the features which are rapidly making the name Cossor known throughout the world, the arched filament, the hood-shaped grid and anode, marked an evolution in Valve design.

It broke away from the accepted tradition that every Valve must necessarily be a general purpose valve. Obviously, high-frequency amplification demands very different characteristics to low-frequency amplification. Its success was never in doubt. The instant users inserted a P.2 into the socket, the Set leaped into life. Signals which all the time had been passing unheard were picked up with ease. Stations that were, on favourable occasions, just audible could be received at excellent 'phone strength. But there's no black magic about Cossor superiority. It lies in the design.

Everyone knows that a Valve functions as a result of the electron stream given off by the filament. Increase the stream, within reasonable limits—and signals become louder. Alternatively, decrease the stream and signal strength falls off; as you can easily prove by turning the knob of your rheostat.

Now in the Cossor every possible effort has been made by arching the filament and making it conform to the contour of the grid and anode, to capture those elusive electrons. In the ordinary Valve, on the other hand, an appreciable proportion leaks away from each end of the tubular grid and anode with a resultant loss in efficiency.

Remember, in long-distance reception you are dealing with infinitesimal currents generated some hundreds of miles away. You cannot afford to take risks with inefficient Valves.

Choose the Cossor P. 2—the Valve with the red top—especially designed for the work.

Remember, all Cossor Valves are now sold in sealed boxes. This patented method of packing ensures every purchaser getting a new and unused Valve.

Valves

BRIGHT EMITTERS

Pr₁ for Detector and
L.F. use .. 12/6
P₂ (with Red top), for
H.F. use .. 12/6

WUNCCELL DULL EMITTERS

Model A. (With resistance in
base for use with 2-, 4-, or
6-volt accumulator.)

WR₁ for Detector and
L.F. use .. 23/6
WR₂ (with Red top), for
H.F. use .. 23/6

Model B. (Without resistance,
working direct from 2-volt ac-
cumulator.)

W₁ for Detector and
L.F. use .. 21/-
W₂ (with Red top),
for H.F. use .. 21/-

Gilbert A.d. 1825.

It will pay you always to watch WIRELESS WEEKLY Advertisements.

WIRELESS WEEKLY Advertisements

This simple Connector can be clipped to the end of any lead with a pair of pliers. When pressed on to the terminal perfect contact is immediate and permanent.

Could anything be more simple? One movement does the trick.

No more "Odd man out!"

FOOL-PROOF BATTERY TERMINALS AND CONNECTIONS IN COLOUR are provided as an efficient safeguard against the burning out of valves. Each box contains: 6 Terminal Studs, 6 Multi Connectors, 4 Coloured Connectors, 8 Discs (Black, Red and Blue) printed as follows:—

PHONES + PHONES—
HIGH TENSION + HIGH TENSION—
LOW TENSION + LOW TENSION—
EARTH. AERIAL.

With Instruction for use
PRICE 2/-

NO more waiting for your turn—no more missing the very piece you wanted to hear. As many headphones as your set will stand can be added in a second by means of the Newey "Snap" Terminals. All the family can listen in with a small set and extra visitors can easily be accommodated.

The Newey "Snap" Terminals and Connectors can be used in dozens of ways by the Wireless enthusiast. Despite their absolute simplicity they form perfect contact and have been proved to be both electrically and mechanically perfect.

ASK YOUR WIRELESS DEALER ABOUT IT OR SEND FOR LEAFLET TO-DAY.

See this new device on Stands 10, 11, 12 & 13 at the All-British Wireless Exhibition at the White City, November 15 to 29.

Pettigrew & Merryman, Limited
124, Tooley St., London, S.E.1



H.C.T.

Quality RADIO COIL HOLDERS & COMPONENTS

GAM VERNIER

2 coil holder with reaction reverse switch ... 12/6
without switch 9/-
Postage 4d.
PROV. PROT'D.

LEGLESS VALVE HOLDERS

FOR PANEL WIRING FOR SURFACE WIRING

Is fixed by a single screw in centre, the holder itself acts as a jig for drilling the holes for panel wiring. For surface wiring clamp the wires under the heads of screws. Has safety insulated plate socket. (Prov. Prot'd.)
PRICE 1/6 each, postage 2d.

BASKET COIL HOLDER

1/3 postage 2d.

If your dealer has not got them we send post free if you mention his name and address. LIST POST FREE.

GOSWELL ENGINEERING CO., LTD.,
12a, PENTONVILLE ROAD, LONDON, N.1.
LIBERAL TRADE TERMS. Phone: North 3051.

The KUPPEE

Crystal Detector.

Extremely sensitive adjustment of pressure to give extra loud reception by turning the large knob.

Universal movement here—any degree of tension you wish on ball joint. Sensitive spots quickly found. Once set—stays set. No fiddling about.

Very strongly, heavily built. Many other advantages.

Write for Free Folder at once to:—

QUALITY PRODUCTS 29, WATER ST. HYDE

MANUFACTURERS OF UPEL ACCESSORIES

What users say of the "KUPPEE" Crystal Detector

T.M.A., Aberdeen, writes:—"I am very pleased with same."

S.P.S., Liverpool, says:—"Type A 1 here is very satisfactory." (This gentleman has had two of them.)

D.R.H., Bethnal Green:—"Received the detector safely... more than satisfied... speech distinguishable 3 yards from phones."

REAL RADIO

New apparatus evolved by scientists that will interest you.

A postcard brings you full details of sets and components.

GENERAL RADIO COMPANY

Radio House, 235, Regent St., London, W.1.
Telephone: Mayfair 7152. Telegrams: "Alsenrad, London."

THE BOOKS for Beginners and Experts

The Radio Press Series.

- | No. | | Price |
|-----|--|-------|
| 1 | Wireless for All | 5d. |
| | By John Scott-Taggart, F.Inst.P.,
A.M.I.E.E. | |
| 2 | Simplified Wireless | 1/- |
| | By John Scott-Taggart, F.Inst.P.,
A.M.I.E.E. | |
| 3 | How to Make Your Own Broadcast
Receiver | 1/6 |
| | By John Scott-Taggart, F.Inst.P.,
A.M.I.E.E. | |
| 4 | How to Erect Your Wireless Aerial... .. | 1/- |
| | By B. Mittell, A.M.I.E.E. | |
| 5 | The Construction of Wireless Receiving
Apparatus | 1/6 |
| | By P. D. Tyers. | |
| 6 | The Construction of Crystal Receivers | 1/6 |
| | By Alan L. M. Douglas. | |
| 7 | How to Make a "Unit" Wireless
Receiver | 2/6 |
| | By E. Redpath. | |
| 8 | Pictorial Wireless Circuits | 1/6 |
| | By Oswald J. Rankin. | |
| 9 | Wireless Valves Simply Explained... .. | 2/6 |
| | By John Scott-Taggart, F.Inst.P.,
A.M.I.E.E. | |
| 10 | Practical Wireless Valve Circuits | 2/6 |
| | By John Scott-Taggart, F.Inst.P.,
A.M.I.E.E. | |
| 12 | Radio Valves and How to Use Them | 2/6 |
| | By John Scott-Taggart, F.Inst.P.,
A.M.I.E.E. | |
| 13 | 500 Wireless Questions Answered | 2/6 |
| | By G. P. Kendall & E. Redpath. | |
| 14 | 12 Tested Wireless Sets | 2/6 |
| | By Percy W. Harris. | |
| 15 | More Practical Valve Circuits | 3/6 |
| | By John Scott-Taggart, F.Inst.P.,
A.M.I.E.E. | |
| 16 | Home-Built Wireless Components | 2/6 |
| | By E. Redpath. | |
| 17 | Wireless Sets for Home Constructors | 2/6 |
| | By E. Redpath. | |
| 18 | Tuning Coils and How to Wind Them | 1/6 |
| | By G. P. Kendall, B.Sc. | |

RADIO PRESS PANEL CARDS.

- | | | |
|---|--------------------------------------|-----|
| 1 | How to Make the W.I. Receiver | 1/- |
| | By Herbert K. Simpson. | |

SIMPLEX WIRING CHARTS.

- | | | |
|---|------------------------|-----|
| 1 | For 2-Valve Set | 1/- |
| 2 | For 3-Valve Set | 1/- |
| 3 | For 4-Valve Set | 1/- |

RADIO PRESS WIRELESS PANEL TRANSFERS 6d

* "MODERN WIRELESS" COIL TABLE for Aerial, Anode and Re-action Coils 6d.

RADIO PRESS ENVELOPES.

- | | | |
|---|---|-----|
| 1 | How to Build an S.T.100 Receiver | 1/6 |
| | By John Scott-Taggart, F.Inst.P.,
A.M.I.E.E. | |
| 2 | How to Build a 4-Valve Receiver | 2/6 |
| | By Percy W. Harris. | |
| 3 | How to Build the "Simplicity"
3-Valve Set | 2/6 |
| | By G. P. Kendall, B.Sc. | |
| 4 | How to Build the All-Concert-de-Luxe
Receiver | 2/6 |
| | By Percy W. Harris. | |
| 5 | How to Make a 1-Valve Reflex
Receiver | 1/6 |
| | By Herbert K. Simpson | |
| 6 | How to Build an Efficient Single
Valve Set | 1/6 |
| | By Herbert K. Simpson | |

The Radio Press Envelopes are the most complete guide to wireless construction ever devised. They contain exact size panel and wiring blue prints, complete working drawings, sheets of instructions regarding construction and working, lists of components, and many photographs on beautiful art paper showing the set and wiring from every possible angle. Every possible detail is explained and you cannot go wrong.

* Just Published.

Any of the above publications can be obtained from principal wireless dealers and through any bookseller—or direct (plus 2d. postage, or, on Radio Press Envelopes 3d.) from

RADIO PRESS LTD.

BUSH HOUSE, STRAND,
LONDON, W.C.2.

Barclays Ad.



Illustration showing the horn of a Brown Loud Speaker being sprayed with enamel.

From first to last a wonderful Loud Speaker—

MANY people hearing the small Brown H.2 Loud Speaker are amazed at its volume. They think—quite naturally—because it is small in size that its volume is likely to be insufficient for a room of average size. On the contrary, by actual comparative test it is easy to prove that a small Brown Loud Speaker gives greater volume—and certainly incomparably better tone—than many other Loud Speakers twice its size.

The secret of its success lies in the tuned reed principle of reproduction used in conjunction with a cone-shaped aluminium diaphragm.

When it is possible to buy a genuine Brown high-resistance Loud Speaker for as little as 50/- is it worth while to prejudice your enjoyment by purchasing one which cannot approach it either for volume or tonal purity?

Remember that from first to last the H.2 is manufactured under strict Brown supervision—the actual tests that it must pass before being released for issue are stringent and exacting. You may be sure that the one that you buy must have actually conformed to the Brown standard of richness of tone and adequate volume.

S. G. BROWN, Ltd.,
Victoria Road,
N. Acton, W.3.
Showrooms:
19, Mortimer Street, W.1.
15, Moorfields, Liverpool.
67, High St., Southampton.

Prices and Types.		
Type H.1. 21 in. high:		Type H.2. 12 in. high:
120 ohms £5 5 0		120 ohms £2 5 0
2,000 ohms £5 8 0		2,000 ohms £2 8 0
4,000 ohms £5 10 0		4,000 ohms £2 10 0
Type Q. (in all resistances) £15 15 0		



Gilbert Ad. 1830.

It will pay you always to watch WIRELESS WEEKLY Advertisements.

MELLOWTONE VARIABLE H.F. TRANSFORMERS OR TUNED ANODE WITH REACTION

FOR
Mr. John Scott Taggart's Circuits, etc.
(See "MODERN WIRELESS" and "WIRELESS WEEKLY.")

Reg.



Design.

PRICES.

100- 300 METRES	- -	5/6) Postage 4d.
250- 600	" -	5/6	
600-2000	" -	7/6	
1200-3500	" -	10/6	

WOUND FOR EITHER PURPOSE.

TUNE WITH .0005 SQUARE LAW CONDENSER.

**SAVES MONEY, PANEL SPACE & LOOSE WIRES.
PLUGS INTO STANDARD VALVE HOLDER.**

FROM YOUR DEALER or DEPT. W,

Midland Radiotelephone Mfrs. Ltd.

Brettell Lane Works, STOURBRIDGE.

RESULTS

Not only do maximum results accrue from advertisements in the WIRELESS WEEKLY, but, far more important still is that its readers embrace the section that buys on the spot. You therefore get the twofold advantage of immediate and direct results to your advertisement. Write for particulars of this and other Radio Press Publications to the Advertisement Managers.

BARCLAYS ADVERTISING, Ltd.
Advertising Consultants & Contractors,
Bush House, Strand, London, W.C.2.
Telephone: City 9911 (Extn. 9).

"MORRIS" Solid Oak Standard Cabinet,
with lock,
for any kind of receiver. Bottom cupboard with lock. Height 3 ft. 6 in., width 2 ft., depth 15 1/2 in. Back panel removable. Further particulars on application. Price £3 10 0. Part Carriage and Packing 7/6 extra. **SOLID OAK WIRELESS TABLE,** with large drawer and bottom shelf for accumulator, length 25 in., width 16 in. 27/6 Carriage paid.

M. VERSTRAETEN (Dept. 5),
Melvill Chambers, 50a, Lord Street, Liverpool.

CHALLENGE CRYSTAL SETS

No. 40. A new Radiax production. Designed and built on entirely new principles, it is the result of much experiment and test, our object having been to obtain the utmost power of which a crystal set is capable. Range 300 to 500 metres. Price £2/2/-.

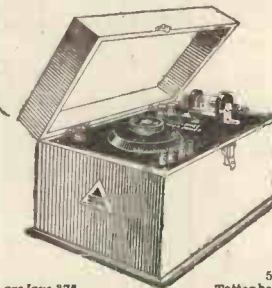

No. 41 LONG WAVE
(100-1,600 metres). Uniform with No. 40, but incorporates the Radiax Universal principle and enables, by means of a switch, perfect results to be obtained on the lower wave band or on the new 1,600 metre High Power Station. Price £2/10/-.

Write for List of full range of Radiax Universal Receivers, 1, 2, 3 & 4 values. Complete or for Home Construction.

RADIAX, LTD. RADIAX

50, Radio House, Percy Street, Tottenham Court Road, LONDON, W.1. **WE SATISFY YOU**

B are tags 375.

REPAIRS TO HEADPHONES TO LOUD SPEAKERS TO COILS

REWOUND to any RESISTANCE & MADE EQUAL to NEW. PRICE QUOTED ON RECEIPT OF INSTRUMENTS. PROMPT DELIVERY.

The VARLEY MAGNET COMPANY
Pl. one: Woolwich 883. WOOLWICH, S.E.18.

Established 26 Years.

CAB NETS YOU WANT

PICKETT'S Insulated Cabinets—for 100% results. From 1/6 each, highly polished. All designs and sizes. "MADE for CONSTRUCTORS." Write now for Constructors' Lists Free. PICKETT'S Cabinet (W.L.) Works - Bexleyheath, S.E.

Radio Press Information Dept.
2/6 QUERY COUPON 2/6

WIRELESS WEEKLY. Vol. 3 No. 6. November 26, 1924.
This coupon must be accompanied by a postal order of 2/6 for each question, and a stamped addressed envelope.

ADVERTISERS—like the public
appreciate the value of Radio Press Publications.

A REMINDER Instructions, Copy and Blocks for WIRELESS WEEKLY should reach us every Monday for following week's issue.

MODERN WIRELESS:—December 14th is the Latest Date for instructions, copy and blocks for the JANUARY 1925 ISSUE.

All instructions to Advertisement Managers:
BARCLAYS ADVERTISING, LTD.
BUSH HOUSE, STRAND : : LONDON, W.C.2.



Don't worry
it out yourself
-let an expert
help you

PERHAPS you have built a Set and you cannot get it to work—don't worry, let a Radio Press expert help you. Probably you have made some little slip in the Circuit—maybe you have mis-read the wiring instructions. All you need is a copy of

Pictorial Wireless Circuits

By Oswald J. Rankin.

(Radio Press Series No. 8.)

This Book contains scores of different Circuits, each one of which is shown in pictorial form instead of the more technical diagrammatic manner.

Thousands of beginners have bought it and have been able to appreciate for the first time how easy it is to wire up a Set when the Circuit diagram is understood.

No matter which type of Set you are building, whether Crystal or multi-valve, and whichever type of tuning you will use, variometer or plug-in coils, you will find a wide variety of practical circuits shown in a manner even the veriest novice can readily understand.

From all Booksellers or sent post free 2d. extra direct from Publishers. **1/6**

Radio Press Ltd
Publishers of Authoritative Wireless Literature
BUSH HOUSE, STRAND, W.C.2.

G. A.

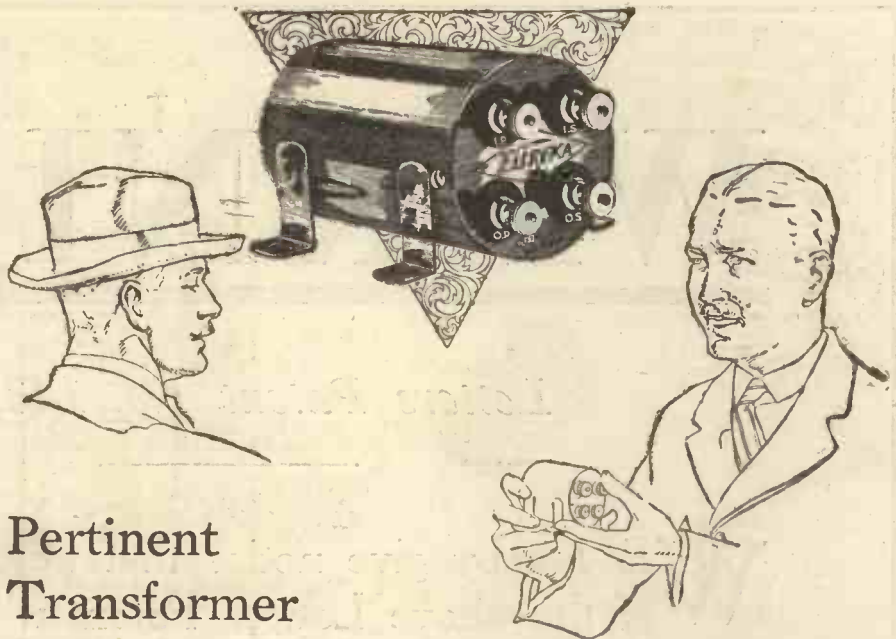

Pertinent Transformer facts

DO you know that there are two methods in use for obtaining volume from L.F. Transformers? One economises in wire by using a high step-up ratio between primary and secondary windings. The other utilises a very low step-up ratio and extremely massive coils. The former is adopted in cheap Transformers but the latter is the method employed in the Eureka. Of course, it costs very much more, but the results are incomparably better and entirely free from distortion.

* * *

Do you know that most Transformers break down owing to the frequent surges of current which find out the weak spot in the soldered joints of the secondary winding? The wire used in the Eureka is absolutely joint-free and therefore more expensive to buy. But it is well worth it, because it permits the Eureka being guaranteed indefinitely against breakdown as against others carrying only a 12 months' guarantee.

* * *

Do you know that two Eureka Transformers can be clamped together without the possibility of interaction? This proves the exceptional efficiency of its design. In reflex Sets such as the ST100 this is an immense advantage.

* * *

Do you know that a Eureka can be immersed in water for a fortnight without harm? No other Transformer in the world could withstand such a drastic test. Obviously such super-insulation qualities will enable the Eureka to stand up to ordinary conditions of use with ease.

Sold by all Dealers and manufactured only by
PORTABLE UTILITIES CO., LTD.
7 & 8, Fisher Street, LONDON, W.C.1
Scottish Agents: FULLER, BLACKIE &
RUSSELL, LTD., 30, Gordon St., Glasgow.

Made in two types
Concert Grand ... 30/-
Eureka No. 2 .. 22/6
(For second stage.)

*Transformer
De Luxe*



Gilbert Ad. 1836

It will pay you always to watch WIRELESS WEEKLY Advertisements.

WARNING

Letters Patent No. 143583.

WE hereby give notice that we are the owners of the above Letters Patent which is the basic patent covering the double detection or 'Supersonic' method of wireless reception and apparatus and circuit arrangements therefor.

The Trade and Public are hereby warned against any or all infringements of this patent whether resulting from the manufacture, sale or use of wireless sets embodying this invention in this country or the sale and use of such sets imported from abroad.

Traders and the Public must bear in mind that the sale or use in this country of one of these infringing sets renders the seller or user liable to action equally with the unlicensed manufacturer and importer.

Western Electric Company Limited.
CONNAUGHT HOUSE, ALDWYCH, W.C.2.



CONFIDENCE AND SKILL

THE classical example of supreme confidence is that of William Tell's son. He trusted his father's aim because he knew his skill.

Such is the confidence of the wireless public in Radio Press sets. They know each set is guaranteed. They read the dozens of letters praising the sets and they know that they can proceed to construct without fear of disappointment.

That is why Radio Press Ltd. are the largest wireless publishers in the world.

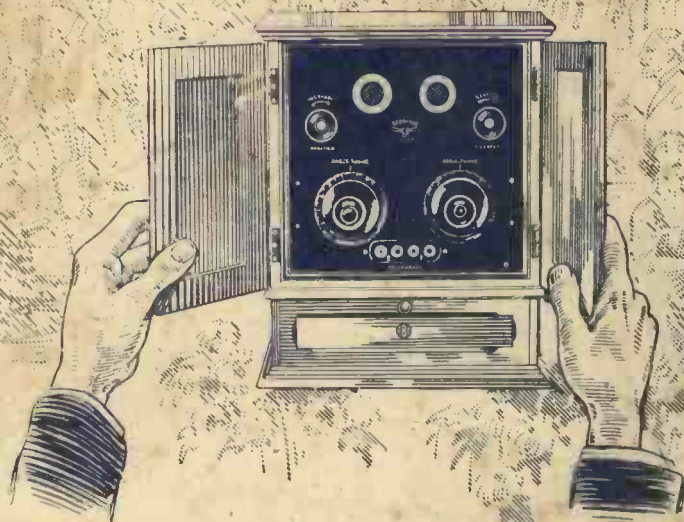

Open the doors to a world of music

November days—long dark evenings—what a comfort radio is! Music, song, speech and news hour after hour. Never a dull moment!

A crystal set is good but so limited. A two-valve set opens up an infinitely wider range of enjoyment well worth the extra cost.

This Sterling Two-valve Receiver brings all British broadcasting favourably situated at headphone strength—

The Sterling Two-valve Receiver illustrated above, is supplied complete with valves, one pair of Sterling Headphones, high tension battery and an accumulator. **PRICE £20**

STERLING TWO-VALVE Long Range RECEIVER

at your radio dealers

Advt. of **STERLING TELEPHONE & ELECTRIC CO., LTD.**

Manufacturers of Telephones and Radio Apparatus, etc.

Telephone House, 210-212 TOTTENHAM COURT ROAD, LONDON, W.1

Works: Dagenham, Essex

other Sterling Receivers

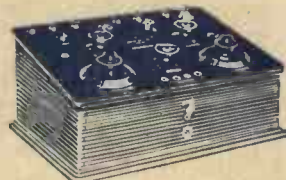

STERLING "ANODION" RECEIVERS

Designed to meet the demand for instruments less expensive than the standard cabinet type. In conjunction with Sterling Headphones or Sterling Loud Speakers, the "Anodion" receivers give the best possible reception of everything broadcast. They are perfectly simple to work and inexpensive to maintain.

"Anodion I" (1 valve)
£7 : 7 : 0

"Anodion II" (2 valves)
£9 : 9 : 0

"Anodion III" (3 valves)
£15 : 15 : 0

"Anodion IV" (4 valves)
£21 : 0 : 0

All accessories extra.

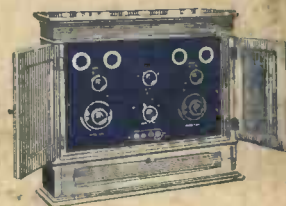

STERLING FOUR-VALVE Long Range RECEIVER

This fine instrument will receive broadcasting over a very wide range and will give excellent loud speaker reproduction within reasonable distance of a broadcasting station. The set comprises one stage of high (Radio) frequency amplification, a detector, and two stages of low (Audio) frequency magnification, the last consisting of a "Power" valve coupled by means of a Sterling "Power" transformer to give great volume whilst still preserving purity of tone. Normally fitted for receiving B.B.C. transmissions, the set can quickly be adapted for others up to 3,000 metres. Complete with valves, headphones, high tension & grid batteries. **PRICE £40**