

# Wireless Weekly

*Tri-Grid  
Reflex*

Vol. 5.  
No. 4

## CONTENTS

A Transformer Coupled  
Three Valve Receiver

An Interesting Method of  
Stabilising H.F. Amplifiers.

Some Notes on French Valves.

A Tuning-Coil Holder Refine-  
ment.

Supersonic Heterodyne Reception in  
Theory and Practice, Valve Notes,  
Jottings by the Way, Apparatus  
We Have Tested, Correspondence,  
Information Department, etc., etc.

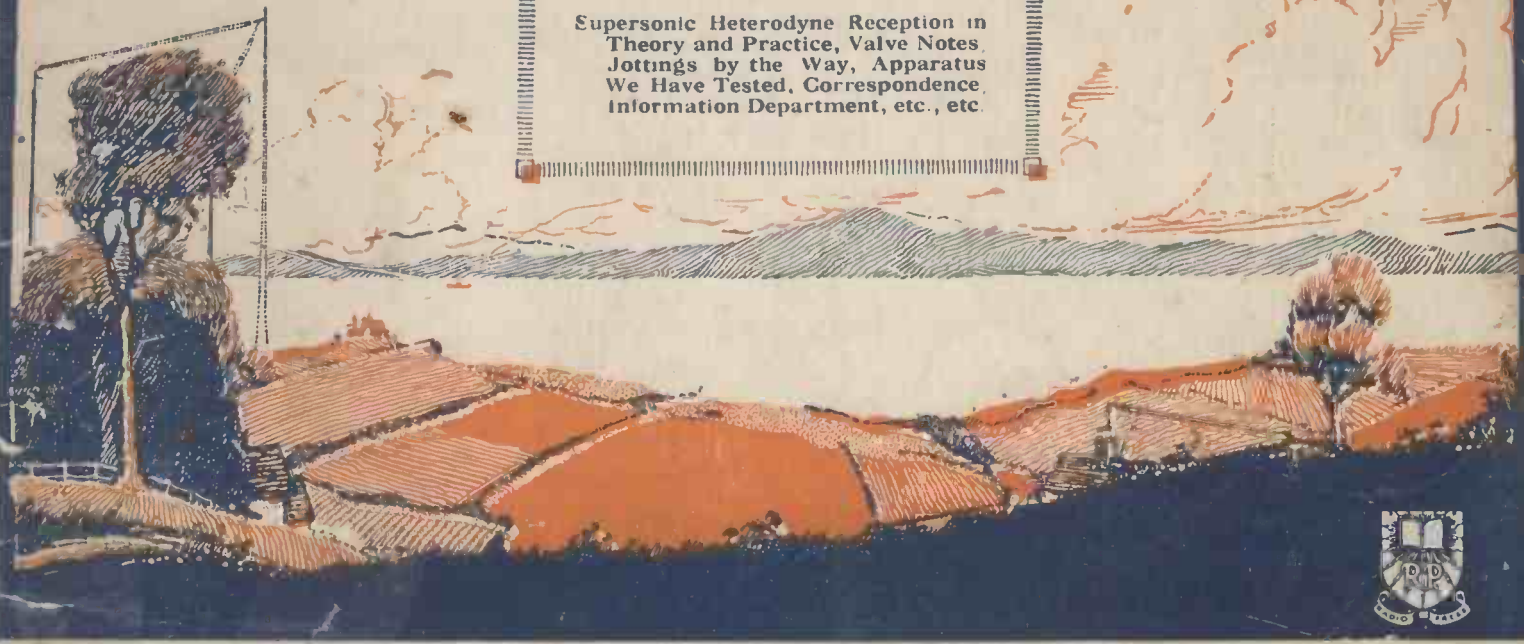

## The Super-Autodyne

By A. D. COWPER, M.Sc.

# A NEW LOUD SPEAKER

## —the Burndept Junior



Though its price is low, the Burndept Junior is *not* a "baby" loud speaker. Its height, from the base to the top of the flair is 19 inches.

### Burndept Junior Loud Speaker

No. 331 : 2,000 ohms resistance.

**£2 15s. 0d.**

**W**HEN cost counts as much as efficiency in the choice of a loud speaker, the Burndept Junior demands first consideration. Its price puts it within the reach of all listeners who are tired of headphones and desire to listen to broadcast the more convenient way—by means of a loud speaker. One should not overlook the fact that the Burndept Junior costs little more than the price of two pairs of good headphones.

On the Burndept Junior, reproduction of speech and music is notable for its clarity and purity, while the volume of sound is sufficient for normal domestic requirements.

As will be seen from the illustration the Burndept Junior is handsomely finished. Made of oxidised metal, its appearance is distinctive. From the inside of the base the position of the magnets in relation to the diaphragm can be adjusted.

Call at the Burndept Agent in your district and arrange to hear and see the Burndept Junior for yourself.

*Purchase Burndept by its name—substitutes are not the same.*

## BURNDEPT

### WIRELESS APPARATUS

BURNDEPT LTD., Aldine House, Bedford St., Strand, London, W.C.2

Telephone : Gerrard 9072.      Telegrams : Burndept, Westrand, London.

LEEDS : 12, Basinghall St. (near City Square).      CARDIFF : 67, Queen Street.

NORTHAMPTON : 10, The Drapery.

Special displays and demonstrations of Burndept wireless apparatus, including the Ethophone-Duplex, are now being held at

**HOLDRON'S**  
Rye Lane,  
PECKHAM, S.E.

Issued by the Publicity Department  
of Burndept Ltd.





# Wireless Weekly

**Radio Press, Ltd.**

BUSH HOUSE, STRAND, W.C.2.  
Tel.—City 9911.

*Assistant Editor:*  
**PERCY W. HARRIS.**

*Scientific Adviser:*  
**Prof. G. W. O. HOWE,**  
D.Sc., M.I.E.E.

*Advisory Editors:*  
**Prof. R. WHIDDINGTON,**  
M.A., D.Sc.  
**Prof. C. L. PORTESCUE,**  
M.A., M.I.E.E.

*Staff Editors:*  
**E. H. CHAPMAN,**  
M.A., D.Sc.  
**A. D. COWPER,**  
M.Sc.  
**R. W. HALLOWS,**  
M.A.  
**G. P. KENDALL,**  
B.Sc.  
**S. G. RATTEE,**  
Member I.R.E.

*EDITED BY JOHN SCOTT-TAGGART, F.Inst.P.,*  
A.M.I.E.E.

## Badges for Good Boys

WE have often referred in critical terms to the activities—or rather the lack of them—of the Radio Society of Great Britain—the leading organisation of experimenters in this country. Perhaps we have been too precipitate in our criticism, perhaps we have been too much influenced by the clamourings of those who have looked in vain for all kinds of feverish activity in this great scientific body. We hasten to apologise to our readers. We had no idea of the immense importance of the great scheme upon which the committee of the Radio Society have been working so long and arduously.

The Radio Society badge will shortly be ready!

This statement demands a line to itself. The thoughtless person might not realise its significance. No longer will it be necessary for members to wend their way along the Embankment as if they were ordinary people; no longer will the street converging upon the Institute of Electrical Engineers appear on meeting nights as an ordinary street. Every member for less than a shilling will be

able to purchase a gilt badge for his buttonhole. Affluent members will be able to buy two, one for the lounge suit and one for the overcoat. Doubtless the badge in the form of a large gilt

smoke can be seen rising. The amateur movement in this country is by no means in the secure position from which we can wave our flags and banners. Unless we are gravely mistaken, wireless experimenters are in no mood to see the society dissipating its energies while there remains so much to be done. It is essential that these matters be pointed out in no uncertain terms or we may have a repetition of similar time-wasting and futile schemes in the near future.

We have no doubt that members as a whole will show their contempt for this absurd and schoolboyish coat-button idea by refusing to take the badges even as a gift. At a time when public attention is being attracted to, and is likely to be still more intensely concentrated upon, the doings of the Radio Society, we can ill afford the loss of dignity which the latest scheme entails. We already hear rumours of strong protests from the affiliated societies as soon as they have been able to consult their members on the subject, and it is certainly not too late for them to make their influence felt.

### CONTENTS

	Page
The Super-Autodyne .. .. .	118
Jottings by the Way .. .. .	121
Supersonic Heterodyne Reception in Theory and Practice .. .. .	123
Random Technicalities .. .. .	126
The "Tri-cell" Circuit on the Omni Receiver .. .. .	128
An Interesting Method of High-Frequency Amplification .. .. .	130
Some Reaction Effects Explained .. .. .	131
Valve Notes .. .. .	133
Some Notes on French Valves .. .. .	135
The Adair Fund for the Wounded .. .. .	136
A Tuning Coil Holder Refinement .. .. .	137
Test Report of a "Two-Valve and Crystal Receiver" .. .. .	138
"The Badge Idea" .. .. .	139
A Transformer Coupled Three-Valve Receiver .. .. .	140
A Useful Frame Aerial .. .. .	145
Correspondence .. .. .	147
Apparatus We Have Tested .. .. .	150
Information Department .. .. .	153

plaque attached to a wide purple sash will be available at a later date for use with evening dress.

Meanwhile Rome smoulders, if it does not actually burn. Here and there ominous clouds of

# The Super-Autodyne

By A. D. COWPER, M.Sc., Staff Editor.

A new principle for obtaining extreme selectivity with minimum equipment.

THE principle of Major Armstrong's "Super-Heterodyne" receiver must be familiar to most readers of technical radio journals by now. It would appear as if the circuit were actually fast becoming established as a popular favourite in the States. A popular account of the principles of the circuit has been appearing in *Wireless Weekly* from the pen of Mr. J. Scott-Taggart. It suffices here to recall that in the Super-heterodyne, by the use of a SEPARATE oscillating valve the incoming short-wave oscillations are heterodyned to give "beats" of medium radio frequency, corresponding to a wavelength of, e.g., 2,000 metres; and then this medium-long-wave signal is received on a tuned grid-circuit of a multi-stage H.F. amplifier, amplified there in a convenient if rather inefficient way, and finally rectified and rendered audible by an ordinary rectifying valve. Thus, in addition to the H.F. amplifying valves (of which several in general will be required to give a reasonable build-up of signals) and any L.F. valves following the last detector-valve, there are a minimum of three valves to do little more than a single-valve autodyne receiver is capable of doing with, of course, less selectivity: viz., one heterodyne oscillator valve and two detector valves, the first to make available the beats, and the second to rectify the final amplified long-wave signal.

### Many Valves

In the Super-Heterodyne, therefore, five valves represent about a practical minimum, and frequently up to nine valves are used. This feature, together

with the complexity of the circuit and the fact that without a carefully calibrated external heterodyne wavemeter "searching" is very difficult, has greatly militated against any widespread popularity on this side of the water.

It occurred to the writer, as the result of considerable experience with oscillation-frequencies just at the upper audio limit (8,000 to 20,000 cycles), in connection with the quenching oscillations in "fliver" and grid-leak-howl types of super-regenerative

required to obtain this beat-frequency works out at about 20 per cent., so that autodyne reception (where an oscillating valve oscillating at a slightly different frequency to the incoming wave is used) would be impossible. The receiver would have to be so far detuned that all sensitiveness would be lost.

But if a beat-frequency corresponding to a wavelength within the range of the highest plug-in coil, No. 1,500, be adopted, from, say, 10,000 to 20,000 metres, corresponding to a frequency of

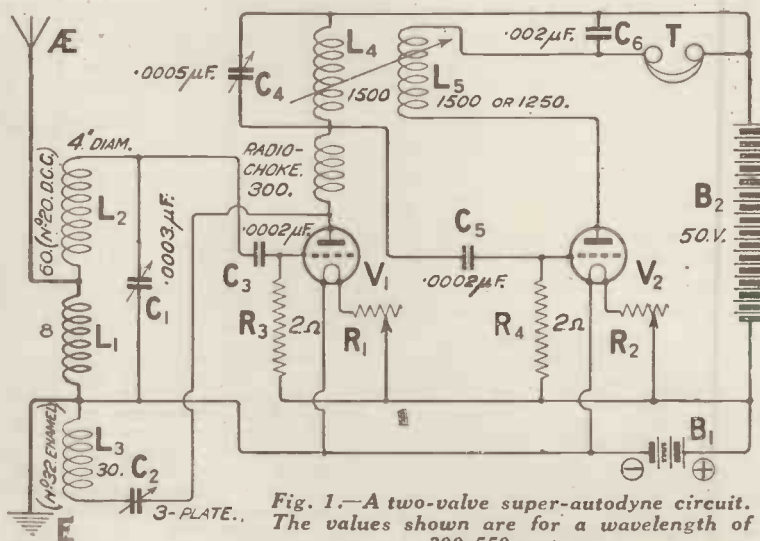

Fig. 1.—A two-valve super-autodyne circuit. The values shown are for a wavelength of 300-550 metres.

circuits, that it might be possible to work with a beat-frequency in this region, and thereby avoid the necessity of sacrificing one valve as an independent heterodyne oscillator.

### Detuning

If a beat-frequency corresponding to, e.g., a wavelength of 2,000 metres is used (i.e., 150,000 cycles), the detuning from a broadcast wavelength

15,000 to 30,000 cycles, the detuning necessary is only 2 to 4 per cent. On the shorter waves the percentage is even less. Accordingly it becomes actually possible to receive with an efficiency, at this point, not so very much less than with a beat-frequency of low-audio-pitch, or even by "homodyne" setting. It requires something much less broadly tuned than the average

aerial-circuit to lose a fair signal at 7 metres on either side of it.

**High-Pitch Notes**

Experience with super-regenerative circuits shows that a very high-pitched note of frequency down even to 8,000 cycles (where the cathode-ray oscillograph actually shows that a stable Armstrong "super" will be operating), can be superimposed on telephony without causing any distress to the listener. An extremely high-pitched whistle of some 20,000 cycles is scarcely audible, in any case, and is rapidly forgotten in practice. If not actually present as a continuous oscillation, its presence as a component of the received signals is absolutely unnoticeable.

be added after the second valve; or, alternatively, a stage of tuned-anode H.F. amplification (of some moderate efficiency on this long wavelength) can be put between this and the rectifier. Reaction is then available between these two circuits. It would appear at first as if this would make the second valve hopelessly unstable; in practice there is a severe damping effect due to the connection to the first valve, so that moderate magnetic reaction is applied, with the plug-in coils in a two-coil holder. This is further assisted by the capacity reaction used on the first valve.

With the Reinartz type of capacity-controlled reaction applied to the A.T.I., in the manner indicated in the figures, using low-resistance circuits which

for final very close tuning of the receiving circuit. If another No. 1,500 is not available, a No. 1,250 can be used for reaction—plenty is required, it will be found. The beat-note in this arrangement is just above the audible limit.

**A Four-Valve Circuit**

In Fig. 2 is shown a more ambitious arrangement of four valves. Here the anode coils must necessarily be of about the same size. Their tuning is not critical, but should approximate, and there should result an extremely high, almost inaudible shrill whistle when actually oscillating. These coils are mounted in a two-coil holder as actually tried, the A.T.I. in each case was a plain solenoid of No. 20

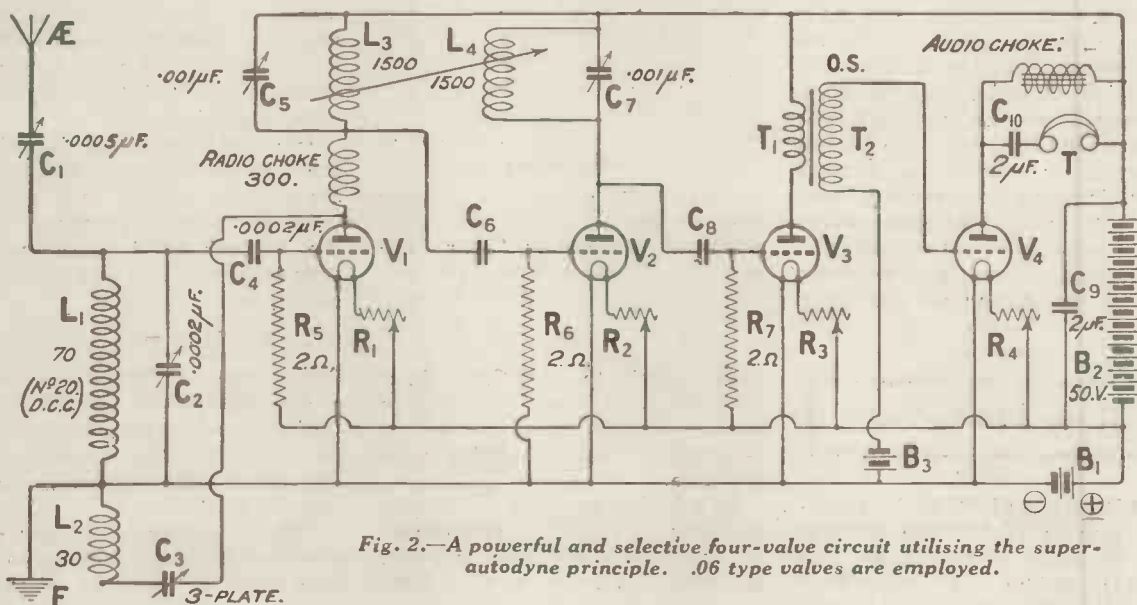

Fig. 2.—A powerful and selective four-valve circuit utilising the super-autodyne principle. .06 type valves are employed.

**The New Circuit**

In the "Super-Autodyne" circuit suggested here, then, an autodyne receiving valve is adjusted to give a beat-frequency in the range indicated; this is then transferred after rectification so that it will be available as periodic impulses of plate-current, to a tuned circuit connected to grid and filament of a second rectifying valve, with reaction from the plate of the latter valve directly on this tuned (15-20 kilocycle) circuit. A fair amount of amplification on this long wavelength is attained in the second valve, as well as rectification, the reaction-control being quite fine. Note-magnifiers can

require only a very small reaction-condenser, the radio-choke (required in any case) serves admirably to filter out the short-wave from the very long-wave oscillations, and the whole circuit is simpler and more compact than if magnetic coupling were used in place of the direct series coupling illustrated.

**The First Circuit**

In the first, two-valve super-autodyne circuit (Fig. 1), the No. 1,500 coil is tuneable with a .0005 μF variable condenser. Experience showed that this condenser was best set, in the circuit as shown, at near its minimum, and was chiefly useful

S.W.G. d.c.c. wire about 70 turns on a 4 in. diam. former, and with a Reinartz reaction-coil of 30 turns of No. 32 S.W.G. enamel-insulated wire wound on closely at the "earth" end, in the same direction and continuous with the main coil. A tapping at the 8th turn was available for "aperiodic" aerial connection. The radio-choke was a narrow slab-coil of 300-400 turns of No. 32 enamel wire, 1-16 in. thick and 3 in. diam. outside; the reaction-condenser a three plate, which amply sufficed. A milliammeter in the plate circuit is quite essential in learning to operate it.



**Method of Operation**

The first high-frequency valve is first set oscillating, then the second (and third, if used) made to oscillate (whistle) by swinging up the reaction-coil; then search is made with the A.T.C. continuous-wave Morse, and carrier-waves are re-heterodyned by the beat-frequency oscillation to give audio-frequency wails of the customary type. One tunes into the silent point approximately, and then (for telephony completely, for C.W. Morse very nearly) stops the long-wave oscillation by cautiously withdrawing the second anode or reaction-coil. Telephony should then come in unblurred, although it has been once autodyned to the high audio- or super-audio-frequency.

**Results Obtained**

Some practice is naturally needed to get good results on this circuit, and the writer does not wish to claim that so-called "super" results will be obtained. It is not the most powerful or economical method of employing two or three valves, but gives extremely good selectivity, from the nature of the heterodyne process and selective second circuit; and an absolutely

silent background. A 1-V-2 "straight" circuit would give very much more noise than the circuit in Fig. 2 under similar conditions. Using "Receptor" and D.E.3 valves, all of the .06 type, circuit No. 1 gave with the addition of a note-magnifier as in Fig. 2, after regular broadcasting had closed down, the Nottingham relay station at something like loud - speaker strength at 100 miles, on a poor test aerial, and Madrid could be got steady and clear. KDKA's upper wave (located on another receiver using the same aerial) was found later on this, but not resolved, owing to fading. The Fig. 2 circuit gave a number of telephony stations immediately below London on a wet afternoon, but completely separated from 2LO. Two degrees either way on the A.T.C. will snuff out anything but a powerful spark station. At 35 miles the local station was easily readable, though faint, on the earth-lead.

**Interference**

Since most severe interference may be caused if this circuit be operated carelessly near the wavelength of a broadcast station during broadcast hours,

even though the heterodyne note is nearly inaudible when properly set, it should not be used in such a case—and is totally uncalled for. Where extreme selectivity with limited controls, and an absolutely silent background, are required, as in some D.X. work, e.g., the super-autodyne may prove to have a useful application. It should not, in any case, be attempted by the inexperienced.

**Short Wave Reception**

It is evident that for short-wave reception the only alteration necessary is in the A.T.I.; some 25 turns of No. 18 or No. 15 S.W.G. d.c.c. wire, with a (e.g.) 15-turn reaction coil, and with an aperiodic primary of half a dozen turns of thick wire, and a series aerial condenser of .0001  $\mu$ F, should give the lower amateur belt of wavelengths. The principle, of course, is particularly adapted to very short-wave reception.

It should be noted that there are two points of correct tuning for any one station, separated by twice the width corresponding to the amount of detuning necessary to give the 15-20 kilo-cycle beat-note.

**Trans-Atlantic Tests**

**T**RANS-ATLANTIC reception is of extreme interest to many amateurs in this country, and of vital importance to the advancement of radio science.

We are able to publish here the first complete details of one of the pre-arranged Trans-Atlantic tests which will be made from the Canadian station CFAC, Calgary, Canada, operated by the proprietors of the *Calgary Herald*. The transmissions, which will occur at 3 to 4 a.m. GMT on four consecutive days, starting Monday, November 24, will be made with an output of 1,000 watts on a true wavelength of 430 metres. Notice of these test transmissions is being given to amateurs in America, and additional interest is provided by the offer from the proprietors of the *Calgary Herald* of three small

cash prizes to the first three listeners who report reception to them, giving some details of the programme heard, together with the time.

In addition to these test transmissions, a regular transmission of one hour's duration is given on Mondays from 5 to 7 a.m.

GMT, and on Thursdays from 4 a.m. to 6 a.m. GMT; this station provides a programme for the Canadian National Railways. This latter transmission is also a regular feature.

The remainder of the test programmes will be published in the next issue of *Wireless Weekly*.

Nov. 25th. HOLDEN IMPERIAL ACADEMY ORCHESTRA.

Fox Trot	...	A New Kind of Man	...	—
"	...	Hinky Dinky Parley Voo	...	—
Waltz	...	Just a Lullaby	...	—
Piano Solo	...	Selected	...	J. E. Holden.
Waltz	...	What'll I Do	...	—
Song	...	Go Long Mule	...	J. E. Holden.
Saxophone Solo	...	Perfect Day	...	J. Rushton.
Fox Trot	...	June Night	...	—
Violin Solo	...	Blue Bells of Scotland	...	Miss Hazel Campbell,
Waltz	...	Broken Dreams of You	...	—
Fox Trot	...	Bringing Home the Bacon	...	—

GOD SAVE THE KING.

Nov. 26th. PALLISER HOTEL ORCHESTRA.

1	Melodious Memories	...	...	—
2	Barcarolle	...	...	Tales of Hoffmann.
3	Selections from Chu Chin Chow	...	...	—
4	Aloha Sunset Land	...	...	—
5	Song of Love	...	...	Lilac Time.
6	Love Song	...	...	By Flegier.

GOD SAVE THE KING.



# JOTTINGS BY THE WAY By Wireless Wayfarer

## A Guide to the Office

IT has occurred to me that lots of you must either have visited or be intending to visit the Office, so that you may gaze raptly upon the features of its famous staff or listen entranced to the flow of words which proceeds from their august lips. If you are one of the has-beens—by which I mean if you have already paid your visit—you probably made an unholy mess of things by not being able to recognise the man whom you were after. It is possible that you may have committed terrible blunders. You

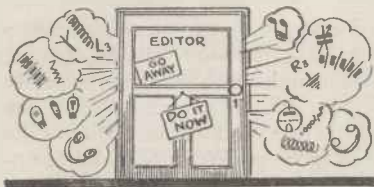

The Editor's Door.

may have mistaken the office boy for the Editor or *vice versa*, with equally appalling results in either case. Or, again, you may have perplexed and confused some perfectly innocent member of the accounting staff by hurling at his head horrible questions about inductances, capacity, or high-frequency resistance. This sort of thing will never do, and, with my usual kindly forethought, I propose to make all future visits to the Office a matter of the greatest ease for those who call. I have long advocated the publication of picture postcard portraits of all the staff, with a ten per cent. royalty on sales to the owners of all the mugs portrayed. This idea, I regret to say, was turned down, chiefly owing to the outcries of the less handsome members of the staff. I am sorry that it did not go through, for I feel that, personally, I should be drawing a small for-

tune from it. Still, we cannot all be good-looking, and the rest make up by their sterling qualities for what they lack in the way of beauty. As no picture postcard portraits are available, I feel that I had better give you general indications which will enable you infallibly to recognise any of the leading lights. Let us imagine that you have invoked my aid—if you have any sense of decency you will have stood me a good lunch beforehand—and that I am taking you for a little tour round the Radiopress offices in Bush House. As we leave the taxi I fumble skilfully whilst saying, "No, no, let me pay," and when you have settled up we enter.

## Our Tour Begins

We halt first of all before a closed door on which is inscribed the word EDITOR. From the keyhole and from every chink and cranny round the door brain-waves are issuing with the speed of light. From within we hear a busy murmur, for the Editor is engaged in dictating four articles simultaneously to as many typists whilst drawing with both hands circuit diagrams which flutter from the table like snowflakes in a winter storm. In spite of your



Dictating four articles simultaneously.

earnest request, we will not enter. I did so once. The Editor's, I may tell you by the way, is a sad, sad story, for his feet were on the downward path at the tender age of twelve when, though quite unable to spell rheostat or hysteresis, he became

both a wireless enthusiast and editor. Taking off our hats, we stand in silence for a moment before the Editor's door, and then move on.

## We Move On

I take you now to a room in which sits no less a person than Mr. Hercy Parris. I do not think that you can make a mistake about him even if I, with bated breath, fail to whisper his name in your ear. The formula for recognising Mr. Hercy Parris is perfectly simple. All



Another telephone bell rings.

that you have to do is to impress upon the left lobe of your brain a clear-cut portrait of Mr. Harold Lloyd, complete with spectacles and smile. Upon the right lobe you implant firmly the picture of Mr. Charles Chaplin, leaving out the boots and trousers, and making a particular point of the moustache. You then combine the two images, adding if you will certain little touches of your own to complete the picture, and there you are. Do not be surprised if, as we approach, Mr. Parris fails to look up. Express no signs of astonishment if you see that he is busily engaged in constructing a crystal detector from a trouser button, a bootlace tag and a lump of sugar. Do not be alarmed if he seizes the ink bottle, and, after depositing its contents upon the mat, proceeds to wind coils of wire round it. He is merely engaged in designing his new "Man Friday" set, which he is working out particularly for the benefit of those



readers who are marooned on desert islands. After a short time he looks up, sees me, frowns slightly, and sweeps all the gadgets on his table out of reach. I then present you with my well-known old-world courtesy, and he is just rising to greet you with a charming smile when the telephone bell rings. He has a long conversation with someone, and as he hangs up the receiver I say, "Allow me to present my friend . . . ." Rrrrrring goes the telephone bell, and Mr. Parris has a further talk. I make half a dozen more futile attempts to present you,



A real cave-man chin.

and when we have listened to his masterful way of conducting as many telephone conversations we steal away into the next room.

**Lion after Lion**

Here we find that well-known member of the staff, Mr. Mousee. He is armed with an enormous pair of scissors, with which as we enter he is engaged in slicing up what are known as galley proofs. Having slashed and measured, he seizes a pot of paste and sticks what he has cut out to the blank page before him. He is employed, my friend, in what is known as a "paste up." Have you not often wondered how articles fit so beautifully into pages? Now you know how it is done. But the scissors and the paste, though we notice them, fail to hold the eye. Our attention—or, rather, yours, for I have seen it before—is riveted upon something else. You have been, I doubt not, on more than one occasion to the cinematograph, and there you have made acquaintance with the strong, silent man whose jutting jaw drives villains into abject humility. That is why your eyes are focussed now upon the real cave-man chin which confronts you. That chin is to Mr. Mousee what his hair was to Samson. I honestly believe that if the crest of its wave were damped by some awful blow of

fate he would never again be able to ply his weapons or to write his stirring articles upon the construction of wireless sets. Mr. Mousee receives us most affably, and whilst you and he are engaged in an animated conversation I am able to slip into my coat pocket a most attractive transformer that stands upon the corner of his table. Having done this, I think it is high time to be moving on, and dig you so heartily in the ribs that you grunt.

**The Trouble Hunters**

I take you now to the Service Department, and hunt out the head of it, Mr. G. P. Bendall, who is easily recognised by even the dullest visitor. I think it best to give you not a portrait but a theoretical lay-out diagram of Mr. Bendall. Mathematicians will spot him at once by working

$$\text{out the formula } \cos \phi = \frac{2\pi L F \times \sqrt{K}}{1.000256C}$$

where  $\pi$ , L, F, and C are the usual things, and K is the last time he had his hair cut. But should he be incapable of figuring out such a simple sum, there are certain outward and visible signs by which you may identify him immediately. In the first place, look at his pockets. From each of them protrude straggling lengths of wire. Then glance at his hands. You will see that as he talks they make what I may describe as zig-zag circular motions as if engaged in winding



Mathematicians will spot him at once.

wire on to some form of coil. Further than this, listen to him as he walks. In addition to ends of wire, his pockets contain the half-crowns which he has collected during the day from inquirers, and their jingling is quite unmistakable. As we leave Mr. Bendall's room we run across Mr. Underdyne smoking an outside in pipes, who prattles incessantly about perfectly controlled high-frequency circuits. We may also encounter Mr. Wallows, who, after trying to

interest us in a gadget for using three valves in one holder, will probably endeavour to talk about the hunting in which he would have us believe he indulges. Smile politely, but do not believe him. Even if he is wearing riding breeches and spurs, you can take it from me—for he and I were at school together—that his equestrian ventures never get further than a donkey ride on Hainpstead Heath or a turn on the merry-go-round at Wembley. If he tells you that he broke an arm last year whilst chasing the fox, smile benignly and express sympathy. Do not let on that



A table encumbered with enormous masses of books.

you know the accident actually occurred on the sands at Margate.

**The Last Celebrity**

I take you now to one of those huts just outside Bush House, which make you think irresistibly of your gallant service during the war when you braved the perils of Ripon or Fovant. We approach. I knock at the door. We penetrate. We are in the presence of the Sales Manager. "Where is he?" you whisper. "There," I breathe, pointing to a table encumbered with enormous masses of books above which appears the top of a head surmounted by a tuft of unruly hairs. You advance hastily, holding out a hand on my words of introduction, fall over all kinds of volumes, and are picked up by the genial Mr. Headbath, who smilingly assures himself that no bones are broken. Here, I think, one word of warning is essential. Get his name well into your head, and make no mistake about it. I once conducted round the office a visitor who addressed him as Mr. Blueprint, and has never smiled again. And whilst you are discussing things with him I hurriedly steal away, well knowing that if I remain you will expect me to pay for the home-ward taxi.

**WIRELESS WAYFARER.**



# Supersonic Heterodyne Reception in Theory and Practice

By JOHN SCOTT-TAGGART, F.Inst.P., A.M.I.E.E.

Part IV.

## Supersonic Heterodyning

LET us suppose that we are using a receiving circuit of the kind illustrated in Fig. 16. This shows three valves, V1 being an oscillating valve for producing the currents which heterodyne incoming signals, V2 is the detector valve operating on the leaky grid condenser principle, and V3 is a low-frequency amplifier which is coupled to the valve V2 by means of the usual iron-core transformer T1 T2. In the anode circuit of the third valve we have the usual telephones T.

The frequency of the local oscillations is governed by the variable condenser C1, the reaction coil L2 being coupled to L1 so that the valve V1 oscillates. The coil L1 is also coupled to L3 which, with the condenser C2, forms the principal part of the aerial circuit.

## Continuous Wave Reception

There are one or two points in connection with this circuit as a receiver of continuous waves which I desire to emphasise before discussing actual supersonic heterodyne reception.

The first point is that the circuit L3 C2 should be tuned to the incoming wavelength, while the circuit L1 C1 is tuned to a slightly different wavelength.

If the frequency difference between the currents in L1 C1 and the incoming signals in L3 C2 is not too large, there is no difficulty in inducing oscillations from the oscillator into the receiver circuit, but if the difference is fairly substantial it will be difficult to induce a sufficient strength of currents into the circuit L3 C2 to be really effective, and it may be necessary to adopt some special method of coupling or feeding the currents into the grid circuit of the valve V2. If

L1 and L3 are very tightly coupled, the circuit L1 C1 will affect the tuning of the circuit L3 C2, a very undesirable state of affairs because the experimenter will never know really when his circuits are properly adjusted without a considerable amount of experimenting.

In order to get sufficiently strong induced currents into the circuit L3 C2 the experimenter may be tempted to tune this circuit nearer to the tuning of L1 C1, but although he may be getting stronger induced oscillations, he will be weakening the incoming oscillations, and

C2, but these beats are merely periodical increases in the amplitude of a high-frequency current and are incapable of operating an apparatus such as telephones without rectification. A similar effect would be obtained if the telephones were included in the aerial circuit without any detector. The high-frequency currents, even though they may be increasing and decreasing in amplitude, cannot cause the telephones to respond, because, in the first place, the telephone diaphragm could never respond to a frequency as high as that normally used in wireless signal-

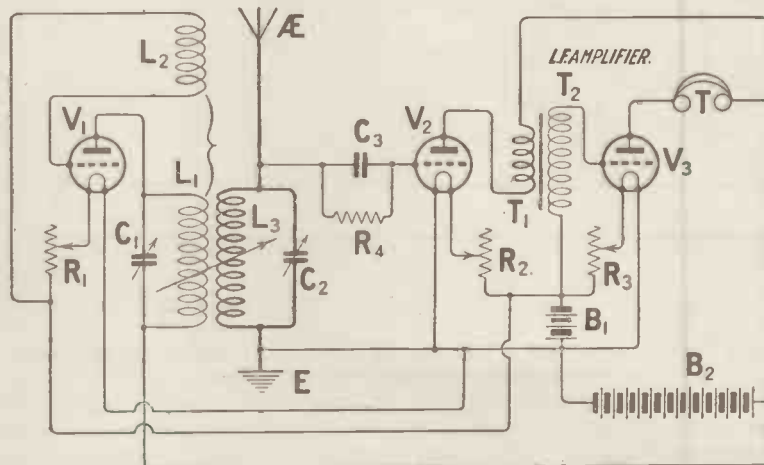

Fig. 16.—The currents for heterodyning the incoming signals are produced by the valve V1.

obviously it is not desirable to take any risks with the incoming currents because these are weak, whereas the local oscillations can be made as strong as is desired.

## Rectification by V2

Another point to notice, is that no signals are going to be obtained in the telephones T unless the valve V2 acts as a rectifier. It is quite true that the local oscillations induced by the valve V1 into the receiving circuit will form beats with the incoming currents in the circuit L3

ling, and, secondly, the human ear could not discern the extremely high note which would be obtained even if the telephone diaphragm could respond to such frequencies. It is necessary to cut out the high frequency and listen to the low-frequency changes in amplitude which are the variations which count in wireless reception.

## Detecting the Beats

Fig. 17 shows graphically what happens when beats are detected by a valve operating with a

leaky grid condenser. The first line shows beats produced by combining local oscillations with incoming currents of continuous wave form. The beats are the points where the high-frequency currents are of maximum amplitude; the second line shows how these high-frequency currents, when applied to the grid of a valve, vary its potential; not only is there a high-frequency fluctuation of the grid potential, but there are also periodical falls and rises of grid potential, these falls and rises corresponding to the beats and having the same

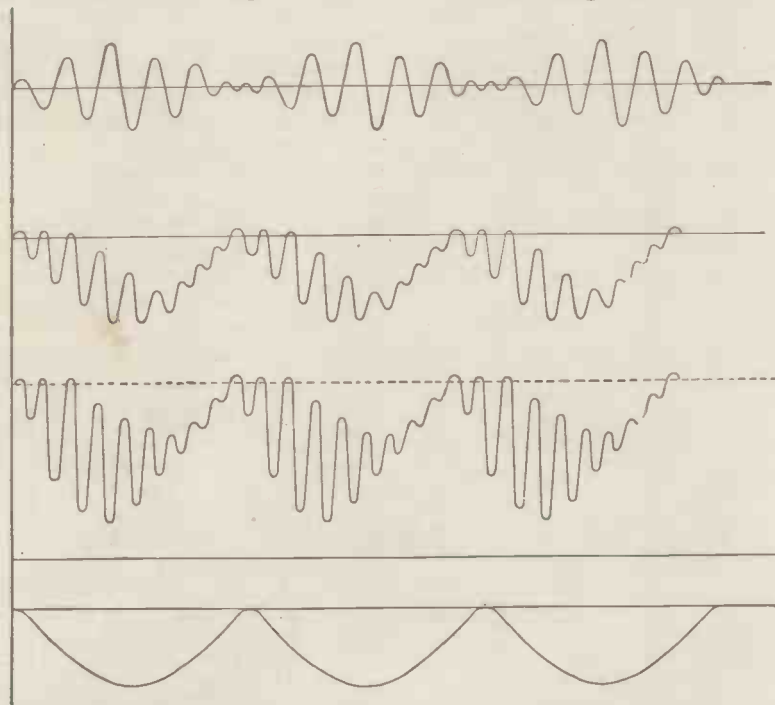

Fig. 17.—Showing what happens when beats are detected by a valve operating on the leaky grid principle.

frequency. These variations of grid potential appear amplified in the anode circuit. The high-frequency fluctuations do not affect telephones or output apparatus which are influenced only by the periodical change in the anode current which is shown in the bottom line of Fig. 17.

It will thus be seen that before the high-frequency current with beats in it can be made to operate telephones, it is necessary to rectify it, and this process cuts out the high-frequency element and leaves the lower-frequency beats, the frequency of which will correspond to the difference in frequency between the local oscillator and the incoming signals.

### Simplified Circuit

Fig. 18 shows a simplified arrangement for explaining the action of the Fig. 16 circuit. V1 is now the oscillator and L2 C2 the receiver circuit. The detector D is represented as a box, and may be a crystal detector or a valve. The output from the crystal detector D is applied to an amplifier A, the output of which goes to the telephones T. The currents in L1 C1 are ordinary continuous wave currents; the currents in the aerial circuit L2 C2 when the valve V1 is not working are assumed to

### Meaning of Supersonic

A very good clear musical note is that round about a frequency of 1,000, and when receiving continuous wave stations it is usual to arrange the difference in frequency between the local oscillations and the incoming oscillations equal to 1,000. If, for example, continuous wave signals of 300 metres were to be received, the frequency of the incoming oscillations will be 1,000,000, while the local frequency will have to be 1,000 different, i.e., 1,001,000 or 999,000.

### Adjustment of the Local Oscillator

It is important to note that to obtain any given note or beat frequency the local oscillator can be adjusted to a frequency either above or below the incoming frequency. This point was explained by means of Fig. 6 of these series of articles. This table shows that to obtain any particular beat frequency, the local oscillations may have a value either above or below the incoming frequency.

Those beat frequencies, or notes, in the telephones which are capable of being heard by the human ear are said to be within the range of the audible frequencies. Generally speaking, they are called low-frequency currents or audio-frequency currents. It is clear, however, from Fig. 6, and from an ordinary common sense consideration of the subject, that if the local oscillations have a very widely different frequency from the incoming oscillations, then the beat frequency will be very high and the note will be higher than can be heard by the human ear. The frequency at which this happens depends upon the hearing of different experimenters. Sometimes the limit of audibility is regarded as 10,000 and sometimes 40,000. For most ordinary purposes 10,000 may be regarded as the extreme limit of audibility, and any beats having a higher frequency than this, although they may be in existence and capable of operating measuring instruments such as milliamperemeters, will not be audible to the human ear, and the currents

be the continuous wave currents from a distant continuous wave station. When, however, the valve V1 is switched in and C1 tuned correctly, there will appear two sets of currents in L2 C2, one set being due to the incoming signals and the other set due to being induced from the circuit L1 C1. These two sets of currents produce beats, and the mixed currents are then applied to the detector D, which cuts out the high-frequency element and simply leaves the beats which are of low and audible frequency. These low-frequency currents are applied to the low-frequency amplifier A, which magnifies them and passes them on to the telephones T.



are then said to be of "supersonic" frequency.

When receiving signals on a circuit of the kind illustrated in Fig. 18, it is possible to tune the condenser  $C_1$  so that a very high-pitched note is obtained. If the condenser  $C_1$  is now turned further round in the right direction this very high note will gradually disappear, not because the beats are no longer formed, but because their frequency is beyond the range of the human ear. Certain insects produce buzzing noises which, although actually of substantial strength, cannot be heard by a human being.

#### Supersonic Beats

If, when working a circuit of the kind illustrated in Fig. 18 we tune the local oscillator by means of the condenser  $C_1$  so that the beats produced in the circuit  $L_2 C_2$  are supersonic, then nothing will be heard in the telephones  $T$ , although there will, of course, be currents passing through the telephones, varying currents having a frequency equal to the beat frequency. If this frequency is, say, 20,000, although the ordinary person will not hear anything, yet the first valve continues to act as a detector, and the second as an amplifier, as before. It must, however, be admitted that the transformer  $T_1 T_2$  will cease to work effectively as the supersonic beats increase in frequency. The fact of the matter is that these supersonic beats, after rectification, produce alternating currents which, if of low frequency, will be amplified by a low-frequency amplifier, and will work telephones; but if of supersonic frequency may be considered like any other high-frequency currents, and such currents require high-frequency apparatus to deal with them.

After all, a frequency of 20,000 corresponds to a wavelength of 15,000 metres, and many high-power stations are working with waves of this length, and there is a station working which has such long waves that these can actually be heard on telephone receivers without rectification by persons having sufficiently sensitive

hearing for these high frequencies.

The question naturally arises, Why should we want to have supersonic beats if it is impossible to hear them? The answer to this question is the same as the answer would be to the question as to why supersonic heterodyne reception is so useful.

In brief, a supersonic heterodyne receiver is one in which the incoming currents are heterodyned so as to produce supersonic beats, these beats being then applied to a detector, and the resulting lower frequency currents, which, however, may be regarded as of high frequency, being then amplified and finally resolve in the low-frequency currents which may operate telephone receivers or similar apparatus.

The supersonic heterodyne

strength obtained and the strength of all sorts of other noises, frequently referred to as "background." Whenever there is much low-frequency amplification, especially when transformers are used, there is a great deal of indeterminate noise going on, this noise being due to a variety of causes, such as minute leakages, due to faulty insulation, minute fluctuations in filament current or high-tension voltage, etc., etc. All these minute fluctuations may occur in the first or early stages of low-frequency amplification, but they are all amplified by subsequent stages; any small interference experienced by the receiving set will be increased to very large proportions by an ordinary low-frequency amplifier, and atmospheric noises are also greatly amplified.

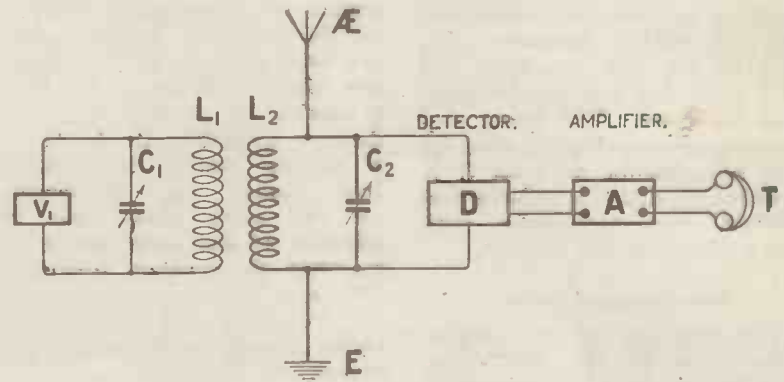

Fig. 18.—A simplified version of the circuit of Fig. 16.

system is therefore essentially a method of obtaining amplification.

The circuit of Fig. 16 may be made to give louder signals by adding more stages of low-frequency amplification. More stages of transformer coupling, at any rate, will result in an unstable set, and the transformers will cause the low-frequency valve to oscillate, at low frequency, of course. Three stages of low-frequency amplification may be employed, but, even so, there is considerable difficulty in preventing low-frequency buzzing.

#### Background Noises

A very important factor which also comes into play when low-frequency amplification is used, is the ratio between the signal

#### Degree of Amplification

In considering the degree of amplification, therefore, it must be borne in mind that what counts is not merely the amplification of the desired signal, but the freedom of the final signal from other noises. It is, for example, better to receive a transatlantic signal weakly on the telephones and free from interference, than to receive the same signal on the loud-speaker with all sorts of other interference amplified to the same extent, or possibly even to a greater extent.

The supersonic heterodyne method of amplification almost cuts out the amplification of miscellaneous mush and parasitic noises.

(To be continued.)

# Random Technicalities

By PERCY W. HARRIS, Assistant Editor.

Some Notes of interest to the Home Constructor and Experimenter.

**N**EWs of a very interesting super-heterodyne improvement has just reached me from the United States. For some time past endeavours have been made to simplify the operation of the super-heterodyne by removing unnecessary controls. It has been found possible to dispense with adjustment of the high - frequency amplifying stages, and, of course, the detector and note magnifiers do not need anything more than a preliminary adjustment. This has left two tuning controls, viz., that of the grid circuit of the first valve and that of the separate oscillator. The latest step consists in removing the need for two adjustments, as now it is possible to make a reliable and efficient super-heterodyne with but a single tuning control.

## One Handle Control

The working of the super-heterodyne, as Mr. Scott-Taggart has explained in the series of articles now running in *Wireless Weekly*, is based upon the production of "beats" between the incoming oscillations and those locally generated by the heterodyning valve. By making the frequency of the separate oscillator differ from that of the received oscillations by, say, 100,000, and by rectifying the beats so produced, an intermediate frequency is set up, and this is amplified at radio frequency. Super-heterodynes are designed to amplify an intermediate frequency of some figure which is kept constant for the particular instrument, so that our problem in tuning is to keep the frequency of the separate oscillator different from that of the incoming oscillations (whatever these may be) by a predetermined figure. Expressed in another way, we want a constant frequency difference be-

tween the received signal and that of the local oscillator.

If now we place the variable condenser of the oscillator on the same shaft as that of the circuit tuned to the incoming oscillations, and arrange one condenser to be always in advance to the other, we can keep a constant capacity difference between the two condensers. This, however, will not create a constant frequency difference, and so, as there is not a satisfactory square law condenser available on the American market, gears are used so as to give a square law effect. Here, as we have a number of square law condensers available, it should be a simple matter to arrange two square law condensers on the same shaft, one in advance of the other so as to maintain the constant frequency difference, for, as is well known, the frequency and not capacity varies directly as the scale of the square law condensers.

## About Ebonite

Lunching recently with a man well known in the ebonite world, I was discussing the means by which the ordinary man thinks he can judge the quality of ebonite. Good ebonite generally cuts well, has a consistency like that of very hard cheese, and when drilled, if the drill is sharp, will give a practically continuous shaving. Furthermore, there is a distinct "rubbery" smell when the substance is cut. Inferior ebonite is often very brittle and of high specific gravity, cuts badly, and drills in a very powdery fashion. Yet none of these general indications is a proof of quality, for the hardness and brittleness of the ebonite is largely determined by the curing process to which it has been submitted. Some trades require the ebonite to be supplied to them in a very hard state. Pipe mouth-pieces are an example. While inferior ebonite is often very

## AT BELFAST.



The control room at the new Belfast broadcasting station.



brittle, the fact that the ebonite we buy is brittle is not an indication that it is a bad insulator or unsuitable for our work (other than mechanically). I discussed many points of this kind, and could only come to the common-sense conclusion that the ordinary man-in-the-street can be given little guidance in testing ebonite, and must therefore rely on the reputation of the firm selling it.

#### Bakelite

Speaking of insulating materials reminds me that the majority of moulded objects, such as valve sockets, coil plugs, and the like, have no ebonite whatever in them, many being made from most inferior compositions, in which it is next to impossible either to drill or tap a hole. A number of the best-moulded objects are made of bakelite and similar compounds, which, when cut, have a smell which suggests both ink and carbolic. In the United States bakelite panels are sold very widely for radio purposes, but in this country such panels are not on the market. Good bakelite is considerably dearer than ebonite. It has the virtue that it gives excellent mouldings, and is little affected by temperature changes.

#### Indicators

I am glad to say that the point I made recently regarding the absence of condenser indicators has been taken up by at least one manufacturer, and Messrs. L. McMichael, Ltd., are shortly marketing a little indicator of the type suggested.

I have written often enough on the subject of cheating in condenser values, particularly in the case of some of the cheaper variable makers. Now that square law condensers are coming on the market in large quantities, the manufacturers should take great care to see the values are as stated. I purchased one recently which had only 70 per cent. of the stated capacity. I have not measured all makes, but Sterling, Bowyer - Lowe, Fallon, Ormond, and Jackson Brothers, at least, have the capacity claimed.

#### KDKA

Something seems to have happened to KDKA's 68-metre trans-

mission lately. A fortnight or three weeks ago I could reckon on hearing him any night after half past eleven or quarter to twelve in excellent strength, but for the last week or so he has been steadily fading, so that at the present time I find it very difficult to do more than just hear him. Others seem to have noticed the same. The longer wave American broadcasting, on the other hand, is coming in exceedingly well at the present time.

\* \* \*

I hear that Goyder is still doing great things with two-way working with New Zealand. The other evening he had just finished working an American amateur when New Zealand Z4AA gave him a call, and said that he had heard both the American and British messages, and had copied them both.

#### A Suggestion

Here is a suggestion for an enterprising manufacturer. Now that interest in short wave reception is high, and as most experimenters prefer a "board hook-up" for their short wave tuner owing to the constant changes in circuit, why doesn't someone put on the market a low-loss coil former, say, in the form of an insulating cylinder (out of which large sections have been cut to remove solid dielectric), fitted with feet at each end, drilled and fitted with securing screws to hold it to a base board? It could be, say, 6 in. long by 3 or 4 in. diameter, and could be wound by the experimenter himself with heavy gauge wire according to his needs. A couple of terminals, one at each end, would be useful for securing the wire and making suitable connections.

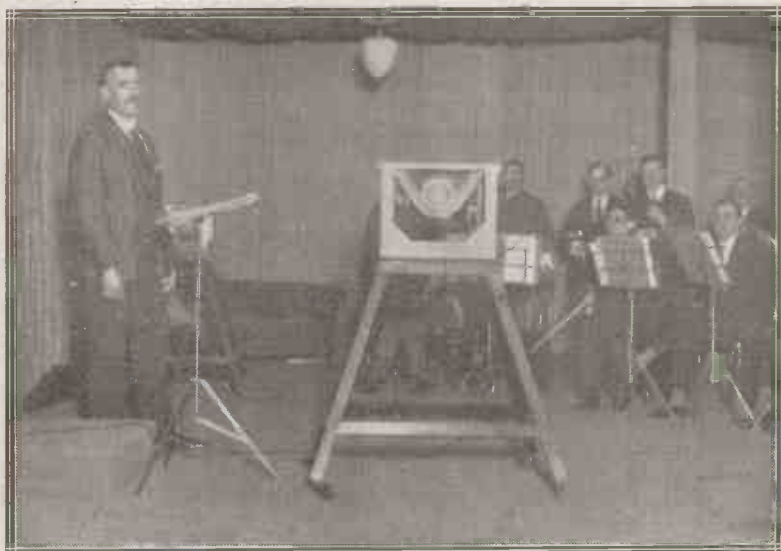

This photograph shows the announcer, Mr. Godfrey Brown, and the orchestra of the new Belfast station.

## OUT 15th NOVEMBER!

*The December issue of "The Wireless Constructor," the great new Radio Press monthly, will be published next Saturday. Order your copy at once, or you may be too late. 250,000 copies of last month's issue were sold!*

*Edited by PERCY W. HARRIS.*

*Price 6d. everywhere.*

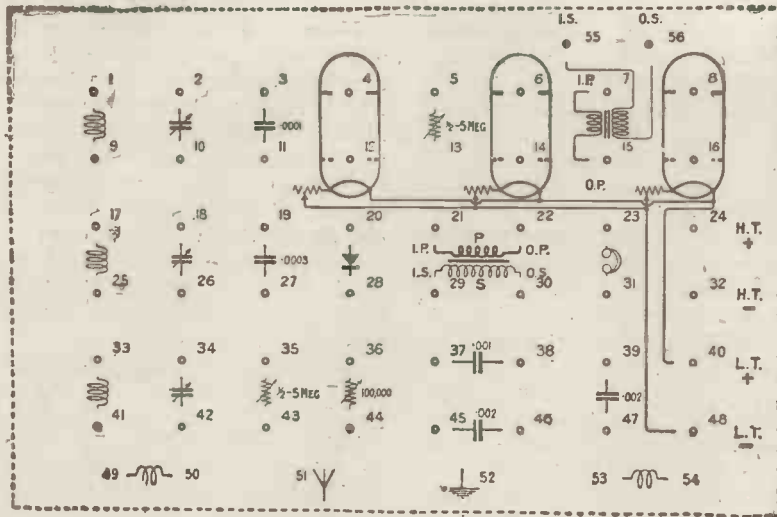

Fig. 1.—The terminal board.

The "Tri-Cell"  
Circuit  
on the  
Omni Receiver

THE lack of selectivity in most dual circuits is probably one of the chief reasons why these are not more widely used, for although it is possible to obtain considerable volume without sacrificing quality, long-distance reception, which is coveted by many listeners, is made extremely difficult when ordinary interference cannot be eliminated.

In the September number of *Modern Wireless* Mr. Percy W. Harris described a "Tri-Cell" receiver, the circuit of which is given in Fig. 2. The tuning system has been given the name of "Tri-Coil" tuning, which was fully described by Mr. John Scott-Taggart in the same issue of *Modern Wireless*. With this form of tuning a considerable improvement in selectivity is possible, while the volume of sound obtained is excellent.

Tuning Arrangements

The aerial is tuned by the coil L1 and variable condenser C1 of 0.0005  $\mu$ F capacity, the incoming oscillations being applied direct to the grid of the valve, and through the fixed condenser C2 of 0.0003  $\mu$ F, to the negative side of the filament. In the anode circuit of the valve is the primary coil L2 of the H.F. transformer L2 L3, and the telephones shunted by C4 of 0.001  $\mu$ F.

The fluctuations in L2 set up similar fluctuations in the secondary coil L3, tuned by C3 of 0.0005  $\mu$ F maximum capacity, these being rectified by the

crystal detector D. The resulting potential fluctuations across the primary winding T1 of the L.F. intervalve transformer T2 induce similar fluctuations of higher voltage in T2, which is in the grid circuit of the valve. Being rectified, these fluctuations occur at low frequency, and after being amplified by the valve, operate the telephones.

The coils L1, L2 and L3 are variably coupled, L2 being in the centre. The coupling between L1 and L2 controls the reaction used, while that between L2 and L3 is varied when selectivity is desired. Normally L2 and L3 are closely coupled to secure maximum transfer of energy.

The circuit is easily wired on the Omni receiver, the three-coil holder on the side of the cabinet being utilised to allow variable coupling between L1, L2 and L3.

Connections

The necessary connections between the various terminals are:—

51—1	17—31
1—2	31—38
10—9	37—23
9—30	23—24
30—19	32—40
27—29	22—28
29—52	20—41
1—12	41—42
52—48	21—33
4—25	33—34

Coils to Use

The aerial coil socket is the rear moving socket of the three-coil holder; the primary coil is plugged into the centre socket

and the secondary coil into the moving socket at the front.

For the usual broadcast wavelengths a No. 50 or 75 coil will be required in the aerial socket, a No. 100 coil in the centre socket, and No. 50 or 75 for the secondary coil.

For the Chelmsford wavelength in the order of aerial, primary and secondary coils, suitable sizes are Nos. 150, 250, and 200 respectively.

Operating the Receiver

The valve is inserted in the first of the three sockets on the front of the panel, and the batteries and telephones connected to their respective terminals.

L1 should first be kept well away from L2, and L3 coupled closely to L2. The crystal detector should be frequently adjusted when first searching for a station.

Tuning is carried out on the two variable condensers C1 and C3 until signals are heard at their loudest. The aerial coil may now be brought slowly towards the primary coil, retuning simultaneously on the variable condenser C1. If this does not increase the strength of the signals it is necessary to reverse the connections to the aerial coil, and the following alterations on the terminal board are necessary:—

Disconnect 51—1, 1—12 and 9—30; join 9—12, 51—9 and 1—30. A repetition of the above procedure will now strengthen signals considerably.

Experiments

The tuning of the secondary coil may be found so sharp as to



This circuit, which was described in the September issue of "Modern Wireless," in the "Tri-Cell" receiver, may be tried on the Omni receiver as explained in this article.

cause difficulty in working the receiver. In this case it will prove beneficial to substitute for the variable condenser  $C_3$  one of lower value. The equivalent to this is obtained by connecting in series with  $C_3$  a fixed condenser of  $0.002 \mu\text{F}$  capacity. The alterations necessary are:—Disconnect 41—42, and join 45—41 and 46—42.

#### Selective Reception

Selective reception is made possible by varying the coupling between  $L_2$  and  $L_3$  with subsequent adjustments of  $C_1$  and  $C_3$ . It will be found, however, that there is a limit to the satisfactory loosening of the coupling between the two coils, for the valve tends to rectify, instead of the crystal detector, if allowed.

Should difficulty be experienced in getting the set to oscillate, a small fixed condenser may be connected in the aerial circuit. A suitable value is  $0.0001 \mu\text{F}$ ; on the Omni receiver this condenser is numbered 3 and 11. The required alterations are thus:—Disconnect 51—1 and join 51—3 and 11—1. This condenser introduces "constant aerial tuning" as might be expected, although a form of this tuning was already in use owing to the presence of the  $0.0003 \mu\text{F}$  fixed condenser across the secondary winding of the low-frequency transformer  $T_1$   $T_2$ . The inclusion of the  $0.0001 \mu\text{F}$  condenser does, however, enable one to say with confidence exactly what size of aerial coil is necessary for a given wavelength. Thus, for broadcast wavelengths

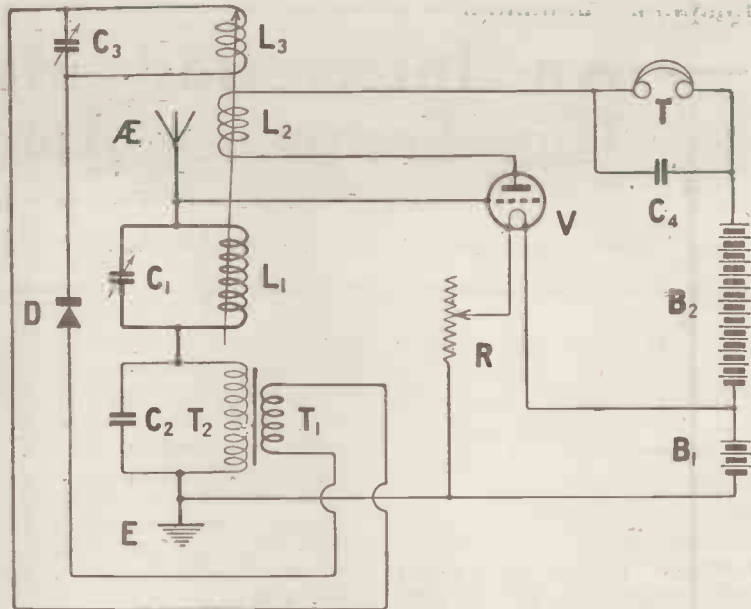

Fig. 2.—The "Tri-Cell" circuit which may be adapted to the Omni receiver.

below 420 metres it may be stated that the correct size of aerial coil is a No. 50, while for those above 420 metres a No. 75 coil should be used.

The secondary winding  $T_2$  of the low-frequency transformer may be reversed with possible advantage. The original key must be altered thus:—Disconnect 9—30 and 29—52; join 30—52 and 9—29. If this gives poorer results, the former connections should, of course, be reverted to.

It is unlikely that a reversal of the connections to the primary winding will make any appreciable difference, but such experiments are always worth trying if it is intended to get the most out of the circuit under test.

Disconnect 21—33 and 22—28; join 21—28 and 22—33.

It will be understood that the crystal detector plays a very important part in this circuit, and it may require patience to obtain a really good adjustment. It is surprising to note the difference sometimes effected in the volume of sound obtained after taking the trouble to clean the cat's-whisker. The crystal detector is probably one of the most neglected components on the Omni receiver owing to its infrequent use, but it should be remembered that even in cases where the detector is entirely enclosed a little cleaning periodically is by no means out of place.

#### SIMPLE TERMINAL BRIDGES

WHERE square tinned copper wire is used as a connecting-link between panel terminals, the device shown in the diagram may prove useful. It has an advantage over the plain straight piece of wire frequently used, owing to the fact that it is adjusted more quickly and does not become lost, or accidentally fall across two points on the panel which may cause a short circuit. All that is necessary is to bend one end of the wire to form a pivot on the terminal screw. The diagram

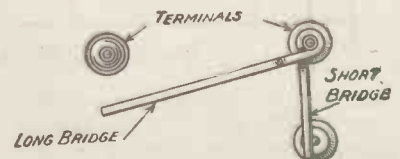

A simple method of bridging terminals with square wire.

shows two bridges pivotted to one terminal, one being a short bridge and the other a long one. The same idea may also be employed for another purpose by soldering the two bridges together in the position in which they are shown. On pushing the long bridge into place, the short bridge comes out, and *vice versa*, thereby forming a simple but effective on and off switch.

H. B.

# An Interesting Method of High-Frequency Amplification

By *PERCIVAL J. FRYER, F.I.C., F.C.S.*

*Seekers after additional selectivity will find the method here described of great utility*

THESE are at the present time three methods of valve coupling in use to produce high-frequency amplification, viz. :—

- Tuned anode;
- Resistance capacity;
- Transformer.

Of these the tuned anode method of coupling is still very popular as it produces a relatively high degree of amplification on short and medium waves, and is simple to control, especially when the anode coil is variably coupled with the reaction coil. Unless, however, some form of the neutrodyne principle is

which in practice means that a low degree of amplification only is obtainable with very poor selectivity. The usual form of introducing the necessary damping is by the use of fine gauge wire for the anode and grid circuits which are very closely coupled, and are either semi-aperiodic or have one of the circuits tuned with a condenser.

Now, in order to produce anything like the degree of amplification of which the valve is capable, it is necessary to have freely resonating circuits of low resistance. Further, to obtain a high degree of selectivity—which is now becoming absolutely essen-

ing increasingly serious. If an attempt is made to use two loosely-coupled circuits, tuning each sharply with condensers in the usual manner, it will be found that control of the valves is, in practice, exceedingly difficult since oscillation soon intervenes as soon as the circuits become even approximately attuned. Mr. Harris has, however, shown that it is possible to obtain a high degree of amplification if two coils are used in place of the conventional transformer, and these are loosely coupled in an ordinary 2-coil-holder, the grid-circuit being tuned with a condenser. Under these circumstances he found that on adjusting the movable coil a point was found at which critical coupling was obtained giving remarkable signal strength and at the same time a very high degree of selectivity. The amplification was indeed so marked that Newcastle was for a little time believed to be London. At the same time, when the grid circuit was in tune, there was no observable tendency to oscillation, the stability being, in fact, very noticeable.

## Movable Coil Objections

This method, while giving excellent results very far superior to the conventional transformer circuit, was open in practice to the grave objection that it involved the simultaneous adjustment of moving coils (four in the case of two H.F. stages) and the tuning of condensers, in addition to the control of the aerial tuning system. For this reason Mr. Harris did not recommend the method for incorporation in a set for the reception of broadcasting.

While experimenting on these lines the writer found that it was possible to obtain these advantages to an even more marked degree, and at the same time to do away with the moving coils. Further,

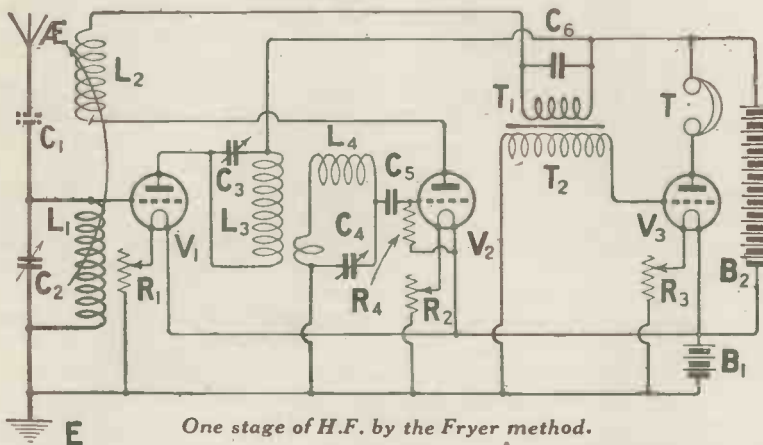

One stage of H.F. by the Fryer method.

successfully applied, there is a limit to the amplification obtainable owing to the liability to oscillation when the aerial and anode circuits are in tune.

## Drawbacks

The resistance capacity method of coupling high-frequency valves gives excellent results on wavelengths exceeding 1,000 or 1,500 metres, but is unsuitable for the shorter waves.

Transformer coupling, although becoming increasingly popular is, like the tuned anode, exceedingly liable to cause oscillation unless heavy damping is introduced,

tial on broadcasting wavelengths owing to the ever-increasing number of transmitting stations on this comparatively narrow band of waves—it is necessary that the circuits should be sharply in tune one with the other.

## A Modification

Any possibility of sharply tuning the conventional form of closely-coupled, highly-damped transformers is, of course, out of the question. Consequently, sets made up on the transformer principle are not remarkable for selectivity, a drawback which, as previously pointed out, is becom-



it was possible to employ freely-resonating circuits of low H.F. resistance by the use of heavy gauge wire, while at the same time retaining the stability and freedom from the bugbear of oscillation.

**Tuning Both Circuits**

This is accomplished by tuning both circuits, and employing a method of fixed coupling of very small degree. In practice it was found that the best and simplest way of getting this result was to wind two turns of the primary or anode coil around the secondary (grid) and then to remove and dispose each coil so as to avoid any further degree of coupling by the inductive action of one on the other. Under these circumstances tuning is sharp, and a remarkable degree of amplification is obtained with great selectivity and marked stability. Further, the tuning is quite simple, the operation of the two condensers being very smooth and reliable. Once the position of a given station is found on the condensers it is the work of a few seconds only to obtain the correct setting for that wavelength on any future occasion.

In the case of two stages of high-frequency amplification it is only necessary to wind each primary and secondary coil in the two stages in a uniform manner,

and tune these simultaneously with double condensers to obtain a very extraordinary degree of amplification and of selectivity.

This method of fixed coupling of low degree was described for aerial tuning by Mr. Cowper in his now famous series-tuned-anode circuit (*Wireless Weekly*,

The theoretical circuit, using one and two stages of H.F. amplification is as shown. In a future issue the writer hopes to show how to apply the principle to existing sets employing transformer coupling, and also to give practical details for the construc-

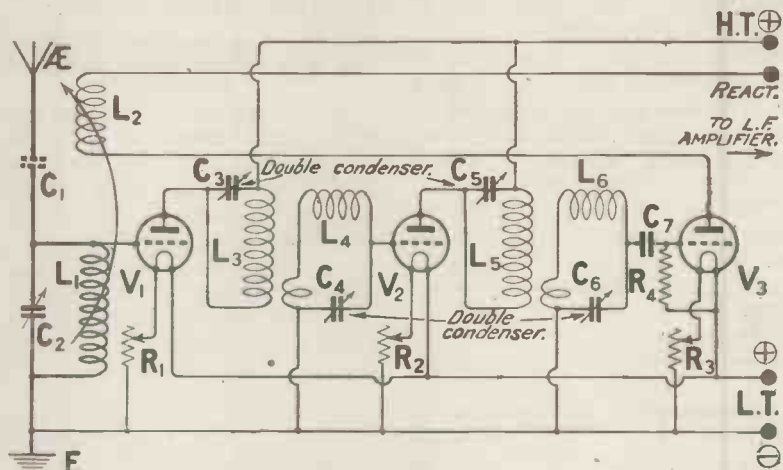

Two stages of H.F. with two double condensers.

January 9). Owing to the high degree of selectivity obtained by the method of intervalve coupling described the writer has found that it is quite unnecessary to employ a loose-coupled aerial, the ordinary single tuned direct-coupled aerial coil being quite adequate for completely separating stations separated by only a few metres in wavelength.

tion of the coils and the condenser connections, etc.

Sets of which details have been given in this journal and in *Modern Wireless*, to which this method is applicable, are as follows:—

- Single valve reflex.
- Puriflex.
- 3-valve dual.
- Transatlantic.

**Some Reaction Effects Explained**

By J. F. JOHNSTON (5LG)

PRACTICALLY every user of valve apparatus is familiar with the phenomenon of reaction, knows how to produce it, how to control it, and knows its effects upon his reception. But how many really understand how and why the various effects are produced? The whole phenomenon has become so familiar to most people that the effects of its application are apt to be taken for granted without inquiry as to the why and wherefore.

Here are a few of the problems that confront the beginner who stops to think. Why does not the valve oscillate most violently when the reaction coupling is the

closest possible? Every transmitter knows that the most powerful oscillations are produced soon after the reaction coil has been brought past the point where oscillations commence. Why is the plate current less when the valve is oscillating than when it is not? When the experimenter first connects a milliammeter in the plate circuit he is usually surprised to find the plate current drops sharply as soon as the valve commences to oscillate, when he rather expected it to increase. Then again, what really causes the valve to oscillate at all? It would seem to many that, if when the grid became more positive the anode current

increased, causing the grid to become still more positive, the effect of reaction ought to be to cause the grid to become as positive as possible and for the valve to reach a state of stability passing the maximum anode current until the H.T. battery ran down.

**Why a Valve Oscillates**

To take the last question first, Fig. 1 shows the simplest reaction circuit, while Fig. 2 shows the characteristic curve of the valve. It will be seen that normally the valve is operating at point A on the zero-grid-volts axis. Suppose now an incoming signal makes the grid slightly more positive. This causes the current flowing through L2 to increase, and as L2 is coupled to L1 in the right sense to produce a current in L1 in the same direction as before, the grid becomes

still more positive. This cycle of operations goes on until the grid reaches point B on the curve. Here, however, must come a change. Beyond this point an increase of positive potential on the grid can obviously have no effect on the anode current, which is already at its maximum. The position of affairs is now this:—The grid and the side of  $C_1$  connected to the grid have been raised to a considerable positive potential by the continually increasing current through  $L_2$ , inducing a corresponding current in  $L_1$ .

The current through  $L_2$  having now become steady, the induced current in  $L_1$  ceases. There is

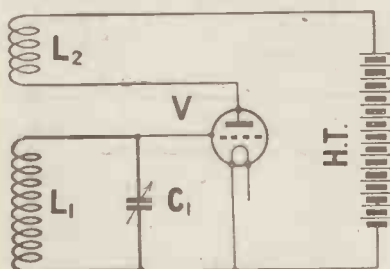

Fig. 1.—A simple reaction circuit.

now nothing to maintain the grid at its abnormal positive potential, and the condenser  $C_1$  commences to discharge through  $L_1$ .  $L_1$   $C_1$  constitute an oscillatory circuit, and therefore the discharge of  $C_1$  would in any case be oscillatory, and would cause the valve to oscillate until the grid had settled down at its normal potential.

However, as soon as the grid potential starts to fall the current through  $L_2$  decreases, and a current is induced in  $L_1$  assisting that produced by the discharge of  $C_1$ . A cycle of operations now begins exactly similar to that which brought the grid to its positive potential, but in the reverse direction.

Under the combined influence of the decreasing anode current and the discharge of  $C_1$  the grid potential is hurled swiftly down the curve until point C is reached. Here, again, must come a change. The anode current having reached zero, the induced current in  $L_1$  ceases. The grid (and  $C_1$ ) are again at an abnormal potential (but in the opposite sense), and as there is now nothing to hold them there they at once begin to revert to

normal.  $C_1$  commences to discharge and the grid begins to move up the curve towards point A. The original cycle begins again, and again raises the grid to point B, and thus, although the effect of the original impulse which first altered the potential of the grid has passed away, the valve continues to oscillate.

**Why the Optimum Reaction Coupling is not Necessarily the Closest Possible**

It will be seen from the foregoing that after the grid has reached the end of its first swing it is kept moving up and down the characteristic curve by the combined influence of the varying anode current and the oscillatory discharge of  $C_1$ . To produce the most powerful oscillations it is therefore necessary to arrange that the varying plate current moves the grid from point B to point C in the same time that the condenser  $C_1$  would take to discharge if left to itself. The natural discharge period of  $C_1$  depends upon its capacity and the inductance of  $L_1$ . Therefore there will be a different optimum coupling for different values of  $C_1$  and  $L_1$ , which is quite unlikely to be the closest possible.

**Why the Plate Current is less when the Valve is Oscillating**

It is true that when a valve is oscillating, and when the grid is at its maximum positive potential, the anode current is greater than it was when the valve was in a condition of stability. But it is also true that when at the other extreme of its oscillatory swing the grid is at its negative maximum, the plate current is

□ □ □

**A Reader's Results**

SIR,—It may interest you to know early Monday morning between 12.30 and 3 a.m. I received American broadcasting on a single-valve reflex circuit, No. 18, by John Scott-Taggart in the July issue of *Modern Wireless*; the programme was as follows:—

12.30 : A sermon.

1 a.m. : Music by Blind Institute, on the organ, the items being as follows—"Killarney," "Come Back to Erin," and other Irish melodies.

for the moment zero. Now there is no instrument capable of mechanical movement which can follow the extremely rapid variations of current that take place in the anode circuit of a valve oscillating at high frequency. Even if there were the human eye would not be able to follow the movements of a needle swinging a million or so times a second. All that a milliammeter can do, therefore, is to show the average current flowing through the valve.

Now the average value of an alternating current of pure sinu-

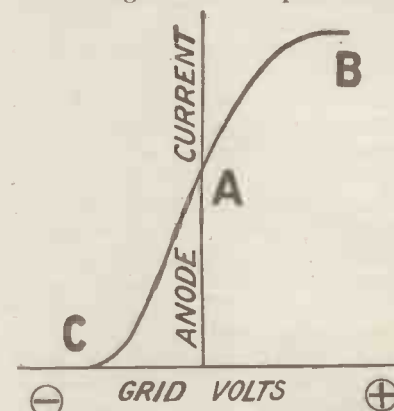

Fig. 2.—A characteristic curve.

soidal form is .707 of its highest (or peak) value. The average value of the anode current of an oscillating valve will therefore be a fraction of its highest value, depending on how much the waveform of the oscillations differ from a pure sine curve (which in turn depends on the constants of the valve and circuits), but will always be considerably less than the current at the moment the grid is at its maximum positive potential.

□ □ □

2 a.m. : Baritone and soprano songs and orchestral items until 3 a.m.

I was unable to understand the call sign, but think it was WGY, fading at times. Taking things on the whole it was good reception for a single valve.

I would like to know if this is correct, as an attempt to broadcast KDKA through London on Sunday evening failed owing to atmospheric disturbances. I feel confident it was American broadcasting.

Yours faithfully,  
W. H. CURTIS.

Boston, Lincs.





WITH regard to my note last week about the use of neon lamps for smoothing, the only real disadvantage of this arrangement is that it is not possible to tell what the actual high-tension voltage is. The high-tension voltage depends upon the amount of current taken from the mains, and if a voltmeter is connected across the high-tension terminals of the set, the current taken by the voltmeter will affect the true reading. The number of valves used in the set will also affect the high-tension voltage, but generally speaking, this disadvantage is not an important one.

#### Voltages Obtainable

The ordinary standard neon lamp, which may be purchased for 3s. 6d., is reversible, and it is possible to obtain two voltages by the simple process of reversing the lamp in the socket. In one case the voltage to the valve may be 60 and in the other 85; by using two neon lamps in parallel further voltages may be obtained.

There is absolutely no wastage by using neon lamps as there would be if some kind of potentiometer arrangement were used. The neon lamp takes just about enough current to work an ordinary receiving set, the maximum amount being about 10 milliamperes. If more than this is wanted, of course, more neon lamps may be connected in parallel.

#### C.A.T. in Reflex Circuits

When using my method of connecting the secondary of the transformer in the aerial circuit in reflex circuits, the condenser across the secondary, which will usually have a value of  $.001 \mu\text{F}$ , will lessen the effective capacity across the aerial inductance, and this will be equivalent to connect-

ing a series condenser in the aerial lead. The value of the condenser across the secondary of the transformer will consequently affect tuning and a larger constant aerial tuning condenser may be employed. In the case of reflex circuits, the C.A.T. condenser may have a value of  $.0002 \mu\text{F}$ .

#### Counterpoise Earth

Counterpoise earths are well worth trying, and I have had many reports from readers who find that a counterpoise earth not only eliminates troubles due to

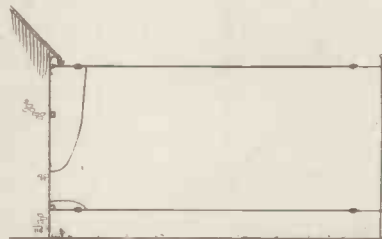

Fig. 1.—A counterpoise arrangement

the proximity of tramways, or cables carrying varying currents, but causes a general increase in signal strength. The use of a counterpoise generally means that less reaction is required, so that instability of high-frequency amplifying valves is to be expected.

There are some quarters where it is very difficult to say exactly why a counterpoise earth should give better results than an ordinary one, but there is no doubt that such is the case.

Much, of course, can be done in the way of improving the ordinary earth connection, which is usually the last item in an installation which receives careful attention. The best kind of earth seems to be one in which a number of wires are buried under-

ground, the position being usually underneath the main aerial.

If an experimenter feels that he is in a particularly poor spot for reception, it may be that his earth is the trouble, and that a counterpoise earth will remedy matters.

#### Stabilising H.F. Circuits

Although perhaps not widely appreciated, a detector valve also carries out high-frequency amplification. It depends entirely on the experimenter whether the high-frequency output of a detector valve is used or not. If it is desired to introduce reaction into some part of the circuit, a reaction coil may be included in the anode circuit of the detector valve, but if this reaction is not needed, and there may be reaction in other parts of the circuit, either intentional or inherent, the best thing to do is to kill this high-frequency output of the detector valve. Do not allow it to do what it likes, but the chances are that it will make for instability without contributing in any way to the advantageous working of the set. Take, for example, the case of a two-valve receiver in which the second valve acts as a detector, and the first as a high-frequency amplifier. If the telephones, or low-frequency output circuit of the second valve, are not shunted by any condenser, the anode circuit of the second valve will vary at high-frequency potential to the filament, and these high-frequency potentials on the anode of the second valve, while not doing any good, tend to increase the instability of the whole circuit.

#### Telephone Condenser

Stability may often be regained by simply connecting a condenser across the telephones, or whatever low-frequency circuit

is in the anode circuit of this second valve. This condenser short-circuits the high-frequency output of the detector and so reduces the chance of complications. Of course, I do not mean to imply that the connection of this condenser is going to improve signal strength. It may be that when no special reaction is provided, the high-frequency potentials on the anode of the second valve may introduce a reaction effect which will strengthen signals, but I always believe in stabilising a circuit first and then introducing reaction afterwards, rather than have to rely on a peculiar inherent reaction effect which will vary with different valves and different telephones,

or a different low-frequency output circuit.

IP and OP

With regard to the IP and OP terminals, and IS and OS terminals of iron-core transformers, the position now has become very complicated, and the rule I gave many months ago about connecting the OS terminal of the secondary to the grid does not necessarily apply. For example, the new R.I. transformer has a different method of winding and best results are obtained by connecting the IS terminal to the grid. As a matter of fact, since I made the original note, many new transformers have been placed on the market and all sorts of different kinds of wind-

ing are employed. Sometimes the primary is inside and the secondary outside, and sometimes the position of the windings is reversed. Sometimes the windings are placed side by side, or in alternate grooves. In other cases, the two windings are wound on together, and so it is almost impossible to tell which is the best way round for the transformer to be connected without actually trying it.

It is therefore safest to try reversing the secondary connection to the low-frequency transformer and then to reverse the primary connections and repeat the process. You are then sure of finding out which way round gives the best results in your particular case.

A Useful Home-made Potentiometer

A SIMPLE potentiometer may be made as follows. The complete instrument is shown in Fig. 1. Material required will be 1 ebonite knob, some 1/8-in. or 3/16-in. thick ebonite strip brass, 3 terminals, (small), 3-in. external dia. cardboard former, and a quantity of No. 30 gauge resistance wire. Cut off a piece of cardboard former 1/2-in. deep, as shown in

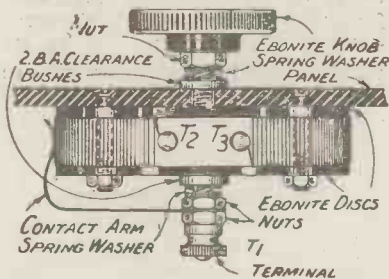

Fig. 1.—The complete potentiometer.

Fig. 3. Wind the wire closely by passing the bobbin through the centre, and continue until the former is full, when each end is secured by means of a terminal, as indicated. Next, cut two discs of ebonite, 3 in. in dia., and make a 2 B.A. clear centre drilling in each, and two further drillings in each for the panel securing screws. Having drilled the panel hole, secure the three pieces firmly by means of two 4 B.A. screws. Now insert the 2 B.A. spindle, assembling a

2 B.A. clearing bush, a spring washer, and an ebonite knob on the panel end of the spindle. Next secure a 2 B.A. clearing bush, spring washer and nut on

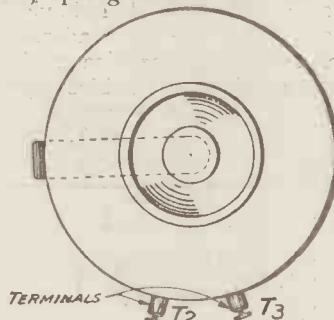

Fig. 2.—A plan view of the underside of the potentiometer.

the underside. Assemble the contact arm, which may be made of brass strip, as shown, and secure by means of a lock nut. To complete the component screw on to the spindle the upper portion of a 2 B.A. terminal. The method of embodying the potentiometer in a crystal receiving circuit is shown in Fig. 4. Terminal T1 is connected to the crystal cup, T2 to a 4 1/2-volt pocket battery on the positive

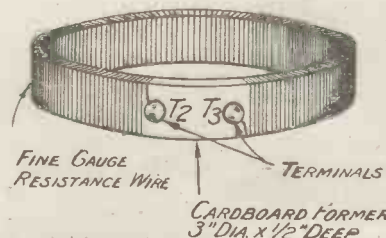

Fig. 3.—Showing how the resistance is wound.

side, the negative being joined to the positive of a further 4 1/2-volt battery and the negative of the second battery to a switch which is connected to T2. Connection is made from the junction of the two batteries to the telephones. The 'phones should be disconnected when the set is not in use, and the battery switch opened, thus preventing the battery from discharging itself through the resistance of the potentiometer.

H. B.

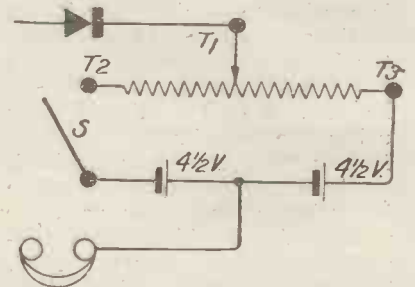

Fig. 4.—How to connect up to a crystal receiver.

MODERN WIRELESS COIL TABLE.

A Useful Aid to All Listeners.

Readers will be glad to know that tables, giving coils for aerial, anode, and reaction, for different stations, are now available, printed on stiff card and varnished, suitable for hanging up near the wireless receiver. See our advertisement columns for detail.



## Some Notes on French Valves

WHAT OUR GALLIC NEIGHBOURS ARE DOING

By J. W. DAVIES (6NH)

**D**URING the last year or so tremendous strides have been made by the English valve manufacturers, and it is interesting to note whether this progress has been paralleled in other countries. Wireless in France has not "caught on" to such an extent as it has in England, so there are not so many types of valves produced;



The French R valve closely resembles our own.

nevertheless, considerable progress has been made.

### The R Valve

The French R is a general purpose valve and very similar to our own R valves. It consumes approx. .6 amp. at 4 volts and is produced by different manufacturers in different forms, and although the prices are the same, the construction of some makes is far better than others. Up to the present no valves have been produced for one specific purpose, with the exception of an anti-capacity valve for high-frequency amplification. This valve has the plate and grid leads brought out to "horns" in the top of the glass, and resembles a transmitting valve in appear-

ance. Although there is now a very comprehensive range of power valves in England, as far as the writer knows, there is not a single power valve produced in France, or if they are produced they are certainly not available to the amateur. Such a state of affairs is surprising, and it can only be expected that it will be remedied in the near future.

### Four-electrode Valves

It will be remembered that during the recent "booming" of "high-tensionless" receivers in England, the majority of four-electrode valves used were of French manufacture. These valves have only been manufactured during the last six months, and although they are used by experimenters, they have certainly not been generally adopted.

### Low-consumption Types.

Turning now to the question of low-consumption valves, it may be as well to give particulars of a valve which is unknown in England, but which has been produced in France for a considerable time. The valve referred to is not a dull-emitter, but a valve whose filament has been reduced to such small proportions that it only takes .15 amp.—a figure usually associated with dull-emitters. Naturally, the performance suffers to a certain extent, although this valve gives excellent L.F. amplification. This was the only attempt made to produce a low-consumption valve until just recently, when .06 valves were introduced. These valves can be bought in England, and like French R's are very similar to the English product; the filament voltage is rated at 4 volts maximum and the plate at 80. Although these valves are slightly microphonic, they are very efficient in performance.

This concludes the receiving valves, and although progress has run on similar lines, there are, however, some notable omissions. Firstly, there is no dull-emitter consuming about a quarter of an ampere; secondly, there is the striking lack of power

valves already noted, and thirdly, the recent policy of English manufacturers to produce special H.F. and L.F. dull-emitters does not seem to have been copied. It might also be added that there is no soft valve made for detection, but this omission also applies to England, and amateurs in both countries have to rely on Dutch valves for this purpose.

There are numerous French valves on sale in England and the variance in prices is amazing. Below will be found the prices of the valves which have been referred to in this article; the first column gives the retail price in France; the second, the equivalent value in English money at the present rate of exchange, and the third, this value with an addition of 33½ per cent. duty which has to be paid on all valves brought into the country:—

Type	Frs.	s.	d.	s. d.
French R valve	18	4	2	5 7
H.F. anti-capacity valve	35	8	2	10 11
0.15 Bright-emitter ...	25	5	10	7 9
0.06 Dull-emitter...	37.50	8	9	11 8
4 Electrode valve ...	30	7	0	9 4

Although the prices of different makers vary a franc or two, the above prices are those of the most prominent manufacturers.



A type of .06 valve very popular across the Channel.

# The Adair Fund for the Wounded

A Matinee at the Palladium

IT may come as a surprise to many of the "listener" readers of *Wireless Weekly* to learn that in our War Hospitals around London there are still some 5,000 badly-wounded soldiers who have little left to brighten their ravaged lives. The Adair Wounded Fund has consistently for nearly four years provided weekly Entertainments for these unfortunate sufferers, who, in spite of their varied and multitudinous casualties provide wonderful audiences that would be difficult to equal anywhere.

### Previous Entertainments

Ninety-four of these Entertainments have already been held at Wigmore Hall, the Palladium, and elsewhere, but on the afternoon of Sunday, November 23, a specially gorgeous treat awaits our ex-Tommies, as the British Broadcasting Company will act as Hosts on this occasion, and will provide the expenses for the Entertainment and the Tea. Over 600 wounded soldier guests will be present, and the news that the B.B.C. are to be "in command" has aroused much more than a passing interest amongst them. One great and popular feature of the event will be that the world-famous "Uncles" and "Aunts" and other Officers of the B.B.C. will be present and each one will take charge individually of one of the 16 private boxes available—each box representing a Hospital and containing a party of patients from that particular Hospital.

### John Henry and Blossom

As the subjoined list shows, there will be much friendly and jovial rivalry between the boxes to gladden for a time the hearts of those "broke in our Wars." As is fitting with any function associated with the Adair Wounded Fund the Entertainment provided will be absolutely one of the best, with John Henry and Blossom, dainty Isobel Elsom, and many other great stars shining in the artistic firmament. "Gaiété, toujours la gaiété" is the motto of this

Fund, and is thoroughly lived up to on all these occasions.

### The Lucky Draw

Miss Phyllis Dare will distribute the gifts in the "Lucky Draw," which is such a humorous and much-welcomed part of the Entertainment, and Ben Lawes, the popular rotund Comedian, will, as he always does at these Palladium functions, act as M.C.

### Further Information

Mr. Basil F. Leakey (Alan Adair), the Honorary Organising Secretary of the A.W.F., will be more than grateful for the support and co-operation of all connected with "Wireless," and will be delighted to furnish from Somerset House, New Barnet, any further information required, or to issue tickets to any of our readers wishing to be present on the 23rd.

Although no personal services are paid for—artists, orchestras, film operators, transport drivers, etc., all giving their services free—yet funds are urgently needed to meet the unavoidable out-of-pocket expenses of the weekly

Sunday afternoon Entertainments and Teas.

There are no administrative expenses whatever and absolutely no waste, and it will be indeed a gracious act if the general run of "Wireless" folk back up the kindly and worthy efforts of the B.B.C.

### RADIO NOTES

#### College Graduates Swarm to Radio Research Work

The radio research laboratories of the A.T. and T. Co. and the Western Electric Co. are full of men who have graduated from the various technical schools of New York City, and they have now reached a total of 79. Columbia heads the list with 33, Brooklyn Poly is second with 28, and New York University and the City College are represented by 9 men each. In all there are 800 college graduates engaged in radio research work with these two companies, and 35 of these are PhD's.

#### Whalers Adopt Direction Finders

Whaling ships plying the North Sea are now fitted with Marconi direction finders, in order to locate each other and avert collisions in fogs or darkness.

### ADAIR WOUNDED FUND.

Third Palladium Matinee, November 23rd, 1924.

	Box.	Hospital.	Host.
Right	A.	—	Miss Phyllis Dare and Party.
	B.	Fulham (War Seal).	Capt. C. A. Lewis (Uncle Caractus).
	C.	Ealing (St. David's).	Mr. Rex Palmer (Uncle Rex).
	D.	Hendon (Colindale).	Miss Yvette Pienne (Auntie Yvette).
	E.	Shepherd's Bush (M.O.P.).	Mr. J. G. Broadbent.
	F.	St. Dunstan's.	Capt. P. P. Eckersley.
	G.	Ewell (M.O.P.).	—
	H.	Cheam (St. Anthony's)	Mr. G. V. Rice.
Left	AA.	—	—
	BB.	Sidcup (Queen's).	Miss Cecil Dixon (Auntie Sophie).
	CC.	Ebury Street.	Mr. Arthur R. Burrows (Uncle Arthur).
	DD.	Poplar.	Mr. Leslie G. Mainland.
	EE.	Fernbank (M.O.P.).	Mr. Stanton Jefferies (Uncle Jeff).
	FF.	Roehampton.	Mr. J. S. Dodgson.
	GG.	Orpington (M.O.P.).	Mr. John Henry and Blossom.
HH.	Bethnal Green.	Mr. K. A. Wright.	



# A Refinement for Coil Holders

By WILLIAM SERIGHT, M.A.

*A useful device for quick and accurate tuning, lessening risk of disturbance by oscillation*

IN the issue of October 15 of *Wireless Weekly* attention was drawn to the value of accurate tuning and the need for condenser indicators, by Mr. Percy W. Harris, under "Random Technicalities."

"We all want accurate tuning, yet how can we get it without some kind of indicator?"

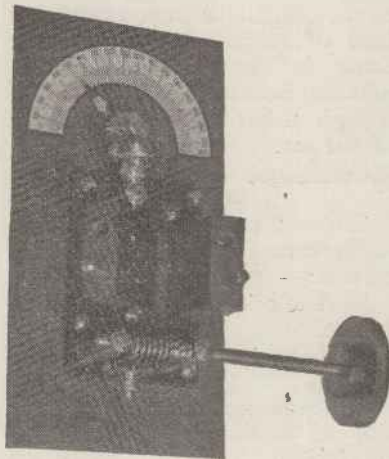

*By means of gears as shown, the degree of reaction is recorded on the scale.*

The same problem faced the present writer some time ago in its bearing on coil separation in reaction, with a view to cutting out unnecessary oscillation.

The set in use was the ST100 (now modified to 3rd coil for crystal). The pointers fixed gave definiteness and accuracy so far as the condensers were concerned, but the adjustment of reaction was unpleasant and unnecessarily slow.

The pump action of a model steam engine suggested worm and gear wheels of Meccano make—an idea recently dealt with in *Wireless Weekly*—but in this case the idea was carried further, viz., a right-angled-acting gear wheel coupled to an ordinary gear wheel of like size, which, having pointer fixed, gave scale readings of actual reaction in degrees.

This arrangement enabled the writer to use with accurate results the table shown.

After several observations, the best readings being noted as above, the set could be adjusted prior to lighting the filaments to the required amperage.

This standardisation brings in Broadcasting, B.B.C. and Conti-

degree scale and 6 in. by 3 in. ebonite, the experimenter can make up a two-coil holder, stronger and more efficient than any so far observed on the market, and by its calibration sense how his set is working to

Coils.	Coil Separation.	Aerial Var. Con.	Secondary V. Con.	Vernier to Secondary Con. in degr's.	Ammeter.		Station.	Wave.
					1st Valve.	2nd Valve.		

mental stations, etc., with comforting speed, and any tendency to oscillation can be met by the vernier of the secondary condenser. The accompanying photograph gives an idea of the simplicity of the arrangement.

The coil holders are of the 1½ in. variety, sold everywhere, the swinging one having ½ in. sawn off in present case to allow clearance; 3-16 in. rod is used for axles, a 3-16th drill being used on the approximately 5-32 bore of Meccano parts, and so simplifying fitting.

Thus with two coil holders at 7½d. apiece, four smaller Meccano fittings at 6d. apiece, 4 in. of 3-16 in. brass rod, 4 in. of ½ in. brass rod, a transfer or ivorine

the different wavelengths. Care in fitting parts will avoid all backlash, and the satisfaction of greatly increased control be experienced.

## U.S. PACIFIC COAST STATIONS HEARD IN ENGLAND

Mr. W. A. S. Batement, of London, listened to four American amateurs on the Pacific Coast on October 12, 1924, which he logged as follows: 6 BKA, 6 BQR, 6 BJJ and 6 ARB. The messages were received on one or two valves, and 79 other American amateurs were heard the same evening by Mr. Batement.

## THE NITON TRANSMITTING STATION.

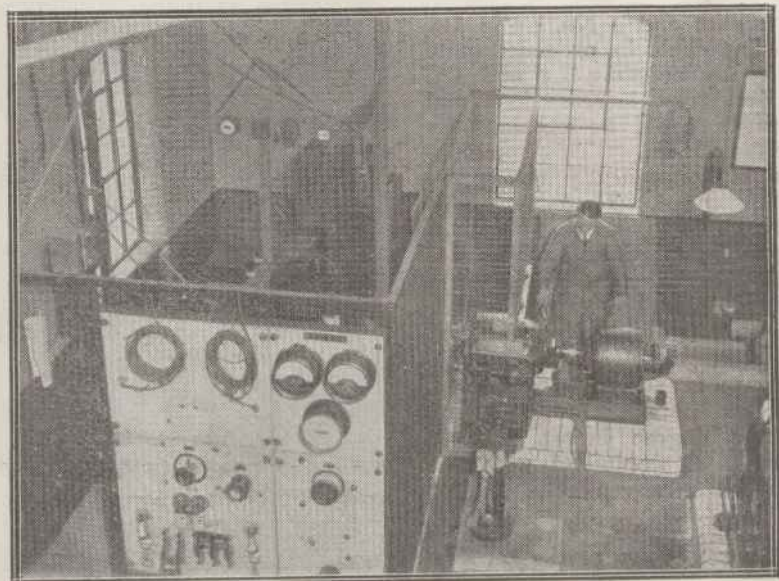

*This photograph shows the spark transmitter at the Niton station, one of the busiest stations on the south-coast of England.*

## Test Report on the "Two-Valve and Crystal Receiver using the ST152 Circuit"

*Constructional details of this receiver appeared in our last issue*

THE ST152 set was tested on an aerial, 75 ft. twin, 45 ft. high, about 9 miles from 2LO.

Owing to 2LO's power being less than normal, the usual loud-speaking obtained with a circuit of this class was not obtained, although sufficient to be heard outside the house with all windows and doors shut. A standard ST100 was placed on test at the same time, so that a comparative test could be made.

The ST152 proved to give slightly greater signal strength, owing to the fact that the reaction effect could be taken further than is usual in the same circumstances with a standard ST100.

### Constant Aerial Tuning

During the tests constant aerial tuning was employed. A No. 50 coil was placed in the aerial socket (L1), a 75 in the grid circuit (L2), a 50 in the first part of the anode circuit, a 50 in the other portion across which the crystal and transformer primary are placed. A 200 coil was inserted in the high-tension lead supplying the first anode (L5). The tuned part of the anode circuit was then modified, a No. 25 being placed in L3 socket and a No. 75 in L4. Buzzing could be produced quite easily by coupling L2 and L3, and no great increase in signal strength could be obtained by coupling them. This combination is consequently not to be recommended. These two coils were changed, so that the No. 75 was in socket L3 and the No. 25 in L4. The set was slightly retuned and the crystal reset. It was found that when L2 and L3 were coupled, considerable increase in signal strength and reaction obtained to a much greater degree before buzzing started, as compared with the previous arrangement.

### Selectivity

The selectivity of the set was greatly increased, it being especially noticed that the anode

tuning condenser was very sharp, 2LO at 9 miles being lost 5 deg. each side of the loudest point on the 180 deg. dial, on 'phones. However, including the effect obtained with the use of reaction, signals on the loud-speaker were not quite so loud as were at first obtained, with two No. 50 coils in L3 and L4. So two 50 coils were replaced in this circuit which gave the most satisfactory results, reaction being obtained with good increase in signal strength. This proved to be the most efficient combination for the reception of 2LO, the final coils being as follows, for constant aerial tuning. The choke L5 was a No. 200 throughout:—

L1	L2	L3	L4	L5
50	75	50	50	200

2LO tuned on the aerial condenser at 80 deg. and the tuned-anode condenser at 60 deg. As stated before, very good loud-speaker results were obtained, rather better than with a standard ST100. The selectivity was much better than with the usual ST100. A 6-volt accumu-

lator was used on the filaments and approximately 100 volts on the anodes, and a 1½-volt grid-bias battery was found sufficient on the grids of the valves, which were of the "general purpose" type.

### Setting for 5XX

5XX came in, with parallel tuning, using a No. 150 for L1, No. 200 for L2, 150 for L3, 150 for L4, and a 300 coil in L5. The aerial tuning condenser was set at 20 deg and the anode condenser at 110 deg. Signals were so strong on the loud-speaker that the set had to be detuned to enjoy the programme. The set suffers from the same trouble as the original ST100, as regards lack of range, but Manchester came in on the loud-speaker without interference from 2LO, a high tribute to the selectivity of the set.

### Advantages over the Standard ST100

The set possesses the following advantages over the standard ST100:—

- (1) The selectivity is very much greater.
- (2) Signal strength is slightly improved.
- (3) Stability is much greater and no stabilising resistance is required.
- (4) The disturbance from electric light mains, etc., which sometimes troubles the ordinary ST100, is eliminated.

## THE BELFAST STATION



*This photograph shows the Marconi Transmitter at the Belfast Station, which was opened recently.*



# THE BADGE IDEA



OF COURSE ONE CAN DO THIS SORT OF THING IN AMERICA WITHOUT LOSING ONE'S STATUS AS A NORMAL HUMAN BEING

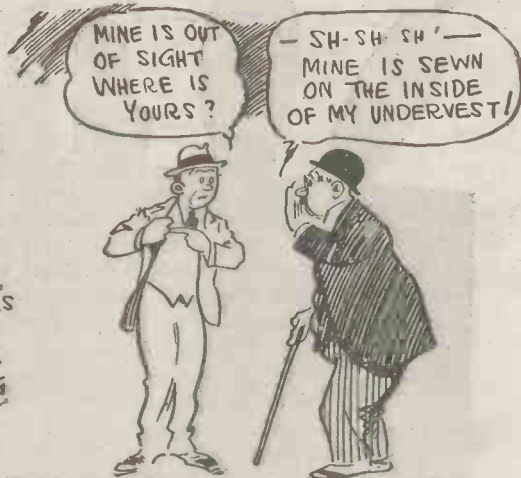

BUT THE AVERAGE BRITISHER SIMPLY HATES TO BE CONSPICUOUS.

BUT REALLY — IF THIS BADGE IDEA DOES CATCH ON

ONE NEVER KNOWS



WHERE — IT — MAY



— END — BUT — WE HAVE A GOOD IDEA!!!

— Gen Shaw 1924



The receiver complete with valves, H.F. transformer and plug-in coils.

THE combination of one high-frequency valve, detector and note magnifier so connected as to form a straight three-valve circuit, is, perhaps, one of the most popular arrangements of modern radio, and makes a good all-round broadcast receiver which is neither costly in its demands upon the pocket of the experimenter so far as component parts or running expenses are concerned.

When building a receiver incorporating this arrangement of valves one is immediately faced with the question of how to couple the high-frequency valve to the detector which follows, the four most useful methods being tuned anode coupling, tuned transformer, semi-periodic transformer and resistance-capacity coupling.

The method which is most commonly used when employing only one high-frequency stage is the tuned anode, and for this reason transformer coupling was

chosen in the receiver under description as being a departure from the more usual practice without loss of efficiency. The method of coupling described in more detail is the "tuned transformer," but unlike most circuits using this coupling the secondary is tuned instead of the primary winding, giving thereby slightly better stability.

#### Switching

In the present receiver no switching arrangements have been introduced, and in those cases where readers intend to deliberately depart from the design given here, it must be remembered that there will be certain losses in efficiency by the introduction of such switching, especially in the circuit of the high-frequency valve. In receivers where switching forms part of their make-up the position and wiring of such switches have been carefully thought out and planned by the author in order

## A Transformer-Coupled Three Valve Receiver

By STANLEY G. RATTEE, Member I.R.E., Staff Editor.

Three-valve combinations containing one L.F. valve are deservedly popular. In this article the transformer type of coupling is described.

to avoid "capacity effects," involving very often many hours experimenting and testing. To introduce into a receiver haphazard switching when the original set was designed for use without switches is neither fair to the author nor oneself, and more often than not results in a poor and unselective instrument.

The make-up of the receiver and the neat lay-out of the panel may be observed from the photographs. The arrangement of the terminals may be also seen, those on the left being for the aerial and earth, whilst those on the right are for the telephones. The terminals for the batteries are at the back of the set, and the reason for this arrangement is to permit the wiring of the high-frequency transformer connections to be kept as short as possible, the H.T. positive and

L.T. positive, for instance, being immediately behind the H.F. transformer.

In order to allow the wavelength range of the receiver to be as broad as possible, plug-in coils are used as inductances and the well-known method of constant aerial tuning is employed; the three left-hand terminals permitting either its inclusion or exclusion as may be desired. Two special terminals for grid cells should the reader desire to use dull-emitter valves, are provided, in addition to suitable filament resistances for both types of valves.

#### The Circuit

A theoretical understanding of the arrangement may be gathered from a careful study of the circuit diagram, wherein  $L_1$  is the aerial coil tuned by the condenser  $C_1$ ,  $L_2$  the reaction coil

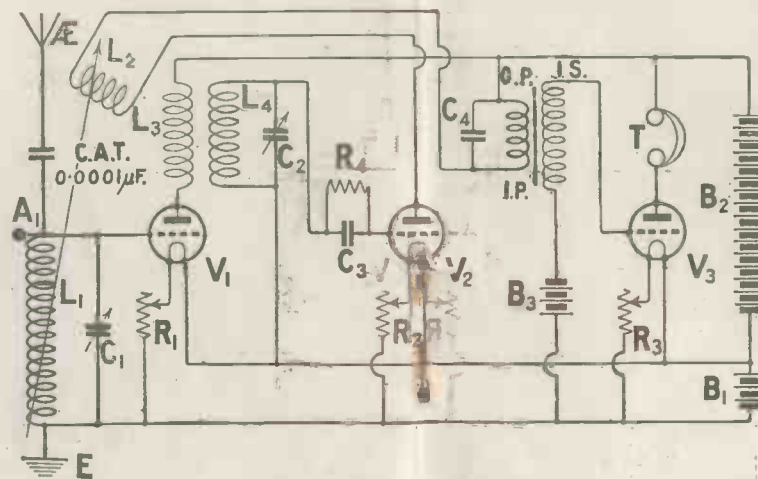

Fig. 1.—The circuit arrangement of the receiver.  $L_3$  and  $L_4$  are the windings of the H.F. transformer, of which the secondary is tuned.





*A view of the panel showing the layout of the parts.*

and L<sub>3</sub> and L<sub>4</sub> the primary and secondary, respectively of the high-frequency transformer. The constant aerial tuning condenser is marked C.A.T. in the diagram, and it will be seen that if we connect the aerial as shown and the earth to E, leaving the terminal A<sub>1</sub> free, then the 0.0001  $\mu$ F condenser is in circuit. On the other hand, if we connect the aerial to A<sub>1</sub> and the earth to E, leaving the terminal A free, then the aerial circuit includes L<sub>1</sub> and C<sub>1</sub> only. The values of the various components indicated by letters will be found in the list of components. It will be seen that aerial reaction is employed, and though most readers will by now be acquainted with the interference which the injudicious use of this form of reaction is capable of making, still further does it seem necessary to advocate careful adjustment of this coil without that tendency to force the receiver to do its very utmost. Too close adjustment of the reaction coil does everything to mar good reception, in that whatever telephony is being received it is bound to be distorted, whereas with the proper adjustment, reception is good and clear with the set off that point of oscillation.

#### Components

The instrument, as photographed, is made up with the following materials and component parts, and in accordance with our usual practice the names

of manufacturers are given for the assistance of readers. Though this information is given, it is not intended, however, that readers should bind themselves to these particular makes, but is merely for the assistance of those readers who wish the information. In so far as values are concerned it is imperative that these be treated with every respect, in that any departure from the figures given may result in either the receiver failing to work at all, or else not working with that efficiency which is expected of it.

One ebonite panel, measuring 9 in. by 14 in. by  $\frac{3}{8}$  in. (Radion).

One 0.0005  $\mu$ F variable condenser (Bowyer-Lowe).

One 0.00025  $\mu$ F variable condenser (Bowyer-Lowe).

One two-way coil holder (Burne-Jones).

Three Lissenstat minors (Lissen, Ltd.).

One "Eureka" transformer.

One H.F. plug-in transformer (300-600 metres) (Peto Scott).

One similar transformer (1,200-2,600 metres) (Peto Scott).

One 0.0003  $\mu$ F fixed condenser with clips (Dubilier).

One 2-megohms grid-leak (Dubilier).

One 0.0001  $\mu$ F fixed condenser (Dubilier).

One 0.001  $\mu$ F fixed condenser (Mansbridge).

Sixteen valve sockets or alternatively four valve holders.

Eleven brass terminals.  
Set of plug-in coils for the wavelengths desired.  
Quantity of No. 16 tinned copper wire for connecting purposes.

**The Panel**

This is made from the ebonite sheet appearing first in the list of components, and is drilled in accordance with the instructions given in the illustration of the panel lay-out. When purchasing the ebonite for this panel readers should ascertain whether or not the material supplied is guaranteed to be free from surface leakage. This precaution is necessary, in view of the fact that there is now on the market ebonite of both types, meaning guaranteed and unguaranteed. Whenever possible the former should be purchased, but in cases where only the latter is possible, after the drill holes and counter-sinkings have been made, the surface skin should be removed by means of fine emery or glass paper, the final finishing being made with a soft rag and drop of oil to retrieve the deep black it originally possessed.

The ebonite used in the set under description is what is known as "Radion," and be-

sides being guaranteed has the added advantage of possessing a highly-glossy finish, which adds to the appearance of the set; in cases where this material is used the precaution of rubbing is

other that some readers experience difficulty in wiring receivers with stiff wire, preferring the somewhat easier method of using soft tinned copper wire and insulating sleeving. In these circum-



A view of the back of the panel, which will help constructors in wiring up.

totally unnecessary, and will spoil an otherwise good panel.

**Wiring the Receiver**

The various photographs of the receiver will show to the reader the method of wiring employed, namely, stiff wire without the use of systoflex, all connections being soldered. It would seem for some reason or

stances readers may, of course, use the easier method, but extreme care must be taken to keep all leads as short as possible, and where leads cross each other they should do so at right angles, otherwise the set will show a very great tendency to burst into oscillation, besides presenting considerable difficulty

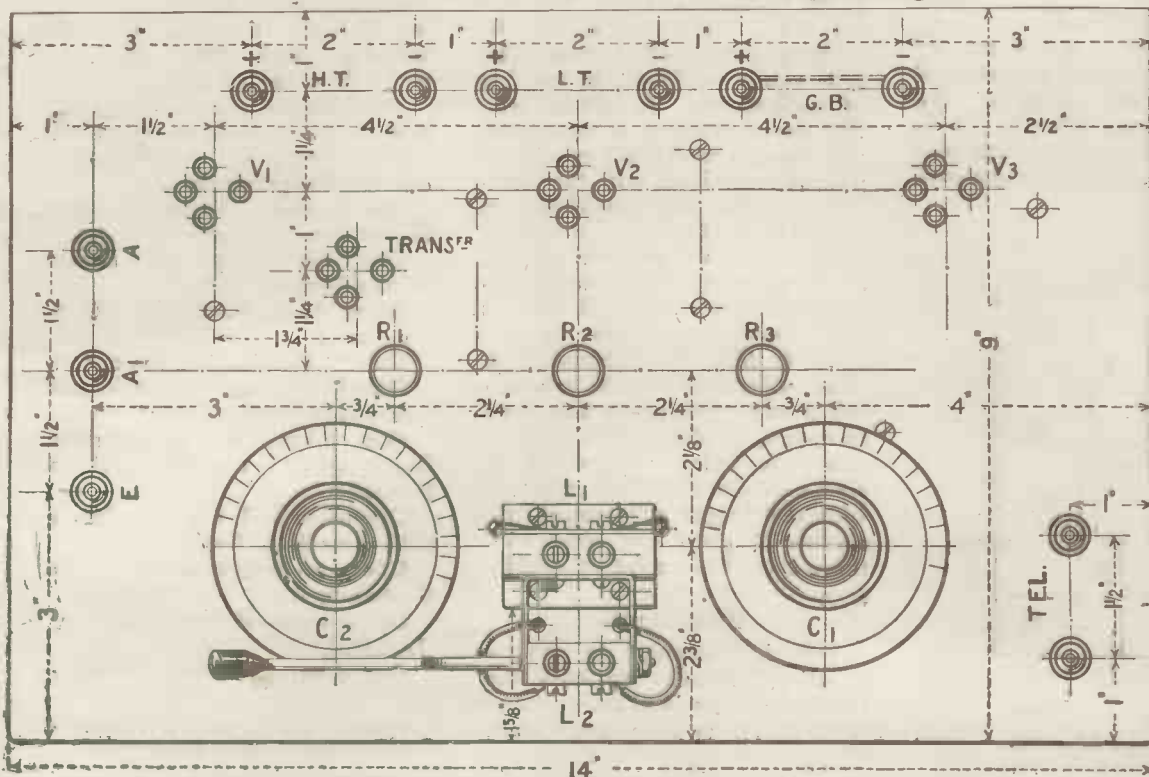

Fig. 2.—The layout of the panel. It will be seen that few holes are required. A full-size blue-print is obtainable, No. 73A.



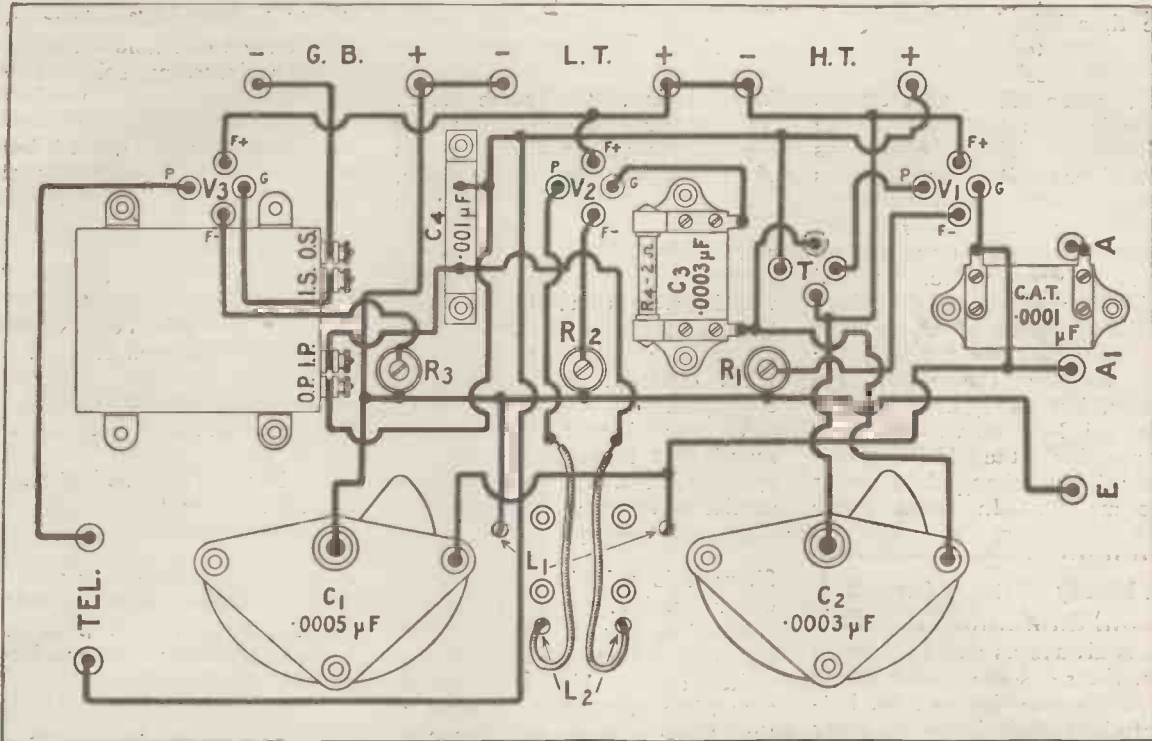

Fig. 3.—The wiring of the receiver. This will be found easy to follow when used in conjunction with the photographs, but for those who desire it, Blue-print 73B, full size, is available.

when tuning to the lower wavelengths.

**Valves**

In view of the fact that the receiver is fitted with suitable filament resistances, either bright or dull-emitter valves may be used. When operating this receiver particular attention should be paid to the H.T. voltage applied to the plates of the valves in that such voltage is common to all three valves, and though the low-frequency valve will not be particularly critical to high voltages, such values may give very poor results when applied to the first two valves, similarly, too low a voltage will also be a disadvantage. Subject to the use of a tapped H.T. battery of about 70 volts, quite a satisfactory voltage will be found without any difficulty.

In the case of dull-emitter valves it may be found that results are somewhat "woolly" when using the best H.T. voltage, in which case a small battery of about 4½ volts, made up from flash-lamp cells, should be connected across the terminals provided for these grid cells; all information concerning grid bias as applied to the valves chosen will be found as a rule upon the wrapper.

**Operating the Receiver**

With the receiver finally completed connect the accumulator, H.T. battery and telephones in accordance with the terminal markings given in the panel layout; if grid cells are not being used the two terminals should be joined together by means of

insert a No. 50 plug-in coil in the fixed coil-socket and a No. 75 coil in the moving coil-socket; a plug-in H.F. transformer, covering the wavelengths 300-600 metres, should now be inserted in the socket intended for that purpose. Before turning on the filament resistances move the two

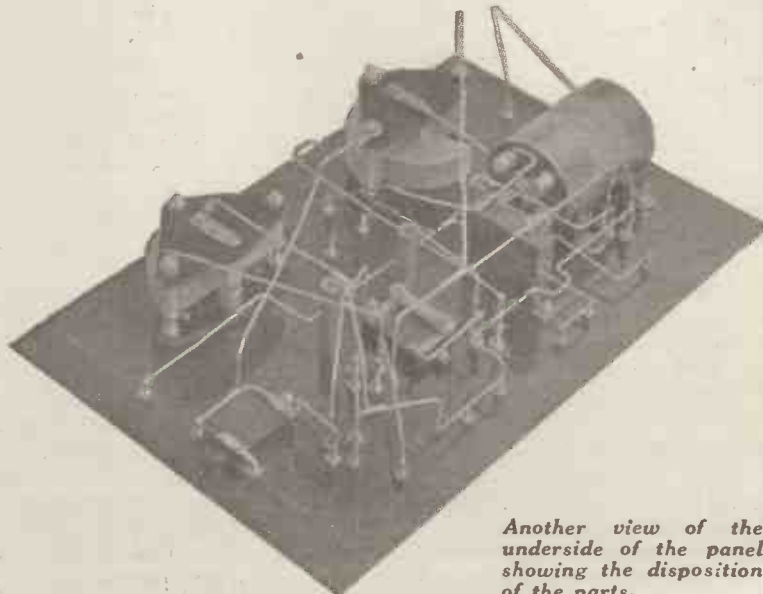

Another view of the underside of the panel showing the disposition of the parts.

a piece of wire. Turn the filament resistances to the "off" position and insert the valves. At this stage connect the aerial to A (C.A.T.), the earth to E,

coils at right angles to each other, then light the valves to a suitable degree of brilliancy. Tuning is now made upon the two variable condensers, at the

same time bringing the reaction coil nearer to the aerial coil, until the desired signals are heard, when final adjustments are made upon the two variable condensers. Using the coils as above given, B.B.C. wavelengths up to 400 metres are covered by the receiver, whilst for wavelengths above 400 metres and up to 500 metres a No. 75 coil should be used for aerial tuning. For the reception of Chelmsford the connections are precisely the same as for the short-wave stations, but using in the aerial socket coil No. 200 with No. 250 for reaction, the H.F. transformer being changed to cover 1,600 metres. In cases where

C.A.T. is not used for 5XX then a No. 150 should be used for the aerial inductance and a No. 200 for reaction, the same H.F. transformer being used. Using these same values the reception of Radio-Paris may also be made, whilst a No. 250 aerial coil with a No. 300 for reaction will receive the Eiffel Tower. The operation of the receiver over all wavelengths is exactly the same, though readers will find that the set will oscillate more freely when constant aerial tuning is employed.

When making tests it may be found that the receiver will not oscillate, in which case the connections to the moving coil

should be reversed (this may be done on the coil holder itself and so save disturbing soldered connections beneath the panel). The condition of oscillating will make itself known by a "cluck" being heard in the telephones whenever the moving coil is moved too near to the fixed coil; continuing to move the coils nearer to each other after the "cluck" has been heard will cause the set to howl. Readers should be extremely careful to keep well clear of this oscillating condition, otherwise considerable discomfort and interference will be caused to other listeners.

[A Test Report will appear in our Next Issue.]

### A Handy Battery Switch

It is always as well to provide on the set some device which enables the low-tension battery to be switched off altogether without the trouble of disconnecting its leads. In some rheostats of the compressed carbon type a current leakage is often present when the rheostat is in the "off" position if it has been used for some time. The reason

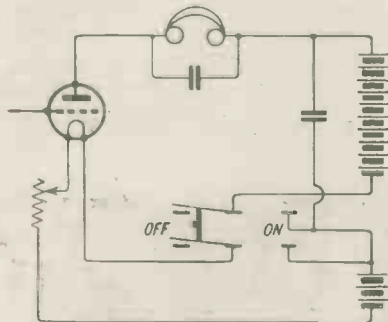

Fig. 1.—A useful switch for cutting out both batteries.

is that the material packs to some extent and do not spring properly apart when the pressure upon them is released. Hence a tiny path is left for current from the low-tension battery. This is particularly undesirable if dry cells are used for filament heating purposes, for to obtain good results with them they must have a complete rest between periods of working in order to give them time to recuperate. A very small leakage through the rheostat will soon run down a battery of dry cells. Leakage from the high-tension battery when the

filament is cold is not likely to occur unless the condenser shunted across it is defective. But one wants to be able to switch off the high-tension battery when valves are changed so that there may be no chance of a burn-out.

The diagram shows a neat and handy way of arranging a small switch which cuts out both batteries simultaneously. When the switch is turned over to the left the junction between H.T. negative and L.T. positive is broken by the upper arm, and the condenser is no longer in shunt with the high-tension battery. At the same time a break is made between L.T. positive and the positive leg of the filament. Valves may thus be changed without the slightest risk, and with the switch in the off position there is no chance of any kind of a leakage occurring when the set is out of use. A further point is that the adjustment of the rheostat, which is often critical with detector valves, and takes a considerable amount of finding, need not be disturbed when reception comes to an end.

It has often been said that it is undesirable to turn the low-tension current on or off by the sudden action of a switch. The writer has done so habitually for a very long time and has never found that his valves suffered in any way by this treatment. If, however, any doubts are felt on this score the experimenter may adapt the low-tension part of the switch, as shown in Fig. 2. Here an extra clip is mounted

between the pivot of the arm and the right-hand clip. Between the clip X and L.T. positive is fitted a small resistance  $R_2$  of suitable value. When the switch is turned over towards the right to throw the set into action the low-tension arm makes contact first of all with the clip X, and so brings the resistance  $R_2$  into circuit. On being pushed right home the arm makes contact with the right-hand clip, cutting out the resistance. Suitable values for  $R_2$  are from 2 to 3

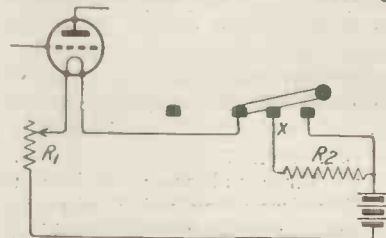

Fig. 2.—A simple "gradual" L.T. switch.

ohms in the case of bright emitters worked off a 6-volt accumulator, 10 ohms for an ".06" valve whose filament is heated by a 4-volt accumulator, and 25 ohms for a similar valve worked off a 6-volt accumulator. Resistances can be made up very easily by winding enamelled Eureka wire round a piece of ½-in. ebonite rod. For bright emitter valves with a current consumption of about .7 ampere rather less than one yard of No. 26 Eureka will suffice. A 10-ohm resistance for dull emitters may be made from one yard of No. 30 wire, whilst rather less than two yards of No. 36 will give 25 ohms.



# A Novel Frame Aerial

By R. W. HALLOWS, M.A., Staff Editor.

How to construct a useful piece of apparatus for experimental work.

THE frame aerial is very popular as an indoor collector of oscillations nowadays owing to its compactness. Even if one has a good

that the outdoor aerial cannot, with any degree of comfort.

of wire. To the studs of the selector switch are attached tapplings from the seventh, eighth and ninth turns, and the "out" end of the wire. The aerial can

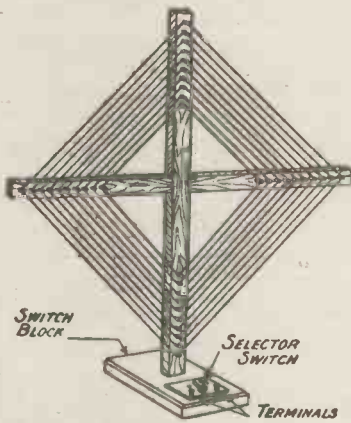

Fig. 1.—The frame when finished is a useful piece of apparatus.

aerial outside the house it is as well to have a frame in addition, for it comes in very useful for testing out new circuits since one need have little fear of causing interference even with those most prone to oscillate. Further, a frame aerial can often be used when atmospheric are so bad

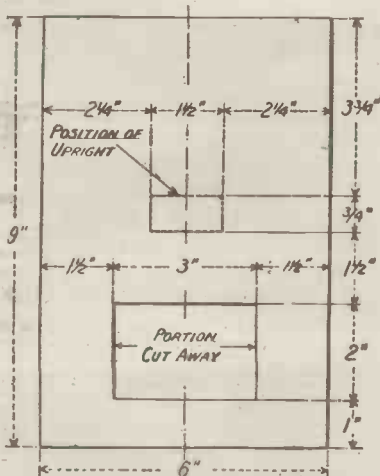

Fig. 2.—Showing how the stand is constructed.

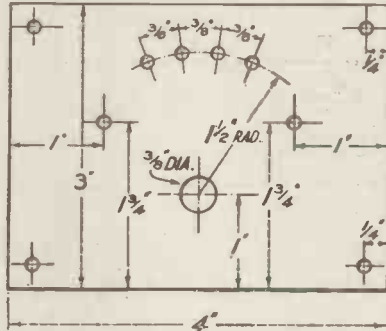

Fig. 3.—The ebonite block is drilled as shown.

### Materials Required

Here is a simple way of making a very handy frame at small expense. The materials required are a switch block 9 in. by 6 in., such as can be purchased cheaply from any electrician; two pieces of white wood, 1 1/2 in. wide by 3/4 in. thick, one 2 ft. 10 in. in length and the other 3 ft.; a 4-stud selector switch; two terminals; a piece of 1/4-in. ebonite 3 by 4 in.; 40 glass-headed draw-

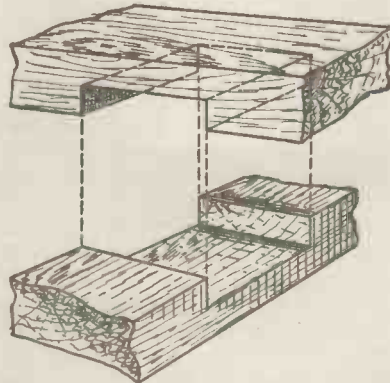

Fig. 4.—Details of the halved-in joint.

ing pins, obtainable from any shop which deals in draughtsman's materials, and 27 yards of good quality single flex.

### The Finished Frame

Fig. 1 shows the finished frame, which contains ten turns

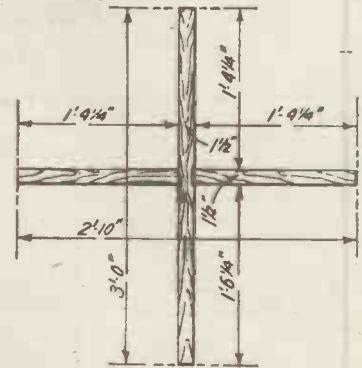

Fig. 5.—The arms, when fixed together, should be quite rigid.

thus be used conveniently with a variable condenser of quite small capacity in parallel. Fig. 2 shows the way in which the switch block is laid out and cut, and in Fig. 3 the layout of the ebonite block is given. The holes for the four studs and for the two terminals are 4 B.A. clearance, whilst those close to the corners are of a size suitable to pass the wood screws used for fixing the block to the stand. Mount the selector switch and the terminals upon the block, and screw it to the stand.

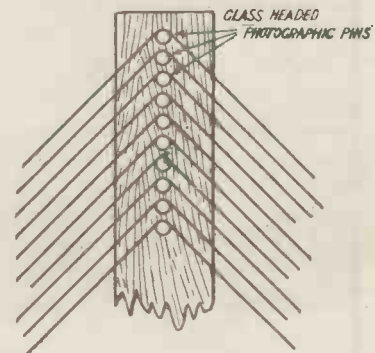

Fig. 6.—The end of one arm showing how the pins are used to hold the wire in position.

**Constructional Details**

Fix the two arms together by means of a halved-in joint (Fig. 4) so that they are in the position shown in Fig. 5. Next attach the frame firmly to the base by driving two screws from below the stand into the upright member. Push ten of the glass-headed drawing pins firmly home into the top end of the upright. The first pin should be quite near the top, and the rest should be so close together that the flex will just pass between them. Treat the two arms in the same way,

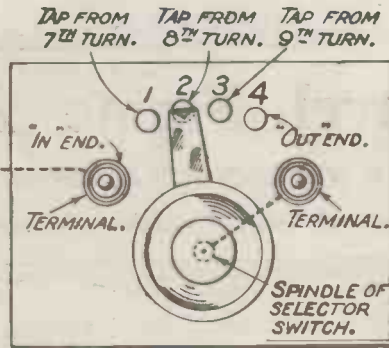

Fig. 7.—The connections to the terminal block.

and at the lower end of the upright place the pins so that the lowest is 2 in. above the stand. Now wind on ten turns of wire tightly attaching the "in" end to the left hand terminal and the "out" end to stud No. 4. Take a tapping from the seventh turn and connect to stud No. 1. Tap the eighth and ninth turns, connecting respectively to studs Nos. 2 and 3. Fig. 7 shows a diagram of connections. This completes the construction of the frame aerial, which will be found a very handy piece of apparatus.

**A Series-Parallel Connector for Telephones**

THIS article describes a small extension unit, which may be added to any receiver, and which enables one to switch a number of telephones in series or in parallel with each other at will. All that is required is a piece of ebonite, measuring 4 by 2 by 3/16 in., or 1/4 in., half a dozen terminals, or more (according to the number of 'phones it is desired to use), and one double pole single-throw switch. The connections are shown in Fig. 1. In this case

minerals, as shown. The length of flex used should suit the requirements of the constructor. The telephone unit is next made by

the ends of the telephones, which in turn connect to the unit.

When using this unit in conjunction with a valve set care must be taken to connect the 'phone-leads to the terminals as follows, when series connection is required:—Negative lead of 'phones A to terminal T<sub>1</sub>; positive lead to T<sub>2</sub>. Negative lead of

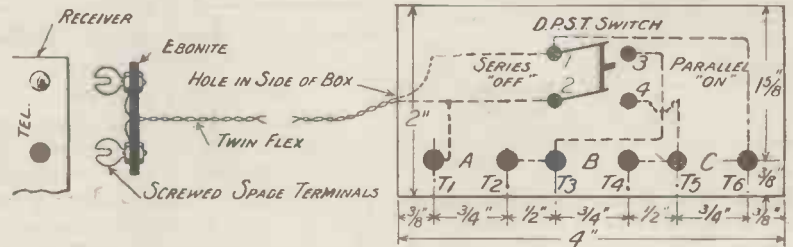

Fig. 2.—The layout and method of joining up to the receiver.

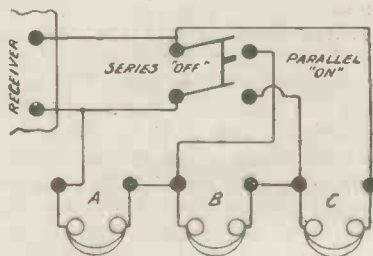

Fig. 1.—The connections of the extension unit.

three sets of 'phones, A, B and C, are employed. The complete arrangement is shown in Fig. 2. A connecting link is made which connects up with the actual receiver. For this two screwed spade terminals are secured to a piece of ebonite by passing each through a hole which has been drilled to clear, and securing by means of nuts. The centres of these holes should be equal to the distance of the centres of the telephone terminals on the receiver itself. Insulated twin flex is then connected to the two spade ter-

cutting and drilling an ebonite panel to the dimensions given, six terminals are then secured to the panel to take three pairs of 'phones, the double-pole single-throw switch is then assembled, the panel holes for which are drilled to suit the size of switch used, a miniature panel switch being quite suitable. A shallow box may be made to receive the panel. The disengaged ends of the flex are next connected, one end going to point 1 of the switch and the other end to point 2. Point 1 of the switch is then connected to the terminal T<sub>1</sub>. Terminal T<sub>2</sub> is connected to T<sub>3</sub>, and T<sub>4</sub> to T<sub>5</sub>. Terminal T<sub>6</sub> connects to point 4 of the switch, which also connects to T<sub>3</sub>. Point 3 of the switch connects to T<sub>5</sub>. It will be seen that when the switch is in the off position all the 'phones are in series, and when in the on position the 'phones are in parallel. The connecting link which attaches the unit to the receiver may also be adapted to

'phones B to terminal T<sub>3</sub>, positive lead to T<sub>4</sub>. Negative lead of 'phones C to terminal T<sub>5</sub>, negative lead to T<sub>6</sub>. This precaution is, of course, not necessary when using the unit in conjunction with a crystal receiver.

H. B.

**The "Simplicity" Receiver**

SIR,—I recently constructed the "Simplicity" three-valve receiver (Radio Press Envelope No. 3) for a friend. With a very poor aerial, screened at both ends, we succeeded in tuning in all the B.B.C. stations on 'phones with the exception of Belfast. We got 2ZY, 5NO, 2LS and 5XX on the loud-speaker. The set was made to the design, with no modifications whatever. Thanking you for such an efficient circuit,—  
Yours faithfully,  
T. K.  
Yorkshire.



# Correspondence



## RESULTS WITH THE ST100.

SIR,—As a keen amateur wireless enthusiast I feel compelled to write and tell you of the splendid results which I have obtained with the ST100 circuit.

Having made up several sets, I eventually decided to buy the Radio Press Envelope No. 1, from which I constructed the ST100, using all the components recommended.

The same evening as I had screwed down the last screw I connected up the set, and in a few hours I had succeeded in getting all the B.B.C. stations and a large number of the Continental ones.

I live about 22 miles from 2LO, but it, as well as Bournemouth, came in with great volume on the loud-speaker; in fact, 2LO was audible outside on the road some

thirty yards away. Not feeling very sleepy, I decided to remain up and have a go at the more elusive stations.

At 11 o'clock I got Madrid perfectly on the loud-speaker, and every word was audible in the room.

At 1 a.m. with breathless excitement I carefully manipulated the condensers and rheostats, and to my astonishment I was able to get the three American stations, WGY, KDKA and WBZ, absolutely clear of atmospheric or distortion, on the head-phones, of course.

My heartiest congratulations to the Radio Press and the Editor for having produced such a fine circuit.

I give you full permission to publish this letter, should you wish, so as to clear away any doubts from the amateur who is wondering

which set to build.—Yours faithfully,

A. W. V. HENDY (Capt.).  
Welwyn Garden City, Herts.

## AN H.F.-CRYSTAL RECEIVER WITH REACTION

SIR,—I should feel only justified in complimenting Mr. Stanley G. Rattee on his one-valve high-frequency and crystal, employing reaction, described in *Wireless Weekly* dated August 27. This set I made and waited anxiously to see and hear the results of my labour, which, I might add, were beyond all my expectations for such a simple and straightforward "hook-up." My aerial is very badly screened with high buildings and trees, placed in a valley. Still, with a single wire slung from these trees and attached to the top window

# B.T.H. LOUD SPEAKERS

**B**T.H. Loud Speakers are soundly constructed, both mechanically and electrically, and reproduce speech and music without distortion or undue resonance. They give the greatest volume of sound that it is possible to obtain without impairing the tone. Each instrument is provided with an adjustable air-gap. The magnets, of cobalt steel, retain their magnetism permanently, and are unaffected by changes of polarity.

FORM C1. The ideal Loud Speaker for a small room.

Price ... .. £2 10 0

FORM C2. A beautifully finished instrument designed for general use in or out of doors.

Price ... .. £5 0 0

FORM C3. A gramophone attachment having the same element as the Form C1. Loud Speaker.

Price ... .. £2 2 0

FORM D. A super-sensitive electro-dynamic pattern ideally suitable for large halls or outdoor use.

Price ... .. £9 10 0

Obtainable from all Electricians and Radio Dealers

**The British Thomson-Houston Co Ltd**

Works Coventry

Offices Crown House, Al'wych, London, W.C.2



30 ft. above the ground the following results were obtained with No. 35 aerial coil and No. 75 reaction "Igranic": London was unbearably strong, Bournemouth, Newcastle, Glasgow.

With No. 50 aerial, No. 75 reaction: Aberdeen, Birmingham, also a foreign station (call sign was missed), possibly a German or Dutch, who transmitted on October 4 at 10.45 p.m. a gentleman singing "O Soul e Mio" (?) and closed down at 11.15 p.m. I was using "Cossor Red Top" with 48 volts on the plate.

I think this performance is worthy of great praise to Mr. Rattee, whose teachings are a practical gain to everyone interested in this fascinating hobby. All the above stations were received at a good strength and clearly, Bournemouth being the strongest. (excepting London, of course).

I only wish that *Wireless Weekly* could be a bi-weekly journal for us all.

Thanking you and wishing *Wireless Weekly* continued success,—  
Yours faithfully,  
Tooting. GRATEFUL NEB.

**GRAMOPHONES AND WIRELESS**

SIR,—I have been greatly interested in the correspondence

appearing in your columns on the question of the respective merits of the gramophone and the wireless receiver as reproducers of speech and music. My own experience, for what it is worth, is that, with the gramophone, no matter how good it may be of its kind, one can never entirely eliminate the scratching of the needle point on the wax record and that there is always a certain "throatiness" which detracts from the purity of the sound. To my mind proof positive of the superior purity of wireless reception is not difficult to find. Some months ago operatic performances at the "Old Vic." theatre were transmitted from the South of London to 2LO by short-wave wireless and relayed by the main transmitter. The results were excellent, as all who heard will admit. Most people must also have heard gramophone records played in a broadcasting studio and transmitted by wireless. The result here is quite different. You can tell the gramophone at once, for its own peculiar distortion comes out clearly, and in no case could a band piece from the gramophone be mistaken for the playing of the actual orchestra. The results, then, are: Wireless relayed by wireless, reception pleasant with no noticeable distortion; the gramophone relayed by wireless, very

throaty and considerable distortion: We have therefore in this way a chance of comparing the gramophone and wireless receiver under exactly the same conditions, that is, by the wireless relaying of their sound reproductions. No one, I think, with anything of a musical ear could possibly give his vote to the gramophone.

I may mention that when broadcasting first started in America many of the smaller stations used gramophones very largely in their programmes, which produced a chorus of disapproval from listeners who objected strongly to what they termed "canned stuff." There have never been any objections to wireless relaying.—Yours faithfully,  
Berkhamsted. R. W. HALLOWS.

**WILL OUR READERS PLEASE CO-OPERATE ?**

SIR,—A Dutch amateur station in Amsterdam is regularly rendering organ recitals on *Sundays* from 12.10 p.m. until 1.10 p.m. Wavelength about 1,000 metres.

It would be very interesting to us to have some data respecting the range of these transmissions, and reports from British listeners would therefore be much appreciated. Will some of your readers drop me a postcard occasionally? (Address: A. A. Posthumus, Baarn, Holland.)

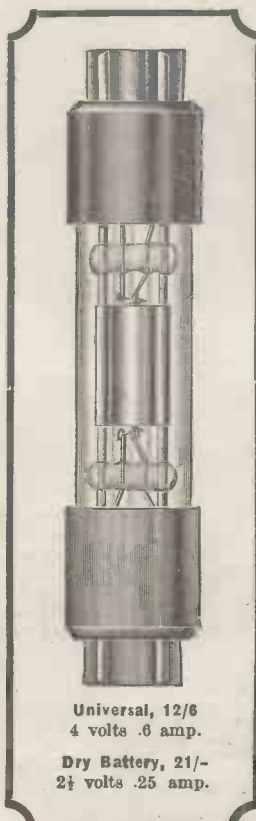

Universal, 12/6  
4 volts .6 amp.  
Dry Battery, 21/-  
2½ volts .25 amp.



*Put the World on your Dial.*

Capturing the signals of distant stations presents no difficulty to those experimenters who have wisely stipulated MYERS. For them—fortune indeed—complicated H.F. Panels and tuning difficulties are problems relegated to the user of ordinary valves. That MYERS used in the H.F. Stage are surprisingly sensitive and readily responsive to the very weak initial signal energy needs no emphasis when they render possible the "making a round" of the distant stations simply by controlling filament emission.

Recollect that in the MYERS the grid and anode leads are brought out at opposite ends, freeing it of a paralysing inter-electrode capacity present in ordinary valves with bunched electrode leads. Eminent authorities are unanimous in their opinion that for any serious H.F. work or short wave experiments it is essential to use valves of low internal capacity—for preference—the MYERS.

**Myers** PRACTICALLY UNBREAKABLE  
**Valves**

It is the experience of well-known Amateurs that the MYERS is the only Valve which can be made to oscillate on 40 metres—*Verb Sap.*

- SELLING AGENTS :**
- LONDON**—The Dull Emitter Valve Co., 83, Pelham St., South Kensington, S.W.7 (Kensington 3331).
  - MANCHESTER**—R. Davis & Sons, Wireless Depot, Bilberry Street.
  - LIVERPOOL**—Apex Electrical Supply Co., 59, Old Hall St.
  - GLASGOW**—Milligan's Wireless Co., 50, Sauchiehall St.
  - YORKSHIRE**—H. Wadsworth Sellers, Standard Buildings, Leeds.
  - SOUTHERN COUNTIES**—D.E.D.A., 4, Tennis Road, Hove.



Thanking you in anticipation for your kind assistance,—Yours faithfully,  
Baarn.

A. POSTHUMUS.

### AN INTERESTING PHENOMENON

SIR,—Noticing in *Wireless Weekly* of October 29 a letter from Mr. W. G. Pullen under the heading of "An Interesting Phenomenon," might I be permitted to relate an experience of mine that has bearing upon the subject. It will also serve to answer his question as to the possibility of an "electrical discharge passing to earth *via* aerial and earth wires."

During the summer months, while using my ST100 set, I chanced to see the threatening appearance of the sky through the window and immediately took the usual steps to safeguard my set.

I had already disconnected the aerial and earth leads from the set (they are of the heavy rubber insulated type) and was looking for the spare terminal with which to join them together. At that moment a vivid flash of lightning lit up the sky, and I found the missing terminal. Some seconds must have elapsed between the flash and my putting the aerial and earth leads together preparatory to finally joining with the terminal. Imagine my

surprise and amazement to see the vicious spark and hear the ominous crackle of a "short" that ensued when the two leads were touched

Luckily I held the leads by the rubber insulation, otherwise I might have been still more scared, and thus not able to give to the company present an exhibition of electrical energy from apparently nowhere in particular!

This lasted for several more seconds, until caution overcome my "valour," and I finally connected up.

All thanks to the Radio Press for the many splendid hours spent in their company, and wishing you all success that is due to a "good thing."—Yours faithfully,

ERNEST DEWEY.

Alresford, Hants.

### TRANSMITTERS, PLEASE NOTE

SIR,—I have received a letter from "F.8NS" asking me if I know of any English amateur transmitters who would work with him. As I do not know any who have a permit to work with foreign amateurs, I wondered if you would be so good as to insert this letter in your paper in the hope that it might catch the eye of one or two who have this permit. If any transmitter with this permit sees this letter, would he be good enough to write to me

and I will write across to "F.8NS," giving his address. Thanking you in anticipation.—Yours faithfully,  
NORMAN GUY.

Pinner, Middlesex.

### A CRYSTAL SET IN VIENNA

SIR,—I have just constructed the new crystal set described by Mr. P. W. Harris in the September number. It is really the loudest crystal set I ever handled. No fewer than six of my wireless friends are now constructing it.

Results are very delighting. I have it tested on several aerials indoors and outdoors; on my outdoor aerial, 70 ft. long, 30 ft. high, it works five pairs of phones just as a one-valver, on an "indoor" 10 ft. long, single wire, fair phone strength speech is intelligible without aerial, earth connection on earth terminal. All this on a distance of over 2½ miles.

Many thanks for this interesting set and for the wonderful "All Concert," which brings now nearly all the European stations. Last week I picked up speech from Moscow, in Russia, on a wavelength of about 3,500 metres.

Wishing your papers every success,—Yours faithfully,

OTTO KOPECKY.

Vienna 18; Marlinstr. 66/3.

# SIEMENS

## BATTERIES FOR WIRELESS



Size No. 829. 60 Volts.

Also manufacturers of

RECEIVING SETS, HEADPHONES, LOUD-SPEAKERS, EBONITE, ETC.

Obtainable from all leading dealers.

# SIEMENS BROTHERS & CO., LTD., WOOLWICH, LONDON, S.E.18



# Apparatus we have tested

Conducted by A. D. COWPER, M.Sc., Staff Editor.

## The "Super Success" L.F. Transformer

Messrs. Beard & Fitch have submitted for trial a number of samples of their new pattern L.F. intervalve transformer, the "Super Success." These are similar in size and general appearance to the small "Success" transformer, later patterns of which gave satisfactory results in a recent test carried out by this department. The finish of the brass case is now in black, with black terminals; the internal construction appears to be similar to that of the earlier instrument, i.e., a hedgehog type of transformer inserted tightly in the outer case, but now made solid with wax, and with empire-cloth spacing and separating the leads to the terminals at

one end. The latter are arranged conveniently on the ebonite cover of the case at the top.

On testing the samples, in comparison with our standard and with other instruments of similar moderate price, these showed a very satisfactory performance. The tone was good, but little of the lower audio-frequencies being absent, and compared favourably with ordinary types. The actual build-up, both by aural comparison and by actual measurement of resulting signal-voltage, fell a little short of the standard. In each case a suitable L.F. amplifying valve was used with ample H.T. and optimum grid-bias.

Tested in the second stage of L.F. amplification, the performance of

this instrument was excellent, and the amplification of a high order. Small power valves were used with ample H.T., and great care was necessary, as usual, to avoid that distortion due to overloading the last valve which is often blamed, unjustly, on the transformer. With a poor aerial at 35 miles from 2LO it was only just possible, with efficient H.F. arrangements, to avoid horrid blasting on loud notes (when two of these transformers were used in a three-valve set) by the use of power valves and heavy grid-bias on both of the last two. Then powerful loud-speaking resulted, with little noticeable distortion in general.

Properly used, these instruments should give every satisfaction at the price asked. The insulation-resist-

Quality RADIO

## DUPLEX BASKET COILS.

The most efficient inductance coil made for short waves, mounted on standard plugs. No wax or varnish used.



Number	Mounted	Mounted with Reaction Reverse Switch	Unmounted.	Number
25	1 6	3 0	0 9	25
35	1 9	3 3	1 0	35
50	2 0	3 6	1 3	50
75	2 3	3 9	1 9	75
100	2 9	4 3	2 3	100
150	3 0	4 6	2 6	150
175	3 6	5 0	2 9	175
200	3 9	5 3	3 0	200

Postage: 3d. each. Set of eight coils post free.

If your dealer cannot supply, we send post free if you mention his name and address.

**GOSWELL ENGINEERING CO., LTD.**

12a, PENTONVILLE ROAD, LONDON, N.1.

Liberal Trade Terms.

LIST FREE.

'Phone: North 305K.

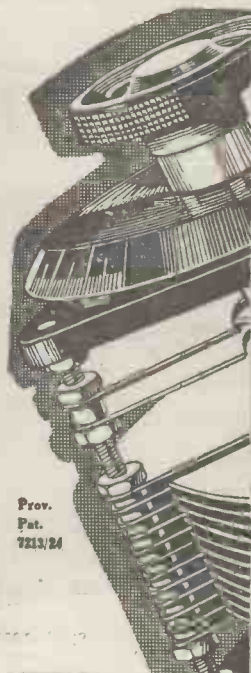

Prov. Pat. 7213/24

## Expect more

When you buy and fit to your set Bowyer-Lowe Square Law Condensers you are justified in expecting from them a higher standard of performance than you could otherwise get. They have the highest capacity ratio in wireless and have become famous because of their unparalleled efficiency.

## Bowyer-Lowe SQUARE LAW CONDENSERS

will give your set greater wavelength range and selectivity with exceptional volume and purity of tone. They simplify tuning and calibration. All good dealers stock them.

Made in Four Types.

STANDARD TYPE

from .00003 to .0015

VERNIER TYPE from .0002 to .001

DOUBLE TYPE from .0001 to .0005

TRIPLE TYPE from .0002 to .0003

Order direct in case of difficulty.

# Bowyer-Lowe Tested RADIO COMPONENTS

BOWYER-LOWE CO., LTD., LETCHWORTH.



ance, on a severe D.C. test, both between windings and from windings to the case, proved excellent; the general finish and appearance of the instrument are distinctly pleasing.

We would like especially to commend the policy of the makers in submitting a number of samples of their products for comparative test. This is so much fairer to the public and to themselves than when all conclusions have to be drawn from a single isolated sample submitted. In this case the performance of each of the samples tested proved very uniform.

**"Kriscross" Connectors**

Messrs. the "Kriscross" Co. have sent for our examination samples of their special type of connectors and terminals for radio construction work. These consist of a brass bush about  $\frac{3}{8}$ -in. diameter, fitted with a nut, and having four slots cut in the screwed end in the form of a cross. The type A pattern No. 1 is  $\frac{3}{4}$  in. long, and has a tapped hole in it of No. 2 or 4 B.A. size. Type No. 2 is only  $\frac{1}{2}$  in. deep, and has no tapped hole; type No. 3 is similar to No. 1, but rather shorter ( $\frac{1}{2}$  in.), and can have a No. 6 B.A. thread. The particular purpose of these is to provide a convenient and secure multiple electrical connection,

whilst avoiding the necessity of any soldering at all. Types 1 and 3 screw up tightly on the back studs of any terminal in a panel, in place of the usual small back-nut, and will take any number of connecting wires up to four 1-16th inch square bus-bars, these being held tightly by screwing up the large nut. Pattern No. 2 is for making similar connections in line-wires or in the middle bus-bars, etc., which are not supported by the panel at that point. The No. 1 can also be used for multiple telephone connections, provided that the telephone tags are of small size.

These connectors appeared to be very practical little devices, and should have manifold applications in temporary experimental types of receivers, and in the hands of those who dislike or have no facilities for soldering.

**Substitute Resistances for D.E. Valves**

Messrs. Ward & Goldstone, Ltd., have sent us samples of their asbestos-cored spiral-wire resistance, intended to be substituted for the ordinary spiral of comparatively low resistance in filament rheostats, in order to adapt these for use with low-consumption D.E. valves.

These have an asbestos core a little under  $\frac{1}{4}$ -in. diameter and  $\frac{5}{8}$  in.

long, wound spirally with fine resistance-wire, and flexible enough to bend round the ordinary circular former. The core material is soft enough to permit of good contact between the wire and the usual rotating finger. The resistance, on measurement, came out at about 20 ohms. The fitting appeared to be quite suitable for the purpose indicated, and there was no difficulty, on trial, in getting an effective and silent electrical contact.

**"A.S." Crystal**

Messrs. McKensie & Co. have sent us samples of a new crystal, the "A.S." This is a bright, somewhat irregular-appearing crystal of the galena type, and rather brittle. On trial, with all three specimens submitted (which were packed in cottonwool in tin boxes), some difficulty was experienced in finding good sensitive spots with a fine, springy cat's-whisker, a considerable proportion of those actually found giving, quantitatively, sensibly less signal strength (both by aural observation and actual measurement) than average galenas tested under identical conditions on the same signals—2LO at 35 miles giving normally about 4 microamperes on a moderate aerial, and with the standard low-resistance tuner. A freshly-broken surface showed no

Choose and Use—

**"Tangent" Tuning Coils**

—and thus ensure low self-capacity



"No second-rate effects will satisfy the intelligent purchaser, for whom 'Tangent' fittings are designed."

Ask for Leaflet 197

Sizes	
Coil No.	Price
25	4/3
35	4/3
50	4/3
75	4/6
100	5/-
150	6/-
200	7/-
250	7/6
300	8/-
400	9/-
500	10/-

**Unshrouded Efficiency**

In order to obtain satisfaction

**Rigid as a Motor Wheel**

you must have a tuning coil that is **STRONG and yet HIGHLY EFFICIENT**

SELF-CAPACITY has been reduced to a minimum owing to the fact that the impregnated cord not only passes between the layers and thus provides air spacing, but also firmly braces up the whole coil so that no empire cloth or shellac is required

Ask your dealer—Take no substitute

**GENT & CO. LTD. Faraday Works, LEICESTER. Established 1872.**

Manufacturing Electrical Engineers.

London: 25, Victoria St., S.W.1.

Newcastle-on-Tyne: Tangent House, Blackett St.

Complete set of 4 Concert Coils (Nos. 25 to 75), 19/- the set.  
Complete set of 11 Concert Coils (Nos. 25 to 500), £3 7s. the set.

better results, though an occasional good point would give the full 4 microamperes. We cannot therefore recommend this crystal for use, other than in the immediate neighbourhood of a powerful station, in its present form.

**"Uralium" Crystal**

We have tested exhaustively some samples of the "Uralium" crystal and silver cat's-whisker marketed by Messrs. G. Street & Co., Ltd. This is a bright, coarsely-granular galena, and showed on trial an excellent proportion of sensitive spots both on the original and on freshly broken surfaces. Quantitatively it showed, in actual reception of 2LO at 35 miles, the standard optimum signal strength attainable with a first-class galena crystal. The cat's-whisker included with it in the transparent topped sealed box proved also to be of a favourable type, having just the right degree of spring. The combination can certainly be recommended.

**A Microammeter**

The methods of measurement of actual signal-strength obtained in a receiver consistently advocated by the writer for some time past imply

the use of a microammeter of preferably a robust design. For direct measurement of the whole rectified wave in crystal reception a range of some 10 or 20 microamperes is indicated, unless situated very close indeed to a powerful station; one microampere representing a practical limit of comfortable crystal reception. For measurement of actual signal-voltage across the 'phones in valve-reception, in the manner practised regularly by the writer, by using a choke-capacity filter-circuit to eliminate the steady plate-current, and rectifying the A.C. component by a carborundum crystal, calibrated on low-frequency A.C., a maximum of some 150 microamperes rectified current may be recorded with good loud-speaking signals, ordinary good 'phone strength giving about 2 microamperes here. The higher range can evidently be reached by shunting the microammeter by a suitable resistance, so that a sensitiveness of about 1 microampere per division, combined with sturdy build and a fairly slow-swinging dead-beat needle, are indicated.

We were very glad, accordingly, to receive on trial from Messrs. W. G. Pye & Co., the well-known Cambridge instrument makers, one of their moving coil pointer galvanometers which fulfils these requirements admirably, and at the same

time is listed at a moderate price comparable with that of a couple of D.E. valves. This instrument is about 4½ in. by 4 in., and stands 4 in. high. It is equipped with two levelling screws and a circular spirit level. A brass tube with knurled top encases the suspension and provides for zero adjustment. There is also a self-releasing device for the suspension which protects the latter during transportation. Large terminals are provided, with insulated knobs; the general workmanship and finish are that of a high-class scientific instrument of precision.

The scale is divided 40-0-40 in single microamperes. The pointer has a slow period, and is fairly dead-beat, so that rapidly fluctuating audio signal-voltages are easier to read as a time-average than with a livelier needle. The resistance is but 12.8 ohms in the particular instrument tested; the accuracy of the scale, on calibration, was close enough for any ordinary purpose.

For measurements of signal-strength as indicated, with suitable shunts for the higher ranges, or for measurements of high-resistance up to 100 megohms (with a suitable D.C. high-tension supply), this instrument can be strongly recommended. For the latter purpose it was found best to stand the microammeter on a sheet of glass.

**STAND  
57**

**The White City  
Radio Exhibition**

— Nov. 15th to 29th —

**STAND  
57**

**ABGAR**

**Radio Receivers De Luxe.**

A range of Crystal, 1, 4 and 5 valve instruments designed for the discriminating listener. The larger models will receive American broadcast on the loud speaker under favourable conditions, in addition to the European Concerts. All prices include a complete and liberal equipment. These receivers are built to a standard and not to a price.

TRADERS AND FACTORS SHOULD WRITE FOR PARTICULARS OF OUR AGENCY AND DISTRIBUTING POSITIONS.

ALL OUR RECEIVERS CARRY OUR GUARANTEE AGAINST FAULTY WORKMANSHIP.



Reg. Trade Mark.

Mr. D. GLOVER,  
23, Collings Park, Plymouth,  
and of Calcutta,

writes:—  
..... I have consistently received several American broadcast Concerts, particularly W.B.Z. Boston, K.D.K.A., E. Pittsburgh and W.J.Z., Schenectady, N.Y.

The two former Stations were distinctly audible on the loud speaker using only three valves.

Mr. Glover owns and uses a Standard ABGAR receiver.

Write for Catalogue and further information to:—

**ABGAR ELECTRICS**

(Dept. R).

**39/40, St. Andrew Street, Plymouth, Devon**

Giving your dealer's name and address.

**REDSPOT**

**Guaranteed Radio Components.**

A complete range of high class accessories for the home Constructor who requires the best components at reasonable prices. The range includes:

Coil Holders, Potentiometers Rheostats for D.E or R type valves, including our dual rheostat. No-capacity valve holders and switches together with laboratory and standard condensers.

ENQUIRIES FROM OVERSEAS BUYERS INVITED.

ALL OUR REDSPOT COMPONENTS ARE GUARANTEED AGAINST DEFECTS IN WORKMANSHIP.



# Information Department



SUPPLIED BY RADIO PRESS SERVICE DEPT., LTD.

A. D. (KINGSTON) asks whether the catwhisker contact in a crystal detector may be replaced by a mercury contact, the cup containing the crystal being mounted vertically over another small cup containing mercury from which the other contact is taken, and whether this would result in greater sensitiveness and stability.

This method, suggested some time ago, has been tried practically, and has met with a fair degree of success, using a silicon crystal and even crystals of the synthetic or treated galena type. It is important to observe that the mercury does not come into contact with any solder, or the latter will form an amalgam with the mercury, with a resulting loosening of the soldered

joint; a short length of platinum wire should also be used to make contact with the mercury. For the best results it will be found that the lower surface of the crystal should dip only just below the surface of the mercury. Perfectly clean mercury should be used.

J. H. S. (NORBURY) asks our opinion on the use of plastic metallic compositions containing mercury for fixing crystals in their holders or cups.

These plastic compositions, which usually consist of mercury amalgams containing a large proportion of mercury, are not recommended for this purpose. They never fix the crystal rigidly, and we advise the use of Wood's Metal in the usual way, due care being taken to prevent any overheating of the

crystal by placing the latter (held in tweezers) well into the Wood's Metal just before it solidifies.

V. D. K. (STREATHAM) requires to know why a radio-choke coil is often included in series with the condenser providing capacity reaction from the plate of the detector valve, particularly in circuits designed specifically for short-wave reception.

The function of a radio-choke coil in the position indicated is to choke back the incoming oscillations so that they follow their normal course to the aerial tuning inductance and the grid of the first valve. Normally, on broadcast wavelengths, the telephones, in the plate circuit of the detector valve, provide a

## "Perfect Reception"

GUARANTEED

WITH OUR

## REPAIRED VALVES

Whenever your valves burn out or filaments are damaged in any way

**Send them to us**

We repair them equal to new.

**DON'T DELAY**

*The actual valve you send us is repaired  
and returned to you within 7 days.*

PRICE

POSTAGE

PRICE

6/6

3d.

6/6

(Bright Emitter Valves).

**WE ARE ALWAYS AT YOUR SERVICE.**

Price list for D.E. and Power Valves

:: :: on Application. :: ::

**The North London Valve Repairing Co.,  
22½, Cazenove Road, Stoke Newington, N.16.**

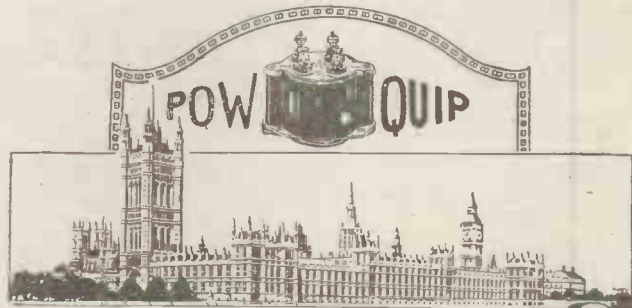

### The Decision of the Public

regarding "POWQUIP" Transformers.

They do give volume.  
They do give clarity.  
They do work with standard valves.  
They do give value for money.

Also:-

They do not distort.  
They do not howl.  
They cannot break down.

RESULT:-Production already 300 per cent. above last year's maximum.

Open Type 14/6 Shrouded Type 18/-

STOCKED BY ALL RECOGNISED WIRELESS DEALERS.

The

**POWER EQUIPMENT COMPANY LIMITED**

KINGSBURY WORKS, THE HYDE HENDON, N.W. 9.

suitable substitute for this radio-choke, but on the shorter wavelengths, where the frequency is correspondingly higher, the windings of the telephones are not sufficient.

**H. B. E. (BEXHILL)** submits a circuit diagram for a five-valve set using 2H.F., 1 detector, and 2L.F. for criticism.

The diagram submitted is technically sound, but we would suggest that provision be made for separate H.T. leads to the anode of the valves, especially in the case of the detector valve, which will usually require a lower anode voltage than the low-frequency amplifiers. This alteration will involve little extra complication, and should give more efficient working. We would also suggest that terminals for grid bias for the low-frequency valves be provided.

**L. J. (CARDIFF)** asks whether resistance-capacity coupled low-frequency amplification is comparable with transformer coupled note magnification as far as signal strength is concerned, and whether purer reception is obtained.

With resistance capacity coupling it will usually be easier to obtain better quality reception, but it will usually be necessary to use three

stages of note magnification by this method to obtain equally loud results as when two stages of transformer coupling are employed. This, of course, is only the approximate ratio, as no rigid ruling can be given in such a case.

**P. R. G. (MORTLAKE)** asks whether it is possible to calculate the inductance value of a given honeycomb coil or similar multi-layer coil, and to deduce therefrom the wavelength range covered by the coil, when used in conjunction with a given aerial and tuning condenser.

This is certainly possible, but not to a high degree of accuracy, and such formulæ as exist for this purpose are too complicated for general use. We therefore recommend our correspondent to ascertain by practical experiment what wavelength range a given coil will cover under specified conditions.

**G. E. O. (HARROGATE)** seeks information regarding variable grid-leaks and asks whether we could recommend one of reliable manufacture and whether this should be used in preference to a gridleak of fixed value.

We are unable, for obvious reasons, to recommend any particu-

lar commercial products in these columns, but there are variable gridleaks on the market which are quite satisfactory in use, but for ordinary purposes the use of a good type of fixed gridleak will be found quite satisfactory. The type employing spring-clips for fixing is preferred, since this method enables a quick substitution to be effected.

**W. E. A. (GLASGOW)** asks why it is desirable to use thick wire for the construction of tuning coils for short wave reception, and what gauge should be used.

The use of thick wire for the purpose mentioned ensures a low resistance to high-frequency currents. An additional advantage is that a coil so constructed is mechanically stronger and the wire requires less support than is the case with finer wire. Well-spaced turns to reduce the self-capacity of the coil are also advised. The gauges in general use are Nos. 16, 18 and 20. No. 14 (S.W.G.) has also been used with success for wave-lengths below 75 metres.

**HAVE YOU ordered  
your copy of "The  
Wireless Constructor"?**

## GET FINE TUNING

—it gives accuracy.

"Necessity is the mother of invention," they say. The veriest tyro, and the expert alike, soon feel the inadequate control given by large tuning condensers which are inaccurate simply for the reason that they do not permit of delicate movement. When searching for distant stations, for instance, it is the easiest thing in the world to miss any particular station solely due to the fact that the smallest variation of capacity possible by hand on a large condenser passes over the desired signal.

It is not enough to fit a large condenser into which is built a vernier. This arrangement—in association with the unwieldy—is strongly affected by the large condenser. Our experience in the reception of K.D.K.A. on 68 metres asserts that really accurate tuning—fine and delicate control—calls for the COLVERN. Fit it to balance your circuits.

**PRICE  
2/6**

The addition of the COLVERN (max. cap. .000014) will demonstrate that your set is more selective, a receiver of distant stations and more sensitive to perfect balance than you have yet experienced.

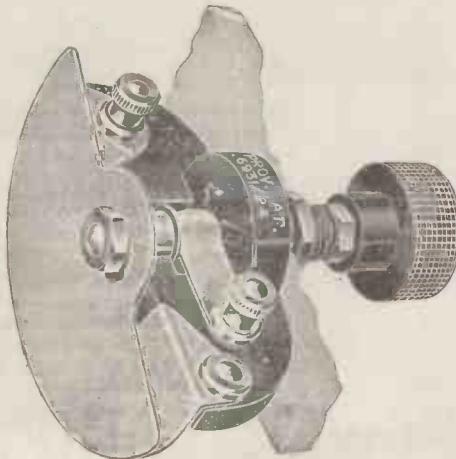

If your local dealer does not stock the Colvern Tuning Condenser  
:: :: kindly send his name and address when ordering :: ::

MANUFACTURERS:

**COLLINSONS PRECISION SCREW CO., LTD.,**  
Macdonald Road, Walthamstow, LONDON, E. 17.  
Telephone: Walthamstow 532.

Barclays Ad. 30r.

## CABINET AND PANEL WORK A SPECIALITY.

Non-standard Cabinets and Panels to Customers' designs produced at short notice.

We supply Cabinets, drilled and engraved Panels and any Components for all Radio Press Receivers. Send 2d. stamp for our new 100-page Catalogue and descriptive Leaflets.

Examples:	Cabinet.	Panel.
Four-Valve Family .. .. .	18/-	15/6
Simplicity Three-Valve .. .. .	21/-	12/-
All Concert-de-Luxe .. .. .	26/-	15/-
Extra for carriage and packing on post orders ..	1/6	9d.

All Cabinets are best-seasoned walnut, hand-made and polished. Panels are guaranteed electrically, matt non-metallic finish, edges squared, accurately drilled and engraved.

RADION Panels supplied if desired at slight extra cost.

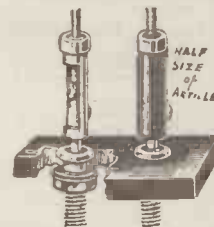

Plug and Socket Terminals.

### S.A.C. "Tapa" Plug and Socket Terminals

"the gadget of a thousand uses," in red or black and five other colours. "Once used always used." 6d. each. Sample pair free to all Clients ordering Panels or Cabinets.

### S.A.C. Fireside Plug.

The last word in comfort and efficiency, for plugging in distant headphones, loud speakers, etc. 2/6 each.

Our London Office is in a central position: we welcome inspection of our Cabinets and Panels.

**"S. A. CUTTERS,"**

**15, Red Lion Square, London, W.C.1.**

Phone: Chancery 8042.





*Reproduction*

**T**HE Artist builds up his masterpiece in such a manner that the living model is faithfully portrayed on his canvas. All the delicate gradations are there, the high lights, half-tones and shadows all combining in giving life and character to the subject. Speech, song and music must be reproduced in exactly the same way

to be worthy of your attention; there must be the faithful reproduction of the slightest inflection until you can actually visualise the musician. The Western Electric Loud Speaking Equipment will give you the most perfect rendering of broadcast programmes and prove itself to be the premier equipment of the day.

## *Western Electric* Celebrated **LOUD SPEAKERS**

Loud Speaker £8  
Amplifier - £24



***Western Electric Company Limited.***

GONNAUGHT HOUSE, ALDWYCH, W.C.2.

Central 7345 (9 lines).

Branches — Birmingham, Leeds, Glasgow, Newcastle, Cardiff, Manchester, Southampton, Liverpool, and Dublin.

*It will pay you always to watch WIRELESS WEEKLY Advertisements.*

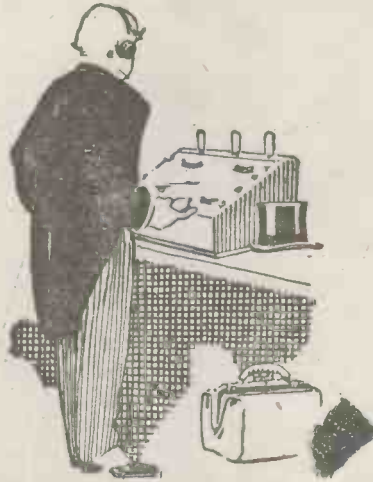

## Has your set valvular disease?

**GENERAL PURPOSE VALVES:**

**Type R. ... 12/6 each**

Filament Voltage.....4 volts  
 Filament Current.....0.7 amp.  
 Maximum plate voltage...100 volts  
 Plate resistance.....27,000 ohms.

**Type B 3 ... 21/- each**

Filament voltage.....1.8 volts  
 Filament current.....0.35 amp.  
 Maximum plate voltage...80 volts  
 Plate resistance.....27,000 ohms.

**\*Type B5. ... 25/- each**

Filament voltage.....2.8—3 volts  
 Filament current...0.06 amp. (at 3 v.)  
 Maximum plate voltage...80 volts  
 Plate resistance.....17,000 ohms.

**POWER AMPLIFYING VALVES :**

**Type B4. ... 35/- each**

Filament voltage ..... 5—6 volts  
 Filament current...0.25 amp. (at 6 v.)  
 Maximum plate voltage...120 volts  
 Plate resistance ..... 6,000 ohms.

**\*Type B6 ... 35/- each**

Filament voltage.....3 volts  
 Filament current.....0.12 amp.  
 Maximum plate voltage...120 volts  
 Plate resistance ..... 9,000 ohms.

**\*Type B 7 ... 37/6 each**

Filament voltage.....6 volts  
 Filament current.....0.06 amp.  
 Maximum plate voltage...120 volts  
 Plate resistance ..... 9,000 ohms.

\*For use with Dry Cells



The heart of your set is the valve, and in wireless a hard heart is better than a soft one. "Soft" is a euphemism for bad vacuum. A valve with a little air in it is liable to oxidation of the filament, and soon loses its efficiency. B.T.H. Valves are very highly exhausted by a special patented process. This ensures long life and maintained efficiency. They last longer and give infinitely better results than "soft" foreign (or English) valves.

**FIT B.T.H. VALVES AND GIVE YOUR SET A GOOD HEART**

*From all Electricians and Radio Dealers.*

# B.T.H. RADIO VALVES



# LISSENIUM

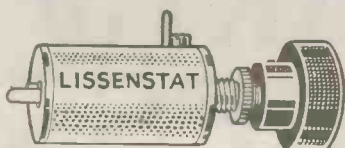

LISSESTAT (patents pending)—gives the most acute tuning possible **7/6**

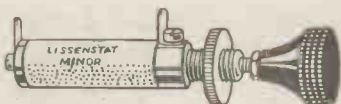

LISSESTAT MINOR (patents pending)—is replacing thousands of discarded and inefficient rheostats. Provides LISSESTAT control at a popular price **3/6**



LISSESTAT UNIVERSAL (patents pending)—with its protective device for dull emitters **10/6**  
All types have LISSEN ONE-HOLE FIXING, OF COURSE.

# CONTROL—

and what it means.

The express train—

the huge liner—

the record breaking car—

the super aeroplane—

Efficient — powerful — capable of covering great distances at tremendous speed. Each and every one dependent upon efficient control. So, too, with the radio receiver used for distant reception—**EFFICIENT VALVE CONTROL IS ESSENTIAL.**

For the purpose of covering distance—for bringing in that elusive station — efficient control is of vital importance, and efficient control means **LISSESTAT CONTROL.**

**RECEIVERS FITTED WITH LISSESTAT CONTROL ARE EQUIPPED FOR THE FINEST DETECTION POSSIBLE.**

# SENSITIVITY

and its allied control, the LISSEN GRID LEAK



**SMOOTH OUT YOUR LOUD SPEAKER DISTORTION BY PUTTING A LISSEN VARIABLE GRID LEAK ACROSS THE SECONDARY** of the last transformer or across the loud speaker itself. First position is best. The difference will be very noticeable.

**DON'T MIX YOUR PARTS**—There is a LISSEN Part for every Vital Place.

**PARTS THAT PULL TOGETHER**—When you know that every vital part in your receiver is pulling strongly with each other, you know that you have a receiver which is the best you can ever get. With all LISSEN Parts you will get results which would never be possible with mixed parts.

Every valve you use has different characteristics—every circuit, too. Whether you are out for distant stations, or undistorted reception of nearby stations, you will find the **LISSEN VARIABLE GRID LEAK** very important in its effect. Only by using it can you be sure that you are using the correct grid potential for every condition of reception.

It covers a wide range of resistance values, with continuous variation throughout.

**LISSEN ONE-HOLE FIXING, OF COURSE— POSITIVE STOPS BOTH WAYS. 2/6**

**LISSEN VARIABLE ANODE RESISTANCE, 20,000 to 250,000 ohms, same outward appearance as the LISSEN Variable Grid Leak .. .. . 2/6**

**LISSEN LIMITED, 30-32, Woodger Rd., Goldhawk Rd., Shepherd's Bush, London, W.12.**  
Phones—3380, 3381, 3382, 1072 Riverside. Grams—"LISSENIUM, London."

*It will pay you always to watch WIRELESS WEEKLY Advertisements.*

# The HEART of WIRELESS

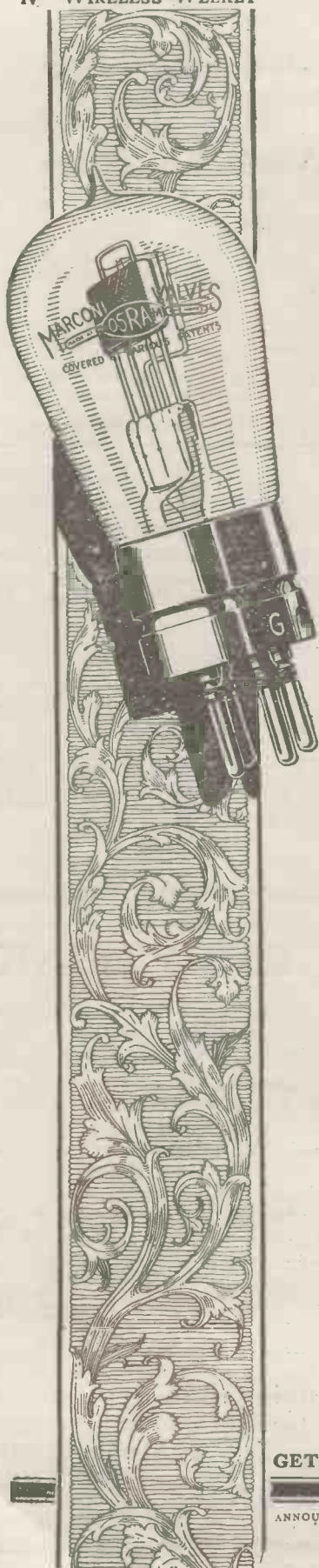

As the human heart is to the human body, as the lens is to the camera, and the engine to the motor car, so is the valve to the wireless set.

It is the main essential. . . . "Get the essentials right" is the commonsense policy in wireless reception as in all else.

Common-sense is the attribute of the majority, and perfect reception of broadcasting the aim of every keenly interested listener ; hence the general preference for

**MARCONI VALVES**  
MADE AT THE OSRAM LAMP WORKS

*Sold by Wireless and Electrical Dealers, Stores, etc.*

Have you read the now famous wireless publication—The Book of MOV ? It is the most authoritative work of its kind—and free. Get a copy at once from your dealer, or cut out and use the voucher below.

Messrs. The M.O. VALVE Co., Ltd.  
Brook Green, London, W. 6.

Please send me, post free, a copy of  
The Book of MOV.

Name .....

Address .....

W.Wy. 12/11

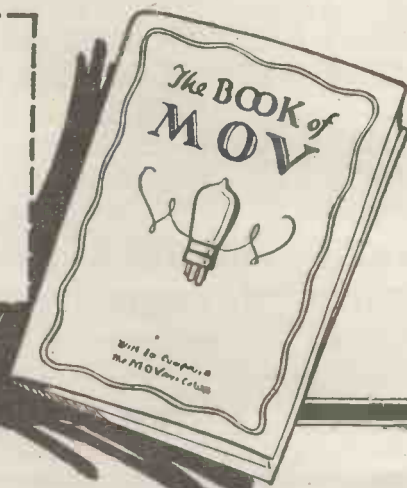

**GET THE VALVE IN THE PURPLE BOX!**

ANNOUNCEMENT OF THE M. O. VALVE COMPANY, LIMITED.

*It will pay you always to watch WIRELESS WEEKLY Advertisements.*



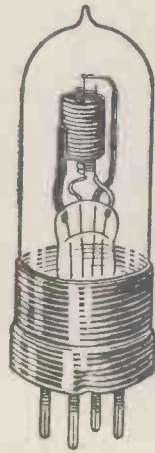

THE FIRST VALVE EVER MADE, WAS  
PRODUCED IN THE EDISWAN LABORATORY

## The lamp that learnt to talk

**T**HIRTY years ago the first electric lamp was making its reputation. Everybody considered it a useful substitute for paraffin oil. Nobody dreamed it would ever "talk." It was Dr. Fleming who found that something more was happening inside the lamp than other people had thought of. He introduced a metal plate into the bulb and made the lamp into a detector. Later evolutions provided the grid and the electric lamp

was able not only to detect but to amplify. - It had learned to "talk."

The first wireless valve was made in the Ediswan laboratories. It was the parent of the very reliable types of valve that bear the name "Ediswan" at the present day.

*Ediswan Valves will bring the best out of your wireless set—get some on the way home and enjoy better programmes from to-night onwards. All dealers sell them.*

*You will be interested in our booklet "The Thermionic Valve." It's free—send for a copy.*

THE EDISON SWAN ELECTRIC CO., LTD.,  
QUEEN VICTORIA ST., LONDON, E.C.4

# EDISWAN VALVES

An interesting study of early wireless history may be made at the Science Museum, South Kensington, London, where the complete series of Dr. Fleming's experimental valves can be inspected.

162-2

It will pay you always to watch WIRELESS WEEKLY Advertisements.



## A Reference Library for 2/6.

WITH the large number of really good Books on Wireless published by Radio Press Ltd., it is a little difficult for an enthusiast to pick out the most useful of them. The Book *500 Wireless Questions Answered*, however, by its immense sales, has already proved itself as being the most popular — two editions having been exhausted since last November.

Its wide scope—coupled to the fact that it deals only with live and useful information—is rendering it indispensable to every

Broadcast listener and experimenter.

Certainly, previous to its publication it would not have been possible to have obtained one half of the information contained within its two covers under an expenditure of several pounds. And even then the information would not have been given in such a concise and compact form, well indexed, and available at a moment's notice.

Such a Book as this will save its cost many times over—it can certainly be described as a *Reference Library for half-a-crown*.

### Contents

Aerials.  
 Amplifiers.  
 Crystals and Crystal Sets.  
 Earths.  
 Frame Aerials.  
 Grid Leaks and Condensers  
 Interference.  
 Loud Speakers.  
 Morse.  
 Primary Batteries.  
 Ranges.  
 Reaction.  
 Secondary Batteries.  
 Sounds and Signals.  
 Telephone Receivers  
 Tuning Coils.  
 Tuning Condensers.  
 Valves.  
 Wavelengths.  
 Waves.  
 Wire.  
 Miscellaneous problems.

RADIO PRESS, Bush House, Strand, W.C.2.

Post free  
2/8

# 2/6

# 500 Wireless Questions Answered

By G.P. Kendall & E Redpath. Post free 2/8

Gilbert Ad.

It will pay you always to watch WIRELESS WEEKLY Advertisements.



# Safety First



## The Mullard Service Safeguards All Valve Users

YOU can avoid accidents to your Valves by using Mullard Safety Discs.

Your dealer will supply them **free on request**. These patented discs are perfect insulators under all conditions of service and are purposely designed to prevent filament burn out by H.T. battery short circuit. Simple to use and effective in operation these discs are another striking feature of Mullard Service to ensure continued perfect reception for the radio public. Complete instructions with each disc. Make sure you get these Mullard Safety Discs. Send us the name and address of your dealer if you cannot get what you want, and we will supply his requirements.

# Mullard

## THE • MASTER • VALVE

Obtainable from all Radio Stores, Electricians, etc.

Advt. The Mullard Radio Valve Co., Ltd. (W.W.), Batham, S.W.12

It will pay you always to watch WIRELESS WEEKLY Advertisements.

# Brown



—from the tiniest nut to the finished Loud Speaker

THE non-technical visitor to the works of S. G. Brown, Ltd., will be amazed at the large number of processes and the magnitude of the equipment necessary to produce Brown Loud Speakers and Headphones.

To many, a pair of headphones consists merely of a couple of coils in each ear-piece, together with a circular magnet and a diaphragm. But see even the simplest type of Brown headphones—the famous featherweight F. Type—manufactured under ideal conditions, and you will appreciate that parts ground to 1/1,000 part of an inch must obviously give infinitely better results.

And it is the same with Brown Loud Speakers. Not only has their design—based on the world-famous A. Type Headphones—been proved superior for sensitiveness and tonal purity, but their success is due in no small degree to the wonderful accuracy of the many manufacturing processes. Remember that your Loud Speaker should be an investment—the few shillings necessary to obtain a Brown will be more than repaid to you by the increased enjoyment of hearing really true-to-life reproduction and by the knowledge that you own an Instrument capable of giving you many years of service.



Types and Prices:	
H.1.	120 ohms .. .. £5 5 0
	2,000 ohms .. .. £5 8 0
	4,000 ohms .. .. £5 10 0
H.2.	120 ohms .. .. £2 5 0
	2,000 ohms .. .. £2 8 0
	4,000 ohms .. .. £2 10 0
Q.	All resistances .. £15 15 0

From all Dealers or can be demonstrated at the following Showrooms:  
 19, Mortimer Street, W.1.  
 15, Moorfields, Liverpool.  
 67, High Street, Southampton.

S. G. BROWN, LTD.,—Victoria Road, N. Acton, N.W.3.

Gilbert Ad. 1743.

It will pay you always to watch WIRELESS WEEKLY Advertisements.

IT'S THE LEAK THAT DOES IT



The "Bretwood" Grid Leak (Guaranteed) tunes a carrier wave from the silent point up. The "Bretwood" is recognised by highest experts and experimenters as the only variable and reliable Grid Leak.

PRICE  
**3/-**  
 Postage 3d

If you are not satisfied within 7 days, money will be refunded.  
**RADIO IMPROVEMENTS, LTD.,**  
 12-18, London Mews, Maple St., London, W.

Barclays 162

## THE MASTER ONE-VALVE SET

Receives all B.B.C. and CONTINENTAL STATIONS. Operates Loud Speaker under favourable conditions. Simple to operate. **43/-** including B.B.C. coils, plus Royalty. Marvellous Range and Power. Genuinely worth £4.  
**WORLD'S WIRELESS STORES, WALLINGTON.**

## TWO MORE!

### Radio Press Envelopes

which are recognised as the greatest aid to constructors yet evolved.

How to make:

### A ONE-VALVE REFLEX RECEIVER

By Herbert K. Simpson

### Loud-Speaking with One Valve

In this set the valve functions in a dual capacity, amplifying first at high frequency, and then again at low frequency. At short distances from a B.B.C. station it will therefore work a loud-speaker with sufficient volume for a small room if an outside aerial is used. Strong headphone signals can be obtained up to much longer distances.

### Universal Wavelength Range

PRICE **1/6** (Postage 3d.)

### AN EFFICIENT SINGLE-VALVE SET

How to build it

By Herbert K. Simpson

This set is so easy to build and so simple to work that it forms a perfect starting point for the novice. With an outside aerial a little practice will enable quite a number of the B.B.C. and Continental stations to be received with ease. A dull emitter valve can be used without any alterations.

### The Ideal Beginner's Set

Will receive 5XX practically anywhere in Great Britain.

PRICE **1/6** (Postage 3d.)

"Modern Wireless" Coil Table sets aside all doubts as to the correct coils to use for Aerial, Anode and Reaction. Price 6d. (Postage 2d). Obtainable from principal wireless dealers and through all booksellers or newsagents—or direct from

## RADIO PRESS LTD.,

Bush House, Strand, London, W.C.2.

RADIO PRESS INFORMATION DEPT.

**2/6** QUERY COUPON

WIRELESS WEEKLY.

Vol. 5. No. 4. Nov. 12, 1924.

(This coupon must be accompanied by a postal order of 2/6 for each question, and a stamped addressed envelope.)



# WITHOUT

## ELECTRON WIRE THE PERFECT AERIAL

### YOU CANNOT KNOW REAL AERIAL EFFICIENCY

WIRELESS enthusiasts must be on their guard. There are dealers all over the country who are trying to foist upon the public colourable imitations of the famous "ELECTRON WIRE."

IF "ELECTRON WIRE" IS THE WIRE YOU WANT BE CAREFUL THAT YOU GET IT.

It brings envied results. Multitudes of wireless experts as well as enthusiasts all over the world are using it.

Every day we get shoals of letters telling us of the remarkable reception amateurs and experts are getting with "ELECTRON WIRE."

If you ever find a better aerial get it. A good reception is worth any price you pay.

BUT AVOID DECEPTION. LOOK AT THE NAME AND THE BOX. If it is not our distinctive box refuse it and save disappointment.

Ask for and insist upon "ELECTRON WIRE" in our distinctive white box printed in blue. Refuse any wire which may look like "ELECTRON WIRE," and may even be boxed under a similar name.

### TAKE NOTICE OF THIS WARNING!

Buy "Electron Wire" in our distinctive box only, plainly printed in blue on every side with "ELECTRON WIRE" and the price 1/8. Refuse all others.

Try It then you will know why it is so popular. Ask your dealer for ELECTRON WIRE. But you must agree to return it if it does not "prove up" to every claim made for it. If your dealer does not sell ELECTRON WIRE yet, he can get it for you, or we will send it direct to you upon receipt of P.O. or cheque. Do not send stamps, PLEASE.

## The CHEAPEST AERIAL 1/8 and the Best in the World.

Also laid double for extending 'Phones, Loud Speakers, etc.	Two 150 feet lengths twisted.	Two 250 feet lengths twisted.	Two 500 feet lengths twisted
	300 ft	500 ft.	1,000 ft.
	5/-	8/-	15/-

Carriage Paid.

BRITISH WIRELESS EXHIBITION COME and SEE  
WHITE CITY : : Shepherd's Bush. OUR  
November 15th to 27th. MODEL HOUSE  
STANDS Nos. 8 & 15.

## New London Electron Works

(Members of the B.B.C.) LIMITED

65, REGENT'S DOCK, LONDON, E.14.

Telephones:  
EAST 1821; EAST 6043.

Telegrams:  
"STANNUM, LONDON."

BUSES Nos. 15, 23, 40. 1d. from Aldgate. (Near East Stepney Station, L.N.E.R.)



## Hello Everybody!

Here I am at the Exhibition waiting to welcome you all. We've got here the finest and most representative wireless show you have yet seen. Everything from Super-receiving sets, with more valves than you'd care to contemplate, to little crystal sets, costing a few shillings apiece. Loud speakers, headphones, components, valves, in fact, everything that could possibly be required for broadcasting or experimental work; and you needn't go beyond the first stand in the show to find them. We're right at the entrance, you can't miss us; you wouldn't want to either, as you know perfectly well that from our new Super-one to our Super-five we provide first-class apparatus at really economical prices. In fact, just what I always say:

Quality apparatus at low cost.

*Mulla Fellows*

# FELLOWS WIRELESS



### The Lightweight Headphones.

Highly finished, good workmanship and extreme sensitiveness. They are very comfortable, headbands are duralumin, and will not rust or tarnish. Weight with cord, 6 oz. Resistance 4,000 ohms.

Price 18s. 6d.

Stands 1 & 22, British Wireless Exhibition, White City.

Advt. of the Fellows Magneto Co., Ltd., Park Royal, London, N.W.10

B.P.B. 94.

It will pay you always to watch WIRELESS WEEKLY Advertisements.

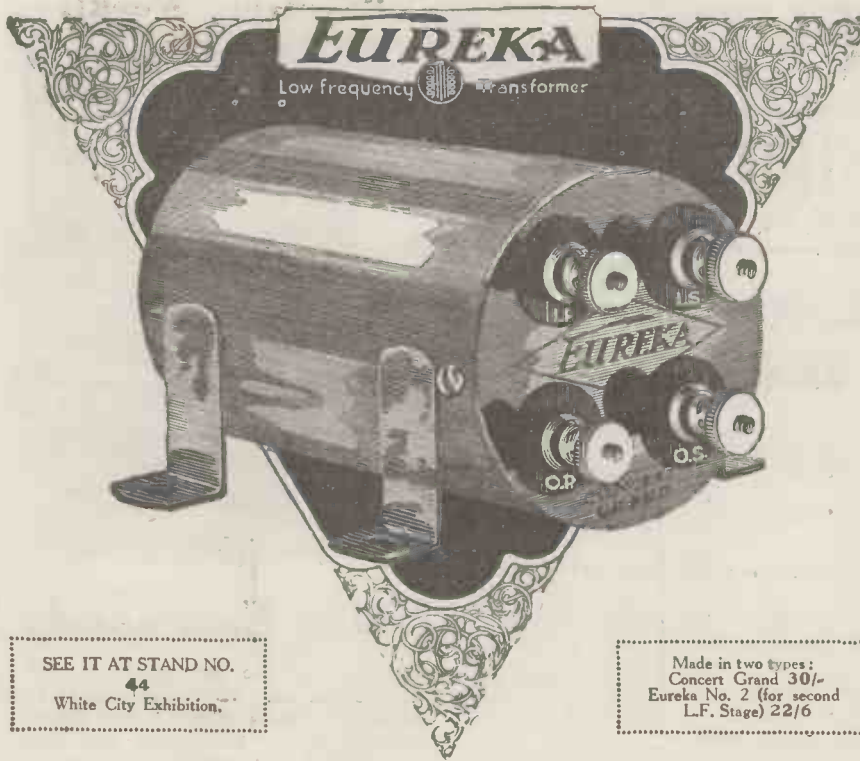

SEE IT AT STAND NO. 44  
White City Exhibition.

Made in two types:  
Concert Grand 30/-  
Eureka No. 2 (for second  
L.F. Stage) 22/6

## Guaranteed indefinitely against breakdown.

OUT of all the scores of Transformers on the market today, how many carry—either in letter or in spirit—the guarantee that is at the back of every Eureka? Not only must it satisfy your most critical demands—and you shall be the judge—within a reasonable period of trying it out, or your purchase price will be refunded in full, but we will actually guarantee it against breakdown throughout its normal life.

We make this offer for two reasons: first, because we have the most complete confidence in our Transformers, and secondly, because the unique construction of every Eureka prevents the possibility of any atmospheric influence acting upon it.

As is well known, the air is often heavily charged with dampness, which can be readily absorbed by any ordinary Transformer exposed to it for any length of time. This dampness—sooner or later—will probably cause a breakdown in the insulation of any exposed winding, or at least create a serious falling off in signal strength.

But look at the Eureka, see its massive coppered-steel case, and

know that the whole of its contents is hermetically sealed—actual tests have even demonstrated that fourteen days under water does not harm the Eureka in the slightest degree.

Thus the insulation—tested at 2,000 volts by Faraday House—is absolutely permanent.

But insulation is only one of the Eureka exclusive features—anyone who has had the opportunity of using one will enthuse over its wonderful volume and purity of tone.

If you are building a new Set—or bringing your existing one up-to-date—be sure to fit a Eureka Transformer and have no regrets.

Portable Utilities Co., Ltd., Eureka House, Fisher St., London, W.C.1

Gilbert Ad. 1757

It will pay you always to watch WIRELESS WEEKLY Advertisements.

### WIRELESS WEEKLY SMALL ADVERTISEMENTS.

**AERIAL SATISFACTION!** Use clear reception Radiowire for your aerial and lead direct to set. Easily fixed, requires no insulators. Only 1/8d. for 100 ft. with instructions! Useful for earthing and 'phone extensions and is waterproof insulated. From your dealer or post free from David Green & Son, 656 Department, Lytham.

**HEADPHONE REPAIRS.**—Rewound and remagnetised, readjusted. Lowest prices quoted on receipt of telephones. Delivery three days. Est. 26 years.—Varley Magnet Co., London, S.E.18.

**TELEPHONE RECEIVERS and Loud Speakers** Rewound, 2,000 ohms, 3/6.—A Roberts & Co., 42, Bedford Hill, Balham, S.W.12.

**BATY Condenser, High Max., Low Min., High insulation, Min. weight, 5/3 post free.** Coil to match, 230/4,000 metres, 6/9 post free. Combined space 4"x1", weight 2 oz. Suitable for all circuits. Technical reprints giving circuits, 1/3 post free. Ernest L. Baty, Luton.

**PARTNER or Director** required for Involute Helical Inductor Cylinder Generators and Motors, D.C. (Self-commutated) and A.C. Adapted for press too mass products, suitable all sizes and purposes. Patented in all countries. Great opportunity to obtain large or controlling interest (£5,000 upwards) in British Patent as affecting aircraft and wireless, for which large orders are promised. Invaluable first hand knowledge and experience could be acquired.—Reply to Box A22, "Wireless Weekly," Barclays, Bush House, Strand, W.C.2.

**AGENTS Wanted.** Wireless valve repair business. Deal with the actual repairers. Lowest trade terms. All types repaired. A hard vacuum guaranteed. Also old valves bought for cash, 6d. each. Cossors 1/- each. M. & G., 60, Churchfield Road, Acton, W.3. Telephone Chiswick 2681

**12/6.** Crystal Set 1 Valve Amplifier increases signals four times. Pledge Bros., 26, Woodstock Rd., Oxford.

**PRACTICAL INVENTIONS** are required in connection with the Wireless trade. Inventors should send brief particulars in first instance to Box A.25, "Wireless Weekly," Barclays, Bush House, Strand, W.C.2.

### EL-BE UTILITIES

The "MIKROTUNE" MAKES TUNING SIMPLE & CERTAIN

Reversible Coil-holder.

—

Adds 50% value to any set.

—

**12/6**

—

Coils under minutest control. A Perfect VARIOMETER. Send us the name of your Dealer and we will arrange a demonstration for you.

**LEIGH BROS.,** 37, Sidmouth St., Gray's Inn Rd., LONDON, W.C.1  
Telephone: MUSEUM 4192.

### CABINETS YOU WANT

PICKETT'S Insulated Cabinets = for 100% results. From 1/6 each, highly polished. All designs and sizes

**"MADE for CONSTRUCTORS."**  
Write now for Constructors' Lists Free.

**PICKETT'S Cabinet (W.L.)**  
Works, Bexleyheath, S.E.



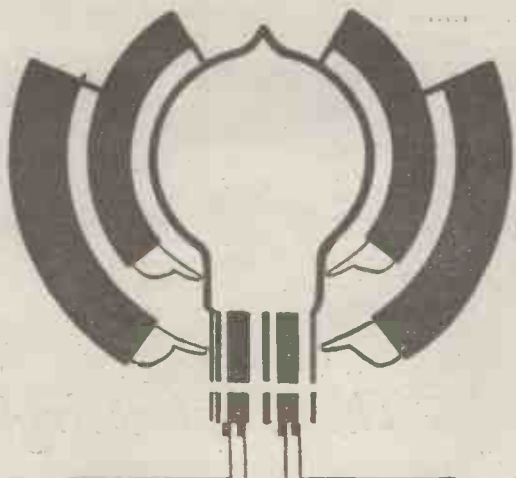

## FIT THE NEW RADION G.P. VALVE

AND SIMPLIFY RECEPTION.

Here's an economical bright emitter general purpose valve with amplification factor of 9. filament 3.5 to 4 volt. .48 amp. Anode 30 to 90. Use it in any part of your set. Let us send you free and post free the curve for this valve. Just a P.C. will do.

RADIONS LTD., BOLLINGTON, MACCLESFIELD,

From Dealers **10/-** or direct.

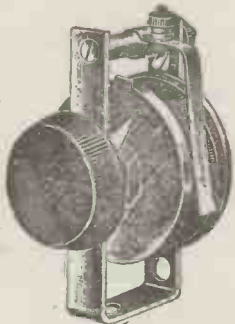

IGRANIC  
Filament RHEOSTAT  
30 Ohm Type.



include :

- Honeycomb Coils
- Filament Rheostats
- Intervalve Transformers
- Variometers
- Vario-couplers
- Bi-plug Coil Holders
- Tri-plug Coil Holders
- Battery Potentiometers
- Vernier Friction Pencils
- etc., etc.

All carry a six months' guarantee.

You should see  
this Rheostat and  
other IGRANIC  
Radio Devices on  
Stands 9 and 14

at the

Radio Exhibition

and

Wireless Convention

White City, Shepherd's Bush, W.12.

NOV. 15 to 29, 1924.

If you cannot visit the White City

Write to us for List Y41.

IGRANIC ELECTRIC Co., LTD.,

149, Queen Victoria Street, LONDON.

Works: Elstow Road, BEDFORD.

Branches :

Birmingham      Bradford      Cardiff  
Glasgow            Manchester      Newcastle

Build your own set



— and  
USE ONLY



## COMPONENTS

### H.F. TRANSFORMERS

A series of H.F. plug-in transformers in six ranges of wavelength. They are made of our highly-polished non-loss ebonite. The windings are carried in staggered slots, well protected. For successful H.F. amplification it is essential to use really efficient transformers. Users' opinions confirm that those of M.H. manufacture are the best.

No. 00.	80 to 150 metres	.. .. .	10/-
No. 0.	150 to 300 metres	.. .. .	10/-
No. 1.	300 to 600 metres	.. .. .	10/-
No. 2.	550 to 1,200 metres	.. .. .	10/-
No. 3.	1,100 to 3,000 metres	.. .. .	10/-
No. 4.	2,500 to 7,000 metres	.. .. .	10/-
The Complete Set			55/-

Can be supplied in matched pairs at NO extra charge if requested at time of ordering.

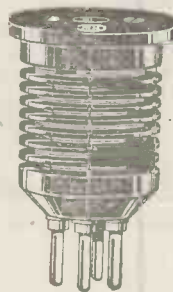

### L.F. TRANSFORMER

A high-grade and efficient Transformer of pleasing design for all intervalve purposes, possessing the best possible electrical characteristics. A fixed condenser is nearly always used with an intervalve transformer; provision is made in this model by the clips at Price the top to take our standard flat 21/- type condenser of suitable value.



### FIXED CONDENSERS

Each supplied with two Clips.

PRICES:  
0.001  $\mu$ F to 0.0001  $\mu$ F 1/9 each.  
0.01  $\mu$ F to 0.002  $\mu$ C 2/3 each.



We introduced, and have adopted as our standard, the flat type of fixed condenser which slips into two clips. They are made of high-grade ruby mica and tinfoil. Connection is made by their solid metal ends to two spring clips. This type is a distinct advance in the design of the fixed value condenser; its utility and adaptability are at once obvious and appeal to all users.

The Best results can only be secured through buying and building into your set the best components possible. To achieve this end, insist on M.H. components; unimpeachable quality and manufacture throughout.

**L.M. MICHAEL LTD**

IN CONJUNCTION WITH B. HESKETH LTD

WIRELESS ENGINEERS

RADIO CORNER, 179, Strand, W.C.2

Barclays 240

## A word to the serious experimenter

The "Mars" Aerial, which consists of 84 fine strands of phosphor bronze wire, spirally wound so that each strand is air insulated, is attracting the earnest attention of many serious experimenters. That it gives at least 50 per cent. better results (compared with 7/22's) when used for reception and 90 per cent. better results when used for transmission is generally admitted.

It has the lowest ohmic resistance yet attained—this too has been endorsed after exhaustive tests.

It has been found that two "Mars" Aerials twisted together make an unusually fine earth, especially if enamelled. (For earth wire only.) Certainly the "Mars" appears to be a super aerial with great potentialities yet unexplored.

What's your opinion ?

All leading wireless dealers stock the "Mars" in 100 ft. lengths at 9/6. Extra lengths up to 600 ft. supplied to order. In case of difficulty in obtaining please write to:—



## THE MARS AERIAL

E. & W. G. MAKINSON, LTD.,  
Wellington Works, Wellfield Road,  
PRESTON.

Established over 40 years.

Tel. No. : Preston 112.

Tel. Address : "Gold, Preston."



## The Compleat Angler

*"He that hopes to be a good angler must not only bring an enquiring, searching, observing wit, but he must bring a large measure of hope and patience, and a love and propensity to the art itself."*

IZAACK WALTON.

The above lines, by Izaak Walton, in "The Compleat Angler," may be just as appropriately applied to Wireless as to Fishing. How often does the enthusiast sit for hours in the early watches of the morning patiently searching for that carrier wave that denotes a message from a far-off land. Does not this, in your imagination, correspond to the first nibble of a fish at the bait, and the subsequent fine tuning and amplification of the signal correspond to the playing and successful landing of the fish ?

As successful angling depends on fine tackle and patience combined with the requisite skill, so does the reception of distant messages by wireless depend on the correct design of apparatus and the knowledge of their use.

The Radio Press, Ltd., teach the inexperienced how to design and make apparatus of guaranteed efficiency in "Modern Wireless," "Wireless Weekly," and "Wireless Constructor," and the necessary skill in handling can be acquired by following advice invariably given.

SUCCESS in any Wireless Magazine or Book depends on one feature only—the dependability and accuracy of its information.

Radio Press, Ltd., are not general publishers, making Wireless a side line, but are an organisation of technical experts engaged exclusively in the publication of Wireless Books and Magazines. In fact, they are the world's largest publishers of Wireless literature. Obtain your needs from your Local Newsagent, or Wireless Dealer.

wireless Weekly, 6d net

# Wireless Weekly

## RESULTS

Not only do maximum results accrue from advertisements in the WIRELESS WEEKLY, but, far more important still is that its readers embrace the section that buys on the spot. You therefore get the twofold advantage of **immediate** and **direct** results to your advertisement. Write for particulars of this and other Radio Press Publications to the Advertisement Managers.

**BARCLAYS ADVERTISING, Ltd.**  
Advertising Consultants & Contractors,  
Bush House, Strand, London, W.C.2.  
Telephone : City 9911 (Extn. 9).

**RADIO PRESS, LTD., BUSH HOUSE, STRAND, W.C.2.**



# REGENERATION IN THE DETECTOR CIRCUIT.

The damping effect of a grid leak having the wrong value is an experience which has to be tried to be fully understood. Damping in circuits where Detector Valve Regeneration is employed does actually destroy, or rather counteracts, the gain in signal strength secured by regeneration.

Ability to adjust grid leak resistance to just the correct proportion for the full employment of regeneration is only possible with a VARIABLE GRID LEAK. By working the detector valve on the correct portion of the curve for perfect rectification—AND HERE A VARIABLE GRID LEAK IS INDISPENSABLE—the detector valve may be sufficiently controlled to give maximum signals without any possibility of the rectifier tipping the set into self-oscillation. CHOOSE ALWAYS A WATMEL. IT GIVES DELICATE CONTROL. BUT BE SURE YOU FIT A

All goods of our manufacture bear this mark. It is your only guarantee

are now fitted with a spring contact on the control ensuring good electrical connection.

## IMPORTANT NOTICE to intending purchasers



Patent  
206098

5 to 5 Megohms ... 2/6  
50,000 to 100,000 Ohms. 3/6  
Other Resistances to suit  
any circuit.

Send P.C. for Descriptive Folder.  
SEE THE TRADE MARK

ON EVERY GRID LEAK.  
BEWARE OF IMITATIONS.

The Watmel Wireless Co. wish to notify the trade and public that their Variable Grid Leak Patent Application No. 206098 was contested in the Comptroller's Court, and on Appeal; in both instances the Patent Grant was upheld and costs awarded.

It is the aim of this Company to protect traders', customers', and also its own interests by securing Patent protection for the novelties in its specialities, as it is these novelties, invented by experts and exhaustively tested, which are the Hall Mark of all Watmel Products.

## THE WATMEL WIRELESS CO.

332a, Goswell Road, London, E.C.1.

Telephone - - - - - CLERKENWELL 7990.

## REAL RADIO

New apparatus evolved by scientists that will interest you.

A postcard brings you full details of sets and components.



GENERAL RADIO COMPANY

Radio House, 235, Regent St., London, W.1.  
Telephone: Mayfair 7152. Telegrams: "Algenrad, London."

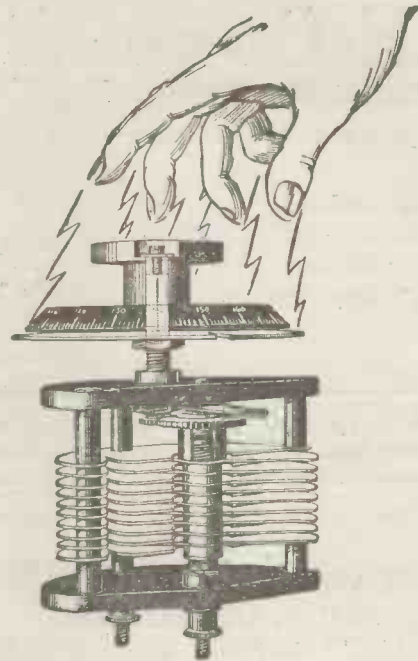

# FINER TUNING

The Naylor "Fulstop" Condenser enables tuning to be carried out with a wider range of accuracy than has hitherto been obtained. In addition to being a square law condenser, which avoids the overcrowding of stations at any particular point, the dial of the "Fulstop" Condenser is graduated over the complete circumference and geared at two to one in relation to the moving plates, thereby giving twice the rotary movement of any other condenser and enabling stations to be picked out with the greatest of ease. Further still, the abolition of all hand capacity effects is guaranteed unconditionally by the makers.

Read what "Modern Wireless" says:

"We can strongly recommend this type of geared condenser for careful tuning and for use in situations where hand capacity effects are troublesome." October, 1924.

Protected throughout the World.

Prices { .001 ..... 13/6 .0003 ..... 10/3  
.0005 ..... 11/3 .0002 ..... 9/6

Stocked by most Wireless Dealers,  
but if you have any difficulty write to

J. H. NAYLOR Ltd. Central Brass Works, WIGAN.

# The E-C (Easy) COIL FORMER

Is indispensable to the amateur

Fully described and illustrated on page 28 of "Wireless Weekly," Oct. 22 issue.

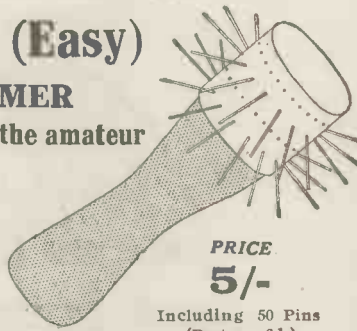

PRICE  
**5/-**

Including 50 Pins  
(Postage 6d.).

Obtainable from most Wireless Dealers.

For both Fine and Coarse Spacing

Cost Saved on First Coil Wound.

These Formers will wind every type of Plug-in Coil described in

## "Tuning Coils and How to Wind Them"

By G. P. KENDALL, B.Sc.

Published by "Radio Press" at 1/6. Post Free 1/8

# HUGHES & COMPANY

19-21 FORE STREET AVENUE, E.C.2

Telephone: CENTRAL 1096.

A FEW PROVINCIAL AGENCIES STILL OPEN.

## Our New SQUARE TYPE VARIOMETER



A departure from the normal everyday variometer which gives results equal to the best at double the price. One hole fixing terminal connections, no loose and unsightly ends. Price 4/6  
HEADPHONES, 4,000 ohms 15/-

Tapped Inductance, Broadcast Wavelength - - - 3/-  
For Chelmsford, 5XX - 4/-

You cannot get better value, and we pay all postage.

Send Cheque or P.O., crossed Not Negotiable to

**M TEMPLE, Walmar House North,  
296, REGENT STREET, W.1.**

Barclays 316

## FIT Radiax SQUARE LAW CONDENSERS



Of splendid quality and finish, very strong construction and highest possible electrical efficiency, this new Radiax production will

### REVOLUTIONIZE YOUR TUNING

The use of a good Square law condenser facilitates the tuning on that portion of the scale hitherto difficult or impossible, and gives uniform results over the whole range.

A RADIAX CHART, FREE WITH EACH, enables you to identify by wavelength each station you tune in. It includes valuable hints on logging all stations heard.

Without Vernier With Vernier

PRICES  
.001 9/-  
.0006 7/6  
.0005 7/-  
.0003 6/6

8/6

8/-

**RADIAX LTD., 50, Radio House,  
Percy Street, Tottenham Court Road, London, W.1.**



**RADIAX**  
WE SATISFY YOU

Barclays, 309



## Reversible VALVE HOLDER

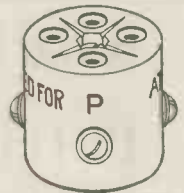

The Universal Valve Holder.  
One Hole fixing and will fit front or back of vertical or horizontal panels.

Lowest Capacity and  
**HIGHEST INSULATION OBTAINABLE**

If your dealer cannot supply we will send post free if you mention his name and address.

**ATHOL ENGINEERING COMPANY,**  
CORNET ST., HIGHER BROUGHTON, MANCHESTER.  
LIBERAL TRADE TERMS. Phone: 469 H.B.

**1/3**

PATENT  
APP'D FOR.

SEND P.C.  
FOR LIST.

## 230 MILES with a Crystal Set

With our "Chelmsford" Crystal Receiving Set 5XX has been received clearly and regularly at a distance of 230 miles. This set will also receive the Eiffel Tower at a distance of 600 miles, in addition to being the ideal and most efficient set for the local broadcasting station, radius 35 miles.

**NO PLUG-IN COILS.**

Continuous wave-length range from 160 to 3,000 metres.

**ASTOUNDING LOW PRICE! 15/6 Post 1/-**

Send 2d. in Stamps for our list containing bargains in complete sets and accessories.

**WHITE & CO., 95, Old Kent Road, S.E.1.**

## THE NEW "DEXTRAUDION"

DULL  
EMITTER

PRICE  
**21/-**

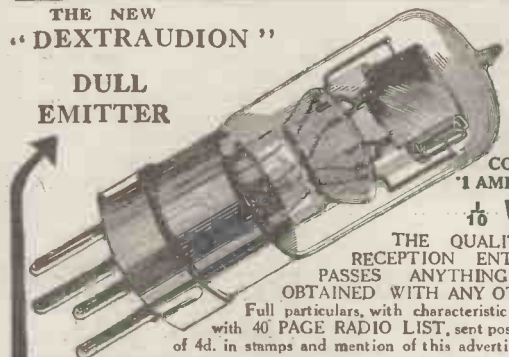

MAXIMUM  
CONSUMPTION  
1 AMP. AT 1 VOLT.

**1/6 WATT!**

THE QUALITY OF THE RECEPTION ENTIRELY SURPASSES ANYTHING HITHERTO OBTAINED WITH ANY OTHER VALVE.

Full particulars, with characteristic curves, together with 40 PAGE RADIO LIST, sent post free on receipt of 4d. in stamps and mention of this advertisement.

**ECONOMIC LTD.  
ELECTRIC**

Head Office: 10, FITZROY SQUARE, LONDON, W.1.

Showrooms: 303, EUSTON RD. N.W.1



When fitting an Earthing Switch fit the **ARGUS** LIGHTNING PROTECTOR

AND USE YOUR SET IN SAFETY EVEN DURING A THUNDERSTORM

PRICE - POST 3/4 **2/9** COMPLETE WITH INSTRUCTIONS

Obtainable from all Wireless Dealers or direct from - **ANDERSON'S WIRELESS SALES AGENCY 915 Oxford Street W.1.**  
Telephone - Overland 1783 Telegrams - ANWALG, WESTCENT, LONDON.



Established 26 Years.

## REPAIRS TO HEADPHONES TO LOUD SPEAKERS TO COILS

REWOUND to any RESISTANCE & MADE EQUAL to NEW. PRICE QUOTED ON RECEIPT OF INSTRUMENTS.

PROMPT DELIVERY.

**The VARLEY MAGNET COMPANY**  
Woolwich, S.E.18.

Phone: Woolwich 888.



# Tune the Table-Talker with the "Matched Tone" Headphones



The Brandes Family Series.

**B**ABY sits intently watching Young Bill tuning up the receiver. He finds it mighty hard not to take up a roving commission among the shining accessories. He wonders devoutly to himself why Brother Bill should find it necessary to become involved in a mass of tangled wire and mutter wholeheartedly to himself. But he knows just what it will mean to him. In a little while the *Table-Talker* will speak easily and naturally of the many phantasies of his youthful imagination. Fascinated by the burnished discs and metal of the "Matched Tone" Headphones, he will be able to place them on his tender head with their gentle comfort, and listen to the sweet bell-like notes. Ask your dealer for Brandes.

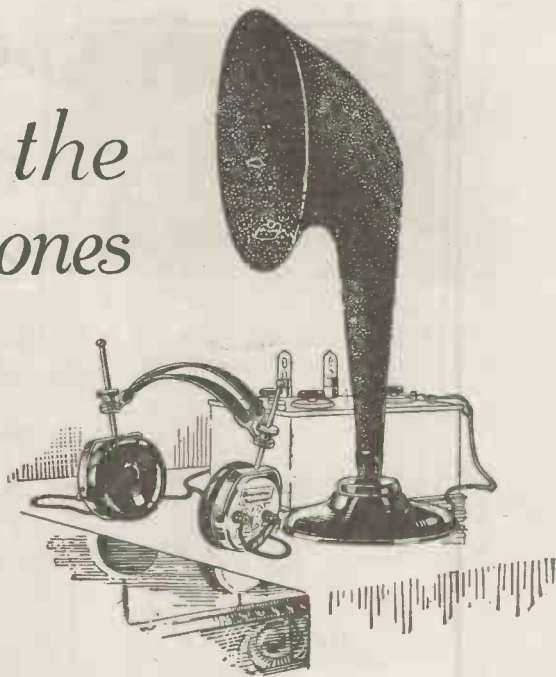

All Brandes products carry our official money-back guarantee, enabling you to return them within ten days if dissatisfied. This practically constitutes a free trial.

The "Matched Tone" feature means that both your ears hear exactly the same sound at the same instant—and you learn a new beauty of tone. They are tested and re-tested for just this one vital point, and in addition their strength, long-wearing comfort and reliable efficiency make them undoubtedly superior. **25/-**

The *Table-Talker* is a Brandes quality product at a moderate price. The non-resonant, specially constructed horn is matched to the unit so that the air resistance produced will exactly balance the mechanical power of the diaphragm. This means beautiful sound-balance and remarkable tone qualities. It is twenty-one inches high, has a self-adjusting diaphragm and is finished a **42/-** shade of neutral brown.

British Manufacture (B.B.C. Stamped).

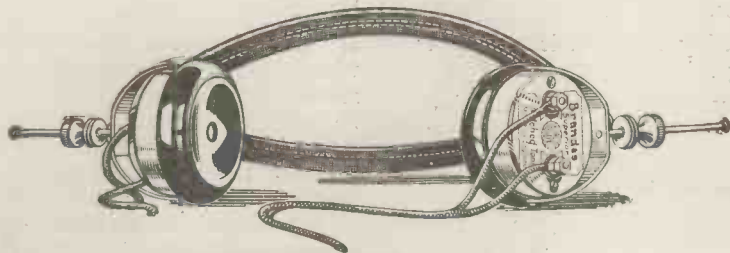

# Brandes

Result of  
16 Years  
Experience

The name  
to know in Radio

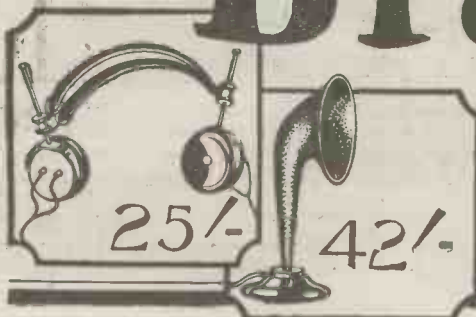

It will pay you always to watch WIRELESS WEEKLY Advertisements.

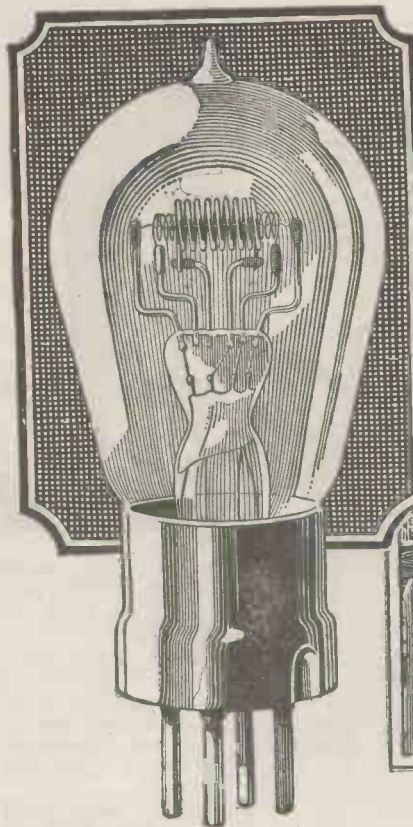

# Louden



*"Fine knacks for ladyes"*

10/-

Stands 1 and 22,  
British Wireless  
Exhibition,  
White City.

If good trading consists in getting the utmost return for one's outlay, then buying a Louden Valve is excellent business.

The outlay required is only ten shillings.

In return you will get a valve which we consider represents by far the best value yet offered.

Only one of its good qualities is the saving which it will effect in your accumulator bill.

The current consumption of the Louden Valve is exceptionally low (0.4 ampere) whereas that of the ordinary bright filament valve is almost double this figure. Satisfied users of Louden Valves report that their

accumulators now last twice as long, that the journeys to the charging station are now halved as also is the accumulator bill.

If this were the only advantage which the Louden Valve possessed over others it would alone be sufficient to recommend it, but when you consider that in addition it gives a reproduction startling in its silver clarity, that it gives the same volume as valves costing considerably more, and that the life of the filament is greatly prolonged by the absence of "bombardment," you will agree that in fairness to your purse you should fit your Set with Louden Valves at the earliest possible date.

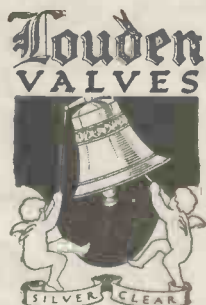

*The Plain Louden for Detecting and Low Frequency Amplifying.*

Filament Volts ... 4.8-5  
Filament Amps. ... 0.4  
Anode Volts ... 40-80

**FELLOWS WIRELESS**

*The Blue Louden for H.F. Amplification.*

All Loudens are silver clear and free from mush. The current consumption is very low and the life long.

## Louden Valves - Silver Clear



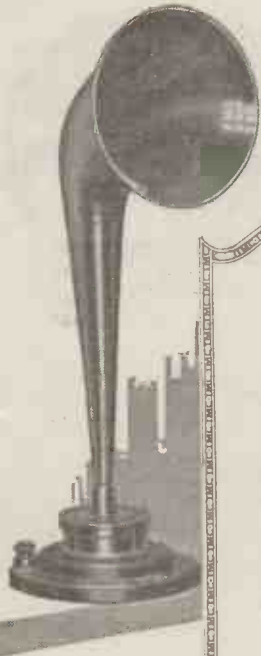

Ask to see the  
**TrueMusiC JUNIOR**  
Loud Speaker.

Before you decide on the Loud-speaker for your Set, see, and listen to a TrueMusiC Junior.

Its clear, pure tone is a revelation.

Reproduction of Broadcasting is so faithful, because the metal in the Horn is not stretched or twisted. It is made in one piece of electrolytically deposited copper.

Drop us a Post Card for our Catalogue.

True Music Junior.  
£2 : 17 : 6

The Telephone Manufacturing  
Co., Ltd.,  
Pollingsworth Works, West Dulwich  
London.

E.P.S.  
194

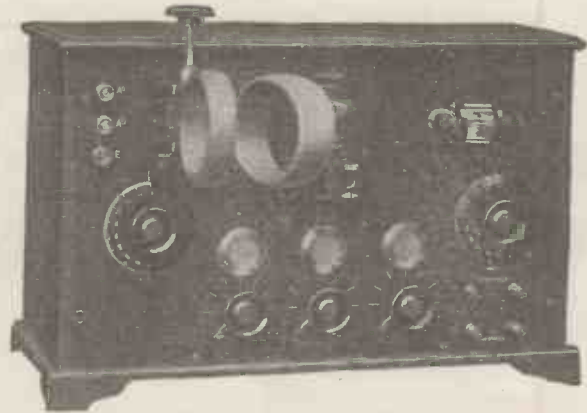

## The Puriflex Receiver

Anyone can build this Puriflex Receiver (designed by Mr. Harris and fully described in "Modern Wireless"). The only tools required are a screwdriver and a pair of pliers. An ideal Loud Speaker Set. We guarantee you complete success and maintain a Service Dept., to ensure all Pilot Sets giving first-class results.

Price of complete kit of components (less coils and valves) .. .. £4 5 0  
Pilot Panel, drilled, tapped and engraved .. .. 12 6  
Polished Oak Cabinet .. .. 17 0  
Finished Instrument, complete with coils and royalties paid .. .. £11 11 0

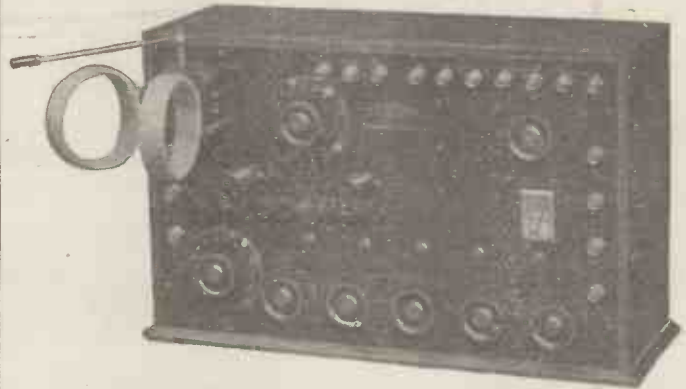

## The Transatlantic V

A wonderful long distance Receiver—makes American Broadcasting a certainty. Build this splendid 5-valve Set yourself, at less than the cost of a ready-made 2-valve Set. Exceptional selectivity—will work excellently from an indoor aerial.

Price of complete kit of components (less coils and valves) .. .. £5 4 6  
Pilot Panel, drilled, tapped and engraved .. .. 13 6  
Polished Oak Cabinet .. .. 17 0  
Finished Instrument, complete with coils and H.F. transformers (Royalties paid). .. .. £18 18 0

Get particulars of other "Modern Wireless" Sets now ready under the Pilot Service.

Send to-day for copy of large folder of the Pilot Panel Service for Home Constructors.

ALL the principal Receivers described in recent issues of "Modern Wireless" are available under the Pilot Panel Service. This scheme takes all the worry and trouble out of Set building and makes the assembling of a Receiver a task of only a few hours. All Pilot Sets are guaranteed to work—you cannot go wrong. Our Service Dept. will see that you get perfect results. Before building any Set it will pay you to get in touch with us. Why run the risk of building a Set after your own design, that may not work, when you can build up a guaranteed Pilot Set in a couple of evenings?

Send for a free copy of our large Folder to-day. Catalogue of all Wireless Components, 3d. (post free).

**PETO-SCOTT CO. LTD.** *Reg. Offices (for all Mail Orders).*  
77, CITY ROAD, E.C.1.  
BRANCHES: LONDON, 62, High Holborn., W.C.1, and 230, Wood Street, Walthamstow. CARDIFF, 94, Queen Street. LIVERPOOL, 4, Manchester Street. PLYMOUTH, Near Derry's Clock. [Gilbert Ad. 1751]

Barclays 310.

It will pay you always to watch WIRELESS WEEKLY Advertisements.

## The SHIPTON New Type Strip Rheostat & Potentiometer PROTECT YOUR VALVES



British Made.

When you fit the SHIPTON Rheostat (one hole fixing) your valves are protected, since the SHIPTON 7 ohm model is fitted with a fuse. A spare fuse is contained in every box.

This Rheostat, besides combining a safety fuse, is designed with a special tension spring on the spindle assuring good contact while retaining a silky action, and actually costs no more than the now obsolete rheostat.

### RHEOSTAT YET INTRODUCED

The resistance wire is wound on insulated strip. Noises due to uneven spacing of the wire cannot occur with the SHIPTON.

Three models are available so that whatever valves you may use there is a SHIPTON Rheostat to give you perfect filament control. Ask for it by name.

Apply to your local dealer or direct, giving your dealer's name and address.

- THE MOST PERFECT**
- SHIPTON New Type STRIP RHEOSTAT 7 ohm (with fuse) .. .. 3/-
  - SHIPTON New Type STRIP RHEOSTAT 30 ohm .. 3/-
  - SHIPTON New Type STRIP RHEOSTAT 60 ohm .. 3/-
  - SHIPTON POTENTIOMETER 600 ohm .. .. 4/6
- Packed in neat linenette boxes.

Sole Agency applications considered for certain territories.

## E. SHIPTON & CO., LTD.

37, Tothill Street, Westminster, S.W.1.

Telephone: Victoria 7.

Telegrams: "Rentfones, Parl."

Also at 14, King Street, Covent Garden, W.C.

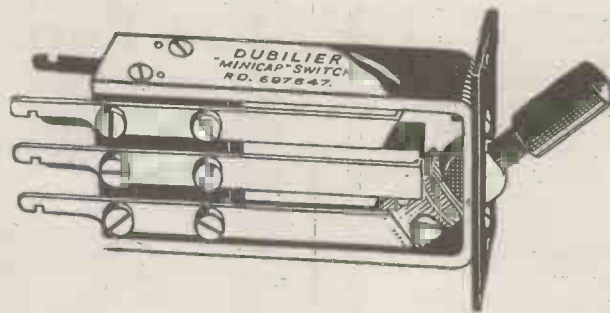

## THE "MINICAP."

Every serious experimenter or constructor should number amongst his accessories at least one double-pole-double throw switch.

The uses for such a switch are numerous and varied.

With its aid can be compared the reproduction from different telephones, loud speakers, detectors, transformers, circuits, or even complete sets, and, since the change-over is instantaneous, the comparison is far more effective than when numerous leads have to be changed.

Further uses are those of switching in and out steps of high or low frequency amplification, changing over from "series" to "parallel" adjustments, from "tune" to "stand-by," etc., etc.

In some of the instances mentioned, a small capacity between the various contacts of the switch is not harmful; in other cases, such as in H.F. circuits, it is imperative to eliminate self-capacity wherever possible.

The Dubilier MINICAP (minimum capacity) switch has been designed with the object of ensuring that no undue capacity effects occur in the switch itself.

It can be mounted on the panel of a set if it is to be fixed permanently in one position, or, for experimental work, it may be mounted on a separate panel of its own and provided with terminals. In this way it becomes one of the most useful pieces of apparatus on the experimenter's bench.

Price, with screws for panel mounting **8/-**



Ducon Works,  
Goldhawk Road,  
London, W.12.

**DUBILIER**  
CONDENSER CO. LTD

Telephone :  
Riverside 1084.  
Telegrams :  
Hivolteon, Phone,  
London.





## To a - Hair's Breadth

**T**HE Smith demands the highest degree of accuracy from his steam-hammer.

It must respond instantly, and deliver a giant blow of twelve tons or a light tap barely sufficient to crack a watch glass, and it must never make a mistake.

The Smith gets the best out of his hammer because the best workmanship and materials have been put into it.

You should see that no component finds its way into your wireless set unless you can feel entire confidence in it.

Eighty per cent. of the complete-set manufacturers in Britain, as well as thousands of experimenters, employ Dubilier Condensers and Resistances in their sets.

They *know* that a product bearing the name Dubilier can be trusted implicitly to do what is expected of it, and they count the few extra pence spent on it a sound insurance against disappointment.

*You should specify Dubilier.*

**DUBILIER**  
CONDENSER CO LTD

*Advt. of the Dubilier Condenser Co., Ltd., Goldhawk Road,  
London, W.12.*



No. 1 of a Series.

**Broadcasting From Spain.**

Broadcasting Station "Radio Iberica," situated in Madrid, transmits every evening on 392 metres (nearly the same wavelength as Newcastle). At present its programmes begin at 9.30 and conclude at midnight—thus there is ample opportunity for anyone to enjoy them without interference from our own B.B.C. Stations.

"Radio Iberica" uses a power of nearly 5 k.w., therefore, at the moment, it is easily received. With a good aerial, any user of a two-valve set, fitted with Cossor Valves, should be able to receive this station in any part of the British Isles—adding a Cossor P.1 as an L.F. amplifier would probably bring it in on the Loud Speaker.

**Cossor**

A. C. Cossor, Ltd., Highbury Grove, N.5.

It will pay you always to watch WIRELESS WEEKLY Advertisements.



# An international education for users of Cossor Valves

A year ago Continental broadcasting, as received in this country, was more a matter for the experimenter. But to-day a great change has been wrought. New Stations in almost every European Country are springing up overnight. Splendid programmes are now available for all who will take the trouble to equip themselves for it. From Scandinavia to Spain the ether is alive—take advantage of it.

Any good Receiving Set using at least one stage of high frequency—two stages would be better—and a good aerial, will be all the equipment necessary provided you are using the correct type of Valves.

For long distance work use a Cossor P.2 (the valve with the red top) in the high-frequency socket, and a Cossor P.1 as a detector. These two valves have been definitely worked out as a combination where the greatest efficiency is required.

Any experimenter knows that high-frequency amplification must be treated quite differently to rectification or low-frequency amplification—therefore the Cossor P.2 possesses very different characteristics to the P.1. But both of them use the same master principle which has always distinguished Cossor Valves—

the arched filament and the hood-shaped Grid and Anode.

It is a strict adherence to these principles that cause Cossor Valves to give results that are entirely without equal.

When dealing with the minute oscillations generated by a Broadcasting Station hundreds of miles away, you cannot afford to risk inefficient methods of valve design. And the ordinary valve with straight filament and tubular Anode is inefficient when compared with a Cossor. You know, of course, that the effective working of a valve depends on the electron stream given off by its heated filament. To prove this, turn the rheostat knob and lower the filament temperature—the output of electrons is diminished and signal strength falls off.

In the Cossor Valve the filament is arched and follows closely the contour of the hood-shaped Anode, therefore, few—if any—electrons can escape.

But in an ordinary valve a large proportion of the electron stream leaks away at each end of the Anode and causes a serious fall in efficiency.

If you are seriously interested, therefore, in getting good results from Continental Broadcasting, be sure to use Cossor Valves. *They cost no more — but what a difference in results!*

# Valves

Gilbert Ad. 1734.

#### BRIGHT EMITTERS

P1 For Detector and  
L.F. use .. 12/6  
P2. (With Red top) for  
H.F. use .. 12/6

#### WUNCCELL DULL EMITTERS

Model A. (With resistance in  
base for use with 2-, 4-, or  
6-volt accumulator.)

WR1. For Detector and  
L.F. use .. 23/6  
WR2 (With Red top) for  
H.F. use .. 23/6

Model B. (Without resistance  
working direct from 2-volt ac-  
cumulator.)

W1. For Detector and  
L.F. use .. 21/-  
W2. (With Red top)  
for H.F. use .. 21/-

It will pay you always to watch WIRELESS WEEKLY Advertisements.







# Observation and application

About the year 1749 an engraver named John Sadler, of Liverpool, whilst taking proofs off a plate he had engraved, was suddenly startled by shouts of jubilation from his children in the room. On turning round to see the cause he found that one of them had picked up a still wet spoilt copy that he had thrown on the floor and applied it to a piece of crockery, and was triumphantly holding up the decorated piece of china. This accidental revelation was pursued by Sadler, and it is on record that together with a master printer named Green they, a short time afterwards, printed "1,200 earthenware tiles in about six hours, better and neater than one hundred skilful pot-painters could have painted in the common and usual way of painting with a pencil."

This is probably the earliest known transfer printing; after Liverpool many other factories, such as Battersea, Worcester, Bilston, Staffordshire, Swansea, Coalport and others, made transfer-printed ware.

Transferring is a common process in Lithography where it is used for "making up work," viz., transferring a lot of impressions either all of the same matter or different to a large stone so that they can all be printed at once.

Ladies use transfers for getting their designs on material for silk and other fancy work, in fact, its uses are innumerable.

The "Radio Press," were quick to realise the immense advantage the process offered to amateurs in lettering their panels as against the comparatively costly method of engraving, and thus have placed in the reach of everyone the Radio Press Panel Transfers.

By using "RADIO PRESS WIRELESS PANEL TRANSFERS" (6d. per large packet of 80 labels), you can give to your set that finished appearance which makes all the difference. Not only are these transfers the cheapest and best but they are officially issued by the Radio Press for their sets. Buy a packet or two from your wireless dealer. They are also obtainable through every bookseller, but get the title right, if you want Radio Press quality.



8d. post free from

**Radio Press, Ltd.**  
**BUSH HOUSE, STRAND, LONDON, W.C.2.**



The  
**STERLING  
BABY**  
Loud Speaker

still rides on a wave  
of popularity which  
has never subsided

As a "junior" loud speaker  
the "Baby" has never been  
equalled for tone-perfect  
reproduction, excellence  
of finish & value for money

Your radio dealer will  
confirm this-and supply

at **55/-** Black or brown  
tinted finish

Advt. of **STERLING TELEPHONE and ELECTRIC CO., LTD.**

*Manufacturers of Telephones and Radio Apparatus, etc.*

210-212 TOTTENHAM COURT ROAD, LONDON, W.1.

Works: DAGENHAM, ESSEX.