

Wireless Weekly

and the Wireless Constructor.

Vol. 3.
No. 17.

CONTENTS

- “One-Handle” Control.
An Easy Selective Two-Valve Receiver.
- An Ultra Simple Crystal Set.
Another Circuit for the Omni-Receiver.
- Valve Telephony.
- Random Technicalities, Jottings by the Way, An Experimenter's Unit Receiver, More Simple Wireless Questions Answered, Valve Notes, Apparatus We Have Tested, Correspondence, Information Department, etc., etc.

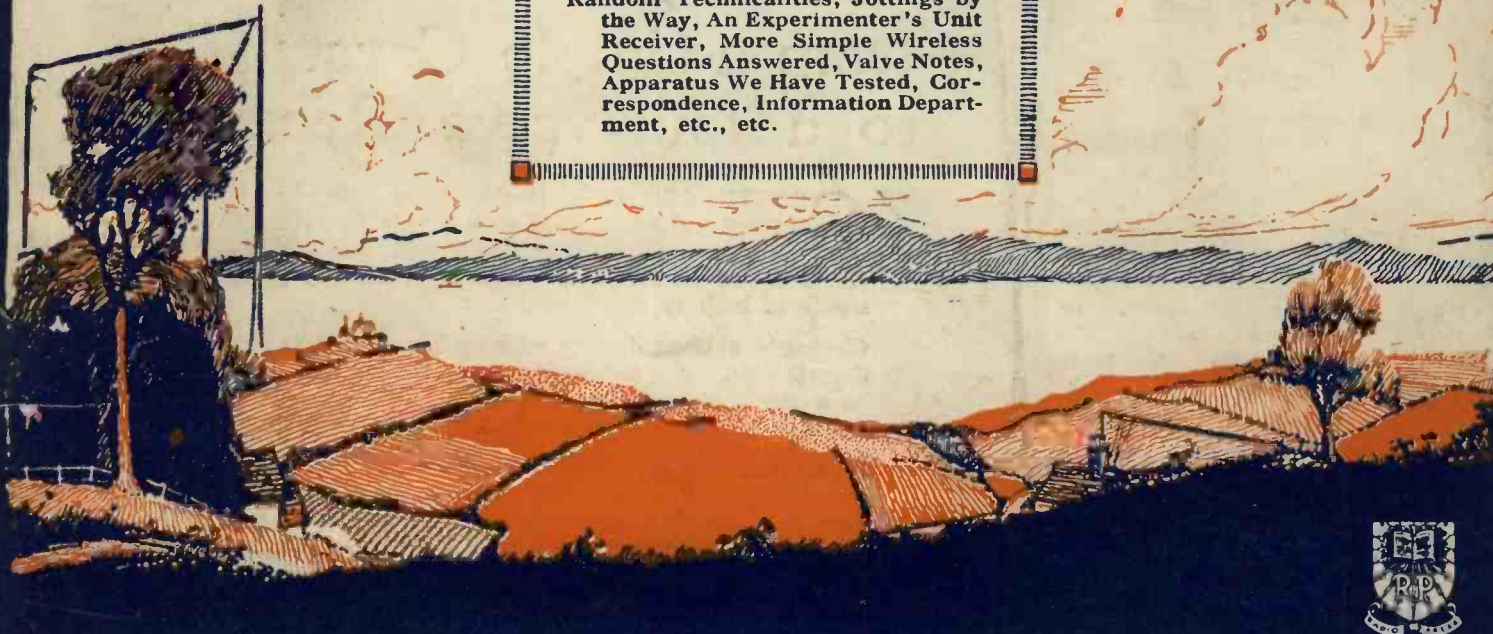

Circuit Diagram of His Majesty's Receiver

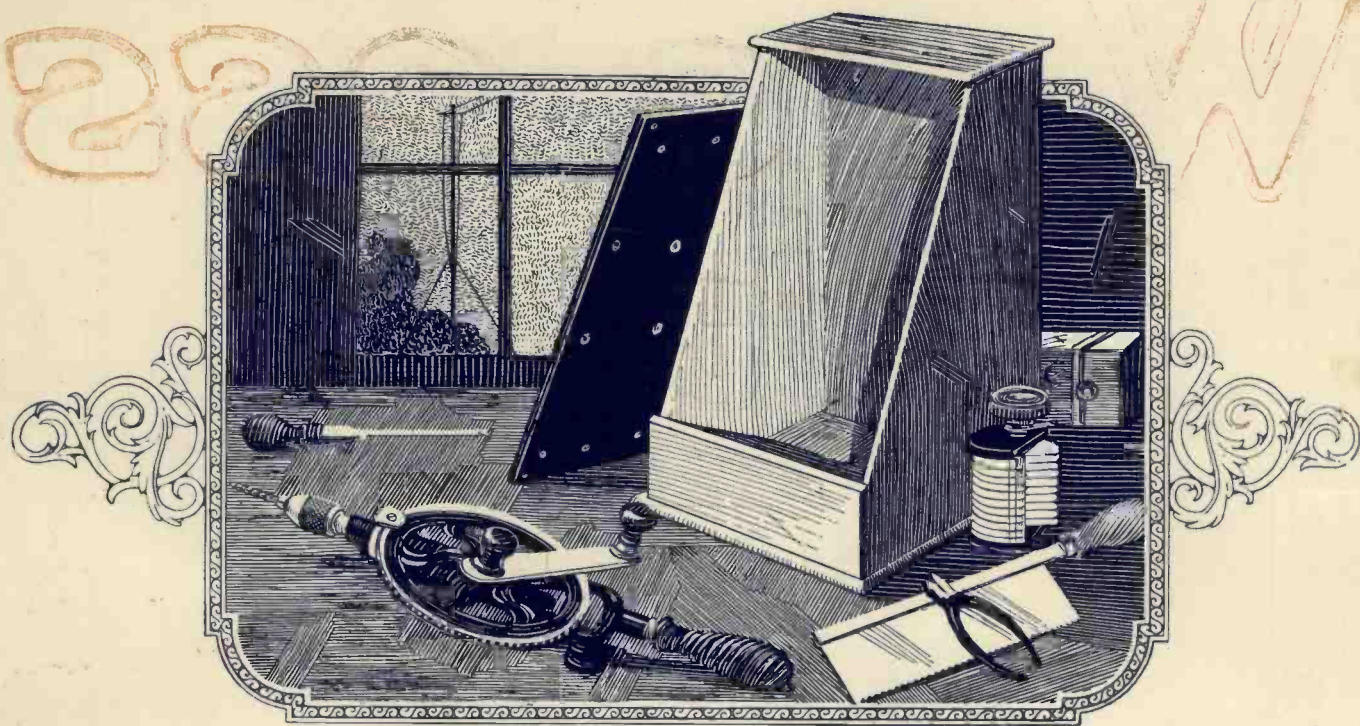

Wireless Sets for Home Constructors

By E. Redpath.

CONTENTS

- Simple Crystal Receivers
- An inductively coupled Crystal Set
- Testing and operating Crystal Sets
- A 2-Valve L.F. Amplifier
- Adding amplifiers to Crystal Sets
- A 2-Valve Broadcast Receiver
- A 3-Valve Regenerative Receiver
- A 1-Valve Reflex Receiver
- A 3-Valve Broadcast Receiver
- A 4-Valve Universal Receiver

—from a simple Crystal Set to a four-valve Receiver

CONSTRUCTIONAL Books have already been published which deal with simple Receiving Sets and also with more elaborate ones, but this is one of the first R.P. Books in which the reader is given a choice of both types of Sets.

Obviously a Book dealing with such extremes as simple Crystal Sets, which can be constructed in an hour or two, to a complex and ultra-efficient 4-Valve Set is a very useful adjunct to any Wireless enthusiast's Bookshelf.

Its frank advice and help in the choice of Sets to build will be appreciated by the complete novice, while the more expert will be glad to have authentic constructional details of the more advanced models capable of receiving American Broadcasting with certainty.

From all Booksellers or post free direct 2/8

RADIO PRESS, LTD. - Devereux Court, Strand - W.C.2

Series No. 17

2/6

Books like this make set building easy

Wireless Weekly

Vol. 3, No. 17
April 2, 1924

CONTENTS

	Page
Editorial	542
Single Control Tuning: Its Practice and Possibilities	543
Jottings by the Way	545
The Radio Society of Great Britain	546
C.W. and Telephony Transmission Using Valves	547
Getting at Awkward Nuts: A Useful Tip	548
An Experimenter's Unit Receiver	549
His Majesty's Wireless Receiver	550
Random Technicalities	552
ST 100 on the Omni Receiver	553
A Two-Valve Dual Receiver	555
An Ultra Simple Crystal Set	558
Neat Inter-Panel Connections	559
A Simple and Selective Two-Valve Circuit	560
Soldering Wires to Terminals	562
A Universal Transformer	563
Telephone First Aid	564
More Simple Wireless Questions Answered	565
Valve Notes	566
Method Means Quickness	567
Looking After the Soldering-Iron	567
Apparatus We Have Tested	568
Correspondence	571
Information Department	573

Editor: JOHN SCOTT-TAGGART, F. Inst. P., A.M.I.E.E.

Assistant Editors { E. REDPATH.
P. W. HARRIS.

Radio Press, Ltd.

Publishers of Authoritative Wireless Literature.
DEVEREUX COURT, STRAND, W.C.2

Tel.—Central 3763.

Advertisement Managers: } SCHEFF PUBLICITY ORGANIZATION,
LTD., 125, Pall Mall, London, S.W.1

Tel.—Regent 2440.



All correspondence relating to contributions is to be addressed to the Editor of "Wireless Weekly."

Nothing contained herein is to be regarded as permission or encouragement to infringe any patent rights.

Editorial



The B.B.C. as Secret Police

MANY of our readers will have been astonished to note in the issue of *Radio Times* of March 21 a column headed "The Oscillation Nuisance—An Official Effort to Assist Listeners."

The Officials of the British Broadcasting Company, in this "Important Notice," ask for information to be sent to them on a particular Form, which should state:—

Your name;

Your address;

Nature of complaint (duration, intensity, whether constant or intermittent);

Name and address of offender (if known).

The note which appears under this Form indicates that the information will be treated confidentially, and with regard to the third item, it is pointed out that it is useless to make wild guesses.

We believe that this is the first occasion on which the B.B.C. have gone to the extent of encouraging their clientèle to write to them complaining of oscillation. It should be noticed, in the first place, that the B.B.C. have no control whatever over receivers of broadcasting; the Post Office is the responsible authority for the supervision of wireless receiving sets, and their licence is the one we all hold. As far as we are aware, the Post Office has not handed over any part of their responsibility or their authority in the matter.

We feel that the B.B.C. can do much to lessen the oscillation nuisance, which has certainly almost reached a stage where any means should be employed to stop it. That stage, however, has not quite been reached.

We have every respect for the B.B.C. in their attempt to lessen the oscillation trouble, but we

rather feel that their enthusiasm has carried them outside their proper sphere of activities, an enthusiasm which we have occasionally noticed in other directions.

We see no objection to the B.B.C. inviting people to complain to them of oscillation in their district, but we do very strongly resent the invitation to supply the B.B.C. with the names and addresses of offenders.

Even if the British Broadcasting Company had any status in the matter, such an invitation would be strongly resented by all listeners. If, for example, the British Post Office invited people to tell them the names of people thought to be offending, there would be an outcry which would find very strong voice in Parliament. How much more undesirable is it for a non-official body to encourage giving information against one's neighbour.

Happily, those in authority in this country have not invited people to communicate to them their suspicions when an offence has been committed. History in past centuries, and even in this century, has indicated that the encouragement of giving information to those in authority, whether this authority has been the Inquisition or the Secret Police under the Czarist régime, has led to the worst form of despotism and misery.

When an important body like the British Broadcasting Company practically invites listeners to send them the names and addresses of people they think are oscillating, things have come to a pretty pass. Although the offence of oscillating is not a serious one in comparison with certain crimes, yet the principle is not altered, and the people of this country resent any interference with their liberty and peace.

If the B.B.C. continues this invitation, no one will be safe from the secret postcard to the B.B.C. which "will be treated confidentially," and which, in most cases, will be an outrageous, and sometimes spiteful, libel. Jones will not be able to meet Smith without wondering whether he has turned informer.

As a matter of fact, in ninety-nine cases of a hundred, it is impossible to identify who it is that is causing the interference, although in 75 per cent. of the cases those suffering have their own ideas, which are probably entirely wrong. As one listener said the other day: "I know exactly who it is that's causing the trouble. I can tell from the sound of the whistle which direction it is coming from." This, of course, was not one of our readers, but the "important official notice" goes out to many who are less enlightened.

We have too much respect for the B.B.C. to suggest that they should attend to their own business. We believe that they honestly consider that the end justifies the means. We, just as honestly, consider that the method of inviting confidential reports giving the names and addresses of offenders is contrary to all British instincts.

In all friendliness we trust that this error of judgment is not repeated. The mere statement of the B.B.C. that they did not wish to adopt a "policeman's" attitude in no way glosses over the fact that they desire to inaugurate a system which is both unjustifiable and likely to lead to many abuses. In any case, whether they wish to exercise it or not, the B.B.C. have no status as "policemen"; the most they could do would be to act as a go-between, passing on the information of a common informer.

Single Control Tuning: Its Practice and Possibilities

By PERCY W. HARRIS, Assistant Editor.

The simplicity and convenience of "one handle" tuning appeals to many enthusiasts. This article shows how even a tuned H.F. set can be worked with one control.

Two Schools

AMONGST the users of wireless apparatus there are two schools of thought—those who delight in a multitude of adjustments and those for whom the single control for all tuning is the ideal. The former class are well catered for, but as for the latter it is too often assumed that simplicity of control must necessarily stand for inefficiency and that such simplicity is impossible with multi-stage receivers. That such is not the case is the purpose of this article to show.

Simple Forms

In Fig. 1 we have the three popular forms of single-control tuners. One or other of these forms is used in practically every popular broadcast receiver. The chief disadvantage of such devices is their lack of selectivity, and it is usually assumed that if selectivity is to be obtained a loose-coupler with at least three controls is possible (Fig. 2). In the conventional loose-coupler the aerial circuit is tuned in some fashion (such as by the slider S), the coupling between L_1 and L_2 being variable. The second oscillatory circuit (closed circuit) is generally tuned by means of a condenser C_1 . Much greater selectivity and, on short waves, slightly greater signal strength is often obtainable by this means, particularly when careful adjustment of coupling and tuning of both circuits is made. Except for the sharpness of tuning, however, it is doubtful whether the additional elaboration of this method is justifiable.

A Modern Method

In Fig. 3 we have a more modern method which possesses practically all the advantages of that depicted in Fig. 2. L_1 is now a fixed coil of a few turns (say 6 to 10 for broadcast wave-

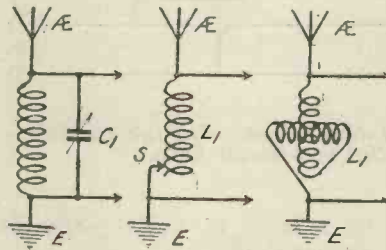

Fig. 1.—Some common forms of single control tuning.

lengths), whilst L_2 is made of a suitable size to cover the broadcast band. Such a coil can well be about 60 turns of No. 18 or 20 d.c.c. wire on a 3-in. former. The condenser C_1 can be .00025 to .0005 μ F. Very sharp tuning is possible in this way, and the sole tuning control is C_1 .

In Fig. 4 the circuit is shown with one high-frequency valve

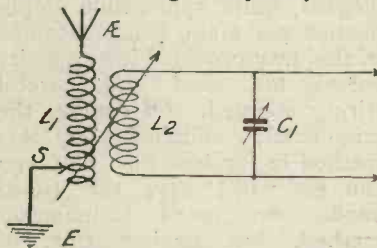

Fig. 2.—A conventional loose-coupler.

coupled by the tuned anode method to a detector valve. If we adopt the aperiodic aerial method of obtaining selectivity along the lines just mentioned it will be found that the tuning of the circuit comprising L_2 and C_1 is practically unaffected by changes in aerial, or indeed in removing the aerial from the set.

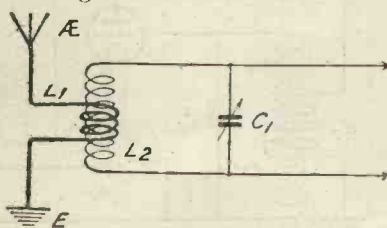

Fig. 3.—A single control loose-coupler.

This being so we can arrange the oscillatory circuit consisting of L_3 , C_2 to have the same value of inductance as that in L_2 , C_1 circuit. We can then make condenser C_2 of the same value as C_1 , and connect the two sets of rotating plates to the same shaft. It must be pointed out here that for this circuit a special condenser is needed. We cannot use the ordinary double condensers sold for simultaneous tuning, as these invariably have the two sets of moving plates in contact with one another. In this case we must use two condensers, in which both sets of plates are electrically insulated from one another.

Precautions Necessary

For the successful operation of this circuit one or two precautions are necessary. First of all it must be remembered that in tuning the circuit L_3 , C_2 the valve capacity and other factors enter into our reckoning, and for this reason it is advisable to have a very small condenser in parallel with C_1 , made in such a form that its capacity can be accurately adjusted once and for all when setting up the receiver. Such a condenser can be made up by using two metal plates of small area (say a square inch), which can be made to approach one another by means of a fine screw adjustment. L_2 and L_3 should be carefully made to be as near as possible identical, and when preliminary adjustments are made the small variable condenser C_3 should be adjusted until the two circuits come into resonance (the variables being at zero). As such resonance will almost invariably be accompanied by self-oscillation a potentiometer P is fitted.

Use of Potentiometer

By its help a positive bias can be put on to the first grid to stop self-oscillation, and once a good adjustment of this potentiometer

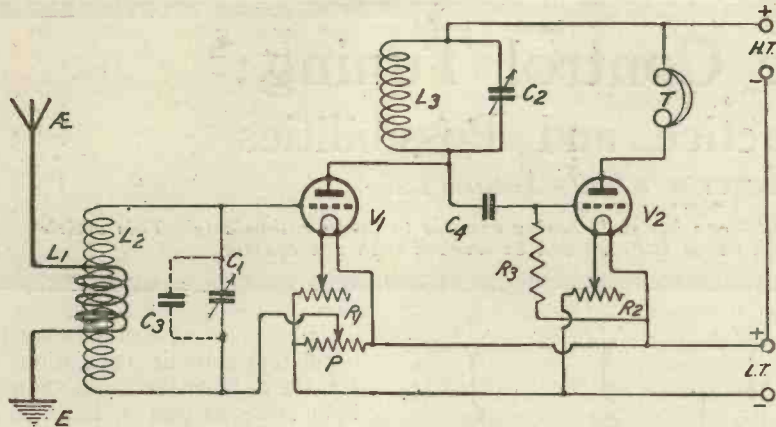

Fig. 4.—A single control H.F. and detector set. The two variable condensers are controlled by a single knob.

has been found it can be left so set. Obviously one or two note magnifiers can be added to this pair of valves, in which case we should get a 3- or a 4-valve receiver having only one tuning control, i.e., the knob controlling condensers C_1 and C_2 . A further advantage of this circuit is that owing to the fact that a change in aerial makes practically no change in the tuning of the circuit L_2, C_1 , it is possible to calibrate the set for any aerial. Strangely enough, such a remarkably simple all-purpose receiver with a single calibrated dial has not yet been placed on the market, although for distance work it would be far more efficient than many single-control sets consisting of a detector with two-note magnifiers and using one of the simple methods of tuning shown in Fig. 1.

Another H.F. Circuit

Fig. 5 shows another "one-handle" tuner with sharp tuning and a stage of high-frequency, this time an untuned semi-aperiodic transformer T_1 being the method of coupling. Such transformers, while not giving the same degree of amplification as the tuned type, are yet still fairly efficient over quite a wide band of wavelengths. They may be made using No. 38 or 40 resistance wire. The primary winding may consist of a single layer of this wire on a 1-in. former, about 350 to 400 turns being used. The secondary should be of the same number of turns wound over the primary, the two windings being separated

by a layer of waxed paper or empire cloth.

Several H.F. Stages

Two and even three stages of such aperiodic transformers can be used, but in the event of more than one such stage being fitted, potentiometer control of the grids should be introduced.

Resistance Coupling

It is not generally realised that resistance capacity coupling can be used on broadcast wavelengths, quite appreciable amplification per stage being obtained in this way provided low-capacity valves are used and careful wiring adopted. Of course, the amplification obtainable by this method is far less than that you can get with, say, the tuned anode or tuned transformer method, but against this, of course, we have the great simplicity of this method which is quite useful when valve current is easily obtainable and first cost is not taken too seriously into account.

Modifications

Several modifications of the methods depicted are possible. For example, if we use in Fig. 4 a specially wound variometer in which part of the windings are coupled to the aerial in the manner previously shown, we can use a variometer for tuning the plate circuit. This can be operated on the same shaft as the first variometer. This method, however, is somewhat more tricky to handle, as the slightest change in capacity makes a considerable difference in tuning. For this reason the method is only advocated when a small fixed condenser is placed across each of the variometers. Perhaps, best of all, is to make one of these condensers fixed and the other variable, so that capacities can be adjusted once and for all to suit one another. Simultaneous tuning of the two circuits is then much easier.

On Matching

It has sometimes been thought that unless condensers and windings are perfectly matched simultaneous tuning of two circuits is impossible. Actual practical experience has shown me that slight differences do not matter a great deal, and I have been able simultaneously to tune two circuits on wavelengths as short as 110-120 metres. The simultaneous tuning of two stages of high-frequency has been achieved on shorter wavelengths even than these. So far as I know, however, very little experimenting has been carried out along the lines suggested in Fig. 4, and the method is commended to all readers who are experimentally inclined.

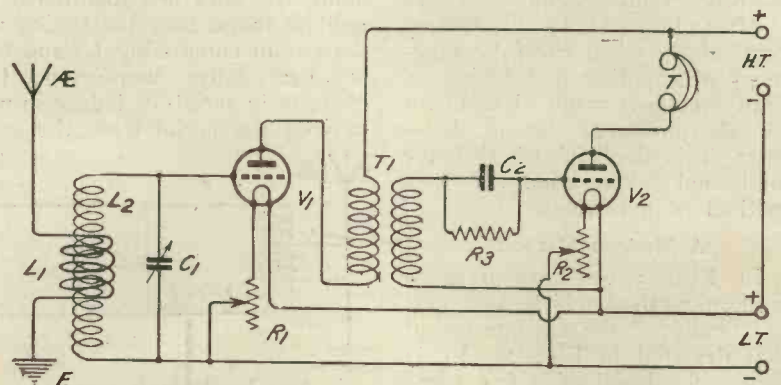

Fig. 5.—A "one-handle" receiver with semi-aperiodic H.F. transformer.



Jottings by the way

Eternal Hope

IT is difficult sometimes for even the most naturally truthful man to maintain an unsullied reputation for veracity once he becomes a radio addict. Wireless, in fact, has much the same effect upon its devotees as the gentle art of angling, and, when you come to think of it, both make much the same kind of demands upon their followers. Your fisherman casts his line with the hope that springs eternal in the angler's breast. He is always trying for a big one, but he never knows what will attach itself to his deftly-cast fly. It may be that he will hook only youthful fish too young to know better. If fortune smiles upon him he will land a fair basket of respectable fish. Should his lucky star be really in the ascendant he may go so far as to capture Old Bill, the well-known monster trout who has hitherto eluded all attempts to compass his undoing. Again, he may return home having caught no more than several tufts of buttercups, a selection of branches, an ex-boot and a cold—you never know. Like the angler, the wireless man sets out full of hope, and not knowing what he may bag. His most cherished wish is to pick up some faint distant station that no one else has managed to hear. He fishes, so to speak, in the ether. Sometimes he can get nothing but broadcasting stations or things like GNF and FL that are within the power of the novice whose home-made crystal set, contrived from odds and ends, is the radio equivalent of the youthful tiddler fisher's hedge stick, bent pin and pickle jar. At times again he enjoys good average luck, hearing comfortably all the things that he ought to. But there are moments of joy, of triumph, of just pride when he tunes in after long labour a voice which though still and small is

yet quite plain, and whose nasal accents eventually give clearly and beyond any possibility of error the call sign of some trans-Atlantic station rarely, if ever, heard before on this side of the Herring Pond.

Both angler and wireless man must study to be quiet. Both must develop an iron self-control in the face of pin-pricks from fate exasperating enough at times to make a saint fling his halo to the ground and dance upon it. Both want to talk shop at all times and with all men. Both want to spread abroad the glad news when they have performed some almost incredible feat—and neither is believed when he does so. This is one of the saddest of thoughts, for wireless men, like anglers, form one of the most truthful sections of the community. If only scoffers would realise as a scientific fact that the signal strength of receptions goes on increasing for weeks, or even months, after they have terminated, just as any self-respecting fish continues to grow heavier after death, we should hear less of the taunts and gibes that are too often levelled at the heads of the two noble brotherhoods.

The Sequel

Referring to our friends, Horace Pottlesdown and his spouse, and the enthusiasm displayed by Horace on account of his good wife's interest in the more serious side of wireless, there is a sad tale to tell.

After Mrs. Pottlesdown had revealed her secret teaching the quiet happiness of the domestic hearth began to change.

It was about a week later that the first tiff came. Horace had always used high-frequency transformers, but Amelia had set out to convert him to a proper appreciation of the tuned anode.

Beginning in the friendliest way the discussion became first animated, then heated, then frankly acrimonious. He told her that beginners always thought that they knew far more about it than the old hands, whilst she retaliated by saying that too often the old hand was a mere stick-in-the-mud.

Failing to convince the man she set out to build a receiver of her own, meeting her expenses by economising in the house-keeping account. The fact that he was cut down to one egg for breakfast and that hash became the staple dinner dish had not a good effect upon Horace's temper. When at the end of a month or so she suddenly sprung her new set upon him, gave him a demonstration, and showed him that it succeeded where his own failed, I am afraid he rather went in off the deep end. He rebuilt his own set to show her what the expert could do when he was put to it. She, of course, riposted by going just one better. In the early days of the struggle they were perfectly polite to one another, but later, when they wanted to use the aerial at the same time, relations became so strained that they were hardly on speaking terms. She sought to solve the problem by erecting an aerial of her own, but this merely opened the way for further hostilities, for the party who had been defeated either in argument or in practical tests could always get his or her own back by howling down the other when they had retired to their separate wireless dens.

What is to be Done?

How it will all end I cannot think. Meantime it is a pretty kettle of fish. Certainly it has brightened our wireless club meetings in Little Puddleton, for any discussion is likely to be a lively one since Amelia and her

spouse invariably take opposite sides and go for each other hammer and tongs. The most dreadful moment will come next month, when the club competition for the best home-made set comes off. Both, I know, are entering, and I do not envy the judges their job.

There is some talk of a deputation from the club being sent to the Pottlesdown villa to endeavour to straighten things out by arranging a kind of peace conference. The suggestion, I hear, is that Amelia should be urged to specialise on high-frequency amplification and Horace on low. Then they could make a combined set, the rectifying portion being provided by the club committee and being regarded as neutral ground. This might work, but again it might not, for I am quite sure that the high-frequency partner would blame the low-frequency valve for all the defects in reception and vice versa. Anyhow, it is a very difficult business and reconciliation really seems impossible, for, as all wireless men know, it is a recognised convention amongst experts that none of them must ever admit that

any other knows anything at all about the subject. Time alone can tell what will be the outcome.

Components

Why, I ask, should not those responsible be able to make holders that will fit valves or vice-versa. It is not quite fair, I think, to turn out holders that are so tight a fit that the valve must be driven into them with a sledge hammer, for during this process one is as likely as not to inflict an injury which may impair the working of the apparatus. But there are still more fiendish things than these. I bought a holder the other day which appears to have been designed by the man who invented the rat-trap. Your valve slips in as nicely as you please, but once it is in, it finds itself fairly caught by the leg. In fact, with this particular holder I invariably have to use a boot-jack to free the valve which it has embraced.

And then there are "mush-room" transformers. You know the things I mean. They have four pins which fit into a valve-holder. Here a splendid jest has been perpetrated. You purchase a new one which is not

of the same make as those already in your possession. Expecting great things, you slip it into the holder. There are two possibilities: either nothing at all happens or all kinds of things happen with great rapidity. Some makers, you see, think that the pins which look like the filament prongs of a valve should be for the primary and the others for the secondary. Others juggle about with them, giving you all kinds of combinations. Hence, unless you are wise enough to inspect carefully before use and then to pull your entire set to pieces in order to alter the wiring, disappointment is likely. I rather admire the jester who has to do with the drilling of holes for the attaching screws in low-frequency transformers, rheostats, condensers and the like. Have you ever yet found such a piece of apparatus provided with holes through which the 4 B.A. screws which you have in stock will pass? I have not. About the only thing that does seem to be standardised is the $\frac{3}{8}$ -in. bush for spindles of various kinds. I suppose we must be thankful for this small mercy. WIRELESS WAYFARER.

The Radio Society of Great Britain

Report of Informal Meeting of the Transmitter and Relay Section, held at the Institution of Electrical Engineers on March 14th, 1924

THE difficulties that confront the wireless receiving amateur who is handicapped by limitations of space, environment, etc., may be great, but the trials that beset the transmitting amateur in similar circumstances are ten times greater and more difficult to overcome.

An interesting and entertaining account of obstacles surmounted in the erection of a transmitting station was given by Captain Hartridge, opening a discussion at a meeting of the Transmitter and Relay Section of the Radio Society of Great Britain at the Institution of Electrical Engineers on Friday, March 14. The chair

was occupied by Mr. Philip R. Coursey, B.Sc.

Captain Hartridge opened his remarks by cataloguing the obstacles that confronted him when first setting out to design his transmitter. The only source of power supply was alternating current from the borough mains, by no means best suited to transmitting requirements, and the only earth connection was a water pipe situated 60 ft. below in the basement. Moreover, he was limited to a flat on the fourth floor of a rather shaky house, and it was impossible to run a generator without disturbing other occupants. Many arrangements were tried for the supply of high

tension current, including dry batteries and the series valve method of feeding H.T., all with indifferent success. Finally, Captain Hartridge experimented with a master oscillator circuit, and by this means was able to overcome the disadvantages of the high earth resistance.

The circuit employed, embodying choke control for the supply of H.T. from the A.C. mains was illustrated on the blackboard, and evoked a favourable discussion.

The meeting possessed an added interest in being the first to be held since the recent amalgamation of the Radio Transmitters' Society and the Radio Society of Great Britain.

C.W. and Telephony Transmission Using Valves

No. XII.

By JOHN SCOTT-TAGGART, *F.Inst.P., A.M.I.E.E.*

Introductory to Telephony Transmission

PRIOR to the introduction of the thermionic valve there were no really reliable and convenient methods of transmitting speech by radio. The use of spark systems had been suggested, but such methods were quite unsuitable, because the wave groups produced a note at the receiving station which interfered with the speech; moreover, the portions of speech in between the sparks were not reproduced. It was realised at a very early date that it was necessary to employ continuous waves if the transmission of speech were to be a practicable proposition. We therefore find that the usual method of transmitting speech by wireless, before 1913, was to use an arc to generate continuous oscillations and to connect a microphone in series with the aerial to vary the energy radiated; the higher the resistance of the microphone the smaller is the current in the aerial circuit. In all wireless telephone systems we use a "carrier" current which is varied by a microphone, and the current, which is varied, is a high-frequency one.

Microphone Current

It might be thought that we could use the actual microphone currents—perhaps after increasing their voltage by means of transformers—to energise the aerial, but such method cannot be used because such low-frequency currents produce practically no radiation. By using radio-frequency oscillations and by causing them to produce a varying effect on a distant receiving station, we can successfully transmit speech by wireless means. When the radio-frequency waves are received, they are rectified and only audio-frequency telephone currents are passed on

to the telephone receivers; the high-frequency waves, therefore, only serve to carry the telephonic currents through space. Receivers using valves should not oscillate when receiving speech.

Methods of Modulation

We generally use the term "modulation" to express the effect on the radio-frequency currents of the microphone's varying resistance during speech transmission. There are numerous methods of modulating radio-frequency currents, but these may be classified under the following headings:—

- (a) By varying the magnitude or amplitude of the oscillations and, therefore, of the waves.
- (b) By varying the wavelength of the radiated waves.
- (c) By a combination of the above two methods.

We usually modulate the radio-frequency waves by altering their amplitude in such a way that the amplitude depends upon the microphone currents. The most direct way of varying the amplitude of radiated waves is to include a microphone directly in the earth-lead; since the aerial current has to pass through the microphone, speech will vary the total aerial resistance and, therefore, the aerial current.

Another Method

The other method of modulation, which consists in varying the wavelength of the transmitting station, is rarely used, although it plays a part in probably all modulation systems. When it is employed deliberately, the microphone is caused in some suitable manner to vary the wavelength of the waves radiated from the transmitter; the actual extent of the variation is made to depend upon the variation in microphone resistance. In such a system the receiving station is tuned to the normal wavelength;

when speech is being transmitted, the receiving circuit will be more or less out of tune with the incoming waves, the length of which is continually varying. The result at the receiving station will be between the incoming wavelength and the wavelength to which the receiver is tuned is varied. The third class of modulation is nearly always accidental, since it is practically impossible to prevent the first two methods from being present.

Subdivisions

We can sub-divide the systems of radio-telephone communication into two further classes:—

1. Systems using a carrier-wave.
2. Quiescent aerial systems.

A carrier-wave system, as its name implies, utilises a steady stream of waves which is modulated at the transmitting station. When not speaking, there is still a normal radiation from the aerial, which would give a steady note at the receiving station working on the heterodyne principle. This continuous radiation from the transmitting aerial means a great wastage of power at the transmitter and also results in greater interference at wireless receiving stations. To overcome these disadvantages we may employ a quiescent aerial system which only radiates waves when there is actual speech; although the modulating currents are carried by radio-frequency waves, yet there is no continuous carrier-wave.

In Line Telephony

We could obtain a similar effect in an ordinary line telephone arrangement by using a microphone of very high resistance. The current in the line circuit is normally very small or negligible, but when the microphone is spoken into a substantial current of varying magnitude flows

through the circuit and operates the telephone receiver. We could, theoretically, employ a microphone of high normal resistance in the earth-lead of an arc generator to produce a quiescent aerial effect. Most practical quiescent aerial systems usually radiate to a small extent, even when not speaking. It is to be understood that it makes no difference to the quality of the speech whether we vary the radiated energy from zero between zero and the maximum value, or between points above and below a steady normal value. We could, in fact, obtain perfectly good speech by simply varying the output from the aerial either above or below the normal radiation. In the former

case, however, we will not be obtaining complete modulation; we will only be modulating a portion of the radio-frequency energy radiated; the unmodulated portion will be wasted, although it will have no injurious effect on the speech received. The most efficient system is one in which the radio-frequency output is varied between zero and maximum value.

Coming to a more detailed consideration of valuable methods of modulation, we can classify such systems as follows:—

1. The method of varying the character of the energy in the aerial circuit without directly influencing the generator of the radio-frequency current.

2. The methods in which the

power developed by the generator is varied by causing the microphone to act in some way on the generator itself.

3. Separately excited systems in which:

- (a) the high-frequency generator is itself affected by the microphone currents;
- (b) the radio-frequency currents are modulated in between the generator and the amplifier;
- (c) modulation is obtained by causing the microphone currents to act in some way on the amplifier.

The individual methods will be fully explained when we discuss them in detail with reference to particular examples.

A USEFUL TIP

EVERY constructor has occasion now and then to shorten small screws by cutting off portions with a hacksaw. All those who have carried out this process know what an exasperating business may follow when an attempt is made to induce a shortened screw to start in the female thread prepared for it. With large screws it is not a hard task to trim up the ends with a fine file so that they start without much trouble, but when we come to small fellows, such as 4, 6 and 8 B.A., then matters become very much more difficult. The reason is that their fine threads are slightly mutilated, so that the first turn cannot obtain a grip in the nut or tapped hole into which it is meant to go.

Here is a very simple tip which will save any amount of trouble. Before shortening a screw, take a nut of the same size and pass it on right, down to the head. Then cut, using preferably a fine-bladed jeweller's hacksaw, and trim up with a small file. Now unscrew the nut until the point of the screw is just level with its outer surface. At this moment a slight jamming effect will be felt owing to the mutilated end thread coming into contact with those in the nut. Take a screwdriver and work the screw two or three times in and out of the nut. This will smooth off any rough-

nesses and will straighten out the thread at the end. It will now be found that the screw will start quite easily. If a die of appropriate size is available, it is, of course, an improvement to use it rather than a nut, but the latter will answer quite well.

R. W. H.

Getting at Awkward Nuts

A very useful gadget for getting at nuts which are in awkward positions may easily be made, as shown in the accompanying diagram. Some fairly

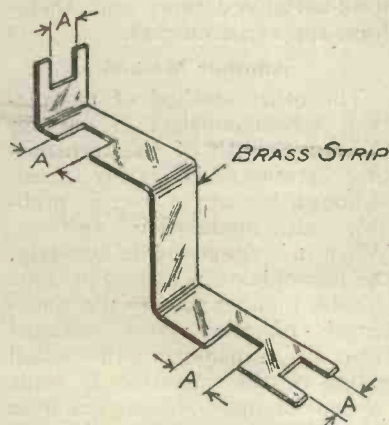

A.—TO SUIT FLATS OF B.A. NUT.
Constructional details of the spanner.

stout gauge of strip brass should be procured and bent to shape. The slots should then be cut to suit the size of the flats of standard B.A. nuts. Three of these spanners could be made. One for 2B.A., one for 4B.A., and one for 6B.A. nuts.

H. B.

TYPE W1 RECEIVER

SIR,—Some time ago I made the sixth set I have had in four months, using the same components each time, which means that I am, perhaps, hypercritical as to results obtained. The last set is the type W1, and though I would hesitate to say this combination is a permanent installation, still it is incomparably the best I have seen or had.

All my tuning is with loud-speaker only, as I do not use 'phones at all. I have omitted the .0001 series tuning condenser.

With 60 v. H.T. and carefully adjusted filaments, I can tune in all British stations at L.S. strength, quite clear and audible at 24 ft. The foreign stations (below 500 metres) are obtained with equal ease, and the recent transmission from *Le Journal*, Paris, was extraordinarily loud and clear.—Yours faithfully,

PERCY VARLEY.

Kingston-on-Thames.

An Experimenter's Unit Receiver

By H. BRAMFORD

The following is the ninth of a series of articles which began in Vol. 3, No. 9.

Unit No. 8

This unit takes the form of a variable condenser, and as several makes of condensers are now procurable at reasonable prices, only the method of assembling these to the panel is described. A photograph of the complete unit is shown in Fig. 35.

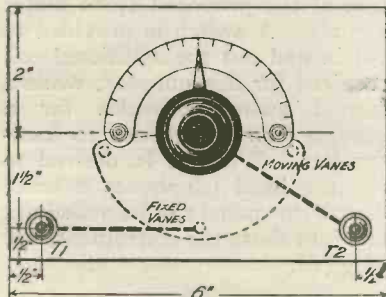

Fig. 36.—Details of panel drilling and connections.

Panel Drilling

Details of the panel drilling are shown in Fig. 36. Two holes are made to clear the screws of terminals T₁ and T₂, and then two holes are drilled to clear the screws of two stop pins. A centre hole is drilled to clear the spindle bush of the

MOST of us, when we instal sets, rig up a moderately-good earth, and do not bother any further about it so long as the set works satisfactorily. As a matter of fact, the earth is one of the most important factors in reception, and a little time devoted to experiments with earths of various kinds will lead to a great improvement in results. If you are working upon a water-pipe earth spend an afternoon when you have nothing better to do in rigging up and testing out a direct earth connection made to a buried piece of metal or to a stout rod driven into the ground.

variable condenser. For this purpose it is advisable to use

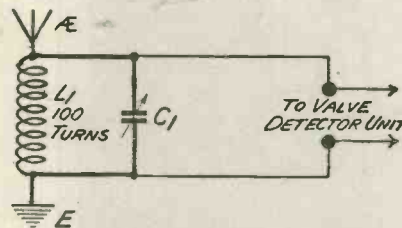

Fig. 37.—A circuit using the condenser for tuning the aerial.

condensers which require only one hole for fixing.

Assembling

First mount upon the panel the terminals T₁ and T₂; next assemble the scale by means of the two stop pins as shown in Fig. 36. Fix the condenser to the underside of the panel and assemble an ebonite knob and pointer on the projecting spindle. Connect terminal T₁ to the fixed vanes of the condenser and terminal T₂ to the moving vanes.

Operation

A circuit involving the use of this unit is shown in Fig. 37. In this case unit No. 7 (L₁) is used

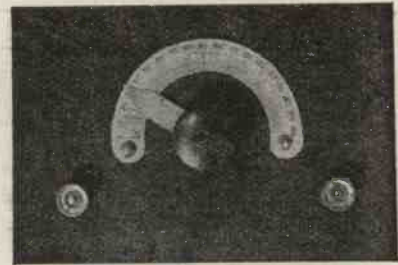

Fig. 35.—A top of panel view of the unit.

as an aerial inductance, and is tuned by the condenser C₁. A further circuit is shown in Fig. 38, using unit No. 7 (L₁) in parallel with the condenser (C₁), both being placed in series with the aerial. This arrange-

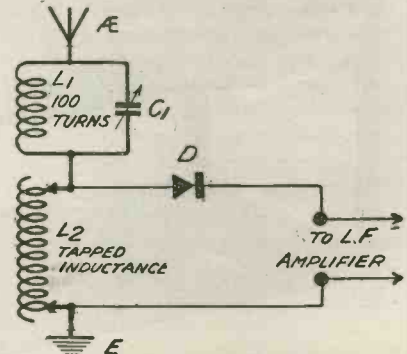

Fig. 38.—Showing method of using the condenser and loading coil as a wave-trap.

ment may be used as a wave trap. Unit No. 1 (L₂) act as the aerial tuning inductance, and a L.F. amplifying unit as previously described may be added if desired. The next units to be described will enable the operator to employ reaction.

Finding the Best Earth

Try the effect of using first one and then the other, and finally both together upon a given signal. Usually, you will find either that the water-pipe connection gives better results than the direct earth, or *vice versa*, and one of them may be markedly superior. If it is not the one that you were previously using your subsequent procedure is clearly indicated. It is usually a

bad practice to employ two separate earth connections simultaneously unless they consist of plates buried upon the circumference of a circle at whose centre is the receiving set. But there are occasions in which better results are obtained by using both water-pipe and earth connection at the same time; at any rate, the experiment is worth trying.

R.W. H.



The cabinet encloses the whole of the apparatus, including all batteries.

His Majesty's Wireless Receiver

simplicity of control and comfort. There are but two main controls, these being a pair of knobs, one of which controls the aerial tuning condenser and the other the reaction. In view of the fact that the instrument will be required to receive any broadcast messages that may be sent out, provision is made for the reception of the proposed 1,600 metre signals. A switch is provided to cut in and out the additional coil required for this purpose, while a second switch provides for a change from telephones to loud-speaker. When it is desired to use the head telephones a small distributor panel can be pulled out and into these the instruments are plugged.

General Features

The set is completely self-contained, there being no exterior aerial or earth connection. Batteries, both low and high tension, are also included in the cabinet. The aerial and earth (or rather the capacities playing the part of these two), are two sheets of copper, one concealed in the top of the cabinet and the other in the base.

The wire connecting the lower capacity plate to the instrument is

IN our last issue we briefly indicated the leading particulars of the cabinet broadcast receiver designed by the experts of the British Broadcasting Company and installed at Buckingham Palace. This week we are able to give our readers further photographs and fuller particulars, which we believe will prove of considerable interest to beginners and more advanced students. The general appearance of the instrument can be gathered from our right-hand photograph, which shows the exterior of the cabinet, which, by the way, was made by a well-known London firm of house furnishers. When the two doors are opened we find on the right-hand side the mouth of a loud-speaker, whilst on the left are seen the valves and tuning controls. These details were well shown in the photograph published last week. Four pairs of

telephones are contained in a drawer when not in use.

General Convenience

Considerable ingenuity has been displayed by the designers in arranging everything possible for

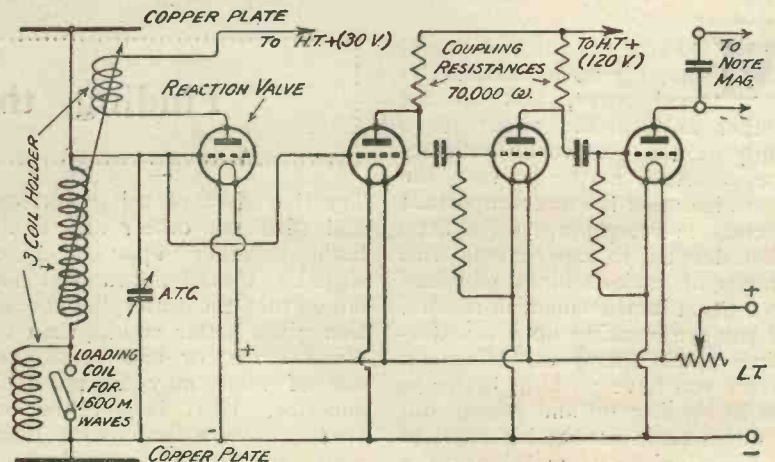

Circuit on the H.T. and detector panel.

**An interesting
New Instrument
installed at
Buckingham
Palace**

carried up one leg of the cabinet. As generally arranged with this capacity aerial, the set will receive 2LO in excellent strength, but will not normally receive the more distant stations. These can, however, be brought in if necessary by attaching the more conventional outside aerial and earth connection.

Number of Valves Used

Seven valves are used in all, but owing to the peculiar arrangement of the first two these act as one, and therefore the instrument is really a 6-valve receiver. There are two stages of high-frequency coupling, a detector valve, and three stages of resistance capacity coupled note magnification so as to give the purest possible reproduction.

Technical Details

At the foot of this article will be seen in detail the circuit diagram of the complete instrument. It will be noted that the grids of the first two valves are in parallel, a reaction coil being included in the plate circuit of the first valve, which incidentally is fed from a 30-volt high-tension battery. The object of this first valve is solely to provide reaction effects, the necessary coupling

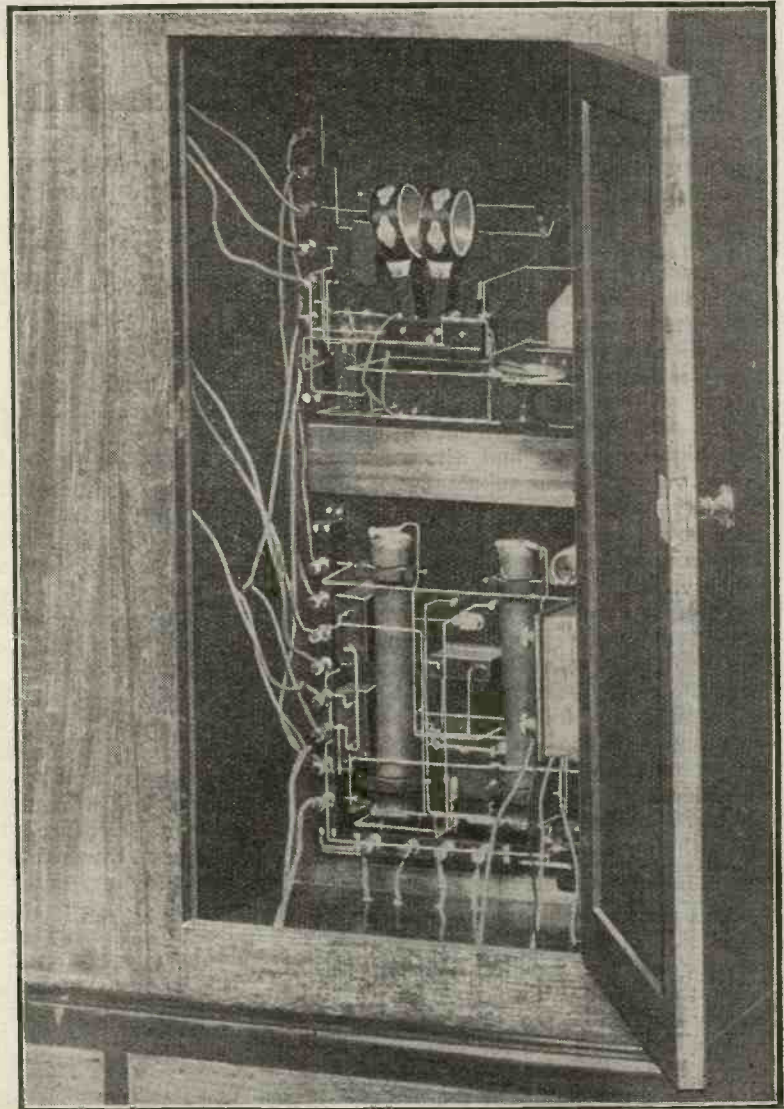

A door at the back of the cabinet allows the components to be examined.

between the reaction coil and the tuning coil being provided by a

conventional three coil-holder. One socket of the coil-holder is used for the reaction coil, a second for the tuning coil, and a third for the additional loading coil, which is brought into circuit when it is desired to receive 1,600 metre signals. The tuning coil may be a No. 50 or 75, and the reaction coil 75 or 100 of any of the well-known makes if readers desire to reproduce this portion of the circuit. The loading coil for the 1,600 metre wave will probably be 100 or 150, which, being placed in series with the ordinary tuning coil, will gain in inductive value by being coupled to it in the coil-holder.

High-frequency Amplification

High-frequency amplification is obtained by resistance capacity

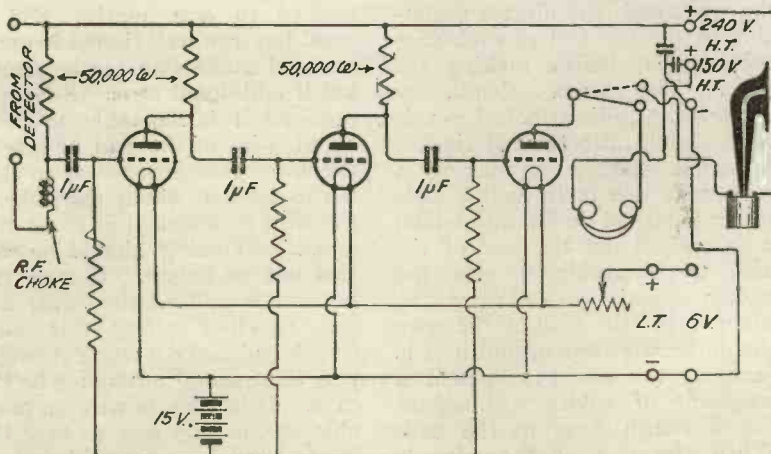

Circuit of note-magnifying portion, including switch for telephones or loud speaker.

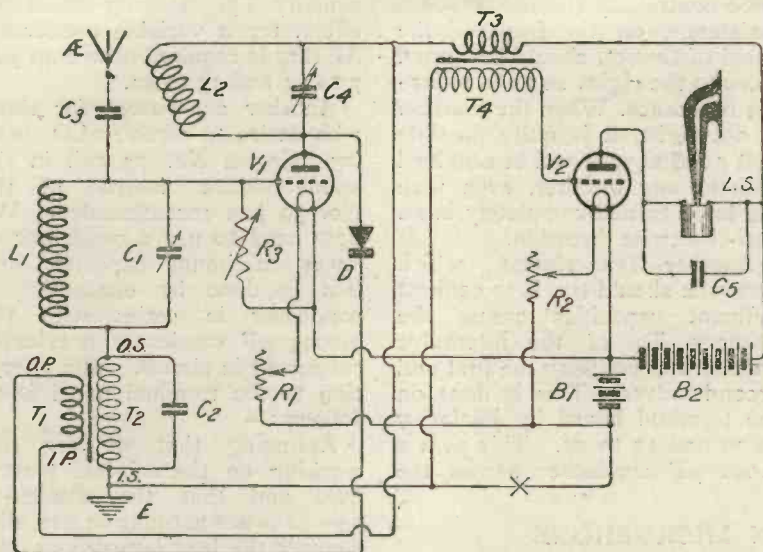

Fig. 1.—The ST100 circuit using constant aerial tuning.

THE ST100 circuit may very readily be connected up on the *Wireless Weekly* Omni receiver. Fig. 1 shows the ST100 receiver using constant aerial tuning.

In this circuit C₃ has a capacity of 0.0001 μF, L₁ is a No. 75 coil, while C₁ is a 0.0005 μF variable condenser. The fixed condenser C₂ has a capacity of 0.001 μF, while C₄ has a value of 0.0005 μF. The inductance L₂ is a No. 50 plug-in coil, or a No. 75 for the longer wavelength broadcasting stations. The variable resistance R₃ has a maximum value of 100,000 ohms; the condenser C₅ may have a capacity of 0.002 μF, or 0.004 μF; when using the Omni receiver, a capacity of 0.002 μF is used. The high-tension battery has a value of 100 volts. At the point X in the circuit, a grid battery, such as a flash lamp battery of 4½ volts, may be included, so as to give both grids a negative potential; very frequently this battery may be eliminated from the circuit without any ill effects whatever, but, on the other hand, a certain amount of negative grid bias is frequently beneficial with some valves.

Connections

The following table indicates the various connections which require to be made:—

51	—	11
3	—	2
2	—	1
3	—	12

9	—	10
30	—	10
29	—	52
29	—	37
30	—	38
52	—	48
32	—	40
12	—	36
44	—	40
4	—	17
17	—	18
25	—	26
26	—	15
7	—	24
18	—	20
28	—	22
21	—	15
56	—	14
55	—	48
6	—	23
31	—	24
23	—	45
31	—	46

ST 100 On The Omni Receiver

By JOHN SCOTT-TAGGART, F.Inst.P., A.M.I.E.E.

A further chat dealing with circuits which may be experimented with on the Omni Receiver

Coils

As regards the inductance coils, the back one of the three coil holders on the side of the cabinet should have a No. 50, which will be in the aerial circuit. The middle coil holder may have a No. 50 or a No. 75 plugged into it. These coil holders should be kept well apart at first. Tuning is accomplished by means of the two condensers C₁ and C₄, and practically the only adjustments required are these two condensers. When good signals are being obtained, carefully re-adjust the crystal detector until the maximum response is obtained in the loud-speaker or telephone receivers. If one is anxious to obtain the absolute maximum output, it is desirable to detune one of the condensers C₁, C₄, and to adjust the detector on weaker signals. The next step in the operation of the set is to bring the reaction coil closer to the aerial coil, at the same time retuning on C₁ and C₄ at every small movement of the reaction coil. If the signal strength does not increase, try reversing the reaction coil. This may be done by disconnecting the leads between

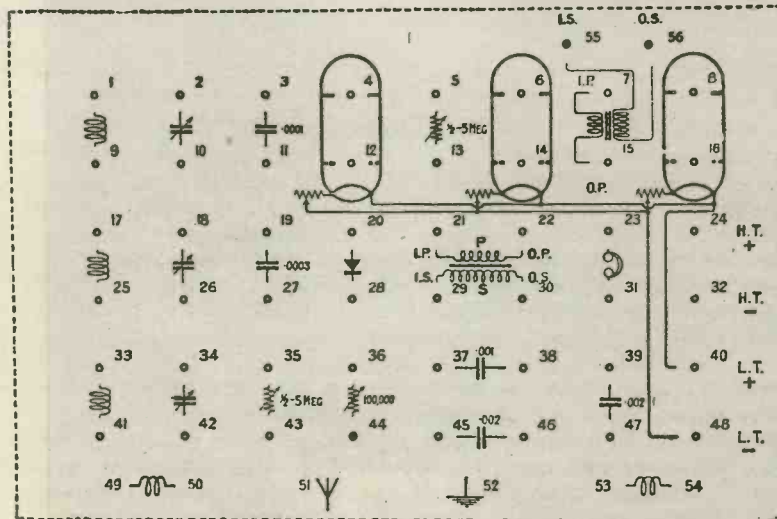

Fig. 2.—The terminal board.

1-2, and 9-10, and join 2 to 9 and 10 to 1.

Experiments with the ST100

An interesting experiment is to try reversing one of the leads to one of the intervalve transformers. This may be done by disconnecting the leads between 56 and 14 and between 55 and 48. Now connect 55 to 14 and 56 to 48. It is quite likely that this will increase the tendency of the set to buzz at audible frequency. If the tendency to buzz is greater than before, revert to the old arrangement for ordinary working. If there is still a tendency towards grumbling, the

knob controlling the 100,000-ohm resistance, on the front of the panel of the set, should be turned more to the right, so as to reduce the resistance. When the reaction is not tight, it is quite possible that good signals will be obtained without any buzzing, even with the knob turned completely in an anti-clockwise direction.

Another experiment which everyone should try is to connect different capacities across the primary T₃ of the intervalve transformer coupling the first and second valves. This is done on the terminal board by joining 7 to 39 and 15 to 47. This puts a 0.002 μ F condenser across the

primary T₃. Having noted the effect, try a variable condenser. All that is required now is to join 7 to 34 and 15 to 42.

Another experiment for those who desire to receive 2LO is to try using a No. 75 coil in the anode circuit instead of the No. 50 just recommended. We now need to use a condenser of lower minimum capacity, and this is done by connecting a condenser in series with the 0.0005 μ F condenser previously connected in circuit. The alteration to the terminal panel is as follows:—

Assuming that we are still working on the original master key, and that the condenser 34-42 is not actually in use, disconnect the lead between 25 and 26 and between 26 and 15; join 25 to 42 and 42 to 15, and join 34 to 26. The two variable condensers, 18-26 and 34-42, are now in series, and the anode coil 17-25 is now replaced by a No. 75 coil, which should now bring in 2LO at even better signal strength than when a No. 50 coil is employed, although this will not be noticeable when within 10 miles of 2LO, because in any case the signals will be very loud.

FACING THE GERMAN MICROPHONE



□ □ □

The Italian Opera singer, Pasquale, singing into the microphone at the Berlin (Radiostunde) studio.

Notice the difference between this instrument and that used in the British studios. The German broadcasting programmes are steadily improving.

□ □ □

A Two-Valve Dual Receiver

Type W 3

By HERBERT K. SIMPSON

Below will be found further constructional details together with wiring diagram of the two-valve dual receiver.

(Concluded from Vol. 3, No. 16, page 530.)

WHEN all the necessary holes have been drilled in the panel, and the components mounted, as described in our last issue, the wiring may be commenced. Use No. 20 tinned copper wire, covering it with systoflex tubing.

A detailed wiring diagram is seen in Fig. 10, and as all points to which contact has to be made are numbered, and a list of points to be joined is given, the process of wiring up is greatly simplified.

Numbers Allotted to Components

- Circuit changing terminals, T₁ to T₁₂.
- A, 1; A₁, 2; B, 3; C, 4; D, 5; E, 6.
- .0001 constant aerial condenser, 7, 8.
- Aerial tuning condenser, 9, 10.
- 100,000 ohm resistance, 11, 12.
- First valve, P, 13; G, 14; filaments, 15, 16.
- H. F. Transfr., IP, 17; OP, 18; IS, 19; OS, 20.
- Second valve, P, 21; G, 22; filaments, 23, 24.
- L. F. Transfr., IP, 25; OP, 26; IS, 27; OS, 28.
- Transfr. bypass condenser, 29, 30.
- Grid condenser, 31, 32.
- Grid leak, 33-34. H. F. tuning condenser, 35, 36. H. F. fixed condenser, 37, 38.
- Telephone bypass condenser, 39, 40.
- Filament resistances, R₃, 41, 42; R₄, 43, 44. HT₁, 45; HT₂, 46; HT -, 47; LT +, 48; LT - GB +, 49; GB - 50.
- Aerial tuning coil, 51, 52.

Connections

- (1-7), (51-2-8-9-12-14), (3-52), (4-10), (5-28-30), (6-41-43-49), (11-15-20-23-47-48), (13-17-35-T₆), (16-42), (18-T₁₁-39-T₅), (19-32-33), (21-T₁₀), (22-31-34), (24-44), (25-T₂), (26-T₄),

(27-29-50), (36-T₇-37), (38-T₈), (40-T₁₂-45), (46-T₃), (T₁-T₉).

A dimensioned view of the cabinet is given in Fig. 9. The work is carried out in 3/8 in. finished mahogany, and should present no difficulty to the constructor who has a little know-

ledge for these being shown in the drilling diagram.

For broadcast wavelengths, the aerial coil L₁ may be a No. 50 and the reaction a No. 75. The high tension battery should have a voltage of 70-100 volts, especially when the dual circuit is in use. As the carbon compression type of filament resistance is employed, either bright or dull emitter valves may be used, without alteration to the existing apparatus.

Testing

It is best to commence by using the constant aerial tuning system, and it may either be applied to a "straight" or dual circuit as explained above. Whichever circuit is used, the connections must be as indicated in the table. Separate high-tension positive terminals are provided for each valve, enabling the best voltage to be applied in each case. It should also be noted that if no grid bias battery is used, the terminal GB must be connected to L.T.

Tuning will be carried out on the condensers C₁ and C₂, keeping the two coils well separated. When signals are heard the two coils may be brought closer, but care must be taken that the set is not allowed to oscillate, or inter-

EDITORIAL TEST REPORT ON THE TYPE W 3 RECEIVER.

This receiver gives loud-speaker results of medium magnitude on the indoor aerial, and really good results on the 75 ft. aerial (single wire). The results with the set on local broadcasting (12 miles distant) were no better than a valve detector followed by a low-frequency amplifier, reaction on to the aerial being used.

As regards distance range, the dual circuit under test was found to be more effective than the detector and note magnifier type of receiver.

ledge of wood-work. If desired, the cabinet could, of course, be bought from any firm of cabinet-makers, and the price given is an outside figure for a professionally-made article.

The panel is secured to the cabinet by means of one wood screw near each corner, the holes

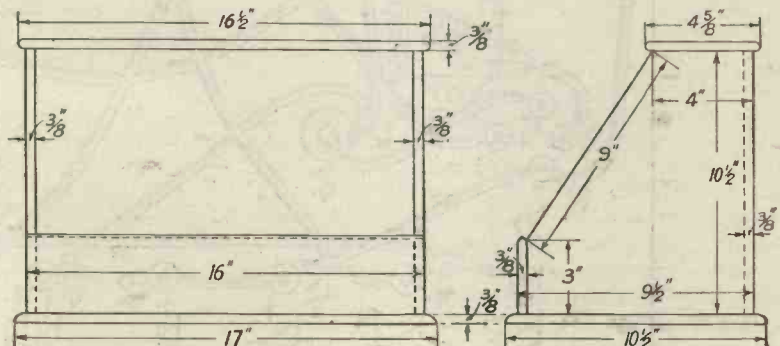

Fig. 9.—Two views of the cabinet, giving all dimensions.

ference will be caused to nearby stations.

When commencing to use the set it may be found easier to connect both high tension terminals together, and to short the ter-

минаl GB to LT-. When a little experience in operating the set has been acquired, the separate terminals may be applied to wander plugs on the high-tension battery, and the grid bias ter-

минаl may be used for applying negative bias to the grid of the first valve. This will enable the high tension voltage for this valve to be increased, thus obtaining greater signal strength.

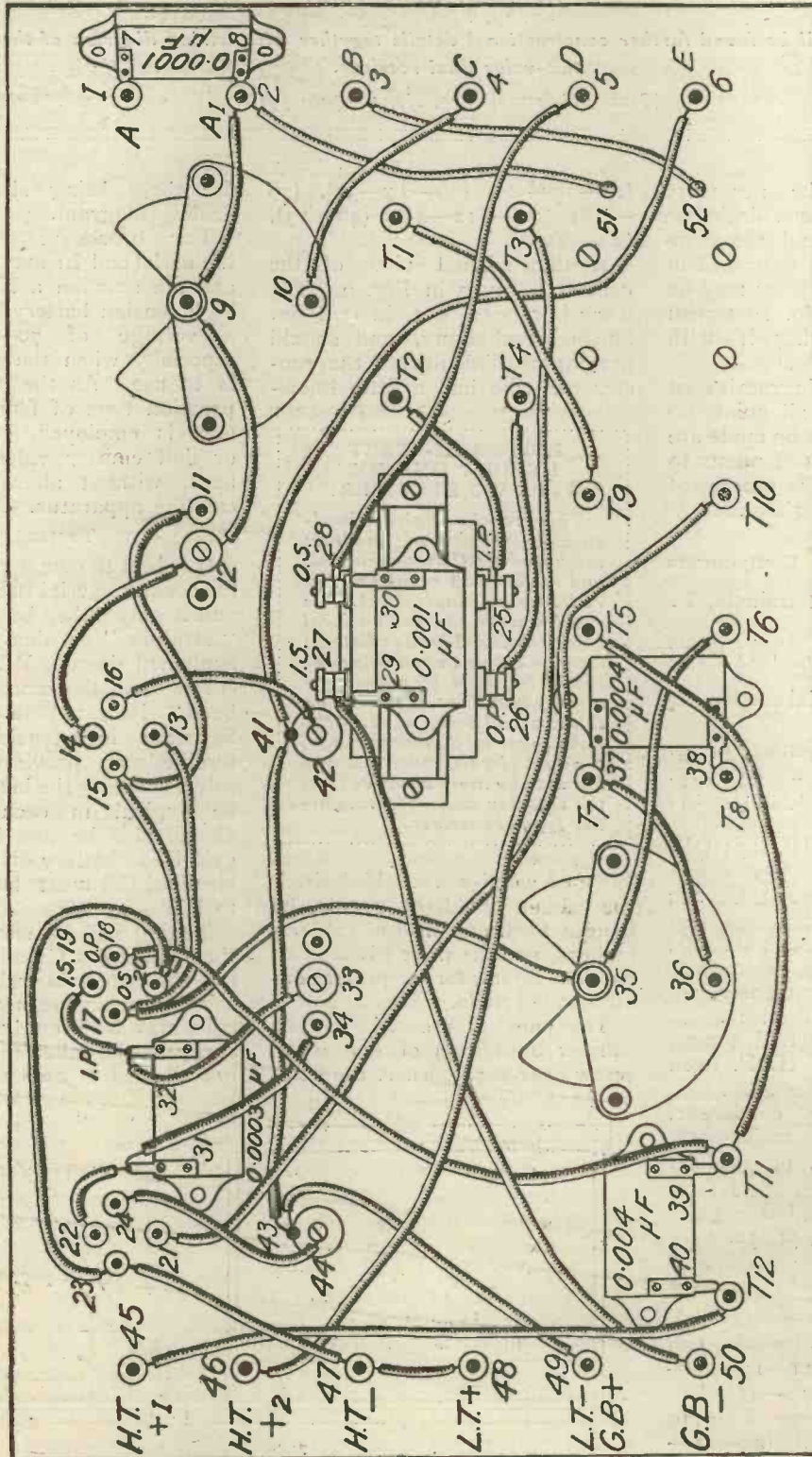
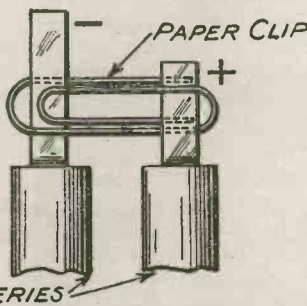

Fig. 10.—A detailed wiring diagram of the under side of the panel. This is exactly half size, and shows very clearly the disposition of the parts. The wiring is easily followed, and to make the task of wiring-up as simple as possible each point is numbered. A key to the numbering will be found on the previous page. Full size blue prints of this diagram are obtainable from these offices, price 1/6 each, post free.

A Tip for H.T. Battery Connections

A SIMPLE method of connecting H.T. batteries of the type built up from flash-lamp batteries is provided by means of paper clips, as shown in the diagram. The advantage of this simple device is the ease with which the cells may be connected or disconnected. The connections will be found to be quite firm and neat in appearance.

H. B.



Showing the method of using paper fasteners for connecting flash-lamp batteries for H.T. supply.

When One Valve Oscillates

USERS of multi-valve sets may sometimes find that reception is not up to its normal standard of purity, though there is apparently nothing at all wrong with the set. In such cases there are many who lay the blame upon the transmission, though often the cause is to be found in a rather curious effect in his receiver. For the reception of telephony it is essential that the set should not be in oscillation; in fact, for the best as opposed to the loudest results it should be so adjusted that it is well away from the oscillating point. Now it sometimes happens that though the aerial terminal has been tapped with a wet finger without producing the characteristic "plocks" which betoken oscillation, speech and music are a little woolly. When this happens tap the grid leg of each valve in turn, beginning from the high-frequency end of the set. It will often be found that the rectifier is oscillating mildly all by itself. Though this will not cause interference by re-

radiation it is quite enough to account for indistinctness. It is usually due to the use of a grid-leak with too high a value. The writer has found that it is frequently better to employ one megohm leaks in place of those of two megohms which have now become almost a standard fitting on so many sets. Better still it is to use a good variable gridleak which allows the resistance to be adjusted to any value between, say, .5 megohm and 5 megohms. With a variable gridleak one can generally control a rectifier without difficulty.

Occasionally the culprit will be one of the low-frequency valves, though this is not very common. In this case two remedies may be tried. Test first of all the effect of shunting the primary of the second L.F. transformer with a condenser. This will sometimes work the cure. If it does not try the effect of reversing the primary leads of one of the transformers. See also that the plate and filament potentials of the valves are properly adjusted.

R. W. H.

Connections for the Omni Receiver

TO those who experiment with bench hook-ups of the kind that have long been advocated by this journal, or make use of the Omni Receiver, the provision of suitable connecting wires is always rather a problem. Bare wire has a great deal to recommend it since it undoubtedly reduces unwanted capacities. It has, however, a nasty habit of causing short circuits if one is careless or is suffering from one of those fits of absentmindedness which occur to all of us at times. For general all-round utility the writer has found nothing to beat stout single flex. An excellent wire of this kind consisting of fifteen copper strands with an inner covering of cotton and an outer of thick black rubber is obtainable from advertisers in this journal at very low prices. This is flexible enough to go just where one wants it to, and at the same time it has sufficient firmness to enable it to "stay put" when connections have been made. The writer keeps on his table a box contain-

ing a large number of pieces of this wire cut to different lengths—2, 4, 6, 8 and 10 ins., and a few longer ones for special jobs will be found to be the most handy lengths.

If the ends of flex wire are simply twisted tightly together it will be found that they soon show a tendency to bruise and break owing to the wear and tear of constant attachment to and detachment from terminals. A very good tip which makes no great demands upon the amateur's time, and which in the end saves an enormous amount of trouble, is as follows: Prepare your lengths of wire in the ordinary way—flex with no outer silk covering does not require to be "made off" at the ends—and twist the strands tightly together, having first scraped them gently with a knife. Now dress them with a little Baker's soldering fluid or fluxite, and dip into some solder which has been melted in an old iron spoon. This will bond them together into one solid mass. The soldered ends can now be bent round as shown in the drawing into a hook which slips most easily between the nuts of terminals. Wires treated in this way will last for a very long



ENDS TWISTED BONDED WITH SOLDER AND BENT INTO HOOK.

Illustrating the finished connection.

time, and one may feel, when using them, that connections are always good. With unbonded flex it not infrequently happens that many of the strands make no contact at all with terminals, which means that a fairly high resistance may be set up.

R. W. H.

FLATTERY!

From Our Post Bag—

I dropped your paper once, but as others are not better, I bought all the back numbers.

R. F. G.

Kingston-on-Thames.

An Ultra Simple Crystal Set

By NORMAN K. JACKSON.

The ease with which a simple crystal receiver may be made is revealed by the constructional details of this efficient little instrument.

THE crystal set to be described may seem on the face of it to be so exceedingly simple as to cause doubt as to its efficiency, but it will be found not only ultra simple, but also highly efficient. It will be noted that there is no method of tuning other than the selection of a suitable coil to give the required wavelength, which is the one essential in this set.

When it is realised that one merely balances inductance and capacity in any aerial system it is easily seen that, if a suitable coil is chosen to give

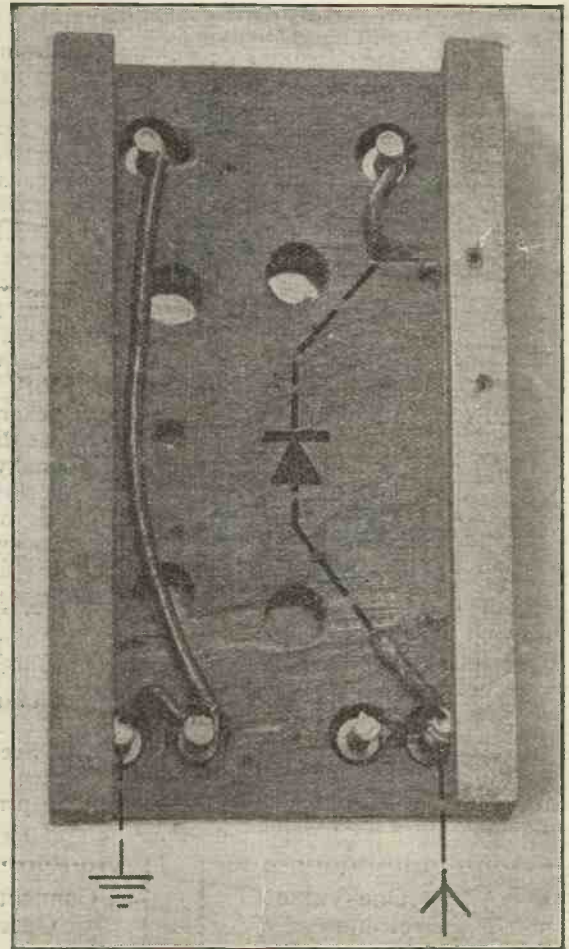

The wiring as seen beneath the panel, the crystal, aerial and earth connections being shown dotted.

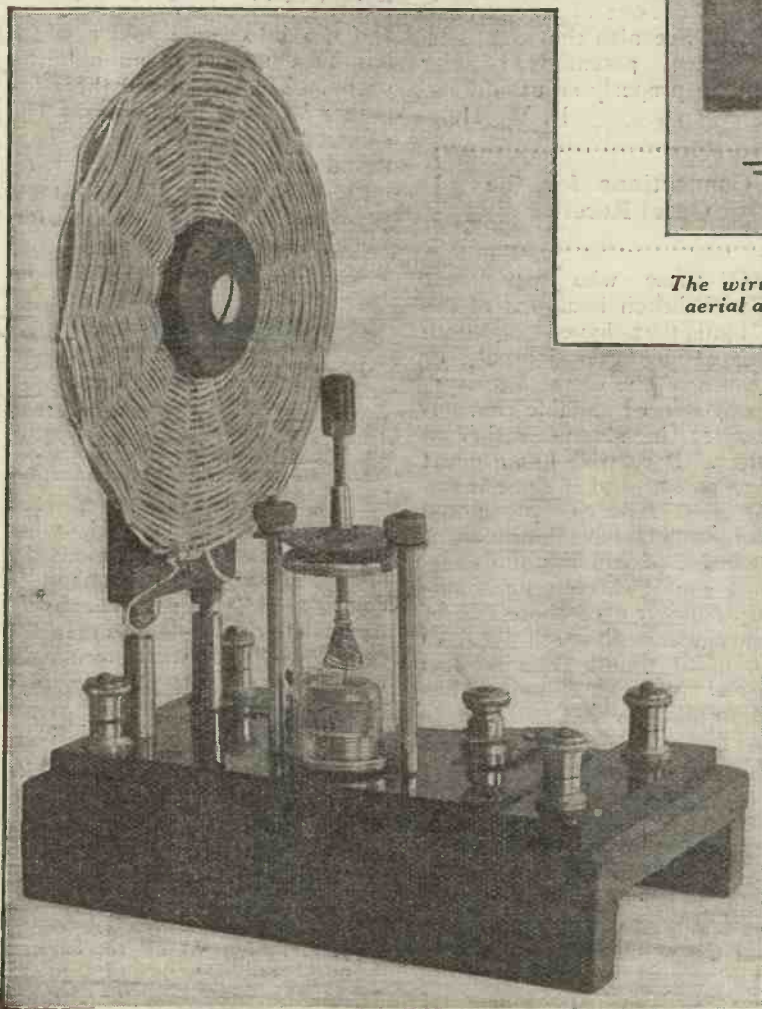

A photograph of the receiver showing positions of components.

that balance, we have obtained all that is required for a given wavelength.

The set may be fitted with the constant aerial tuning system recently mentioned in *Modern Wireless* and *Wireless Weekly*, where it is required to use the set on different aerials, or where aerial characteristics differ, but it may be made without this and a coil chosen of a size to suit the aerial used.

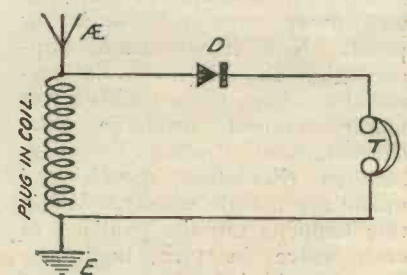

The circuit.

Very little need be said of the construction, which is obvious

from the photograph; a 50-turn basket coil of No. 22 double cotton-covered wire, on a 1-in. former having 13 spokes, is the size used by the writer for his aerial when used on 2LO's wave-

length, at a distance of about 12 miles, and a glass-enclosed detector, using Hertzite and a copper catwhisker. A .002 fixed condenser may be required across the 'phone terminals, but this, of course, depends on the 'phones

used, and is not found necessary by the writer.

It merely remains to be pointed out that the aerial and earth terminals are those on the left in the photograph, and those for the 'phones on the right.

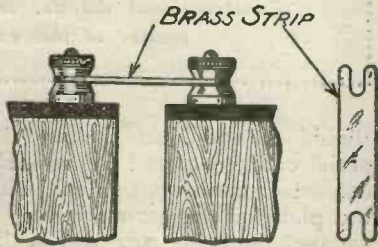

Fig. 1.—A simple form of connecting link, using brass strip.

MANY constructors nowadays adopt the unit system either completely or partially. A set built on this principle is extremely handy, for it is like an expanding bookcase, always complete but never finished. One can make, for example, two or three different types of high-frequency units, any of which can be placed in front of the rectifier very quickly. Or several different tuners may be constructed, any of which can be brought into use in a few moments. Again, it is very handy to have an extra note-magnifier which can be attached to the set to bring up distant signals which, though distinct, are so faint that it is an effort to listen to them. The two ways of connecting panels which are most commonly used are shown in Fig. 1. Either of these answers very well indeed. In the first ordinary screw-down terminals are used, connection being made between them by a brass strip with forked ends. The second uses terminals of the "push in" or telephone type, which can be linked by short pieces of $\frac{1}{8}$ -in. round brass rod.

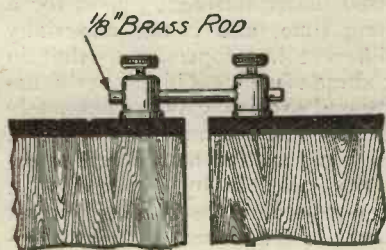

Fig. 1a.—The principle of Fig. 1 applied to push-in terminals.

Neat Inter-Panel Connections

The chief disadvantage of either of these methods is that to connect any one unit to another one has to unscrew and screw up again at least four terminals, and there is always the risk that one of these may be overlooked during the tightening-down process, to the detriment of the set's efficiency.

A type of connection which the writer has found very convenient and most satisfactory to use is seen in Fig. 2. In place of terminals, standard coil plugs are mounted on panels. The connec-

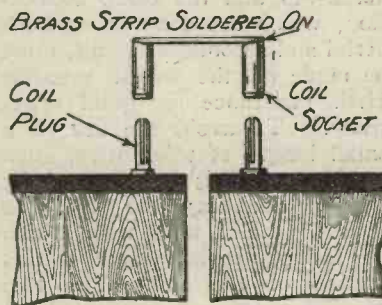

Fig. 2.—A neat arrangement employing standard coil plugs and sockets.

tion consists of a pair of coil sockets, to the ends of which is soldered a brass strip of suitable length. A still neater job can be made as shown in Fig. 3. Here coil sockets are mounted upon the panels, the connecting link being made from a piece of $\frac{3}{16}$ -in. diameter round brass rod bent into a U-shape. The ends are rounded off and split with a fine-bladed hacksaw, so as to fit nicely into the sockets. Valve legs may be used if desired in place of coil sockets, the link in this case being made from $\frac{1}{8}$ -in. round brass rod. This can be split at the ends quite easily if one possesses that most useful tool, a jeweller's hacksaw.

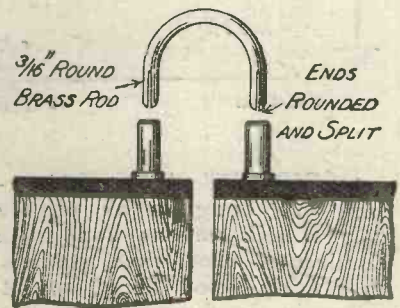

Fig. 3.—A suggested method of inter-panel connecting, using coil sockets.

Yet another kind of connection is seen in Fig. 4. Here coil plugs or valve pins are mounted upon the edge of one unit and coil sockets or valve legs upon the other. Connection is made by simply pushing the two panels together. Though it is very neat and at first sight most attractive, this is a connection to be used only by those who can turn out neat, accurate work, for unless both plugs and sockets are exactly spaced, it will be difficult to put the panels together and harder still to separate them. Plugs, pins, sockets and valve legs used in this type of connection must, of course, be mounted upon ebonite in order to provide proper insulation. This is best done by making use of panel bushes, which can be obtained from advertisers.

R. W. H.

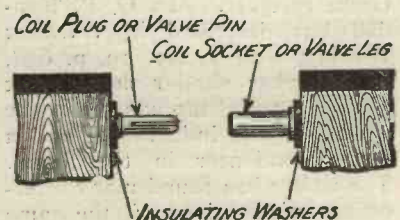
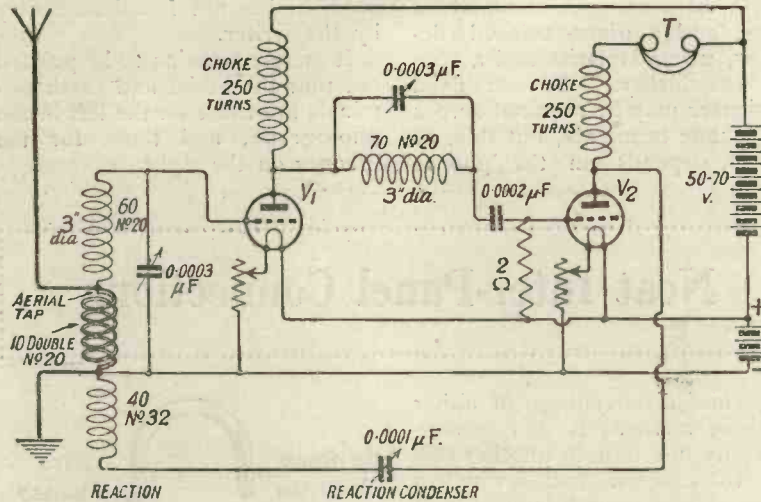

Fig. 4.—A novel method of connecting units by pushing the pins of one unit into the sockets of the next unit.



A Simple Two-Valve

By A. D. COWPER

Constructional details, together with matter of this extremely interesting

A CIRCUIT which will generally bring in all of the B.B.C. stations and some Continental short-wave stations on a fairly good aerial is that shown in the figures. This has the advantage of being exceedingly easy to set up, as the inductances are of a straightforward solenoid type wound on ordinary cardboard formers. The tuning devices are the standard variable condensers of 0.0003 and 0.0001 μF maximum capacity. The circuit is also quite easy to work with, the reaction-control being particularly smooth; the selectivity is, nevertheless, of a high order. Manchester, on 375 metres, is easily read in outer London whilst 2LO is transmitting on 365 metres. On a fairly good aerial the local station comes in at moderate loud-speaker strength, nearly as strongly in fact as with a detector-note-magnifier two-valve receiver with reaction.

The Aerial Inductance

The aerial inductance is of the auto-transformer or aerial-tap variety, some versions of which have been widely used in the States, as, for instance, in the Grebe receiver. Mr. G. P. Kendall has described in *Wireless Weekly*, Vol. 2, No. 19, p. 658, a somewhat similar device, but using an aerial tap exactly in the middle of the inductance, and a series condenser in the aerial. The writer has found many interesting applications of the same principle, some of which are indicated in his articles in *Wireless Weekly*, Nos. 10 and 11, Vol. 3.

In the first, there was described in the text a similar tuner (the figures illustrated a somewhat different type, due to Mr. P. W. Harris) for use in a reflex circuit; in the second extreme selectivity was aimed at.

The Aerial Tap

The ten turns between the aerial-tap and the earth connection, which are common to both aerial and secondary circuit, must be made of the lowest possible H.F. resistance for good selectivity. To avoid the use of a small length of thick wire, such as No. 15, this is provided by simply doubling the No. 20 S.W.G. d.c.c. wire with which the inductance is wound, in this section of the coil. The two parallel wires are connected at each end and laid side by side on the former when winding the inductance. With 70 effective turns in all in the secondary circuit, on a 3-in. former, this tunes from below 350 metres to just below 500 metres with an ordinary 0.0003 μF variable condenser in parallel. With some commercial types of "cheap" variable condensers of uncertain capacity, rather more than 70 turns may be needed to reach Aberdeen's wavelength. With a low-minimum condenser, the coil will tune considerably below 350 metres, but the circuit will not oscillate with the same certainty here.

Reaction

Reaction is provided, after the Reinartz method, by a reaction coil continuous with and wound upon the same former in the same

direction and just below the aerial coil. A 0.0001 μF variable condenser connects this coil with the plate of the second valve, a radio-choke being provided in the plate-circuit to divert the H.F. impulses this way. Occasionally, with a high-minimum reaction-condenser, and when enough care has not been taken effectively to isolate the two oscillating circuits (grid and tuned anode), the circuit will be found to oscillate even when the reaction-condenser is at zero. In such a case the remedy is in rearrangement of the inductances, and if needed, the use of a three-plate or vernier condenser in the place of the 0.0001 μF . An alternative method is to put another small fixed condenser in series with the 0.0001 μF so as to decrease its effective capacity. More rarely, the maximum capacity will not suffice to make the circuit oscillate; this is generally due to mistuning of one part.

H.F. Coupling

The H.F. coupling is a modification of the "series-tuned-anode" circuit originally described by the writer in *Wireless Weekly*, Vol. 2, No. 19: i.e., a tuned-anode with the tuning inductance in series with both valve-capacities (not a "series-resonant circuit" with a conventional parallel anode inductance with a series condenser between it and the plate, which has been used under different guises for a long time, and is not materially different in properties to that in common use). If properly arranged, this gives completely stable H.F. amplification of a high order, and makes real selectivity possible by the use of a low-resistance oscillating circuit here; in the present circuit the inductance is a simple 3-in. solenoid inductance wound with 70 turns of No. 20 S.W.G. d.c.c. wire,

and Selective ve Circuit

R, M.Sc., Staff Editor.

practical hints, form part of the subject
resting article on a selective circuit.

almost exactly similar to the A.T.I., but minus the reaction-coil. It is connected in series with the anode and next grid-condenser, as shown in the circuit diagram; and is tuned by a $0.0003 \mu\text{F}$ variable condenser precisely as the A.T.I. is tuned. With this comparatively large tuning capacity across it, the build-up of signal-voltage across it is not quite so large as with the special variometer and inductances given by the writer in *Wireless Weekly*, Vol. 2, No. 21, p. 720, so that the amplification will be sensibly less. The circuit is much more easy to set up and handle, and the actual signal-strength will be found to compare very favourably with that obtained with conventional fine wire or artificially damped circuit, whilst the selectivity possible is immensely greater.

Tuning Range

The tuning-range is naturally almost identical with that of the aerial-secondary-tuning, as in each case the variable condenser provides most of the available tuning-capacity. In practice it will be found that the setting of the two condensers will be very close together at all wavelengths; if identical condensers are used, which very much simplifies the tuning. With both, the tuning is practically "wavemeter," that is to say, independent of external influences, such as different aerial characteristics, etc., so that wavelength scales can be set up in a permanent type of receiver in place of meaningless degree scales.

Radio Chokes

The radio-chokes needed in connection with this H.F. coupling, as well as for the reaction device, can be ordinary plug-in coils of about 250 turns; frame-aerial coils of $\frac{1}{2}$ lb. No. 26; or

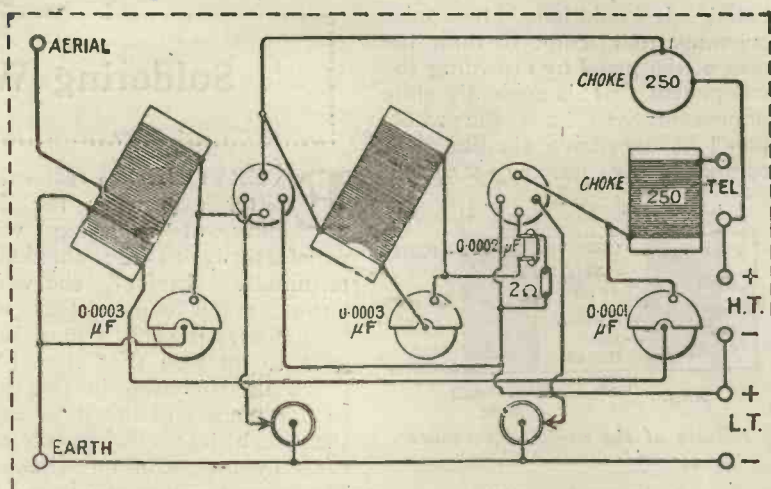

A suggested panel layout and practical wiring diagram.

plain solenoid coils 3 in. by 3 in. of No. 32 S.W.G. enamel-covered wire, etc.

Disposition of Inductances

An extremely important point is the arrangement of the two principal inductances, A.T.I. and anode; these must be placed at least a foot apart, if the circuit is to be easily manageable—the ordinary crowded small cabinet is quite inapplicable with a sensitive and selective circuit which has no artificial damping—and best at an angle of 60 degrees to the horizontal, so as to minimise coupling. The radio-chokes should be arranged fairly remote, and mutually at right angles or as with the tuning inductances at 60 degrees. Connections to the grids should be as short as is consistent with this arrangement and well separated from other wires, especially the reaction-circuit wires.

Operation

As with any really selective circuit, nothing at all will be heard except from a noisy local station, unless both circuits are accurately tuned and reaction is properly applied. A stony silence will be observed, which is most disconcerting to one accustomed to the general noise and mush present in an ordinary non-selective circuit. Sometimes it is even hard to determine whether the circuit is actually oscillating or not, unless a plate milliammeter is available, so quiet is its operation. If a wavemeter be not procurable, it is best to get the right setting for the local

station by using the first valve alone as a rectifying valve, by putting the 'phones in after the radio-choke and dimming the filament temporarily. Then the second stage is brought in, and with maximum reaction the local station sought with the anode tuning condenser at about the same setting as the primary one. It may be found difficult to get the circuit to oscillate with small values of the condensers, but it is needless to search there for B.B.C. stations.

When once the loud local station is found, the others can be searched for by successive small movements of primary and anode condensers, following up the movement of the first with the latter so as to keep the circuit in a state where it will oscillate as easily as possible—i.e., with reaction-condenser at lowest possible setting; this automatically keeps the two circuits in tune. When once found, the condenser-settings can be noted, or, better still, marked on the scales, for future use without any preliminary search.

Results

Excellent results were obtained by the writer, both with French R valves (with liberal emission) and Penton R and H.E. valves, with about 60 volts H.T. In general, the hard type of R valve will give more consistent results with this kind of H.F. circuit than the dull-emitter type, which tends towards soft characteristics.

Note-magnifiers can be added as desired. A suggested lay-out for a permanent panel-set is indi-

cated. It would indeed be a false economy to attempt to limit the size of the panel by crowding the components. It is evidently quite unnecessary to have the whole panel of expensive ebonite. A comparatively narrow strip to

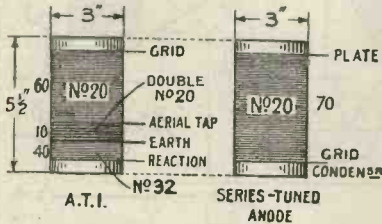

Details of the aerial inductance and anode coil.

carry the three tuning condensers and another for the valve-sockets is all that is necessary, together with terminal strips. The inductances are mounted on the back of the panel by short bolts of No. 2 B.A. screwed brass rods, fitted with backnuts.

Microphonic Valves

A VALVE is said to be microphonic if when it is jarred a pong is heard in the receivers. All valves have this undesirable quality to some extent, but some are very much worse than others. Some types of dull emitter in particular are so microphonic that pongs will be heard at every footstep as a person crosses the room in which the receiving set is worked. A great deal depends upon the way in which the set is made up. If the panels upon which the components are mounted are thin and the cabinets are made of light wood which vibrates easily, the microphonic tendency will be much more noticeable than when stout ebonite and solid woodwork are used. If the set is so microphonic that the continual ponging caused by the valves becomes a nuisance, matters can be improved to a very great extent by standing it upon a pad of thick felt or upon a table cover folded several times. As good a preventive as any of microphonic troubles can be made by using as a pad for the set to stand upon one of the rubber bath mats which are now obtainable. Their springiness is such that they act as shock absorbers, preventing jolts and jars from reaching the set. R. W. H.

Soldering Wires to Terminals

EVERYONE has realised by bitter experience the difficulty of soldering wires satisfactorily to the shanks of terminals. In fact, the writer knows many constructors who have found it such a hard business to do well that they have given up soldering in this particular place and taken to using the much less efficient connections by means of nuts instead. The trouble is twofold; in the first place, if a terminal is unduly heated during the soldering process, it becomes loosened and it is most difficult in many cases to tighten it up again once the wire has been fixed to it. Secondly, the heat may cause the ebonite to flow a little on the surface next to the soldering iron. This, besides impairing the insulating qualities of the

a lock nut is placed upon the shank. As regards soldering, be careful to clean the end of the terminal with a fine file first of all, use a suitable flux—Baker's soldering fluid is excellent and does not splutter—and get the iron quite hot. In this way the solder will run on instantly and the contact between the iron and the shank of the terminal is so short that the latter has no time to become hot enough to do much harm.

Those who have not thoroughly got the "feel" of the soldering iron will find that matters are simplified in the following way: Before mounting the terminal upon the panel, drill in its shank a hole just large enough to take the gauge of wire that is to be used; a hacksaw cut will do instead. Cut off about an inch of the wire and insert its end into the hole; then solder. Do not place the terminal in the ebonite until it is cool. When it can be handled without discomfort it may be inserted into either a tapped or a clearance hole and tightened up. The connecting wire is now soldered to the far end of the short length fixed to the terminal. Even if the soldering is not very quickly done, the shank of the terminal is not unduly heated up, so that no loosening takes place and there is no running of the ebonite.

R. W. H.

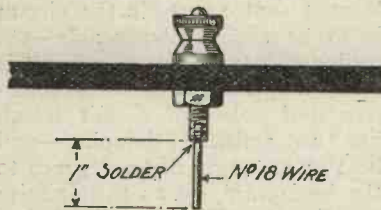

A suggested method for easy soldering.

material, makes for a very unsightly job.

Those who are skilled in the use of the soldering iron will find that the following hint makes matters fairly easy. The writer always taps terminals, valve legs, and so on, into panels instead of passing them through clearance holes and fixing with a nut. This process means the devotion of very little extra time to the work. When the panel has been marked out, make all holes 4 B.A. tapping size (No. 34 drill), then fix the 4 B.A. tap into the drill stock and run it through each hole in turn. If the tap is lubricated with turpentine and wiped after each hole has been dealt with so as to remove fouling from its threads, a dozen holes can be dealt with in two or three minutes, for it can be run in quite quickly. Terminals mounted in this way do not show the same tendency to loosen, especially if

How can Howling be Stopped in a Low-frequency Amplifier

Separate out all the wiring as much as possible to reduce inductive effects, place the intervalve transformers at suitable distances from one another, and arrange their windings at right angles if possible. Also try the effect of reversing the connections to one or more of the primary windings of the low-frequency transformers, and also experiment with connections from the iron cores of the transformers, either to earth or to the positive of the high-tension battery.

A Universal Transformer

By R. W. HALLOWS, M.A., Staff Editor

THE experimenter who likes to have upon his bench articles that are neat and handy, as well as being thoroughly efficient, will find most useful the three-winding transformer, with the construction of which this article deals. Upon the same core are high, medium and low resistance windings. The first consists of about 10,500 turns, the second of about 2,650 and the third of about 650, their respective direct current resistances, if No. 40 copper wire is used, being in the neighbourhood of 1,600, 400 and 100 ohms. It will be seen that the medium winding used in conjunction with either high or low provides a step up or a step down of 4 to 1, whilst if high and low are used together the ratio is 16 to 1. If the medium winding is employed as the primary and the high resistance winding as the secondary the apparatus can be used as a low-frequency intervalve transformer. The combination of the high-resistance winding as primary and low as secondary, it gives an excellent telephone transformer, whose voltage step down and current step up are ample to ensure the efficient working of low-resistance 'phones. The three-winding transformer has also many uses with dual and reflex circuits, which will suggest themselves to those who experiment with apparatus of this kind.

The amateur constructor might be inclined to shy at first sight at the 10,500 turns required for the high-resistance winding, but there is no need for him to be frightened, for, as we shall see, the turns are not counted as they are put on. A simple method makes it quite easy to ensure that the correct amount of wire is put on to each winding without calling for any mental effort.

The foundation of the transformer is a 4-in. length of good quality ebonite tubing with an internal diameter of 1 in. As the price of this is 3½d. per in. the total cost will be 1s. 2d. The tube should be fitted with two temporary wooden plugs, in the

exact centre of which a hole is drilled to take a short length of 2 B.A. studding, secured in place by a nut on either side of the plug. This will enable the work to be mounted on a lathe, if one is available for winding purposes.

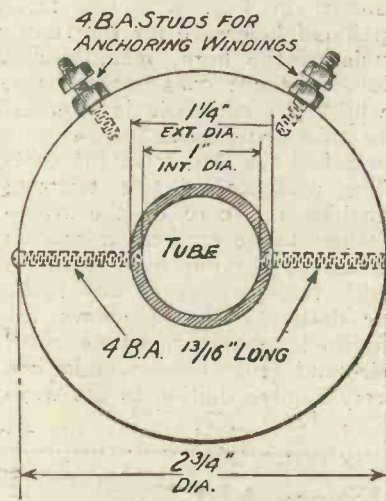

Fig. 1.—Constructional details of the discs.

Should the constructor not be so fortunate as to possess a lathe he can rig up an improvised winder by fixing his breast drill horizontally in a vice, inserting one of the rods into its chuck, and supporting the other in a bearing made from a block of wood in which is fixed a standard

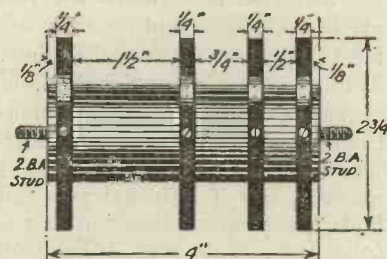

Fig. 2.—Dimension for spacing discs.

2 B.A. brass bush. Upon the ebonite tube are mounted four discs, each 2½ in. in diameter, cut from ¼ in. ebonite. This is a job which one can get done at very small expense if no lathe is available. The discs are fixed in place by 4 B.A. screws, 13/16 in. long, driven through them

into the tube (Fig. 1). They are spaced as shown in Fig. 2, the length of the high-resistance winding being 1½ in., that of the medium ¾ in., and that of the low ¼ in. Into each disc are screwed two studs, provided with nuts, which will serve as anchorages for the ends of the wire.

To each of these studs is attached a piece of stout wire about ½ in. long, to which is soldered the bared end of the No. 40 S.W.G. double cotton-covered, or preferably double silk-covered wire, which will be used throughout for making the transformer. Begin by covering the tube in each compartment with a layer of empire cloth. Then weigh the whole thing very carefully and make a note of its weight. Now wind on the wire of the high-resistance coil. The windings, when finished, will have a depth of rather more than ¼ in. When you think that you are approaching the correct number remove the tube from the winder and weigh it again. When the difference between its original weight and that with the high-resistance wound is exactly four ounces, the correct amount of wire has been put on. Note the weight again and proceed to wind the medium coil, which, when finished, should add exactly one ounce to the weight. The windings of the low-resistance coil should weigh just ¼ ounce.

The finishing end of each winding is soldered like the starting end to one of the lengths of stout wire. When all the coils have been wound, each is finished off by a layer of empire cloth.

The next process is to make the core, which consists of 4-in. lengths of thin wire made of pure iron of the best and softest quality obtainable. These are best inserted by making them up into a bundle which will slide fairly easily into the tube, and then forcing in other lengths until the whole core fits the tube quite tightly. If it is not found possible to force in sufficient wire to make it quite tight, little wooden pegs may be used to jam it firmly.

Now solder stout, well-insulated flex leads to each of the studs to which the ends of the windings are attached. Solder

a seventh lead to one wire of the core itself. To mount the transformer a wooden box is needed, 5 in. long and $3\frac{1}{2}$ in. in width

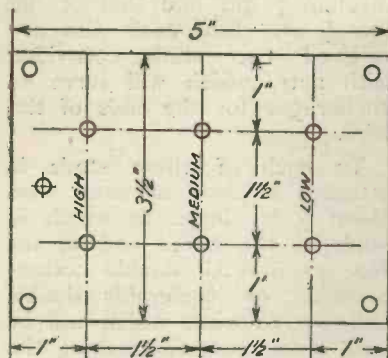

Fig. 3.—Layout of the panel.

and depth. This can be made from any wood that is handy, mahogany, oak or walnut being especially suitable, on account of the good finish that they take. Run a little wax from an old high-tension battery into the bottom of the box and place the transformer upon it with the studs uppermost. Separate the leads

well and mark each by means of different-coloured silk bindings, so that they cannot be mixed up. If the transformer has not already been tested thoroughly for continuity of windings, this process should be done before it is finally boxed in. Next run in sufficient wax to cover the transformer and almost entirely to fill the box.

On the top of the box is an ebonite panel, measuring 5 in. by $3\frac{1}{2}$ in., which is laid out as shown in Fig. 3. The three pairs of holes are for the terminals of the high, medium and low-resistance coils respectively, whilst the odd hole is intended to take a terminal to which is attached the lead from the core. The presence of this terminal enables the core of the transformer to be earthed, a process which usually improves reception with transformers of any make or design. Fig. 4 shows the finished apparatus, whose small size and general utility make it a very handy addition to the wire-

less outfit. In the drawing, clips for condensers are seen. These are very easily added by drilling appropriate holes in the panel and bolting them down. It is most convenient to have such

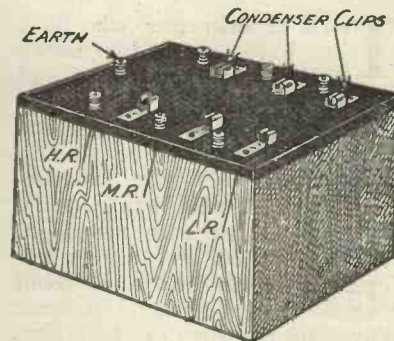

Fig. 4.—The appearance of the finished transformer as specified herein will be as given above.

clips, since a condenser of any desired capacity, made in the way previously described in *Wireless Weekly*, can be placed in shunt with any of the windings.

Telephone First Aid

IT happens sometimes that either the telephones or the loud-speaker appear to have lost their sensitiveness so that signals which used to be very strong come in quite feebly. In many cases this is due to the diaphragms having become bent. It is of very little use to try and straighten them when this has happened, and it is certainly not worth while to waste time in the attempt. Diaphragms of all standard diameters can be bought from most large dealers in wireless goods quite cheaply. All that is necessary is to measure the diameter of those you are about to discard and to obtain others of the same size. Should your 'phones not be designed to take a standard diaphragm obtain one that is rather too large and trim it down with a pair of scissors, taking care not to bend it in the process. When purchasing diaphragms always take care to buy the thinnest and lightest that you can get.

Another cause of loss of sensi-

tiveness is to be found in the demagnetisation of the permanent magnets which occurs through the passage of the current in the wrong direction. When it is passing as it should the electromagnetic effect is added to that of the permanent magnets, but if the direction is reversed the two are in opposition and the magnets tend to become weakened in time. The only remedy for this disorder is to have the 'phones reconditioned by the makers. The positive terminal of many 'phones is marked, but if it is not you can find the proper direction in the following simple way. Take off the cap and diaphragm, hold the receiver upside down and apply to one of the pole pieces some iron or steel object whose weight is such that the magnets can only just hold them in place. Now attach the 'phones to a battery. If the current is passing in the wrong way the piece of metal will fall off, whereas if the direction is correct it will stick more tightly.

R. W. H.

OMNI RECEIVER

SIR,—It may be of interest to you to hear of the success which has attended my efforts in the construction of your Omni-circuit receiver as described in *Modern Wireless* and *Wireless Weekly*.

I have obtained remarkably good results with it so far. For instance, with two valves—H.F. and rectifier—I have received all the British Broadcasting stations clearly on the 'phones, cutting out 2LO by means of a wave-trap circuit consisting of a coil closely coupled to the A.T.I. and shunted by a variable condenser. Also using one detector valve only, without aerial or earth, 2LO is quite good on 'phones, while adding one L.F. valve brings up the strength sufficient for the loud-speaker.

Although detrimental capacity effects might be expected with so much wiring, I have had no difficulty in controlling oscillation when the set is connected up as 2 H.F. and rectifier.—Yours faithfully,

S. G. TURNER.
New Cross, S.E.

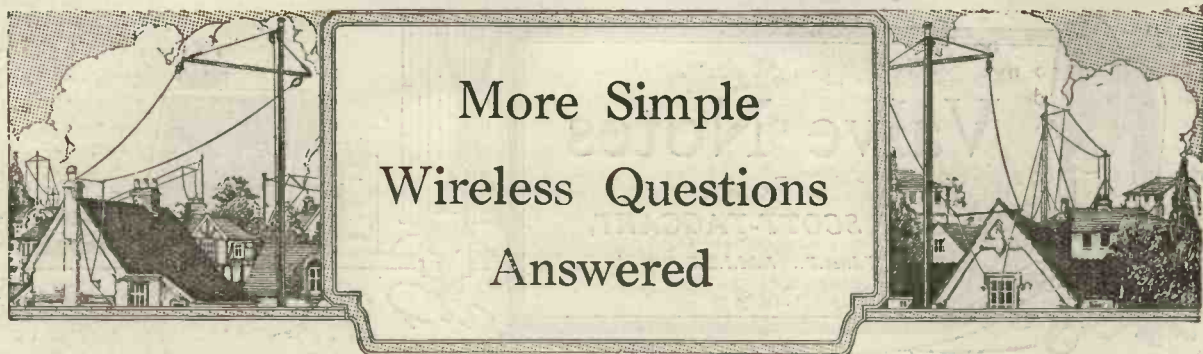

More Simple Wireless Questions Answered

Why should a series condenser reduce, and a parallel condenser increase, the wavelength of the aerial circuit?

When a condenser is connected in series in the aerial circuit it is really in series with the aerial capacity itself. Whenever any two condensers are connected in series the total capacity is reduced. The resultant capacity will always be less than the smaller of the two condensers connected in series, and, therefore, the smaller the capacity of the condenser inserted in series in the aerial circuit the greater will be the reduction of the total capacity in that circuit and, consequently, of the wavelength to which it is tuned.

When a variable condenser is connected in parallel across the aerial tuning inductance its capacity is added to that of the aerial, the result being that the total capacity of the circuit, and consequently the resultant wavelength, is increased.

When one says that an intervalve low-frequency transformer has a ratio of 1 to 5, is reference made to the number of turns on the windings or to their resistances?

The ratio referred to is the actual number of turns on primary and secondary windings, and does not refer to their resistances. Thus there might be 2,000 turns on the primary and 10,000 on the secondary.

Why is it that some low-frequency amplifiers are very prone to howling?

When several stages of low-frequency amplification are used the inherent reaction effects in the circuit become more pronounced, and produce a tendency to self-oscillation at audible frequencies. Such self-oscillation produces the phenomenon known as howling.

In what way does an oscillating receiving set cause interference with adjacent receiving stations?

When a receiving set is oscillating, and oscillatory currents are set up in the aerial circuit, either by direct connection with the oscillating valve or by inductive coupling with it, the complete station is in reality a low-power transmitter. The frequency and wavelength of the radiated waves depends only upon the tuning adjustment of the receiver circuit. Suppose these adjustments to be varied, say, between 360 and 373 metres, during the time that a neighbouring station is receiving signals from 2LO on 363 metres; each time the wavelength of the oscillating aerial passes the 363-metre point beat oscillations of varying frequency are set up between the radiated waves and the carrier wave of 2LO, giving rise in the telephone receivers of the unoffending receiving station to rapidly varying notes or "squeals."

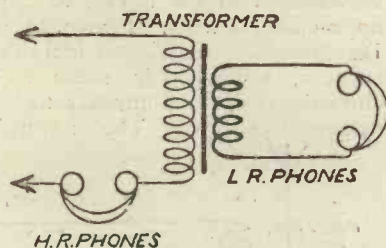

How to use high and low resistance 'phones together.

Is it possible to use both high and low resistance 'phones with the same receiver?

Yes. Connect the high-resistance 'phones in series with the primary of the telephone transformer and the low-resistance ones across its secondary in the usual manner. This is shown in the accompanying figure.

Can a Crystal Receiving Set be employed with a frame aerial?

No, except for very short distances. The minute amount of energy collected by the frame windings is insufficient to operate a crystal detector, and requires the application of two or three stages of high-frequency amplification.

How may the maximum capacity of an ordinary air dielectric variable condenser be increased in an emergency?

Two methods are in fairly common use, both of them of a rather messy nature. Firstly, the whole of the condenser may be placed in a jar containing oil up to the level of the tops of the plates, thus replacing the air dielectric with oil, which has a much higher specific inductive capacity, or alternatively, both moving and fixed vanes may have the spaces between them thoroughly filled with vaseline.

What is the best combination of low and high-frequency amplifying valves to give distortionless loud speaker signals?

Sufficient amplification should be used to enable the rectifier, whether valve or crystal, to function efficiently, but not so much as to overload it, since this in itself may introduce distortion; the amount of H.F. amplification will therefore vary according to the distance from a broadcasting station. Further, it is desirable to employ sufficient high-frequency amplification to enable one to dispense with reaction, since the use of reaction, even to a limited extent, introduces a certain amount of distortion by interfering with the damping effects of the modulation upon the carrier wave. The amount of low-frequency amplification to be employed should always be limited to two stages if the best of reproduction is desired.

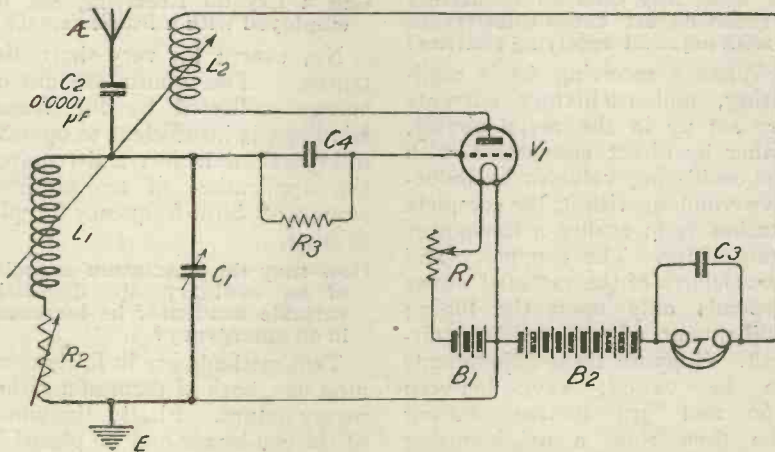

Fig. 1.—A Circuit involving the use of a variable resistance R_2 , by means of which a fine control of reaction is obtainable.

The Fine Adjustment of Reaction

THE fine adjustment of reaction becomes more and more important as the wavelength of the signals to be received decreases and the strength of the signals themselves decreases.

On the shorter wavelengths, the adjustment of reaction by moving a reaction coil, becomes extremely clumsy, and two troubles are experienced. In the first place, there is not a coil holder on the market which will give really fine adjustment of reaction. By really fine, of course, I mean sufficiently fine to please the really exacting experimenter. In addition, there is always a certain tendency for the weight of the coil to cause slight wobbling which will vary the reaction effect.

Recently in these notes I described the advantages of a parallel variable resistance of the order of 100,000 ohms, and a large number of readers are finding this method extremely useful. As an alternative, the use of a series variable resistance will also probably find favour.

Fig. 1 shows how a variable resistance R_2 , having a maximum value of about 30 to 50 ohms, may be included in the grid circuit of a valve in which reaction is obtained by coupling L_2 to L_1 . The resistance R_2 should be non-inductive so that its adjustment does not alter the wavelength of the circuit to any appreciable extent. I have used Lissenstats, with considerable success, although in some circuits the resistance appears to be rather too low. The natural

effect of the resistance R_2 in the circuit, as illustrated, is to weaken the strength of the high-frequency currents, but the effect of the resistance may be neutralised by adding a little more reaction. Assuming that the resistance R_2 is at its medium adjustment, and that the reaction is just a little less than that required to produce self-oscillation, an adjustment of R_2 will enable a beautifully accurate setting of reaction to be obtained, and, what is more, no change in wavelength is noticeable, as is the case when one coil is made to swing closer to, or further from, another coil, thereby altering the mutual inductance and capacity effect.

In Fig. 1 constant aerial tuning is shown, but, of course, the idea may be applied to almost any kind of circuit in which there is an oscillatory circuit.

The idea of a series resistance of this kind is not new, but the idea has certainly been neglected. It will be noticed that in Fig. 1 a resistance R_2 is connected near the earth, the idea being that, in this position, hand capacity effects will be least noticeable. We are, in effect, obtaining a

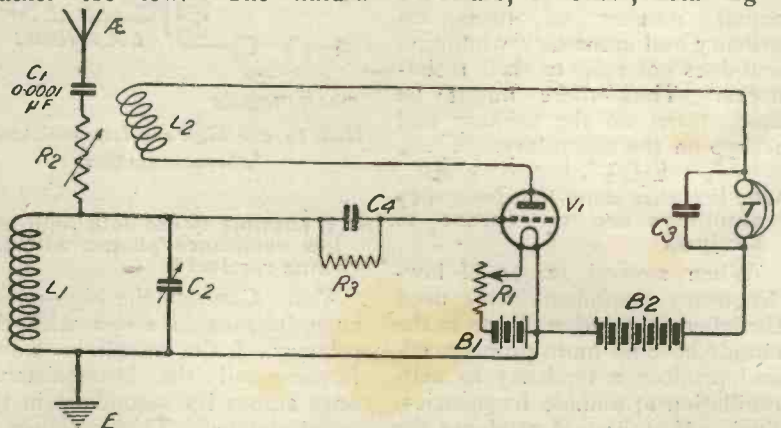

Fig. 2.—The resistance is at the high potential end of the aerial circuit. This arrangement is not so good as Fig. 1.

kind of remote control of the reaction.

Fig. 2 shows the rheostat connected at the high potential end of the oscillatory circuit. It is, in fact, connected in series with the aerial. I do not particularly recommend this arrangement.

Fig. 3 shows how two resistances, R_3 and R_4 , each of about 30 ohms, are connected in such a way as to enable variable reaction effects to be obtained. The resistance R_3 stabilises the first valve, and will prevent it from oscillating. A negative potential may even be applied to the grid of the first valve without self-oscillation occurring. A certain amount of reaction is desirable in the aerial circuit, and the resistance R_3 will control the amount to a nicety. The variable resistance R_4 in the anode circuit is also connected at the low poten-

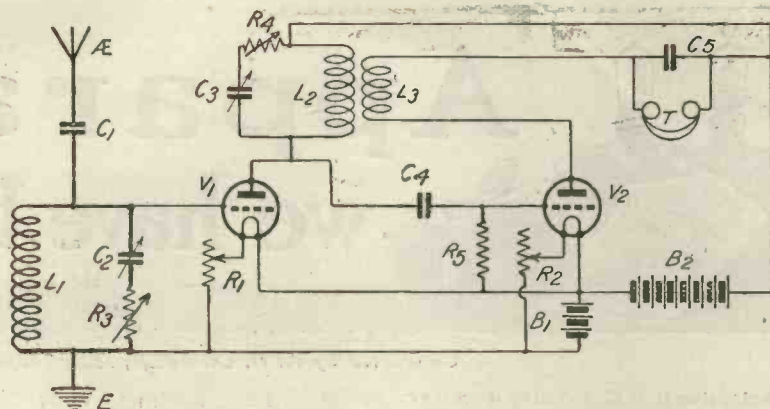

Fig. 3.—Separate resistances are employed for stabilising the first valve, and for controlling reaction, a fine control being obtainable by this method.

tial end of the circuit for the reasons given above, and the reason for R_4 is not so much for the purpose of preventing the second valve from oscillating, which it is not likely to do if the reaction coil L_3 is not too close to L_2 , but to enable the reaction

effect to be very carefully adjusted.

It will be seen in all these circuits that the exact position of the resistance is not of vital importance, provided it is included somewhere in the oscillatory circuit.

Method Means Quickness

IF you visit the workshops of two of your friends who are engaged in making up wireless apparatus, you may find that though their work is equally good one does his jobs quite quickly though the other needs much more time for them. It is a very great advantage to be able to work quickly, especially if one's spare time is limited. Here are one or two tips which make things considerably easier. When you have laid out and centred-punched a panel for drilling, scribe small circles round the punch marks where $\frac{3}{8}$ in. holes are to come, make crosses against those where there will be $\frac{1}{4}$ B.A. holes, and so on. Then fit up the appropriate drill and make all the holes that are of one size. Do not drill first a $\frac{3}{8}$ in. hole, then a $\frac{1}{4}$ B.A. clearance hole, and then another $\frac{3}{8}$ in. hole, and so on. When tapping has to be done make all the holes first, then put the tap into the drill stock and run it through each in turn.

Do not dash at things. See that before you make your final layout you are quite certain that all your components will fit in when mounted. There is no greater waste of time than to do

the laying out so hastily that when you come to the actual mounting you find that you have not left sufficient clearance for the arm of the rheostat, or room enough for the moving vanes of variable condensers.

Do your soldering methodically. Place the panel that has to be wired in front of you and begin by tinning the ends of all terminals and valve legs before anything else is done. Plan out your wiring before starting it, and do first the jobs that are in the most awkward corners. If you leave them to the last you may find that there are now so many crossing wires that it is quite impossible to get at the difficult spots.

R. W. H.

Looking After the Soldering Iron

TREAT your soldering iron well and you will find that your work is made easier, but neglect it and you will be bothered continually by the difficulty in making the solder stick and by connections that come loose some time after they have

been made. A new soldering iron should be filed to a smooth, flat point before it is brought into use. It should then be carefully tinned and every effort should be made not to burn off the tin by overheating. Be on the look out for pits. Even if one is careful, as a rule the iron must be occasionally overheated, and this will cause the surface to lose its old smoothness and to become badly pitted in time. Should you attempt to solder with an iron in this condition you will find it rather a difficult business. Solder will not stick well to the bit when you try to pick it up, it will not run nicely when you want it to, and connections made with such an iron will show a tendency to crack after a time. When pits appear trim the iron up again with a fine file and re-tin it.

Many people find it rather difficult to wield the ordinary soldering iron on account of the length of its shaft. The writer nearly always shortens a new one before bringing it into use in the following way: The iron is clamped in a vice and the handle is worked off by twisting and pulling it. With a hacksaw the shaft is then reduced to about $5\frac{1}{2}$ in., after which the handle is replaced. An iron shortened in this way makes an exceedingly convenient tool which is very easy to work with.

R. W. H.



Conducted by A. D. COWPER, M.Sc., Staff Editor.

A Selective B.B.C. 4-Valve Receiver

An ambitious B.B.C. receiver is the "Hogarth IV," distributed by Messrs. International Motors, Ltd., which we have had the opportunity of putting to exacting tests.

It is notorious that although most 4-valve receivers will give lots of noise on the near-by station, and will often bring in the more distant stations quite loudly under favourable circumstances, lack of selectivity limits their usefulness. With the average B.B.C. set, neither the local station nor Morse jamming, atmospheric, etc., can be tuned out sufficiently to make listening to distant stations other than an unpleasant ordeal. We were pleasantly surprised to find real selectivity, combined with power, in the "Hogarth IV."

The circuit has obviously been worked out by a radio engineer conversant with the best short-wave practice, thus a substantial gauge of wire is used throughout on the H.F. side, and combined with careful spacing, short connections, and an effective type of loose-coupler, really satisfactory signal-strength is obtained for the number of valves in use as well as a high degree of selectivity.

The receiver occupies a cabinet, panel-fronted, something after the American type, with the valves enclosed in the upper portion of the case, a hinged lid providing access. All connections are taken to a row of terminals at the back, giving a much more clean-cut appearance than the usual untidy bunch of trailing connections.

There is a tapped primary, 45 degree loose-coupler with tuning condenser, tapped anode coil with tuning condenser, and reaction-coil of the same vario-coupler type on this tuned anode.

Plugs for loading coils in primary, secondary, and anode, for the reception of Radiola and the Eiffel Tower are provided. Separate filament resistances control H.F. and detector-valve; a single resistance controlling the two L.F. amplifying valves. Provision is made for an extra 100 volt H.T. battery for power amplification.

Using two R valves, and two power-amplifying valves, with the 50 and 150 total volts H.T. prescribed, and a six-volt accumulator, the local station came in overpoweringly loud, too much, in fact, for the loud-speaker in use, on a good suburban aerial. In searching for distant stations some little trouble was experienced from self-oscillation, as was to be expected with tuned anode, loose coupling, and no special stabilising devices. Careful adjustment of the H.F. valve filament resistance was necessary; another point is that the note-magnifier valves had to be dimmed for comfort with the headphones, as no switching gear is provided to cut these valves out at will. With nine adjustments, searching, even with the aid of a wave-meter, is not the easiest task, and a more complete calibration would be of great value. With some pains, one could go the round of most of the B.B.C. stations, also Brussels, etc., the less remote being quite pleasant on the loud-speaker. Whilst London was transmitting only 13 miles away, Bournemouth could be tuned in, with care, so as to be actually enjoyable, there being no sign of London. This is, as mentioned, quite an unusual feat in a B.B.C. type of receiver, and the makers are to be congratulated on their achievement.

In general finish and workmanship, and in the quality of com-

ponents used in this receiver, there is evident a high standard. For regular long-distance reception, the experienced would prefer to see incorporated some means of control of oscillation on the longer waves, and of shutting out the powerful note-magnifiers when using headphones, while a terminal to provide the necessary grid-bias to avoid distortion would not be a difficult matter to incorporate.

N.S. Battery

Messrs. N. S. Battery & Equipment Co., Ltd., have submitted for test a 6-volt 30 ampere-hour (actual) accumulator, of a type for which they claim peculiar immunity from sulphating and other common effects of neglect and misuse in lead accumulators.

This battery was already filled and charged. Tested in connection with a two-valve receiver in ordinary broadcast reception it showed full capacity during a couple of discharges and charges at the usual rates, giving satisfactory service. Then after a full charge at a low rate, it was immediately connected up with a resistance so as to maintain a current of approximately ten amperes—very excessive for a battery of this size. The voltage fell rapidly from 6.5 volts to 5.8, and then (in $\frac{3}{4}$ hour) to 5 volts; and in one hour 40 minutes from the start the voltage was down to 1 volt, the current being then 3 amperes. On breaking the circuit the volts rose in five minutes to $5\frac{1}{2}$ at once, and to 5.5 volts in a couple of hours. Another five minutes' discharge at a round 10 amperes brought the voltage down to 3, so that the battery was evidently nearly completely discharged. A 16-hour charge at 2-3 amperes followed, after which the cells were gassing freely, and the open

circuit voltage was 7 volts. On standing, this fell to 6.5 volts. Then, on connecting up to a two-valve set, both valves were lighted for some hours with a steady reading on the voltmeter of 6 volts, recovering to 6.2 volts on open circuit. There were no noises in the 'phones traceable to the L.T. supply.

Evidently the battery had fully recovered from this drastic treatment, and was behaving quite normally.

The makers submit reports from the Faraday House Testing Laboratories, and elsewhere, of still more drastic ill-treatment successfully survived by their batteries. It would appear accordingly that they have been able to develop an unusually robust and trouble-proof cell.

The battery submitted was in a large, opaque, black composition case, 8 in. by 6 in. by 3½ in. Large wing-nut terminals were provided. Plain vent-plugs were fitted, without anti-splashing devices. It was noticed that both in transportation by hand, and during the latter portion of the charge when the cells were gassing freely, there was a distinct tendency for acid to splash up

and out of these vents. For radio purposes, where batteries have frequently to be carried to and fro from the charging station, this is a matter that might well have the attention of the makers.

A Safety Valve-Holder

A valve-holder which incorporates a safety fuse for the protection of the valve filament from accidental short-circuits of the H.T. battery through it, etc., has been sent us for test by Messrs. Scientific Appliances.

This consists of a small fitting plugging into the side of an ordinary type of ebonite valve-holder. The latter has four split legs for mounting in existing valve-holders. The little fuse-fitting holds an extremely fine fuse-wire between two small terminals in a block of ebonite, the ebonite surface being protected by mica. The block has brass legs to plug into corresponding brass sockets let into the side of the valve-holder, completing thereby the electrical circuit for the neighbouring filament-leg connection.

Accordingly, it would be difficult to complete a connection through the filament without including this fuse in the circuit.

On test, the fuse-wire gave out at about 2¼ amperes, a gradually increasing current being applied. It therefore represents some measure of protection against a sudden rush of current through an accidental short-circuit. The device readily fitted into existing valve-sockets, and carried the valve properly without demanding a great deal of extra space.

A Condenser Cleaner and Set Cleaner

Messrs. Quality Radio have sent for examination a useful little accessory in the form of a brush and cleaner device for removing dust from between condenser-plates and from out of the odd corners of a radio receiver.

This has a good quality soft brush at one end of a handle, and at the other end a loop of flexible wire covered with a downy material. On trial it was surprising how much dust this little instrument was able to remove from between the plates of a much-used exposed variable condenser. The soft brush also proved admirable for removing dust from behind and around knobs and dials, etc.



Burndept Rheostat

Price in Sealed Carton

7/6

with Drilling template

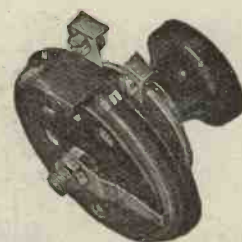

THE ideal all-purpose Rheostat—can be used with dull Emitter Valves and Dry Batteries, or Bright "R" Type Valves and Accumulators. The only Rheostat of its kind on the market.

Air space provided between the panel and resistor former; smooth and quiet in action; an exceedingly handsome and well-finished "Quality" component.

- No. 270. Standard single valve Rheostat, 7 ohms 1 amp. Price 6/-
- No. 313. 15 ohms .5 amp., suitable for 1 "D.E.3." (6v.), 2 "Weco" (4 or 6v.), 2 "D.E.3." (4v.) .. Price 6/6
- No. 274. 30 ohms .25 amp., suitable for 1 "Weco" (4 or 6v.), 1 or 2 "D.E.3." (4v.), 1 "D.E.3." (4v.), 2 "D.E.3." (6v.) .. Price 6/6

Each model in sealed carton with drilling template. Details of other models on application. **BURNDIPT LTD., Head Office: Aldine House, Bedford St., Strand, W.C.2**

Stocked by all dealers selling High Grade Wireless Components.



IGRANIC RADIO DEVICES SATISFY.



INTERVALVE TRANSFORMERS
(Patent No. 205013).

Designed for the distortionless reproduction of speech and music. The steel shroud effectively shields from external interference. Recent improvements in design render it the finest amplifying transformer obtainable.

PRICE: Shrouded 21/- Open 20/-

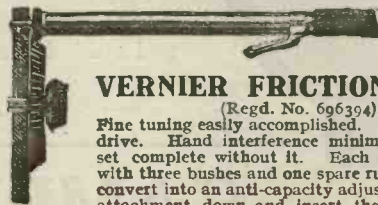

VERNIER FRICTION PENCIL

(Regd. No. 696394)

Fine tuning easily accomplished. Positive friction drive. Hand interference minimised. No radio set complete without it. Each pencil complete with three bushes and one spare rubber ring. To convert into an anti-capacity adjuster, slip the clip attachment down and insert the brass pin and ball into two holes drilled in the knob.

PRICE: 2/-

Obtainable from all dealers.

149, Queen Victoria Street, LONDON.



Works: Elstow Road, BEDFORD.

Write for Lists Y23.

L.F. Intervalve Transformer and Choke

Messrs. H. B. (Engineers), Ltd., have sent for test samples of their L.F. intervalve transformer, and audio-choke coil for choke capacity L.F. amplification.

The iron-cored choke coil is $3\frac{1}{2}$ in. long over all by about $1\frac{1}{4}$ in. diameter, and carries small terminals on each of the square ebonite ends. The core is a straight one, and does not project beyond the windings to any extent. The D.C. resistance of the windings was found to be quite moderate, so that its introduction into the plate circuit does not appreciably cut down the steady plate current.

On trial in actual reception in a L.F. stage beyond a rectifying valve in a broadcast receiver, with R valves and 60 to 100 volts H.T., grid-condenser on the L.F. valve from .01 to .001 μF in value (higher values were also tried), and grid-leak to the L.T. minus, quite good amplification resulted, though, of course, appreciably lower than with various standard makes of L.F. transformers tried in direct comparison with identical apparatus

and conditions. This was to be expected, both from elementary theoretical principles and from current practice. Distortion was absent to a degree that was noticeable in comparison with poor intervalve transformers, though again not appreciably superior to a first-class one giving greater amplification. Compared with the regular ex-Army 500-ohm choke, or chokes consisting of the secondary windings of a well-known make of L.F. transformer, the amplification was noticeably higher and the tone better.

For those who desire to experiment with choke-capacity L.F. amplification this choke will be found to give satisfactory results.

The L.F. intervalve transformer from the same makers was of the hedgehog type, of extremely small dimensions, measuring only $1\frac{3}{4}$ in. by $1\frac{1}{2}$ in. by $1\frac{1}{4}$ in., and possessing a very small iron core. Accordingly, no very remarkable performance was to be expected from it; nor was it found in actual trial in comparison with standard makes. While the insulation resistance was excellent when tested with

500 volts D.C. by means of the "Meg" tester, and both primary and secondary windings appeared to be intact, small amplification resulted when introduced into a two-valve broadcast receiver, whilst considerable distortion was observed. Changing round the windings, and altering grid-bias, etc., made no material improvement. It was noticed that the resistance of the primary was unusually low, while that of the secondary was less than that of many primary windings. This is not, of course, any very positive evidence in connection with the poor performance of the instrument, but taken in conjunction with its small dimensions appears to indicate inadequate windings as a contributory cause. We cannot recommend this small transformer to our readers in its present form.

Thousands were disappointed in not being able to obtain the March issue of "Modern Wireless," which was sold out almost at once. Make sure of the April number by placing your order to-day.

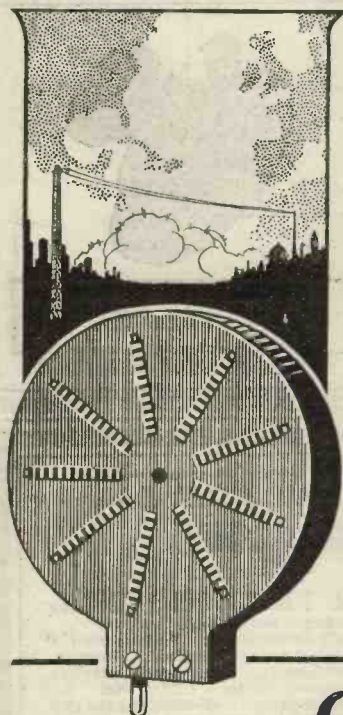

Efficiency Inductances

The name "Efficiency" was not given to Gambrell Coils in an idle moment. It was chosen because it most accurately described all the features of these coils. True efficiency can only be obtained by careful design and construction and by paying attention to every point. The efficiency of a motor car for example does not lie in the engine alone, but in gear box, axles, springing, brakes and many other details. In the same way the efficiency of a coil does not depend on one point only.

The "Efficiency" Coil is superlative in the following respects:—

- Low Self Capacity.
- Maximum Inductance.
- Low Effective Resistance.
- Uniform Distribution of Current.
- Uniform Size for all Wavelengths.
- Great Mechanical Strength.
- Larger Tuning Range.
- A Backing of 30 years' Coil Winding Experience.

If you are trying for K.D.K.A. use coil a/2 in the aerial with series condenser and "a" for secondary and tuned anode.

A postcard will bring a copy of our leaflet on Inductances.

GAMBRELL BROS., LTD.,
76, VICTORIA STREET, S.W.1.

Phone: Victoria 9938.

Works: Southfields, S.W.18.

Correspondence

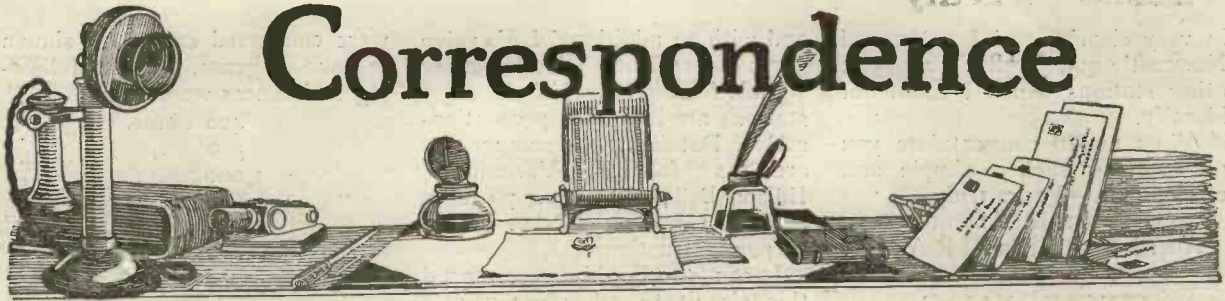

ACCUMULATOR RATING

FROM THE EARL RUSSELL.

SIR,—What Mr. Freeman says in March 12 issue of *Wireless Weekly* is, of course, perfectly true, viz., that if an accumulator is discharged above its proper reading it will not give its full capacity, but the rating of accumulators has long since been standardised. Moreover, the converse is not true, as the absurd expression

EXPERIMENTS IN DISTORTIONLESS AMPLIFICATION.

Captain H. J. Round, M.C., the famous wireless inventor, has written a remarkable article on the above subject, giving working circuits. "Modern Wireless" for April. Order your copy now!

"Ignition ampere hours" suggests, viz., that if discharged below its proper rate its capacity will be increased. There is no honest reason for the use of this term.—Yours faithfully,

RUSSELL.

ST100

SIR,—It may please you to know that using the ST100 I am receiving 2LO 32 miles away. His signals are too loud for the house using an Amplion Junior loud-speaker, and detuning is necessary to avoid overloading.

Newcastle and Glasgow are audible in two or three downstairs rooms. Also Radiola and Croydon. Without earth connection 2LO is nearly as loud as with, and now, to my mind, comes the most astonishing part. Without aerial or earth 2LO can be tuned

in, and is just audible in the loud-speaker. In this case, of course, a larger coil is required in the aerial circuit. It is no doubt a splendid circuit, and very interesting to experiment with.—Yours faithfully,

S. C. BONE.

Leigh-on-Sea.

COMBINED H.F. AND CRYSTAL UNIT

SIR,—A fortnight ago I was in the chrysalis (crystal) stage when I read your article in *Wireless Weekly* for March 5 on how to make "A Combined High-Frequency and Crystal Unit." The following day I had roughly connected up the circuit described and had blossomed into an oscillating butterfly!

My results were, I think, remarkable. Bournemouth came



Claristal
RECEIVING
SET

"SONOLA" LOW FREQUENCY TRANSFORMER.



Size $3\frac{1}{2} \times 2\frac{1}{2} \times 3\frac{1}{2}$ ins.
Unsurpassed for Silence, Efficiency and Reliability. Equally suitable with the Ordinary, D.E.R., Low Current Consumption and High-Power Valves.
Terminal Type, No. 800, 17/6.
No Transformer gives better results!

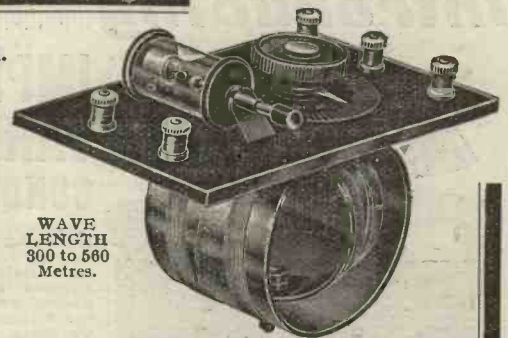

WAVE
LENGTH
300 to 560
Metres.

VARIOMETERS.

Suitable for Panel Mounting. Fitted with Ebonite Knob and Indicating Finger. No. 54A/14. 2/6. Superior finish, fitted with Ebonite Knob and Engraved Dial. No. 54A/16. 6/-. As illustrated, mounted on Ebonine Panel. $6\frac{1}{2} \times 4$ ins., fitted with improved type dustproof Crystal Detector, and Terminals for Aerial, Earth and Phones. Supreme Value. No. 54A/12. 10/6.

NEW Fully-illustrated Radio Catalogue, R165, post free on request. Enclose Business Card or Memo. for Special Trade Terms.

These Lines are stocked by All High-class Radio and Electrical Dealers. Refuse substitutes. Write direct if unobtainable.

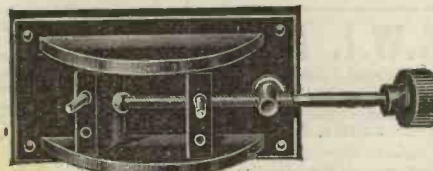

"SONOLA" MICROMETER REGULATING TWO COIL HOLDER. P. Patent.

Enables the finest possible tuning, and adds considerably to the selectivity and efficiency of the Receiving Set. No. 58/40. 10/- each.

ALL BRITISH MADE. Licence No. 901. Receives Signals and Broadcasting Entertainments loudly and clearly within a radius of 20 to 25 miles. The volume and purity of sound is equal to crystal sets sold at many times the price. Price complete with the "Sonyte" Crystal 5/6. Plus 1/- extra British Broadcasting Fee.

The "SONYTE" Double Head Receivers. British Made. 4,000 ohms. Complete with cords .. 17/6 Single Head ditto .. 8/-

The "CLARISTAL" Aerial Set. Comprising 100 feet Stranded Aerial Wire, 6 Insulators, Porcelain Leading-in Tube, Leading-in Wire, etc., 3/6. Complete Set, as illustrated, including Double Head Receivers & Aerial Set, 27/-, including B.B.C. Fees. Complete with Single Head Receiver, 18/-, including B.B.C. Fee.

FIRMLY REFUSE SUBSTITUTES;

Ward & Goldstone
PENDLETON MANCHESTER LTD.

Address all communications to Head Office. Works—PENDLETON, MANCHESTER. Glasgow Depot—95, PITT STREET.

in very clearly, and London and Newcastle quite well. I also got other stations which I could not identify.

Allow me to congratulate you on evolving such a simple and efficient set.—Yours truly,

RUDOLF D. ALLOWAY,
Aberdeen. Capt. R.A.M.C.

**SINGLE - VALVE
BROADCAST RECEIVER**

SIR,—I feel I must write you giving my experiences with the single-valve set described in your paper on November 21 last year.

I have been experimenting with various circuits for the past two years, and have tested most of your circuits given, both in the *Wireless Weekly* and *Modern Wireless*, and I have so far never had results to equal those obtained on this little set. All the wiring is as per instructions, with one exception, namely, that I earth the negative side of the L.T. battery. Using an average outdoor aerial on 'phones I get all B.B.C. stations with the utmost ease, and find no difficulty in tuning out 5SC (19 miles). The set is delightfully easy to handle,

and with an additional L.F. valve gives excellent loud-speaker signals from 5SC, while the other stations are increased proportionately. Details of the components are as follows:—Variometer, Edison Bell; coil, 4 in., 70 turns 20 S.W.G., d.c.c. Other details as per instructions.

I can thoroughly recommend this circuit to other enthusiasts after exhaustive tests.—Yours faithfully,

RALPH KEITH COMMON.
Stirling, N.B.

L.F. CHOKES

SIR,—I was interested in your article, December 12 issue, on the use of iron core choke coils in L.F. amplifiers, and note that you will welcome reports from readers on the subject.

A few months back I purchased fifteen very good ex-Government enclosed chokes at about 7d. each, and carried out a series of experiments with them in radio circuits.

The chokes were wound with stranded silk-covered wire of very small gauge. During the preliminary experiments they

were connected exactly as shown in your diagram, and the following resistances were tried.

- 400 ohms.
- 500 "
- 1,000 "
- 1,500 "
- 2,000 "
- 2,500 "
- 3,000 "

Coupling condensers of various capacities were experimented with, including the following:—0.005 μ F, 0.01 μ F, 0.015 μ F, 0.03 μ F.

Plugs and sockets were fitted, in order to facilitate the variation of resistances and capacities at will during signal reception.

Results

Very clear telephony was obtainable with any of the values given. No appreciable improvement was detected on the higher resistances and capacities, but I fancied that speech was a trifle clearer when using the 3,000 ohms. choke. No advantage was gained by increasing the size of the coupling condenser above 0.005 μ F.—Yours faithfully,

Worcestershire. F. MARKS.

Introducing

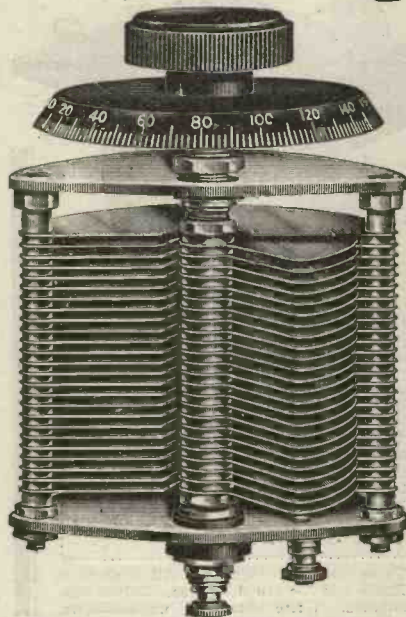

**IMPERIAL
VARIABLE
CONDENSERS**

Realising the necessity to-day for most accurately calibrated accessories, we have placed on the market the following range of Variable Condensers. Every Condenser is carefully packed and delivered in neat dust-proof cardboard container.

Write to-day for details of our valve renewal service, home accumulator charging apparatus and general wireless accessories.

G.W.I. Ltd.,

The Original Valve Repairers.
Imperial Works, Shanklin Road, Crouch End, London, N.8.

Telephone: Hornsey 3065.
Telegrams: White, Hornsey 3065.

PRICES: No. 2 size Fitted with aluminum top and bottom plates, ebonite bushes, knob and dial complete, centre hole fixing, spacers 0.73 in. Vanes 24 gauge, capacity guaranteed.

.001	each 8/-	.0002	each 4/6
.00075	" 7/-	.0001	" 4/-
.0005	" 6/-	.00005	" 4/-
.0003	" 5/6		

Delivery by return of post. Please remit ample postage. Excess Refunded.

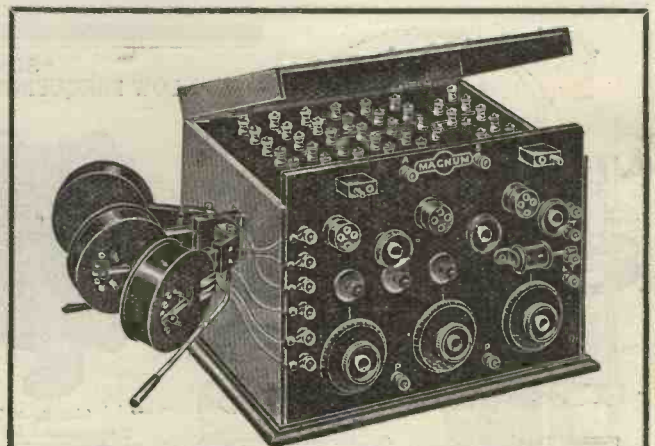

The Wonderful OMNI

as described by Mr. J. Scott-Taggart.

As illustrated, including coils, 18 Guineas.

RECEIVES EVERYTHING FROM EVERYWHERE.

TO CONSTRUCTORS.—All Components supplied separately if desired. Send stamp for Illustrated List and set of leaflets dealing with "Tested Sets," also the OMNI, S.T.100, 4-Valve Family Receiver and all circuits described in "Wireless Weekly," "Modern Wireless" and Radio Press Envelopes.

Connecting Links, per set of 50, 8/- Carr. paid on Retail Orders value £2 and over. ALWAYS SPECIFY "MAGNUM."

MAGNUM TAPPED COILS—REDUCED PRICES.
No. 1. 180-1000 metres ... 12/6
No. 2. 600-2600 metres ... 15/-

BURNE-JONES & Co. Ltd.

Manufacturing Radio Engineers,
MONTFORD PLACE, KENNINGTON, LONDON, S.E.11.
Phone: Hop 6257
Experimental Stations:—2 F.P. New Cross. 2 P.B. Kennington.
2 C.T. Lambeth. 6 C.W. Streatham.

Information Department

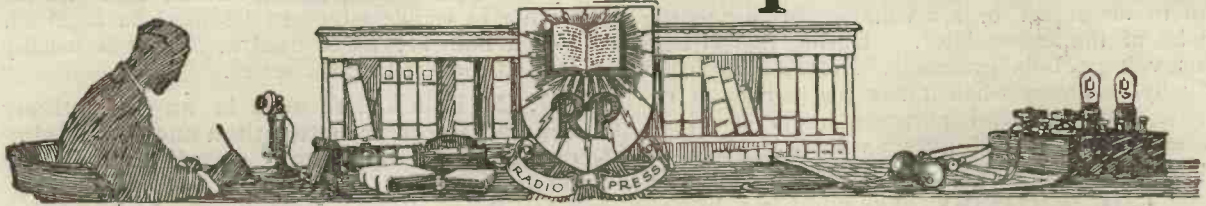

W. P. R. (BRIXTON) states that he has made the 2-valve low-frequency amplifier described in "Wireless Sets for Home Constructors," but finds that the instrument is very prone to howl. He has used low-frequency transformers of two different makes, and has not adhered to the various connections to the IP OP, etc., terminals of the transformers shown in the wiring diagram.

The following are the usual remedies for self-oscillation in low-frequency circuits. The first experiment should be to try the effect of reversing the connections from the secondary winding of the first low-frequency transformer. This usually puts an end to the trouble, but should it merely alter the pitch of the note, or result in a series of slow ticks instead of a howl, the same test should be performed upon the second transformer. In the unlikely event of these reversals proving unsuccessful, the effect should be tried of

connecting in parallel with the secondary winding of the second transformer a resistance of 100,000 ohms, or preferably one of the variable type of anode resistances.

A possible cause of howling in low-frequency circuits is a high-tension battery which is nearing the end of its life and whose internal resistance is becoming very high. A temporary remedy can be effected in these cases by the use of a reservoir condenser of 1, or preferably 2 μ F capacity in parallel with the battery.

W. L. O. (LIVERPOOL) asks what is the voltage given by a single accumulator cell? Further, does this voltage vary with the size of the cell?

The voltage given by an accumulator cell is quite independent of the actual ampere hour capacity, so long as the cell is not giving an abnormally large current. For general purposes it can be assumed that the voltage is quite independent of

E

E

C

WRITE NOW!

OUR NEW RADIO CATALOGUE

comprising 40 pages and 300 illustrations of all classes of instruments, component parts, materials, etc., is just off the press. IT WILL PAY YOU WELL to remit 4d. in stamps and secure this money-saving publication.

Head Office: 10, FITZROY SQUARE, LONDON, W.1.
Showrooms: 303, EUSTON RD., N.W.1.
Branch and Works: TWICKENHAM.

BEWARE OF WORTHLESS IMITATIONS, SEE THE TRADE MARK *WatMel* ON EVERY GRID LEAK.

WATMEL VARIABLE GRID LEAK
(Patent No. 206098).

Constantly Variable Silent in operation. Constant in any temperature. Dust and Damp proof. Each tested and guaranteed. Neat and well made.



GRID LEAK
.5 to 5 megohms
2/6

ANODE RESISTANCE
50,000 to 100,000 ohms 3/6.

Suitable for S.T. 100 Circuit.

SEND P.C. FOR DESCRIPTIVE FOLDER.

WATMEL WIRELESS CO., Comaught House, 1a, Edgware Road Marble Arch, W.2. Tel. 4575 Paddington

Two Outstanding Achievements.

THE PORTABLE-FIVE

The only Portable Receiving Set in a leather suitcase, requiring no Aerial and no Earth. It is entirely self-contained, including valves, batteries, invisible loop aerial and Loud Speaker. Really good reception on the Loud Speaker at 25 miles or on Headphones at 500 miles.

THE SUPERFIVE

A Five-Valve Cabinet Receiver for use with either Dull or Bright emitter valves—owing to its many Special and Exclusive features really good Loud Speaker reception may be easily obtained at 500 Miles under normal conditions—under reasonably favourable circumstances good Loud Speaker reception at 3,000 Miles has been frequently obtained by private users.

Write for special illustrated catalogues describing the above to:—



TINGEY WIRELESS LTD.

Offices & Showrooms (Open 8 to 7; Saturdays 8 to 1):—
92, QUEEN ST., HAMMERSMITH, LONDON, W.6.
'Phone: Hammersmith 1916. 'Grams: "Tingoldar, London."
FEW AGENCIES STILL OPEN.

the size. When the cell is fully charged, and is still on charge, the voltage should read about 2.6 volts, and as soon as the cell is taken off charge and the gassing stopped, the voltage will fall to about 2.1 or 2.2 volts, according to the make of the accumulator. During this charge this voltage falls gradually, and recharging is usually necessary when it has reached about 1.8 volts. For practical purposes it is usual to assume that each cell gives 2 volts.

A. T. H. (GRIMSBY) asks what is a super-heterodyne, and what are its advantages ?

The amplification of short wave signals at high-frequency is a very difficult matter, and the super-heterodyne is an ingenious method of solving the problem. The short wave signals are heterodyned by local oscillations of closely similar frequency, so that the beats which result are still at radio-frequency, corresponding usually to a wavelength of about 3,000 metres. These beats are then transferred to another tuned circuit, where they are regarded as signals of 300 metre wavelength, and amplified with a simple resistance capacity or aperiodic transformer high-frequency amplifier and heterodyned afresh to produce audible beats. This latter operation, of course, is omitted in the case of telephony.

F. G. L. (BRADFORD) has just bought a 2,000 ohms loud - speaker, and inquires whether he should use this in series or in parallel with his high-resistance telephones ?

It is not as a rule necessary to use both loud-speaker and telephones simultaneously, and therefore the best arrangement is usually to arrange a double-pole change-over switch, or a Dewar switch to enable either to be used as required. When both are to be used at once it is usually best to connect them in series.

J. C. (BURNLEY) asks is an inductively coupled Receiver better than one comprising only a single oscillatory circuit ?

Yes, for the following reasons :—

(1) By the use of more turns of wire on the secondary coil than upon the primary, something resembling a step-up effect is obtainable, which means that higher potentials will be available to actuate the crystal or valve detector.

(2) The excessive "damping" of the aerial circuit in a single-circuit receiver, due to the detector and telephones being shunted directly across the aerial tuning inductance, is, in the case of an inductively coupled receiver, obviated, and the looser the coupling between the circuits, the less will be the damping of the aerial circuit. This renders more accurate tuning of the aerial circuit possible, and, in fact, necessary.

(3) Greatly increased selectivity is obtained, especially when a loose coupling is employed, because not only must the aerial circuit be more accurately tuned to the desired wavelength, but the closed or secondary circuit must also be accurately tuned to the aerial circuit, under which condition the maximum effect is obtained from the desired wave, whilst the effect of any undesired waves is greatly reduced.



The
JEJCO
Crystal Receiver
is all that a High
Class Set should
be.
Good Reception
Quick Tuning
Reliable Fittings
Handsome
Appearance

The fact that REFTY Terminals, Crystal Cup and Reftone Crystal are used proves that the last word in efficiency has been insisted upon. Guaranteed under money back if not satisfied principle.

Fitted with Single 'Phone Terminals
35/- Post and Tax free.

Fitted with Double 'Phone Terminals
36/- Post and Tax free.

REFTY ELECTRICAL APPLIANCES LTD.

2, Featherstone Buildings, High Holborn, London, W.C.1

'Phone : Chancery 8264.

'Grams : "Reftinal. Holb. London."

The "TOME"
Intervalve L.F. Transformer

IF
YOU ENJOYED
THE PRIVILEGE



Turns Ratio 3 1/2 to 1. Distortionless.
Stalloy Iron Core. Highest Insulation
throughout.

of reading the Trade Journals, you would have learned recently that this exceedingly low priced Transformer was tested by the Trade Experts, and gave an exceedingly high service. Far better than many Transformers selling at nearly double the price. Refty Terminals also are used on the TOME, giving, in addition to its own good qualities, all the advantages which instant and certain connection presents to the discriminating buyer.

ONLY 14/6 EACH

Postage 6d. Extra.

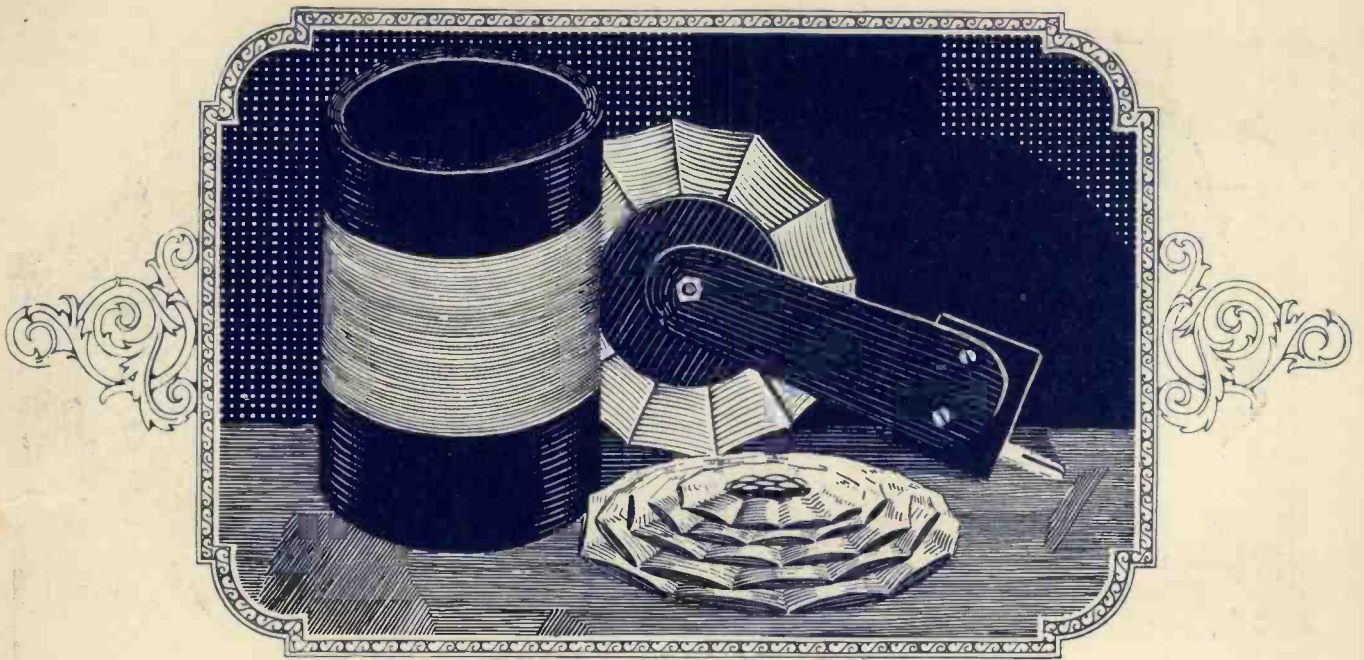

Tuning Coils and How to Wind Them.

By G.P. Kendall, B.Sc.

CONTENTS

How Circuits are tuned
Turn numbers
The choice of wire
Taking tappings
Damp proofing
Single layer coils
Basket coils
Slab coils
Pile winding
Lattice coils
Honeycomb and duo-
lateral coils
Mounting coils
Aperiodic Aerial coils

Series No. 18

Post free 1/8

1/6

—time spent in winding
good Coils is never wasted

AS the Author says, "Many of the coils used are directly responsible for the mediocre results obtained by some experimenters."

Yes, that is the whole point. Because the Set works in a more or less unsatisfactory manner, yet apparently all is in order, the experimenter blames either his locality, his aerial or even the transmitting station. And the whole trouble often lies in his inefficient tuning arrangements.

Sharp tuning cannot be obtained with inefficient coils. Once you have learnt how to make good ones from this new Book you'll be sorry to think that you have wasted so much time with your earlier inefficient ones.

Buy a copy to-day—a surprisingly large amount of accurate information is yours at barely the cost of half-a-dozen terminals.

RADIO PRESS, LTD. - Devereux Court,
Strand - W.C.2

IF IT IS A RADIO PRESS BOOK IT IS TECHNICALLY CORRECT



Listen and you will hear

"Sterling" Lightweight Radio Head Telephones are British made throughout at Sterling works. They are fitted with polished Duralumin headbands and supplied in the following resistances:

120 ohms the pair £1 : 2 : 6
 2000 ohms the pair £1 : 4 : 0
 4000 ohms the pair £1 : 5 : 0

Obtain from your Dealer.

all that is broadcast with a fidelity beyond question, with a clearness beyond compare, and with a comfort beyond belief—if you use *Sterling* Headphones. Men and women alike approve them everywhere. Get the utmost out of radio music and speech. Listen with—

STERLING LIGHTWEIGHT RADIO HEAD TELEPHONES

Advt. of STERLING TELEPHONE & ELECTRIC CO. LTD.

Manufacturers of Telephones and Radio Apparatus, etc.

210-212 Tottenham Court Road, London, W.1. Works: Dagenham, Essex

Wireless Weekly

and the Wireless Constructor.

Vol. 3.
No. 18.

CONTENTS

Variometers in Wireless Reception.

Dull-emitting Filaments.

A Combined Wavemeter and Receiver.

A "Straight" Three-valve Receiver.

Jottings by the Way, An Experimenter's Unit Receiver, C.W. and Telephony Transmission Using Valves, Apparatus We Have Tested, Valve Notes, Information Department, etc., etc.

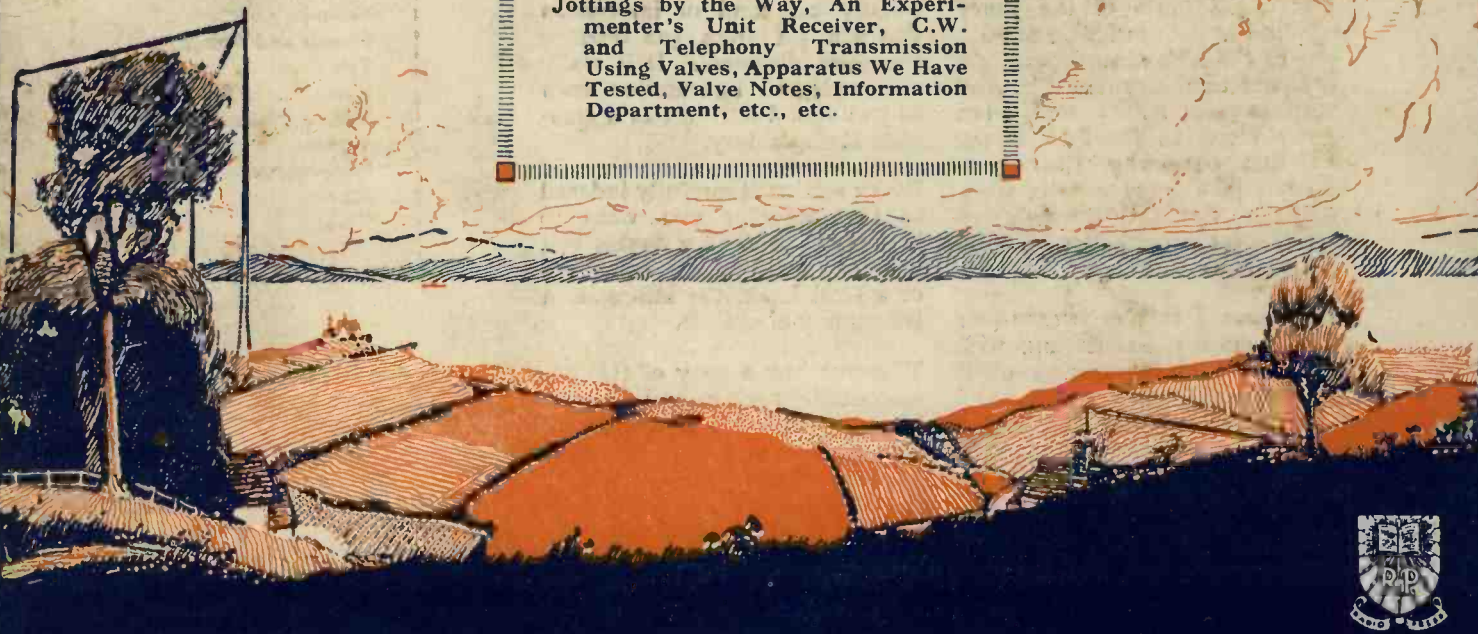

The "Super-Plidyne" Circuit

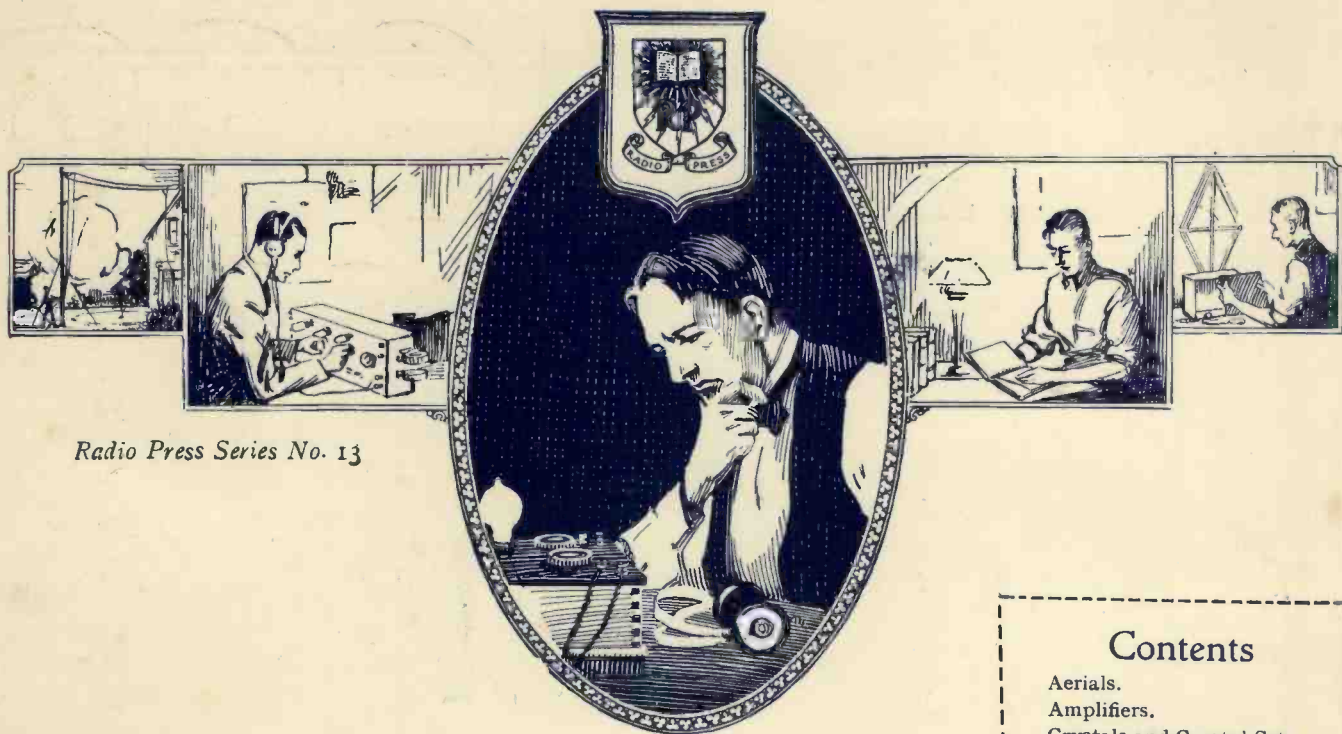

Radio Press Series No. 13

Don't worry any longer! —here's a Book to help you out of every trouble

THREE parts of the worry and trouble in Radio are due to the lack of understanding of some elementary principle. And wireless enthusiasts will often grope along in the dark trying to find out why their Sets do not give good results when a little technical advice from an expert would put them right.

Imagine a library of twenty-four Books on Wireless dealing with practically every section of it from aerial to earth. And imagine this library condensed into one volume. Now that is

exactly the kind of impression you will get from 500 *Wireless Questions Answered*. It is really the condensed information such as you would only get in a complete Radio library.

Every section is carefully indexed so that whether you want to know how to wind a basket coil or what should be the resistance or a Grid Leak, the information is instantly accessible.

Why not buy a copy of this encyclopædia to-day and keep it handy—you'll use it a score of times in a week.

Contents

Aerials.
Amplifiers.
Crystals and Crystal Sets.
Earths.
Frame Aerials.
Grid Leaks and Condensers.
Interference.
Loud Speakers.
Morse.
Primary Batteries.
Ranges.
Reaction.
Secondary Batteries.
Sounds and Signals.
Telephone Receivers.
Tuning Coils.
Tuning Condensers.
Valves.
Wavelengths.
Waves.
Wire.
Miscellaneous problems.

Published by
Radio Press, Ltd.,
Devereux Court
Strand, W.C.2.

2/6

500 Wireless Questions Answered

By G.P. Kendall & E. Redpath. Post free 2/8

Wireless Weekly

Vol. 3, No. 18
April 9, 1924.

CONTENTS

	Page
Editorial	576
Thermionic Valves with Dull-emitting Filaments	577
Jottings by the Way	580
A Word on High-Tension Batteries	581
An Economical Broadcast Receiver	582
C.W. and Telephony Transmission Using Valves	586
An Experimenter's Unit Receiver	588
The Use of Variometers in Wireless Receiving Circuits	589
Mounting Valves in Portable Sets	591
Improving the Tone	591
A 1,000-ohm Choke	592
A Simple Tuning Stand	593
All the B.B.C. Stations on a Loud Speaker	594
The Super-Plidyne Receiver	599
Valve Notes	601
Cutting Out a Note Magnifier	602
Apparatus We Have Tested	603
Correspondence	605
Information Department	607

Editor: JOHN SCOTT-TAGGART, F. Inst. P., A. M. I. E. E.

Assistant Editors { P. W. HARRIS.
E. REDPATH.

Radio Press, Ltd.

Publishers of Authoritative Wireless Literature.
DEVEREUX COURT, STRAND, W.C.2
Tel.—Central 3763.

Advertisement } SCHEFF PUBLICITY ORGANIZATION,
Managers: } LTD., 125, Pall Mall, London, S.W.1
Tel.—Regent 2440.

Advisory Editors:
Prof. R. WHIDDINGTON,
M.A., D.Sc.

Prof. C. L. FORTESCUE,
M.A., M.I.E.E.

Staff Editors:

E. H. CHAPMAN, M.A., D.Sc.
A. D. COWPER, M.Sc.
G. P. KENDALL, B.Sc.
R. W. HALLOWS, M.A.
S. G. RATTEE.

All correspondence relating to contributions is to be addressed to the Editor of "Wireless Weekly."

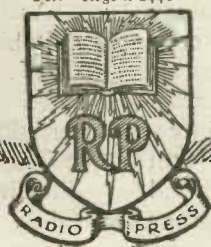

Nothing contained herein is to be regarded as permission or encouragement to infringe any patent rights.



The Spark Jamming Problem

AS one week succeeds another the problem of spark jamming in broadcasting programmes becomes more and more acute. In early broadcasting days, when the London station alone was working, residents in that particular area had little of which to complain. More distant listeners, however, particularly those in seaboard towns, were troubled from the first, the degree of amplification necessary to bring in 2LO being also sufficient to amplify the interfering spark signals. The provision of local stations for some of these areas has only partially remedied the trouble, and although the matter has been brought to the attention of the British Broadcasting Company by innumerable correspondents, and also raised in the House of Commons, nothing has yet been done. Why?

Mainly, we believe, because of several fallacious arguments that have been put forward in regard to the working of wireless on board ship. No one seriously suggests that the wireless work between merchant, warship and coast stations should be interfered with to suit the pleasures of the broadcast listener. Everyone realises the paramount importance of wireless in the safety of life at sea. It is useless then to dismiss the whole question, because ship and shore working is necessary. The least the broadcast public desires is that these stations shall adhere to the wavelengths granted to them, and not stray into the band of waves which have been officially allotted to the great art and industry of broadcasting.

Any experimenter with adequately calibrated apparatus finds, when investigating the spark interference, that trouble comes from nominal 300, 450 and 600 metre interference. Most trouble seems to come from ships and coast stations, working a nominal 450 metre wave. Cases where such stations use waves as far away from the 450 figure as 400 and 500 metres are quite frequent, whilst

the 600 metre people stray down quite considerably, and the 300 metre users frequently show an upward tendency. The first remedial measure, then, is to force these people to adhere to the stipulated wave.

In the United States we understand there has been a complete abandonment of the 450 metre wave for commercial work owing to the interference caused to broadcasting.

The arguments which have been put forward from year to year, especially by the Post Office, are threefold:—

- (1) That the capital sunk in present-day apparatus is so great that a scrapping of the sets is unthinkable.
- (2) That C.W. does not provide a ready means of broadcasting the S.O.S. signal.
- (3) That a change of policy can only emanate from an international conference.

In reply to this, we agree to (1), but suggest that contractors should be given so many years notice that new sets, after a certain date, should use continuous waves. As matters stand, more and more potential jammers are being installed, and delaying the change-over to non-interfering apparatus. It is not merely a matter of interference with broadcasting, but one of ether congestion generally.

As regards (2), C.W. is certainly not very suitable for broadcasting an S.O.S., but each C.W. set could be adapted to radiate modulated signals having much the same characteristics as those from spark stations.

The reason (3) is really only an excuse. The initiative in the matter should most certainly be taken by Great Britain, whose interests in ship wireless stations exceed those of any other country.

Thermionic Valves with Dull-Emitting Filaments

Abstract of a paper by the Research Staff of the General Electric Co., Ltd., delivered before the Wireless Section of the Institution of Electrical Engineers.

Summary

AN account is given of the history of the dull-emitting thoriated tungsten filament and of the development of thermionic valves containing these filaments. Intrinsic properties are described and discussed.

Introduction

Now that the thermionic valve has become a standardised engineering product it is of great importance in this progressive industry that the operating efficiency of the product should be increased to the greatest possible extent. Broadly speaking, there are two methods by which the efficiency of the valve can be, and is being, improved.

One method consists in so balancing the operating characteristics of the valve against the electrical constants of the circuit of which it forms part, that the maximum output is obtained from the valve with the minimum dissipation of power in the anode of the valve itself.

The second method, with one form of which it is proposed to deal briefly in this paper, consists in reducing the power consumed in heating the cathode to the temperature at which the necessary electrons are liberated from it. (The authors then show mathematically that substances highly electro-positive should emit electrons more freely than those which are not so electro-positive.)

The Problem

In order, therefore, to obtain most economically the necessary electrons for our valve, why should we not take the most electro-positive substance known and simply arrange to maintain it at the requisite temperature? The problem is not, however, quite as simple as that, on account of other factors, mainly those depending upon the physical and chemical properties of the substance.

Sodium, for example, will give 14 mA of electron current per cm² of surface at about 400 deg. C., but it is easier in practice to heat a thin tungsten filament to 2,000 deg. C. than it is to maintain a small amount of sodium at 400 deg. C. Again, the vapour pressure of sodium at 400 deg. C. is so considerable that we should no longer have a hard valve; and, lastly, highly electro-positive substances are generally chemically reactive and cannot be maintained unchanged in the presence of any appreciable quantity of the residual gases, which are difficult to remove completely from an evacuated vessel.

emission from these oxides at moderate temperatures was observed by Wehnelt* in the early days of thermionics. The Wehnelt or "oxide-coated" cathode has been developed very skilfully by the Western Electric Co. A very complete and authoritative account of their work is given by H. D. Arnold in the *Physical Review* (vol. 26, p. 76), and it is therefore unnecessary to offer any further account of them here.

The second form of electro-positive cathode is the thorium-coated tungsten cathode, with which alone this article is concerned. It is usually known as the "dull-emitting" filament because it gives the requisite emission at a temperature much lower than that of the plain tungsten filament. This temperature is higher than that at which oxide-coated filaments are run, and consequently the term "dull emitter" might with even greater justice be applied to the latter. However, it is not generally so applied. It is unnecessary to discuss here the appropriateness of the nomenclature, so long as it is realised that by a "dull emitter" is here meant, not any valve with a cathode at a relatively low temperature, but only that form which employs the thorium-coated tungsten filament.

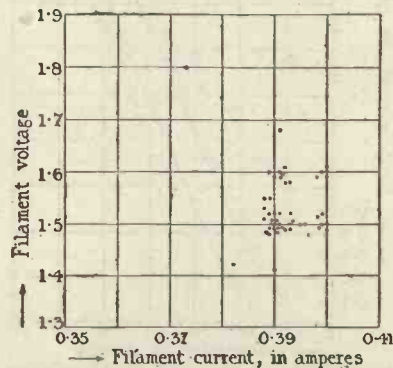

Fig. 1.—Target diagram for first 50 dull emitters produced in 1920; filament voltage and current required to give 5 mA of electron emission.

Such considerations have so far prevented the use of any material but tungsten for the cathodes of large transmitting valves where mechanical strength is important and the removal of the last traces of residual gas almost impossible, owing to the high temperature attained by the anode. But in the smaller valves used for wireless reception and for the amplification of telephone currents, two forms of electro-positive cathode have been introduced. The first is the cathode covered with oxides of the alkaline earth metals. The great

History of the Thorium-coated Tungsten Filament

The admixture of a small proportion of thorium oxide with tungsten has for very many years been common practice amongst electric lamp manufacturers when preparing their tungsten filaments, which as a result of this admixture are then less brittle than similar filaments not containing this or some other "impurity." For example, British Patent 18,467 of 1911 (W. D. Coolidge) claims the use of thoria

* *Philosophical Magazine*, 1905, vol. 10, p. 88.

and other refractory oxides mixed with tungsten powder before sintering, etc.

The first reference to any electrical peculiarity being shown by these thoriated-tungsten filaments is contained in, and forms the subject matter of, two patents taken out in 1914 by Langmuir in America.* The first of these patents describes a method of heat treatment for such filaments, resulting in an extraordinary increase in the electron emission from the filament, the treatment consisting in heating the filament to a temperature of about 2,900 deg. K. for a period of 1 or 2 minutes, followed by a few minutes at about 2,250 deg. K. The electron emission from the filament was then measured at 1,380 deg. K., and found to be equal to that obtained from a similar pure tungsten filament at about 2,000 deg. K.

The changes brought about by this heat treatment were considered by Langmuir to be:—(a) The evaporation of all gaseous and solid impurities from the filament surface at 2,900 deg. K., followed by (b) the diffusion from the interior of the filament of thorium material which gradually formed a film covering the surface of the filament. The enhanced electron emission was then characteristic of this surface film of thorium material.

Effect of Residual Gas

The emission from this activated or dull-emitting filament was, however, found to be quickly destroyed in the presence of traces of residual gas, and Langmuir's second patent describes a valve containing the dull-emitting filament and also a small amount of hydro-carbon or alkali-metal vapour, introduced in order to fix all those residual electro-negative gases which were likely to combine with the thorium on the surface of the filament.

Although no valves utilising these dull-emitting filaments were being commercially manufactured at the end of 1919, the phenomenon could not escape the attention either of valve users or of valve manufacturers. It was a frequent occurrence during the war for thoriated filaments, especially in the hardest valves, to show unusually high electron

emission, which sometimes survived several hundred hours of operation.†

One of the first problems undertaken by the Research Laboratories of the General Electric Co. was that of investigating the electrical behaviour of thoriated-tungsten filaments, with the object of stabilising their enhanced electron emission so that use could be made of them in valves.

By June, 1920, it was possible to draw up a schedule for the production of dull-emitter valves, and about this time, in order to test the process, the first fair-sized batch (about 50) was made at the works of the Marconi-Osram Companies by partially-skilled girl labour working in accordance with this schedule. Uniformly good valves were the result, and as a matter of interest

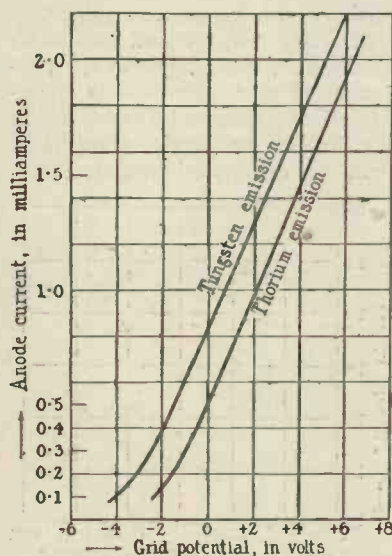

Fig. 2.—Anode-current grid-voltage characteristics for one valve, with the same total emission (9.6 mA) from the same filament with (1) tungsten emission, and (2) thorium emission.

the target diagram is reproduced in Fig. 1, which depicts the filament voltage and current required by these first 50 valves for the emission of 5 mA of electron current. Meanwhile, life tests under operating conditions of earlier valves showed steady electron emission for a period of 800-1,000 hours, so that by September it was possible to market the valve. Actually, the first large order was placed in March, 1921, after considerable trial of sample valves.

The first type of dull emitter manufactured was then known as the "L.T.1," and, except for small modifications, has been in continuous production ever since, although it is now usually known as the "D.E.R." valve. The filament of this valve required 0.38 to 0.40 ampere of heating current at 1.5 to 1.8 volts, the total emission under these conditions being 5 mA. Compared with an ordinary tungsten filament of the same dimensions, this showed a saving of about 75 per cent. in the power consumed in filament-heating.

The possibility of using as a dull emitter the thinnest filament of lamp manufacture has recently been demonstrated by the General Electric Co., of America, who have returned to the subject of the thoriated filament. They have met the difficulty of filament tension by using no tension at all, and arrange the dimension of filament length and grid diameter so that the filament, on being heated, does not expand sufficiently to cause it to sag on to the grid. This American valve takes 0.06 ampere at 3 volts, and is truly within the capacity of dry cells. A similar type of valve is also made by several manufacturers in this country.

Properties of the Dull-emitting Thoriated Filament

(a) Contact-Potential Effects.

—When carrying out the first experiments on thorium emission in a complete triode, a valve of a standard type was used. Thorium emission having been stabilised, there appeared to be a considerable reduction in the grid current at zero grid volts, and on plotting the usual anode and grid current characteristic curves it was clear that both curves were shifted bodily to the right, when compared with a similar valve containing an ordinary tungsten filament. The amount of shift was equivalent to about 1.5 volts on the grid. By plotting the characteristic curves before and after the formation of the thorium surface layer it was possible to demonstrate this particular effect with the same filament in the same valve (Fig. 2).

In addition to the bodily shift of the curves, the anode-current/anode-voltage characteristic was also less steep with the dull-

* U.S. Patents 1,244,216 and 1,244,217.

† B. S. Gossling: *Journal I.E.E.*, 1920, vol. 58, p. 682.

emitting filament, while in diodes the saturation part of the curve was less flat than it is for tungsten emission. Both these effects are illustrated in Fig. 3. This lack of sharp saturation was ascribed by Langmuir to a kind of grid effect at the heterogeneous filament surface which is not completely covered with thorium, the tungsten part of the surface acting in the same way as a negatively-charged grid.

Very numerous life tests carried out on valves have shown that, with filament temperatures not exceeding about 1,900 deg. K., practically constant electron emission is obtained during periods which are very seldom less than 1,000 hours and are generally in excess of that figure. In general, the life of the emission is longer the lower the temperature of the filament.

At the operating temperatures of 1,700 to 1,900 deg. K. our early results showed that some diffusion of thorium to the surface must be occurring, although much more slowly than at 2,250

deg. K., for if for any reason, such as the presence of excessive residual gas, the electron emission decreased during the life test, it would increase almost to its former value if the filament

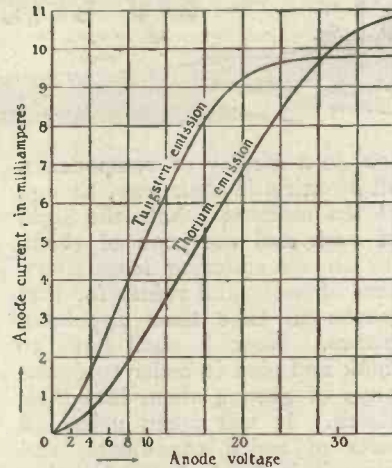

Fig. 3.—Anode - current/Anode-voltage characteristics for two similar diodes; (1) tungsten filament and (2) dull-emitting filament.

was kept at the same temperature but with zero anode potential,

so that no space current was flowing.

Langmuir* has recently attempted to separate the two factors (diffusion to the surface and evaporation from the surface) which govern the amount of thorium in equilibrium at the surface at any particular temperature. Amongst other results, he finds that thorium atoms evaporate from underlying thorium atoms at a rate very high compared with that of thorium from underlying tungsten atoms.

In general, and with other factors constant, the life of thorium emission in a valve was found to decrease with increasing anode voltage. Also the maximum anode voltage which would allow of a satisfactory life was a function of the size and shape of the enclosing bulb, the permissible voltage increasing with increasing bulb diameter.

(To be continued.)

* *Physical Review*, 1922, vol. 20, p. 107. (The full paper read before the American Physical Society has not come to hand and reference has therefore to be made to the abstract published in the *Physical Review*.)

THE BELLS OF ST. CLEMENTS

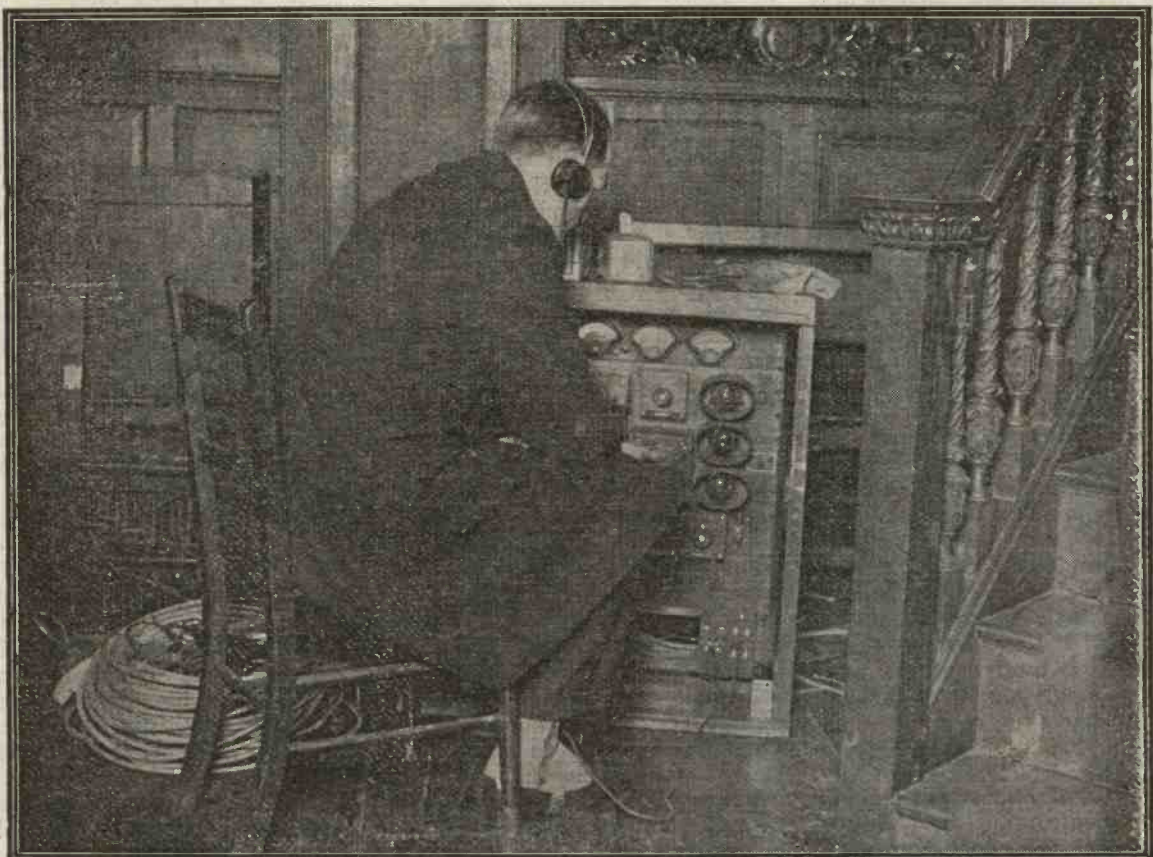

Our photograph shows the apparatus used in the church for broadcasting the bells of St. Clements from 2LO.



Ebonite

I had a few hard words to say a week or two ago on the subject of the alleged B.A. screws that were not B.A., of the criminals who will drill and tap their components so that you must use 5 B.A. screws (which no sane man wants to use) to mount them, instead of the sound and solid No. 4 of which all of us have sufficient stocks in our workshop drawers, and of other matters of that kind. To-day I have discovered a new grievance and feel that I must proceed at once to air it. Many of you will have been bitten in the same way, and will read these lines with feeling. Some makers seem to think that no constructor ever uses anything but quarter-inch ebonite for the panels of his sets. Therefore, when they devise all kinds of natty little methods of mounting and fixing their gadgets, they almost invariably make them suitable only for this material. Now, if filled with vaulting ambition, you plan out a monster set to do great deeds, it is likely that you will select three-eighths-inch ebonite to give greater solidity to its broad panels. Very well, you do so. You mark it out, you drill it and proceed to assemble, only to find that rheostats, condensers, variable grid-leaks and things of that kind simply will not go near it. Matters are still worse when overtaken by a fit of economy you decide to use wood for your panels, insulated everywhere with ebonite bushes. As the flanges of these little fellows are $\frac{1}{8}$ in. thick, and you want two of them, you have a total depth of $\frac{7}{16}$ in., even if you use thin-ply wood.

Nightmare

A horrid nightmare of this kind is now confronting me. Before me lies a large panel containing holes innumerable, all neatly drilled and bushed. Before me,

too, is a medley of components, all beautiful in their way, though at the moment I hate the sight of each and everyone of them, for all are suffering from shortness of neck, and refuse for that reason to take their appointed places. Now I shall have to think and plan in order to devise ways of getting them into their places. It will mean using all sorts of weird expedients, and when it is finished, the set that was to be a thing of beauty will be little better than a piece of botching, whilst there is a distinct possibility that its wooden panel will be badly warped by my salt tears. One little ray of consolation emerges to brighten the disaster. I want publicly to thank a certain firm for making their rheostats with beautiful long necks, so that you can mount them in anything up to $\frac{3}{4}$ in. in thickness. So pleased am I over this little act of thoughtfulness that I will not draw attention to the fact that the holes for the mounting screws are tapped 5 B.A. If only other makers would follow where these people lead in the matter of necks! You can always shorten the blessed things if they are too long, but you cannot lengthen them, try as you will.

The Latest Development

America, I see, lays claim to possessing something entirely new in the way of wireless and kindred phenomena. It seems that there is in New York a damsel who possesses what the papers are pleased to term a radio-like mind. She merely looks at you, sums up your natural wavelength, tunes herself to it, and then it is a case of two minds with but a single thought, for she is aware instantly of anything that is passing through what you are pleased to call your brain. This is, of course, in some ways a delightful power to possess. Suppose, for instance, that I had it I should

be very careful to get the precise wavelength of the fellow who sold me the World's Worst Transformer some time ago. Next time I entered his emporium I would see that I was correctly tuned before starting to do business. Then when I mentioned condensers I should at once hear him say to himself, "Looks rather a mug; wonder if I could plant that dud on to him," and so, following the devious workings of his criminal mind, I should safeguard myself in future from his machinations. That would be a splendid achievement, for he is a fellow with a winning way who has often persuaded me into buying some new thing which I have subsequently hurled with bitter words into the waiting dustbin. I once thought of designing a purchaser's protector for the use of wireless men. The idea was splendid. The device contained a megger, a milliammeter, a voltmeter, a calibrated condenser, and a set of inductances of known value, in addition to a whole heap of other fraud-detecting gadgets. Unfortunately, when I came to make the scale drawings I found that the would-be purchaser would require a handcart to carry his protector about with him, so I gave up the idea as not strictly practical.

But to revert to the radio mind, one of whose beauties is that it is easily transportable; one can think of thousands of other uses for it, so long as its possession is confined to oneself; but it would be a dreadful thing if one's friends should develop it. Then all one's ingenious taradiddles would be disclosed even before they were uttered. Jones, for example, from whom I have frequently borrowed small parts, would know at once that I had the acquisitive reflex and would no longer be so ready to part with the odds and ends that I urgently required for serious

experimental work. This would be a tragedy, especially if the radio mind extended also to Poddleby, Broggsworth and all the rest, for it is entirely owing to the way in which they have lent me what I needed that I have been able to preserve myself from a too close acquaintance with the bankruptcy court. If one really had to return things after borrowing them, or worse still, if one could not borrow them at all, I should have to give up wireless in favour of Mah Jongg.

Too Many Cooks

One of the newest recruits to the wireless brotherhood is my old friend Snaffleton. He has postponed the launching of his ship into the deep waters of radio, not because he was scornful, or anything of that kind, but through sheer diffidence. His is not what you would call a scientific mind; in fact, I do not really know, if it comes to that, what sort of a mind you would call it. But for all that he is a very charming fellow, even if he is a little over-modest about his own powers. He has long wanted to take up wireless, but we never could convince him that even he was capable of operating, and still more of making a receiving set. At last, however, he found himself one day in the showroom of the radio department of Messrs. Guffle and Snappit, where a smart salesman fairly talked him off his feet. Snaffle-

ton left at the end of an hour or two bearing under his arm one of the famous "Soweezi" sets, guaranteed foolproof and even Snaffleton-proof. There was simply one knob to turn, nothing more than that. As the salesman very justly remarked, a child could do it.

The thing worked very well indeed on the whole, and Snaffleton would have been a happy man if he had not lived in Little Puddleton, which has for some time been a prescribed area, on account of the virulence of the outbreak of radiomania which took place there. Naturally, he asked all of us to come in and inspect the "Soweezi." He twiddled his one knob, and we had to admit that the results were not at all bad. "But," said Poddleby, "you could improve this thing quite a lot, you know, in the simplest possible way by fitting a thingmejig." Snaffleton had never heard of a thingmejig, and the last thing he wanted to do was to fit one himself. However, he had no objection to Poddleby's doing it, and the latter departed bearing away the "Soweezi" to his workshop. Subsequent work saw the addition of a whatyoumaycallit by Snaggsworth and a thingmebob by Breadsnaap, a thingmetite by Gupplesby, and various other little aids to perfect reception by each and everyone of the members of the wireless club. At the end of that time the panel was no

longer content with a single modest knob. It looked, in fact, rather like a mushroom bed bearing a particularly fine crop. It was Snaffleton himself who said pathetically that one needed at least six pairs of hands in order to work it, and even when the experts were present to show him how it should be done, it always required the efforts of three or four of them simultaneously to tune in 2LO. Nor can I honestly claim that the quality of his reception has improved. I rather think that there is interaction between the thingmebob and the whatyoumaycallit. Snaffleton is still faint, though pursuing in his quest for knowledge and experience. He is a little damped at times by the fact that when alone he cannot now pick up any broadcasting station at all, but this is counterbalanced by his feeling that he no longer has a set of which any decent man would feel ashamed. Nobody with one knob can claim to be anything of a wireless man, but when experts see a panel such as his, where the knobs stand in serried ranks, they cannot fail to respect the owner. Snaffleton has already written to the makers suggesting that they should place upon the market a more advanced form of the "Soweezi." He is offering his own set, with its improvements, as a model, and suggests that the new pattern should be called the "Notsobloomineezi."

WIRELESS WAYFARER.

A Word on High-Tension Batteries

THE market at the present time is being flooded with cheap—and very nasty—high-tension batteries of foreign make. The writer took one of these things to pieces the other day. Under the pitch covering, which was no more than a thin lid, was a series of very small pocket flashlamp batteries. The soldering of the leads connecting them was very badly done, and there was no insulation at all between the closely-packed batteries. When one of the cells was dismembered an even worse state of affairs was disclosed. There was hardly any manganese dioxide depolariser round the cen-

tral carbon rod. A battery of this kind would polarise rapidly when in use owing to the unchecked deposit of hydrogen bubbles on the carbon. The result would be a varying current, and the presence of all kinds of unpleasant noises in the receivers. A similar H.T. unit when tried out on a five-valve set gave poor results from the first, and was completely done for within ten days. In that short time its total voltage had fallen from 36 to 20. A British-made battery of the same size has been in use on the set for five months, and still shows an E.M.F. of over 30.

R. W. H.

ST136

SIR,—In your recent book, "More Practical Valve Circuits," several of which I have tried, there is one—ST136—which has given me very good results indeed. Using an aerial (single wire) about 80 ft. in length and of mean height of about 30 ft., I can get all B.B.C. stations clearly and of sufficient strength to operate the loud-speaker very satisfactorily. I can also work the loud-speaker from Radiola very well indeed.

For a straightforward circuit this seems to me to be really good, and I should like to express my appreciation of the value of your book.—Yours sincerely,

S. R. COLLINS.
Keston, Kent.

An Economical Broadcast Receiver and Heterodyne Wavemeter

By A. D. COWPER, M.Sc.,
Staff Editor.

THAT it is not necessary to spend a great deal in purchasing high-priced components, in order to obtain efficient reception of even distant broadcasting, is illustrated by the set described here. Simple and moderate-priced parts, if of reliable make, amply suffice, provided that the all-important tuning inductances are properly designed and constructed, and that an effective circuit is used. This little receiver has the added advantage of being available as a heterodyne wavemeter on occasion, as the tuning scale is graduated directly in wavelengths over the broadcast band. Even those who possess an elaborate set can find many uses for a heterodyne wavemeter, in tuning-in to distant stations and in all experimental work with new circuits, etc. To such, the relative simplicity and economy of this set may appeal.

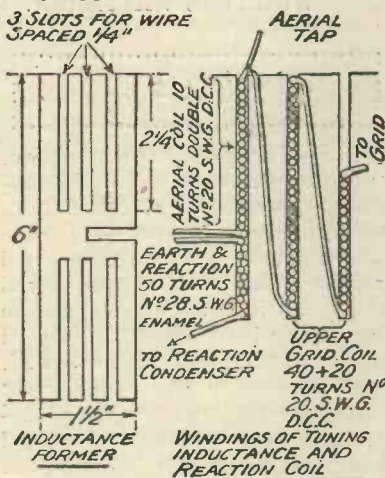

Coil details.

Cost of Materials

The actual cost of materials, including a Penton R valve, but without batteries and phones, was under thirty shillings. If

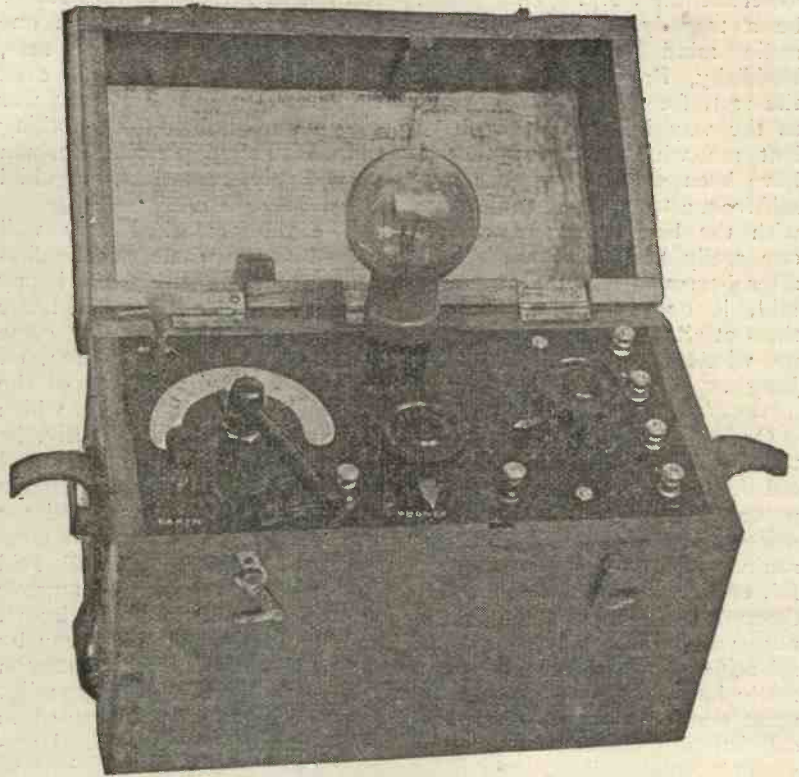

A "Disposals" box proved useful in this case.

the battery unit is added, with ten flash-lamp batteries and four small Siemens' inert cells for L.T. supply, the cost is still under two pounds. As excellent high-resistance phones can be obtained at prices to suit all pockets, and as almost any kind of improvised aerial will give passable results with this receiver in the neighbourhood of a broadcast centre, the total expense is not prohibitive.

Containing Boxes

The set is made up in one of the various types of ex-war instrument boxes, of which some are still procurable from the disposal dealers. They are generally very strongly made and well finished. After removing any odd fittings left in, rubbing down with fine glass-paper, and giving a good coat of shellac varnish, the appearance is quite passable, and being fitted with strong hinges and fasteners, etc., such boxes are much better than flimsy new cabinets. In the set illustrated, the boxes once contained trench Fullerphones, and cost under two shillings each from S. T. Cory, Southampton Row, London. The A.T.C. is one of the later pattern

single-hole-fixing 13-plate Raymond condensers, of 0.0003 μF maximum capacity. The reaction condenser is a two-plate Baty mica and air, of very low minimum capacity. The filament resistance is a two-shilling Raymond; the ebonite valve-holder is the foolproof type of Leigh Bros. The grid-condenser and leak must be of reliable type, and readers are warned that there is much rubbish on the market. Many of the cheap fixed condensers sold will be found to have only a fraction of their marked capacity, or even be completely short-circuited! As they only represent a saving of a few pence over a reliable component, they should be left severely alone.

Connections without Solder

As many home constructors object to soldering, in this receiver all connections have been made without solder, even the connections to the inductances being made by small No. 4 B.A. bolts and nuts. This should not be taken as endorsing the policy, as soldered joints, if well made, are much neater and more permanent. For the same reason a type of grid-condenser and leak is used which is mounted be-



Interior of the battery unit.

tween clips screwed on a slip of ebonite, instead of soldering. A 0.0002 μ F Grafton condenser and 2-megohm leak are carried on a strip of $\frac{1}{4}$ -in. or $\frac{3}{16}$ -in. ebonite $3\frac{1}{2}$ in. by $1\frac{1}{2}$ in.; this bridges the gap between the grid-connection on the valve-holder and the A.T.C. terminal, being supported by its connecting wires, as there is not much room on the small panel for it. Four ordinary terminals and two phone terminals are required. The aerial and earth connections are made by ordinary wander-plugs fitting into valve-leg sockets, in place of the more usual terminals, as this is found more convenient for hasty connections. About $\frac{1}{2}$ lb. of No. 20 S.W.G. d.c.c. wire for the A.T.I.; a little over 1 oz. of No. 32 S.W.G. enamel-covered wire for the radio-choke; and an oz. of No. 28 S.W.G. enamel-covered wire for the reaction coil will be needed, and a 3-in. cardboard former about $4\frac{1}{2}$ in. long (or long enough to fit tightly inside the box). No. 4 B.A. screwed brass rod and nuts, together with some bare No. 18 or No. 16 wire for wiring-up, and shellac varnish, complete the list. The tuning condenser should be fitted with a long ebonite extension handle, as the tuning is extremely fine; and it should have a blank scale for

marking the wavelength scale. The back of an ordinary ivory semi-circular scale, stuck face downwards on the panel with thick shellac, suffices for this.

The Battery Unit

If the battery unit is constructed, a similar box and of the same height is required. A small ebonite terminal strip is fixed across one end, carrying the four terminals corresponding to those on the valve-panel, so that short, straight connections can be made by small pieces of flex. The ten (or more) flash-lamp batteries, of the sort which sell for around four shillings a dozen, are arranged in this box, with brass connector clips. This should leave room for four small inert cells which supply the L.T. current for occasional use as a wavemeter, in which case the Penton H.E. 6 valve is preferable, as it consumes only about 0.2 amperes at a little over 4 volts. For regular use a small 6-volt accumulator and the R valve (0.3 amperes in the filament) are indicated.

Inductances

The radio-choke is a plain solenoid coil 3 in. by 3 in., wound on a cardboard former with No. 32 enamel-covered wire (about 250 turns), and is mounted on

The circuit used in this instrument closely follows the Reinartz, but the values of inductance and reaction condenser have been considerably modified.

two short columns of No. 4 B.A. screwed rod behind the panel and beneath the Baty two-plate reaction condenser. Connections are made as indicated in the diagrams via these brass columns, the ends of the wires being pinched under the back-nuts. This simplifies the wiring and makes it neater in appearance.

The Aerial Tap

The main tuning inductance is of the aerial-tap auto-transformer type, which has been described several times recently, which gives very great selectivity for a simple circuit, and renders the tuning nearly independent of aerial characteristics. Here it is in the form of a three-fold flat slab coil, wound on a square miniature frame-aerial former of a type familiar to readers of *Wireless Weekly*, in three narrow

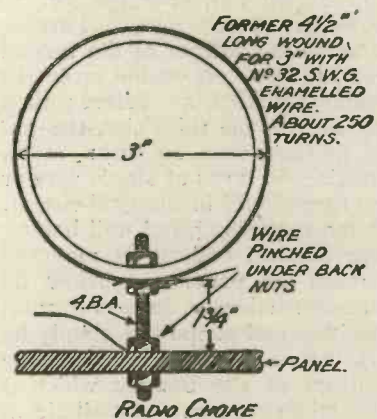

Details of former mounting screws and coil.

slots. The former is constructed of three-ply wood, thin ebonite or fibre, two pieces 6 in. by $1\frac{1}{2}$ in., being notched deeply so as to fit together in an X, and provided with three narrow saw-slots each $2\frac{1}{2}$ in. deep and spaced at $\frac{1}{4}$ in. in which the wire is bound;

Starting with the reaction coil, 50 turns are wound in the first slot, of No. 28 S.W.G. enamel-covered wire. The wire will pile up a little in the slot, as the latter will be too wide—this is of no moment. The end of this wire is made fast to the end of a length of doubled No. 20 S.W.G. d.c.c.

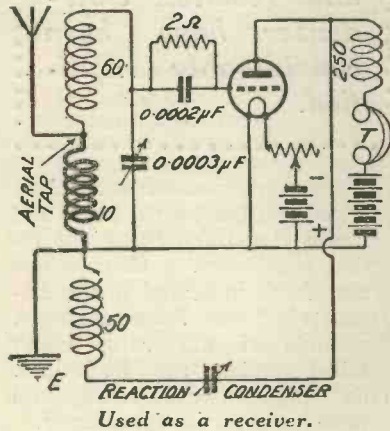

wire (to reduce H.F. resistance whilst avoiding the use of a small quantity of thick wire, such as No. 15), the junction-point being connected to the earth terminal.

The Double Turns

Then ten doubled turns are wound on over the reaction-coil in the same slot, the double wires lying one on the other. The end of both wires is connected to the aerial—"aerial-tap" point—and to the commencing end of the upper grid coil, of single No. 20 S.W.G. d.c.c. wire. Passing now to the bottom of the second slot, 40 turns are wound on in the same direction as before; then passing to the third slot, the coil is finished with 20 turns more, making 60 turns of single wire or 70 turns in all in the grid-circuit. After varnishing and well baking the finished coil, it is mounted behind the panel and below its tuning condenser, in a horizontal position and supported simply by its connecting wires (and the bottom of the box on which it lies when in place). Small No. 4 B.A. bolts and nuts are used for connections in lieu of solder.

Wiring Up

The simple wiring of the panel is carried out as shown, with No. 18 or No. 16 bare wire, a couple of short pieces of insulating sleeving being used where needed. All the components named have terminals or screws

for connections. No tapped holes are needed in the panel, the components providing their own means of fixing with plain drilled holes in the panel.

Operation

The first task is to obtain the calibrations of the wavelength scale—which, as already stated, is largely independent of aerial characteristics. If a good calibrated wavemeter is available for comparison, this is a simple task, as one only needs to place this instrument near, listen on the phones with the reaction taken to the critical point, and mark the positions on the blank scale for different wavelengths when optimum signals are heard from the wavemeter (or zero beat note with another heterodyne wavemeter).

The instrument itself will give some points with a fair degree of accuracy by first connecting up in the usual way to a good outside aerial, tuning in a recognisable station, noting the point at which this tunes, and then removing the aerial and replacing it (if necessary) by the smallest indoor aerial, which will just give an audible heterodyne note in the receiver whilst the latter is just oscillating. The zero-beat point will give very approximately the wavelength setting for no aerial

lation when three or four points are obtained from the louder stations. The range as shown is from well below 300 to over 650 metres wavelength, with a .0003 μF (actual) variable condenser, the range from 300 to 500 metres occupying about 90 degrees of the scale. As the resonance is sharp with this low-resistance coil, the tuning is extremely sharp even on telephony, so that careful searching with the aid of an extension handle is necessary. A very small movement of the A.T.C. handle causes a distant station to vanish completely. At first this may trouble those accustomed to the ordinary high-resistance fine-wire plug-in coils, with their relatively flat tuning, but it gives an unusually high degree of selectivity in return, as well as excellent signal-strength. The thoughtless "condenser twiddler" will miss even the local station on this receiver.

Results as a Single-valve Receiver

As an important feature of the receiver is the remarkable property of this type of aerial-tap-auto-transformer coupling, whereby the tuning and reaction adjustments are very nearly independent of the aerial used; this is illustrated in some detail. The

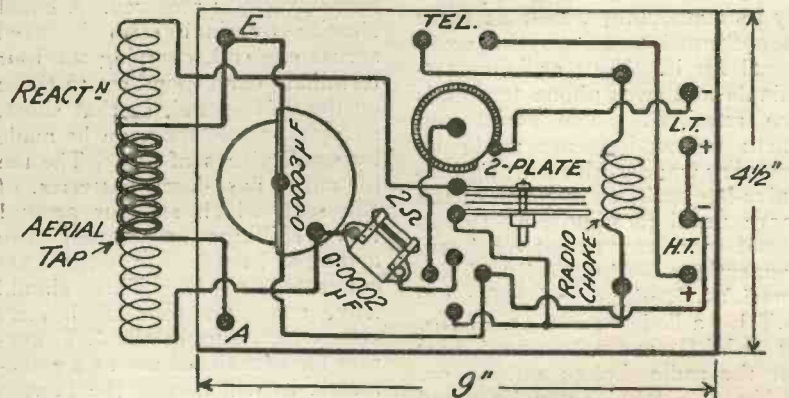

Practical wiring details.

load. A long earth-lead alone will generally suffice to bring in two or three B.B.C. stations' waves audibly enough for this purpose.

Wavelength Scale

The wavelength scale will be found to be so nearly uniform that other points can be marked off by simple arithmetic interpo-

receiver might well merit the name of "Aerial-proof."

Local Broadcast Reception

On a full P.M.G. aerial the reception of local broadcasting, with Penton R valve and 40 volts H.T. as specified, is of the loud-speaking order. With a pea-nut valve and 20 volts H.T., on a twin 40-ft. aerial the

reception was loud indeed on two pairs of phones; on switching in the low 30-ft. test-aerial (badly screened), and switching off the high twin aerial, the reception was still satisfactory, even without retuning; and only a very small movement of the condenser-handle was necessary to give good tuning. The reaction control did not need touching at all, although usually reaction which only just suffices with the big aerial will produce hopeless oscillation with the small single aerial. Actually the station could be heard uninterruptedly during the switching operations. With the R valve, on a first floor in a house 13 miles from 2LO, excellent reception was obtained, as loud as most would want in the headphones, with a small inside aerial, about 6 ft. by 8 ft., and no earth; but helped, of course (as usual in such cases) by casual aerials in the shape of electric-light wires and neighbouring aerials, etc. Without any aerial at all, merely long battery leads and the observer's body, London was readily tuned in at readable strength. Even with short leads to the battery unit on the same table, he could still be found; best when the observer touched either aerial or earth terminal with a moistened finger. Actually when *both* aerial and earth terminals were touched by the fingers of the same hand under these conditions, 2LO could still be read, and steadily, *i.e.*, not jumbled by oscillation. With no earth and an improvised aerial of twin flex carried through a doorway and along nails in the wall (an extension phone lead), excellent reception was obtained, especially when the wire was connected to one terminal and the finger was applied to the other—it did not matter much which way round.

Results on Short Aerials

In order to eliminate as far as possible the effect of casual aerials, the set was then taken into the garden and placed on the ground well away from any radio apparatus. A 10-ft. length of insulated steel cable (London Electron Co.) was attached to the aerial terminal, and thrown over a convenient bush. Another 10-ft. length of cable was attached to the earth terminal,

and spread out on the snow on the ground for an earth. With this absurd aerial equipment, badly screened, London came in at 13 miles comfortably loudly on the headphones, so that the latter could be slightly displaced from the ears without losing the drift of the transmission, in the open air. Bringing the same equipment into a ground-floor room, where the screening was much, worse, of course, London was very faint, though just readable. Upstairs, and helped by casual aerials, both Bournemouth and Birmingham gave an audible wave on the tiny indoor aerial and no earth. Accordingly, it is evident that this simple one-valve receiver is available for the reception of local broadcasting at enjoyable strength on the most indifferent of aerials, within a

selectivity of this tuning device. During one test, it happened that both Brussels (on about 405-410 metres) and the Paris Ecole (450 metres) were transmitting at the same time as the B.B.C. stations. It was actually possible to tune in in succession at readable strength, *i.e.*, steadily audible and not spoilt by incipient oscillation, every station in turn—London, Bournemouth, Newcastle, Brussels, Glasgow, Paris, Birmingham and Aberdeen — on this single-valve set, and with the Penton R valve, within one minute of time. This was made possible by the fact that the reaction is almost independent of wavelength, so that only the slightest adjustment of the former was necessary; and by the wavelength scale, which makes the picking-up of a desired

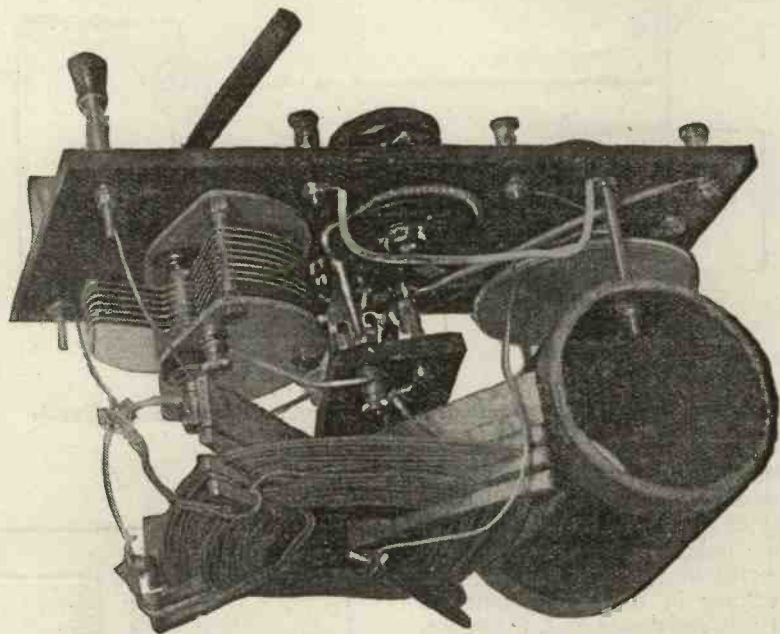

Underside of panel with all components in place.

fair distance of the transmitting station.

Selectivity

On the full outside P.M.G. aerial, the selectivity is sufficient to separate, with care, London and Bournemouth. Cardiff and Manchester are both swamped, of course, in London by 2LO, and Cardiff at least read while London is silent. From Bournemouth up, all stations can be read under favourable circumstances and on a good aerial, without interference: generally on an extremely silent background, on account of the high

station a simple mechanical operation of putting the pointer to a given figure on the scale.

Another unit containing a note-magnifier and uniform with the two units described here can be added, if desired. The H.T. and L.T. battery leads should be taken to four terminals at *both* ends of this unit, so that it can be interposed without needing lengthy connections. In this connection the effect should be tried of placing a condenser of e.g. 0.002 μ F capacity across the primary of the L.F. transformer used.

C.W. and Telephony Transmission Using Valves

No. XIII.

By JOHN SCOTT-TAGGART, F.Inst.P., A.M.I.E.E.

Modulating the Output of a Radio-frequency Generator

The first method of speaking by the aid of wireless waves involved the use of a microphone connected directly in the aerial circuit of a transmitting station. Fig. 30 shows a circuit of this kind in which a three-electrode valve is used as the radio-frequency generator. Although a particular set of connections is

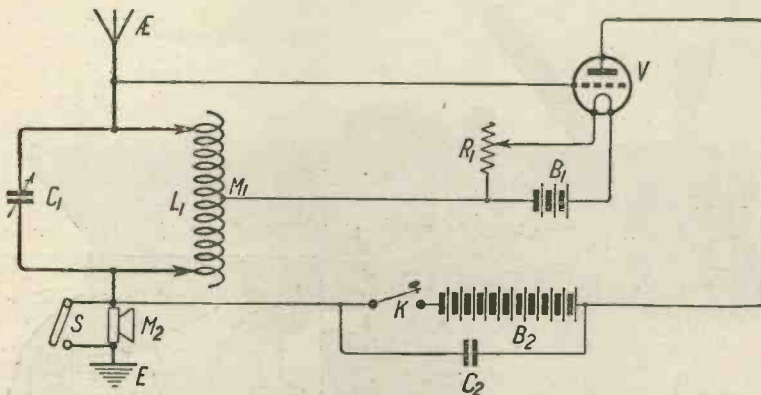

Fig. 30.—A telephone circuit using a microphone connected directly in the aerial circuit.

shown, yet any other method of producing continuous oscillations may be employed, the microphone M_2 being always connected directly in the earth-lead. By speaking in the microphone we vary its resistance and, therefore, vary the current in the aerial circuit.

Since it is convenient to be able to transmit continuous wave telegraph signals as well as speech, a key K is shown connected in series with the anode battery B_2 . When signalling in morse characters, a short-circuiting switch S across the microphone M_2 is closed; when speaking, the switch S is left open and the key K is kept down.

This use of a microphone is only of value in the case of very small powers, such as 5 watts. In the case of higher powers the microphone M_2 is not capable of handling the heavier aerial cur-

rents. The arrangement of Fig. 30 may be modified in several ways to obtain better effects. A common variation is that which employs the microphone as a shunt to an inductance coil coupled to the aerial circuit.

Another arrangement, an example of which is shown in Fig. 31, employs a microphone as a shunt across a portion of the aerial inductance. In this figure,

M . This method of modulation causes a variation in aerial current, and also varies the radiated wavelength since M is really a variable resistance in shunt to a portion of the oscillatory circuit, and the frequency of such circuit depends on the value of the resistance shunted across a portion or the whole of it.

Absorption Methods

Instead of using a microphone as a current-absorbing element, as in Fig. 31, we could use a valve, such as a three-electrode valve, and by connecting the anode and filament across the circuit from which energy is to be absorbed, could produce an effective method of modulating the radio-frequency currents.

Fig. 32 shows a circuit which has been used with great success on powers up to 15 kw. The normal current in the aerial circuit is supplied by a radio-frequency generator R.F., which may be a high-frequency alternator, arc or oscillating valve system. We are not concerned

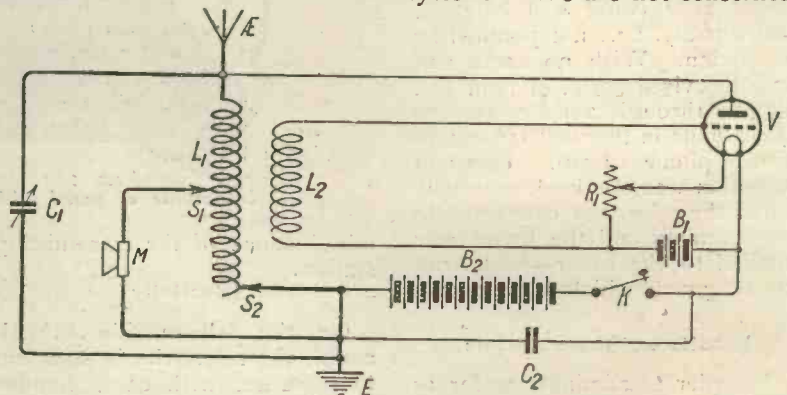

Fig. 31.—In this circuit the microphone is shunted across a portion of the aerial inductance.

we have an ordinary kind of valve transmitter, which may take any convenient form, and we connect the microphone M across a small portion of the inductance L_1 , the best results being obtained by correctly adjusting the number of turns of L_1 , which are shunted by

with how the high-frequency oscillations are produced in the aerial circuit; the generator might be connected in series with the aerial or coupled by means of an inductance coil L_1 to the aerial circuit inductance L_2 . Assuming we have

a steady oscillatory current flowing in the aerial circuit, we are concerned with a method of modulating this current, and the Fig. 32 arrangement shows the anode and filament of the three-electrode valve connected across the inductance

in the circuit T_1 , M , B_2 varies. When speaking into the microphone M , we vary the strength of current flowing through the primary T_1 of the transformer T_1 , T_2 , and so produce alternating electromotive forces across the ends of the secondary T_2 .

place from filament to anode, and the positive half cycle in L_2 will be damped out to an extent depending upon the conductivity of the valve.

When the grid is made positive by the microphone potential, the current which is "side-tracked" from L_2 through the valve, varies in accordance with the microphone potentials on the grid. If the grid is at a high positive potential, the current diverted from L_2 will be large and the energy radiated from the aerial will be small; if the positive potential on the grid, however, is small, then at that moment the diversion of current from L_2 will be small.

It will readily be seen that only the positive half-cycles of oscillating current in L_2 will be modulated, since the negative half-cycles will make the anode negative, and so produce no current through the valve; in other words, the valve will act as an insulator to the negative half-cycles.

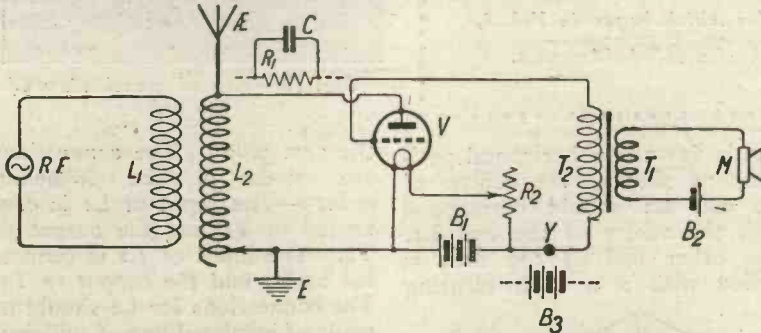
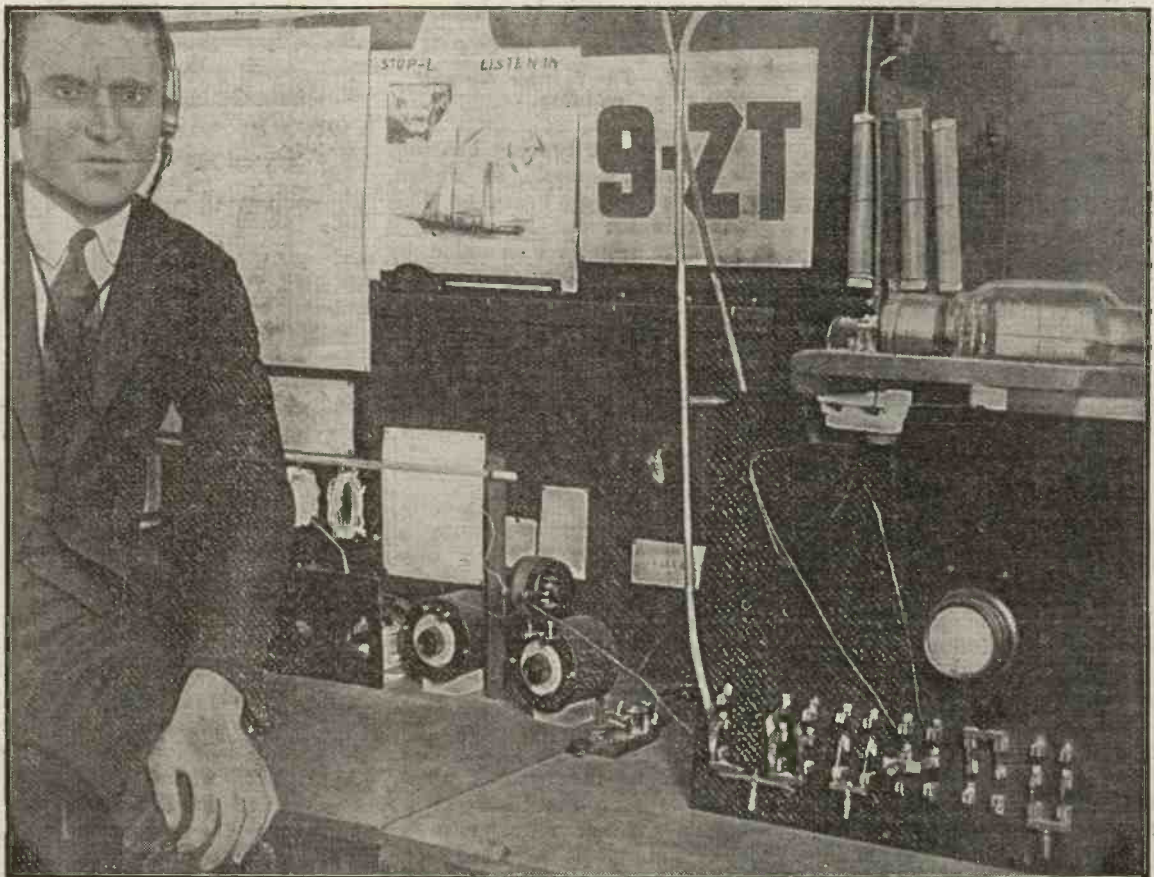

Fig. 32.—A very successful method of modulation which has been used on powers up to 15 kilowatts.

L_2 . Across the grid and filament of the valve is the secondary T_2 of a microphone transformer T_1 , T_2 . This microphone transformer enables us to obtain high voltage alternating current which varies in amplitude as the current

These varying electromotive forces are communicated to the grid, and vary the conductivity of the valve. When the anode is made positive by the positive half cycle of the oscillating current in L_2 , a flow of electrons will take

WINNER OF THE ANNUAL "HOOVER" PRIZE.



Mr. Donald G. Wallace, the American amateur who recently won the 1923 cup offered by Secretary Hoover for having the "best all-round" amateur station in the U.S. 20,000 amateur stations were eligible as contestants.

An Experimenter's Unit Receiver

By H. BRAMFORD

This, the tenth of a series of articles which began in Vol. 3, No. 9, describes the construction of a coil-holder unit.

THIS unit takes the form of a two-coil holder, adaptable to basket or spider coils, the only components required being a piece of ebonite 6 in. by 4 in. by $\frac{1}{4}$ in., two terminals, some cardboard for making the coil formers, some spare ebonite, nuts and screws, etc., and a piece of strip brass. A photograph of the complete unit is shown in Fig. 39. Those who desire to use honeycomb coils may purchase a three-coil holder, having one fixed and two moving coil sockets.

Panel Drilling

The panel is drilled to correspond with the details shown in Fig. 40. Four holes are drilled

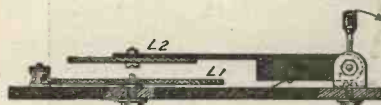
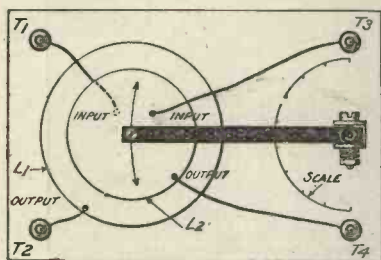

Fig. 40.—The connections.

to clear terminal screws and the remaining two holes are drilled to clear 4 B.A. screws.

Assembly

The assembly of this unit is executed in the following manner:—First mount upon the panel the terminals T1, T2, T3 and T4, as shown in Fig. 40. The extension arm which holds the coil L2 is constructed as shown in the diagram. The arm itself is made of ebonite, and a 6 B.A. nut and screw is passed through a clearance hole in the end of the arm centrally to secure L2. When the

arm is down in a horizontal position, as shown, the centre of the coil L2 should correspond with the centre of the coil L1. The other end of the arm is drilled with a 4 B.A. clearing

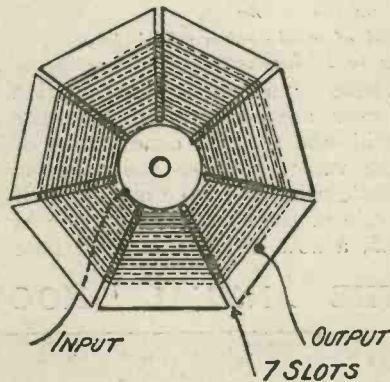

Fig. 41.—The former for coil winding.

drill to take the bracket bearing. The bracket is made, as shown, of some strip brass. This bracket is secured to the panel before the arm is assembled by means of a 4 B.A. screw and nut, and a spring washer. It is intended that the bracket should move in a radial direction. The ebonite arm is now pivoted into the bracket by means of a 4 B.A. screw, nut and spring washer,

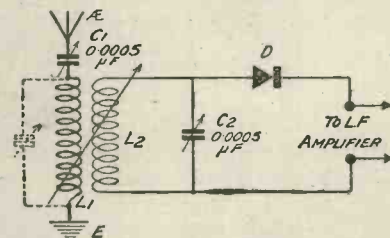

Fig. 42.—Using the unit as a loose coupler in a crystal circuit.

which act as the bracket pivot. It will be seen that the coil L2 has two distinct movements by which tuning is effected, one being a radial movement from the bracket pivot, and the other a similar radial movement from

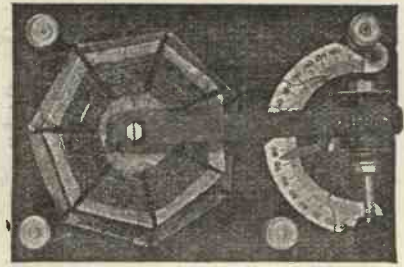

Fig. 39.—Top of panel view of the unit.

the arm pivot. The connections are made in the following order:—The input of L1 is connected to T1 and the output to T2. The input of L2 is connected to T3 and the output to T4. The connections for L2 should be made of insulated flex of sufficient length to allow for a free movement of the coil in either direction.

Coils

The method of winding the coils is shown in Fig. 41, the former being cut of cardboard. A set of six of these coils would make up a very useful combination, if made in the following order:—

- Coil 1, 25 turns, No. 22 S.W.G. d.c.c.
- Coil 2, 35 turns, No. 22 S.W.G. d.c.c.
- Coil 3, 45 turns, No. 24 S.W.G. d.c.c.
- Coil 4, 50 turns, No. 26 S.W.G. d.c.c.
- Coil 5, 75 turns, No. 28 S.W.G. d.c.c.
- Coil 6, 100 turns, No. 30 S.W.G. d.c.c.

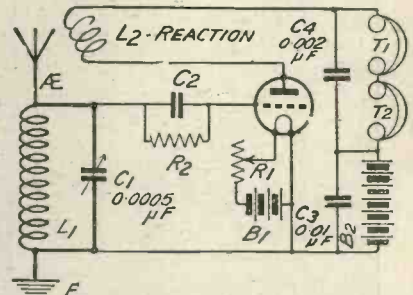

Fig. 43.—A single-valve circuit using the unit for obtaining reaction.

- Coil 3, 45 turns, No. 24 S.W.G. d.c.c.
- Coil 4, 50 turns, No. 26 S.W.G. d.c.c.
- Coil 5, 75 turns, No. 28 S.W.G. d.c.c.
- Coil 6, 100 turns, No. 30 S.W.G. d.c.c.

Operation

A circuit describing the use of this unit is given in Fig. 43. A further method of using it is depicted in Fig. 42. L1 is connected to the aerial on one side, and to the earth on the other. L2 is connected to the detector and 'phones, and is tuned by C2.

The Use of Variometers in Wireless Receiving Circuits

By HERBERT K. SIMPSON.

A non-technical description of a very popular method of tuning, of interest to the beginner.

WHEN it is desirable to have a continuously variable inductance to cover a certain range of wavelengths, an instrument, called a variometer, is used. The principle of

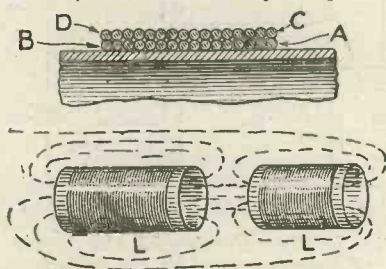

Fig. 1.—Illustrating the principles involved.

this instrument is, that there are two coils, one of which is capable of rotation with respect to the other, the magnetic field of one coil thus assisting or opposing that of the other coil.

The former upon which the fixed coil is wound is termed the "stator," and that upon which the moving coil is wound, the "rotor."

There are many forms of variometer in use in radio receiving circuits, but perhaps the type most frequently encountered is that in which both stator and rotor are cardboard tubes, the inside one being of such a size that it can easily turn within the outer. This is by no means the most efficient type, owing to the fact that the windings are, of necessity, at some distance from each other. The windings may be brought much closer together by winding the coils upon portions of spheres, the type employing this form of winding being undoubtedly the best.

In order that the action of a variometer may be clearly understood, let us consider a two-layer coil such as that shown in Fig. 1. For the purpose of simplifying our explanation, we will consider that the turns are of very thin wire, so that the mean diameter of each of the two windings may

be considered to be the same. Thus, the inductance of each coil is the same. Join the ends C and B, so that we have a straightforward two-layer coil. The total inductance is now four times that of either winding by itself. Now disconnect C and B, and join A to C, so that B and D are free ends. We now have what is known as a non-inductive winding, such as is used for winding coils in resistance boxes, where coils having as little inductance as possible are required.

Thus we see that when the two coils are joined so as to help one another, we have the effect of a much larger coil, whereas if the coils are in opposition, the total inductance approaches zero.

Let us suppose we have two cylindrical coils, connected in series, as in Fig. 1, and further,

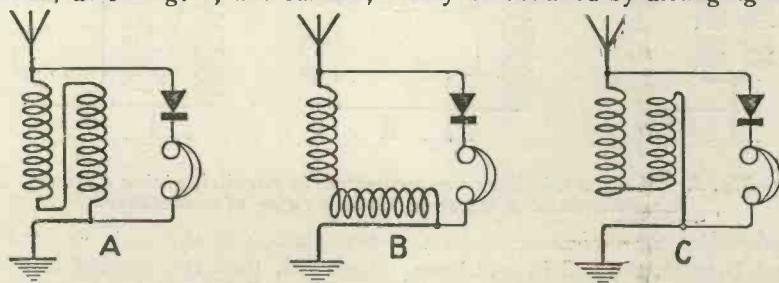

Fig. 2.—A variometer with the windings connected in series; A, maximum; C, minimum.

let us suppose these coils have exactly the same inductance.

A current flowing through the coils would produce magnetic fields, as shown, when the coils are far apart. There is very little linkage between the two fields, and consequently the effective inductance is approximately the sum of the inductances of the two coils. If the coils are brought nearer to one another, the magnetic fields tend to link up, or combine together, and thus increasing the effective inductance. This effect between two coils is known as mutual induction, and is expressed in the same units as inductance, i.e., henries, or parts of a henry. The amount

of mutual inductance between any two coils depends upon the distance between the coils, the inductance of each, and the material separating them. The mutual inductance is a maximum when both windings are close together and in the same direction, decreases as the distance between the coils is increased, reaching its minimum when the coils are opposing one another.

Thus, the inductance of a variometer, with the windings connected in series, is given by

$$L = L_1 + L_2 \pm 2M.$$

where L_1 and L_2 are the inductance values of the two coils, and M is the mutual inductance between them. M is either + or - according to whether the coils assist or oppose one another.

Greater variation of inductance may be obtained by arranging to

connect the coils in series or parallel at will, as a lower minimum, and, of course, a lower maximum value, of inductance is obtained when the two windings are connected in parallel.

A very important point which

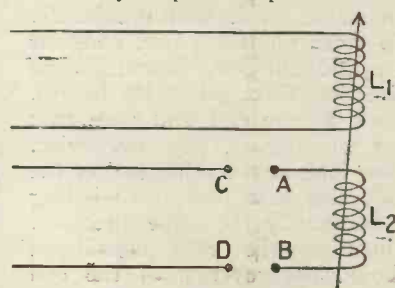

Fig. 3.—The effect of reversing one coil.

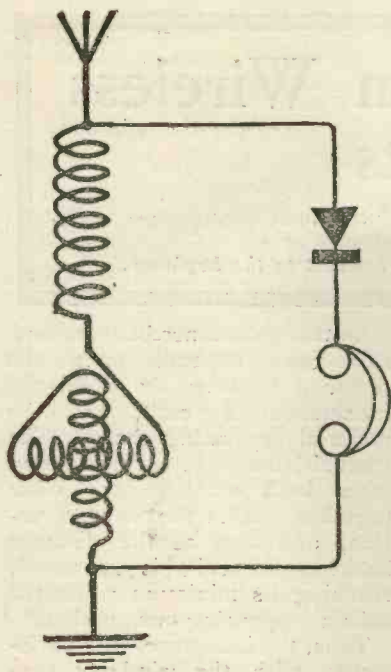

Fig. 4.—How to use a loading coil in conjunction with a variometer.

must be grasped is, that if we have two coils L_1 and L_2 , as in Fig. 3 (the leads to L_2 being

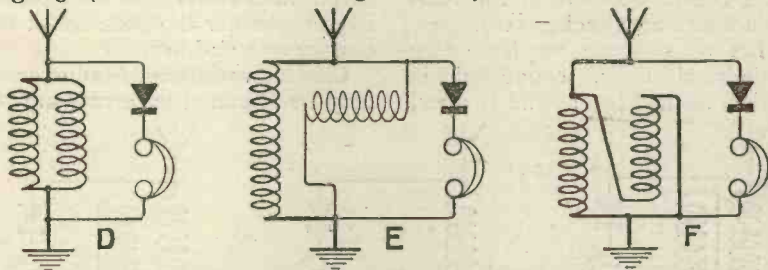

Fig. 5.—The two windings are connected in parallel, giving a lower maximum and a lower minimum value of inductance.

reversible), and connect A to C and B to D, the coil L_2 will have a certain definite direction with regard to L_1 . Now disconnect AC and BD, turn the coil through 180° , and join B and C, A and D, which will be respectively opposite. It may seem strange at first to some, but it is to be noted that the direction of the field produced by the coil is exactly the same as it was previously. To clear up this point, consider a cylindrical coil, wound in one direction throughout its length. Look at one end and note that the winding is, say, clockwise. Now look at the other end of the coil, and note that the winding is in exactly the same direction. Thus, in the case considered above, the reversal of the coil has no effect whatever upon the direction of the magnetic field.

In a variometer (and also, incidentally, in the case of a reaction coil), therefore, the only action which takes place upon turning the rotor through 180° , is a reversal of the connections to the ends of the rotor winding, the direction of the winding itself remaining unchanged.

Having grasped the action of a variometer, we will consider its application to receiving circuits.

In Fig. 2 are seen three diagrams of a variometer applied to a simple crystal receiver. A shows the two coils assisting each other, the inductance value, and consequently the wavelength to which the circuit will tune, being a maximum. At B, the coils are as far apart as possible, that is, with their planes at 90° ; in this position the mutual inductance is a minimum, and the total inductance value is the sum of the separate values of the two coils.

At C, we have the position of opposition between the magnetic fields of the two coils. The relative positions of the two coils are exactly the same as at A, but the

connections to the ends are now reversed, thus the current in the moving coil flows the reverse way

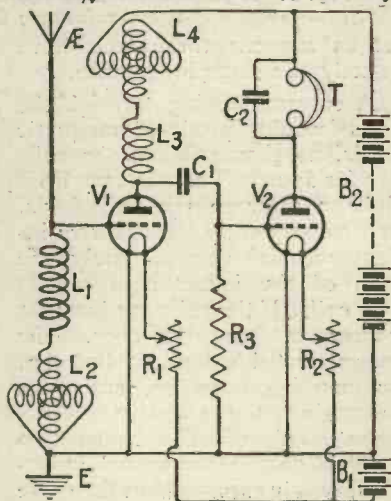

Fig. 6.—Showing how a variometer may be used for tuned anode coupling.

to A, giving us, in this case, the position of minimum inductance.

In Fig. 5 the two coils are joined in parallel. D shows the two coils arranged so that their magnetic fields assist one another, this being the position of maximum inductance with the coils in parallel. This maximum value is somewhat higher than the minimum value obtainable with the coils connected in series, hence there is a certain amount of overlap, and, if provision is

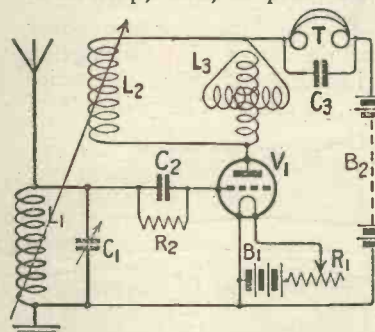

Fig. 7.—By adjusting L_3 , the degree of reaction may be controlled.

made to connect the coils in series or parallel, a continuously variable inductance is obtained from the minimum in parallel, Fig. 5 F, to the maximum when coils are in series, Fig. 2 A.

The wavelength of a variometer-tuned circuit may be increased by the addition of a "loading-coil." This is simply an inductance, which may conveniently be a plug-in coil, connected in series with the variometer windings. A diagram showing how a loading coil is used with a variometer-tuned crystal set is seen in Fig. 4. The loading coil may be short-circuited when not required.

The tuned anode method of coupling high-frequency amplifying valves is very popular, and a variometer may be used with advantage in this position, thus obviating the use of a variable condenser.

A circuit showing this is given in Fig. 6, in which L_1 is a loading coil and L_2 a variometer, in the aerial circuit, while L_3 and L_4 perform the same respective functions in the anode circuit. Thus in each circuit we have the means of varying the wavelength within the limits of parallel and series connection of the windings of the variometers, while the loading coils will govern the minimum wavelength to which the circuit will tune.

Mounting Valves in Portable Sets

WITH the coming of spring many amateurs will turn their attention to making up portable sets suitable for taking to picnic parties or on holiday trips. One of the difficulties about the portable set is that owing to the jolting which it has to endure the valves which form part of it not infrequently become casualties through broken filaments. The wise man removes the valves before starting and places them in carrying boxes; but even this is not a perfect method of preventing accidents, for the valve must submit to a jerk when it is pulled out of a tight holder, and if this happens frequently the filament may be damaged during removal. Again, unless the carrying box is very carefully designed it may not give the valve very much protection from jolts and jars.

The writer has found the method illustrated in the drawing very satisfactory as a valve preserver for travelling sets. For each valve a little wooden box about 5 in. high by 3 in. wide

and 3 in. deep, with an ebonite bottom, is provided. The valve-holder consists of a $2\frac{1}{2}$ in. square of $\frac{1}{4}$ in. ebonite to which are attached near the corners four small coil springs. These springs, besides supporting the valve holder, also form the contacts, being attached to brass strips on the underside of the ebonite, which run to the shanks of the valve legs. Fixed to the top of the box is another coil spring of rather larger size whose end rests on the top of the valve.

It will be seen that any shocks are taken up by the springs, and that the valve itself is protected from them. The springs must not be too hard, but at the same time they must be strong enough to support the valve properly and not to allow it to come into contact with either the top or the bottom of the box when a jolt occurs. Those who are familiar with the Army pattern of heterodyne wavemeters will remember that a similar mounting (though without the spring at the top of the valve) is used in it. When

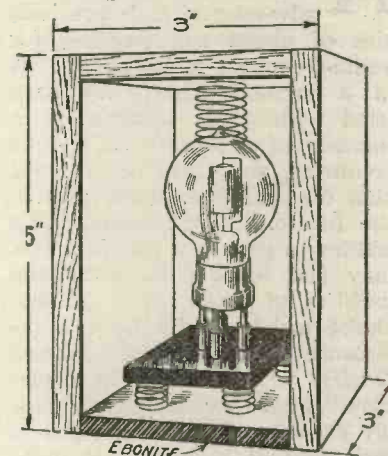

A safety holder for portable sets.

for valves in sets which may be fairly roughly handled at times. The spring method is also quite useful on sets of the non-portable type for reducing the noises that occur when valves of a markedly microphonic type are used.
R. W. H.

IF your low-frequency transformers are not quite up to the mark, reception may be rather strident at times owing to their tendency to over-emphasise certain frequencies. This makes the set very unpleasant to listen to, especially if it is used for loud-speaker work. A simple method of improving matters is shown in the diagram. It will be seen that

has the effect of flattening the tuning and therefore allows the transformer to respond more evenly to a wide range of audio-frequencies.

The value of the resistance

Improving the Tone

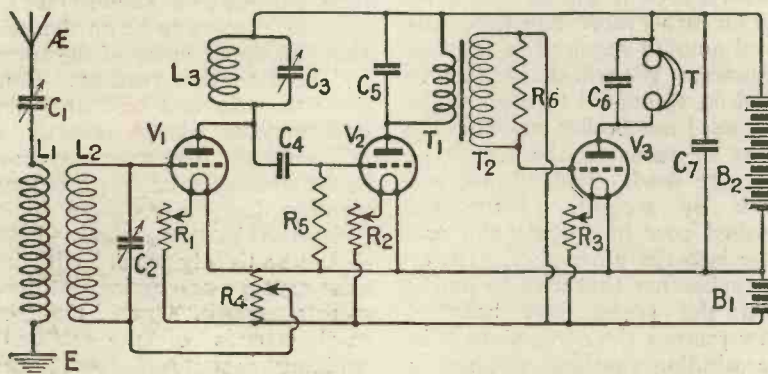

The shunt resistance R6 will often improve the tone of a L.F. stage.

the secondary of the low-frequency intervalve transformer is shunted by a resistance. This

which will give the best results will depend upon the transformer itself; but, as a rule, one of

70,000 or 80,000 ohms will be found quite satisfactory. Such a resistance can be made quite easily by soaking a match-stick in Indian ink and fixing a metal clip tightly to each end. If 4 B.A. clearance holes are drilled in the tags of the clips the arrangement can be fixed to the secondary terminals of the transformer. Though this simple resistance will work quite well it is not intended to be used as a permanent fixture. It is meant that the experimenter should use it to see whether shunting the secondaries of his transformers in the way described has a good effect upon his reception. If it has not then there is no need to bother further. But if results are better a more workmanlike resistance can be made up by any of the methods that have been described in the columns of *Wireless Weekly*.

R. W. H.

A Home-made 1,000 ohm Choke

A GOOD deal has been written lately upon the advantages and possibilities of choke coil coupling for audio-frequency amplification. It is a method which has been used with great success by a number of designers in various countries, and there is no doubt that we shall hear more of it in the future. The amateur who wishes to give it a practical test may find himself faced by the problem of procuring a suitable choke which should have a resistance of about 1,000 ohms. Dealers who specialise in "surplus" goods can frequently supply ex-Army chokes wound to a resistance of 500 ohms at quite moderate prices, and it is possible to use two of these in series in certain circuits. As a makeshift one can use one of the receivers of a pair of 2,000 ohm 'phones. This will answer quite well, but one does not always wish to risk a good pair of telephones in this way. A very

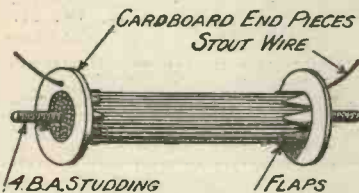

Fig. 1.—Illustrating the method of mounting the end pieces.

satisfactory 1,000 ohm choke can be made up at home at quite small cost. Here are the constructional details.

Obtain a supply of the best quality thin soft iron wire and cut sufficient 2-in. lengths to make a bundle $\frac{1}{2}$ in. in diameter. In the middle of this place a 3-in. length of 4 B.A. studding, arranging it so that $\frac{1}{2}$ in. protrudes beyond the wires at each end of the bundle, as shown in Fig. 1. Bind the whole together tightly with strong thread and give it a coating of shellac. Now cut out two discs of stout cardboard $1\frac{1}{2}$ in. in diameter. Mark out a $\frac{1}{2}$ -in. circle in the middle of each of these, as shown in Fig. 2, and cut along the dotted lines with a sharp knife, afterwards bending up the triangular pieces of card-

board so as to form flaps. Push one of these discs over each end of the bundle of wires (see Fig. 1). Pierce a small hole in each and through these pass short lengths of fairly stout insulated wire, as shown in the drawing. Now bind the whole bundle with two layers of insulating tape, put on as tightly as possible. This binding will fix the card-

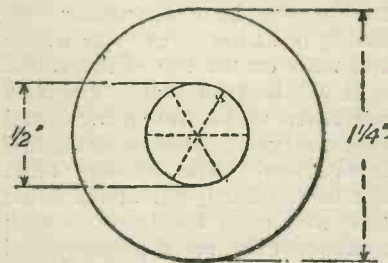

Fig. 2.—Constructional details of the cardboard end pieces.

board end pieces firmly in position and will also secure the pieces of stout wire, whose ends must be brought up between the layers of tape and bared. The core is now ready for winding. The $\frac{1}{2}$ in. ends of 4 B.A. studding will enable it to be mounted readily in an improvised winding machine, such as can be made up very simply from Meccano parts.

The windings will consist of No. 40 S.W.G. double silk-covered copper wire, which retails at about half-a-crown an ounce. This wire has an approximate resistance of 6,350 ohms per pound, or roughly 395 ohms per ounce. As it varies a little it will be as well to put on rather more than the calculated amount required in the first instance. We will decide then to wind on $2\frac{3}{4}$ ounces to begin with. We need not bother to count the turns or measure the length of the wire used. Instead, we will work by weight. Place the finished core in a scale pan and pour into the other shot, salt, or any substance that may be handy until the scales just balance. Now remove the core, place it in the winding machine and solder the end of the thin wire to the bared end of one of the stout lengths of wire which we passed through the end-pieces. Wind the wire on as evenly and as tightly

as possible until the windings have reached a depth of about one-third of an inch. At this point make fast the wire with a rubber band, remove the choke from the winder and place it in the empty scale pan. How are we going to obtain weights equivalent to $2\frac{3}{4}$ ounces? Not everyone knows that three unworn pennies weigh exactly an ounce. If, therefore, we add eight pennies to the pan containing the original weighting material, the choke will have been wound to about the right size when the two pans exactly balance. If a resistance of approximately 1,000 ohms is all that is required, the end of the windings may now be soldered to the second stout wire. If, however, it is desired to obtain a choke whose resistance is exactly 1,000 ohms, tests and adjustments should be made before the soldering is done.

For this we shall require a battery whose exact voltage is known and a milliammeter. Wire the battery and the milliammeter in series with the choke

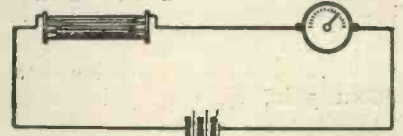

Fig. 3.—Method of finding resistance of choke.

and take the reading. By Ohm's Law a resistance of 1,000 ohms will allow one volt to drive one milliampere through it. If we are using a 6-volt accumulator we shall probably find that when first tested the reading is rather less than 6 milliamperes, since we have put on a little more wire than calculations showed to be necessary, so as to be on the safe side. Strip off some of the turns and take another reading. Continue to strip and test until the milliammeter shows exactly 6 milliamperes. The wire may now be cut and soldered as previously mentioned.

After this, the whole choke should be tightly wound with insulating tape or empire cloth, so as to protect it. One of the protruding ends of the 4 B.A. studding is cut off short; the other is left and is provided with two terminal nuts, so that when desired the core of the choke may be earthed without difficulty.

R. W. H.

A Simple Tuning Stand

At one time the 3-coil stand was very popular indeed; in fact on valve sets it was almost universal. The idea was that one coil should be the primary, the middle one the secondary, and the third the reaction. The coupling between primary and secondary inductances was first adjusted, then the reaction, nominally coupled to the secondary, was brought up. As has already been pointed out, the great drawback to this type of holder is that there is a mutual coupling between all three coils, so that a set to which it is fitted is exceedingly difficult to handle owing to its proneness to fall

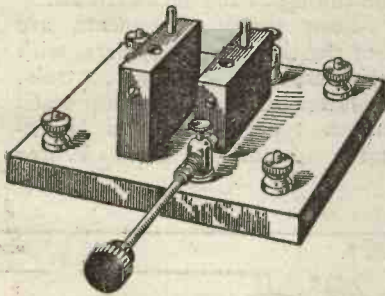

Fig. 1.—The completed stand.

into self oscillation. It is far better therefore to use a 2-coil holder, "splitting" the secondary into two and coupling one part of it to the primary and the other to the reaction. This necessitates the use of a pair of double-coil stands, which should be mounted at right-angles to one another so that there may be no interaction between the inductances which they support.

The very simple double-coil stand described below, will be found most useful either by those who are about to make sets or by those who desire to convert receivers fitted with triple stands to a type which is much easier to operate.

Fig. 1 shows the complete stand, which consists as will be seen, of two holders, one of which is fixed, whilst the other may be revolved to an angle of 90 degrees; mounted upon a small ebonite base, upon which are 4 terminals for the necessary connections. If desired this stand may be made up directly

on to the panels of the set without any intermediate base. The holders (Fig. 2) are made from two pieces of $\frac{1}{2}$ -in. ebonite $1\frac{1}{2}$ ins.

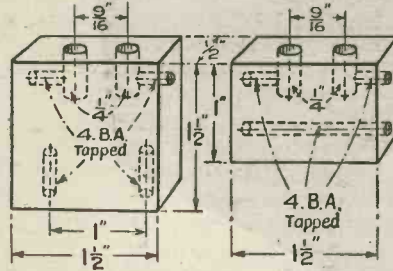

Fig. 2.—Details of the holders.

in width. The fixed one is $1\frac{1}{2}$ ins. in height, the moving one 1 in. In each are mounted one plug and one socket $\frac{9}{16}$ -in. apart from centre to centre to take the standard honeycomb or duolateral coils. Plugs and sockets may be obtained from advertisers in this journal for a very small figure. Their shanks will be found to be a good tight fit for the $\frac{1}{4}$ -in. holes bored to receive them. They are firmly fixed by two screws driven into them from the edges of the ebonite, these screws also serving as connections for the necessary leads.

The moving holder is fixed to the base by means of a pair of countersunk screws driven upwards from below. Fig. 3 shows the way in which the moving holder is mounted. Two terminals are fixed to the base 2 ins. apart. These terminals are of the "push in" or telephone type. A length of 4 B.A. screwed rod is passed through one of the terminals and screwed through the hole running from edge to edge of the moving holder until its far end passes through the second terminal and protrudes $\frac{1}{2}$ -in. beyond it. A lock nut and a washer are placed upon either side of the holder, as shown. On the outside of each terminal are placed a flat washer, a spring washer, a second flat washer, a nut and a lock nut. By means of the nuts the pressure of the spring washer is adjusted until the holder is able to be turned quite easily but will remain in any position once it has

been put there. The long end of the screwed rod may be of any desired length. It should be provided with a small ebonite knob with a 4 B.A. thread, such as can be purchased from advertisers at 3d. per piece. The knob is secured by means of a lock nut tightened hard against it.

The setscrews of the terminals will normally be so adjusted that they are quite slack and exert no pressure at all upon the rod. They can, however, be employed very usefully. If a particularly fine adjustment has been found after considerable labour the moving coil can be locked in position by simply turning these setscrews tightly down.

If the tuning-stand device is meant to stand alone it must be mounted upon a sub-base of wood of slightly larger size, in which recesses are made with a $\frac{1}{2}$ -in. auger bit to clear the nuts and shanks of the terminals. In spite of its small cost, and the use of which it can be made, this

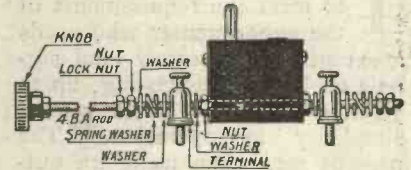

Fig. 3.—Illustrating the method of mounting the moving holder.

little coil stand will be found most satisfactory to work with. Those who are fortunate enough to possess a lathe can, of course, improve upon it by turning up special pillars to replace the telephone terminals which act as bearings for the spindle of the moving holder.

R. W. H.

Lettering Panels

SIR,—The lettering of ebonite panels, particularly those for the "Omni" receiver, can be easily and effectively done by the use of a hard steel pen and white ink. This commodity is waterproof, and is used particularly by draftsmen. It dries quickly, and "clings" very well to ebonite, and if carefully carried out makes a very effective finish.—Yours faithfully,

H. S. HENLEY.
Sydenham, S.E.

All the B.B.C. Loud S

A description of the type

By HERBERT

Readers should study the Editor's test re

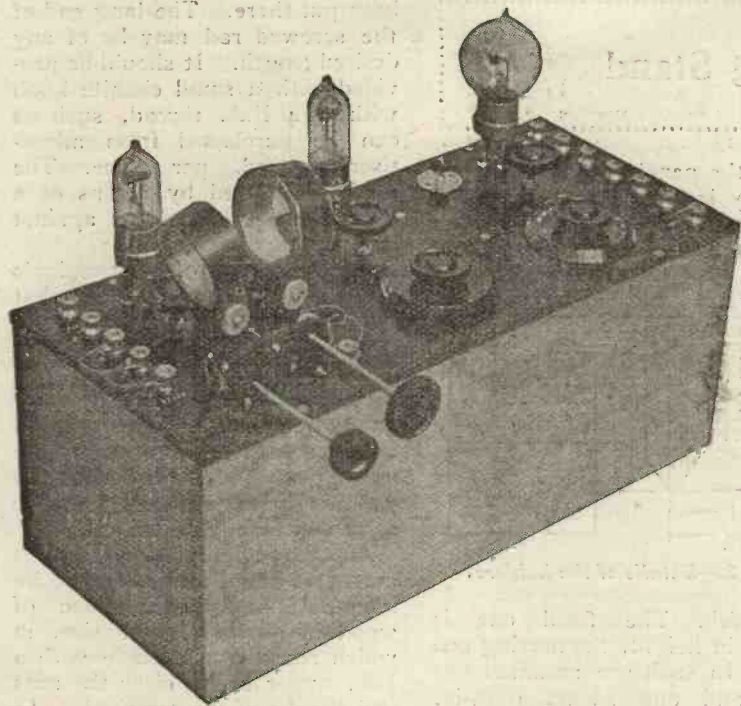

Fig. 1.—Note the method of varying the reaction.

THIS set has been designed to meet the requirements of the experimenter who needs a set giving extremely loud signals on local broadcasting, up to 30 miles, which is of the utmost simplicity in operation. The present set, when using an outside aerial, gives sufficient signal strength to operate a loud-speaker in a large room, and may even be found overpowering up to 15 miles from the local station. At greater distances the loud-speaker is comfortably strong, up to about 30 miles. Good headphone signals may be received at greater distances.

At 9-10 miles from London excellent loud-speaker signals have been received using a short wire connected to the aerial terminal, using the usual earth connection.

The set, which is seen in Fig. 1, is mounted in a mahogany box, which may be polished if the constructor has the necessary ability.

It will be seen that the set is simple from the point of view of controls. The terminals on the left are the aerial and earth circuit connections, by means of which various arrangements are possible.

Next these terminals the two-coil holder is to be seen, which is of the Cam-Vernier type made by the Goswell Engineering Co.,

Ltd. To the right of the coil-holder are two terminals, marked "Reaction," by means of which

the reaction coil may be reversed. Connection is made from these two terminals to the coil socket by rubber-covered flexible leads, terminating in spade terminals.

Next these two terminals are seen two condensers, the left-hand one being the 0.0005 μ F aerial tuning condenser, while the other is a 0.00005 μ F single-plate vernier, which permits of fine tuning of the aerial circuit.

Above these components are seen the three valve-holders, with their respective filament controls, the latter being of the compressed carbon type, known as Microstats, obtainable from Wates

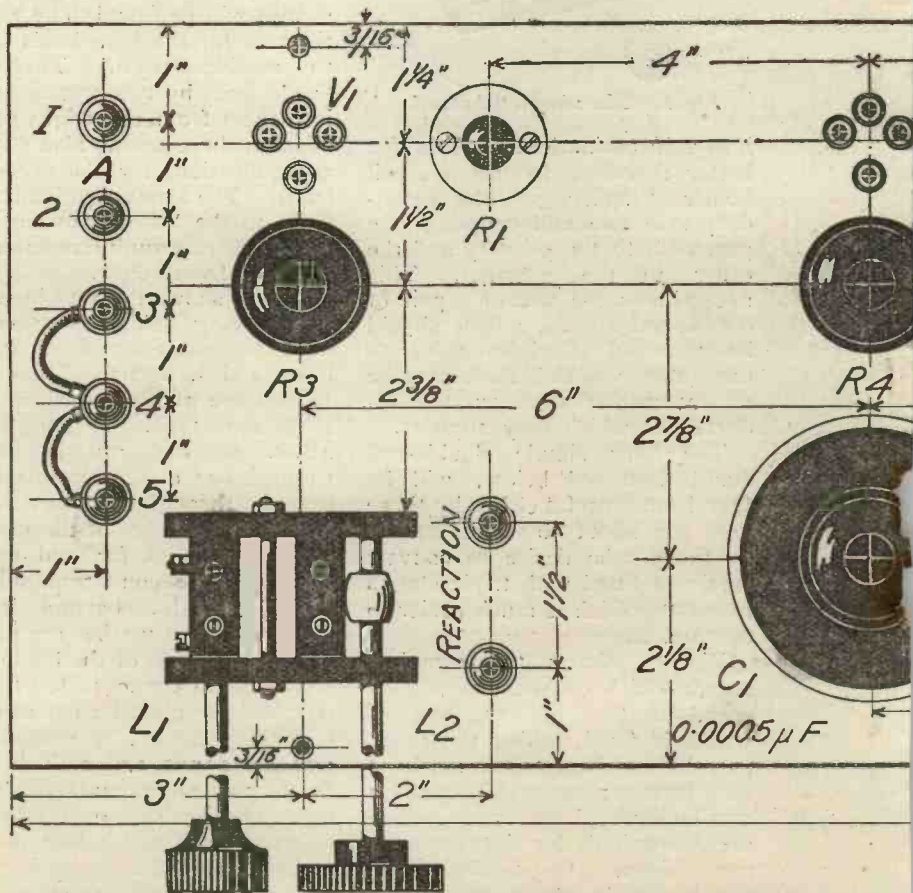

Fig. 3.—The top of the panel: this is exactly half-size, so that all distances take

Stations on a speaker

the W4 three valve set
K. SIMPSON.

Report on this set appearing on page 597

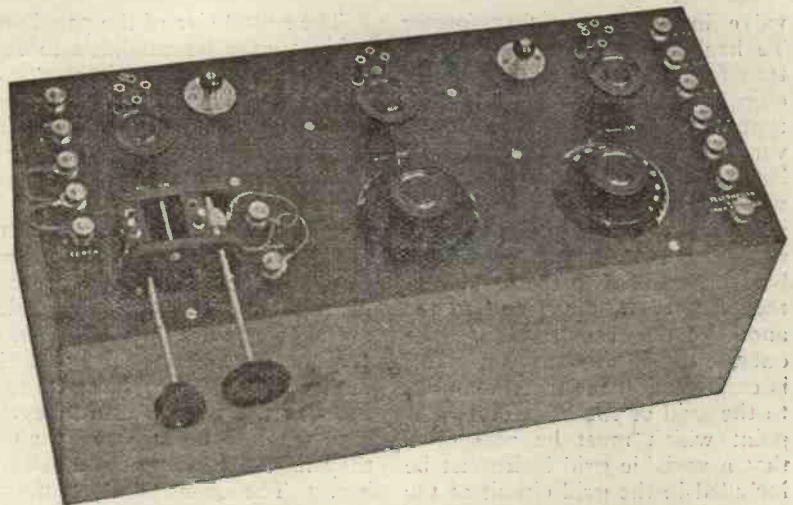

Fig. 2.—The method of reversing the reaction coil is clearly seen.*

Bros., Great Queen Street, W.C.2. The use of this type of resistance permits either bright or dull emitter valves to be employed without any change in the set being rendered necessary. Lissenstats are also to be recommended, and have special advantages of their own. The terminals on the right-hand side of the instrument are those for the batteries, the bottom pair being those to which the telephones or loud-speaker is connected.

The Watmel grid leaks are seen at the back of the instrument, between the valve-holders. The circuit diagram of the receiver will be seen in Fig. 4.

C1 is the aerial tuning condenser, and C2 is the vernier. Constant aerial tuning may be applied by including in the aerial circuit the 0.0001 μ F fixed condenser CA. This is done by joining the aerial to terminal 1. L1 is the aerial tuning inductance, which is the left-hand coil in the two-coil holder. L2 being the reaction coil.

Aerial Circuit

It will be seen that several types of aerial circuit tuning are possible, e.g., constant aerial tuning, with parallel condensers, series condensers with no constant aerial tuning, frame aerial, and so on, and a list is given of the connections which have to be on the grid of the valve.

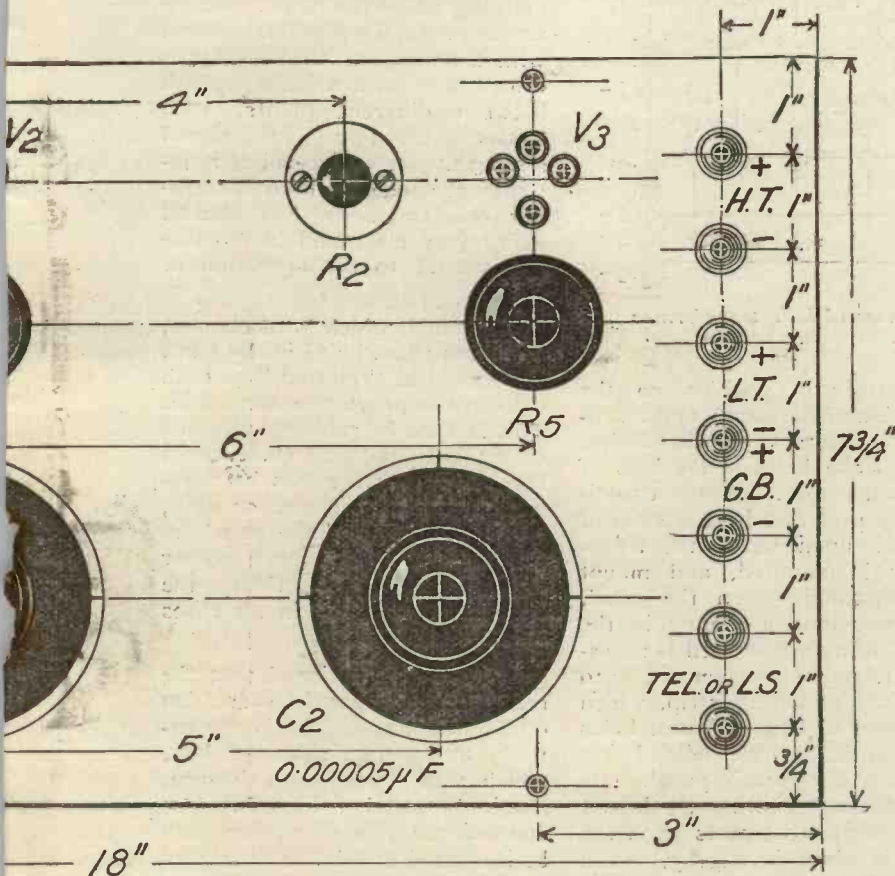

	Aerial.	Earth.	Other Connections.
Const.-Aerial tuning: (Parll. Condenser)	1	5	3 to 4 and 4 to 5.
Parallel Aerial Condenser. No C. A. T.	2	5	3 to 4 and 4 to 5.
Series variable Condenser.	4	5	3 to 5

For a frame serial, the frame is connected across terminals 2 and 3, while 3, 4 and 5 are joined together. This places the inductance L1 and condensers C1 and C2 in parallel with the windings of the frame aerial. If it is desired to use the frame alone, tuning it with the condensers, all that is necessary is to pull the coil L1 from its socket. The windings of the frame aerial are now directly across the grid and filament of the valve. If it is desired to have the inductance in series with the frame aerial, the usual arrangement, the ends of the frame are connected across 3 and 5, 4 being joined to 5.

Transformer Connection

It will be seen that a new method of connecting the inter-

* Mark off with a pair of dividers should be doubled before marking off on the panel.

valve low-frequency transformer T₂ has been incorporated. This transformer, which is a "Pow-quip," with a ratio of 2 to 1 (a type of transformer I have found very effective for all purposes), has the inside of the secondary winding connected to a condenser, C₅, of 0.002 μF capacity, the other side of this condenser being connected to the outside of the primary winding, and to the anode of the second valve. The outside of the secondary winding is connected in the usual manner, to the grid of the last valve. A point which must be noticed is that a variable grid leak must be included in the grid circuit of the last valve, as shown, to prevent a negative charge accumulating on the grid of the valve.

By connecting the transformers

The actual size of the panel and cabinet may be modified to suit the reader's own requirements.

It is, of course, not essential that the components should be of the make specified, and other reliable parts will be quite satisfactory: but care must be taken in drilling the panel, that the holes are the requisite size for the components. It must be pointed out in this connection that no holes are shown in the drilling diagram for the transformers, as it is realised that the same transformers will not be used in every case, and if holes were shown, they might easily prove misleading. The constructor is, therefore, left to drill his panel in accordance with the requirements of the transformers he is using. This is easily done by placing the

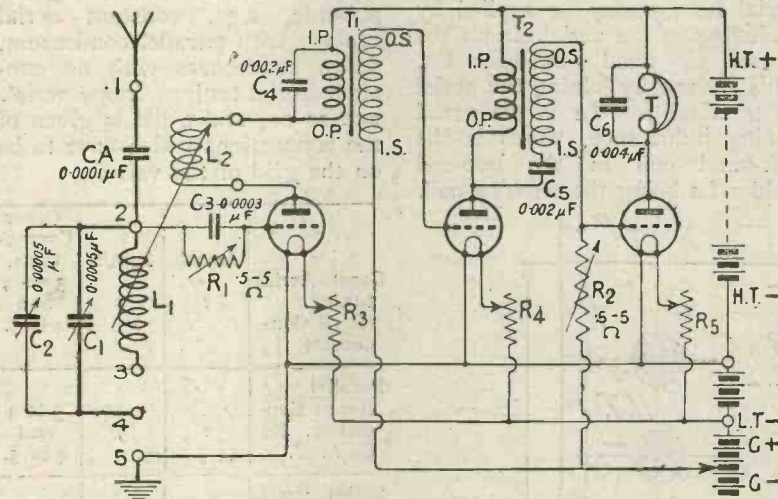

Fig. 4.—The unusual connections of the second L.F. transformer are shown above.

in this manner, slightly better results are obtainable than with the more conventional connections, and very much purer reproduction was obtained than with both transformers connected in the ordinary manner. It is not suggested that this form of circuit is better in all cases. Much depends upon the types of transformers working in harness.

A grid battery is included, and terminals for this are provided, but should the battery not be used at any time, the terminal G.B.—must be connected to L.T.—by an external short link.

A list of the components required is found very useful by readers, and the price list forms a useful guide as to the cost of the instrument.

transformer in position on the underside of the panel, and marking the centres of the holes, through the holes in the legs of the transformer. Some experimenters prefer to have a strip of ebonite, upon which the transformer is mounted, and mount this separately upon the panel. If at any time a change in the type of transformer used is necessary, the only alteration will be to the small mounting strip, which may need to have different holes drilled in it, no fresh holes being necessary in the main panel.

A drawing showing the layout of the component parts upon the panel is given in Fig. 3, which makes all details very clear. This drawing is also fully dimensioned, so that it may be used as a drill-

List of Components

Component.	£	s.	d.
Panel 18 in. × 7½ in. × ¼ in.	0	5	6
One 0.0005 μF variable condenser (Jackson Bros.)	0	7	0
One 0.0005 μF Variable Condenser (Jackson Bros.)	0	4	6
1 Two-coil holder (Goswell Eng. Co., Ltd.)	0	7	6
3 Microstat Filament resistances	0	8	3
1 Powquip 2/1 L.F. Transformer	0	18	0
1 Igranic shrouded L.F. Transformer	1	1	0
2 Watmel 0.5—5 megohm Grid Leaks	0	5	0
14 4B.A. W.O. type terminals at 2d. each	0	2	4
12 Valve Sockets, with two Nuts, at 2d. each	0	2	0
Dubilier Condensers:			
One 0.0001	0	2	6
One 0.0003	0	2	6
Two 0.002	0	6	0
One 0.004	0	3	0
Box (home-made)	0	4	6
Wire, covering, screws	0	1	6
Total	£5	1	1

ing diagram. It is exactly half-size, so that all measurements taken off it with a pair of dividers must be doubled before marking off on the panel. On no account must the panel be marked with a pencil, as the lines thus drawn will form a leakage path between different points, with consequent loss in signal strength. A sharp-pointed instrument should be used in marking out, the lines thus formed being very clear and in no wise detrimental to the operation of the set.

The panel, which is of ebonite, measures 18 in. by 7½ in. by ¼ in., and should be "matted" on both sides, to improve the insulation. This is done by rubbing with fine emery cloth until all evidence of the glossy surface has been removed. The surface, or skin, which is taken off the panel by this means, is of a much poorer insulating quality than the ebonite, and should in all cases be removed.

It may be mentioned that the reason why the panel has such an odd dimension as 7½ in. is due entirely to the fact that the box, which was already in existence, required a panel of this size. For convenience this dimension may be increased to 8 in. or decreased to 7½ in. by respectively adding or subtracting ½ in. to or from each side of the panel. To make this

clear, do not take the whole $\frac{1}{4}$ in. off one side, otherwise some of the components may foul the box, whereas if only $\frac{1}{8}$ in. were taken off, this would not occur.

The necessary holes should be drilled in the panel, after having decided the sizes of holes required by the various components. To do this, first mark all the holes

$\frac{1}{8}$ in. in diameter, and drill these. Then change the drill to the next size required, and make all the holes of this size. In this way considerable time is saved, and the task of drilling the panel becomes extremely simple.

The parts may then be mounted upon the panel in their respective positions. The writer finds that

the simplest way of assembling the parts is to mount up the smallest and lightest parts first, leaving the heavier components, such as transformers, until the last. The panel thus does not become so awkward to handle in the early stages of the proceedings.

(To be concluded.)

Editorial Test Report on the Type W4 Receiver

THIS particular instrument was handed over to me on April 2, and during the evening I carried out innumerable tests which gave surprisingly good results. I expected to receive loud signals from the local broadcasting station, some 10 or 12 miles away, but was agreeably surprised to find that the set was equally successful on distant stations, and eight B.B.C. stations were actually received on the loud-speaker, without the slightest difficulty or straining. The expression "all the broadcasting stations" generally leaves me cold, but this set gave what is undoubtedly a remarkable performance.

I have four aerials in action, one being a twin-wire aerial about 35 ft. high and built to Post Office specifications (this I refer to as the large aerial). The ordinary aerial consists of a total length of wire of 75 ft., including down-lead and lead-in; a single wire is used, and the height of the aerial is about 15 ft. The third aerial consists of a piece of No. 30 gauge cotton-covered wire having a total length of 15 ft. (including down-lead) suspended inside a ground floor room at a height of about 10 ft. The fourth aerial consists of a 5 ft. length of insulated wire going from the aerial terminal of the set on the table to a point on the wall.

The first tests were carried out for the purpose of finding the wavelength range of the set. In all the following cases, and in all the results obtained, constant aerial tuning was embodied in the receiver, a 0.0001 μ F fixed condenser being in series with the

aerial. The use of this constant aerial tuning enables a wider range of wavelengths to be obtained with a single coil, and also makes the set capable of being reproduced by thousands of different experimenters in all parts of the country with the certainty of obtaining similar results. A No. 50 coil was inserted in each coil holder, and, when using the large aerial, it was found that a variation of the two condensers enabled all wavelengths to be received between 290 metres and 585 metres. Spark stations, presumably working on 600 metres, came in loudly on the loud-speaker, which was used throughout these tests, with the maximum capacity connected across the aerial coil.

On the 75 ft. aerial, which has a capacity of about half the large aerial, the wavelength range was from 275 metres to 575 metres, which is practically the same range as before—a tribute to the constant aerial tuning arrangement. Even with the 5 ft. aerial the wavelength range was little different and on test with the wavemeter proved to be 250 metres to 560 metres. In all these cases a No. 50 coil was used in each coil holder, and constant aerial tuning used; in other words, the aerial was connected to the top terminal on the left-hand side of the set.

The next test was to introduce a No. 75 coil in the aerial circuit, keeping the reaction coil a No. 50.

On the large aerial the wavelength range began at 430 metres, and not having a wavemeter which went much above 600 metres on hand at the time, I

only noticed that the 600 metre wavelength came in on 58 deg. on the main condenser, and 100 deg. on the vernier (both condensers have a scale of 180 deg.).

On the 75 ft. aerial the lowest wavelength which could be received was 385 metres, and 600 metres came in 60 deg. on the main condenser, and 80 deg. on the vernier.

When using the 5 ft. aerial, the minimum wavelength obtainable was 340 metres, while 600 metres came in on 74 deg. on the main condenser, and 80 deg. on the vernier.

In all these tests a full measure of reaction was applied.

From the above, the experimenter will see what stations he may expect to get on a No. 75 coil on his own particular aerial. It may be stated that whatever aerial you use, you should be able to get all the B.B.C. stations using a No. 50 coil in the aerial, and a No. 50 as the reaction coil, but slightly better results are obtainable by using a No. 75 coil in the aerial circuit, in the case of the stations using longer wavelengths.

Local Broadcasting

Local broadcasting came in very loud using only the 5 ft. aerial, and the adjustments for 2LO proved to be 46 deg. on the main condenser and 90 deg. on the vernier. A No. 50 coil was in the aerial circuit, and a similar coil in the reaction, and the coils were about 45 deg. with respect to each other. The results were so extremely good with only a 5 ft. aerial, that the aerial was disconnected altogether, and feeble loud-speaker signals could still be obtained, using a piece of wire 1 ft. long sticking up from the aerial terminal as the aerial; much louder signals were attained than without this diminutive aerial.

The next test was to disconnect the earth lead and to connect it on the aerial terminal (i.e., the

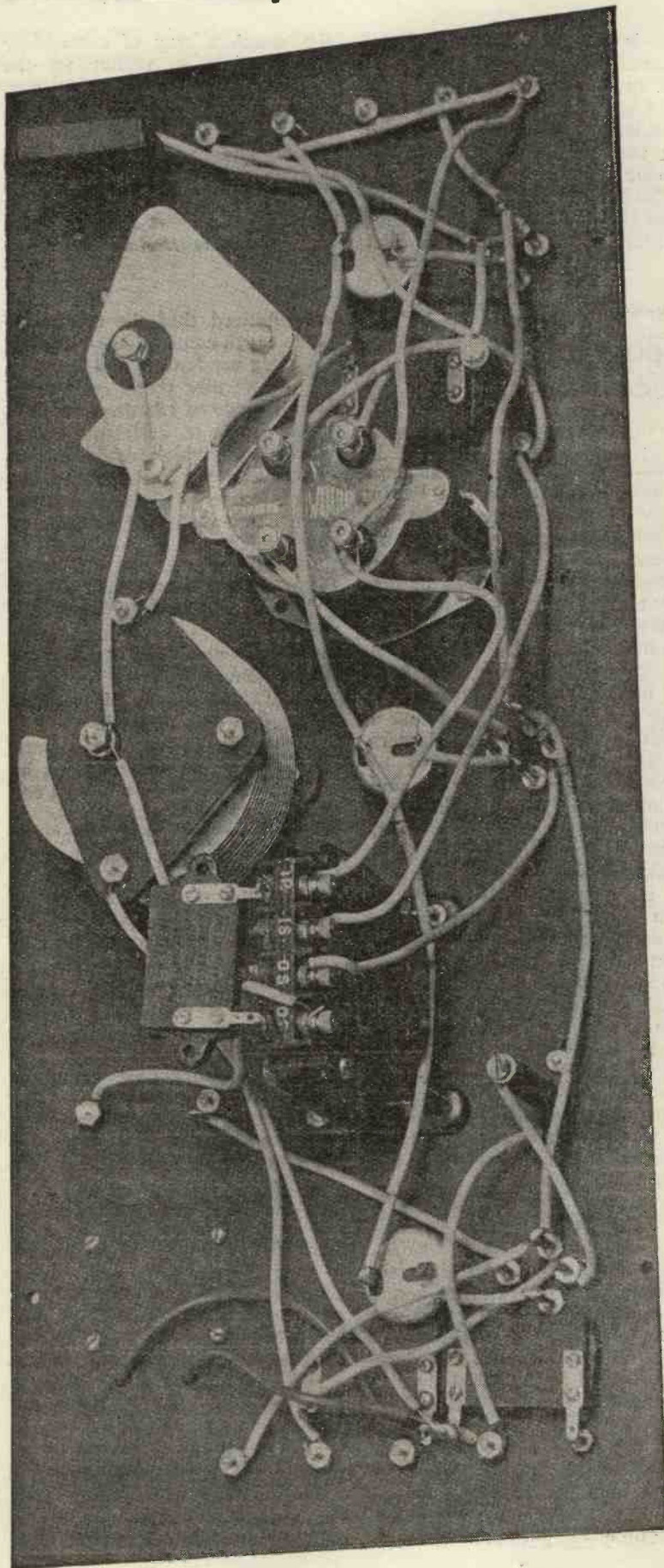

Fig. 5.—The actual wiring of the receiver. This photograph clears up all points of difficulty in the wiring.

constant aerial tuning terminal). The signals now were still as good as when using the 5 ft. aerial, and the valves appeared to be giving their maximum output. At any rate, when the 75 ft. aerial, and the large aerial were tried, signal strength was not increased, indicating that the valves were doing their utmost. This, of course, would not apply to those living at a greater distance than about 12 miles from a broadcasting station, and I therefore give the adjustments for receiving 2LO on the two larger aerials. When using the 75 ft. aerial, 2LO came in on 36 deg. on the main condenser and 80 deg. on the vernier. When using the large aerial, the station came in on 30 deg. on the main condenser and 90 deg. on the vernier.

Receiving Distant Stations

The next step was to listen to each of the different broadcasting stations, and to note the adjustments and signal strength. The results, as already indicated, were surprisingly good.

The first station heard was Aberdeen, jazz music, including "Wana," came in on the 75 ft. aerial at good loud-speaker strength, with the main condenser adjusted to 30 deg. and the vernier at 50 deg., the aerial coil being a No. 75 and the reaction coil a No. 50. The music was amply loud enough for dancing purposes. Birmingham came in using a No. 75 coil in the aerial and No. 50 as reaction on the 75 ft. aerial, with adjustments at 27 deg. on the main condenser and 32 deg. on the vernier. The signals, however, were not as loud as those of Aberdeen. Substituting a No. 50 coil for the No. 75 in the aerial circuit, Birmingham was received on the 75 ft. aerial with 109 deg. on the main condenser and 100 deg. on the vernier.

Songs by Ernest Eady, from Bournemouth, came in very loudly and as well as many people get 2LO at this distance. Using the large aerial, and No. 50 coil in the aerial circuit and No. 50 as reaction coil, Bournemouth came in on 44 deg. on the main condenser and 80 deg. on the vernier. Changing over to the 75 ft. aerial, the same station came in on 48 deg. on the main condenser, and 80 deg. on the vernier. The interference from

(Concluded on page 600)

The Super-Pliodyne Receiver

America's latest contribution in Multi-Valve Sets

SCARCELY a month goes by without the announcement of some new "super" circuit from the United States. The latest to catch the fancy of the technical reader is the "super-pliodyne," the invention of Mr. C. L. Farrand, a consulting radio engineer of New York City. Mr. Farrand has made many important inventions in wireless telegraphy and telephony, therefore anything he produces is worthy of serious consideration. Brief particulars of the circuit reached us a week or two ago, but we held up an announcement until we had had time to make certain investigations in regard to it.

Tuned Radio-Frequency

In this country tuned radio-frequency is the rule rather than the exception. We have, for example, the well-known tuned anode method, the amplification of which is very high. The tuned "plug-in" type of transformer is also highly popular. In the United States, however, what little radio-frequency work is done is almost entirely carried out with a peculiar type of radio-frequency transformer. To the best of our knowledge this type is not on the market on this side of the Atlantic. It is, in fact, a semi-periodic method of coupling, the windings being placed over iron

cores, the laminations of which are extremely fine so as to reduce as far as possible the losses due to eddy currents. It would appear that two or even three stages of radio-frequency amplification in this method are about equal to one good tuned anode or tuned transformer. So little gain is apparent by this method that most of the more experienced American amateurs use straight detector-reaction circuits followed by one or two stages of note magnification, ignoring the radio-frequency side. Good radio-frequency amplification is, however, obtainable by the super-hetero-

Transformer Details

The super-pliodyne high-frequency stages are low resistance intervalve high-frequency transformers consisting of primaries of 25 turns of No. 26 d.s.c. wire and secondaries of 100 turns. The primaries are wound on insulating tubes $1\frac{1}{4}$ in. in diameter and 3 in. long pushed inside slightly larger tubes 2 in. in diameter, on the outside of which are 100 turns of the same sized wire. The secondaries are tuned by variable

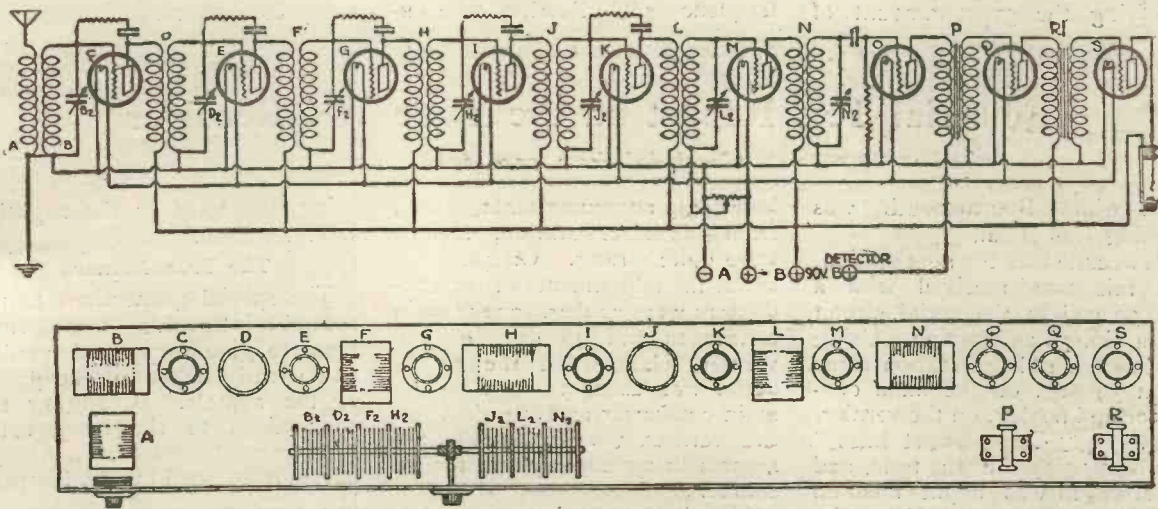

Circuit Diagram and lay-out of the Super-Pliodyne Receiver. Seven tuning condensers are controlled by one shaft. These are shown in the lower picture.

Unlike many "stunt" circuits the general principles are easy to follow from the circuit diagram which we reproduce above from the pages of our contemporary "Radio Digest." Simply explained the set consists, in the particular instrument illustrated, of six stages of high-frequency, a detector and two stages of audio-frequency or note magnification. So far as the detector and note magnifiers are concerned there is nothing novel, ordinary standard practice being followed. The interest in the receiver lies therefore in the radio-frequency

cores, the laminations of which are extremely fine so as to reduce as far as possible the losses due to eddy currents. It would appear that two or even three stages of radio-frequency amplification in this method are about equal to one good tuned anode or tuned transformer. So little gain is apparent by this method that most of the more experienced American amateurs use straight detector-reaction circuits followed by one or two stages of note magnification, ignoring the radio-frequency side. Good radio-frequency amplification is, however, obtainable by the super-hetero-

condensers, all being mounted on a common shaft, which enables them to be turned at the same time. There is no doubt some difficulty in adjusting these condensers so that all of the circuits are properly in tune with one another. The value of these condensers is given as .00025 μ F.

Preventing Self-Oscillation

The chief interest in the circuit, centres around the method adopted to prevent self-oscillation. Between the plate and grid of each high-frequency valve is connected a resistance in series with a fixed condenser. The value of the condenser is not

critical; it is stated it can be any value from .0001 μ F to .1 μ F, as it simply serves as a blocking condenser which will effectually stop the passage of the high tension current. The resistance, however, seems to depend upon the particular valves used. For dull emitters the value had best be about 100,000 ohms, and for bright emitters between 25,000 and 35,000 ohms.

It is difficult to explain exactly what happens in this circuit, for the effect of the condenser without the resistance would be to add to the reaction effect and not to neutralise it. As the resistance is of the non-inductive variety and as the condenser is not of any critical value, the device is not comparable with the ordinary neutrodyning method. The inventor states that this resistance changes the phase of the coupling current flowing between the grid and plate circuit, thus nullifying the great amount of

reaction caused by the capacity in the valves.

Precautions Necessary

Certain precautions are stated to be necessary with regard to the high-frequency transformers. The coils should be wound in opposite directions (one wound clockwise and the other anti-clockwise) and all coils of one type (either primaries or secondaries) should be wound in the same direction. The primary terminal directly under the secondary terminal which goes to the grid should go to the high tension battery. Reaction can be provided by omitting the stabilising condenser and resistance in the detector circuit, and controlling self-oscillation by means of a potentiometer.

There is, of course, no need to make the set with so many valves, and this stabilising principle can be adapted to any high-frequency set. Readers who ex-

periment in this way are invited to send us their results. The ordinary variable high-resistances (Watmel, etc.), such as are used in the ST100 circuit and any suitable fixed condensers, would do here. Two of these resistances in parallel will, of course, bring the value down to 25,000 if necessary.

A Lecture

Mr. Farrand recently gave a paper on this receiver before the Radio Club of America, and brought with him the instrument, which is over a yard long. Reports of the meeting seemed to confine themselves to a description of the circuit and the practical data regarding it. We notice that there seems no enthusiasm about the actual results, which are scarcely mentioned. There would appear to be many difficulties in the practical working out of the design, particularly in the preliminary adjustment of so many condensers.

Editorial Test Report on the Type W 4 Receiver

(Concluded from page 598.)

2LO while Bournemouth was working was small.

Newcastle was the next station, and this was received with a No. 50 coil in the aerial circuit and a No. 50 as reaction. Using the large aerial the station came in on 54 deg. on the main condenser and 80 deg. on the vernier. Huntley's "Come Sweet Lass" was being played at the time, and the strength was about medium loud-speaker strength. Using the 75 ft. aerial, the same station came in a little weaker on 60 deg. on the main condenser and 69 deg. on the vernier.

Glasgow was the next station to be received, using a No. 50 coil in the aerial circuit and a No. 50 as reaction. The large aerial was used, and the signals were received on 68 deg. on the main condenser and 60 deg. on the vernier. Results on this occasion were poor, and could not really be called loud-speaker signals in the honest sense of the words.

Cardiff, however, came in well on the loud-speaker, and, as before, No. 50 coils were used in both positions. Cardiff could not be heard through 2LO, but in

between announcements, etc., from this latter station, signals were quite strong. On the large aerial the adjustments of the condensers were 30 deg. for the main condenser and 48 deg. on the vernier, while, when the 75 ft. aerial was used, 35 deg. on the main condenser and 50 deg. on the vernier were required, the signals being slightly weaker, of course.

Manchester, always rather elusive, as far as London reception is concerned, came in at weak to medium loud-speaker strength. Using the 75 ft. aerial and No. 50 coils in each position, the adjustment of the main condenser was 40 deg. and the vernier 100 deg. A considerable amount of interference from 2LO was experienced.

In all the above tests, including the wavelength range tests, reaction was used to the fullest extent, and the vernier adjustment on the coil holder proved invaluable. The high-tension voltage was in the neighbourhood of 75 to 100 volts, and ordinary bright emitter valves were used. No grid bias battery was employed, the grid bias terminal

being connected to the negative L.T. terminal.

The Transformers

The special connections to the second intervalve transformer seem to give very good results, and greatly improved the purity of the signals. Changing the connections to the more usual arrangement, resulted in the effects mentioned by Mr. Simpson in his article.

Conclusion

From the tests carried out with the set, I would strongly urge those about to build a three-valve receiver to try this particular pattern, which gave results greatly superior to most of the sets I have yet tried. As the sensitivity, etc., was the same on all wavelengths, the 2LO standard of results should be capable of being reproduced in the case of all the other B.B.C. stations by experimenters living near to a station.

The set should give correspondingly efficient results on foreign broadcasting, but at the time of writing no attempt was made.

JOHN SCOTT-TAGGART.



A Peculiar Phenomenon

I EXPERIENCED the other day a very interesting effect which caused me some temporary puzzlement. I was using a three-valve receiver in which the last two stages consisted of low-frequency amplification. I found that on adjusting the

value, the howling stops for another reason—namely, that the increase in the emission from the filament results in a heavier grid current, and this grid current introduces damping into the secondary of the transformer, which is in the grid circuit.

I therefore thought that I was

I expected, of course, that by the addition of a condenser across the telephones, the tuning of the oscillating low-frequency circuit would be altered, and that there would be an immediate change in the note heard. This effect, however, was not noticed, and the high-pitched whistle continued absolutely unaltered.

I then suspected what was happening, and short-circuited the telephone receivers. To find out if the valve was still producing low-frequency oscillations, I took another pair of telephones and connected simply one lead to the grid of the oscillating valve. A low-frequency buzz was heard distinctly in the telephones, indicating that oscillations were taking place in the grid circuit.

The explanation of the phenomenon lies in the fact that the grid current curve (the characteristic curve connecting grid voltage with grid current) took the form of that illustrated in Fig. 2. In the case of an ordinary three-electrode valve, the general impression is that a grid current begins to flow to the grid when the latter is made positive. We would therefore expect a grid

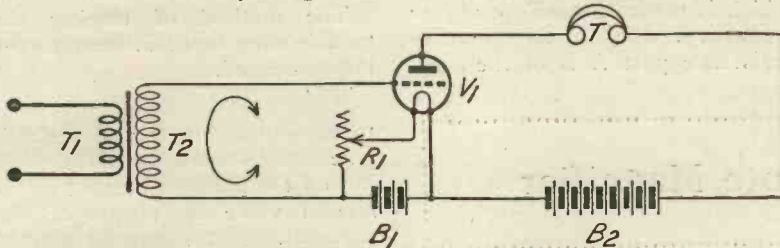

Fig. 1.—Circuit in which L.F. oscillations are produced by negative resistance effect in grid circuits.

filament current of the third valve, *i.e.*, the second low-frequency amplifying valve, that a loud musical note was heard in the telephone receivers. If the filament current was decreased somewhat, this note disappeared, and if on the other hand the filament current were increased beyond the critical value, the note also absented itself.

I thought at first that it was probably due to low-frequency reaction, owing to two stages of low-frequency amplification. This effect is, sometimes obtained when two or more valves are employed, although if the amplifier is suitably designed, no trouble whatever should be experienced. Nevertheless, it sometimes happens that there is a critical medium adjustment of the filament current which results in a howl, and this is due to the fact that when the filament current is decreased below this critical value, the amplification, and therefore the low-frequency reaction, is not so great and the howl stops. If, on the other hand, the filament current is made brighter than the critical

obtaining this particular effect, and that I was either using unsuitable transformers, that I had the connections the wrong way round or that they were placed too close together. I therefore switched off the second valve to find out whether this was, in fact, the case, but I was considerably surprised to find that the musical note continued to be obtained when the filament was adjusted to a certain brightness. The switching off of the other valve, of course, altered the adjustment of the filament rheostat necessary to produce the musical sound.

The continuation of the buzzing noise with only one valve surprised me, because I think it was the first time that I have noticed the effect when using a single-valve amplifier. My first thought was that it must be due to some stray inductive effect from the anode circuit to the grid circuit, producing reaction which set up low-frequency oscillation. I therefore tried connecting a small condenser across the telephone receivers (Fig. 1 shows a circuit which will help to make the following explanation clear).

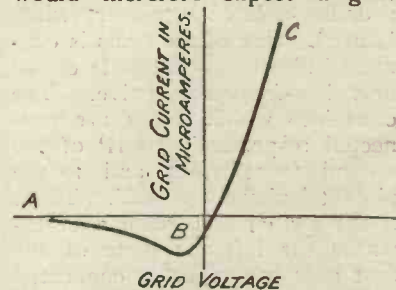
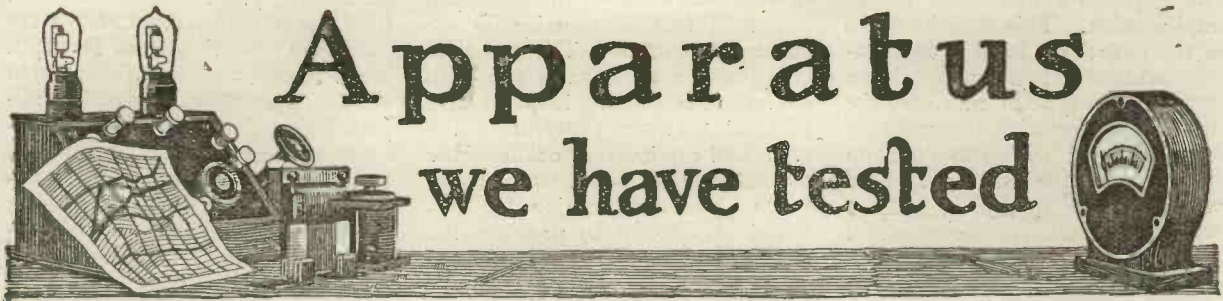

Fig. 2.—A grid current curve, showing negative resistance effect.

current to start at zero volts on the grid. This is more or less correct, but if we examine the curve very closely, by using a microammeter for our measurements, we will find that the curve actually goes a little below the



Conducted by A. D. COWPER, M.Sc., Staff Editor.

Renewed Valves

From the G.W.I., Ltd., we have received two valves, the filaments of which had been renewed by their process. These were a L.S. 3 and a Mullard Ora.

On practical test, both showed good rectifying qualities, even up to 90 volts H.T., and operated satisfactorily as H.F. and L.F. amplifiers, and in a dual circuit. The Ora valve gave with .64 amperes in the filament and 3.8 volts across it, a saturation current of the order of five milliamperes, and showed good grid control. There were no signs of softness.

The L.S. 3 gave a characteristic as shown with 3.75 volts on the filament, which appeared to be a safe and reasonable value.

The filament current was then fairly high: 82 amperes. The impedance was low under these circumstances, suggesting that it

PLATE CURRENT
ma.

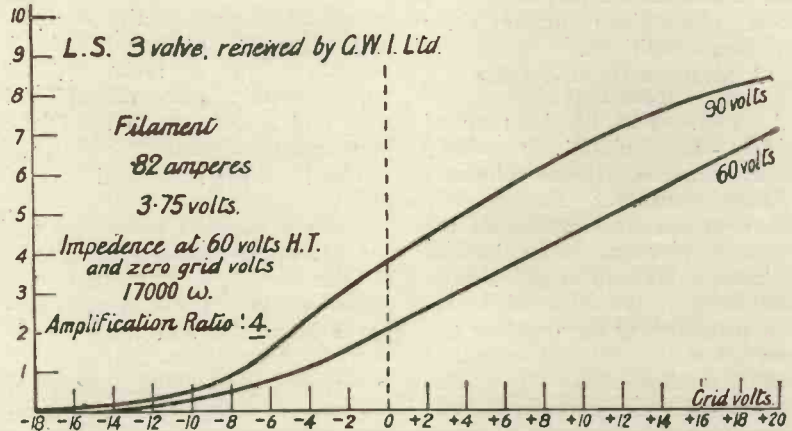

An Ideal Gift

to your "Wireless" friend is the unique all-purpose Portable Amplion suited to Radio reception both in and out of doors.

The price of this model, which is obtainable from all Wireless Dealers of repute, is six guineas.

Folder W.R.3 gives full particulars. A postcard brings it free to you.

THE PORTABLE
AMPLION
LOUD SPEAKER

"Buy British Goods Only."



ALFRED GRAHAM & Co.
E. A. GRAHAM.
St. ANDREW'S WORKS,
CROFTON PARK, LONDON, S.E.4
Telephone :
Sydenham 2820, 2821, 2822.
Telegrams :
"Navalhadn, Catgreen, London."
West End Showrooms :
The Airphone Salon,
25-26 Savile Row, Regent St. W.1
Telephone : Regent 1076.
Also
82 High St., Clapham, S.W.4.

would prove suitable for power amplification. This was found to be the case; on local broadcasting with the two valves in a conventional type of receiver, the Ora as rectifier with 100 volts on the plate, and with 150 volts on the plate of the L.S. 3 and 16 volts negative grid-bias, with a really good L.F. transformer and reliable loud-speaker the volume of sound was quite overpowering, whilst more free from distortion than is observed in the great majority of even the best-managed loud-speaker demonstrations. Actually the result was louder and clearer than with new L.S. 1 and L.S. 2 valves tried in direct comparison under their optimum conditions.

A Multiple Quick-release Terminal

A modification of the type of quickly-manipulated terminal, already noticed in these columns, is brought out by N. K. Mousley. This provides accommodation for one or more extra connections in addition to the principal screw-down one, by the effective device of a spiral spring surrounding the stem below the lock-nut, together with a washer under which one or more of the conventional type

of spade-terminals can be slipped and held fast frictionally by the spring-pressure. The principal connection is made as before, with a knob-ended or looped wire pinched between the end of the stem and the internal collar of the milled-edge lock-nut.

On close examination the terminal was found to provide the rapid detachment and ready replacement of connections claimed for it, and could readily be adjusted by one hand, giving effective firm contact each time. It was neatly finished in nickel plate.

Re-wound and Re-Magnetised Head 'Phones

Messrs. S. A. Cutters have given us an opportunity of testing a pair of 'phones re-wound by them to a resistance of approximately 4,000 ohms, and they had also re-magnetised the permanent magnets.

The head-set submitted was of an ordinary inexpensive type, without a maker's name.

On test, the resistance (D.C.) of the windings was just over 4,000 ohms. They were compared in crystal and valve reception of local broadcasting with a well-tried standard type, and the two ear-pieces were also com-

pared singly. It was noted that the permanent magnets were quite up to the usual strength when tested, and the diaphragms were apparently properly adjusted for distance. The sensitiveness was found, in general, to nearly reach that of the standard pair, the difference being more noticeable in crystal reception than in noisy valve reception after a note-magnifier. There was a noticeable difference between the two ear-pieces.

It is evident that a new lease of life, at any rate for valve reception, can be given to a pair of high-resistance 'phones which have unfortunately developed a fault in the winding or have been de-magnetised.

EXPERIMENTS IN DISTORTIONLESS AMPLIFICATION

Captain H. J. Round, M.C., the famous wireless inventor, has written a remarkable article on the above subject, giving working circuits.

"Modern Wireless" for April. BUY YOUR COPY TO-NIGHT.

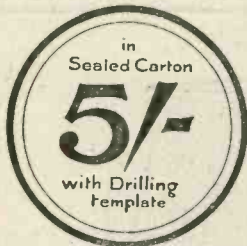

Burndept Crystal Detector

(Prov Patent No 23937/23)

Mr. J. Scott-Taggart in *Wireless Weekly* says:
 "The Crystal Detector should be of a good pattern, and the latest Burndept Crystal Detector is the type used on original omni receiver itself."
 "This detector has a beautiful control and is one of the best types on the market to-day."

Fix it on your Crystal Set and note the difference.

Mounted on Ebonite with walnut sub-base as illustrated ... Price 12/6
 For Panel Mounting, with Drilling Template 5/-



Stocked by all Dealers selling High Grade Wireless Components.

BURNDEPT
 WIRELESS APPARATUS

BURNDEPT LIMITED, ALDINE HOUSE, BEDFORD STREET, STRAND.

Phone: Gerrard 9072.

ECONOMIC ELECTRIC CO. LD. WRITE NOW!

OUR NEW RADIO CATALOGUE

comprising 40 pages and 300 illustrations of all classes of instruments, component parts, materials, etc., is just off the press. IT WILL PAY YOU WELL to remit 4d. in stamps and secure this money-saving publication.

Head Office: 10, FITZROY SQUARE, LONDON, W.1. Showrooms: 303, EUSTON RD., N.W.1. Branch and Works: TWICKENHAM.

BEWARE OF WORTHLESS IMITATIONS, SEE THE TRADE MARK **WatMel** ON EVERY GRID LEAK.

WATMEL VARIABLE GRID LEAK
 (Patent No. 206098).

Constantly Variable
 Silent in operation.
 Constant in any
 temperature.
 Dust and Damp
 proof.
 Each tested and
 guaranteed.
 Neat and well
 made.



GRID LEAK
 .5 to 5 megohms
 2/6

ANODE
 RESISTANCE
 50,000 to 100,000
 ohms 3/6.
 Suitable for S.T.
 100 Circuit.

SEND P.C. FOR DESCRIPTIVE FOLDER.

WATMEL WIRELESS CO., Connaught House, 1a, Edgware Road
 Marble Arch, W.2. Tel. 4575 Paddington

Correspondence



APPRECIATION

SIR,—I have in the past few months, since I became interested in wireless, made two or three sets from crystal, pure and simple, to ST100, from the No. 1 Envelope of Radio Press. This is excellent, most successful, and it really amazed me to get Königswüsterhausen, Berlin, on headphones well on Sunday mornings when there was no interference. I then got your 4-Valve Family Receiver, Envelope No. 2. I have built it up with R.I. transformers and vernier condensers; all other parts Burndept, except coilholder. I have made use of a full ebonite panel, and it looks most handsome.

Results

Berlin good on loud-speaker, every other station as loud as

you could want. I am 16 miles from the Bournemouth Station, so can get them very economically as regards current. The worst station down here in the New Forest is 2LO; everyone finds great difficulty in getting it well. Aberdeen is about the best. I see at the end of your instructions you would like to hear from amateurs who have made up the set, so this prompted me to write. I am more than delighted with it. I could not be bothered with a set I had not made up myself, so the results are more gratifying.

I use Cossor valves, P₂, H.F. P₁, all others. Have tried an L.S.3 in 2nd stage L.F., but see no improvement on the P₁ Cossor.

I have a very good twin aerial, 60 ft. by 6 ft. span, and good earth.

Again I say it is splendid.—
Yours truly,

T. G. WILLS-SANDFORD.
Hants.

ST100

SIR,—May I express my appreciation of the ST100; it is the finest set I have listened to, and I have made most of the ST circuits.

Why all the excitement over hearing America? On the first valve of my ST100 with two home-made basket coils, 0.005 variable condenser in shunt, 0.002 fixed condenser in series, KDKA comes in as loud as Aberdeen or Glasgow on any suitable night. Twin aerial, 50 ft. long, 20 ft. high, and my set is below ground level.—Yours faithfully,
H. R. ORAM.

Ask your Dealer for

RADION HIGH EFFICIENCY VALVES

Filament Volts	3.5 to 4
Filament Amps	.25
Anode Volts	30 to 90

Each valve is tested before leaving the works and the guaranteed minimum radiation shewn on the box.

Manufacturers:

RADIONS LIMITED,
Bollington, near Macclesfield.

ARE YOU CERTAIN

that your set is all that it should be?

CAN YOU HONESTLY SAY

that Better Results are impossible?

IF NOT—

Change your Transformer at once for a **Powquip Shrouded Model** and you are then on

THE ROYAL ROAD TO SUCCESS

PRICE 18/-

The Power Equipment Co., Ltd.
CROWN WORKS, CRICKLEWOOD, N.W.2.

A NEW STATION

SIR,—On Saturday, March 22, about 11.15 p.m., I picked up a broadcasting station on a wavelength of about 360 metres. Several pieces were played by a band, and between 11.30 and 11.45 the announcer made a short statement (in English) to the effect that the date and time of the next broadcast could not be stated owing to the fact that the wavelength and hours of transmission had not been settled by the French postal authorities. He mentioned "friends across the Channel," and stated that the station had been heard in the north of Scotland. It appeared, from the trend of the announcement, that the broadcast had been arranged specially for reception in Great Britain. I heard no mention of a "call sign."

I should be glad if any reader of *Wireless Weekly* received this same station to know whether any call sign was given during the performance. If so, what it was and also the particulars of the station.—Yours faithfully,

ASHER S. LILL.

London, E.

FRANCO-BRITISH TESTS

SIR,—In *Wireless Weekly*, Vol. 2, No. 20, I notice mention of the Franco-British Tests on about 200 metres. I think I heard some of these amateurs on December 3, when listening-in on short waves, and am herewith giving you the call-signals heard.

At 22.58 2ON sending v's and the word "Test." Later I heard "Society test de 5KO." At 23.20 2AQ was called by 5PU. 23.30 Test de 2FQ (very satisfactory). At 23.32 2IN called RSBG and was heard with the 'phones on the table.

The receiver used was practically the same as that given in *Wireless Weekly*, Vol. 2, No. 14, honeycomb coils being used, size 25, 35 and 50 for primary, secondary and reaction respectively. The valves were of the American Radiotron UV-201-A.—I am, etc.,

SNORRI P. B. ARNAR.

Reykjavik, Iceland.

AS OTHERS SEE US

SIR,—It would appear that the free and easy announcing of

5WA annoys you. As a regular listener to the Cardiff programmes I deprecate the unfairness and bias in which your Editorial in Vol. 3, No. 16, has been conceived.

Cardiff is more than a mere broadcast station to its followers—it is a valued friend. In fact its "comrados" (and that's a better name than "listener" Mr. Editor) are one big family. The London station, that you hold up as example, is merely a highly efficient service. It lacks the warm-heartedness and friendly personality of the Welsh station.

Perhaps, Sir, it is because I read both your magazines regularly; and have hitherto admired the fair way you have had in dealing with previous questions, that I regret so much the carping, snobbish, unsociable and mean attack on the Cardiff announcer. Even though you are unsporting, I cannot afford to stop taking your mags., they're too valuable.—Yours faithfully,

COMRADIO.

GAMAGES of Holborn

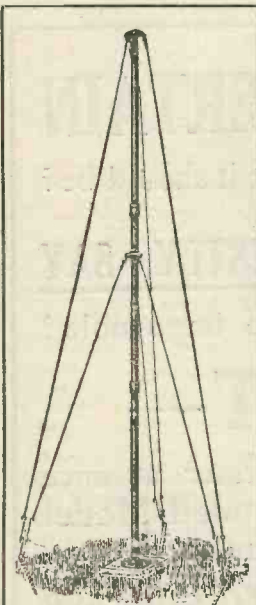

AERIAL MAST

Wooden Mast in 3 sections, 2 1/2 in. dia. All finished Grey Lead Paint, 30 ft. high. Complete with hooks, double straining screws, iron ground stakes, cord cleat and galvanised pulley. Price 52/6 Carr. extra.



FULLER'S BLOCK ACCUMULATORS

Special offer of ex-Government Stock but absolutely unused. 2 volt, 40 amp. 10/6 post 1/6. 4 volt, 40 amp. 21/- post 1/6. 6 volt, 40 amp. 31/6 post 1/6. Boxes to hold 5 of these fitted with lid and carrying strap. Each 1/6, postage extra. Five accumulators and box sent post free.

If you are unable to pay a visit to the Premier Store for Wireless, write for WIRELESS CATALOGUE. It contains your every need. We will send it post free on request.

COIL HOLDER VALUE

Ideal for Honeycomb and Burndept Coils. In best ebonite, with all brass parts finished dull nickel. Perfect movement, which can be tightened when using large coils. Price for two coils 6/6 Post 6d.



Price for 3 Coils. 8/6



THE BEST CRYSTAL

is Gamage's Permanite—the one with the Regd. Trade Mark.

PERMANITE CRYSTAL

Regd. No. 438341.

Clear, powerful results. Remains in adjustment longest. Price per large specimen. 1/6 Post free

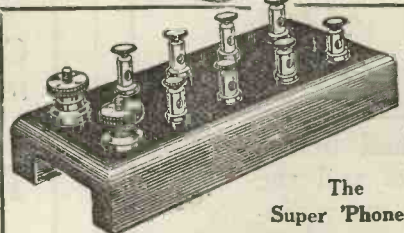

The Super 'Phone

DISTRIBUTOR BOARD

A beautifully made component with lacquered terminals. To take four pairs of 'phones. Size 5 ins. x 2 ins. x 1 1/2 ins. A most useful component for the experimenter. Write for yours to-day—Satisfaction or money refunded in full. Price 3/6 Post 4d.



THE "BROWNIE" Crystal Set

With Solid Moulded Ebonite Cap and highest grade nickel fittings. British made. Sold ready for use, it will operate 4 pairs of 'phones.

Price 7/6

Plus B.B.C. Tax 1/- Postage 9d.

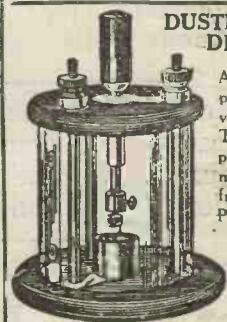

DUSTPROOF DETECTOR

A beautifully made piece of apparatus, very efficient in use. Transparent Cover protects the "Permanite" Crystal from dust.

Price complete with "Permanite" Crystal

3/9 Post 4d.

A. W. GAMAGE, Ltd., Wireless Experts, HOLBORN, LONDON, E.C.1.

Cheapside House: Benetfinks.

Information Department



F. O. H. (CARLISLE) asks how he can decide whether he is using his high-resistance telephones correctly in circuit so as not to de-magnetise their permanent magnets?

Probably the most reliable method is the following:—Remove the earcap from the 'phones and attach to the centre of the metal diaphragm by means of an adhesive or a piece of plasticine a piece of cotton thread, to whose other end a small weight can be attached. A suitable weight consists of a small paper bag in which sand or small shot can be inserted. Adjust the weight hanging from the diaphragm to such a value that the diaphragm itself is just retained in place by the magnetism of the field magnets, and then pass a current through the windings from a dry cell. If the weight is still retained, the connections to the tags should be marked positive and negative according to the polarity of the dry cell to which they are connected, but if the weight falls off when the current flows the connections should be reversed and then marked.

K. R. (KINGSTON) says that he has seen a reference to double basket coils, and asks whether there is any difference between such coils and the ordinary basket wound type?

The conventional type of basket coil, wound by passing the wire alternately over and under the pins of a spider, is probably one of the most efficient concentrated inductances at present used, but it has certain serious defects from a practical point of view, the principal one being its mechanical weakness. The simple modification known as double basket winding removes several of the most important drawbacks, and appears to deserve general adoption. It enables one to put approximately twice the number of turns in a given space, and comparative tests indicate that its efficiency remains very high. The actual method of winding consists in simply passing the wire over and under two spokes of the spider at a time instead of one, hence the name double basket.

OMNI-ST100—ST100 STAR CIRCUITS & MANY OTHERS

Complete Components, including Drawings, Instructions, Panels, Cabinets, Valves, H.T. Terminals, etc., for Building the above Circuits. PARTS SUPPLIED SEPARATELY IF DESIRED.

All Components of **BRITISH** Manufacture.

'S.A.C.' PLUG AND SOCKET

'The Gadget of a 1,000 USES.' 1/- per Pair Complete.

'S.A.C.' MAGNIPHONE, 4,000 ohms

19/6

'S.A.C.' OPERAPHONE (LIGHTWEIGHT), 18/-

All 'Phones fitted with 'S.A.C.' Plugs and Sockets.

Send for **NEW LIST**, with which we issue **FREE** a New Electrical Game of interest to Radio Enthusiasts.

PRICE 1/- Credited against First Purchase.

'S.A. CUTTERS'

15, RED LION SQUARE, LONDON, W.C.1.

Phone: Chancery 8042.

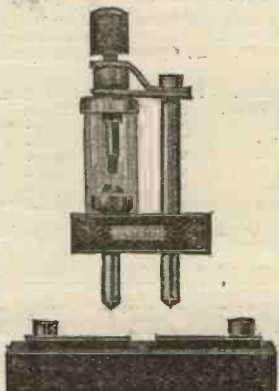

'S.A.C.' Detector from 3/-

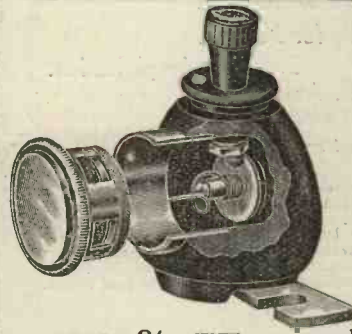

The ECCENTRO DETECTOR (PATENTED)

This Detector is undoubtedly **THE BEST ON THE MARKET**. It reduces crystal adjustment to the fool-proof operation of turning a knob. It is a real piece of mechanism. Dustproof & Shockproof.

POST 8/- FREE.

A BOON TO ALL CRYSTAL SET USERS.

French Thomson-Houston Headphones.

(Guaranteed for two years). **NONE BETTER.** 4,000 ohms 19/- 8,000 ohms 24/- post free.

F. T. H. SINGLE RECEIVERS.

Complete with Cord. 2,000 ohms 8/- 4,000 ohms 10/6 post free.

The finest phone obtainable.

Illustrated lists post free.

If your local dealer cannot supply you send direct to us.

TO THE TRADE. Our revised discounts will interest you. Send for particulars. **NOW!**



F.T.H. PHONE.

W. JOANES, 42, JENNER ROAD, STOKE NEWINGTON, N.16.

Phone: Dalston 4741.

Telegrams: "Creneva," Stoke, London.

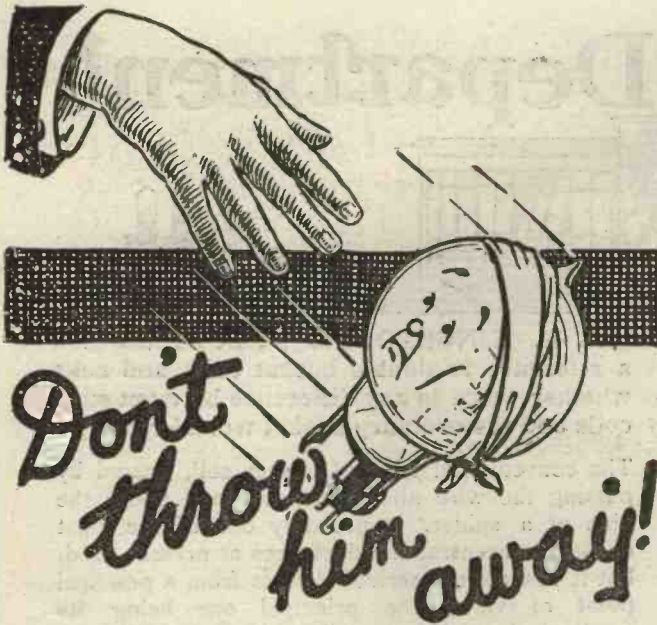

Just because he's worn out or his filament broken. Take advantage of

REVALCO Valve Repairs

—the most efficient yet discovered, which

GUARANTEE

entire satisfaction.

Valves repaired especially for 3 stages.

1. Detecting.
 2. L.F. Amplification.
 3. H.F. Amplification.
- (State which required.)

Read this extract from our post :—

Gentlemen,
I should like to take this opportunity of expressing my appreciation of the very satisfactory repair of a Marconi valve which I sent you some little time ago.

This valve has been in constant use since last December (546 hours actual burning) and has stood up to as much as 140 Volts on the plate and has functioned in Reflex, "Straight" and Super-regenerative circuits with equally good results.



NO DELAY—

Definite 7 day delivery

Send now, stating stage required.

REVALCO Limited

Dept. C, 15, Grape St., Shaftesbury Av., London. W.C.2

PARTS, COMPONENTS, SETS—they all sell equally well in WIRELESS WEEKLY.

A DEPARTURE

IN

Valve-Holder Construction for Every Experimenter

who knows that high resistance and low capacity are determined by the spacing of the valve legs themselves. In the manufacture of the H.T.C. Valve-Holder, allowance is made for the varying spacing of legs of the different types of valves.

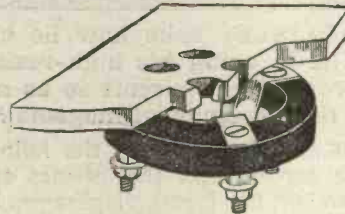

Patent pending.

Type "C" for below Panel Mounting. Template Supplied.

No metallic parts used in construction are exposed, making it impossible to short the H.T. across the filament.

PRICE

1/6

We are also Manufacturers of the Famous **H.T.C. INTERVALVE TRANSFORMER** the success of which has succeeded good craftsmanship and good materials, observing good design. Obtainable from your Local Dealer, or direct from the Manufacturers. Price **15/-**

H.T.C. Electrical Co., Ltd.

2 and 2a, BOUNDARIES ROAD, BALHAM, S.W.12

Telephone : BATTERSEA 374.

Trade Enquiries Invited.

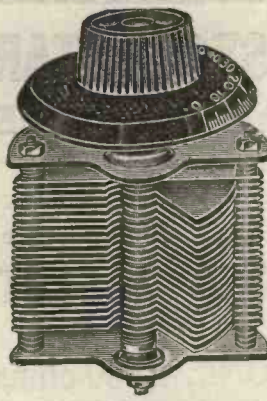

**Fit 'Utility'—
the accurate
components.**

Experimenters—the men who know—always specify "Utility," for experience has taught them that "Utility" means accurate, reliable performance. Here is conclusive proof of the efficiency of "Utility" Variable Condensers

A .001 mf. "Utility" Condenser taken from stock when tested by National Physical Laboratory was found to have an equivalent resistance at 400 metres of .04 ohms—a negligible quantity. Exceptionally close spacing, large adjustable bearings, one hole fixing.

For Panel Mounting.			In Polished Walnut Box.	
Maximum Capacity.	Ref. No.	Retail Price.	Ref. No.	Price.
.0015 mf.	W.122.	18/-	W.1220.	31/-
.0010 mf.	W.123.	14/-	W.1230.	24/-
.00075 mf.	W.144.	13/-	W.1440.	22/-
.0005 mf.	W.124.	11/6	W.1240.	20/-
.0003 mf.	W.125.	9/6	W.1250.	18/-
.0002 mf.	W.145.	8/6	W.1450.	17/-

Combined Vernier Adjustment to any size 3/- each extra. Other capacities to order.

Ask your dealer to show you these and the other interesting "Utility" products.

WILKINS and WRIGHT, Ltd.
"Utility" Works, Kenyon Street, Birmingham.

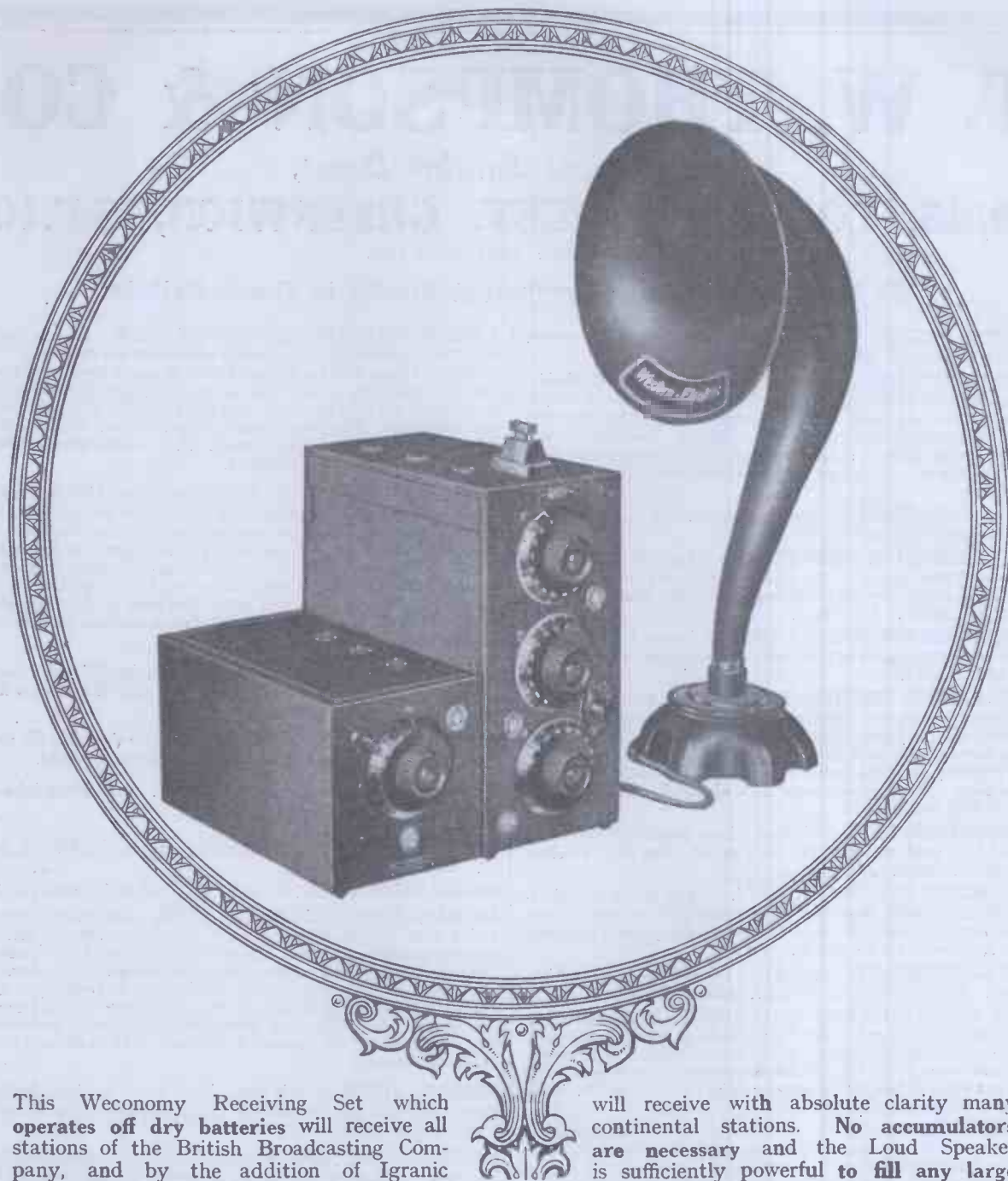

This Weconomy Receiving Set which operates off dry batteries will receive all stations of the British Broadcasting Company, and by the addition of Igranic Coils, for which holders are provided,

will receive with absolute clarity many continental stations. No accumulators are necessary and the Loud Speaker is sufficiently powerful to fill any large reception room.

The set consists of:—No. 44081 Weconomy Detector .. £16 0 0 No. 44005 Loud Speaker £5 17 6
 No. 44013 Weconomy Amplifier .. £19 0 0 (B.B.C. Contributions extra).

A RECEIVING SET THAT WILL GIVE YOU LASTING SATISFACTION.

WECONOMY SETS ARE DRY BATTERY SETS.

Western Electric

MAKERS OF OVER HALF THE WORLD'S TELEPHONES.

Connaught House, Aldwych, LONDON, W.C.2.

Telephone: Central 7345 (9 lines.)

Branches: GLASGOW, LEEDS, BIRMINGHAM, MANCHESTER, NEWCASTLE, CARDIFF, SOUTHAMPTON, DUBLIN.

PARTS, COMPONENTS, SETS—they all sell equally well in WIRELESS WEEKLY.

T. W. THOMPSON & CO.

Government Surplus Depot,

39/43, LONDON STREET, GREENWICH, S.E.10.

TELEPHONE: GREENWICH 1259.

We hold the Largest Government Stocks in Great Britain.

STATION TESTER WAVEMETERS, Range 100-3,500 metres. Accuracy guaranteed. £5 each. 100 in stock.

HIGH TENSION DYNAMOS. Makers B.T.H. Co. and W. Mackie. Output 600 volts direct current. Low Tension, 8 volts, direct current. These machines are brand new and guaranteed fully tested on output of 600 volts, approximately 80 to 100 milliamps. The highest grade machines to be obtained, costing £45 each. Our clearance price, £10. All machines sent on three days' approval against cash. Trade supplied. 20 in stock.

SPARE ARMATURES for above generators. £3 each. Price for spare armature, with machine, £2.

G.P.O. SOLID BACK MICROPHONES. These microphones work on 6 volts $\frac{1}{2}$ amp, and have the loudest speech, and are as free from distortion as any we have yet had through our hands. Cost 25s. Price to clear, 6/6, post 6d. 500 in stock.

MANSBRIDGE CONDENSERS, 1 M.F. We have at last managed to obtain another good stock of these valuable condensers. Price 3/-, post 6d. 2,000 in stock.

R.A.F. REMOTE CONTROL PANELS. This set contains two variable condensers, one being micrometer racket vernier. Filament rheostat, ebonite panel. Engraved scales, contained in mahogany canvas covered case, with terminal board, etc. Everyone will find a great improvement in the tuning of their set by the simple insertion of one of these. Owing to our large stock of 5,000, we are clearing these at 10/6 each, post 9d.

TRANSMITTING KEYS. We have a large quantity of beautifully finished keys, good movement and heavy points. Cost 25s. To clear, 3/6. 4,000 in stock.

R.A.F. MORSE PRACTICE OUTFITS. These have a fine adjustment, high note buzzer, heavy key, which is detachable from set; 'phone, terminals and other terminals, and fittings mounted on polished mahogany base. 3,000 to clear at 5/-, post 9d.

D. III. MICROPHONES. Complete with case and inset loud speaking, 2/- each. Microphone transformers, 2/-, post 4d. 500 in stock.

MK. II. PORTABLE FIELD TELEPHONES. Each telephone is a complete receiver and transmitter, containing telephone magneto, magneto ringing bell, telephone, transformer, ebonite, with terminals, hand combination phone, with 150 ohm earpieces and microphone. Each set is in a polished teak case, measuring 12 in. by 11 in. by 6 in. Cost £6 each. Knock-out price, 12/6 each. 4,000 in stock.

WIRELESS HEADPHONES. Ex.-Government 4,000 ohms, guaranteed rewound and remagnetised, in new condition. These are a far superior headphone, having 3 magnets in each earpiece. All leading instrument makers. Made to Government specifications. Cost 30/- . Price to clear, 12/6 each, post 6d. Cash returned if not satisfied. 2,000 in stock.

VALVE BOXES. These cases are specially designed to take 3 valves, being softly padded and neatly lined with baize. All oak wood. Don't break any more valves by leaving them about, but install in one of these cases. 10,000 in stock at 1/6, post 6d.

MARCONI SPREADER INSULATORS. These insulators are 10 ft. long with shackle in centre which goes to rope, and shackle at each end which goes on each end of spreader. These will give an efficient aerial. Cost 18/- . Price to clear, 2/6, post 6d.

1 INCH WIRELESS STERLING SPARK COILS. Ebonite panels, nickel fittings, all brand new, complete with points and condenser. The windings of these coils are highly effective in use as modulation transformers without conversion. There are numerous experiments that have been carried out with these coils, and prove valuable, both to receivers and transmitters. Every one guaranteed tested perfect. Cost 50/- each. Price, 6/6 each, post 9d. 3,000 in stock. These are also interchangeable with transformer in 52A transmitters.

TRANSMITTING SETS (R.A.F.). These sets are high-class instruments, containing 1 in. Sterling spark coil, ebonite panels, high-grade aluminium spark gap mounted on ebonite, with adjuster, mica dielectric condenser, ebonite panel, helix variable tuning from 0 to 600 metres wavelength, terminals and other sundry fittings. All above are mounted in ebonite panelled case. Ebonite alone would cost more than we ask for complete article. Cost £15 each. Our price to clear 15/6 each, post 1/3. Useful to all experimenters. Anyone can send for these sets. 1,000 in stock.

CONDENSERS, Mica dielectric to stand 2,000 volts, .025 μ F. capacity. Each condenser contains 30 sheets of .002 mica. 20,000 in stock to clear at 6d. each. Mica alone worth treble. Post 2d.

AERIAL ROPES, 47 ft. long by $\frac{1}{2}$ in. diameter, best Manilla rope, complete with shackles and eyes. No pulley. 2/- each, post 6d.

PLUGS AND JACKS. 2/- per Plug and Jack. Spare plugs, 1/3 each. **EBONITE KNOBS**, 1/6 per doz., post 6d.

SINGLE EARPHONES, 2,000 ohms, beautiful results, 4/6 each, post 3d. Limited number only.

SINGLE EARPHONES, 120 ohms. Fine quality, 2/- each, post 3d.

MARCONI SHIP TYPE CRYSTAL SETS. Containing 5 separate tuning coils and variometer. Tapped inductance, Marconi variable condenser, ebonite dielectric, Bili vernier condenser, Potentiometers, switches, resistance and innumerable other fittings. These have an approximate 200 metres to 5,000 metres designed for reception of long distance stations. It may be the luck of some readers to have had experience with these sets, these will know that for the class of instrument, this set could not be obtained to-day under £40. Clearance price, £4 10s. 80 in stock.

ACCUMULATORS, 12 volt amp. With 6 volt tapping. Leading makes; all brand new, contained in carrying case. To clear, 8/- each, post 1/- . 300 in stock.

MK. III. CRYSTAL CUPS. Mounted with Zincite and copper pyrites. The best combination used in Government sets. All these crystals have been passed tested. Price for 2 crystals and 2 cups, 8d. 10,000 in stock.

AERIAL AMPMETER. 1 $\frac{1}{2}$ amps. 10/6 each, post 6d. 1,500 in stock.

MK. III. TUNER CASES. Polished mahogany, very good for portable sets. 10/- each, post 1/- .

Notice—We regret we are unable to print a complete catalogue at present, but owing to our large stocks, it is impossible to include the whole. All material will be advertised as sorted.

Agents for Brighton District:

A. J. HILL & CO., Electricians, 8, York Hill, Brighton.

LISSENIUM MAGIC PARTS—

Minute energy coming miles through space—just think how carefully each part in your receiver must nurse these vital impulses which come to it! Parts of assorted make! If you use them, can you tell which one is letting your receiver down? Can you tell which part is leaking its precious energy? **MIXED PARTS—WHY USE THEM?** The writer in an article specifies mixed parts because it would appear to confer an undue preference if he used parts of all one make. **NO SUCH CONSIDERATION WILL WEIGH WITH YOU**, for you want your receiver to be full of "life"—responsive to each control—sensitive to every vibration of your aerial. You can build a receiver with mixed parts, of course, but it will never give you the same results as your receiver built with **ALL LISSEN PARTS.**

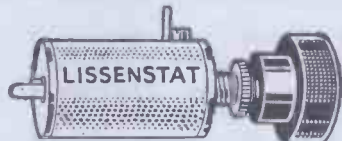

THE LISSENSTAT AS AN AID TO TUNING. In tuning, particularly in long-distance work, and also where extremes selectivity is desired, there is always one spot which will give the best results. LISSENSTAT control makes it possible to regulate critical electron emission to correspond exactly with the degree necessary for perfect detection. There are three types of LISSENSTAT: Lissenstat (prov. pat.), the super filament control ... **7/6**

Lissenstat Minor, intended to provide something of the beautiful Lissenstat control at a popular price ... **3/6**

Lissenstat Universal, with its protection for dull emitter valves ... **10/6**
To those who think Lissenstat Control is the same thing as an ordinary rheostat—Let them try the difference.



MAKES A WHISPER LOUD. This LISSEN type T1 Transformer will amplify a whisper to a great degree of loudness in a background of absolute silence. The coil alone weighs 8 ounces. The primary has an exceptionally large impedance value, and the windings are subjected to an exceptional test. No other transformer has such a valuable coil. Will give great amplification with entire absence of distortion due to the design of the coil and the magnetic field. The metal screen also shields it from all local low frequency currents. This LISSEN Transformer should be used always immediately behind the detector valve and also for **POWER WORK.** Use it throughout if superlative amplification is desired. **30/-**

AUDIO-FREQUENCY IN REFLEX CIRCUITS. It has been found that the LISSEN type T2 Transformer is a fine transformer in these circuits, including the ST100, where it yields pure and very **25/-** powerful amplification.

AN EXCELLENT LIGHT TRANSFORMER— Skillfully balanced in design, this LISSEN T3 Transformer actually compares with many expensive transformers. It is one of the best light transformers made ... **16/6**

AERIAL REACTION is no alternative to LISSEN Radio-Frequency Amplification. It is a mistake to assume that because aerial reaction is used in a receiver there is no need for LISSEN Radio Frequency Amplification in the same receiver. If your aim is distance add one stage of LISSEN REACTANCE (prov. pat.). Its great efficiency, its rapid tuning, have made radio-frequency amplification more widely used in tuned anode circuits than anything else. Complete with switch already mounted—no complications—no soldering—**LISSEN ONE HOLE FIXING, OF COURSE.** Diagram with each shows how to connect.

- 150 to 10,000 metres ... **19/6**
- 150 to 600 metres ... **17/6**

To cover distance, every receiver should have one stage LISSEN REACTANCE—lower in cost than a set of plug-in coils—self-tuned, but sometimes a vernier might be an advantage (preferably use the LISSEN Vernier).

PUTTING THE CONDENSER IN SERIES OR PARALLEL.

On the shorter wavelengths it is sometimes difficult to get regeneration with the condenser in parallel, but when the condenser is used in series the set oscillates very much more readily. On the longer wavelengths, however the condenser should always be used in parallel. If you have fitted the LISSEN Series Parallel Switch you can put the condenser in series or parallel quickly with just a gentle pull or push of the knob. It takes up hardly any room. Lissen One Hole Fixing, of course ... **3/9**

WHEN SOME SETS WILL FUNCTION WITHOUT A GRID LEAK. The distance between the grid and filament pins in an ordinary R valve is only one centimetre, and if the valve holder should be made of slightly conducting or hygroscopic material, or if there should be anything on the surface of the ebonite such as tinfoil, or flux, or dirt, which will cause a leak between the grid and filament pins, you have a **Grid Leak without putting one in!** But obviously this is an undesirable means of obtaining correct grid potential! In some circuits and with some valves variable grid control is not so important, but with others it is extremely important. It is an excellent thing to be able to alter leak resistance, so that the correct value is obtained for every varying phase of the valve and circuit. If the LISSEN Variable Grid Leak be used correct grid potential can be obtained under all conditions. An interesting alternative use is across the secondary of a transformer, or across the loud-speaker itself, when it will improve reproduction by suppressing any tendency for the high notes of the musical scale to be amplified disproportionately to the lower ones.

LISSEN ONE HOLE FIXING, OF COURSE. POSITIVE STOPS BOTH WAYS. 2/6
LISSEN Variable Anode Resistance, same outward appearance as the LISSEN Variable Grid Leak, 2/6
20,000 to 250,000 ohms continuous variation ...

HOW BLIND SPOTS ARE ELIMINATED IN THE LISSEN TUNER.

If the tapped and untapped portions of an inductance which is intended to cover a wide range are resonant to each other, signals over these particular resonant points will be seriously diminished in strength, and although the inductance would function after a fashion, it would be a common thing to find blind spots in such a poorly designed inductance—particularly on the shorter wavelengths. Each tapping point on the LISSEN TUNER is arranged so that the natural frequency of the untapped portion is not the same as that of the tapped portion, nor does it come within the band of frequencies which would be covered by the tapped portion when it was tuned by a condenser (otherwise a serious loss of signal strength in this case would also result). To make doubly sure the untapped portion of the LISSEN TUNER is short-circuited, which further eliminates the possibility of its having any resonant point. The LISSEN TUNER, besides being very efficient, is also convenient—covers 150 to 4,000 metres with a .0005 condenser (preferably use the LISSEN Mark 2 Mica Variable Condenser, price 17/6)—has a switch already mounted—no drilling—no soldering—high inductance for a given length of wire—**LISSEN ONE HOLE 22/6**
FIXING, OF COURSE ...

COILS IN LOOSE COUPLED CIRCUITS.

The use of a loose coupled tuner has the effect of isolating the aerial damping losses from the grid circuit, so that the grid circuit is not influenced by them, and can therefore be tuned up as sharply as the design of the coils employed will permit. Much of the advantage of a loose coupled circuit is lost, however, if there are damping losses left in the coils themselves. Some makes of coils do not tune very sharply, so that they do not afford the full advantages of the loose coupled circuit. LISSENAGON COILS, however, are ideal for use in this circuit, as owing to the negligible losses, and because also of the strong magnetic linkage between the coils themselves, extremely sharp tuning is possible, and the full effect of a loose coupled circuit obtained. **HOLD A LISSENAGON COIL UP TO THE LIGHT.**

MAKE YOUR BATTERIES LAST LONGER.

When using dull emitter valves, although the current taken per valve is small, yet it imposes a distinct drain on the cells. When a dry cell is switched on, the voltage gradually drops owing to polarisation process, but if it is given a rest the cell will recuperate, and its voltage will rise to normal again. If you work your cells for too long a stretch, the recuperation will be partial. If, for instance, one dry cell is worked to destruction, and two cells are worked alternately during the period of their life, it is a fact that they will last a good deal more than twice as long as the one cell worked continuously. And more efficiently also, because the voltage would be far steadier. It is an advantage, therefore, to use two sets of dry cells and to switch over from one set to the other by means of the LISSEN Two-way Switch. This takes up hardly any room. **LISSEN ONE HOLE FIXING, OF COURSE. 2/9**

LISSENAGON TUNING CHART. Note the Intermediate Coils, 30, 40 and 60

No. of coil	TABLE 1. Wavelength range when used as Primary Coils with Standard P.M.G. Aerial and .001 mfd. condenser in parallel.		TABLE 2. Wavelength range when used as Secondary Coils with .001 mfd. condenser in parallel.		PRICE
	Minimum Wavelength	Maximum Wavelength	Minimum Wavelength	Maximum Wavelength	
25	185	350	100	325	4/10
30	235	440	130	425	4/10
35	285	530	160	490	4/10
40	360	675	200	635	4/10
50	480	850	250	800	5/-
60	500	950	295	900	5/4
75	600	1,300	360	1,100	5/4
100	820	1,700	500	1,550	6/9
150	965	2,300	700	2,150	7/7
200	1,885	3,200	925	3,000	8/5
250	2,300	3,800	1,100	3,600	8/9
300	2,500	4,600	1,400	4,300	9/2

A SENTINEL BESIDE YOUR RECEIVER.

No difficulty will be experienced in cutting out any nearby broadcasting station. Most Morse interference will also be successfully eliminated. There is, however, a certain type of Morse interference which calls for greater skill. Even where the operator cannot quite get rid of all interference it can be subdued to the extent that it ceases to spoil reception of broadcasting. The LISSENCEPTOR is a useful thing to add to any receiver. It needs a separate condenser to tune it (preferably use the LISSEN Mica Variable Condenser Mark 2, 17/6). Lissenceptor Mark 1, for broadcasting, 7/6; Lissenceptor Mark 1, for 600 metres, 7/6; Lissenceptor Mark 2, for broadcasting and 600 metres combined (this type has a switch for more selective tuning) 15/6 The Lissenceptor Intercepts Frequencies.

LISSEN LTD., 30-32, WOODGER ROAD, GOLD-HAWK RD, SHEPHERD'S BUSH, LONDON, W.12.
Phone: 2339 Hammersmith. Telegrams: (Inland) "Lissenium, Shepherds, London." (Foreign) "Lissenium, London."
BUILD—WITH THE AID OF PREDOMINANT PARTS.

"The Result was Amazing"

"THE SOUND INCREASED ALMOST TWO-FOLD"

166, Church Road,
Upper Norwood, S.E.19.
29th Jan., 1924.

DEAR SIRS—
I bought a Thorpe K.I Valve last week. I had never heard of your firm, but was struck by your advertisement. Putting it as H.F. into a three-valve set in place of a standard make, THE RESULT WAS AMAZING. The sound increased almost two-fold in volume. I understand you are also making a detector, and when ready I shall make it my work to get one.

This testimonial is spontaneous and bona fide, and you can make what use of it you like.

Yours faithfully,
S. L. SALZEDO.

MESSRS. BOWER ELECTRIC, LTD.,
15, Grape Street, Shaftesbury Avenue, W.C.2.

(The original of this and hundreds of other testimonials can be seen on application.)

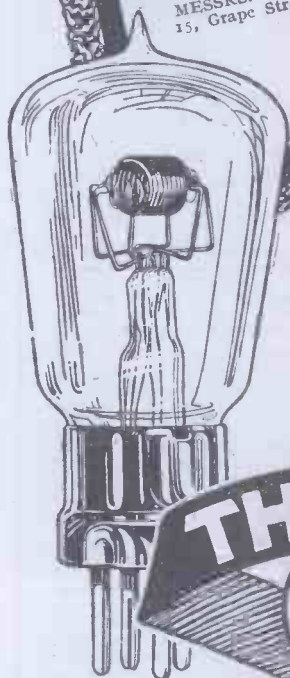

Consumption 0.42 amp. average.
Filament Voltage - 5.0 Volts.
Anode Volts - 50-100

ALL BRITISH.

EVERY VALVE STAMPED B.B.C.

Adaptable to every type of receiving circuit, but more especially to those employing dual amplification and super-regeneration.

THORPE K.I. VALVE

Obtainable of all Dealers or direct from the Sole Distributors for Great Britain and Ireland:— PRICE 10/-

BOWER ELECTRIC, LTD.

Offices, Works & Showrooms : 15, Grape St., Shaftesbury Avenue, W.C.2.

PARTS, COMPONENTS, SETS—they all sell equally well in WIRELESS WEEKLY.

Sparta LOUD SPEAKER

—for natural tone

With the "Sparta"—the speaker of combined excellence—there is never any suggestion of harshness. The tone is surprisingly rich, full and natural—in fact the degree of perfection achieved in this instrument must be heard to be appreciated. Why not attend a demonstration to-day?

Type "A" 120 ohms. ... £4 : 15 : 0
Type "H.A." 2,000 ohms. ... £4 : 15 : 0
Type "H.H.A." 4,000 ohms. ... £4 : 15 : 0
Type "B" 120 ohms. The first Loud Speaker to provide for additional control through a 6-position tone selector ... £5 : 15 : 0

Write to-day for Lists No. 315a.

Fuller's United Electric Works Ltd.
Woodland Works, Chadwell Heath, Essex.

Telephone :
Hford 1200 (6 lines).

Telegrams :
"Fuller, Chadwell Heath."

London
Depot :
88, High St.
W.C.2.

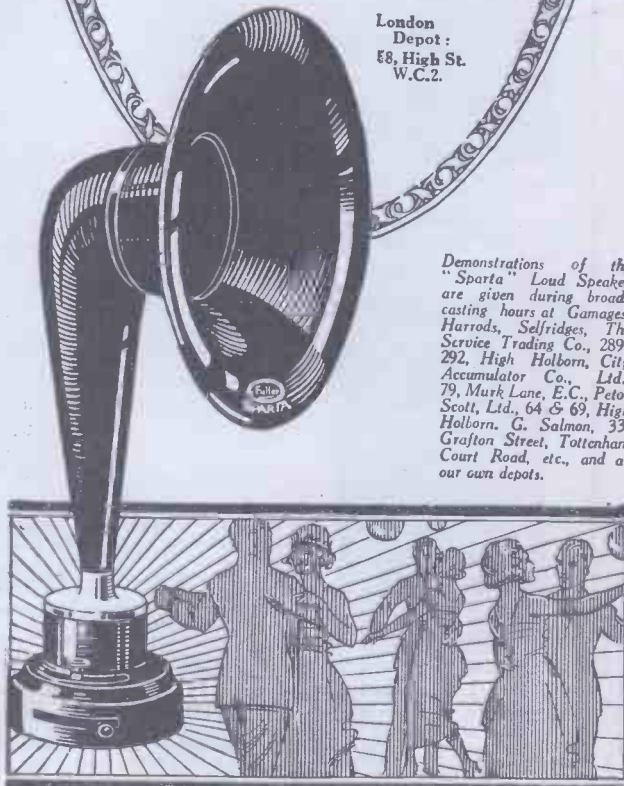

Demonstrations of the "Sparta" Loud Speaker are given during broadcasting hours at Gamage's, Harrods, Selfridges, The Service Trading Co., 289-292, High Holborn, City Accumulator Co., Ltd., 79, Mark Lane, E.C., Peto-Scott, Ltd., 64 & 69, High Holborn, G. Salmon, 33, Grafton Street, Tottenham Court Road, etc., and at our own depots.

HULLO, EVERYBODY!!

Post Free Column.

VARIABLE CONDENSERS.

Callers Only!

No Post Orders Executed at Callers Prices.

- Basket Coils (6) 200/3,600 2/6
- Waxless (5), 200/2,000M. 2/6
- Twin Flex, 12 yds. 2/-
- Bell Wire, D.C.C. I.R.O., 10 yds. 10d.
- 100 ft. Aerial, 7/22 3/3
- Rubber Lead-in, 10 yds. 1/6
- Basket Coil Holder and Plug 1/9
- Do., 2-way on Stand 5/9
- 2-way for Igranic Coils 4/11
- Various Designs do. 5/11, 6/11 & 7/-
- Shaw's Genuine Hertzite Spade Screw Terminals 1/3
- Pin do. doz. 1/6
- Ebonite Dial and Knob doz. 1/3
- Do., Extra Quality 1/6
- Ebonite Valve Holders doz. 1/3
- Do., Cut from Solid 1/6
- Valve Sockets, Best, doz. 1/3
- Do., Plain doz. 1/-
- Terminals, Telephone doz. 1/6
- Do., Pillar doz. 1/6
- Do., Small Pillar doz. 1/4
- Do., W.O. Patt. doz. 1/6
- (All above with Nut.)
- Insulating Sleeving, 3 yds. 1/3
- Tinned Copper, 3 yds., 14 or 16 gauge 9d.
- Do., 3 yds., 18 or 20 gauge 6d.
- Ebonite Coil Plugs, 2 for Do., on Stand 1/9
- 100,000 ohm Resistance Switch Arm, 12 Studs and Nuts 2/6
- Ormond Filis. Resistance Fixed Condensers, .001 Do., .001 to .0005 1/2
- Do., .002 to .005, 1/3, .006 (Above best quality.) 1/6
- Grid Leak and Condenser, .003 2/6
- Ebonite Varlo, D.C.C. 250/260 4/11
- Do., D.C.C. Ball Rotar Ebonite (Inside Winding) Variometers 6/9
- Contact Stops doz. 1/3
- Battery Clips doz. 1/-
- Coil, 26 tpgs., 1,600 M. 2/6
- 4 Whiskers, 1 Gold 6d.
- Spear Point Whisker 4d.
- 12 yds. Empire Tape 1/-
- Plug and Socket, 12 prs. Gecosite Crystal 1/6
- Minicap Switch 8/-
- Radio Ins. Transformer Igranic 8 threaded, L.F. 5-8 21/-
- Formo 8 threaded, do. 18/-
- Formo Open Type, do. 12/6
- Royal, do. 20/-
- Tested on Aerial, do. 12/8
- Raymond, do. 12/8
- Ormond Filis. Rheostat Raymond do. 2/-
- Rheostat and Dial 2/8
- Ajax 25.5 4/-
- Ajax with Vernier, 30.5 ohms 5/-
- Ajax Potentiometer, 464 ohms 6/8
- Igranic Rheostat 4/8
- Peerless Rheostat, 6 ohms 4/8
- Peerless 15 ohms 4/9
- Peerless 30 ohms 5/-

NEW MODEL, POST 6d. SET EXTRA.

Capacity.	Plates.	Price.
.001	49	7/11
.00075	37	6/11
.0005	25	5/11
.0003	15	5/3
.0002	11	4/11
.0001	6	4/3

One Hole Fixing.

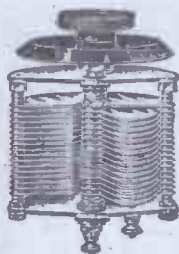

AS SHOWN with Knob and Dial.

NATIONAL LABORATORY CERTIFICATE.

Above new model specially adapted for taking up min. amount of space. All parts nickelled. PASSED NATIONAL LABORATORY TEST. One hole fixing.

HEADPHONES.	
Sterling B.B.C., high-class (4,000)	25/-
B.T.M., B.B.O. None better (4,000)	25/-
Brunet. Very fine value (4,000)	17/6
Brunet. for Crystal Sets (8,000)	19/11
N. & K., all stamped (4,000)	12/9
Sippe, very best	12/9

CRYSTAL DETECTORS.	
Post 9d. each.	
Glass enclosed Whisker, Brass Fittings, 1/9, 2/3, & 1/6	
Glass enclosed Perikon, with Zincite and Bornite 1/11 & 2/9	
Nickel enclosed, 3/6, 2/6, 1/11	
Edison Bell Twin 5/6	
Choice Designs, 5/- & 7/6	

Lissen Grid Leak (Var.)	2/6
Lissen Anode Resistance	2/6
Lissen T1 Transformer	30/-
Lissen T2	25/-
Lissen T3	16/6
Lissen Series Parallel Switch	3/9
Lissen Two-way	2/9
Lissenstat Minor. Out of 100,000 ohm Resistance	2/6
Edison Bell Fixed .001	1/3
Do. .001 to .0005	1/3
Do. .002 to .006	2/-
Do. .0003 and Grid Leak	2/6
Raymond Fixed .001	1/3
Do. .0002 to .0005	1/1
Do. .002 to .005	1/5
Do. .008	1/6
Do. .0003 and Leak	1/10
Dubilier Fixed .001	3/-
Do. .002 to .006	3/-
Do. .0001 to .0005	2/6
Do. .0003 and Grid Lk.	5/-
Phone Cords, 54 in.	1/3
Do. 72 in. Double	1/9
Variometer 250/650, 3/-	3/6
Do. Ebonite 250/650	3/11

H.T. BATTERIES.	
Post 1/- each.	
36 v tapped	5/- & 5/6
60 v tapped	9/6 & 10/6
Cheaper kinds usually in stock.	

DISCOUNT to TRADE and MEMBERS of Radio Clubs.

ERICSSON E.V. type, World Famous Continental Head-phones, 4,000 ohms.

13/9 Post 1/- per pair.

VALVES	
Marconi R. Ediswan	12/6
Mullard O. Cossor P.1. Cossor P.2.	
Post 1/- each.	

VALVES.	
Phillips R.	7/11
French R.	
No post Orders.	

DULL-EMITTERS. All makes in stock.

SNIPS I EBOHITE VARIOMETER	
250/260, Ball Rotar wound D.C.C. with knob	6/11
Post 1/-.	

N. & K. (The Goods)

Best. Stamped Genuine. 4,000 ohms 12/9 Pair. Post 1/- pair.

"A" TYPE. POST 6d. SET EXTRA.

Cap. Approx.	Plates.	Price.
.001	57	6/6
.00075	43	5/9
.0005	29	5/-
.0003	19	4/6
.0002	13	4/-
.0001	7	3/6

Vernier, 2/6. (No knob or dial.) Above "A" type is a wonderfully cheap and reliable condenser. One hole fixing. Thousands of testimonials from satisfied users.

SUPER CONDENSER WITH SINGLE PLATE VERNIER "IT" FOR VERY FINE TUNING.

.001	12/6
.0005	10/6
.0003	8/6

Post 6d. set extra.

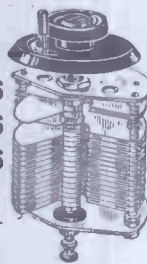

FILOSTAT FOR D.E. and R. VALVES	
Post 6d.	
each	2/6

EDISON BELL or IGRANIC VARIOMETER	
Inside winding including knob and Dial	
Post Free.	15/-

SNIPS I COIL HOLDERS.	
Plug-in type, Ebonite, Brass fittings on base.	3/3
Two-way	
Three-way	4/6
Post 1/- each.	

BASKET COILS	
Set of 6	1/11
Set of 7	2/3
Post 6d. set.	
to 3,600 metres	

WAXLESS. Set of 5 1/11 Set of 6 2/3 Post 6d. set.

This list is subject to alteration without notice.

All Post Orders from other Columns.

- Telephone, large each 11d.
- Telephone .. each 1d.
- Pillar .. 1d. & 11d.
- W.O. patt. .. 2 for 21d.
- Large size .. each 3d.
- Various doz. 1/- & 1/6
- Valve sockets doz. 10d. & 1/-
- Contact studs .. doz. 4d.
- 2, 4, 5, 6 B.A. Nuts 3 doz. 6d.
- 2 B.A. Rod .. foot 3d.
- 4 B.A. Rod .. foot 21d.
- Valve Pin .. 2 a 1d.
- Brass Bushes .. 1d.
- Spade Tags, best quality doz. 3d.
- Screw Spade Terminals 1d.
- Pin Screw do. .. 4 for 3d.
- Stop Pins .. 2 a 1d.
- Plug and Socket pair 11d.
- Easyfix Cup .. 11d.
- Switch Arms 8d., 9d. & 10d.
- Do., with 12 Studs and Nuts 1/-
- English Flash Lamp Batt. doz. 4/3
- H.T. Batteries, 36 v. 5/-
- H.T. Batteries, 60 v. 8/6 & 10/6
- Filament Res., with Dial 2/-
- Set of Names (12) .. 5d.
- 0-300 Dial .. 5d.
- Scales (Engraved 0-180) 3d.
- Multiphone Terminals 9d. & 11/-
- Insulators, Egg 6 for 6d.
- Aerial Wire, limited, 100 ft. 1/10
- Extra Hard Drawn, 7/22 100 ft. 2/6
- Valve Windows .. 7d.
- Res. Dials, 0-100 .. 4d.
- Ebonite Dial and Knob, 0-180 .. 1/1 & 1/3
- Filament do. and Knob 9d.
- Filament Dial, 0-10 .. 6d.
- Fixed Condensers to .001 10d.
- Ins. Screw Eyes .. 1d.
- 4 Cats Whiskers (1 gold) 3d.
- Gold Whisker .. 11d.
- Shaw's Hertzite .. 1/-
- Zincite 6d.; Bornite .. 1/6
- Coil Holders .. 1/1 & 1/3
- Coil Plugs, Ebonite 7d. & 9d.
- Do. on Base .. 1/- & 1/3
- Best Valve Holders .. 1/3
- 3 makes, above 10d., 1/- & 1/3
- Tinned Copper, 15, 18, 20g. Steaving, best .. 3 yds. 1/-
- Copper Foil .. 3 yds. 3d.
- Filament Res., good .. 1/6
- Rubber Lead-in 10 yds 1/- & 1/3
- Bell Wire, D.C.C. I.R.C., 10 yds. 5d.
- Twin Flex .. 12 yds. 1/6
- Heavy Rubber Lead-in yd. 2d. & 3d.
- Basket Coils (6) 200/3,500 1/9
- Waxless (5) .. 1/11
- D.P.D.T. Switches for Panel 1/6
- S.P.D.T. do. .. 1/3
- Telephone Cords 1/6 & 8d.
- Grid-Leak (2 meg.) .. 1/-
- Do., and Condenser .0003 1/9
- Empire Tape .. doz. 9d.
- Adhesive do. .. roll 4d.
- A.A. Earth Clips .. 7d.
- Washers, 2 and 4 B.A. 3 doz. 2d.
- 100,000 ohms Res. .. 1/6
- Fine Variometers .. 2/6
- Nugraving Set .. 71d.

Right Opposite DALY'S Gallery Door

K. RAYMOND 27, LISLE STREET, W.C.2

Phone: Gerrard 4637.

HOURS OF BUSINESS:

Daily - 9 to 7.45
Sundays 10.30 to 1

EDISWAN

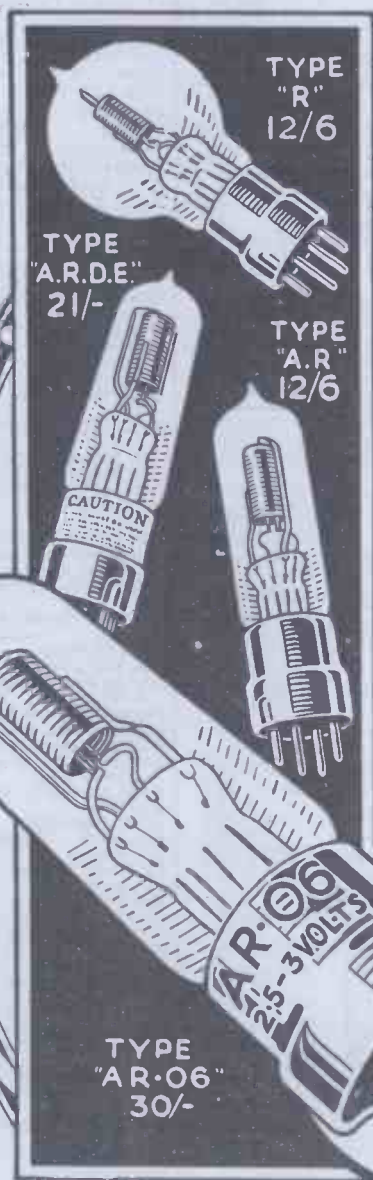

-for accuracy

Unmistakable indications of accuracy and meticulous attention to detail, are manifest in "the valve with a name behind it." Made in the same factory as the famous "Ediswan" Lamps, full advantage is taken of the manufacturing experience and research which has made the name "Ediswan" famous as a guarantee of perfect satisfaction. Ediswan Valves are preferred by all discriminating experimenters and such convincing results as the following soon confirm the wisdom of their choice.

"Leicester, February 6th, 1924.

"A.R. Valves.

"I am able to receive all B.B.C. Stations on my two Valve Set H.F. and Dect. home made. I have now had these two valves in constant use since last May, which speaks only too well of their good quality and long life. I consider them superior to any other make on the market.

L. RENALS."

Have you had your FREE copy of illustrated booklet "The Thermionic Valve"? If not, send a postcard to-day

Your Dealer holds stocks to supply you. If not, write us direct, giving his name & address

The safety cap (Prov. Pat.) which is now fitted to all Ediswan Valves. The filament pins are shorter in length than the plate and grid pins, thus avoiding any chance of making surface contacts with the wrong sockets.

THE EDISON SWAN ELECTRIC CO., Ltd.

Contractors to H.M. Admiralty, War Office, Royal Air Force.

123/125, Queen Victoria St., E.C.4, and 71, Victoria St., S.W.1

Works: Ponders End, Middlesex.

Branches in all Principal Towns.



Buy British

Goods Only.

PARTS, COMPONENTS, SETS—they all sell equally well in WIRELESS WEEKLY.

GENTS MANUFACTURE AND STOCK
"Tangent Transformers"
 for Radio Outfits

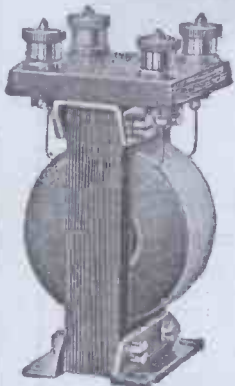

THE "TANGENT"
 L.F. TRANSFORMER

Fitted with or without terminals.
 Insulation perfect and guaranteed permanently and fully efficient.
 Connections clearly marked for identification.
 Every transformer is individually TESTED FOR SILENCE AND SPEECH.



THE DISCOL
 H.F. TRANSFORMER

Fitted with strong, real ebonite checks, unbreakable.
 All wavelengths from 275 to 4,000 metres.
 Is recognised as a standard fitment.

British Broadcasting is received on every Transformer before despatch.

Send for Leaflets "W."

GENT & CO., Ltd., Faraday Wks., LEICESTER—Est. 1872
 LONDON—25, VICTORIA ST., S.W.
 NEWCASTLE-ON-TYNE—"TANGENT HOUSE," BLACKETT ST.

You need this Book



The "BBL" Booklet of Wiring Diagrams is appreciated by thousands of Radio enthusiasts. In showing all the components required in their relative positions for wiring up, the diagrams are extremely simple to follow. From all Wireless Dealers 1/- each.

VALVES
 for DRY CELLS



B.T.H. Valve, Type B.5. Takes only .06 of an ampere, and can be operated from standard dry cells. Fitted 4-pin cap, thus obviating use of special adapter. No. 17276 ... Price 30/-

Mullard D.F. Ora Valves for use with dry cells. Very little current is required (.06 amps.) for Filament, yet results are of the highest efficiency. No. 17252 ... Each 30/-

Ashley Filament Resistance. Evenly wound upon heat resisting former, and splendidly finished. Highly efficient. No. 16820 ... Each 4/6



Brown Brothers with which is amalgamated Thomson & Brown Brothers
 Wholesale only. Head Offices & Warehouses: Ltd.
 Great Eastern St., London, E.C.2.
 118, George St., Edinburgh, and Branches

We desire to warn the public that cases of infringement have been brought to our notice. If any doubtful crystal is sold to you as "Talite," for your own protection it is requested that you send us full particulars of the purchase together with the name and address of the dealer concerned.

TRADE **TALITE** MARK.

IS STILL THE GREATEST CRYSTAL THAT HAS BEEN INTRODUCED INTO TELEPHONY, AND THE ONLY CRYSTAL USED BY THE ALLIED ARMIES THROUGHOUT THE WAR

"Talite" will resist the heavy plate current of a reflex circuit as well as the most violent atmospherics.

ALL OTHER CRYSTALS SUPPLIED.

Large specimens of "Talite," as well as our Super-Crystal-Hertzite supplied direct at 1/6 each post free, or from all reputable dealers.

TRADE ENQUIRIES SOLICITED.

SUPPLIED IN BOXES BEARING OUR OFFICIAL STAMP.

SOLE SELLING AGENTS:

HARDING, HOLLAND & FRY, LTD.,
 27, GARLICK HILL, LONDON, E.C.4.

Telephone: City 591, 2146.

Telegrams: Seedtime, London.

PARTS, COMPONENTS, SETS—they all sell equally well in WIRELESS WEEKLY.

3

first-class Receivers

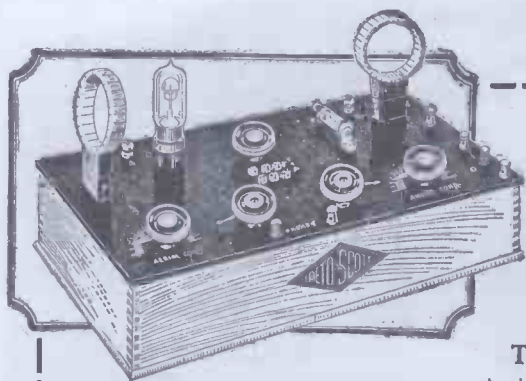

The Peto-Scott One-Valve Reflex.

A one-valve set with an excellent reputation. When used with a good Aerial this Receiver will pick up every B.B.C. Station and will operate a Loud-Speaker within 5 miles from the nearest one. Can be used as a Crystal Set only or with one L.F. Valve, or as a reflex merely by switches. Complete set of parts for home assembly (Marconi royalty paid) with full instructions and wiring diagram. .. £4 7 6
 Polished cabinet to fit .. 7 6
 Finished Instrument, aerial tested (Marconi royalty paid) .. £7 12 6

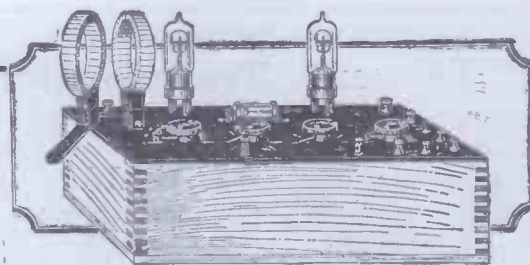

The wonderful S.T.100 with full instructions.

This Receiver easily operates a Loud-Speaker 40 miles from B.B.C. Station, and will pick up every B.B.C. station together with most Continental stations.
 Although only two valves are used, the circuit gives an efficiency of approximately four valves with a marked economy in the first cost and upkeep. Complete set of parts, with blue prints containing full instructions for wiring and assembly, including crystal detector, two variable condensers, two rheostats, two Max-Amp transformers, two coil holders, valve sockets and terminals, etc. £4 17 6
 Polished cabinet 7 6
 Finished Instrument (aerial tested) .. £8 5 0
 All Marconi royalties paid.

The All-Wave Receiver.

As designed by Mr. Scott-Taggart, F.Inst.P. and fully described in the February issue of "Modern Wireless." This set is particularly stable and free from risks of self-oscillation—as such it is excellent for long distance work. Complete Set of parts, including variable resistance, variable grid leak, two variable condensers, Max-Amp transformer, fixed condensers, two-coil holders, terminals, valve sockets, etc., together with wiring diagram and all instructions. (Marconi royalties paid) .. £6 6 0
 Polished cabinet extra .. 7 6
 Finished Instrument, aerial tested (Marconi royalty paid) .. £9 10 0
 Panel alone, engraved, drilled and tapped, together with wiring and assembly instructions 17s. 6d.

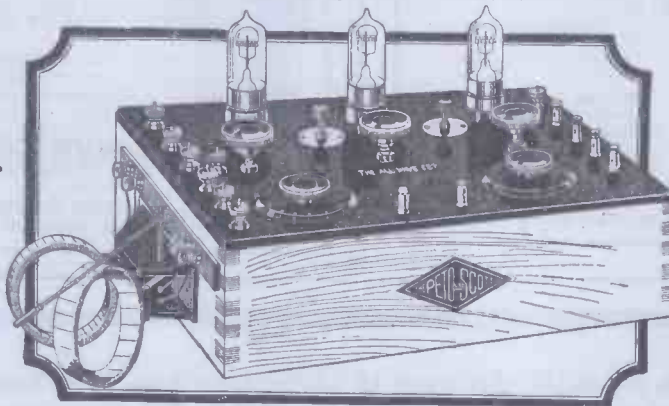

Send 3d. to-day for a copy of our 48-page Catalogue. Fully illustrated.

Peto-Scott's Wireless Book costs 1/3 (post free 1/5) and contains over 80 circuit Diagrams. Send for a copy to-day.

"MAX. AMP." POWER TRANSFORMER.

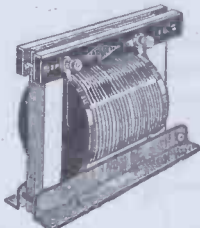

A very substantial power transformer for use with heavy currents. Gives wonderful amplification with a total absence of distortion. Can be used with ordinary valve if required. Superbly finished. 30/-

"MAX. AMP." TRANSFORMERS.

Finest quality intervalve Transformer. Laminated stalloy core, well insulated windings, tested to 500 volts between windings. Outer layers protected with protective cord winding. Very silent in action and free from all distortion. Carries our full guarantee. Primary wound silk covered wire. 18/6 each



CHOKE COIL (for S.T.100 Star.)

Specially designed to take the place of intervalve transformers for Low-frequency amplification.

Price 7/6

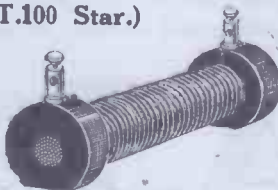

FRAME AERIALS.

Excellent folding frame aerial—can be instantly taken down and packed away. Most convenient design. Special construction permits aerial being swung to point in any direction without lifting off the table. Complete set of parts and full instructions. All machine work and polishing already completed, 27/6; wound and assembled, 37/6.
 Special Note.—We will assemble in our own workshops the first 50 Frame Aerials ordered in Sets of parts. Send your order to-day and take advantage of this exceptional offer.

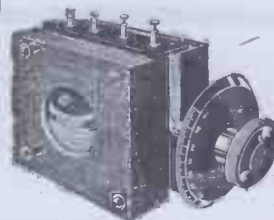
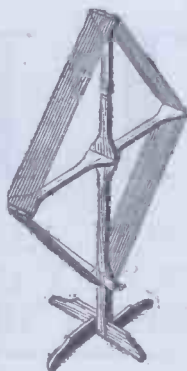

"VARIOBLOC" VARIOMETER.

An internally wound Variometer of high efficiency, conforming to the latest American Practice. Permanent contacts made with copper strip. Fitted with terminals and brass rod so that it can be instantly converted into a Vario-coiler. Made in two patterns:
 No. 1—250-720 metres } 17/6
 No. 2—250-840 metres }
 (Fitted with engraved dial as shown.)

PETO COILS.

Highly efficient Coils at a moderate price.



Wave-length in metres.	Price.
No. 1 290-390	2/-
No. 2 340-470	2/6
No. 3 420-650	3/-
No. 4 570-900	3/6
No. 5 780-1,140	4/-
No. 6 1,100-1,850	5/6
No. 7 1,800-3,000	6/3
No. 8 3,000-4,050	7/-

Engraved Terminals for Omni Wave Set.

These terminals are mounted in pairs and engraved as indicated. All terminals necessary for building the complete Set are supplied and numbered according to Mr. Scott-Taggart's plan. Price 9d. each (containing 2 terminals).



PETO-SCOTT Co., Ltd., 64, High Holborn, W.C.1.

Head Office:

Branches: Cardiff: 94, QUEEN STREET.
 Liverpool: 4, MANCHESTER STREET.
 Plymouth: Near DERRY'S CLOCK.
 New Branch: 230, WOOD ST., WALTHAMSTOW, E.

Demonstration Lounge: 99, HIGH HOLBORN, W.C.1. (For all Mail Orders.)

A Valve for Every Wireless Circuit



The two masters

There he is, the new Caruso, pouring out his soul in notes of exquisite beauty.

All the long years of training, of aspirations, of ambitions are summoned and a masterpiece is rendered—to a microphone.

And to a microphone it will remain, *unless* in your receiving set, in every valve socket, there is the *other* masterpiece.

It is called a Mullard valve.

Profound research, extensive manufacturing facilities and wide experience, make every Mullard valve a *master* valve.



THE MULLARD D.F. "ORA,"

a dull filament receiving valve.

ANODE VOLTS	20/100
FILAMENT VOLTS	2/3
FILAMENT AMPS... ..	0.05

Accumulators unnecessary. dry cells sufficient.

Price **30/-**

A Master Valve.

ALL DEALERS STOCK THEM.
ASK FOR THEM BY NAME.

Mullard
THE · MASTER · VALVE

Adv. The Mullard Radio Valve Co., Ltd.,
Nightingale Works, Nightingale Lane, Balham, S.W.12.

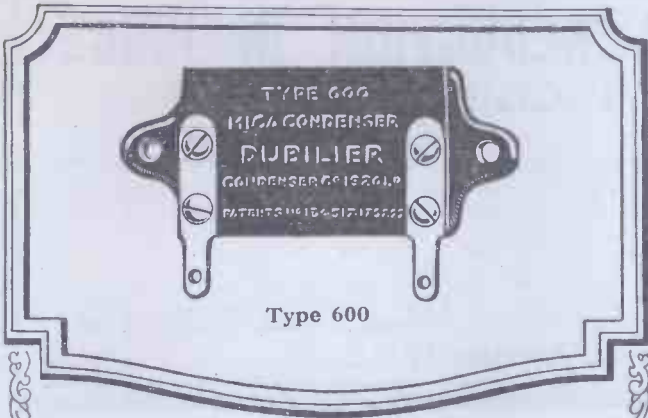

Type 600

Do you know—

That the insulation between the plates (the dielectric) of the 600 condenser is of selected RUBY MICA ?

That the moulded case prevents leakage between the terminal strips ?

That the condenser "unit" is held tightly clamped together, making variations of capacity impossible ?

That the condenser will withstand a test voltage of 1,000 volts ?

That the public is demanding these condensers at the rate of 15 every minute of the working week ?

THE DUBILIER CONDENSER CO.

(1921) Ltd.

Goldhawk Road, Shepherd's Bush,
LONDON, W.12

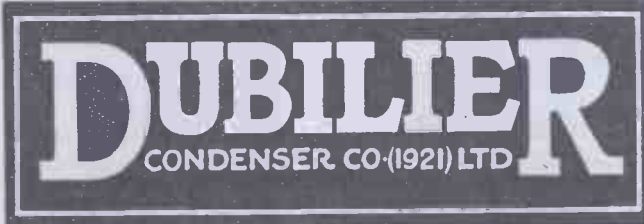

E.P.S.44.

PARTS, COMPONENTS, SETS—they all sell equally well in WIRELESS WEEKLY.



SUBSTANTIAL REDUCTION IN PRICE

BURNDEPT COILS (Patents 168249 & 191550)

OWING to the world-wide demand for Burndept Coils necessitating greatly increased production, we have been able to effect economies in manufacture. The Burndept policy is to pass on to the public the benefit of any such economies, by reducing their list prices and so enable the wireless enthusiast to purchase efficient apparatus at the lowest possible prices.

Extra Short-wave coils, 80-150 metres each 4/3
Concert coils, for all British Broadcast each 4/3 Set of 4 16/-
Set of 4 16/-

Particulars of other Reductions in Price may be had on application.

BURNDEPT

WIRELESS APPARATUS

BURNDEPT LTD., Head Office: Aldine House, Bedford St., Strand, London, W.C.2.

'Phone: Gerrard 9072.

Dead accurate— setting & re-setting

The Bowyer-Lowe Condenser with Vernier will definitely increase the efficiency of ANY set to which it may be fitted.

This because the high capacity ratio represents a longer wavelength range than that possessed by any other condenser, and because the mechanical operation of the Bowyer-Lowe instrument gives unique advantages:

Dial indicates setting of both main plates and vernier. Main condenser CANNOT move while Vernier is being operated.

Send card NOW for brochure explaining just why Bowyer-Lowe Condensers will make your set better. A postcard with your name and address brings prices and all information.

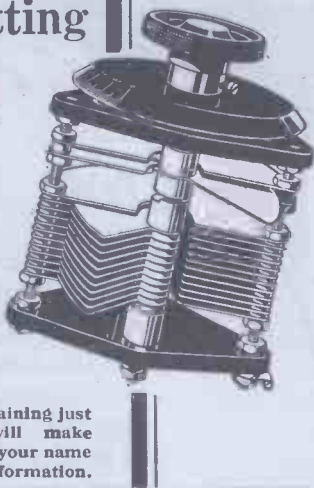

Bowyer-Lowe Tested Variable Condensers

London Retail Agents, from whom all Bowyer-Lowe products may be obtained: Hamley Bros. Ltd., 200/202, Regent St.; Bond's-o'-Euston Rd. Ltd. 254 Euston Rd.

Bowyer-Lowe Co. Ltd., Letchworth

EXPERIMENTERS

Write for list of our Testing Equipment for every purpose.

Scrap Your Crystal

WITHOUT SUBSTITUTING VALVES

The Permion Detector, the latest scientific achievement, signs the death warrant of the old-fashioned crystal uncertainty!

NO ADJUSTMENT NEEDED
Automatically gives clearest tone.

1. Permanent adjustment (abolishes crystal and cat's-whisker).
2. Improves with age.
3. Perfect clearness of tone.
4. Louder reception.
5. Where two or more valves are used one can be dispensed with, giving increased efficiency and consequent saving in upkeep.
6. Where one valve is used the Permion Detector is as good as another valve but, of course consumes no current.
7. Increases range of reception.

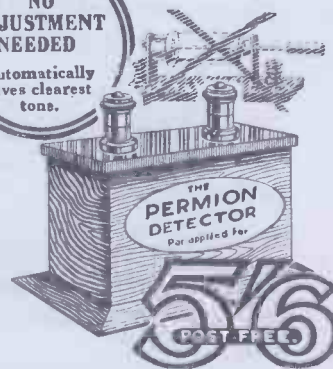

THE NEW PERMION DETECTOR

The Soul of Clarity.

Send P.O. to-day. Money Refunded if not absolutely satisfied.

If able to call at the Western Union Showrooms in Regent Street, the extraordinary advantages of the Permion Detector will be gladly demonstrated without obligation.

**WESTERN UNION WIRELESS COMPANY,
99, Regent Street, London, W.1.**

'Phone: GERRARD SEVEN THOUSAND.

"EL-BE MODERN" TUNER

Polished Stand
Ebonite Plugs
and
Terminal Panels

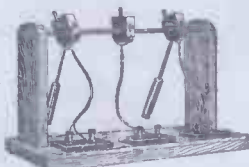

Handles lock
in
any position
Reduced Price
15/- each
Post free

EL-BE Patent VALVE HOLDER (Ebonite) "Legless & Harmless."

Impossible to put FILAMENT across Plate Voltage
Remove Screws and Holder is its own jig for drilling panel



Your Dealer will supply you

LEIGH BROS.,
37, Sidmouth Street, Gray's Inn Road, LONDON, W.C.1.

Price 1/5 Post free

Telephone: Museum 4192.

THE ORIGINAL AND GENUINE BUS BAR

"RADIOHM" 1/8" Square Tinned COPPER ROD

We were the first to place this wiring rod within reach of the British Constructor. Many soft substitutes have since appeared, but "Radiohm" is still the best. It is stiff and sturdy and stays put. It is really square.

It is the finest wiring rod for the Omni Circuit.

REDUCTION IN PRICE. SEND FOR PAMPHLET. Having placed large contracts for the supply of this wiring rod we are able to announce reduction in price. We could offer a cheaper wire, but we prefer to maintain the quality.

1 Dozen 2-ft. lengths, 2/-. Postage and packing, 3d.

"RADIOHM" STRIP COPPER AERIAL is just as good. 3/- per 100-ft. reel. Postage 5d.

SPARKS RADIO SUPPLIES

(Dept. W), 43, GREAT PORTLAND ST., LONDON, W.1
TRADE SUPPLIED. Telephone: Langham 2463.



—and the night shall be filled with music.

*“And the night shall be filled with music;
And the cares that infest the day
Shall fold up their tents like the Arabs,
And as silently steal away.”*

YES! Only the home possessing a Radio Receiver is fully equipped to charm away all the little cares and worries which tend often to make life a burden.

But to obtain the maximum enjoyment from Broadcasting only reliable apparatus should be used. The Valves, for instance, must be ready at the snap of a switch or the twist of a rheostat to give you faithful and unvarying service for many, many months.

One of the recognised strong points of the Cossor Valve is its extremely

long life. This is entirely due to the filament which—arched like a bridge—is entirely self-supporting.

Obviously any Valve with a long straight filament, constantly stretching and contracting as current is passed through it, must eventually either sag or fracture.

When buying your first Valve or replacing an existing one, make sure you choose a Cossor. In spite of its innumerable advantages, it costs no more than an ordinary Valve.

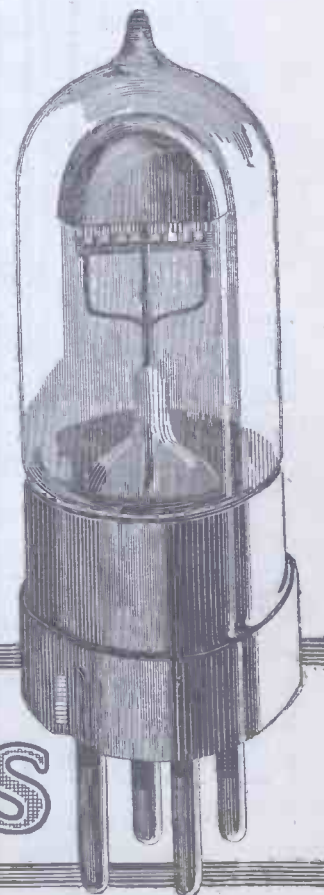

A. C. Cossor Ltd.
Highbury Grove,
London, N.5.

TYPES:
Pr. For Detector and L.F. use **12/6** Pz. (With red top) For H.F. use **12/6**

Sold by all
Wireless
Dealers.

Cossor Valves



THIS IS THE
"MORRIS"
 (ALL STEEL)
VALVE
TEMPLATE

No Centre Punch required,
 no instruments.
 Post Free
10½d.

NOTE THE ADDRESS:
NICHOL & CO., 46, Lancaster Av., Fennel St., Manchester



Soy Colored
 to your dealer
 you'll get the
Best Crystal there is

TRADE ENQUIRIES INVITED
N. HEYWOOD INVENTOR & SOLE
 MANUFACTURER
 386 Richmond Road,
 Twickenham, Middx.

PER BOX
16
 LARGE P.L.C.

Patents, Designs & Trade Marks.

H. D. FITZPATRICK & Co.
 - Chartered Patent Agents -
 49, Chancery Lane, LONDON. 'Phone: Holborn 459.

MAKE SUCCESSFUL SETS



Components make or mar your set. Make sure beforehand by buying parts which are used and specified by foremost experimenters. Every one tested before despatch. Electrical and mechanical accuracy guaranteed. Special dinged components for board mounting are easiest of all to assemble, and most handsome in appearance.

WRITE FOR LIST.—A postcard brings our complete list of Tested Components. Write for it now.

BOWYER-LOWE CO., LTD.,
 RADIO WORKS, LETCHWORTH

BOWYER-LOWE COMPONENTS



CABINETS YOU WANT

PICKETT'S Cabinets—they're good value, from 1/6 each, highly polished. Cabinet Works, Albion Rd., Bexley Heath, S.E. Write for Lists W.L.

Fix your crystal in



GOLD SEAL PLASTIC METAL
 the best contact possible, and get LOUDER & CLEARER SIGNALS.
 Contains no mercury. Of all Wireless Stores.
 Enough for 3 cups **6d.** per packet.
 Wholesale enquiries (or sample packet 6d.) to
S. LEVY, 53, BEN JONSON ROAD, LONDON, E.1.

Radio Press Information Dept.

2/6 QUERY COUPON 2/6

WIRELESS WEEKLY. Vol. 3. No. 18. April 9, 1924.
 (This coupon must be accompanied by a postal order of 2/6 for each question, and a stamped addressed envelope.)

Charge your ACCUMULATORS at HOME for a FEW PENCE by the

L O N G T O N
I M P R O V E D
E L E C T R O L Y T I C
C H A R G E R
 (FOR USE ON A.C. SUPPLY.)

NOTHING TO ADJUST—
 SILENT—NO MOVING PARTS

Price **£5 15 0**

SENT ON TRIAL FOR 1 WEEK
 And money returned if not satisfied

H. LONGTON,
 Manufacturing Electrical Engineer,
 43, Johnson St., Westminster, S.W.1.



REPAIRS TO HEADPHONES
 TO LOUD SPEAKERS
 TO COILS

REWOUND to any RESISTANCE & MADE EQUAL to NEW.
 PRICE QUOTED ON RECEIPT OF INSTRUMENTS.
 PROMPT DELIVERY.

Established 26 Years. 'Phone: Woolwich 888.

The VARLEY MAGNET COMPANY
 WOOLWICH, S.E.18.

E B O N I T E

Sheet rod and tubing in all sizes kept in stock and cut to any required size while you wait, or sent by post on receipt of cash.

WE CAN TURN ANYTHING IN EBONITE.

BURGE, WARREN & RIDGLEY, LTD.,
 91/92, GREAT SAFFRON HILL, LONDON, E.C.1. 'Phone: Holborn 50.

FINEST WORK & PROMPTITUDE.
 INCOMPARABLE
 WHITE
 FILLING.

ENGRAVING

HAND AND MACHINE
 ON ANY MATERIAL.

'Phone Central 1137.
CLIFFT & COCKLE,
 51, Arcade Chambers, St. Mary's Gate,
 MANCHESTER.

CAM-OPERATED VERNIER COIL HOLDER.

Quality
 RADIO



The usual fixed socket has a very slow movement giving a microscopic adjustment in both directions through 10°. This is effected by a cam operated by a separate knob.

Price, 2 way (only) 7/6, on base 1/- extra. Post 3d.

With Reaction Reverse and Short-Circuiting Switch, 12/6.

GOSWELL ENGINEERING CO., LTD.,
 12a, PENTONVILLE ROAD, LONDON, N.1.
 Liberal Trade Terms. 'Phone: North 3051.

WIRELESS APPOINTMENTS

WE GUARANTEE ALL OUR STUDENTS
 GOOD BERTHS WHEN QUALIFIED.
No Waiting List of Unemployed.

For Prospectus apply:

WIRELESS COLLEGE, CARDIFF.
 Principal: Hon. Lt.-Comdr. J. R. Schofield, M.B.E.

*This multi-valve receiver
grew from the crystal-set
below!*

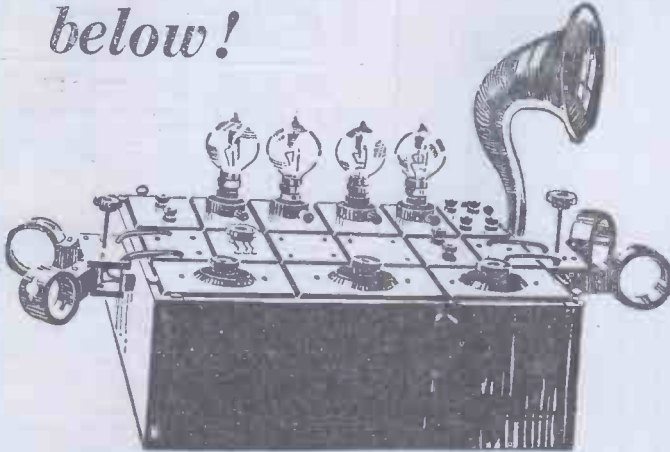

*You can build this
Four Valve set—*

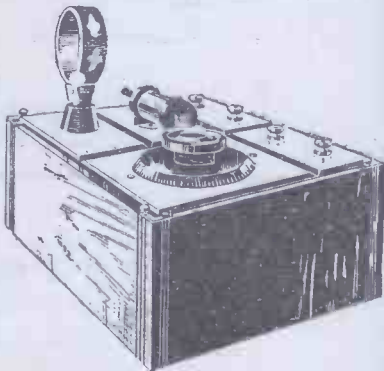

*by starting with this
Crystal Receiver.*

**USE THIS
COUPON**

Please send **POLAR BLOK BOOKLET**,
for which is enclosed 5d.

Name

Address

**POST
TO-DAY**

*It was built by an amateur
without tools or special knowledge.*

Like you—like hundreds of other enthusiasts he was wise enough to want a wireless set, and too wise to buy a ready-made, rigid and costly affair which might be satisfactory, but which could never be more than what it originally was. He was too keen to be restricted to fixed circuits built by engineers—he wanted to build and to learn, to experiment and to extend from a crystal to whatever greater achievement he might afford.

So he chose the system of

POLAR BLOK
ELASTIC SET CONSTRUCTION

With a screwdriver, pliers, common sense and an inexpensive set of Polar Blok standard frames, panels and components he set to work—and in one evening finished his crystal receiver in time to hear the last two items from 2LO.

For a month he enjoyed and experimented, all the while purchasing by degrees further frames, panels and accessories from his Polar Stockist. To-day most of his Crystal Set components form part of the efficient 4 valve Polar Blok Receiver illustrated above—built without tools or engineering skill, yet giving him everything he needs in broadcasting.

*Get particulars of Polar Blok from your local
Polar Stockist or send the coupon on this page.*

RCC
RADIO COMMUNICATION
COMPANY, LTD.
34-35 NORFOLK ST. LONDON, W.C.2

Branches
NEWCASTLE: 21 Colinton St.
GLASGOW: 27 Queen Street
CARDIFF: 49-51, High Street
LIVERPOOL: 12 Colton St.
SOUTHAMPTON: 21 Queen Terrace

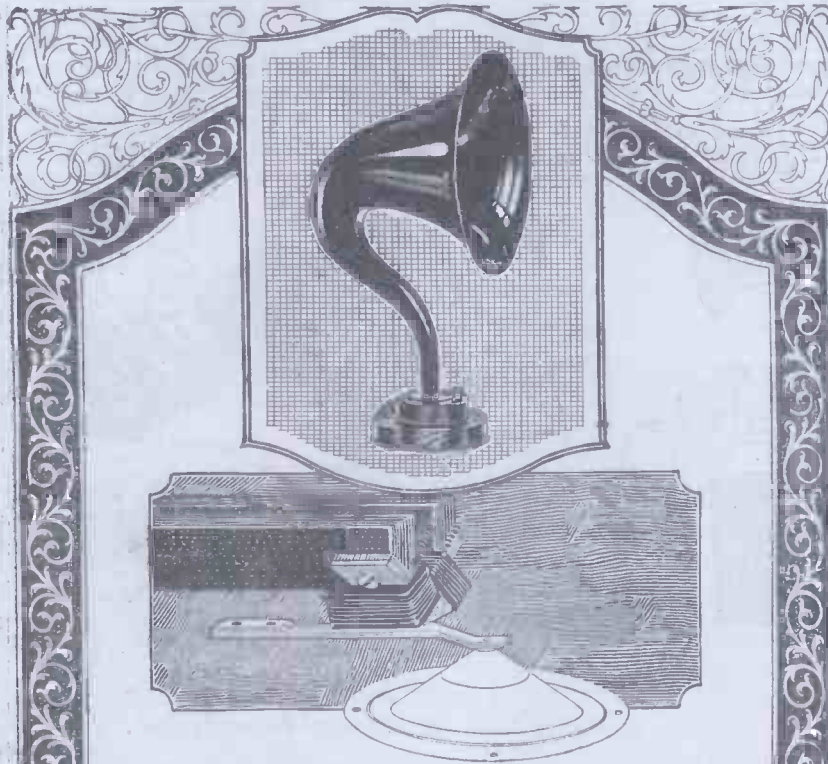

—this shows the vital difference between the Brown and all others.

NO other Loud Speaker can approach the Brown for volume and purity of tone because the principles employed are totally different.

Instead of an ordinary flat diaphragm (usually of soft iron) attracted in two places by the poles of a magnet, the Brown uses a vibrating reed. In the illustration above you will notice that instead of the diaphragm being attracted to the poles of the magnet, it is the reed that is attracted. At the end of the reed is anchored the centre of a cone-shaped aluminium diaphragm spun to the thinness of paper.

It is due to the sensitiveness of the moving reed and the flexibility of the aluminium diaphragm that the Brown Loud Speaker can give such truthful tone renderings.

Remember, the purchase of a Loud Speaker is an investment—if you select a Brown you will know that you have chosen the one approved by music critics and those who are in a position to judge.

S. G. BROWN, LTD., VICTORIA RD., N. ACTON, W.3
Retail: 19, Mortimer St., W.1. Liverpool: 15, Moorfields.

PRICES:

Model H1.	21" high.
120 ohms...	£5 5 0
2,000 ohms...	£5 8 0
4,000 ohms...	£5 10 0
Model H2.	12" high.
120 ohms...	£2 5 0
2,000 ohms...	£2 8 0
4,000 ohms...	£2 10 0

Brown

WIRELESS WEEKLY SMALL ADVERTISEMENTS

WANTED, STUDENTS for Wireless—Appointments; we find berth when qualified; situations waiting now; prospectus free.—Wireless Training College, Lansdowne Road, Bournemouth.

BROWN'S A 8,000 Headphones. Few pairs ex-W.D. Guaranteed O.K., 35/- pair. Registered post, 9d.—Williams, 99, Keogh Road, London, E.15.

1/16" SQUARE TINNED COPPER WIRE Finest quality at cheapest price. 1/9 per dozen 2 ft. lengths. Postage 4d. extra. Special terms to the Trade.—Bowyer-Lowe Co., Ltd., Letchworth. London Retail stockists—Hamley's, 200, Regent Street, W. Bonds, Ltd., 254, Euston Road.

TELEPHONE RECEIVERS and Loud Speakers Rewound, 2,000 ohms. 3/6.—A. Roberts & Co., 42, Bedford Hill, Balham, S.W.12.

AGENTS WANTED for special new line Wireless Crystals on commission basis. Only live men need apply.—Write, giving full particulars to Box 1644, Hart's Advertising Agency, 93/4, Chancery Lane, W.C.2.

WIRELESS Stampings at cut prices on 100 gross orders, to customer's own design. Sample Contact Tabs, 2 or 4 B.A., 3 doz. Stamped envelope.—Hoare & Bellamy, 61, Como Road, S.E.23.

PAPIER MACHE Loud Speakers, unsurpassed for true and natural sound, £2 2s. complete; height, 22 in.; Horn only 17/6; carriage paid. Trade inquiries invited.—KERNAHAN, 45, Elm Road, New Malden, Surrey.

Leadership

IN every sphere of life or field of business, one man or one firm leaps to the front.

LEADERSHIP, however, creates responsibilities. We realise ours, and appreciate that our duty to the ever increasing number of readers of *Modern Wireless* and *Wireless Weekly* lies in maintaining the high standard of quality prevailing at their inception.

RADIO PRESS LTD.

Devereux Court, Strand, W.C.2.

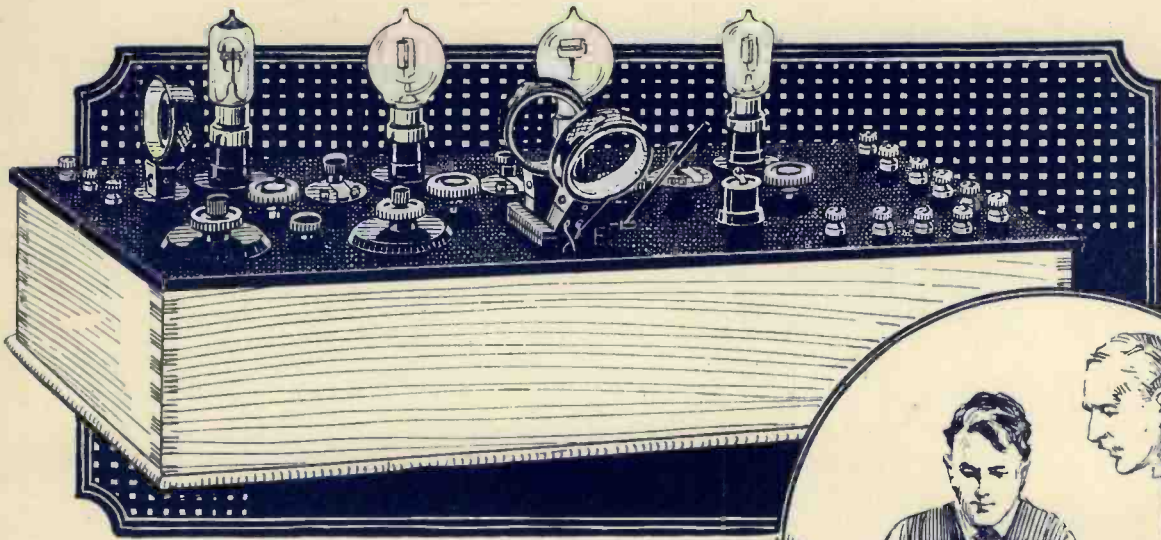

Even if you've never built a Set before . .

THERE are still plenty of Wireless enthusiasts who have still to build their first Valve Set. If they are afraid that they lack skill, here is a new method which will certainly smooth out difficulties.

Radio Press have issued two envelopes (No. 1 deals with the S.T. 100 Receiver). Each contains blue prints showing the lower side of the Panel and also the upper portion. All wiring connections are plainly indicated so that it is absolutely impossible for a wrong connection to be made.

Enclosed also is a portfolio with full instructions for assembly and operating. Nothing, in fact, has been omitted in an endeavour to make Set-building really simple.

Magazine articles are often, through exigencies of space, kept somewhat brief, and points which might prove difficult to the novice are overlooked.

In this envelope scheme, however, Radio Press are confident that, at last, a method has been devised whereby anyone can build up a first-class Receiver, professionally designed, at a most moderate cost.

The family four-valve Set shown above gives excellent Loud-Speaker volume, yet, by means of switches, any combination of Valves from one to four can be used at will.

Also on sale:

"How to Build an S.T. 100."

This envelope contains full instructions, together with set of blue prints and working diagrams for building up the S.T. 100. Remember this Set uses only 2 Valves, yet will receive every B.B.C. Station and work a Loud-Speaker with good volume at 50 miles. Price 1/6 (1/9 post free).

RADIO PRESS LTD., DEVEREUX COURT, STRAND, W.C.2.

2/6

Envelope No. 2

How to make A Family Four-Valve Receiver

By Percy W. Harris.

Post free 2/9

The World's Transformer

Our new 50-page
(T2) Catalogue
free on request.

25/-
One price, One quality

IT is recognised that an L. F. Transformer gives higher amplification than any other form of L. F. Intervalve coupling; it is therefore essential that the best transformer only should be used. This is less important where a single stage is employed, but absolutely vital if more than one stage is used. Perfect results with an R. I. Transformer are certain. Wireless dealers realise this, and therefore recommend the R. I. Transformer when they want their customers to be satisfied.

R.I. TRANSFORMER ADVANTAGES:—

- Its unique system of winding.*
- Its extremely large copper and iron area.*
- Its enormous amplification.*
- Its freedom from distortion.*
- Its capability of taking high voltages.*
- Its robustness and its absence of internal noises.*

CHEAPEST IN THE END.

RADIO INSTRUMENTS LTD.

Managing Director—J. JOSEPH, M.I.E.E.
Chief Designer—W. A. APPLETON, M.B.E., M.I.R.E., late Admiralty Tech. Research Officer.

Works, Offices and Showrooms:

12, HYDE STREET, NEW OXFORD STREET, W.C.1.

Telephone: Regent 6214-6215-6216.

Telegrams: "Instradio, London."



Wireless Weekly

and the Wireless Constructor.

Vol. 3.
No. 19.

CONTENTS

- A Practical Double Reaction Receiver.
- Neutrodyne Control in Valve-Crystal Circuits.
- Screening L.F. Transformers.
- A Detector and Note Magnifier Circuit on the Omni Receiver.
- Thermionic Valves with Dull-emitting Filaments, Random Technicalities, Valve Notes, A Good Fifty ohm Rheostat, C.W. and Telephony Transmission using Valves, etc., etc.

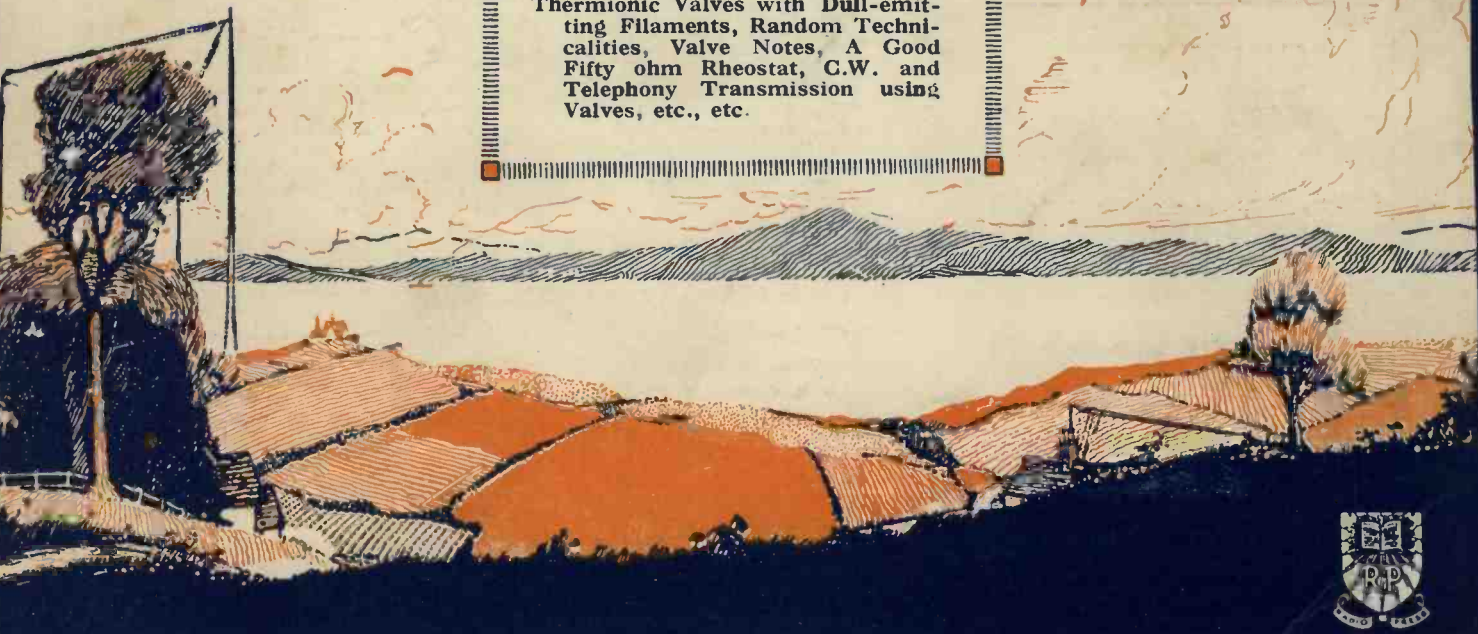

A New Armstrong Super-Heterodyne

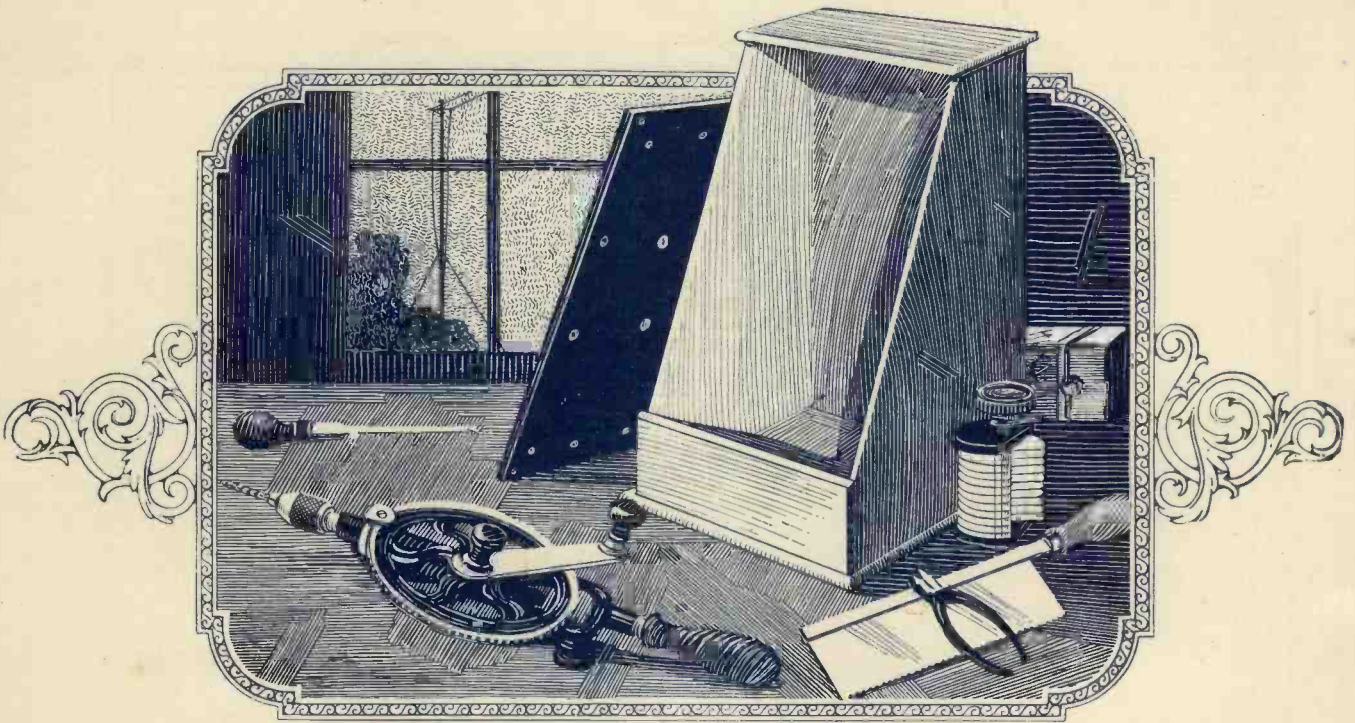

Wireless Sets for Home Constructors

By E. Redpath.

CONTENTS

Simple Crystal Receiver
 An inductively coupled
 Crystal Set
 Testing and operating
 Crystal Sets
 A 2-Valve L.F. Amplifier
 Adding amplifiers to
 Crystal Sets
 A 2-Valve Broadcast
 Receiver
 A 3-Valve Regenerative
 Receiver
 A 1-Valve Reflex Receiver
 A 3-Valve Broadcast
 Receiver
 A 4-Valve Universal
 Receiver

—from a simple Crystal Set
 to a four-valve Receiver

CONSTRUCTIONAL Books have already been published which deal with simple Receiving Sets and also with more elaborate ones, but this is one of the first R.P. Books in which the reader is given a choice of both types of Sets.

Obviously a Book dealing with such extremes as simple Crystal Sets, which can be constructed in an hour or two, to a complex and ultra-efficient 4-Valve Set is a very useful adjunct to any Wireless enthusiast's Bookshelf.

Its frank advice and help in the choice of Sets to build will be appreciated by the complete novice, while the more expert will be glad to have authentic constructional details of the more advanced models capable of receiving American Broadcasting with certainty.

From all Booksellers or post free direct 2/8

RADIO PRESS, LTD. - Devereux Court,
 Strand - W.C.2

Series No. 17

2/6

Books like this make set building easy



Wireless Weekly

Vol. 3, No. 19
April 16, 1924

CONTENTS

	Page
Editorial	610
A Reflex Super Heterodyne	611
Device for the Automatic Simultaneous Tuning of Two or More Wireless Circuits	612
Jottings by the Way	613
An Experimenter's Unit Receiver	615
Neurodyne Control in Valve-Crystal Circuits	616
A Detector and Note Magnifier Circuit on the Omni Receiver	618
Random Technicalities	619
All B.B.C. Stations on a Loud-Speaker (Conclusion)	620
C.W. and Telephony Transmission Using Valves	623
Screening L.F. Transformers	625
A Good Fifty Ohm Rheostat	627
A Double Reaction Receiver	628
Valve Notes	631
Thermionic Valves with Dull-Emitting Filaments	633
The Radio Society of Great Britain	635
Correspondence	636
Apparatus We Have Tested	639



Editor: JOHN SCOTT-TAGGART, F.Inst.P., A.M.I.E.E.

Assistant Editors { P. W. HARRIS.
E. REDPATH.

Radio Press, Ltd.

Publishers of Authoritative Wireless Literature.
DEVEREUX COURT, STRAND, W.C.2

Tel.—Central 3763.

Advertisement Managers: } SCHEFF PUBLICITY ORGANIZATION,
LTD., 125, Pall Mall, London, S.W.1
Tel.—Regent 2440.

Staff Editors:

E. H. CHAPMAN, M.A., D.Sc.
A. D. COWPER, M.Sc.
G. P. KENDALL, B.Sc.
R. W. HALLOWS, M.A.
S. G. RATTEE, M.Inst.Rad.E.

Advisory Editors:
Prof. R. WHIDDINGTON,
M.A., D.Sc.

Prof. C. L. FORTESCUE,
M.A., M.I.E.E.



All correspondence relating to contributions is to be addressed to the Editor of "Wireless Weekly."

Nothing contained herein is to be regarded as permission or encouragement to infringe any patent rights.



The Mullard Result and the Moral

THE Marconi *v.* Mullard action for the alleged infringement of two of the plaintiff's patents has now been finally decided in favour of the Mullard Radio Valve Co. The High Court, the Court of Appeal, and now the House of Lords have, in turn, given judgment to the effect that the Mullard valves do not infringe the Marconi patents.

The action is undoubtedly one of the most important of recent years, and we believe we are right in saying that the defendant company are the strongest opponents the Marconi Co. have yet had to face.

Patent litigation, at all times, is highly unsatisfactory. It is extremely costly, and in the present case we would not be surprised to find that the financial loss to the Marconi Co. was very appreciable. A sum of £20,000 is not infrequently the price paid for a defeat in the House of Lords, and for this reason only the largest organisations can take the risk.

The threat of patent litigation is the terror of many of the smaller manufacturers, and it is interesting to note that several firms have submitted to judgment when the Marconi Co. have sued them for infringement of patents, including the very ones which have been mentioned in the Marconi *v.* Mullard action.

There is always a tendency for a large corporation, holding many patents, to dominate the whole industry, and therefore there is often much rejoicing when a strong defendant company decides to fight to a finish, and especially if it wins.

The result of this case is ample proof of the desirability of healthy competition amongst manufacturers, and also points a moral. An amicable settlement is usually much better than a legal fight, in which there is always an element of doubt. There are many further patents which may, or may not, be of value, and in these cases a settlement on a reasonable royalty basis is usually preferable to litigation. The days of patent monopoly have gone, and

yet it is extremely likely that patent litigation will continue.

We are happy to note that the manufacturer of broadcast apparatus is in a much more satisfactory position than he used to be. The Marconi attitude has completely changed in this direction, and from what we know of the operation of the Department concerned, manufacturers are treated in a very fair manner. A royalty of 12s. 6d. per valve holder is imposed, which is really a very reasonable sum when it is remembered how great the expense has been to place the art in its present position. The average manufacturer would be in a poor plight if he had to pay royalties to some half-a-dozen owners of patent rights. Fortunately for him, most of the patents are the property of the Marconi Co.

As regards the larger interests, there are evident signs that the opposition is stiffening very considerably, and quite probably on-lookers will be entertained by a series of legal fights which may result in a more even balance of power. The defendant of to-day may be the plaintiff of to-morrow.

The King's Speech.

We strongly appeal to dealers and others who will be giving public demonstrations with loud speakers at the time of the broadcasting of the King's Speech to take the utmost care in arranging for pure and, as far as possible, distortionless reproduction. Immense harm has already been done by overloaded and mishandled loud-speakers, and the opinion is generally expressed that "all loud-speakers distort." That this is far from being the case is known to all genuine experimenters.

If very great volume is required, the only satisfactory method is to run a number of loud-speakers in parallel.

A Reflex Super-Heterodyne

MAJOR ARMSTRONG'S LATEST INVENTION.

EDITOR'S NOTE.—The supersonic heterodyne receiver, imagined by many experimenters to be the "last word" in short wave radio-frequency amplification, has now been improved by a special form of reflexing which enables us to obtain with six valves results which were previously only obtainable with eight or nine. The article below gives sufficient practical details for the experimenter to grasp the fundamentals.

THE word "super" attached to wireless circuits and receivers has been so frequently used within the last year or two that we are in danger of overlooking the fact that there are at least two receivers which really justify the name. Both of these are the invention of Major Armstrong, the well-known American inventor. The first, the supersonic heterodyne, more frequently abbreviated to "super-heterodyne," has well



Fig. 1.—Showing how the signals are amplified at radio frequency.
R.F.=Radio Frequency.
I.F.=Intermediate Frequency.
OSC.=Oscillator Valve.

been named the "Rolls Royce" of radio, for by its aid we are able to obtain true amplification on wavelengths as short as any so far used. The second, also emanating from Major Armstrong, is the super-regenerative receiver. This last came into great prominence a year or two ago owing to the enormous amplification possible with a single valve. A few months' practical experience with the super-regenerative receiver showed us that whilst with careful adjustment and manipulation it was possible to obtain this enormous amplification, yet the practical difficulties in the way of its use quite out-balanced the benefits obtainable.

The Super-Heterodyne

The super-heterodyne, however, has remained very popular with the more advanced experimenter, and deservedly so, for once it has been built, its manipulation is simple and sure. Briefly explained, it consists of a simple

receiving circuit tuned to the incoming frequency and a separate oscillator adjusted to such a frequency that the beat note produced between the oscillation frequency and that of the incoming signal gives a frequency corresponding to a much longer wavelength. Thus we may tune signals of a wavelength of 100 metres, and by means of the separate oscillator "beat-up" these signals to a frequency corresponding to, say, 2,000 metres.

Stable R.F. Amplification

Radio-frequency amplification on the longer waves is a relatively simple and stable matter, so that once we have produced a frequency corresponding to the longer waves we can amplify this at radio-frequency in several stages, finally rectifying the radio-frequency signals so produced by means of a valve detector. On top of this, further

frequencies corresponding with, say, 100 metres.

An Example

A ten-valve Armstrong supersonic heterodyne may consist in this manner of a detecting valve, an oscillator valve, five radio-frequency stages, a second detector, and two audio-frequency stages. With such a receiver it is possible to receive short wave signals from the other side of the Atlantic on a small frame aerial at sufficient strength to operate a loud-speaker. The re-broadcast signals from KDKA and WGY have been frequently received in this fashion by the British Broadcasting Company.

A very important improvement on the original supersonic heterodyne has now been produced and perfected in the United States. The inventor of the modification is Mr. Harry Houck. This improvement was made after carry-

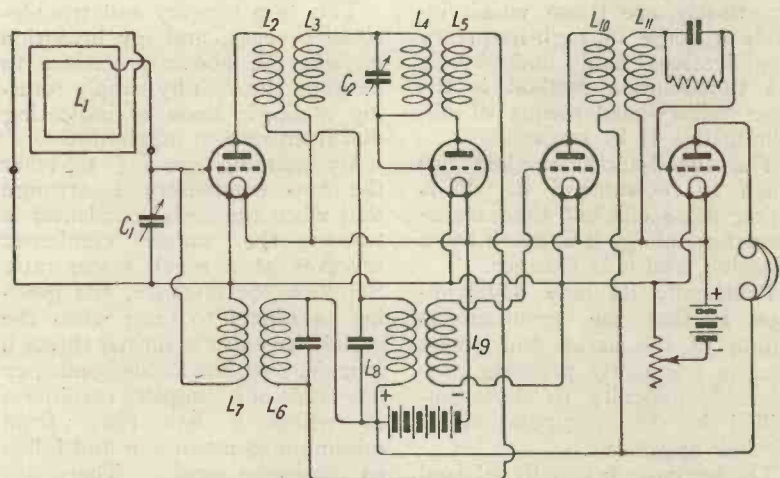

Fig. 2.—The theoretical circuit. C1 tunes the incoming signals, and C2 controls the oscillator frequency.

audio-frequency amplification may be imposed if necessary. The result is that we can obtain genuine radio-frequency amplification of very short waves without the difficulties inherent in the amplification of the very high fre-

ing out experiments with radio-frequency amplification of the incoming signal before it is heterodyned by the oscillator. The use of radio-frequency amplification at the incoming frequency has been developed in this country by

a number of amateurs, and it is found to help the sharpening of the tuning. Mr. Houck, in trying to simplify the circuit, found that the use of the second harmonic was a practical solution of the problem.

A Simplified Diagram

The diagram in Fig. 1 shows how the oscillator valve may be used to amplify. As will be seen, the first valve amplifies at radio-frequency, and is coupled to the oscillator valve by a short-wave radio-frequency transformer. Passing through the oscillator, the incoming signal is heterodyned and its frequency reduced by the well-known beat method. The second harmonic of the oscillator frequency is used to give the beat frequency. The output of the oscillator passes through an intermediate frequency transformer, which is connected to the first valve reflex fashion, so that it amplifies at two frequencies simultaneously. From the out-

put circuit of the first valve the intermediate frequency passes through another transformer and is further amplified by the third valve, then detected by the detector valve and amplified at audio-frequency through the last two valves. For simplicity the last stages of audio-frequency amplification have been omitted from the drawing, as they represent nothing new in the way of technique. The general working can be understood by examining Fig. 2.

Extreme Sensitiveness

The new arrangement is stated to be extremely sensitive, its main advantage being that it requires only six valves to do the work of eight or nine, if these were arranged in the ordinary standard super-heterodyne circuit.

Although the circuit would appear at first glance to be rather complicated, it will be noticed that there are only two variable

condensers, C₁ and C₂. C₁ tunes the frame aerial circuit to the incoming frequencies, while C₂ controls the beat frequency. The radio-frequency transformers are of the semi-a-periodic type and do not need individual tuning, the condensers across them being fixed.

On the Market

The new modified supersonic heterodyne is already sufficiently developed to place on the American market, and it has been found practicable to incorporate the receiver, batteries, and a suitable frame aerial in one cabinet. The receiver has but four exterior controls, i.e., the two variable condensers and a pair of filament resistances, one of which controls the filaments of the high-frequency and detector valves, and the other those of the audio-frequency valves.

There are certain features of the circuit which require elucidation, and we hope to publish further details later.

Device for the Automatic Simultaneous Tuning of Two or more Wireless Circuits

PROBABLY the most useful and popular wireless circuits to-day are those which include a stage of high-frequency amplification, and undoubtedly the tuned-anode method is the most widely-used means of obtaining this H.F. stage.

The tuned-anode method has much to recommend it. It is rather more efficient than transformer coupling, it is much more selective, and it is cheaper.

Practically its only disadvantage is that the simultaneous tuning of the aerial and anode circuits frequently presents considerable difficulty to those unskilled in the manipulation of wireless apparatus.

The beginner is usually advised to adopt the following procedure:—"With the aerial condensers (or variometer) set at zero turn the anode condenser (or variometer) from zero to maximum. If no signals are heard, advance the aerial condenser a few degrees and again turn the anode condenser through

its whole range, and so on until the desired station is picked up."

This is a lengthy and troublesome process, and my invention enables the above procedure to be gone through by simply rotating a single knob or indicating dial from zero to maximum.

By suitably gearing together the two condensers I arrange that when the aerial condenser is turned the anode condenser revolves at a much faster rate. Suppose, for instance, the gearing is ninety to one; when the aerial condenser is turned through four degrees, the anode condenser has made one complete revolution in which it has risen from minimum to maximum and fallen to minimum again. Therefore, for every two degrees the aerial condenser turns the anode condenser goes through its whole range of capacity.

Thus, by turning the aerial condenser from zero to maximum the whole range of wavelengths of the instrument is thoroughly explored, the anode circuits

coming into tune with aerial circuits once every two degrees the aerial condenser is turned, which is fine enough for ordinary work. Of course, by increasing the ratio of gearing, the tuning can be made as fine as desired.

The arrangement can be applied to condensers, variometers, or any other similar tuning devices.

In some cases it may be preferable to reverse the gearing, so that it is the anode condenser which revolves slowly.

J. F. JOHNSTON.

"Modern Wireless"

BACK NUMBERS.

We shall be pleased to hear from any reader who is prepared to dispose of his copy of the September issue of "Modern Wireless"—Vol. 1, No. 8.

Communications should be addressed to our Sales Department and should mention the price required for the copy, which, of course, must be in good, clean condition.



Fashion's Fancies

Radio has its fashions just as much as dress or the method of doing one's flowing locks. In this country we have perhaps hardly felt the full effects of crazes in fashion, but America, which had a good year's start of us in the way of broadcasting, has been very badly bitten by what the Yanks picturesquely call the radio bug. Over there it is practically impossible for even the wildest and most extravagant of enthusiasts to keep pace with the changing wireless fashions of the day. A circuit is published and boosted up until it becomes the rage. Everybody sets out to make it up, but long before they are half way through the job it has retired into the background in favour of another one with still greater merits. Every one is called a super-something. The first to start the craze was Armstrong's Super-Regenerative.

A New One

Then came one which, though it could not boast a super to its name, did at all events go in for rather a forbidding title—I mean the Neutrodyne. This was followed by a whole crowd of supers, from which the Super-Heterodyne emerged as perhaps the top-notch circuit, for to possess one was to be stamped with a hall mark of up-to-date-ness. Thousands of Super-Heterodynes were ordered, tens of thousands of constructors started out to make them, and all who purchased or began to make are now shedding scalding tears of rage, for the Super-Plodyne, whose name is a terrible example of the Latin-Greek hybrid of which science is so fond, has stepped in to claim to be the very latest and most fashionable thing in wireless. The name means, if it means anything at all, to signify "extraordinarily more" powerful. An American friend wrote to me only

the other day to say that the Super-Heterodyne which he had ordered would have a range of 2,000 miles without either aerial or earth, so what the Super-Plodyne, which he has doubtless be-spoken by this time, will do I shudder to think.

Why, Oh, Why!

Myself, I often wonder why the world in general and Americans in particular are so keen upon having immensely powerful sets. Over there the difficulty is not to bring in more than one broadcasting station but rather to avoid doing so, for there are more than 500 working on a band of wavelengths about equal to our own; even with a single high-frequency valve and a straight circuit you frequently have the Presidential address to which you want to listen inextricably mixed up with a little chat on hygienic feeding bottles to which you do not, which must be rather trying. Broadcasting is all very well, but what we want is "narrow catching," and it is very hard to get that if you go on increasing the sensitiveness of your receiver.

An Idle Boast

Much the same thing happens over here in the case of those enthusiasts who boast proudly (I do it myself) of their ability to run round the broadcasting stations. When all is said and done, the only one that is really worth listening to, if you are out to hear music and not merely to hear wireless, is that which is nearest to you. Whenever you try to get the others, especially very distant ones, you must ginger the set up so much that it invariably brings in all kinds of mush. Still, there is no accounting for tastes. Now Poddleby, though he professes to be musical, would far rather listen to a wheezy concert from Aberdeen with a spark-signal *obbligato* all the time than to a perfectly clear transmission

from 2LO. To tune in 2LO, so he says, is so easy that he really cannot take any pleasure in listening to it. If there was a still more distant station on 600 metres I feel quite sure that Poddleby would always go for it, despite the ceaseless efforts of GNF. and the ships that spark in the night.

Insult to Injury

I wrote a little time ago, more in sorrow than in anger, about the crime wave which seemed to be sweeping over the makers of components, under the influence of which they were apparently cudgelling their brains to find ways of driving the luckless constructor to distraction. Recently I had a horrible experience with a variable condenser. It was a beautiful thing to look at, and I anticipated with great joy the smoothness of its working when it should be fitted to the new set that I was making. In its stout and solid aluminium top were two tapped holes for the fixing screws. I drilled holes in my panels and proceeded gaily to insert a couple of trusty 4 B.A.'s. Nothing doing. Inspection showed that the holes were 5 B.A. I heaved a little sigh, but was not downcast, for it is surely an easy task with a drill and tap to change 5 into 4 B.A. Very well. I stuck in a No. 35 drill and went to work whistling a merry tune. Perhaps I was too enthusiastic in the pressure that I exerted, for somehow that drill went through with a bang and dented in the top plate so successfully that the moving vanes were locked as if held in the jaws of a vice. Nothing daunted, I removed the stout top plate and proceeded to care for the injured vane. At the end of about six hours I had the thing working again. I was not to be caught this time. I drilled the other hole out with extreme care.

Then I inserted a tap which had done months of good service. A twist to the right, half twist to the left, a twist to the right, half a—snap! And there I was with a little piece broken from the end of the tap firmly fixed in the hole. Ever tried to get a tiny portion of broken tap out of a hole? No? Then take my advice and do not. You cannot get hold of it with anything, you cannot drill it out because it is too hard; in fact, nothing short of dynamite will remove it, and dynamite is not good for condensers. Oh, yes, I know the obvious solution; drill and tap a new hole in the aluminium. Quite so, but in my fair ebonite panel I had already made two holes, and I did not want any more. I think I found the only possible solution. I flung the condenser through the window, which happened to be closed, though I had not noticed it, and went out to buy a new one. When I returned with a new one at 8.15 pip emma I found, as you may guess, that I had no 4 B.A. tap. You smile; very well, smile. True, I had no tap, but I brought back some 5 B.A. screws. I am writing this on the first of April, and I cannot resist the spirit of the day.

True Genius

I was immensely tickled by an account in the newspapers of the fellow who styled himself an in-

spector of the B.B.C. and went round to various houses striking terror into those who were using unlicensed sets. Now that I call a real stroke of genius. He knew human nature pretty well, and the only mistake he made was in being overactive in the same district. Apparently his *modus operandi* was simply to notice which houses sported aerials and then to ring the front door bells. If a licence was produced, well and good. But apparently he had not far to go before he discovered that he was in a pirate's lair. His demand for the production of a licence having been met with "hums" and "ha's," and a reddening of the countenance of the unlicensed, he was at once able to assume a beautiful dictatorial manner and to hector for all he was worth.

Inspiration

Naturally, he clicked every time. His doings inspire me to deal thusly with my friend Radiating Rupert, who lives just across the way and makes every night hideous with his welkin-rending howls. I shall borrow a tram conductor's uniform and make some B.B.C. badges with aluminium paint. Disguised with a neat beaver and an Old Bill moustache, I shall call upon Rupert and threaten him with such horrible things that he will forthwith forswear all his scan-

dalous proceedings. It is quite possible that I shall meet Little Puddleton's arm of the law in the shape of P.C. Bottlesworth in Rupert's back parlour, and that he will use as evidence against me anything that I say. But I care not a jot. If I can terrify Rupert it is worth even fourteen days without the option. If I can carry the thing off well I may even be able to strike fear into the sturdy soul of Bottlesworth himself by threatening to charge him with the crime of being an accessory to the fact in that he (shades of the Great War) at 9.30 p.m. on such and such a day at Chirpsqueak Little Puddleton, in the County of Mudshire, knowingly and wittingly assisted to spread alarm and despondency amongst the inhabitants of the town by condoning flagrant oscillation on the part of the co-defendant, to wit (I feel almost bound to add "to whooo") Rupert Knobwangler, of the aforesaid address. If I know anything of Bottlesworth he might be the more terrified of the pair. Everything depends upon the impressiveness of my uniform and of my facial fungus. If any ex-officer who served with the Allies during the War has by any chance the uniform of a Samoan field marshal I should feel vastly obliged if he would lend it to me for one night only.

WIRELESS WAYFARER.

Standard Coil Connections

WHEN mounting a set of home-made coils upon the standard plug fitting it is extremely desirable to adopt some universal convention for the connections. If this is done, all the coils of the series will behave similarly as reaction coils, and also as primary and secondary coils, when they are used as transformer couplings. The relative novice is often very much puzzled by the peculiar effects which result from the use of a series of coils whose connections are not uniform, especially in the case of sets using one or more H.F. valves. In such sets very erratic reaction effects may be

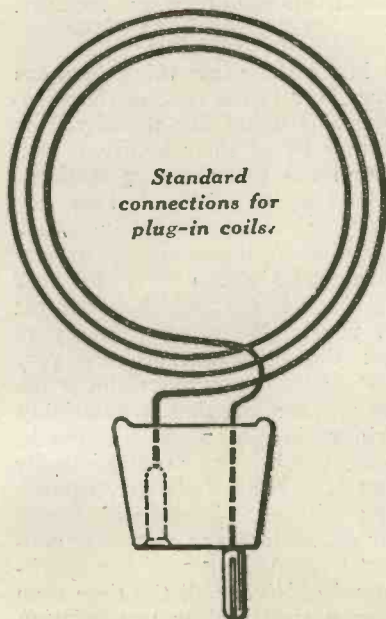

produced by the capacity between the coils when they are wrongly connected for magnetic reaction. It is best to adopt the same convention as that used by the manufacturers of coils, in order that the home-made ones may be interchangeable with bought coils, and the standard connections are as follows:—When the coil is held with the pin of its plug mounting towards the right and the socket to the left, the current flows clockwise upon entering *via* the pin and leaving from the socket. It is immaterial whether the inner or outer end of the coil be connected to the pin or socket, so long as the correct direction of rotation is preserved.

The figure shows the standard arrangement diagrammatically.
G. P. K.

An Experimenter's Unit Receiver

By H. BRAMFORD.

The following is a description of the tenth unit of the receiver, the series having begun in Vol. 3, No. 9.

Unit No. 10

THIS unit consists of a potentiometer, a photograph of the complete unit being shown in Fig. 44.

Materials Required

- 1 piece of Ebonite, 6 in. x 4 in. x $\frac{1}{4}$ in.
- 6 Terminals.
- 2 Stop Pins.
- 1 Scale Reading.
- 1 Ebonite Knob bushed 2 B.A.
- 1 Pointer.
- Some No. 40 Resistance Wire.
- 1 Wire Bobbin.
- Nuts and Washers, etc.

Panel Drilling

The panel is drilled in accordance with the details shown in Fig. 45. Four holes are drilled



Fig. 45.—Lay-out of the panel.

to clear the screws of terminals T1—T4. The centre hole is drilled to receive a 2 B.A. clearing bush. Two further holes are drilled to clear the screws of two stop pins, which are placed in a corresponding position to the perforations in the scale reading.

The Winding

The potentiometer former may be made either from a wooden bobbin about 4 in. long, or from a flat piece of ebonite, 4 in. x $1\frac{1}{2}$ in. x $\frac{1}{2}$ in. In either case the process of winding is similar. Procure some resistance wire of fine gauge, say, No. 40, and wind closely upon the former for a distance of about 3 in., leaving $\frac{1}{2}$ in. of former clear each end. Secure the beginning and finish of the windings by passing each end through a small hole drilled for that purpose at each end of the former. Next make two side

supports, as shown in Fig. 46, and secure one to each end of the former by means of small brass screws. These end pieces should preferably be of ebonite. The terminal T5 is secured to one end piece, as shown, and terminal T6 is secured to the other. The beginning of the winding is then held between a washer and T5; the end of the

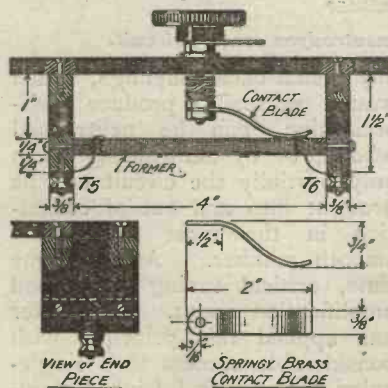

Fig. 46.—Details of side support and method of mounting arm.

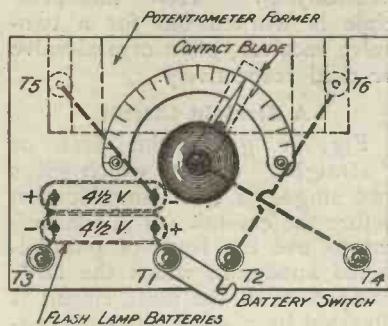

Fig. 47.—Under-panel connections.

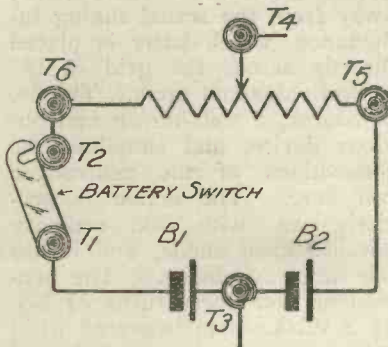

Fig. 48.—Theoretical circuit.

winding being held in a similar way to T6. The wound former

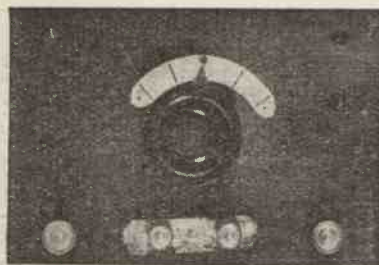

Fig. 44.—The potentiometer unit.

is now ready for assembling on the underside of the panel.

Assembly

First mount upon the panel the terminals T1 to T4. Next secure the scale reading by means of the two stop pins. The contact blade is assembled, as shown in Fig. 46, the centre hole in the panel being first fitted with a 2 B.A. clearing bush. The contact arm, which should be of corresponding dimensions to those given in the diagram,

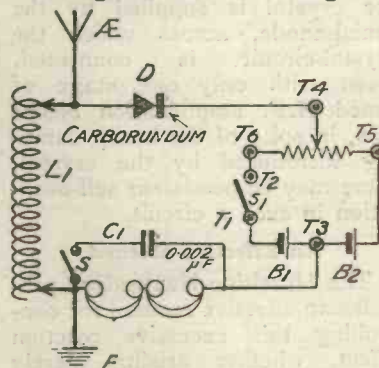

Fig. 49.—The connections for use in a crystal circuit.

should be made of springy brass. Place the wound former on the underside of the panel, in the position shown, and secure by means of small brass screws which pass through the panel into the side supports.

The connections are as shown in Figs. 47 and 48.

Operation

A simple crystal circuit, showing the use of a potentiometer, is shown in Fig. 49. The crystal indicated is of the carborundum type. The crystal cup is connected to T4 of the potentiometer and T3 is connected to the 'phones. When this unit is not in use it should always be remembered that the switch between terminals T1 and T2 should be broken and telephones disconnected, otherwise the battery current will be wasted.

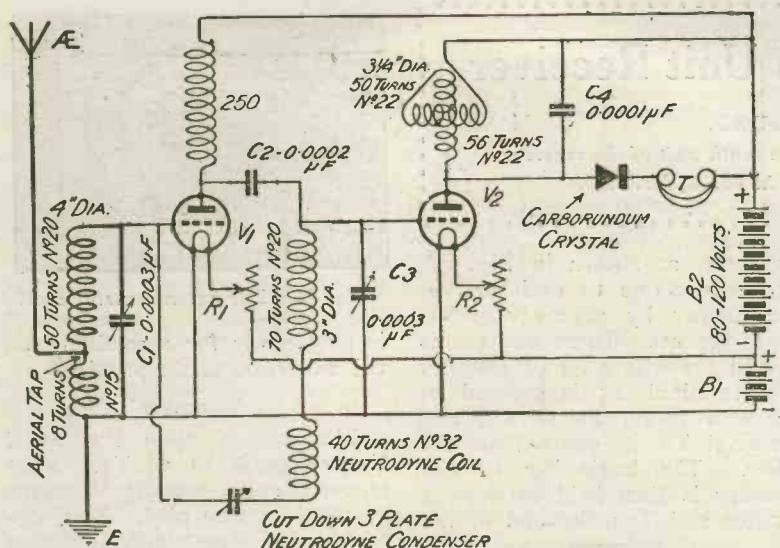

Fig. 1.—A two H.F. and crystal neutrodyne control circuit.

IN valve-crystal circuits, whether dual or "straight," a most efficient coupling between the last H.F. valve and the crystal is supplied by the tuned-anode, across which the crystal-circuit is connected. Even with only one stage of tuned H.F. amplification before this, in spite of the heavy damping introduced by the crystal, there may be persistent self-oscillation in such a circuit.

An Effective Method

The Hazeltine Neutrodyne provides an effective method for controlling this excessive reaction effect, whether arising merely from electrostatic coupling through the internal valve capacities, or, as is more often the case, through casual magnetic (and electrostatic) couplings between the inductances and wiring of the receiver. The simple modification of the Neutrodyne applied to tuned-anode, described by the writer in *Wireless Weekly*, Vol. 2, No. 8 (September 5, 1923), is most suitable, and actually lends itself to a very compact and convenient arrangement. If the tuned-anode inductance is wound as a plain cylindrical coil on a cardboard former, e.g., 3-in. diameter, the Neutrodyne effect can be obtained by winding another coil on the same former close to the first, and connected at one end to the earth, at the other via a very small variable condenser (the "neutrodyning condenser") to the grid of the same valve. By suitable adjustment of this tiny condenser

any casual back-couplings, which would normally produce self-oscillation, can be neutralised wholly, or by neutralising them only partially the circuit can be brought into and out of oscillation in the most delightfully smooth manner. At the same time, critical tuning and good amplification result. The writer has applied this principle with considerable success to a single-valve dual circuit (of inherent instability in the absence of the neutrodyne).* Here the principle is worked out for a two-valve receiver, plain crystal-valve or dual respectively.

A Straight Circuit

Fig. 1 gives the first or "straight" circuit, which gives two stages of H.F. amplification before the crystal. It is convenient to use the form of parallel-tuned anode, in which the D.C. component of the plate circuit is diverted by a small blocking condenser and via a radio-choke, away from the actual tuning inductance, which latter is placed directly across the grid of the second valve and earth. This is, of course, a well-known and obvious device, and simplifies the connections of the neutrodyne coil here. The action is precisely as with an ordinary parallel-tuned anode, and it has the same instability. The neutrodyne coil (forty turns of No. 34 S.W.G. enamel-covered wire) is then actually an extension of this anode coil, below the earth

* *Modern Wireless*, April, 1924, Issue.

Neutrodyne Control in Valve-Crystal Circuits

By A. D. COWPER, M.Sc., Staff Editor.

connection, and wound on the same 3-in. former in the same direction, alongside of the main coil. The latter has 70 turns of No. 20 S.W.G. d.c.c. wire, so as to have a low H.F. resistance and give good selectivity and signal strength. There is no point here in using high-resistance fine wire in order to achieve stability. The neutrodyne condenser used by the writer was a three-plate vernier cut down, so that the plates were only 120 degrees and well apart. The minimum capacity must be extremely low. There is room for a suitable small-capacity variable condenser in the English market.

Use of Carborundum

The carborundum crystal (galena and perikon are too fickle in a powerful circuit such as this, with two H.F. stages in front) is placed across a variometer-tuned anode after the second valve. A fairly large variometer with 50 turns on a 3½-in. stator and a 2½-in. ball rotor full—about 56 turns—of No. 22 S.W.G. d.c.c. wire, bridged by a fixed .0001 μF condenser, gave good signals and fairly sharp tuning. The aerial tuning indicated is the aerial-tap auto-transformer type, extremely selective and almost independent of aerial characteristics for wavelength and reaction, which has already been fully discussed (*Wireless Weekly*, Vol. 3, No. II). A total of 58 turns on a 4-in. former tunes over the broadcast band with a .003 (actual) μF variable condenser, as do also the intervalve inductance (with a .0003 μF variable condenser) and the last tuned-anode. The radio-choke is the usual high inductance, about 250 turns of wire being needed in some convenient form and of ordinary dimensions.

Some Useful Methods of Obtaining Stability

The circuit is extremely selective and of unusually sharp tuning. With the inductances well spaced, say, at a foot apart and inclined at 60 degrees, to diminish residual magnetic couplings, the tiny neutrodyne condenser gives ample and smooth control over reaction and oscillation. A wave-meter is useful for first tuning, after which directly calibrated scales are available at each of the tuning points. The tuning is best carried out backwards, starting at the crystal end.

Great Range

With two effective H.F. stages the range of this circuit is very great, and it can be recommended for long-distance work with some confidence. Without aerial or earth, but helped as usual by "casual aerials," the local station at 13 miles came in in the head-phones at very comfortable strength, and free from any distortion or unsteadiness, provided

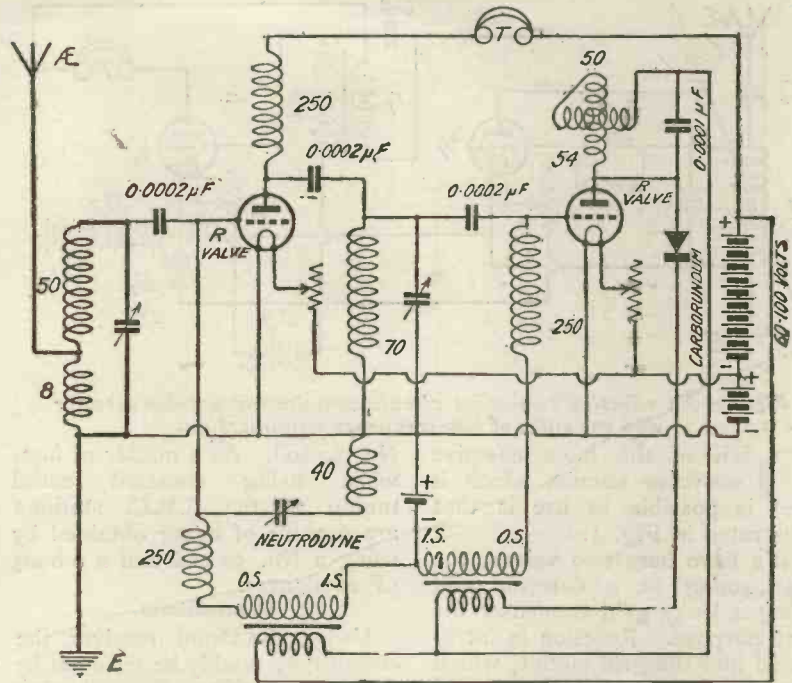

Fig. 3.—A two-valve four-stage dual circuit with neutrodyne control.

that hand-capacity effects were avoided by the use of long tuning handles at each point.

Fig. 2 shows the same developed into a dual circuit with two H.F. and one L.F. stages. The 'phones are replaced by an ordinary L.F. transformer primary, and the L.F. impulses fed back to the grid of the second valve behind a small grid condenser and via a radio-choke, which latter can be similar to the plate-choke on the first valve.

The 'phones are then placed in the plate circuit of the second valve beyond the tuned-anode.

This gives a satisfactory L.F. stage if proper negative grid-bias be applied as shown, by a small grid-cell between the I.S. of the transformer and earth. It is fairly stable when neutrodynded, so that searching can be carried out (with great caution!) in the dual position. It is, however, better to revert to Fig. 1 for this purpose.

An Ambitious Circuit

In Fig. 3 a more ambitious four-stage dual is shown, which will be found proportionately harder to control. On account of its tendency to follow the usual habit of multiple duals and to howl when oscillation starts, the second stage of L.F. is obtained at the cost of some inefficiency in the H.F. circuit—a very frequent occurrence in complex simultaneous amplification circuits. A certain amount of juggling with the H.T. and filament voltage, etc., may be found necessary, and it must be worked well away from oscillation. It is not recommended for general use. Actually a fair measure of loud-speaking resulted from 2LO at 13 miles without either aerial or earth.

In each of the dual circuits the effect of changing round the crystal and L.F. transformer leads should be tried.

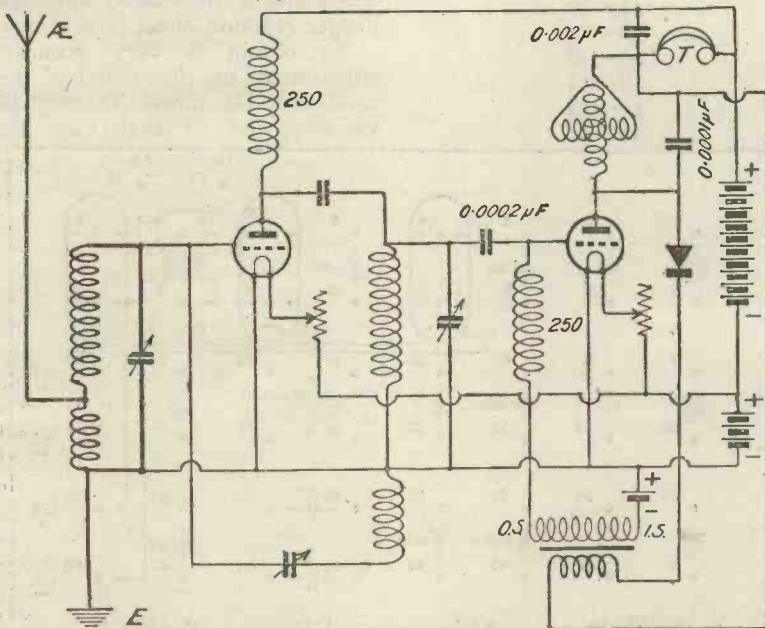

Fig. 2.—A two H.F., crystal and one L.F. circuit with the first H.F. stage neutrodynded.

following alterations to the master key will have to be made. Disconnect the link between 21 and 45, and the one between 22 and 46; now join 21 to 34 and 22 to 42. This will now place the variable condenser 34-42 across the primary T₁.

A Further Experiment

Another experiment is to try a variable condenser of very small capacity across L₁. We have not got a condenser of 0.00025 μF maximum capacity, but by connecting the two condensers 2-10 and 18-26 in series we get what is equivalent to a 0.00025 μF variable condenser, having a very low minimum capacity. This enables a larger coil L₁ to be employed, and some

improvement in signal strength will probably result. Even if a No. 50 coil is still used more accurate tuning will result. To make this alteration disconnect the lead between 3 and 10 and between 10 and 9; join 9 to 26 and 26 to 3; now join 10 to 18, and the desired result is obtained.

Many of the experiments described in these or other notes may be tried together, provided no component is used twice over.

Fine Adjustment of Reaction

To enable a very fine adjustment of reaction to be obtained in another way try connecting a variable resistance having a maximum value of about 100,000 ohms across the circuit L₁, C₂ in Fig. 1. This is done by using

our resistance 36-44 on the panel, and all that is necessary to do is to join 36 to 1 and 44 to 9.

Those who desire to use a series variable condenser instead of constant aerial tuning should make the following alterations. Disconnect the lead between 51 and 11 on the master key, and join 51 to 26; the terminal 18 is now joined to terminal 10, the link between 1 and 2 is removed, and the terminal 52 is joined to terminal 1.

If parallel tuning is employed without constant aerial tuning the following correction of the master key is necessary. Disconnect the lead between 11 and 51, and join 51 to terminal 3.

Random Technicalities

By PERCY W. HARRIS, Assistant Editor.

Some notes of interest to both experimenters and home-constructors.

Comparatively few experimenters use soldering lugs. These are very useful, and can be obtained quite cheaply from any of the larger dealers. The use of a soldering lug saves all the trouble which is likely to arise in fixing a piece of No. 16 square sectioned wire under a small terminal. Soldering lugs should be chosen of a size suitable to go on any terminals of your set, and a drop of solder adhering to the tongue will enable you to join your wire neatly to it. These lugs should always be used when making connections that you may possibly desire to take apart at a later date.

I have often been asked why it is that, if the British amateurs are more advanced than the Americans in the design of receiving equipment, how it is that the Americans receive such tremendous distances with their broadcast receivers. The pages of any American radio journal will show that on a 2- or 3-valve set reception of broadcasting at 1,000 miles distance is quite a regular occurrence. The answer

is that the atmospheric conditions in America are vastly different to those which obtain here.

This has been brought home to me by some reports I have recently received of British designed receivers used in Canada and the United States. An "All Concert" receiver used in Alberta, Canada, has received 2LO on several occasions, whilst the reception of United States broadcasting with it seems to be a common occurrence at night. I had a letter the other day from a reader in the United States who had built up the ST100 set and was obtaining quite remarkable distances regularly. Still another case is of a "Transatlantic" set used in Kingston, Jamaica. Six or seven American broadcasting stations are regularly heard in Jamaica with this set, and the writer of the letter tells me that KDKA comes in with the new set in Jamaica as loudly as 2LO used to do when he lived at Edmonton. These three cases should make it quite clear that our Transatlantic cousins are much more favoured

than we are in regard to reception of long-distance signals.

Variable condensers in ninety-nine cases out of a hundred are made to tune with inductance coils, and obviously if we can calibrate our sets by taking only two readings, one at the beginning and the end of the wavelength scale, and joining up these two points on the chart with a ruler, we shall be able to read off the position for any intermediate wavelengths without further ado. This we can do with square-law condensers.

A particular advantage of square-law condensers is that the various stations to which we desire to tune are spread more evenly over the scale. For example, with an ordinary condenser half of the evenly spaced wavelengths possible to be tuned with a given coil are found in the first quarter of the scale, whereas, with the square law, the distribution is regular.

NEW BROADCASTING STATIONS

Name of Station.	Approximate Date of Opening.
Belfast	June 1
Bradford	July 1
Edinburgh	May 1
Hull	Aug. 1
Leeds	July 1
Liverpool	July 1

All B.B.C. Stations on a Loud Speaker

By HERBERT K. SIMPSON

Further details for the construction of this receiver are given herewith, and when complete, this receiver will be found to give good results for loud-speaking, and general reception.

HAVING mounted up the components upon the panel, the task of wiring-up may be commenced. Many readers have expressed their liking for the numbered-point method of wiring, and this principle has been incorporated in the present set. The usual list of numbers allotted to components will be found below, together with the list of points to be joined.

Wiring Up

With regard to the wiring, stiff tinned copper wire, of either round or square section, may be used, or alternatively a thinner wire may be employed covered with systoflex insulating tubing. The "bus-bar" method of wiring, namely, that employing square-section wire, presents an extremely neat and workmanlike appearance when finished, but needs considerable skill in soldering, and may be found tedious by some, owing to the precision with which the wires must be fitted between terminals. A hint to those who employ this method of wiring, however, will not be out of place, as possibly some constructors may prefer this wire. All points should first be well tinned, and then the wire bent to fit exactly between two points. This needs extreme care and must not be hurried. The ends of the wire are then further tinned (although the wire itself may be "tinned copper"), and, using as little solder as possible, join the wire up to the correct point. Do not use too much solder, and be certain that the wire is really soldered to the point, and not stuck there by the flux. This may seem unnecessary advice, but the writer has seen several sets in which this fault was present, causing unlimited trouble and lack of signal strength.

For those who intend to use the simpler method, of wire covered with systoflex tubing, the following remarks may be of assistance.

Using the wiring key, start at, say, terminal 5, securing the wire here by means of solder, or alternatively by twisting it under the nut on the terminal. Then measure off the length of wire necessary to reach from No. 5 to No. 21, then on to 25, 29, 53 and 54, and, leaving about one inch to spare, cut the wire at this point. Measure off a length of systoflex to cover up the wire from point 5 to point 21, slip it

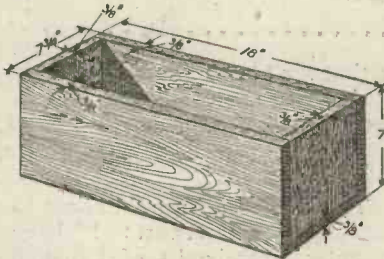

Fig. 6.—Showing how the containing box is made.

on the wire, and solder the wire to the filament leg of the first valve, marked 21 in the wiring diagram, Fig. 8. Next cut a strip of tubing of sufficient length to cover up the wire from 21 to 25, slip it on the wire, and solder the wire to the filament leg of the second valve, marked 25. Continue in this manner until all the points are joined up according to the wiring key.

Flexible Leads

It will be noticed that, in the wiring key, there are two sets of points marked "flexible." These are the leads to the aerial tuning coil, and are passed through holes in the panel, as indicated, and joined to the screws on the left-hand socket

on the coil-holder. Ordinary flexible bell-wire will be quite satisfactory for these leads.

In some cases the lugs of the Dubilier condensers may be soldered directly on to another point, for example, the point 6 of the constant aerial condenser is soldered directly on to terminal 1. Other cases where this occurs are as follows:—

First transformer bypass condenser 48, 49, soldered directly on to IP and OP, 30 and 31 respectively.

Lug 60 of telephone condenser to terminal 58.

List of Numbers Allotted to Components

Aerial circuit terminals, 1 to 5.
0.0001 μ F constant aerial condenser, 6, 7.

Grid condenser (0.0003 μ F), 8, 9.

Aerial tuning coil, 10, 11.
Reaction coil terminals on panel, 12, 13.

Aerial tuning condenser, 14,

15.
Aerial vernier condenser, 16,

17.
First valve, P, 18; G, 19; filaments, 20, 21.

Second valve, P, 22; G, 23; filaments, 24, 25.

Third valve, P, 26; G, 27; filaments, 28, 29.

First L.F. transformer T₁, IP, 30; OP, 31; IS, 32; OS, 33.

Second L.F. transformer T₂, IP, 34; OP, 35; IS, 36; OS, 37.

Filament resistances R₃, 38, 39; R₄, 40, 41; R₅, 42, 43.

Wattmel grid leaks R₁, 44, 45; R₂, 46, 47.

First transformer bypass condenser C₅, 48, 49.

Second transformer series condenser C₆, 50, 51.

HT+, 52; HT-, 53; LT+, 54; LT-GB+, 55; GB-, 56.

Telephones, 57, 58.

0.004 μ F telephone bypath condenser, 59, 60.

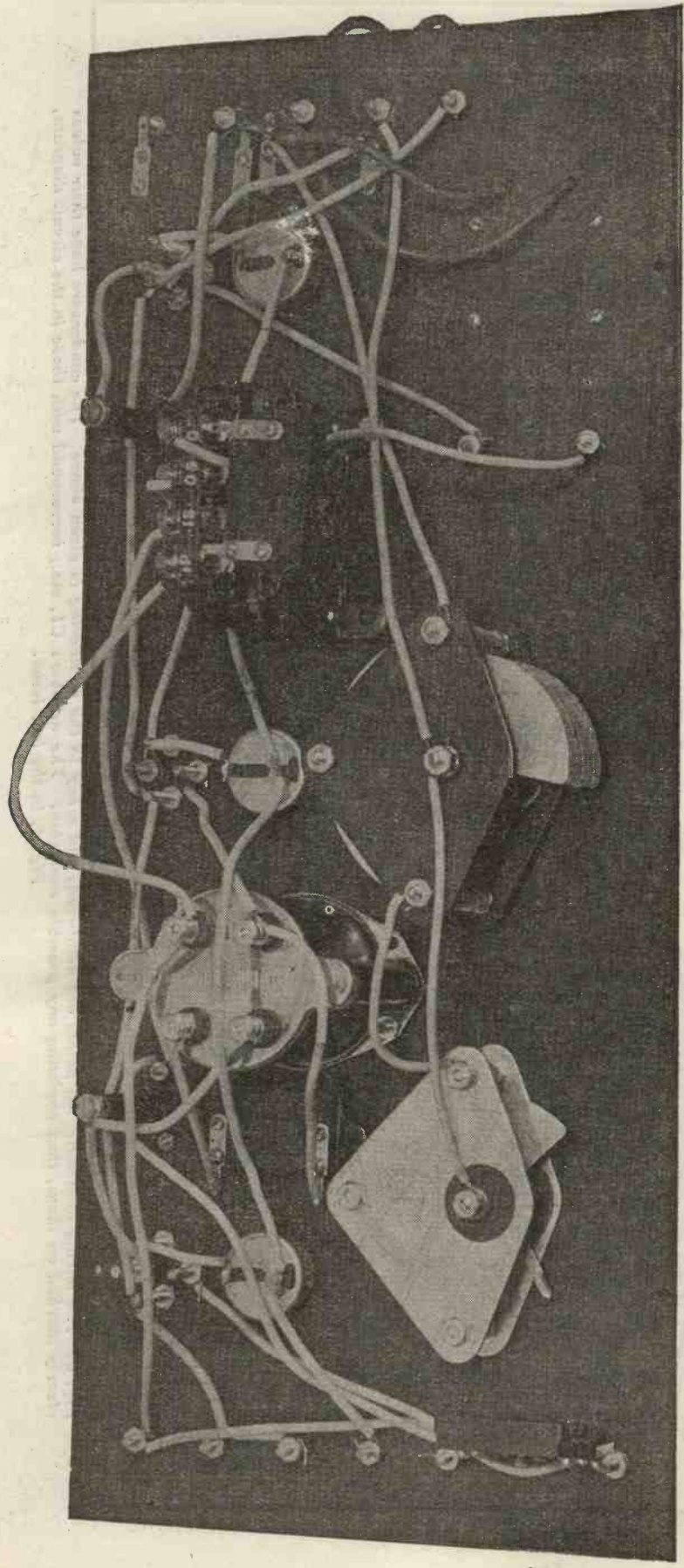

Fig. 7.—The use of this photograph, in conjunction with the wiring diagram, will make wiring up a very simple operation.

Wiring Key

- (1-6) (44-2-7-8-14-16)
- (10-2 flexible) (3-11 flexible)
- (4-15-17) (5-21-25-29-53-54)
- (9-19-45) (18-12) (13-31-49) (30-48-34-52-57-59)
- (20-38) (22-35-51) (36-50) (37-46-27) (26-58-60)
- (32-47-56) (33-23) (24-40) (28-42)
- (39-41-43-55).

Large photographs of the back of the panel are given, and will help to make the wiring clear.

The Cabinet

The cabinet is of the simplest design and construction. It consists of two pieces of wood (mahogany was used in the set described) 18 in. long by 7 in. wide by $\frac{3}{8}$ in. thick for the sides of the box; two pieces 7 in. long by $6\frac{1}{2}$ in. wide by $\frac{3}{8}$ in. thick for the ends, and one piece 18 in. long by 7 in. wide by $\frac{3}{8}$ in. thick for the bottom. A dimensioned sketch of the cabinet is shown in Fig. 6, and should enable the constructor to make the box very easily.

The panel is secured to the box by means of four screws, two in each of the longer sides, the holes for these being given in the front of panel diagram in our last issue.

Testing the Set

When testing the set it is best to start with constant aerial tuning. Connect the aerial to 1, earth to 5, and join 3 to 4 and 4 to 5. A high-tension battery of 75 volts should be used and connected to the correct terminals, these being the top two on the right-hand side of the receiver. The low-tension battery is joined to the two terminals below these, and the positive of the grid battery is connected to L.T.—. If no grid battery is used, the terminal GB— must be connected by a short piece of wire to L.T.—, the terminal immediately above it.

Valves and Coils

Any good make of valve will be quite satisfactory with this set, and the same remark applies to coils.

With regard to dull emitter valves, the provision of the carbon-compression type of rheostat will obviate any change in the low-frequency part of the set if these valves are used. Suitable high-tension voltage should be applied, and as this varies

with the make of valve, no definite figure can be given here. When using constant aerial tuning, a No. 50 coil may be used in the left-hand socket, while the reaction coil may be a No. 50 or a No. 75. With no C.A.T., and using a parallel condenser, either a No. 35 or a No. 50 coil may be required in the aerial socket, according to the size of the aerial.

When the aerial tuning condenser is used in series with the aerial coil, a larger coil may be required, and a No. 75 should be used. Having connected up, the local station should be easily tuned in when using constant aerial tuning. The correct settings of the condensers on the set described, for the reception of the more distant stations, will be found in the Editorial Test Report given in our last issue. It must be pointed out, however, that these settings may not apply in every case, but will form a useful guide when other stations are listened for.

A little practice will enable the novice to pick up the more distant stations with considerable ease, and at good strength, as the Report stated last week.

The set is made to oscillate gently by bringing the coils together, and the aerial tuning condenser is moved slowly over its scale until a carrier wave is heard. The coils and condenser are adjusted until the set just stops oscillating on the silent point of this carrier wave, and the speech is then heard.

As reaction on to the aerial is provided, care must be taken that the two coils are not coupled too closely together, or the set will oscillate and cause interference to nearby listeners.

Blue Prints

For the convenience of readers, full-size blue prints of Fig. 3, the drilling diagram and Fig. 8, the wiring diagram, have been prepared, and are obtainable from the offices of Radio Press, Ltd., price 1s. 6d. each, post free.

Blue print No. 30A is the drilling diagram, while No. 30B shows the back of panel wiring. Readers may like to fix No. 30A to their panels as an easy method of fixing the positions of the holes, in which case the paper should be removed before assembling the components on to the panel.

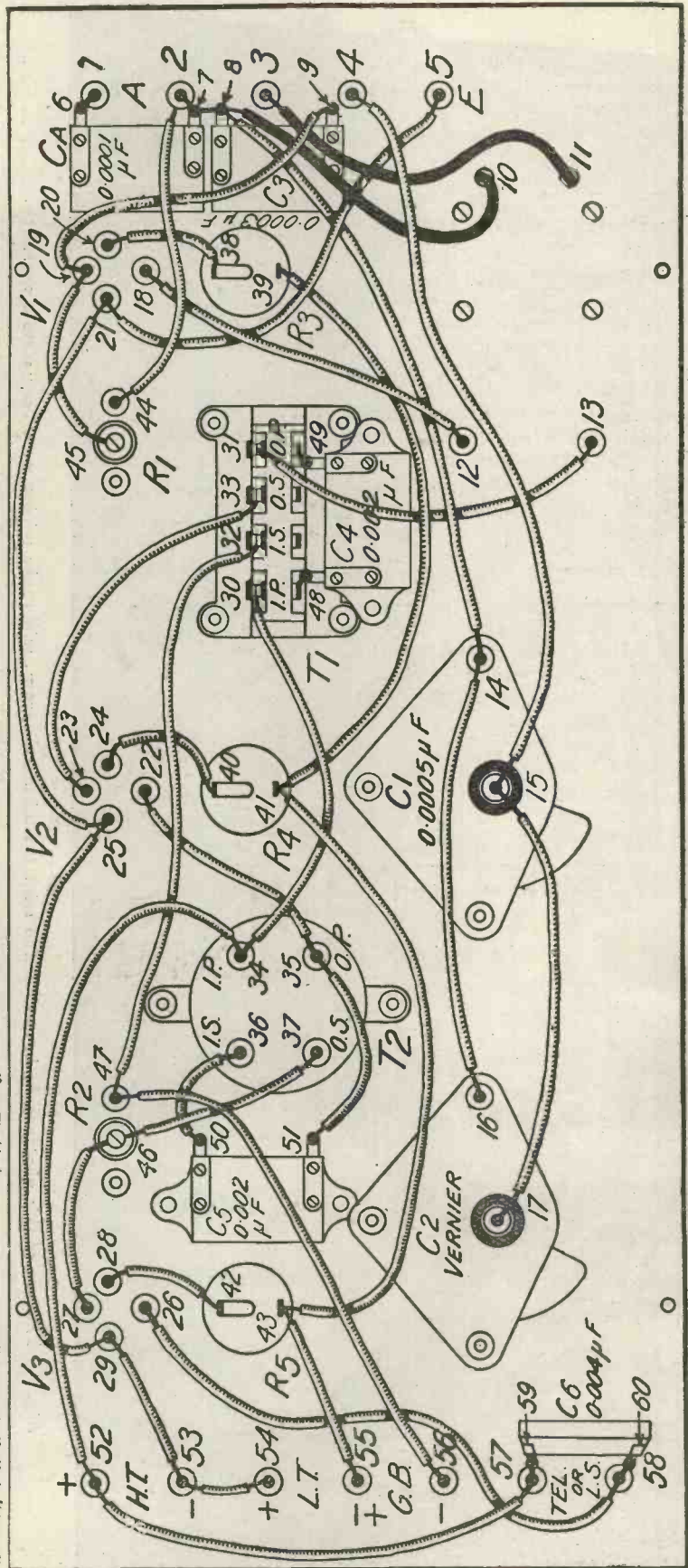

Fig. 8.—The wiring diagram. All points are numbered, and a key to the numbering is given above. The condensers have their values clearly marked on them, thus obviating any possible confusion. The numbers C1, etc., correspond with those in the circuit diagram, Fig. 4, in the last issue.

C.W. and Telephony Transmission Using Valves

No. XIV.

By JOHN SCOTT-TAGGART, F.Inst.P., A.M.J.E.E.

Absorption Modulation

IN order to enable us to absorb both half-cycles of oscillating current, we can use two valves, as shown in Fig. 33. In this figure we have two valves, V_1 and V_2 , arranged in opposition. The plate and filament of V_1 are connected to the aerial circuit, or other source (such as

being taken from the middle point M of L_1 to the filaments. When an oscillatory current is flowing in L_1 C_1 the anodes will always be of opposite sign; the valve V_1 will absorb current from the top portion of the inductance L_1 , while V is inoperative and V will absorb current from the lower half of L_1 when V_1 is not

valve V , the anode usually becoming red-hot. The condenser C is to allow the high-frequency potentials to be communicated to the anode.

Reducing Speech Distortion

Another variation is obtained by connecting a source of negative potential in the grid circuit of the valve V . By connection, say, a battery B_3 at the point Y in series with the secondary T_2 of the microphone transformer T_1 T_2 , we could lessen the distortion of the microphone potentials on the grid which would otherwise occur, owing to the flow of electron current to the grid when it is made positive with respect to the filament by the positive half-cycles of the modulating current. We can, if we so desire, make the potential of the grid so negative that there is no absorption, except when speaking. The usual alternative is to allow the valve V to absorb half the total energy, when speech is not being transmitted.

A Practical Circuit

Fig. 35 will be of interest, as it shows a practicable method of modulation which has been

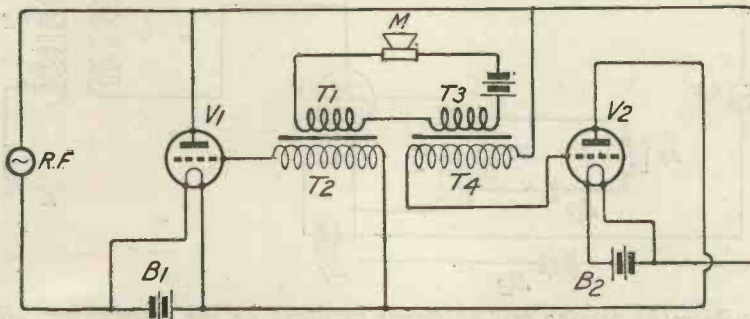

Fig. 33.—A circuit in which both half-cycles are absorbed by means of two valves.

R F) from which current is to be absorbed. When the anode is positive with respect to filament of V_1 , current will flow through the valve V_1 and not through V_2 ; when the anode of V_1 is negative with respect to its filament, the valve V_1 will pass no current, while the valve V_2 will absorb current from the oscillatory circuit, since its anode is positive with respect to its filament. In order to vary the absorption, the microphone M is arranged so as to apply the modulating potentials to both grids; two microphone transformers, T_1 T_2 , T_3 T_4 , enable this to be done.

Another Method

Still another method of absorbing both half-waves is shown in Fig. 34. The oscillatory circuit L_1 is the circuit from which we desire to absorb energy; this circuit may be the aerial circuit of the transmitter or a circuit coupled to it. Two valves, V_1 , V , are used, as before, a connection

working. The grids have their potentials varied by the usual microphone transformer T_1 T_2 .

With reference to Fig. 32, there are several important variations which we may incorporate in the circuit. A possible addition to the circuit is an ohmic resistance R_1 shunted by a condenser

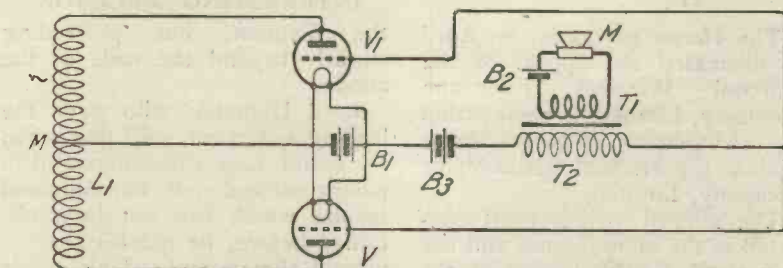

Fig. 34.—Circuit in which current is diverted from the inductance L_1 at each half-cycle.

C ; this resistance is sometimes connected in the anode circuit for the purpose of dissipating the energy withdrawn from L_2 . If this resistance is not employed, the energy (the absorbed current) is dissipated on the anode of the

successfully employed up to 15 kw. A power valve V_1 is coupled to an aerial circuit L_3 . Across the inductance L_3 is a three-electrode valve V_2 which absorbs current from it. The modulating potentials are obtained from the

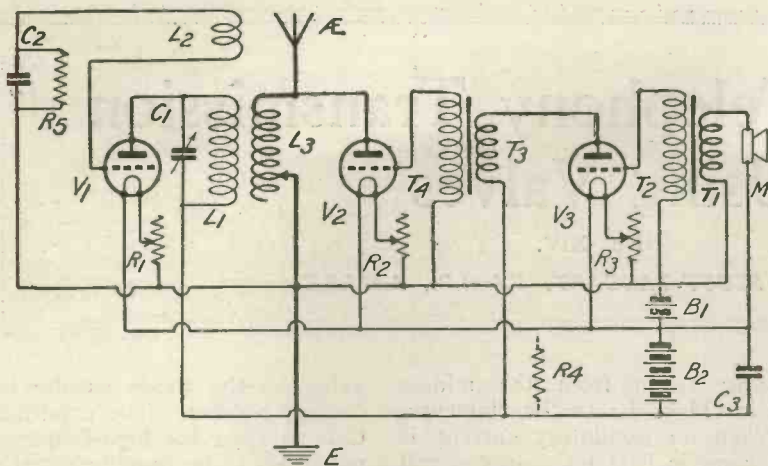

Fig. 35.—A useful circuit for medium power work. The valve V2 acts as the energy absorber.

microphone M and amplified by a low-frequency amplifier V3 in a manner with which the reader will, by now, have become familiar. Several practical features are incorporated in this circuit. A single source of direct current B2 provides the high-tension voltage for the anodes of the valves V1 and V3. Instead of using a separate microphone battery, we can use the filament heating accumulator shown. This may be done in nearly all cases and is particularly convenient in small-power transmitters, the 6-volt accumulator acting admirably. It will usually be desirable to give the grids of V2 and V3 a negative potential, and this may be obtained by connecting the bottom end of T4 and the bottom end of T2 to a point on the grid-leak R5 of the oscillating valve V1; as we have previously indicated, there is a steady D.C.

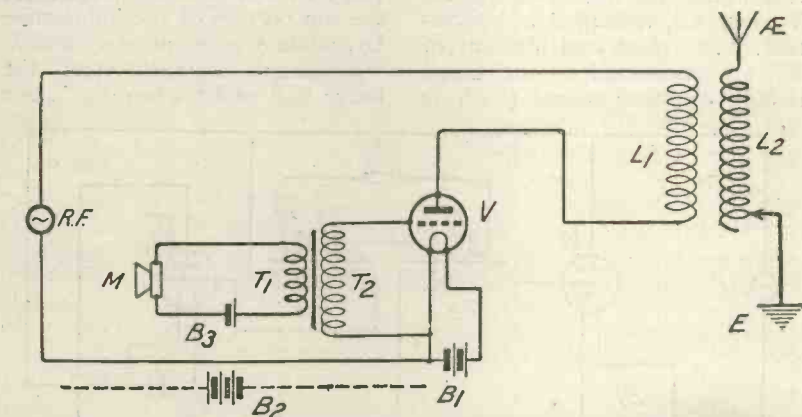

Fig. 36.—The varying grid potentials produced by the microphone allow varying H.F. currents to flow in L1.

potential drop across the gridleak of an oscillating valve, which may be utilised in this manner.

Use of Valves as Variable Conductors

Since a valve acts as a variable conductor, we can use it in the

manner shown in Fig. 36. In the anode circuit of the valve is a high-frequency generator R F and an inductance L1 coupled to the aerial circuit L2. There is normally a flow of positive half-cycles through L1 which will energise the aerial oscillatory circuit. By causing the microphone M to vary the potential of the grid, we can increase or decrease the oscillatory current passing through L1, and may therefore use this as a means of producing a modulated aerial current. In order to make the valve V conduct both half-cycles, we can give the anode a steady positive potential by means of

the battery B2, or we can use arrangements operating on the lines described in connection with Fig. 33 and Fig. 34. This use of a three-electrode valve does not appear to be of practical value.

THE MARCONI v. MULLARD APPEAL INTERESTING DECISION

The House of Lords, on April 7, dismissed the appeal of the Marconi Wireless Telegraph Company, Limited, in their action for infringement of patent rights against the Mullard Radio Valve Company, Limited.

The alleged infringement consisted in the manufacture and use of a type of valve known as the Mullard valve. In this construction the filament consists of a substantially straight piece of tungsten wire which is surrounded by a cylindrical grid, which in its turn is surrounded by a cylindrical anode, the ends of the cylindrical grid being substantially level with the ends of

the filament, but protruding slightly beyond the ends of the anode.

Lord Dunedin, who gave the leading judgment, said that when he found that the subject of a patent worked well, and obtained results which had not been obtained before, he did his best to uphold that patent. Unless fair protection was given to the patentees, research was crushed in the bud, and with it all that eventual benefit to the public which research brought. He found it impossible, though against his will, to come to any conclusion other than that the appeal failed.

The patentee's own explanation seemed to be conclusive, for he said he could not claim as a new arrangement a vacuum tube containing a hot filament, a grid, and a third electrode. That had already been invented, and he did not propose to add anything new. When one came to the claim it seemed impossible to read the word "closed" except in its ordinary and natural meaning, physically and geometrically closed.

Viscount Cave and Lord Buckmaster concurred, and the appeal was dismissed with costs.

Screening L.F. Transformers

FOR ordinary purposes those who value purity of reception will seldom make use of more than one stage of low-frequency amplification. But there are times when one wishes to be able to turn weak and distant transmissions on to the loud-speaker, and then a second stage is almost always absolutely necessary. The main difficulty in the way of adding one so as to get perfectly satisfactory results from it is that no matter how transformers are placed, there is nearly always a certain amount of interaction between them which leads to distortion. Before any double-stage note magnifying unit is made up in cabinet form, the parts should always be laid out upon a board and tested. If the transformers are provided with flexible leads, one can try the effect of moving them into various

pose, preferably one which contains *fortissimo* passages, where the brass instruments are in evidence. A second stage of note magnification, which may seem to do quite well during speech or when singers or instrumental soloists are performing, may show up pretty badly when the orchestra becomes enthusiastic.

After a long series of experi-

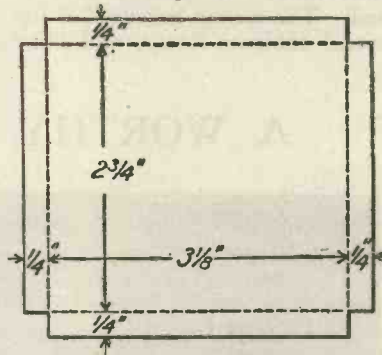

Fig. 2.—Details of the base.

ments, with a view to eliminating all the discordance that can be traced to L.F. transformer interaction, the writer has come to the conclusion that the only one that is really satisfactory is to screen both the transformers in the way to be described in this note. Briefly the method consists in enclosing the transformer in a metal-lined wooden box, whose top is provided with five terminals. Four of these are connected to those upon the transformer and the fifth goes direct to the metal casing, which can thus be earthed with the greatest ease should it be found desirable to do so. The dimensions of the box will, of course, depend upon those of the transformer. Those given in the drawing are for the smaller Sullivan transformer, which has a height over all of $4\frac{5}{8}$ in., a width of $2\frac{5}{8}$ in., and a depth over terminals of $2\frac{1}{4}$ in. In general, the inside dimensions of the box should be about $\frac{1}{2}$ in. greater each way than the overall measurements of the transformer which it is intended to contain. The box may be made from any kind of seasoned wood $\frac{1}{2}$ in. thick. If it is intended to mount the transformer on the underside of the panel on the set or unit, its bottom should be provided with a pair of the little brass tags which

are used for fixing mirrors and so on flat against walls.

It will sometimes be possible to adapt a tobacco or cocoa tin to make the metal lining; but as a rule fate is so perverse that though any amount of tins may be handy none of them is of the right size or shape. In this case the only thing to do is to make the lining oneself, which is quite a simple job if one has any skill at all with the soldering iron. Obtain a supply of stout tin—this is really sheet iron with a plating of tin upon it. From this cut out first of all a strip long enough to make the body of the case. Fig. 1 shows the dimensions for the case of the transformer referred to. For other sizes the length of the strip will always be twice the width plus twice the depth, plus $2\frac{1}{2}$ ins., the extra $\frac{1}{2}$ -in. being the allowance required for the overlap. The breadth of the strip will be the height of the transformer plus $\frac{1}{2}$ -in. In this case we require a strip $12\frac{1}{4}$ ins. long by $4\frac{5}{8}$ ins. deep. It is shaped by bending it round a block of wood with square corners and tapping with a mallet. This is not at all a difficult business, especially if deep scribed lines are ruled at the places where the bends will come. When all this has been done the overlap is soldered—a simple job, for nothing is easier to solder than tinned surfaces. Fig. 2 shows how the bottom of the case is cut out. Deep marks with the scriber should be made where the dotted lines are shown; the flaps can then be bent up without difficulty. The bottom is fitted over the end of the case

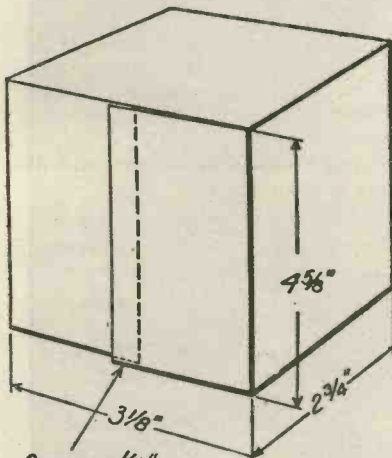

Fig. 1.—Dimensions of the casing.

positions and of bringing them close together or separating them. It will be found as a rule that when they are side by side with their windings co-axial, distortion is at its worst, and there may even be howling on the note-magnifying side of the set. An improvement will be manifested as they are moved further and further apart, and interaction may appear almost to cease when they are placed so that the axes of their windings are at right angles to one another.

The test should always be made upon a very strong signal. If possible, an orchestral selection should be chosen for the pur-

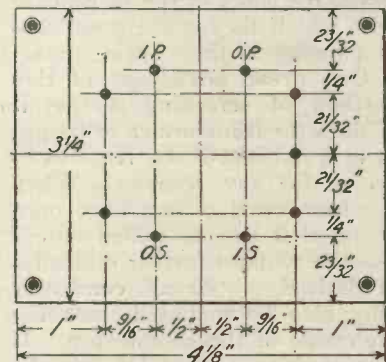

Fig. 3.—Layout of the panel.

and soldered. The case may now be placed inside the wooden box. It will not require to be fixed with screws, since the ebonite top of the box will keep it in place.

Fig. 3 shows the layout of the top which is made from $\frac{1}{4}$ -in. ebonite. Its dimensions will both be 1 in. greater than those of the bottom of the case to allow it to cover the box, which is made of $\frac{1}{2}$ -in. wood. All holes are 4 B.A., except those in the corners which are of suitable size for the wood screws used, and are countersunk so that their heads lie flush. The four holes not marked are for the screws

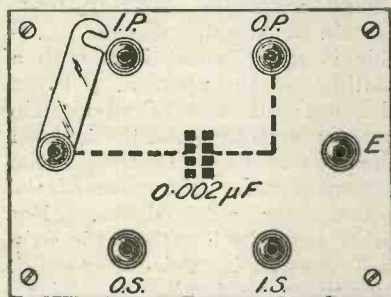

Fig. 4.—Showing method of introducing condenser.

which secure the transformer to the top by passing through the holes in its frame. The other five are for the terminals. It will be found as well to screen the top of the box also. This is done by cutting out another piece of tin of the shape shown in Fig. 2, but $\frac{1}{16}$ -in. less each way. The flaps are bent up as before and the tin is fixed to the underside of the ebonite by the screws which hold the transformer in place. Four $\frac{1}{2}$ -in. holes should be cut in the tin to allow the shanks and nuts of the IP, OP, IS and OS terminals to clear. The shank of the earthing terminal may be soldered direct to the tin. When the top of the box is put on the flaps go inside the walls of the metal case with which they make good contact owing to their springiness.

One great advantage of this method of screening is that it enables the transformer to be got at in a moment if one requires to do so for any reason. When the four wood screws have been removed it can be pulled out of its case without further difficulty. If desired, a .002 μF condenser may also be mounted upon the underside of the ebonite top. If this is done a neat job can be made by providing a sixth terminal fitted with a swing hook as shown in Fig. 4. The condenser can thus be thrown into or out of use instantly as required.

R. W. H.

A Good Wood for Cabinets

THE majority of cabinets are made of mahogany, oak or teak, none of which are very easy for the amateur carpenter to work in. An excellent wood for the purpose is American white wood, which has the advantage of being neither very hard nor very soft. It is quite easy to deal with, and it will take a very good finish indeed if a little care is used. The writer has used it for several cabinets lately, and likes

its appearance very much. Its yellowish colour contrasts strikingly with the black ebonite panels, and when it has been thoroughly smoothed with fine sandpaper it makes a very good-looking cabinet. White wood may also be used for the panels themselves of sets if all the holes are insulated with the excellent little panel bushes which can be obtained from advertisers.

R. W. H.

A WORTHY INSULATOR

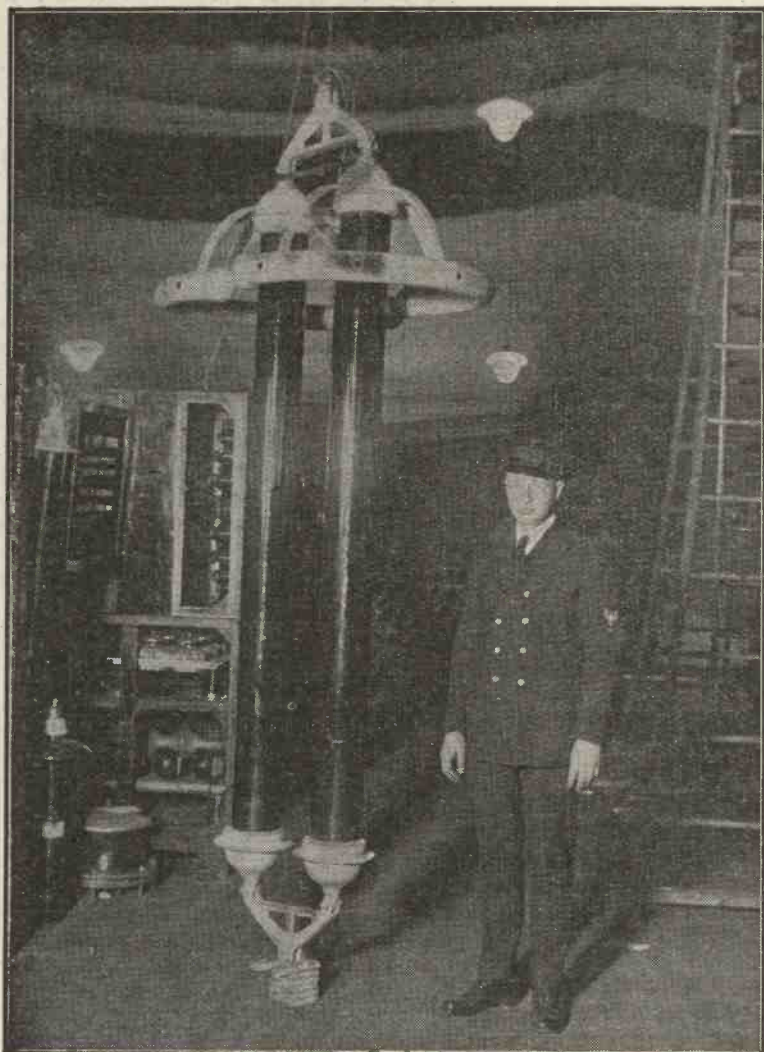

One of the exhibits at the Washington Radio Show is the largest insulator in the world. Such insulators as these are used by the U.S. Navy at the American high-power stations.

A Good 50 ohm Rheostat

There is quite a demand among amateurs for a good 50-ohm rheostat for use with dull-emitters. It was pointed out a short time ago in these pages that most of those which rely upon carbon granules become unsatisfactory after they have been in use for a short time, owing to the fact that "packing" takes place. This means that though the rheostat, when new, may be variable between, say, zero and 50 ohms, when it has seen service for a week or two its maximum resistance may have dropped off to something very much less than the original figure and only slight variations may be obtainable. There is no doubt, I think, that for general purposes there is nothing to beat the rotary type of rheostat. The type with a straight, sliding movement similar to that of the ordinary potentiometer is fairly satisfactory, but it does not allow quite the same delicacy of adjustment as is possible with a contact arm as a rotary movement controlled by a knob. The 50-ohm rheostat to be described in this note will be found to be perfectly satisfactory for operating all types of dull-emitter. It is intended that it should be used in series with a 5- or 6-ohm rheostat of standard pattern. Rough adjustments are obtainable by means of the big resistance whilst the small rheostat is used for regulating the current supply exactly.



Fig. 1.—Illustrating the former.

Obtain two ebonite discs, such as are used for making standard rheostats. If old ones are not available in the scrap box, these can be obtained at 4d. apiece from advertisers in this journal. Clamp the two together by means of screws and turn them down in the lathe until the grooves in their edges have been removed. If you are not the possessor of a lathe this job will not cost more than a few pence to have done

for you at a cycle shop. Next cut out a piece of $\frac{1}{8}$ -in. ebonite, $\frac{3}{4}$ in. wide and $\frac{1}{2}$ in. less in length than the distance round the circumference of your ebonite discs. Place this strip in boiling water until it is quite soft; then bend it until it will fit exactly round the discs, as shown in Fig. 1. Drill two 4 B.A. clearance holes at either end and make tapped holes in the discs to correspond to them, so that the strip may be attached, as shown in the drawing.

On to the strip wind 260 turns

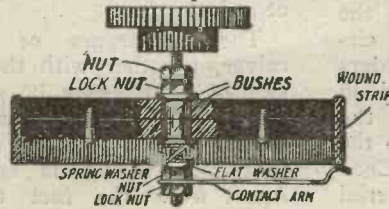

Fig. 2.—Cross section of the rheostat.

of No. 28 s.w.g. enamelled Eureka wire, placing them as close together as possible and making them quite tight. Winding is not nearly such a difficult matter as it might seem at first sight, for since there is a gap between the ends of the strip, and it is not a continuous ring, matters are made much easier. When all the wire is on anchor the end firmly and give the turns a good coating of enamel so as to hold them firmly in place. Do not enamel the lower edge of the strip.

As soon as the enamel is dry the wound strip may be fixed in place by means of the four screws already mentioned. The lower edge is now scraped with a piece of glass paper so as to remove the enamel from it and to leave the turns bright in order to form a path for the contact arm. Fig. 2, which is a sectional view of the apparatus, shows how the spindle and the contact arm are mounted. A pair of standard 2 B.A. bushes are inserted, as shown, to form a good bearing for the spindle, which is a piece of 2 B.A. studding. The contact arm, made from springy sheet metal, is locked between two nuts at the lower end of the spindle. Above these nuts is a flat washer which is followed by a spring

washer. The pressure of the contact arm upon the edge of the wound strip is adjusted by means of the nut immediately above the top bush. This nut is prevented from shifting once it has been set by the lock nut which is placed over it. A standard ebonite knob completes the apparatus.

R. W. H.

Finding the Relative Diameters of Formers for Variometers

A good method of finding the relative diameters of formers required for the stator and rotor of a variometer is shown in the accompanying diagram. First, a full-size chart should be carefully drawn in 1-in. squares, and the inches subdivided into quarters of an inch. Having determined the length of rotor required, mark the point on the corresponding

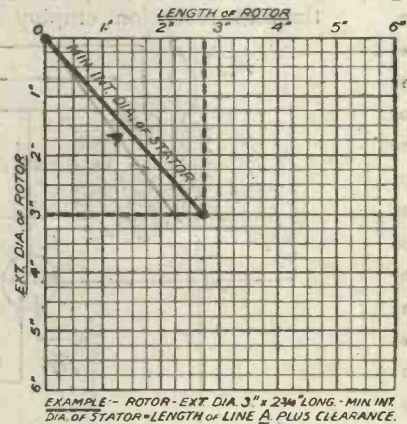

Fig. 1.—The relative sizes of stator and rotor may be found by means of this graph.

scale, and draw a line at right angles to meet a line also drawn at right angles to the scale marked "Ext. diameter of rotor" from a point which corresponds to the external diameter of rotor being used. Draw a diagonal line from the point marked O to the point where the two lines meet. By carefully measuring the length of this line we ascertain the minimum internal diameter of which the stator must be, to allow free movement for the rotor.

H. B.

OUR NEXT ISSUE
will contain
full constructional details of a
NEW DESIGN OF ST100
RECEIVER.

A Double Reaction Receiver

By STANLEY G. RATTEE,
M.Inst.Rad.E., Staff Editor.

IN most regenerative circuits, whether single or multi-valve, reaction is applied at only one point, whereas in the receiver to be described it is possible to react into either the aerial circuit, the anode circuit, or into both circuits. With this receiver readers may, for the reception of British broadcasting, therefore use the safe method of reacting into the tuned anode circuit, or for Continental reception employ aerial

wavelengths with the same degree of efficiency extending over each, plug-in coils of the ordinary type are used for purposes of tuning. To permit the use of either bright or dull emitter valves, the receiver is fitted with suitable filament resistances, and experiments with both types go to show that there is nothing to choose between them so far as this receiver is concerned so long as the specification given herein is adhered to; departure from it, however, may quite conceivably result in excessive oscillation on account of the "softness" of certain of the dull-emitter types of valves.

The appearance of the receiver, together with the underside of panel, may be gathered from the photographs, from which also it will be observed that stiff wiring is employed. Apart from the fact that this



Fig. 2.—The general appearance from this

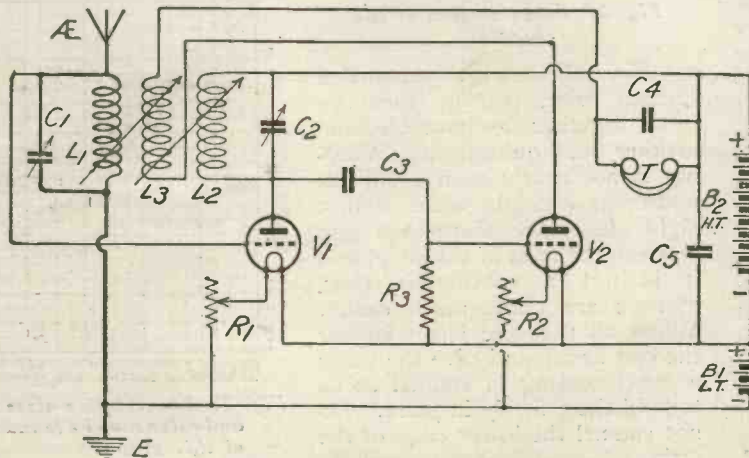

Fig. 1.—The circuit arrangement.

anode method of coupling is employed, as may be seen in the circuit diagram, with the reaction coil situated between the aerial and anode coils.

The condenser C_1 is for aerial tuning, and is of $0.0005 \mu\text{F}$ capacity; the anode coil L_2 is tuned by a $0.0003 \mu\text{F}$ condenser C_2 . C_3 is the usual grid condenser, and R_3 its leak, whilst C_4 is a fixed condenser of $0.002 \mu\text{F}$ capacity, connected across the telephones, and without which the receiver will in all

reaction. Further, the more experienced operator may use the double reaction method; that is, reaction into both aerial and anode circuits at the same time with decided improvements upon the signal strength. For the beginner, however, application of reaction in its dual sense is not to be recommended until he has thoroughly acquainted himself with the operation and control of reacting at one point in the circuit.

Considerations in Design

In order that the receiver may be used over a multiplicity of

method of wiring adds considerably to the neatness of the work, it possesses the additional virtue that all leads must be kept well spaced and short in order to avoid "short-circuits"; two very important conditions in receiver construction, which many constructors are somewhat prone to overlook in the safety afforded by the use of insulating sleeving.

The Circuit

The circuit is a simple, straight, two-valve arrangement, wherein the first valve acts as a high-frequency valve and the second serves as a detector; the tuned

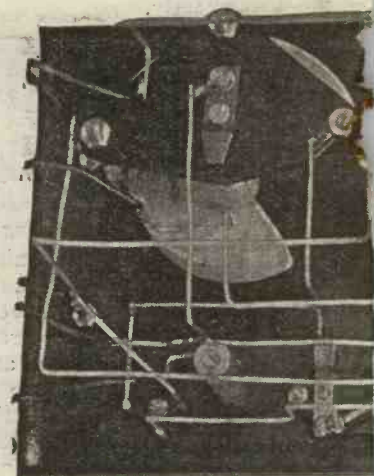
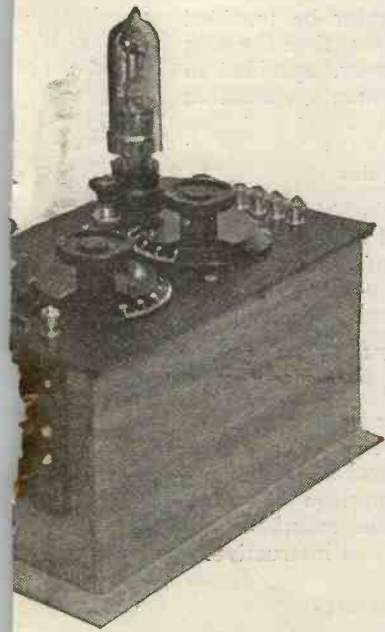

Fig. 3.—The unde



- 1 Containing box to take panel and 4 3/4 in. deep.
- 2 Valve holders.
 - 1. Three-coil holder. That illustrated was supplied by the Beldam Tyre Co., Ltd.
 - 1 Variable condenser of 0.0005 μF capacity (Radio Instruments, Ltd.).
 - 1 Similar condenser of 0.0003 μF capacity (Bowyer Lowe Co., Ltd.).
 - 2 Lissenstat minors (Lissen, Ltd.).
 - 8 Brass terminals.
 - 1 Grid condenser of 0.0003 μF capacity (Dubilier).
 - 1 Grid leak of 2 megohms resistance (Edison Bell).
 - 1 Fixed condenser of 0.002 μF capacity (Dubilier).
 - 1 Similar condenser of 0.05 μF capacity (Dubilier).
- Quantity of No. 16 tinned copper wire for connecting purposes.
- Set of plug-in coils for the wavelengths desired:—

A two-valve circuit in which reaction is employed in such a manner as to give two distinctive arrangements.

such as that made by the Ever-Ready and Siemens companies. The telephones most suitable for use with a receiver of this type should be wound to either 2,000 or 4,000 ohms, and should be of good manufacture.

Wiring Up

The wiring up of the receiver should be carried out in conformity with the instructions given in the practical wiring diagram. All leads should be kept as short

of the receiver may be gathered photograph:

probability fail to oscillate on account of the high impedance of the telephone windings.

Components and Materials

The components embodied in the receiver illustrated are given below, and though readers may, of course, depart, if they wish, from the manufactures given, those components chosen should be of good manufacture and of correct values.

- 1 Ebonite panel measuring 9 in. by 5 3/4 in. by 1/4 in

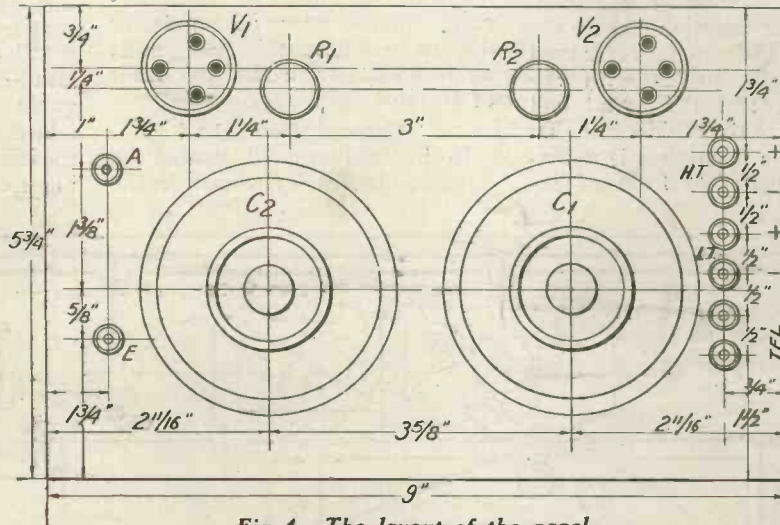

Fig. 4.—The layout of the panel.

For British Broadcasting: Set of Concert coils (Burndept, Igranic, or other similar well-known makes). For Eiffel Tower, 200, 300, 400. For Radiola, 150, 200, 300. Ecole Superieure des Postes et Telegraphes, same as for British broadcasting.

For L.T. supply a 6-volt accumulator should be used if bright emitter valves are chosen or a 4-volt accumulator in the case of dull emitters.

The H.T. supply should consist of a 50-volt dry cell battery,

as possible, and all connections should be soldered. Before taking the flexible leads through the box to the different connections upon the three-coil holder, holes of 1 in. diameter should be drilled in the box immediately beneath those in the coil holder, in order to eliminate the possibility of the leads touching the wood, and so resulting in loss of insulation.

Should readers prefer to use the Systoflex method of wiring this system may, of course, be

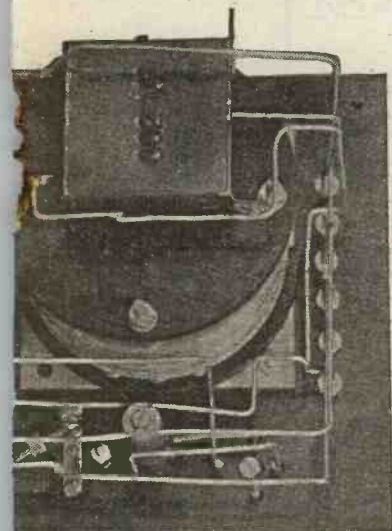

side of the panel.

used, bearing in mind the fact that shortness of leads, together with the avoiding of parallel wires, are two conditions which must be adhered to.

Operating

When the receiver is completely wired up and undergoing test it may be found that the reaction coil does not give the desired increase in signal strength which one may expect. To remedy this condition it is necessary to reverse the connections to this coil.

For the reception of broadcasting from the British stations insert a No. 35 coil in the aerial circuit, a No. 50 in the anode socket, and a No. 50 for reaction for the lower wave band. For the higher wave band coil Nos. 50, 75, 75 respectively should be used. In order to introduce reaction into the anode circuit the aerial coil should be moved at right angles to the middle coil and the anode coil moved towards the middle coil until the desired amount of reaction is obtained. Similarly for reaction on to the aerial coil the anode is moved until at right angles with the middle coil, and the aerial coil moved near to the middle coil. To obtain double reaction it is necessary to adjust one form of re-

action to its best position and to then adjust the second form; it will be found easier if the anode reaction is first adjusted and then followed by adjustment of the aerial coil and further adjustment of the condensers. Though this form of reaction would at first appear to be simple it will be found that considerable experiment is called for before the operator is able to obtain the very best results with the high degree of selectivity which this form of reaction permits.

Continental Telephony

For the reception of the Eiffel Tower the operator choosing to employ aerial reaction should use in the aerial socket a No. 200 coil, a No. 400 coil for the anode, and a No. 300 for reaction. In the case of anode reaction and for double reaction a No. 400 coil should be inserted in the reaction socket. Radiola may be received using a No. 150 for the aerial, No. 300 for the anode, and No. 200 for reaction when this latter coil is made to react upon the aerial circuit; in the case of anode or double reaction this coil must again be larger, a No. 300 being of suitable size.

General Remarks

In the receiver as illustrated the fixed condenser C₅, shown in the

circuit diagram as across the H.T. battery is omitted, but should the operator be troubled with battery noises, then the 0.05 μ F fixed condenser, specified in the list of components, should be incorporated.

Results

The efficiency of this receiver may be gathered by the fact that during the test of the set following its completion all the B.B.C. stations were easily received, as were also the Eiffel Tower, Paris, Radiola, School of Posts and Telegraphs on the following evening. So far as operation is concerned the receiver is easily handled, the effects of double reaction and comparison between aerial and anode reaction are most interesting and instructive.

Blueprints

For the benefit of those readers who prefer to work from full-size drawings, blueprints of the wiring diagram, Fig. 5, are being prepared.

When applying for these full-size drawings, readers should quote "Blueprint No. 32," addressing their application to the offices of this journal, enclosing 1s. 6d.

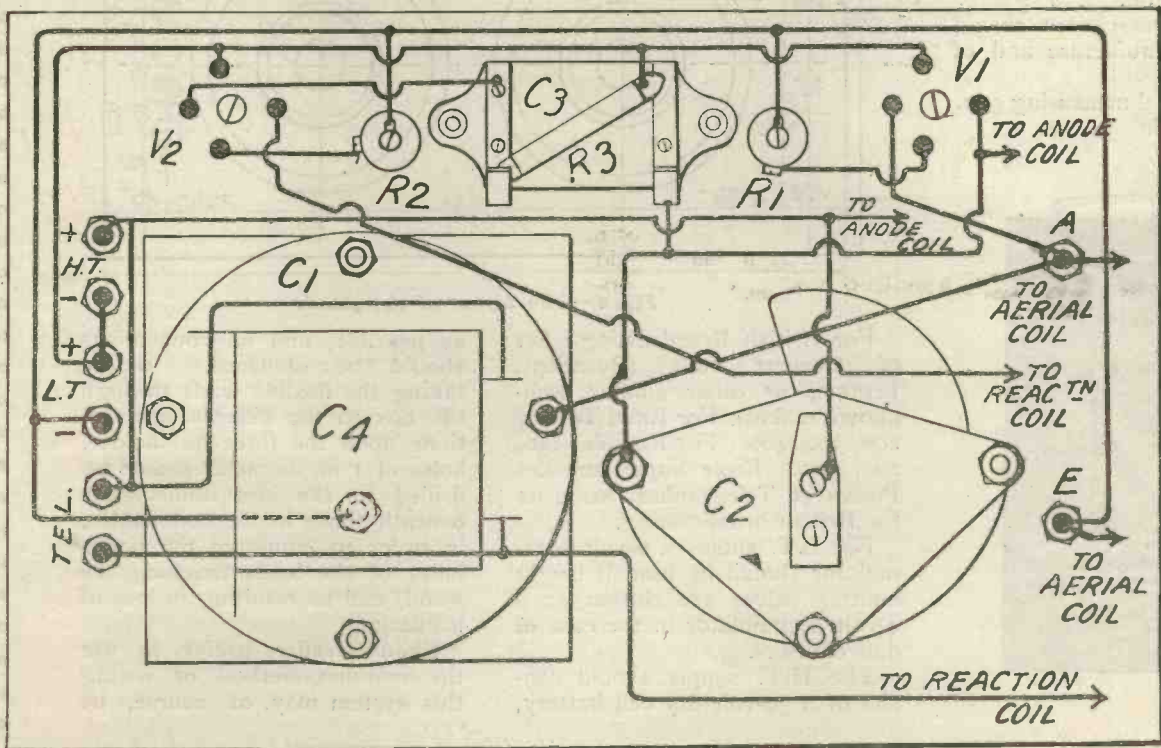

Fig. 5.—Practical wiring diagram showing disposition of components.



I.P. or O.P.

I WAS speaking, the other day, to the Head of the Testing Department at the National Physical Laboratory, who superintends the tests of low-frequency intervalve transformers. In carrying out the tests, a reversal of the primary and secondary windings is always carried out, and there is considerable difference between the degrees of amplification obtained.

I asked him which arrangement usually gave the best results, and he stated that his experience was that the O.S. (outside secondary) of an intervalve transformer should be connected to the grid, while the primary connections were not so important. This corroborates my own experience, but whereas I have generally preferred to connect the O.P. (outside primary) to the anode of the preceding valve, he indicated that with the transformers he had tested there was a majority which gave slightly better results if the I.P. (inside primary) terminal were connected to the anode. He stated that in some cases exactly the opposite effect was obtained, and that in most cases it made little difference which way round the primary connections were made.

Readers' Views

If any readers have decided views on the matter, I would like them to write to me so that others can read their results.

I.S. or O.S.

Fig. 1 shows a cross-section of a transformer showing the primary winding (which is next to the iron core C) surrounded by a secondary winding. The inside and outside of the primary and secondary windings are indicated by the letters I.P., O.P. and I.S. and O.S. We may assume that the heavy iron core is substan-

tially at earth potential. The portion of the winding next to the I.S. terminal of the secondary is nearest to the iron core, and consequently if we connected O.S. to the negative terminal of the filament accumulator, and therefore to earth, the potential variations at the point I.S. would be lessened by the proximity of the winding to the core, which we have assumed is substantially at earth potential. If, however, we reverse the procedure and connect the I.S. terminal to the negative terminal of the filament accumulator, and therefore to earth, the potential fluctuations at the terminal O.S. will be greater, because the portion of the winding near O.S. is well away from the iron core; for this reason the O.S. terminal is best connected to the

the end of a portion of the secondary winding which is in close proximity to the iron core, and to a portion of the primary winding, both of which are substantially at earth potential. The effect is therefore rather similar to connecting a condenser between I.S. and the filament battery. If, however, we reverse the connection so that I.S. is connected to the grid and O.S. is left free, we will find that very poor signals indeed are, in most cases, obtained, and this is because the O.S. terminal and the portion of the winding, of which it represents the end, is well away from the core and primary winding, and therefore cannot be said to be at anything like earth potential.

Earth Potential

It is good practice, in all wireless circuits, whether of high- or low-frequency, to have one end of each coil connected to earth (sometimes through a battery, such as a high-tension battery). As we have agreed that the I.S. terminal should be connected to the negative terminal of the filament accumulator, and therefore to earth, we see that the O.P. terminal of the primary, and a portion of the winding near the O.P. terminal, is substantially at earth potential, because of the very close proximity between the outside portion of the primary winding and the inside portion of the secondary winding. The primary winding of an intervalve transformer is therefore sandwiched between two masses of metal, the iron core on the inside and the inner winding of the secondary, both of which are either at earth potential or substantially at earth potential. This flanking of the primary winding is calculated to impair the efficiency of the transformer, and if the secondary and primary

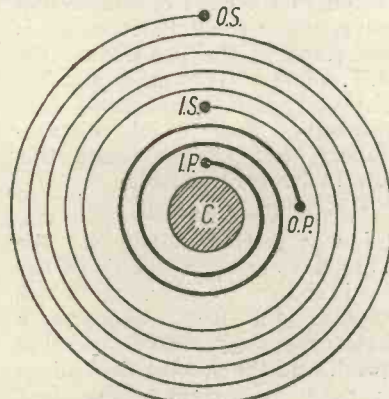

Fig. 1.—A cross-section of a L.F. transformer showing the windings.

grid, and in practice we find that the theory is borne out. An interesting experiment is to connect the O.S. terminal of the intervalve transformer to the grid and leave the I.S. terminal free.

An Interesting Experiment

It will be found that excellent results are still obtainable, and the reason is simply that the I.S. terminal, although not connected to earth or the negative terminal of the filament accumulator, is

windings changed position, transformers would be very inefficient.

O.P. to H.T. Positive

It is reasonable to suppose that the outside windings of the primary are more at earth potential than the inside windings, since the outside windings come absolutely next to the inside windings of the secondary which have their nearest end (I.S.) connected to earth. Theoretically, therefore, it would seem that the O.P. terminal of the transformer should be connected to the positive terminal of the high-tension battery which, as far as low-frequency current variations are concerned, is at earth potential, and that the I.P. terminal should be connected to the anode of the first valve which is, as it were, in the air.

This analysis, however, does not hold good for all transformers, because different methods of winding are employed, and the spacing between the two sets of windings vary. Moreover, shrouding has an effect which varies in different cases.

Trial and Error

It therefore becomes a matter for the individual experimenter to try out which way round gives the best results, although everyone may take it for granted that the secondary should have the O.S. terminal connected to the grid of the following valve.

The position is somewhat complicated when using two or more intervalve transformers, or when using dual circuits, by the fact that low-frequency reaction is liable to be introduced. A reversal of one of the windings of one of the intervalve transformers will usually lessen the tendency of a dual circuit, or a straight circuit using two or more intervalve transformers, to oscillate at audible frequency. I would advise all experimenters to do the reversing on one of the primaries of one of the intervalve transformers, leaving the

secondaries so that the O.S. terminals go to the grids. A reversal of one of the primaries will usually accomplish the desired result.

ST100 Connections

In the case of the ST100 circuit, my own experience is that the I.P. terminal of the transformer in the aerial circuit should go to one side of the crystal detector and the O.P. terminal to the side of the anode oscillatory circuit nearest the high-tension battery. The O.S. terminal comes nearest the grid of

signals too much. I found with this circuit (and without using the condenser C₄) that there was a good deal of noisy background which, to an ear trained to detect distortion, was very troublesome.

Eliminating Noises

This background effect is a very prevalent one, and many experimenters get so used to it that they do not realise that they miss the joys of an absolutely silent background. A noisy background seems to be due, largely, to a number of high notes creating a hissy, mushy effect.

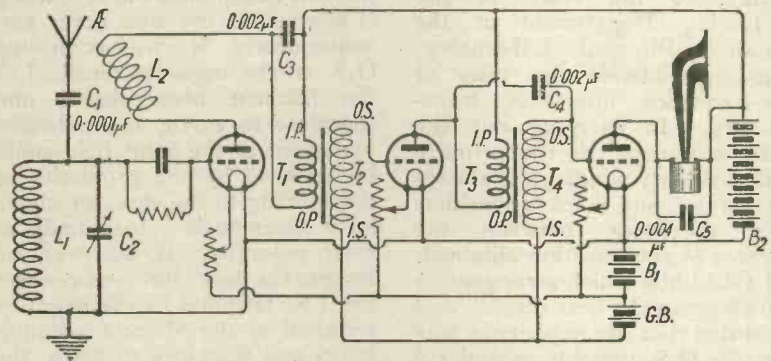

Fig. 2. — Showing how the second L.F. Transformer may be connected with decidedly purer speech resulting.

the first valve. With regard to the second intervalve transformer, the O.S. terminal is connected to the grid of the second valve, while the I.P. terminal is connected to the positive of the H.T. supply. It is quite possible that different connections are necessary in special circumstances, but I have found this rule to be very reliable.

Pure Speech

I was testing out a set the other day, using a circuit of the kind shown in Fig. 2, which employs the first valve as a detector, using reaction on the aerial, and the second two valves as note magnifiers. The first transformer was an Igranic and the second an R.I. I find that a fixed condenser of 0.004 μ F is about the best value for use with most loud-speakers without deadening and weakening the

I obtained a vast improvement, without loss of signal strength, by connecting a condenser C₄ of 0.002 μ F capacity across the grid and filament of the third valve. I was surprised to find that so large a capacity was necessary, because I had on previous occasions found that a 0.0005 μ F condenser sufficed. It seems to depend a great deal on the type of transformer used, and the particular combination of two transformers. It is therefore impossible to make any definite rule. Radio Instruments, Ltd., I note, use a 0.0005 μ F fixed condenser across anode and grid in their new set.

It is impossible to state what condenser to use, even for a particular transformer, because the effect may be coming from a preceding valve.

SIR,—I feel sure you will be pleased to hear of the excellent results I have obtained with ST74, as shown in "More Practical Valve Circuits" From here, a few miles west of Preston, I have received all the B.B.C.

ST74

stations, Brussels, Ecole Supérieure and Eiffel Tower telephony, and recently, while tun-

ing around 400 metres, I picked up the Vox haus, Berlin, with perfect clarity and an astonishing absence of atmospherics.—I am, yours faithfully,
S. H. DEARDEN.
Lytham, Lancs.

Thermionic Valves with Dull-Emitting Filaments

Abstract of a paper by the Research Staff of the General Electric Co., Ltd., delivered before the Wireless Section of the Institution of Electrical Engineers.

Concluded from Vol. 3, No. 18, page 579.

IN the early days of the development of dull emitters it was apparent from the results of life tests that, although thorium emission might be shown by the filament, in any particular valve this emission was not stable under operating conditions for more than 100 or 200 hours unless the degree of vacuum were very high, and, generally speaking, the higher the pressure of residual gases the shorter was the satisfactory life.

*Life-Test.**—A small percentage of the Marconi-Osram works production is collected periodically (actually two or three times a week), and this small percentage is subjected to various tests by the laboratories, including life test.

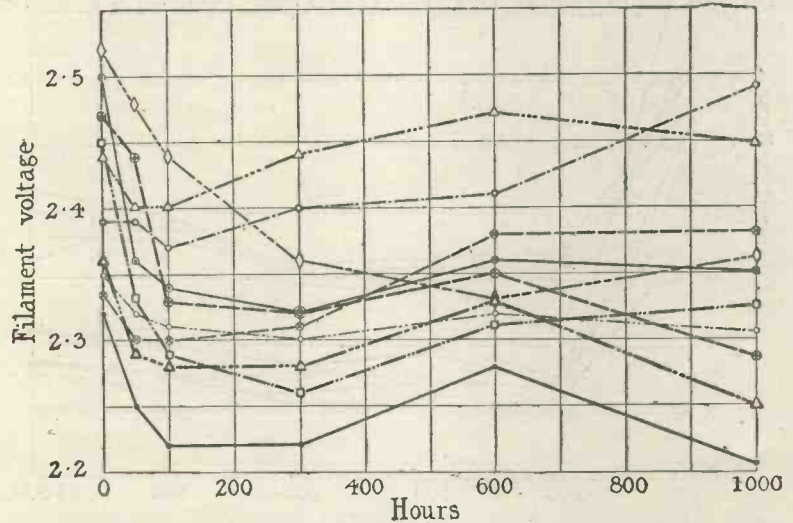

Fig. 5.—Life test of D.E.V. valves; filament voltage required to give a constant emission of 5 mA.

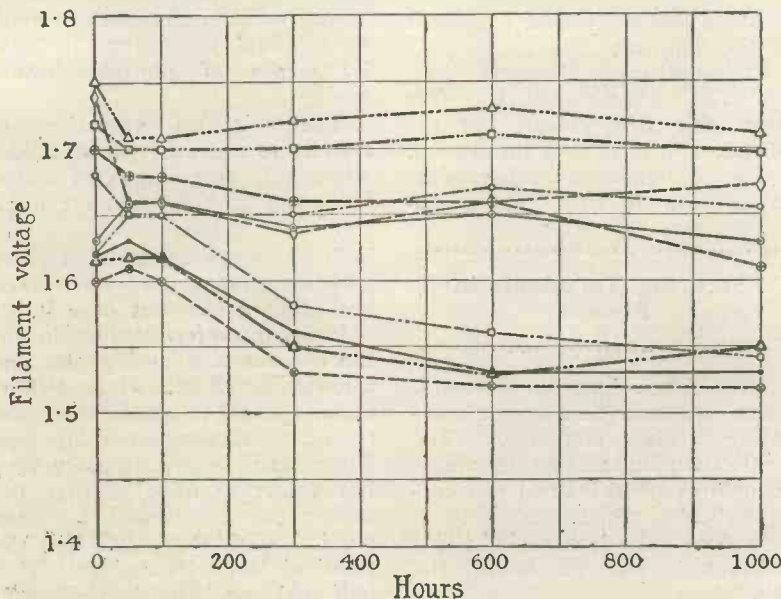

Fig. 4.—Life test of D.E.R. valves; filament voltage required to give a constant emission of 5 mA.

With regard to the life tests on dull emitters, we may take the D.E.R. valve as an example. In our routine tests the valves are run with a steady A.C. filament

voltage of 1.8 and anode voltage of 50, the grid being connected to one filament lead so that the grid potential virtually oscillates between zero and 1.8 volts positive. Except for the alternating voltage on the filament, these conditions are then very similar

to actual operating conditions. The test is run on each particular collection of valves for 1,000 hours, measurements of emission, etc., being made at the end of 50, 100, 300, 600 and 1,000 hours. The emission measurement consists in reading the filament voltage necessary for obtaining a flow of 5 mA of electron current to the grid and anode, which are connected in parallel while the potential of 50 volts is applied to them. The filament voltage required is then plotted against the time during which the life test has run.

Typical curves obtained in this way for the D.E.R. valve are shown in Fig. 4, where the voltage scale is purposely made very open.

Similar curves for the D.E.V. valve, of which the filament takes 0.2 ampere at 3 volts, are shown in Fig. 5, and other curves for the power-amplifier valve (L.S.5) in Fig. 6.

Valve Noises.—Under this heading are included the two effects generally known as (a) crackling, and (b) microphonic noise. Both phenomena only become important in receiving

* The methods adopted in the life-testing of valves will be described in a later paper.

circuits in which more than two stages of audio-frequency amplification are employed.

By the first term is meant the continuous series of sharp reports frequently heard in the telephones

has not proved easy to discover, although the phenomenon is generally looked upon as being due to impurities in the filament and although, also, the magnitude of the effect can be reduced

phonic noise characteristic of dull-emitter valves have driven us to the conclusion that the effect is entirely due to the filament retaining a high degree of elasticity at its normal operating temperature. At present the only practicable method of eliminating these noises seems to be to mount the valve on a special type of holder designed to prevent any except very low-frequency vibrations from reaching the valve.

There is no doubt, therefore, that these noises are due simply to the transverse vibrations of the filament, although we have a certain amount of evidence that the rate of damping of these vibrations is influenced slightly by the kind of supports used.

In order to eliminate the noises entirely, the only practicable way seems to be to prevent any vibrations from reaching the filament from outside. A design of valve holder which achieves this object depends upon the fact that a spiral spring can be made which has a very low natural periodicity for transverse, longitudinal and torsional vibrations. The valve holder is supported on such a spring and connections are made to terminal points on the base by means of phosphor-bronze springs.

There is no necessity, of course, to use this type of holder when only two stages of audio-frequency amplification are used.

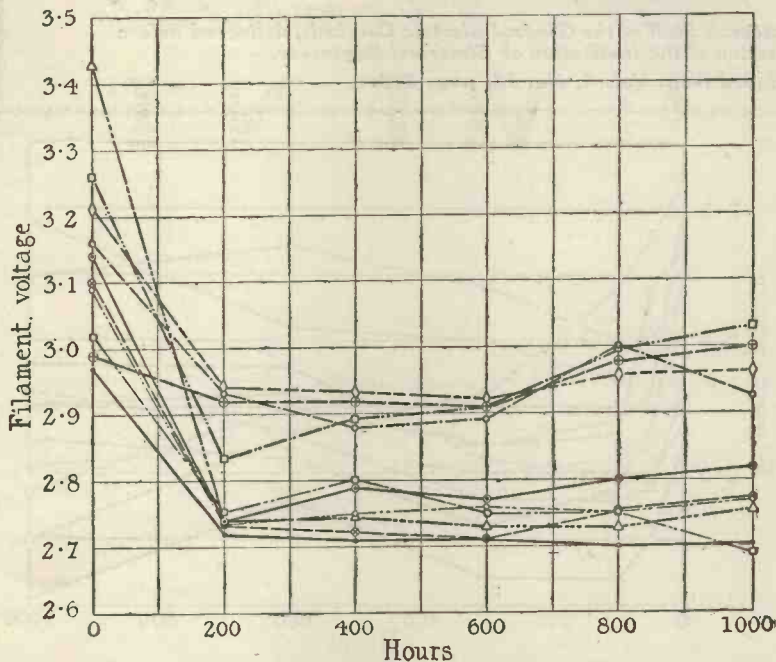

Fig. 6.—Life test of L.S.5 valves; filament voltage required to give a constant emission of 5 mA.

when valves with hot tungsten filaments are employed, and by the second term the more or less musical note similarly heard when a blow or tap is delivered to a valve occupying a position before the last two.

The cause or cure of crackling

□

It is always rather a problem to find some way of fixing terminals in ebonite so that they will not work loose when the set has been in use for some time. The matter is particularly important in the case of such terminals as are frequently screwed up and unscrewed. The loosening of terminals in ebonite is due to two causes. In the first place, the material itself is elastic to some extent, though under continued pressure it loses its elasticity. Hence, if a terminal is placed in a clearance hole and secured by a nut beneath the panel, it may be made perfectly tight in the first instance, but a little later it may have been found to have loosened. The ebonite is compressed by the nut, against which it springs until its elasticity is gradually reduced under the pres-

sure. Then loosening occurs.

Dull-emitting filaments are, however, almost entirely free from this first defect, but are offenders in respect of the second.

Very numerous experiments in connection with the micro-

□

Securing Terminals in Ebonite

sure. Then loosening occurs. There are several ways of combating this tendency. The writer usually screws terminals in, using tapped instead of clearance holes, which makes them very firm indeed, especially if a lock-nut is put on below the panel.

Another method which is also quite effective is as follows:—Be careful to drill your clearance holes so that they only just take the shanks of the terminals. Use a washer between the nut and the panel, and tighten all nuts as hard down as you can. Put all terminals, valve legs, and so on, on the ebonite at least a day before soldering is done, and

before this operation takes place give each nut a hard turn down and place a lock-nut over it.

Heating the terminal up during the process of soldering also has a loosening effect. Heat softens ebonite where it comes under the pressure of the retaining nut. The remedy here is to use a very hot soldering iron, so that the solder can be flowed on very quickly, with the result that the terminal is not heated up. If a half-cold iron is used, one has to make prolonged efforts before the solder will form a proper "blob" and the shank of the terminal is heated up excessively. Immediately after soldering all nuts on the shanks of terminals and valve legs should be tightened down with the pliers, or, better still, with a small thin spanner.

R. W. H.

The Radio Society of Great Britain

*The Report upon a Lecture given before the Society by
Mr. A. A. Campbell-Swinton, F.R.S.*

"The possibility of Electrical Television, both by wire and by wireless" was the subject of a lecture given by Mr. A. A. Campbell-Swinton, F.R.S., before the Radio Society of Great Britain, on Wednesday, March 26, 1924. Dr. W. W. Eccles, President of the Society, occupied the chair.

Mr. Campbell-Swinton began by declaring that, so far as he was aware, no practical method of real television has as yet materialised, television being distinct from the telegraphic transmission of pictures, which has actually been practised for more than fifty years.

One of the earliest systems devised for telegraphing pictures, but commercially impracticable, was that of Carley, in 1880, in

which a multiple system of wires connecting individual selenium cells with individual electric lamps, formed a coarse mosaic utilising the principle used in half-tone illustrations.

An interesting suggestion for television, discussed recently by Mr. Nicholas Langer, makes use of exceedingly minute synchronously oscillating mirrors connected to a single selenium cell at the transmitting end. This too, was considered mechanically impossible, owing to the inability to keep the mirrors oscillating in perfect synchronism at a very high speed.

The lecturer then pointed to the possibilities of cathode rays. In 1908 he had suggested the employment of two beams of cathode rays, one at the transmitter and one at the receiver,

synchronously deflected by the varying fields of two electromagnets placed at right-angles to each other, and energised by two alternating currents of widely different frequencies. The two beams would thus be caused to sweep synchronously over the whole of the required surface within a tenth of a second. Thus in the receiving apparatus, by causing the moving cathode beam to play on a sufficiently fluorescent screen and by giving it suitable variations in intensity, it would be possible to transmit an actual image.

Mr. Campbell-Swinton's lecture evoked an interesting discussion, in which Mr. L. B. Atkinson, Dr. Fournier D'Albe, Mr. F. Phillips, Mr. P. R. Coursey and Mr. K. G. Blake took part.

TRANSMITTER AND RELAY SECTION

Informal Meeting held at the Institution of Electrical Engineers on 28th March, 1924

Mr. F. L. Hogg (2 SH), the Highgate transmitter, who has recently achieved remarkable success in communicating with American Amateurs, opened an interesting discussion on Friday, March 28th, before an informal gathering of members of the Transmitter and Relay Section of the Radio Society of Great Britain.

The meeting, which was held at the Institution of Electrical Engineers, was presided over by Captain Ian Fraser.

Mr. Hogg dealt with the question of H.T. supply for valve transmitters, paying special attention to the less widely used but more economical methods of deriving power. With regard to the use of mains, attention was drawn to the necessity of inserting a high-frequency choke in the main leads in cases where the filament battery is charged during use. The speaker also referred to a useful method of balancing the earth afforded by the mains, and the balanced earth by means

of a tuning inductance and series condenser placed in the leads between the valve filament and the earth.

When D.C. mains are used a step-up may easily be obtained by coupling up two small motors to operate a motor generator, and by connecting the output in series with the main supply.

The D.C. Raiser, the T.V.T. Unit and the Synchronous Rectifier were all dealt with by Mr. Hogg. His condemnation of chemical rectifiers was warmly opposed by Mr. Hugh N. Ryan, and provoked a lively discussion.

A mild sensation was provided when, several speakers having given their experiences in earthing on the borough mains, a member of the audience announced that he was a Borough Supply Engineer. He appealed to transmitters to avoid as far as possible the risk of causing leaks by this method, which gave infinite trouble to the Engineers concerned, and advocated the use of a large condenser in the earth

lead in order to obtain perfect insulation.

A profitable discussion was brought to a close with a hearty vote of thanks to Mr. Hogg.

Useful Notes

We have received from Messrs. A. J. Stevens & Co. (1914), Ltd., a small booklet entitled "Instructions and Information." This contains a brief description of the principles of wireless, together with many useful hints for the operation of the sets made by this company. The book concludes with some notes on the regular programmes of broadcasting stations in this country and on the Continent. The final "don'ts" are amusing and interesting. One of these we would like every listener to take to heart. It is: "Don't tune in for far-off stations until you are O.K. with the near stations."

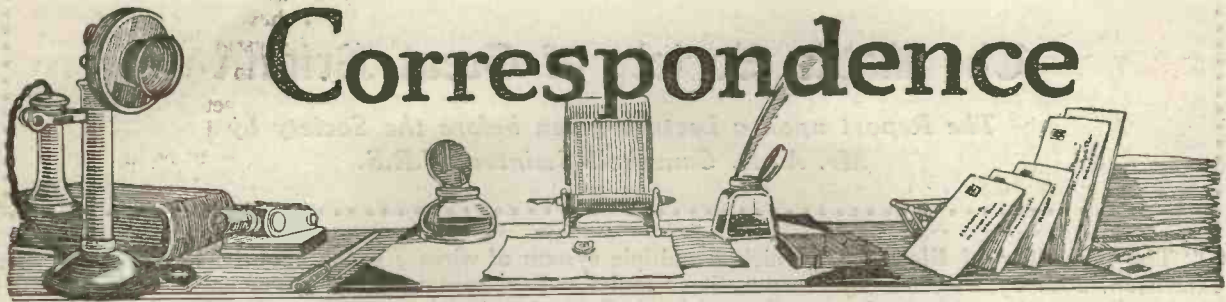

Correspondence

OMNI RECEIVER

SIR,—Having recently completed a unique set to your specification, I enclose photos herewith. You will see I have amended the original a good deal.

Materials in Set

Light oak cabinet.
 Two R.I. transformers.
 One burnt-out transformer (using sec. as choke coil).
 Two 0.001 μ F Polar condensers (variable).
 One W. & M. 0.0005 μ F variable condenser.
 One Edison-Bell twin crystal detector.
 Two Bretwood variable grid-leaks.
 One Lissen variable anode resistance.

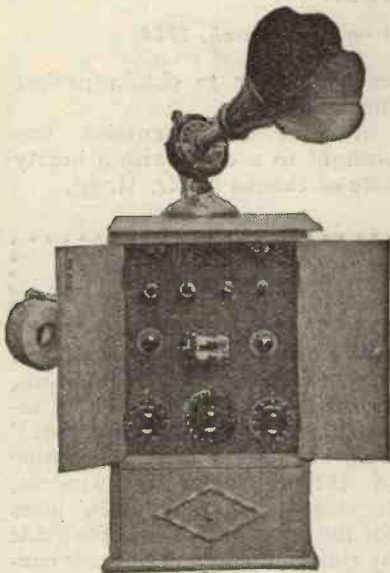

Illustrating the receiver as made by Mr. Featherstone.

Two Lissenstat fil. resistances.
 One Lissenstat minor fil. resistance.
 Two fixed coil plugs.
 Two plugs and jacks.
 One telephone transformer.
 One Dewar switch.



Internal wiring of the instrument.

One three-way coil holder.
 One 0.0001 μ F Dubilier fixed condenser.
 One 0.0003 μ F Dubilier fixed condenser.
 One 0.001 μ F Dubilier fixed condenser.
 Two 0.002 μ F Dubilier fixed condensers.
 One 0.006 μ F Dubilier fixed condenser.
 One 0.0005 μ F Dubilier fixed condenser.
 75 terminals.
 Twelve valve legs.

The valves are enclosed, but are easily reached from back of cabinet, and being enclosed, the light from valves is made to illuminate the twin crystal by holes being drilled through the panel behind crystals. All connections are made to rear of set, and two jacks are in the set. One is for high resistance, and one for low resistance, a telephone transformer being connected with it. In addition there are two terminals for high-resistance 'phones. Extra fixed condensers are included and extra terminals

are on terminal board, but the numbers correspond to those of the original printed receiver. Numbers and ciphers were painted on with white enamel, care being taken to see that terminals were not shorted by means of the enamel. There are still a few blank terminals which may yet prove useful. The Dewar switch is used to cut out the + and - of H.T. and L.T. The circuit at present wired is the ST100.

Results

There does not appear to be the slightest ill-effect from the crowding of the components, and here in Bristol I get 5WA exceptionally loud; in fact, I have to detune it for the loud-speaker. 6BM, 5IT, Ecole Superieur, FL, 5SC, and 5NO all come in in the order named. I may say I also

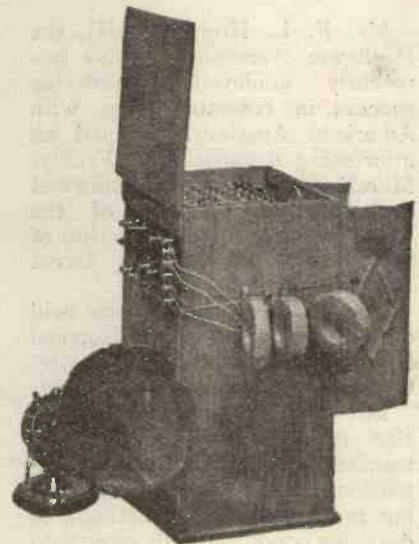

A view of the receiver showing terminal board.

added an extra valve to ST100 by means of the choke coil, fixed condenser, and variable leak, but 5WA and 6BM were far too loud for an ordinary room. I have also wired up ST34 and ST150 with quite good results.

April 16, 1924

I consider the arrangement a splendid idea, and no one can say in my case that the instrument is not fit for any drawing-room.

Yours faithfully,
Bristol. W. FEATHERSTONE.

RECEPTION IN CORNWALL

SIR,—A reply of yours in March 26 issue to J. P. (Clapham) has been sent on to me, and possibly the following notes may be of general interest to readers in this part of Cornwall. I brought with me from London a straight-circuit 3-valve set (H.F. D. L.F.), using D.E.3 valves and H.T. up to 54 v. It proved useless until I made the following alterations: Fil, controls changed to + L.T. and grid-leak to + L.T. instead of E. The A.T.I. was changed from 50 to 75 and reaction coil 75 to 100. The A.T. condenser was altered from 0.0005 μ F to 0.0002 μ F. Also I added another dozen T.E.C. cells, so that I have 108 v. The results of these changes were startling. On the first evening I got EVERY British station, Newcastle, Manchester and Bournemouth being the best; since then London and Cardiff have been equally as good.

I may say that earth trouble is frequent on this rocky soil, and I was advised, and have found it very successful, to bury a biscuit tin in ashes and also to fill same with similar material.

I am 9 or 10 miles south of St. Austell and 29 to 30 west of Plymouth, but Plymouth is not good, compared with the others. I have not yet tried to locate the trouble with a frame, but there appear to be one or two stations persistently Morsing with high power on a wavelength somewhere in the neighbourhood of 300 metres. The result is terrible. It is not a question of flatness in tuning, for I can isolate London 365, Manchester 375 and Bournemouth 385, without interference, but it is not until the 400 metres of Newcastle is reached that reasonable peace from Morsing is secured. Plymouth on 340 metres is hopeless, excepting in the intervals of Morsing.—Yours faithfully,

COLMAN C. STARLING.

Cornwall.

A COMBINED HIGH-FREQUENCY CRYSTAL UNIT

SIR,—I feel I must write and

Wireless Weekly

let you know what excellent results I have obtained on the combined crystal and H.F. valve set described in Vol. III., No. 13.

I made this set up as per your instructions, and it worked the first time I connected up to my outside aerial (25 feet effective height).

The results surprised me, considering only one valve is used.

I obtained Aberdeen and Glasgow loud enough for comfortable hearing with four sets of 'phones; Bournemouth also came in as strong, and all other stations were tuned in without any difficulty. I used a .0003 condenser for the H.F. tuning, as you suggested, if only the Broadcast band is to be used.

I found the unit very selective, and the only time 2ZY (20 miles from my house) interfered was when London came on, but considering the new aerial at Manchester, one can only expect this in our district.

I noticed your amplifying unit to work in conjunction with the above valve set, with interest in Vol. III, No. 15, and I shall be very delighted to see something from your pen regarding further



Ethovox

The Perfected Loud Speaker.

BURNDEPT
WIRELESS APPARATUS

Value for Money

A Full Sized Loud Speaker



AN increasing demand for the "Ethovox," the world's best loud speaker, has made possible a substantial saving in the cost of production. This saving we have pleasure in passing on to the public as a reduction in price.

The "Ethovox" is a superb musical instrument, reproducing speech and music purely and clearly. Its technical perfection is backed up by a twelve months' guarantee given with each instrument. The fair and graceful swan-neck are a rich mahogany colour—not black. At any of our Branches or Agents you can hear the "Ethovox" in operation.

Full-size table pattern, height 26 in., either Low Resistance, 120 ohms (No. 203), or High Resistance, 2000 ohms (No. 204) ... Price £5 0 0

BURNDEPT LTD., Aldine House, Bedford St., Strand, London, W.C.2. Phone: Gerrard 9072.

experiments possible on your set, such as introducing reaction and other possibilities.

I use a *Cossor* valve, and reception is remarkably quiet and pure.

I am now making a similar unit for a friend of mine, who is delighted with my set. Wishing you and the "Weekly" every success.—Yours faithfully,

H. H. DARBY.

Near Wigan.

ST100

SIR,—Perhaps it may interest you to know that using your ST100 circuit I can receive 2ZY, which hitherto I have not been able to hear on three valves, 1 H.F., D., 1 L.F., with reaction on tuned anode. I have heard all the B.B.C. stations on this circuit, as well as Croydon and Brussels.—Thanking you, I remain, yours faithfully.

F. CULLING.

Romford.

CARDIFF ANNOUNCING

SIR,—I have read your Editorial headed "Cardiff Announcing," with feelings of resentment and indignation.

What right have you, even though you are privileged to use the word "we," to use your excellent paper to give offence to listeners in this part of the country, who have long since come to appreciate the Cardiff Station, and especially the announcer evidently referred to?

No doubt London is supreme in everything, and why *Wireless Weekly* is not "The London Wireless Weekly" is a mystery; nevertheless, comradios down here, puerile and otherwise, are justly proud of the Cardiff Station, its achievements and its staff.

The word "Comradio" appearing strange to you is plain proof that you have very seldom listened to Cardiff, which is hardly to be wondered at, when London is always at hand. To us, now, "Comradio" is quite intimate.

The whole drift of the matter is this, to my mind, that we are quite happy down here with our station and its announcers, and keenly resent any "mud slinging" and interference from you. The whole article reads more like the effluence of a blasé office boy than a dignified criticism of

a B.B.C. station.—Yours faithfully,

A COMRADIO.

Westward Ho!

[This letter really raises an important point. Do loyal supporters of a provincial station regard "London" criticism as offensive, whether true or not?—ED.]

ST75

SIR,—Might I take this opportunity of congratulating you on your ST75 circuit? I have been experimenting with dual-amplification circuits for a number of months, and I think that your circuit is easily the most efficient one that I have tried so far. It may interest you to know that I am able to work a loud-speaker (small Claritone) on every station except Cardiff. At the opening of the Bournemouth broadcasting station the speech was readable about 15 feet away. I have also picked up the London amateur 2OM on 440 metres on headphones.

Thanking you again for the ST75.—Yours faithfully,

ROBERT B. BROWN.

Keith, N.B.

Myers Valves

Practically Unbreakable

DON'T blame your set—it may be the valve that is responsible for poor reception or distortion.

The Myers valve, in addition to being practically unbreakable, possesses remarkable properties as both detector and amplifier.

These valves can be used in any circuit—H.F. or L.F.—dual or Armstrong and equally satisfactory results obtained.

Made in two types—Universal for use with accumulators and the Dry Battery type for dry batteries. *Both types are sold complete with clips ready to mount on your set.*

Insist on Myers at your dealers or send P.O., and be supplied post free.

Cunningham & Morrison

49, Warwick Road, Earl's Court, London, S.W.5.

The biggest little thing in Wireless.

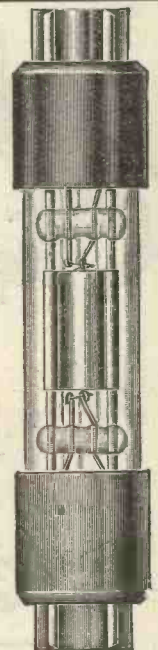

EXACT SIZE.

UNIVERSAL 12/6
4 Volts .6 Amps
DRY BATTERY 21/-
2½ Volts .25 Amps
Plate Voltage 2 Volts to 300 Volts.



Apparatus we have tested

Conducted by A. D. COWPER, M.Sc., Staff Editor.

A Transmitting Generator

We have recently had an opportunity of putting to practical test a high-tension generator manufactured by Messrs. Evershed & Vignoles, Ltd., the well-known makers of electrical testing apparatus.

The generator, which is designed for an output of 30 to 40 milliamps at 600 to 1,000 volts, is of the permanent magnet type, and the armature, with extremely well protected winding, together with specially-designed commutator, runs easily in bearings of ample size, and may be run for lengthy periods without attention.

Two types of generator are available, one provided with a pulley secured upon the end of the armature spindle and intended to be belt-driven, and the other type of machine is provided with a spur-gear reduction with a ratio of 27 to 1, for hand power.

The latter type is the one which we have tested, and the power output obtained with comparatively slow rotation of the driving handle, is excellent. Except at the lowest speed, the output is very steady, and, by means of a direct-coupled short-wave transmitting set connected to a fairly large aerial and

counterpoise, it was a comparatively easy matter to maintain an aerial current of over $\frac{1}{2}$ an ampere, whilst current up to 1 ampere could be obtained by increasing the revolution, without apparently overloading the generator.

For those who have power supply available, the belt-driven generator will no doubt prove most useful, especially if comparatively long runs are to be made, but the hand-driven machine affords a reliable and independent source of H.T. supply for those who would otherwise have to rely upon batteries.



"IGRANIC" SHROUDED TYPE
L.F. TRANSFORMER.
(Pat. No. 205013.)

For Maximum Volume with richness, depth and purity of tone use "IGRANIC" Low Frequency TRANSFORMERS

Scientifically constructed of the finest materials, and being the result of careful and accurate design and research work by skilled Radio Engineers, it embodies all those features which stand for efficiency.

The totally enclosed construction not only affords the maximum amount of mechanical protection to the windings, but also acts as a magnetic screen, thus preventing the transformer affecting, or being affected by, external circuits.

Price 21/-

Obtainable from all dealers.

Write for Lists Y24.

Manchester.
30, Cross Street.
Birmingham.
73/4, Exchange Buildings.
Glasgow.
50, Wellington Street.
149, Queen Victoria Street,
LONDON.



Cardiff.
Western Mail Chambers.
Bradford.
18, Woodview Ter., Manningham.
Newcastle.
90, Pilgrim Street.
Works: Elstow Road,
BEDFORD.



The "Fynetune"
Gives
**HAIRSBREADTH
ADJUSTMENT TO
CONDENSERS ETC.**
Three Minute-One Hole Fix

YOU can get the Distant Stations.

DON'T fix a fishing rod on your condensers—Fit a "FYNETUNE." It gives absolute micro-meter control and enables you to get—and hold—the distant stations.

THE LATEST AND MOST EFFICIENT VERNIER ADJUSTER. ELIMINATES THE TROUBLESOME HAND CAPACITY EFFECTS. THE KNOB ROTATES IN SAME DIRECTION AS CONDENSER KNOB.

Can be obtained from most Live Wireless Dealers or sent direct for **2/6** and your dealer's name and address.

Sole Distributors:—
SPARKS RADIO SUPPLIES, 43, GREAT PORTLAND STREET, LONDON, W.1.
Telephone: Langham 2463.

OTHER GOOD LINES—"Radiohm" Bus Bar $\frac{1}{16}$ square Tinned Copper, 2/- doz. Postage 3d. "Radiohm" Ribbon Aerial. Helps you across the Atlantic. 100 feet on reel, 3/- Postage 5d.

THE
"OMNI-CIRCUIT" PANELS
CUT TO SIZE, DRILLED AND ENGRAVED.
Best Ebonite and Workmanship.
Size of Panels:— 14 x 10 x $\frac{1}{4}$ 14 x 9 $\frac{1}{4}$ x $\frac{1}{4}$
£1:10:0 Per Pair.
ANY SIZE PANELS SUPPLIED AND ENGRAVED TO CUSTOMERS' SKETCHES

S. MARKS & SON,
7 & 8, CARTHUSIAN STREET, E.C.1.
Telephone: Clerkenwell 6318.

Quality COMPONENTS.
RADIO

ALTERATION OF PRICES.

Cam-operated Vernier Coil Holder 9/- each
Basket Coil Holder 1/6 "
Legless Valve Holder 1/6 "

Other Prices Unchanged.

GOSWELL ENGINEERING CO., LTD.,
12a, PENTONVILLE ROAD, LONDON, N.1.
Liberal Trade Terms. Phone: North 3051.

IRISH

Experimenters can obtain all types of Component Parts at London Prices from us. Here are a few examples of our prices:—

French Thomson-Houston 'Phones, 19/- per pair.
Filament Rheostats, from 2/- each.
L.F. Transformers, from 15/- to 25/- each.
Valve Holders, 1/-. Switch Arms, 1/3.
H.T. Batteries, 10/- and 13/6 per 66 v. unit.
Variable Condensers, aluminium end-plates, complete with knob and dial:—
.001, 8/-; .0005, 6/-; .0003, 5/6; .0002, 4/6.

IRISH RADIO STOCKISTS 3, Crow Street, DUBLIN.

BEWARE OF WORTHLESS IMITATIONS, SEE THE TRADE MARK **Watmel** ON EVERY GRID LEAK.

WATMEL VARIABLE GRID LEAK
(Patent No. 206098).

Constantly Variable Silent in operation. Constant in any temperature. Dust and Damp proof. Each tested and guaranteed. Neat and well made.



GRID LEAK .5 to 5 megohms 2/6
ANODE RESISTANCE 50,000 to 100,000 ohms 3/6.
Suitable for S.T. 100 Circuit.

SEND P.C. FOR DESCRIPTIVE FOLDER.

WATMEL WIRELESS CO., Connaught House, 1a, Edgware Road, Marble Arch, W.2. Tel. 4575 Paddington

ECONOMIC ELECTRIC WRITE NOW!

OUR NEW RADIO CATALOGUE

comprising 40 pages and 300 illustrations of all classes of instruments, component parts, materials, etc., is just off the press. IT WILL PAY YOU WELL to remit 4d. in stamps and secure this money-saving publication.

Head Office: 10, FITZROY SQUARE, LONDON, W.1. Showrooms: 303, EUSTON RD., N.W.1. Branch and Works: TWICKENHAM.

THE ORIGINAL AND GENUINE **BUS BAR**

"RADIOHM" $\frac{1}{16}$ " Square Tinned COPPER ROD

We were the first to place this wiring rod within reach of the British Constructor. Many soft substitutes have since appeared, but "Radiohm" is still the best

It is stiff and sturdy and stays put.
It is really square.
It is the finest wiring rod for the Omni Circuit.

REDUCTION IN PRICE. SEND FOR PAMPHLET.
Having placed large contracts for the supply of this wiring rod we are able to announce reduction in price. We could offer a cheaper wire, but we prefer to maintain the quality.

1 Dozen 2-ft. lengths, 2/-. Postage and packing, 3d.
"RADIOHM" STRIP COPPER AERIAL is just as good. 3/- per 100-ft. reel. Postage 5d.

SPARKS RADIO SUPPLIES
(Dept. W), 43, GREAT PORTLAND ST., LONDON, W.1
TRADE SUPPLIED. Telephone: Langham 2463.



The Finishing Touch

TO YOUR RECEIVER

is provided by

MARCONI VALVES

MADE AT THE OSRAM LAMP WORKS

Which have set the standard by which others are judged. The choice of valves is most important and it is essential that YOU SHOULD AVOID Foreign substitutes which are offered as being "Just as Good."

We are exhibiting at the BRITISH EMPIRE EXHIBITION, WEMBLEY, —1924.

Electrical and Allied Engineering Section. STANDS—Avenues 11-13 Bays 11-15

Remember; each replacement costs you at least 12/6, therefore be sure of the best results during the longest useful life by insisting on MARCONI VALVES which are used in the world's largest wireless stations.

NOTE—The Osram Factories were, nearly four years ago, producing "Dull Emitter" Valves; the experience thus gained is at your service.

R. Type 12/6

D.E.R. „ 21/-

D.E.3. „ 30/-

Prices and specifications of other types on request.

SOLD BY ALL LEADING WIRELESS DEALERS, ELECTRICAL CONTRACTORS, STORES, ETC.

BUY BRITISH GOODS ONLY

LISSENIUM

A STONEWALL WITHIN YOUR RECEIVER

If you use assorted parts some of these may be good others may be leaking energy—others may be so useless that they **STAND LIKE A STONEWALL ACROSS THE ENERGY PATH.** Parts of assorted make! Why use them? Every vital part is so important that there is a LISSEN Part for every vulnerable point of a receiver. If you wish to easily fix responsibility for the behaviour of your Set, you will use a LISSEN Part wherever you can. And we are content that you should do—for **WE GUARANTEE EVERY LISSEN PART TO SATISFY YOU PERFECTLY—we EXPECT TO HEAR FROM YOU IF YOU ARE NOT SATISFIED.**

NOT THE CORE—BUT THE COIL—



It is the valuable coil in the LISSEN T1 Transformer which gives that pure and powerful amplification—this LISSEN coil would amplify if there were no iron core at all—the transformer is **COPPER WEIGHT, NOT IRON WEIGHT.** For use immediately behind the detector valve always, but can be used throughout where superlative amplification is desired—a wonderful power amplifier also, 30/-.

AUDIO FREQUENCY IN REFLEX CIRCUITS. It has been found that the LISSEN T2 Transformer is a fine transformer in these circuits. 25/-.

AN EXCELLENT LIGHT TRANSFORMER. Skillfully balanced in design—compares with many expensive transformers—this LISSEN T3 Transformer is one of the best light transformers made. 16/6.

AN IMPORTANT USE FOR—



the LISSEN (prov. pat.) Series Parallel Switch. Sets with aerial reaction always oscillate most easily with the condenser in series, because then the natural inductance and capacity of the aerial do not have the same damping effect as when the condenser is in parallel. **PARTICULARLY IS THIS SO WHEN WORKING ON SHORT WAVELENGTHS.**

BUT WHEN WORKING ON THE LONGER WAVELENGTHS, over say 600 metres, it is essential that the condenser should be in parallel, as if the condenser were in series on a wavelength, say of 2,000 metres, it would be necessary to use a coil probably three or four times larger than the coil which you now use, with the condenser in parallel, to tune to this wavelength.

It is obviously an advantage, therefore, to fit the LISSEN (prov. pat.) Series Parallel Switch into a receiver, so that tuning can be suited to the wavelength on which it is desired to receive.

The LISSEN Series Parallel Switch takes up hardly any room—and LISSEN ONE HOLE FIXING, OF COURSE 3/9.

PUT IT IN THE L.T. LEA—

This LISSEN 2-Way Switch.



And at any interval in Broadcasting the receiver can be put out of commission temporarily by just a gentle push or pull, instead of it being necessary to turn every filament rheostat off, and then readjusting the individual controls when reception is resumed. This is only one use for this handy little switch. Others will readily suggest themselves—the switch itself takes up hardly any room—and LISSEN ONE HOLE FIXING, OF COURSE. LISSEN (prov. pat.) two way switch, 2/8.

JUMPING ACROSS THE GRID—

ELECTRONS! Think how they jump across! Positive and negative electrons alternating—**IF THE GRID LEAK RESISTANCE IS CORRECT.** If there is no means of regulating grid potential, however, the grid of the valve will become highly positive, and this will stop the electronic flow between filament and plate. With some circuits and some valves variable grid control is not so important, but with others it is extremely important. By using the LISSEN Variable Grid Leak (prov. pat.), the exact value of leak resistance can be selected to suit every varying phase of the valve and circuit, and it is, of course, an excellent thing to be able to obtain correct grid potential all the time.

LISSEN ONE HOLE FIXING, OF COURSE. POSITIVE STOPS BOTH WAYS. Conservatively rated $\frac{1}{2}$ to 6 megohms. 2/6.

LISSEN Variable Anode Resistance, same outward appearance as the LISSEN Variable Grid Leak, continuously variable, 20,000 to 250,000 ohms. Price 2/6.



NOISES ARE DISASTROUS TO CLEAR RECEIVING—

Any noise in a receiver gets multiplied many times with each stage of amplification. A rheostat that does not pass a steady current excites extraneous noises in the valve. You may think any device for filament control is good enough—**BUT IS IT?** Those who value fine detection are fitting LISSENSTAT Control—its improved effect on tuning is at once noticeable—here is a control that keeps your valves quiet—**THROUGH A DEAD BACKGROUND OF SILENCE STATIONS COME THROUGH THAT PREVIOUSLY ELUDED EVERY OTHER CONTROL OF THE RECEIVER—**stepless, noiseless, perfect control from the first turn to the last. Fit one LISSENSTAT, and you will surely have all your valves LISSENSTAT controlled. There are three types to choose from—each is suitable for dull emitter and all valves—

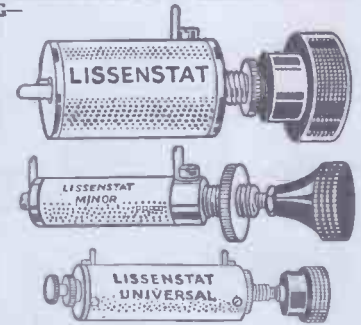

LISSENSTAT, the super filament control, 7/6.
LISSENSTAT MINOR, the perfect little control (intended to provide something of the beautiful LISSENSTAT control at a popular price), 3/6.
LISSENSTAT UNIVERSAL, protects expensive dull emitter valves, 10/6.

TO THOSE WHO MAKE THE MISTAKE OF THINKING THAT LISSENSTAT CONTROL IS THE SAME THING AS AN ORDINARY RHEOSTAT—LET THEM TRY THE DIFFERENCE.

ELECTROSTATIC FIELD IN SOME COILS—

It is impossible entirely to eliminate the electrostatic field, because any conductor has both an electrostatic and an electro-magnetic field. The shape of the coil, the method of winding the conductor and so on, all influence the strength of the respective fields. LISSENAGON (prov. pat.) coils are so designed and made that the electro-magnetic field in them is ever so much stronger than the electrostatic field. That is one reason why LISSENAGON (prov. pat.) COILS TUNE SO SHARPLY AND SO STRONGLY.

LISSENAGON TUNING CHART. Note the Intermediate Coils: 30, 40, and 60.

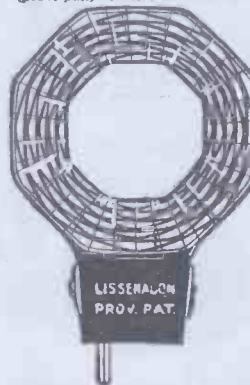

No. of Coil	TABLE I. Wavelength range when used as Primary Coils with Standard P.M.G. Aerial and .001 mfd. condenser in parallel.		TABLE II. Wavelength range when used as Secondary Coils with .001 mfd. condenser in parallel.		PRICE.
	Minimum Wavelength.	Maximum Wavelength.	Minimum Wavelength.	Maximum Wavelength.	
25	185	950	100	325	4/10
30	235	440	130	425	4/10
35	285	530	160	490	4/10
40	360	675	200	635	4/10
50	480	850	250	800	5/-
60	500	950	295	900	5/4
75	600	1,300	360	1,100	5/4
100	820	1,700	500	1,550	6/9
150	965	2,300	700	2,150	7/7
200	1,885	3,200	925	3,000	8/5
250	2,300	3,800	1,100	3,600	8/9
300	2,500	4,600	1,400	4,300	9/2

HOLD A LISSENAGON COIL UP TO THE LIGHT—SEE THE GREAT AIR SPACE RIGHT THROUGH.

ADD RADIO FREQUENCY—and How.

Say you have a receiver with aerial reaction—you can make it more powerful by far if you add one stage of LISSEN REACTANCE (prov. pat.). This should be introduced in the anode circuit of the H.F. valve—diagram with each shows how. Ordinary radio frequency parts do not amplify loud signals to any great extent, but the LISSEN REACTANCE does. It has a switch complete—tuning is rapid—a vernier condenser is oftentimes an advantage, although not essential, as this LISSEN Part is self-tuned (preferably use the LISSEN Vernier, which is specially designed for fine tuning in H.F. circuits. Price 12/9).

150-10,000 metres 19/6
150-600 metres 17/6

Make a set powerful by adding one stage LISSEN REACTANCE.

ON USING THE LISSENCEPTOR—to cut out interference.

First adjust the receiver to the wavelength on which it is desired to receive. Then slowly adjust the condenser tuning the LISSENCEPTOR until a point is reached at which signals from the interfering station fade away. This condenser cannot be turned too slowly, as the tuning is extremely critical. After tuning up the LISSENCEPTOR, by means of its separate condenser, it may be necessary to slightly retune the set, and this may again necessitate a slight readjustment of the LISSENCEPTOR tuning condenser. But when the LISSENCEPTOR has been properly tuned, the UNWANTED STATION WILL BE FORGOTTEN ABOUT, SO COMPLETE IS THE ELIMINATION OF THE INTERFERENCE.

Broadcasting is very easy to eliminate with the LISSENCEPTOR, and also about 95 per cent. of more. There is, however, a certain type of more interference which calls for greater skill. But even the worst interference can be subdued to the extent that it no longer spoils reception of music.

LISSENCEPTOR Mark 1	type, for broadcasting	7/6
"	" " 600 metres	7/6
"	" 2 for broadcasting and 600 metres combined (this type has a switch for more selective tuning)	15/6

Diagram with each shows easy alternative connections.
A SENTINEL BESIDE YOUR RECEIVER.
Text Book of LISSEN PARTS post free 8d.—free to the Trade.

LISSEN LIMITED 30-32, WOODGER RD., GOLDHAWK RD., SHEPHERD'S BUSH, LONDON, W.12.

Telephone: 2339 Hammersmith.

Telegrams: (Inland) "Lissenium, Shepherds, London."
(Foreign) "Lissenium, London."

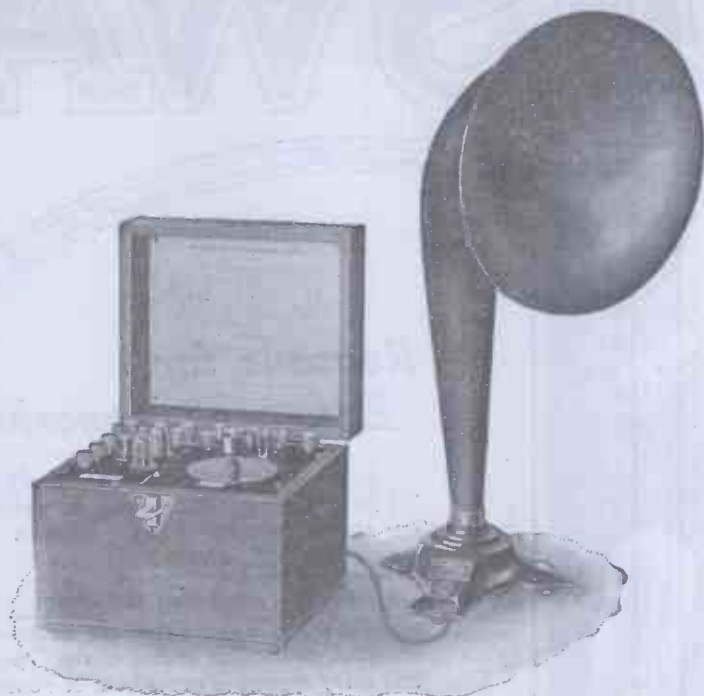

WECONOMY SETS *are* DRY BATTERY SETS.

THE illustration shows the No. 44080 Weconomy Set—a Crystal Set with double amplification, and the No. 44004 Western Electric Loud Speaker, designed and assembled for the efficient reception of a local B.B.C. Station. The combination will be found suitable to fill any medium sized room, and if desired Head Receivers may be used in place of the Loud Speaker, the range thereby being at least doubled. The Amplifier contains transformers and filament resistance, while the two Wecovalves *operate off dry cells, no accumulators being necessary.* The special distortionless properties of the transformers of the Amplifier and the exceptionally silent operation of the Wecovalves will render the complete equipment perfect in its reception of local Broadcasting programmes.

No. 44080 Weconomy Set including Valves
but not Head Receivers..... £12 : 0 : 0

No. 44004 Western Electric Loud
Speaker£3 : 17 : 6

(B.B.C. Contribution Extra.)

Western Electric Company Limited,
CONNAUGHT HOUSE, ALDWYCH, W.C.2.

Telephone : Central 7845 (9 lines).

Branches : Birmingham, Leeds, Glasgow, Newcastle, Cardiff, Manchester, Southampton and Dublin.

EDISWAN

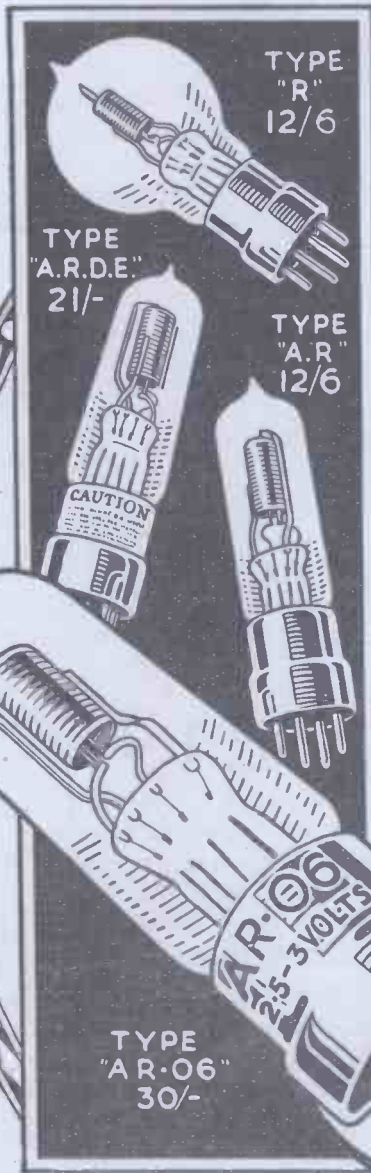

Reasons for "Ediswan" superiority

Actual results have conclusively proved "Ediswan" superiority—yet, in design, they are similar to other valves. Wherein lies the reason for their unrivalled efficiency?

Firstly, in the fact that the complete valve is made at our Works. From the manufacture of the glass, to the final sealing of the "pip," each and every process is carried out at Ponders End.

Secondly, every valve is subjected to four separate tests before it finally passes the standard of excellence which the "Ediswan" reputation demands.

You have only to insert an "Ediswan" to appreciate the difference "the valve with a name behind it" will make to your receiving set.

Have you had your FREE copy of illustrated booklet "The Thermionic Valve"? If not, send a postcard to-day

Your Dealer holds stocks to supply you. If not, write us direct, giving his name & address

The safety cap (Prov. Pat.) which is now fitted to all Ediswan Valves. The filament pins are shorter in length than the plate and grid pins, thus avoiding any chance of making surface contacts with the wrong sockets.

THE EDISON SWAN ELECTRIC CO., Ltd.

Contractors to H.M. Admiralty, War Office, Royal Air Force.

123/125, Queen Victoria St., E.C.4, and 71, Victoria St., S.W.1

Works: Ponders End, Middlesex.

Branches in all Principal Towns.



Use Ediswan, and Hear Everything.

Buy British Goods only.

PARTS, COMPONENTS, SETS—they all sell equally well in WIRELESS WEEKLY.

HULLO, EVERYBODY!!

RAYMOND

Post Free Column.

- Basket Coils (6) 200/3,600 2/6
- Waxless (5), 200/2,000M. 2/6
- Twin Flex, 12 yds. 2/-
- Bell Wire, D.C.C. I.R.C., 10 yds. 10d.
- 100 ft. Aerial, 7/22 3/3
- Rubber Lead-in, 10 yds. 1/6
- Basket Coil Holder and Plug 1/9
- Do., 2-way on Stand 5/9
- 2-way for Igranic Coils 4/11
- Various Designs do. 5/11, 6/11 & 7/-
- Shaw's Genuine Hertzite Spade Screw Terminals 1/3
- Pin do. doz. 1/6
- Pin do. doz. 1/3
- Ebonite Dial and Knob Do., Extra Quality 1/4
- Ebonite Valve Holders 1/3
- Do., Cut from Solid 1/6
- Valve Sockets, Best, doz. 1/3
- Do., Plain doz. 1/-
- Terminals, Telephone doz. 1/6
- Do., Pillar doz. 1/8
- Do., Small Pillar doz. 1/4
- Do., W.O. Patt. doz. 1/6
- (All above with Nut.)
- Insulating Sleeving, 3 yds. 1/3
- Tinned Copper, 3 yds., 14 or 16 gauge 9d.
- Do., 3 yds., 18 or 20 gauge 6d.
- Ebonite Coil Plugs, 2 for Do., on Stand 1/9
- 100,000 ohm Resistance Switch Arm, 12 Studs and Nuts 2/6
- Ormond Fils. Resistance Fixed Condensers, '001 Do., '001 to '005 1/2
- Do., '002 to '005, 1/3, '006 (Above best quality.) 1/6
- Grid Leak and Condenser, '003 2/6
- Ebonite Varlo, D.C.C. 250/260 4/11
- Do., D.C.C. Bail Rotar Ebonite (Inside Winding) Variometers 13/6
- Contact Slips doz. 1/-
- Battery Clips doz. 1/-
- Coil, 28 tps., 1,600 M. 2/8
- 4 Whiskers, 1 Gold 6d.
- Spear Point Whisker doz. 4d.
- 12 yds. Empire Tape 1/-
- Plug and Socket, 12 prs. Geocite Crystal 1/8
- Minicap Switch 8/-
- Radio Ins. Transformer Igranic Shrouded, L.F. 5-1 25/-
- Formo Shrouded, do. 18/-
- Formo Open Type, do. 12/6
- Royal, do. 20/-
- Tested on Aerial, do. 12/6
- Raymond, do. 12/6
- Ormond Fils. Rheostat Raymond do. 2/-
- Rheostat and Dial 2/6
- Ajax 25-5 4/-
- Ajax with Vernier, 30-5 ohms 5/-
- Ajax Potentiometer, 464 ohms 6/8
- Igranic Rheostat 4/6
- Peerless Rheostat, 8 ohms 4/6
- Peerless " 15 ohms 4/9
- Peerless " 30 ohms 5/-

VARIABLE CONDENSERS.

Our Air Dielectric Condensers are the simplest and MOST efficient on the market. Lowest in price, Highest in quality. Made for panel mounting and are the most suitable condensers for Broadcasting or Amateur work. They have passed THE TEST for guaranteed capacities, are scientifically accurate and built for durability.

NEW MODEL, POST 6d. SET EXTRA.

Capacity.	Plates.	Price.
*001	49	7/11
*00075	37	6/11
*0005	25	5/11
*0003	15	5/3
*0002	11	4/11
*0001	5	4/3

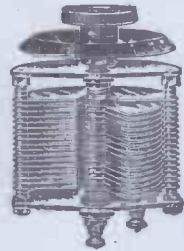

Prices include KNOB and Dial. Without Dial 6d. set less

Vernier, 3/11.

NATIONAL LABORATORY CERTIFICATE.

Above new model specially adapted for taking up min. amount of space. All parts nickelled. PASSED NATIONAL LABORATORY TEST. One hole fixing.

"A" TYPE. POST 6d. SET EXTRA.

Cap. Approx.	Plates.	Price.
*001	57	6/6
*00075	43	5/9
*0005	29	5/-
*0003	19	4/6
*0002	13	4/-
*0001	7	3/6

Vernier, 2/6. (No dial.)

Above "A" type is a wonderfully cheap and reliable condenser. One hole fixing. Thousands of testimonials from satisfied users.

Callers Only!

All Post Orders from other Columns.

- Telephone, large each 14d.
- Telephone .. each 1d.
- Pillar .. 1d. & 1 1/2d.
- W.O. patt. .. 2 for 2 1/2d.
- Large size .. each 3d.
- Various doz. 1/- & 1/6
- Valve sockets doz. 10 1/2d. & 1/-
- Contact studs .. doz. 4d.
- 2, 4, 5, 6 B.A. Nuts doz. 6d.
- 2 B.A. Rod .. foot 3d.
- 4 B.A. Rod .. foot 2 1/2d.
- Valve Pins .. 2 a 1d.
- Brass Bushes .. 1d.
- Spade Tags, best, doz. 3d.
- Screw Spade Terminals 1d.
- Pin Screw do. 4 for 3d.
- Stop Pins .. 2 a 1d.
- Plug and Socket pair 1 1/2d.
- Easyfix Cup .. 1d.
- Switch Arms 8d., 9d. & 10d.
- Do., with 12 Studs and Nuts and Washers .. 10 1/2d.
- English Flash Lamp Batt. doz. 4/3
- H.T. Batteries, 36 v. 5/-
- H.T. Batteries, 60 v. 8/6 & 10/6
- Filament Res., with Dial 2/-
- Set of Names (12) .. 5d.
- 0-300 Dial .. 5d.
- Scales (Engraved 0-180) 3d.
- Multiphona Terminals 9d. & 1/-
- Insulators, Egg 6 for 6d.
- Aerial Wire, 100 ft. 1/10
- Extra Hard Drawn, 7/22 100 ft. 2/6
- Valve Windows .. 7d.
- Res. Dials, 0-100 .. 4d.
- Ebonite Dial and Knob, 0-180 1/1 & 1/3
- Filament do. and Knob 9d.
- Filament Dial, 0-10 .. 6d.
- Fixed Condensers to '001 10d.
- Do., '002 to '005 & '006 1/3
- Ins. Screw Eyes .. 1d.
- 4 Cats Whiskers (1 gold) 3d.
- Gold Whisker .. 1d.
- Shaw's Hertzite .. 1/-
- Zincite, 6d.; Bornite .. 6d.
- Coil Holders .. 1/1 & 1/3
- Coil Plug, Ebonite 7d. & 9d.
- Do., on Base 1/- & 1/3
- Best Valve Holders .. 1/3
- 3 makes, above 10d., 1/- & 1/3
- Tinned Copper, 18, 18, 20g. Slewing, best .. 3 yds. 1/-
- Copper Fil .. ft. 3d.
- Filament Res. good .. 1/6
- Rubber Lead-in 10 yds 1/- & 1/3
- Bell Wire, D.C.C. I.R.C., 10 yds. 5d.
- Twin Flex .. 12 yds. 1/6
- Heavy Rubber Lead-in yd. 2d. & 3d.
- Basket Coils (6) 200/3,500 1/9
- Waxless (5) .. 1/11
- D.P.D.T. Switches for Panel 1/6
- S.P.D.T. do. .. 1/3
- Telephone Cords 1/6 & 8d.
- Grid-Link (2 meg.) .. 1/-
- Do., and Condenser '0003 1/9
- Empire Tape .. doz. 9d.
- Adhesive do. .. roll 4d.
- A.A. Earth Clips .. 7d.
- Washers, 2 and 4 B.A. 3 doz. 2d.
- 100,000 ohms Res. .. 1/6
- Fine Variometers .. 2/6
- Nugraving Set .. 7 1/2d.
- Enclosed Detectors .. 11 1/2d.

HEADPHONES.

- Sterling B.B.C., high-class (4,000) 25/-
- B.T.H., B.B.C. None better (4,000) 25/-
- Brunet. Very fine value (4,000) 17/6
- Brunet, for Crystal Sets (8,000) 19/11
- N. & K., all stamped (4,000) 12/9
- Sidpe, very best 12/9
- Premier, B.B.C., full of music, 4,000 ohms Post 1/- pair. 17/6

CRYSTAL DETECTORS.

- Post 9d. each.
- Glass enclosed Whisker, Brass Fittings, 1/9, 2/3, & 1/6
- Glass enclosed Perikon, with Zincite and Bornite 1/11 & 2/9
- Nickel enclosed, 3/6, 2/6, 1/11
- Edison Bell Twin 5/6
- Choice Designs, 5/- & 7/6
- Post 9d. each.

- Post 3d. each.
- Lissen Grid Leak (Var.) 2/6
- Lissen Anode Resistance 2/8
- Lissen T1 Transformer 30/-
- Lissen T2 25/-
- Lissen T3 16/6
- Lissen Series 'Parallel Switch 3/9
- Lissen Two-way 2/9
- Lissenstat Minor. Out of Stock
- 100,000 ohm Resistance Edison Bell Fixed '001 1/3
- Do. '0001 to '0005 1/3
- Do. '002 to '006 2/-
- Do. '0003 and Grid Leak 2/6
- Raymond Fixed '001 1/1
- Do. '0002 to '0005 1/1
- Do. '002 to '005 1/5
- Do. '006 1/6
- Do. '0003 and Leak 1/10
- Dubiller Fixed '001 3/-
- Do. '002 to '006 3/-
- Do. '0001 to '0005 2/6
- Do. '0003 and Grid Lk. 5/-
- 'Phone Cords, 64 In. 1/3
- Do. 72 In. Double 1/9
- Variometer 250/850, 3/-, 3/6
- Do. Ebonite 250/850 3/11

H.T. BATTERIES.

- Post 1/- each.
- 36 v tapped 5/- & 5/6
- 60 v tapped 9/6 & 10/6
- Cheaper kinds usually in stock.

DISCOUNT TO TRADE and MEMBERS of Radio Clubs.

ERICSSON E. V. type, World Famous Continental Mead-phones, 4,000 ohms.

13/9 Post 1/- per pair.

VALVES

- Marconi R. 12/6
- Ediswan
- Mullard O. 12/6
- Cosser P.1.
- Cosser P.2.
- Post 1/- each.

VALVES.

- Phillips R. 7/8
- French R. 6/11
- No post Orders.

DULL-EMITTERS

All makes in stock.

SNIPS I EBONITE VARIOMETER

250/260, Ball Rotar wound D.C.C. with knob 6/11

Post 1/-

N. & K. (The Goods)

Best. Stamped Genuine. 4,000 ohms 12/9 Pair. Post 1/- pair.

SUPER CONDENSER WITH THREE PLATE VERNIER "IT" FOR VERY FINE TUNING.

IMPORTANT.

VERNIER IS AN INDEPENDENT CONTROL.

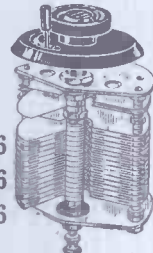

- '001 .. 12/6
- '0005 .. 10/6
- '0003 .. 8/6

Reg. Post 6d. set.

FILOSTAT FOR D.E. and R. VALVES

Post 6d. each 2/6

LOUD SPEAKERS

- Sterling Baby 55/-
- Sterling Floral 60/-
- Amplion Junior 42/-
- Sidpe Loud Speaker Complete 25/-
- Post Free

SNIPS I COIL HOLDERS.

- Plug-in type, Ebonite, Brass fittings on base. 3/3
- Two-way .. 4/6
- Three-way .. 4/6

Post 1/- each.

ACCUMULATORS.

- 2 v 40 a. 10/6
- 11/6
- 4 v 40 a. 17/6
- 19/6
- 4 v 60 a. 19/6
- 23/-
- 6 v 60 a. 28/-
- 33/-
- 6 v 80 a. 35/-
- 39/-
- Post 1/6 each.

EBONITE

- 3/16" 6 x 6 .. 1/6
- 8 x 6 .. 2/-
- 9 x 6 .. 2/3
- 12 x 9 .. 4/6
- 12 x 12 .. 6/-
- Post 6d. piece.

BASKET COILS

- Set of 6 .. 1/11
- Set of 7 .. 2/3
- Post 6d. set. to 3,600 metres

WAXLESS.

- Set of 5 .. 1/11
- Set of 6 .. 2/3
- Post 6d. set.

This list is subject to alteration without notice.

Right Opposite DALY'S Gallery Door

K. RAYMOND
27, LISLE STREET, W.C.2

HOURS OF BUSINESS:
Daily - 9 to 7.45
Sundays 10.30 to 1

Phone: Gerrard 4637.

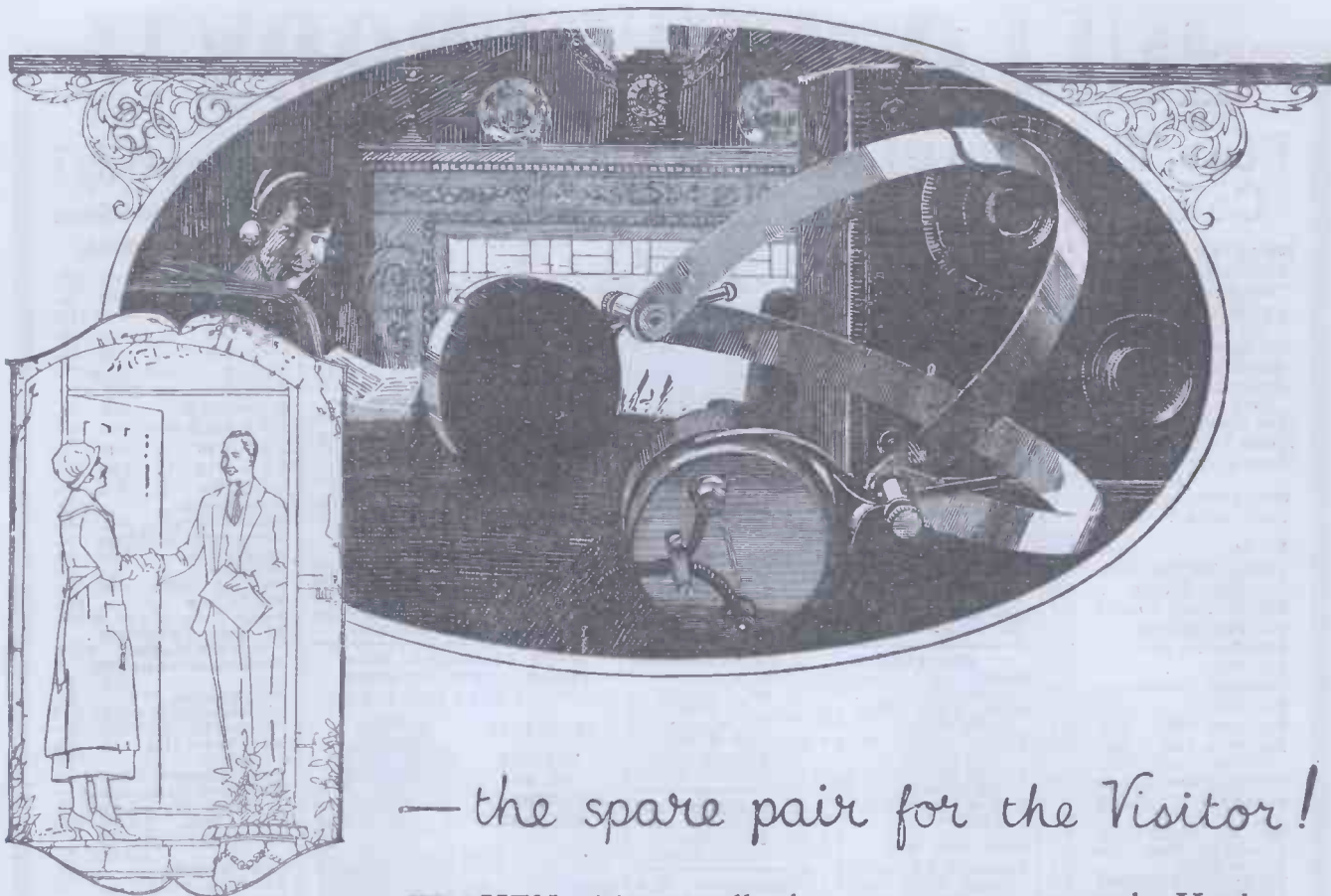

— the spare pair for the Visitor!

WHEN visitors call there are never enough Headphones to go round. Why not decide now to keep one or two pairs in reserve and so share your pleasure with those who visit you?

As an inexpensive Headphone the Brown F. type Headphone has achieved a wonderful measure of popularity, and has proved beyond doubt, that for sensitiveness and comfort it is ideal for Broadcast use. Its weight, including cords is but 6 ounces, and it can be instantly adjusted to any head—child or grown up.

The construction of the A. type Headphone with its tuned reed and aluminium cone shaped diaphragm (spun to the fineness of paper) is of necessity more elaborate. It is a Headphone to be selected where extreme sensitiveness is desired—such as in long distance work or for use with a Crystal Set giving weak signals.

Remember whether you buy a pair of F. type Headphones for 25/- or the famous Brown A. type at 66/- the quality of material and standard of workmanship is identical.

The D. type Headphone is the orthodox flat diaphragm pattern made under typical Brown supervision and sold at a most reasonable price.

TYPES AND PRICES:

A. Type	—120 ohms ..	per pair	58/-
	2,000 } ohms ..		62/-
	4,000 } ..		66/-
D. Type	—120 ohms ..		48/-
	2,000 } ohms ..		52/-
	4,000 } ..		56/-
F. Type	—120 ohms ..		22/6
	4,000		25/-

S. G. BROWN, LTD.

Wholesale : Victoria Road, N. Acton, W.3
Retail : 19, Mortimer Street, W.1
15, Moorfields, Liverpool.



Gilbert Ad. 729

PARTS, COMPONENTS, SETS—they all sell equally well in WIRELESS WEEKLY.

WIRELESS VALVES J U D G M E N T

IN THE HOUSE OF LORDS

In the case of the Marconi's Wireless Telegraph Co. Ltd., *v.* The Mullard Radio Valve Co. Ltd., their Lordships after careful consideration

UPHELD THE MULLARD RADIO VALVE

Company's claim, that they in no way infringed the patents of the Marconi Co. They therefore *unanimously* confirmed the judgments of the First Court and Court of Appeal and dismissed the Marconi Co's petition with costs.

J U D G M E N T

THE PEOPLE

The judgment of the people is equally clear. More Mullard valves are sold than any other kind.

THE REASON

The Mullard Radio Valve Co. Ltd. own and operate nearly one hundred valve patents, every one of which implies a definite advance in valve construction and makes every Mullard valve a *Master Valve*.

Be Wise.

Ask for them by Name.

Mullard

THE MASTER VALVE

(E.P.S. 130.)

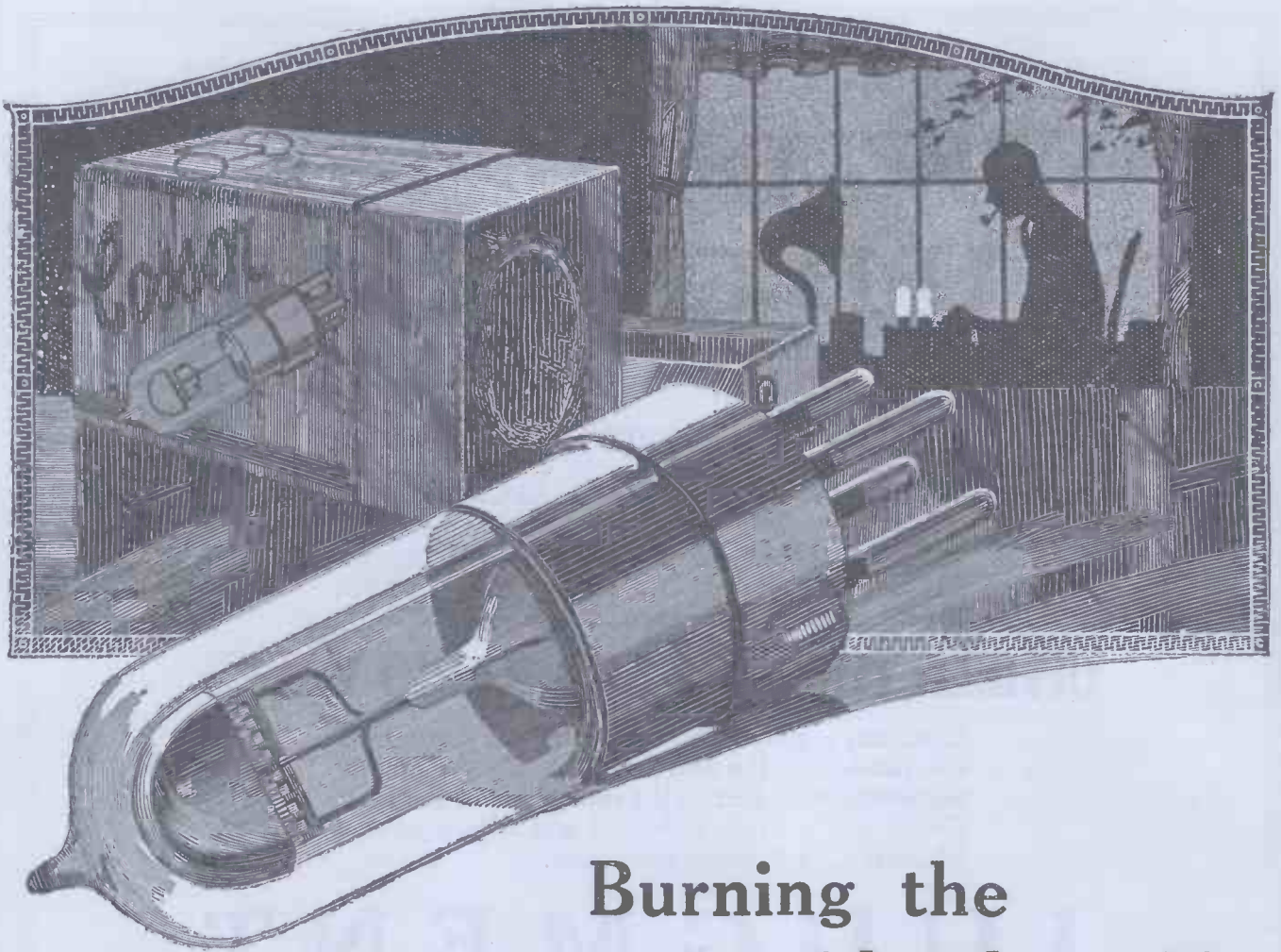

Burning the midnight oil!

Experimenters should note that due to its design and the stringent care lavished upon it during every detail of manufacture, that the *Cossor Valve* is particularly suitable for reflex and other circuits where a high efficiency Valve is required. Owing to the construction of the Grid—in which each wire is securely anchored in three positions—microphonic and other noises are totally eliminated, and the *Cossor Valve* enjoys an exceptional reputation for quiet working.

THAT'S just the trouble with *Cossor Valves*! It is so easy to pick up long-distance stations and the "ro-Watters" who shake the ether after the B.B.C. stations have closed down, that one is sorely tempted to sit up late and see how many can be logged. And the reason for this marked superiority in long-distance reception lies in the unique construction of the *Cossor Valve*. Its curved filament, inside the hood-shaped Grid and Anode, gives off an immense stream of electrons, and, because it is thoroughly shielded against leakage, practically the whole of the electron stream is used.

But this special design of the *Cossor* is productive of other advantages. In the ordinary

Valve, for instance, the straight filament is stretched between two supports, and because metal when heated, expands and when cool contracts, so the filament is constantly undergoing a stretching and shrinking process as current is passed through it. Obviously, this is not good for it, and sooner or later (generally sooner!) it fractures, and the Valve is rendered useless.

The curved filament of the *Cossor* is not kept under tension, but is held in such a position that it supports its own weight—like the arch of a bridge—and the result is exceptionally long life.

Next time you buy a Valve see that it is a *Cossor*—no other Valve in the world can be an effective substitute, no matter what price you are prepared to pay.

A. C. Cossor, Ltd.

P.1. For Detector and Low Frequency use **12/6** P.2. (With red top) for H.F. use only **12/6**
From all Dealers.

Highbury Grove, London, N.5.

Gilbert Ad. 730.

PARTS, COMPONENTS, SETS—they all sell equally well in WIRELESS WEEKLY.



without bother is now within your reach.

The new Fellows Portable Set is shown below. It requires no aerial or earth wires whatever; all being included in the case. Dry cells are also fitted inside so that there are no accumulators to require constant re-charging. It will give excellent results on several pairs of headphones and a Loud Speaker may be used when close to a Transmitting Station.

The compactness and high-class finish will be seen at once on inspection. Can be used indoors, or with equal facility, in a punt, motor car or train.

Price complete with headphones :

£14 : 0 : 0

Extras : B.B.C. tax £1 0 0, Marconi tax £1 17 6, and 3 Marconi D.E.3 Valves.

Fellows Magneto Co., Ltd.
Park Royal, N.W.10. 'Phone : Willesden 1560.



A Valve for Every Wireless Circuit



The two masters

There he is, the new Caruso, pouring out his soul in notes of exquisite beauty.

All the long years of training, of aspirations, of ambitions are summoned and a masterpiece is rendered—to a microphone.

And to a microphone it will remain, *unless* in your receiving set, in every valve socket, there is the *other* masterpiece.

It is called a Mullard valve.

Profound research, extensive manufacturing facilities and wide experience, make every Mullard valve a *master* valve.



THE MULLARD D.F. "ORA,"

a dull filament receiving valve.

ANODE VOLTS	20/100
FILAMENT VOLTS	2/3
FILAMENT AMPS.	0.06

Accumulators unnecessary. dry cells sufficient.

Price 30/-

A Master Valve.

ALL DEALERS STOCK THEM.
ASK FOR THEM BY NAME.

Mullard
THE · MASTER · VALVE

Adol. The Mullard Radio Valve Co., Ltd.,
Nightingale Works, Nightingale Lane, Balham, S.W.12.



Write for the
ELWELL
Catalogue
containing full
particulars
of this SET
and also
Accessories

*Smith faced
the family-man's
problem this way—*

THE kiddies were outgrowing their toys and needed amusement. Mother showed a decided reluctance to leave her needlework and go out in search of pleasure. Smith wanted to provide them all with entertainment within the limits of his purse—and so, with great wisdom, he chose wireless. And Smith's wisdom showed its greatest depth in his choice of Elwell's

ARISTOPHONE

FOUR VALVE RECEIVER No. 53

Thirty-five Pounds seemed an effort at first—but Smith counted ahead and worked out the saving on outside amusements, and also on sets more costly but no better.

This model gives him a wave length of 300 to 3,000 metres with excellent loud speaker results from all B.B.C. stations, and Paris for a complete change. No alteration to coils is necessary to vary wavelengths, and selectivity is perfect.

You can see or order this Receiver at any of the Elwell Retailers whose names appear on this page.

Trade Enquiries direct to—

C. F. ELWELL LIMITED
CRAVEN HOUSE, KINGSWAY, LONDON, W.C.

FLEET AD. CO.

WRITE FOR CATALOGUE.

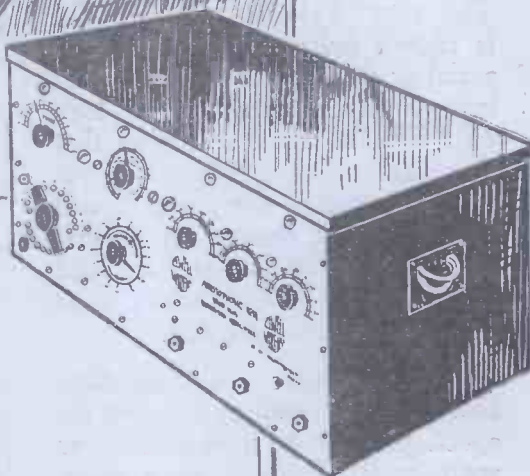

RETAILERS

LONDON:—Messrs Houghtons, Ltd., Ensign House, 88-89, High Holborn W.C.2; Messrs. Chellis, 257, High Holborn, W.C.2; Messrs. Troughton & Young, 145, Knightsbridge, S.W.1; Messrs. W. N. Froy & Sons, Ltd. Brunswick Works, Hammersmith, W.6; Messrs. A. Hinderlich, 1, Lechnere Road, Willesden Green, N.W.2. CROYDON:—Messrs. J. & T. Robinson, 49-51, George Street, Croydon. BLACKPOOL:—Messrs. Jones Bros., 1, Birley Street, Blackpool. MANCHESTER:—Messrs. The Century Electric Co., 28, Brown Street, Opposite G.P.O., Manchester. STOKE-ON-TRENT:—Messrs W. & H. S. Emery Co., Ltd., Old Drill Hall, Hill Street, Stoke-on-Trent. WATERLOOVILLE, HANTS.:—Messrs. Wadham Bros., Radio Engineers, Waterlooville, Hants. TORQUAY:—Messrs. Bathes Photo Stores, 24, Fleet Street, Torquay. CANTERBURY:—Messrs. The Canterbury Motor Co., The Pavilion, Canterbury. EXETER:—Messrs. E. Pincoff & Co., 8, Market Street, Exeter. NEWCASTLE-ON-TYNE:—Messrs. Bells Radio and Electrical Co., Ltd., 46, Blackett Street, Newcastle-on-Tyne. ILFRACOMBE:—F. H. Reed, 28, High Street, Ilfracombe. ROCIDALE:—Messrs. John Barton (Rochdale) Ltd., Townlead Garage, Yorkshire Street, Rochdale.

An Ideal Gift

to your "Wireless" friend is the unique all-purpose Portable Amplion suited to Radio reception both in and out of doors. The price of this model, which is obtainable from all Wireless Dealers of repute, is six guineas. Folder W.R.3 gives full particulars. A postcard brings it free to you.

THE PORTABLE AMPLION LOUD SPEAKER

"Buy British Goods Only."

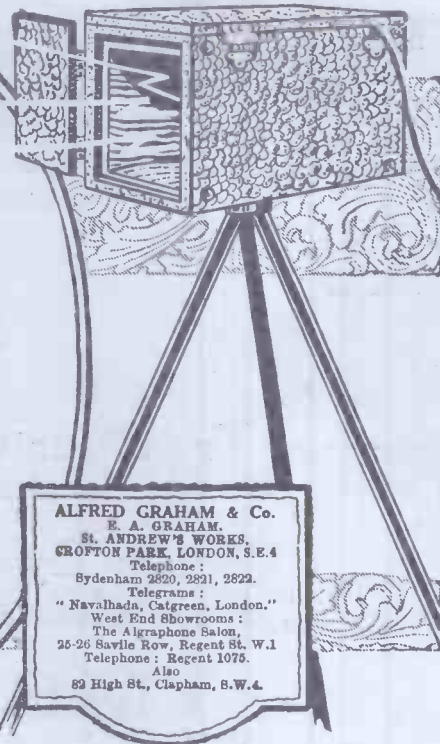

ALFRED GRAHAM & Co.
E. A. GRAHAM.
ST. ANDREW'S WORKS,
GROTON PARK, LONDON, S.E.4
Telephone :
Sydenham 2820, 2821, 2822.
Telegrams :
"Navalhadra, Catgreen, London."
West End Showrooms :
The Algraphone Salon,
25-26 Savile Row, Regent St. W.1
Telephone : Regent 1075.
Also
82 High St., Clapham, S.W.4.

w.26.

LONGER RANGE

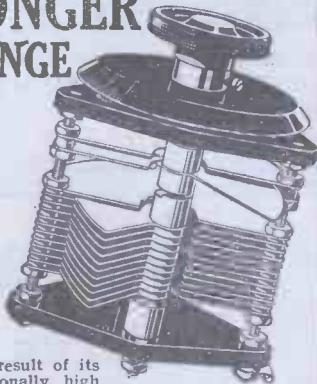

As a result of its exceptionally high capacity ratio (equal to 50 to 1 in the .0005 type) this Variable Condenser with Vernier gives a longer wavelength range to any set. Its unique features give it unequalled accuracy for setting and re-setting. One knob operates Vernier and Main Condenser. One dial gives readings for both parts.

Write NOW for Complete List.

A Better Transformer

The new Bowyer-Lowe Plug-in H.F. Transformer is guaranteed. The performance of every one is exactly like that of every other one in the same series. Low self-capacity results in high efficiency. Any two of the same range can be used with our dual condensers to provide two stages of H.F. amplification with the certainty of similar results in each stage. Range covers E.B.C. wavelengths 300 to 600 metres, when primary is tuned with .0003 Variable Condenser. Primary and Secondary terminals clearly marked.

Price **7/-** each.
Send Card for Full Particulars.

Bowyer-Lowe Tested Radio Components

London Retail Stockists from whom all our products may be obtained: Hamley Bros., Ltd., 200/202, Regent Street; Bond's-O'-Euston-Road, Ltd., 254, Euston Road.

Bowyer-Lowe Co., Ltd., Letchworth

EXPERIMENTERS!
Write for our Lists of Testing Equipment.

WIRELESS from your BELL-PUSH

A WIRELESS SET CAN BE USED IN ANY ROOM WHERE AN ELECTRIC BELL IS FITTED
Just slip into the Bell-Push
The "BELRADIO" Adapter
(PAT. APPL. NO. 10202)

The Bell-wire will then function as an Aerial (or Earth if you have an Aerial) The "BELRADIO" consumes no current, nor does it interfere with use of bells.



Price **2/6** per Set
(THREE SETS)

DEMONSTRATION ANY DAY DURING BROADCASTING HOURS

JOHN MACLENNAN & CO.
115 NEWGATE ST., LONDON, E.C.1 | 116 INGRAM ST., GLASGOW.

TRADE TERMS ON APPLICATION

REVALCO

VALVE REPAIRS are Guaranteed Repairs.

Each valve sent out is guaranteed equal to, if not better than, when last functioning.

Price 6/6 each
postage 6d.

Money back if not entirely satisfied.

Revalco Ltd.

Dept. C. 15, GRAPE ST.,
Shaftesbury Avenue., W.C.2.

True Music Loud Speakers

Clear as Crystal Headphones

◇ **TMC** ◇

Wireless

If unable to obtain locally write to us direct.

THE TELEPHONE MANUFACTURING CO., LIMITED,
 Hollingsworth Works, Dulwich, London. (EPS 169)
British Empire Exhibition, Wembley, 1924.

Two Outstanding Achievements.

THE PORTABLE-FIVE

The only Portable Receiving Set in a leather suitcase, requiring no Aerial and no Earth. It is entirely self-contained, including valves, batteries, invisible loop aerial, and Loud Speaker. Really good reception on the Loud Speaker at 25 miles or on Headphones at 500 miles.

THE SUPERFIVE

A Five-Valve Cabinet Receiver for use with either Dull or Bright emitter valves—owing to its many Special and Exclusive features really good Loud Speaker reception may be easily obtained at 500 Miles under normal conditions—under reasonably favourable circumstances good Loud Speaker reception at 3,000 Miles has been frequently obtained by private users.

Write for special illustrated catalogues describing the above to:—

TINGEY WIRELESS LTD.

Offices & Showrooms (Open 8 to 7; Saturdays 8 to 1) —
92, QUEEN ST., HAMMERSMITH, LONDON, W.6.
 'Phone: Hammersmith 1916. 'Grams: "Tingoidar, London."
FEW AGENCIES STILL OPEN.

Useful Advice!

Unless a Leak of the proper resistance is placed across the grid condenser the valve will either choke or the effect of the Condenser be destroyed. The value depends on both the characteristics of the valve and the circuit, and can only be obtained through using the "BRETWOOD," the only accurate variable grid leak of watch-like precision and scientific design. **PRICE 3/-**

The only Grid Leak with which it is possible to supply a reliable Chart giving 25 different readings covering from 100,000 ohms to 10 megohms. This Chart is supplied for use with the "Bretwood" Grid Leak only, at a cost of 1/3.

Send yours to be calibrated and chart supplied.

IMPOSSIBLE to short circuit valve when using the BRETWOOD valve holder which acts as its own jig and valve fits flush to panel. Valve legs are held yielding by ball bearing spring device, thus always assuring perfect contact. One screw fixing only. **PRICE 1/3.**

RADIO IMPROVEMENTS, Ltd.,
95, GREAT PORTLAND STREET, W.1.

(Prov. Pat.)
Liberal Trade Discounts.

THIS IS THE

"MORRIS"

(ALL STEEL)

VALVE TEMPLATE

No Centre Punch required, no instruments.

Post Free

10½d.

NOTE THE ADDRESS:

NICHOL & CO., 46, Lancaster Av., Fennel St., Manchester

Charge your ACCUMULATORS at HOME for a FEW PENNY by the

LONGTON IMPROVED ELECTROLYTIC CHARGER

(FOR USE ON A.C. SUPPLY.)

NOTHING TO ADJUST—SILENT—NO MOVING PARTS

Price £5 15 0

SENT ON TRIAL FOR 1 WEEK
And money returned if not satisfied

H. LONGTON,
Manufacturing Electrical Engineer,
43, Johnson St., Westminster, S.W.1.

YES, WE MAIL CABINETS!

And you receive them by return. Solid Mahogany and Hand Finished

OMNI, 25/-; 3 VALVE DUAL, 25/-; W2 & W3, 16x9 Panel, 17/6; ST 100, enclosed, 27/6; ST 100, standard, 15/-; 4-Valve FAMILY and Panel, 18/6; W1, 12x8 Panel, 16/-; ALL CONCERT and Panel, 18/-; ST 100, 16/-.

All Types of Cabinets kept in Stock. Special Cabinets at 48 hours.

Carriage and Packing Free.

WRIGHT & PALMER, Cabinet Makers, 335, Katherine Rd., Forest Gate, E.7
Trade enquiries invited. Phone: East Ham 1151.

GENTS MANUFACTURE AND STOCK

"Tangent Transformers" for Radio Outfits

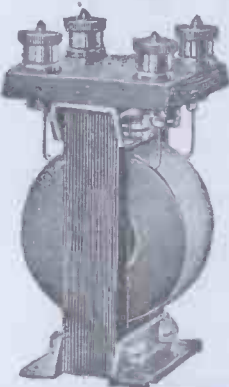

THE "TANGENT" L.F. TRANSFORMER

Fitted with or without terminals.
Insulation perfect and guaranteed permanently and fully efficient.
Connections clearly marked for identification.
Every transformer is individually TESTED FOR SILENCE AND SPEECH.



THE DISCOL H.F. TRANSFORMER

Fitted with strong, real ebonite checks, unbreakable.
All wavelengths from 275 to 4,000 metres.
Is recognised as a standard fitment.
British Broadcasting is received on every Transformer before despatch.
Send for Leaflets "W."

GENT & CO., Ltd., Faraday Wks., LEICESTER—Est. 1872
LONDON:—25, VICTORIA ST., S.W.
NEWCASTLE-ON-TYNE:—"TANGENT HOUSE," BLACKETT ST.

REGISTERED TRADE MARK **HAH** TRADE MARK REGISTERED

HELLESEN BATTERIES are ACKNOWLEDGED BY THE TRADE AS "The Best in the World."
These are a few only of our standard types.

GENUINE HIGH DRY HELLESEN TENSION BATTERIES

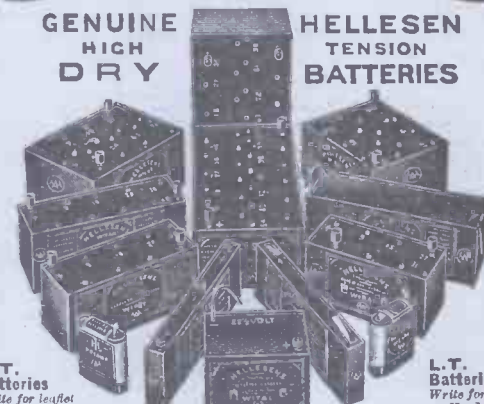

H.T. Batteries Write for leaflet No. 134 B

CODEWORD	VOLTS	DETAILS	PRICE
"WIRAY"	9	Grid Battery	2/3
"WIRIS"	15	" "	3/9
"WIRON"	15	H.T. Battery 4½ v.appings	3/6
"WIRIT"	36	" "	8/6
"WIRIN"	60	" "	14/-
"WIRUP"	99	" "	23/-

L.T. Batteries Write for leaflet No. 142 B

NOTE. Prices include 1 Red and 1 Black Wander Plug. NOTE.

ALSO A COMPLETE RANGE OF L.T. BATTERIES FOR EVERY CONCEIVABLE USE.

PLEASE NOTE WE ARE NOW ABLE TO DELIVER FROM STOCK.
Croydon 2225. **A. H. HUNT, LTD.** "Keyage, Croydon."
H.A.H. Works, Tunstall Road, Croydon.

G.W.I. Valve Renewal Service

G.W.I.—the pioneers in valve repair research—having extended their organisation and effected considerable economies in production, now offer still lower prices. THE G.W.I. VALVE RENEWAL SERVICE covers every make of valve, including Dull Emitter, Filament amps. .4 to .5.

5. Volts 4 to 6. Anode volts 50 to 120. Not only is the user provided with a new valve at less than half the original cost, but his valve will give him a better service than when new. All valves stamped "G.W.I." are thoroughly tested before despatch, and guaranteed to be improved in filament current. Valves are returned carefully packed in special boxes. Just two testimonial extracts typical of many: "Give better results than new," and "I have never handled better valves than the three repaired by you. Herewith four more types for repair (R, O.R.A., Cossor and Dutch)."

PRICES

Standard	6/6	Cossor	7/-
----------	-----	--------	-----

Dull Emitter Valves, excepting Wecovalves, renewed with H. F. Filament, 6/6.
Save 5/- on Every Special Valve you buy. The sum of 5/- net may be deducted from the standard selling price of new valves of the following types, on condition that you send to us your burnt-out valves, which we will replace with new ones. Types V.24, Q., Q.X., Wecovalves and Dull Emitters.
Cash with order, delivery from stock.

Send to-day for details of our home accumulator charging apparatus, general wireless accessories and the new valve which we shall shortly place upon the market.

G. W. I. LTD.

The Original Valve Repairers,
Imperial Works, Shanklin Road, Crouch End, London, N.8
Telephone: Hornsey 3065. Telegrams: "White, Hornsey 3065."

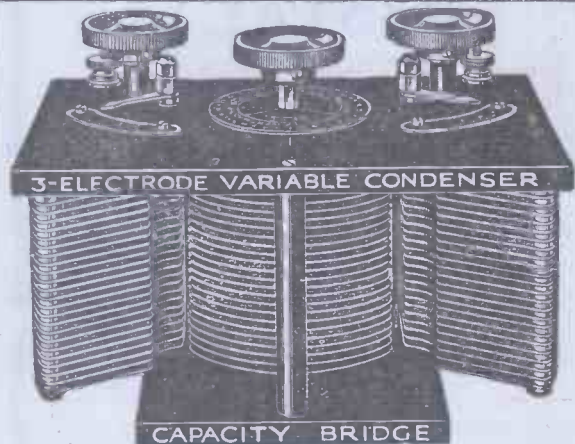

3-ELECTRODE VARIABLE CONDENSER

CAPACITY BRIDGE

INTERFERENCE CAN BE ELIMINATED
Perfect reception is possible only when your receiving set rejects all signals except those coming from the particular transmitting station to which your receiver is tuned.

The 3-E.V.C.

IS THE ONLY PROVED REJECTOR.

The "bridge of radio science" eliminates troublesome local stations, minimises statics and selects the particular broadcast programme desired. Its addition will make your set 100 per cent. more selective and sensitive.

Send 3d. in stamps for our new 1924 Variable (Capacity Bridge) Condenser Booklet, which contains much valuable information.
Prices: .001 mfd. panel mounting ... 47/6
.001 " cabinet mounted ... 55/-

Obtainable from all high-class dealers or direct from the manufacturers and patentees:

AUTOVEYORS, LTD.

Radio Engineers and Contractors,
84, VICTORIA ST., WESTMINSTER, LONDON, S.W.1.

A DEPARTURE in Valve-Holder Construction for Every Experimenter

who knows that high resistance and low capacity are determined by the spacing of the valve legs themselves. In the manufacture of the H.T.C. Valve-Holder, allowance is made for the varying spacing of legs of the different types of valves.

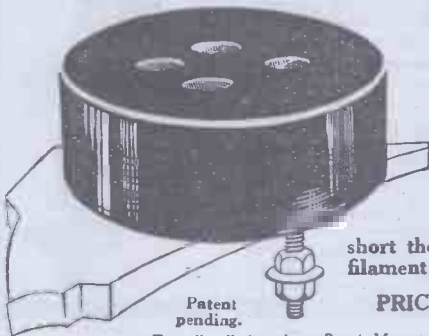

No metallic parts used in construction are exposed, making it impossible to short the H.T. across the filament.

Patent pending.

PRICE 1/9

Type "A" for above Panel Mounting.

We are also Manufacturers of the Famous
H.T.C. INTERVALVE TRANSFORMER
the success of which has succeeded good craftsmanship and good materials, observing good design.
Obtainable from your Local Dealer, or direct from the Manufacturers. Price **15/-**

H.T.C. Electrical Co., Ltd.

2 and 2a, BOUNDARIES ROAD, BALHAM, S.W.12
Telephone: BATTERSEA 374. Trade Enquiries Invited.

Manufacture of Broadcasting Apparatus

USE OF PATENTS

The pioneer work of the Marconi Company in connection with wireless telegraphy and telephony is well known, and as the result of many years of research work and considerable expenditure, the Company controls numerous patents relating to the manufacture or use of wireless telegraph and telephone apparatus.

The Company is prepared to grant a licence for the use of its patents in connection with the manufacture of Broadcasting apparatus to any member of the British Broadcasting Company, Ltd.

A large number of firms (including the principal manufacturers) are already so licensed and pay royalty for the use of these patents, and all apparatus manufactured under licence is so marked.

Any persons or firms manufacturing or offering for sale valve apparatus embodying patents controlled by Marconi's Wireless Telegraph Company, Ltd., without its permission render themselves liable to legal proceedings for infringement.

Whilst hoping that it will not be forced to take legal proceedings the Marconi Company wishes to give notice of its intention to protect its own interests and those of its licensees, and in cases of infringement the Company will be reluctantly compelled to take such steps as may be necessary to defend its patent rights.

Marconi's Wireless Telegraph Co., Ltd.

Marconi House, Strand, LONDON, W.C.2.

HEADPHONES

FOR 14/6 POST FREE

Exceptionally light (only 9½ ozs.). Built for long wearing comfort and embody special ebonite earpieces. Adjustable to any size. Strong, durable and well finished. Clear, distinct, undistorted reception assured. Complete with 6ft. cord.



NOTE TO THE TRADE. Original importers of the famous N. & K. Headphones. Considerable stocks always on hand.

ALL ORDERS FORWARDED BY RETURN
ON RECEIPT OF REMITTANCE.

A. & J. JAMES,
MAXWELL HOUSE, ARUNDEL STREET,
STRAND, LONDON, W.C.2.

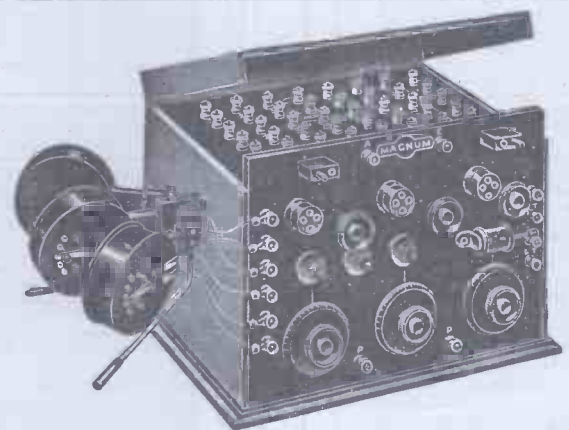

The Wonderful OMNI

as described by Mr. J. Scott-Taggart.
As illustrated, including coils, 18 Guineas.

RECEIVES EVERYTHING FROM EVERYWHERE.

TO CONSTRUCTORS.—All Components supplied separately if desired. Send stamp for Illustrated List and set of leaflets dealing with "Tested Sets," also the OMNI, S.T.100, 4-Valve Family Receiver and all circuits described in "Wireless Weekly," "Modern Wireless" and Radio Press Envelopes.

Connecting Links, per set of 50, 8/- Carr. paid on Retail Orders value £2 and over.

ALWAYS SPECIFY "MAGNUM"

MAGNUM TAPPED COILS—REDUCED PRICES.

No. 1. 180-1000 metres 12/6
No. 2. 600-2600 metres 15/-

BURNE-JONES & Co. Ltd.

Manufacturing Radio Engineers,
MONTFORD PLACE, KENNINGTON, LONDON, S.E.11.
Phone: Hop 6257
Experimental Stations:—2 F.P. New Cross. 2 P.B. Kennington,
2 C.T. Lambeth. 6 C.W. Streatham.

WIRELESS WEEKLY SMALL ADVERTISEMENTS.

WANTED, STUDENTS for Wireless Appointments; we find berth when qualified; situations waiting now; prospectus free.—Wireless Training College, Lansdowne Road, Bournemouth.

PAPIER MACHE Loud Speakers, unsurpassed for true and natural sound, £2 2s. complete; height, 22 in.; Horn only 17/6; carriage paid. Trade inquiries invited.—Kernahan, 45, Elm Road, New Malden, Surrey.

BROWN'S AMPLIFIER, 120 ohms, in and out, £4 5s., or nearest offer; 1 pair Brown's A type adjustable 'phones, 120 ohms, 38/-; 2 pairs Sullivan's 'phones, 120 ohms, 10/- per pair, all in excellent condition.—G. Holland, 30, St. Thomas Road, Mile End, E.3.

LATEST "MARCONIPHONE" Complete. Perfect, £13. Townsend Wavemeter to 4,000 metres, £4. Wates' Valve Amplifier and Valve, £2 10s. Autoveyors 3 E.V.C., 30/- All new. Lot £20. Offers considered.—40, Pollard Road, Whetstone, N.

4,000 OHMS SINGLE LOUD-SPEAKING RECEIVERS, entirely new, super-sensitive design, each guaranteed three times louder tone than best double headphones known, or cash returned. Powerful adjustable magnets, large sensitive diaphragm, nickelled case, terminals, detachable tube fitting for fixing gramophone horn or trumpet, universal fitting for fixing receiver to base, stand, headband, handle, etc.—Below.

CRYSTAL SET LOUD-SPEAKERS. Boon for deaf people. New single loud-sounding receivers, above, register weak or distant wireless transmissions which cannot be heard at all in ordinary double headphones. Call and hear one on 15 feet indoor Aerial and 5/- Crystal Set. First-rate receivers for constructing powerful Microphone Button Amplifiers. 2,000 or 6,000 ohms wound to order. British made. 10/6 each, post free.—McKimms Telephones, 1, St. James' Walk, Clerkenwell Green, E.C.1.

AUDIO-CHOKE COILS. For Choke Capacity L.F. Amplification. 7/- each, post free.—W. Hutchings, The Market, High Street, Barking, Essex.

1/16 in. SQUARE TINNED COPPER WIRE. Finest quality for reduced price, 1/3 per dozen 2 ft. lengths. Postage 4d. extra. Special terms to the Trade.—Bowyer-Lowe Co., Ltd., Letchworth. London Retail stockists—Hamley's, 200, Regent Street, W. Bonds, Ltd., 254, Euston Road.

MATERIALS for "Selective Broadcast Tuner." Prepared Tube, 6 in. diameter, 1/6; 3 1/2 in. diameter, 11d. per foot. Ebonite Rotors, 2 1/2 in., 1/4; 15 d.c.c., 1/11; 18 d.c.c., 2/1; 20 d.c.c., 2/4; 2 B.A. Terminals, with 2 nuts, 2/3 doz. Also Bushes, Bearings, Rod, etc. Post extra.—Charles Davis, Water Lane, Leeds.

VOICI—FOR SALE.—Fellowcryst Super, Sterling No. 1 Crystal Set, 2-Valve L.F. Amplifier (All as good as New), at £2 each. 3 R.F. Transformers (New) at £1 each (post free); Lot £8. Cash with order.—Sammons, 180, Birmingham Road, Walsall.

YES! YOU HAVE NO OUTSIDE AERIAL?—Then increase your Signals 50-100 per cent. by fitting our guaranteed Amplifier to your weak Crystal Set. Amplifier and instructions, price 1/3, post free. Mail business only.—W. Matthews, D.B., 42, Rosedale Terrace, Sandford, Newcastle-on-Tyne.

3-VALVE DUAL—OMNI—ST. 100 Enclosed.—Cabinets for the above and other Radio Press circuits, see our larger advertisement in this issue.—Wright and Palmer, Cabinet Makers, Forest Gate, E.

5-VALVE WIRELESS SET.—2 H.F. 2 L.F. 1 Detector, Sterling Condensers, Power L.F. Transformers, McMichael Plug-in H.F. Transformers, Lissenstat Rheostats, Polar Coil-holder. Beautiful tone, very selective and powerful. Brings in all Continental Stations. A Bargain at £25. Can be seen and heard by appointment.—F. G. Horne, Warren Gate, Kingswood, Surrey.

TURNED EBONITE VARIOMETERS with knob, 250 to 650 metres. Fine value, 3/- each, post 3d. "Ericssons" Continental 4,000 ohm 'Phones, 12/9 pair, post free. Tinned Copper Wire, 1/2 in. sq., 8 feet for 6d., post 2d. Money returned if not satisfied. Goods by return certain. Write for list.—The "EKKO" Radio Co., 236, Rolfe Street, Smethwick, Birmingham.

Patents, Designs & Trade Marks.

H. D. FITZPATRICK & Co.

Chartered Patent Agents

49, Chancery Lane, LONDON. 'Phone: Holborn 459.

Fix your crystal in



GOLD SEAL PLASTIC METAL

the best contact possible, and get **LOUDER & CLEARER SIGNALS.**

Contains no mercury. Of all Wireless Stores.

Enough for 3 cups **6d.** per packet.

Wholesale enquiries (or sample packet 6d.) to

S. LEVY, 53, BEN JONSON ROAD, LONDON, E.1.

PARTS, COMPONENTS, SETS—they all sell equally well in WIRELESS WEEKLY.

THREE "EL-BE" UTILITIES. "EL-BE" ANTI-CAPACITY HANDLES.

No Screws.



No Clamps.

Fixed by Suction—Removed in a second.
A Type for Horizontal working. Price 2/2 each.
O Type for Vertical working. Post free.
A perfect combination with the "EL-BE" Coil Holder.

"EL-BE" COIL HOLDERS

USE SINGLE COIL HOLDERS FOR MAXIMUM EFFICIENCY. HIGHLY RECOMMENDED.

Price 1/8 each. 5/- Set of three. Post Free.

Ebonite Basket Coil Mounts to plug in above, 2/- each.

Short Circuiting Plug for Coilholder, 1/3 each.

Ask your Dealer for them.

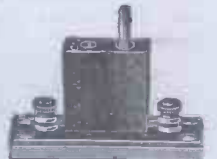

"EL-BE" INSULATING PANEL BUSHES.

Experimenters save cost of EBONITE.

4 B.A. Pillar-Terminals with one BUSH, 2/- doz.

2 " " (with nut and washer). 3/- "

Extra BUSHES Tenpence per doz.

Bushes tested for insulation to 25,000 volts.

YOUR DEALER WILL SUPPLY YOU.

LEIGH BROS.,

37, Sidmouth Street, Gray's Inn Road, LONDON, W.0.1.

Telephone: Museum 4192.



CABINETS YOU WANT

PICKETT'S Cabinets—they're good value, from 1/6 each, highly polished. Cabinet Works, Albion Rd., Bexley Heath, S.E. Write for Lists W.L.

Say
Galene!
to your dealer & you'll get the *Best Crystal there is*
TRADE ENQUIRIES INVITED
N. HEYWOOD INVENTOR & SOLE MANUFACTURER.
286 Richmond Road, Twickenham, Middx.



REPAIRS TO HEADPHONES TO LOUD SPEAKERS TO COILS

REWOUND to any RESISTANCE & MADE EQUAL to NEW. PRICE QUOTED ON RECEIPT OF INSTRUMENTS. PROMPT DELIVERY.

The VARLEY MAGNET COMPANY

Established 26 Years.

'Phone: Woolwich 888.

WOOLWICH, S.E.18.

TESTED COMPONENTS

Each Bowyer-Lowe Component is tested before despatch and guaranteed to be mechanically and electrically accurate. As used by foremost experimenters and specified in famous sets.

SEND POSTCARD for complete list of these trustworthy parts.

BOWYER-LOWE CO., LTD., LETCHWORTH



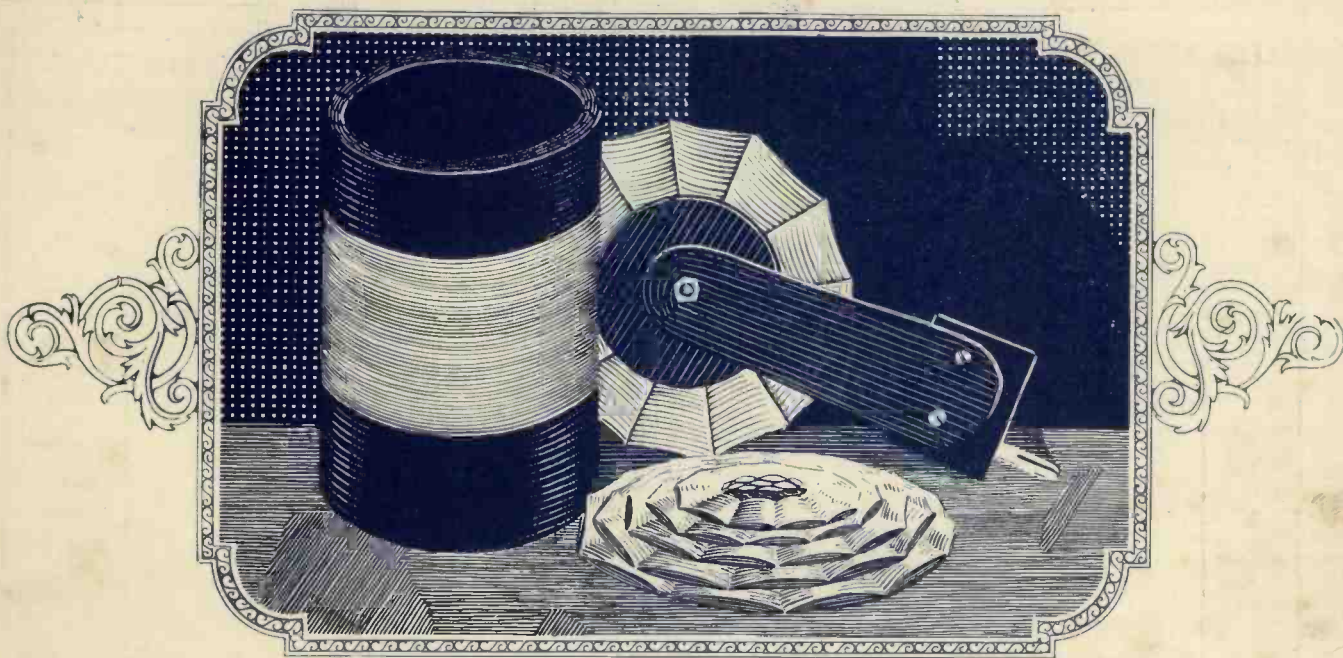

Tuning Coils and How to Wind Them.

By G.P. Kendall, B.Sc.

CONTENTS

How Circuits are tuned
Turn numbers
The choice of wire
Taking tapings
Damp proofing
Single layer coils
Basket coils
Slab coils
Pile winding
Lattice coils
Honeycomb and duo-
lateral coils
Mounting coils
Aperiodic Aerial coils

Series No. 18

Post free 1/8

1/6

—time spent in winding
good Coils is never wasted

AS the Author says, "Many of the coils used are directly responsible for the mediocre results obtained by some experimenters."

Yes, that is the whole point. Because the Set works in a more or less unsatisfactory manner, yet apparently all is in order, the experimenter blames either his locality, his aerial or even the transmitting station. And the whole trouble often lies in his inefficient tuning arrangements.

Sharp tuning cannot be obtained with inefficient coils. Once you have learnt how to make good ones from this new Book you'll be sorry to think that you have wasted so much time with your earlier inefficient ones.

Buy a copy to-day—a surprisingly large amount of accurate information is yours at barely the cost of half-a-dozen terminals.

RADIO PRESS, LTD. - Devereux Court,
Strand - W.C.2

IF IT IS A RADIO PRESS BOOK IT IS TECHNICALLY CORRECT

Buy STERLING *Lightweight* Radio Head Telephones



The sooner the better!!

At your Dealers

Advt. of STERLING TELEPHONE & ELECTRIC CO. LTD.
Manufacturers of Telephones and Radio Apparatus, etc.
 210-212 TOTTENHAM COURT ROAD, LONDON W.1
 Works: DAGENHAM, ESSEX

"Sterling" Lightweight Radio Head Telephones are British made throughout at Sterling works. They are fitted with polished Duralumin headbands and supplied in the following resistances:
 120 ohms resistance the pair in series ... £1 : 2 : 6
 2,000 ohms resistance the pair in series ... £1 : 4 : 0
 4,000 ohms resistance the pair in series ... £1 : 9 : 0

Wireless Weekly

and the Wireless Constructor.

Vol. 3.
No. 20.

CONTENTS

Tuning Inductances for Selective Reception.

Some Useful Switches.

Practical Loud Speaker Notes.

A 100-Metre Loose Coupler.

Ideas for Inventors.

C.W. and Telephony Transmission Using Valves, Jottings by the Way, Valve Notes, An Experimenter's Unit Receiver, Apparatus We Have Tested, Correspondence, Information Department, etc., etc.

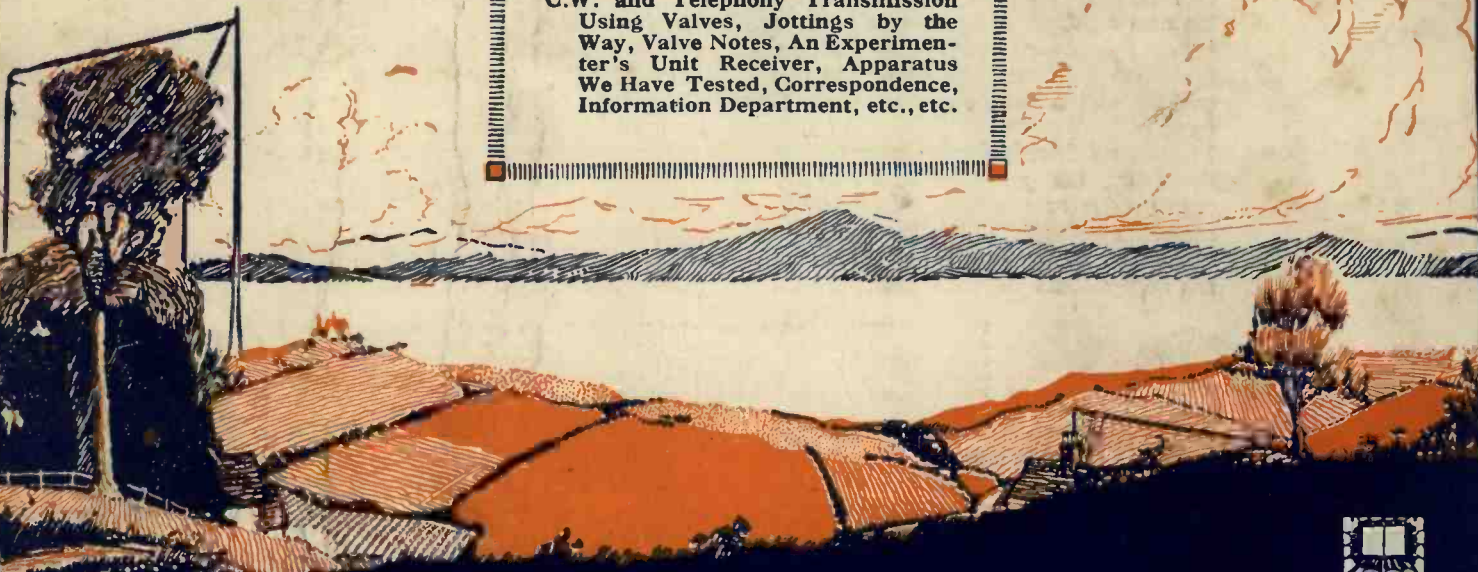

A New Design of ST100 Set



“—my Transatlantic Set has a record of five American Broadcasting Stations:”

says Mr. McIntyre.

NOT bad for a home built Set, is it? And it was really the first serious Receiver I had built. Its cost? Well, apart from the three valves I dare say the whole Set cost me less than four pounds, including the cabinet and a couple of H.F. Transformers.

I have read descriptions of many other Receivers, but none aroused my interest quite as much as this one. It seemed so simple to make, and as a matter of fact, once I had collected the components together and planned

them out on the panel, the whole job took just two evenings—one for the drilling and assembly and the other for the wiring.

Certainly I am much indebted to Mr. Harris for the clever way in which he has planned this two-H.F. Receiver. Its sensitiveness is astonishing and yet, with potentiometer control it is childishly simple to operate.

Up-to-date I have logged five American Broadcasting Stations and of course all the BBC Stations and most of the principal Continental ones.

The Transatlantic Set referred to by Mr. McIntyre is only one of a dozen described in Mr. Harris' Book. Whether your tastes lie in long distance reception or merely a Set to pick up your local Station you will find a ready choice available. Get a copy to-day from the Publishers (Radio Press Ltd., post free, 2s. 8d.) or from your Bookseller.



2/6

12 Tested Wireless Sets
By Percy W. Harris.



Wireless Weekly

Vol. 3, No. 20
April 23, 1924

CONTENTS

	Page
Editorial ..	642
Some Practical Loud-Speaker Notes ..	643
Jottings by the Way ..	645
An Easily Made Lead-in Insulator ..	646
An Experimenter's Unit Receiver ..	647
Tuning Inductances for Selective Reception ..	648
C.W. and Telephony Transmission Using Valves	650
Switches: Their Use and Abuse ..	652
Calculating Dull Emitter Resistances ..	654
What is the Best Ratio for L.F. Transformers }	654
Ideas for Inventors ..	655
A Hundred Metre Loose-Coupler ..	658
A Home-Made Dual Condenser ..	659
An Enclosed ST100 Receiver ..	660
Random Technicalities ..	664
Valve Notes ..	665
An Experiment with Vegetable Grid Leaks ..	667
Correspondence ..	668
Apparatus We Have Tested ..	671
Information Department ..	673



Editor: JOHN SCOTT-TAGGART, F. Inst. P., A.M.I.E.E.

Assistant Editors { P. W. HARRIS.
E. REDPATH.

Radio Press, Ltd.

Publishers of Authoritative Wireless Literature
DEVEREUX COURT, STRAND W.C.2

Tel.—Central 3763.

Advertisement } SCHEFF PUBLICITY ORGANIZATION,
Managers: } LTD., 125, Pall Mall, London, S.W.1
Tel — Reent 2440.

Staff Editors:

E. H. CHAPMAN, M.A., D.Sc.
A. D. COWPER, M.Sc.
G. P. KENDALL, B.Sc.
R. W. HALLOWS, M.A.
S. G. RATTIE—M. Inst. Rad. E.

Advisory Editors:
Prof. R. WHODINGTON,
M.A., D.Sc.

Prof. C. L. FORTESCUS,
M.A., M.I.E.E.



All correspondence relating to contributions is to be addressed to the Editor of "Wireless Weekly."

Nothing contained herein is to be regarded as permission or encouragement to infringe any patent rights.



RADIO BANKRUPTS

COMMENT has been made in some quarters on the number of bankruptcies which have occurred in the wireless industry within the last twelve months, surprise being expressed that this should be so, seeing that radio has become so immensely popular and should be a thriving industry. The surprise is natural, and we think it will not be without interest to explore some of the reasons for the state of affairs.

Firstly, the advent of wireless brought into being a number of "mushroom" firms, started with the idea that there would be "big money in wireless," and that large profits could be made very rapidly. Many such firms were staffed with people with no real knowledge of wireless, the apparatus sold being merely a feeble and inefficient imitation of some well-known brand. For a time, and before the public had settled down to buy with discrimination many such firms were quite prosperous, but imitation never pays for long, and their demise was only a matter of time.

A second kind of company, with which we have much more sympathy, originated at the same period. This frequently consisted of two or three ex-Service men with genuine wireless experience and really good ideas. A good sound design was evolved, and with modest manufacturing facilities work was commenced. After a short time a satisfactory number of orders was received, and all seemed well. Satisfied customers recommended the sets and parts to their friends, further large orders were received, larger premises taken, and still further progress followed. Then, in many cases, unexpected difficulties seemed to arise, payments could not be met, and within a very brief period a bankruptcy petition was filed. In a word, the firm seemed killed by prosperity. Why was this?

The reason is not far to seek, and in nearly every case has been due to an inadequate conception of the business side of wireless, particularly costing. When two or three

friends are working together in a small shop, the rental of which is very low, when every member of the firm has been working with enthusiasm from early morning till late at night, often at very great pressure, and when a few notes in a black-covered book seem to be all the book-keeping necessary, the firm may seem prosperous. If, for example, a set costs in raw material four pounds, and can be sold for twelve pounds, a large margin of profit may appear to exist. The business seems well worth developing. If, however, larger premises are taken, mechanics (who naturally will not work with the same enthusiasm) have to be employed, and when it is necessary to engage clerical assistance to keep the books, the overhead charges can very easily swamp the seeming profit and give a loss on every set sold.

The wireless industry has splendid prospects for the small and keen manufacturer. Many of the best ideas on the market have been evolved in quite humble conditions and without elaborate research departments. It is possible to start with a few sound ideas and quite small capital, and by judicious advertising in the journals known to be widely purchased by home constructors to build up a splendid, sound and paying business in but a few months. Many have done this, and by sheer persistence have held their market. Others have been flooded with orders, and dropped their advertising, believing their business would continue. The reaction inevitably sets in after about a month, and it often takes months of costly advertising to get back into the public eye.

The public, including the wireless public, we fear, is very fickle and soon forgets a manufacturer, and there are always others ready to fill the breach, often with a better article to sell.

Many a small retailer, provided he has an originally-designed component, and is prepared to tell the public about it, can launch out into the 100,000 market instead of remaining the centre of a very small circle.

Some Practical Loud-Speaker Notes

By G. P. KENDALL, B.Sc., Staff Editor.

Intelligent use of the Loud-Speaker will do much to eliminate troubles sometimes thought to be inseparable from these devices.

IT is no doubt true that the present-day loud-speaker is a very imperfect instrument, but it is remarkable how enormously its performance can be improved by sympathetic handling, so that, assuming that distortion in the receiver itself has been reduced to negligible proportions, reproduction which was previously harsh and unnatural sounding may become mellow and life-like. In this connection it must be remembered that the human ear itself is not merely imperfect, but is quite used to certain forms of distortion, notably those due to reverberation effects; so used to them, in fact, that it will accept as faithful much reproduction which is really quite badly distorted. All that we have to do is to reduce

deliberate introduction of distortion of an *opposite* kind at some point in the receiving circuits. For example, if you come to the conclusion that your loud-speaker has a tendency to reproduce the higher notes unduly strongly, thereby upsetting the balance of music and distorting speech, it will probably be found that shunting quite a small fixed condenser (.0001 might be tried) across the secondary winding of one of the L.F. transformers will cause the set to emphasise the lower frequencies to a greater extent, and with a little experiment one tendency can be made to roughly balance the other. The whole subject is a most fascinating one, and I hope the following condensed notes may serve to indicate some of the most salient points of departure for the experimenter.

Adjusting the Mechanism
Most loud-speakers possess a screw device for adjusting the gap between the electro-magnet pole-pieces and the diaphragm, and we find in this another of the preliminary adjustments which must be made before proceeding to matters of refinement. The correct method of making the adjustment is to advance the pole-pieces by means of the adjusting screw or lever until the diaphragm is pulled against them (a click is usually heard when this occurs), and then to withdraw them until it just falls clear again. The loud-speaker is then in its most sensitive condition, but for the reproduction of really strong signals it may be necessary to increase the air gap still further, to allow for the rela-

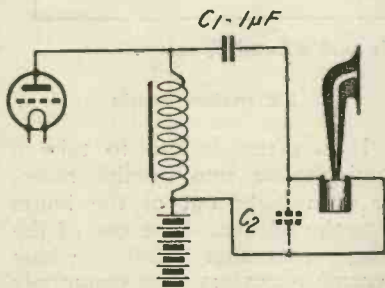

Fig. 1.—A common type of filter for loud-speakers.

the inevitable distortion to the type and amount to which the ear is accustomed and which it will tolerate, and much ingenuity can be expended in this direction, ingenuity, moreover, which will be repaid by reproduction, which even the unkindest scoffer could not liken to a cheap gramophone.

The user of any type of loud-speaker should learn to regard his instrument as one whose failings he must discover and analyse, with a view to camouflaging them, even if they cannot be eliminated. Much can be done, too, in balancing out the defects of the loud-speaker by the

Adjustment of Volume

Practically the first thing to do when setting to work to arrange a loud-speaker so that it may give the best possible reproduction is to determine just how much energy it will carry without overloading. It will be found that if the signal strength is gradually increased a point is reached above which such distortion as may be present suddenly becomes greatly intensified, and the reproduction is completely spoiled. Whether or not the point in question is very sharply defined depends upon the type of loud-speaker, but it will be found to exist to some extent in practically every pattern on the market. It is worth while to learn to estimate this overloading point accurately, and then to take pains never to exceed that volume. The actual adjustment of volume, by the way, is best done by varying the tuning of the set, and not the filament current of the valves.

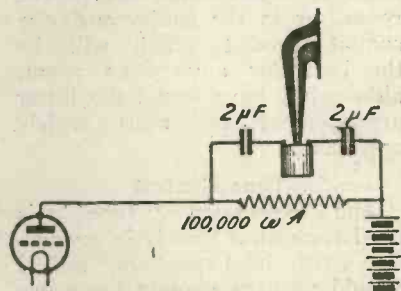

Fig. 2.—Isolating the loud-speaker.

tively large motion of the diaphragm. This final adjustment must obviously be made when the instrument is actually working.

The Disposition of Loud-Speakers

The actual placing of the loud-speaker in the room has often a considerable influence upon the pleasing quality of the reproduction, and this is particularly true of cases where more than one instrument is used. It must be remembered that the naturalness of speech and music depends to some extent upon the presence of a certain amount of echo or reverberation in the room, and when once this effect has been suitably adjusted quite a marked im-

provement is often evident in the general tone of the music reproduced by the loud-speaker. As an instance of the importance of a certain amount of echo in producing the desired sense of illusion in listening to a loud-speaker I will adduce the well-known fact that broadcast opera and concerts performed in a really large hall often sound more natural and pleasing than the musical items broadcast from the studio. The reason is simply that in the studio little or no echo can be allowed, whereas in concert halls the reverberation is usually considerable.

It is unfortunately impossible to predict the proper positions for one or more loud-speakers in any given room, and experiment is really the only guide. In general, it will be found correct to put the instrument near one of the corners of the room, usually with the horn facing into the corner. A little time spent in making small changes of position will then soon show exactly how it should be placed to give the most natural effect. Where two loud-speakers are used the matter is somewhat more complicated, and one has the choice of standing them in separate corners of the room, or in the same, and one cannot predict which will be the best for any given room, although I have found the latter arrangement the more widely applicable.

Tone Control

The expression "tone" is used somewhat loosely in connection with loud-speakers, and I should perhaps explain the sense in which I am using it here. Under some conditions a loud-speaker will give a rendering which sounds high pitched and metallic, as though it were emphasising the high notes, and by the use of certain modifications it can be made to sound low-toned and muffled, with a tendency to give undue prominence to low notes. It is the control over this variable factor that I purpose discussing under this heading.

Practically every make of loud-speaker requires adjustment of this sort, the form usually needed being the provision of a condenser of experimentally-determined capacity in parallel with the windings. The correct capacity will commonly be between

0.002 μ F and 0.01 μ F for the average high resistance instrument, and it will be found that the larger the condenser the fuller and lower becomes the tone of the reproduced speech and music until finally it becomes hollow and muffled.

With a low resistance instrument the condenser will usually give the best results in parallel with the primary winding of the telephone transformer, and its value will commonly be of the same order. This will depend, however, not merely upon the loud-speaker and the constants of the associated circuits, but also upon the telephone transformer.

Another form of so-called tone control which I find valuable consists in the use of a variable high resistance of the type known as an anode resistance in parallel with the loud-speaker windings, the combination of variable resistance and condenser of adjusted capacity producing a

speaker and condenser. This is shown in Fig. 1, while in a very popular modification the iron core choke is replaced by a resistance of 100,000 ohms. This arrangement does not seem to give quite as good signal strength as the previous one (the difference is slight), but possesses the merit of cheapness. Fig. 2 illustrates a method of entirely insulating the loud-speaker from the anode circuit to eliminate the risk of shocks in handling it. The device simply consists in placing it in series between two condensers, and can just as well be applied to the choke type of filter.

It is sometimes claimed that filters of the types described improve the reproduction, but this depends upon the type of loud-speaker in use; with two well-known makes which I have used no improvement whatever could be detected, while with a third it was exceedingly slight.

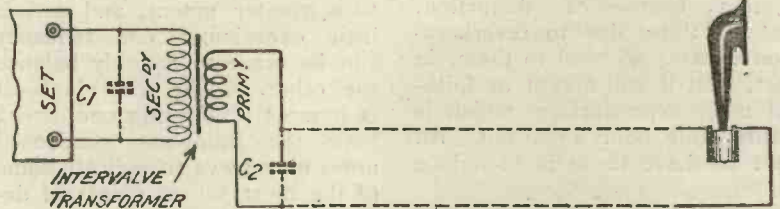

Fig. 3.—How to use long leads with a Loud-Speaker.

wonderful improvement in the quality of the reproduction given by most types.

Filter Circuits

Although loud-speakers are much more robust than high resistance telephones it is often argued that they are liable to suffer damage from the steady anode current of the valve, more particularly when a power valve is used. In order to remove this objection to the high-resistance type various filter circuits have been devised whose purpose is to separate the steady anode current from the pulsations representing the signals and to ensure that the latter alone reach the loud-speaker.

A common type of filter consists of an iron-cored choke coil of high inductance, across which is shunted the loud-speaker in series with a large condenser. The steady current then flows through the choke, while the pulsations take the path of lower impedance through the loud-

Extension Leads

It is often desired to take a loud-speaker into another room, or even right out of the house into the garden. The use of the long-extension leads which become necessary very commonly results in howling or the picking up of induction currents from A.C. mains. The best remedy is probably that shown in Fig. 3, consisting in the use of an ordinary L.F. transformer in the same way that a telephone transformer is used with a low resistance loud-speaker. Condensers may be needed across both primary and secondary windings, their values depending upon the make of the transformer. In very extreme cases of interference by induction from lighting and power alternating current mains it may be necessary to use shielded extension leads, but this is a somewhat expensive expedient, since the price of suitable cable is rather high.

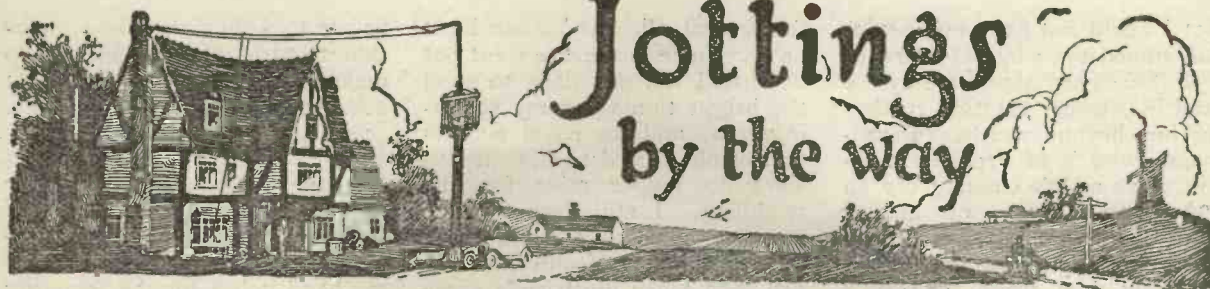

Plain Sailing

I AM just making a new set, and thanks to the beautifully clear instructions given in the numerous wireless books on the subject all is perfectly plain sailing. I know, for example, that all connections must be soldered if the finished article is to be worthy of the name of a wireless receiver; I know, too, that they must not be soldered, for if you apply a hot soldering iron to the shank of a terminal you cause the ebonite to flow and so play the deuce with its insulating qualities. Again, I realise fully that for those connections which are hidden away beneath the panel I must use square tinned wire in order that I may reduce the resistance to as near nothing as makes no matter. Equally do I realise that I must not use square tinned wire anywhere because, owing to the large opposed surfaces between two crossing leads, capacity is greatly increased. I must have a telephone condenser because nearly everybody says that it is meet and proper so to do; but I must not have one because other people say that it is not only unnecessary but also a positive nuisance. I shall, of course, use high-resistance 'phones because they help to increase the purity of reception; on the other hand, I shall not use them because it appears that they invariably go up in a blue flame if one throws more than a paltry volt or two to the hungry anodes of the low-frequency valves.

An Easy Path

You will see then that my path is a perfectly easy one. I know exactly what to do, and I have no doubt that I shall make a thorough success of my receiver, whose range will be enormous on account of its employing reaction to bustle things up a bit, whilst the purity of its reception will be unexceptionable since I shall fit no reaction, having been told that its use leads invariably to distortion.

Save Me From My Friends

This is the kind of thing that happens to you when you resolve to lay aside your old evil ways and to do everything as it should be done. Time was when I merely lumped together a few transformers, rheostats, valve holders, and so on, wiring them together with any odds and ends of wire that were handy, whilst the soldering iron was seldom used except perhaps as a make-shift poker for a sulky fire. My aerial was a horrid thing, low, screened by buildings, badly insulated, and in every way an offence to the eyes of all real wireless folk. The down lead wandered in through the window, which was shut down upon it; the earth wire was twisted round a handy gas bracket. And yet, to the horror and dismay of all my friends, who looked with loathing upon my unseemly hotch-potch of gear I obtained really wonderful results. America?

America in Comfort

Well, I should say so! With a good fire kept cheerfully blazing with the help of my trusty soldering iron, I would sit up into the small hours; I would twiddle a knob here, a knob there, and straightway would come the welcome accents from across the "Herring Pond." I had no fear of visitors, for when they came my set could be relied upon to work. It did not scream at me if I waved a hand over it in blessing, nor did its valves "pong" loudly as I strode across the room in search of my tobacco jar. It was, in fact, a delightful thing to use.

The Worst of Friends

The worst of friends is that they will never leave one in peace. You would hardly believe the bother that I have with fellows like Gubbsworthy, Snaggsby and fellows of that k'ndev. They used to drop in and regard my set, wearing the kind of look that you see upon the face of a bad sailor just as the ship which bears him

is about to sink into the trough that follows the tallest wave. Breadsnaapp's eyebrows rose on one occasion so high that he had a most painful attack of cramp in the skull. And the things they said! I can stand a good deal, but when it comes to a man like Goopston comparing the wiring of one's set with the mazes of a macaroni pudding that has been struck by lightning, then I think that even the mildest of men has some excuse for becoming roused.

A Reformed Character

At first their taunts fell off me like water from a duck's back. But as somebody once said very truly "in throwing mud some of it sticks, even if none does." I was at length borne down by the murmurings of all my friends, and resolved to make myself a man whose den they might enter without feeling that they were being contaminated thereby. My mind once made up, the process of reforming was carried out in the most thorough manner, and at record speed. Smashing my bank balance to smithereens, I made daily journeys to wireless shops returning now burdened with a cargo of insulators, now weighed down with ebonite and wire and tools and all kinds of things. I hewed down my faithful little aerial mast and replaced it with a forty-footer. With mighty labour I pierced a hole through a solid wall for the reception of a perfect lead-in tube. I delved deep into the soil to make a worthy resting place for the wide copper plate that was henceforth to be my earth.

Flung into the Dust Bin

My odds and ends of wire once so dear to me were flung into the dustbin. I bought a drawing board, a setsquare and all kinds of impedimenta for the designing of the perfect set. I made it. It was a thing so beautiful that Wortlesby wept upon it until I was constrained to draw him aside, pointing out that salt water was an excellent conductor, and

that I could not have my insulation ruined even by his tears of joy. Snaggsby shook me by the hand in silence, emotion rendering him beyond words. Bread-snapp, who is of French extraction, gave a little choking cry on seeing this thing of perfect beauty, and would have embraced me in the Gallic manner had I not held him firmly at arm's length. "And how does it work?" they all cried, when they were sufficiently recovered to find utterance. "Work?" I asked "my dear fellows, I have not had time to see how it works yet, and I do not know that I ever shall. I am far too busy polishing it up and fitting gadgets. Besides, if you used it you would probably scratch the panels and that would never do."

Cut to the Heart

At last, though it cut me to the heart to do so, I did try my beautiful set, wearing gloves the while lest I should finger-mark it. Alas, the loftiness of my aerial, the depth of my earth, the solidity of my soldered connections, did not do all that they should have done. Voices, which once were loud and many were still and small and far away. Stations which I used to tune in with a turn of the wrist refused

to come at all. And when I sat up for America the fire went out because I did not dare to spoil the bright tinning on my soldering iron, and the nasal accents that of old I used to hear at will were no longer mine for the twiddling. I still keep that set standing beneath a glass cover in a prominent position in my den, and when my friends come in we look at it and admire and suggest improvements. But when they have gone I open the double-locked door of a little cupboard in the wall and withdraw from it a board of common deal upon which sits the despised thing which used once to arouse the wrath, the pity and the scorn of my acquaintances. I fix it up; I light my pipe; I sink into an easy chair with the 'phones caressing my ears and I hear as of old just what I want to hear.

Pity Me

If only they had left me alone all would have been well; as it is their criticisms, their gibes, their scorn, have sown within me the seeds of a discontent which I do not think is divine. Even I can no longer look complacently upon my faithful board, with its quaint jumble of bits and pieces. For some months now I have been

trying to fight down the temptation to straighten it up and to make it into the sort of thing that other people say it should be.

The Mighty Struggle

But the struggle is too much for me; I am too far gone now. If I see a connection made by twining two wires round one another my hand itches for the soldering iron. The fact that one wire is pink, another blue, another black, and that a fourth has no covering to hide its shame is beginning to disturb me. I am developing the tidy eye. I want all my wires to be the same. I want them to run in beautiful straight lines and to cross each other at right-angles instead of forming a tangled pattern of varied hues after the manner of the Turkey carpet or the Fair Isle jersey. That is why I am engaged now upon the making of a new set. I have read all the books and collected information from all my friends. I have tabulated the results and they are as I have said. I shall undoubtedly make this set, cost what it may in money and trouble, and I shall scrap my old faithful servant—but I think that when he has gone I shall always regret him.

WIRELESS WAYFARER.

An Easily-Made Lead-in Insulator

THE making of a well-insulated device for bringing the lead-in into the house is a problem that perplexes many amateurs. It must be neat, for one does not want to disfigure the woodwork of window frames, and it must be draught-proof, especially if one engages often in the practice of sitting up for America. Here is a tip which allows a lead-in insulator to be made for a matter of a few pence and with the minimum of trouble. It is extremely neat and is efficient as can be desired. With an auger bit drill a 1/2-inch hole through one side of the window-frame. A little care is required in doing this if the wood is not to be badly split at the point where the bit makes its exit.

How to Do It

Here is the way to do it. Drive the bit through until its screw point is just visible on the far side. Then withdraw it and

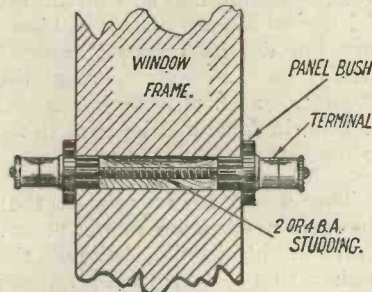

The leading-in tube.

complete the hole from that side, using the little orifice made by the point of the bit as the centre. This method ensures a perfectly

clean-cut hole. Take a pair of the little ebonite panel bushes sold by advertisers in this journal and insert one in each end of the hole as shown in the drawing. It will not be necessary to fix them with cement, since they fit very tightly into 1/2-inch holes. Now cut off a piece of 4 B.A. studding about 2 in. longer than the distance through the wood of the window-frame. Push it through the holes in the bushes and secure at either end with a round nut from a 4 B.A. terminal. A milled-headed terminal nut at each end completes the device. As the flanges of the bushes are squeezed tightly up against the wood, both draught and damp are successfully excluded.

Those who want to use something heavier than 4 B.A. studding will find no difficulty in making a 2 B.A. clearance hole in the bushes if drilling is done slowly and carefully without the exercise of undue pressure.

R. W. H.

An Experimenter's Unit Receiver

By H. BRAMFORD.

The twelfth article on the construction of a simple receiver. The first article of the series appeared in Vol. 3, No. 9.

Unit No. 11—Variometer

The only components necessary are:—

1 piece of ebonite, 6 in. \times 4 in. \times $\frac{1}{4}$ in.; 1 cardboard former, $3\frac{1}{2}$ in. long, having an internal dia.

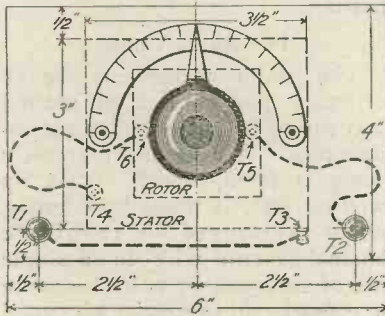

Fig. 51.—The panel layout.

of 3 in. minimum; 1 cardboard former, 2 in. long, having an external dia. of 2 in.; 1 ebonite knob bushed 2 B.A.; 1 scale plate; 2 stop pins; 2 terminals; some 2 B.A. rod; some No. 22 S.W.G., d.c.c.; and nuts and washers, etc.

Photographs of the complete unit are shown in Figs. 50 to 52.

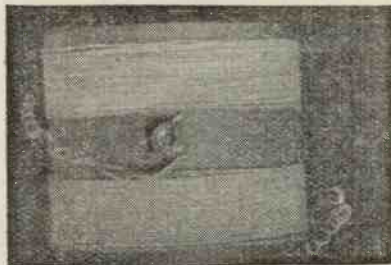

Fig. 52.—The underside of the panel.

Panel Drilling

Details of the panel drilling are shown in Fig. 51. Two holes are first drilled to clear the screws of the terminals T1 and T2. A hole is next drilled in the centre of the panel to fit a 2 B.A. clearing bush. The holes for the two stop pins are drilled in a position corresponding with the perforations in the scale reading.

Constructing the Variometer

The design chosen for this unit is one having a single spindle passing right through the stator and rotor, the reason being that those having a rotating spindle built upon two sections are very difficult to construct, the slightest error resulting in a "wobbly" movement. The details of con-

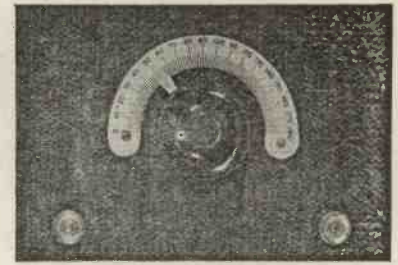

Fig. 50.—Unit Number 11.

these two points are exactly opposite each other on the axis of the former, resulting in a perfectly true working of the rotor spindle. Now wind the stator with 30 turns of No. 22 S.W.G. d.c.c. spacing 15 turns each side of the spindle bearing holes, leaving a good clearance for the

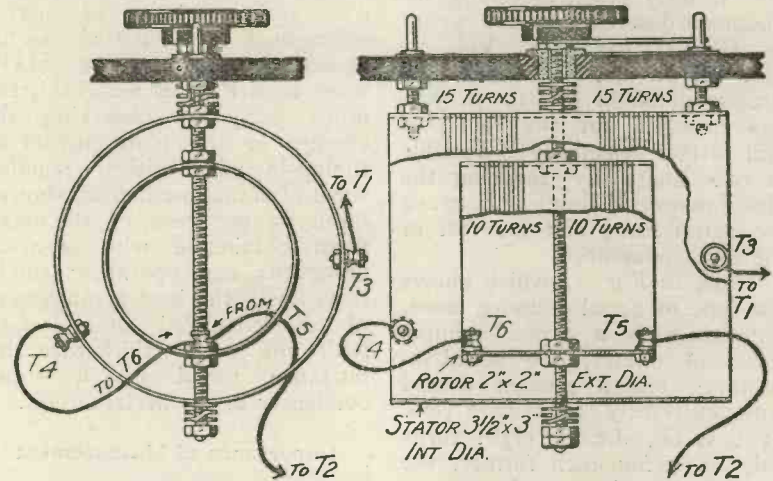

Fig. 53.—Constructional details of the variometer.

struction are clearly shown in Fig. 53. The stator is first made from the cardboard former, $3\frac{1}{2}$ in. long by 3 in. internal dia. Two holes should be drilled in the centre of former lengthwise and in a line with the axis. These holes should clear 2 B.A. rod. A simple method of finding the true corresponding positions of these holes is to cut a strip of paper $1\frac{1}{2}$ in. wide (being half the length of the former) and wrap it round the circumference of the former, keeping one edge of the paper flush with the edge of the former. Mark the point where the ends of the paper meet, take the paper off and fold on to the mark made. This gives us the exact distance of half of the circumference. Wrap the paper once more round the former and mark one point where the paper meets and the other point where the paper has been folded. It will be found that

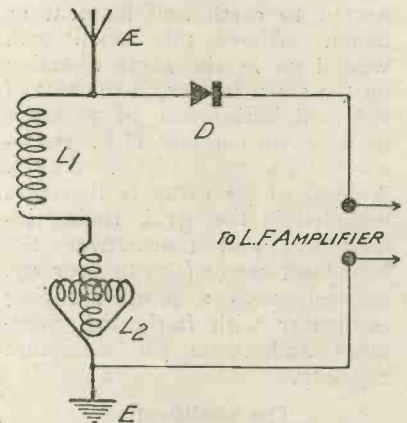

Fig. 54.—A simple circuit for long waves.

spindle, nuts and washers. Secure the beginning of the winding to terminal T3, and the end of the winding to terminal T4, as shown.

(Concluded on page 667.)

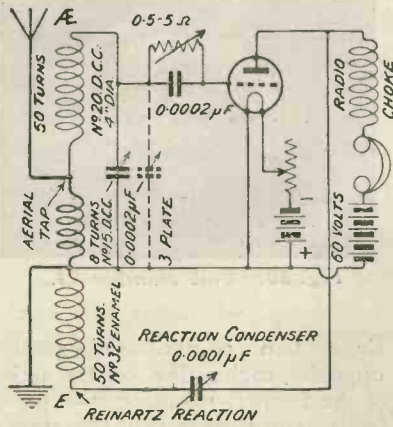

Fig. 1.—How selectivity can be enhanced.

FURTHER practical experience with the form of extremely selective tuning inductance described by the writer in *Wireless Weekly*, Vol. 3, No. 11, p. 348, and figured in greater detail in No. 12, p. 397, has brought out the fact that still further selectivity is possible in one stage by reducing the direct magnetic coupling between the aerial turns and the rest of the grid inductance.

Thus, in Fig. 1, which shows the type of aerial coupling used, together with a typical simple receiving circuit, the aerial inductance has a portion wound with extremely thick wire (No. 15 S.W.G., d.c.c.), eight turns only on a four-inch former, the aerial tap being made at the upper end and the lower end connected to earth and filament as usual. Above this small coil, wound on in the same direction on the same former, is the rest of the grid inductance, of 50 turns of wire with a low H.F. resistance (No. 20 S.W.G., d.c.c.). A total of 58 turns is therefore included in the grid tuning inductance, and tunes over the broadcast range (300 to over 495 metres), with a parallel tuning condenser with fairly low minimum and .0002 μF maximum capacity.

The Modification

In the preceding article it was suggested that the two parts of this inductance be wound continuously; the modification suggested here is that the second part of the inductance should be removed to some distance away from the first part (which is common to both aerial and grid cir-

Tuning Inductances for Selective Reception

By A. D. COWPER, M.Sc., Staff Editor

cuit), so as to reduce the magnetic coupling between them, and thereby diminish the shock-excitation effect of powerful signals. The two parts of the inductance are therefore separated by a distance of 1½ in., this length on the former being left bare of wire. This distance was arrived at by careful experiments with a divided coil, so as to get the best selectivity possible without serious loss of signal strength. The actual signal strength, measured on 2LO's wave on a P.M.G. aerial thirteen miles away by observing the change in the plate current on tuning-in with critical reaction short of actual oscillation, showed quite 75 per cent. of the maximum obtainable with identical apparatus and operating conditions, with the best arrangement of direct-coupled aerial, i.e., with the same thick-wire inductance tuned by a series condenser in the aerial circuit.

Importance of Measurement

Such quantitative methods of checking the efficiency of tuning devices are absolutely necessary if real progress is to be made, in the place of the usual vague and totally uncontrolled casual observations that so often pass muster as admissible evidence in radio. By direct aural observation there did not appear to be the slightest difference in signal strength, either on the local or on distant stations; only, of course, with the direct-coupled aerial the local station swamped everything else over a wide band of wavelengths.

Reaction is best obtained (when one valve or series-tuned-anode H.F. coupling with more than one valve is used) by the method made popular by Reinartz. A radio-choke is put in the plate circuit, and a reaction condenser of low minimum and quite low maximum value (.0001 μF) connects the plate with the reaction coil of 50 turns (No. 32 enamel) wound on the end of the A.T.I.

former, close to and continuous with the eight aerial turns, as shown. This gives an extremely smooth and convenient reaction effect. By adding a variable grid-leak, back-lash in oscillation can be entirely avoided, so that searching becomes an easy matter.

The Radio Choke

The radio choke can be an ordinary plug-in coil of around 250 turns, or some equivalent inductance. A neat and extremely compact form, which shows up well on test, is made by winding about 300 turns of No. 32 S.W.G. enamel-covered wire in a single set of slots cut by a hack-saw in a short hexagonal ply-wood former of the type described below. The distributed capacity of this is so small that it affects sensibly neither the wavelength nor reaction requirements of a single-valve circuit when shorted across grid and filament—a good test of a radio choke.

An alternative form for this selective tuning inductance is made by winding the corresponding amounts of wire in multiple single-layer slab coils, in slots cut in a hexagonal star-shaped

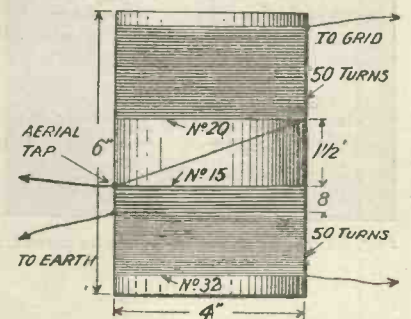

Fig. 2.—Showing how the parts of the coil are separated.

former, made up of three pieces of ply-wood, thin ebonite or fibre. These latter are notched deeply so that they can be slipped together in star formation, as indicated in Fig. 3. The whole is bound together by string around

The remarkable selectivity obtainable with the circuit already described by Mr. Cowper is still further enhanced by the modification here illustrated.

the centre until the wire is wound on, when the latter holds it together firmly. The winding slots—six at $\frac{1}{4}$ in. spacing for the upper grid coil, one very wide, one for the ten aerial turns of No. 15 wire, and a narrow one at $\frac{1}{4}$ in. from this for the reaction coil—these are made with a hacksaw. In this case a space of $2\frac{1}{2}$ in. is left between the aerial and upper grid turns. for the reason stated above. The wire is wound tightly in the slots, all in the same direction. The 110 turns of No. 28 S.W.G. enamel-covered wire that form the reaction coil are wound necessarily in more than

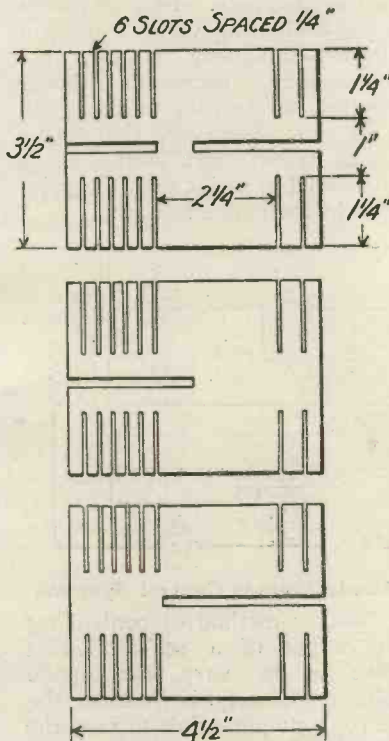

Fig. 3.—Slotted formers for alternative inductance.

one layer, as the slot is too wide for the wire. Some care will be needed in putting on the ten No. 15 aerial turns, to avoid breaking the former. The 120 turns of the upper portion of the grid coil should fit neatly in single layers, 20 turns in each of their six slots. The connections are made as in-

dicated in the circuit diagram. This coil tunes from about 300 to well over 500 metres with a parallel .0002 μ F variable condenser, and a .0001 μ F reaction condenser suffices over the range with a good R valve and 50-60 volts H.T.

Independent of Aerial Tuning

As indicated in the article referred to, this type of aerial-tap auto-transformer aerial coupling is almost independent of the characteristics of the aerial, as to wavelength and ease of oscillation. The tuning is extraordinarily sharp, so that with the small tuning condenser specified, a parallel vernier or three-plate with long ebonite handle for fine adjustment is absolutely necessary. There is scarcely any noise with a full outside P.M.G. aerial to tell one whether the circuit is oscillating or not; a wavemeter is quite essential for the first tuning. Even the local loud station comes in but faintly without reaction adjustment.

Comparisons

The first cylindrical type of inductance (Fig. 2) gives a little better signal strength than the second (Fig. 3), but at the price of less extreme selectivity. Both give a measure of loud speaking on a good aerial with a single valve and the local broadcast transmission; this is with a liberal R valve and 60 volts H.T. With the solenoid type, London at 13 miles is cut out from 385 metres up, so that Bournemouth can be listened to in comfort without trap circuits and on a single valve, whilst all the other B.B.C. stations above him can be found, on a silent background, at readable strength. Manchester's and Cardiff's waves can be heard through London, and occasionally something distinguished in spite of 2LO.

Signal Tests

With the second type, as the coupling is weaker with the flat

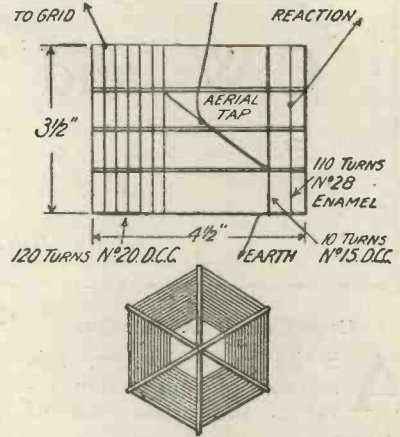

Fig. 4.—Further details of alternative inductances.

slab coils, London vanishes just about 10 metres either way, so that both Manchester and Cardiff can be read through London on the single-valve, whilst Bournemouth is clear of 2LO. Aberdeen and Glasgow were particularly clear and enjoyable with this tuner, with no Morse to jam them, and were easily picked up with a little help from the wavemeter. Of course, with a selective H.F. stage beyond the first valve, there is no difficulty in completely isolating the desired transmission.

Ranges

The wavelength ranges indicated will be given only if the tuning condenser is of low minimum and the specified actual maximum. There is often a large variation between different variable condensers of the same nominal capacity. The experiments described here were made with a Jackson Bros. (old-type ebonite top) .0002 μ F variable condenser, and a low-minimum .0001 μ F condenser for reaction. Some types with metal end-plates, and most mica variable condensers, are apt to display an unduly high minimum.

THE BRITISH EMPIRE EXHIBITION.

All indications point to the fact that the wireless exhibits at the British Empire Exhibition will be particularly interesting. Special efforts are being made by British firms to show our visitors the high quality of British productions.

C.W. and Telephony Transmission Using Valves

No. XV.

By JOHN SCOTT-TAGGART, F.Inst.P., A.M.I.E.E.

Grid Circuit Modulation

AS its name implies, this method of modulation involves the application of

T₂. The microphone is shown operating off the filament accumulator B₁. Since the output of the oscillating valves depends

upon the flow of current in the anode circuit, it will be readily understood that, by applying the microphone potentials to the grid, we can control the flow of electrons to the anode and in this way modulate the output.

Another way of explaining this is to say that the microphone potentials vary the normal operating point on the characteristic curve of the valve.

This type of circuit may be varied in very many ways, and it is only proposed to show a further example. Fig. 38 shows a self-oscillating valve V using a single oscillatory circuit, the microphone potentials being applied, as before, to the grid. This time, however, the microphone transformer secondary is connected in series with the grid-leak in the manner shown.

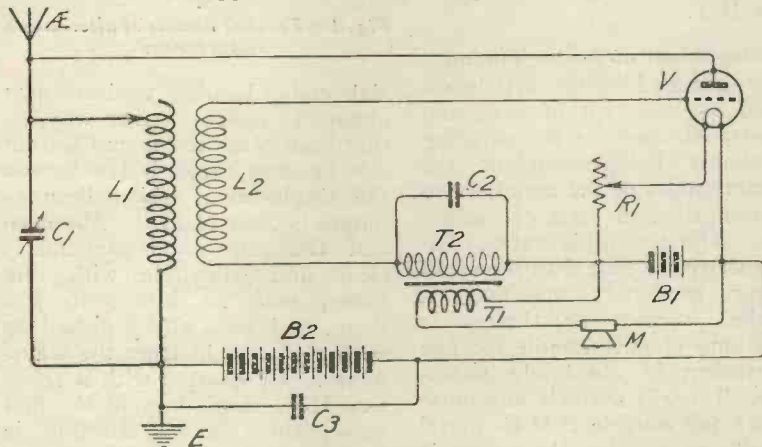

Fig. 37.—A practical grid control circuit.

the modulating potentials to the grid of an oscillating valve. Fig. 37 shows a typical transmitter. The ordinary oscillating circuits are shown and a leaky grid condenser may be connected in the grid circuit, if desired. A microphone M applies the modulating potentials by means of a step-up microphone transformer T₁ T₂ to the grid circuit of the oscillating valve. A condenser C₂ is shunted across the secondary

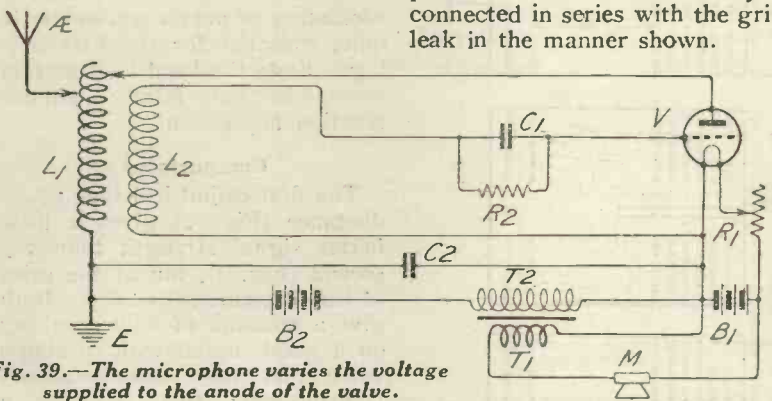

Fig. 39.—The microphone varies the voltage supplied to the anode of the valve.

Anode Voltage Control Systems

Another method of controlling the output of a self-oscillation valve is to vary the anode voltage. Clearly, if we cause the microphone potentials to vary the voltage of the anode of the self-oscillation valve, we will vary the output. It has been found that the oscillatory output of an oscillating three-electrode valve varies directly with the anode voltage; if we double the anode voltage, we double the output current.

Fig. 38 shows a simple valve generator in which we have connected a secondary T₂ of a microphone transformer T₁ T₂ in series

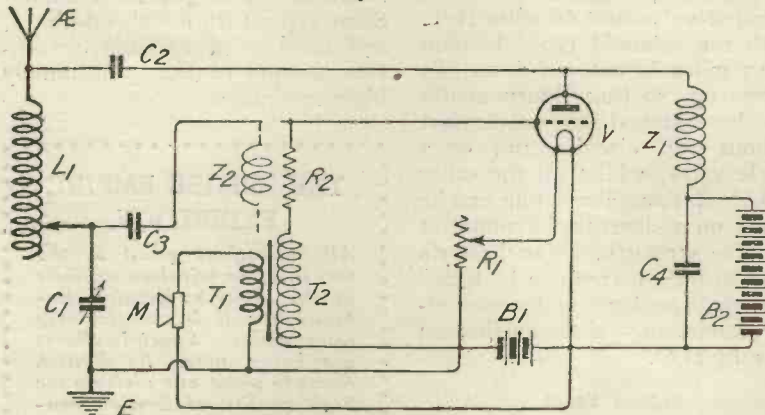

Fig. 38.—Another grid control circuit in which the single circuit oscillating system is used.

with the anode battery B2. When speaking into the microphone, we cause positive and negative potentials to be developed at the left-hand side of T2. The potential variations across T2 will therefore add or subtract themselves to or from the voltage of the anode battery B2, and the aerial current will vary in sympathy. If we cut out battery B2 altogether, we can still use the arrangement as a wireless telephone, but in this case the microphone potentials across T2 supply the whole anode voltage, and the valve will only oscillate when speaking; this arrangement is, consequently, a quiescent aerial system. The speech obtained under these conditions is poor, because the smaller current variations through the microphone are insufficient to set the valve oscillating; in all cases it is preferable to have the valve oscillating when not speaking.

In the case of this class of circuit, the microphone potentials provided by an ordinary microphone transformer are not sufficiently high to operate any but the weakest transmitters. To obtain proper results it is necessary to amplify the microphone potentials by a second three-electrode valve.

Fig. 40 shows an arrangement

for accomplishing this. The valve V1 now acts as a generator of the continuous oscillations to be modulated. The anode circuit is fed from a battery, generator or rectifier unit B2 through a choke coil Z and the secondary T4 of a transformer T3 T4. The choke coil Z is, of course, to prevent radio-frequency current from flowing in the D.C. anode cir-

The anode battery B2 supplies the anode circuits of both valves. When the microphone potentials are applied to the grid of this second valve they are amplified by V2 and are passed on by the transformer T3 T4, so as to vary the normal anode voltage of V1. If this anode potential is normally 500 volts, we can arrange that when we speak into the micro-

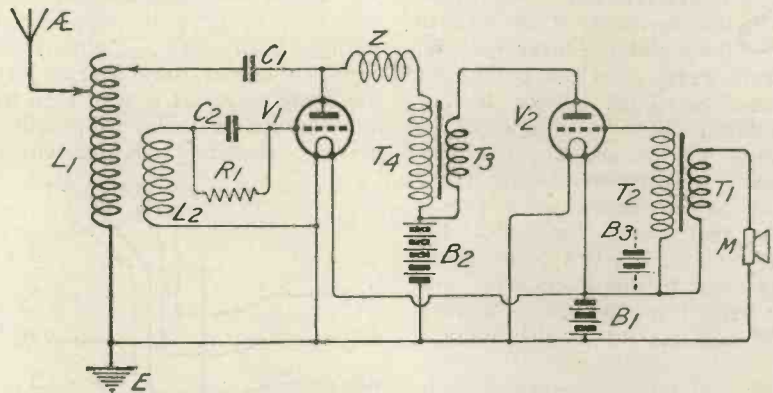

Fig. 40.—A choke control circuit. The microphone potentials are amplified before being applied to the anode of the oscillating valve.

cuit. The second three-electrode valve V2 acts as an audio-frequency amplifier; the microphone potentials are applied by means of a transformer T1 T2 to the grid of V2, a source of potential B3 being preferably arranged to give the grid a negative potential.

phone M we cause the voltage of the anode of V1 to vary between the limits 1,000 volts and zero volts. In practice, we arrange that the anode voltage is never brought lower than the smallest value necessary to maintain continuous oscillations.

Tests for Oscillation

IT is said that interference by oscillation is on the decrease, but the fact remains that it is still a sufficiently common occurrence to be something more than a nuisance during broadcast reception. The vast majority of offenders err because they do not know that their sets are in oscillation. One sometimes hears when a set is being worked so as to give very strong signals, a little faint moaning noise that is often put down to a heterodyne accompanying the transmission, which cannot be avoided. As a rule, it is due entirely to the receiving set, which is "broadcasting" it on its own district to the despair of others. Should you notice this symptom you can easily ascertain whether your own set or the transmission itself is responsible for the subdued

noise. Turn your tuning condensers, one by one, a few degrees to either side of the adjustment which you are using. If the note of the moan varies, or if it becomes a definite howl when this is done, then your own set is oscillating, and you must detune slightly in order to avoid spoiling the pleasure of others. Don't forget that if you are liable to make squeaks and chirps when tuning in, all your wireless neighbours can hear them. Therefore, find your adjustments as quickly as possible, and once you have found them leave the knobs alone. The very worst offender is the man who is never quite content with his tuning, but is always trying to get it just a little better. There can be radiation from the receiving set without there being any audible note

in the receivers, though there will probably be a slight rustling noise, and the presence of what are usually called atmospherics, but are really battery noises, will be noticed. To detect the presence of oscillation, touch the aerial terminal with a wet finger. A distinct click will take place at each touch if there is oscillation. In a well-controlled set it should be possible to touch, not only the aerial terminal, but also the grid leg of each valve without there being any click at all.

R. W. H.

"Modern Wireless"

BACK NUMBERS.

We shall be pleased to hear from any reader who is prepared to dispose of his copy of the September issue of "Modern Wireless"—Vol. 1, No. 8, also "Wireless Weekly"—Vol. 1, No. 2. Communications should be addressed to our Sales Department and should mention the price required for the copy, which, of course, must be in good, clean condition.

Switches: Their Use and Abuse

By PERCY W. HARRIS, Assistant Editor.

A few notes of interest to experimenters and home-constructors.

"SWITCHITIS," which, like measles, it is well to have and get over quickly, affects every wireless enthusiast sooner or later. Once having mastered the workings of a simple crystal set the beginner usually desires to plunge right into the intricacies of a seven-valve set with "switches for every valve." Whatever profit may come to the dealer who sells our friend his accessories, very little will accrue to the builder, for such complex circuits rarely work satisfactorily, even if their construction is ever completed.

Switching Good and Bad

Before setting out to design a receiver utilising a large number of switches, consider very carefully just what purpose they will serve and whether they are being used merely as a "stunt," or because they are really necessary.

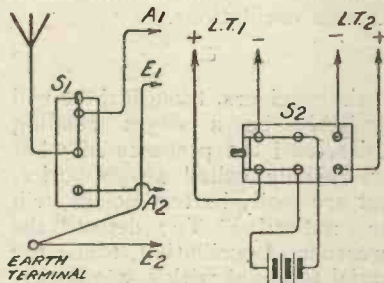

Fig. 1.—A bench arrangement of great value for rapid change.

The secret of good design is simplicity, both in layout and in wiring, more particularly in the wiring of grid circuits where it is our aim to utilise very minute changes of potential to the best advantage. The introduction of switches almost invariably means the introduction of long leads and, what is just as bad, the criss-crossing of wires and the bringing together of connections which otherwise would be well apart. When we think that the tiny capacity existing between the filament, grid and plate of a valve is sufficient (on short wavelengths) to by-pass energy which

we cannot well afford to lose, it will be realised that complicated wiring with its accompanying capacity effects may act in just the same way. It is well then to avoid switches so far as possible in high-frequency circuits where

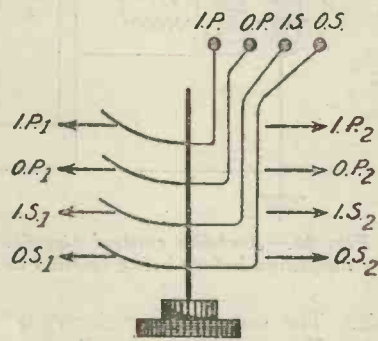

Fig. 2.—A switch for comparing transformers.

such capacity effects are most detrimental. In low-frequency circuits it is not so essential to avoid their use, but even here switching, with long leads, may appreciably diminish efficiency and set up audio-frequency oscillation, better known as "howling."

A Few Useful Switches

In certain parts of our apparatus switches can be used without detriment and to very great advantage. It is surprising how few experimenters use switches on their instrument benches, preferring as they do to disconnect and connect up batteries for every change of set. In Fig. 1 an arrangement is given which I have used for some time with great success. S1 is a single pole double-throw switch, the centre point of which is connected to the lead-in insulator. A1 is taken to the broadcasting set kept tuned to 2LO for family use, whilst A2 is a lead with a spade terminal which can be rapidly connected to any set for test purposes. E1 and E2 are the two earth connections. These are not included in the switch, as the earth connection can be left perman-

ently on both sets. S2 is a double-pole double-throw switch which serves to change over the 6 volt accumulator from the broadcast set to the set which it is desired to test. Thus without disturbing family reception one can connect up the leads A2, E2 and LT2 to the set it is desired to try, and when everything is ready a change-over of aerial and battery can be made in a moment. As soon as the experiment is over the change back can be effected in a moment, and the test set disconnected at leisure. At one time I had a switch for changing over the high-tension battery in a similar way, but soon abandoned it as I found it more practical to keep a separate high-tension battery for test use, as the voltage needed varies with practically every set I try.

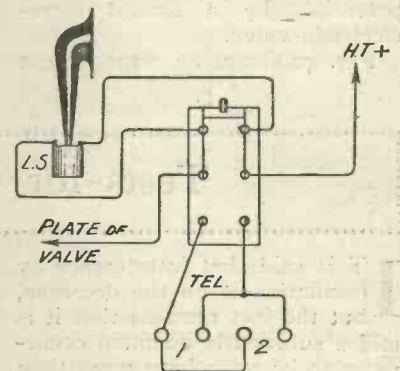

Fig. 3. A "loud-speaker-telephones" switch for multi-valve sets.

A Useful Transformer Test

It is frequently desirable for test purposes to be able to make a rapid change with two interval transformers. Fig. 2 shows the switch I use for this purpose. It is a 4-pole two-way switch of the "Utility" pattern, the blades being connected as shown to the portions of a simple receiving circuit which would normally go to IP, OP, IS and OS. IP1, OP1, IS1, OS1 correspond to the connections of the first transformer, while IP2, OP2,

IS₂, OS₂ are those of the second. The nearest broadcast station is first of all tuned in on the transformer which one may take as a standard, whereupon a turn of the knob will transfer all connections to transformer No. 2, which is to undergo test. Five minutes use of this change-over switch enables comparisons to be made on speech, music, or any other items which may be broadcast, and if, in addition, an audibility meter is to hand a test of the amplification as well as the quality can be given. Such tests should not be done on signals which are very loud or the ear may not detect the slight differences which are noticeable on weak signals.

Another useful switch which can be incorporated in any receiving set without sacrificing efficiency is that shown in Fig. 3. A double pole double throw switch of any suitable pattern (for panel mounting there are several kinds sold, known generally as anti-capacity switches) is connected up as shown, one of the blades being connected to the plate of the last valve and the other to the positive high tension. On one side a loud-speaker can be thrown into circuit and on the other side the telephones. I find it useful to put two pairs of telephone terminals, wired in parallel, as when telephones are used for reception there is usually more than one person to listen in.

A Useful ST100 Switch

A very useful switch which can be incorporated in any ST100 circuit is that illustrated in Fig. 4. Normally the lead from the anode coil would be connected to one side of the primary of the second inter-valve transformer, the other side being joined to the positive H.T. If now we connect the anode coil to one blade of a double-pole double-throw switch, the other of which is connected to the positive high tension, and if we connect one pair of switch contacts to the transformer and the other to a pair of telephones, we can change in a moment from a single-valve reflex to a two-valve. Very frequently the strength obtained with an ST100 is far too great for comfort in a living room, and a single-valve reflex is amply powerful enough to

operate a loud-speaker. With such a switch we can economise quite considerably, only throwing in the second valve when it is actually needed. I have actually handled several sets with this switch and found them very convenient. I recommend an anti-capacity switch here and not the Dewar, or telephone, switch, as this latter has considerable self-capacity which

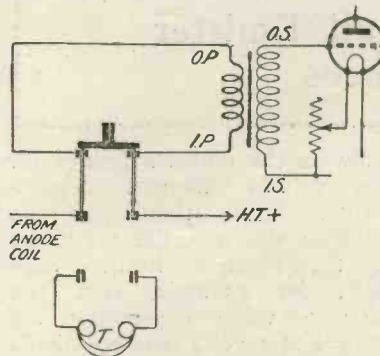

Fig. 4.—A useful switch for ST100 circuits.

may detrimentally affect the receiver. If a three-pole double-throw switch is used, the third blade can be made to disconnect the accumulator lead to the

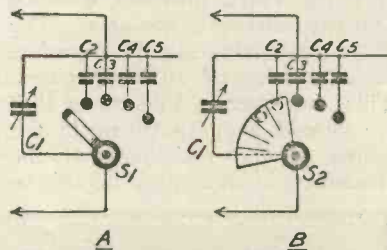

Fig. 5.—Two switches for continuous increase of capacity.

second valve, thus cutting off the current automatically when we change over from one to another.

Capacity Switching

Fig. 5 shows two methods of capacity switching when it is

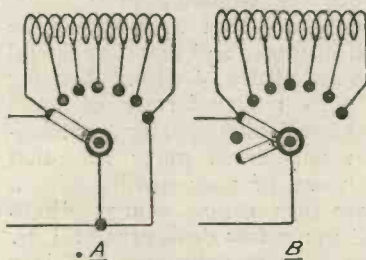

Fig. 6.—Two methods of "dead-end" switching.

desired to vary capacity over a very wide range. This is desirable in wavemeters, filter cir-

cuits and the like. In Fig. 5A we have a 5-point switch, 4 points being connected to fixed condensers and a variable condenser being connected permanently across the switch. If C₁, the variable, has a value of .001; C₂ should have a value of slightly less than .001, C₃ slightly less than .002, C₄ slightly less than .003, and C₅ just below .004. If the circuit is now connected across the points marked with arrows, we shall have on the first stud a variation of capacity on the minimum of the variable condenser up to .001. On stud 2 we can increase from .001 up to .002, and so on until on the last switch we can obtain a total capacity of .005. This arrangement is very simple, but is rather extravagant in its use of condensers. In Fig. 5B we have a similar circuit with a slightly different switch. In this case the switch is provided with a fan-shaped blade of such a shape and size that it is capable, when necessary, of covering all the stud points at once. It must also be possible to move it round so that it only makes contact with the first dummy stud. In this case the condensers C₂, C₃, C₄ and C₅ should all be of equal value, slightly below the maximum of C₁. By changing one point of the switch to another we can bring in the various condensers in parallel with C₁. The total capacity obtainable is again .005, but in this case we have greater economy in the use of condensers which are of a size readily obtainable. The switch arm may be a little difficult to make, but if it is cut out of springy brass and slit as shown, there will be no trouble in obtaining good contact if the studs are quite level.

Dead-end Switching

Fig. 6 shows two methods of "dead-end" switching which are not so well known as they might be. Fig. 6A is a method frequently used by manufacturers of tapped transformers and tapped anode coils. It consists in connecting the last stud of the switch to the switch blade so that the whole of the turns not in use are short circuited. This arrangement is fairly efficient, but alters the tuning to some extent, the effect not being the same

as if the end of the coil is left open. In Fig. 6B a method is depicted which has become very popular in America, and is used in the American Navy and Army receivers quite extensively. It consists in having a double-blade switch arranged as shown, so that two sections of the coil

ahead of the portion used are short circuited. It is claimed for this method that dead-end losses are satisfactorily eliminated without the loss of efficiency associated with the method shown in Fig. 6A.

The present article is only intended to be a few useful notes

on switching, and obviously many practical methods have been omitted. The subject is a very large one, but it is hoped that these notes will be acceptable to those who have recovered from "switchitis," but still desire to use switches in an efficient manner.

Calculating Dull Emitter Resistances

QUITE a number of different types of dull emitter have been placed upon the market recently requiring all kinds of filament voltages, and it seems not unlikely that others will follow at fairly frequent intervals in the months to come. To use any sort of dull emitter with an accumulator it is necessary to place an extra resistance in series with the existing 4- or 5-ohm rheostat. These resistances are of course easy enough to make by winding enamelled Eureka wire round formers made from $\frac{1}{4}$ in. ebonite rod, but the difficulty is to discover exactly what resistance value is suitable for any particular kind of valve. Here is one way of making a calculation which involves no great feats of mathematics. All that you require to

know is the maker's figures for the valve's filament requirements. From these you can at once discover the resistance of the filament itself. Suppose, for example, that you have a valve consuming .25 ampere at 1 volt; then by Ohm's Law, $R = \frac{E}{I}$, the resistance is $\frac{1}{.25}$ or 4 ohms. Now let us suppose that you wish to work this valve from a 4-volt accumulator. The current to be passed is .25 ampere, hence the total resistance necessary is $\frac{4}{.25}$ or 16 ohms. Of this the valve provides 4 ohms and the existing rheostat 5. The extra resistance should therefore have a value of $16 - 9 = 7$ ohms. This, however, would mean that we should have to throw in the whole of the resistance of the rheostat and should not be able to

make any fine adjustments. Hence it is better to make the extra resistance with a value of about 10 ohms. The rule, then, simply is: first find the filament resistance, then find the total resistance necessary to cut down the voltage of the battery so that only the required current is passed; from this subtract the resistance of the filament and about half that of the existing rheostat. The answer will be the number of ohms required for the fixed resistance. There is even a shorter method, which is as follows: Divide the drop in voltage required by the amperage of the valve. This will give the total resistance required in circuit with the valve. If we work the last example in this way we have a voltage drop from 4 volts to 1 volt = 3, amperage of valve = .25; $\frac{3}{.25} = 12$ ohms, of which the rheostat provides 5. With an ".06" valve and a 6-volt accumulator the calculation would be $R = \frac{3}{.06} = 50$ ohms.

R. W. H.

ONE often sees low-frequency intervalve transformers advertised with the proud claim that they have a ratio of 10 to 1, or even more, between primary and secondary. There are many who think that, owing to the step-up in voltage which is theoretically obtainable with a large turn ratio, much greater amplification should be obtained with a 10 to 1 than with a 4 to 1. This, as a matter of fact, is not the case. The writer much prefers, at any rate for the first low-frequency valve, a

What is the Best Ratio for L.F. Intervalve Transformers?

transformer with a ratio of 1 to 1, and he never uses one with a greater ratio than 3 to 1. The only things that really matter about the windings of a transformer are that they should be well insulated and that they should contain plenty of wire. Actually a 1 to 1 transformer of good make will give greater amplification and much purer reception than one of poor quality with a large turn ratio. Many writers and not a few designers of L.F. intervalve transformers fall into the error of applying to them the laws which govern transformers used for power or lighting work. The difference between the two is very great indeed. In power

and lighting transformers the secondary circuit is under load—that is to say, current is drawn from it; but in the low-frequency transformer there is practically no load at all—certainly not more than a minute fraction of a microampere passes through it if the grid of the following valve has a proper negative bias. The full load of a low-frequency transformer, through whose primary one milliamperere is passing from the high-tension battery, would, if the ratio were 4 to 1, be in the neighbourhood of .25 milliamperere, an amount which is several thousand times greater than that ever reached in the wireless set. R. W. H.

SPANISH BROADCASTING

Numerous reports are being received of the successful reception of Spanish broadcasting on wavelengths of about 410 metres and 2,000 metres. The modulation and steadiness seem good, and even single valve sets occasionally suffice for reception.

Ideas for Inventors

By OSWALD J. RANKIN

An informative and suggestive article on novel lines

EDISON has said that invention is a science and that it should be taught as a profession. This is true, for after all invention is nothing more than the happy knack of finding the "better way" of doing things, and before one can do this one must, of course, first acquire the necessary experience. In the wireless world to-day there is much scope for the practical man who possesses the gift of originality, and it is the purpose of this article to advise and assist the more serious and advanced enthusiasts who may be interested in inventions by putting forward a few feasible suggestions in matters pertaining to improvements on present-day apparatus. The ideas outlined in the accompanying diagrams are intended as a little food for thought, each one representing a sort of guide to any well-meaning inventor who may be working on the wrong lines.

Condition for Success

It should be remembered that the ultimate success of any invention depends on its commercial possibilities rather than on the actual ingenuity of the thing, and for this reason a new idea or an improvement on any existing device should be carefully worked out in the following order:—(1) Advantages gained; (2) estimated demand; (3) simplicity, if easily applied to modern mass production methods; and (4) low cost of production. Many ingenious inventions remain on the shelf because the existing article is *cheaper* than the improved article, even though it may be inferior in many ways. To the inventor who takes his business to heart this is a somewhat sad state of affairs, but such

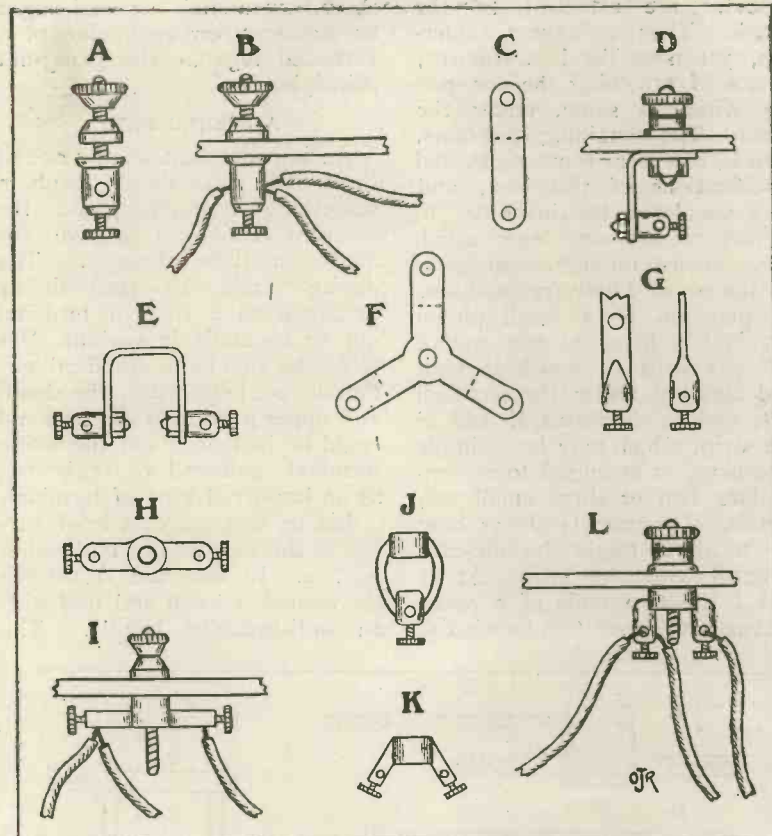

Fig. 1.—A collection of terminal suggestions.

are the powers that be, and therefore we have to adopt ourselves to the circumstances. All this is mentioned to signify the fact that invention is a business, and not a mere pass-time for fanciful dabblers. In the writer's opinion anyone can become a successful inventor providing he possesses a creative mind, a fair amount of mechanical ability, much experience and patience, and a little capital. But as the title of this article implies, we are not so much concerned with the subject of *how* to invent as we are with the problem of *what* to invent. In most cases the practical man will invariably score over the purely theoretical man, and, bearing this in mind, the writer has skipped over much theory in favour of some really practical suggestions, which are most likely to meet with success in the commercial world. It should be clearly understood that the ideas illustrated are by no means intended as representations of the finished products: they are merely suggestions forming a basis on which an inventor might direct his efforts.

Terminal Ideas

Fig. 1 deals exclusively with terminals, or, to be more precise, with that particular part of a terminal which has suffered neglect; namely, the lower shank or under-panel fixing and connecting arrangements. Out of every dozen enthusiasts who are instructed to solder all connecting wires to terminals there are probably ten who dodge this little performance and resort to a more simple method. This fact should not be overlooked, for it is a sign that there is a definite demand for some arrangement which permits an alternative method to soldering. That there is nothing to equal a well-soldered joint is also a fact which we cannot ignore, but as this article is intended for the inventor and his opportunities, we must, for the moment, ignore our own views and knuckle down to the actual requirements of the multitudes of inexperienced newcomers. In diagrams A and B (Fig. 1) a medium-size telephone terminal is fitted to the panel in an inverted position, and the clamping collar and milled nut from an ordinary

terminal are attached to the shank. Thus we have a solderless, yet none the less efficient, means of attaching the connecting wires to same, under the panel. The remaining diagrams, C to L, represent some suggested modifications of this idea, and here we leave the inventor to further modify any one which may, in his opinion, appear to be the most likely proposition. In diagram D a small phone terminal is fitted to one end of a brass strip C, which is bent and clamped under the terminal nut, and in diagrams E and F the strip, which may be a simple stamping, is arranged to accommodate two or three small terminals. Diagram G shows how the terminal might be die-cast integral with the strip. At H and I the two ends of a small busbar function as two terminals,

show how a small terminal might be arranged on each side of a threaded lug on the wing-nut principle.

A Fruitful Field

An improvement on any one of these little ideas should result in something interesting, and the inventor is advised to give the matter a little thought. The device could be conveniently arranged as a sort of terminal nut to be made in various sizes to fit the shanks of standard terminals, or, better still, the shank and upper portion of the terminal could be included, and the whole terminal patented or registered as an improved type of terminal.

Let us now make a brief survey of the suggestions outlined in Fig. 2. In diagram A we see the orthodox knob and dial with an anti-capacity handle. The

fairly satisfactory, providing it happens to fit the selected water-pipe, but an idea worked out on the lines shown at D and E would give greater satisfaction to all concerned. A suitable earth spike for portable sets in summertime might be a success. Such an idea is shown in diagram F.

Coming Down to Earth

Do not overlook the fact that a soldering outfit does not blend nicely with nature's work in the country-side, and pay particular attention to the efficiency of the terminal to which the earth lead is attached. There is room for improvement in the present type of knife switch. We now have to choose either one of the two types shown in diagrams G. and H. At G the contacts or "clips" are cut out from a solid square bar, and at H they are formed from sheet metal stampings. The former possesses a very neat appearance, but good contact is always more or less uncertain; the latter is most efficient, but unsightly. Try to introduce the spring action of H into the solid deadness of G.

Mounting Coils

A further selection of ideas is given in Fig. 3, where diagrams A and B suggest a simple method of mounting cylindrical inductance coils, either (A) under the panel, or (B) on the usual base-board. Such a fitting would meet with the immediate approval of all users of cylindrical coils. It must be simple, inexpensive, and of attractive design.

Battery Connectors

A cheap and efficient connector for pocket-lamp batteries is badly needed, since so many enthusiasts prefer to build up their own H.T. units from same, and a simple suggestion is presented in diagram C, where two slotted members are electrically joined by a flexible lead and made to engage the contact strips of alternate batteries. The present type of H.F. plug-in transformer is quite efficient, but the design could be greatly improved since it occupies a good deal of valuable panel space. Get away from the mushroom idea and arrange the instrument as

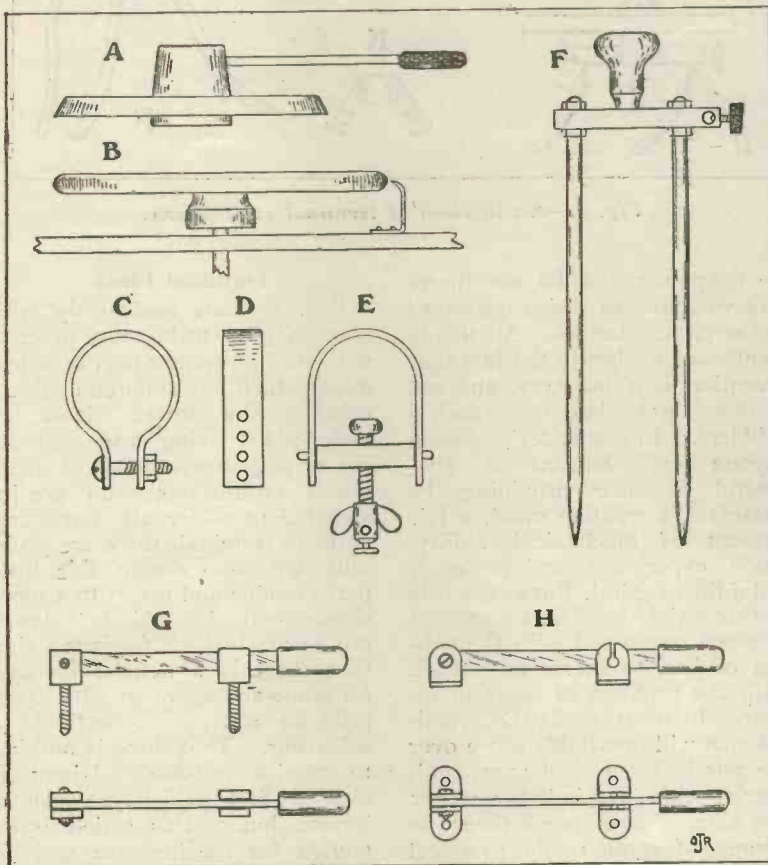

Fig. 2.—Anti-capacity handles, earth clips, and switches need much attention.

the centre boss being threaded to replace the usual terminal nut. J shows a rather elaborate arrangement, which would require simplifying before being practical. Diagrams K and L

knob is useless except for accommodating the handle, so why not introduce a combined dial and anti-capacity manipulating disc as indicated roughly at B?

The usual earth clip, C, is

shown at D. Also include a variable mica tuning condenser if possible. The outer casing could be of ebonite, and if a suitable linking-up system could be devised there is no reason why the instrument should not be arranged to cover a wider range of wavelengths than usual by winding the coils in pancake fashion and dropping them in the casing as required.

Why is the Perikon detector unpopular? Simply because the design of the instrument has been neglected. There must be no rubbing or grating movement between the two crystals, and therefore the arrangement shown at E would seem to be most suitable. Here the movable crystal cup is attached to one end of a square brass rod, which slides accurately in a bearing-block. This principle assures a perfectly parallel movement between the two crystals, but get away from the screw adjustment idea and try some simple air pressure device, as suggested at F.

When using a frame aerial it is usually necessary to provide a tuning condenser. Why not embody this instrument in the design of the frame aerial, as indicated at G? The windings

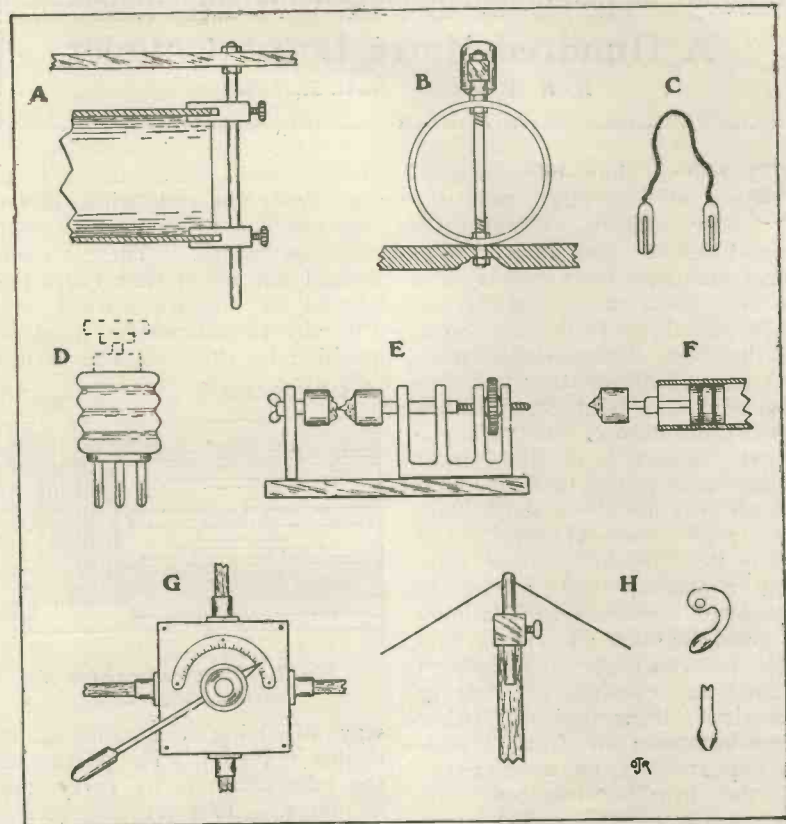

Fig. 3.—Inductance coil mounts and other badly-needed fittings.

of frame aerials often become slack through various causes, and some simple adjusting device, as

shown at H, would be an all-round improvement.

(To be continued.)

KING'S SPEECH TO BE BROADCAST IN ESPERANTO.

A UNIQUE event, and one significant in its bearing on the possibilities of international broadcasting, will take place at 10.30 p.m. on Wednesday, April 23, when the speech of His Majesty the King, delivered at the opening of the British Empire Exhibition at Wembley the same day, will be broadcast in the international language, Esperanto, from the London Station simultaneously to all B.B.C. stations.

Special arrangements are being made throughout the Continent for the reception of this speech, which will be listened to by thousands of people, to whom otherwise the King's speech would have been a mere jumble of incomprehensible sounds.

The Esperanto version will be broadcast by Mr. H. A. Epton, F.B.E.A., Hon. Secretary of the Internacia Radio-Asocio.

The British Broadcasting Company are to be congratulated on their enterprise in enabling many thousands of listeners-in, who, if not subjects of our King, are at least his affectionate friends, to hear and understand his speech without loss of time at the opening of the greatest Exhibition ever held.

Another event of interest will occur on May 7, 6.45 p.m., when Mr. Charles H. Edmonds, Editor of *International Language*, will broadcast a talk in Esperanto on "Broadcasting, Present and Future," dealing with the work of the B.B.C., for the benefit of foreign listeners-in. This talk will be given from the London Station, and will be S.B. to other stations.

Postcard reports of reception of both above talks will be welcomed by the B.B.C., 2, Savoy Hill, W.C.2.

Increased Power for Sheffield

The fact that the B.B.C. have agreed to the Sheffield Relay Station having its power increased from 100 to 200 watts is very satisfactory, and the question is now being raised whether this will not have to be still further increased in the near future.

The districts around Sheffield, the vast industrial area which includes Rotherham, Barnsley, Chesterfield, Mexborough and Doncaster, will have to be catered for sooner or later, and the question is as to whether 200 watts will be adequate.

It is not known yet whether new apparatus will be needed at Sheffield to double the present transmitting power, or whether the present plant can be used with one or two alterations.

A Hundred-Metre Loose Coupler

By R. W. Hallows, M.A., Staff Editor

SO much has been accomplished recently upon the very short wavelengths round about 100 metres that most amateurs have endeavoured to find some means of tuning their sets down to them. Some of the best Transatlantic work yet done, both amateur and professional, has been accomplished upon these waves, which seem to "get across" in the most remarkable way. In fact, with an efficient aerial—a single wire for preference—KDKA is in many localities little more difficult to pick up than several of our own broadcasting stations. If conditions are at all favourable, one can make fairly sure on almost any evening of hearing American transmissions, either from amateurs or from broadcasting stations, on wavelengths in the neighbourhood of 100 metres.

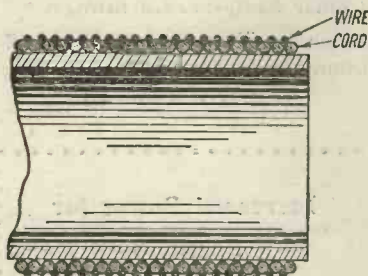

Fig. 1.—Method of spacing winding.

Those who have so far been successful in receiving upon these short waves are fairly well agreed that it is desirable to use a loose-coupled tuner of some kind with an untuned aerial circuit in order to obtain the best results. A very simple little tuning device can be made up at home by anyone which, if the rest of the set is efficient, will do all that is asked of it.

Obtain two pieces of good stout cardboard tubing, the first $3\frac{1}{2}$ in. in diameter and 6 in. in length, the second 4 in. in diameter and $2\frac{1}{2}$ in. in length. The larger tube is for the primary and the smaller for the secondary, the former being made to slide over the latter, which is a departure from the usual principle of making the secondary the

moving coil. Starting half an inch from one end, wind fifteen turns of No. 22 d.c.c. wire on to the secondary. These turns should not touch each other but should be slightly spaced, and the wire should not be fixed in position by shellac. The easiest

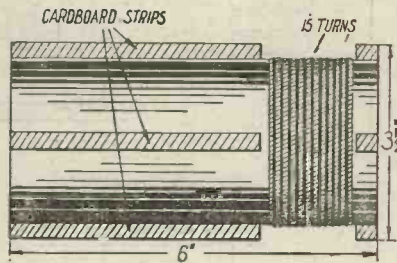

Fig. 2.—Showing position of cardboard guides.

way of doing the winding is shown in Fig. 1. The portion of the tube which is to carry the windings is first of all bound tightly with cord whose diameter is a good deal larger than that of the wire. This cord, once in place, should be either enamelled or shellacked so as to render it immune from the effects of damp. The wire is now wound on so that its turns lie between those of the cord. They are thus automatically spaced, and nothing is required to hold them in place but good anchoring of the ends and tight winding. Cardboard strips are now glued to the unwound por-

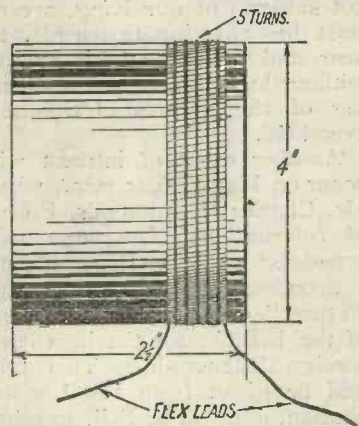

Fig. 3.—The primary winding.

tions of the tube as shown in Fig. 2. The thickness of these should be such that when they

are in place the tube is just an easy sliding fit inside that which will carry the primary windings.

The primary is wound in the same way as the secondary so far as the spacing of the turns is concerned; but in this case winding should begin as close as possible to the end of the tube and only five turns of wire are put on. To the anchored ends of these stout flex leads 6 in. long are soldered. The apparatus may now be mounted upon a stand as shown in Fig. 4. Great care must be taken to insulate the terminals efficiently, and the flex leads of the primary must be kept well apart. The ends of the secondary windings should also be kept as far distant from each other as possible, so that no unnecessary capacity may be introduced. For this reason it is best to mount the terminals of both primary and secondary coils at either side of the uprights, and not on top of them. A good method of doing this is shown in Fig. 5. Small ebonite strips about $\frac{3}{4}$ in. wide and $1\frac{1}{2}$ in. in

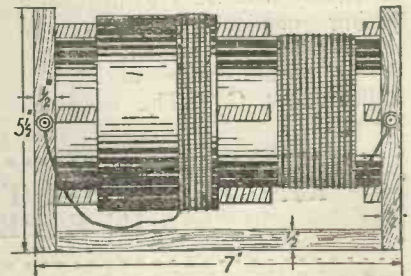

Fig. 4.—Primary and secondary windings mounted in position.

length are cut out, two holes being drilled close to one end to take the wood screws which fix them to the end piece, and a 4B.A. clearance hole being made near the other for the shank of the terminal. Fig. 6 shows the way in which the loose coupler should be used. It is essential to have a small three-plate vernier condenser in parallel with the main closed circuit tuning condenser in order that the necessary very fine adjustments may be made. If one attempts to tune without the assistance of a vernier, it may be found impossible to resolve carrier waves of weak telephony into speech or music.

It must not be imagined that any set provided with one stage of high-frequency amplification

will bring in 100-metre transmissions even when used in conjunction with such a loose coupler as that under description. A very great deal depends upon the wiring and the general layout of the receiver itself. If these are such that there is considerable capacity between leads and between the high- and low-potential parts of the apparatus, success cannot be hoped for upon waves where the frequency is of the order of 3,000,000 cycles per second. A set which performs quite satisfactorily on broadcast wavelengths may give a very poor account of itself when called upon to deal with short-wave transmissions. An

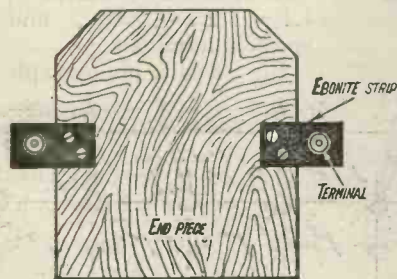

Fig. 5.—Method of mounting terminals.

interior capacity whose effects will be hardly noticeable at, say, 350 metres, where the frequency

is less than 1,000,000 cycles per second, may cause the apparatus to become so unstable that it is quite unworkable upon 100 metres. If capacities are large within the set no form of tuner can be designed which will ever enable it to get down to 100 metres. Therefore, if your set has not been specially designed for short-wave work, it should be overhauled before you make any attempt to use it for this purpose. If wire protected either by sleeving or by the ordinary cotton covering has been used, replace it with bare wire, keeping all leads at different potentials as widely spaced as possible. So far as you can without entirely rebuilding the set, do away with any crowding of apparatus that may exist.

For short-wave work it is most desirable to use valves with very low internal and external capacity, such as the V24 and the Ora B, or amongst dull emitters DEV and DEQ. Reception is, however, possible with 4-pin valves provided that they are properly mounted. Eschew moulded ebonite valve-holders, in which the capacity is large owing to the presence of a first-rate dielectric between the sockets. In their place fit separate valve legs and screw

them into the ebonite. If this is done they will not require nuts below the panel to fix them. Where nuts are used they must come very close together, which means an increase in capacity. Should you find it impossible to screw your leg valves in owing to the fact that clearance holes are already drilled in the panels, here is a tip that may be found useful. Take some thin 6 B.A. nuts, running a 4 B.A. tapping drill through them, and following it with the 4 B.A. tap. Their diameter is very much less than that of standard 4 B.A. nuts, so that when they are fitted the space between the metal parts of the

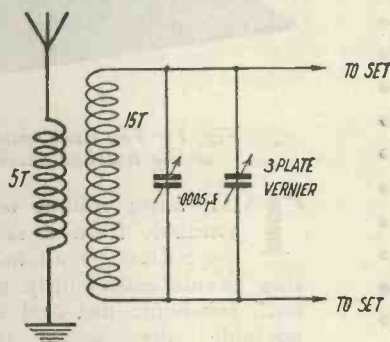

Fig. 6.—The circuit arrangement.

valve connections below the panel is greater than if ordinary nuts were used.

A Home-Made Dual Condenser

IT is a very great advantage to be able to tune a pair of high-frequency transformer coupled or tuned anode coupled circuits by means of one movement, for to do so considerably facilitates the process of searching for weak signals. There are several excellent dual condensers on the market, and these are coming more and more into favour with amateurs who use two stages of high-frequency amplification. Many who would like to give the method a trial before launching out into the purchase of a double condenser will find that the method outlined below enables them to do this quite simply provided that two condensers of equal capacity are available. A pair of condensers can be tested for equality of capa-

city by trying first one and then the other in the same tuned circuit and seeing whether they give identical readings on the same

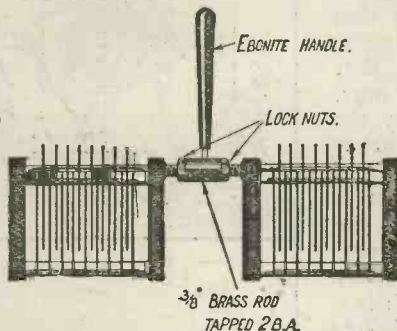

Fig. 1.—The dual condenser mounted for use.

wavelength. If one has a slightly greater capacity than the other the two can be matched

by the method which was described some time ago in the pages of *Wireless Weekly*.

Having matched the condensers, mount them upon a board lying on their sides as shown in the drawing with their knobs removed and the screwed ends of their spindles pointing towards each other. Take a short length of $\frac{3}{8}$ -in. round brass rod and make a 2 B.A. tapped hole right through it. Screw it on to one of the condensers and tighten up with a lock-nut. Screw the spindle of the other condenser into it and tighten up as before, taking care to see that the movable vanes of each condenser are in exactly the same position. A short length of $\frac{1}{2}$ -in. ebonite rod, into one end of which a piece of 4 B.A. studding has been fitted, is used as a handle, the studding being screwed into a 4 B.A. tapped hole made in the middle of the connecting link.

R. W. H.

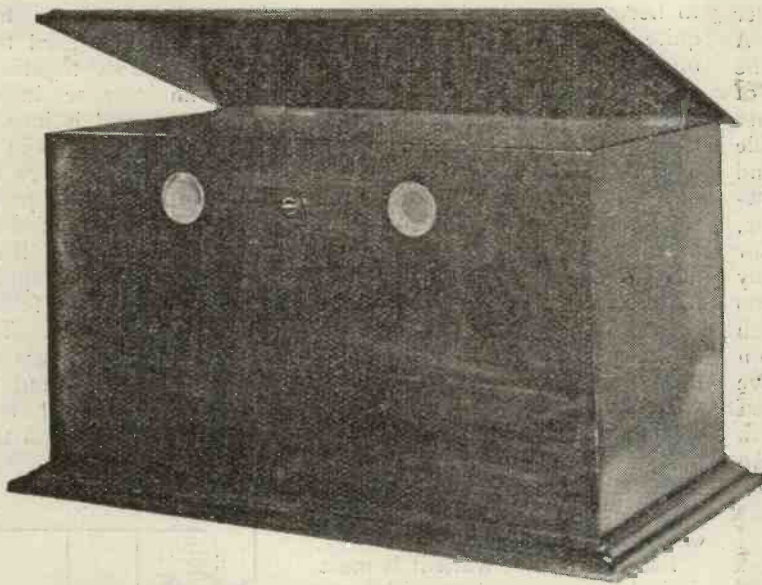

Fig. 1.—The neat appearance of the finished receiver.

THE large volume of sound available from a set using the ST100 circuit has made this circuit exceedingly popular, both for home use and also for portable sets, which may be taken about during the summer months. The present set is of the former variety, being designed for use in the home, in a position where a set of good appearance is essential. The set is enclosed in a polished mahogany box, the lid of which, when raised, discloses the panel upon which the various parts are mounted. In the front of the box two "windows" are provided, in order that the valves, when alight, may be seen without raising the lid. In the centre of the front, between the two windows, is a switch, by means of which the valves may be switched on or off. Thus it is seen that once the set has been tuned to any station it may be left, so that other members of the family may, by pulling the switch, enjoy the broadcast concerts in the absence of the experimenter himself. A distinct advantage of the set is that when the lid is closed the apparatus is entirely dust-proof.

The switch and windows are clearly seen in Fig. 1, which is a photograph of the finished set, with the lid raised.

Terminals

At the back of the cabinet a

An Enclosed ST

Typé

Designed by JOHN SCOTT-TAC

A handsome-looking set in a d the ST100

strip of ebonite is fixed, which carries twelve terminals. Looking at them from over the front of the set, the first five on the left-hand side are the usual aerial-earth circuit terminals, and the others, in order, are HT+, HT-, LT+, LT-, G-, and loud-speaker terminals.

Fig. 2 is a photograph of the

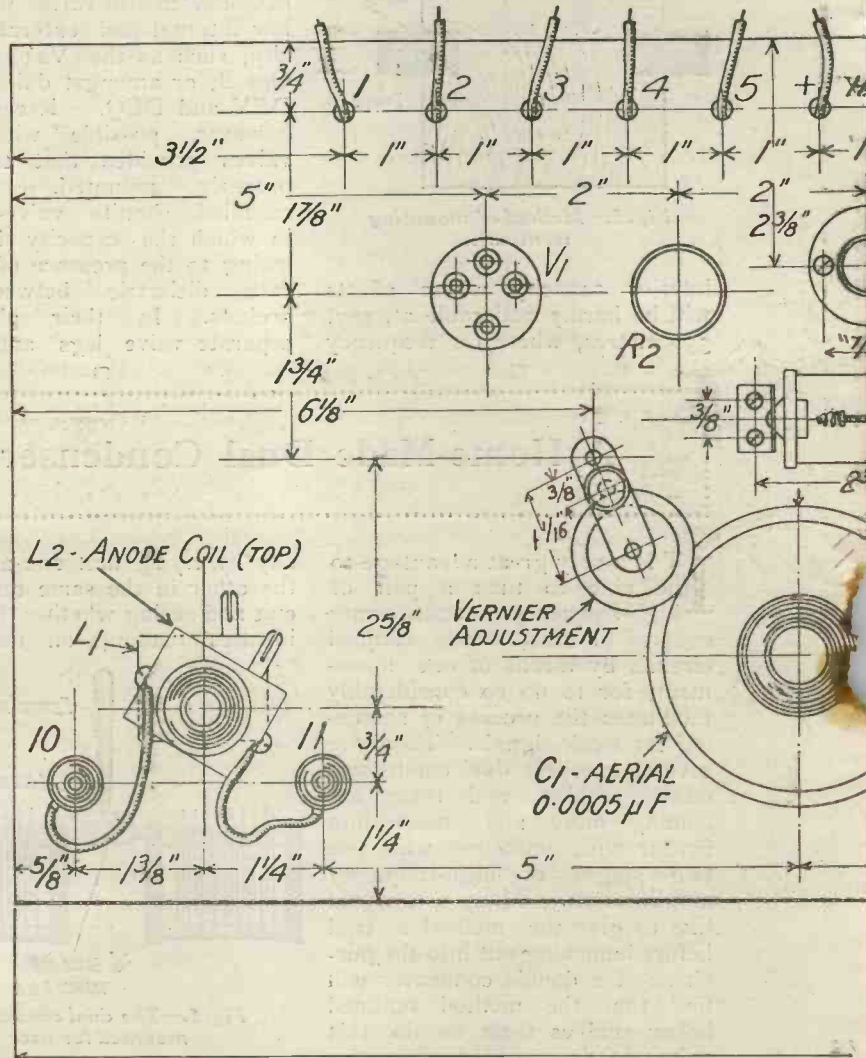

Fig. 3.—The layout of the parts on the panel. All dim

100 Receiver

W5
GART, F.Inst.P., A.M.I.E.E.

ustproof cabinet, employing
circuit

panel with valves and coils in position. It will be seen that the coil-holder on the left of the panel is of an unusual design, being, in fact, home made. Two terminals are provided, in accordance with a practice commonly employed in this journal, by means of which the reaction coil may be reversed. The two valves, with their respec-

tive filament controls, are seen at the back of the panel, slightly in front of the row of holes through which the leads to the back ter-

minial strip are threaded. The two tuning condensers are mounted in the front, the four terminals between them being those by means of which the amount of capacity in the tuned anode circuit is varied.

Circuit Diagram

Fig. 4 is the circuit diagram of the set, and it will be seen that the aerial circuit consists of an inductance L_1 and a condenser C_1 . Constant aerial tuning may be used if desired by connecting the aerial to terminal 1. In all cases, except when a frame aerial is used, the earth is connected to terminal 5. A table of connections for the aerial circuit is given below.

Aerial Connections

Circuit.	Aerial.	Earth.	Other connections
Const. aerial tuning Parallel condenser	1	5	3 to 4 and 4 to 5.
Parallel condenser No C.A.T.	2	5	3 to 4 and 4 to 5.
Series condenser.	4	5	3 to 5

When a frame aerial is used, the ends of the frame are connected across terminals 3 and 4, while 4 is joined to 5. This places the aerial coil in series with the frame aerial, with the condenser in parallel. If no coil is required, the frame is connected across terminals 2 and 4, 4 joined to 5, and the aerial coil removed from its socket.

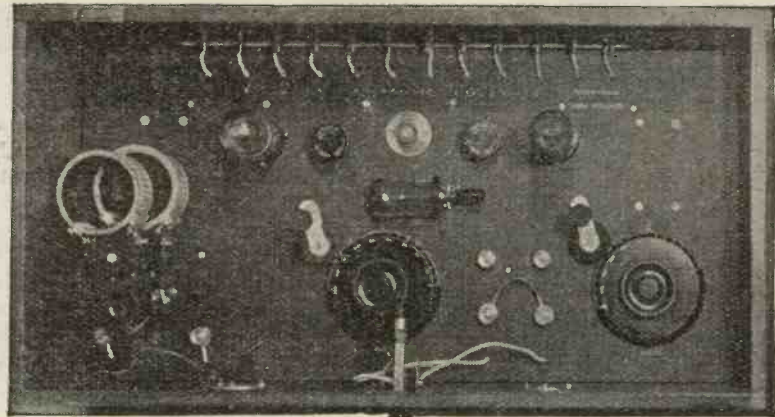
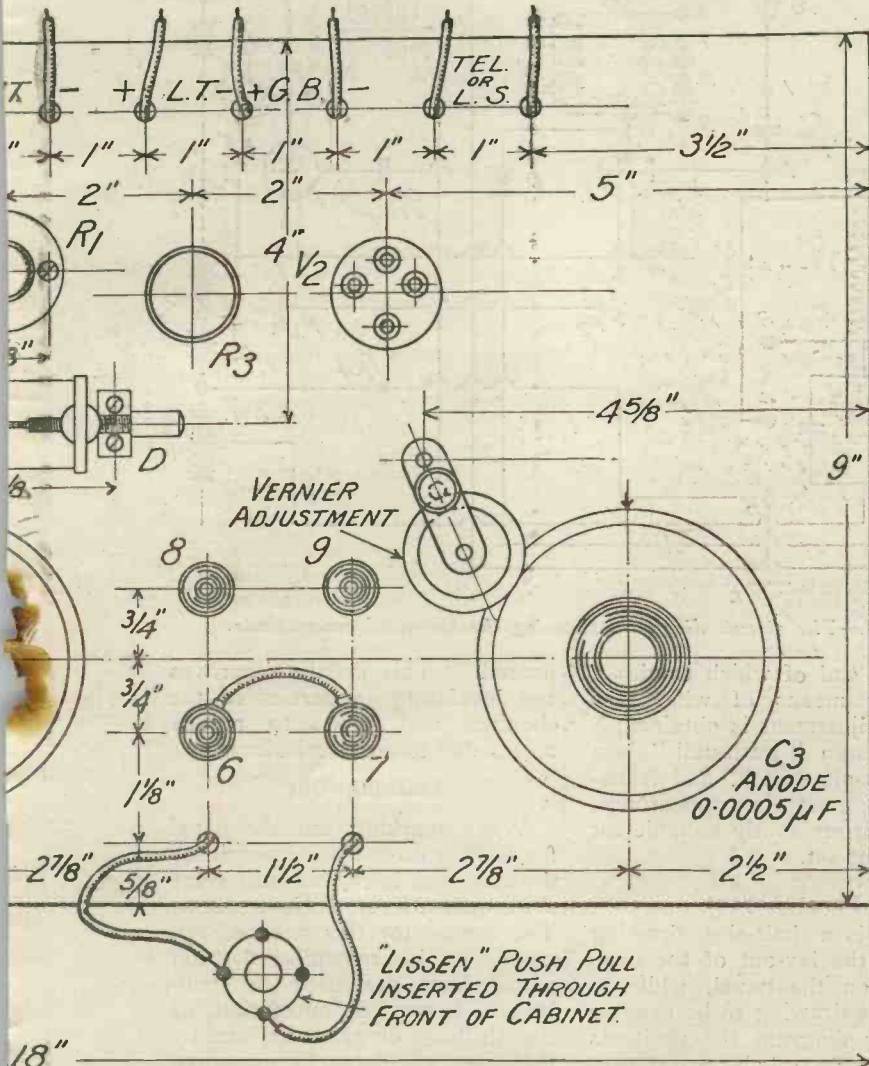

Fig. 2.—The panel, looking down into the cabinet.



Dimensions are given, and the drawing is exactly half size.

Anode Condensers

In the anode circuit of the first valve will be seen two condensers, one variable, of 0.0005 μ F, and one fixed, of 0.0004 μ F, by means of which a wider tuning range is obtainable with a given coil than when the variable condenser alone is provided.

By connecting the fixed condenser in series with the variable a lower minimum capacity is obtained, hence, with a given coil, we can tune to a lower wavelength. By means of a parallel connection of the two condensers a much greater capacity is the result, and consequently we have the choice between three capacities.

To use the variable condenser alone the only connection to be made is from terminal 8 to terminal 6; if a condenser with a lower minimum capacity is required, the two condensers are connected in series by joining 6 to 7, while if a larger condenser is necessary the two are connected in parallel by joining 7 to 9 and 6 to 8.

Price List

Component.	£	s.	d.
Cabinet (Wright & Palmer)	1	7	6
Panel 18 ins. \times 9 \times $\frac{1}{4}$ in. ...	0	6	9
2 0.0005 Variable condensers (New type. K. Raymond)...	0	11	10
2 Vernier attachments (Sparks Radio Supplies)...	0	5	0
Dubilier fixed condensers:			
one 0.0001 ...	0	2	6
one 0.0004 ...	0	2	6
one 0.001 ...	0	3	0
one 0.002 ...	0	3	0
one 0.004 ...	0	3	0
1 2 μ F T.C.C. condenser (Leslie Dixon) ...	0	5	6
2 Powquip, L. F. Transformers ...	1	16	0
1 Burndept Crystal Defector ...	0	5	0
1 Two-coil holder (home-made, cost about) ...	0	2	6
2 Lissenstats ...	0	15	0
2 Valve holders (Goswell Eng. Co.) ...	0	2	6
1 Watmel 50,000-100,000 ohm resistance ...	0	3	6
16 Terminals at 1 $\frac{1}{4}$ d. ...	0	2	0
2 Valve windows (Grafton Elec. Co.) ...	0	1	0
1 Lissen Push-Pull switch, Wire, covering, screws, "Nugraving," etc. ...	0	3	9
Total ...	£7	4	7

Components

A list of component parts required will be found above, together with the retail price. This is a useful guide to the cost

of the set and is appreciated by most readers.

It is not essential that the parts used should in all cases be of the make specified, and the constructor may make use of any components which he may already possess, but it must be noted that the transformers are the chief feature of the ST100, and most frequently the cause of trouble with this circuit is attributable to the use of cheap and inefficient transformers. Those in use in this set are of the Powquip 4 to 1 type, and have been found very efficient for all purposes.

The vernier attachments used consist of a rubber band in contact with the dial of the condenser, which is rotated by a milled head at the end of a rod,

realised that readers may-like to use makes of transformer other than that incorporated in this set, and under these circumstances the provision of holes in the drilling diagram might easily prove misleading. As Mr. Simpson recently suggested, the transformers used may be mounted upon a separate piece of ebonite, this platform being secured by two or four screws of, say, 4B.A. to the main ebonite panel. This will obviate the necessity for re-drilling the panel should a change of transformer be required at any time. The ebonite panel measures 18 in. by 9 in. by $\frac{1}{4}$ in. thick, and should have the shiny surface removed from both sides by rubbing with fine emery cloth until all evidence of gloss has disap-

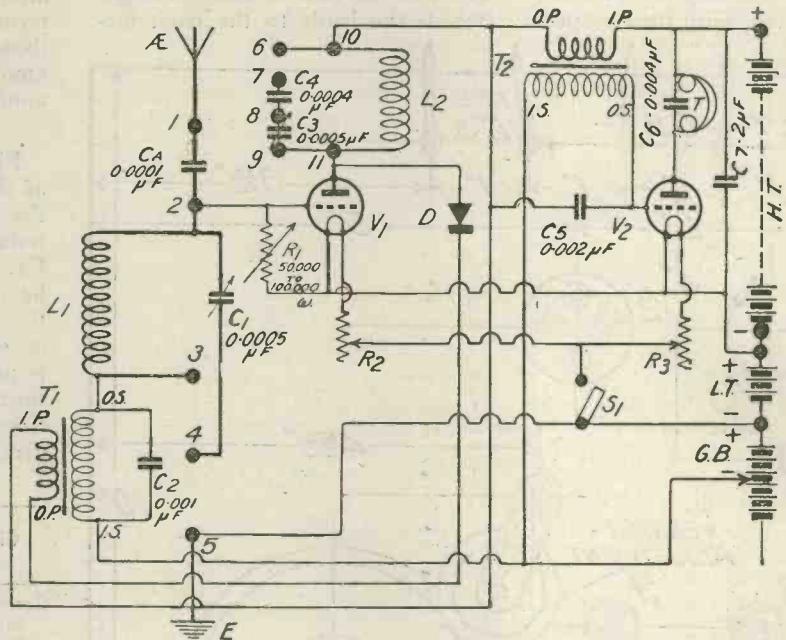

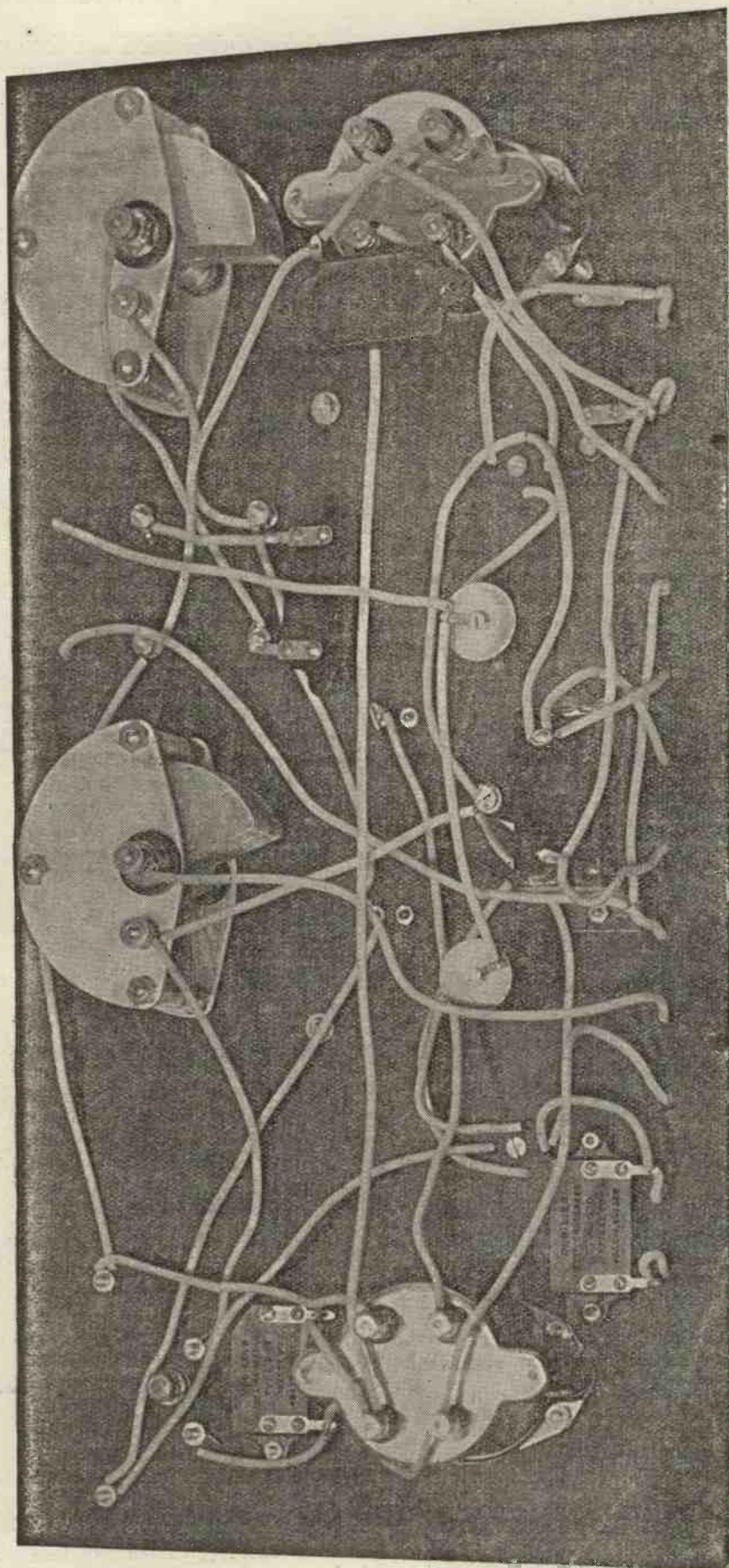

Fig. 5.—The back of the panel. Used in conjunction with the wiring diagram, to be given next week, the wiring up becomes very simple.

method will be found an exceedingly simple one, but should the constructor desire he can obtain a full-size blue print of this figure (No. 31A) from the offices of Radio Press, Ltd. [Practically any blue print of any set described in *Wireless Weekly* or *Modern Wireless* may be obtained for 1s. 6d., post free.] When the panel is marked off and the sizes of the necessary holes have been ascertained, it will be found easiest to mark off all the holes of one size and drill these first; change the drill to the next size and drill all the holes required. This way will be found quicker and easier than haphazard drilling, and is to be recommended. After all holes have been made, the constructor is advised to mount up the lighter components first, leaving the transformers until the last. The Burndept crystal detector should be dissected and the clips only mounted upon the panel, leaving the glass cylinder and other parts in a safe place until the set is ready for use. The glass is thus protected from possible damage during the process of wiring up. The valve-holders used are of a neat type, which does away with soldering, the wires being secured in position by screws. The need for accurate drilling of the panel for valve legs is thus obviated also.

In our next issue instructions for wiring the set will be given, together with details of the cabinet and how to work the set.

□ □ □

MANCHESTER RECEPTION

The reception of the Manchester Broadcasting Station in London, until recently a matter of some difficulty, has now greatly improved. The station can now readily be heard on one or two valves when 2LO is not working. We believe slight changes in the aerial is the cause of the improvement.

□ □ □

Random Technicalities

By PERCY W. HARRIS, Assistant Editor.

The story of an A.C. hum.—A hint for filter users.—Temporary use of valves without holders.—A loud-speaker misconception.

I WONDER how long it will be before the electricity supply undertakings think it worth while to track out the sources of those irritating buzzing noises which so frequently interrupt reception in districts where alternating current supply is laid on. In some parts the interruption from A.C. mains is so bad as to make broadcasting reception practically impossible. If everything is in order there should be no interruption whatever from this source, and in my present house I can use any kind of set, even the most sensitive, without the slightest interference. Some of my friends, however, have had to introduce special receivers before they could get rid of the annoying hum. For this reason I am particularly interested in a case in Hartford, Connecticut, reported in an American journal. Goaded to exasperation by letters received from broadcast listeners blaming them for starting and maintaining a terrific buzz just when it became dark, the local electrical undertaking appealed in desperation to the Radio Club at Hartford to help them. First of all, the attempt was made to locate the buzz by frame aerials and radio-frequency amplifiers, but no success was obtained. Next a map of the city was tacked on a board and a systematic charting of the city undertaken. With the aid of an audibility meter and a larger number of observations taken with a special receiving set installed in a motor car the buzz was finally tracked down to the Washington Street district. It was then found that the buzz became much more pronounced as each lamp standard was passed, and finally, when turning into School Street, the buzz increased a hundred-fold, still increasing until the second electric light standard was reached. This standard seemed to be the cause of the trouble, and

when it was shaken the buzz went off and on intermittently. Lighting officials came along, the offending lamp was removed, but still the noise continued! All kinds of further stunts were tried, but the buzz still persisted until the electric light company went to the expense and trouble of tearing out the whole of the street lighting circuit and installing new wire insulators, lamps and fittings, when, to the great relief of everyone concerned, the buzz was finally "killed."

If you are experimenting with filter circuits for loud-speakers and other similar devices, and want to try a large number of values of fixed condenser, try using those which are sold to push into spring clips. If with

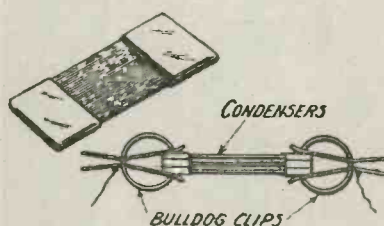

A useful dodge for varying capacities.

a pair of bulldog clips, to each of which a wire is soldered, you clamp sets of these together you will be able to make all kinds of combinations and capacities at a moment's notice. The condensers can simply lie on top of one another, sufficient contact being given by the spring clips at the end. The diagram shows the method.

In rigging up a temporary single-valve circuit it is often quite handy to leave the valve in the box with the four pins upwards and slip a thin wire into the slit of each valve pin for connection.

This method is very convenient if you have not a coil socket at hand and do not wish to mount up separate legs. A plug-in transformer can also be utilised in a similar fashion.

Although loud-speakers are far more popular than they were twelve months ago, a large number of people are still under the impression that the larger size of loud-speaker is too "powerful" for their living-room, and that only the "baby" type is suitable for the average house. This is quite a mistaken impression. The amount of sound given out by a loud-speaker is almost entirely dependent upon the amount of energy put into it, so that if the volume of music is just comfortable with the small type, it will not be noticeably louder with the bigger instrument. There will, however, be an immense improvement in the quality by substituting the larger loud-speaker for the small type, and while I do not dispute for a minute that the small and cheaper loud-speakers are excellent value for the money, I always recommend the larger type wherever the reader can find the necessary cash. Instruments with small horns cannot possibly give the quality of those with the larger types of trumpet.

I still continue to hear of ebonite troubles. After a lecture at a London society the other evening a member informed me that he had bought a sheet of ebonite from one of the most famous electrical firms in the country. The insulation resistance on test of the surface was about 50,000 ohms per inch only! Moral: Always remove the surface skin unless the ebonite is guaranteed free from surface leakage.

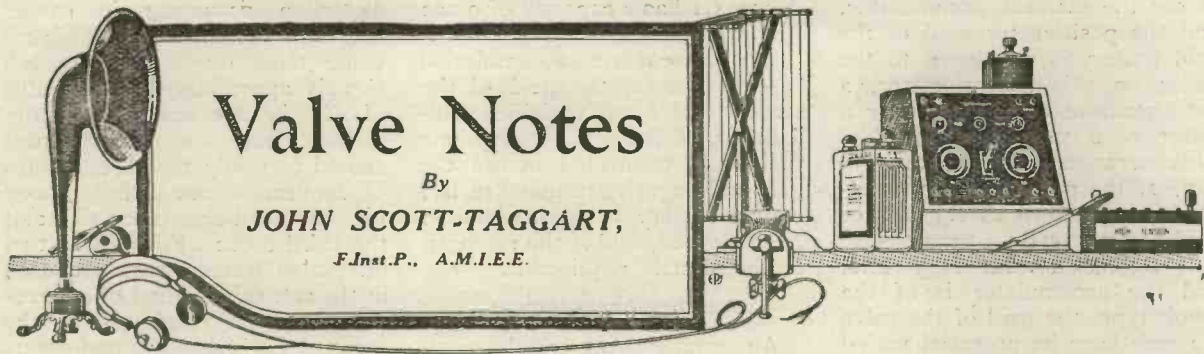

Interval Couplings which Prevent Distortion

A SERIES of experiments which I have recently carried out on numerous interval transformers make it quite clear that a large percentage of the poor reproduction on a loud-speaker is due to the design of the transformer. Some

only when they have carried out a few experiments on the lines described below do they realise the difference in reception which may be accomplished.

A Note on Components

It would be as well to point out that pure reproduction is only obtainable by correct opera-

Problems with Two Stages

It will therefore be seen that two stages of low-frequency amplification and a loud-speaker present distinct problems in pure reproduction, and the following hints should therefore prove useful. A description of how to build a certain set is sufficient if the exact components described are used, but if, for example, the constructor wishes to use the transformers he already has, in place of those described in the set, he must not be surprised if he does not get perfectly pure reproduction of speech and music. The actual sets described in *Wireless Weekly* are tested, not only for signal strength, but pure reproduction, but if the components are altered the experimenter is advised to try one or two modifications, such as those described below.

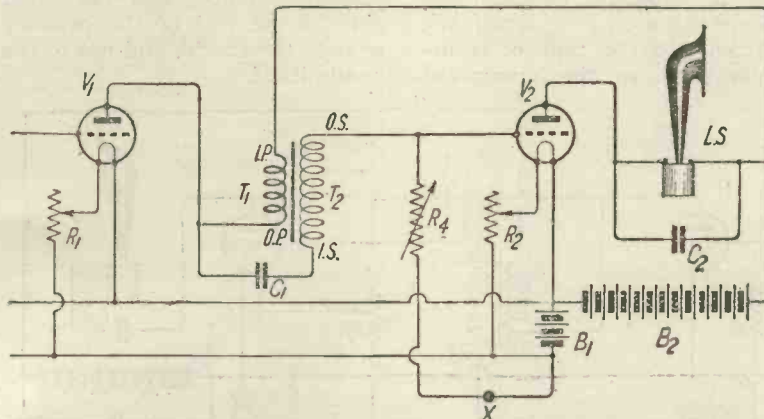

Fig. 1.—The Simpson connection for the L.F. transformer, which sometimes gives much purer reproduction.

types have been planned to give faithful reproduction without the necessity for using anything but the ordinary conventional circuit. In the case of other types, however, the distortion may be eliminated by using certain modifications or additions to the conventional diagram. Even with cheap transformers, which produce, in some cases, considerable distortion, much purer speech and music is obtainable by carrying out one or two experiments on the method of coupling the low-frequency valves.

The distortion usually takes the form of a hissy, mushy sound, and even, in some cases, a tinny reproduction in the loud-speaker. I am convinced that many experimenters, through long experience of these sounds, do not really appreciate the extent of the distortion which is going on, and

tion of the set, and the choice of suitable apparatus, such as transformers and loud-speaker. The mere fact that a transformer or loud-speaker is expensive is not sufficient guarantee that pure reproduction will be obtained, although it will usually indicate that loud signal strength may be achieved. Sometimes a certain amount of distortion occurring in a transformer may be adjusted on the loud-speaker by shunting the latter, for example, by a condenser. Sometimes, when two interval transformers are being used, it is a matter of luck whether, with the conventional circuit arrangement, pure reproduction is obtained; possibly one of the transformers of a certain type will over-accentuate the high notes, and the second transformer will tone them down again.

Experiments

The first point of importance, of course, is to see that the low-frequency stages are carried out without the establishment of any grid current, and therefore a negative grid bias is to be recommended, and a fairly high high-tension voltage. The high-tension voltage should be sufficiently great to bring the characteristic curve of the low-frequency amplifying valve to the left of the zero grid ordinate, as explained in the current issue of *Modern Wireless*. A sufficient negative potential should now be applied to the grid to bring the operating point to about the middle of the steep portion of the characteristic curve. Under these conditions any distortion which may occur cannot be blamed on the valve. To obtain the best grid potential it is necessary to try different values, from zero to about 9 volts, and if a potentiometer is connected

across the filament accumulator, and the positive terminal of the grid battery is connected to the slider on this potentiometer, a very accurate adjustment over a range of 6 volts is obtainable. This arrangement is shown in Fig. 2, the potentiometer resistance being shown as R_3 and the grid battery as B_3 .

If B_3 has a value of 9 volts, and the accumulator is of the 6-volt type, the grid of the valve V_2 may have its potential varied from -9 volts to -3 volts. If the battery B_3 had a value of 6 volts, the grid potential could be varied between -6 volts and zero.

Reservoir Condenser

Another point is to connect a 1 microfarad condenser across the high-tension battery. This condenser may be of the Mansbridge type, and this will cut out any crackling noises which may be due to fluctuations in the voltage of the high-tension battery. The condenser, of course, will not affect ordinary distortion.

Capacity Across the Loud Speaker

The next thing to try is a fixed condenser across the loud-speaker terminals. This is shown as C_2 in Fig. 1. This condenser has a value depending upon the type of loud-speaker employed, and the extent of any distortion in preceding stages of the amplifier. If the high notes and hissing have been eliminated in the earlier stages of the receiver it is quite likely that a condenser across the loud-speaker will have no effect at all, but usually a value of from $0.002 \mu F$ to $0.006 \mu F$ will be found beneficial. Higher capacities than this will so reduce signal strength as to make them undesirable, although as much as $0.05 \mu F$ can sometimes be used with good effect, as regards purity. My own recommendation is to use a $0.004 \mu F$ condenser.

The Simpson Connection

Fig. 1 shows an arrangement described by Mr. Simpson in connection with the type W_4 receiver, which employs two stages of low-frequency amplification. I have tried this arrangement out myself and found that signal strength is greatly improved in many cases, and also greater purity results. The con-

denser C_1 has a capacity of $0.002 \mu F$.

To prevent an accumulation of electrons on the grid of the second valve, a variable grid-leak R_4 of the $\frac{1}{2}$ to 5 megohms variety is connected across the grid and negative terminal of B_1 , a grid battery being inserted in X , if desired, and if the strength of the signals requires it.

Another Arrangement

An arrangement which every experimenter should try, whatever transformers he may be using, is that illustrated in Fig. 2. It will be seen that the ordinary conventional method of coupling the valves is employed, but that in addition a condenser C_2 is connected across the anode of the first valve and the grid of the second valve. This condenser C_1 requires, I find, to have a capacity of anything between $0.0005 \mu F$ to $0.002 \mu F$, according to the type of transformer used, or the amount of

distortion occurring in earlier stages of the receiver. A higher value than $0.002 \mu F$ deadens signals appreciably. The value of C_1 is not critical by any means, but the experimenter should certainly try three values of condenser, one being $0.0005 \mu F$, another being $0.001 \mu F$, and the third $0.002 \mu F$. Where two intervalve transformers are used in the set, this method of connection may be employed, in the case of each transformer, although usually a smaller capacity will be required in each case.

It must be remembered, of course, that if there is a reaction coil or a tuned anode circuit in the anode circuit of a valve containing the primary of an intervalve transformer to which the condenser is to be added, the condenser should have one side connected to the grid of the following valve, and the other side to the end of the primary next to the anode, and not to the anode itself.

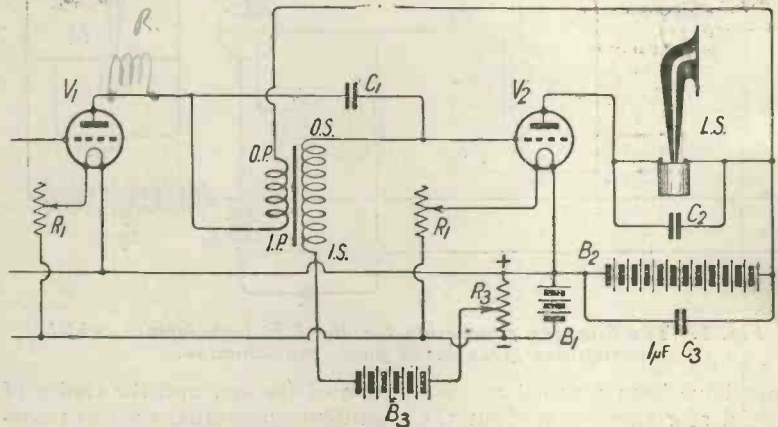

Fig. 2.—Another method of obtaining pure reproduction is to shunt the windings of the transformer with a condenser C_1 .

FRENCH CALIBRATION WAVES.

Owing to the large number of requests received by our French contemporary, "T. S. F. Moderne," the calibration waves sent out from their station 8 Aê have been augmented. They are now as follows, the times being G.M.T. throughout:—

Monday.

- 8.0 p.m. to 8.10—400 words on 200 metres.
- 8.10 p.m. to 8.20—800 words on 200 metres.
- 8.30 p.m. to 8.35—cq. de 8 Aê NNN on 170 metres (approx.).
- 8.40 p.m. to 8.45—cq. de 8 Aê DDD on 160 metres (approx.).
- 8.50 p.m. to 8.55—cq. de 8 Aê BBB on 150 metres (approx.).

Wednesday.

- 8.0 p.m. to 8.10—400 words on 200 metres.
- 8.10 p.m. to 8.20—800 words on 200 metres.

Friday.

- 8.0 p.m. to 8.10—400 words on 200 metres.
- 8.10 p.m. to 8.20—800 words on 200 metres.
- 8.30 p.m. to 8.35—cq. de 8 Aê TTT on 200 metres (approx.).
- 8.40 p.m. to 8.45—cq. de 8 Aê AAA on 190 metres (approx.).
- 8.50 p.m. to 8.55—cq. de 8 Aê UUU on 180 metres (approx.).

An Experiment with Vegetable Grid Leaks

By "OLD CHAP."

A LITTLE while ago, I happened to get into conversation with an old Army signaller, who had done a good deal of wireless work both during and after the war. At one stage of the conversation our talk was on grid leaks, and the old soldier made the somewhat curious statement that one of the best variable grid leaks he had ever used was a carrot. The method of operation, he explained, was to bring out two leads from the receiving set, solder a pin to the end of each lead, and stick the two pins into the carrot.

Having had some experience of leg amplification in the army, I was inclined to be a little sceptical with regard to this particular form of ex-W.D. variable grid leak. However, the other evening, for the want of something more serious to engage my attention, I decided to try this carrot dodge.

From an ordinary one-valve receiver I removed the 2 megohms grid leak, brought out two leads from the clips, and

secured a pin to the end of either lead.

As a first test I jammed the pins in the carrot about an inch apart. Switching on, I found the results were somewhat poor. Placing the pins right at the ends of the four-inch carrot improved results considerably. Cutting the carrot in two made things much better, and indicated the way things should go. Finally, having boiled down my grid leak to a thin strip of carrot about 2½ inches long, I got extremely good results.

My ex-Soldier friend had also informed me that a potato did not make at all a good grid leak, but I determined to try my luck with this well-known vegetable. Selecting a fairly large specimen, I first stuck my two pins into it an inch apart. With the pins so placed, the results were very poor indeed. Increasing the distance between the two pins improved results, as did also decreasing the length of pin inserted in the vegetable. Cutting the potato into thin strips of varying width gave interest-

ing results, the best coming from a thin strip some three inches long and ¼ inch wide, the pins being carefully placed at the extreme ends of the strip.

Next I tried an onion with the pins stuck into it at either end of its polar axis. The results were poor. They were no better with the pins at the opposite ends of an equatorial diameter. Knowing what a crying shame it is to cut an onion, I refrained from proceeding further with my experiments with this particular vegetable.

Launching out into the fruit line, I tried a banana. The whole fruit was very poor, but a thin strip of the peel, 5 inches long, worked fairly well. A thin slice of apple gave fair results.

Lastly, for the sake of comparison, I tried a match. The pins were stuck in the match at the extreme ends, and the resultant leak gave me as good results as any of the vegetable or fruit grid leaks I had tried, so I brought my experiments to an end. Having refrained from obvious comments on the possibilities of the Welsh national emblem in connection with my experiments, I may perhaps be permitted to suggest that, with a heterodyne receiver, a suitable grid leak might be made from a beetroot.

An Experimenter's Unit Receiver

(Concluded from page 647).

The rotor is constructed on similar lines, the same device being used for finding the spindle centres. The rotor is wound with 20 turns of No. 22 S.W.G. d.c.c., ten turns being spaced each side. The beginning and end of the rotor winding is secured as before, the terminals T5 and T6, which are placed in the position shown in the diagram, project on the inside of the rotor, in order to allow a free movement. The spindle, which is quite independent of the variometer connections, is assembled as shown in Fig. 54.

Assembling

First mount upon the panel the terminals T and T2, then pass the variometer spindle through the clearing bush in the centre of the panel, having first inter-

posed a nut, spring washer, and washer upon the underside. The portion of spindle projecting above the panel is equipped with a nut, indicator, and bushed ebonite knob. The scale reading is next placed in position and secured by means of two stop pins which, passing right through the panel and into the stator, act as securing pins to keep the stator in position, as shown in the diagram.

The connections are made in accordance with the figures.

Operation

A simple crystal circuit, showing the use of the variometer as an aerial tuning inductance, is shown in Fig. 55. L1 is the loading coil unit, previously described, and tuning is effected by the variometer L2.

THE INSTITUTION OF ELECTRICAL ENGINEERS.

The following is part of a new Bye-law of the Institution of Electrical Engineers which was adopted at a Special General Meeting of the Corporate Members held on the 28th February, 1924, and was allowed by the Lords of His Majesty's Most Honourable Privy Council on the 20th March, 1924:—

"Every Member and Associate Member is, and is entitled to describe himself as, a Chartered Electrical Engineer, and in using that description after his name shall place it after the designation of the class in the Institution to which he belongs, stated in accordance with the following abbreviated forms, namely, M.I.E.E. or A.M.I.E.E. as the case may be."



Correspondence

AMERICAN AMATEUR RADIO RELAY LEAGUE

SIR,—I have received a request from Mr. Schnell, the traffic manager of the American Amateur Radio Relay League, for a list of hours of operation, wavelengths, and power used by various British amateur transmitters interested in Transatlantic communication.

Will all those, therefore, interested in Transatlantic tests kindly communicate with me at the address below, embodying at the same time any special points they wish me to raise, as I shall be in Hartford on May 14, and as I am very anxious to further International radio I shall be glad to receive observations by return, together with full details of stations, etc.—Yours faithfully,

GERALD MARCUSE,
British Representative, International Amateur Radio Union.
Hon. Secretary T. & R. Section of the Radio Society of Great Britain.

Coombe Dingle,
Queen's Park,
Caterham, Surrey.

LE PETIT PARISIEN

SIR,—In reply to the query of your correspondent "Asher S. Lill, London, E.," in Vol. 3, No. 18, the station in question was that of Le Petit Parisien, of Paris.

This station has been testing frequently during the past fortnight, and apparently commenced these tests a few evenings previous to that mentioned by Mr. Lill, as on searching round after London had closed I heard a Frenchman talking and various musical items. He then made an appeal in English for reports of reception from any British listeners.

The strength on four valves, 1 H.F., D., 2 L.F., was almost equal to 2LO, and I wrote him to this effect.

On the night mentioned by Mr. Lill the Frenchman thanked those who had written him, and said that he had been heard in the North of Scotland on a loud-speaker. He also remarked that no definite times of future transmissions could be given until the French postal authorities had arranged wavelength, etc.

The wavelength used for these tests was 340 metres, and they took place between 11 and 12 p.m.—Yours faithfully,

WM. A. LATHAM.
Hampton-on-Thames.

The Radio Society of Great Britain

Will all members of the Radio Society of Great Britain please note that the Ordinary General Meeting of the Society originally arranged for the 23rd April has been postponed until Wednesday, the 30th April, 1924. The Meeting will be held at 6 p.m. at the Institution of Electrical Engineers, Savoy Place, and will be the occasion of an interesting lecture by Captain P. P. Eckersley, on "Faithful Reproduction by Broadcast."

WIRELESS OPERATORS AND UNEMPLOYMENT

SIR,—With reference to the article published in your journal in January last there appears to be an erroneous statement with regard to wireless operators. In the second paragraph it is stated, *inter alia*, that the approximate surplus of operators over actual requirements is 2,898, and in the following paragraph it states that the number of unemployed persons holding the P.M.G. First-Class Certificate approximates 1,800.

If these figures are accurate we fail to reconcile the number of unemployed with the surplus, as you will observe there is a difference of no less than 1,000. One naturally asks what has happened to the latter number.

We would also like to ask through the medium of your Journal whether the figure of 1,000 wireless operators being unemployed can be substantiated. We ask this question definitely, as it does not seem to us to be supported by the actual conditions now prevailing in the employment of wireless operators. For some months past we have had no difficulty whatever in obtaining employment for all students who obtained the Postmaster-General's Certificate trained at our schools, and we can further state that there is no difficulty whatever in obtaining positions for all future students who obtain the said certificate.

We respectfully ask you to publish this letter, as under the present circumstances the article is certainly misleading.—We are, yours faithfully,

For and on behalf of the
British School of Telegraphy,
Ltd.,

JAMES H. WEBB,

Manager,

J. R. SCHOFIELD (Comdr.),

Principal,
Wireless Colleges, Cardiff and Bournemouth.

AN APPRECIATION OF THE ST100

SIR,—From time to time during the past few months I have heard many criticisms of the ST100 circuit. About six weeks ago it was my good fortune to hear a set that struck me as being very good, giving far better results than I was led to expect, so I decided to build one for myself.

After purchasing a No. 1 Envelope, I proceeded to follow the instructions very closely, and with one or two exceptions, used the components mentioned. The components employed were Polar variable condensers, R.I. transformers, Edison Bell fixed condensers, Mic-Met crystal detector with Hertzite crystal and a very sharp pointed catswhisker, Igranic filament rheostats and a Bretwood variable 100,000 ohms resistance.

The set was wired throughout with No. 16 tinned copper wire, and all the joints, with the exception of the transformers and resistance, thoroughly well soldered, great care being taken to space the wires as shown by the diagram.

At first I had some difficulty in operating the set, the tuning being critical and oscillation not always easy to avoid, but after experimenting with many coils of various makes, two were found that gave really wonderful results, and now it is a difficult matter to make the set oscillate at all, and is remarkably easy to tune. The coils in question are Lissenagon Nos. 40 and 60. I do not sug-

gest that other makes of coils would not give as good results on other aerials, but these are particularly suitable for mine. The terminals used are B for the aerial and E for the earth, C and D being coupled by the bar. I use 120 volts on the plate and 4 volts on the grid, that is connected across terminals F G. The aerial is not a particularly good one, being the usual outdoor twin type, about 50 ft. long and 25 ft. high.

Now the results obtainable from this set are astonishingly good, the purity and fidelity of tone being remarkable, and the volume quite equal to many four-valve circuits that I have tried. So true indeed is the tone, that it proves in a most conclusive and convincing manner that loudspeakers of reliable make are not anything like so much at fault as is generally supposed. In fact, so far as purity and beauty of tone is concerned, it makes one wonder if they can be very much improved upon. Of course, most people know that the "Electro-Acoustic" efficiency, if I may use the term, leaves much to be desired.

It is an easy matter to pick up other B.B.C. stations on the loudspeaker when 2LO is not working, but being so close, a matter of twelve miles, I have so far not been able to cut London out.

The set is certainly very sensitive, and there is a tendency to pick up A.C. hum, this being the current supplied for lighting purposes in the locality, but by the choice of suitable coils and correct tuning, it is only noticeable when the music ceases, and then only very slightly. By switching off the lighting mains, the hum almost disappears. I find that the variable resistance is not at all critical and does not seem to matter very much what adjustment is made within fairly wide limits; it seems, however, that it is necessary to heat the valve filaments to just the right temperature, but this is easily found.

Several different makes of valves were tried; Cossor proved to be excellent. Really good results were also obtainable with Ora, and some French as well as others.

I have arrived at the conclusion that all those who have tried the circuit and have not been

U.S.A. RECEPTION

DID YOU notice the terrific thunderstorm prevailing during the recent S.B. transmission from

AMERICA?

WE DID NOT but of course we use

"POWQUIP"

TRANSFORMERS

PRICES:

Open Type 14/6. Shrouded 18/-.

The POWER EQUIPMENT CO., LTD.,

22, Cricklewood Lane, N.W.2.

Telegrams: "Powquip," Crickle, London.

Phone: Hamstead 1395.

YOU CAN'T EXPERIMENT

with any hope of obtaining maximum results if you are working

with **INFERIOR COMPONENTS**

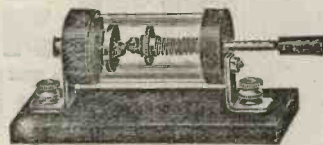

Enclosed Perikon Detector. Nickel plated finish, dustproof, fitted with Bornite & Zincite Crystals. Mounted on ebonite base. No. 15413.

each 4/-

Radio "A" Dry Cell for dull emitter valves. Economical in use and ensures excellent results. 1.5 volts. No. 15070. each 2/6.

"Duco" Panel Switches. Highly finished. Nickel plated. Specially adaptable for panel mounting.

No. 17036a. S.P.D.T.

each 1/9

No. 17036b. D.P.D.T.

each 3/-



Brown Brothers (with which is amalgamated Thomson & Brown Brothers Ltd.) Wholesale only. HEAD OFFICES & WAREHOUSES: GREAT EASTERN ST., LONDON, E.C.2. 118, George Street, Edinburgh, and branches.

Trade only supplied.

Please order from your Wireless Dealer

favourably impressed have either not properly carried out the instructions, or have chosen unsuitable components and coils.

It only remains for me to express my keen appreciation of this wonderful circuit and to wish yourself and your journals every success.—Yours faithfully,

HARRY A. GAYDON.

Croydon.

[Mr. Gaydon is an authority on sound as applied to the gramophone, and has designed a great deal of apparatus for recording sound. The Stentophone is one of his inventions.]

□ □ □

ST100 STAR

SIR,—I have been using the ST100 for some time and have recently tested it against the ST100 "Star." I have a slight preference for the latter, as it gives rather clearer reproduction, and is a little easier to tune. As regards signal strength they seem to be identical.

I have made up a portable set, using the ST100 "Star" circuit, D.E.R. valves, about 50 volts H.T. on the first and about 70 volts on the second valve. It might

interest you to know that the transformer is home-made. It is wound on a 3/8-in. core (open) and has a ratio of 1:1, 10,000 turns of 40 D.S.C. on each winding. I have tested it against several of the best makes of transformers, and find it gives clearer reproduction than any, and as good signal strength as the best.—I am, yours faithfully,

J. H. WALKER.

Westmoreland.

□ □ □

CARDIFF ANNOUNCING

SIR,—I was surprised to see that "Comradio" is offended by your Editorial on the announcing at 5WA, since the article in question accurately summarised the opinions of MANY listeners in the Cardiff area.

From your correspondent's remarks one is led to believe that, from a broadcasting point of view, a tranquil state of comradeship exists in the district, but this is disproved by the numerous heated communications which have recently appeared in the local press on the subject.

Your editorial remarks, far from being "carping, snobbish, unsociable, and mean," undeni-

ably reflected the true facts, and were consequently welcome; my only regret is that this nuisance was not exposed in your valuable columns earlier. The *sotto voce* jokes with artists and the disrespectful attitude of the announcer towards the listening public were most annoying; after all, the announcer is the servant of the public.

However, now that the "one-man band" has moved to another town, doubtless "Comradio" and I, and you, Mr. Editor (for we welcome you to our peaceful "family"), will be freed from this vexatious self-satisfaction on the part of the announcer; we will hope so.—Yours faithfully,

D. WRIGHT.

Cardiff.

[These are purely matters of opinion, and our previous correspondents are perfectly entitled to their views.

With regard to "London" criticism being distasteful, readers may rest assured that every matter is treated from a national aspect. It may interest readers to know that 75 per cent. of the editorial staff—including the Editor—has been recruited from the provinces!—ED.]



FULLER'S BLOCK ACCUMULATORS

The Ideal Accumulator for Dull Emitter Valves, etc., etc.

Special offer of ex-Govt. stock, but absolutely unused.

- 2 volt 40 amp. ... 10/6 Post 1/-
- 4 volt 40 amp. ... 21/- Post 1/-
- 6 volt 40 amp. ... 31/6 Post 1/6

No Wireless Enthusiast should be without a copy of Gamages 1924 fully illustrated Wireless Catalogue. It shows how Gamages serve you best in your every need—from a complete set to the smallest accessory. We will send you a copy post free on request.

Read This Testimonial!

'Tis but one of many in praise of

GAMAGES PERMANITE

Regd. No. 438341

With it you'll always get the maximum results, wherever the Broadcasting Station. It is the only crystal that can guarantee this efficiency—but it must be Gamages "Permanite"—the one with the regd. trade mark. Highly sensitive, and remains in adjustment longest. Clear, powerful results. Price per large piece

1/6 Post Free

Send for your piece to-day and improve your results.



Without doubt the finest Crystal on the market to-day.

18, Burmas Road, Plumstead.

Dear Sirs,
A few days ago I purchased a piece of Gamages "Permanite" Crystal. . . . I gave this crystal a good test, and to my astonishment was able to work a Loud Speaker without using any amplification whatever. Thinking it might be in the nature of a freak I tried again. . . . I again had the satisfaction of hearing the music and speech from 2 LO through the Loud Speaker. Considering I am from 10 to 15 miles from the London Broadcasting Station I don't think the results have been too bad. Yesterday I had a further remarkable experience. By adding a 2 L.F. amplifier I was able to get 2 ZY, and also Paris. . . . In my opinion Gamages "Permanite" is far and away the best crystal on the market. Yours faithfully,

F. S. FENNELL.

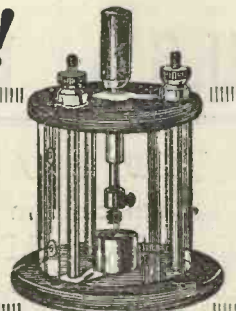

DUSTPROOF DETECTOR with "Permanite" Crystal. Beautifully made. Transparent cover protects the "Permanite" Crystal from dust. Price complete with crystal, Post 4d. 3/9



CRYSTAL DETECTOR Complete with "Permanite" Crystal. Lacquered Brass, mounted on ebonite, ball joint and "cat's whisker." Fitted with our famous "Permanite" Crystal. Post 6d. Price 2/6

A. W. GAMAGE, LTD., HOLBORN, LONDON, E.C.1

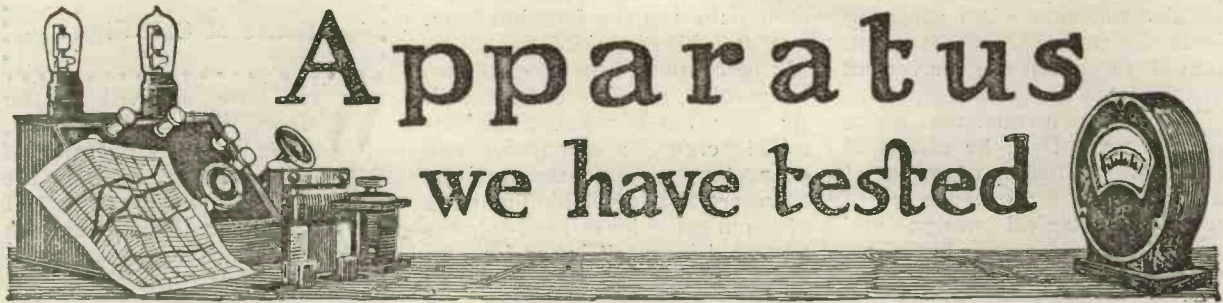

Apparatus we have tested

Conducted by A. D. COWPER, M.Sc., Staff Editor.

St. Ivel Crystal

Messrs. British General Radio Co., Ltd., have submitted a sample of their "St. Ivel" crystal.

This is of the sensitised galena type, and coarsely crystalline in appearance.

On test, it was found to possess a large number of sensitive points, and others could be readily found on a freshly-fractured surface. Quantitatively measured, its rectifying efficiency came up to the standard expected of a good galena crystal. In reception of local broadcasting, the signal-strength appeared to be excellent.

Variable Condensers

Messrs. Jackson Bros. have sent for test two samples of their new-pattern variable condensers for panel mounting. These have metal end-plates, and the same one-hole fixing as the earlier type with ebonite end-plates already noticed in these columns.

Those submitted were both of the nominal value of .0005 μ F. On actually measuring the capacities, these were found to be in the one case just below the nominal figure, in the other appreciably above that value. This represents a great improvement over the far-too-common usage of listing condensers as of

a certain "nominal capacity," when in reality their maximum capacity falls far short of this figure. The minimum of each condenser was unusually low, especially in view of the metal end-plates: actually .00017 μ F (seventeen micro-microfarads). This is due to the ample size of the ebonite bushes used for the insulation of the spindle carrying the moving plates, and to the good clearance allowed.

Contact is made to the moving plates either *via* the bottom pivot, or alternatively by means of a soldering-tag on a large spring washer at the upper end. Spade terminals held fast under nuts

Ethophone V

Buy out of Income



First Instalment

£11.18.9

12 Monthly Payments of

£2.8.5 INCLUDING BBC TARIFF

The above prices include Valves, High Tension Battery and Coils only. Complete set of extras amounting to £11 5 0 can be supplied on the same basis.

THE Ethophone V is one of the most sensitive and most satisfactory wireless receivers on the market. It will receive the British Broadcast Station in any locality, while, under favourable conditions, the reception of Continental and American stations is practically certain. Stations having wavelengths up to 4,000 metres will be received, too. The Ethophone V is a Tuner, Receiver and Power Amplifier combined.

For the convenience of those who would prefer to purchase this famous 4-valve receiver out of income, a special arrangement has been made, placing the instrument within everybody's reach. Payment of the sum of £11 18 9 down and 12 monthly payments of £2 8 5 complete the purchase. Write for full particulars.

BURNDEPT, LTD., Aldine House, Bedford Street, Strand, W.C.2.
Phone: Gerrard 9072.

The Hire Purchase system may be applied to any piece or pieces of Burndept apparatus, when the total cost of purchase amounts to £20 or over. Basis of Charging: First Instalment, 25 per cent. of list price — 5 per cent. Accommodation Fee and 6/- Insurance Fee. The balance to be paid in 12 monthly instalments.

BURNDEPT

provide an easy method of electrical connection when soldering is to be avoided. On trial in actual reception the movement of the plates was noiseless.

The insulation resistance, tested on 500 volts D.C. by means of the "Meg." tester, came out at a satisfactory large figure.

The mechanical design and workmanship shown by these condensers were of a high order, and the finish excellent for the purpose for which they are intended to be used. They can be confidently recommended for general use in radio construction and experimentation.

Multiple Telephone Connector

Messrs. Drake & Gorham, Ltd., have submitted for our inspection a new type of multiple telephone connector, by means of which several pairs of head-phones can be used in series or in parallel arrangement with the same receiver.

This takes the form of a square ebonite pillar, carrying brass bus-bars and terminal screws, mounted on a neat polished wood base 3 in. square. The pillar stands about 3½ in.

high. By means of small bridges across the top the four bus-bars, one at each corner of the pillar, can be connected up two and two in parallel, or isolated at will. As each bus-bar has three terminal screws, allowing for two connecting wires to the receiver, there are thus available five pairs of outlets for head-phones arranged in parallel; or for four arranged two in series and two pairs in parallel. Various other arrangements are manifestly possible.

On test with the "Meg," the insulation resistance was found excellent. The finish and workmanship are equally good. The appearance is certainly a great improvement over the shoddy stamped-metal type of multiple connector.

Although the makers have been successful in producing a more substantial and finished fitting, we scarcely think that persons of refinement would like to see permanently installed on their drawing-room tables so very unpromising an electrical fitting. For the experimental stage of radio reception, however, it is an excellent accessory.

Misuse of Call Signs

WE have received a letter from Mr. A. E. Hay, chief wireless operator of R.M.S. *Avoceta*, reporting the misuse of his own amateur call sign 2KG. Mr. Hay points out that he returned to marine wireless operating in November, 1922, since which date he has received numerous reports of signals from a station purporting to be 2KG. As his station has not been working since the date given he will be very grateful for any information friends may send him to his private address at "Glendale," Abermant, Aberdare, South Wales. Most of the reports Mr. Hay has received have come from the London area, and it has been noted that one amateur who is heard very frequently on the ether has been heard working to the alleged 2KG on a number of occasions. Our correspondent says that he does not intend to let the matter rest where it is, and will take strong steps on identifying the station.

A DEPARTURE

IN

Valve-Holder Construction for Every Experimenter

who knows that high resistance and low capacity are determined by the spacing of the valve legs themselves. In the manufacture of the H.T.C. Valve-Holder, allowance is made for the varying spacing of legs of the different types of valves.

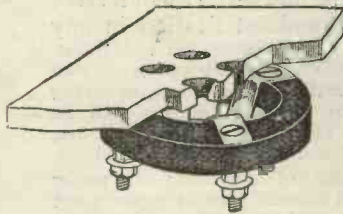

Patent pending.

Type "C" for below Panel Mounting. Template Supplied.

No metallic parts used in construction are exposed, making it impossible to short the H.T. across the filament.

PRICE
1/6

We are also Manufacturers of the Famous
H.T.C. INTERVALVE TRANSFORMER
the success of which has succeeded good craftsmanship and good materials, observing good design. Obtainable from your Local Dealer, or direct from the Manufacturers. Price **15/-**

H.T.C. Electrical Co., Ltd.

2 and 2a, BOUNDARIES ROAD, BALHAM, S.W.12
Telephone: BATTERSEA 374. Trade Enquiries Invited.

BEWARE OF WORTHLESS IMITATIONS, SEE THE TRADE MARK **WatMel** ON EVERY GRID LEAK.

WATMEL VARIABLE GRID LEAK

(Patent No. 206098).

Constantly Variable
Silent in operation.
Constant in any
temperature.
Dust and Damp
proof.
Each tested and
guaranteed.
Neat and well
made.

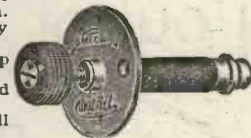

GRID LEAK
.5 to 5 megohms
2/6

ANODE
RESISTANCE
50,000 to 100,000
ohms 3/6.

Suitable for S.T.
100 Circuit.

SEND P.C. FOR DESCRIPTIVE FOLDER.

WATMEL WIRELESS CO., Comaught House, 1a, Edgware Road
Marble Arch, W.2. Tel. 4575 Paddington

ECONOMIC ELECTRIC LTD WRITE NOW!

OUR NEW RADIO CATALOGUE

comprising 40 pages and 300 illustrations of all classes of instruments, component parts, materials, etc., is just off the press. IT WILL PAY YOU WELL to remit 4d. in stamps and secure this money-saving publication.

Head Office: 10, FITZROY SQUARE, LONDON, W.1.

Showrooms: 303, EUSTON RD., N.W.1.

Branch and Works: TWICKENHAM.

Information Department



B. F. C. (TINTAGEL) asks how to count the number of turns upon a basket coil while the latter is still upon the spider used for winding.

If the coil has been wound upon the single basket method, count the number of turns upon the side or any one of the pins, and double this number. In the case of a double basket coil, the number of turns counted up one of the pins should be multiplied by four.

H. C. T. (CARDIFF) asks whether it is possible to incorporate reaction in a 3-valve Neutrodyne receiver. He states that his instrument is of American origin.

The addition of reaction to such a receiver is a somewhat complicated matter, since it must be done in such a way that it does not upset the balancing of the intervalve couplings. Probably the best method for ordinary broadcast reception is to put a large variometer in the plate circuit

of the rectifying valve, and rely for the production of reaction upon the actual tuning of this circuit. This will usually produce all the reaction that is needed, but should it fail to do so a small coil should be coupled from the detector anode circuit to the aerial coil, although this is not so desirable a method.

H. T. I. (IPSWICH) states that he has seen various inductance coils referred to as a No. 250, No. 300 and so on, and asks the actual meaning of these figures.

We print this question here because it appears to be a difficulty which besets many beginners, and it may be helpful to them to explain that the numbers quoted are, in the great majority of types, the actual numbers of turns upon the coil. An exception occurs in the case of certain of the sets of short-wave coils, such as the concert coils sold by many makers, which are distinguished by a letter of the alphabet or the actual number of the coil in the series.

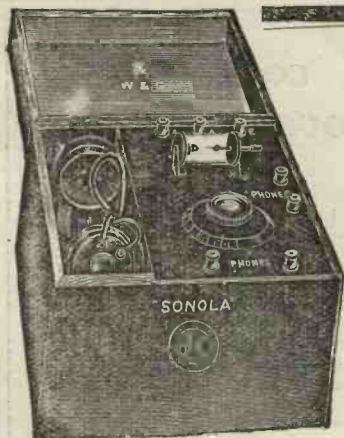

"SONOLA" CRYSTAL RECEIVING SETS.

Licence No. 315.

High grade set mounted on substantial Ebonite Panel and enclosed in highly polished hardwood Cabinet. Fitted with Variometer Tuner and improved type Dust-proof Crystal Detector. Price complete with the "Sonyte" super Crystal (without Phones), 30/- Plus British Broadcasting Fee 1/- extra. Also supplied in polished hardwood case without fall down lid, 21/- Plus British Broadcasting Fee 1/- extra.

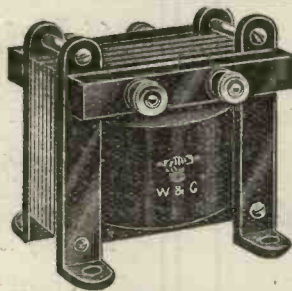

"SONOLA" LOW FREQUENCY TRANSFORMER.

Size $3\frac{1}{2} \times 2\frac{1}{2} \times 3\frac{1}{2}$ ins.
Unsurpassed for Silence, Efficiency and Reliability. Equally suitable with the Ordinary, D.E.R., Low Current Consumption and High-Power Valves.

Terminal Type, No. 800, 17/6.
No Transformer gives better results!



RADIO WIRES.

Silk, Cotton and Enamelled Wires, Aerial Wires, Leading-in Wires, Telephone Receiver and Loud Speaker Cords, etc., etc.

COMPETITIVE PRICES. PROMPT DELIVERIES.

New fully illustrated Radio Catalogue, W/105, showing a wide range of Complete Sets, Constructional Sets and Component Parts of every description on request. Enclose Business Card or Memo for Special Trade Terms and Discounts.

These Lines are stocked by all High-Class RADIO and ELECTRICAL DEALERS. REFUSE SUBSTITUTES. Write direct if unobtainable.

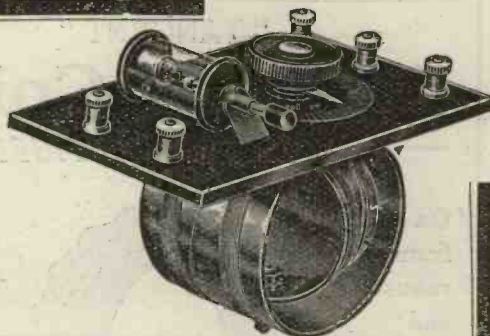

VARIOMETERS. WAVE LENGTH 200-500 Metres.

Suitable for Panel Mounting. Fitted with Ebonite Knob and Indicating Finger. No. 54A/14. 2/6. Superior finish, fitted with Ebonite Knob and Engraved Dial. No. 54A/16. 6/-.

As illustrated, mounted on Ebonite Panel. $6\frac{1}{2} \times 4$ ins., fitted with improved type dustproof Crystal Detector, and Terminals for Aerial, Earth and Phones. *Supreme Value.* No. 54A/12. 10/6.

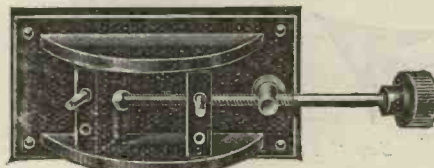

"SONOLA" MICROMETER TWO COIL HOLDER. P. Patent.

Enables the finest possible tuning, and adds considerably to the selectivity and efficiency of the Receiving Set. No. 58/40. 10/- each.



Address all communications to Head Office and Works—PENDLETON, MANCHESTER. Glasgow Depot—95, PITT STREET.

I. E. V. (BRISTOL) enquires whether **ebonite tubing is really the best material for the winding of cylindrical inductances.**

From the point of your insulation ebonite is no doubt to be preferred, but it is somewhat doubtful whether upon the extremely short wavelength the dielectric losses introduced by its use are not somewhat serious. It is probable that a coil supported as far as possible in air and separated from dielectric material is to be preferred upon all the shorter wavelengths. Such coils can be wound by running their turns into saw cuts in an ebonite cross piece, or by winding them upon a tube from whose surface they are separated by strips of ebonite laid along the actual length of the tube.

T. M. L. (HULL) asks why a loud-speaker cannot be operated directly from a crystal set.

It must be remembered that the loud-speaker is merely a large reproducing mechanism exactly similar in most cases to that of a telephone receiver, and that when signals cannot be heard strongly in the 'phones, neither will they be audible from a loud-speaker. To make a loud enough sound to be heard throughout a room a good deal of energy is needed, much more in fact than can be obtained from a crystal receiver. A good deal of amplification by means of valves or other relay devices is always necessary, the actual amount depending upon the initial strength of the signals. Usually, two stages of low-

frequency amplification are required to operate a loud-speaker successfully (except, of course, in the immediate proximity of one of the broadcasting stations).

W. T. R. (BARROW-IN-FURNESS) enquires whether there is any theoretical justification for the very common practice of inserting the aerial condenser in series upon the shorter wavelengths.

Certainly. The effect of a moderately small series condenser is to reduce the effective capacity in circuit necessitating the use of a much larger tuning coil. Bigger differences of potential are therefore produced across the ends of the coil, and are available to operate the detector or amplifying valve. There are, however, drawbacks to the use of a series condenser, and the whole question is one of the points upon which experts differ.

F. S. T. (WINDERMERE) states that he has seen a statement to the effect that a variable grid condenser is a great advantage in an ordinary receiver, and enquires as to our opinion upon this point.

So far as the strength of signals is concerned it is doubtful whether a variable grid condenser is worth while, but in some circuits employing critical reaction it is a great help. It enables the operator to so adjust the functioning of the valve as to make the reaction coupling easy to adjust to the desired point. In all straightforward circuits, however, a fixed condenser of .0003 μ F is usually the best practice.

"TANGENT" Tuning Coils

— TESTED AND TRIED —

On
frames—
robust
and
SUB-
STANTIAL



Their efficiency—which is second to none—is not impaired by the Special material of the frames

No self-supporting coil excels them

Say "TANGENT" to your dealer and refuse substitutes.

Send for LEAFLET 101 W.

GENT & CO. LTD. "PARADAY WORKS," **LEICESTER** EST. 1872.

LONDON: 25, Victoria Street, S.W.1.
NEWCASTLE-ON-TYNE: "Tangent House," Blackett Street.

"Utility" components will improve your set

The experimenter who is satisfied only with the best possible results knows that nothing serves his purpose like "Utility" Components. Where accuracy is essential they cannot be bettered.

"UTILITY" NO-CAPACITY CHANGE-OVER SWITCH.

Lever Pattern.		Knob Type.	
No. W.147/2 (2-pole change-over)	each 5/-	W.130/2	each 4/-
No. W.147/3 (3-pole change-over)	each 6/-	W.130/3	each 5/-
No. W.147/4 (4-pole change-over)	each 7/6	W.130/4	each 6/-
No. W.147/5 (6-pole change-over)	each 10/-	W.130/6	each 8/-



Ask your dealer to show you these and many other interesting "Utility" products, including the well-known "Utility" Boxed Sets of Condenser Parts.

**WILKINS
and
WRIGHT
LTD.**

Utility Works, Kenyon Street, BIRMINGHAM

Safety First

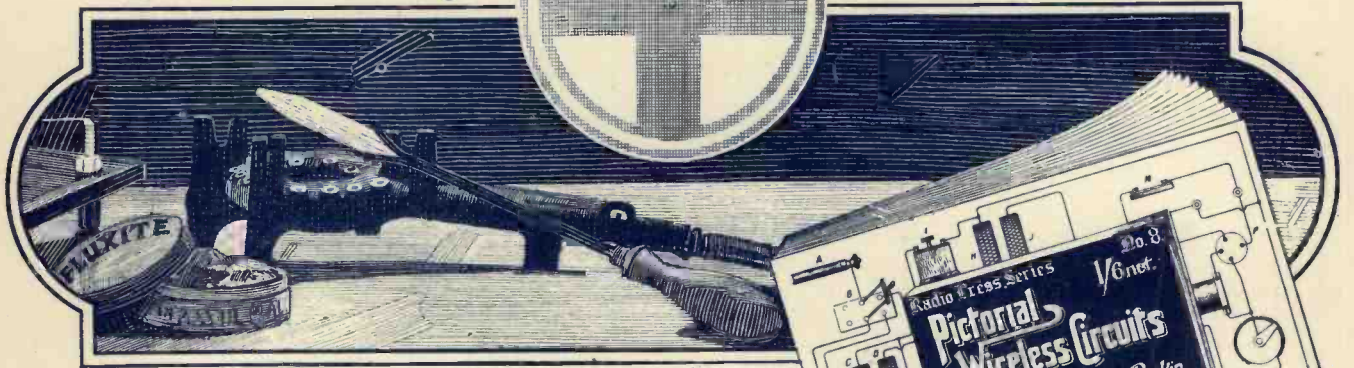

Before soldering a single connection make certain your Circuit is correct.

MANY a man has built up a Receiving Set, inserted the Valves, coupled up the batteries and hoped for the best!

Perhaps at the worst the result of his efforts has only been complete silence, but if he has been really unlucky, and his wiring inextricably mixed there has been a blue flash indicating the premature decease of his valves.

And almost invariably the cause of the whole trouble is inability to read a Circuit diagram.

Now Radio Press, Ltd., have published an entirely new Book, "Pictorial Wireless

Circuits," which makes use of a different principle to that usually employed. Instead of conventional signs every Circuit is shown with illustrations of the actual components connected together. It gives in effect, a bird's-eye view of the finished set.

Naturally such a method makes wiring up extremely simple and as a very wide range of circuits is shown, ranging from simple Crystal Circuits to multi-valve Circuits, it is a Book which should be in the hands of every Wireless enthusiast.

Obtainable from all Booksellers or direct from publishers (postage 2d. extra).

Every Circuit is individually described and its advantages explained. Full details of all variable components, such as condensers, resistances, grid leaks are given, so that the home constructor can build up a Receiving Set from the information furnished.

R. P. Series
No. 8.

Radio Press Ltd., Deyereux Court, Strand, W.C.2

16

Pictorial Wireless Circuits

By Oswald J. Rankin.

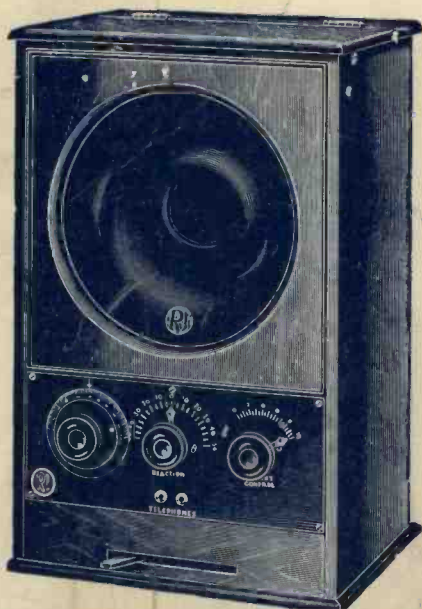

The Lyrianette Receiver for B.B.C. Wave-lengths. Complete portable Wireless Receiver, Standard Loud Speaker, D.E. Valves, Batteries, 2 Valve set. PRICE Complete 19 Gns. B.B.C. Tax 15/-
3 Valve set. PRICE Complete £25 18 0 B.B.C. Tax £1

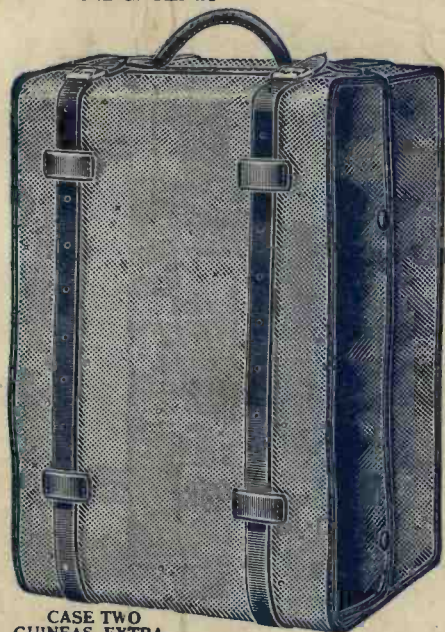

CASE TWO
GUINEAS EXTRA.

Really Portable

You can carry it about anywhere, on the river, to the tennis club, in fact to any gathering, and it is always ready to put into operation at a moment's notice.

It is a complete receiver, the first of its kind, and will reproduce perfectly the Broadcasting Concerts on its Standard Loud Speaker. Its classic cabinet contains batteries, valves, all the accessories, and

No accumulators are required

Its case is strongly made, is easily adjustable and provides a perfect way of carrying this really portable set anywhere.

Unlike many of the firms who supply the public with wireless sets, R.I. never make sensational claims for their goods.

Write now for Folder (M) describing this Receiver.

RADIO INSTRUMENTS Ltd.

Managing Director—J. JOSEPH, M.I.E.E.
Chief Designer—W. A. APPLETON, M.B.E., M.I.R.E., late Admiralty Tech. Research Officer.

Works, Offices and Showrooms :

12, Hyde Street, New Oxford Street, W.C.1

Telephone : Regent 6214-6215-6216.

Telegrams : "Instradio, London."



Wireless Weekly

and the Wireless Constructor.

Vol. 3.
No. 21.

CONTENTS

Fading and Deadspots.

A Triple Unit.

Designing Portable Receivers.

A Wave-Trap Circuit on the
Omni Receiver.

C.W. and Telephony Transmission
Using Valves, An Experimenter's
Unit Receiver, Jottings By the
Way, Random Technicalities,
Valve Notes, Apparatus We Have
Tested, Correspondence, Infor-
mation Department, etc., etc.

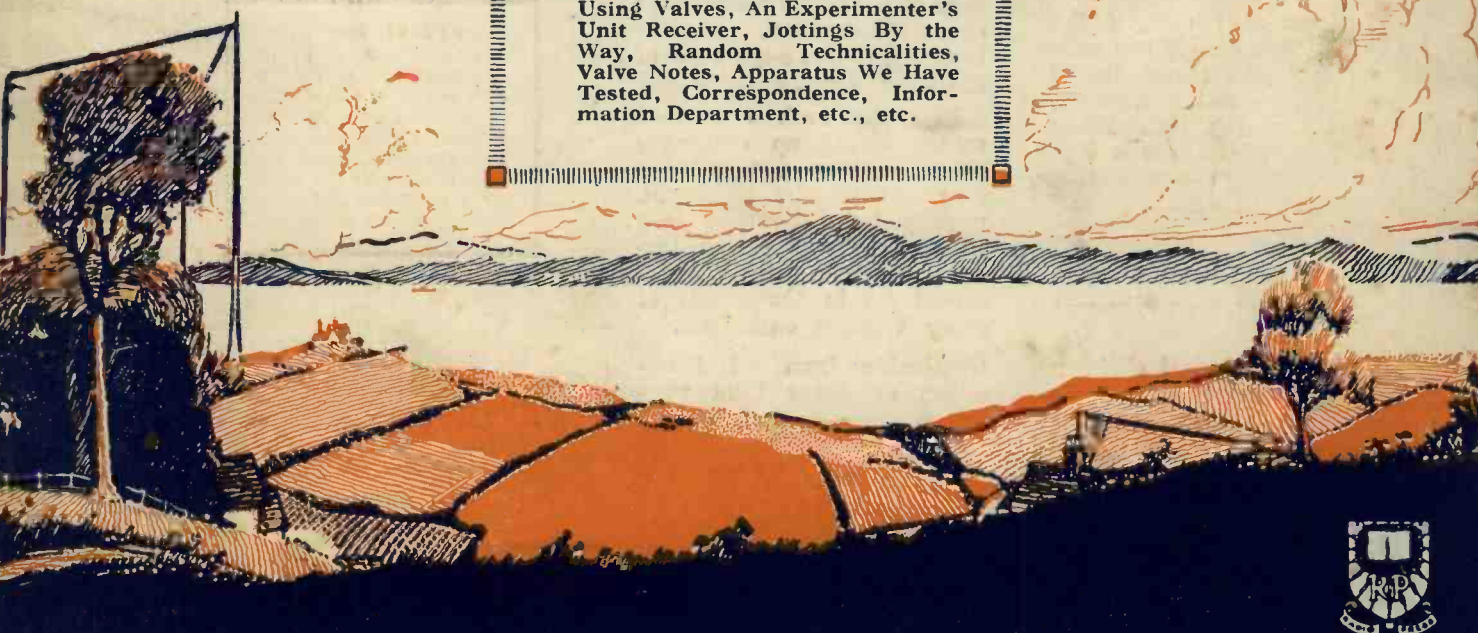

Full Details of the 2LO Microphone

Safety First

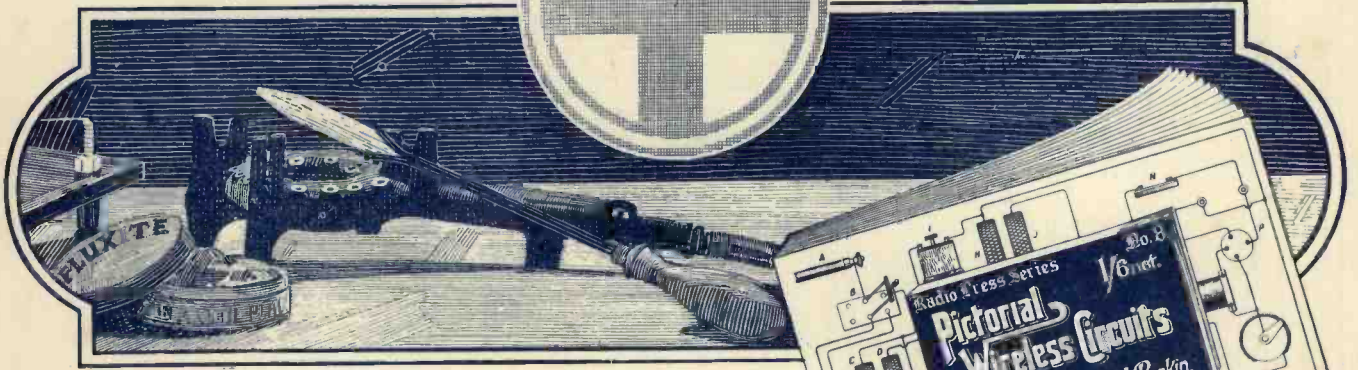

Before soldering a single connection make certain your Circuit is correct.

MANY a man has built up a Receiving Set, inserted the Valves, coupled up the batteries and hoped for the best!

Perhaps at the worst the result of his efforts has only been complete silence, but if he has been really unlucky, and his wiring inextricably mixed there has been a blue flash indicating the premature decease of his valves.

And almost invariably the cause of the whole trouble is inability to read a Circuit diagram.

Now Radio Press, Ltd., have published an entirely new Book, "Pictorial Wireless

Circuits," which makes use of a different principle to that usually employed. Instead of conventional signs every Circuit is shown with illustrations of the actual components connected together. It gives in effect, a bird's-eye view of the finished set.

Naturally such a method makes wiring up extremely simple and as a very wide range of circuits is shown, ranging from simple Crystal Circuits to multi-valve Circuits, it is a Book which should be in the hands of every Wireless enthusiast.

Obtainable from all Book-sellers or direct from publishers (postage 2d. extra).

Every Circuit is individually described and its advantages explained. Full details of all variable components, such as condensers, resistances, grid leaks are given, so that the home constructor can build up a Receiving Set from the information furnished.

R. P. Series
No. 8.

Radio Press Ltd., Devereux Court, Strand, W.C.2

1/6

Pictorial Wireless Circuits

By Oswald J. Rankin.

Wireless Weekly

Vol. 3, No. 21
April 30, 1924

CONTENTS

	Page
Editorial	676
Designing a Portable Receiver	677
Jottings by the Way	679
A Three-Valve Circuit with Wavetrap on the Omni Receiver	681
An Experimenter's Unit Receiver	683
The Distribution of Signal Strength Around a Broadcasting Station	684
C.W. and Telephony Transmission Using Valves Valve Notes	689
The Radio Society of Great Britain	690
The Microphone at 2LO	691
A Triple Unit (1-Valve Receiver—Note Magnifier —Reflex Unit)	694
Springtime Wireless Jobs	698
An Enclosed ST100 Receiver	699
Correspondence	702
Apparatus We Have Tested	705
Information Department	707

Editor: JOHN SCOTT-TAGGART, F.Inst.P., A.M.I.E.E.

Assistant Editors { P. W. HARRIS.
E. REDPATH.

Radio Press, Ltd.

Publishers of Authoritative Wireless Literature.
DEVEREUX COURT, STRAND, W.C.2

Tel.—Central 3763.

Advertisement Managers: } SCHEFF PUBLICITY ORGANIZATION,
LTD., 125, Pall Mall, London, S.W.1

Tel.—Regent 2440.



Advisory Editors:
Prof. R. WHEDDINGTON,
M.A., D.Sc.

Prof. C. L. FORTESCUE,
M.A., M.I.E.E.

Staff Editors:

E. H. CHAPMAN, M.A., D.Sc.
A. D. COWPER, M.Sc.
G. P. KENDALL, B.Sc.
R. W. HALLOWS, M.A.
S. G. RATTEE M.Inst.Rad.E.

All correspondence relating to contributions is to be addressed to the Editor of "Wireless Weekly."

Nothing contained herein is to be regarded as permission or encouragement to infringe any patent rights.



Another Milestone

TO say that the broadcasting of the King's speech was an immense success is but to state an already well-known fact. Nothing in the annals of broadcasting has done more to remove the few remaining prejudices or to emphasise the immense social significance of broadcasting than this triumph of the ether wave. In rejoicing at the triumph of wireless in difficult circumstances we must not overlook the important fact that it is the first real triumph for the loud-speaker. The fears expressed in these columns recently that much harm might be done by overloading loud-speakers were happily dispelled by the reports received from all over the country of excellent outdoor and indoor distribution of the speech and ceremony from loud-speakers adequately adjusted and properly handled. We have already heard of many cases where people who were previously prejudiced against loud-speakers have now realised how good is the reproduction with this well-designed modern instrument, and have placed their orders accordingly.

Technically the broadcasting of the King's speech was interesting from a number of points of view. Altogether the reproduction was remarkably pure and clear. There was, however, a somewhat unpleasant echo effect, due no doubt to the enormously amplified speech, broadcast from the immense loud-speakers above His Majesty's head, being reflected from the opposite walls of the Stadium.

The congratulations and praise showered upon the British Broadcasting Company, and in particular upon Captain P. P. Eckersley, the Chief Engineer, are indeed well merited. The success was a double triumph of radio engineering and organisation—perhaps most of all for the latter. It has been said that genius is 5 per cent. inspiration and 95 per cent. perspiration. Only those intimately acquainted with the details of the arrangement can realise the intricacies and innumerable vital details in the great chain connecting His Majesty with those of his subjects who were

not in the immediate vicinity of the Royal dais, for it must be remembered that not only had the engineers to face the problem of conveying the modulated current from the microphones in the vicinity of the Royal chair to the distributing board for simultaneous broadcasting at 2LO—there was also the difficult problem of adequately distributing the speech throughout the great loud-speakers in the Exhibition itself. We feel that it is our duty to offer to the company, its officials and all concerned, on behalf of our thousands of readers, the heartiest congratulations upon their epoch-making success.

America's Broadcast Problem

Wireless writers on the other side of the Atlantic were somewhat facetious in their comments on the British broadcasting arrangements when, at the beginning of the broadcasting era, endeavours were made to organise our programmes and our broadcasting on a sound businesslike basis. It was pointed out how well America was able to do without licence fees, royalties, etc. We were, in fact, held up to ridicule.

In view of this it is interesting to notice that a large headline on a recent issue of an American weekly wireless publication reads, "PROPOSED TAX ON SETS. LISTENER TO PAY IF BILL PASSES." The object of the tax is not as might at first be thought to provide a revenue for better broadcasting, but merely to give the Government additional revenue! It is, of course, unlikely that the Bill will pass, but to American critics of the British broadcasting organisation we would like to point out that no single person in this country has yet suggested imposing a tax on broadcasting to bring additional revenue to the exchequer!

A Wise Decision

We are happy to understand that the British Broadcasting Company, after careful consideration, have decided to abandon their endeavours to obtain the names and addresses of listeners thought to be oscillating. The form in the *Radio Times* which created so much comment will not in future appear.

Designing a Portable Receiver

A Topical Article for the Home Constructor.

By PERCY W. HARRIS,
Assistant Editor.

THE design of a wireless set of any description is not a matter to be undertaken without considerable thought. In fact, the amateurish appearance of so many receivers is largely due to the want of intelligent planning by their builders. Unless we have first of all a clear conception of what we actually need the finished instrument will neither fulfil adequately the requirements we have to meet, nor satisfy us by having a trim and businesslike appearance.

Fundamental Points

The design of a portable receiver is something quite different from that of the average table instrument. Almost every aspect of the case must be separately considered. It will perhaps save time if we tabulate the chief requirements of a good portable set and then later see how we can mould our design to comply as far as possible with these requirements.

The first requirement of a portable set is that it shall be genuinely portable. This point is frequently overlooked by builders who seem to think that portability means simply the attachment of a handle to any type of apparatus. If any pleasure is to be obtained from the use of a portable set it must be both light and compact, for bulk is as inconvenient as weight.

The second requirement is that the set shall be adequately sensitive. It must always be remembered that portable sets are in nine cases out of ten used with very small and inefficient aerials. Adequate sensitiveness means that it is desirable to have at least one stage of high-frequency preceding the detector, and reaction must be used to get the utmost out of the valves. It is

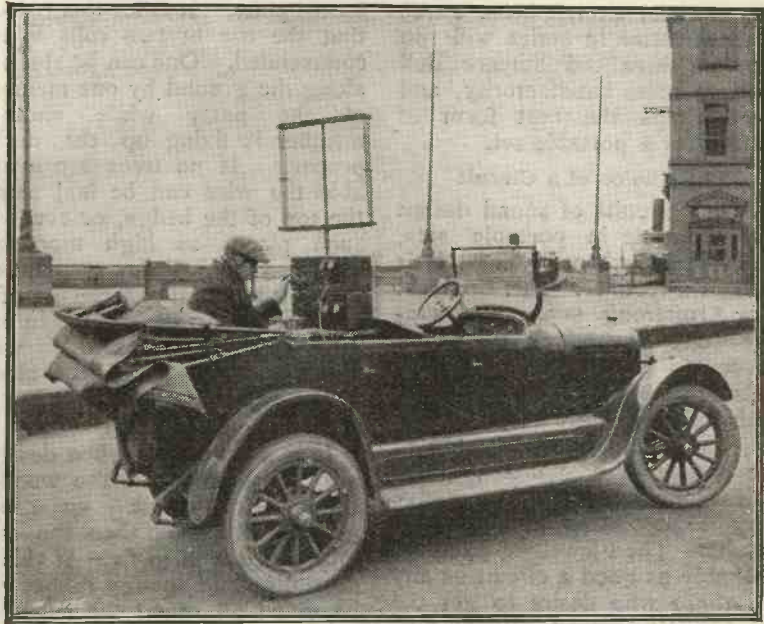

The portable receiver used in the experiments described on p. 685.

the lack of sensitivity which rules out the crystal set without valves in our design of a portable receiver. Note magnifying valves are not so important, save when we desire to work a loud-speaker.

Requirement No. 3 is that the circuit used should be one which uses the valve economically so as to make the smallest possible drain upon the source of filament current. Do not forget that even with the most modern of dull emitters several valves will consume more current than can be safely taken from really portable dry cells.

Our fourth requirement, also one frequently overlooked, is that the set must be robust and not likely to be upset in adjustment or have its connections broken by the joltings inseparable from country outings. Do not forget that much of the pleasure of a picnic can be lost if the portable wireless set gives rise to constant anxiety lest it should be injured.

The final requirement is that the set shall be simple to handle. Sets with many controls and delicate adjustment may give admirable service in the hands of the one skilled member of the party, but here again much of the pleasure of the picnic will be lost if a set cannot be simply tuned by any member of the party.

Points which Make for Portability

A portable set can be divided into the three chief parts of carrying case, receiver and amplifier,

and batteries. The first and third of these are by far the heaviest, for even a multi-valve set apart from its batteries and case is by no means a heavy piece of apparatus. The carrying cases should not be made of solid wood throughout. There is no need for this, and wood is very heavy. The best way to proceed is to make a skeleton framework to hold the receiver and batteries and then to place this within a light case. Large size attache cases or small size suit cases in cloth covered with millboard, finished to imitate leather and provided with good, strong-carrying handles are obtainable for very modest prices at any of the leading stores. Even leather cases on millboard bases are quite cheap. Such a case should be purchased of a size thought to be adequate for the purpose in view, and the framework just referred to cut and fitted within it. This will give a very neat receiver with a maximum of portability.

It is not wise in portable sets to cut down the size of the high-tension battery too greatly in order to obtain further portability. Good results will not be obtained with very small high-tension batteries. In the case of the low tension supply, however, we can have recourse to several alternatives. We can have either a 4-volt unspillable accumulator (the spillable type will sooner or later ruin the set), or we may use the conventional dry

cells used for electric bells. Three of these latter in series will run two or three .06 ampere dull emitters quite satisfactorily, and are perhaps the best form of battery for a portable set.

The Choice of a Circuit

Reflex circuits of sound design are admirable in portable sets, particularly when a crystal is used as a rectifier. This time last year Armstrong super regenerative circuits were frequently advocated for portable sets, but although the results obtainable with this circuit are very wonderful, the circuit itself is more in the nature of a "stunt," and unless handled with skill may give very disappointing and distorted results. The Flewelling circuit is probably as good a circuit as any for those who desire to get the most out of a single valve without using a crystal, and, of course, the famous ST100 circuit and its modifications are admirable. For those who prefer the straight type of circuit there is much to recommend the high-frequency valve and crystal detector circuit. It is very sensitive, very easy to handle and completely free from any troubles, such as instability, which occasionally mar the results obtained with reflex and super circuits. Whilst writing of reflexes it should be pointed out that these become progressively unstable as we reduce the size of the aerial used with them.

Aerials for Portable Sets

Few beginners realise the possibilities of long low aerials which are very easy to erect when we take a portable set to the countryside. Insulated wire should be used, for there is always a risk of branches of trees coming into contact with the bare wire, and, of course, we do not want to go to the trouble of fixed insulators here and there when rigging up the set. Excellent aerials for portable sets can be made up rapidly with the "Electron" wire now obtainable at such a low cost. Two rolls of this wire should be taken, one for the aerial and the other for the earth. It is not necessary to dig a hole and bury a metal plate when making earth connections with portable sets. A long wire run along the ground underneath the aerial wire will often prove quite as good as a most elaborate

buried plate. It is for this reason that the use of two rolls is recommended. One can be run out along the ground by one member of the party while another member is fixing up the aerial proper. If no trees are available the wire can be laid along the top of the hedge, or even, in such places as high moorland where very little vegetation exists, the aerial can consist of a wire laid along the ground in one direction, the "earth" wire being a similar length run along in the opposite direction.

Robustness

It is a good plan when designing the set to make the wooden framework about an inch smaller all round than the case into which it is to fix. If this is done pieces of spongy rubber can be glued all round the edges of the framework so as to lessen the

shock given to the set if the box or case should be dropped. The valve sockets should also be mounted on bases of spongy rubber (the cheap red rubber sponges such as are obtainable at Woolworths will serve admirably here). Unless the valve sockets are very well mounted it is wise to pack the valves themselves in separate well-padded boxes rather than to leave them in the set when carrying it. The crystal detector if used should be of a fairly robust type, for the joltings may scratch the surface of the crystal a great deal.

One great advantage of using the round dry cells such as are used for ringing electric bells is that if they should run out on a trip substitutes are obtainable of good quality in any town. If an accumulator runs down it cannot be rapidly charged.



Loud-speakers are distributed everywhere throughout the Wembley Exhibition. This photograph shows the B.B.C. Headquarters.



JOTTINGS BY THE WAY

The Beautiful Spring

SPRING is really with us at last. I am quite sure about this, for whilst I write snowflakes are eddying and swirling against the window-pane and a young gale is blowing. Poets and quaint people of that kind always have the utmost admiration for spring, with its accompaniment of gambolling lambs, yellow primroses and purple violets. Epicures look forward to its coming, because it brings them lambs also (but with mint sauce in their case) and many other little ticklers for the jaded palate. But we wireless folk, being a race apart, do not regard the spring with anything like the same kind of rapture. To us it is rather a gloomy time, when our wives borrow our best bandana handkerchiefs to wrap round their *coiffures* and arm themselves with brooms and dusters for the annual onslaught upon comfort and decent untidiness.

Allies

Their stout allies the charwomen arrive with pails and scrubbing brushes, and to them nothing is sacred. Let them but see a speck of dust upon your best precision condenser, and if no one is looking they will have washed it before you have time to say "knife" or the much worse things that are called for by such an occasion. When the preliminary symptoms of the spring feeling begin to manifest themselves amongst the female members of his household, that is to say, when they begin furtively to tidy up, which means (A) putting everything behind or under something else and (B) flicking dust off things on to the floor, afterwards swishing it up off the floor back to where it came from—when these symp-

toms begin to be observed, the wise man steals out to the ironmonger's, purchases the largest and most ingenious lock that he can find and fits it solidly to the door of his wireless den. Neglect this precaution, and you will return from your labours one evening to find that spring has let loose its havoc amidst the hallowed disorder of your most treasured bits and pieces. Your ebonite panels will reek of furniture polish, and until you have managed to scrape it off things will not work properly. Valves will be stacked neatly in a box. The filaments of many will have been broken in the process, but they must be regarded as a sacrifice to Pan or whoever is the god of the springtime.

Neat Wiring

If there are any loose wires knocking about on your set, they will have been screwed to the nearest terminals, and in consequence you will probably find that the plates of your best accumulator have taken to themselves the contours of corrugated iron. These and many other things of an even worse nature will befall you if you are foolish enough to disregard the signs and portents which herald the coming of the season of discomfort and destruction.

Incurable

Some of you will smile when you read what I have written, saying to yourselves with no small satisfaction: "Poor chap, poor chap. Thank heaven I am a bachelor and am therefore free from any such terrible visitations." I do not grudge you that smile in the least, for as an ex-bachelor I know that your time will come just as surely as if you were married. For you have a landlady, a housekeeper or a bed-

maker, and as sure as mice are mice the spring will seize them, and you will find yourself tidied up and made uncomfortable like the rest of us. Every woman, no matter who or what or where she may be, is taken with the spring cleaning frenzy, and you can no more cure her of it than you can cure a man who sings in his bath or a dog who has once tasted the joys of chasing chickens.

Even Men!

These things are ineradicable. I have even known *men* who were infected at this time of year with the disease which causes folk to turn the untidiness in which everything can be found in a moment into the perfect order which means that nothing can ever be found, no matter how hard you look for it. Fortunately, however, the disease is of rare occurrence in the male sex, or else one trembles to think what might happen to the country. Imagine, for example, for one moment what would be the results if the average lawyer was suddenly seized with a tidying fit and made his office spick and span and neat!

The Gardening Scourge

One of the worst features of the springtime is that it brings out a violent enthusiasm for gardening which makes its appearance first of all in odd corners of the country and then spreads like a pestilence over the land as the longer days draw on. Now, I am not one of those who decry gardens. I think that they are the most excellent things if used for their proper purpose, which is to act as planting places for aerial masts and earths. The garden also serves very well indeed when you want to empty

the old acid out of your accumulator, and you must of course have a rubbish heap for the reception of ancient high tension batteries, burnt-out valves and other discarded impedimenta. But if it is a question between a counterpoise and a cabbage patch, then I am for the counterpoise every time, for you can always buy a cabbage from the shop round the corner.

Cabbages and Onions

And what I do so much object to is the disgusting garden shop which horticulturists will talk incessantly at all times and in all places. When you are in the train they produce from their pockets paper bags full of earth and ask you whether you think that nitrates or phosphates are required, or they go into rhapsodies over some wretched sweet-

pursuit so that they might be able to give full and undivided attention to wireless.

The Case of the Bumbleby-Browns

The terrible epidemic of gardening fever now sweeping over the country has had very serious effects in Little Puddleton. The Bumbleby-Browns, for instance, who were once the most devoted couple, now appear to have wrecked a lifelong happiness on this rock. It all came about through the realisation on the part of Horace Bumbleby-Brown that his aerial was not all that it should be. He had erected it two years ago when his knowledge of wireless was still quite small. For this reason it had not occurred to him that it would be badly screened by three large apple trees in his garden.

The Climax

The climax came when the time arrived for the entire revising of the aerial. There were obviously two alternatives, and two only. Either the apple trees must fall before the axe or the mast must be moved and replanted in the midst of the asparagus bed, which seemed to have been made specially for its reception. Priscilla was firm about the thing; equally so Horace. She would not have either the trees or the bed touched, whilst he insisted that one or the other must go. So furious did the quarrel become that she eventually went home to her mother and he, seizing the opportunity, sallied forth to try both alternatives in turn. First he felled the trees; then, finding that the resulting improvement

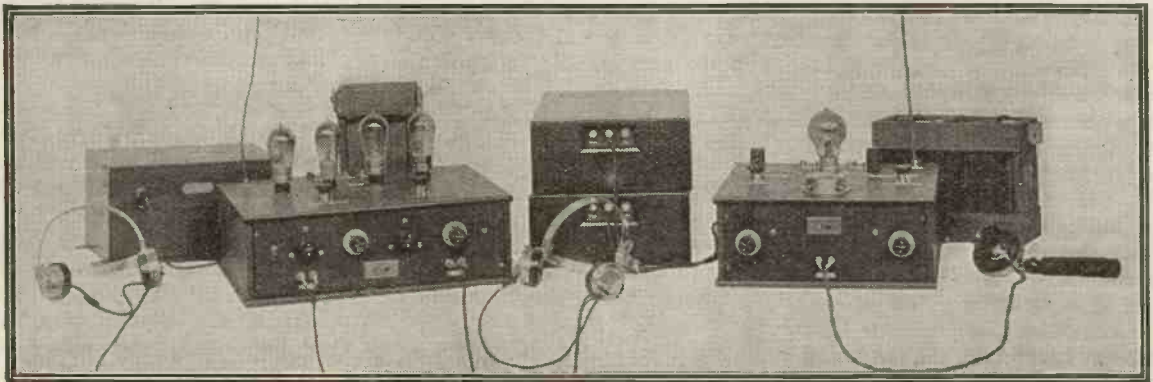

One of the exhibits at the Wembley Exhibition is the Marconi Duplex Telephony Set, Type X.P.I., allowing telephony to be conducted without the usual "change-over" switch.

pea or cauliflower or onion and expect you to do the same. When you gently strive to turn the conversation into more decent channels by speaking of super-heterodyne reception they merely say "Yes, yes, I know, but do you think that half-hardy annuals ought to be bedded out now?"

An Appeal to the R.S.G.B.

The minds of these unfortunate people run entirely upon one subject, and it is impossible for the time being to get them to listen to you when you wish to air your latest feat of long-distance reception. I hope that the Radio Society of Great Britain and other responsible bodies will take the matter up and that they will spare no pains to institute a crusade against gardening, for it is high time that these people were weaned from their horrible

The Reason

Having found that he was unable to receive America without the aid of fairly extensive perversions of the truth, he came to the conclusion that as his set was all that it should be, the fault must lie in the aerial. He therefore set himself the task of studying the whole aerial question thoroughly. But first he turned his attention to the earth which had previously been a convenient water pipe. This he replaced by a copper plate which he buried one day during his wife's absence in the midst of a snapdragon bed. Naturally the flowers had to be removed in the process, and he found that if he had lowered the resistance of his aerial he had undoubtedly increased that of his spouse Priscilla.

was not so great as he expected, he uprooted the asparagus and installed in its stead a more worthy plant in the shape of a 40 ft. mast. Even here reception was not so good as it should have been, but the installation of a counterpoise which entailed the removal of a small shrubbery and a herbaceous border improved things a little.

A Rumour

Priscilla Bumbleby-Brown is still with her mother, and I hear a rumour that Horace is contemplating yet another position for the aerial mast, this time in one of the service courts of the tennis lawn. I suppose that in time he will find the ideal spot for it, and an armistice be arranged, the garden being apportioned between them.

WIRELESS WAYFARER.

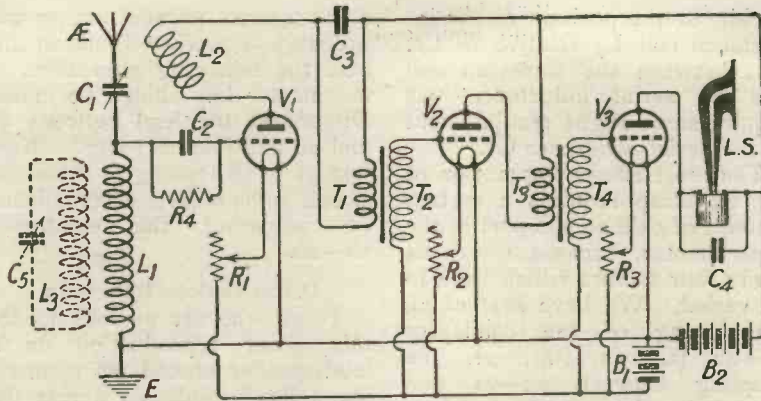

Fig. 1.—The three-valve circuit with the wavetraps L3 C5, which may be tried on the Omni Receiver.

FOR powerful results it is hard to beat a three-valve circuit using a detector with reaction and two stages of note magnification. A suitable circuit of this kind is illustrated in Fig. 1, and a loud-speaker LS is shown in use, although, of course, telephones may be employed. In the latter event the condenser C4, which, when employed with a loud-speaker, usually has a value of 0.002 μ F or 0.004 μ F, may be omitted.

The variable condenser C1 is shown in series with the inductance L1, and it has a capacity of 0.0005 μ F. The grid condenser C2 has a capacity of 0.0003 μ F, as usual, while R4 is a variable gridleak. The fixed condenser C3 has a capacity of 0.002 μ F and acts as a by-path for the high-frequency currents in the anode circuit of the first valve. For the British broadcast waveband, the inductance L1 may consist of a No. 50 or No. 75 coil, according to the size of aerial and the wavelength of the incoming station. The reaction coil L2 is a No. 50 coil, or a No. 75.

It will be seen on the left-hand side of this figure that an inductance L3 shunted by a variable condenser C5 is coupled to the inductance L1; the circuit L3 C5 is shown in dotted lines because it is in the nature of a luxury and a refinement which need only be tried when the circuit has been made to work effectively without it.

When the coil is used, L3 may be a No. 50 and the condenser C5 a 0.0005 μ F condenser.

Using the Omni receiver, the circuit may readily be tried out by simply connecting the following terminals:—

51—26	22—46
18—25	30—14
17—52	29—48
18—27	6—7
19—12	15—24
27—13	56—16
12—5	55—48
52—40	8—23
32—40	31—24
4—9	31—39
1—21	23—47
22—24	33—34
21—45	41—42

No coils are plugged in on the front of the panel, but a coil is placed in each of the three coil-holders at the side of the cabinet. The middle coil is the aerial coil and is either a No. 50 or No. 75 coil (see remarks above); the coil at the back is a No. 50 or a No. 75—it matters very little which; the coil nearest the front is a No. 50.

Operating the Set

First take out the coil nearest the front, i.e., the wavetraps coil; then have the reaction coil, which is the one furthest to the

**A
Three-Valve Circuit
with Wavetraps
on the Omni Receiver**

A short chat explaining a further circuit which may be tried with the Omni Receiver.

back, well away from the other, and tune on the condenser 18—26. This will really be the only adjustment necessary to start with. Now bring up the reaction coil 1—9 closer to the aerial coil 17—25 and retune on the condenser 18—26. The signal strength should increase after 18—26 has been retuned; if so, bring the reaction coil up a little closer still and retune again on 18—26. This method of tuning is proceeded with until the first valve is on the verge of oscillation. Great care should be taken to see that the first valve does not oscillate.

If bringing up the reaction coil does not increase the signal strength, the reaction coil connections should be reversed. This is done by disconnecting the lead going to 1 and connecting it to 9; the lead which was on 9 should be taken off and placed on 1; in other words, the connections to 1 and 9 are reversed. Now bring up the reaction coil closer to the aerial coil once more.

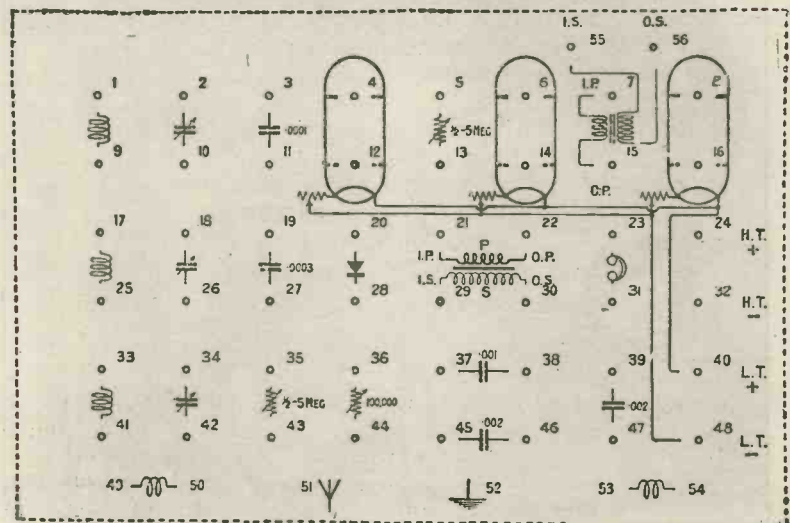

Fig. 2.—The terminal board.

Experiments to Try with this Circuit

The experiments described in *Wireless Weekly* of April 16 may be adapted to this circuit which only differs from the other one in that an extra stage of low-frequency amplification is employed, and that constant aerial tuning is not shown in use.

The most interesting experiment is in connection with the use of a wavetraps to cut out interference, the idea being that the oscillatory circuit $L_3 C_5$, by being tuned to an interfering wavelength, absorbs energy from the aerial circuit, due to the incoming interfering signal, without materially absorbing the energy of the signal which is desired.

Having obtained a sensitive adjustment of the three-valve receiver, a No. 50 coil may now be plugged into the coil holder 33—41, which is the one nearest the front. While first adjusting the three-valve circuit, no coil should be in this holder, because it would only complicate matters, but when you are ready to try the wavetraps, the coil is inserted and brought about half-way towards the middle coil 17—25. A very careful adjustment of the variable condenser 34—42 is required, and any alteration to this

circuit, or the position of the inductance coil L_3 relative to L_1 , i.e., between the wavetraps coil and the aerial inductance, will require some slight readjustment of the aerial condenser C_1 .

The most efficient operation of the wavetraps requires a certain amount of skill on the part of the experimenter, because there are really four factors which have to be varied. We have first of all the tuning of the condenser 34—42 (C_5 in Fig. 1), the coupling between 33—41 and 17—25 (i.e., between L_3 and L_1), the variable condenser 18—26 (i.e., C_1), and the coupling between the reaction coil 1—9 and the aerial coil 17—25 (i.e., between L_2 and L_1).

Constant Aerial Tuning

If it is desired to adapt the circuit for constant aerial tuning, the following alteration to the master key should be made.

Disconnect the lead between 51 and 26 and join 17 to 26; 51 should now be joined to 11 and 3 joined to 18. A No. 50 coil may now be tried in the 17—25 socket (i.e., the middle coil-holder) or a No. 75 when the wavelength to be received is over 420 metres.

If long-wave stations are to be received, e.g., Eiffel Tower on

2,600 metres, parallel tuning will probably be preferred, and in this case the following alterations to the master key should be made: Disconnect the lead between 51 and 26 and join 26 to 17. Now join 51 to 18; tuning of the aerial circuit is, as before, accomplished by adjusting the condenser 18—26.

Distortionless Reception

Those who are anxious to obtain purer reproduction on a loud-speaker should try connecting a fixed condenser across the anode of the second valve and the grid of the third. This may be tried on the Omni receiver by joining 37 to 6 and 38 to 16. This will place the condenser 37—38, which is a $0.001 \mu\text{F}$ condenser, in the required position. A $0.002 \mu\text{F}$ condenser may now be tried. The leads between 37 and 6 and between 38 and 16 are now taken out. The original master key is modified by taking out the leads between 45 and 21 and 46—22; 21 is joined to 37 and 22 to 38. This puts a $0.001 \mu\text{F}$ condenser instead of a $0.002 \mu\text{F}$ condenser across the primary T_1 in Fig. 1. This makes no difference to the operation of the circuit, but enables the condenser 45—46 of $0.002 \mu\text{F}$ capacity to be employed for the special experiment we have in hand. A lead is now taken between 45 and 6 and between 46 and 16. If it is desired to try an even smaller condenser than $0.001 \mu\text{F}$ to assist in the transformer coupling, the variable condenser 2—10 may be tried out, this condenser not being in use.

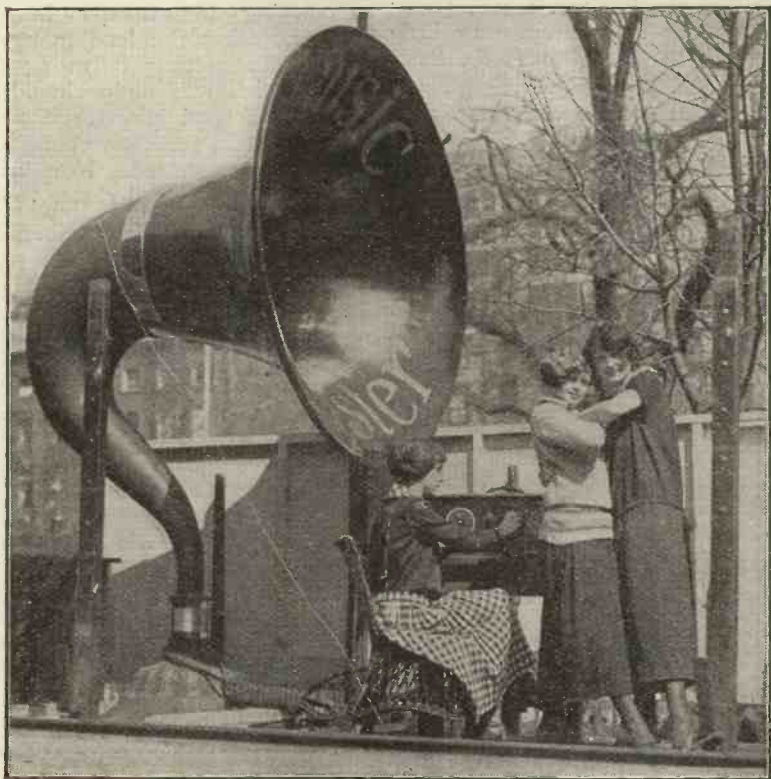

This loud speaker, built to the order of the New York Edison Co., is claimed to be the largest in the world. Six weeks were required to build the horn, 4,000 pieces of wood being used. An aluminium base houses the diaphragm of the reproducer, which in turn is connected to the receiver by a cable as thick as a thumb.

An Experimenter's Unit Receiver

By H. BRAMFORD.

Below is described the twelfth and last unit of this receiver

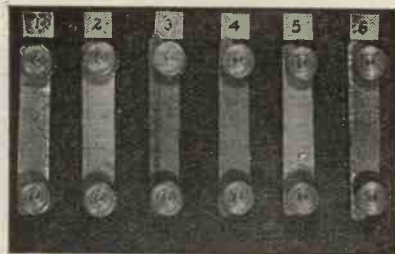

Fig. 55. Unit 12.

Unit No. 12

THIS unit takes the form of a switchboard, and is intended to eliminate confusion when difficult circuits are being tried out, and also to enable circuits to be experimented with

than those provided by the brass clips, details of which are given in Fig. 57. By this means the switches may be connected as desired. The unit may also be used as a condenser bank by soldering brass clips to the fixed

switchboard may be used for arranging a three-in-one circuit, the terminals being numbered to correspond with the numbers indicated on the panel diagram, shown in Fig. 56. The circuit is self-explanatory, and it will be seen that by manipulating the switches in different positions, as indicated, either a crystal circuit, or a crystal circuit with a note magnifying unit added, or a single valve detector circuit may be operated, as desired.

Brief details have been given throughout this series of articles in simple form, but the experimenter will have realised that great possibilities are embodied in a set of this description, and the beginner should now be in a position to progress along his own lines in arranging any circuit desired. By constructing further valve panels, etc., he will be able to operate circuits employing four or more valves, the only care needed being close attention to the connections made in joining up the panels. A series of flexible wires, of varied

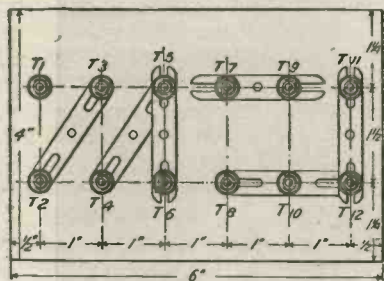

Fig. 56.—Drilling plan and panel layout.

without having to disassemble the other unit connections. A photograph of Unit 12 is shown in Fig. 55.

Panel Drilling

Details of the panel drilling are clearly shown in Fig. 56. All the holes are 4 B.A. clearance holes. The diagram also shows the different positions in which the clips may be placed, giving single, two-way, three-way or four-way connections.

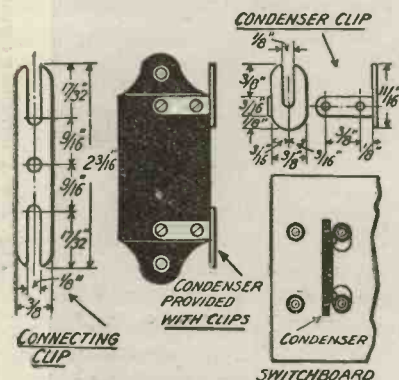

Fig. 57.—Details of the connecting links and condensers.

Assembling

Mount upon the panel the terminals T₁ to T₁₂, and the assembly is complete. There are no panel connections other

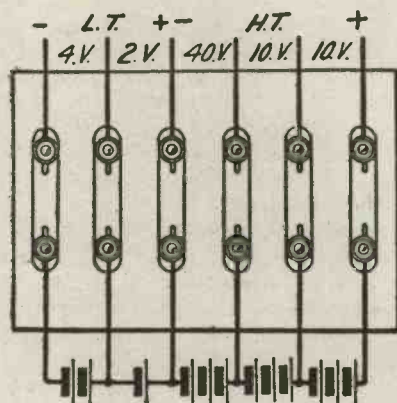
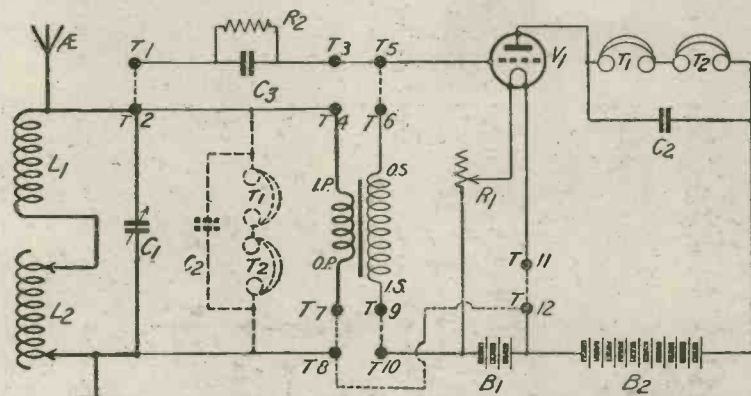

Fig. 58.—Method of using the unit for tapping batteries.

condensers and inserting them upon the panel. Yet another use to which this unit may be put is shown in Fig. 58. In this case we employ it for arranging the high-tension and low-tension battery connections.



TO OPERATE CRYSTAL DETECTOR CIRCUIT:— PHONES IN DOTTED POSITION ALL SWITCHES OUT.
 " " " UNIT WITH NOTE MAG ADDED:— SWITCH IN 7-8, 5-6, 11-12, 9-10. OTHER SWITCHES OUT.
 " " " VALVE DETECTOR CIRCUIT:— SWITCH IN 1-2, 3-5, 8-12, 12-11, OTHER SWITCHES OUT.

Fig. 59.—Illustrating how the unit may be used for experimental purposes.

Operation

The circuit given in Fig. 59 shows theoretically how the

lengths, having spade terminals at each end, are useful for this purpose.

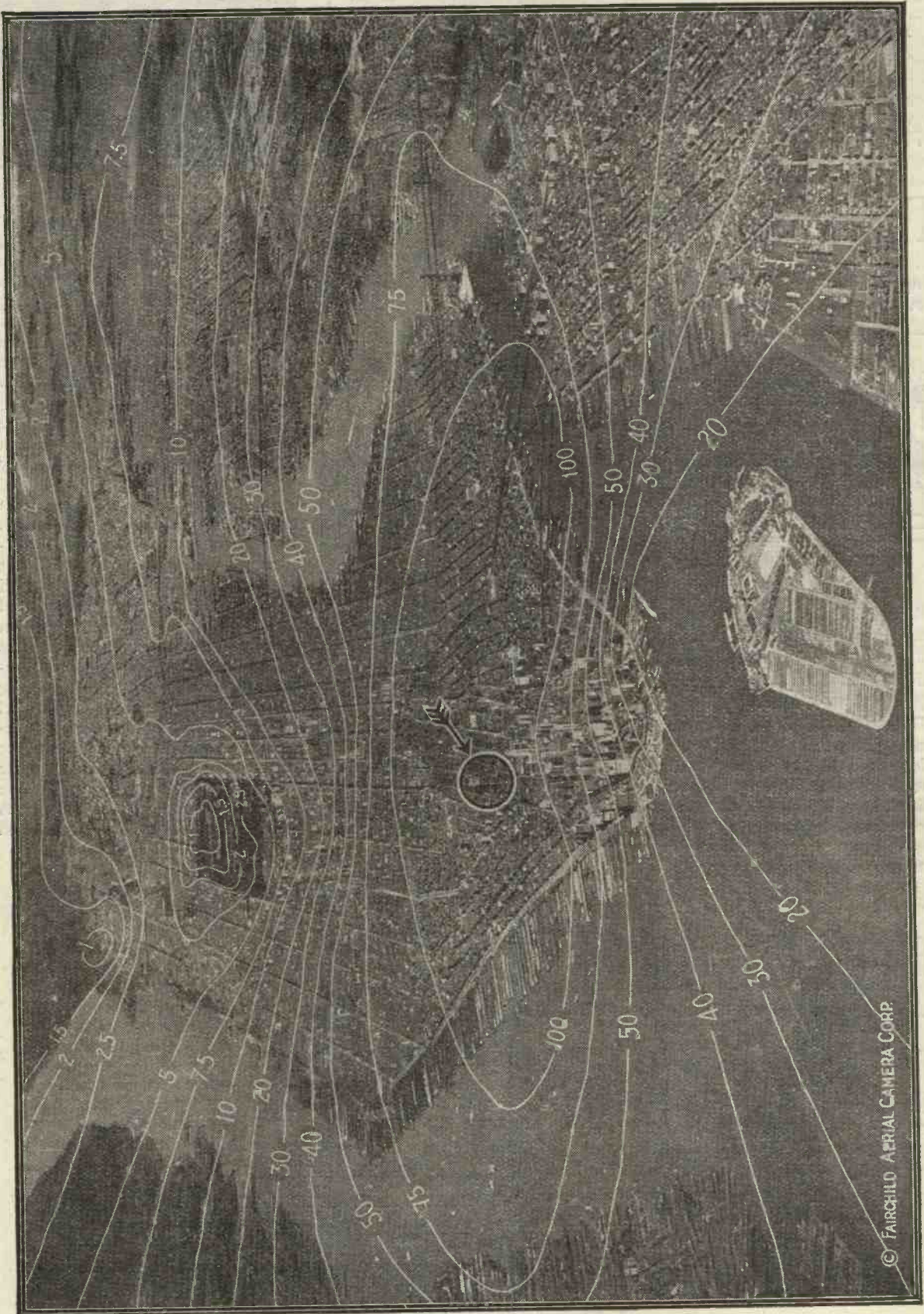

Fig. 1.—A wireless contour map of the New York area. The lines join points of equal signal strength. The broadcasting station referred to in the article is shown in the circle indicated with an arrow.

The Distribution of Signal Strength Around a Broadcasting Station

IMPORTANT LIGHT ON FADING AND "DEAD SPOTS"

Some remarkable results are disclosed in the following article

THE problems of fading and the attenuation, or gradual weakening, of wireless signals as the distance from the station increases have never been properly investigated, but some extremely interesting work has been carried out by Ralph Bown and G. D. Gillett, of the American Telephone and Telegraph Company. Tests have been carried out in and around New York, and the field strength, due to a broadcasting station, has been measured at different points and contour lines have been drawn on a map to indicate the areas where the field strength of certain value has been obtained.

The field strength is measured in microvolts per metre, and it is, of course, upon this field strength that the strength of the signals received depends.

Two Kinds of Variation

There are essentially two kinds of signal strength variations. There are those due to time variations, which cause fading at long distances. The other variations, or inequalities, are most easily distinguished at short distances where they are not complicated by the presence of time variations. It is, of course, well known that fading is not experienced within a short range of a broadcasting station, but, on the other hand, very large variations in signal strength may occur in the same town. It is a more or less simple matter, if a tedious one, to measure these latter variations, which are more or less constant.

Screening Effects of Buildings

In a rather general sense every one is familiar with the screening effect of mountains and houses, but few appreciate the enormous extent to which buildings may cause attenuation, or weakening, of the field strength from a broadcasting station. Moreover, the effect is not as local

as one may suppose, but may extend over areas quite remote from the source of absorption.

The ideal state of affairs for a broadcasting station would be to have a zone of equal signal strength around a station, and to be able to define this zone within definite limits.

Unfortunately, not only is the field strength reduced with increasing distance on account of the spreading of the energy over a larger and larger circle, but it is also reduced in addition by the fact that some of the radiated energy is transformed into heat by electrical losses in the transmission medium, and therefore lost to radio uses.

If the Earth were Flat

If the surface of the earth were flat and of uniform electrical

characteristics, the falling off in field strength of the waves, due to spreading of the energy and losses in the earth, would be perfectly uniform and circles of ever-widening radius might be drawn round the broadcasting station, the signal strength at any point on any circle being the same. As a matter of fact, however, in actual practice, this symmetrical arrangement is not found, and instead of concentric circles, the "contours" are most irregular in shape.

This is due, in large measure, to buildings in a town, but the presence of water, hills, etc., interferes very greatly.

Characteristics of Earth's Surface

The characteristics of the earth's surface which affect radio transmission may be roughly

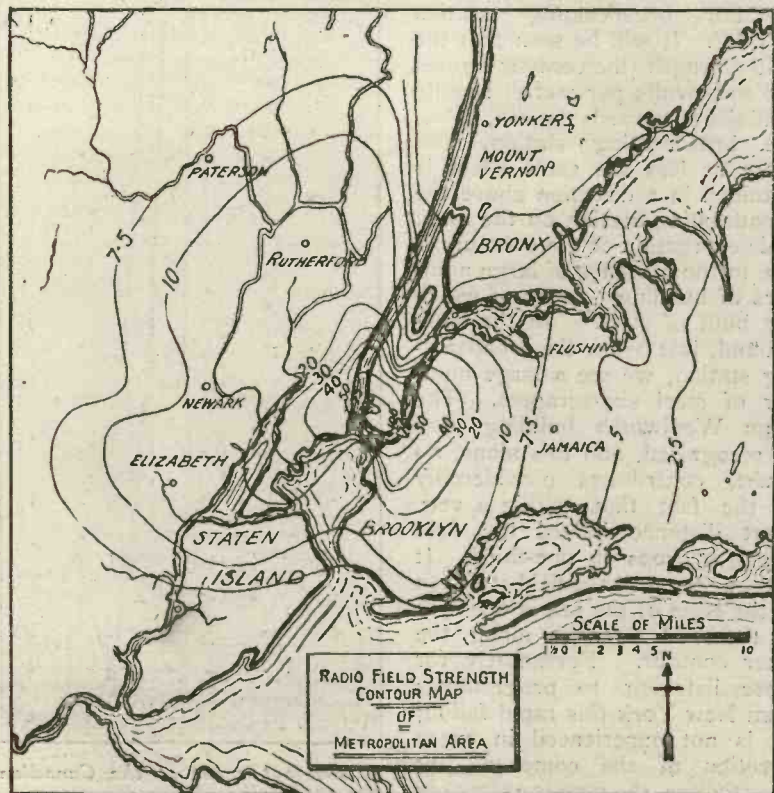

Fig. 2.—A map similar to fig. 1, but covering a wider area.

classified under three headings as follows:—

1. Areas of different electrical constants; fresh water, salt water, dry land, wet land, rock, snow, and so on.
2. Differences of elevation; hills, valleys, mountains, etc.
3. Absorbing structures; man-made buildings, towers or other structures, many of which have resonance characteristics producing selective absorption.

Investigation by the Institute of Radio Engineers

An investigation into these matters has been carried out by the two engineers mentioned above, and the results have been presented to the Institute of Radio Engineers at New York. The results have shown what is already well known, but the data are of great value and the contours are of a nature hitherto unpublished. It is therefore with great pleasure that we are able to reproduce these data for the first time in this country.

The Results

The most interesting illustration is undoubtedly that shown in Fig. 1, which is a contour map showing New York. The circle in the middle of the 100 contour is the broadcasting station WEAf. It will be seen that the field strength (the contour figures are microvolts per metre) rapidly diminishes towards the sea, below the broadcasting station, and more or less the same effect is obtained in a direction above the broadcasting station on the map. This elongation of the contours is due to the presence of large numbers of buildings, many of which are built of steel. In the foreground, just below the broadcasting station, we see a large number of steel sky-scrapers. The huge Woolworth building may be recognised, and this alone, no doubt, contributes considerably to the fact that within a very short distance indeed the field strength drops to one-third. It will be seen that the field strength at the edge of the sea is one-fifth of the field strength along the inner contour. Fortunately for those listening to programmes from New York this rapid falling off is not experienced in every direction of the compass, but nevertheless, the map is extremely instructive.

Blind Spots

If we look to a point above the broadcasting station on the map, we will see four contour lines marked 1, 1.5, 2, 2.5. These contours are very interesting because they indicate the presence of a blind spot. As a matter of fact this portion, curiously enough, is a park (known as Central Park). At this point, which is surrounded by the city on all sides, the field strength drops to as low as 1, which is as weak as many points 30 miles, or more, out in the country. Another dead spot will be noticed in the little contour by itself marked 1. This point lies down in a valley behind a hill, and the weakness of signals is probably due to the shadow of

the hill. Before leaving Fig. 1 it is to be noticed that the presence of all the buildings and steel work suck in, as it were, the contours around New York. It will be noticed, for example, that the contours 20, 30, and 40 on the bottom left-hand corner are sucked into the city and then travel outwards again to assume a more normal position. This proves that buildings, etc., can influence the strength of signals many miles away.

Open Country

Fig. 2 is another map, almost equally as interesting, and still more so in certain respects. This is a map covering a wider area, the inside portion being drawn on a larger scale in Fig. 1 on an aerial view of the city. It will be seen that the contours, at about 15 miles from the city, assume a more circular form, and that especially to the west of New York, the field strength falls off more slowly, with the result that much better signals are obtained in this direction. This is due to the good transmission over the New Jersey meadows.

The final conclusions which may be drawn are as follows:—

1. The radio attenuation over different kinds of earth surface varies widely. It is low for sea water and for flat, moist ground. For dry ground the attenuation is relatively much greater (with consequent reduction of signal strength, of course). In the case of closely-built cities filled with steel buildings the local attenuation may be enormous.
2. Sudden changes in land elevation and large masses of conducting material cast radio shadows which may be very heavy in extreme cases.
3. Shadows cause local dead spots, but usually within a relatively short distance beyond the shadow is wiped out by refraction, or defraction, of the waves.

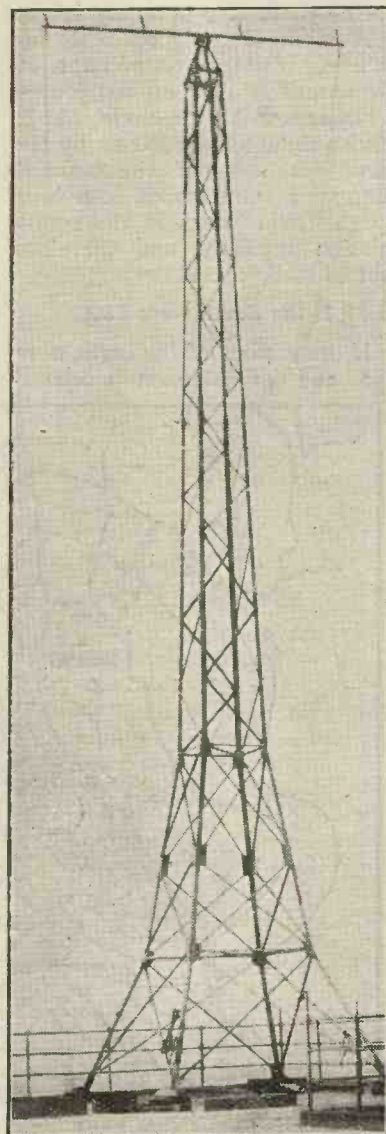

A 300-foot mast at the Canadian National Railway's new broadcasting station at Ottawa.

"MODERN WIRELESS"

The May issue of "Modern Wireless" will contain a number of valuable articles, including full working details of how to make a powerful portable receiver, how to construct a distortionless three valve receiver, and several other interesting sets. A special feature article will explain how the valve acts as a detector—a subject of great importance often shirked in text books.

Tonic-train Transmission

Although installations with ordinary non-oscillating receivers are unable to receive the continuous waves obtained from the valve transmitter, they are, however, able to receive wireless telephone speech without any special apparatus. To enable such installations to pick up

means of a buzzer. By connecting the key in circuit with this buzzer and using the latter to supply the modulating potentials, we are able to signal by Morse code, the received signals resembling those obtained from a spark station. By the use of a simple switch we can telegraph by means of continuous waves, we

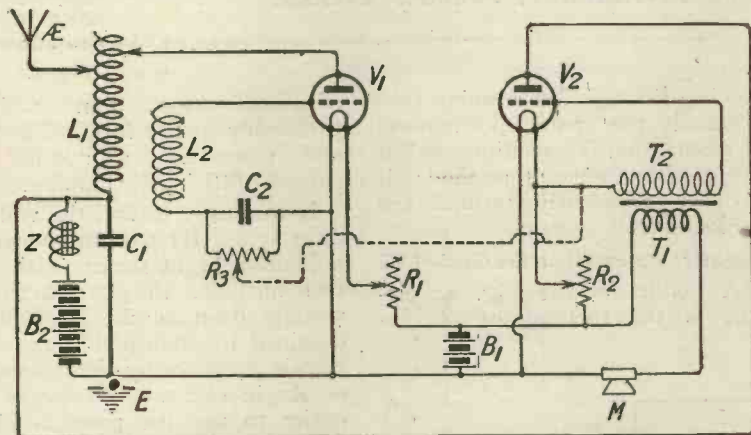

Fig. 43.—A choke-control circuit, particularly recommended to experimenters.

Morse signals from a valve transmitter we frequently arrange to modulate the radio frequency output of a C.W. transmitter by

can telegraph by means of modulated waves, or we can use the transmitter as a wireless telephone.

Fig. 44 shows how a switch may be used for modulated Morse signalling or telephony. The switch S, when in the left-hand position, places the microphone M in series with the battery B and the primary T1 of the microphone transformer T1 T2. The secondary transformer terminals Y Z provide the modulation potentials. When the switch S is over to the right the buzzer E is connected in series with B and the current from this battery operates it when the key K is depressed. The output from T1 T2 is now an alternating current.

This method of signalling Morse characters, involving modulation, is known as interrupted continuous wave (I.C.W.) or tonic-train transmission.

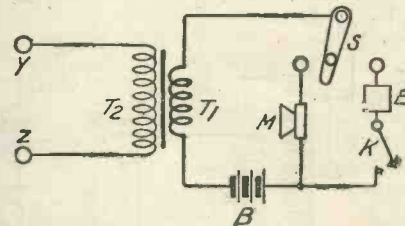

Fig. 44.—Showing how to switch over from telephony to tonic-train transmission.

Don't Overwork Valves

ONE often finds a set giving woolly and distorted reception simply because some or all of its valves are being overworked by the use of excessive filament potentials or of anode currents that are far too high. The maker's figures for their own products may be relied upon. If they tell you that the proper filament potential for a particular valve is 3.5, and that the anode voltage for rectification should be 40, do not try one extra volt on the filament and 20 or 30 on the plate. By doing so you may obtain louder signals, but they will not, as a rule, be so clear as if the valve were properly treated. Also you are shortening the life of your valve in the most certain manner possible. Speaking generally, the average general purpose valve which will work in any position requires a moderate anode voltage as a high-frequency amplifier, a small one

as a rectifier, and a high one as low-frequency amplifier, in which last case a negative grid bias is essential. Many sets never attain to real efficiency because the high-tension wiring is done upon the single busbar system. It is far better to make the set with three busbars for the high-frequency valves, the rectifier, and the low-frequency valves respectively. The same battery can be used for all valves if three high-tension positive terminals are provided each with its own H.T. lead and wander plug. This really gives the valves a proper chance of doing their best, and it leads to very much improved results. Another point to remember is that the proper use of a grid biasing battery cuts down the amount of current passed by the note magnifying valves to quite small limits without in any way reducing signal strength. This means that the high-tension

battery lasts very much longer than it would otherwise do, for note magnifying valves are apt to make a bigger drain upon it than others in the set.

R. W. H.

Another reader's views on Cardiff announcements.

SIR,—As you have published two quite extraordinary letters on the subject of the Cardiff programmes, will you allow me to say that I read your leading article with joyful thanksgiving that someone had at last said what I had been thinking for weeks.

If Cardiff listeners like that kind of stuff, let them have it by all means. But it is *not* wanted by London listeners.—Yours faithfully,

H. A. P.

Fairview Road,
Norbury, S.W.16.

Valve Notes

By
JOHN SCOTT-TAGGART,
F.Inst.P., A.M.I.E.E.



Crystal Damping

AS is well known, a crystal detector introduces a great deal of damping into any circuit associated with it. Although this fact is well known, yet very few experimenters try and overcome the trouble. In nearly every case the crystal detector and telephone receivers, or the primary of an intervalve transformer are connected across the whole of the inductance of the oscillatory circuit carrying the oscillations to be rectified.

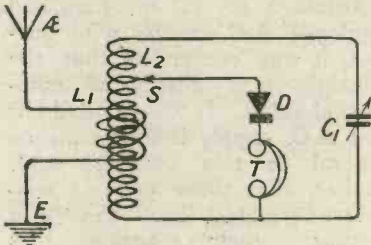

Fig. 1.—A selective crystal circuit.

A crystal detector, when receiving fairly strong signals, has a resistance of the order of 1,000 ohms which, when connected in parallel with an oscillatory circuit, has a very appreciable effect.

A Very Selective Circuit

Those who are anxious to obtain high selectivity with a crystal detector are recommended to try the circuit I give in Fig. 1. Half-a-dozen turns of insulated wire are wound round the middle of the inductance L_2 , which is tuned by means of a condenser C_1 . The crystal detector D and telephones T are connected, not across the condenser C_1 as is usual, but across only a portion of the inductance L_2 . It will usually be found that the best position is about half-way along the inductance. Under these conditions not only is selectivity obtained through the loose-coupling between L_1 and L_2 , but the damping of the circuit $L_2 C_1$ is made very much less, with the

result that the oscillations build up better and the decrement of the circuit being reduced, the selectivity of the circuit $L_2 C_1$ is much greater.

No Loss of Signal Strength

It may be argued, of course, that the potentials across the detector D are clearly not as great when the detector and 'phones are connected across only half the inductance as when they are across the whole, but whereas this argument would be fully justified if the current in the oscillatory circuit $L_2 C_1$ remained the same, yet practical results confute it, the reason being that the oscillations in $L_2 C_1$ are considerably greater in strength when the detector is connected across only a portion of the inductance. The signal strength, in most cases, will remain the same, even though the tapping is taken across only half the inductance. The same experiment, of course, may be tried on a direct-

crystal detector and 'phones being connected across the lower half of the variometer.

Application to a Valve Circuit

The increase in selectivity is the chief advantage, and this advantage may be retained in a valve set of the kind illustrated in Fig. 2, where the first valve acts as a high-frequency amplifier, being followed by a crystal detector and one stage of low-frequency amplification. It will be seen that the top half of the reaction inductance L_2 only is connected across the detector and the primary T_1 of the intervalve transformer $T_1 T_2$. Any experimenter who has spent much time on a circuit using high-frequency amplification, followed by a crystal detector, will have found that the addition of a crystal detector seriously interferes with the selectivity of the set, which is much less than when a plain tuned anode circuit is used, followed by a valve detector. The

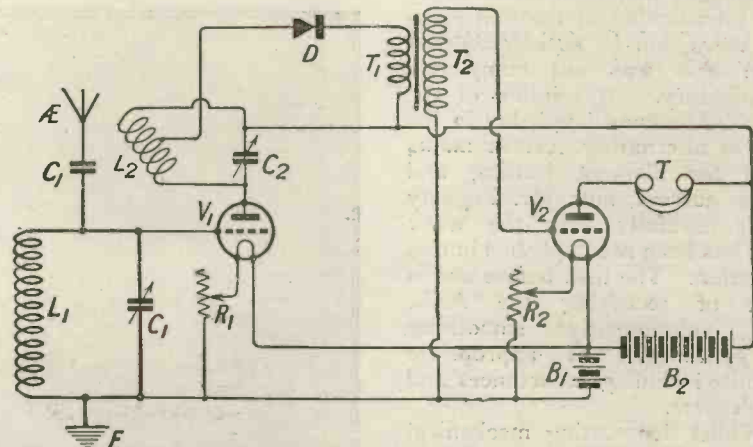

Fig. 2.—The principle applied to a circuit consisting of one high-frequency amplifier, crystal detector, and one note magnifier.

coupled aerial circuit, and one of the most popular crystal sets in the State consists of a $0.0003 \mu F$ fixed condenser in the aerial lead, followed by a variometer, the

valve detector, although it introduces a certain amount of damping into the tuned anode circuit, only does so to a much smaller extent than a crystal, because the

grid currents are small and the gridleak has a high value. Workers with the ST100 circuit will also experience a certain deadness in tuning the tuned anode condenser. This effect is more noticeable in the case of certain adjustments of the crystal than in others, the reason being that the greater the pressure on the crystal the greater the damping and the greater the decrement to the tuned anode circuit, with the consequent result of inferior selectivity. A very light contact on the crystal detector, however, increases the sharpness of tuning on the secondary condenser, this

being due to the fact that the damping is less, due to the resistance of the crystal detector being higher.

In those cases where an experimenter finds he gets better results with the crystal detector disconnected on the ST100 circuit, the chances are that he is either using a very poor crystal detector or that by releasing the detector a greater degree of reaction is obtained, and the probability is that with the crystal detector in, and the consequent damping, he cannot obtain sufficient reaction to neutralise the damping effect of the crystal detector.

A rather curious effect that is obtained when using a crystal detector is that, even though the damping of the oscillatory circuit may be reduced so that the first valve is just on the point of oscillating, the selectivity of the anode circuit is not so great as when using the ordinary tuned anode method of coupling.

The arrangement of Fig. 2 is certainly worth trying, whenever a crystal is used in conjunction with a high-frequency amplifying valve, although when plug-in coils are used it is rather difficult to make a neat job of it.

The Radio Society of Great Britain

Report of Informal Meeting held at the Institution of Electrical Engineers, on the 9th April, 1924.

THE use of A.C. mains as a means of dispensing with accumulators and dry batteries in wireless reception formed the basis of a discussion at an informal meeting of the Radio Society of Great Britain held on April 9, at the Institution of Electrical Engineers.

In opening the discussion, Mr. L. F. Fogarty, A.M.I.E.E., referred to the low efficiency and inconvenience of accumulators and the short life of high-tension batteries. To some extent these drawbacks had been obviated by the introduction of the dull emitter valve, but he considered that even this was not completely satisfactory. A solution of the trouble, he considered, lay in the use of alternating current mains both for filament heating and plate current, and Mr. Fogarty dealt carefully with the work that has been accomplished in this direction. The task before one is that of rectifying the A.C., and subsequently smoothing it by means of appropriate circuits including inductances and condensers.

Whilst deprecating mechanical devices, Mr. Fogarty spoke in favour of the electrolytic rectifier, and his remarks concerning the use of thermionic valves for the purpose were interesting. Certain disturbances are produced by heating the filaments of valves with A.C., and these were classi-

fied as follows:—Firstly, those due to the varying voltage introduced into the filament plate and the filament grid circuits; and, secondly, those due to the low thermal inertia of the filament. To overcome this, Mr. Barthelmy patented in 1919 a method whereby the grid was connected to the middle point of the filament in such a way that when one half of the filament is positive in respect of the common point of connection between the

plate and the filament, the other half becomes negative.

Although several speakers had employed A.C. mains with success, it was contended that the principle was hardly of commercial value. It was pointed out that A.C. supply is by no means general in this country, and, further, that those persons who suffered greatest inconvenience in getting their accumulators charged are for the most part without access to A.C. mains.

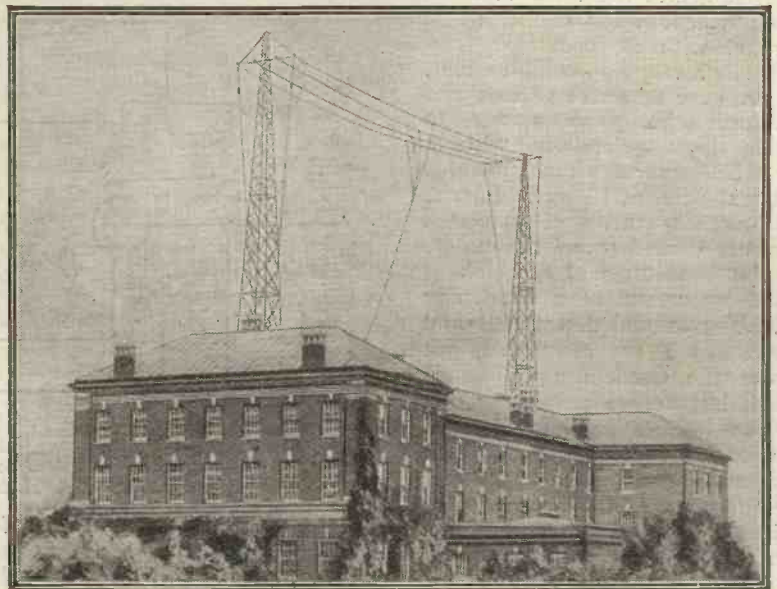

The well-known American broadcasting station WHAZ, which has often been heard in this country by readers of "Wireless Weekly."

The Microphone at 2LO

The first published account of the Round microphone as employed by the B.B.C. at 2LO and at Wembley.

Fig. 1—The microphone itself is very carefully suspended.

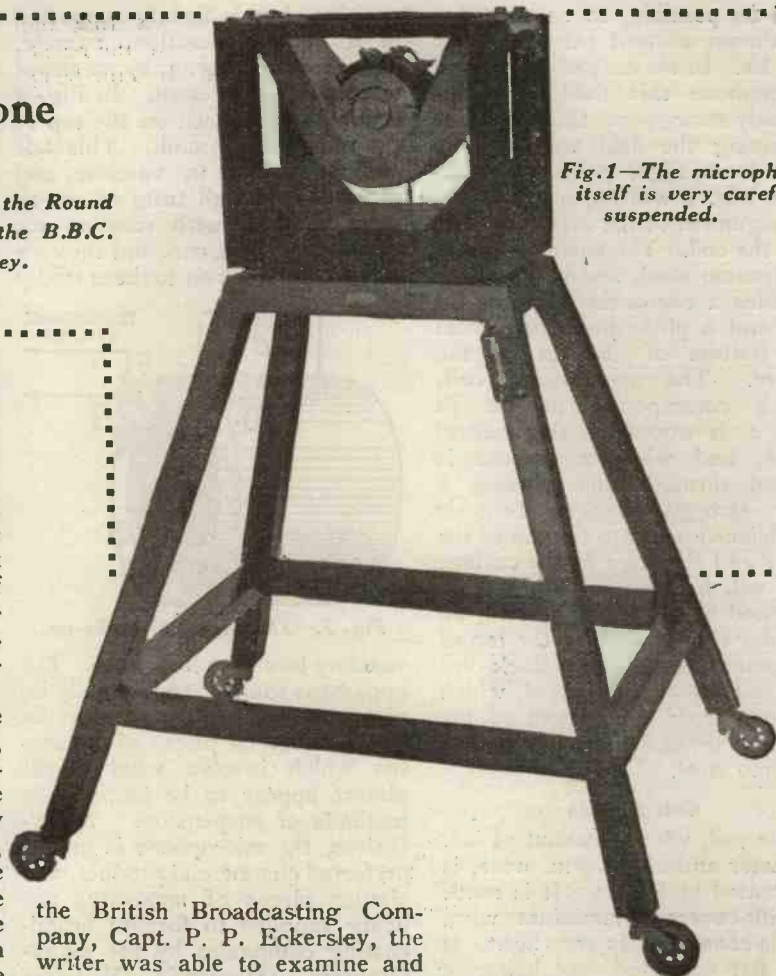

MANY rumours regarding the exact nature of the microphone at 2LO have been spread, and many of these are entirely wide of the mark. Readers of *Wireless Weekly* will therefore be pleased to have placed before them the first technical account of a type of microphone which gives remarkably fine results, and which has taken years to evolve to its present high stage of perfection.

The principle on which the microphone works is very old, and, curiously enough, the microphone itself is a very simple piece of apparatus operating on a very simple principle. Nevertheless, the stages of development have been gradual, and innumerable practical troubles have had to be eliminated by very careful design and many models were made before the present one achieved exactly that standard of reproduction which is so necessary for effective broadcasting.

B.B.C. Intentions

The work on this microphone has been carried out by Captain H. J. Round, and we believe we are right in saying that it is proposed to equip the other B.B.C. stations with this apparatus.

the British Broadcasting Company, Capt. P. P. Eckersley, the writer was able to examine and take note on the microphone and its auxiliary apparatus.

Fig. 1 is a photograph of the microphone, which very much resembles a large cocoa tin measuring about 5½ ins. by 8 ins. laid on its side supported in a hammock, which is designed to obviate any shocks to the microphone.

The Principle explained

The principle on which the microphone works is the same as that of a magnetophone. It is well known that if one speaks into an ordinary pair of telephone receivers the movement of the diaphragm will vary the magnetic field through the coils of wire and set up varying currents which may be transmitted to another pair of telephones in which the speech or signal will be heard. It is quite easy to try this with a pair of ordinary ear-pieces, one in each room, or with a loud-speaker and a pair of telephones. No battery, of course, is required because the currents are generated by a movement of the diaphragm which produces a variation of the

magnetic field. The same principle may be employed if the magnetic field is made to influence a coil of wire placed in it, this coil of wire being readily movable. If speech is made to cause the coil of wire to move, this movement in the magnetic field will set up varying currents in the coils and this current may be made to operate telephone receivers.

Fig. 2 shows, more or less, what happens in the case of the Round microphone. A coil of wire L_1 has its ends connected to two terminals Y Z, and is suspended in front of a magnet which may consist of a piece of iron on which is wound a coil L_2 , current from a battery B magnetising the iron bar. Sound waves, approaching in the direction of the arrow head, moves the coil L_1 , and so alters its position with regard to the magnetic field produced through the coil by the magnet.

Great Field Strength

It is, of course, desirable when using this arrangement as a microphone to have as strong a

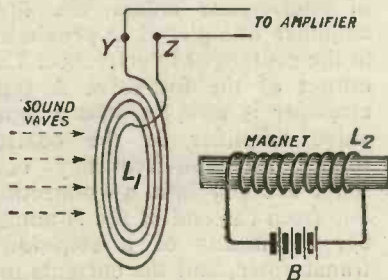

Fig. 2.—The elementary principle explained.

Capt. Round is certainly to be congratulated on carrying to a successful conclusion a distinct engineering achievement.

Thanks to the unflinching courtesy of the Chief Engineer of

field as possible, so as to get a maximum current set up in the coil L_1 . In the case of the Round microphone this field is exceptionally strong, and the method of obtaining the field will best be seen from Figs. 3 and 4. Perhaps Fig. 4 will explain best the arrangement of the magnetic field and the coil. The casing is made of dynamo steel, and in shape resembles a cocoa tin with the lid off, and a pillar projecting from the bottom of the tin up the centre. The magnetising coil, which corresponds to L_2 in Fig. 2, is wound on this central pillar, and when a current is passed through this winding a very strong magnetic field is established between the top of the pillar and the edge of the casing.

It will be seen in Fig. 4 that, fastened by means of screws, an annular ring is fixed to the top of the outer casing, and a thick disc is fixed to the standard, which projects from the bottom of the casing; these fittings are also of dynamo steel.

Coil Details

The coil, which is about $3\frac{1}{2}$ ins. diameter and about $\frac{3}{4}$ in. wide, is illustrated in Fig. 5. It is made of silk-covered aluminium wire, and is consequently very light. It is a flat coil, and, not being of basket formation, requires support which takes the form of an annular paper ring the same size as the coil. The coil is stuck on to this paper ring by means of rubber solution. The two ends of the coil are connected to the terminals T_1 and T_2 , which are shown in both Fig. 3 and Fig. 5. In Fig. 3 they are shown simply going in front of the microphone, but in Fig. 5 the actual details are given. The leads, as a matter of fact, are wound round lengths of cotton wool marked C, this being to damp down any tendency for the wires to vibrate, because it was found in earlier experiments that these connecting wires resonated to their own frequency, which greatly interfered with the purity of reproduction. It is a consideration of such small details that has led to the perfection of the completed instrument.

How it is mounted

The coil itself takes up the position shown in Fig. 4, the flat coil being shown in cross section. The coil is not securely fixed in

position, but is lightly supported in a vertical position, namely, that shown in Fig. 3, by means of vaselined cotton wool. In Fig. 4 a felt pad is placed on the top of the magnetising coil. This felt pad is soaked in vaseline, and about three small tufts of cotton wool smeared with vaseline are stuck on this felt pad, and the very light coil is stuck on to these sticky

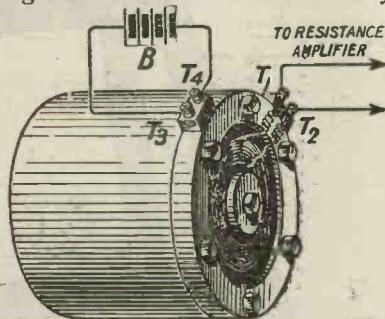

Fig. 3.—The practical make-up.

vaseliny bits of cotton wool. The apparatus sounds, and actually is, rather messy, and there must be few commercial pieces of apparatus which involve what might almost appear to be home-made methods of suspension. Nevertheless, the microphone is now a perfected commercial product, and similar pieces of apparatus are being supplied to foreign broadcasting companies by the manufacturers (Marconi's Wireless Telegraph Company Ltd.). This method of suspension, which seems very rough and ready, appears to be essential to get that absolute dead-beat effect so neces-

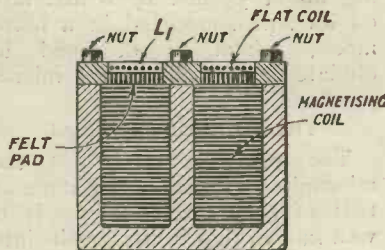

Fig. 4.—A sectional view of the magnet and coils.

sary to avoid all resonance effects. The microphone will actually work by holding the light coil in the hand in front of the microphone, but, of course, some permanent method of suspension is necessary, and the apparently rough-and-ready method described seems to be the best. The movement of the "diaphragm" (the suspended coil) is probably of the order of a thousandth part of an inch.

A Remarkable Feature

The most remarkable feature of the microphone is its extreme insensitivity. When speaking close to the microphone it is impossible to distinguish any sound at all in a pair of telephone receivers connected across the output terminals of the coil. It is, in fact, impossible to use telephones at all in any manner whatsoever without the use of amplification. The microphone, therefore, is essentially a device for giving very pure reproduction, but very weak signals. One might imagine that this would result in a lot of incidental noises being amplified, but every precaution is taken to see that the output currents of the microphone are not interfered with before amplification. The current taken to magnify the core of the microphone is taken from an 8 volt. accumulator, the current being 4 amperes. The output currents, which are taken from the terminals T_1 T_2 in Fig. 3, are applied to the input of a five-valve resistance amplifier, which is known as the A amplifier. This is a resistance-coupled amplifier properly designed to avoid all possible distortion.

Amplifier arrangements

The amplifier is placed as near to the studio as possible, and when broadcasting from a theatre or from any other distant spot, the A type amplifier is always kept within a few yards of the actual microphone. This is to prevent induction effects picked up by the leads being amplified by the five-valve amplifier. In a building such as 2, Savoy Hill, the lighting system and the lift would certainly cause a great deal of interference unless the first amplifier was placed in proximity to the sources of interference. The output of the five-valve A type amplifier is now fed into a four-valve amplifier in the control room; the low-frequency currents are fed into a connecting line from the end of the A amplifier by means of a step-down transformer, and the currents are then stepped up again to feed into the grid circuit of the four-valve resistance amplifier. Two transformers are therefore used, the reason again being to prevent the troubles due to long leads in the grid circuits of the four-valve amplifier. The four-valve ampli-

fier is fitted with controls, and the output feeds the line going to the actual broadcasting station. Here there is a sub-control valve which amplifies the low-frequency currents, which are then passed on to the control valve of the main transmitter, which is of the choke control type.

Before being fed into the transmitter proper the microphone currents are therefore amplified by ten valves, and all these stages

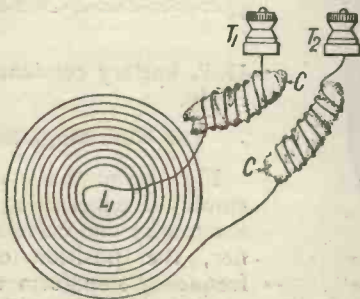

Fig. 5.—How resonance in the suspension is obviated.

of amplification are accomplished without distortion, a remarkable achievement.

Before actually being passed over to the transmitting station, the signal strength, we noticed, was equivalent to loud signals in telephone receivers.

J. S. T.

The Telephone Condenser

If no note magnification is used a telephone condenser may be unnecessary with either a crystal or non-regenerative valve set; but when the receiver is a single valve reaction set, or if signals are increased to a large volume by the use of low-frequency amplification, it is generally found that it is an advantage to shunt the telephones or the loud speaker with a condenser. Those who have tried the experiment of placing the loud speaker in a room far from that which contains the wireless set and connecting it up by means of a long stretch of flex may have noticed a distinct improvement in the quality of the signals received. This is due to the added capacity of the long wires which are very close together and separated by a fairly efficient dielectric. In such cases, when the loud speaker is

reinstalled in its own place, a considerable improvement may be effected by increasing the size of the shunted condenser. This has the effect of flattening the resonance so that the instrument does not respond so readily to certain frequencies which, without the condensers, it would have a tendency to over emphasise. The writer uses a clip-in condenser across the output terminals of his set, and alters the capacity to suit the particular loud speaker that is in use. With some types it will be found that a large condenser—up to as large as .01 μ F occasionally may make the reproduction of orchestral items very much

more mellow. But such a condenser is usually too large for the reception of speech. If the loud speaker requires a large condenser when music is coming in it is best to arrange a "speech-music" switch by means of which a large or small capacity can be thrown into shunt at will.

Manufacturers have an excellent opportunity to provide experimenters with a condenser variable in steps with a switch so that suitable values can be found with ease. One such device, known as a tone-filter, is already available, but there should be many others.

R. W. H.

FAMOUS STARS AT 2LO



Mary Pickford and Douglas Fairbanks, so often seen yet seldom heard, reversed the usual procedure at 2LO recently, and for once were heard yet not seen. Notice the Round microphone in practical use.

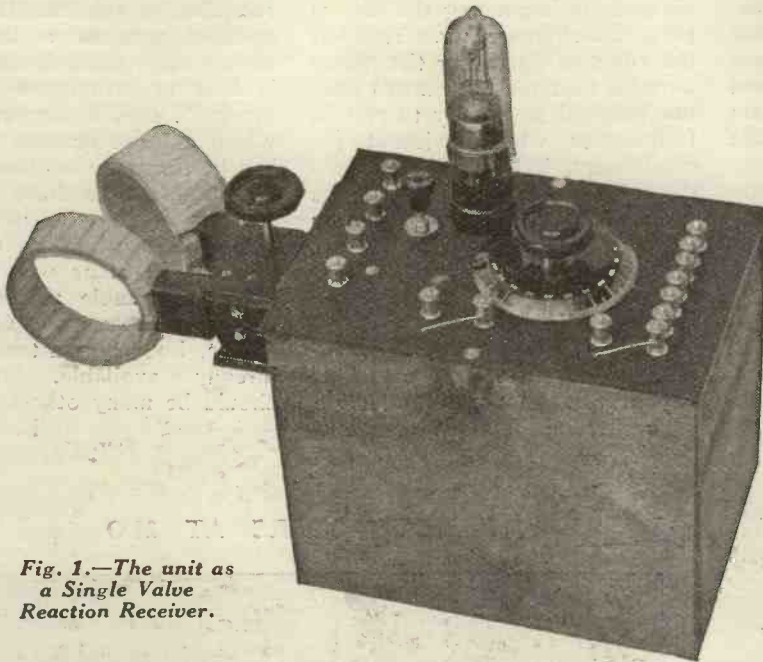

Fig. 1.—The unit as a Single Valve Reaction Receiver.

THOUGH the unit to be described is intended primarily for use as a single-valve reaction receiver, its design is such that with a few rapid changes in the external connections other purposes may be found for it.

For instance, by removing the aerial coil from its socket and performing two other equally simple operations, the unit becomes a single-valve note-magnifier, which may be added to any crystal or valve receiver for further amplification.

Another purpose to which the unit may be put is that of converting any crystal receiver to a single-valve reflex receiver without any further complications than connecting both crystal and unit together by means of straight-forward external connections.

The receiver, when used as a straight single-valve set, may be seen in the first photograph, whilst the second photograph shows the unit for use as a low-frequency amplifier. It will be seen from this latter illustration that the reaction coil socket is short-circuited, though this is not necessary so long as the reaction coil, if left in, is not of too big dimensions, i.e., not exceeding a No. 150 plug-in coil.

The third photograph shows an underneath view of the panel, and will give to readers some conception of the disposition of components and the method of wiring employed.

General Remarks

To permit the use of either bright or dull emitter valves the unit is fitted with a suitable filament resistance, and experiment with both types of valves leaves nothing worthy of comment. The method of tuning is that of plug-in coils, enabling therefore a variety of wavelengths to be covered without inconvenience or further construction.

The wiring of the receiver is carried out with stiff wiring, as may be seen from the third photograph, though readers may, if they prefer, utilise the more common practice of employing soft-drawn copper wire and insulating sleeving.

The Single-Valve Circuit

When the unit is used as a single-valve reaction receiver the circuit employed is that shown in Fig. 2, in which L_1 is the aerial inductance tuned by the variable condenser C_1 , and L_2 is the reaction coil; R_2 and C_2 are the usual grid-leak and condenser, whilst C_4 and C_5 are the telephone and

A Trip

By **STANLEY G. RATTEE,**

An easily constructed unit, which, receiver, may be used as a note reflexing circuit.

H.T. battery condensers respectively.

The Note Magnifier Circuit

Fig. 3 shows the arrangement employed when using the unit as a straight one-valve note magnifier, the position of the low-frequency transformer being indicated by OP, IP, OS and IS, the only difference in the remaining connections being the elimination of the reaction coil.

The Circuit

In order that the two circuits just given may be connected with the maximum simplicity and yet retain the utmost efficiency in both arrangements, the circuit of the unit is illustrated in theoretical form in Fig. 4, from which the reader will quickly gather

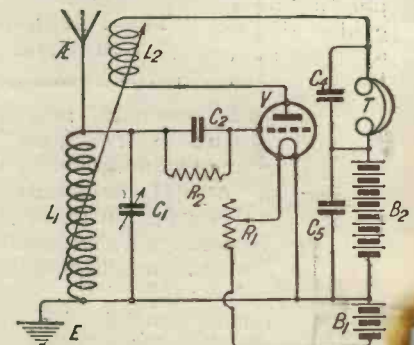

Fig. 2.—The Single Valve Receiver circuit.

how the circuits of Figs. 2 and 3 are evolved; in order to simplify the diagram as much as possible, the aerial and reaction coils are omitted.

The Reflex Circuit

Still another circuit which may be used with this unit is that illustrated in Fig. 6, which is a

le Unit

M.Inst.Rad.E., Staff Editor.

besides being an efficient broadcast magnifier, or for the purpose of crystal receiver.

simple single-valve reflex circuit. The reader will recognise in this diagram all the features of the preceding circuits, with the exception of L_3 , the crystal detector, and C_3 .

The translation of this circuit is found in the combination of a crystal receiver and the unit under description in the following manner: L_1 is the aerial inductance tuned by the condenser C_1 ; C_2 is the grid condenser with leak removed; L_2 is the aerial inductance of the crystal receiver tuned by the condenser C_3 (in cases where the crystal receiver is tuned by a variometer or slider C_3 will be omitted); OP, IP, OS and IS indicate the low-frequency transformer; D the crystal detector, and L_3 a radio-frequency choke consisting of a No. 250 plug-in coil situated between the grid of the valve and the OS terminal of the low-frequency transformer. The remainder of the

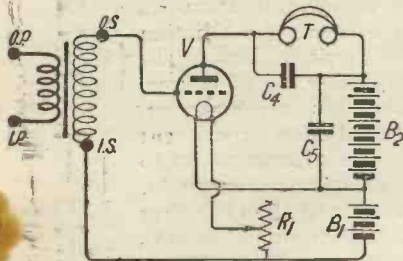

Fig. 3.—The Note Magnifier circuit.

circuit will be recognised as being the same as in the previous arrangements.

Components and Materials

The materials embodied in the receiver as illustrated are given hereunder, and though readers may, of course, vary in their choice of components, it is essen-

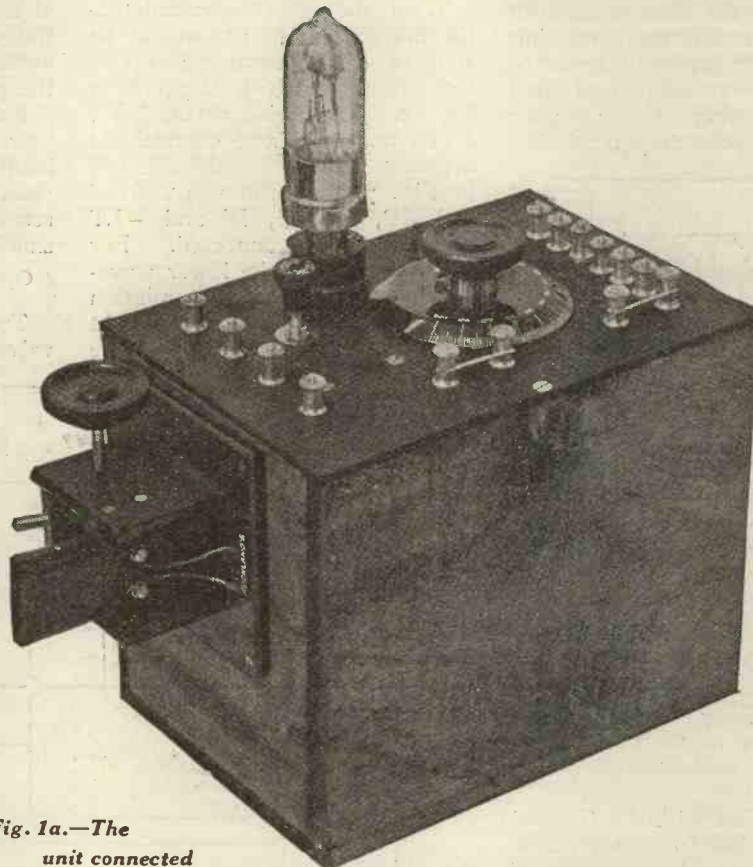

Fig. 1a.—The unit connected for use as a Single Valve Note Magnifier.

tial that the values as given are adhered to:—

- 1 ebonite panel measuring 8 in. by 5½ in. by ½ in.
- 1 two-coil holder (that illustrated is by Aucklands, Ltd.).
- 1 valve socket (McMichael, Ltd.).
- 1 Lissenstat minor (Lissen, Ltd.).
- 1 grid leak of 2 megohms value (Dubilier).
- 1 grid condenser 0.0003 μ F (Dubilier).
- 1 variable condenser 0.0005 μ F (Bowyer, Lowe Co., Ltd.).
- 1 low-frequency transformer (General Radio Co., Ltd.).
- 1 fixed condenser 0.002 μ F (Dubilier).
- 1 similar condenser 0.05 μ F (Dubilier).
- 14 terminals.
- 1 containing box 8 in. by 5½ in. by ½ in. and 5½ in. deep.
- Quantity of connecting wire.
- Set of plug-in coils for the wavelengths desired: For British

broadcasting, School of Posts and Telegraphs, Paris, Concert coils; for Eiffel Tower, Paris, Nos. 200 and 300; for Radiola, Nos. 150 and 200; for Königswusterhausen and Lyons, Nos. 300 and 400.

1 pair 2,000 or 4,000 ohms telephones.

1 accumulator to suit the valve chosen (6 volts for a bright emitter or 4 volts for a dull emitter).

1 50-70-volt H.T. battery.

If the unit is to be used for reflexing a crystal receiver, then a No. 250 coil will also be required.

The Panel

The layout of the panel is given in Fig. 7, from which diagram the purpose of the various terminals may also be seen. The actual dimensions of the condensers and transformers must of necessity vary with the components chosen and care must be exercised if other components are chosen. After the ebonite

panel has been drilled and squared up, the constructor should treat the ebonite on both sides with a thorough rubbing of fine emery paper in order to remove the possibility of bad surface causing either poor reception or poor amplification.

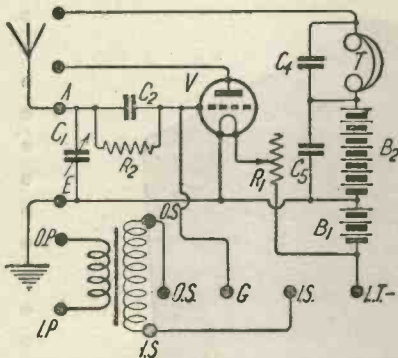

Fig. 4.—The circuit of the unit.

Wiring the Unit

A careful study of the photograph showing the underside of the panel and Fig. 8, which is a practical wiring diagram, will make it clear to the constructor exactly what is demanded of his mechanical skill.

In connection with the General Radio Co.'s low-frequency transformer, the usual markings of OP, IP, OS and IS, are not adhered to, and for that reason readers must bear in mind the fact that the relationship between the letters given in Fig. 8 are $S_2=OS$, $S_1=IS$, $P_1=IP$, and $P_2=OP$.

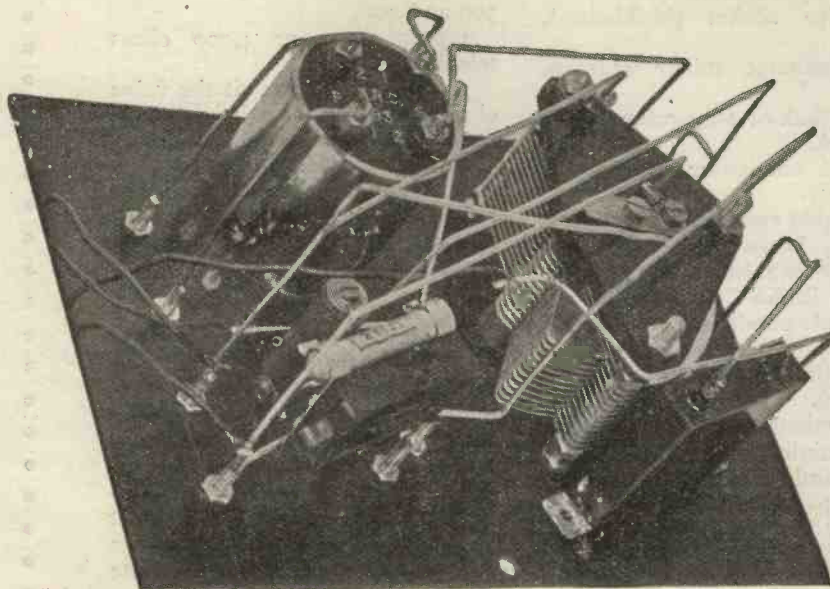

Fig. 5.—The underside of the panel showing components and wiring.

Operating the Unit as a Valve Receiver

With the receiver completed, the first circuit to try should be that of a single-valve receiver, the circuit of which is given in Fig. 2. The aerial, earth, L.T., H.T., and telephone connections are made to the terminals indicated in Fig. 7, the terminals marked OP, IP, OS, G, IS and -LT remaining disconnected. For the reception of the lower waveband of B.B.C. transmission insert the smallest of the concert coils in the aerial socket and the

operations with a slow movement of the aerial tuning condenser, at the same time slowly bringing the reaction coil nearer to the aerial coil, avoiding in so doing the possibility of oscillation.

For the reception of the higher waveband of the broadcast wavelengths the largest of the concert coils should be inserted in the reaction socket, and the next smallest in the aerial socket.

Operating the Unit as a Note Magnifier

To utilise the unit as a single-valve L.F. amplifier, connect the

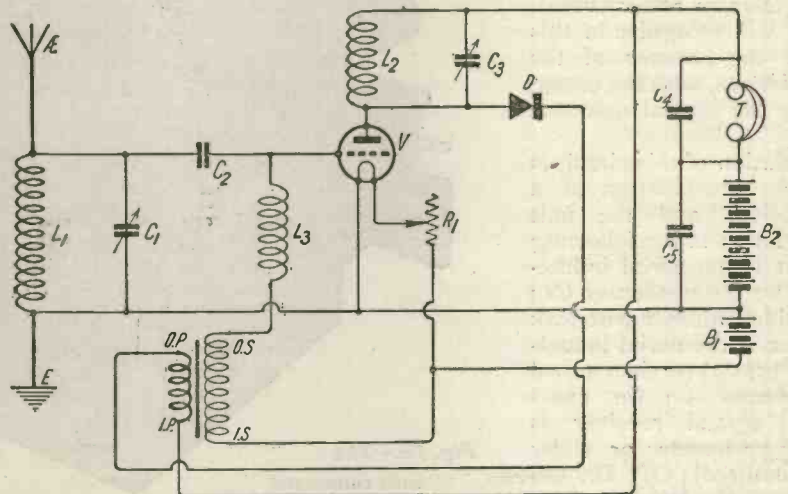

Fig. 6.—The reflex circuit; the crystal receiver is indicated by L_2 , C_3 , and D .

next largest in the reaction coil socket. Turn the reaction coil at right-angles to the aerial coil and switch on first the H.T. and then the L.T., following these

terminals OP and IP to the output or telephone terminals of the crystal or valve receiver whose signals are to be amplified. Connect OS to G, IS to -LT, remove the aerial coil from its socket, short-circuit the reaction socket and switch on. The variable condenser is, of course, not used in this arrangement. It may be found upon experiment that reversing the connections to OP and IP may improve signals, and for this reason the changing of the connections should always be tried before making the final adjustments for the evening's work.

How to Use the Unit for Reflexing

In order to use the unit in conjunction with a crystal receiver in reflex fashion, it is necessary to first remove the grid-leak R_2 . The connections for this arrangement of circuit are aerial, earth, telephones, L.T. and H.T. batteries to their respective terminals, as given in Fig. 7. The aerial terminal of the crystal

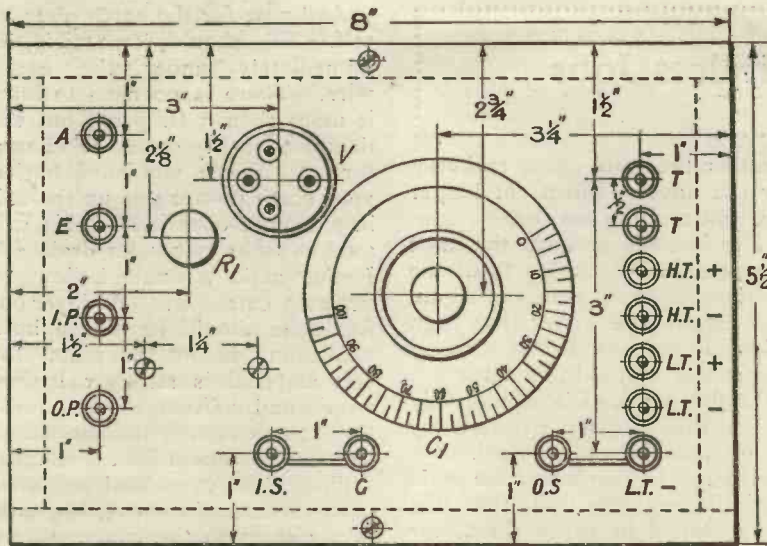

Fig. 7.—The panel layout and dimensions.

receiver is connected to the plate of the valve, or in other words, the lead from the plate, which normally would go to the reaction coil; the earth terminal of the crystal receiver remains disconnected. The telephone terminals of the crystal receiver are one connected to the OP of the LF transformer and the other to IP.

the IS terminal being connected to the L.T. negative terminal.

Operating the Reflex Circuit

Insert in the aerial socket a coil suitable for broadcast reception, switch on both H.T. and L.T. batteries and adjust the crystal detector, tuning the receiver by means of the condenser of the

phone terminals of the crystal receiver should be reversed, upon which the receiver will be found to be highly sensitive and critical in its adjustment.

Blueprints

For the benefit of those readers who prefer to work from full-size drawings, blueprints of the wiring diagram, Fig. 8, are being prepared.

When applying for these full-size drawings, readers should quote "Blueprint No. 37" addressing their application to the offices of this journal, enclosing rs. 6d.

Results

With the receiver as illustrated, and used as a straight valve set upon a moderate aerial in South London, 2LO is reasonably loud on a small loud-speaker, whilst Bournemouth, Birmingham, Aberdeen, Glasgow, Plymouth, School of Posts and Telegraphs, and Radiola are easily audible on telephones, and offer little difficulties in tuning. When the unit is used as a reflex receiver, Birmingham, Bourne-

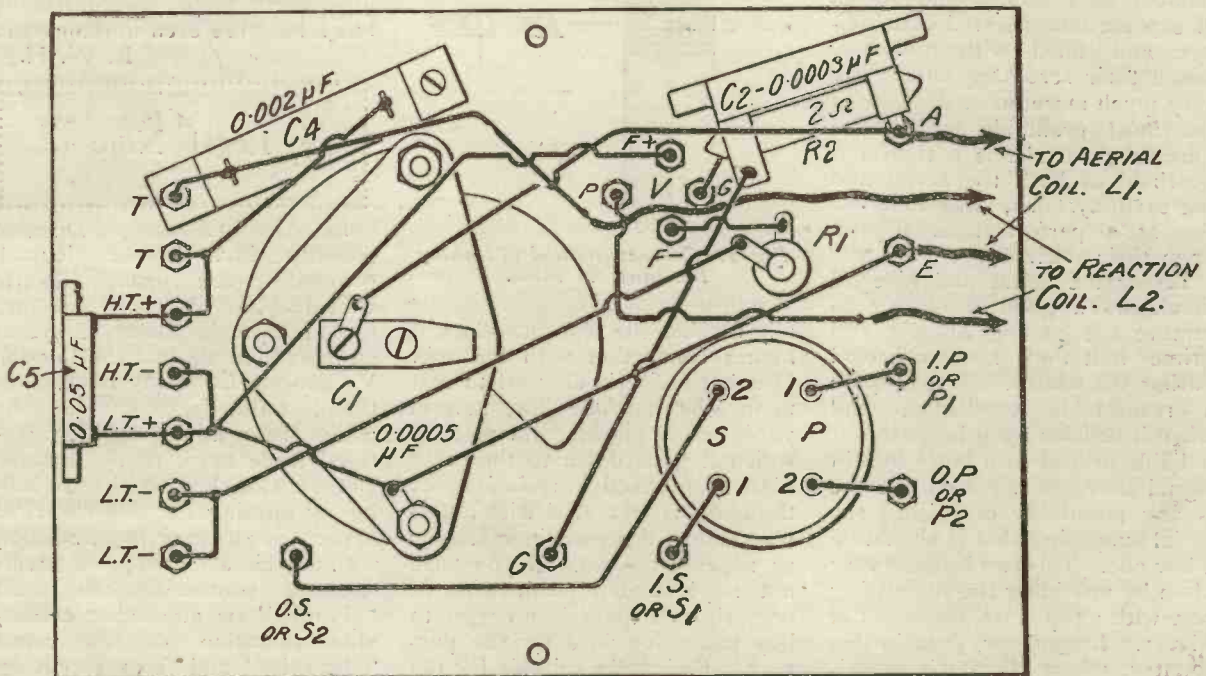

Fig. 8.—Practical wiring diagram. Blueprint No. 37.

The terminal of the Unit marked G, is connected to one side of a No. 250 plug-in coil, the other side of which is connected to the OS terminal of the unit;

unit and the tuning arrangements of the crystal receiver. If the operator finds that no signals can be heard the absence denotes that the connections to the tele-

mouth, Plymouth, Cardiff and, obviously, London, can be easily heard on a small loud-speaker in the same district as previously mentioned.

Spring-Time Wireless Jobs

WITH the coming of the longer days and of summer time every wireless man should realise that he can profitably employ his spare time in bringing his receiving set right up to the mark. In winter reception is always at its best; even a moderately efficient receiver therefore may function quite satisfactorily. But when the summer comes it is only a really well-cared-for set that is able to bring in signals with no diminution in their strength and does not suffer greatly from a shortening in its range. In winter most of our reception is done during the hours of darkness, when conditions are at their best for wireless. The ground is usually damp, which means that the range of transmitting stations is automatically increased; in summer daylight or twilight reception is the rule, and the soil is often baked hard and dry. Further, trees which in the colder months were leafless and devoid of sap are now covered with foliage and filled with moisture, hence their screening effects are very much more marked. One of the most profitable spring-time jobs to undertake is a thorough overhaul of both the aerial and the earth systems, since much of the set's performances depend upon their efficiency.

Lower the aerial and give all insulators a good scrubbing to remove the coating of soot and grime that they have collected during the winter. Soot is quite a respectable conductor, and when it collects upon insulators it is liable to lead to a large loss in signal strength. Next see if there is any possibility of raising the aerial supposing that it should be a low one. This can be done very often by providing the supporting pole with a top mast, as shown in Fig. 1. In summer, even in this country, whose climate is notorious, violent gales and snow-storms are not of very common occurrence, so that such a top mast need not be a very strong affair. It should be taken down again if the aerial does not seem stable enough as winter approaches. The extra height in

summer time will go to make up for the adverse effects of longer daylight and dry soil.

The earth is perhaps the most neglected of all the parts of the average receiving station. Again and again the writer has been asked by a friend to come round and render first aid to a set which refused to work as it should, only to find that the whole trouble lay in an unsatisfactory earth connection. In summer time it is particularly important that the earth should be of the best, for when the soil is dry its resistance increases and a poor connection may lead to an immense falling off in results. The earth lead should be insulated until it actu-

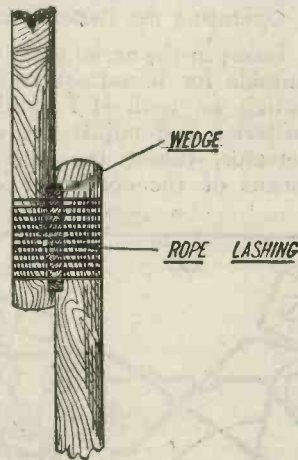

Fig. 1.—Correct method of lashing top-mast to mast.

ally reaches the place at which it makes connection with the soil. If a bare wire is allowed to rest upon the surface for several yards before reaching the place at which it goes down to the earth plate the effective resistance of the earth is increased with a corresponding decrease in efficiency as regards the set. If you have not an insulated earth wire, fit one, though there is no need to buy expensive wire for the purpose. Eminently suitable for the job is the stuff which electricians use for wiring the heating or power circuits in buildings. This is obtainable quite easily in either 7/22 or 7/18, and it is not at all costly. As each strand is tinned soldering is not a difficult business.

And now for the earth plate itself. This should, if possible, be immediately under the aerial wire. There is no need to bury it more than 3 ft. deep, but the dampest locality should be chosen for it. When you have buried your earth do not pile up the soil in a mound over it, for this will tend to make rainwater drain off. Rather make a small hollow to act as a catch-pit. A layer of fine coke should be placed both above and below the plate, for this material is strongly hygroscopic and collects all the moisture that it can. It is an excellent tip to make a little V-shaped "flume" of wood and to run it from the end of the overflow pipe of a cistern to the place where the earth is buried, so that there is a constant trickle of moisture on to the soil.

Excellent earth plates can be made from folded wire netting, from tinned sheet iron or from galvanised corrugated iron. In every case the earth wire should be unstranded and soldered to various points of the earth plate. If you care to go to a little extra expense, a piece of sheet copper about three-feet square makes an ideal earth plate, and it usually has a long life even in damp soil.

R. W. H.

Legal Note

In the Chancery Division recently Mr. Justice Russell granted to the Igranic Electric Co., Ltd., of Bedford, and 149, Queen Victoria Street, London, an injunction against the London Variometer Company restraining them, until judgment in the action, from infringing the registered trade mark of the Igranic Electric Co., Ltd., and from selling or offering for sale electrical apparatus under or in connection with any circular, notice or advertisement containing the word "Ivanic" or any other colourable imitation of the word "Igranic," and from supplying in response to orders for "Igranic" apparatus goods not of the manufacture of the Igranic Electric Co., Ltd., and from otherwise passing off goods not of the manufacture of the Igranic Electric Co., Ltd., as being of the manufacture of that Company.

An Enclosed ST100 Receiver

Designed by JOHN SCOTT-TAGGART, F.Inst.P., A.M.I.E.E.

Further constructional details of the handsome dustproof set, an introduction to which was given in our last issue.

Wiring Up

HAVING mounted up the components on the panel and secured them in place, the wiring may be commenced. Several methods of accomplishing this are available, and the constructor may choose between square section wire, stiff tinned copper wire of round section, or a thinner wire covered with systoflex tubing. A much neater appearance is obtained by using wire of square section, but as this is the most difficult to use, the constructor is not advised to attempt this method unless he possesses considerable skill in the use of a soldering iron, in addition to plenty of patience. The wire must be bent so as to fit exactly between the points to which it has to be soldered, otherwise it will be found quite unmanageable.

Stiff wire of round cross-section is much easier to work with, but most constructors will prefer the

simpler alternative of insulated wire.

A detailed wiring diagram is given in Fig. 6, and will make all points clear. The large photographs of the back of the panel given in Figs. 5 and 7 show what the wiring looks like when completed, and will be found helpful, owing to the fact that the white insulation on the wire stands out, it being almost possible to wire the set up from these alone.

The Coil Holder

The coil holder is of a very simple design, being at the same time quite neat and efficient. The parts required for the construction include two flat type coil plugs, one ebonite knob, a piece of 2BA screwed rod, 3½ ins. long, and two valve sockets.

Two holes in the panel are required, one inch apart, into each of which a valve socket

is fastened. One of the coil plugs has two holes drilled through it, the same distance apart. A hole is drilled through the coil-plug and panel, so that the three holes in each are in register. This last hole must clear a 2BA rod. The valve sockets are tapped out to take a 4BA screw, and the coil plug is secured to the valve sockets by two 4BA screws, countersunk heads, ¾ in. long. Connection is made from the screws on the side of the coil plug to the screws which fasten the plug to the valve sockets by means of short pieces of wire, secured under the head of the screw on the coil plug and soldered to the screw in the valve socket. A piece of 2BA screwed rod, about 3½ ins. long, is passed through the panel and the fixed coil plug, which is the socket for the aerial coil. A collar and one nut are placed on the rod, on top of the aerial coil socket, and

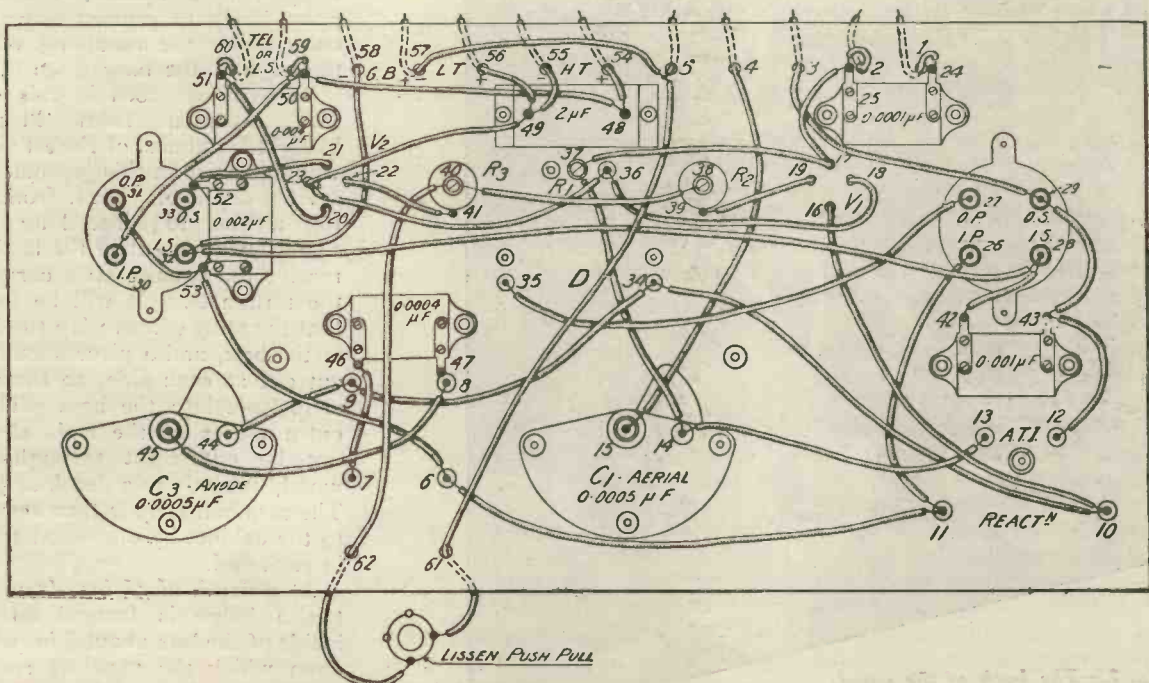

Fig. 6.—A detailed wiring diagram of the receiver.

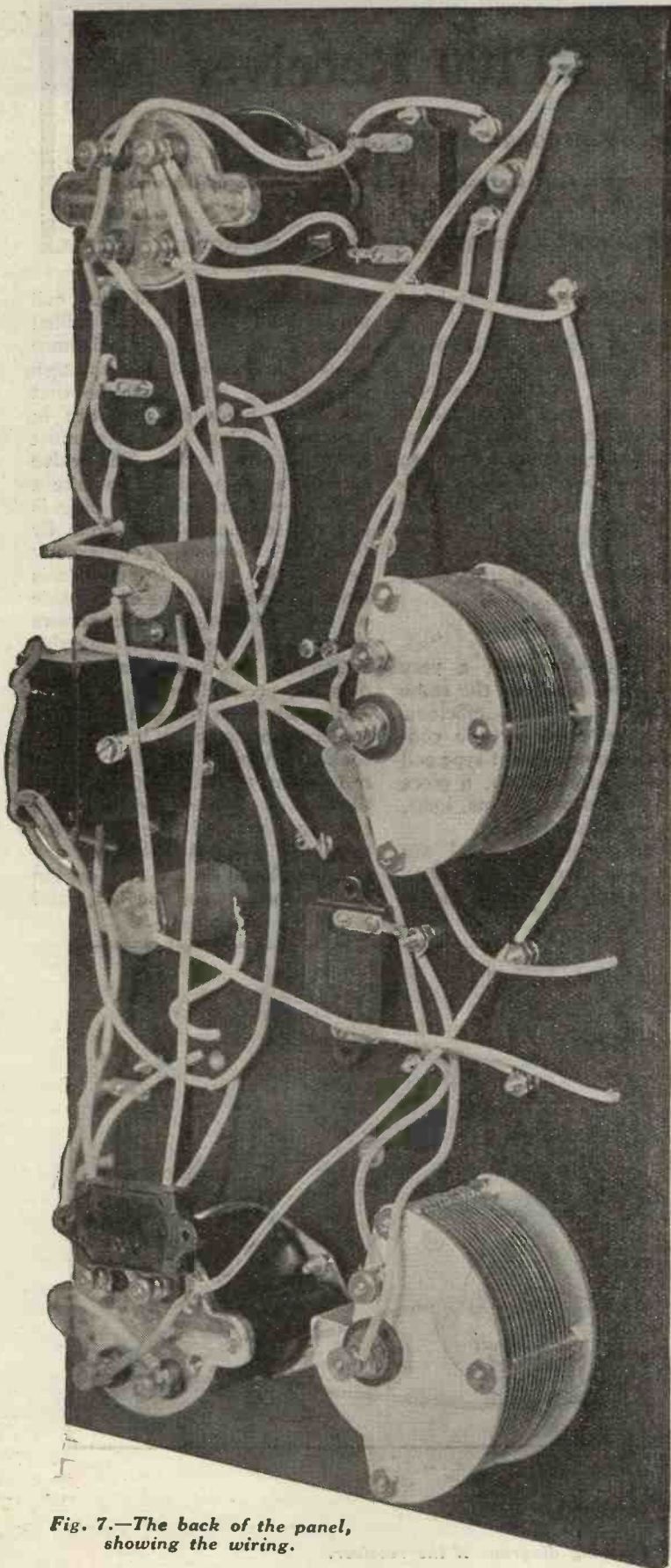

Fig. 7.—The back of the panel, showing the wiring.

screwed up so that half an inch of rod is projecting underneath the panel. This half inch is occupied by an ordinary washer, a spring washer and two lock nuts, the latter being locked together so that the rod can turn easily. A nut is now screwed on the rod from above the aerial socket, so that its flattest side is uppermost; a hole is drilled in another coil plug, also of the flat type, of such a size that the plug will slip on to the rod. An ebonite knob, preferably with a tapped brass insert, is now screwed on to the rod, so that it binds firmly against the top, or movable, coil plug, which is the socket for the anode tuning coil. Flexible leads ending in spade terminals at one end and fastened under the coil plug screws at the other are used to make connection to the anode coil.

The Back Terminal Strip

At the back of the cabinet is a strip of ebonite $13\frac{1}{2}$ ins. long, 1 in. wide and $\frac{1}{4}$ in. thick, upon which twelve terminals are mounted, one inch apart, leaving 1-16 in. on the outside of each of the end terminals. A hole is cut in the back of the cabinet to receive this strip.

The Cabinet

The nature of this cabinet makes its construction an exceedingly simple matter, the only point likely to present any difficulty being the moulding off at the edge of the base (Fig. 8).

The cabinet used in this case was obtained from Messrs. Wright & Palmer, of Forest Gate, who advertise in this journal.

At a depth of $3\frac{3}{8}$ ins. from the top a slot $12\frac{1}{8}$ ins. long and $1\frac{1}{8}$ ins. wide is cut in the back to receive the ebonite strip carrying the terminals. It will be found that the strip will overlap the hole in the box, and a piece should be cut out at each side, so that the strip beds into the box. These extra pieces at the ends should not be cut right through the wood, but only to a depth of $\frac{1}{2}$ in. The terminal strip is then secured to the cabinet by one wood screw in each end.

At a depth of $5\frac{1}{2}$ ins. from the top a ledge is formed on the inside of the box about $\frac{3}{8}$ in. wide, upon which the panel is rested. The strips of wood forming this ledge may be glued on to the

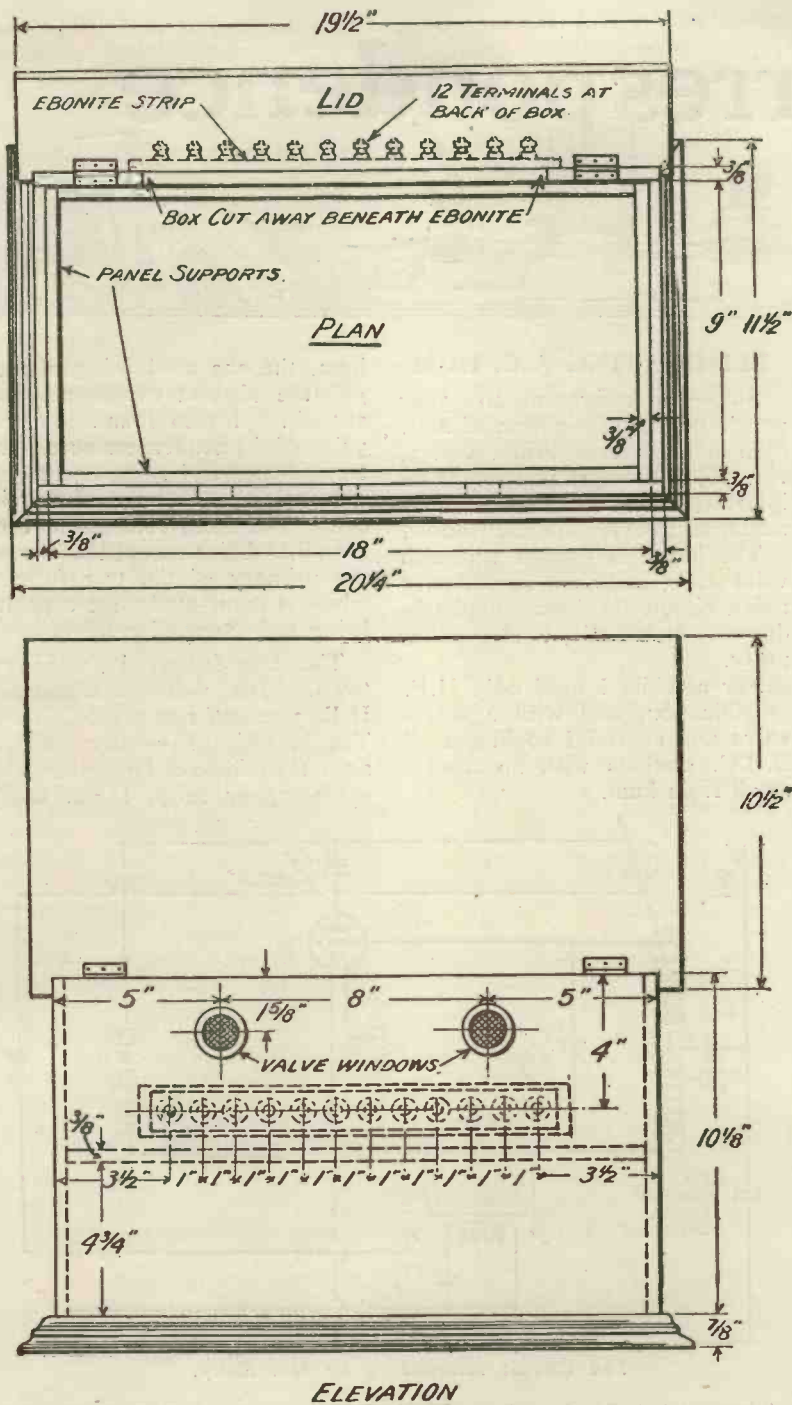

Fig. 8.—Two views of the box, showing the position of the terminal strip.

inside of the box, or alternatively they may be fixed with small brads. Care must be taken that the brads are not of sufficient length to pierce right through the cabinet, or the appearance may be spoiled. Valve windows are fixed in the front of the cabinet, immediately in front of the valves, in order that the brilliance of the filaments may be seen. The centres of the holes necessary are

1 1/2 in. down from the top of the front of the box, and approximately 5 1/2 ins. in from the sides. In between these windows a hole 3/8 in. in diameter is drilled for the Lissen filament switch, the leads to which are brought through two holes in the panel, seen in Fig. 6. The lid is secured to the cabinet by means of two brass hinges on the back of the box, slots of the necessary width

being cut in order that the hinges may be set down to allow the lid to rest flush with the sides of the cabinet.

Coils and Valves

For broadcast reception the coil L1 in the aerial circuit may be a No. 35 or 50, according to the size of the aerial used. If constant aerial tuning is employed, a No. 50 will be found quite satisfactory. When a series variable condenser is used, a somewhat larger coil may be necessary, and a No. 75 should be employed. L2, the anode tuning coil, may be a No. 50. Any good make of valve may be used, and no alterations to the set will be necessary should dull emitter valves be used, owing to the fact that Lissenstats are eminently suitable for either type of valve. For good loudspeaker signals a high-tension battery of 100 volts should be used, together with a grid bias battery of 4 to 8 volts. If no grid battery is used, the terminal GB— must be connected to LT—.

The use of the terminals 6 to 9 has been explained in our last issue and need not be repeated here, since any who intend making this set will have both copies to hand.

Testing

When commencing to use the set it will be found best to employ constant aerial tuning, as this makes the reception of the nearest station almost a certainty. The anode tuning condenser will have to be adjusted so that the anode circuit is in tune to the desired signals.

Connect the aerial to terminal 1, earth to 5, and join 3, 4 and 5 together. The batteries and loudspeaker are connected up to the correct terminals, indicated in Fig. 3. With the coils mentioned above, the local station should be found at once, and good loudspeaker signals should be obtainable up to 50 miles from a broadcasting station.

Blue Prints

Full size blue prints as under may be obtained from Radio Press, price 1s. 6d. each, post free:—

The front of the panel, dimensioned for use as a drilling diagram, No. 31A.

The back of the panel, showing the wiring, No. 31B.

Correspondence



CARDIFF ANNOUNCING

SIR,—There is no accounting for taste, and the replies of "Comrados" I and II to your frank if somewhat blunt criticism of the Cardiff announcer must have convinced you of the truth of the old adage—"One man's meat is another man's poison."

The writer, not being a Londoner, cannot be accused of bias, expressed with reaction in the comrados' letters, but the rude terms indulged in not only lack dignity but arouse suspicions as to their disinterestedness.

An announcer's job, after all, is simply to take the place of the programme provided at the theatre or concert hall, and his efforts should be confined to announcing in a brisk, concise way.

What theatre manager would dare to intersperse the items of his programme with rambling, inane statements about himself, or to indulge in cheap jokes at the expense of the stage carpenter, to say nothing of chipping the gallery? I have only heard the Cardiff station on S.B., and, because of the announcing, feel thankful that I have always been able to cut off the L.T. without hurting anyone's feelings.

I am sure if we asked John Henry's opinion on the matter he would say "It's all wrong," and, judging by the number of comments I have heard during the past few weeks, the majority of listeners would agree with him. Even the kiddies are tired of the sample served up to them a few days ago.

Announcers evidently are born, not made, and the younger they are caught the better.

I congratulate you on your independent expression of opinion on this and other matters.—Yours faithfully,

T. B. BRAID.
Beckenham, Kent.

ELIMINATING A.C. HUM

SIR,—In reference to your article on the elimination of A.C. hum in *Wireless Weekly*, Vol. 3, No. 16, I thought you might be interested to know how I have managed to overcome the trouble.

The house is lighted with 220 volts A.C., and with an ordinary reflex circuit the hum completely drowns Newcastle, twelve miles away.

For a while I used only H.F. amplification, and with a single valve and crystal I could get all B.B.C. stations with no trouble at all from hum.

hum, the one used being of .006 μ F (the highest capacity I possessed). I also found that the value of the condensers across the transformer had some effect.

I enclose a diagram of my circuit. The fixed condensers used are all Dubilier except that across the primary of the transformer, which is home-made, the capacity being only approximate.

The transformer is a Silver-town. The valve is a Marconi D.E. 3 run off two dry cells only. The batteries have been in use since the middle of December last.

On a poor aerial I can easily

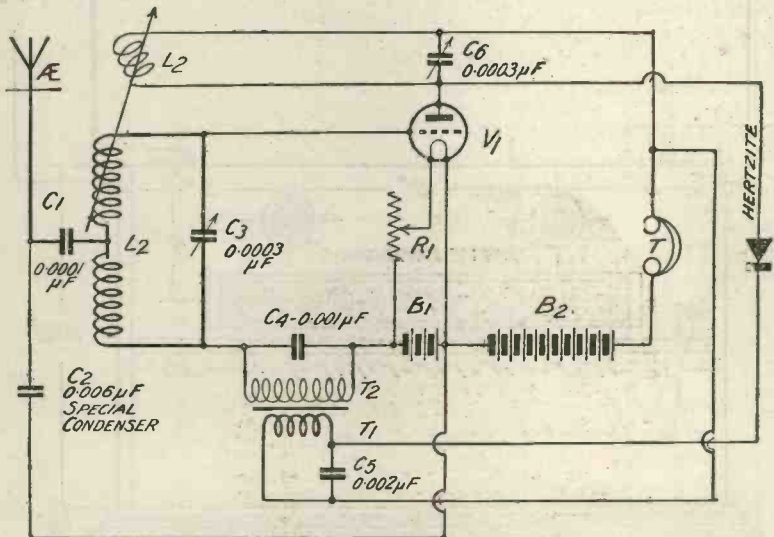

The Circuit referred to by Mr. Batty.

Then I tried the idea of a centre tapped coil from the ST100 circuit described in *Wireless Weekly*, Vol. 3, No. 1. The result showed a great improvement, the hum not being loud enough to spoil Newcastle, but it was still impossible to tune in other stations on account of the hum.

After some experimenting with fixed condensers I found that one of high value connected across the L.T. terminal and the aerial terminal completely eliminated the

tune in all the B.B.C. stations at good strength. Newcastle also comes in very loudly on a gas-pipe aerial. I have not yet tried for distant stations on such an aerial, nor have I tried a loud speaker.

I might also mention that on an ordinary reflex set the hum was distinctly audible with both aerial and earth disconnected, though with this set I can hear Newcastle quite well under such circumstances.

The hum is slightly noticeable using a gas-pipe aerial, but this

might be overcome with a condenser of higher capacity than .006 μ F. Wishing your paper every success.—Yours faithfully,
R. G. BATTY.

Sunderland.

**THE
CARDIFF ANNOUNCER**

SIR,—It gave me great pleasure when reading your sound criticism of the announcer at the Cardiff Station.

This person is apparently very self-opinionated and places himself upon a pedestal, and, judging from the manner in which he commenced the evening programme, it was one great "I," and no one else was of any consequence.

If a census of opinion could be taken of those people who endured the agony (owing to being afraid of switching off and thereby missing the Magic Carpet), I feel certain you would obtain a very large majority supporting your action.

The two subscribers who have written letters of criticism are apparently Welshmen, therefore

encourage familiarity, hence the tone of their letters.

I'm afraid, Mr. Editor, that it is a case of "when in Rome, etc." when listening to Cardiff.

Wishing your two journals still greater success.

"DISGUSTED."

Heybridge Road,
Streatham Hill,
London, S.W.

SIR,—Permit me to refer to the two letters you have received and published on this matter—though not to offer you a totally unneeded sympathy. The writers, both carried away with the fatal impetus of obvious youth, seem to have "run violently down a steep place into the sea" of a publicity in which their unbalanced remarks will suitably perish.

I would like to say, however, that I feel with you that the manager of any public function should aim rather at a courteous dignity of speech than methods of cheap familiarity and childish slang. These latter have perhaps their uses, and a public of their own, but I know South Wales too well

to think it is a large one, and they are out of place in the present instance.

Let me further say that, though I now think you are perfectly right in your opinion, if at another time I should think you perfectly wrong I should not need to violently abuse you to prove it.

Most of us can tolerate a wrong opinion if honestly given, and some of us, seeing the rarity of such a thing in journalism, can even—disagreeing with it—respect it. Continue, then, respected Editor, to say what you think, though we may not always agree with it, it has hitherto always been worth hearing.—

Yours faithfully,

"A SOUTHERN LISTENER."

Portland Street,
Southampton.

SIR,—You appear to have somewhat angered several "Comrados" by your criticism of our announcer. The use of the personal "we" on the part of your correspondents is rather presumptuous. One wonders on whose authority they claim to speak for "all."

Fine Results from Fine Components

Where FALLON products are used there are no failures.

This is our NEW MODEL All Condenser—right up to FALLON standard and will appeal to thousands of constructors who prefer the following points which are included in same:
One Hole Fixing Tag Connections
Heavy Aluminium Top and Bottom Plates
The Best and nothing but the best British material and workmanship are put into this New Fallon Condenser. Metal to Metal adjustable bearings.

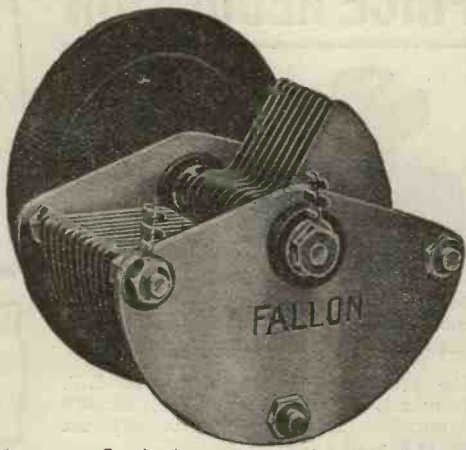

Stout, well-cut aluminium vanes.	Complete in every respect and exactly as illustrated.
.001 .. 57 Plates	Price 8/- .. .00025 .. 15 Plates. Price 5/-
.0005 .. 29 ..	6/- .. .0002 .. 13 .. 4/6
.0003 .. 19 ..	5/6 Vernier .. 5 .. 4/-
	Vernier .. 3 .. 3/6

For those who prefer it, we still supply our well-known All model, which is exactly the same as above, except that instead of having Aluminium ends, it has composition ends and is supplied with our special feature, the Aluminium Screening Disc, which Disc is also supplied with the model above illustrated. We have the courage of our convictions. We put our name "FALLON" on every Condenser we manufacture.
BRITISH REPUTATION—Your condenser is not a FALLON unless the name "FALLON" appears on same.

FOREIGN AND COLONIAL AGENCIES. AUSTRALIA.—The Westralian Farmers, Ltd., PERTH, W.A. SOUTH AFRICA.—G. D. Henderson & Co., 15, Timber Street, MARITZBURG, NATAL. Stuttford & Co., Ltd., JOHANNESBURG and CAPE TOWN. SWEDEN.—Graham Bros., STOCKHOLM. HOLLAND.—De Witt Sadee & Co., 182, De Carpenterstraat, THE HAGUE. Write direct for Trade Terms.

FALLON CONDENSER CO., LTD.,

WHITE RIBBON WORKS, BROAD LANE, N.15

Phone—TOTTENHAM 1932

The "DUANODE" CONDENSER

was the first popularly priced Iwin Condenser placed on the market. There are many imitators but there are no superiors. Amateurs now receive America every night in the week with the "Duanode." In a recent article in "Modern Wireless" on the subject, Mr. Percy Harris gave very favourable reference to the "Duanode." The "Duanode" consists of two matched condensers operated by one knob, thus by using matched COILS it is possible to tune BOTH circuits perfectly with one operation only. This Condenser can be used for other purposes. The two halves (each of .00025 mfd.) can be used in series or parallel, giving capacities of .000125, .00025 and .0005. Price 17/6

FIXED CONDENSERS

Highest Quality Mica and Copper Foil. Fitted with soldering tags and nuts for connections.
Capacities up to .001 .. 1/3
.0015 and .002 .. 2/-
Guaranteed. Neatly Boxed.

VARIOMETER

The finest Variometer on the market at ANY price. Inside winding. Suitable for broadcast reception on any P.M.C. Aerial, extraordinary close coupling, ensuring large tuning range. On a 30 ft. indoor aerial the max. wavelength exceeds 420 metres and the min. on a 100 ft. aerial is below 350 metres. The max. on a full size outdoor aerial is 700 metres and the min. on a 30 ft. is 200 metres. Inductance, the highest possible—9.5 to 1. Metal feet can be adjusted to four different positions.... Price 15/-



Stockists Everywhere.—Every article carries our money-back guarantee. All British Manufacture. Insist upon your local dealer supplying you with FALLON products. If he will not, send cash with order direct to us. The name FALLON guarantees satisfaction. Please include sufficient postage on each article.

My fellow citizens seem to me to miss the point altogether. Undoubtedly, there are many Cardiff listeners who like this "Comrados" style, and it is only just to credit the announcer with the best of good intentions; furthermore, he has possibly been encouraged by many of his correspondents. But, as I see it, the tone of broadcasting must be kept high, and I cannot help thinking that educated people will hardly be enthusiastic about a style of announcement more suited to a free-and-easy smoking concert. Such people are daily being more and more attracted to this new science, and their money is worth just as much as any other class, and their support is even more valuable. Therefore, why not let us copy London in its crisp and courteous style, which can give offence to none? I invite your correspondents to imagine what would happen if, in a high-class concert, programmes were dispensed with and a chairman addressed himself to a cultured audience in our announcer's style. The announcer, in broadcasting, is the programme, and he should endeavor

our to make himself just as impersonal.

For lack of argument, my fellow countrymen seem to have fallen back on the weapon of cheap sneers at London superiority. This is unworthy of them, and at the same time "cheap."

—Yours faithfully,
Cardiff. E. DAVIS.

SIR,—I read with interest the Editorial in *Wireless Weekly* regarding "Cardiff Announcing," also the letters from "Comradio" and "A Comradio" on the subject, both of whom seem to take the matter very much to heart.

Surely a paper like *Wireless Weekly*, which means just as much to enthusiasts in Cardiff as it does in London, has a right to put forward criticism just as it has so often put forward praise.

When London has needed criticism it has got it, and not a bit less strongly than the Station now in question; and I myself have often read words of praise in your paper regarding this very Station.

Although I read the Editorial referred to very carefully I saw nothing in it except sound con-

structive criticism, such as you would give to any of the B.B.C. stations where there was room for improvement.

As a user of a multi-valve set, who often listens to Cardiff, I must agree with your remarks regarding the using of the word "Comradio." In his letter "Comradio" says it is a better word than "Listener"; yes, certainly, but London does not sling the word "Listener" at our heads every few minutes.

Users of wireless in the West of England have every right to be proud of the "Cardiff Station, its achievements and its staff," but they must not imagine that because the London announcers do not use a lot of "funny business" they are any the less intimate with those who listen regularly to them, they can put their personality over without the need of unnecessary limelight.—Yours faithfully,
ALL STATIONS.
Fulham, S.W.6.

[We have confined ourselves entirely to the question of announcing in our criticisms. Announcers and others must expect Press criticism, as do authors and actors.—Ed.]

COIL EFFICIENCY

USE

DIAMOND
SUNFLOWER

PLUG-IN
COILS

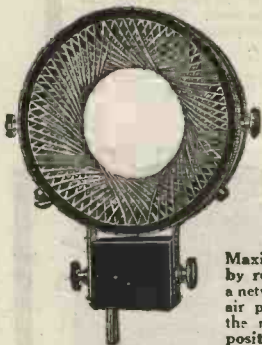

To gain Maximum Signal Strength use coils of maximum efficiency. Briefly, you must substitute your present coils for those whose self-capacity is practically nil, with a high-frequency resistance the lowest yet obtained, and losses through dead end effect entirely eliminated. In fact, you must use "Diamond Sunflower."

Maximum Signal Strength is obtained by their use by reason of their revolutionary design. They are a network of interwoven squares, freely interspersed with air passages which are not clogged with shellac—one of the main causes of self-capacity. A wider range of position is afforded owing to the special mounting of the coil plug.

THE MOST EFFICIENT COIL
THAT HAS EVER BEEN PRODUCED

No.	
20	4/6
30	4/9
50	5/0
70	5/3
90	5/6
110	5/9

The "Diamond Sunflower" are made in all sizes from 20 upwards. Remarkably efficient for the lower wavelengths. Coil against coil "Diamond Sunflower" give the best results. Try them; it will be your conviction.

Ask your dealer for the "Diamond Sunflower."
If he is out of stock, send direct to:

DIAMOND WIRELESS Ltd.
184a, OXFORD STREET, LONDON, W.1.
Phone: MUSEUM 1380.

Standard
Plugs to fit
all sizes,
1/0 each.

PRICE REDUCTION



FILAMENT
RESISTANCE
FOR
0.06
DULL
EMITTERS

Owing to the demand and improved methods of production we are able to announce an important price reduction.

The resistance screws on to the L.T. Terminals of the set or the battery terminal. Instantly converts any set for D.E.3, B.5, etc., use.

Price 3/9 each

Write for List of Shop Soiled Bargains.

L.M. MICHAEL LTD

IN CONJUNCTION WITH B. HESKETH LTD
SHOWROOMS: Radio Corner, 179, Strand, W.C.2.

All correspondence to Head Office.
HASTINGS HOUSE, NORFOLK ST., STRAND, LONDON, W.C.2.



M. H. The Mark of Merit on any Wireless Set or component is a guarantee of efficiency, reasonable price and sound British manufacture. BUY BRITISH GOODS ONLY

We are exhibiting in the Electrical and Allied Engineering Section of the British Empire Exhibition, 1924.

Complete Catalogue, over 30 profusely illustrated pages, Post Free 1/-



Apparatus we have tested

Conducted by A. D. COWPER, M.Sc., Staff Editor.

An Earth-Mat

We have received for test a sample "Terradio" earth-mat, a substitute for the usual earth connection. This takes the form of a small sheet of fine copper-wire gauze, about 10½ in. by 16½ in., stretched over a stout wire frame and provided with a large eyelet for a connecting terminal. It is to be used, according to the maker's instructions, just like the large copper mats used as a temporary "earth" by portable transmission plants, etc., or it can be buried like an orthodox earth-plate. In the latter case it obviously differs in no wise from conventional pat-

terns of earth-plate, except that it is smaller than would be recommended for permanent use, so that tests were conducted only with a view to ascertaining its quantitative efficiency when used, as the makers suggest, as a substitute for a permanent earth of this type.

The tests were conducted with a fairly good P.M.G. twin aerial of very low resistance normally, at 13 miles from 2LO, and with a thick-wire variometer as tuning means which has been proved to give the optimum possible signal strength for the signal energy available. The comparison earth was a multiple-connection one,

the principal member being a securely-soldered connection to a short, thick, lead water pipe going directly down into damp clay.

With good galena crystal, and standard earth, the lower-power mid-day transmission from 2LO gave a total rectified current of 12 microamperes. With the Terradio earth-mat on hard soil, well pressed down and with three bricks on it to maintain good contact with the earth, the current was 5 microamperes; when thoroughly wetted so that there was a pool of water around it, this increased to 7 microamperes. The soil was already fairly moist

"TANGENT"

Tuning Coils

— TESTED AND TRIED —

On frames—
robust
and
SUB-
STANTIAL

Their efficiency—which is second to none—is not impaired by the Special material of the frames

No self-supporting coil excels them

Say "TANGENT" to your dealer and refuse substitutes.

Send for LEAFLET 101 W.

GENT & CO. LTD. "FARADAY WORKS," **LEICESTER** EST. 1872.
LONDON: 25, Victoria Street, S.W.1.
NEWCASTLE-ON-TYNE: "Tangent House," Blissett, Street.

"CONFIDENTLY RECOMMENDED"

"Wireless Weekly."

—the common opinion of all who employ them! See your condensers bear our trade-mark—the secret of almost tuning efficiency. They are proven efficient, manufactured with electrical and mechanical precision.

OUR SUPER ALL-METAL CONDENSER

Capacity:—"Represents a great improvement over the far-too-common usage of listing condensers as of a certain "nominal capacity," when in reality their maximum capacity falls far short of this figure. The minimum of each condenser was unusually low.

The ratio of any .001 "J.B." is 47 to 1. Their extremely low minimum and accurate maximum capacity gives a wide tuning range. You can separate different wavelengths, and tune out unwanted signals. The low minimum is essential for capacity reaction circuits.

To our knowledge the electrical losses are the lowest yet recorded—0.05 ohms, which positively indicates that "J.B." Condensers give very sharp tuning and maximum signal strength.

.001	9/8
.00075	9/-
.0005	8/-
.003	6/9
.00025	6/9
.002	5/6
.001	5/3
Vernier	4/6

BRASS END PLATES give it the finish of the Scientific Instrument which it is. Close accurate spacing (dielectric .028"); plain metal bearings, which do not work slack and are noiseless in use; large top and bottom bush of Grade A Post Office Ebonite, are a few distinctive features. Sold complete with knob, dial, and spade terminal connections.

The mechanical design and workmanship shown by these condensers were of a high order, and the finish excellent. They can be confidently recommended for general use in radio construction and experimentation.

"Wireless Weekly."
Guaranteed for Six Months Against Manufacturing Fault.

Instist on receiving the "J.B." If your dealer cannot supply send direct to the Manufacturers:

JACKSON BROS.

THE CONDENSER EXPERTS. (First Floor).
8, POLAND ST., OXFORD ST., LONDON, W.1. Phone: Gerrard 6187

after recent rain. When thoroughly tramped down on a soft flower-bed, and loaded with three bricks, with enough water poured on to make a puddle, the current rose to 8 microamperes, or 66 per cent. of that with the permanent water-pipe earth. Placing the earth-mat, as the makers suggest, in a wet sink, and loading it with a heavy iron weight so as to get good contact with the wet surface, and with the tap actually running on to the mat in order to keep it well wetted, only 2.5 microamperes were recorded. In each case, the aural signal strength corresponded exactly to the total current measured; in the last test the transmission was scarcely audible at all, though the tuning was correct.

With the much less highly-damped valve reception, and with the free use of reaction up to just below the oscillation point, more favourable results were to be expected. An extremely efficient receiver was used, with small series condenser and a low-resistance variometer as tuning means,

sharp reaction being applied by a plate variometer bridged by a fixed condenser, and an R valve of good rectifying powers. The signal voltage was measured after the manner of the Moullin voltmeter, by the depression of the steady plate current, calibrating with D.C. voltage by means of a potentiometer bridge as usual.

With standard earth, and valve circuit just below oscillation so that speech was loud and clear, but not garbled, the effective signal voltage of 2LO's whole wave was 1.78 volts. The aural signal strength, of course, corresponds exactly with this. With the earth-mat in a wet sink, as indicated, with full permissible reaction the effective signal voltage was .54 volts. Without reaction, the difference was very large, the signals being scarcely readable in the last case.

Safety Wander-Plugs

Messrs. Burne-Jones & Co. have sent for test and comment samples of their wander-plugs for use with tapped H.T. batteries, provided with a safety device to avoid accidental destruction of

the filament of the valves through chance short circuits, as well as to protect the battery against accidental rapid discharge.

These are small plugs, a little longer than usual (about $1\frac{1}{2}$ in.); the safety device is simply a fairly high resistance enclosed in them, which on test proved to be about 700 ohms in each case. This does not involve any serious voltage-drop with the normal plate-current of a few milliamperes at the most; but at the same time effectively prevents any dangerously large current from being drawn from the H.T. battery, even by a complete short circuit outside it. Under any ordinary circumstances the largest current would be less than $\frac{1}{10}$ ampere.

This neat and effective device has the great advantage that it is always on the job, and cannot be forgotten or accidentally wired round; it can be recommended accordingly for general use, with the word of warning that a large blocking condenser (of 1 to 3 μ F) should be placed across the H.T. leads on the receiver side when these plugs are used.



THE WORLD'S STANDARD

AMPLION

WIRELESS LOUD SPEAKER

for "Better Radio Reproduction"

THE AMPLION SERIES COMPRISES A RANGE OF MODELS SUITABLE FOR ALL CIRCUMSTANCES OF USE AT PRICES FROM TWO GUINEAS. STOCKED BY ALL WIRELESS DEALERS OF REPUTE; ILLUSTRATED PARTICULARS FROM THE PATENTEES AND MANUFACTURERS

ALFRED GRAHAM & COMPANY, ST. ANDREW'S WORKS CROFTON PARK, LONDON, S.E.4

Information Department

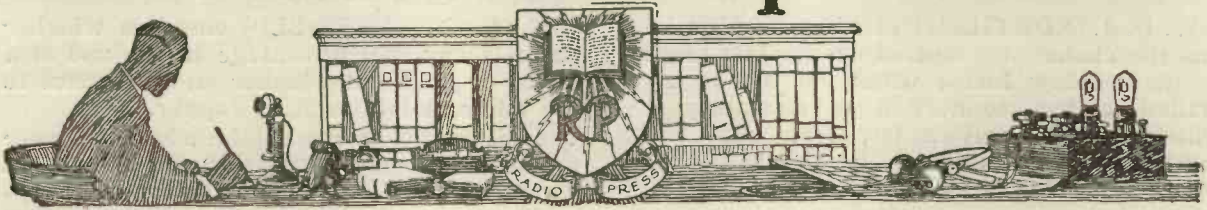

P. J. (BIRMINGHAM) asks what combination of crystals is required to form what is known as a Perikon detector.

The usual combination which forms the Perikon detector is zincite and copper pyrites or bornite. Tellurium is also sometimes used with zincite, and this combination is also often described as the Perikon.

B. W. J. (NOTTING HILL) enquires what is a Nodon valve rectifier.

The Nodon valve is one of the chemical type of alternating current rectifiers, which is often used for accumulator charging. It consists of two metal electrodes, usually aluminium and lead, immersed in a solution of either ammonium phosphate or sodium bicarbonate, and it is found that under certain conditions current will only pass from the lead to the aluminium plate, and not in the opposite direction. It therefore acts as a rectifying valve capable of carrying considerable current.

E. G. R. (HAMPSTEAD) enquires whether with a twin aerial it is absolutely essential that the two wires should be equi-distant through their length.

This is not at all essential, but it is usually concluded to be important that two wires should be of approximately equal length. A possible exception to this general statement is to be found in the case of a cage aerial used for transmission, where it is usually found to be important that the wires should be equally spaced around the periphery of a circle.

E. F. T. (BARNESLEY) has seen references to the capacity of accumulators, and enquires whether this is in any way related to the capacity of a condenser.

The expression "capacity" of an accumulator is hardly a correct designation, since what is meant is the capacity of the accumulator in the sense of the delivery of a current of given size for a given period. Thus, if an accumulator is said to be of

E E C

LD
WRITE NOW!

OUR NEW RADIO CATALOGUE

comprising 40 pages and 300 illustrations of all classes of instruments, component parts, materials, etc., is just off the press. **IT WILL PAY YOU WELL** to remit 4d. in stamps and secure this money-saving publication.

Head Office: 10, FITZROY SQUARE, LONDON, W.1.	Showrooms: 303, EUSTON RD., N.W.1.	Branch and Works: TWICKENHAM.
---	------------------------------------	-------------------------------

BEWARE OF WORTHLESS IMITATIONS, SEE THE TRADE MARK *Watmel* ON EVERY GRID LEAK.

WATMEL VARIABLE GRID LEAK
(Patent No. 206098).

Constantly Variable Silent in operation. Constant in any temperature. Dust and Damp proof. Each tested and guaranteed. Neat and well made.	
	GRID LEAK .5 to 5 megohms 2/6 ANODE RESISTANCE 50,000 to 100,000 ohms 3/6. Suitable for S.T. 100 Circuit.

SEND P.C. FOR DESCRIPTIVE FOLDER.

WATMEL WIRELESS CO., Comaught House, 1a, Edgware Road, Marble Arch, W.2. Tel. 4575 Paddington

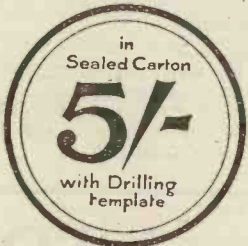

Burndept Crystal Detector

(Prov Patent No 23937/23)

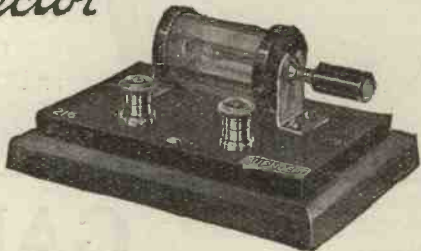

Mr. J. Scott-Taggart in *Wireless Weekly* says:
 "The Crystal Detector should be of a good pattern, and the latest Burndept Crystal Detector is the type used on original omni receiver itself."
 "This detector has a beautiful control and is one of the best types on the market to-day."

Fix it on your Crystal Set and note the difference.

Mounted on Ebonite with walnut sub-base as illustrated ... Price 12/6
 For Panel Mounting, with Drilling Template 5/-

BURNDEPT

VISIT OUR STAND AT WEMBLEY, in the Palace of Engineering, Avenue 13, Bay 13.

BURNDEPT Ltd., Aldine House, Bedford St., Strand, W.C.2.

Phone: Gerrard 9072.

Stocked by all Dealers selling High Grade Wireless Components.

30 ampere hours actual capacity, it is meant that it will give a current of 1 ampere for 30 hours, 2 amperes for 15 hours, and so on.

W. B. J. (NORTHAMPTON) states that he has the choice of a buried earth plate close to the window inside which his set is installed, and a connection to a waterpipe which is also only a few feet from the receiver, and asks which he should use or whether he should use both.

With a receiving set it is often advantageous to use two earth connections, more particularly if the earth wire to each will be of approximately the same length. With a transmitting set it is rather doubtful policy, since to get the two earth connections of equal length is of greater importance and much greater difficulty. In general, the best expedient is to use a buried earth plate, provided that it can be of reasonably large size.

I. W. B. (NEWCASTLE) enquires whether it would be any advantage to use considerably larger dry cells for his high tension battery than the usual type made up in units. For the ordinary type of receiving set there would be no apparent advantage, save that the battery would possibly last a little longer. Where power valves are employed for low-frequency amplification, however, large batteries are a decided advantage, since the ordinary type of small cell in the type of high tension battery put up by the majority of manufacturers is not capable of standing up to the strain of feeding large valves. It should be

remembered that a power valve of quite moderate size may have a regular working current of as much as 15 milliamperes,

W. A. O. (SHEFFIELD) enquires whether there is any real advantage in the use of a silver or gold cat-whisker in preference to the other metals such as copper.

There is certainly a considerable advantage in the use of one of the non-tarnishing metals for this purpose, since a copper cat-whisker is always liable to become covered with a film of atmospheric oxidation products, and therefore to cease to make proper contact upon the crystal. Even when the respective examples of cat-whiskers made from different metals are quite new and clean there is often found a slight increase in signal strength when using one of gold.

H. C. P. (PENZANCE) writes that in his 3-valve receiver he is very much troubled by rushing and grating noises, which are not caused by self-oscillation.

The first step is to determine whether the noise is produced actually in the set itself, and to do this the aerial and earth wires should be removed. If the noise then continues it indicates some trouble in the set, probably one of the following:—

- (1) Defective grid leak or condenser.
- (2) Partial break in the telephones.
- (3) A partial break in the windings of one of the low-frequency transformers.
- (4) A defective valve.
- (5) A run-down high-tension battery.

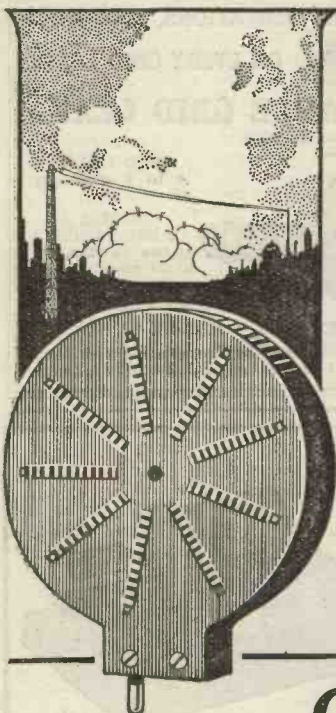

Efficiency Inductances

The name "Efficiency" was not given to Gambrell Coils in an idle moment. It was chosen because it most accurately described all the features of these coils. True efficiency can only be obtained by careful design and construction and by paying attention to every point. The efficiency of a motor car for example does not lie in the engine alone, but in gear box, axles, springing, brakes and many other details. In the same way the efficiency of a coil does not depend on one point only.

The "Efficiency" Coil is superlative in the following respects:—

- Low Self Capacity.
- Maximum Inductance.
- Low Effective Resistance.
- Uniform Distribution of Current.
- Uniform Size for all Wavelengths.
- Great Mechanical Strength.
- Larger Tuning Range.
- A Backing of 30 years' Coil Winding Experience.

If you are trying for K.D.K.A. use coil a/2 in the aerial with series condenser and "a" for secondary and tuned anode.

A postcard will bring a copy of our leaflet on Inductances.

Phone:
Victoria 9938.

Works:
Southfields, S.W.18.

GAMBRELL BROS., LTD.,
76, VICTORIA STREET, S.W.1.

West End Agents: J. V. MULHOLLAND, 4, BLENHEIM ST., BOND STREET, W.1.

It's the valve that counts!



Users of valve receiving sets will do well to realize that the efficiency of their outfit is largely dependent upon the choice of valves. It is the valve that counts!

You will positively ensure the best reception of vocal and musical items by using

MARCONI VALVES

MADE AT THE OSRAM LAMP WORKS

Made with the same scrupulous care that has always characterised the manufacturing operations of the famous Osram factory.

MADE TO LAST.

(Wholesale only)

Sold by all leading Wireless Dealers, Stores and Electrical Contractors.

We are exhibiting at the
BRITISH EMPIRE EXHIBITION
 Wembley, 1924.
 Electrical and Allied Engineering Section Stand
 —Avenues 11 to 13. Bays 11 to 15. B.E.A. Section,
 Stand No. 286 (Fraser & Chalmers) S.E. Block.

Advt. of THE GENERAL ELECTRIC CO., LTD.

Head Office: Magnet House, Kingsway, London, W.C.2.

PARTS, COMPONENTS, SETS—they all sell equally well in WIRELESS WEEKLY.

The WIDTH OF COILS

—and the part it plays

One advantage of using LISSENEGON (prov. pat.) coils is that while they give sharper and stronger tuning, they are freely interchangeable with any existing standard coils. With other makes of coils it is impossible to make them standard width without getting an undesirable capacity effect in the windings, and as coil holders are all made for standard honeycomb coils the use of coils of less than standard width fitted into standard coil holders will leave a gap between the coils equivalent to the extent to which they are less than standard width, and so make it impossible to obtain a close maximum coupling whenever this may be necessary. In general practice it is better to keep coils as far apart as possible. Not many coils will permit of this, but LISSENEGON coils can be kept at comparatively a great distance apart and yet they will oscillate easily. In anode circuits, however, when crystal rectification is used, for instance, it is often desirable to obtain a close coupling owing to the damping effect in the circuit consequent upon the use of a crystal as the detector. The very strong maximum coupling possible when LISSENEGON coils are used is due to the fact that there are no damping losses to be overcome in the coils themselves.

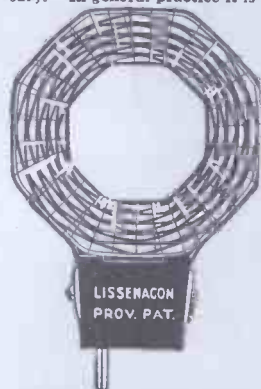

LISSENEGON COILS TUNE SO SHARPLY AND STRONGLY BECAUSE THEY TUNE WITHOUT ENERGY LOSS.

LISSENEGON TUNING CHART. Note the Intermediate Coils: 30, 40 and 60.

TABLE 1. Wavelength range when used as Primary Coils with Standard P.M.G. Aerial and .001 mfd. condenser in parallel.			TABLE 2. Wavelength range when used as Secondary Coils with .001 mfd. condenser in parallel.		
No. of Coil.	Minimum Wavelength.	Maximum Wavelength.	Minimum Wavelength.	Maximum Wavelength.	PRICE.
25	185	350	100	325	4/10
30	235	440	130	425	4/10
35	285	530	160	490	4/10
40	360	675	200	635	4/10
50	480	850	250	800	5/-
60	500	950	295	800	5/4
75	600	1,300	360	1,100	5/4
100	820	1,700	500	1,550	6/9
150	965	2,300	700	2,150	7/7
200	1,885	3,200	925	3,000	8/5
250	2,300	3,800	1,100	3,600	8/9
300	2,500	4,600	1,400	4,300	9/2

BOLTS THROUGH TRANSFORMER LAMINATIONS—

A good transformer never has a bolt running through the laminations—some transformers, designed incorrectly or through carelessness or cheapness have as many as 6 bolts running through the laminations! Yet they are sold because buyers take them, never thinking. If you buy a LISSEN transformer you will never get a bolt running through the laminations. Because of its skillfully balanced design, the

LISSEN T3 transformer actually compares with many expensive transformers—it is one of the best light transformers made—AND IT HAS NO BOLT RUNNING THROUGH THE LAMINATIONS 16/6

MAKES ELIMINATION EASY—

No difficulty will be experienced in cutting out any nearby broadcasting station. Most Morse interference will also be successfully eliminated. There is, however, a certain type of Morse interference which calls for greater skill. Even where this interference cannot be entirely got rid of, however, by those who are not sufficiently skilled it can be subdued to the extent that its troublesome features do not spoil the reception of broadcasting programmes. The LISSENCEPTOR (prov. pat.) is a useful thing to add to any receiver. It needs a separate condenser to tune it. Preferably it should be a really low-loss condenser, such as the LISSEN Mica Variable Condenser 17/6

LISSENCEPTOR Mark 1 type for broadcasting .. 7/6
 " 1 type for 600 metres .. 7/6
 " 2 type for broadcasting and 600 metres combined .. 15/6 (This mark 2 type has a switch all mounted which makes tuning more flexible.)

YOU JUST GENTLY PULL AND PUSH—and you hear these little switches "make" with a reassuring click. The contacts do not short when changing over—they are self cleaning—there are no neater or handier switches. They have many uses. LISSEN ONE HOLE FIXING, OF COURSE. Take up hardly any room. LISSEN two-way Switch 2/9

LISSEN Series-Parallel Switch (prov. pat.) .. 3/9

CHOOSING A TUNER.—If you do not wish to use plug in coils there is the LISSEN Tuner, with its simplicity of control, its switch complete, its sharp tuning on all ranges, with full efficiency at every point—negligible H.F. resistance, largest inductance for a given length of wire—LISSEN multiwound—150 to 4,000 metres range with a .0005 condenser (preferably use the LISSEN Mica Variable Condenser Mark 2 type 17/6) LISSEN ONE HOLE FIXING, OF COURSE 22/6

CORRECT GRID POTENTIAL—

LISSEN VARIABLE GRID LEAK (prov. pat.) besides making a receiver sensitive, especially in some circuits, clarifies signals, and an interesting alternative use is across the secondary of a transformer when it will suppress any tendency for the transformer to amplify the higher notes of the musical scale disproportionately to the lower notes. LISSEN ONE HOLE FIXING, OF COURSE—POSITIVE STOPS BOTH WAYS—the unique resistant element cannot be duplicated LISSEN Variable Anode Resistance, same outward appearance as the LISSEN Variable Grid Leak, 20,000 to 250,000 ohms 2/6

AERIAL REACTION is no alternative to LISSEN Radio Frequency Amplification.

It is a mistake to assume that because aerial reaction is used in a receiver there is no need for LISSEN Radio frequency amplification in the same receiver. If your aim is distance add one stage of LISSEN REACTANCE (prov. pat.). Its great efficiency, its rapid tuning has made radio frequency amplification more widely used than previously. One stage LISSEN REACTANCE in every receiver would give far greater range. Complete with switch already mounted—no complications—no soldering—LISSEN ONE HOLE FIXING OF COURSE. Print with each shows easy connections.

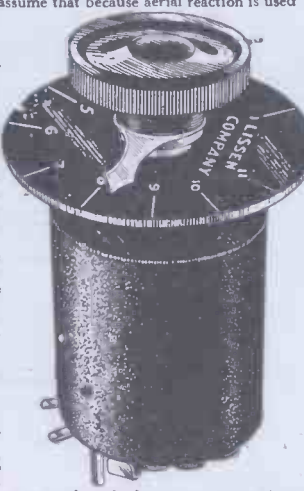

150-10,000 metres 19/6 150-600 metres 17/6
 To cover distance, every receiver should be fitted with one stage LISSEN REACTANCE—lower in cost than a condenser. Sometimes a vernier is useful, however.

OVERLAP

The Explanation of an Unstable Set.

One of the troubles met with in reaction circuits is that reaction is not even and gradual. For instance, as the coupling is increased the set will suddenly burst into violent oscillation, and as the coupling is decreased the oscillation will continue beyond the point at which it started. This condition is known as "OVERLAP," and IS A VERY BAD FAULT WITH A REACTION COUPLING, as in practice it means that the oscillation point can never be reached without the set becoming unstable. The CONSTANTS of LISSEN REGENERATIVE - REACTANCE (prov. pat.) are so arranged that there is a perfect reaction - coupling over the whole range covered. There is no re-radiation, either. There is no "OVERLAP" (providing the correct values of anode and filament are used). There are other advantages in using the LISSEN REGENERATIVE REACTANCE—it takes the place of plug-in coils. If plug-in coils are used (instead of LISSEN REGENERATIVE REACTANCE) to provide reaction in the anode circuit, it will only be possible to use one stage of radio-frequency amplification, because it is next to impossible to control two stages of radio-frequency amplification with plug-in coils. With LISSEN REGENERATIVE REACTANCE, however, other stages of H.F. can be added as desired, and easily controlled, each stage adding immensely to the sensitivity and range of a receiver. Selectivity is also greatly increased when the LISSEN REGENERATIVE REACTANCE is used—nearby broadcasting stations can be tuned out and the others brought in with full built up strength. Much American telephony has been successfully received on two-wave sets. Then, again, a set of plug-in coils to cover the same wide range would cost more than the LISSEN REGENERATIVE REACTANCE—no coil holder to buy with the latter, either. This LISSEN part is provided complete with internally connected switch already mounted—no soldering—no complications—blue print with each shows easy connections—LISSEN ONE HOLE FIXING OF COURSE. 150-4,000 metres £2/12/6
 Tune always with a vernier—preferably the LISSEN VERNIER, specially designed for fine tuning in H.F. circuits, price 12/6



THE LISSENSTAT AS AN AID TO TUNING.

In tuning, particularly in long-distance work and also where extreme selectivity is desired, there is always one spot which will give the best results. LISSENSTAT control makes it possible to regulate critical electron emission to correspond exactly with the degree necessary for perfect detection. There are three types of LISSENSTAT control—

THE LISSENSTAT (prov. pat.)—this is the super filament control, ideal for dull emitter and all valves .. 7/6

THE LISSENSTAT MINOR (prov. pat.)—There must be many hundreds of thousands of inefficient rheostats in use. This latest development of LISSENSTAT control provides something of the beautiful Lisssenstat control at a popular price. For dull emitter and all valves (the Lisssenstat is a still better control) .. 3/6

THE LISSENSTAT UNIVERSAL (prov. pat.) A minimum resistance can be left in circuit to protect expensive dull emitter valves. Full resistance is 50 ohms. To those who make the mistake of thinking that LISSENSTAT control is the same thing as an ordinary rheostat—LET THEM TRY THE DIFFERENCE. Text Book of LISSEN PARTS—post free 8d. Free to the trade. TO THE TRADE—IT IS WORTH A GOOD DEAL TO THOSE TRADERS WHO ARE KNOWN TO SPECIALISE IN LISSEN PARTS.

LISSEN LIMITED 30-32, WOODGER ROAD, GOLDHAWK ROAD, SHEPHERD'S BUSH, LONDON, W.12. Telephone Nos.: Hammersmith, 3380, 3381, 3382, 1072. BUILT WITH LISSEN MASTER PARTS.

THE LISSENSTAT UNIVERSAL (prov. pat.) A minimum resistance can be left in circuit to protect expensive dull emitter valves. Full resistance is 50 ohms. To those who make the mistake of thinking that LISSENSTAT control is the same thing as an ordinary rheostat—LET THEM TRY THE DIFFERENCE. Text Book of LISSEN PARTS—post free 8d. Free to the trade. TO THE TRADE—IT IS WORTH A GOOD DEAL TO THOSE TRADERS WHO ARE KNOWN TO SPECIALISE IN LISSEN PARTS.

A LOUD SPEAKER for Every Home

Visit our Stand at the
**BRITISH EMPIRE
EXHIBITION**
Avenue 9-10 Bay 18-20

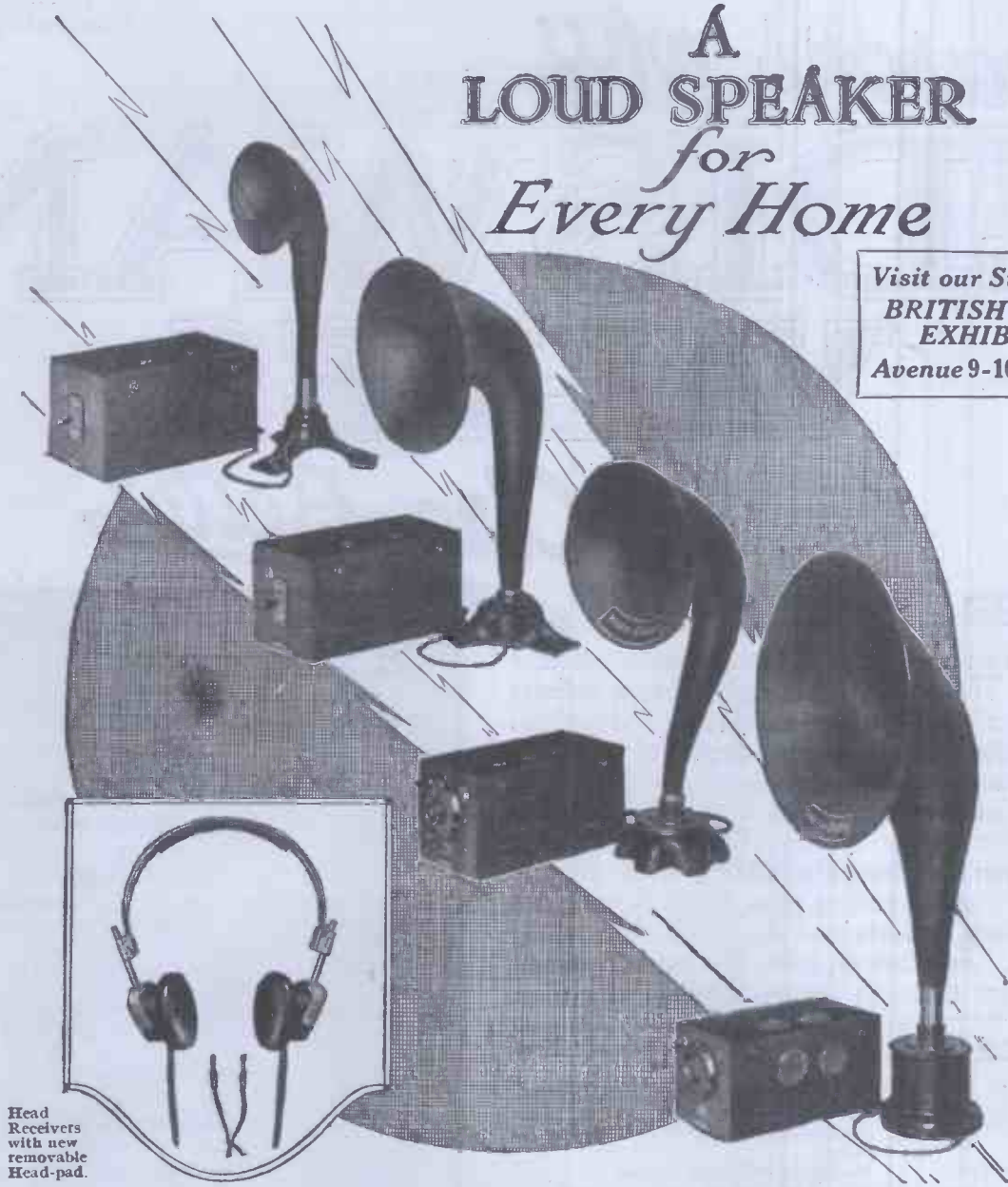

Head
Receivers
with new
removable
Head-pad.

These justly celebrated Loud Speakers are designed on the same principle as those manufactured and used by this Company to distribute the King's Speech in the Wembley Stadium and Grounds.

THEY OPERATE OFF DRY CELLS, NO ACCUMULATORS BEING NECESSARY:

For a Small Room :	No. 44003 Loud Speaker	.. £1 17 6	No. 44010 Weconomy Amplifier	.. £9 17 6
For ordinary purposes :	No. 44004 Loud Speaker	.. £3 17 6	No. 44012 Weconomy Amplifier	.. £12 17 6
For a large reception room :	No. 44005 Loud Speaker	.. £5 17 6	No. 44013 Weconomy Amplifier	.. £19 0 0
For Concert Halls :	No. 44002 Loud Speaker	.. £8 0 0	No. 44014 Power Amplifier	.. £24 0 0
	Head Receivers No. 44011	.. £1 5 0	(This last combination requires an Accumulator.)	

(B.B.C. CONTRIBUTIONS EXTRA.)

WECONOMY AMPLIFIERS ARE DRY BATTERY AMPLIFIERS.

Western Electric

MAKERS OF OVER HALF THE WORLD'S TELEPHONES.

Advert. of WESTERN ELECTRIC COMPANY, LIMITED, CONNAUGHT HOUSE, ALDWYCH. Ask your Dealer for particulars.

PARTS, COMPONENTS, SETS—they all sell equally well in WIRELESS WEEKLY.

Reasons why EDISWAN VALVES Are Better

Glass.

Glass plays an important part in the construction of a Valve. The *quality* of the glass has a definite bearing upon its span of life—the thickness of the bulb must be regulated to a minute degree of accuracy. One important reason for the superiority of Edison Swan Valves is the fact that the whole of the glass required is manufactured at their Ponders End Factory. From the preparing and heating to 1200°C of the mixture which produces the molten glass, to the blowing and final moulding, each stage of the process is carefully supervised. In this way, from the outset, extreme measures are taken to ensure Edison Swan efficiency.



PRICES.

"R" - - 12/6

"A.R." - 12/6

"A.R.D.E." 21/-

Dull Emitter.

"A.R.06." 30/-

Latest Dull Emitter.
Current consumption at 2.5 volts, .06 of an ampere.

Note the safety cap (Pro-Pat.) which is now fitted to all Edison Swan Valves. The filament pins are shorter in length than the plate and grid pins, thus avoiding any chance of making surface contacts with the wrong sockets.

Have you had your FREE copy of Illustrated Booklet, "The Thermionic Valve?" If not, send a postcard to-day.

Also Manufacturers of Headphones, "Toovox" and other Receiving Sets, "Televox" Loud Speaker, Batteries, etc. Send to-day for leaflets.

Your Dealer holds stocks to supply you. If not, write us direct, giving his name and address.

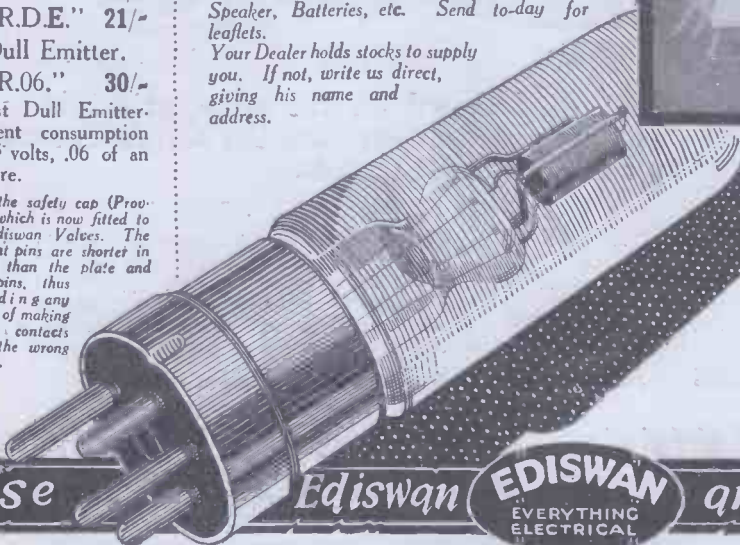

THE EDISON SWAN ELECTRIC CO., LTD.,

Contractors to H.M. Admiralty,
War Office, Royal Air Force.

123/5, Queen Victoria Street, E.C.4,
and 71, Victoria Street, S.W.1.

Branches in all Principal Towns.
Works: Ponders End, Middlesex.

Use

Ediswan



and hear Everything

Buy British Goods only.

PARTS, COMPONENTS, SETS—they all sell equally well in WIRELESS WEEKLY.

HULLO, EVERYBODY!!

RAYMOND

Post Free Column.

VARIABLE CONDENSERS.

Callers Only!

Our Air Dielectric Condensers are the simplest and MOST efficient on the market. Lowest in price, Highest in quality. Made for panel mounting and are the most suitable condensers for Broadcasting or Amateur work. They have passed THE TEST for guaranteed capacities, are scientifically accurate and built for durability.

All Post Orders from other Columns.

- Basket Coils (6) 200/3,600 2/6
- Waxless (5), 200/2,000M. 2/6
- Twin Flex, 12 yds. 2/-
- Bell Wire, D.C.C.I.R.O. 10 yds. 10d.
- 100 ft. Aerial, 7/22 3/3
- Rubber Lead-in, 10 yds. 1/6
- Basket Coil Holder and Plug 1/9
- Do., 2-way on Stand 5/9
- 2-way for Igranic Coils 4/11
- Various Designs do. 5/11, 6/11 & 7/-
- Shaw's Genuine Hertzite Spade Screw Terminals doz. 1/6
- Pin de. doz. 1/3
- Ebonite Dial and Knob Do., Extra Quality 1/6
- Ebonite Valve Holders Do., Cut from Solid 1/6
- Valve Sockets, Best, doz. 1/3
- Do., Plain 1/-
- Terminals, Telephone doz. 1/6
- Do., Pillar doz. 1/6
- Do., Small Pillar doz. 1/4
- Do., W.O. Patt. doz. 1/6
- (All above with Nut.)
- Insulating Sleeve, 3 yds. 1/3
- Tinned Copper, 3 yds., 14 or 16 gauge 9d.
- Do., 3 yds., 18or20 gauge Ebonite Coil Plugs, 2 for Do., on Stand 1/9
- 100,000 ohm Resistance Switch Arm, 12 Studs and Nuts 1/6
- Ormond Fils. Resistance Fixed Condensers, *001 Do., *001 to *005 1/6
- Do., *002 to *005, 1/3, *006 (Above best quality.) Grid Leak and Condenser, *003 2/6
- Ebonite Varlo, D.S.C. 250/260 4/11
- Do., D.C.C. Ball Rotar Ebonite (Inside Winding) Variometers 13/6
- Contact Stops doz. 1/-
- Battery Clips doz. 1/6
- Coil, 26 tps., 1,600 M. 2/6
- 4 Whiskers, 1 Gold 6d.
- Spear Point Whisker 4d.
- 12 yds. Empire Tape 1/-
- Plug and Socket, 12 prs. Gecosite Crystal 1/6
- Minicap Switch 8/-
- Radio Ins. Transformer 25/-
- Igranic Shrouded, L.F. 5-1 21/-
- Formo Shrouded, do. 18/-
- Formo Open Type, do. 12/8
- Royal, do. 20/-
- Tested on Aerial, do. 12/8
- Raymond, do. 12/8
- Ormond Fils. Rheostat Raymond do. 2/-
- Rheostat and Dial 2/6
- Ajax 25'5 4/-
- Ajax with Vernier, 30'5 ohms 5/-
- Ajax Potentiometer, 464 ohms 6/6
- Igranic Rheostat 4/6
- Peerless Rheostat, 6 ohms 4/6
- Peerless " 15 ohms 4/9
- Peerless " 30 ohms 5/-

NEW MODEL, POST 6d. SET EXTRA.

*073 in. SPACERS.		
Capacity.	Plates.	Price.
*001	...49	...7/11
*00075	...37	...6/11
*0005	...25	...5/11
*0003	...15	...5/3
*0002	...11	...4/11
*0001	...5	...4/3

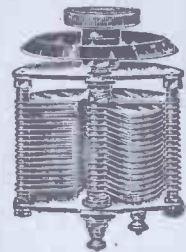

Prices include KNOB and Dial. Without Dial 6d. set less Vernier, 2/8. (No dial.)

"A" TYPE. POST 6d. SET EXTRA.

*088 in. SPACERS.		
Cap. Approx.	Plates.	Price.
*001	...57	...6/6
*00075	...43	...5/9
*0005	...29	...5/-
*0003	...19	...4/6
*0002	...13	...4/-
*0001	...7	...3/6

Trade dis. on Condensers 20% plus postage. Good terms for quantities.

NATIONAL LABORATORY CERTIFICATE.

Above new model specially adapted for taking up min. amount of space. All parts nickelled. PASSED NATIONAL LABORATORY TEST. One hole fixing.

HEADPHONES.

- Sterling B.B.C., high-class (4,000) 25/-
- B.T.H., B.B.C. None better (4,000) 25/-
- Brunet. Very fine value (4,000) 17/6
- Brunet, for Crystal Sets (8,000) 19/11
- N. & K., all stamped (4,000) 12/9
- Sidpe, very best 12/9
- Premier, B.B.C., full of music, 4,000 ohms Post 1/- pair. 17/6

H.T. BATTERIES.

- 30 v. ... 4/3 & 4/6
- 36 v. ... 4/9 & 5/6
- 60 v. 7/6, 8/6 & 10/6
- Post 1/- each.

DISCOUNT TO TRADE and MEMBERS of Radio Clubs.

ERICSSON E. V. type, World Famous Continental Headphones, 4,000 ohms.

13/9 Post 1/- per pair.

CRYSTAL DETECTORS.

- Post 9d. each.
- Glass enclosed Whisker, Brass Fittings, 1/9, 2/3, & 1/6
- Glass enclosed Perikon, with Zincite and Bornite 1/11 & 2/9
- Nickel enclosed, 3/6, 2/6, 1/11
- Edison Bolt Twin 5/6
- Choice Designs, 5/- & 7/6
- Post 9d. each.

VALVES.

- Marconi R. Ediswan 12/6
- Mullard O. 12/6
- Cossor P.1.
- Cossor P.2.
- Post 1/- each.

Lissen Grid Leak (Var.) 2/6

- Lissen Anode Resistance 2/8
- Lissen T1 Transformer 30/-
- Lissen T2 " 25/-
- Lissen T3 " 18/6
- Lissen Series 'Parallel Switch 3/9
- Lissen Two-way 2/9
- Lissenstat Minor. Out of Stock
- 100,000 ohm Resistance 2/6
- Edison Bell Fixed *001 1/3
- Do. *001 to *005 1/3
- Do. *002 to *006 2/-
- Do. *003 and Grid Leak 2/6
- Raymond Fixed *001 1/1
- Do. *002 to *005 1/1
- Do. *002 to *005 1/5
- Do. *008 1/8
- Do. *003 and Leak 1/10
- Dubilier Fixed *001 3/-
- Do. *002 to *006 3/-
- Do. *001 to *005 2/6
- Do. *003 and Grid Lk. 5/-
- 'Phone Cords, 54 in. 1/3
- Do. 72 in. Double 1/9
- Variometer 250/650, 3/- 3/6
- Do. Ebonite 250/650 3/11

SUPER CONDENSER WITH THREE PLATE VERNIER "IT" FOR VERY FINE TUNING.

- *001 .. 12/6
- *0005 .. 10/6
- *0003 .. 8/6
- Reg. Post 6d. set.

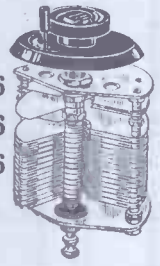

FILOSTAT FOR D.E. and R. VALVES

- Post 6d. each 2/6
- 4 v 40 a. ... 11/6 & 11/6
- 4 v 40 a. ... 17/6 & 19/6
- 4 v 00 a. ... 19/6 & 23/-
- 6 v 60 a. ... 28/- & 33/-
- 6 v 80 a. ... 35/- & 39/-
- Post 1/6 each.

EBONITE 3/16"

- 6 x 6 .. 1/6
- 8 x 6 .. 2/-
- 9 x 6 .. 2/3
- 12 x 9 .. 4/6
- 12 x 12 .. 6/-
- Post 6d. piece.

BASKET COILS

- Set of 6. 1/11
- Set of 7. 2/3
- 200/3,600 metres Post 6d. set.

WAXLESS.

- Set of 5. 1/11
- Set of 6. 2/3
- 200/2,000 metres Post 6t. set.

This list is subject to alteration without notice.

N. & K. (The Goods)

Best. Stamped Genuine. 4,000 ohms 12/9 Pair. Post 1/- pair.

- Telephone, large each 11d.
- Telephone .. each 1d.
- Pillar .. 1d. & 11d.
- W.O. patt. .. 2 for 21d.
- Large size .. each 3d.
- Various doz. 1/- & 1/6
- Valve sockets doz. 10d. & 1/-
- Contact studs .. doz. 4d.
- 2, 4, 5, 6 B.A. Nuts 3 doz. 6d.
- 2 B.A. Rod .. foot 3d.
- 4 B.A. Rod .. foot 21d.
- Valve Pins .. 2 a 1d.
- Brass Bushes .. 1d.
- Spade Tags, best, doz. 3d.
- Screw Spade Terminals 1d.
- Pin Screw do. .. 4 for 3d.
- Stop Pins .. 2 a 1d.
- Plug and Socket pair 11d.
- Easyfix Cup .. 11d.
- Switch Arms 8d., 9d. & 10d.
- Do., with 12 Studs and Nuts and Washers .. 10d.
- English Flash Lamp Batt. doz. 4/3
- H.T. Batteries, 36 v. 5/-
- H.T. Batteries, 60 v. 8/6 & 10/6
- Filament Res., with Dial 2/-
- Set of Names (12) .. 5d.
- 0-300 Dial .. 5d.
- Scales (Engraved 0-180) 3d.
- Multiphone Terminals 9d. & 11/-
- Insulators, Egg 6 for 6d.
- Aerial Wire, 100 ft. 1/10
- Extra Hard Drawn, 7/22 100 ft. 2/6
- Valve Windows .. 7d.
- Res. Diats, 0-100 .. 4d.
- Ebonite Dial and Knob, 0-180 .. 1/1 & 1/3
- Filament do. and Knob 9d.
- Filament Dial, 0-10 .. 6d.
- Fixed Condensers to *001 10d.
- Do., *002 to *005 & *006 1/3
- Ins. Screw Eyes .. 1d.
- 4 Cats Whiskers (1 gold) 3d.
- Gold Whisker .. 11d.
- Shaw's Hertzite .. 1/-
- Zincite, 6d.; Bornite, 6d.
- Coil Holders .. 1/1 & 1/3
- Coil Plugs, Ebonite 7d. & 9d.
- Do., on Base .. 1/- & 1/3
- Best Valve Holders .. 1/3
- 3 makes, above 10d., 1/- & 1/3
- Tinned Copper, 18, 16, 20g. 1/-
- Sleeving, best .. 3 yds. 1/-
- Copper Foil .. ft. 3d.
- Filament Res., good .. 1/6
- Rubber Lead-in 10 yds 1/- & 1/3
- Bell Wire, D.C.C. R.O., 10 yds. 5d.
- Twin Flex .. 12 yds. 1/6
- Heavy Rubber Lead-in yd. 2d. & 3d.
- Basket Coils (6) 200/3,500 1/9
- Waxless (5) .. 1/11
- D.P.D.T. Switches for Panel 1/6
- S.P.D.T. do. .. 1/3
- Telephone Cords 1/6 & 6d.
- Grid-Leak (2 meg.) .. 1/-
- Do., and Condenser *003 1/9
- Empire Tape .. doz. 9d.
- Adhesive do. .. roll 4d.
- A.A. Earth Clips .. 7d.
- Washers, 2 and 4 B.A. 3 doz. 2d.
- 100,000 ohms Res. .. 1/6
- Fine Variometers .. 2/6
- Engraving Set .. 71d
- Enclosed Detectors .. 11d.

Right Opposite DALY'S Gallery Door

K. RAYMOND 27, LISLE STREET, W.C.2

HOURS OF BUSINESS: Daily - 9 to 7.45 Sundays 10.30 to 1

Phone: Gerrard 4837.

PARTS, COMPONENTS, SETS—they all sell equally well in WIRELESS WEEKLY.

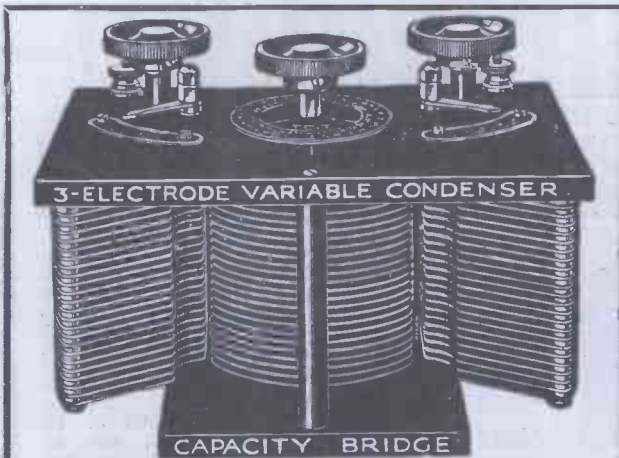

INTERFERENCE CAN BE ELIMINATED
 Perfect reception is possible only when your receiving set rejects all signals except those coming from the particular transmitting station to which your receiver is tuned.

The 3-E.V.C.

IS THE ONLY PROVED REJECTOR.

The "bridge of radio science" eliminates troublesome local stations, minimises statics and selects the particular broadcast programme desired. Its addition will make your set 100 per cent. more selective and sensitive.

Send 3d. in stamps for our new 1924 Variable (Capacity Bridge) Condenser Booklet, which contains much valuable information.

Prices: .001 mfd. panel mounting ... 47/6
 .001 " cabinet mounted ... 55/-

Obtainable from all high-class dealers or direct from the manufacturers and patentees:

AUTOVEYORS, LTD. Radio Engineers and Contractors,
 84, VICTORIA ST., WESTMINSTER, LONDON, S.W.1.

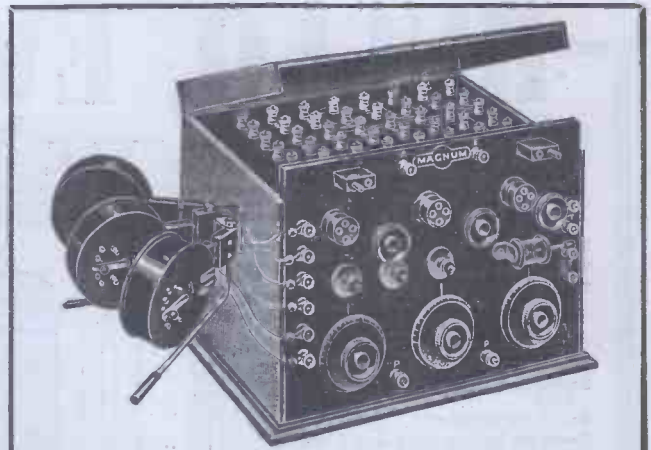

The Wonderful OMNI

as described by Mr. J. Scott-Taggart.
 As illustrated, including coils, 18 Guineas.

RECEIVES EVERYTHING FROM EVERYWHERE.
 TO CONSTRUCTORS.—All Components supplied separately if desired. Send stamp for Illustrated List and set of leaflets dealing with "Tested Sets," also the OMNI, S.T.100, 4-Valve Family Receiver and all circuits described in "Wireless Weekly," "Modern Wireless" and Radio Press Envelopes. Connecting Links, per set of 60, 8/- Carr. paid on Retail Orders value £2 and over. ALWAYS SPECIFY "MAGNUM."
MAGNUM TAPPED COILS—REDUCED PRICES.

No. 1. 180-1000 metres 12/6
 No. 2. 600-2600 metres 15/-

BURNE-JONES & Co. Ltd.

Manufacturing Radio Engineers,
 MONTFORD PLACE, KENNINGTON, LONDON, S.E.11.
 Phone: Hop 6257
 Experimental Stations.—2 F.P. New Cross. 2 P.B. Kennington.
 2 C.T. Lambeth. 6 C.W. Streatham.

ELECTRADIX RADIO STOCK

We have by far the largest stock of High Grade Ex-Govt. Apparatus in Great Britain, both in value and quantity. As Electrical Engineers of 30 years' experience we are able to discriminate in our purchases and stock quality goods only selected by Mr. H. L. Dixon, M.Inst.Elec.Eng. You will find these reliable and prices exceedingly low.

PORTABLE SETS are increasing in popularity. We stock cabinets with ebonite panel at 10/-, or can supply the famous R.A.F. "10" 5-Valve Set, brand new for £5 5 0. 3-Valve Mk. III., £3 15 0 (See leaflet), and others as per list.
AMPLIFIERS in great variety, 3-Valve High Frequency, only £2 10 0, suitable for Super Hetrodynes.

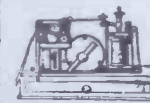

RECORDERS.—The demand for these wonderful bargains has been so great that we have few left now. Makers, Silvertown, Siemens, etc. Cost £40. All are guaranteed O.K. Full instructions with each. A bargain at £6 10 0. See leaflet.

TRANSMITTER RECEIVER COMBINED.—The Celebrated Marconi Trench Set, totally enclosed in polished Mahogany Case, is a bargain for Home Experiments or for use on Motor Boats, etc. Cost £40. Brand new, platinum contacts, £4 only.

VALVE TRANSMITTERS.—One-Valve Mk. III., £5 10 0. Two-Valve R.A.F. Mk. II., £3 10 0. Earth control panel, 17/6.

WAVEMETERS.—The best selection of high-grade sets ever offered. Long-range Townsends, 120/4,000 metres, £6. Broadcast range, £3. Hetrodynes, £6 10 0. 3-range Paul, 100/3,500 metres, £5 10 0. 120/1,200 metres, £4 10 0. Wavetraps, 30/-. See leaflet.

ILLUSTRATED CATALOGUE.—For fuller details see special leaflets on request or our April edition of our Illustrated Catalogue and Price List which every experimenter should have. Special attention to Foreign and Mail Orders if you cannot call at our Show-room in Colonial Avenue.

It will save you 50% to place your enquiries for anything Radio or Electrical with—

LESLIE DIXON & CO.

9, Colonial Avenue, Minories, E.1.

Telephone: Avenue 4166.

Telegrams: "Electradix, Ald, London."

Colonial Avenue is the first turning on the left in Minories from Aldgate Station, Met. Rly. Buses pass close by from Tower and Bank.

True Music Loud Speakers
Clear as Crystal Headphones

◆ **TMC** ◆
Wireless

If unable to obtain locally write to us direct.

British Empire Exhibition, Wembley.
 Palace of Engineering, B.E.A.M.A. Section.
 Stand C1, Avenue 11, Bays 6 & 7.

THE TELEPHONE MANUFACTURING CO., LIMITED,
 Hollingsworth Works, Dulwich, London. (EPS 169)

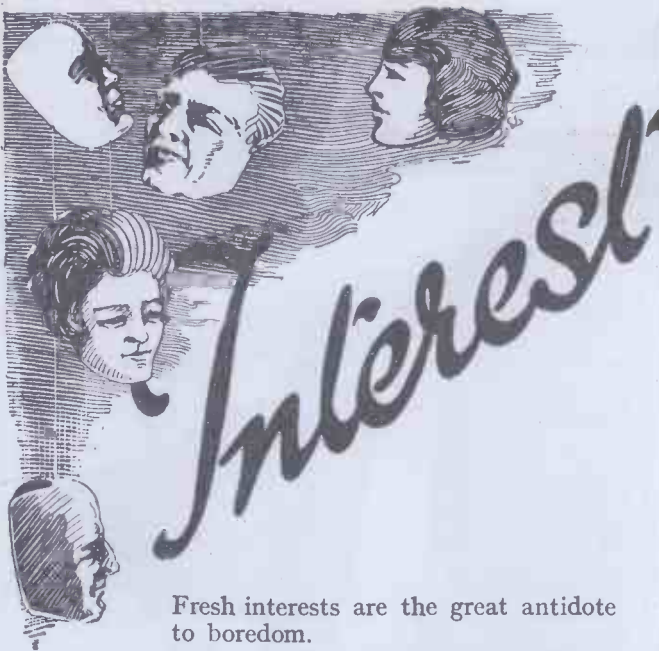

Fresh interests are the great antidote to boredom.

There are endless possibilities with a really efficient portable set that can be carried about like a week-end suitcase. Such a set can be used indoors, on the river, when motoring, or equally well to while away the time on a long train journey.

The new Fellows Portable Set is shown below. It requires no aerial or earth wires whatever; all being included in the case. Dry cells are also fitted inside so that there are no accumulators to require constant recharging. It will give excellent results on several pairs of headphones and a Loud Speaker may be used when close to a Transmitting Station.

The compactness and high-class finish will be seen at once on inspection.

THE FELLOPHONE PORTABLE THREE
complete with headphones :

£14 : 0 : 0

(In real cowhide 15 guineas).

Extras : B.B.C. tax £1 0 0 Marconi tax £1 17 6, and 3 Marconi D.E.3 Valves

Fellows Magneto Co., Ltd.
Park Royal, N.W.10. 'Phone : Willesden 1560



E.P.S. 65

PARTS, COMPONENTS, SETS—they all sell equally well in WIRELESS WEEKLY.

A Valve for Every Wireless Circuit



You wouldn't

be satisfied to overload a one-horse power engine to try and make it give ten-horse power.

Don't use ordinary bright filament valves to give you loud speaker volume, use

THE NEW D.F.A.

the Mullard dull filament MASTER valve, specially designed to give volume without distortion.

If you have bright filament valves working on 4 or 6 volts, replace the last valves with D.F.A.'s—you will be delighted with the increase in volume and clarity.

The same battery will do and it will last you longer.

D.F.A.'s are new dull filament amplifying valves made in two types, the D.F.A.1. for 6 volt batteries and the D.F.A.2 for 4 volt sets, as follows:—

	D.F.A.1	D.F.A.2
Filament volts	5.5	3.3
Filament amps.	0.23	0.25
Anode volts	50-100	50-100
Negative Grid volts	2-6	4-8

Price : 35/- 30/-

Ask your dealer or write to us to-day (Dept. W.W.) for leaflet V.A.3, giving full particulars.

Mullard
THE MASTER VALVE

Advt. — The Mullard Radio Valve Co., Ltd., Nightingale Works, Nightingale Lane, Balham, S.W.12. E.P.S. 131.

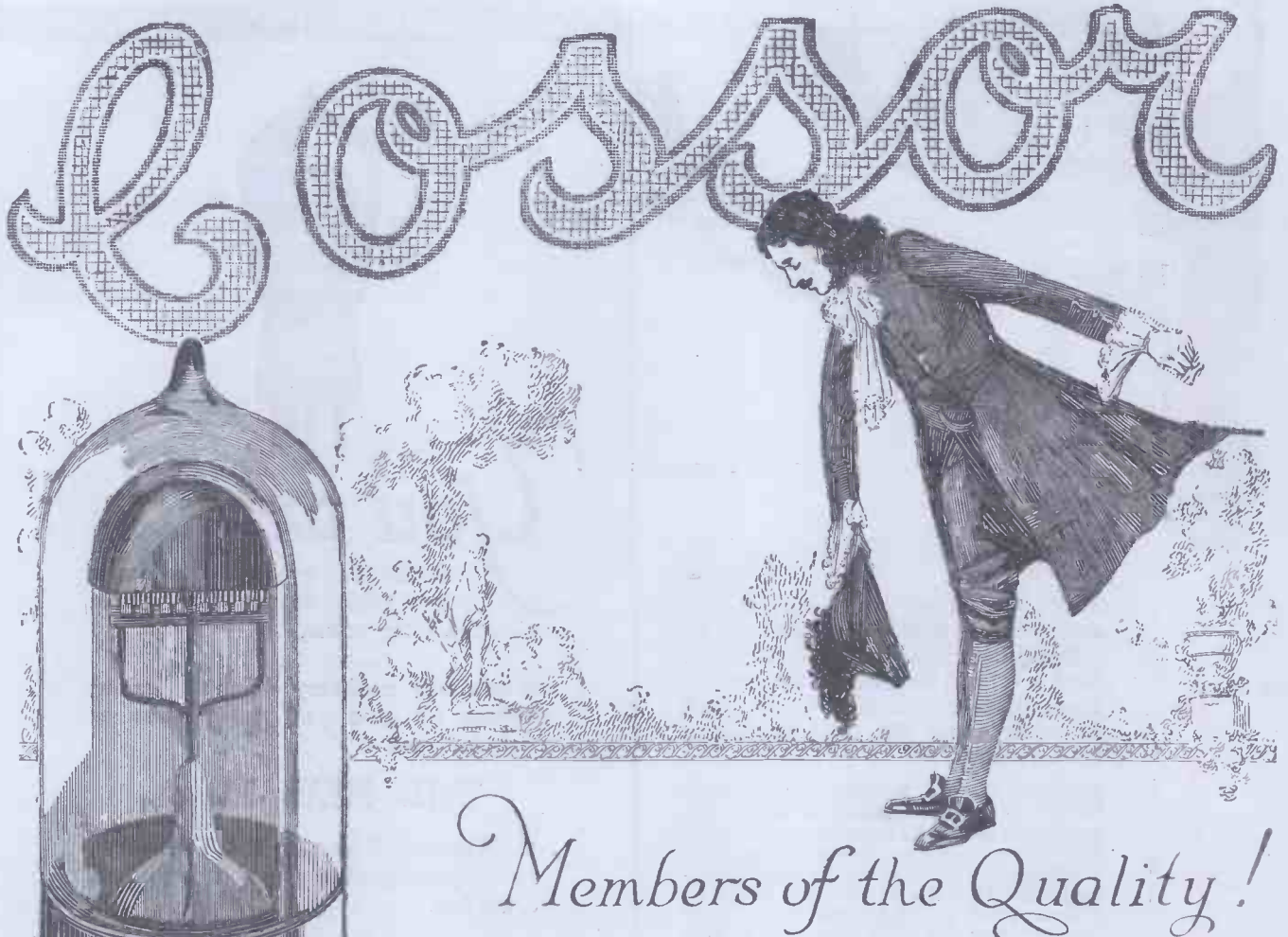

Members of the Quality!

TH**E**RE are Members of the Quality among Valves, too! Take the **COSSOR** for example. With its handsome nickelled cap solidly clamped to a moulded bakelite base, its bulb made from the finest grade of glass and blown to micrometer exactness—it looks what it is, a quality production throughout.

And its performance is thoroughly on a par with its appearance. Insert a **COSSOR** Valve into any Receiver and observe the difference. Used as a Detector, for instance, you will soon appreciate that it possesses infinitely superior rectifying properties owing to its electron stream being almost entirely contained and usefully employed. As an amplifier, the **COSSOR** P.1 is responsible for a remarkable degree of pure, sweet-toned

reproduction, vastly superior to that produced by an ordinary Valve. And when used as an High Frequency Amplifier, the P.2 is a veritable magician, searching out for long-distance Stations and obtaining clear and sparkling music of a quality previously considered impossible.

Truly the **COSSOR** is a Member of the Quality—an aristocrat among valves you would do well to know.

C The **Cossor** P.2 (with red top) is recognised throughout the country as the standard H.F. Valve. If you are interested in receiving long-distance Stations then be sure you have a P.2 in your Set.

A. C. COSSOR, Ltd.

Manufactured in two types:
 P.1.—For Detector and L.F. use ... 12/6
 P.2.—(With Red Top) for H.F. use 12/6

Highbury Grove, London, N.5

Gilbert A.d. 78x

PARTS, COMPONENTS, SETS—they all sell equally well in WIRELESS WEEKLY.

*Please your home
with the Tone*



There is infinite satisfaction in pleasing the folks at home. Let them hear the BARNES!

This new Model No. 2 is the outcome of patient experiment to produce a loud-speaker to please the most sensitive musical ear. Purity and richness of tone are present to an extent exceeding any previous experience. Its volume is such that the largest room will be filled with pleasing music.

BARNES MINORPHONE MODEL NO 2

The BARNES MINORPHONE No. 2 therefore merits your distinction—and your ultimate choice—by virtue of its reasonable price. It is an instrument with a strong, distortionless output obtainable at the minimum expense.

Of robust construction, has large adjustable diaphragm and detachable horn, dull black in finish. The well-designed base is dull black with polished aluminium top

If your local dealer cannot supply *The Barnes Loudspeaker* write us direct, sending his name and address, when we will send you descriptive leaflet.

L. B. TICKLE & Co.
Government Contractors,
61 Borough Rd., London, S.E.1
Phone: Hop 3874. Grams: Elbeetckl, Sedist

PRICE
£2. 5. 0

“ASTONISHING RESULTS!”

THAT'S an amateur's opinion of Myers Valves. No other type of Valve can compare with Myers. The one great defect in all Valves has been eliminated in Myers Valve by bringing the leads from grid and plate out at opposite ends, thus reducing capacity in the valve itself and improving reception to a remarkable extent.



EXACT SIZE.

The logical Valve for front panel mounting. It lends beauty to your set.

No Sockets necessary.

Supplied complete with clips ready for mounting.

The Loud Speaker Valve. The only one that gives perfect amplification without distortion.

Made in two types: Universal and Dry Battery.

UNIVERSAL, 4 Volts .6 Amps. - - 12/6
 DRY BATTERY, 2½ Volts .25 Amps. - 21/-

Plate Voltage 2 Volts to 300 Volts.

PRACTICALLY UNBREAKABLE.

The NEW

Myers Valves

are sweeping the market. Insist on Myers at your dealers or send P.O. to

Cunningham & Morrison

49, Warwick Rd., Earl's Court,
 LONDON - - S.W.5

AGENTS

LONDON
 THE DULL EMITTER VALVE Co.,
 83, Pelham St., South Kensington, S.W.7.
 NEWCASTLE
 GORDON BAILEY & Co., Consett Chambers,
 Pilgrim St., Newcastle.

LIVERPOOL
 APEX ELECTRICAL SUPPLY Co.,
 59, Oldhall St., Liverpool.
 MANCHESTER
 R. DAVIES & SONS, Victoria Bolt and Nut
 Works, Bilberry St., Manchester.

GLASGOW
 MILLIGAN'S WIRELESS Co., 23-25, Renfrew St., Glasgow.

A DEPARTURE in Valve-Holder Construction for Every Experimenter

who knows that high resistance and low capacity are determined by the spacing of the valve legs themselves. In the manufacture of the H.T.C. Valve-Holder, allowance is made for the varying spacing of legs of the different types of valves. No metallic parts used in construction are exposed, making it impossible to short the H.T. across the filament.

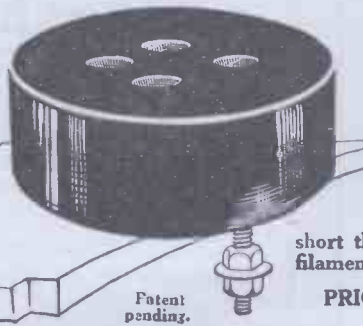

Patent pending.
 Type "A" for above Panel Mounting.

PRICE 1/9

We are also Manufacturers of the Famous
H.T.C. INTERVALVE TRANSFORMER
 the success of which has succeeded good craftsmanship and good materials, observing good design.
 Obtainable from your Local Dealer, or direct from the Manufacturers. Price **15/-**

H.T.C. Electrical Co., Ltd.
 2 and 2a, BOUNDARIES ROAD, BALHAM, S.W.12
 Telephone: BATTERSEA 374. Trade Enquiries Invited.

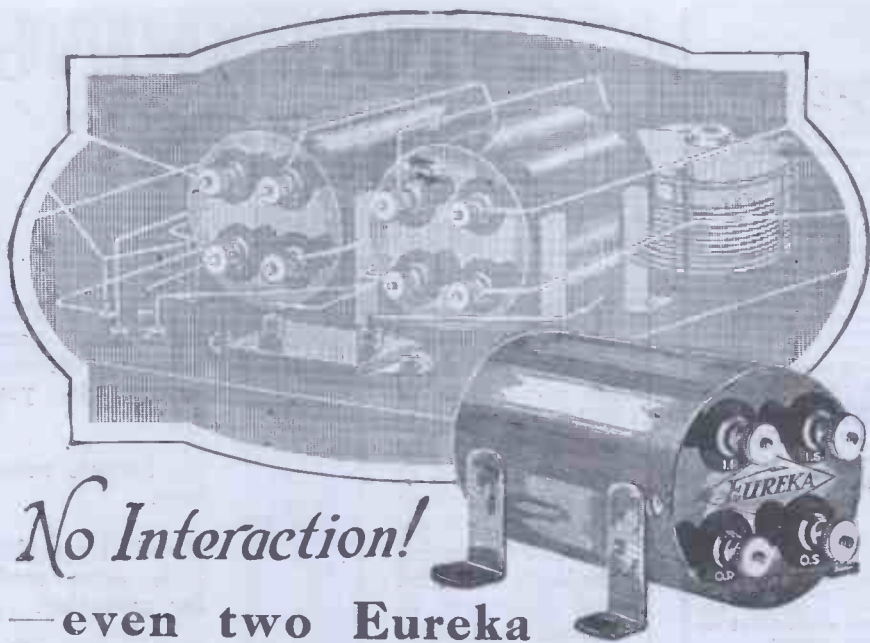

No Interaction!
—even two Eureka
Transformers touching
cannot cause howling!

FOR any Set operating a Loud Speaker and requiring two Low Frequency transformers, the big difficulty hitherto has been the correct position of the transformers.

It is recognised that in a reflex circuit particularly, the slightest interaction between the two transformers will cause howling and other noises. When ordinary transformers are used it is necessary to space them well apart and to place the cores at right angles to each other. This invariably means longer connection wires and inefficiency. Now, however, the Eureka offers complete emancipation from interaction even with the transformers touching. This striking example of efficiency is typical of the superior design and construction of the Eureka. Not

only does it give immense amplification (the Concert Grand Model will give a volume equal to that from two ordinary L.F. Transformers), but its tone is utterly free from distortion and noises.

The small additional cost of the Eureka Transformer (necessitated by the fact that almost twice as much wire is used), is amply recompensed by the vastly superior results you will obtain.

See that your next Transformer is a Eureka and be assured of perfect reception.

Made in two types 1

Concert Grand, 30/- No. 2 (for second stage), 22/6

Sold by all dealers and manufactured only by

ELECTRIC APPLIANCES CO., LTD.

7 and 8, Fisher Street, London, W.C.1.

Branches:—Leeds: 1, Oxford Place.

Manchester: 9, St. James Square.

Scottish Agents: Blackie, Fuller & Russell, Ltd., 30, Gordon Street, Glasgow.



Gilbert Ad. 790

PARTS, COMPONENTS, SETS—they all sell equally well in WIRELESS WEEKLY.

WIRELESS WEEKLY SMALL ADVERTISEMENTS.

BELLTONE CRYSTALS sold with a 12 months' guarantee are best and cheapest in the end. Ordinary, 3/6; Perikon, 4/-; see advert. in "Modern Wireless."—Bell Laboratories, 23, Queen's Chambers, Queen St. Arcade, Cardiff.

£300, £400, £500 Salary for certified Wireless Operators. Only 12 months' Tuition required. Situations Guaranteed when qualified. One exam.: no postal Tuition. Prospectus free.—Wireless College, Bournemouth.

TELEPHONE RECEIVERS and Loud Speakers Rewound, 2,000 ohms. —A. Roberts & Co., 42, Bedford Hill, Balham, S.W.12.

AMPLICRYST (permanently energised), no battery required, guaranteed 100 per cent. greater volume than other crystals. Ideal for Reflex circuits. Price 3/6, including catswhisker and post. Or particulars Ledsham & Co., 297, King Street, Hammersmith, London.

YES! YOU HAVE NO OUTSIDE AERIAL. Then increase your signals 50-100 per cent. by fitting our guaranteed amplifier to your weak crystal set. Amplifier and instructions, 1/3, post free. Mail business only.—W. Matthews, 42, Rosedale Terrace, Sandyford, Newcastle-on-Tyne.

POLISH YOUR OWN WIRELESS CABINETS. Do you want to master French Polishing with little trouble? Write for particulars of our simple polish.—H. Rowe & Son, Ashton-in-Makerfield, Lancs.

AN OPPORTUNITY.—Established Wireless Firm near Charing Cross requires Managing Partner, with small capital, limited liability, age 25 to 30, resident London preferred, previous experience an advantage. Letter, "Compton," 5, Pendennis Road, Streatham, S.W.

TWO-VALVE PANEL (dual amplification, R.I. Transformer), 24. Three-valve panel (tuned anode with reaction), 25 10s. "Sonus" L.F. amplifying panel, 25/—Rev. W. Bloss, St. Thomas' Vicarage, Stepney, E.1.

CRYSTALS.—Listeners with Crystal Sets in Birmingham repeatedly hear Newcastle, Glasgow, London, and amateurs with our "EKKOITE" Crystals. Used throughout the Midlands. Try one. 1/3, post free. — The "EKKO" Radio Co., 236, Rolfe Street, Smethwick, Birmingham.

Leadership

IN every sphere of life or field of business, one man or one firm leaps to the front.

LEADERSHIP, however, creates responsibilities. We realise ours, and appreciate that our duty to the ever increasing number of readers of *Modern Wireless* and *Wireless Weekly* lies in maintaining the high standard of quality prevailing at their inception.

RADIO PRESS LTD.
Devereux Court, Strand, W.C.2.

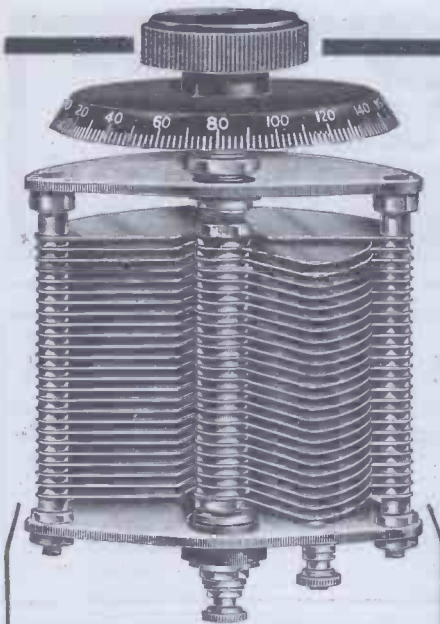

IMPERIAL VARIABLE CONDENSERS

Where accuracy is essential, "Imperial" is always first choice. The following range of Variable Condensers will particularly appeal to the discriminating Experimenter. Every Condenser is carefully packed and delivered in neat, dust-proof cardboard containers.

Write to-day for details of our valve renewal service, accumulator charging apparatus and general wireless accessories

G.W.I. Ltd.,

The Original Valve Repairers

Imperial Works, Shanklin Road, Crouch End, London, N.8.

Telephone: Hornsey 3065. Telegrams: White, Hornsey 3C65.

Delivery by return of post. Please remit ample postage. Excess refunded.

PRICES: No. 2.—Fitted with aluminium top and bottom plates, ebonite bushes, knob and dial complete, centre hole fixing spacers .073 in. Vanes 24 gauge, capacity guaranteed.

.001 each 8/-	.0002 each 4/6
.00075 " 7/-	.0001 " 4/-
.0005 " 6/-	.00005 " 4/-
.0003 " 5/6	.00025 x .00025 .. 17/6

FIXED CONDENSERS

.0001 to .0015 .. 1/6	1 Microfarad .. 4/6
.001 to .003 .. 2/-	2 " .. 5/6
.01 4/6	

Why not use "D.E.3" valves in your set?

BE free from accumulator worries. Work from dry cells and take your set about with you this summer. Extensive and expensive alterations to your set are unnecessary. Fit a screw-holder in series with your existing rheostat and insert fixed resistors of known value. A short circuiting plug used in place of the fixed resistor restores the circuit to its previous condition. Publication No. 42 explains the system, giving details of resistors of various values. Write for it now.

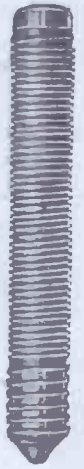

Prices of fixed resistors—from 1/6 to 2/- Screw Holder for these Resistors, in carton with instructions ... 1/6
Brass Shorting Plugs to fit Screw and Holder, three in carton ... 1/6

VISIT our STAND at WEMBLEY in the Palace of Engineering, Avenue 13, Bay 13

BURNDIPT LTD.,

Aldine House, Bedford St., Strand, W.C.2

BURNDIPT

WIRELESS APPARATUS



WIRELESS from your BELL PUSH

A WIRELESS SET CAN BE USED IN ANY ROOM WHERE AN ELECTRIC BELL IS FITTED

Just slip into the Bell-Push The **BELRADIO** Adapter

(PAT. APPN. NO. 10208)

The Bell-wire will then function as an Aerial (or Earth if you have an Aerial) The **BELRADIO** consumes no current nor does it interfere with use of bells.

Price **2/6** Per Set (THREE SIZES)

DEMONSTRATION ANY DAY DURING BROADCASTING HOURS

JOHN MACLENNAN & CO.
115 NEWGATE ST., LONDON, E.C.1. 116 INGRAM ST., GLASGOW.

TRADE TERMS ON APPLICATION

TRADE **Grelco** MARK

EVERYTHING

To make up this handsome ST100 Set is supplied by us—for example—

- Polished Oak Cabinet, with lid as shown ... 30/-
- Size of Ebonite to suit—20 in. X 7 in. X 1/4 in. (best) 8/-
Box 1/- carriage forward.
- Heavy Valve Windows—Polished Brass or Nickel Plate—6d. each—As used by *Wireless Weekly*. These must not be compared with the cheap stampings on the market.
- 2-0005 Improved Variable Condensers with Knob and Dial 6/9 each. Post 9d.

FOR FURTHER ARTICLES NECESSARY TO COMPLETE—SEND 3d. FOR OUR 124-PAGE ILLUSTRATED CATALOGUE—1,500 ILLUSTRATIONS

TOLONGHURST: MUSEUM 241 BLOUGH: BLOUGH

ELECTRIC GRAFTON COMPANY

GRAFTON STREET, LONDON, W.C. TOTTENHAM COURT ROAD,

Another "RADIOHM" SUCCESS
 Makes fine tuning easy. Approved by the Wireless Press. Can be fitted in 5 minutes. 2/6 EACH.

"RADIOHM" BUS BAR
 THE GENUINE ARTICLE. FINE FOR WIRING. IT STAYS PUT. IDEAL FOR OMNI CIRCUIT. 2/- per doz. 2-ft. lengths. Postage 3d.

"RADIOHM" Strip Copper Aerial.
 25% stronger signals. 100 ft. on reel, 3/- Postage 5d.

FOR CONDENSERS.

SPARKS RADIO SUPPLIES (Dept. W.)
 43, GREAT PORTLAND STREET, LONDON, W.1
 Telephone: Langham 2463.

DRY CELLS FOR D.E. VALVES
 Take our Advice With D.E.3 Valves and similar types, use 2 cells in series. With Weeco Valves, Wuncell and similar valves use 2 cells, in parallel.

USE RADIAX SUPER-CELLS AND AVOID DISAPPOINTMENT.
 Price 2/3 each Postage: 2, 9d; 4, 1/- 6, 1/3

H. T. BATTERIES
 with sockets and wander plugs 54 volt 9/9, 66 volt 11/9, 108 volt 17/9
RADIAX SPECIALITIES ARE OBTAINABLE FROM ALL REPUTABLE DEALERS

RADIAX S.S. HEADPHONES
 Really super-sensitive and will almost double the strength of reception, having adjustable diaphragms and are absolutely unbeatable. 4000 ohms. Price 19/6

RADIAX L^{TD.}
 50, Radio House, Percy Street, Tottenham Court Rd. LONDON, W.1. WE SATISFY YOU

Two Outstanding Achievements.

THE PORTABLE-FIVE
 The only Portable Receiving Set in a leather suitcase, requiring no Aerial and no Earth. It is entirely self-contained, including valves, batteries, invisible loop aerial and Loud Speaker. Really good reception on the Loud Speaker at 25 miles or on Headphones at 500 miles.

THE SUPERFIVE
 A Five-Valve Cabinet Receiver for use with either Dull or Bright emitter valves—owing to its many Special and Exclusive features really good Loud Speaker reception may be easily obtained at 500 Miles under normal conditions—under reasonably favourable circumstances good Loud Speaker reception at 3,000 Miles has been frequently obtained by private users.

Write for special illustrated catalogues describing the above to:—

TINGEY WIRELESS LTD.

Offices & Showrooms (Open 8 to 7; Saturdays 8 to 1) —
 92, QUEEN ST., HAMMERSMITH, LONDON, W.6.
 'Phone: Hammersmith 1916. 'Grams: "Tingoidar, London."
 FEW AGENCIES STILL OPEN.

IT IS NOT BY ACCIDENT that Igranitic Honeycomb Duolateral Coils are in greater demand than any other inductance coils.



It follows from combining in them the results of
 The Scientist's Research
 The Technical Designer's Knowledge
 The Expert Craftsman's Skill.

The illustrations which have appeared in the various Radio Journals show that Captain Eckersley used IGRANIC COILS in the Receiving Set for His Majesty the King.
 Obtainable from all dealers. Write for Lists Y25.

IGRANIC 147, Queen Victoria St., LONDON.
ELECTRIC Co. Ltd. Works: BEDFORD.

CAM-OPERATED VERNIER COIL HOLDER.

Quality RADIO

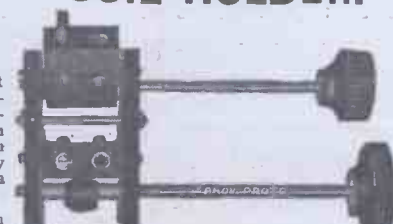

The usual fixed socket has a very slow movement giving a micro-metric adjustment in both directions through 10°. This is effected by a cam operated by a separate knob.

Price 2 way (only) 9/- on base 1/- extra. Post 3d.

With Reaction Reverse and Short-Circuiting Switch 12/6.

GOSWELL ENGINEERING CO., LTD.,
 12a, PENTONVILLE ROAD, LONDON, N.1.
 Liberal Trade Terms. Phone: North 3051.

Useful Advice!

Unless a Leak of the proper resistance is placed across the grid condenser the valve will either choke or the effect of the Condenser be destroyed. The value depends on both the characteristics of the valve and the circuit, and can only be obtained through using the "BRETWOOD," the only accurate variable grid leak of watch-like precision and scientific design. PRICE 3/-

The only Grid Leak with which it is possible to supply a reliable Chart giving 25 different readings covering from 100,000 ohms to 10 megohms. This Chart is supplied for use with the "Bretwood" Grid Leak only, at a cost of 1/3.

Send yours to be calibrated and chart supplied.

IMPOSSIBLE to short circuit valve when using the BRETWOOD valve holder which acts as its own jig and valve fits flush to panel. Valve legs are held yielding by ball bearing spring device, thus always assuring perfect contact. One screw fixing only. PRICE 1/9.

RADIO IMPROVEMENTS, Ltd.,
 95, GREAT PORTLAND STREET, W.1.
 Liberal Trade Discounts.



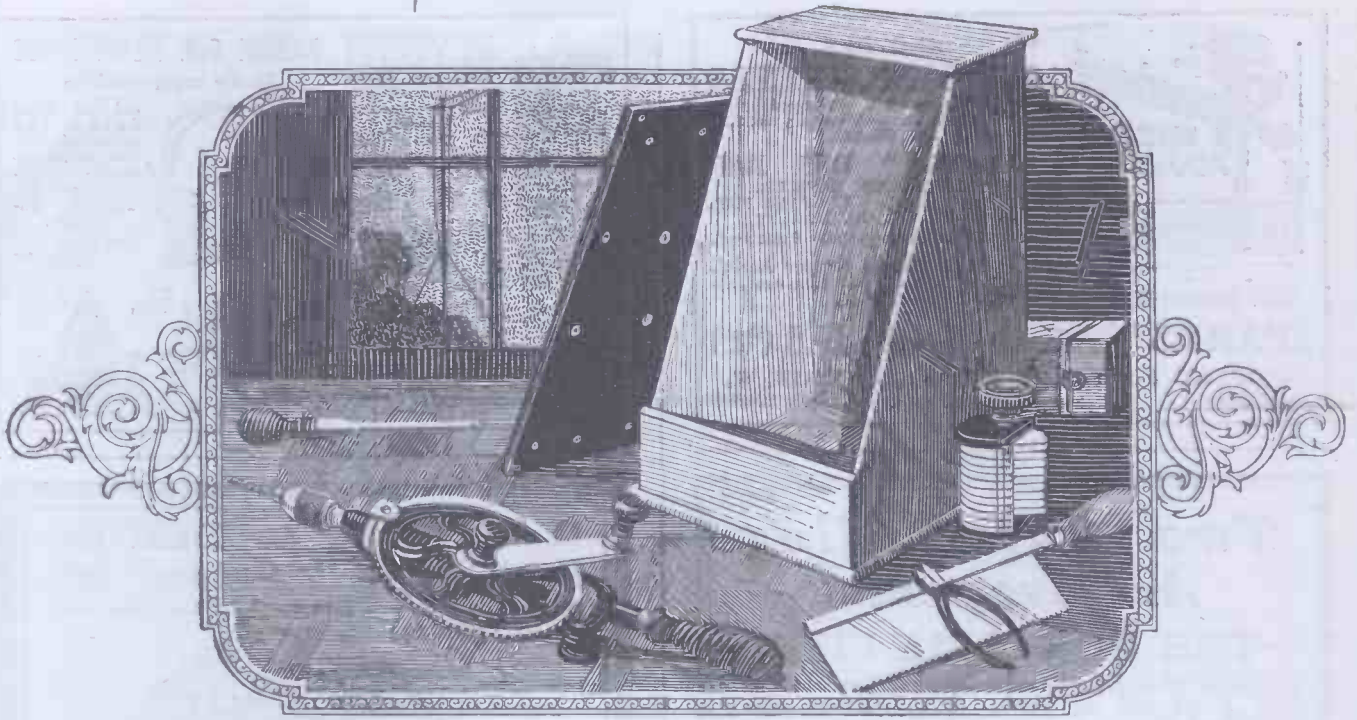

Wireless Sets for Home Constructors

By E. Redpath.

CONTENTS

- Simple Crystal Receivers
- An inductively coupled Crystal Set
- Testing and operating Crystal Sets
- A 2-Valve L.F. Amplifier
- Adding amplifiers to Crystal Sets
- A 2-Valve Broadcast Receiver
- A 3-Valve Regenerative Receiver
- A 1-Valve Reflex Receiver
- A 3-Valve Broadcast Receiver
- A 4-Valve Universal Receiver

—from a simple Crystal Set to a four-valve Receiver

CONSTRUCTIONAL Books have already been published which deal with simple Receiving Sets and also with more elaborate ones, but this is one of the first R.P. Books in which the reader is given a choice of both types of Sets.

Obviously a Book dealing with such extremes as simple Crystal Sets, which can be constructed in an hour or two, to a complex and ultra-efficient 4-Valve Set is a very useful adjunct to any Wireless enthusiast's Bookshelf.

Its frank advice and help in the choice of Sets to build will be appreciated by the complete novice, while the more expert will be glad to have authentic constructional details of the more advanced models capable of receiving American Broadcasting with certainty.

From all Booksellers or post free direct 2/8

RADIO PRESS, LTD. - Devereux Court, Strand - W.C.2

Series No. 17

2/6

Books like this make set building easy

PARTS, COMPONENTS, SETS—they all sell equally well in WIRELESS WEEKLY.

GILBERT AD. 648.



“—my Transatlantic Set has a record of five American Broadcasting Stations:”

says Mr. McIntyre.

NOT bad for a home built Set, is it? And it was really the first serious Receiver I had built. Its cost? Well, apart from the three valves I dare say the whole Set cost me less than four pounds, including the cabinet and a couple of H.F. Transformers.

I have read descriptions of many other Receivers, but none aroused my interest quite as much as this one. It seemed so simple to make, and as a matter of fact, once I had collected the components together and planned

them out on the panel, the whole job took just two evenings—one for the drilling and assembly and the other for the wiring.

Certainly I am much indebted to Mr. Harris for the clever way in which he has planned this two-H.F. Receiver. Its sensitiveness is astonishing and yet, with potentiometer control it is childishly simple to operate.

Up-to-date I have logged five American Broadcasting Stations and of course all the BBC Stations and most of the principal Continental ones.

The Transatlantic Set referred to by Mr. McIntyre is only one of a dozen described in Mr. Harris' Book. Whether your tastes lie in long distance reception or merely a Set to pick up your local Station you will find a ready choice available. Get a copy to-day from the Publishers (Radio Press Ltd., post free, 2s. 8d.) or from your Bookseller.



2/6

12 Tested Wireless Sets
By Percy W. Harris.



Those who buy *STERLING* buy best

A radio receiving set is only as good as its components, so buy them carefully. Ask any radio enthusiast about the merits of "Sterling" Components in design, finish, performance and price and the answer will confirm that those who buy "Sterling" buy best.

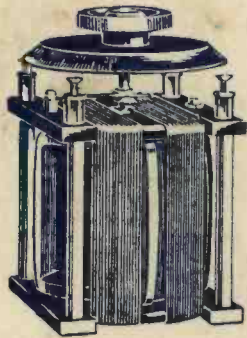

"STERLING" HIGH-GRADE VARIOMETER. An instrument of unique design which tunes from 250 to 2,725 metres. Very selective; electrically and mechanically efficient; inductance ratio 9:1. The rotor and stator windings are connected to separate terminals to facilitate connecting in series or parallel as required, in conjunction with condensers of appropriate capacity to cover the wave-ranges as published in the chart supplied with each instrument. This Variometer is supplied complete with dial and knob as shown. Price 21/-

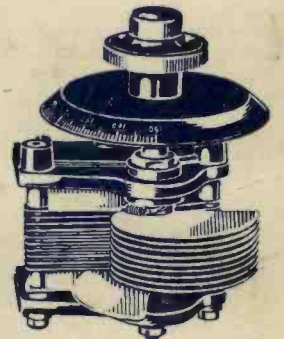

"STERLING" SQUARE LAW VARIABLE CONDENSERS with specially shaped vanes giving uniform wave-length variation and practically zero minimum capacity. The end plates are arranged for either horizontal or vertical mounting. These condensers are unrivalled for use in receiving sets and are specially recommended for use in the construction of wave-meters and other Radio measuring instruments.

"STERLING" VARIOMETER for Broadcast Wave-range only. Ball rotor type. Fitted with reversible mounting brackets for mounting either horizontally or vertically. Complete with dial and knob 13/-

Capacity.	With Vernier Adjustment		Without Vernier.	
	For Panel Mounting as illustrated.	In Case with Ivorine Dial.	For Panel Mounting.	In Case with Ivorine Dial.
.00025 mfd.	R.2724 £1 3 0	R.2733 £2 2 6	R.2729 £1 0 0	R.2737 £1 19 6
.0005 mfd.	R.2725 £1 5 6	R.2734 £2 5 0	R.2730 £1 2 6	R.2738 £2 2 0
.001 mfd.	R.2726 £1 10 6	R.2735 £2 10 0	R.2731 £1 7 6	R.2739 £2 7 0

Obtain from your dealer!

Advt. of **STERLING TELEPHONE & ELECTRIC Co. Ltd.**, Manufacturers of Telephones & Radio Apparatus, etc. **210-212 Tottenham Court Rd., London, W.1** W.orks: **DAGENHAM, ESSEX**