

# Wireless Weekly

and The Wireless Constructor

Vol. 2.  
No. 8.

## CONTENTS

The Neutrodyne and Tuned Anode Coupling.

Reflex and Super-Regenerative Circuits.

A Modified Reinartz Receiver.

An Automatic Alarm Device.

Radiola.

Constructional Notes, Apparatus we have Tested, Jottings by the Way, Mainly about Valves, Broadcasting News, Random Technicalities, News of the Week, Correspondence, etc., etc.

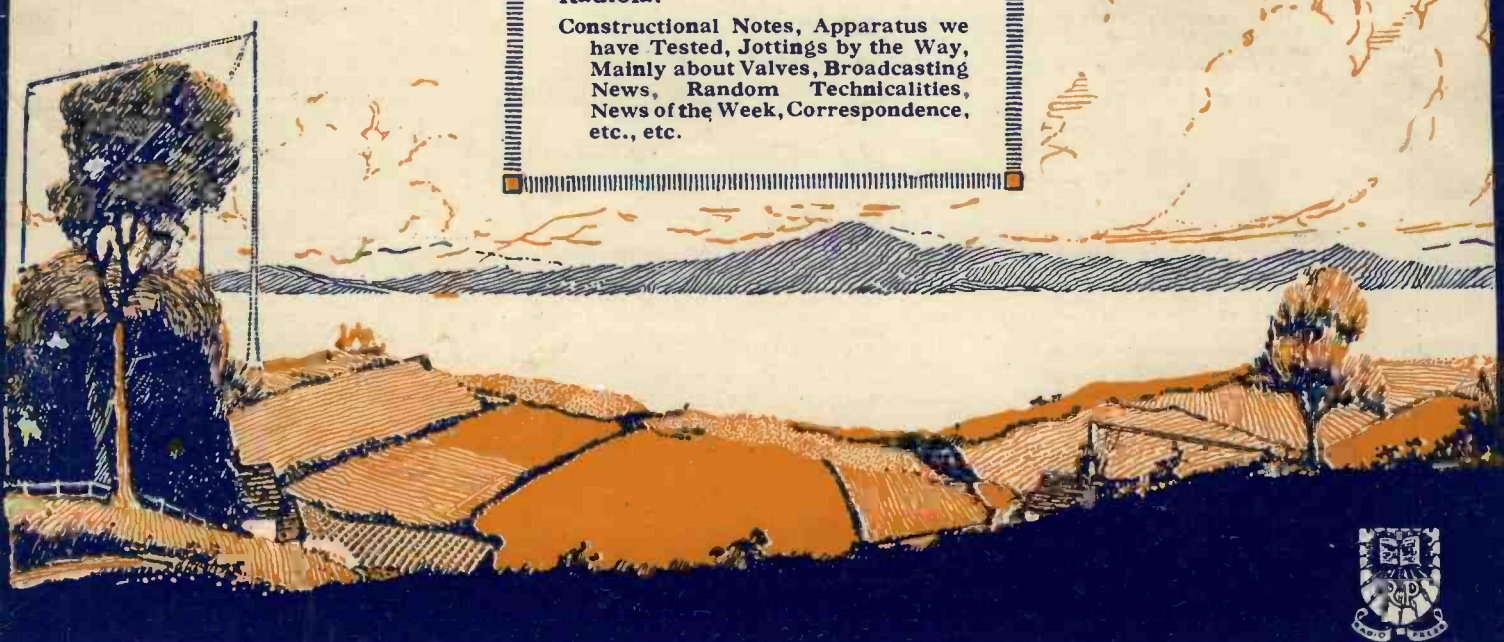

Sir Oliver Lodge on Wireless Pioneers.

# Talks to the Wireless Advertiser.

No. 7.

*I am addressing this to all of you this week because you are all interested.*

Both "MODERN WIRELESS" and "WIRELESS WEEKLY" have become influential journals.

Need I say more in support of my contention that both publications have a claim on your advertising appropriation? Do I need further to emphasise the fact that by regularly using their business pages you can increase your trade and extend the numbers of your customers?

Let some of the satisfied advertisers in "MODERN WIRELESS" and "WIRELESS WEEKLY" speak for themselves:—

The Wilkinson Motor & Engineering Co.,  
10-33 Lonsdale Road,  
Kilburn, N.W.6  
12th April, 1923

Messrs. Modern Wireless,  
125 Pall Mall, S.W.1

Dear Sirs,

We beg to thank you for the list of enquiries received which have had our attention.

Please continue our advertisement until further notice, "MODERN WIRELESS" is a *real* paper.

Yours faithfully,

THE WILKINSON MOTOR & ENG. Co.  
H.E.W

Autoveyors Ltd.,  
84 Victoria Street,  
London, S.W.1  
16th January, 1923

The Advertisement Manager,  
Modern Wireless,  
125 Pall Mall, S.W.1

Dear Sirs,

We thank you for your letter of the 18th instant and we are pleased to find that the advert. inserted in your publication has resulted in so many enquiries.

We are answering each enquiry individually and we are hoping that substantial results will ensue.

Thanking you,

Yours faithfully,  
For and on behalf of AUTOVEYORS Ltd.,  
C. Valley, Secretary

General Radiq Co.,  
Twylford Abbey Works,  
Acton Lane, Harlesden, N.W.10  
24th February, 1923

Modern Wireless,  
The Scheff Publicity Organisation Ltd.,  
125 Pall Mall, S.W.1.

Dear Sirs,

We beg to thank you for your further list of enquiries for our sets as received by you and same will have our prompt attention.

You might be interested to learn that we have received 1,261 enquiries from our advertisement in the first issue of "MODERN WIRELESS."

Yours very truly,

GENERAL RADIO Co.  
By W. Stephenson

The Peto-Scott Co. Ltd.,  
Featherstone House,  
64 High Holborn, W.C.1  
11th, July, 1923

Messrs. The Scheff Publicity Organisation Ltd  
125 Pall Mall, S.W.

Dear Sirs,

We understand from our Agents that our contract for 13 full page insertions has expired with the current issue. Because we are so pleased with the results obtained from advertising in "WIRELESS WEEKLY" we have instructed them to place with you a further series order of full pages.

In our opinion the reader of "WIRELESS WEEKLY" is just the class of customer we desire to do business with, and we have been able to trace a very considerable portion of our business directly to our advertising in that magazine.

Permit us to congratulate Messrs. The Radio Press Ltd. on the production of such a magnificent weekly wireless magazine.

Yours faithfully,

PETO-SCOTT Co., Ltd.  
W. Scott Worthington, Managing Director

The Bowyer-Lowe Co. Ltd.,  
Commerce Avenue,  
Letchworth, Herts.  
July 6th, 1923

Radio Press Ltd.,  
Devereux Court,  
Strand, W.C.2

Dear Sirs,

With reference to our Wavemeter advertisements we have now carefully gone into the results of these and have much pleasure in informing you that our advertisement in "WIRELESS WEEKLY" has been productive of excellent results, and taking the *next best* result as indicating 1, the results, from "WIRELESS WEEKLY" are 41.

As a result of this we shall be booking a series of advertisements with your periodical.

Yours faithfully,

THE BOWYER-LOWE Co., Ltd.,  
(Signed) A. C. Bowyer-Lowe, Director

NOW may I book your order for BOTH Publications.

*All enquiries for Advertising space should be addressed to:—*

**Scheff Publicity Organisation, Limited, 125 Pall Mall, London, S.W.1.**

'Phone—REGENT. 2440 (2 lines).

# Wireless Weekly

Vol. 2, No. 8,  
Sept. 5, 1923

## CONTENTS

	<i>Page</i>
Editorial - - - - -	304
Pioneer Work in Ether Waves - - - - -	305
"Wireless Weekly" Circuits—No. 21 - - - - -	309
A Modified Reinartz Receiver - - - - -	309
Reflex and Super-regenerative Circuits - - - - -	311
Jottings by the Way - - - - -	313
Radiola - - - - -	315
News of the Week - - - - -	316
Random Technicalities - - - - -	318
The "Neutrodyne" and Tuned-anode Coupling - - - - -	320
Constructional Notes - - - - -	322
Broadcasting News - - - - -	326
An Automatic Alarm Device - - - - -	328
Apparatus We Have Tested - - - - -	329
Mainly About Valves - - - - -	330
Correspondence - - - - -	331
Radio Press Information Department - - - - -	332

Editor: JOHN SCOTT-TAGGART, F.Inst.P.

Assistant Editors { E. REDPATH.  
P. W. HARRIS.

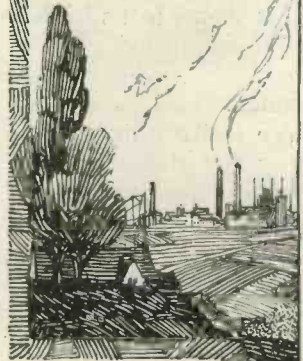

Scientific Adviser:  
Prof. G. W. O. HOWE,  
D.Sc., M.I.E.E.  
Advisory Editors:  
Prof. R. WHIDDINGTON,  
M.A., D.Sc.  
Prof. C. L. FORTESCUE,  
M.A., M.I.E.E.

### Radio Press, Ltd.

Publishers of Authoritative Wireless Literature  
**DEVEREUX COURT, STRAND, W.C.2**  
Tel.—Central 3763.

Advertisement Managers: { SCHEFF PUBLICITY ORGANIZATION,  
LTD., 125, Pall Mall, London, S.W.1.  
Tel.—Regent 2440.

Staff Editors:  
E. H. CHAPMAN, M.A., D.Sc.  
A. D. COWPER, M.Sc.  
G. P. KENDALL, B.Sc.  
A. L. M. DOUGLAS.  
R. W. HALLOWS, M.A.  
S. G. RATTEE.



All correspondence relating to contributions is to be addressed to the Editor of "Wireless Weekly."

Nothing contained herein is to be regarded as permission or encouragement to infringe any patent rights.

# Editorial

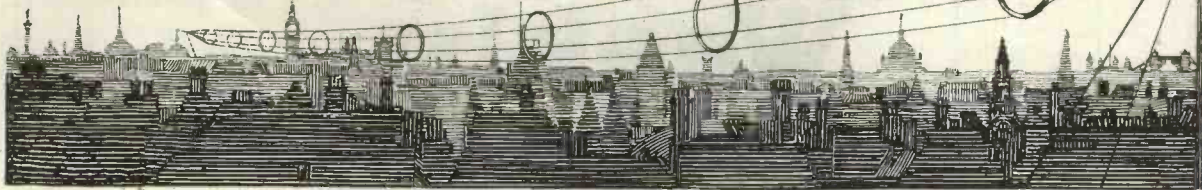

## Wireless Publicity

**I**T appears to us rather a remarkable fact that so far no co-operative effort has been made by the British Broadcasting Company and the wireless manufacturers to stimulate public interest in wireless.

Several more or less successful individual efforts have been made, of course. We ourselves modestly claim to have done a good deal in this direction but, except for the individual advertising efforts of manufacturers and an occasional "popular stunt" on the part of the B.B.C. no real publicity work has yet been attempted. The interests of the B.B.C., the manufacturers, and, in fact, all who are associated with the development of wireless, are identical in this matter, and it seems to us high time that a combined and concentrated effort was made by all concerned in order to make wireless really popular.

We feel certain that now is a good opportunity for the organisation of an intensive campaign, to be designed and carried out in an energetic manner with the special object of popularising wireless, *merely as wireless*, and entirely apart from the question of the merits of any particular make of apparatus or the individual gain of any wireless firm. If such a campaign succeeds, and there is really no reason why it should not, *everyone will gain*.

To ensure that publicity for wireless, in the broadest sense only, is to be gained, it might be desirable to appoint someone with the necessary experience and knowledge, to organise and manage the suggested publicity work, which should be supported to the greatest possible extent by members of the wireless trade arranging numerous and really satisfactory demonstrations, and by the B.B.C. developing their relay station and

simultaneous transmission programme; by unrelaxing efforts to brighten up the transmissions from all stations and by inventing and developing what are perhaps best described as interesting "stunts."

The immense value to be derived from skilful propaganda upon the hoardings and in the daily press should also not be lost sight of—and here we will leave the matter for the present.

## A Mistaken Policy

In connection with this subject of advertising, we notice a tendency upon the part of many manufacturers of wireless apparatus to announce their various products in the daily papers rather than in the established technical journals. We very much doubt the effectiveness of this method in connection with the sale of scientific apparatus such as wireless receiving sets. How many people would buy a set merely from reading the advertisement of one manufacturer? The usual practice is to compare the claims made for a particular set with those made for sets by other firms. Incidentally, of course, comparison of the prices is also made, and for these reasons an advertisement of wireless apparatus is only of real utility to the would-be purchaser when a ready means of comparison is afforded, as when the advertisement appears with its contemporaries in the pages of a technical wireless journal.

## The 2LO Announcer

We understand that the new announcer about whom we made some comments recently has been relieved of his duties. The announcer represents the B.B.C., and the company is wise in considering the public's wishes in these matters.

## PIONEER WORK IN ETHER WAVES

By Sir OLIVER LODGE, D.Sc., F.R.S.

*A fascinating article reminding us of the debt we owe to the early workers.*

EARLY pioneering work is too often overlooked and forgotten in the rush of a brilliant new generation, and amid the interest of fresh and surprising developments. I often think, however, that the early stages of any discovery have an interest and fascination of their own, and that teachers would do well to immerse themselves in the atmosphere of those earlier times, in order to realise more clearly the difficulties which had to be overcome, and by what steps the new knowledge had to be dovetailed in with the old. Moreover, for beginners, the nascent stages of a discovery are sometimes more easily assimilated than the finished product. Beginners need not indeed be led through all the controversies which naturally accompany the introduction of anything new; but some familiarity with those controversies and discussions on the part of the teacher is desirable if he is to apprehend the students' probable difficulties. For though he does not himself feel them now, the human race did feel them at its first introduction; and the individual is liable to recapitulate, or repeat quickly, the experience of the race.

A large number now interested in the most modern developments of wireless will have but little idea—perhaps none at all—of the early work, in apparently diverse directions, which preceded and made such developments possible. And even those who are high authorities in

wireless telegraphy, and know nearly all that can be known about it, can hardly know the early stages quite as well as those who have lived through the nascent and incubating period. Only those who have survived the puzzled and preliminary stages of a discovery can fully appreciate the contrast with subsequent enlightenment. It may suffice to say that the term "inductance" or "self-induction," which we now use so glibly, did not at first exist; and that so late as 1888 Sir William Preece still spoke of it as "a bug-a-boo"; whereas it is the absolute essential to tuning, and even to electric oscillation. Lord Kelvin, who first introduced it as a mathematical coefficient, without any explanation, called it "electro-dynamic capacity." The name "self-induction" was given to it by Maxwell, though it was long before it

was understood or utilised, and the name "inductance" was a nomenclature of Heaviside. It must be very difficult for some of you who are so familiar with these things now to realise the dense state of ignorance in which your scientific ancestors were.

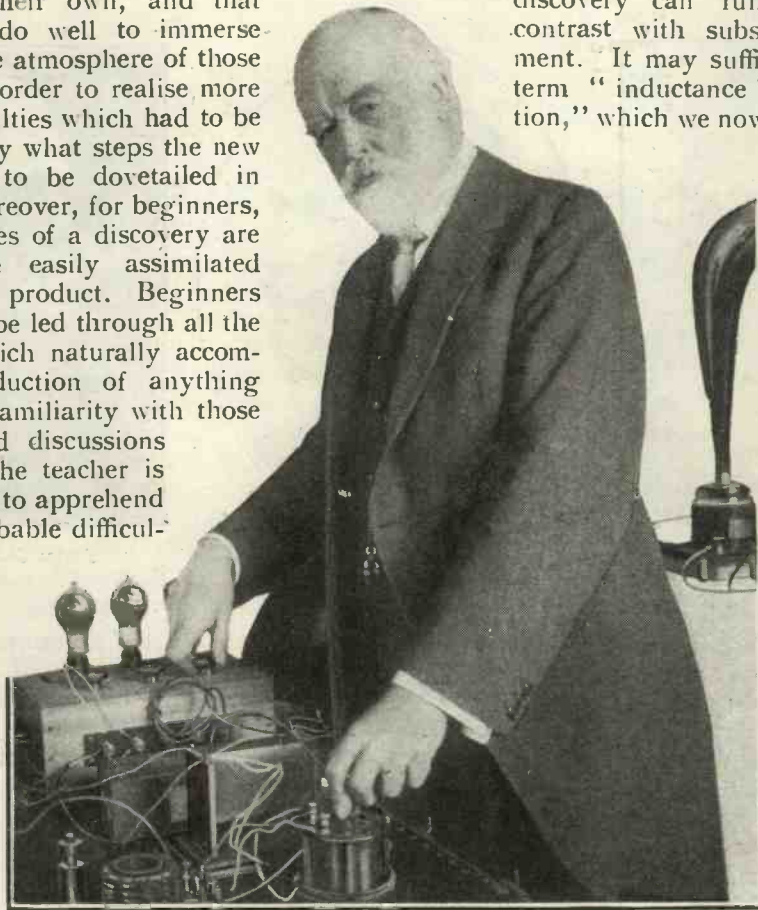

*Sir Oliver Lodge.*

Silvanus Thompson, well known as an historian of science, wrote in 1911 a carefully drawn up pamphlet about the history of wireless (though it was never published) for use in a trial before Mr. Justice Parker when my patent for tuned or selective wireless came up for extension. This patent, dated May, 1897, was extended in 1911 for seven years, and was then acquired by the Marconi Company from the Lodge-Muirhead Syndicate. Its validity was subsequently contested before Lord Moulton, but was triumphantly upheld, after twelve days' trial, as containing the necessary and fundamental principle of all tuned wireless not involving continuous wave transmission

thought it mysterious and almost incredible; and still knew nothing about the early stages. Indeed, I hardly suppose that Signor Marconi himself really knew very much about them. He had plenty to do with the present; he felt that the future was in his hands, and he could afford to overlook the past without regrets.

It may be doubted whether the younger generation, who are so enthusiastically utilising and perhaps improving the latest inventions, will care much about the past either; but still they may like to know more about the early incipient and pioneering work, on the production and detection of electric waves in the ether of space. With part of this work



Sir Wm. Preece, K.C.B., F.R.S.



Heinrich Rudolf Hertz.

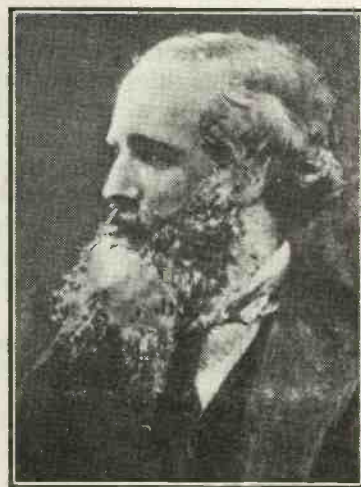

James Clerk Maxwell.

But my present object has nothing to do with details of tuning, nor with wireless in its present condition. That all dates after 1896, most of it after 1900; and I wish to say practically nothing about anything later than 1896. What I have to deal with is the early pioneering work apart from practical developments. And let me here say at once, to avoid misunderstanding, that without the energy, ability and enterprise of Signor Marconi, what is now called wireless would not have been established commercially, would not have covered the earth with its radio stations, and that without the valves of Fleming and Lee de Forest it would not have taken the hold it has upon the public imagination. Before 1896 the public knew nothing of its possibilities. And for some time after 1896, in spite of the eloquence of Sir William Preece and the demonstrations by Marconi, the public

it is true I was myself concerned, but I must not hesitate on that account, since it was this early work—the outcome of splendid achievement by Kelvin and Maxwell and Fitzgerald and Hertz—which laid the foundations and made all the present superstructure possible.

#### Ether Exists

Incidentally, however, I want to say two things to those who are occupied with the subject to-day. First, do not hesitate to speak and think of the *ether of space* as the continuous reality which connects us all up, and which welds not only us, but all the planets into a coherent system. Do not be misled by any misapprehensions of the theory of relativity into supposing that that theory dispenses with the ether, merely because it succeeds in ignoring it. You can ignore a thing

without putting it out of existence: and the leaders in that theory are well aware that for anything like a physical explanation of light or electricity or magnetism or cohesion or gravitation, the ether is indispensable. The ether has all these functions, and many more. I could suggest some which would astonish you! We are utilising it every day of our lives; and it would be ungrateful, as well as benighted, if we failed to render due homage to its omnipresent reality and highly efficient properties. It lies at the origin of all electrical developments and forms the basis for this new and broadcast method of communication.

That is one thing. And the second is to congratulate all those whose wonderful and rapid advances have rendered possible the astonishing feat of, in any sense and by whatever means, carrying the human voice across the Atlantic. When Mr. Marconi succeeded in sending the letter "s" by Morse signal from Cornwall or Ireland to Newfoundland, it constituted an epoch in human history, on its physical side, and was itself an astonishing and remarkable feat. The present achievement of changing over from Morse signals to ordinary speech, made possible by the valves of Professor Fleming and Dr. Lee de Forest and others, is a natural though still surprising outcome and development of long-distance transmission, and must lead to further advances, of which at present we can probably form but a very imperfect conception.

### Early Experiments

Well, now I must go back to early times. In or about the year 1875 Mr. Edison observed something, which at that time could by no means be understood, about the possibility of drawing sparks from insulated objects in the neighbourhood of an electrical discharge. He did not pursue the matter, for the time was not ripe; but he called it "Ethereic Force," a name which rather perhaps set our teeth on edge; and none of us thought it of much importance. Silvanus Thompson, however, took the matter up in a half-hearted sort of way, and gave a demonstration to the Physical Society of London in, I believe, June, 1876, a paper which I have had a little difficulty in finding in the proceedings of that society. Nothing much came of it, however, though his argument tended to show that the sparks

could be accounted for on known principles. The value of this is merely that it must have rendered Thompson susceptible to methods of detecting real electric waves, when they were discovered later.

It was found afterwards that Joseph Henry, at the Smithsonian Institution in Washington, had observed something of the same kind so early as 1842. And he seems to have had an intuition of the possible importance and far-reaching consequences of his observation. For he speaks as follows: (I quote from a passage cited in my "Modern Views of Electricity," an appended lecture "On the Discharge of a Leyden Jar.")

"It would appear that a single spark is sufficient to disturb perceptibly the electricity of space throughout at least a cube of 400,000 feet of capacity, and . . . it may be further inferred that the diffusion of motion in this case is almost comparable with that of a spark from flint and steel in the case of light."

That is to say, so early as 1842 Joseph Henry had the genius to surmise—it was only surmise, of course—that there was some similarity between the ethereal disturbance caused by the discharge of a conductor and the light emitted from an ordinary high temperature source.

In the light of our modern knowledge, and Clerk Maxwell's theory, we now know that the similarity is very near akin to identity. Both sources emit ether waves, though prodigiously differing in length.

Subsequent to these early stray observations, an amazingly suggestive observation, of a partially similar kind, was made by that singular genius and brilliant experimenter, David Hughes, the inventor of the microphone or telephone transmitter, and of the Hughes printing telegraph still used in France.

He was a man who "thought with his fingers," and who worked with the simplest home-made apparatus—made of match boxes and bits of wood and metal, stuck together with cobbler's wax and sealing wax. Such a man constantly working is sure to come across phenomena inexplicable by orthodox science. And orthodox science is usually too ready to turn up its nose at phenomena which it does not understand, and so thinks it simplest not to believe in.

(Continued on page 310.)

"WIRELESS WEEKLY" CIRCUITS—No. 21

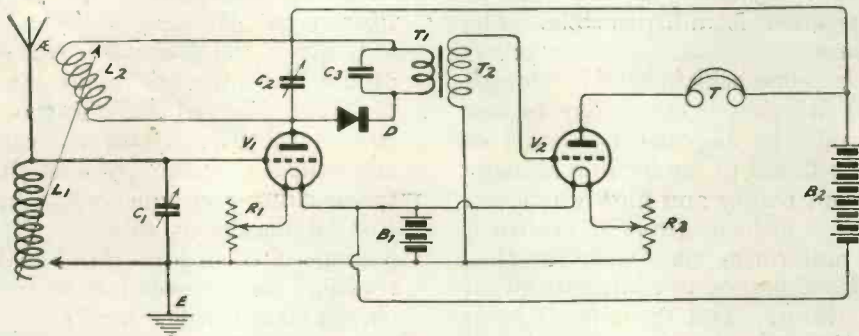

COMPONENTS REQUIRED

- $L_1$  } Variable inductances.
- $L_2$  }
- $C_1$  } Variable condensers having
- $C_2$  } a capacity of 0.001  $\mu$ F or
- $C_3$  } 0.0005  $\mu$ F.
- $C_3$ : Fixed condenser of 0.002  $\mu$ F capacity.
- D: Crystal detector of cat's-whisker type.

- $T_1$  } Step-up intervalve trans-
- $T_2$  } former.
- T: High - resistance telephone receivers.

GENERAL PRINCIPLES

In this circuit the first valve acts as a high-frequency amplifier, the anode inductance  $L_1$ ,

being coupled to the inductance  $L_2$  so as to produce a reaction effect. This considerably strengthens signals. Care should, of course, be taken to see that the leads to the coil  $L_2$  are the right way round. Reaction is not permissible with this circuit when receiving British broadcasting.

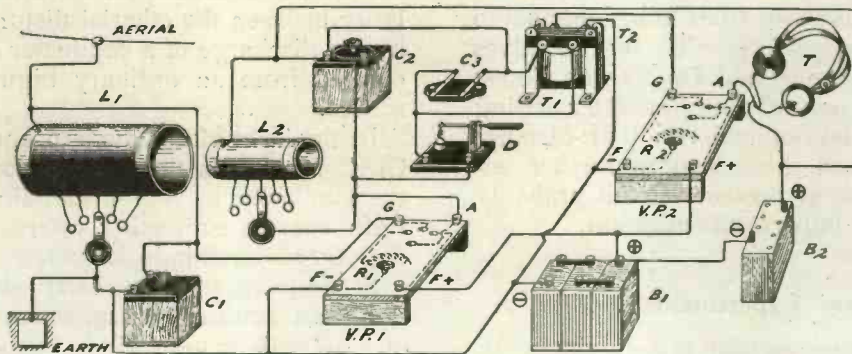

PRACTICAL WIRELESS NOTES—No. 3

VALVES

are often inadvertently burnt out by carelessness in fitting the valve into its holder. Do not attempt to insert all four pins of the valve into the holder at once, twisting the valve about until the pins fit. A safer plan is to tilt the valve slightly, place the little finger against the anode pin and guide it safely into its proper socket, after which the remaining valve pins are easily fitted into place.

In the case of a two or three valve receiving set having only one filament rheostat, it is bad practice to remove one of the valves without first of all reducing the filament brilliancy. If this is not done the remaining valve or valves will increase in brilliancy and, supposing a six-volt accumulator to be in use, are liable to be damaged. It is, in fact, very desirable, and very little extra trouble, to switch off the filament current entirely

before either inserting or removing valves.

Do not connect both L.T. and H.T. batteries to an untried receiving set. Connect up the L.T. battery only, insert and light up the valve and then connect the H.T. battery. Probably the safest plan of all is to include in the H.T. circuit one of the reliable little fuses which are now on the market. They are reasonable in price and easily fitted to a panel or set.



# A MODIFIED REINARTZ RECEIVER

By MAURICE L. MUHLEMAN.

*Readers who have experimented with the original circuit should certainly try this modified arrangement.*

**T**HE excellent results obtained from the original Reinartz receiver have made it one of the most popular sets in use to-day. The variable units, although not unnecessarily complicated, are not, in the usual case, properly adjusted by the novice. A more practical type for the beginner, and one that includes all of the advantages of the original Reinartz receiver, is the modified form described herewith.

The control units of this outfit consist of a simplified form of variocoupler and a  $0.001 \mu\text{F}$  variable condenser. All the actual tuning is accomplished by the two adjusting knobs attached to these instruments.

### Constructional Details

Sufficient details will now be given to enable the prospective builder to proceed without difficulty. The general layout of the receiver is shown in the photograph, Fig. 1. This disposition of apparatus should be followed as closely as possible, especially if the instruments are to be mounted on a panel.

The parts necessary for the construction of the receiver are: One variocoupler (3-4); one  $0.001 \mu\text{F}$  variable condenser (2); one  $0.00025 \mu\text{F}$  grid condenser (5); one 1-megohm grid leak (6); one detector valve (7); one standard filament rheostat (10); one 45 to 60 volt H.T. battery (9); one 6-volt 40 to 60 ampere hour accumulator (11); and a switch-arm and ten contacts (12).

A few words are necessary concerning the variocoupler. It is suggested that a variometer former be purchased, and wound with No. 26 double cotton covered wire,

30 turns on the rotor and 30 turns on the stationary coil. The first 10 turns wound on the stationary coil are to be tapped and their leads connected in consecutive order to 10 switch points. This provides 10 taps, of one turn

point to the end of the rotor coil leading to the grid condenser.

The wiring connections of this receiver are clearly shown in the photograph, Fig. 1. For further reference, however, the complete circuit diagram is given

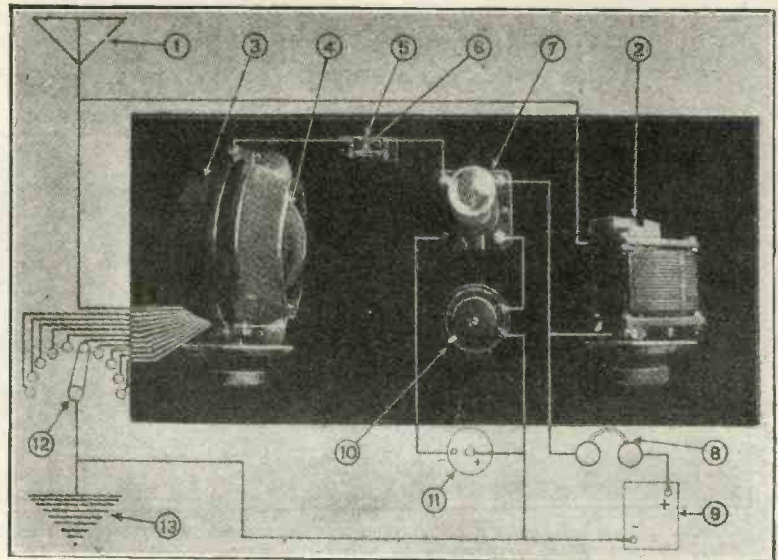

Fig. 1.—Photograph showing general arrangement of the apparatus. The figures are those referred to in the text.

each. A standard variocoupler can be used with its original windings; however, the results obtained from the receiver in this case will not equal the efficiency of a variocoupler rewound in the manner described. It will be noted that the variocoupler is connected in the same manner as a variometer; that is, one of the terminals of the rotor is connected directly to the terminal of the stationary coil farthest from the tapped end of the coil.

To reach the higher broadcast wavelengths, a  $0.0005 \mu\text{F}$  variable condenser should be connected from the eighth switch-

in Fig. 2. The numbers in Figs. 1 and 2 correspond.

### Operation

The operation of this receiver is comparatively simple, the wavelength being controlled by the variocoupler, and regeneration by the variable condenser. Experiment should first be made on some nearby station, to determine the position of the switch-arm for that particular wavelength. Changing the position of the switch-arm tends to loosen or tighten the coupling of the aerial circuit.

When the set is completely

wired and ready for operation, light the filament of the valve, by means of the rheostat. With the switch-arm on the third or fourth switch-point, as a convenient average position, proceed to tune by the simultaneous adjustment of the variocoupler and variable condenser. Starting from zero, on the variocoupler dial, work slowly towards 180 degrees, adjusting the variable condenser at the same time, always keeping below the point where the circuit tends to oscillate.

A squealing noise is a forewarning of such an impending

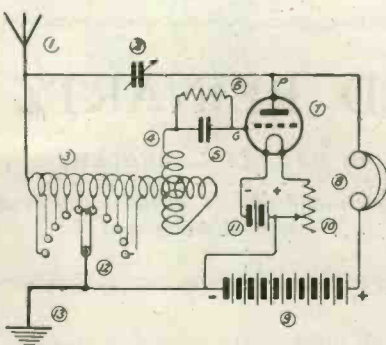
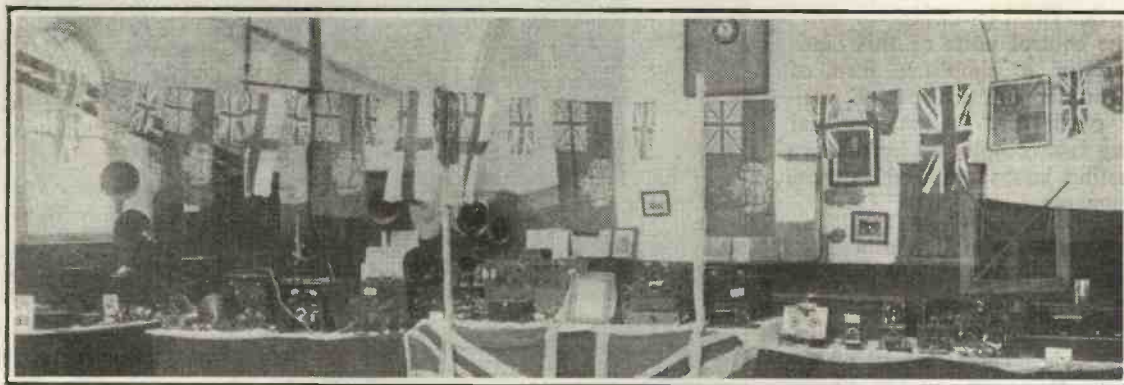

Fig. 2.—Circuit diagram of the receiver. The figures in this illustration correspond with those given in Fig. 1.

condition. When this is heard, slightly retrace the adjustments until operation is again quiet. Broadcasting stations on different wavelengths should be heard at various settings of the variocoupler dial. After a desired station has been picked up, slight adjustments of both dials will considerably increase the volume. This last-mentioned operation is rather critical, and a "vernier" movement of the dials will be found a great advantage. Best results are obtained just below the point on the dials where squealing is manifested.

## STRATFORD-ON-AVON AND DISTRICT RADIO SOCIETY



Our photograph shows a general view of the first exhibition held by the above-named society, on July 22nd. There were among the many exhibits no less than four ST100 sets made by members.

## PIONEER WORK IN ETHER WAVES

(Continued from page 307.)

Hughes unknowingly was very nearly on the trail of what was subsequently discovered, in a so much more enlightened manner, by Hertz. Hughes, too, got sparks in the course of his experiments, but he also got something very like coherer action too, by means of his microphone detectors.

These spasmodic observations are not exactly and strictly discoveries: they were more akin to vague intuitions. The first and gigantic step in the real discovery was made

by Clerk Maxwell, in or about 1865; and he made it in mathematical form, not in experimental actuality, by one of those superhuman achievements which are only possible to our greatest mathematical physicists. He did not discover either the way to generate those ether waves, or to detect them; but he did give their laws; he legislated for them before they were born. He knew the velocity with which they must move, and gave implicitly, without elaboration, the complete theory of their nature.

# REFLEX AND SUPER-REGENERATIVE CIRCUITS

By JOHN SCOTT-TAGGART, F.Inst.P.

This is Part XIX of "Questions and Answers on the Valve."

(Continued from Vol. 2, No. 7, page 273.)

## What are the Disadvantages of Tightening the Reaction to such an extent that Self-oscillation Commences?

There are two principal disadvantages. One is that when listening-in to wireless telephony the speech is distorted, and while carrying out adjustments howling noises are heard. The other disadvantage, which is far more important, is that while the set is oscillating, feeble electrical waves are radiated from the receiving aerial, and these will be picked up by neighbouring receiving stations and will produce howls and other undesirable noises in their receivers. It is almost certain that if, when adjusting your own receiver, you hear squeals and howls, similar noises are being produced in the receivers of neighbours. It is, therefore, very important to stop the receiver from oscillating, and this may usually be done by lessening the degree of reaction or by detuning one of the condensers.

## How may the Fig. 4 Circuit, shown in our Last Issue, be Converted into a Three-valve Receiver Using one Stage of Low-frequency Amplification?

Fig. 1 shows such a circuit. It will be seen that the telephone receivers have been replaced by the primary of a step-up interval transformer  $T_1$ ,  $T_2$ , the secondary  $T_2$ , of which is connected in the grid circuit of the third valve, which acts as a low-frequency amplifier.

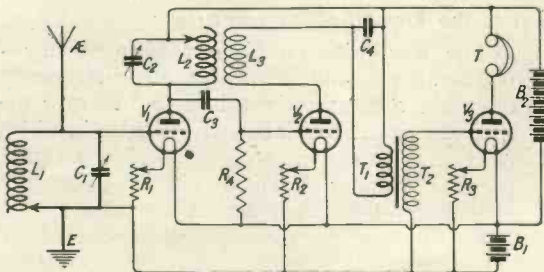

Fig. 1.—A three-valve circuit with permissible reaction.

## What is Meant by "Dual Amplification"?

Dual amplification circuits use a valve in two capacities. A valve, as has been explained,

may be used either as a high-frequency amplifier or as a low-frequency amplifier. In dual amplification circuits, the valve is made to carry out both duties at the same time, and it is found that it can do this quite well without the two duties interfering with each other.

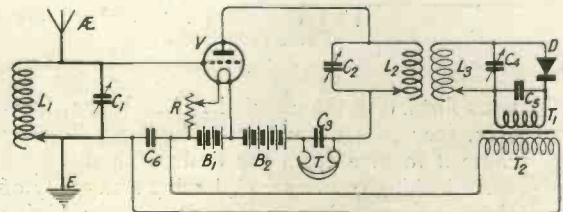

Fig. 2.—A single valve dual amplification circuit.

The valve is used as a high-frequency amplifier, and is followed by some form of detector; the low-frequency currents supplied by the detector are now led back to the grid circuit of the valve and are amplified by it, the telephone receivers, or their alternative, being connected in the anode circuit of the valve.

Fig. 2 shows a simple dual amplification circuit, in which the valve acts both as a high-frequency amplifier and as a low-frequency amplifier. It will be seen that in the anode circuit of the valve we have a tuned circuit  $L_2$ ,  $C_2$ , adjusted to the incoming wavelength. The anode circuit also includes the high-tension battery  $B_2$  and the telephone receivers  $T$ , shunted by a by-path condenser  $C_3$ . For the moment we can leave the telephones  $T$  out of consideration. The high-frequency oscillations in the circuit  $L_2$ ,  $C_2$  are passed on to another tuned circuit  $L_3$ ,  $C_4$ , which is also adjusted to the incoming wavelength, and which will therefore pick up the oscillations passed on from  $L_2$ . The crystal detector  $D$  and the primary of the step-up transformer  $T_1$ ,  $T_2$  are connected across the tuned circuit  $L_3$ ,  $C_4$ . When the oscillations in  $L_3$ ,  $C_4$  are rectified by the crystal detector  $D$ , they produce low-frequency pulses in the primary  $T_1$ , thus producing alternating pulses of higher voltage in the secondary  $T_2$ .

This secondary, it will be noticed, is connected in the grid circuit of the first valve; the low-frequency impulses are, therefore, given to the grid of the valve and amplified. The low-frequency variations of anode current flow through the inductance  $L_2$ , but do not in any way interfere with the high-frequency oscillations

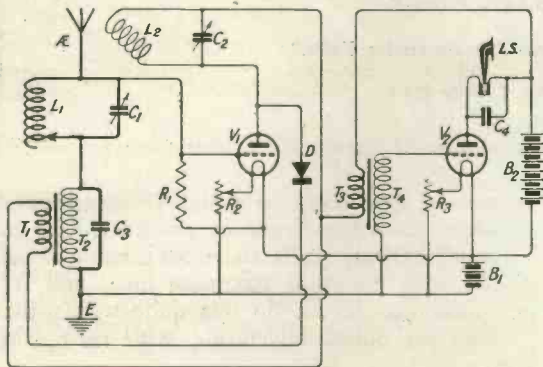

Fig. 3.—The ST100 circuit.

flowing in the circuit  $L_2 C_2$ . When, however, they pass through the telephones T, they cause it to give forth the desired signals.

A blocking condenser  $C_a$  having a capacity of about  $0.0003 \mu F$  (microfarad), or any higher capacity up to  $0.002 \mu F$ , is connected in the position shown in order to prevent the secondary  $T_2$  from choking back the high-frequency currents which are flowing in the grid circuit. In this circuit the high- and low-frequency currents actuate different pieces of apparatus, but they really mix inside the valve, which is amplifying both high- and low-frequency currents simultaneously.

**What is the Advantage of the Dual Amplification Circuit?**

The advantage of this type of circuit, sometimes also known as the reflex circuit, is that as a single valve is used to carry out two functions, an economy of one valve is effected.

**Draw and Explain the Action of the ST100 Circuit.**

This circuit—first described in *Modern Wireless*—has proved to be probably the most popular reflex circuit.

Fig. 3 shows the circuit. It will be seen that the inductance  $L_2$  is coupled to the inductance  $L_1$  to produce a reaction effect, but this is not permissible when receiving British broadcasting. The circuit, however, will work quite

well even with  $L_2$  separated from  $L_1$ . The first valve acts as a high-frequency amplifier, the amplified oscillations in  $L_2 C_2$  being rectified by a crystal detector D. The rectified impulses are passed through the primary  $T_1$  of the step-up transformer  $T_1 T_2$ , the secondary of which is connected in the grid circuit of the first valve. A high resistance  $R_1$  of about 100,000 ohms value, is connected in the position shown, in order to stabilise the circuit. The first valve amplifies the low-frequency currents, which then pass through the primary  $T_3$  of the second transformer  $T_3 T_4$ . The secondary  $T_4$  is connected in the grid circuit of the second valve which acts as a low-frequency amplifier.

The loud-speaker, or the telephone receivers, will be found in the anode circuit, shunted by a condenser of at least  $0.002 \mu F$  capacity. The high tension battery preferably has a value of 100 volts.

**What is the Armstrong Super-regenerative Circuit?**

This circuit, which may take many forms, is a reaction receiver, in which more than the usual reaction is used, but steady self-oscillation is prevented by lessening the degree of reaction by electrical means at, perhaps, a rate

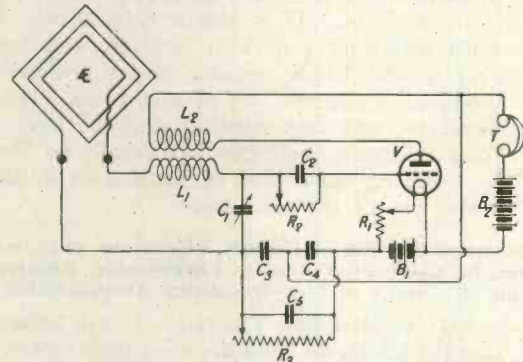

Fig. 4.—The Flewelling circuit with frame aerial.

of 3,000 times per second. Super-regenerative reception involves the use of extra reaction.

**What is the Flewelling Circuit?**

The Flewelling circuit is a form of super-regenerative circuit in which the low-frequency electrical oscillations required to interrupt the tendency to self-oscillation of the valve in which reaction is produced, are generated in a rather peculiar manner. These circuits generally work best when frame aerials are used.

Fig. 4 shows a typical Flewelling circuit.

*This concludes this series, and we shall shortly be in a position to announce its publication, with considerable additions, in book form.*



Ker-ime

THE Postmaster-General, I see, has been complaining rather bitterly of the way in which certain miscreants enter the neat little boxes which he provides for the public, where instead of putting the receiver to its proper use they merely yank it out by the roots and depart with bulging pockets. It is presumed that the criminals are afflicted by the dread disease ingrowing radiomania, and that they appropriate the P.M.G.'s receivers in this scandalous way in order to convert them into wireless headsets. Probably they have been reading articles in non-technical contemporaries on how to construct an efficient wireless set for 2s. 11½d.

These helpful hints usually make no mention of the 'phones, so that the neophyte having wound the mazy tangles of his inductance upon a piece sawn from the drawing-room curtain pole, and having made his condensers from ancient tomato tins in the approved style, suddenly finds himself up against it. There is his set which must perforce remain a mute, inglorious thing until it has 'phones to give it voice. He has spent his 2s. 11½d. 'Tis a point of honour to spend no more. He therefore hies him stealthily to the telephone box and returns with the loot.

Personally I would be a little shy of Post Office telephones, even if acquired by the most honest means. Long use will, I feel sure, have given them certain fixed habits of which nothing can break them. Thus if you try to get 2LO they are sure to give you Birmingham. When picked up they will remark "Number en-

gaged" of their own accord, and they are certain to go on strike when the three minutes to which they have been accustomed all their lives have elapsed.

#### Wireless Photography

I do not think that any proper account has yet appeared of my friend Biffin's noble station. This is a matter that must be set right at once, and I hasten to do so. I would like to give you a photograph in the style adopted by the illustrated dailies of all the Biffin family listening-in with 'phones clamped about their ears what time the loud-speaker bellows upon a nearby table.

You know the kind of thing I mean? There should be Biffin himself, Mrs. Biffin, a crowd of little Biffins, and even the bullpup all wearing the modern ear decoration and a rather strained smile. The owner of the "fine experimental" set should be looking as modest as circumstances permit, and should not allow the strain of wondering whether the B.B.C. mark will show, or whether that infernal hound will shake himself and spoil the picture to discompose the laboriously acquired blend of inanity and fatuity that makes up his expression.

I cannot show you this, for there is no bullpup, nor are there any little Biffins. In fact there is not even a Mrs. Biffin, for he is a bachelor, wedded, as he gracefully puts it, to the art of wireless. And so as I cannot provide you with the conventional wireless photograph I will give you none at all, for it would go sadly against the grain with me to do anything so out of date, so

démodé, so utterly unartistic as merely to serve up a prosaic picture of Biffin (who is not ornamental) or of his set, which is, to say the least of it, untidy.

#### Let Biffin Speak

My best course will, I think, be to give Biffin's own description of his apparatus. When a writer makes such a statement as this it usually means that he is too lazy to do things for himself; he simply cuts out and pastes on to his manuscript the passages that he wants to quote, and goes on his way rejoicing that he will get paid for it just the same. In my case there are no such reprehensible motives. The truth is partly that I am suffering from a severe attack of fly swatter's elbow, which makes it difficult to ply the pen, and partly that no attempts of mine could produce a description so clear and so well put as Biffin's own. Here, then, is what he says.

"I think that a short account of my station may be of interest to readers of *Wireless Weekly*, who are always appreciative of novelty and ingenuity. I will begin with the aerial which is of the recumbent X type. My discovery of this novel form of antenna was purely accidental; it came about actually through the agency of a gale of wind which turned my original aerial inside out, leaving its wires crossed in the middle. Owing to its shape it acts as a drain for atmospherics, none of which reach the set; in fact, there is nothing that I enjoy more than listening-in during a severe thunderstorm. The natural wavelength of such an aerial is

readily calculated by the simple formula :

$$\lambda = \sqrt{\frac{\tan \text{ angle of roof}}{\text{height above sea-level}}}$$

I notice, by the way, that many text-books still print the formula for ordinary aerials as  $\lambda = 1885\sqrt{L \times C}$ . This is, of course, 38 years behind the times ; the correct figures for this year are  $\lambda = 1923\sqrt{L \times C}$ .

**Further Details**

"The inductances used are of my own 'catcradle' design ; the method of winding is simplicity itself. One simply takes a reel of No. 50 d.c.c. wire and gives it to the cat to play with. A feature of the design is the remarkably low self-capacity since no two turns are in the same plane. Coupling between circuits is of the

link type with three forward speeds and reverse.

"The aerial tuning condenser is again a novelty. To make it I covered the door of my den with tinfoil saved from chocolates, and treated in the same way the wall towards which the door turns when open. When the door is partly open the capacity is a jar. I cannot yet give you the precise limits to which the set will tune since not having yet paid my annual visit to the seaside I have had no opportunity of calibrating my wavemeter."

**True Genius**

I will not quote further from Biffin's beautiful description, for I think that I have given you sufficient to show that his is an installation quite out of the

ordinary. It was aptly said not long ago that it is to the experimenter of to-day that we must look for those inventions which will carry on the great forward march of wireless. That is why it is so essential that we should have a new licence.

Can you imagine such a man as Biffin with a B.B.C. set? With his own he has logged such thrilling call-signs as RVR, RSVP, E and OE, RD, GWR, CP, PTO, and ETC. Free from the effects of atmospherics he glories like a Mother Seigel's Chicken in storms that make us leap to our earthing switches. Give such a man a B.B.C. set, and pin him down to a regulation aerial? No, a thousand times no! With them he might even hear 2LO.

**WIRELESS WAYFARER.**



**A "BIG" RECEIVER**

With so many demonstration cars touring the country the public is becoming familiar with all conditions of open-air reception. A few weeks ago the "Daily Express" toured several of our seaside towns with cars fitted with wireless. Before them The City Accumulator Co. gladdened the streets of Cardiff and London in the same way. The Marconi's Wireless Telegraph Co., Ltd., and several others have also contributed towards making open-air wireless a common joy.

The latest firm to take action in this direction is Burndept Ltd., and our photograph shows one of their vans featuring their well-known Ethophone V, the exterior being arranged to represent the receiving set.

# RADIOLA

*A short description of the well-known French station.*

**T**HE first radio-telephonic concert in France took place on June 26th, 1921, from the hall of the Institution d'Ingenieurs Civils: on November 26th, 1921, a great radio concert was given by the Société Française Radioélectrique, on the occasion of the centenary of Ampère's discoveries. On December 15th the same year a reproduction of a performance at the Théâtre des Champs Elysées was given. In February, 1922, the military station of the Eiffel Tower inaugurated a series of regular concerts which met with well-deserved public appreciation.

It was not until November 6th, 1922, that a private organisation was authorised to transmit regular concerts, and the first Radiola concert met with great success. This success has been well maintained, and at the present time, when various similar organisations for the benefit of amateurs are growing up, it is fair to remember that the Radiola station was the first to inaugurate a regular series of transmissions. The orchestra and the artists assemble at 79, Boulevard Haussmann in a large and lofty room with thick curtains round the walls, and external sounds carefully excluded. The

microphone in this room is connected by wires to a power-amplifier in a neighbouring room. The second room contains also the control panels, various ammeters, rheostats, etc.

The amplified microphone-current is carried by a special telephone line to the transmission station at Levallois. This station has three panels: the first carries the

high-frequency oscillations from reaching the lower frequency apparatus and also suppresses the ripple of the converted current and assures a constant anode voltage for the oscillating valves. A resistance shunted by a condenser reduces the mean potential of the grid and thus protects the valves.

An oscillating circuit is arranged in the grid circuit of the oscillatory valves, the latter circuit being coupled with the plate circuits. The oscillating circuit is inductively coupled with the transmitting aerial. A variable inductance and a variometer placed in the aerial-earth circuit permit of the adjustment of this circuit to the transmitted wavelength.

A T-aerial is employed,

supported by two metal masts 65 ft. high. The wavelength used for concerts is 1,780 metres.

The Levallois station is only a temporary one, established on the premises of the Société Française Radioélectrique. It was originally designed for experimental purposes, and consequently it requires several improvements. In particular the various large metallic masses which surround the apparatus have an adverse influence upon the transmission.

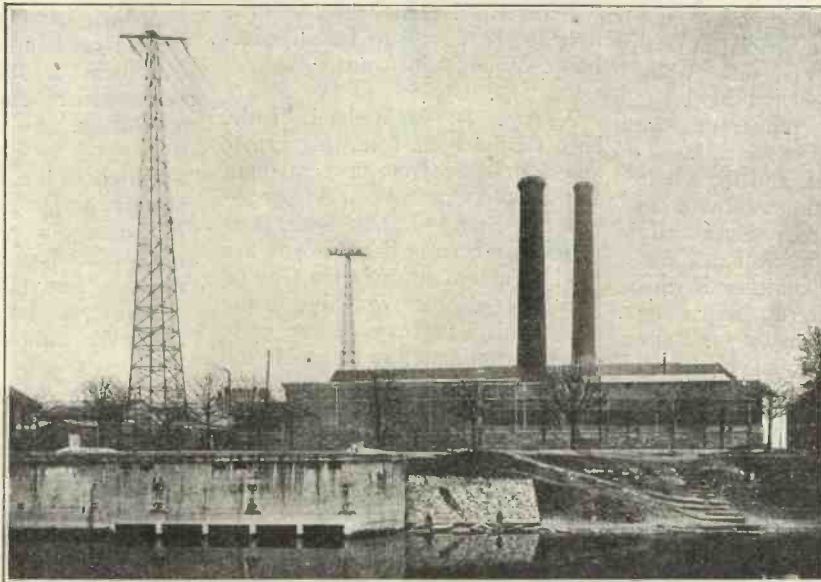

*A general view of the Radiola station.*

modulating valves, which superimpose the sound-waves upon the high-frequency current generated by the valves of the third panel: the second panel carries the rectifying valves. An additional panel carries the aerial regulating coils.

Continuous oscillations are generated by a group of valves mounted in parallel. A system of condensers and inductances placed between the rectifying and the oscillating valves prevents the



# News of the Week

**W**E are given to understand that the Brazilian Wireless Telegraph Company has begun the construction of a high-power station at Rio de Janeiro.

The proposal of the Marconi Co. to erect a high-power station at Avebury continues to evoke a great deal of discussion and opposition. At a specially convened meeting of the Wilts Archaeological Society held at Devizes recently, plans of the positions of the masts and buildings were examined, and the whole question of the proposed station was fully discussed. Eventually the following resolution was passed: "The Committee of this Society, whilst deeply regretting the choice of Avebury as the site of the new station, having seen the plans as at present proposed, and finding that no actual material damage is threatened to the circle of Avebury, or to any other pre-historic remains on the site, and having in addition received an assurance from the Marconi Co. that they will respect the remains within the area, do not see sufficient grounds at present for offering opposition to the scheme."

Excellent results have been obtained with regard to the broadcasting of the Grenadier Band's performances, which have been heard as far south as Portsmouth—and that on a single valve.

With the arrival of the football season provision is being made for the catering of football fare by 5SC. Prominent "Soccer" officials are being approached with

a view to contributing talks on "Football—Past, Present, and Future." The football fan will certainly appreciate this aspect of the wireless programme.

Wireless entertainments are now given daily on board the turbine steamer *Queen Alexandra*, sailing to and from Dunoon, Rothesay and Inverary. This vessel was the first on the Clyde to install wireless receiving apparatus.

Messrs. L. McMichael, Ltd., have received the following rather amusing letter from a gentleman on the Gold Coast, West Africa:—

DEAR SIRS,—Lately seen your name on a certain list that you are the best manufacture in the City of London:—I therefore beg most respectfully to forward me your general catalogue, as to enable me to forward my indent at once; Please I shall be glad if you will forward same:—kindly send me samples of ladies silk handkerchiefs so needfull in our coast here:—

I am, yours truly,  
KWASIE ARMOO.

The Blackburn Reform Club has been presented with a 4-valve Lyrian cabinet set by Radio Instruments, Ltd., by the Rt. Hon. Sir Henry Norman, Bart., M.P. The apparatus has been in constant use for the past month, and is giving very satisfactory results.

Radio telephonic apparatus is to be installed by the Government of Trinidad at the Port of Spain wireless station, to link up with stations already established by the British Oil Company on the Orinoco delta in Venezuela.

According to *The Times* the development of a system of radio telephony throughout the West Indies is in contemplation.

It is reported that a 4-valve set in the Hahnemann Hospital, Philadelphia, supplies amusement to more than 350 patients daily.

A broadcasting service is being carried on temporarily by private enterprise in Rhodesia until the Government stations commence operations.

Fitted with three different transmitters and receivers, the S.S. *Leviathan* is probably the best wireless-equipped vessel in the world. Two transmitters and receivers can be operated simultaneously without interference.

A wireless set has been installed at Shoreditch Public Library so that ratepayers can listen-in. The Corporation claims to be the first municipal authority to introduce wireless in libraries for educational and scientific purposes.

The Wick wireless station recently reported that the Norwegian steamer *Holmedal* was in distress in latitude 53.46 North and longitude 3.39 East, and that the steamer *Precocia* was proceeding to her aid. An earlier message from Scheveningen reported the Lowestoft trawler *Roulette* as being in a sinking condition in the exact latitude and longitude given above, and added that *Terschelling* tugs had gone to her aid. This note may interest those readers who may have heard the S.O.S. calls.



The date for the forthcoming Scottish National Radio Exhibition in the City Hall, Glasgow, is to be from September 10th to 15th. The date has been altered in deference to those members of the public who will be travelling home from their holidays during the first week of the month, and it is felt that the exhibition will now attract much larger crowds of visitors.

That wireless helps to sell gramophone records is the opinion of the majority of American musical instrument retailers.

for transmitting and seven for receiving.

We understand from the *Nottingham Evening Post* that Sir William Noble, who, as a Member of the Board of Directors of the British Broadcasting Co., has been so prominently identified with the development of broadcasting, made the interesting assertion recently that broadcasting in this country has out-distanced that of America in so far as reliability and quality are concerned.

It is a big claim to make, but anyone who is familiar with the

casting and ordinary wireless telephony, which have so far remained entirely neglected in Austria.

The concession in this case, the Government state, will only be granted to an Austrian firm or an amalgamation of such firms, under the condition that exclusively Austrian machinery and appliances are installed. A number of applications for concession have been received, and it is expected that a decision in the matter will be arrived at early in October. The concessionaires will be entitled to fix their own tolls and rentals, in which the Government will partici-

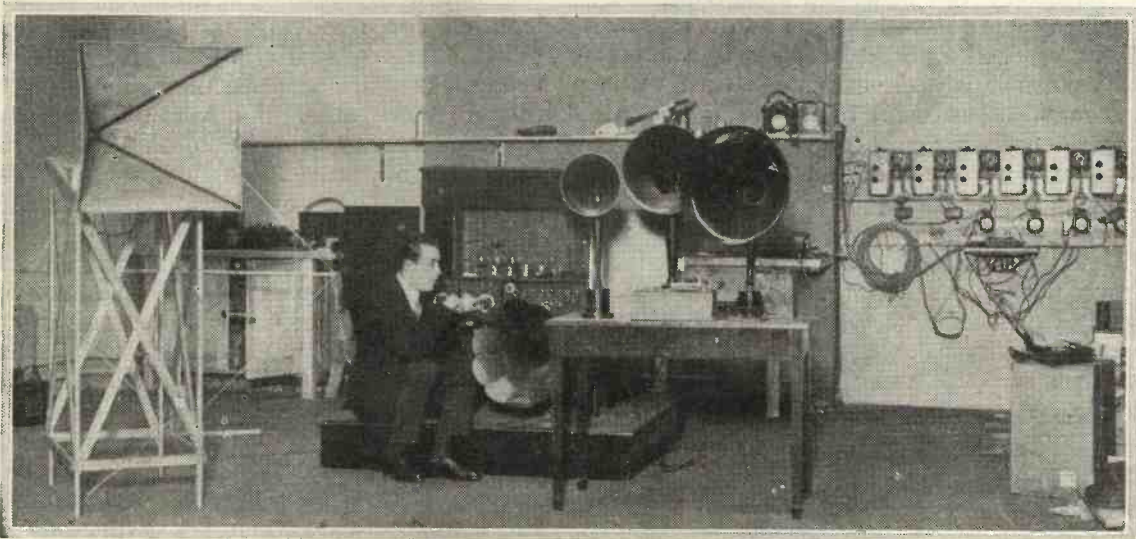

Capt. P. P. Eckersley, Chief Engineer of the Broadcasting Co., is here seen experimenting with power-amplifiers and loud-speakers.

According to *The Westminster Gazette*, the special wireless equipped car for use between Scotland Yard and the famous Flying Squad, after many weeks of experiment, is now an accomplished fact. The car is actually on the road, and is keeping in touch with the Yard by wireless many miles beyond the borders of Greater London. Messages can be transmitted and received when the car is travelling at 40 miles an hour with a working range of 50 miles. The set employed for the purpose was designed by the Marconi's Wireless Telegraph Co., Ltd., in conjunction with Scotland Yard engineers, three valves being used

chaos which reigned in the United States during the first few months of broadcasting there will agree that in avoiding similar confusion those responsible for the development of the art in this country have done extremely well.

The Austrian Government announces the fact that both wireless telephony and wireless telegraphy are to be retained as State monopolies. The rights to develop wireless services between Austria and other countries have, we understand, been leased to the Marconi Co. Negotiations, however, are pending with regard to an inland service, particularly as to broad-

pate on a percentage basis. Large revenues are anticipated by the Government from this source, as tolls are to be levied in gold crowns.

We learn from a correspondent that wireless enthusiasm is very prevalent in Italy, and that a Radio Exhibition will be held at Locarno, commencing on or about September 5th.

At a meeting of the Honor Oak Park Radio Society on August 22nd Mr. J. McVey gave an account of damage done to his wireless set during the storm of August 19th.

# RANDOM TECHNICALITIES

By PERCY W. HARRIS, Assistant Editor.

*A few notes relative to experiments with wave-traps.*

SINCE writing my article in *Wireless Weekly* for August 15th I have been carrying out further experiments with the trap circuit which I designated "C." It seems to have astonishing possibilities, and as it is a little tricky to work I am giving the following few practical hints on its operation.

This trap will only reject the unwanted signals when it is itself exactly in tune with the *wavelength we want to receive*, and not the *wavelength we want to reject*. Many readers have wondered how it is that the few turns across the aerial and earth terminals of the receiver do not act practically as a dead short-circuit for most wavelengths. Actually, however, these turns do not act by themselves, but only in association with the many turns of the trap to which they are coupled. Really these turns and the trap turns act as one inductance. A great virtue of this trap is that it does not upset the tuning of the receiver itself.

The best method is first of all to tune your receiver to the wavelength you wish to receive quite apart from any interference which may occur. Next connect the trap across the aerial and earth terminals as shown in the illustration in *Wireless Weekly* just referred to, and very slowly turn the variable condenser. For some time you will hear nothing whatever—neither your local signal nor the interference, and it will seem as if the coil is acting as the dead short circuit referred to. However, when you have adjusted the condenser for a little time, you will come to a region probably (only two or three degrees) where your signals will return with considerable strength (perhaps 50 or 60 per cent. of normal). This means that the few turns of the coupling coil and the trap itself are now in tune with your local station or whatever it is you wish to receive and act as an impedance to this wavelength.

Signals of this adjustment will therefore pass through both the receiver and the trap, whilst other signals of a different wavelength will go to earth practically entirely through the trap. This is a very fine circuit for cutting out interference from a number of wavelengths, for removing the "mush" from C.W. stations, spark jamming, etc. There is perhaps more sacrifice on signal strength than in some other filter arrangements; but my experiments lead me to think that this may, after all, prove to be the best of the three traps when one becomes experienced in handling it.

The tuning of the trap condenser is very critical, particularly for weak signals, and one can easily miss the correct point of adjustment. I would suggest either that the trap condenser have a vernier adjustment or else you fit some long extension handle which will give you more accurate control. To give an example of the degree with which the local interference can be removed by this trap, I will instance a case where I was tuned on my ordinary receiver to Birmingham, using an indoor aerial. Without the trap Birmingham and London could both be heard on the loud-speaker, the former, however, rather weakly. By attaching the filter and tuning it accurately I was able to hear Birmingham very loudly in the 'phones, whilst not a breath could be heard from London. When it is remembered that previously London could be heard *on the loud-speaker* it gives some indication of the value of the device.

I do not expect it will be long before traps of one kind or another are built into broadcast receivers as a part of the standard equipment. It should be possible to calibrate these traps before they leave the factory, which should considerably facilitate the adjustment of the receiver.

Speaking of inductances, a very convenient

if not a very efficient inductance, variable over say the range between two broadcasting stations, is to wind a small, cylindrical coil in the usual way and pivot within it a disc of copper or brass so that it can be rotated to make its axis either parallel or not to that of the coil. The eddy currents generated when it is placed coaxially with the solenoid will materially reduce the inductance of the coil. When it is at right-angles very little effect will be found. I do not recommend this method when the highest efficiency is desired, but often a variation of inductance, even if some losses are involved, is quite convenient.

\* \* \* \*

I was speaking the other day to a man who had been to one of the "dead spots" where signals from the broadcasting stations—or at least some of them—will not come through at all on most receivers. He was particularly

interested in the fact that whilst several makes of receivers had given no results whatever, one particular make had brought signals through quite well. Seeing that all were good makes normally, he was at a loss to understand the reason. Actually, however, the cause was that the successful set had particularly good high-frequency amplification, and it will be generally found that if anything will bring signals at these spots it will be a set in which the high-frequency amplification is of the most efficient order.

If signals are not strong enough to operate a detecting valve no amount of audio-frequency amplification after this valve will bring them in. If, however, a radio-frequency valve is placed first, it will often bring up signals sufficiently strong to operate the detector, and subsequently allow great amplification.



## THE "RUGBY" STATION



*Photo by Gilbert A. R. Palmer.*

*Our photograph shows the Station Director of the Birmingham broadcasting station, Mr. Percy Edgar, on the occasion of the station changing its quarters, informing the engineers at Summer Lane of their success. The new studio innovation, the modulation light signal, is seen on the wall and has already been nicknamed the "Rugby" station.*

**O**SCILLATION troubles with many-stage high-frequency amplifiers have inspired much experimental work with a view to finding a cure for the phenomenon. It is particularly marked when more than one stage of tuned-anode coupling is used, especially with fairly high plate-voltage.

Generally some form of damping is suggested, either by introducing resistance in the anode circuit, in the form of very fine wire in the tuned-anode coil; a separate resistance unit outside the latter; or even, as in one well-known multi-valve amplifier fitted with transformers, by winding the coils themselves of high-resistance wire. Damping may also be obtained by giving the grid a positive bias by means of a potentiometer, thus producing a grid current.

Another device is a metal damping-plate in which eddy-currents are induced, giving the desired damping effect. All these, however, imply loss of energy. In the "ST100" circuit the energy that would otherwise have to be wasted is utilised by applying damping with the aid of a rectifying crystal-circuit across the anode inductance, the rectified energy being reintroduced into the grid-circuit via a low-frequency transformer.

When straight H.F. amplification is wanted, it is better to avoid the necessity of this (normally wasteful) damping altogether. To do this, the effect of the self-capacity of the valve itself, which is the prime cause of the trouble, has in some way to be neutralised. Mr. J. Scott-Taggart has shown, in No. 12 of *Wireless Weekly*, p. 710, one method by which this can be done by a "bridge" arrangement of balanced capacities and inductances.

The Hazeltine "Neutrodyne" circuit (described in No. 4 of *Wireless Weekly*, May 2nd, p. 225), for which great claims have been made in recent radio literature—some rather rashly—represents another solution of the problem, but based on very much the same principle (as is necessarily the case). Fig. 1, in which the "anode-to-grid" capacity is represented by the small condenser in broken lines, shows how there is a complete oscillation circuit, comprising as inductance the primary of the H.F. transformer (or tuned-

# THE "NEUTRODYNE" ANODE COIL

By A. D. COWPER

The following article deals with the Neutrodyne principle to circuit

anode coil, as the case may be), and as capacity, the tuning-condenser across this inductance together with the anode-to-grid capacity, grid-circuit tuning, and H.T. blocking-condensers in series.

A sudden potential difference applied at the

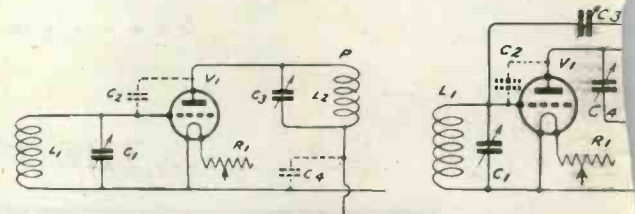

Fig. 1.—Illustrating valve-capacity.

Fig. 2.—The original

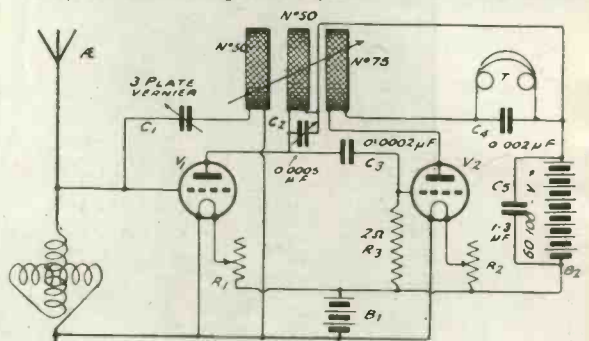

Fig. 4.—A practical broadcast receiver.

point P, which should be handed on to the grid of the next valve by the intervalve coupling, also reacts backwards via this oscillatory circuit, and affects the grid potential in a direction which increases the original P.D., and so on; building up until violent

# "NEUTRODYNE" AND TUNED-COUPPLING

R. M.Sc., Staff Editor.

the practical application of the  
its having tuned-anode coupling.

oscillations are set up, unless the circuit is heavily damped.

Prof. L. A. Hazeltine overcomes this difficulty by introducing another tunable oscillatory circuit, coupled as to its inductance with the former plate-circuit inductance

able condenser to the same frequency as the first circuit. The primary and secondary of the transformer are connected up so that the impulses transmitted to the grid by these two paths simultaneously are of opposite signs; and by suitable adjustment of coupling and tuning these impulses can be made to neutralise each other so completely that the circuit remains stable even when critically tuned and with high plate voltage.

The success of Prof. Hazeltine's "Neutrodyne" circuit using tuned transformers suggested its application to the "tuned anode" H.F. coupling, where oscillation troubles are even more pronounced. Here we have only one inductance, the reaction coil. The first step is to provide a second coil loosely coupled with the first, after the manner of some H.F. transformer-secondaries, but connected only to the local earth, and by a very small variable condenser to the grid of the valve to be stabilised, as in Fig. 3. If the dimensions and degree of coupling be chosen rightly, almost complete neutralisation of any disturbance transmitted back to the grid of the first valve will be obtained.

On actual trial, this was found to be the case. An ordinary 2-coil holder and Igranic coils were used for the intervalve tuning unit, the first or anode coil being tuned by a parallel condenser of  $0.0005 \mu\text{F}$ , whilst a 3-plate vernier-condenser was used in series with the second coil, which was of the same size as the first. Using this arrangement with suitable coils for reception of the Hague, complete freedom from oscillation was readily obtained, with high plate voltage and R valves at maximum brightness; critical tuning of the anode circuit being possible without any damping or positive grid bias, the grid-circuit being connected to the L.T. negative.

Excellent amplification resulted, so that this rather elusive transmission came in at really comfortable strength on two valves, quite undistorted and steady. By careful adjustment of the coupling of the Neutrodyne coil and of the vernier condenser, the circuit could be allowed to oscillate quietly and steadily, or stopped at will. A large Igranic variometer was used for tuning the aerial-circuit.

(Continued on page 330.)

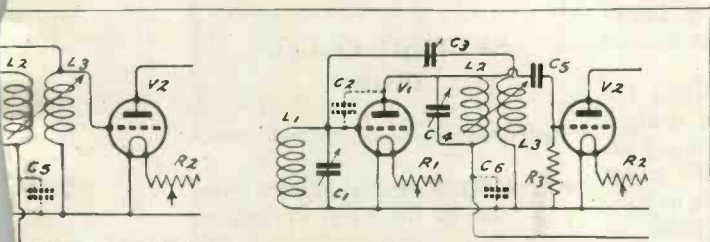

Fig. 3.—A tuned-anode neutrodyne.

minimal "neutrodyne."

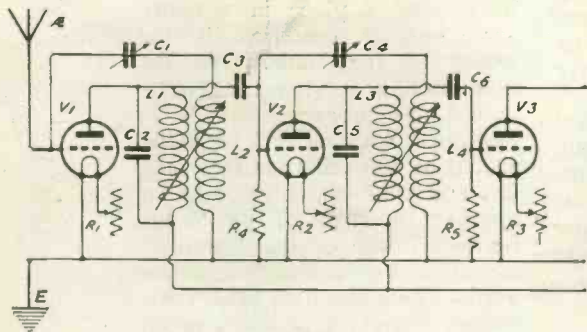
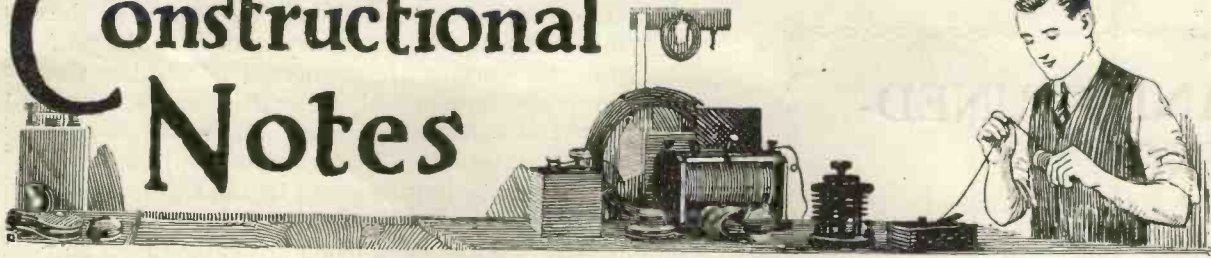

Fig. 5.—A stabilised H.F. amplifier.

(actually the secondary of the H.F. transformer), with a minimal variable capacity in series with it, connected to the grid of the first valve, the circuit being completed via the grids and filament connections as indicated in Fig. 2, and tuned by the small vari-

# Constructional Notes



Conducted by R. W. HALLOWS, M.A., Staff Editor.

## A FOLDING LOUD-SPEAKER HORN

IT is essential that the set that one takes to picnics or on river expeditions should have a loud-speaker, for telephones do not appeal to everyone, and in any

material used may be cardboard, celluloid, or thin sheet fibre. Whichever material is chosen, obtain a piece measuring 12 inches square. Lay this flat on a table and proceed as follows.

Make a mark  $\frac{1}{2}$  in. from the edge AC and rule a line straight down it. Rule a similar line  $\frac{1}{2}$  in. inside the line BC. With centre C and radius AC draw a quarter circle. Now place the point of the compasses on the intersection of the ruled lines at C and draw a quarter circle with a radius of  $1\frac{1}{2}$  inches. Cut out the piece bounded by this smaller quarter circle, and cut along the curve from A to B.

The material can now be rolled into a horn 12 inches in length. A simple way of securing the joint is to use ordinary paper fasteners. If, however, a neater job is desired, get a shoemaker to

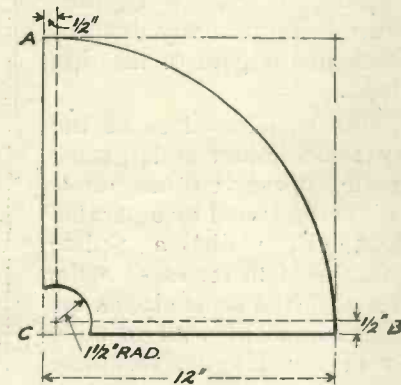

Fig. 1.—The horn unfolded showing dimensions.

case one cannot dance to the music that is brought in by them. Whenever one takes the set about, whether it is merely for a day's expedition or for a summer holiday, the horn of the loud-speaker is always rather a problem, since it takes up so much room.

Nothing can be more convenient when the set has to be packed up for transport than a loud-speaker horn that may be rolled up into a compact bundle or laid flat on the top of one's other gear. To make such a gadget is really quite a simple business. The

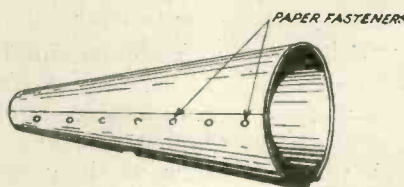

Fig. 2.—The completed horn.

insert half a dozen lace-hole eyelets along the sides AC and BC. The horn can then be held together by means of a piece of string or wire.

To mount the horn on the loud-speaker, slip a 1-inch length of  $\frac{1}{2}$ -inch (or  $\frac{3}{8}$ -inch if necessary) garden hose over the seating of the receiver and work the horn over it. This will give a tight and secure joint.

R. W. H.

## SETTING PLANE-IRONS

THOSE experimenters who are in the habit of making their own cabinets will appreciate the advantages of an efficient wood-plane. The point in keeping a plane in a really good working condition is the setting of the blade. In the first place, a good cutting stone should be procured, which is lubricated with oil. The blade should be removed from the plane box and held on the stone at an approximate angle of  $30^\circ$  to the horizontal face of the stone and moved quickly backwards and forwards. This operation being completed, the blade is tilted to an increased angle of approximately  $45^\circ$ , and the work is proceeded with. The final operation is to lay the blade flat on the stone on its reverse side and give a few strokes backwards and forwards. This removes the burred edge which results when sharpening at an angle. In the final operation it is essential that the blade should lie absolutely flat on the surface of the stone.

H. B.

COUNTING THE TURNS

IF one is winding either inductance coils or transformers in the lathe or in a small winding machine to a definite number of turns, it is not very easy to keep count, especially if the number is a

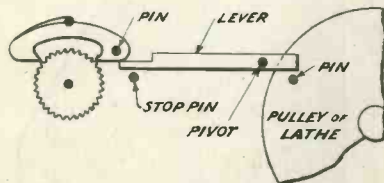

Fig. 3.—Indicating the mechanical action of the counter.

large one. If a lathe is used, one can do fairly well so long as the gearing ratio has previously been ascertained, by counting the number of times that the foot working the treadle descends.

Revolution counters can be bought, but they are usually rather expensive. The ordinary cyclometer is not satisfactory, since if it is intended for a 28in. cycle wheel, about seventy-five turns have to be made before it registers one-tenth of a mile, its smallest graduation. Something, however, can be done with an old clock of the cheap alarm type.

The hair spring is removed and a pin is fixed into one end of the part which regulates the escapement. I do not know its technical name, but Fig. 3 will explain what



Fig. 4.—The clip with piercing needle.

has to be done. A lever is now fixed up on a pivot as shown in the drawing. One end of it engages with the pin mentioned above, the other with a pin fixed into the pulley of the lathe. The lever

should be so mounted that its own weight carries the end nearest the escapement of the clock down against the stop pin. Each revolution of the lathe causes the lever to give a kick to the escapement device, which allows the second hand to move forward usually one space. As different clocks vary slightly, the exact movement that takes place must be ascertained by experiment.

After being moved upwards, the end of the lever falls back against the stop pin. The escapement control also falls back, for the weight of the pin which has been inserted into it is sufficient to overcome its natural balance. With most types of clock, each turn will register one second, sixty turns one minute,

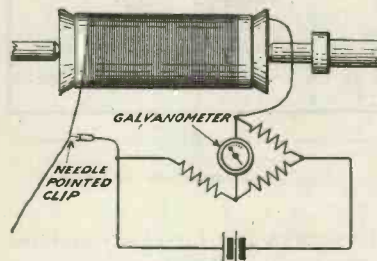

Fig. 5.—Arrangement for measuring the resistance of the windings.

and 3,600 turns one hour. If before winding begins the clock is set at exactly 12 o'clock, the number of turns put on can be read off any moment. If the alarm mechanism is still working, the clock can be set to give warning when one is nearing the end of a long task, such as that of winding perhaps 50,000 turns on to the secondary of a low-frequency transformer.

Another method of counting the number of turns is to measure the resistance of the windings put on at any given time. For this a Wheatstone bridge, which can

often be picked up cheaply, is necessary. The way in which the bridge works has already been explained by another writer (see *Wireless Weekly*, No. 13, p. 743); it is therefore unnecessary to enter into details here. The second appliance needed is a clip, such as that shown in Fig. 4, provided with a needle point which will pierce the silk or cotton covering of the wire without doing any permanent harm to the insulation.

Let us suppose that several coils of exactly the same size have to be wound. The first is wound slowly, the turns being counted carefully. The total resistance of the finished coil is then measured by the bridge. The winding of succeeding coils is done at top speed, no counting being done. As each coil approaches the size of the first, the clip is slipped on and the resistance measured by the method shown in Fig. 5. Winding then proceeds slowly until the resistance, which is measured from time to time, is exactly equal to that of the first coil.

If the coil is not one of a series, but contains a large number of turns, the method is as follows. Suppose that 5,000 turns are to be wound. The first fifty are carefully counted and their resistance is measured. Let us take it that this is 10 ohms. As succeeding layers are wound over the first each turn will contain rather more wire than those of the first layer and will therefore have a slightly higher resistance. Let us strike an average and take a value of 10.5 ohms per fifty turns. Five thousand turns will thus have been put on when we obtain a reading on the bridge of 1,050 ohms.

This method is accurate enough for nearly all purposes, and it saves an immense amount of time when coils containing a large number of turns have to be wound. If no bridge is available, fairly accurate counting can be obtained by using a milliammeter with a large scale and a battery whose exact voltage is known.

R. W. H.

A CABINET FOR "POLAR" CONDENSERS

THE small mica-dielectric variable condensers that are obtainable nowadays are very much more compact than condensers of the rotary vane type; even with a maximum capacity of 0.001  $\mu$ F the depth of one of these handy little instruments is only 1 in. They are very pleasant to use, for, as one has a scale extending for 330 degrees against the usual 180, fine adjustments are not difficult to make. A further good point is that there is no such unsatisfactory brushing contact as that which is made between the spindle and the lower bush of rotary vane condensers.

Mica-dielectric condensers may be mounted in several ways, one of the neatest of which is the small sloping fronted cabinet seen in Fig. 6. This is designed to take a trio of condensers, one of 0.001  $\mu$ F and two of 0.0005  $\mu$ F. The first is intended to be the A.T.C., the others for the secondary and reaction circuits.

The panel for the mounting is a piece of  $\frac{1}{4}$  in. ebonite 13 $\frac{1}{4}$  in. long by 4 $\frac{1}{2}$  in. in width. It is laid out and drilled as shown in Fig. 7. The easiest way of doing this accurately is to paste a piece of paper right over the ebonite and to mark upon it with a lead pencil. A horizontal middle line is first drawn. A second horizon-

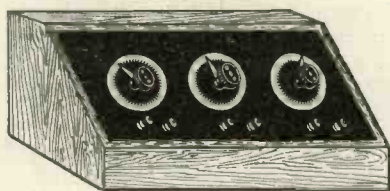

Fig. 6.—The completed cabinet.

tal line follows  $\frac{1}{2}$  in. above the first, then another 1 $\frac{9}{16}$  in. above the middle line. Below the middle line are two more, one  $\frac{1}{4}$  in. and one 1 $\frac{9}{16}$  in. distant.

Three vertical lines are now drawn, one through the middle of the panel, and the others on either side of it at a distance of 4 $\frac{1}{2}$  in. The six centres on the line immediately below the horizontal middle line are drawn as shown, and the panel is ready to be marked with the centre punch and drilled.

With the exception of those for the spindles, which are  $\frac{3}{8}$  in., all the holes may be 4 B.A. clearance size.

The cabinet may be made of any hard wood; oak is inexpensive and easy to work, besides looking very well when finished. Wood  $\frac{3}{8}$  in. in thickness should be used. The end pieces, shaped as shown in Fig. 8, are cut out, then

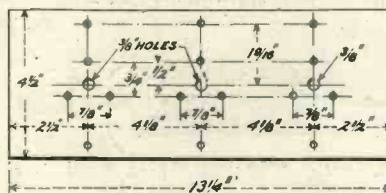

Fig. 7.—Dimensions of panel.

the bottom (14 by 3 $\frac{3}{8}$  in.) and the back (14 by 5 $\frac{3}{16}$  in.).

Place the end pieces upon the bottom and fix them by screws driven up from below; then fix on the back with screws. Inside the sloping part of each end piece  $\frac{1}{4}$  in. below the surface fix a small bead. Secure the ebonite panel, with its condensers mounted, to these beads.

Now cut out the front (13 $\frac{1}{4}$  by 1 in.) and bevel off the inner side of its top edge until it will fit into place neatly. Fix it by screws driven through the end pieces and the bottom. The top measures 14 by 1 $\frac{1}{4}$  in., and is fixed so that it overhangs the sloping panel.

The three pairs of terminals may be mounted on the panel as shown in Fig. 6, or if preferred they can be placed on ebonite

strips either on the top or at the back of the panel.

A very neat way of dealing with this condenser unit is to fix the cabinet by means of brackets to the

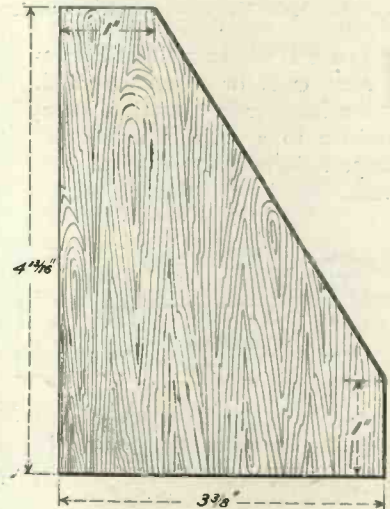

Fig. 8.—Dimensions of side.

underside of the top of the wireless table so that the panel projects with a slope like that of a writing desk. The condensers are then out of the way, and the knobs on the sloping front are conveniently situated for one's hands when tuning has to be done.

R. W. H.

BARING ENAMELLED WIRE

THE job of baring the wire on a slider coil in a neat strip along the track of the moving contact is not always a very easy matter.

A simple method of doing it accurately is to tie upon the coil after winding two strips of wood of suitable length, say, half an inch apart, and arranged along the length of the cylinder. Rub the wire between the strips with emery cloth wrapped round the edge of a matchbox, and a neat job will be made quite easily.

G. P. K.



# THE FIRST VOLUME

*An announcement regarding binding.*

**O**UR readers will be glad to learn that binding cases in two attractive styles have now been prepared for the first volume of *Wireless Weekly*, and can be obtained from the publishers, who will also undertake the binding of readers' back numbers.

The prices of the cases only are 2/6 (2/10 post free) and 4/6 (4/10 post free) respectively, while the cost of binding back numbers is 4/6 (5/6 post free) and 7/6 (8/6 post free). These latter prices include the cost of the necessary cover and also a very full and complete index, which last can be supplied sepa-

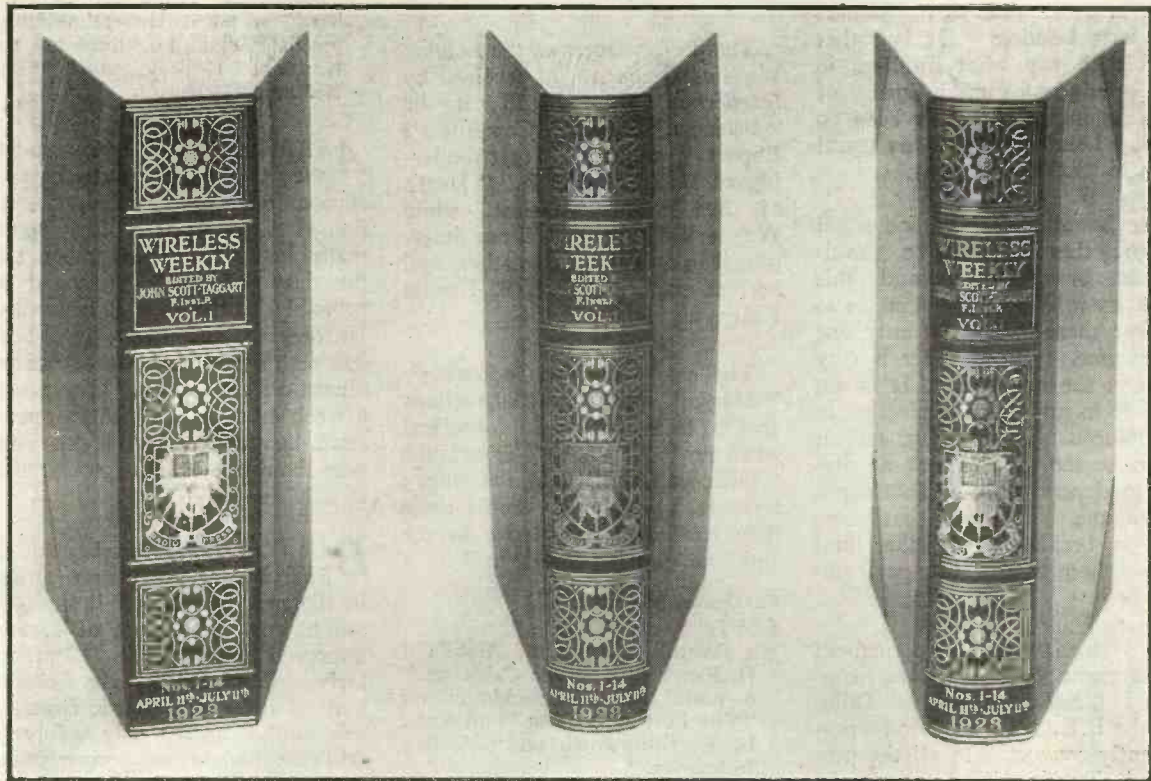

The illustration shows the styles selected, and conveys some idea of their handsome appearance. On the left is a binding case in the cloth style, which is blue in colour and is lettered upon the back in gold. In the centre is a bound volume in this type of cover, and on the right is the half-leather case.

ately at 1/- (1/1 post free). Those readers who do not possess the complete volume are requested to remit also the cost of the missing back numbers. New readers can, of course, obtain back numbers for binding from the publishers, or the volume bound complete for 12/6 (cloth) or 15/6 (half-leather), post free.

# Broadcasting News

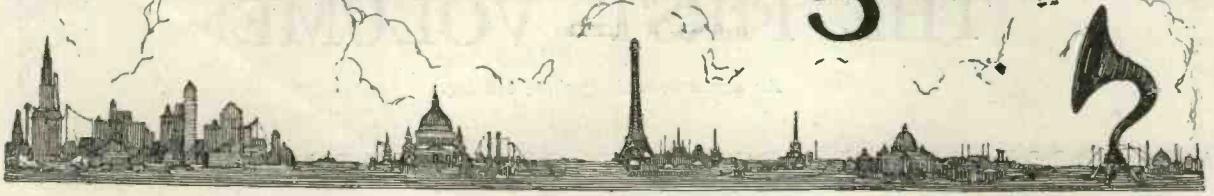

By OUR SPECIAL CORRESPONDENTS.

**LONDON.**—The news bulletins from 2LO are now being broadcast simultaneously from all the stations, and later, musical transmissions will also take place. It may be possible to close down the provincial stations one evening a week in order that their listeners may hear London. It is rather difficult to say what dwellers in the provinces want. Some of them are not particularly keen on hearing London, and others could listen to 2LO every night.

The intention is that one night a week there should be simultaneous broadcasting, and this raises anew the old question as to whether there should be only one programme. The answer is very much in the negative. It is not possible to guarantee perfection in simultaneous broadcasting, and it would be too great a risk at present to depend only on that for a programme. Suppose that there were a breakdown in the land lines, where would the performance be?

We learn that a permanent arrangement has just been concluded between the Post Office and the B.B.C. for 2LO to be permanently connected to all the provincial broadcasting stations by land line from 6 p.m. to 6 a.m. daily. Items of particular interest on 2LO's nightly programmes can thus be broadcast simultaneously from all stations.

"Request Night" has indeed established its right to occupy the premier position in 2LO's transmissions, and we sincerely trust that it will become a regular fea-

ture (weekly for preference). Whether the excellence of these programmes is due to public taste or the fine discrimination of the director of programmes we know not, but the result certainly leaves nothing to be desired.

The performances of the London Wireless Orchestra, as received by listeners-in (or should it be "listeners," *vide* Committee's Report?), are ideal. Their rendering of Grieg's beautiful "Death of Ase" was faultless, while Wagner's "Preislied" was interpreted in a remarkably artistic and perfect manner by Mr. S. Kneale Kelly, on his violin.

The extracts from Chesterton's "Magic" were good, but perhaps just a trifle noisy and hysterical when our "Amurican" friend, the "business man," held the stage; however, our tabloid sample more than confirmed our desire to see and hear more of "Magic."

## Forthcoming Events

### SEPT.

5th (WED.).—7.15 p.m., Archibald Haddon's "Dramatic Criticism." 9 p.m., Sir J. Brookbank on "The Port of London." 10 p.m., F. E. Illingworth on "Woollen Industries."

6th (THURS.).—7.15 p.m., Mr. Percy Scholes, "Musical Criticism." 9 p.m., A. S. Walker on "St. Paul's Cathedral." 10 p.m., E. Farmer, M.A., on "Saving Effort at Work."

7th (FRI.).—6.45 p.m., Ernest Esdaile on "Elocution." 7.15 p.m., G. E. Atkinson on "Cinema Criticism." 9 p.m., Godfrey Cheesman on "The National Union of Manufacturers."

8th (SAT.).—7.15 p.m., Captain J. B. L. Noel, F.R.G.S., on "Climbing Mount Everest." 9 p.m., Mr. E. Kay Robinson on "British Wild Life."

10th (MON.).—7.15 p.m., R. Parks, of Carter, Page & Co., on "Gardening Hints for September." 9 p.m., Hubert Wellington, Official Lecturer to the National Gallery, on "The National Gallery."

**ABERDEEN.**—It is now understood that the new broadcasting station which is in process of erection at Aberdeen is unlikely to be ready in time for September 1st, the date originally mentioned as probable for the opening ceremony. Unforeseen difficulties have been met with in the work, and these are almost certain to retard progress by a week or two. When in operation, however, the Aberdeen station should be a fitting companion to 5SC.

**BIRMINGHAM.**—The staff at 5IT is now completely settled in the new home, and listeners-in are having the benefit of greatly improved programmes. Particularly pleasing is the clarity both of speech and music from the new studio, and it may safely be said that there is not another station more successful from this point of view.

The recent transmission of "Faust," in which Mr. Moses Baritz lectured and the Station Choir and an augmented orchestra rendered selections, was a brilliant affair, and it was not surprising that the station director had over 600 messages of congratulation from all parts of the country.

The first programme by the Station Military Band provided another very enjoyable evening. Here, again, the value of training musicians for the specific purpose of broadcasting was evident, for the performance was marked by an exquisite balance of tone which was the result not only of the right technical control, but of the correct disposition of the instruments in relation to the microphone. Mr. Appleby Matthews (the conductor) knows his work, and it may be taken for granted that he will spare no effort in developing this side of 5IT's music to its highest efficiency.

**Forthcoming Events**

- SEPT.**  
 10th (MON.).—Mr. Walter Hyde, tenor, of the British National Opera Company.  
 11th (TUES.).—Grey's Concert Party.  
 12th (WED.).—Opera, "Merrie England."  
 13th (THURS.).—Miss Beatrice Evelyn, 'cellist.  
 15th (SAT.).—Station Military Band.

**GLASGOW.**—By the time that this appears "Rob Roy" will be broadcast from the Glasgow station by Mr. R. E. Jeffrey, the Glasgow producer. In selecting the cast an effort has been made to secure persons with appropriate voices for each of the characters—English, Glasgow, or Highland. The choral parts will be rendered by a choir composed of 40 members of the Lyric Club, while the band and pipers of the Royal Scots Fusiliers will provide the incidental military music. The production is the largest yet carried out by any broadcasting station. Little did Rob Roy, the old Highland outlaw, dream that the story of his stirring deeds would be wafted through air in this fashion to the most remote hamlet in the land.

**MANCHESTER.**—On Monday, August 20th, we had the monthly operatic lecture by Mr. Moses Baritz, who gave a short biography of Rossini, followed by liberal extracts from the opera "Barber of Seville." The solo-

ists were Miss Madge Taylor, Mr. Lee Thistlewaite, and Mr. Frank Kippax. Every item, without exception, was a pleasure to listen to, and Mr. Baritz gave a translation of the items rendered in Italian: he also gave a general description of the plot and filled in the gaps, so that we had a fairly complete version of the opera. It was altogether a most enjoyable performance, and we shall look forward to Mr. Baritz's next lecture, which will be "Il Trovatore."

A "request concert" is to be given on Friday, October 12th. Listeners-in are invited to write to the Manchester station giving

BROADCAST TRANSMISSIONS	
Call-Sign	Wavelength
CARDIFF	5WA... 353 metres
LONDON	2LO... 389 ..
MANCHESTER	2ZY... 385 ..
NEWCASTLE	5NO... 400 ..
GLASGOW	5SC... 415 ..
BIRMINGHAM	5IT... 420 ..
TIMES OF WORKING.	
Weekdays	3.30 to 4.30 p.m. and 5.0 to 10.30 p.m. B.S.T.
*London	11.30 a.m. to 12.30 instead of 3.30 to 4.30 p.m.
Sundays	8.30 to 10.30 p.m. B.S.T.
	2LO 3.0 p.m. to 5.0 p.m. also.
SILENT PERIODS.	
CARDIFF	8.0 .. 8.30
LONDON	6.15 .. 7.0
MANCHESTER	7.45 .. 8.15
NEWCASTLE	9.0 .. 9.30
GLASGOW	8.0 .. 8.15
BIRMINGHAM	8.0 .. 8.45

their ideal programme, and three prizes will be awarded to those who most nearly specify the list of items actually performed. The closing date for receipt of "programmes" is September 5th. It is intended to give these "request" nights once a month.

Auntie Peggy (Miss Peggy O'Neil, the famous actress) spoke to the kiddies from 2ZY on Friday, August 24th, and her success in this venture may be judged by the fact that she received 75 letters from her youthful admirers. Incidentally, the station received altogether 122 letters on the day in question, and as the studio is on the fifth floor, we do

not envy the lot of the postman on whose round the new station has been thrust.

We have it on good authority that during the winter Sunday afternoon transmissions are to be given from 2ZY, and that commencing at the beginning of October next, the Monday evening transmissions, from 7.15 to 9.45, will be relayed entirely from London. Lovers of organ music will also be glad to hear that Manchester is to have a Mustel organ like the other stations.

**Forthcoming Events**

- SEPT.**  
 5th (WED.).—Jaye Kaye, humorist. Joseph Lingard, flautist. Harold Brown, baritone. 2ZY Orchestra.  
 6th (THURS.).—Shakespeare's "Midsummer Night's Dream," with Mendelssohn's incidental music. Conductor, Dan Godfrey, jun. Producer, Victor Smythe. Lyrics by Winnifred Fisher.  
 7th (FRI.).—Miss Adrine Adjarian, soprano. Massey Dance Orchestra.  
 8th (SAT.).—Olga Telba, soprano. Jessie Cormack, pianiste. George Jeffcock, baritone. Henry J. Winsler, elocutionist.  
 9th (SUN.).—Concert by Oxford Street Picture House, full orchestra. Emily Seddon, soprano. Wm. Stansfield, baritone.  
 10th (MON.).—Foden Williams, entertainer. Stephen Williams.  
 11th (TUES.).—Third Symphony Concert, full augmented orchestra. Conductor, Dan Godfrey, jun., A.R.A.M. Madge Taylor.  
 12th (WED.).—John Henry. Kate Winter, soprano. Beatrice Evelyn, 'cello. 2ZY Orchestra.

**NEWCASTLE.**—The impending departure of Mr. Bertram Fryer to take charge of the new Bournemouth station is greatly regretted by the many friends he has made in the North as well as by those associated with the station's activities. As a sign of their appreciation of his directorship the members of Mr. W. A. Crosse's orchestra have presented him with a silver-mounted ebony walking-stick.

# AN AUTOMATIC ALARM DEVICE

By B. H. J. KYNASTON.

*An interesting description of one of the latest attempts to solve the problem of an automatic call recorder.*

**T**HIS description of a relay action alarm device for which I have applied for patent protection (Application No. 8782/23) will no doubt be of interest to wireless experimenters and others. The circuits of the device are so arranged that, upon the transmitting station sending out a prearranged call consisting of a thirty second dash repeated at intervals for two or three minutes an alarm bell will ring at the receiving station.

Tests were carried out with this device some time ago, in which the transmitter consisted of an ordinary 10-watt C.W. set and the receiver, which was thirty miles away, consisted of a detector and single-valve L.F. amplifier. Successful results were obtained, but for longer distances it was found necessary to add another valve, as strong signals are necessary in order to work the relay.

Fig. 1 shows the complete diagram of the device, the circuits of the valve receiver being omitted. The relay used was constructed from a milliammeter by soldering a small contact to the pointer, and a similar contact to a small spring as shown. The next portion of the device is a small glass tube having a bulb at one end and a fine but stiff wire passing down the centre of the tube. This bulb contains mercury, and is surrounded by a coil of tungsten wire which is known as the heating element. The action of the instrument is as follows:—The transmitting station sending out a continuous dash causes the relay (owing to it being connected in the plate circuit of the receiver) to close its contacts for thirty seconds. The closing of these

contacts connects the small tungsten coil to the filament battery, which results in the coil becoming almost red-hot. The mercury in the tube will, therefore, rise until at the end of about twenty-five seconds it has touched the end of the wire which runs down the tube. When the mercury touches this wire, a current will flow from the battery B through the wire sealed in the bottom of the tube, through the mercury and wire to the magnetic switch coil. The armature of this switch is attracted by the

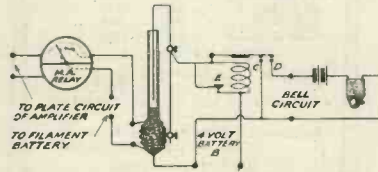

Fig. 1.—The automatic alarm circuit arrangement.

magnets, and the closing of contacts C cause the battery B to keep this coil magnetised after the level of the mercury has dropped.

The closing of contacts D, which are also controlled by the armature, complete the bell circuit, causing it to ring until the button E is pressed. This button shorts the magnet coils so that the armature can return to its normal position. When ordinary Morse signals or atmospherics are coming through, the relay opens and closes repeatedly, and the tungsten coil, therefore, cools during the time the relay contacts are open. The mercury does not therefore rise high enough to complete the magnetic switch circuit.

It will be noticed that a pointer is arranged attached to the fine wire which passes down the tube, and this pointer must be kept level

with the top of the mercury. If, owing to the change in temperature, the mercury rises or falls, the pointer must be adjusted so that it is still level with the top of the mercury. It will be seen from this that the distance between the mercury and wire will always be the same.

As the relay is likely to respond to strong atmospherics even when a long dash is being sent, it is necessary that the call be repeated in order to make certain that the device shall respond to the alarm signal. The device, however, invariably responds to the first or second call. By using this alarm it is possible for the transmitting station to call the receiving station at any time, without the necessity of anyone listening-in continually at the receiving station. Any one out of a large number of stations all in the same vicinity can be called, provided the wavelengths of the various stations are different. With telephony stations the carrier wave is usually of sufficient strength to work the device.

## FORTHCOMING EVENTS

SEPT.

6th (THURS.).—Ilford and District Radio Society. Mr. G. F. Hearn will give a lantern lecture on "Post Office Telegraphs."

7th (FRI.).—The Wireless Society of Hull and District. An informal meeting will be held at the Co-operative Social Institute, Jarratt Street, at 7.30 p.m.



### A Variometer for Secondary Circuits

FROM the Bowyer-Lowe Co., Ltd., we have received a variometer, Model No. 2, wound especially for use in tuned-anode high-frequency coupling. While a variometer wound with a smaller number of turns for use in the aerial circuit can be pressed into use in a secondary circuit with the addition of a condenser of about  $0.0003 \mu\text{F}$  across it—to make up for the lessened capacity of the circuit—it is evidently better to use a variometer designed specially for the task.

This instrument is similar in general design to the No. 1 model already noticed in these columns (Vol. 1, No. 4, page 251), being of the ebonite-tube variety, but wound with a larger number of turns of finer wire. It is intended for panel mounting, and is provided with a high-class fluted knob and bevel scale and pillars which facilitate the fixing behind the panel. The design, workmanship, and finish are sound, a substantial, noiseless contact being provided for the moving rotor connections.

On practical trial, for tuned-anode coupling, etc., it was found to tune from about 240 to 450 metres or a little higher, according to the valve capacity, and gave good tuning adjustment and ample magnification of signals. On the broadcasting waves very satisfactory reception was obtained on two valves, one H.F. and detector, using reactance capacity coupling with this variometer for the reactance. As anode inductance in the ST100 circuit excellent loud-speaking resulted, and Birmingham

and the Ecole Supérieure were successively tuned-in (in N.W. London) while 2LO was transmitting. Although not primarily designed for that purpose, it was of interest to try the range when used as aerial tuning inductance: this proved to be from 750 to 1,400 metres on a (approximate) P.M.G. aerial, bringing in the Hague concert nicely.

### A Comfortable Head-set

Whilst the majority of listeners-in are still subject to the tyranny of the head-phones, the matter of minimising the discomfort often experienced when the head-set is worn for some time continuously becomes of great interest. We welcome, therefore, an opportunity of trying a type of 'phones and head-gear in which a special effort has been made to overcome this drawback.

A head-phone set manufactured by the Radio Equipment Co., Ltd. (No. A.1—R.E.C.), is the subject of special claims for comfort and convenience, and shows a considerable advance beyond some of the types in common use.

The set is light; the leather-covered band does not grip the head uncomfortably; while there is nothing to catch the hair. On appeal to a fair listener-in on this important question the verdict was that the 'phones could be removed and replaced several times without serious interference with the coiffure. When the knack of adjusting had been acquired, the greater comfort of this head-set when worn for many hours continuously in arduous experimental work was noticeable. This is a much severer test than a couple of hours' broadcast reception. The tone and sensitiveness were fair on crystal and valve. A point of

favourable comment was the generous length of lead supplied.

### Basket Coils

From the Cenro Radio Co. we have received a set of basket coils, covering a range of wavelengths from about 300 to 1,500 metres on a P.M.G. aerial when used with a  $0.001 \mu\text{F}$  parallel condenser, the individual coils of the set of six being distinguished, rather ingeniously, by coloured bandings.

On trial these were found to cover the range indicated conveniently, with good overlap, permitting favourable choice of secondary-circuit tuning inductance and reactance coils. The signal strength with the No. 1 (red) of the series on local broadcasting was favourable.

At the very reasonable prices charged for these coils, the amateur has available means of tuning that will give him all of the most interesting transmissions, and enable him to try out many different circuits.

A little criticism might be offered as to the fragility of the larger coils of the series, which show some tendency to break loose at the edges; this will, no doubt, be rectified in later patterns.

Uniform with this series is a tapped basket coil, especially arranged for broadcast reception. This coil has ten fine and ten coarse tapings, by means of which any average aerial can be adjusted to the broadcast waves without further tuning mechanism. On actual trial very good signal strength was obtained at thirteen miles from 2LO; and the tuning proved quite satisfactorily fine. It represents an economical and effective tuning device, which could be readily incorporated into a simple and efficient broadcast receiver with the minimum of trouble.

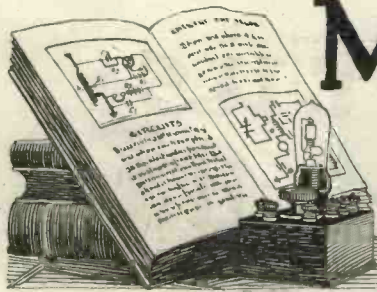

# Mainly about Valves

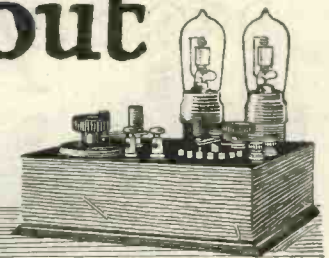

Our weekly causerie written by the Editor.

## Capacity Coupling for Telephones and Loud-Speakers

THERE are several disadvantages in connecting a pair of telephone receivers for a loud-speaker directly in the anode circuit of a valve, particularly when high voltages are employed. When the telephones are connected directly in the anode circuit, the steady current flowing through is a heavy strain on their insulation, and also there is much more chance of them burning out, owing to the fine wire used. A telephone transformer may be employed, but when this is not done the telephones may be coupled to

easily carry the current without danger of injury.

In Fig. 1 is shown an impedance  $Z$  having an iron core which is included in the anode circuit of the valve, which may be the last valve of the receiver. The telephones  $T$  are connected across the impedance  $Z$ , a large fixed condenser  $C$  having a capacity of not less than  $\frac{1}{2} \mu F$  being inserted in one of the leads. In fact, two condensers may be used, one in each lead, in which case the telephones are absolutely insulated from the high-tension voltages, and there is not the slightest danger of receiving a shock. The choke coil  $Z$  should, of course, have a high impedance, and the principle of the idea is that the currents through  $Z$  are practically steady, any current variation, however, passing through the telephones  $T$  and the condenser  $C$ .

Some consider that the use of these chokes and condensers improve the quality of the speech or music.

The idea is also used for interval transformers, the steady anode current of a valve, instead of passing through the primary of the interval transformer, is passed through a choke coil coupled to the primary by means of a large fixed condenser. This idea is particularly useful when the interval transformer is to be protected from a possible burn-out.

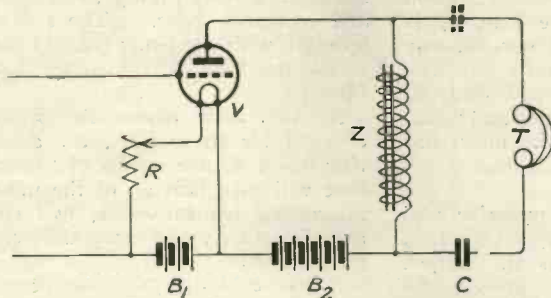

Fig. 1.—Illustrating the positions of the choke and condensers.

a high impedance included in the anode circuit of the valve, this impedance being wound with relatively thick wire which can

## THE "NEUTRODYNE" AND TUNED-ANODE COUPLING

(Continued from page 321.)

On local broadcasting, using No. 50 coils for anode and Neutrodyne, even 2LO's powerful carrier-wave could be held down, on a fair suburban aerial; and with a three-coil tuner and a No. 75 reaction-coil in the detector-valve, plate-circuit, critical reaction at this (allowable) point was obtained, giving a very respectable volume of loud-speaking without risk of causing any interference. The

circuit is shown in Fig. 4. The other broadcast stations were readily tuned in with good signal strength and excellent selectivity. There should be no particular difficulty in applying the principle to a multi-stage H.F. amplifier, as suggested in the last diagram, Fig. 5. The small coupling condensers are tuned once for all, and can be of the simplest description.

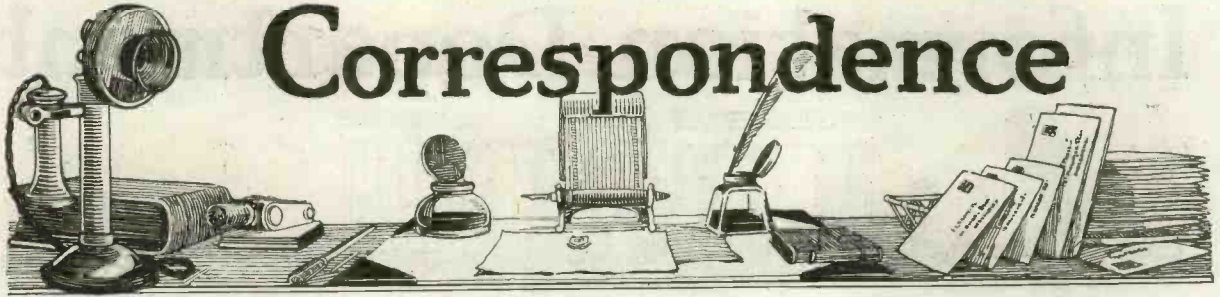

# Correspondence

## THE NEW ORGANISATION

SIR,—I should be grateful if you would permit me, as President of the Radio Society of Great Britain, to make a few comments upon Lt. Burbury's letter appearing in your No. 7 issue, wherein he discusses the Society's efforts to promote national unity in amateur wireless matters.

First, I should like to remind you that when the need for an amateur society of national scope became apparent some years ago, the Wireless Society of London initiated a scheme of annual conferences. At these meetings the organisation of a national amateur parliament was discussed. The conferences were all well attended, and each of them enabled the Wireless Society of London to take a further step towards national accord. As a consequence the present position is as follows:—

1. The Radio Society of Great Britain has been formed from the Wireless Society of London and its affiliated societies.
2. The Radio Society has received the honour of the patronage of H.R.H. the Prince of Wales.
3. The Memorandum and Articles of Association defining the constitution of the Radio Society are now approaching completion.
4. Meanwhile the affiliated societies are being kept in touch with by letter from the Hon. Secretary of the Radio Society, and by memoranda circulated as required.

During the transition period the Committee of the Society is studying how to ensure adequate repre-

sentation of the affiliated societies on the Central Committee. In order to get the best advice on this matter the Committee decided to invite four provincial amateurs to join them. In view of the urgency of the matter, the Committee themselves chose four provincial members instead of trying to organise a special election. This is the step which has called forth the letter of your correspondent. But I can assure him that neither the method of augmenting the Committee nor the proportion of provincial to London members is intended as a permanent arrangement or as a precedent. Arrangements for the future will be made with an open mind by the augmented Committee.

Finally, as a practical step towards helping the Radio Society to obtain complete representation of every view, I suggest that those amateurs who sympathise with your correspondent should communicate with him and then elect a representative, after which I would do all I could to get their representative appointed to the Committee immediately.

I am, etc.,

W. ECCLES.

[This is a very restrained statement of the situation. We feel that Lt. Burbury is more or less alone in his extreme view. There is every indication that the Society is trying to do what we have consistently advocated—by allocating seats on the Committee to provincial representatives. We trust that a change of policy regarding the patronage of ineffective and

unnecessary societies such as the Wireless Relay League will follow.—EDITOR.]

## RE NEW CIRCUITS

SIR,—Your correspondent "C. H. S." appears to be in a bad way.

So far as the various new circuits are concerned, the only comment I can make is that all his troubles will be overcome if he adopts the unit system. Why he, as an experimenter, has not discovered this for himself I do not know.

With regard to his remarks, "Thank goodness amateur transmitting is washed out," goodness only knows what he means. More often than not the 440-metre wave sounds like a fair on a bank holiday, and the 150-200 wave is by no means silent, at any rate, so far as the London district is concerned.

I would like to inform "C. H. S." that I am not (and have no intention of being) "washed out," and doubtless there are many other transmitters who are of the same opinion.

I would advise "C. H. S." to make up a collection of parts and carry on, having a shot at the new circuits as they appear, and I should imagine that his spirits will rise above that level where the B.B.C. is his only benefactor. The chief use I have for this worthy company is in experimenting with rejector circuits to get rid of the London station.

I am, etc.,

E.15.

A. GWINN.

# Information Department



**C. H. F. (BIRMINGHAM)** has a former 1½ in. in diameter and wishes to know how many turns and what gauge of wire will be necessary to wind three coils to function as aerial circuit inductances for the wavelength of the Hague 1,050, Radiola 1,780 and the Eiffel Tower 2,600 transmissions. He also wishes to know windings for suitable anode coils to work in conjunction with these.

Using No. 28 s.w.g. d.c.c. copper wire, 100, 150 and 250 turns will be required respectively for the aerial circuit coil, and 150, 200 and 300 turns for the appropriate anode circuit coil.

**A. V. L. (BARNSELY)** has a small choke-control telephony transmitter, and wishes to apply a speech amplifier to this in such a manner that he can obtain the best results from two microphones in his possession, each having diaphragms of different frequencies.

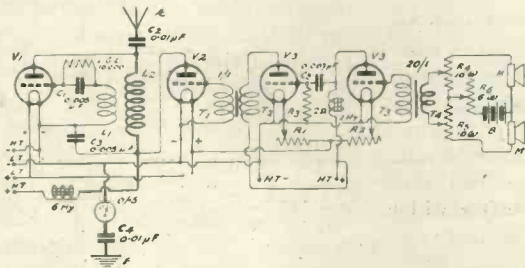

A very efficient scheme of connections for accomplishing what you ask is given in the appended diagram. The essential values are clearly marked.

**F. T. B. (CROSBY)** is constructing a three-valve receiver employing the circuit ST45 in "Practical Wireless Valve Circuits," Radio Press, Limited, and asks the correct values for the different coils for the reception of British broadcasting.

Coil  $L_1$  might have 50 turns of 20 s.w.g. double cotton covered wire on a 3 in. former. Coil  $L_2$  might be similar, and coil  $L_3$  might have 75 turns of No. 28 s.w.g. wire on a 2 in. former.

**J. A. B. (BARNSELY)** has constructed the circuit ST100 from the instructions given in "MODERN WIRELESS," No. 6, but complains that a persistent howl is heard when using telephones with this receiver. He asks what may be done to effect a cure.

The effect you complain of is similar to that experienced when using a high-resistance loud-speaker with long flexible leads, and is due to undesirable capacity effects. It may be controlled to a great extent either by shunting the telephone terminals with a still larger condenser, say 0.005 μF, or alternatively by using a step-down telephone transformer and low-resistance telephones. In this latter case, the primary of the transformer should be shunted by a similar condenser to that in the original circuit.

**N. B. (ELLAND)** has constructed a three-valve receiver described in "MODERN WIRELESS," No. 4 on page 265. He states that mention is made of a condenser  $C_4$  of 0.002 μF capacity, but this does not appear on the diagram, and he wishes to know its position.

We regret that owing to a printer's error this condenser was omitted from the circuit shown on page 267, and have to say that it is placed across the primary winding of the low-frequency interval transformer. If carefully handled, this instrument should be capable of receiving broadcasting successfully in your locality.

**W. A. (TOTTENHAM, N.17)** proposes to construct a circuit in which the high-frequency amplifier is added to ST100 as described in "MODERN WIRELESS," No. 7. He asks, with reference to the Fig. 4, page 528, whether the choke No. 200 would be satisfactory on all wavelengths.

The same size of coil, namely a No. 200 Igranite or an equivalent winding, may be used for all wavelengths, as the object of this coil is simply to keep high-frequency current from getting into the grid circuit of the second valve.



**R. B. (BARNET)** refers to circuit ST34, "Practical Wireless Valve Circuits," Radio Press, Limited, which he is constructing to receive the British broadcasting transmissions. He asks the values of the various components for this purpose.

As you do not wish to use basket or honeycomb coils, we suggest you wind 50 turns of No. 20 s.w.g. d.c.c. copper wire on a 2½ in. tube for the aerial inductance  $L_1$ , which might be tapped at every 5 turns after the 30th. Coil  $L_2$  might be wound on a similar size of former with 75 turns of the same wire, and coil  $L_3$  might consist of 75 turns of No. 26 s.w.g. d.c.c. copper wire wound on a 2 in. former, and a range to couple with  $L_2$ .  $L_2$  might be tapped in three places. The condenser  $C_1$  should have a value of 0.001  $\mu$ F and  $C_2$  0.00025  $\mu$ F. Condenser  $C_3$  should be 0.0003  $\mu$ F and condenser  $C_4$  0.002 to 0.5  $\mu$ F. The resistances  $R_1$  and  $R_2$  should have a value of 6 ohms and  $R_3$  should be from 1 to 5 megohms. The telephones T should be of high resistance.

**A. J. (DINGLE)** asks: (1) Whether a loose coupler with formers 4 in. and 3½ in. in diameter by 10 in. long respectively, and wound with 28 s.w.g. enamelled wire on the primary and 32 d.s.c. wire on the secondary, would cover a range of from 300 to 5,000 metres. (2) Whether he could wind an inductance on a tube 4 in. diameter and 10 in. long to tune up to 25,000 metres. (3) Whether a tube 2 in. in diameter by 10 in. long or 4 in. in diameter by 10 in. long would have a greater inductance value.

(1) If you wind your tubes with 26 gauge enamelled wire on the primary and 28 gauge on the secondary, you will be able to cover this range. (2) It is not a practical proposition to wind an inductance to cover such a high wavelength on such a small tube. A basket coil with an internal diameter of 2 in. and 27 spokes wound with 1,500 turns of No. 38 s.w.g. enamelled wire will cover this range. (3) All things being equal, the tube 4 in. in diameter will naturally have the greater inductance value.

**M. W. (CHORLEY)** is obtaining very satisfactory results with the receiver as described on page 173 of "WIRELESS WEEKLY," No. 3. He wishes to add an amplifying valve and asks our advice.

The addition of a high-frequency amplifying valve will certainly increase the strength of signals considerably, but its special purpose is to enable more distant stations to be received. For the greatest amplification of signals already audible on your crystal set, the addition of a low-frequency amplifier is recommended, and it may take the form of a single valve panel as described in reply to I. H. P. (Manchester) in Vol. 2, No. 2, or a two-valve low-frequency amplifier as described in *Wireless Weekly*, No. 3.

**J. T. (MONKTON)** has constructed a simple crystal receiver described in "WIRELESS WEEKLY," from which he obtains very satisfactory results. In order, however, to extend his range he has been advised to instal a two- or three-valve receiver and wishes to know what circuit he should employ to ensure satisfactory reception of all the British Broadcasting Stations on telephones.

We suggest you adopt circuit ST35, "Practical Wireless Valve Circuits," Radio Press, Limited, which is a very useful arrangement of high- and low-frequency valve amplifier using a crystal as a detector. If carefully operated and under favourable circumstances, you should be able to hear all the British stations with this receiver.

**A. W. B. (MANCHESTER)** has a vario coupler, wound with 80 turns of No. 18 s.w.g. d.c.c. copper wire on a 4 in. tube for the aerial circuit and having the same number of turns of a finer wire on a ball forming the rotor, and wishes to know how to connect this in circuit.

As your primary winding is tapped at convenient intervals, this should be connected in series with the aerial and earth and tuning carried out by means of the tapping switch alone. We do not advise the use of a variable condenser here. The secondary winding, shunted by a small variable condenser having a value of about 0.0005  $\mu$ F, may be connected to the grid and filament negative of your valve receiver in the ordinary manner, and coupling is effected by rotating the ball within the fixed winding.

**M. A. U. (MILE END, E.2)** requires a circuit diagram of a low-frequency amplifier in which the valves are coupled by means of an iron-core choke and a small condenser. He wishes to know the values of the various components for efficient reception of speech and music.

We give herewith a circuit diagram showing the most efficient method of arranging such a circuit. The values of the more important components are clearly marked.

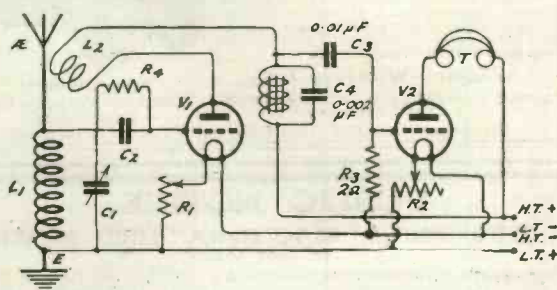



### GOOD TOOLS MEAN EFFICIENT WIRELESS SETS.

We give you Best Quality Tools with lowest prices by supplying the user direct.

Send us your Postal Order or enquiries to-day; you'll get our best immediate attention.

None too small or too large.

### WE PAY CARRIAGE ON ALL ORDERS.

**HAND DRILL** as illustrated, capacity 0-1". Gears cut from full metal. Complete with Three-Jaw Chuck and set of Drills, 1/8", 3/16", 1/4", 5/16", 3/8", 1/2", 5/8", 3/4", 1". **10/6**

**ADJUSTABLE STEEL HACKSAW FRAMES**, 8-12", Nickel Plated, complete with 1 Blade. **2/-**

**SUPERIOR PARALLEL TABLE VICES**, with clamp, 2 1/2" steel jaws, accurate finish **6/6**

**COMBINATION PLIERS**. Flat nose, Burner Hole, side cutting, 6" **1/9**

**SCREWDRIVERS**, London Pattern, flat handles, 6" **1/3**

**ELECTRICIANS' TURNSCREWS**, steel blades, hardwood handles, 4" only. **8d.**

**HAMMERS**, Kent Claw pattern, good quality **1/6**

For light model work, tack or pin hammers **1/6**

**FILES**, Best Cast Steel, set of 3, 6" (Flat Bastard, Flat 2nd-cut, Flat Smooth) **1/8**

Half-round 6"—Bastard, each 7d., 2nd-cut, each 8d., Smooth, each 9d.

**STOCKS & DIES**, B.A. (Dies 1/8" dia.) cutting 2, 4, 6 and taps. London made. **10/- per set.**

On card with Taper Taps **12/6**

with Taper and Plug Taps

**THE BILLING TOOL CO.**, 303, HIGH HOLBORN, 'Phone: Holborn 898. LONDON, W.C.1.



**"ON THE S.T. 100 IT GAVE A FINE ROAR WITH 2LO's DANCE MUSIC AUDIBLE AT THE END OF A LARGE SUBURBAN GARDEN."**

*Extract from test report by Mr. A. D. Cowper, B.Sc. (Lond.), in "Wireless Weekly," July 25, regarding the EEC "Xtraudion" Valve.*

## ECONOMIC ELECTRIC

Telephone: MUSEUM 1055.

Head Office: 10, FITZROY SQUARE, LONDON, W.1. Showrooms: 303, EUSTON RD., N.W.1. Branch Showrooms: TWICKENHAM.

Price 15/-

**WATMEL VARIABLE GRID LEAK** (Patent applied for.)

The Resistance is steadily Variable between 1/4 to 5 megohms. Only requires a 1/16 in. hole in panel for fitting. Suitable for use in any circuit, and improves the working of any valve detector (50,000 to 100,000 ohms for the S.T. 100 Circuit. Price 3/6.)

**Watmel Wireless Co.**

Connaught House, 1a Edgware Road, Marble Arch, W.1 Tel.: 4375 Paddington.

Be sure to see our Trade Mark "Watmel" engraved on the plate.



Price 2/6 each.

The best Variable Grid Leak made.

### PUBLIC NOTICE.

**THE WONDERFUL "MAGNORA" LOUD SPEAKER.**

42/- post free.

There appears to be some misunderstanding amongst the General Public regarding the proprietorship of the "MAGNORA" Loud Speaker. Mr. C. Hering has now absolutely no connection with the "MAGNORA," the Sole Manufacturers and Concessionaires being

**The CONDUIT WIRELESS COMPANY, 47, Conduit St., London, W.1.**

'Phone: Regent 5476.

W. B. (JARROW) has constructed a receiver embodying the circuit ST45, and would like to know what size of former, how many spokes, and what gauge of wire will be required to make suitable basket coils for use with the above to cover the British broadcasting range of wavelengths. He also asks whether this is in our opinion the most efficient method of using three valves for the reception of British broadcasting, and whether it is a permissible circuit.

There are three coils in this instrument, L<sub>1</sub>, L<sub>2</sub> and L<sub>3</sub>. For the reception of British Broadcasting, using a 2 in. former, 15 spokes and 24 s.w.g. d.c.c. copper wire, coil L<sub>1</sub> might have 35 and 50 turns, coil L<sub>2</sub> 50 and 75 turns, and coil L<sub>3</sub> 75 turns. This is probably the best way of connecting up three valves for the reception of British broadcasting, and comes under the category of non-radiating circuits. The following specification, if carefully followed, will result in a very satisfactory device:—

Core, 26 s.w.g. soft iron stamping, cross-section 1/2 in. by 1/2 in., each lamination insulated from its neighbour. Primary winding, 4,500 turns. Secondary winding, 11,000 turns. D.C. resistance, primary 1,100 ohms, secondary 3,600 ohms. Inductance value, primary 8 henries, secondary 50 henries. Gauge of wire, 44 s.s.c. Quantity of wire required, primary 1/2 oz., secondary 1 1/2 oz.

M. S. I. (OLD TRAFFORD, MANCHESTER) wishes to know how to make a high-frequency transformer to cover the broadcast band of wavelengths. He wishes to make this from two basket coils if possible.

If the internal diameter of your basket coils is 1 in., and you have 15 spokes per former, you would require 80 turns on each basket of No. 28 s.w.g. single silk covered wire. The range of the apparatus you mention is in the neighbourhood of 50 miles.

**BRIEF REPLIES**

B. J. (NORWICH).—The most sensitive crystal detector is usually one of the various galena crystals such as Hertzite, used with a light wire contact, commonly called a "cat-whisker." The Perikon combination, however, is very nearly as sensitive, and is considerably more stable.

J. S. W. (BABBACOMBE).—Since you are quite a beginner, we do not advise you to attempt to use a frame aerial, since the attendant valve amplifiers which would be required to give you a reasonable prospect of hearing the broadcasting stations would be of rather a complicated nature. We should advise you to put up the best possible aerial and to use a simpler receiving set.

J. N. DA C. (LISBON).—We think that to have a reasonable prospect of receiving any of the British broadcasting stations, you will need to use at least two high-frequency valves and probably one or two low-frequency also.



*Where Performance  
Equals Ambition*

To produce a Loud-Speaker which is worthy of the artistes who nightly broadcast has been our ambition.

A Loud-Speaker which reproduces the fullness of the violin, the delicacy of the flute, the blare of the trombone, and the characteristic quality of the voice, *that* has been our ambition and that is the guaranteed performance of

**TMC**

## Loud-Speakers

Obtain one from your usual stores, electrician or wireless dealer, and judge for yourself.

We are confident your verdict will be



**THE TELEPHONE MANUFACTURING  
CO., LTD.**

London Showrooms: 68, Newman Street,  
Oxford Street, W.1.

Telephone: Museum 5581.

Price £6-10-0

(E.P.S.02)

# New Post Office Regulations

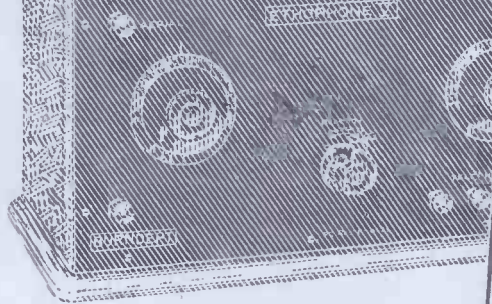

**BURNDEPT LIMITED**  
 MANUFACTURERS OF WIRELESS APPARATUS.

HEAD OFFICE  
 ALDINE HOUSE, BEDFORD STREET,  
STRAAND, WESTMINSTER, LONDON

STRAND, LONDON, W.C. 2.  
TELEPHONE GERRARD 7794. PRIVATE BRANCH EXCHANGE

Inv No. 0654 Date Sept. 1. 1923

**VOUCHER FOR REFUND OF BROADCAST FEES**  
Subject to Post regulations issued by G.P.O.

This is to certify that Mr. Brown Thompson has been invoiced  
 with the sum of Two pounds / five Shillings  
 representing B.B.C. Tariff on Set No. 3268 Type Cellulose V

In the event of the Broadcast Regulations being altered that we are not called upon to pay this tariff to the British Broadcasting Company the amount will be refunded or credited to the person forwarding this Voucher to our Head Office.

For Burndept Ltd. [Signature]  
 (Sales Department)

Accountant. [Signature]

£2. 15. 0

NOTE.—When Sets accompanied by Vouchers are sold by retailers, they should endorse purchaser's name on the back of this Voucher and attach their signature.

## Note :-

THERE is no reason to delay purchasing Burndept Receiving Sets pending the official announcement by the Postmaster-General of the new regulations.

# Protection for Burndept customers

WITH all Burndept Receiving Sets bearing B.B.C. mark purchased from September 1st will be given a voucher facsimile above—which explains itself.

We have also made some reduction in the list price of various of our Receiving Sets, particulars of which can be obtained from our Head Office, Branches and Service Depots.

A large new edition of our Catalogue is in the Press. Write now for your copy, which will be sent POST FREE as soon as ready.

**BURNDEPT Ltd.** Aldine House, Bedford St., Strand, W.C. 2.  
 London Showrooms: 15, Bedford Street, Strand, W.C. 2.  
 (London—Phone: Gerrard 7794. Private Branch Exchange.)

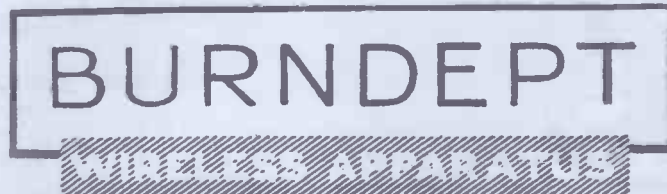

### BRANCHES

- LEEDS: The London Assurance House, Bond Place
- NEWCASTLE-ON-TYNE: 7 St. Andrew's Buildings West, Coleridge
- CARDIFF: 67 Queen Street
- HEAD DISTRIBUTING SERVICE DEPOTS.
- ENGLAND.**
- BIRMINGHAM: C. S. Bayson, 133 New Street
- MANCHESTER: W. C. Barralough, 61 Bridge Street
- BRIGHTON: H. J. Callers, 32 St. James's Street
- NOTTINGHAM: Pearson Bros., 14 Long Row
- YEovil: Western Casson Electrical & Engineering Co., Electricity House, Princess Street
- BRISTOL: King & Co. Western Electric Works, Park Row
- SCOTLAND.**
- GLASGOW: W. A. C. Smith Ltd, 93 Hain Street, 216 Argyle Street
- IRELAND.**
- BELFAST: R. & S. Scott, Kingsdown Wellington Place
- DUBLIN: Davis & Hempstead, 17 Safford St.
- CANADIAN OFFICES.**  
 171 King Street West, Toronto
- SERVICE DEPOTS IN ALL LOCALITIES

# No More Wireless Masts

UTILITY ENDORSED BY THE EDITOR OF "WIRELESS WEEKLY."



OUR HIGH GRADE RUBBER COVERED TELEPHONE CABLE GIVES WONDERFUL RESULTS AS AN AERIAL INDOORS AND OUT, AND IS GUARANTEED TO HAVE PASSED THE BRITISH GOVERNMENT TEST FOR INSULATION, BREAKING STRAIN AND CONDUCTOR RESISTANCE.

## WIRELESS MASTS AND INSULATORS ABOLISHED.

The simplicity in erection is beyond the dreams of all wireless enthusiasts, as the troublesome insulators are absolutely unnecessary. Suspend this wire where you will, lead in, and your result is there.

It is a simple matter to make a portable aerial from this wire or to run a lead-in from the house to the garden, whether it is a few yards or half a mile.

Ideal for telephone work all over the world.

**Wire It Right, Electron Less Expensive, Satisfaction Secured.**



**WIRELESS** wire for the wireless to-day, it need not cost you much. Right stuff is required they say; Electron is safe as such. Less costly wire cannot be found; expensive is always at hand. Satisfaction, smiles and saving abound, secured by procuring our brand.

**AERIAL.**

**1/8**

100 feet.

POST PAID ANYWHERE.

Supplied in 3 Thicknesses.		Special terms to the Trade.	
<b>Class 0</b>	1/4 mile drums (Thin for light work)	<b>15/-</b>	} Per drum Carriage forward.
<b>Class 1</b>	1 mile drums (medium for most jobs)	<b>35/-</b>	
<b>Class 2</b>	2 mile drums (Thickest for heavier work)	<b>70/-</b>	
Orders for 6 miles assorted (if required) carriage paid.			
Smaller Quantities of Class 1 (medium) sent carriage paid.			
100 feet	1/8	500 feet	6/3
(Sufficient for the finest AERIAL.)		Carriage Paid.	
		1,000 feet	10/3

**NEW LONDON ELECTRON WORKS LTD.,**  
65, REGENT'S DOCK, LIMEHOUSE, E.14.  
Telephone: East 1821. Telegrams: "Stannum, Step, London."

# SIEMENS

## DRY CELLS & BATTERIES

FOR ALL PURPOSES.

Whatever the purpose for which you require a dry cell or battery use one bearing this trade mark.



The prices are reasonable and the name is a guarantee of quality and good service.

It pays to be discriminating in your choice of a **DRY BATTERY.**

## SIEMENS BROTHERS & Co. Ltd.

**WOOLWICH, LONDON, S.E. 18.**

Telegrams—Siemens, Woolwich. Telephone—City 6400

STOCKS HELD AT  
 BELFAST—36, Mill St. BIRMINGHAM—111, New St. BRISTOL—30, Bridge St. CARDIFF—57-59, St. Mary St. DUBLIN (Irish Free State)—52, William St. GLASGOW—40, Wellington St. & 144, St. Vincent St. LEEDS—129, Park Lane. LIVERPOOL—81, Dale St. LONDON—38-39, Upper Thames St. MANCHESTER—196, Deansgate. NEWCASTLE-ON-TYNE—64-68, Collingwood Bldgs., & Exchange Bldgs., Quayside. SHEFFIELD—22, High St. SOUTHAMPTON—46, High St.

**A** MPLION RECEIVERS are designed and produced by the world's original and largest manufacturers of Loud-speaking Telephones. First demonstrated in 1887, commercially introduced in 1893, adopted by the British Admiralty in 1894, and by Foreign Governments and the leading Steamship Lines in the following years, no less than 12,000 vessels were fitted with Graham's instruments by the end of the year 1919, besides installations in numerous power stations and for other purposes. To-day the number of Graham Loud-speakers in use exceeds that of all other makes combined.

More Loud-speakers than ever are now produced in the Graham Factories or under licence, and in the Wireless field the Graham Amplion represents the utmost technical efficiency and unequalled commercial value.

Ask for Folder "W.W."

**ALFRED GRAHAM & CO.** ST. ANDREW'S WORKS,  
Crofton Park, LONDON, S.E.4

'Phone : Sydenham 2820-1-2. 'Grams : "Navalhada, Catgreen, London."

**Demonstrations  
at our  
Showroom**

The Algraphone Salon,  
25-26, Savile Row,  
Regent Street,  
London, W.1

'Phone : Regent 1075.



# AMPLION

The World's

Standard

## Wates Batteries Will Improve Your Reception.

Pyramid High Tension Batteries will enable you to tune in a little louder and clearer than you have been able to previously, due to their steady, noiseless, consistent power and long life.

They are the results of 40 years' manufacturing experience.

The Ideal Valve Accumulator is built of the finest materials with extra stout plates enclosed in a thick glass case, and has proved itself to be without rival for valve work.

Always look for the trade marks. They ensure Efficiency, Long Life and Reliability.

Your Local Dealer will supply, or send direct to the manufacturers.

Send for lists of our complete Wireless Sets (Crystal or Valve) and all component parts.

**WATES BROS.,**  
13-14, Great Queen St., London, W.C.2.

'Phone : Gerrard 575-6. 'Grams : Zywateseng, Westcent.

*Wates Bros*  
**PYRAMID**

**"PYRAMID" HIGH TENSION BATTERIES.**

are the result of forty years of experience in the manufacture of Dry Batteries.

**PRICES.**

15 volts	3/6
36 volts	7/6
66 volts	12/6

All above are supplied complete with two wander plugs, being variable—tapped at each 3 volts.



*Wates Bros*  
**IDEAL**

**"IDEAL" VALVE ACCUMULATORS**

are stoutly made of the finest materials, with thick glass case. Numerous letters have been received giving remarkable evidence of long life and reliability.

Prices : Complete in wooden case with leather strap handle.  
4 volt 50 amp. 24/- (Carriage 2/-). 6 volt 50 amp. 35/- (Carriage 3/-)  
Prices of other size Batteries on application.



**AN APOLOGY**

We regret that in our Advertisement in last week's issue of Wireless Weekly, the price of the 6 volt Ideal Accumulator was stated as 24/-. This should have been 35/-.

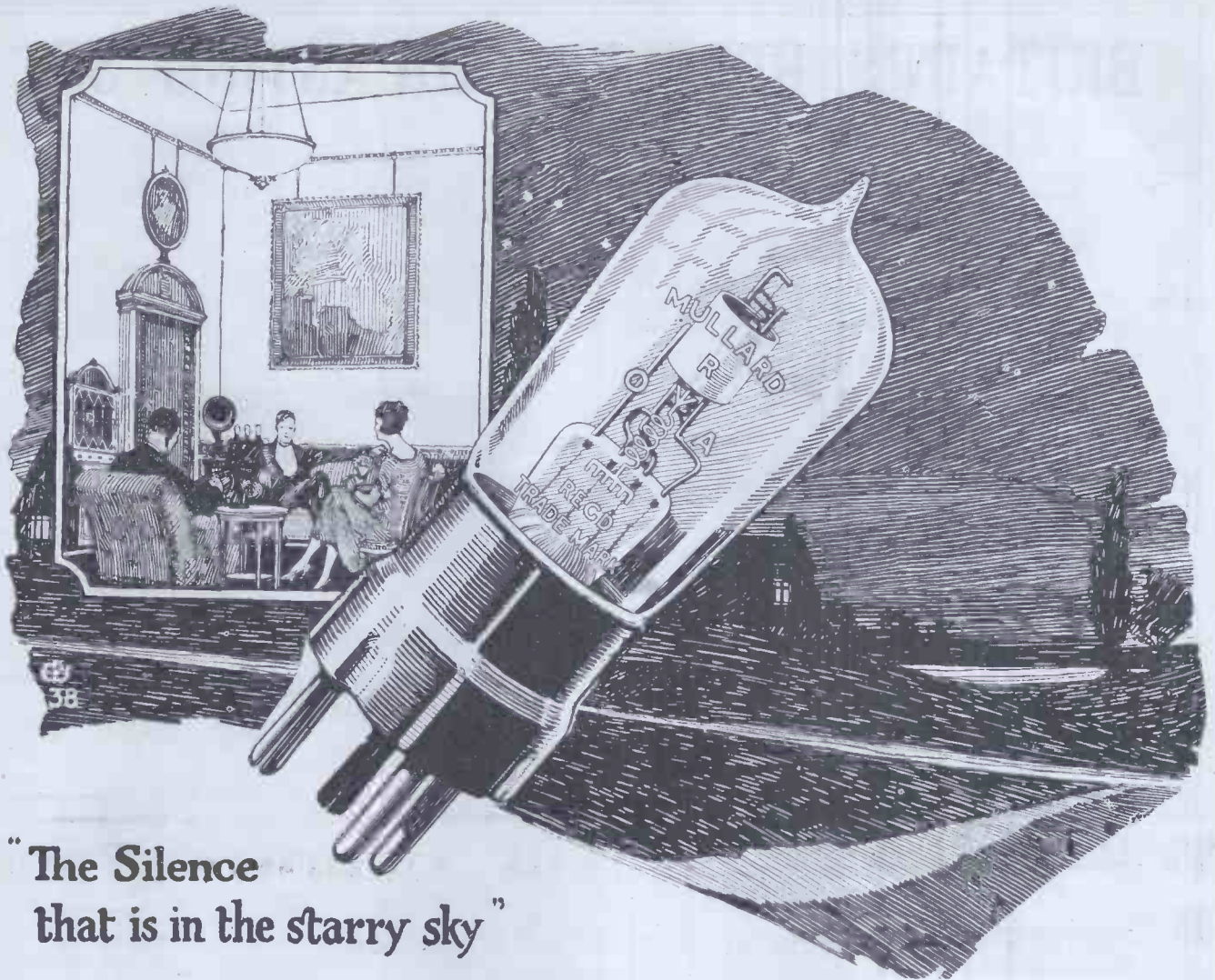

"The Silence that is in the starry sky"



HE human ear can only detect from 12-33,000 vibrations per second. A Valve translates up to 1,000,000 vibrations per second.

**TURNING SILENCE INTO SOUND.**

Good Listening requires a perfect ear. Good "Listening-in" requires a perfect valve. That means a

**MULLARD.**

Obtainable from all the best Electricians, Wireless Dealers, etc.

*Advt. of The Mullard Radio Valve Co., Ltd., Balham, S.W.12.*



MULLARD "R" VALVE. **REDUCED PRICE:** 15/-

Get MORE business by advertising in WIRELESS WEEKLY.

# BRITAIN'S BEST BROADCASTING SET



THE remarkably fine results obtained by thousands of GECOPHONE users throughout the country have earned for this Receiving Set a reputation second to none.

The vast research and manufacturing experience of The General Electric Co., Ltd., is reflected in the workmanship of the GECOPHONE, which has set a standard of efficiency unequalled by any other Receiving Set.



## GECOPHONE CRYSTAL SET No. 1

Complete with one set double headphones and aerial equipment. Approx. range 25 miles. Price complete - £5 10 0

## GECOPHONE CRYSTAL SET No. 2

Complete with one set double headphones and aerial equipment. Approx. range 30 miles. Price complete - £9 15 0

## GECOPHONE 2-VALVE SET

A mahogany cabinet set, complete with valves, all batteries and one set double headphones. Approx. range 100 miles. Price complete - £25 0 0

# GECOPHONE

## "LISTENING-IN" SETS

Sold by principal Electricians, Stores, Wireless and Musical Dealers

Sole Selling Agents for the Music Traders in Great Britain and Ireland; Columbia Graphophone Co., Ltd.,  
102-108, Clerkenwell Road, E.C.

(Manufacturers and Wholesale)

THE GENERAL ELECTRIC Co., Ltd.,  
Head Office: Magnet House,  
Kingsway, London, W.C.2.



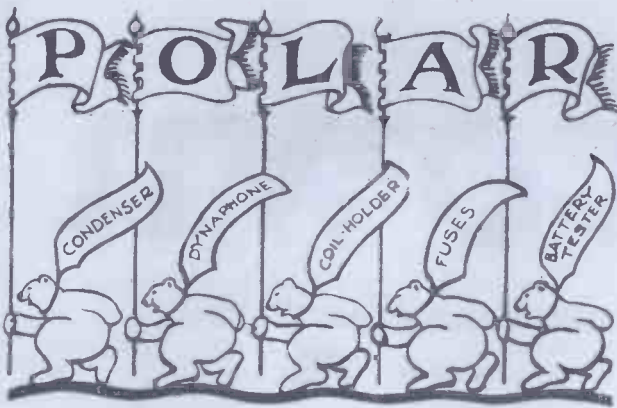

## The FOREMOST FIVE

The little things that make the big difference to your set—Polar Guaranteed Accessories—can now be purchased in most parts of the country. Look for the Wireless Dealer who displays the POLAR STOCKIST sign—he is the friendly fellow who will give you sincere advice, and sell you nothing but what he can GUARANTEE as satisfactory and sound. What do YOU need out of the following Polar Accessories?

### POLAR BATTERY TESTER

Fitted with 4½ volt bulb for testing individual units of H.T. Batteries. Spare bulbs 2½ volts can be supplied for testing L.T. Batteries. Price with bulb 3/-, spare bulb 6d.

### POLAR DYNAPHONE

The only receiver which CAN reproduce Music and Speech without the distortion present in all usual types of purely magnetic headsets. Selling in hundreds, at 24/-

### POLAR CONDENSER

Universally accepted as the super tuning unit, the Polar Condenser has as yet no competitor for accuracy, variability and compactness.

"POLAR" Condensers (3 Capacities) .001 } Unmounted 14/-  
 and  
 .003 } Mounted .. 20/-  
 .005 } Postage .. 6d.

### POLAR CAM VERNIER COIL HOLDER

Another Polar accessory which tends to make tuning a simple and exact matter.

"POLAR" Cam Vernier 2 Coil Panel Mounting .. 13/-  
 " " " 3 " " .. 20/-  
 " " " 2 " Mounted " .. 22/-  
 " " " 3 " " .. 29/6

### POLAR FUSES & FUSE HOLDERS

The most secure insurance policy you could possibly take out for the protection of your valve filaments costs you only 7d. per valve—the price of a Polar Fuse. Postage costs 1½d. up to 12 fuses. Polar Fuse Holders, mounted, 2/- each, Panel Mounting, 1/6.

Obtain these accessories from your local Polar Stockist, or direct from

**RADIO COMMUNICATION CO., LTD.,**  
 34-35, NORFOLK STREET, STRAND, W.C.2.

Telephone: Central 8480 (3 lines). Telegrams: Radiocomco-Estrand, London.  
 BRANCHES: NEWCASTLE—17, Sandhill, and 23, Collingwood St. CARDIFF—Atlas Chambers, James St. WARRINGTON—105, Bridge St. GLASGOW—125, Hope St. ABERDEEN—9, Hadden St. LIVERPOOL—67, Dale St. SOUTHAMPTON—19, Queen's Terrace.

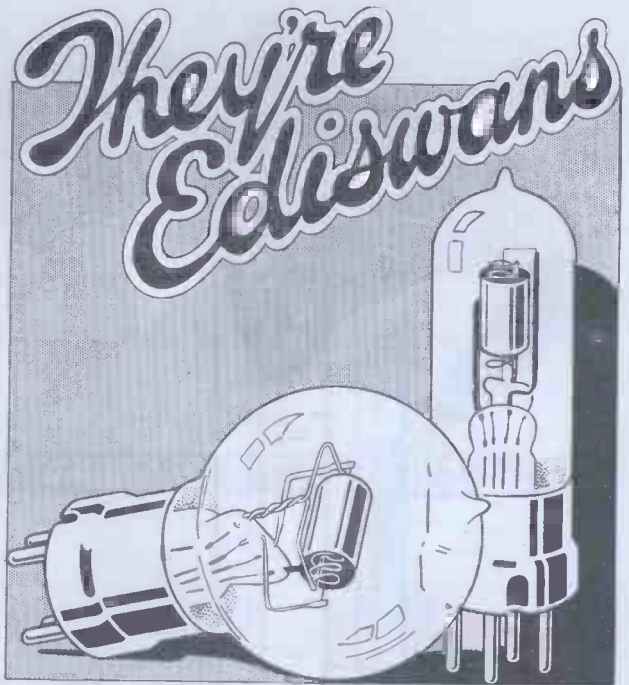

and that's all you need know—because 'EDISWAN' means the best valve

REDUCED PRICES.



TYPE "R"	TYPE "A.R."
15/-	15/-
COMPACT ECONOMICAL RELIABLE	SENSITIVE SILENT ROBUST

New Low Temperature. (Dull Emitter)

**EDISWAN VALVE**  
 TYPE "A.R.D.E."  
 27/-

Filament Volts ..	1.8—2.0
Current ..	.30
Anode Volts ..	20—50
Bulb diameter ..	29 mm.
Overall length, including pins, ..	110 mm. max.
Cap, standard 4-pin. Do not put more than 2 volts across the filament.	

Eminently suitable for reflex circuits.

Buy the valve with a name behind it.

We also manufacture Complete Receiving Sets and Accessories, also H.T. and L.T. Batteries. Ask or write for leaflets. Your Dealer holds stocks to supply you — if not write us direct and give his name and address—a postcard will do. FREE ON REQUEST. Write now for our Free copy of Illustrated Booklet "The Thermionic Valve."

**EDISON SWAN ELECTRIC CO., Ltd.,**

Contractors to H.M. Admiralty, War Office, Royal Air Force,  
 123/125, Queen Victoria Street, E.C.4, and 71, Victoria Street, S.W.1.

Works: Ponders End, Middlesex.

Branches in all principal towns.





# Brown

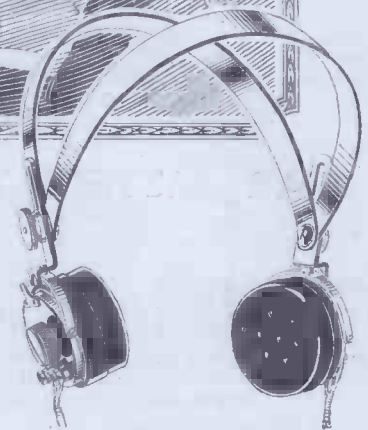
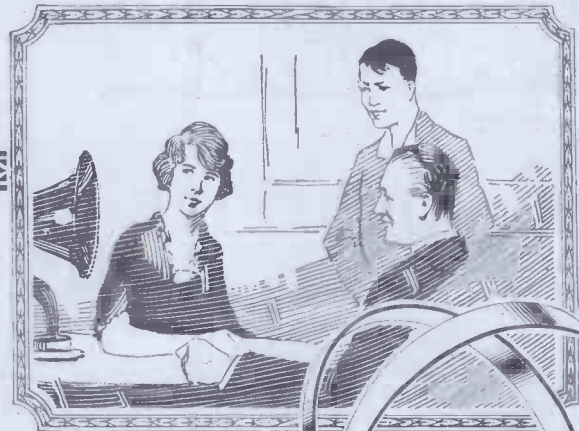

## Distortion impossible

—the centre pull on the conical aluminium diaphragm prevents it.

The same unique principle which has brought world wide fame to the BROWN A type Headphone, is employed in the BROWN Loud Speaker.

Shorn of technicalities its basic feature lies in the use of a conical aluminium diaphragm to the centre of which is attached the end of a vibratory reed.

This reed is attracted by the pole pieces of the permanent magnet in much the same way as the ordinary flat diaphragm of a telephone.

Just as in the sound box of a gramophone the end of the stylus is secured to the centre of the mica diaphragm, so in the BROWN

exactly the same well-proved principle is used.

Any Loud Speaker using the ordinary telephone method of a flat diaphragm must distort because it is attracted in two positions by each pole of the magnet.

Further, owing to the extreme thinness of its aluminium diaphragm, the BROWN is infinitely more sensitive to the tone gradations of speech and music it is called upon to reproduce.

Remember this, a good Loud Speaker is an investment which will give your friends much pleasure —why not buy a BROWN and make sure of having the best from the first?

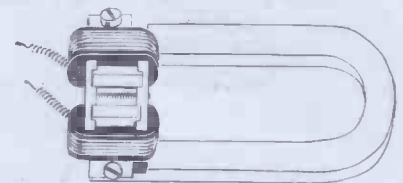

Showing laminated pole pieces and coils from Brown Loud Speaker type H.1.



Here is the vibratory reed which is attracted by the poles of the magnet shown above.



To the end of the reed is secured the centre of this aluminium diaphragm. Although extremely thin to obtain wonderful sensitiveness, its method of construction ensures great strength.

### PRICES.

Model H.1 21" high.		Model H.2 12" high.	
120 ohms	£5 5 0	120 ohms	£2 5 0
2000 ohms	£5 8 0	2000 ohms	£2 8 0
4000 ohms	£5 10 0	4000 ohms	£2 10 0

**S. G. Brown Ltd.,**

Retail: 19, Mortimer St., W.1.  
Wholesale: Victoria Rd., N. Acton.  
W.3.

For any type or make  
of Receiving Set . .



**Ships**  
—Cut them out!



**Commercial  
Stations**  
—Cut them out!



**Your local  
B.B.C. Station**  
—Cut it out!

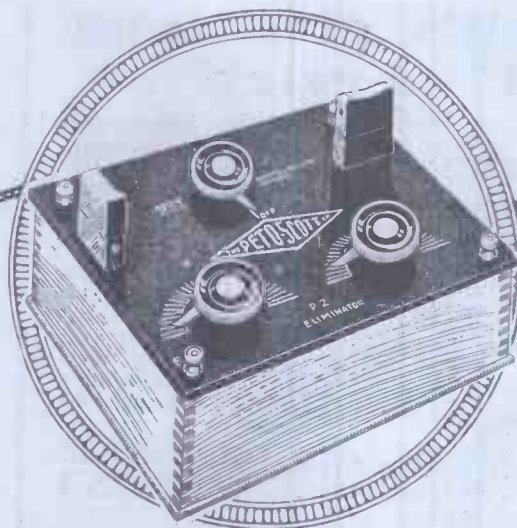

## P.2 ELIMINATOR

*Pat. applied for.*

—the wonder Instrument which  
cuts out every Station except the  
one you actually want.

**A**T last that bugbear of Wireless—interference—has been conquered. Here is an Instrument which you can add to any Set which will definitely *balance out* the signals from any Station which has been troubling you in the past.

No matter whether you are living on the sea coast, you can cut out ship talk—even if you are in sight of 2LO you can cut it right out with the greatest of ease—if you have been troubled by the harmonics of Leafield you can silence them—all by means of this new *P.2 Eliminator* and a little practice in handling it.

This new Instrument is going to make Broadcasting possible for thousands of unfortunate would-be wireless folk who live in neighbourhoods where interference is rife.

For all wavelengths up to 600 metres it is self-contained, and for higher wavelengths ordinary plug-in Coils are used in addition.

A four-way switch enables you to:

1. Cut out interference immediately below the station you want.
2. Eliminate interference immediately above.
3. Neutralise Stations working above and below simultaneously.

No other Instrument can do all this. To get the utmost enjoyment from your Set you must have a *P.2 Eliminator*.

Manufactured and sold only by—

**PETO-SCOTT CO. LTD.**

Head Office:  
64, High Holborn, W.C.1.

Branches:  
99, High Holborn, W.C.1.  
3, Wellington St., Strand, W.C.2.  
4, Manchester Street, Liverpool

**63/-**

Carriage Paid

40 page Catalogue  
cramped with illustrations—most useful. 4d. post free.



Gilbert Ad.

Get **MORE** business by advertising in WIRELESS WEEKLY.

# Norwell's give long "smart" service

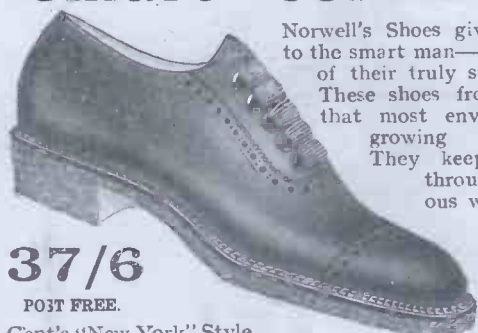

Norwell's Shoes give long service to the smart man—the surest proof of their truly splendid quality. These shoes from Perth have that most enviable knack of growing old smartly. They keep their shape through most strenuous wear, giving perfect comfort and fullest support from the first time on to the last.

**37/6**

POST FREE.

Gent's "New York" Style G 20. A new Brogue made up on one of the latest American lasts. Cut from finest grade leather with leather lined back quarter. Black or Brown. Fitted with Crepe Rubber soles and heels.

**GUARANTEE.**  
Money refunded in full if there should be the least dissatisfaction.

Single shoe sent on approval anywhere in Great Britain on receipt of gd. to cover postage.

When ordering send a pencil outline of the stockinged foot obtained by running pencil around foot resting lightly on paper. Perfect fit assured.

## Norwell's Perth Brogues

"Direct from Scotland."

Orders from abroad receive special attention; postage abroad extra.

Write for free illustrated Catalogue, mentioning "Wireless Weekly," to

**NORWELL'S 'PERTH' FOOTWEAR LTD.,**  
PERTH, SCOTLAND. ©W.6

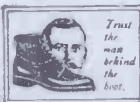

## 25% Reduction in Price

owing to increased output caused by enormous demand.

"FILTRON" Variable Grid Leak (Patd.).

Price was 5/- NOW 4/- each.

(Zero on outer Grooves.)

Approximate Calibration with H Graphite.

Degree Rotation	0°	90°	180°	270°	360°	540°	720°	1080°	1170°
Megohms Resistance	∞01	.4	.8	1.2	1.6	3.2	4.1	7.6	10.7

Harder Graphites increase and Softer Graphites decrease these readings proportionately. This device has proved thoroughly efficient in every application to Radio Circuits which necessitate a Variable High Ohmic Resistance of Precision.

"FILTRON" COMBINATION (Patd.).

Price was 10/- NOW 7/6 each.

This instrument consists of a combined:—  
**VARIABLE GRID LEAK**

(Providing Resistance from Zero to 7 Megohms approx.)

**VARIABLE GRID CONDENSER**

(Providing Capacity from Zero to .0007 mfd. approx.)

The Variable Grid Leak is described above. The Variable Condenser which has been embodied in the "FILTRON" is of great importance as it ensures the highest degree of efficiency in both

Valve Amplification and Rectification.

"S AT.C-RSTER" (Regd. Design).

Price was 3/6 NOW 2/9 each.

Our "STATIC-RSTER" ensures perfect safety to all Wireless Receiving Apparatus whether in operation or not. This protector may be fitted to any set in two minutes.

Obtainable from all dealers or direct from the Sole Manufacturers and Patentees. Cheques and Postal Orders to be crossed & Co. and made payable to:—

## RADIO SPECIALITIES,

57a, Denbigh St., Pimlico, S.W.1.

Phone: Victoria 6463.

(GENEROUS TRADE TERMS.)

## SWITCHES

are indispensable. Fit the best and neatest anti-capacity switches yet offered.

No. 1. Series-Parallel and Earthing Switch.

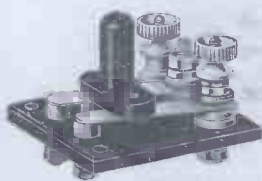

No. 2. Tune-Stand by Switch.

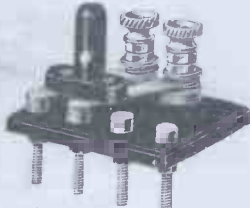

Actual size 2" x 1 1/4".

The HARROLD Series-Parallel, and D.P.D.T. Switches have been most carefully designed, are beautifully made, tested and guaranteed. They replace the ugly and cumbersome knife switches for every purpose, and are an ornament to any panel.

HARROLD Switches may be used effectively in any circuit where switches are desired. We will, on application, supply free a sheet of switching diagrams giving full and clear details of connections for any switching or cut-out operation where HARROLD Switches can be used. Write us for free advice on your switching problems.

Prices of HARROLD Switches.

- |   |           |            |
|---|-----------|------------|
| No. 1. Series-Parallel and Earthing Switch          | 5/- each. | Post free. |
| No. 2. Tune-Stand by Switch                         | 4/- "     |            |
| No. 3. Reaction Reverse and General Circuit Cut-out | 4/- "     |            |

Made only by:—

**THE HARROLD MANUFACTURING CO., LTD.,**  
246a, Corporation Street, BIRMINGHAM.

TRADE QUOTATIONS ON APPLICATION.

# MICA

CONDENSER PLATES

AND

INSULATING MATERIALS OF EVERY DESCRIPTION.

**MICA & MICANITE SUPPLIES, Ltd.,**

MICA HOUSE, OFFORD STREET, CALEDONIAN RD., LONDON, N.1

Phone North 805.

## Wickens' Wireless Message Recorder

A new book for the Experimenter. It contains a large number of blank leaves with such printed headings as:—Inventory of Receiving Set, Wireless Library, Inventory of Workshop, Material and parts in stock, Memo of Circuits, etc., Wireless Message Records, Technical classified pages for press cuttings, etc., together with a copy of the Morse Code on fold-over sheet. An exceedingly useful Book for any Wireless enthusiast.

Postage 3d. extra.

**2/6**

**RADIO PRESS, Ltd.,**  
Devereux Court, STRAND, W.C.2

Direct orders only accepted.



# FELLOWS

## AMUSEMENT ALWAYS.

Wherever you are, under whatever conditions, the Fellows Super 2-Valve Set will bring the real pleasures of good entertainment produced in the best possible form to your door.

A 2-valve Set of superior quality mounted in a highly-finished case, that will receive any British or Continental Telephony even though the nearest Broadcasting station is working.

PRICE: COMPLETE WITH H.T. BATTERY, ACCUMULATOR, 100 ft. 7/22 STRANDED COPPER WIRE, 2 INSULATORS, 1 pair 4,000 ohms HEADPHONES.

**£15**

plus B.B.C. tax, £1 15s.; Marconi tax, £1 5s.; and 2 valves.

A new 2-valve amplifier mounted in cabinet uniform with super 2 set, £6, plus B.B.C. tax, £1, plus 2 valves, FELLOWS MAGNETO Co., Ltd., LONDON, N.W.10.

Telephone: Willesden, 1590-1.

Telegrams: "Quizmag" Phone, London.

PS  
16



## EQUIPMENT FOR EXPERIMENTERS

### PETTY ASSEMBLY.

The keen experimenter has little time for the petty assembly of necessary parts. They involve wasted time and never look neat.

Study the various WEBBER PRODUCTIONS. They are supremely neat, compact and economical. The WEBBER TUNED ANODE UNIT W71 is illustrated. With the insertion of a standard coil this unit is ready for tuned anode circuits. The coil is wired in parallel with a POLAR .0003 mfd. variable condenser and the Plate and H.T. positive terminals are clearly marked. All other connections are made. A reaction coil can be coupled with the anode coil at the back of panel.



W 71

PRICE 23/6

The Webber Tuning Aerial Unit as above with the addition of fixed condenser and series-parallel switch.

PRICE 27/6

Write for descriptive list of all WEBBER EXPERIMENTAL EQUIPMENT post free.

**N. V. WEBBER, Radio Engineer,**  
WALTON HOUSE, WALTON-on-THAMES,  
SURREY. ARKS 1

## BUTTLO NINE-FOUR HIGH-FREQUENCY PIN TRANSFORMER.

RANGE 120-4,600. REQUIRING NO TUNING CONDENSER.

**27/6** POSTAGE FREE FOR CASH WITH ORDER, UNITED KINGDOM.

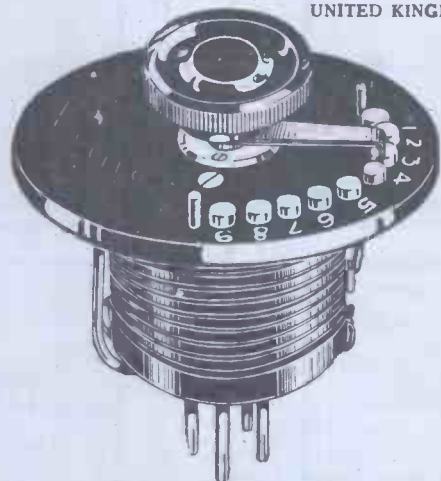

FOUR STAGE. SIMILAR DESIGN. RANGE 120-2,600 metres REQUIRING .0002 TUNING CONDENSER.

**18/-** POSTAGE FREE FOR CASH WITH ORDER, U.K.

NEW FULLY ILLUSTRATED LISTS, POST FREE 6d.  
**H. D. BUTLER & CO., LTD.,** Barclays Bank Bldgs,  
222, Great Dover Street, Borough, London, S.E.1.

Telephone: Hop 3029.

5 minutes from LONDON BRIDGE.

# Cosser

— the Research Director explains the reasons for Cosser superiority

“YOU know, of course, that when the Filament of any Valve is glowing that it is giving off a constant stream of electrons.

“These electrons travel in every direction away from the whole length of the Filament and not from just merely a portion of it. It is the object of the Anode (or Plate) to catch these electrons—or as many of them as travel past the Grid.

“Now in the ordinary tubular Anode, it must be obvious to you that a very considerable portion of the electron stream escapes out of each end without touching the Anode at all. These electrons being put to no use lower the efficiency of the Valve very considerably.

“But observe what happens inside a Cosser. Here we have an arched filament almost completely enshrouded by a hood-shaped Grid and Anode. The emission from the filament—travelling in every direction—is success-

fully trapped, first by the Grid and secondly by the Anode. Practically no portion can escape to the sides of the glass.

“Here, then, is the secret of the wonderful success of the Cosser Valve. Other exclusive features are responsible for its high amplification factor, its lack of distortion and its absence of micro-phonous noises—but space does not permit me to explain these to-day.”

**TYPES:**

- P.1 (Detector or Note Magnifier)
- P.2 with red top (High Frequency)

**15/-**  
Retail.

From all Dealers.



**COSSOR VALVE Co., LTD.,**  
HIGHBURY GROVE, N.5.

Gilbert Ad.

**YOU** can have this service by sending to-day for our lists.

A Club Secretary writes:—  
..... I consider it all to the benefit of the members to know of your firm. I personally have always been struck with the quality of your goods, and the promptitude of your service . . .

**ELECTRICAL SUPPLY STORES,**  
Wireless Specialists,  
11, FOUNTAIN STREET, HALIFAX.  
Telegrams: Terminals Hx.

## ELECTRADIX RADIO SERVICE.

When you are tired of adverts of Condenser bits and foreign phones read this.

- WAVEMETERS 200 in stock, all ranges from £4. MILLI-AMMETERS for Grid control 35/-.
- VOLTMETERS 500 in stock from 3 Volts to 2500 v.
- DYNAMOS charging £3 10, H.T. £10.
- NEW MORSE RECORDERS, cost £50, for £5.
- CABINETS EBONITE PANELS 10/-.
- TESTING SETS £12.
- BUZZERS 2/6.
- NEWTON ALTERNATORS £5.
- 5000 volt TRANSFORMERS £10.
- VALVE TRANSMITTING SETS complete £7 10.

Thousands of other goods to the Experimenter in stock. See detailed advertisement in "Wireless World," or send 3d. stamp for special catalogue.

**LESLIE DIXON & Co., 9, Colonial Ave., Minories, E.1.**

Near Aldgate Station. It will pay you to call and view goods.

## The Other Wireless Men say these nice things about The Bowyer-Lowe Variometer

"It is mechanically and electrically sound."  
"It is eminently fitted for the purpose indicated."  
"Materials—excellent; Finish—of the best."  
"It is stoutly made and well finished."  
"It tunes on a 30' aerial from 230 to 450 metres and on a twin 40' aerial from 340 to 680 metres."

"It does not fail to bear out the promise of its appearance."  
"It does perform actually and efficiently the duties for which it is constructed."  
"Efficiency as shown by signal strength on Broadcast transmission with crystal detector alone is as high as that of any commercial tuning device we have tested."

**This is experience worth acting upon. Be certain you use The Bowyer-Lowe Variometer.**

"Can be recommended with confidence as a thoroughly sound and efficient tuning device, either for B.B.C. crystal or for more elaborate sets."

- No. 1 — for AERIAL TUNING.
- No. 2 — for TUNED ANODE COUPLING.

Price 17/6; post free 18/-.  
Obtainable from all Wireless Dealers.

### The Bowyer-Lowe Co., Ltd.,

Manufacturers and Suppliers of High-grade Wireless and Scientific Instruments,

The Radio Works, Commerce Avenue, Letchworth, Herts.

Telephone: Letchworth 246.  
Telegrams: "Bowyer-Lowe Co., Letchworth."



Wholesale Distributor for Scotland:  
F. M. MILLIGAN, 23-25, Renfrew Street, GLASGOW.

# FREE

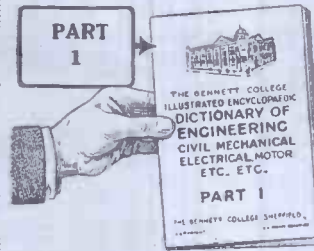

To extend the name of the Bennett College to everyone engaged in the different branches of Engineering, we are publishing an Illustrated Dictionary of Engineering, in about 24 MONTHLY PARTS. You can have each monthly part as it comes out, FREE.

### 1/- Postage only to pay

The Dictionary is free to those engaged in any of the following trades: *Engineering, Civil, Mechanical, Electrical, Structural, Motor, Sanitary, Boiler, Internal Combustion, Draughtsmanship, Marine, Shipbuilding, Naval Architecture, Building, Architecture, Quantity Surveying, Aviation, Chemistry, Foundry Work, Metallurgy, Matriculation, Mining, Surveying and Levelling, Telegraphy, Telephony, Wireless*, and the conditions are that you send your name and address, your age and occupation, with one shilling (to cover postage), writing your name and address very clearly. We shall then place your name on our Free List and send you part 1 at once. The others will be forwarded as issued.

(Do not fail to give the particulars required, and use this full address.)

Department D 133,  
**The Bennett College,  
Sheffield.**

## SCHEFF PUBLICITY ORGANISATION

125, PALL MALL,  
LONDON, S.W. 1,

ARE ADVERTISEMENT MANAGERS

for  
**WIRELESS  
WEEKLY**  
and  
**MODERN  
WIRELESS**

Particulars on application of RATES  
— for both publications —

\*Phone: Regent 2440 (Two Lines).

## ELBE COIL HOLDERS

USE SINGLE COIL HOLDERS FOR MAXIMUM EFFICIENCY. HIGHLY RECOMMENDED.

Ebonite Basket Coil Mounts to plug in above  
2/- each.

Ask your Dealer for them.

LEIGH BROS., Tel: Mus. 4347.  
37 Sidmouth Street & 1a Prospect Terrace,  
Gray's Inn Road, LONDON, W.C. 1.



Price 1/9 each. Post  
5/- Set of three. Free.

## Reduced Advertisement Rates.

During the Summer Months the Publishers of WIRELESS WEEKLY have pleasure in offering REDUCED rates for Display Advertising Space as follows.

### ORDINARY POSITIONS.

13 insertions consecutive - £15 per page and pro rata.  
6 " " " - £15 plus 5% per page and pro rata.  
1 to 5 " " " - £15 plus 10% per page and pro rata.

### NEXT MATTER (In columns only):

13 insertions consecutive - £20 per page and pro rata.  
6 " " " - £20 plus 5% per page and pro rata.  
1 to 5 " " " - £20 plus 10% per page and pro rata.

### SCHEFF PUBLICITY ORGANISATION, LTD.

(Advertisement Managers *Wireless Weekly* and *Modern Wireless*).

125, Pall Mall, London, S.W. 1, Phone—Regent 2440 (2 lines).



# Components of Quality

<b>AERIAL WIRE</b> —Bare, 100ft. .. .. .	s. d.
150ft. .. .. .	3 3
.. .. .	4 9
<b>BRASS LAMINATED SWITCH ARMS</b> (laminations similar to W.D. type) ..	2 9
<b>COIL HOLDERS</b> , best quality, 2 Coil ..	10 0
3 Coil ..	14 6
<b>COILS</b> (Tingey Patent) .. .. .	Write for details.
<b>COILS</b> (Igranic plug-in):—	
L.50. 240-730 metres .. .. .	5 2
L.75. 330-1030 metres .. .. .	5 6
L.100. 450-1460 metres .. .. .	7 0
etc.	
<b>CONDENSERS</b> , fixed:—	
'0001-'0009 .. .. .	2 6
'001-'005 .. .. .	3 0
1 mf. New .. .. .	4 6
2 mf. .. .. .	4 9
<b>CONDENSERS</b> , for panel mounting:—	
'001 .. .. .	10 6
'0005 .. .. .	6 9
'0002 .. .. .	4 6
'00005 .. .. .	3 3

<b>CONDENSERS</b> , sets of parts:—	s. d.
'001 .. .. .	9 0
'0005 .. .. .	5 6
'0002 .. .. .	3 6
'00005 .. .. .	2 3
<b>CONDENSERS</b> , Polar, '001 .. .. .	14 3
<b>CONDENSER VANES</b> , special slip-in type .. .. .	per pair 2
<b>CONTACT STUDS</b> , with nuts and washers .. .. .	per doz. 11
<b>CRYSTALS</b> , Hertzite .. .. .	1s. and 1s. 3d.
<b>DEWAR SWITCHES</b> (ex-Government) ..	4 0
<b>FILAMENT RESISTANCES</b> on Erinoid Former .. .. .	3 0
<b>EBONITE</b> , lin., per square inch .. .. .	per doz. 4 9
.. .. . special matt. .. .. .	4 9
<b>ELIMINATOR</b> , Tingey, Interference ..	£1 12 6
<b>GRID LEAKS</b> and Anode Resistances, any value, own make .. .. .	2 0

<b>HEADPHONES</b> —Brown's, G.E.C., Sterling.	List prices.
<b>INSULATORS</b> , Shell .. .. .	s. d. 9
Keystone .. .. .	6
<b>SWITCHES</b> , Brass, D.P.C.O., Mark III type, for panel mounting .. .. .	2 0
<b>SYSTOFLEX TUBING</b> .. .. .	per yd. 5
<b>TERMINALS</b> , with two nuts .. .. .	per doz. 2 6
<b>TELEPHONE TRANSFORMERS</b> for 120 ohm phones, own make .. .. .	12 0
<b>VALVE LEGS</b> , with nuts and washers ..	per doz. 1 3
<b>VALVE HOLDERS</b> , with flange, with washers and nuts .. .. .	10
<b>VALVE HOLDERS</b> , fitted with 4 terminals, G.P.F. plugs and minus .. .. .	2 6
<b>WAVEMETERS</b> , new, 150-600 metres ..	£4 4 0
<b>WIRE</b> , cotton and silk, all grades.	

POSTAGE EXTRA.

We manufacture Valve Sets—1, 2, 3, 4 and 5 Valves, also an excellent Crystal Set. Send for our new Components LIST—free on request.

—please mention "Wireless Weekly."

Offices and Showrooms:

Phone: Hammersmith 1916. **92, QUEEN ST., HAMMERSMITH, LONDON, W.6** Grams: "Tingoidar, London."

## STOP THE GLARE.

Fit THERMIC ANTI-GLARE VALVE CAPS. (Prov. Patent.)

Converts a tiring glare into a pleasant subdued glow. Protects the sight; lasts indefinitely; the cost is insignificant. 1/- post free.

**THE THERMIC MANUFACTURING CO.,**  
46, HAMPTON ROAD, SOUTHPORT.

Radio Press  
Information Department

## QUERY COUPON

WIRELESS WEEKLY. Vol. 2. No. 8. Sept. 5, 1923

(This coupon must be accompanied by a postal order of 1/- for each question, and a stamped addressed envelope.)

## Wireless Weekly

### SMALL ADVERTISEMENTS.

PREPAID Advertisements are accepted under this heading for Wireless Apparatus and Parts WANTED or FOR SALE, etc. at the rate of 1s. 6d. per line, MINIMUM THREE LINES.

Advertisements should reach Scheff Publicity Organisation, 125 Pall Mall, London, S.W.1, LATEST by first post FRIDAY preceding date of publication.

The publishers are not responsible for clerical or printer's errors, but every care is taken to avoid mistakes.

**EXPERIMENTAL** 3-valve panel, boxed (Radio Instruments anode reactance, detecting low frequency) Watmel potentiometer, 50/-; '001 enclosed variable condenser, 15/-; two broadcast plug H.F. transformers, new, 10/-; 6/40 Fuller accumulator, 30/-; 6/60 Exide, 45/-; practically new; oddments. £7 lot. Nash, Crail.

**EXPERIMENTERS:** Don't twist wires round terminals. Be definite; use our plugs and terminal adaptors. Plugs; red, blue, or black insulation, solid brass plunger and socket, 2/6d. a pair. Postage 1½d. The Austin-Ratcliffe Trading Co., Palace Cinema Chambers, Slough.

**GENUINE Philip's Valves.** D11 type fil. 3.5 volts, plate 30-70 volts; 9/8 each. "E" type (especially recommended for S.T. 100) fil. 4 volts, plate 60-100 volts; 10/6 each. Post free, sent at purchaser's risk. Shaftesbury Wireless & Engineering Co. Ltd., St. Stephen's House, Westminster, S.W.1.

**HEADPHONE pads.** Listen-in in comfort, and deaden outside noise. 2/- per pair. From N. Heywood, 386, Richmond Road, Twickenham.

**THEY'RE Good Value.** Pickett's Cabinets, highly polished, 1/6 each. Write for lists (W.L.). Works: Albion Road, Bexley-heath, S.E.

**2/3 tons silk covered and enamelled h.c. copper instrument wire,** fine and coarse gauges: to be sold cheap. J. Reynolds & Co., Metal Merchants, Beech Street, Liverpool.



# QUARTER OF A MILLION SATISFIED CUSTOMERS WIRELESS! WIRELESS! WIRELESS! and EVERYTHING for it. DON'T PAY MORE!

Great Britain's largest  
exclusive Wireless Stores.

**NOTE.** We are exclusively **WIRELESS** — NOT **DABLERS!**  
Quality, Quantity and Consistency our Motto.  
Pioneers of Cheap Prices. See our six-window display of popular bargains.

**SPECIAL OFFER**

## "ELKAY" LIGHTWEIGHT HEADPHONES 12/9 BROWN'S FEATHERWEIGHT 19/6 HEADPHONES

(4000 ohms).

Stamped B.B.C., 4,000 ohms., our price

N. & K. 'PHONES, the genuine article.....	12/9	SWITCH ARMS, 4 laminations, ebonite knob, complete with panel, bush, nuts, and spring washer.....	8/4d.	VARIABLE CONDENSERS of high quality. Vanes and Spacers of aluminium. Complete with knob and dial, guaranteed accurate:	
SIDPE HEADPHONES 4,000 ohms, genuine, our price.....	12/9	FILAMENT RESISTANCES, smooth action, marvellous value.....	1/10	Vernier.....	4/9
THOMSON - HOUSTON HEADPHONES (FRENCH) 4,000 ohms, our price.....	15/3	With engraved dials.....	2/9	'0002.....	5/9
ERICSSON (genuine French 'phones, maker's name embossed) 4,000 ohms. Each pair tested and guaranteed. Don't pay 32/-, our price.....	16/9	STOPS, with nuts..... per doz.	6d.	'0003.....	6/3
MULLARD "ORA" VALVES.....	12/9	VALVE LEGS, nut and washer..... each	1d.	'0005.....	7/-
DUTCH VALVES.....	8/3	VALVE PINS, nut and washer..... each	10d.	'00075.....	8/6
EDISWAN VALVES.....	12/3	PLUNGER SPRINGS, complete..... each	3/1d.	'001.....	9/9
(All Guaranteed New.)		SLIDER ROD, brass, 13ins. long, $\frac{1}{16}$ square, drilled.....	each	EBOHITE CONDENSER KNOB AND DIAL.....	1/9
L.F. TRANSFORMERS Ratio 5 to 1. All guaranteed (postage 1/-).....	11/3	SLIDER KNOB.....	each	SUPER QUALITY 2-WAY COIL HOLDER.....	5/3
CRYSTAL DETECTORS..... 1/9, 1/3 and	10/1d.	SWITCHES ON EBOHITE, S.P.S.T. (quality the best).....	each	REAL EBOHITE 3-WAY COIL HOLDER.....	7/9
CRYSTAL DETECTORS, enclosed in glass case, 2/6, 2/3, 1/6	2/3	SWITCHES ON EBOHITE, S.P.D.T. (quality the best).....	each	FILAMENT COMPLETE CIRCLE RESISTANCE SCALES, 0 to 300.....	each
WATMEL PATTERN GRID LEAK.....	2/3	SWITCHES ON EBOHITE, D.P.D.T. (quality the best).....	each	O.B.A. NUTS..... per doz.	6d.
AERIAL WIRE, 7/22, guaranteed hard-drawn -copper, 100 ft. (postage 1/-).....	1/10	CONDENSER SPINDLES, all sizes in stock, from.....	each	DETECTOR ARMS, Ball Joints, Ebonite Handle and Whisker Holder.....	3/1d.
CONDENSER VANES, fixed or moving, per doz.	3/1d.	SCREWED ROD, 2 B.A., 12ins. long.....	each	WOOD SCREW TERMINALS.....	each
REAL GOLD CAT'S WHISKERS.....	2d.	SCREWED ROD, 4 B.A., 12ins. long.....	each	SHELLAC..... per bot.	10/1d. and 6d.
REAL GOLD CAT'S WHISKERS..... per doz.	1/5	RUBBER-INSULATED LEADING-IN WIRE.....	per yd.	AERIAL PULLEYS each 10/1d., 8/1d., 6d. and 4/1d.	4d.
SILVER CAT'S WHISKERS.....	1d.	CHINA INSULATED SPRING CONNECTORS.....	per yd.	TINFOIL..... large sheet	4d.
SILVER CAT'S WHISKERS..... per doz.	7d.	1 way.....	3d.	COPPER FOIL, 6in. wide.....	per ft.
CONDENSER SCALES, 0 to 180.....	3/1d.	2 way.....	4d.	GRID LEAKS, 2 $\frac{1}{2}$ and 2 meg.....	each
IVORINE LABEL SET, 12 different titles, the set	6/1d.	3 way.....	4d.	FLEX (Twin), various colours.....	per yd.
BATTERIES, 44 volts, best quality.....	each	INSULATORS, white reel, 2in., each 1d. per doz.	11d.	CONNECTING WIRE, tinned copper, 20 gauge 3 yds.	2d.
BASKET COILS, set of 6, up to 3,000 metres.....	2/4	INSULATORS, white egg, each 2d..... per doz.	1/8	ENAMEL WIRE, in $\frac{1}{16}$ , $\frac{1}{8}$ and 1 lb. reels:	
SLEEPING, 3 yds. assorted colours, for.....	11/1d.	WOUND INDUCTION COILS (postage 9d.):		22..... 24..... 26..... 28.....	
NUTS, 2 B.A..... per doz.	2/1d.	12 x 4..... 9 x 4..... 8 x 2 $\frac{1}{2}$ ..... 6 x 3..... 6 x 2.....		per lb. 2/4..... 2/8..... 3/2..... 3/6	
NUTS 4, 5, 6 and 8 B.A..... per doz.	2d.	2/5..... 2/3..... 1/11..... 1/8..... 1/5		Note: Bobbins 2d. each extra.	
WASHERS, 4 B.A..... per doz.	1/1d.	TAPPED INDUCTANCE COILS, 20 tapplings, wound to 1,600 metres.....	each	POTENTIOMETERS, guaranteed up to 900 metres, superior make, compact size.....	7/3
WASHERS, 2 B.A..... per doz.	1/1d.	VARIOMETERS (Tube type), complete with knob.....	3/11 and 2/11	CRYSTAL DETECTOR, glass enclosed, fitted on 4 x 2 ebonite panel with terminals for aerial, earth and 'phones, already wired and beautifully finished.....	4/9
CONTACT STUDS, with nuts and washers, per doz.	4d.	DOUBLE 'PHONE CORDS, full length.....	11/1d.	VALVE HOLDERS..... each 11/1d., 10/1d. and 9/1d.	
TERMINALS with nut and washers, each 1d., 11d. & 2d.	each	HERTZITE, Genuine Large Piece.....	9/1d.	BATTERIES, H.T., dry:	
EBOHITE KNOBS, 2 B.A..... each 11d., 3d. & 4d.	each	TALITE, Genuine Large Piece.....	9/1d.	30 volts, including Wander Plugs.....	5/9
SPACING WASHERS, large..... per doz.	2/1d.	PERMANITE, Genuine Large Piece.....	9/1d.	60 volts, including Wander Plugs.....	9/6
SPACING WASHERS, small..... per doz.	1/1d.	BORNITE, Genuine Large Piece.....	9/1d.	FILAMENT RESISTANCE DIALS.....	9/1d.
CRYSTAL CUPS, 2 screw..... each	1d.	MIXED CRYSTALS (6 kinds).....	9d.	AMALGO-PLASTIC METAL, for fixing crystals. No Woods metal necessary.....	6d.
CRYSTAL CUPS, 4 screw..... each	2d.	CARBORUNDUM.....	5/1d.	GOLD SEAL PLASTIC METAL, for fixing crystals.....	6d.
FIXED CONDENSERS, all capacities..... each	10/1d.	ZINCITE and BORNITE, both in box.....	1/-	IVORINE NAME-PLATES, all readings each	1d.
EBOHITE, cut to any size by machinery while you wait..... per lb.	3/6	COIL PLUGS, real ebonite..... 1/3, 10/1d., and 9/1d.		per doz.	9d.
TELEPHONE TERMINALS, nuts and washer, each 11d..... per doz.	1/3	H.F. PLUG TYPE TRANSFORMER:		EARTH CLIPS, Copper, adjustable..... each	5/1d.
W.O. TERMINALS, nuts and washers, each 2d. per doz.	1/7	1..... 250 to 600 metres.....	3/9	RADIONETTE CRYSTAL SET, complete, stamped B.B.C. and including one pair 4,000 ohms 'phones, 100ft. 7/22 aerial wire, 4 insulators, lead-in tube, 6yds. lead-in insulated wire and adjustable earth clip. Ready to listen-in. Honestly worth 3 gns.....	36/6
PANEL BUSHES, drilled..... each	1/1d.	2..... 350 to 700.....	4/-	RADIONETTE ONE-VALVE L.F. AMPLIFIER for above.....	34/6
TOP CONDENSER, bushes..... each	1d.	3..... 500 to 900.....	4/3	CABINETS, all shapes and sizes in stock from 1/6 each	
BOTTOM CONDENSER, bushes..... each	1d.	4..... 800 to 1350.....	5/6		
BELL WIRE, tinned copper, 12 yds..... per doz.	7d.	5..... 1600 to 3200.....	4/9		
	6d.	6..... 2200 to 5600.....	5/-		

**IMPORTANT NOTICE.** We have repeatedly said **DON'T PAY MORE**, and having served the masses well, the large return of business has made it necessary for us to acquire extensive additional premises adjoining our present address.

Follow the crowd to Elkay Corner.

# "ELKAY" WIRELESS CO.,

225 & 227, BISHOPSGATE, LONDON, E.C.2.

Open Saturday all day. (To the Trade—New Trade Counter now open. Send for NEW LIST.)  
We open Sundays 11 to 2.30. Special Terms to Radio Clubs. Note new Telephone No.: Central 8544.

PLEASE REMIT AMPLE POSTAGE.

**SAVE MONEY BY STUDYING OUR ADVERTS.**

**With the approach of the Autumn**

you will be considering what type of Receiver you are going to build. The various Wireless periodicals are full of brilliant suggestions of such variety that you will probably have some difficulty in making up your mind as to which one to adopt.

**But—**

whatever circuit you finally decide upon, there is one factor which must not be overlooked. No matter how good and how practical the circuit may be, no matter how painstaking you may be in the assembly and general workmanship of your set,

**You will not be satisfied**

unless you incorporate the very best components, of correct values, purchased through a firm with a reputation for first-class quality and efficiency of their apparatus, who are prepared to stand by every article they sell.

**Every article advertised below**

can be explicitly relied upon to give the utmost satisfaction. If you have the slightest cause for complaint or dissatisfaction, we ask you not to hesitate to return the goods at once, and the

**FULL AMOUNT PAID WILL BE REFUNDED**

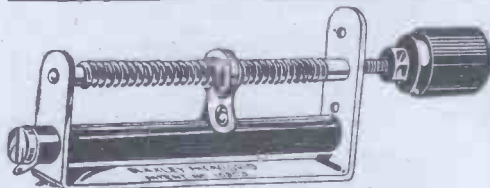

**The "Microgrid" Variable Leak**

Although only recently placed on the market, this Grid Leak is commanding an astounding sale. It has a vernier adjustment and the resistance is unaltered by use or atmospheric conditions. It occupies only 1½ in. by ½ in. on the panel and has a resistance of from 0 to 10 megohms.

Price - - - - 4/6 each

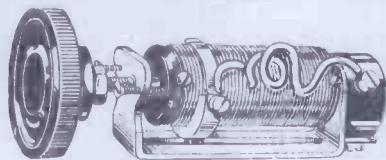

**The "Microswitch" Rheostat**

Vernier adjustment, whereby the adjustment can be regulated to 1/1000th of an inch. By raising the knob, the filament current is broken, leaving the resistance permanently and correctly set. Resistance approx. 4½ ohms.

Price - - - - 6/6 each

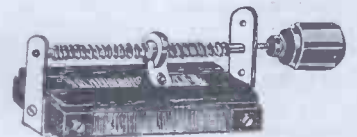

**The "Micro-potentiometer"**

A compact and efficient Potentiometer at a reasonable price. First-class design and workmanship. 500 ohms.

Price - - - - 6/6 each

**Hellesen H.T. Batteries**

Manufactured specially for us by Hellesen's, 15 volts, 4/- 36 volts, 8/6 60 volts, 14/-

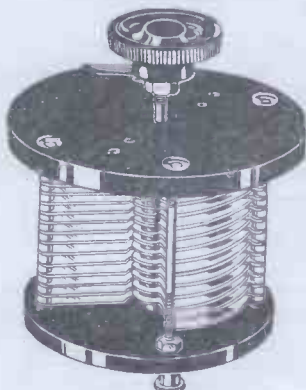
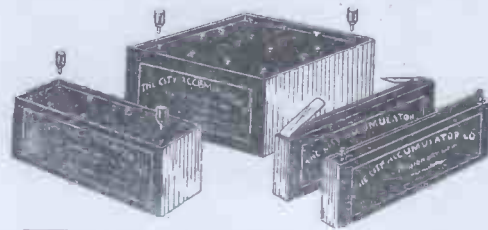

**VARIABLE CONDENSERS**

	0005	001
Best quality	18/6	24/6
Second quality	14/-	17/6
Third quality	8/-	12/6

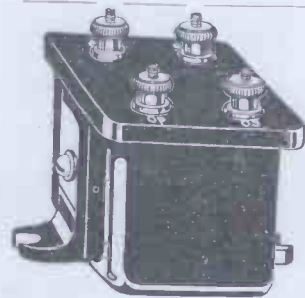

**Interval Transformers.**

**Telephone Transformers.**

Fitted in iron cases which effectively screen surrounding apparatus from stray fields. This is a very important feature. No loose wires or face ends to break, and no tiny screws or nuts in odd corners.

Price - 25/- each

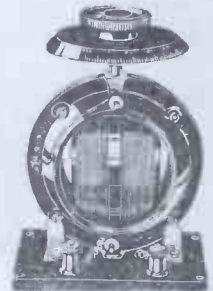

**McClelland Variometer**

Made in three designs:  
 (i) Vertical (as shown).  
 (ii) Horizontal.  
 (iii) For suspension through panel.  
 Fully mounted as indicated, connections made and carried to terminals. 240-750 metres.

Price - - - - 27/6 each

**NOTE** In accordance with our Free Accumulator Offer, recently extensively advertised, with all orders of £5 or over made up from any of the items shown above, we will include, FREE OF CHARGE, a 6-volt 40 ampere hour FULLER BLOCK TYPE ACCUMULATOR value £2 8s. 9d.

**The CITY ACCUMULATOR Co**

79, MARK LANE, LONDON, E.C.3.

'Phone: AVENUE 1316

10, RUPERT STREET, COVENTRY STREET, W.1.

'Phone: GERRARD 3036

Agents (where the free Accumulators may also be obtained):

**LANCASHIRE & CHESHIRE:**

Henry Hollingdrake & Son, Ltd., Princes Street, Stockport.

**S. WALES:** South Wales Wireless Installation Co., Ltd., 18, West Bute Street, Cardiff, and at Cambrian Road, Newport.

**YORKSHIRE (West Riding):** Messrs. H. Wadsworth Sellers & Co., Standard Buildings, Leeds.

**GLOUCESTERSHIRE, SOMERSET & WILTS:**

Bristol Wireless Co., 52, Cotham Hill, Bristol.

**LEICESTERSHIRE:**

Walter Rowe, Ltd., Eldon House, 97, London Road, Leicester.

**FRANCE:** 33, Rue d'Hautville, Paris.

**AUSTRALIA:** 4, Teakle Street, Sutherland Hill, Sydney.



# Radio Press Books give him all the information he needs

## Complete List

	Price.	Post Free
1. Wireless for All . . . . . John Scott-Taggart, F.Inst.P.	-/6	-/7½
2. Simplified Wireless . . . . . John Scott-Taggart, F.Inst.P.	1/-	1/1½
3. How to Make Your Broadcast Receiver . . . . . John Scott-Taggart, F.Inst.P.	1/6	1/7½
4. How to Erect Your Wireless Aerial . . . . . B. Mittell, A.M.I.E.E. . . . .	1/-	1/1½
5. The Construction of Wireless Receiving Apparatus . . . . . P. D. Tyers.	1/6	1/7½
7. How to Make a "Unit" Wireless Receiver . . . . . E. Redpath.	2/6	2/8
9. Wireless Valves Simply Explained . . . . . John Scott-Taggart, F.Inst.P.	2/6	2/8
10. Practical Wireless Valve Circuits . . . . . John Scott-Taggart, F.Inst.P.	2/6	2/8
11. Wireless Licences and How to Obtain Them . . . . . E. Redpath.	1/-	1/1½
Elementary Text-book on Wireless Vacuum Tubes . . . . . John Scott-Taggart, F.Inst.P.		10/- (Post free)

Those printed in heavy type have been published recently.

HOW many turns for a Coil to reach the Paris Wavelength—the type of circuit to operate a Loud Speaker using only an indoor Aerial—Crystal or Valve rectification in a multi-valve Set? These are a few of the questions which confront the amateur constructor.

Some will find out the correct answers by expensive experiment—others, more wisely, will benefit by the experience of those who have trodden the thorny paths of Radio before them.

The concentrated experience of some of the best known Wireless engineers and experimenters is available for all readers of Radio Press Books. You cannot do better than purchase the complete Library—one Book at a time. Each Book covers a different phase of Wireless and none overlap. Get one or two to-day and keep them by you for ready reference—they are sure to save their cost many times over. From all Booksellers.

RADIO PRESS LTD.,  
Devereux Court, STRAND, W.C.2.

**Radio Press Books**  
— a complete Wireless Library

# STERLING

BRITISH MADE

## RADIO COMPONENTS



No. R 1416 (mounted)  
TELEPHONE TRANSFORMER.

A high-grade instrument for low resistance telephones. Laminated stalloy closed core. Mounted on insulating base with four terminals. Ratio of windings—13 : 1.

No. R 1416 (mounted) £1 10 0  
No. R 1416a (unmounted) £1 5 0

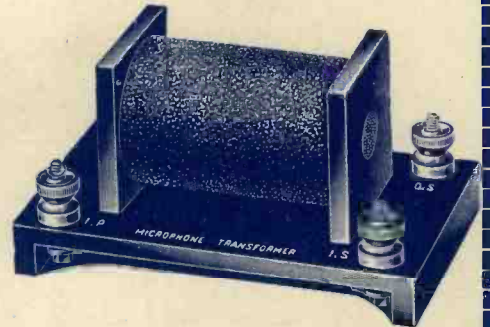

No. R 1417

MICROPHONE TRANSFORMER.

For radio transmitting circuits, and also for power amplifiers when used for amplifying local speech and music. Ratio of windings 1 : 28. Mounted on insulating base with four terminals.

PRICE (mounted) £2 0 0

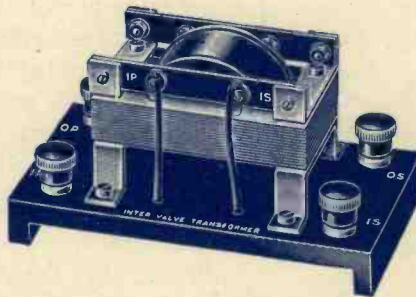

No. R 1414 (mounted)

INTERVAL TRANSFORMER.

Of efficient design with laminated stalloy closed core. Mounted on insulating base with four terminals. Ratio of windings—1 : 4.

No. R 1414 (mounted) £1 7 6  
No. R 1414a (unmounted) £1 2 6

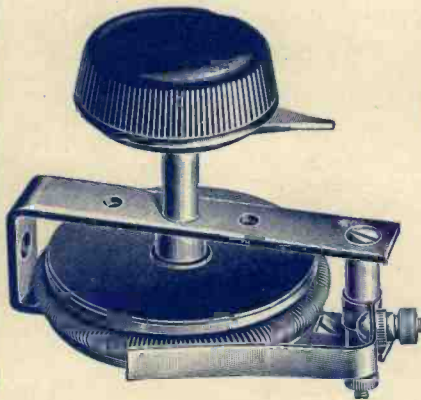

No. R 1390

ROTARY FILAMENT RESISTANCE.

Of improved design, with special features embodying critical filament control and adjustability to panels of various thicknesses. May be used to control a single valve, or two valves simultaneously.

PRICE - - - 4/8

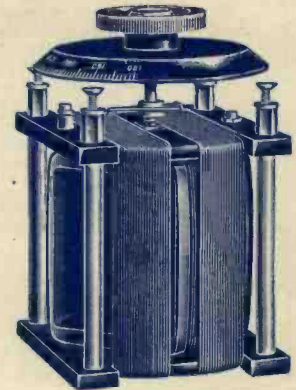

No. R 2674  
VARIOMETER.

Inductance Ratio 9 : 1.

Unique construction providing efficient tuning. Range 250 to 2725 metres with '0005 mfd. Condenser in conjunction with necessary disposition of rotor and stator windings.

PRICE - - - 21/-

Obtainable from all Electrical Dealers and Stores.

## STERLING TELEPHONE & ELECTRIC Co., Ltd.,

Manufacturers of Telephones and Radio Apparatus, etc.,  
(WHOLESALE ONLY)

Telephone House, 210-212, TOTTENHAM COURT ROAD, LONDON, W.1.

Telephone : Museum 4144 (7 lines).

Telegrams : "Cuomis, Wesdo, London."

BIRMINGHAM :  
150, Edmund Street.

CARDIFF :  
10, Park Place.

MANCHESTER :  
14, St. Peter's Square.

NEWCASTLE-ON-TYNE :  
9, Clavering Place.

WORKS :  
Dagenham, Essex.

# Wireless Weekly

and The Wireless Constructor

Vol. 2.  
No. 9.

## CONTENTS

“Wireless Weekly” Reflex Receiver.

Practical Tuning.

Wireless on Ships' Lifeboats.

An Easily Constructed Crystal Set.

A New 7-Valve Set.

Jottings by the Way, Constructional Notes, Broadcasting News, Random Technicalities, News of the Week, Mainly about Valves, Radio Press Information Department, Correspondence, etc., etc.

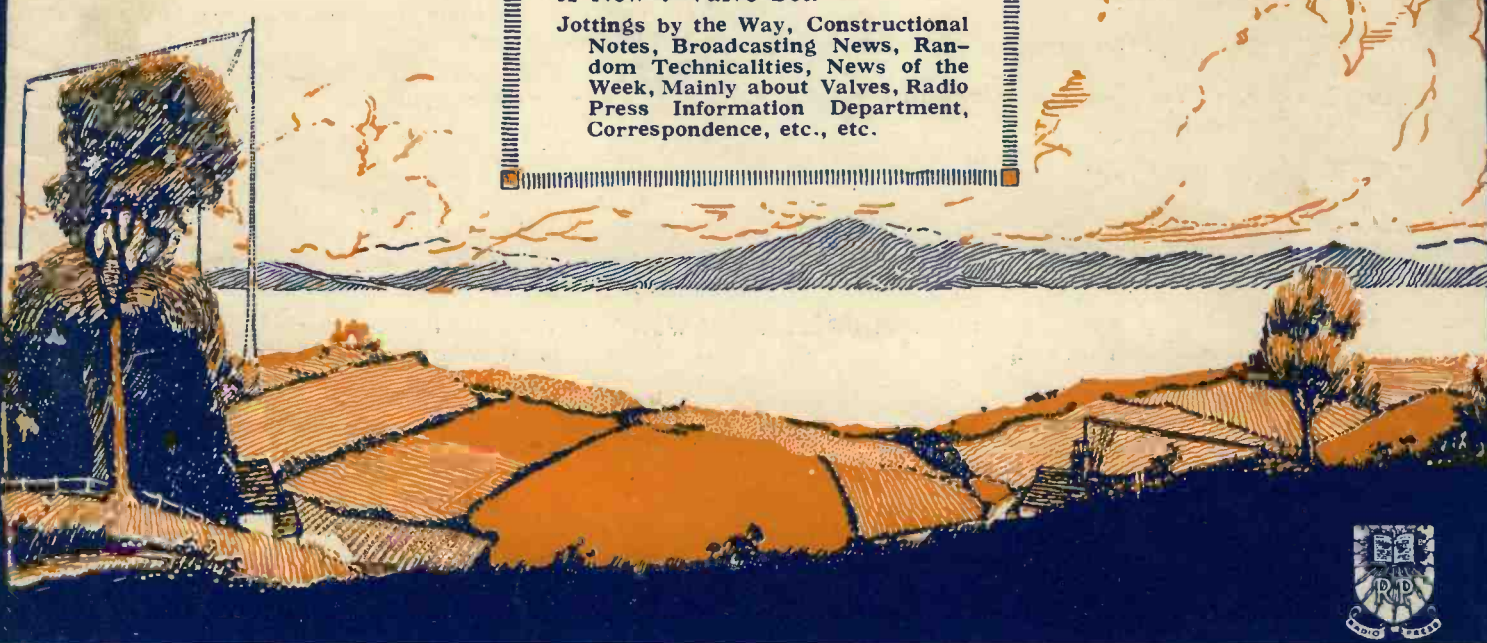

Early Developments in Wireless.—By Sir Oliver Lodge.



Talks with the  
Wireless  
Advertiser  
No. 8

## We're Getting Busier *and* Busier—

Advertiser : Come in.

" W.W. " : Thanks, I—

Advertiser : Wait a minute!—

" W.W. " : Certainly, sorry—

Advertiser : Things are moving and they look as if they will continue to keep going.

" W.W. " : I have said that for several weeks now.

Advertiser : Ah! Yes! but you fellows have got to be optimistic.

" W.W. " : We like to give the lead, of course.

Advertiser : True, but we can't always follow so easily. However, my stocks have fallen this last fortnight and without a penny for advertising.

" W.W. " : I daresay, but you're getting some of the benefit of the other fellow's ads.

Advertiser : Well, I must start again and yours certainly looks the best of the Weeklies, for quality and number of pages.

" W.W. " : It has been for weeks and right through the slump, *and* it's got the best editorial.

Advertiser : How's your price?

" W.W. " : Just the same. £15 per page and pro rata for a series of thirteen insertions.

Advertiser : That's cheap compared with most of the other weeklies.

" W.W. " : Cheap Sir! but also GOOD, judging by what my advertisers tell me.

Advertiser : And I suppose they don't buy space for your benefit.

" W.W. " : By Jove, NO! They only spend money with me because it produces RESULTS.

Advertiser : I'll start next week with a page and test the market. If that goes I'll keep it up.

" W.W. " : You'll find that, as Coué said, "You're better and better every day!" Thanks! Good morning.

All enquiries for Advertising space in "Wireless Weekly" should be addressed to:—

**Scheff Publicity Organisation, Limited, 125, Pall Mall, London, S.W.1.**

Phone—Regent 2440 (2 lines).

# Wireless Weekly

Vol. 2, No. 9,  
Sept. 12, 1923

## CONTENTS

	Page
Editorial - - - - -	336
Early Developments in Wireless - - - - -	337
"Wireless Weekly" Circuits—No. 22 - - - - -	340
Practical Tuning - - - - -	341
Jottings by the Way - - - - -	343
A New Seven-Valve Set for "Bart.'s" - - - - -	345
News of the Week - - - - -	347
Wireless on Ships' Lifeboats - - - - -	349
An Easily Constructed Crystal Receiver - - - - -	350
The Physics of the Valve - - - - -	351
"Wireless Weekly" Reflex Receiver - - - - -	352
Seeing Atmospheric - - - - -	354
Book Notes - - - - -	354
Constructional Notes - - - - -	355
Broadcasting News - - - - -	358
Single or Double Wire Aerial - - - - -	360
Random Technicalities - - - - -	361
Apparatus We Have Tested - - - - -	363
Mainly About Valves - - - - -	364
Correspondence - - - - -	365
Radio Press Information Department - - - - -	366



Scientific Adviser:  
Prof. G. W. O. HOWE,  
D.Sc., M.I.E.E.  
Advisory Editors:  
Prof. R. WHIDDINGTON,  
M.A., D.Sc.  
Prof. C. L. FORTESCUE,  
M.A., M.I.E.E.

### Radio Press, Ltd.

Publishers of Authoritative Wireless Literature  
**DEVEREUX COURT, STRAND, W.C.2**

Tel.—Central 3763.

Advertisement Managers: { SCHEFF PUBLICITY ORGANIZATION,  
LTD., 125, Pall Mall, London, S.W.1.  
Tel.—Regent 2440.

#### Staff Editors:

E. H. CHAPMAN, M.A., D.Sc.  
A. D. COWPER, M.Sc.  
G. P. KENDALL, B.Sc.  
A. L. M. DOUGLAS.  
R. W. HALLOWS, M.A.  
S. G. RATTEE.



All correspondence relating to contributions is to be addressed to the Editor of "Wireless Weekly."

Nothing contained herein is to be regarded as permission or encouragement to infringe any patent rights.

# Editorial

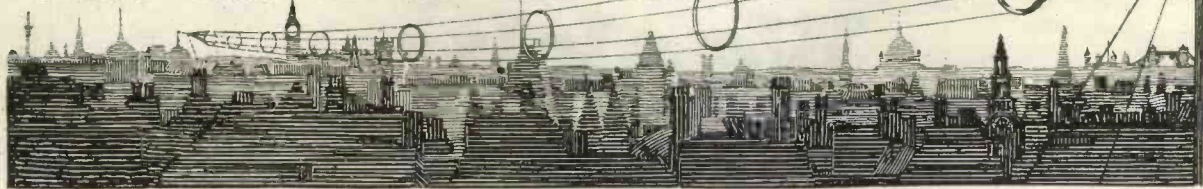

## The Outlook

**S**IGNS are not lacking of a continued improvement in general conditions in the world of wireless. With the gradual shortening of the hours of daylight, public interest in broadcasting is reawakening, and there is no doubt that, when the change over from "Summer" to "Winter" time is made, on Sunday next, many who have not yet installed apparatus will consider doing so in order to enjoy the broadcast programmes. Those who purpose building receiving sets are advised to put the work in hand at once, so as not to miss any of the winter programme.

## The Report

Although conditions are certainly more favourable, one of the chief obstacles to further progress, namely, the lack of a definite settlement of the licensing question, remains. There is also the important question of the provision of adequate revenue for the Broadcasting Company, this being to some extent involved with the question of licence fees.

At the time of going to press we are unable to obtain any definite information regarding the publication of the Broadcasting Committee's report, beyond the fact that H.M. Stationery Office will publish it in the form of a White Paper, copies of which will be available to the public. As pointed out in a previous issue, the report will give the results of the Committee's investigations, together with certain recommendations, the final decisions resting with the Postmaster-General. In view of this, the publication of the report could not prejudice the case in any way, but would let the public know exactly how matters stand, and the delay in publishing it appears to be quite unreasonable.

## Crystals

It has often occurred to us that the average purchaser entering a wireless shop and enquiring for crystals is at a considerable disadvantage. The experienced experimenter can probably recognise a particular crystal, but a beginner asking for one of the proprietary substances is more or less obliged to accept whatever is offered.

We suggest, therefore, that it would be greatly to the interest of all concerned if manufacturers of crystals supplied them in sealed boxes, distinctly labelled, ready for sale. The adoption of this scheme would protect all parties—the manufacturer, the dealer and the purchaser—whilst the cost involved would be very slight and would be more than repaid.

## Valves

Valve manufacturers also would do well to consider a similar scheme. At present there is nothing whatever to prevent stock valves being used—for demonstration purposes, for instance—and being subsequently replaced in their original wrappings and sold.

Some purchasers of sets will no doubt prefer to buy the actual valves which they have seen used with the set, as possibly not understanding very much about valves, they wish to acquire those which they know to give satisfactory results, but we consider that the great majority of purchasers would prefer to buy their valves enclosed in a sealed carton and thereby guaranteed unused. It could no doubt be arranged that the valve pins projected, so that the usual "filament test" could be applied at the time of purchase, the glowing filament being observable through a small aperture in the side of the carton. A valve so protected *could* still be used, of course, but not without silently calling attention to the peculiar circumstance.



## EARLY DEVELOPMENTS IN WIRELESS

By SIR OLIVER LODGE, D.Sc., LL.D., F.R.S.

*A further instalment of the fascinating story of wireless which began in our last issue.*

UP to the year 1842 the nature of light was unknown. All the other theories of light had attempted to explain it on mechanical principles, like the vibrations of an elastic solid. Light was known to consist of transverse waves: the wavelength and the frequency of oscillation could be determined. But no one knew what was oscillating, nor what the mechanism of propagation was. With extraordinary genius Fresnel and MacCullagh had explained the phenomena of light in all detail as regards reflection, refraction, diffraction, interference, and polarisation. But the nature of the waves was unknown; and the elastic solid theory, though fascinating, was felt by those who dived most deeply into it to contain some flaw and to be, strictly speaking, unworkable. Light did not seem explicable on dynamical principles—the principles which were so fruitfully devised by Galileo and Newton for dealing with ordinary matter.

MacCullagh's theory, indeed, was not dynamical, and in that respect had some advantage. But it was also more vague and less definite on that account; though, being thus indefinite and yet enabling results to be achieved, it was less liable to be upset and replaced by future discovery.

To Clerk Maxwell we owe the epoch-making discovery that light was not a mechanical oscillation at all, that the ordinary mechanical properties of matter did not apply to it, but that it was explicable solely and wholly in terms of electricity and magnetism. It is impossible to sum up his discovery in a few words, but roughly we may say that the most obvious outcome was:

(1) That if electric waves could ever be generated they would travel with the velocity of light.

(2) That light was essentially an electromagnetic and not a mechanical phenomenon.

(3) That the refractive index of a substance was intimately related to its dielectric coefficient.

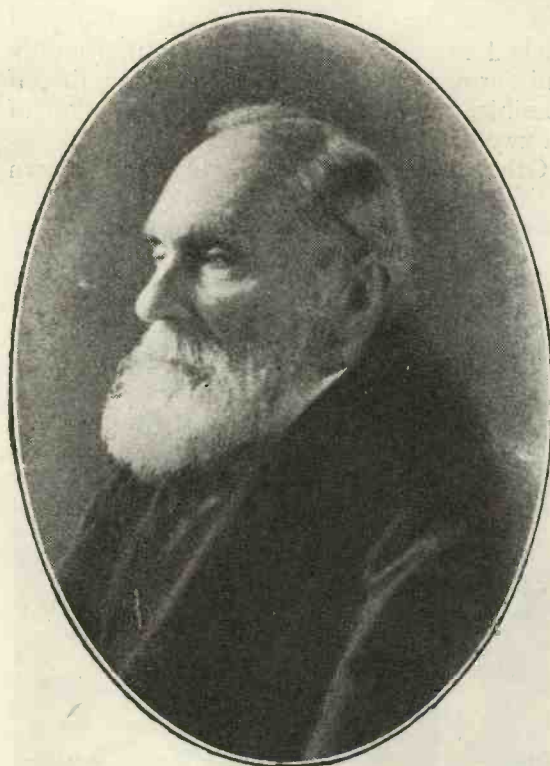

Lord Kelvin, O.M., G.C.V.O., F.R.S., LL.D.

(4) That conductors of electricity must be opaque to light.

He showed further, though he did not then express it in language of this character, that the ether had two great and characteristic constants of value utterly unknown to this day, though guessed at by a few speculators like myself—one of them the electric constant of Faraday called  $K$ ; the other, the magnetic constant of Kelvin called  $\mu$ . It was impossible then, and it is impossible now—though it is not likely always to remain impossible—to determine the value or even the nature of either of these constants. But he did perceive a way of measuring their product; and he was the first to measure it. Their product is known; and it is equal—as Maxwell showed it must be—to the reciprocal of the square of the velocity of light.

Well, now, this great discovery aroused in us young physicists the greatest enthusiasm. And in the early 70's—I think about 1871 or '72—I remember discussing it with J. A.

Fleming, who at that time was a fellow student with me in Professor Frankland's advanced chemical laboratory at the brand-new College of Science, South Kensington.

A year or two later, at Heidelberg, I studied Maxwell's treatise pretty thoroughly and formed the desire to devote my life, if possible, to the production and detection of Maxwell's electric waves.

Other things supervened. One had to earn a living; we all got immersed in teaching. Some of us got married, and the pursuit of

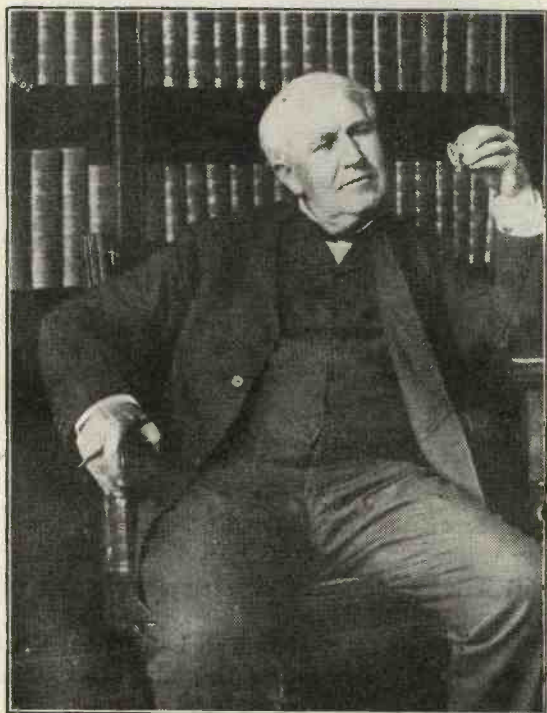

Thomas A. Edison.

the ether had to be accommodated with a few hours of spare time every now and then.

I used to discuss the possibility of producing these waves with my great friend G. F. FitzGerald, whose acquaintance I made at the meeting of the British Association in Dublin in the year 1878; and he wrote some mathematical papers discussing the possibility of experimentally producing such waves. I myself also spoke at the British Association about them in 1879, 1880, and again in 1882 at the Royal Dublin Society. FitzGerald, as I say, mathematically examined what then seemed the abstruse question of electric wave production; and after some hesitation came

to the conclusion that direct artificial generation of waves was really possible on Maxwell's theory, in spite of certain recondite difficulties which at first led him to doubt it. (See "Scientific Writings" of FitzGerald, edited by Larmor, pages 90 to 101.) Indeed, one of his papers on the subject was originally entitled "On the Impossibility of Originating Wave Disturbances in the Ether by Means of Electric Forces." The prefix "im" was subsequently dropped, although his first, or 1897, paper concluded thus:

"However these (displacement currents) may be produced, by any system of fixed or movable conductors charged in any way, and discharging themselves amongst one another, they will never be so distributed as to originate wave-disturbances propagated through space outside the system."

In other words, Hertz's discovery was impossible on Maxwell's theory.

In 1882 he corrected this erroneous conclusion, and referred to some early attempts of mine at producing the waves. ("Scientific Writings," page 100.) I state all this in order to emphasise the difficulty which in those early days surrounded the subject on its theoretical as well as on its practical side.

In 1883, at the Southport meeting of the British Association, FitzGerald took a further step and surmised that one mode of attaining the desired result would be by utilising the oscillatory discharge of a Leyden jar, if only we had the means of detecting such waves when they were generated.

#### Production of Waves

In 1887 and 1888 I was working at the oscillatory discharge of Leyden jars (initially in connection with the phenomena of lightning), and I then found that the waves could be not only produced but detected, and the wavelength measured, by getting them to go along guiding wires adjusted so as to be of the right length for sympathetic resonance. Thus I obtained the phenomenon of electric nodes and loops, due to the production of stationary waves by reflection at the distant end, and in my own mind thus verified Maxwell's theory.

Transmission along wires popularly sounds different from transmission in free space, but it was well known to me that the process was the same, and that the waves travel at the same speed, being only guided by the wires,

much as sound is guided in a speaking-tube, without the velocity of transmission being to any important extent altered. The theory is given near the end of my paper—an important one, as I think—in the *Phil. Mag.* for August, 1888, where the experimental production of much shorter waves is foreshadowed.

The beginning of my experiments was reported to the Society of Arts in April, 1888; they are recorded in the *Philosophical Magazine* for August, 1888, and they were more completely described orally at the British Association at Bath that year. (See *The Electrician*, Vol. 21, pp. 607-8, Sept., 1888.)

In that year, also, I heard for the first time of Hertz's brilliant series of experiments, where, by the use of an open-circuit oscillator, he had obtained waves in free space, and by reflection had also converted them into stationary waves and observed the phenomena of nodes and loops, and measured the wavelength.

These experiments of Hertz were called attention to by FitzGerald in his Presidential Address to Section A of the British Association meeting at Bath in 1888. And no wonder they interested him; for they showed that his method of utilising the oscillatory discharge of a Leyden jar was effective; and, to the surprise of all of us, including Hertz himself, that the waves from an opened-out condenser had sufficient power to generate sparks in an insulated conductor upon which they impinged; the detecting conductor, as generally used by Hertz, being in the form of a nearly closed circle with a minute spark gap at which the scintilla appeared. The radiating power of even a small Hertz oscillator was calculated by me in a subsequent paper (*Phil. Mag.* for July, 1889, p. 54), and was found to be 100 horse-power, while it lasted. The duration was excessively short, for at that rate practically all the energy was expended in a single swing (about the 100 millionth of a second), but its power of producing little sparks was explained.

The work of Hertz was splendid. He was then Professor at Karlsruhe, still quite a young man. He had been trained under Helmholtz; and I had made his personal acquaintance in Berlin when I went to call on Helmholtz in 1881, on a tour of the univer-

sities of the continent. He was then Helmholtz's demonstrator, and was thought highly of by that great master. He could speak English, and was very friendly. I did not see him again till some time after the publication of his great discovery.

He was not at that time fully acquainted with Maxwell's Theory, though he knew his equations better than any other German except Helmholtz. Maxwell had not then made any serious impression on the Continent. Even Hertz does not seem at first to have realised what he was doing, and did not use the words "electric waves." That title was attached to his subsequently translated book at the suggestion of Lord Kelvin. He spoke about the outspreading of electric force; somewhat as Joseph Henry had done. That was one title of his book. But he worked out the phenomena he observed with extraordinary skill, both experimentally and mathematically, rapidly perceiving that Maxwell's Theory could be applied to it and that it might be elaborated in detail so as to include the whole of his phenomena. He it was who drew those accurate diagrams of the genesis of the waves, showing what is happening near the oscillator at every phase—diagrams which now appear in most textbooks and of which the upper half is represented as scouring across the country. He knew that true waves were not emitted till beyond a quarter-wavelength from the source. He knew how they were polarised, and how their intensity differed in the equatorial and polar directions and how it varied with what may be called latitude. In fact he rapidly came to know all about these waves. As to us, we knew not which to admire most—his experimental skill when working with a tiresome and irritating mode of detection, or his mathematical thoroughness in ascertaining the laws of their propagation. A synopsis of his equations will be found clearly cited in Preston's "Theory of Light," as well as in other books. I translated some of his papers into *Nature*. And never was there the smallest iota of jealousy between us, or anything but cordial and frank appreciation. Maxwell and Hertz are the essential founders of the whole system of wireless. That is to say, they constructed the foundations solidly and well.

“WIRELESS WEEKLY” CIRCUITS—No. 22

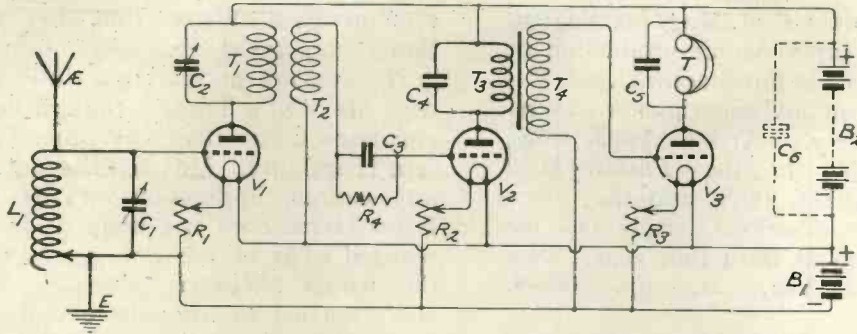

COMPONENTS REQUIRED

- L<sub>1</sub> : Variable inductance.
- C<sub>1</sub> : Variable condenser, capacity 0.0005 μF.
- R<sub>1</sub> } Three filament rheostats.
- R<sub>2</sub> }
- R<sub>3</sub> }
- T<sub>1</sub> } H.F. plug-in transformer.
- T<sub>2</sub> }
- C<sub>2</sub> : Variable condenser, capacity 0.0003 μF.
- C<sub>3</sub> : Grid condenser, capacity 0.0003 μF.

- R<sub>4</sub> : Grid leak, value 2 megohms.
- T<sub>3</sub> } Iron-core intervalve trans-
- T<sub>4</sub> } former.
- C<sub>4</sub> : Fixed condenser, capacity 0.002 μF.
- T : High-resistance telephones.
- C<sub>5</sub> : Fixed condenser, capacity 0.002 μF.
- B<sub>1</sub> : 6-volt accumulator.
- B<sub>2</sub> : High-tension battery, 45 to 100 volts.
- C<sub>6</sub> : Large capacity reservoir condenser (up to 1 μF).

GENERAL NOTES

This is a straightforward circuit comprising one H.F., detector and one L.F. valve, the high-frequency intervalve coupling being performed by means of a suitable plug-in type of interchangeable transformer with its primary tuned by means of the variable condenser C<sub>2</sub>. The tuning of the “transformer” and aerial circuits should be varied simultaneously when searching for signals.

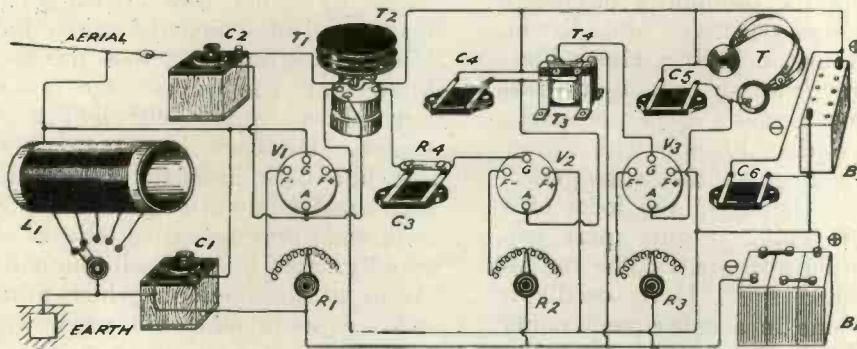

PRACTICAL WIRELESS NOTES—No. 4

FILAMENT RHEOSTATS

not only control the amount of current flowing through the valve filaments, but, in so doing, afford a very convenient additional means of control of the action of the valve. For instance, when difficulty is experienced in obtaining a fine adjustment of reaction coupling, a small movement of the filament

rheostat will often produce the desired effect.

It is important that the resistance wire employed in the construction of the rheostat should be capable of carrying the required current without undue heating. This overheating will be particularly noticeable when a single rheostat controls the filament current of several valves.

The fitting of a separate rheostat for each valve is recommended. The additional cost is not excessive, and not only can each valve be adjusted to give the best results, but the burning out, or inadvertent removal of one valve, does not involve the remaining valves in any risk of damage due to excessive filament current.

# PRACTICAL TUNING

By G. P. KENDALL, B.Sc., Staff Editor.

*Facility in tuning a receiving set is best acquired by an understanding of the logical sequence of operations. The following article explains how single-circuit receivers should be handled.*

WHEN the novice attempts to tune in for the first time he quickly realises, as a rule, that the matter is by no means so simple as he had anticipated. He knows in a general way what he has to do; he understands that he must adjust whatever kind of detector or amplifier he employs to its working condition, and that there are certain "tuned" circuits which must be adjusted to resonance with the wave it is desired to receive, and so on. All this seemed easy before he attempted it in practice, but on the application of that test proved otherwise, for the simple reason that, to hear the desired transmission, there are perhaps as many as three or four controls on the receiver which must all be set correctly, and of which any one being out of adjustment will prevent reception.

To make matters more difficult for him there are no audible indications (with most sets) which he can easily recognise to tell him when any one of the adjustments has reached its correct point, so long as the others are still some way out, and it may be seen that, so long as he proceeds in a haphazard manner, it may be hours before he chances to hit the right

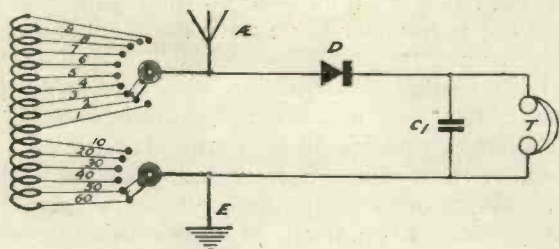

Fig. 1.—A single-circuit crystal receiver with two sets of tappings.

combination, and he may even fail to do so altogether.

Now all these difficulties can be overcome if the novice is given a few simple rules, and led to understand the elementary principles of

tuning in a practical manner, coupled with a few instructions for ensuring that his crystal or valve shall function correctly.

To understand the best methods of tuning-in with complex circuits, it is necessary to

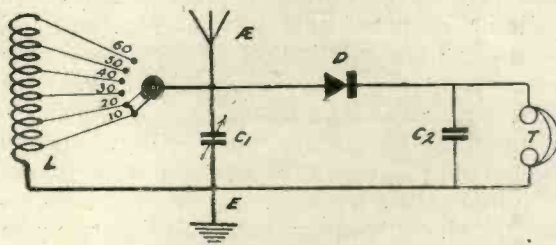

Fig. 2.—A similar receiver provided with a single set of tappings and a variable condenser.

understand these methods in detail, and by far the best way of getting the necessary grasp of the subject is to take at first quite simple circuits and see how they should be operated, gradually passing to more complicated types, which will be the more readily understood with the knowledge already gained. We will take first some simple types of crystal receivers, reminding ourselves at the outset of these fundamental facts: to tune a circuit to a given wavelength we may vary its "inductance," which may be taken to mean the number of turns on the tuning coil, or the "capacity" in circuit, which involves turning the knob on a variable condenser, or we may vary both.

The first example is a crystal receiver tuned by means of a variable inductance of the type known as a slider coil. The tuned circuit here is composed of the capacity formed by the aerial and earth, and the inductance provided by that portion of the coil which is included in the circuit. Hence it may be seen that this is a very simple circuit to tune, since only the inductance is variable. The procedure is, therefore, as follows: First adjust the crystal to a sensitive condition, thus push the slider

slowly along the coil until "signals" are heard. If the coil is of the correct size a point will be found at which the sounds are heard clearly and on either side of which they die away. The set is then correctly adjusted.

Another popular type of receiver is shown in Fig. 1, having a coil provided with two sets of tappings, one for coarse adjustment and one for fine. The former varies the inductance to the extent of 10 turns at a time, and the latter in "ones," and the two together enable any desired number of turns to be included in circuit at will. Thus, suppose 25 turns are required, set the "coarse" switch to stud 2 and the "fine" switch to stud 6. These switches, by the way, are often referred to as the "units and tens" switches. The process of tuning-in with this type of variable inductance is less simple, and unthinking manipulation of the switches may never yield the exact adjustment needed for perfect reception at a distance. Tuning-in, to be quick and accurate, must be done upon a logical plan such as the one about to be given.

Suppose that we wish to tune-in to a wavelength which happens to require 45 turns in circuit. Place both switches back to the minimum position, then place the tens switch on stud 1 and rotate the units switch until each of its studs has been tried. Nothing will be heard, so we know that the correct number of turns does not lie between 10 and 19. Now place the tens switch on stud 2 and again try each of the units studs, starting with No. 1, thus trying turns varying from 20 to 29. Still nothing will be heard, so we proceed to stud 3 on the tens switch and test turns 30 to 39, still with no results. We next turn the tens switch to stud 4, and again commence to turn the unit switch, commencing with stud 1. On stud 2 we begin to hear faint sounds, which become successively louder on studs 3, 4 and 5, reach their maximum on stud 6, and then diminish again and become inaudible on stud 9 of the "fine" switch. Thus, if we had left the unit switch alone and proceeded by haphazard twisting of the tens switch, we should have missed the station altogether.

Another somewhat similar arrangement is shown in Fig. 2. Here a coil tapped at every

10 turns provides the "coarse" adjustment, the "fine" being given by a small variable condenser in parallel with it. The method of tuning is very similar to that given, the only difference being that where the "fine" switch was used previously the variable condenser is now to be employed. The method would, of course, be the same if the alternative type of circuit was used, in which the variable condenser is placed in series with the aerial tuning inductance.

The method of operating the two remaining methods of tuning simple circuits is so straightforward that there is no wrong way of setting about it. The two methods referred to are those employing a variable condenser and fixed-value plug-in coils, or a variometer. In the case of the plug-in coils the procedure is simply to insert a coil of a size guessed to be suitable in the holder and rotate the variable condenser until the desired signals are picked up. If they cannot be found, try a larger or a smaller coil. An estimate for the right coil for given wavelengths can be made by using the table given in *Modern Wireless*, No. 6, for the purpose. Assuming that the aerial has a capacity of  $0.0003 \mu\text{F}$  (very roughly correct for an average P.M.G. aerial), add another  $0.0003 \mu\text{F}$  if the tuning condenser is used in parallel, and read off the required coil number from the chart. If the condenser is used in series the total capacity in circuit will be reduced, and may be taken as about  $0.0002 \mu\text{F}$  for purposes of chart-reading.

Of variometer-tuned sets there is little to say; in such a circuit, for example, as would result from the substitution of a variometer for the slider coil in the circuit first considered, all that has to be done is to set the crystal and turn the variometer knob until the signals are picked up.

In a further contribution two- and three-circuit receivers and their operation will be considered, and it will be found that the elementary rules which we have deduced from the foregoing simple circuits will be a great assistance. Even users of multi-circuit sets should follow the argument from the beginning if they are to obtain a proper understanding of their receivers.

HAVE YOU READ THE SEPTEMBER "MODERN WIRELESS" ?  
ON SALE EVERYWHERE. ————— PRICE ONE SHILLING.

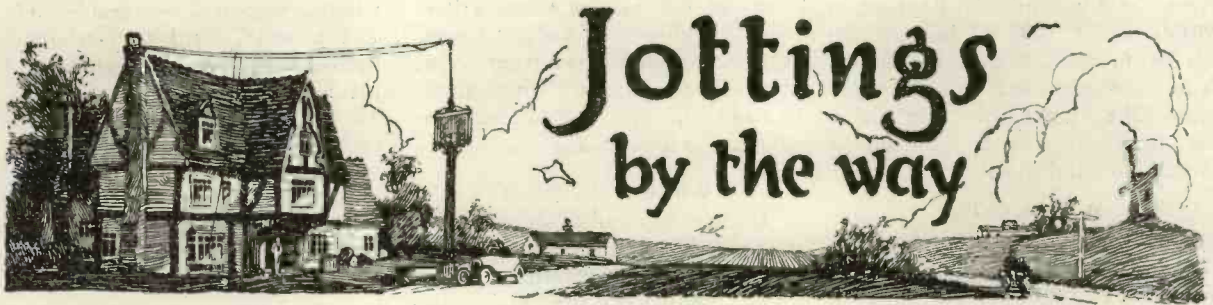

#### An Aerial Adventure

**A** FRIEND has just had an experience with his aerial that moved me to ribald laughter and him to the use of such naughty but useful words as can be recorded in cold print only by the use of dashes (how feeble!), blanks or asterisks. Asterisks always seem a poor substitute to me. Do you not think that those wicked looking little daggers would be far better? At present their use is confined to people like Professor Slushitosh, who having made an abstruse statement that no one can understand follows it with a dagger. Hoping to find explanations in a footnote, your eyes seek the bottom of the page, where they are met with nothing but a reference to some fearsome German book, whose very title is enough to strike terror into the stoutest heart.

My friend's house stands on top of the highest hill in Little Puddleton. He was determined that he would take the fullest advantage of the height kindly provided by nature by erecting upon its summit an aerial, to be the very last word in aeri-als. Therefore he betook him to the builder's, and there bought the mightiest pole to be had, fitting it with a topmast almost as long as itself. A wondrous concrete "step" was contrived, and the mast was provided with a maze of steel wire ropes.

#### Up She Goes!

At length the moment arrived when all was ready for the aerial to rise and proudly flaunt its twin wires to the ether. A gang of

strong men pushed and pulled and sweated and heaved and swore as strong men will. Slowly the mast rose. Its foot was poised over the step. Heave followed heave and at last—triumphant moment—it swung into place.

In an ecstasy of joy my friend flung up his arms and cheered, and with that cheer came tragedy, for the halyards flew from his grasp, and not even the Lenglen leap that he made sufficed to enable him to catch the end as it sped heavenwards. The block sang shrilly and next moment he and his fellow toilers were enmeshed in the coiling mazes of many yards of wire cable, which descended upon them from aloft.

When they had disentangled themselves and said their heartfelt say, the fruits of their labours were represented by a mast that stood proudly erect it is true, but as no tame chimpanzee was available to shin up it and rethread the halyards through the block, there was nothing for it but to take it down again and begin anew. At this point the helpers went on strike, declaring that they had done enough for one hot day.

#### Those Blocks

And so the mast stands, beautiful to behold, but quite useless until such time as another band can be collected to take it down and put it up again. Like most sad little stories, this one has a moral, which is: make the halyards fast to their cleat before you begin to raise your mast. It is just as well, too, to make sure that they are not jammed between the pulley and the cheeks of the block. Some blocks are so poorly made

that to use one of them is to ask for trouble. If there is a big wobble on the pulley, and fairly big gaps between it and the sheaves, a jam will take place sooner or later as sure as eggs are eggs. Therefore when you fare forth to purchase yours you may find it well to "blue" a few pence more than you expected and to purchase a really good block that can be counted upon to behave itself properly.

#### An American View

Our American friends, the dryness of whose throats is equalled only by that of their humour, have been terribly tantalised by a receiving set that was designed some weeks ago by some enthusiast on this side of the water. Fired with a noble desire for novelty, he wound the turns of his inductance upon a whiskey bottle. Then he had the set photographed to show how it could be used to provide either cheerful music or timely solace in case a breakdown occurred. Instead of moaning like one demented and tearing tufts from your scalp in a frenzied endeavour to find the cause of the trouble, you merely removed the cork from the inductance and at once felt better.

The photographs were published in some of the dailies here and in due course they found their way into the teeming pages of one or two of Uncle Sam's monster Sunday papers, there to revive old, half-forgotten longings in the breasts of his pussy-footed children. But I think that it was unkind of one of the editors to publish the picture with the cap-

tion "Why Radio is Popular in England"! Still he did have the grace to predict that if the set could be imported fully charged into the Land of the Great Drought it would establish a record in wireless sales.

#### A Bone to Pick

Then I have a bone to pick with the book reviewer of another American journal. He devotes some of his space to an examination of our wireless books. Of one of them he says, "In spite of certain Englishisms, it is a fine book, which our amateurs will find useful." *Englishisms*, mark you. The cheek of the fellow! Surely we, who invented the blessed language, have the right to use it in our own way. One might as well accuse a Frenchman writing in his own tongue of being guilty of committing Gallicisms.

I suppose that what he means is that a good many wireless terms used by his countrymen are different from ours. That is certainly the case, as you will discover if ever you tackle an American work on the subject. Such words as antenna and ground for aerial and earth are easily understandable, but you may be left wondering when you find references to the tickler, which is their beautiful name for the reaction coil. If they don't use that term they call it the reactance—as do

some of our own wireless writers who ought to know better. Valves across the Herring Pond are always tubes (pronounced "toobs"), and a wireless enthusiast is a radio fan.

#### Which is the Worst

I can never quite make up my mind which part of the receiving set is the most infernal, but I rather incline towards giving the palm for sheer malicious and uncalled for misbehaviour to the high-tension battery. It looks an innocent thing enough, for what is it after all but a glorified flash-lamp battery! Yet beneath that simple looking exterior of white wax (or black pitch) lurk untold powers of evil. Mine played up terribly the other week. Something was wrong, but individual cells tested at either end showed that the battery was apparently up to snuff. After many profane researches I put the voltmeter across every single cell and discovered one that was absolutely dud, bang in the middle of the thing. Is this playing the game? Would any other part of the set behave in quite such a low down manner with the thermometer at something over 80 in the shade? I think not!

#### Converting the Unbeliever

Did you hear the rather beautiful story about the disbeliever in

wireless who was converted? He was a mean, hard man who expected something for nothing and the blazes of a lot for sixpence. He scoffed at wireless as simply a craze. He could not, it seemed, see anything wonderful in it. "You can get music," quoth he, "by letting a needle scratch round on a revolving chunk of wax, so what is there wonderful in getting it through the same old trumpet by means of a row of electric lamps?"

A friend asked him round to hear wireless for the first time one Sunday evening. It was unjust, he explained, to condemn a thing until you had given it a fair trial. The mean one came, occupied the most comfy chair, accepted an expensive cigar and listened sceptically. It happened that a sermon was being broadcast not from the studio but direct from the pulpit. "And now," said the preacher as he wound up his peroration, "there will be a collection in aid of the benighted inhabitants of Darkest Africa." "M'yes," said the erstwhile sceptic as he jingled the coins in his breeches pocket, "you've quite convinced me. This wireless is quite the most wonderful thing I ever struck." Thus are conversions made!

WIRELESS WAYFARER.

## CATALOGUES RECEIVED

**G. Davenport and Co., Ltd.**, publish a monthly bulletin giving the latest particulars and prices of wireless accessories and spare parts. Wireless enthusiasts should obtain copies of these leaflets, thereby being informed of latest prices and developments.

**Radio Specialities.**—We have received two leaflets from this firm describing the "Filtron" variable gridleak and the "Static-Rster" protective de-

vice. The former, which may be obtained as a variable gridleak or as a combined variable leak and variable condenser, might be used in the Flewelling circuit described in *Wireless Weekly*, Vol. 1, No. 8, with advantage.

**Bay-Brooke Co., Ltd.**—The Bay-Brooke valve template should be of great assistance to the constructor who finds difficulty in drilling his valve panels. These templates are not of

paper, and consequently will not be so liable to stretch or tear; it is claimed that they will adhere to almost any flat surface whilst the necessary holes are being drilled.

**The Eagle Engineering Co., Ltd.**—We are in receipt of the "Chakophone" catalogue describing complete instruments, accessories, and also parts. A great variety of components and sundries may be obtained from this firm.



## A NEW SEVEN-VALVE SET FOR "BART.'S"

*A detailed description of a specially designed set, built by the Radio Communication Co. to the order of Dr. Drysdale, for presentation to St. Bartholomew's Hospital.*

**T**HE special features of the set are, firstly, the ease and simplicity with which it is put into use by means of a single master control, making it suitable for operation by

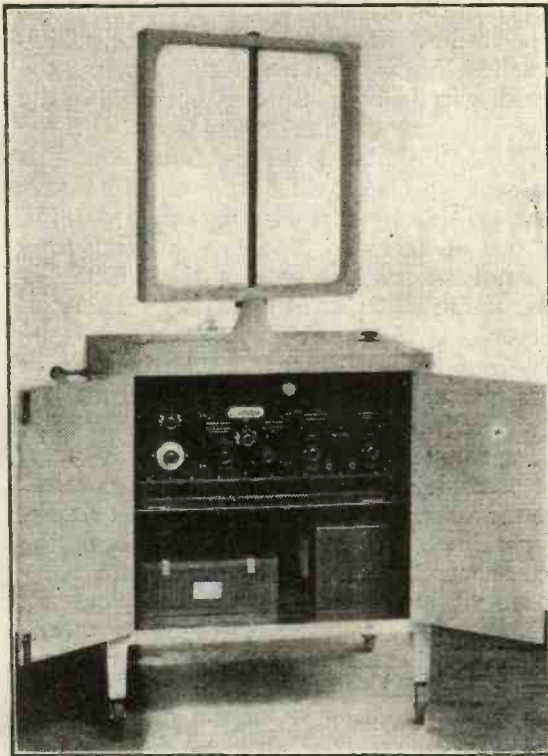

*The front of the apparatus with doors opened to show the set.*

nurses and sisters not possessed of technical knowledge; and, secondly, the finish of the cabinet and fittings, which, with rounded corners, smooth white enamel and polished aluminium, at once present a handsome appearance and conform to the best standards of modern hospital practice. The cabinet is mounted on rubber-tyred castor wheels, so that it can be easily wheeled from ward to ward, and a special self-contained frame aerial

avoids the necessity for the repeated making and breaking of connections.

In technical details the set follows generally the well-known practice of the Radio Communication Co. in their standard Polar radiophones, except in the case of the tuner panel, the use of a frame aerial making it possible to employ a 0.0005  $\mu$ F Polar condenser only, connected directly across the aerial. Two knobs on the face of this panel control respect-

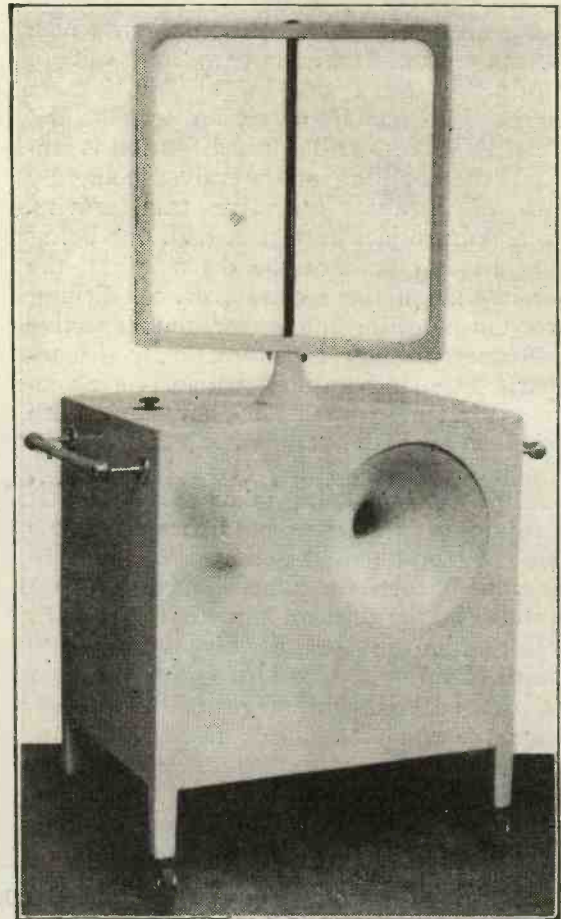

*A view of the back showing the loud-speaker horn.*

tively the tuning condenser and a master switch for the filament current to all valves.

Coupling of the three H.F. amplifying valves to one another is effected by transformers, whilst the third H.F. valve is connected to the detector by the tuned anode system. The two transformers and the anode coil are made up as a detachable unit, which automatically completes all circuits when slid into position in the case. The primaries of the transformers and the anode coil are tuned by three small variable condensers mounted on a single spindle, earthed screening plates being provided between the sections, to avoid interaction. These three condensers may be varied simultaneously by a single knob, with a pointer reading on a scale calibrated directly in wavelengths from 300 to 450 metres. The method of amplification employed affords the maximum of sensitiveness, selectivity and stability. Two other knobs on this panel, in addition to that of the triple condenser, regulate respectively a filament rheostat controlling all three valves and a switch which cuts the entire H.F. unit in and out of circuit.

In the third panel, containing detector and three L.F. valves, gridleak rectification is employed, the coupling of the valves being by means of Igranic intervalve transformers. Two telephone jacks are provided, one being in the anode circuit of the detector and the other in that of the second L.F. amplifying valve. On plugging into either, the respective transformer primary is automatically disconnected. The loud-speaker, which is a 2,000-ohm Amplion, with white-enamelled horn fitted flush with the cabinet, is connected in the anode circuit of the third L.F. valve, special precautions being taken to ensure that the sound from it does not react upon the valves and produce "booming." The two knobs on the detector panel control filament rheostats for the detector and first two L.F. valves, and for the last L.F. valve respectively. Mullard R valves are used throughout, except for the second and third stages of L.F. amplification, for which loud-speaker type valves are employed.

High- and low-tension batteries are contained in the lower compartment of the cabinet.

The filament current is provided by an 85-A.H. accumulator. A potential of about 120 volts is applied to the anodes of the three H.F. valves and the last two L.F. valves, some 45 volts only being employed for those of the detector and the first L.F. valve. The result of this is to increase the purity of the tone, while eliminating microphonic noises, even if the set is jarred or shaken. Large condensers are connected across the terminals of both high-tension supplies. In addition, a small dry battery gives a negative bias of 9 volts to the grids of the two L.S. 3 valves, which are thus enabled always to work on the straight part of their characteristic curve, giving increased amplification with a complete absence of distortion.

The frame aerial consists of a square, white-enamelled frame with rounded corners, the turns of wire being completely enclosed in the frame: the connections are made through the centre of the plated pillar about which it rotates. A stop is provided, to prevent damage to these leads by turning the frame too far. The use of as many as seven valves allows the aerial and frame to be kept of small dimensions, while still providing a large factor of safety.

The outstanding feature of the instrument is the master control already referred to. As it is desired to pick up, in this particular case, the transmissions of one station—2LO—only, it is possible to arrange all internal controls once for all at the point where the best results are obtained. On turning the knob of the master control in a clockwise direction, a relay is brought into action, which completes all circuits; further rotation operates, by means of a rheostat controlling the detector valve, to regulate the brightness of this valve and, through it, the strength of the music. By turning in the reverse direction the relay is cut out and the circuits opened. In this simple way, therefore, one totally unskilled in wireless can both put the instrument into action and regulate the sound to the desired volume. The instrument has proved remarkably satisfactory and, alike in its technical details and its general appearance, it reflects great credit upon its designers and makers. "Bart.'s" is to be congratulated.

All enquiries regarding Patents, Trade Marks and Designs should be addressed to Mr. Gee, Patent Agent, 51-52, Chancery Lane, E.C.4, at the same time mentioning *Wireless Weekly*.



**T**HE first amateur in the Isle of Wight to receive a licence for transmission is Mr. W. T. Sherratt, of 11, Bath Road, Cowes. He proposes to experiment on Sundays at 2 p.m. on a fixed wavelength of 440 metres, the call sign being 5 TZ.

The Director of the Norwegian Telegraph Services has recently returned from a tour of inspection in the northern provinces, where he prepared the plans for the new wireless station to be erected at Vardoe. This station will have a transmission radius sufficient for messages to be sent to the station at Ingøe, near Hammerfest, and to the Meteorological Institute's station at Tromsø. Weather reports are to be sent regularly from Tromsø, and these will be of very great importance to British and other trawlers fishing in Arctic and White Sea waters.

According to reports in the Lithuanian press, the Minister of Communications is negotiating with the Marconi Company regarding the erection of a big wireless station in Lithuania.

*Reuters* are given to understand from Moscow that the Soviet Government has ratified a five years' agreement with the General Wireless Telegraph Co., Paris, the latter to supply apparatus for erecting wireless stations in Russia.

A further report from Moscow states that the Soviet Government is erecting a large wireless station on the Island of Nova Zembla capable of transmitting to Arch-

angel and Siberia. The station will be specially fitted up for scientific and meteorological purposes, and the personnel will include a meteorologist, a zoologist, and a geologist.

Volunteers willing to give their blood in order to save the life of a patient in King's College Hospital, Denmark Hill, S.E., were asked for by wireless from the London station on September 3rd. The Governor of the hospital stated that half a pint of blood was required. Volunteers were asked to be at the hospital for medical examination on the following morning, when, we understand, some fifty persons put in an appearance, amongst whom were five women.

We are given to understand that there has been formed in Calcutta the Radio Club of Bengal, the official opening of which took place on August 1st. Any reader interested in the particulars of this club should make application to the hon. secretary, Mr. G. Briggs, addressing him at the Radio Club of Bengal, Calcutta.

In connection with the extension of the Handley-Page London-Paris Air Service to Zurich, a temporary wireless telephone station was established at the Zurich aerodrome by Marconi's Wireless Telegraph Co., at very short notice.

Within six days of the order being received in London the station was in operation at Zurich. It consists of a Marconi standard A.D. 2 aircraft transmitter and

receiver with master control attachment. Marconi aerodrome stations are now in operation at Croydon, Haren, Ostend, Cologne, Geneva, and several aerodromes in Spain.

*Reuters'* Agency is informed that the Commercial Cable Co. laid the American end of the world's greatest cable on August 25th at Far Rockaway, Long Island, and the British end on August 31st at Weston-super-Mare.

The cable is expected to be in actual operation by September 15th, establishing the sixth complete cable circuit between the United States and Europe for this company. In the construction of this new cable, which is the largest ever manufactured for deep sea operations, more than 4,000,000 lb. of copper, 1,800,000 lb. of gutta-percha, and some 80,000 miles of iron and steel wire (more than enough to go three times round the earth) of various sizes were used.

The deep sea portion of this cable will not be much more than  $1\frac{1}{4}$  inches in diameter, and, contrary to common belief, it will everywhere sink down in the ooze at the bottom of the sea to lie there some two to three miles below the surface. It is interesting to note that the entire cable has been manufactured in England by British labour.

We are given to understand that the Radio Orient Co., of Paris, has recently opened for public traffic the Beyrouth coast station. This station commenced service on

August 20th on a normal wavelength of 600 metres; other wavelengths used by the station are 450 and 800 metres. The call sign of this station is FFD, and the hours of working are 6 to 10 a.m. G.M.T., and noon to 4 p.m. G.M.T.

According to *The Times*, the Bulgarian Ministry of Railways, Posts and Telegraphs has under consideration a scheme for setting up twelve wireless telegraphic

of humble listeners-in whose only means of hearing one of the greatest singers in the world was by means of broadcasting. They doubtless thought that listeners-in would get something for nothing. It should be remembered that these people pay for their licences, and in the country places it is their only means of entertainment. Those who were responsible for this outrage upon the listeners-in can expect but little sympathy from the country when they growl about the

bicycles, the local police would be less busy in this sphere. Lately there have been one or two cases of drunken drivers. Perhaps Captain Twelvetees could tell us one of these nights something about the possibility of "spirit fuel" fumes affecting drivers.

*Reuters* are given to understand that the Government of Macao, the Portuguese colony in China, is to accept tenders for the construction of a racecourse, a big market equipped with freezing chambers, an electric supply station, a system of electric tramways, and last, but not least, a wireless station is also to be established.

In the army manoeuvres during the last week or so the new military wireless sets have been thoroughly tested, and the "C" set, with a range of from 20 to 60 miles, has been successful for communication between divisional and brigade headquarters. The light "A" set, which can be carried in mule panniers, has linked up brigade headquarters to battalions, and wireless telephony between "contact" aeroplanes and various land formations has been utilised. Telephonic communication between tanks on the move has been shown to be possible if the tanks are not more than five or six miles apart.

We are given to understand that Marconi's Wireless Telegraph Co., Ltd., has presented a two-valve Marconiphone to the Royal Berkshire Hospital, Reading.

The Mexican Government, we are given to understand, intends to change the apparatus in use in its radio stations from the present spark system to the continuous wave type. It is said that four modern stations of this class have already been ordered from Germany at a cost of 200,000 dollars. They are to be installed in Mexico City, Merida, Vera Cruz, and Tampico.

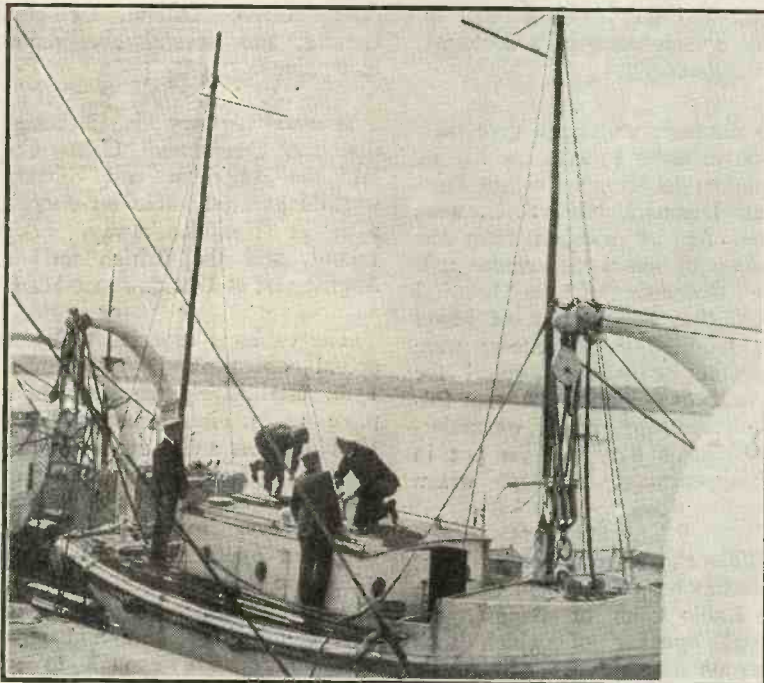

A lifeboat aerial being erected prior to the wireless apparatus being used for practice.

stations in the principal towns of the country.

Captain Viscount Curzon, M.P., writing in the *Yorkshire Observer* in an article "The Theatre and Broadcasting," states: "Quite recently a body of purblind persons approached Madame Melba's agent and persuaded him not to permit her to broadcast one act of the opera in which she was to appear. Apart from the anti-artistic and the inquisitorial aspects of this action, they succeeded in disappointing thousands

high charges and taxes. Wise managers who are in accord with the spirit will doubtless give this point serious thought. Any man who hopes to live by the public must have the sympathy of the public, and that is not won by such exhibitions of meanness as the one indicated above."

One has read a good deal lately about careless motor drivers. If some of these people would only listen-in to Captain Twelvetees' absorbingly interesting lectures and talks upon motor cars and

## WIRELESS ON SHIPS' LIFEBOATS

*A short article of topical interest in view of the remarks recently made in the Press in connection with the s.s. "Trevesa."*

**P**ROBABLY the first vessel to carry a lifeboat fitted with wireless was the Cunard ss. "Aquitania," in 1914. Since that date many experiments have been conducted with a view to making the apparatus more efficient without disturbing to any appreciable degree its overall dimensions.

One of the most successful sets designed for lifeboat use is that manufactured by the Radio Communication Co., Ltd., a photograph of which is given below. Tests carried out with sets of this type installed in the lifeboats of the Union Castle Company's R.M.S. "Windsor Castle" have demonstrated that communication can be carried out over ranges of from 200 to 300 miles, although the normal working range is given as 40 to 60 miles only. Sets similar to the one illustrated are at present being fitted to the motor lifeboat on each of the vessels of the Bibby Line, and many other shipping companies have under consideration the question of fitting wireless to the lifeboats of their passenger ships.

The set is primarily intended for use in ships' lifeboats, and is designed to operate on an aerial suspended from two light masts. Tuning can be adjusted instantly to suit aërials differing widely in dimension without loss of efficiency, though the range obtainable will be roughly proportional to the height of the aerial. The set is arranged for transmission and reception on 600 and 300 metres, the former being used to call up ships which are normally listening in on 600 metres, the latter being provided so that the set may be worked on the wavelength which gives the better results when communicating with a particular ship.

The transmitter is operated from an accumulator battery of 10 cells, which is placed in a watertight box. The battery has sufficient capacity to operate the set continuously for a period of six hours. It is usually charged by means of a flexible lead running to a watertight socket fitted in a convenient position on the ship's deck, so that it is not necessary to remove the cells from the lifeboat for this purpose.

The complete transmitter and receiver unit

is fitted in a canvas-covered wood box, the front of the box is divided into two parts, one of which opens downwards and provides a support for the transmitting key and for writing, the other opens upwards and serves as a shelter for the set from rain, etc.

The set contains a panel on which are mounted a wave change switch, variometer handle (for adjustment of aerial tuning for transmission and reception), aerial ammeter, spark gap and "send and receive" switch. The rotary interrupter and transformer are

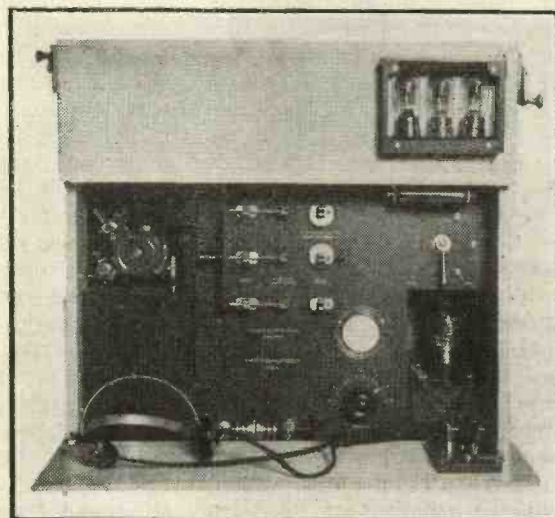

*Illustrating the lifeboat equipment designed by the Radio Communication Co., Ltd., and being fitted by them on motor lifeboats of the Bibby Line vessels.*

placed on the left of the panel and can be easily removed for purposes of cleaning or inspection.

On the right of the panel is placed the receiver which embodies three-valve amplification. The valves used are specially designed to operate on a low anode voltage, which is obtained from the transmitter battery. This arrangement avoids the necessity for employing any form of dry high-tension battery, the reliability of which in an emergency could not be guaranteed. The current for lighting the filament is also supplied from the battery used for transmission.

## AN EASILY CONSTRUCTED CRYSTAL RECEIVER

By STANLEY G. RATTEE, Staff Editor.

The receiving set described in the following article is easily made, simple to operate and will give excellent reception of broadcasting at distances up to about 20 miles.

**P**ROCURÉ a cardboard former 4in. in diameter and 5in. in length, and about half a pound of No. 24 or No. 26 s.w.g. d.c.c. wire. Punch two small holes in the tube about  $\frac{1}{2}$ in. from one end and weave the wire through these holes in such a way that the end of the wire will be firmly anchored, leaving about 6in. free for connections. Wind the remainder of the wire in a single layer, tightly and closely, until 10 complete turns have been wound. At this point make first tapping, leaving a few inches of wire free for connecting purposes.

Proceed in this manner until 6 tappings have been made, one at every 10 turns. After these 60 turns have been wound on the former, take off further tappings for every succeeding turn until 9 additional turns have been wound, leaving ten complete turns between the last 10-turn tapping and the first single-turn tapping. After winding the last turn of wire anchor the end by weaving through two holes punched in the former as was done with the start of the winding.

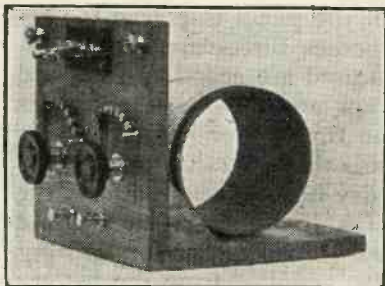

Fig. 1.—Photograph of the completed receiver.

Having completed the tuner to this point construct the panel and wood base shaped as shown in the photograph, Fig. 1. The wood for these may be any dry, hard wood about  $\frac{3}{8}$ in. thick. The terminals for aerial, earth, and telephones may be any that the constructor has available. The switch arms and contact studs, together with the crystal detector, are best purchased complete. The contact studs should be spaced so that the switch arms will not drop between the contacts during rotation.

Having constructed or purchased the several component parts and mounted them on the wood base, proceed to connect the tappings of the inductance to the contact studs and attach other necessary wires. Scrape the cotton insulation from the ends of the tapping wires as well as from the two wires constituting the start and end of the coil. Solder the bare ends of these several wires to the contact studs or fasten securely beneath lock-nuts. Soldered connections are greatly to be preferred. The method of connecting the various tappings will be gathered on reference to Fig. 2.

A wire from the aerial terminal is taken to the switch controlling the single turn tappings and to the crystal detector. Another wire is taken from the crystal detector to one of the telephone terminals; from the other telephone terminal a connection is made to the switch arm controlling the 10-turn tappings and from thence to the earth terminal, as shown in Fig. 2.

Across the telephone terminals

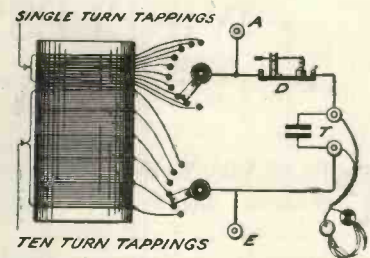

Fig. 2.—Explanatory diagram of the apparatus.

is connected a small fixed condenser, capacity about  $0.0003 \mu\text{F}$ , but in many cases this may be omitted without any appreciable reduction in efficiency.

After all the parts of the receiver have been assembled the first essential operation is to adjust the detector. This may be accomplished in several different ways, the most satisfactory of which requires the use of a testing buzzer.

This—the buzzer—is used as a miniature transmitting station, the signals from which are converted into sound by the telephones and crystal, the loudness of the signals depending upon the position and pressure of the cat-whisker on the crystal. To find the most sensitive spot connect the buzzer to a dry-cell, place it fairly close to the receiving set and adjust the armature so that a clear note is emitted. Vary the position of the cat-whisker upon the crystal until the loudest sound is heard in the telephones. Move the buzzer farther away from the receiver and readjust the detector until the very best result is obtained.

So far as the tuning of this set is concerned, this is attained by adjusting the inductance of the tuner. That is, one or both of the switch arms are rotated until the proper number of turns of wire of the tuner form part of the aerial-earth circuit, to bring it into resonance with a particular transmitting station.

*Note.*—The tuning of a receiver of this type is dealt with at some length in an article entitled "Practical Tuning" appearing elsewhere in this issue, and to which readers are referred for further details.

# THE PHYSICS OF THE VALVE

By J. H. T. ROBERTS, D.Sc. F.Inst.P.

*An interesting explanation of the physical action of the dull-emitter valve.*

## The Advantage of the Thoriated Filament

THE addition of thoria into tungsten during the process of manufacture has the effect of improving the mechanical properties of the filament, and it is, of course, well known that it also increases the electron emission per unit area at a given temperature.

The "dull-emitter" filaments have been principally developed by the General Electric Company in America, and various percentages of thoria have been introduced for the purpose of increasing the thermionic emission. In addition, the rare earth oxides are sometimes coated upon the surface of the filament.

It is considered by some investigators that the use of thoriated tungsten for amplifying valves is unsatisfactory in that it causes an irregular electron emission and leads to valve noises, but others hold quite a contrary view. In so far as the use of these dull emitter filaments permits a great saving in heating current, so that dry batteries can be employed instead of accumulators, there is an obvious advantage, particularly for portable receiving sets.

A thoriated filament should not under any circumstances be raised to a temperature much above that at which it is intended to be operated, otherwise the thoria will be driven off and the filament will for practical pur-

poses revert to the condition of an ordinary tungsten filament. There is a difficulty in this connection in the exhaustion of dull-emitter valves, as great care has to be exercised in the bombarding of the electrodes during the exhaustion process.

## Relative Sizes of Valve Electrodes

The dimensions of the electrodes of a valve depend in a general way upon the intended power or rating of the valve. Valves are now made to cover a very large range of powers, from small receiving valves, having an output of perhaps a milliwatt, to transmitting valves with a rating of 10 or 20 kilowatts.

Considerations which arise when dealing with the design of a valve are:—How to make the electrodes and glass envelope sufficiently massive for mechanical strength, without causing the evolution of unduly large quantities of absorbed gas in operation; how to arrange that the heat radiation from the parts, particularly the anode, shall be the most efficient; how to provide for the greatest possible amount of thermionic emission; and how to secure the maintenance of the insulation between the electrodes.

The relative sizes of the anode diameter, the grid diameter, and the grid mesh for any particular purpose can now be calculated with fair accuracy.

## "WIRELESS WEEKLY" BINDING CASES

THE prices of the cases only are 2/6 (2/10 post free) and 4/6 (4/10 post free) respectively, while the cost of binding back numbers is 4/6 (5/6 post free) and 7/6 (8/6 post free). These latter prices include the cost of the necessary cover and also a very full and complete index, which last can be supplied separately at 1/-

(1/1 post free). Those readers who do not possess the complete volume are requested to remit also the cost of the missing back numbers. New readers can, of course, obtain back numbers for binding from the publishers, or the volume bound complete for 12/6 (cloth) or 15/6 (half-leather), post free.

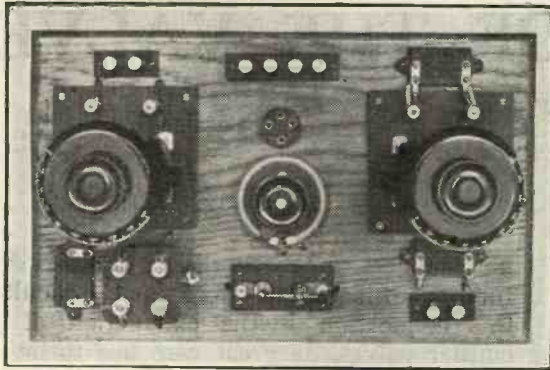

Fig. 1.—The completed receiver as seen from above.

It is expected that forthcoming changes in the licensing regulations will do much to stimulate the home construction of wireless receiving sets. A considerable amount of literature is available for those who wish to undertake the actual construction of all the items which go to make up an efficient set. Many would-be constructors, however, are deterred from making a start owing to lack of the time and facilities necessary for the proper construction of small parts.

Many no doubt realise that the present-day skill and enterprise of wireless instrument makers render available well-finished and highly efficient components, better in appearance and performance than can be produced by the home constructor with only limited workshop facilities.

The purpose of the present article is to show how an efficient modern receiving set can be built up from readily obtainable components with the aid of a few simple tools such as a brace and bit, screwdriver and soldering iron.

The completed instrument is shown in the accompanying photographs, Fig. 1 being a plan and Fig. 2 a front elevation. Fig. 3 is a complete circuit diagram, whilst Fig. 4 is a back view showing the simplicity of the wiring.

#### Components Required

With the exception of the three small ebonite strips which provide adequate insulation for the various terminals, and which will no doubt be on the market shortly, all the components are readily obtainable from advertisers in this journal.

## “WIRELESS WE RECE

By E. REDPAT

No doubt many readers desire to have the set, but lack time or facilities for making valve-crystal reflex receiver which any

The set comprises the following parts:—

**Two variometers.** These may be of any reputed make, those illustrated being of the well-known McClelland type, tuning from about 250 to about 700 metres. The left-hand variometer tunes the aerial circuit and that on the right the tuned anode circuit. The latter variometer is shunted by a fixed condenser (Dubilier) having a capacity of 0.0003  $\mu\text{F}$ . Variometers with specially fine wire windings are now being introduced for use in tuned anode circuits, and, if one of this type is purchased, the parallel condenser may be dispensed with or reduced to a value of about 0.0001  $\mu\text{F}$ .

**Three fixed condensers** of the Dubilier or other equally reliable type. Two of these should have a capacity of 0.0003  $\mu\text{F}$  and one of 0.001  $\mu\text{F}$ .

**One intervalve transformer** having a step-up ratio of about 1 to 4. The transformer

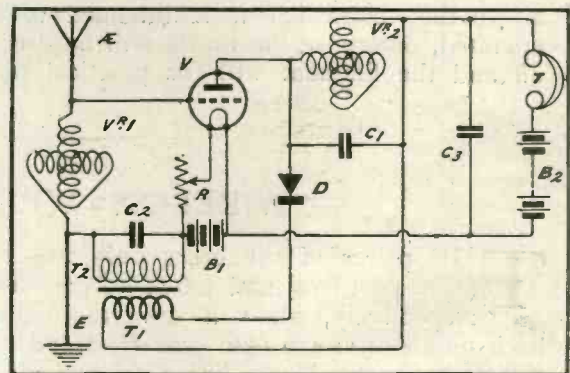

Fig. 3.—The circuit diagram.



## WEEKLY" REFLEX RECEIVER

Assistant Editor.

pleasure of assembling their own receiving  
individual parts. Here is an efficient  
set can build from standard components.

shown in the photograph is one of the Elwell "ironclad" type. The screening which this type of transformer affords is a desirable feature, though perhaps not strictly necessary in this case, and any carefully designed and well-made transformer should prove quite satisfactory.

The remaining components, namely, the crystal detector, filament rheostat, and valve holder are all standard articles, and readily obtainable from wireless dealers.

### Assembling and Connecting Up

All the components are to be assembled upon and properly secured to a wooden baseboard measuring 14 in. by 9 in., and provided with cross pieces beneath each end to raise the board about  $\frac{5}{8}$  to  $\frac{3}{4}$  in.

The actual arrangement will be clearly seen on reference to the photograph, Fig. 1, whilst Fig. 4 shows that holes are to be drilled through the board to clear the projecting

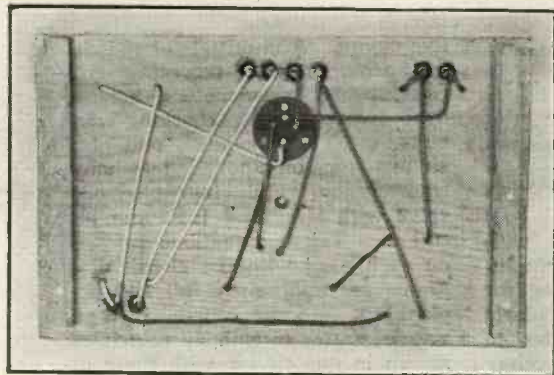

Fig. 4.—The wiring beneath the baseboard.

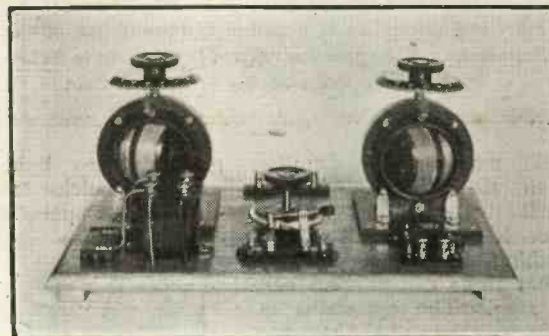

Fig. 2.—A front view of the set.

points of the terminals, to permit the valve-holder to be inserted from the under-side, and to allow the various connecting wires to pass through. Fig. 4, referred to in conjunction with the circuit diagram, Fig. 3, should enable all connections to be correctly made.

### Preliminary Assembly

Those who are desirous of testing the various stages as the work proceeds are advised to try two preliminary assemblies as follows.

Firstly, fit into place one variometer, the crystal detector, and the aerial, earth and telephone terminals. This makes a complete crystal receiver, and the results obtained should be noted so that subsequent improvement can be appreciated. Secondly, add the second variometer with its parallel condenser, the filament rheostat, valve-holder, reservoir condenser ( $0.001 \mu\text{F}$ ), and the battery terminals. Connect up as shown in the circuit diagram, Fig. 3, but short-circuit the telephone receivers in place of the primary winding of the "reflex" transformer,  $T_1 T_2$ .

This will enable the results obtained by one stage of HF amplification, followed by crystal rectification, to be observed, and incidentally will indicate whether everything is in order so far.

### Action of the Set

Upon transferring the telephones to their proper terminals and completing the connections to the primary winding of the reflex transformer, the action taking place in the set is as follows.

(Continued on page 362.)

## SEEING ATMOSPHERICS

*An interesting description of a method of investigation into the properties of atmospherics. The apparatus referred to was recently shewn at a meeting of the Radio Society of Great Britain.*

**M**OST amateurs are familiar with that bugbear known variously as atmospherics, statics, or X's (X often standing for something unprintable), but few realise that these disturbances can also be seen. The apparatus is beyond the resources of the average amateur, but an account of the method used may be interesting.

The chief piece of apparatus is what is known as the Cathode Ray Oscillograph. This consists of a glass vacuum tube A, at one end of which is a small filament B, which can be heated by an accumulator in series with a rheostat. This filament when glowing pro-

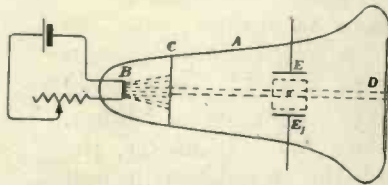

Fig. 1.—The cathode ray oscillograph.

duces a stream of cathode rays which are reduced to a narrow beam by means of a diaphragm C with a circular hole. At the other end of the tube is placed a screen of a certain phosphorescent substance which glows with a

greenish-blue light where the cathode particles strike it. E and E<sub>1</sub> are two parallel metal plates

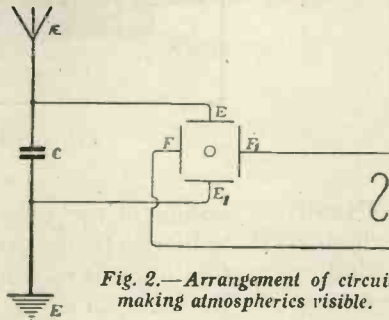

Fig. 2.—Arrangement of circuit making atmospherics visible.

inside the tube, so placed that the beam of cathode rays passes between them. By applying a difference of potential to these plates, the beam will be deflected, which is shown by the movement of the spot of light on the screen D. There are also another pair of plates at right angles to E, E<sub>1</sub>, which are shown by dotted lines in Fig. 1.

To make atmospherics visible the tube is used as shown in Fig. 2.  $\mathcal{A}$  and E are the aerial and earth, C is a condenser, E and E<sub>1</sub>, F and F<sub>1</sub> are the two sets of plates. To F, F<sub>1</sub> is applied a pure alternating E.M.F. produced by a triode oscillator. Its frequency is from 200 to 500 per second. The effect of this

pair of plates alone is to produce, instead of a spot of light, a horizontal line of light since the alternating E.M.F. causes the spot to move rapidly backwards and forwards. When now an atmospheric (or other strong impulse) is received by the aerial, a potential difference is applied to the plates E, E<sub>1</sub>, and this tends to deflect the spot vertically up or down. Hence the two movements combined produce on the screen the wave form of the impulse received by the aerial.

In this way atmospherics may be said to have been seen, and much information as to their properties has been obtained. They are found to be heavily damped trains of waves, their typical appearance being as shown in Fig. 3.

This method is hardly sensitive enough for rendering ordinary wireless signals visible, but this is not to be wondered at, seeing that the average E.M.F. of a signal is 80 micro-volts, whereas that of an

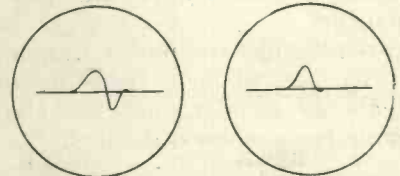

Fig. 3.—Curves representing the appearance of atmospherics.

atmospheric is in the region of 100,000 micro-volts.

The Cathode Ray Oscillograph can also be employed in order to see the wave form of other alternating currents, such as town supplies.

W. E. M.

**The Amateur's Book of Wireless Circuits.** F. H. Haynes. Med. 8vo. Pp. 107. (The Wireless Press Ltd., London). 2s. 6d. net.

This volume includes 111 wireless circuit diagrams covering every conceivable requirement of the wireless experimenter. It commences with a representation and explanation of the graphical symbols used in wireless diagrams and proceeds from the simplest aerial circuit to the loose-coupled crystal receiving circuit; reacting circuits with single inductances are treated together with the wiring of a valve panel. Single valve receivers with tuned

### BOOK NOTES

magnetic reaction are dealt with and so on with many variations including, of course, the wiring for note-magnifiers. A particularly useful set of diagrams relates to an experimental three-valve receiver and includes an actual practical wiring of the set. The Reinartz circuit with variations is illustrated, and the Armstrong super-regenera-

tive circuit. A multitude of switching arrangements, recording circuits, buzzer wave-meters, heterodyne wave-meters, charging circuits, etc., are included, and also circuits for high-power telephony transmission, and four-electrode valve with H.F. and L.F. amplification. The explanations printed on each page with the circuit diagrams are sufficiently full and explanatory and, of course, it is a simple matter to embody principles shown in one circuit with those of another. The book is a compendium of wireless circuits and should prove invaluable to the serious experimenter.

J. H. T. R.



a very simply made turntable, which can be relied upon to give good service and to remain perfectly steady in its action.

The base (Fig. 2) consists of a piece of wood—any kind of wood

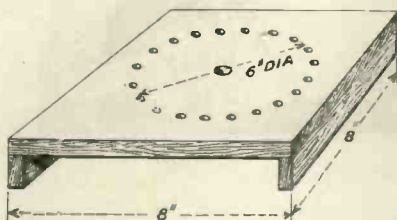

Fig. 2.—Illustrating the base for the frame aerial support.

will do provided that it is seasoned and unwarped—8 in. square and  $\frac{3}{4}$  in. thick. It is provided with two small battens which raise it sufficiently to allow clearance for the nut and shank of the spindle. A  $\frac{1}{4}$  in. hole is drilled through its midpoint, and a 6 in. circle is marked out. Round the circumference of this circle brass escutcheon pins are driven in.

The disc (Fig. 3) is made of similar wood. A brass strip  $\frac{1}{2}$  in. wide is secured round the edge of the under surface by means of screws whose heads are countersunk. The best way of making this strip is to mark it out in segments on a sheet of brass and then to cut out the segments with the shears. The disc is attached to the upright member of the frame by means of two small angle brackets, which are obtainable from any ironmonger. Through the centre of the disc and up into

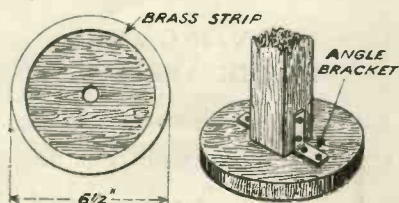

Fig. 3.—Showing disc on which is mounted the frame aerial support.

the upright member is drilled a hole just large enough to take a 4 in. length of brass tubing with an inside diameter of  $\frac{1}{4}$  in. This

tube is to act as a bush for the pivot.

The pivot is a 6 in. length of  $\frac{1}{4}$  in. round brass rod, one end of which is threaded for  $1\frac{1}{2}$  in., and it is fixed to the base by means of a pair of nuts as seen in Fig. 4. It must be so arranged that its upper end does not reach the bottom of the hole in the upright member, for it must not act as a support.

The frame mounted on the disc is now slipped on to the pivot, a little vaseline being applied to the surface of the brass strip. It will be found that it turns quite easily and with perfect steadiness. The brass strip travels smoothly over the heads of the escutcheon pins which take the whole weight of the aerial. The pivot is thus subjected to only the most trifling

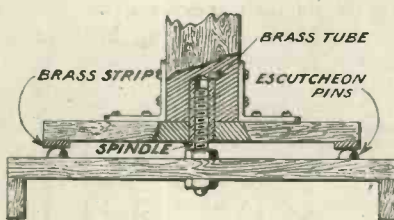

Fig. 4.—General view of the arrangement, showing the respective positions of the different parts.

strains, and as it moves in a long brass bush there is no fear of its becoming loose. This type of mounting can be fitted to any existing frame aerial, and it will be found to repay well the trouble taken in putting it together.

R. W. H.

window cement a piece of tin or copper foil of from 8 in. to 1 ft. square, and connect this to the aerial lead-in wire. On the inside of the window pane, and directly opposite the outer sheet of foil, cement another sheet of the same dimensions. A wire is

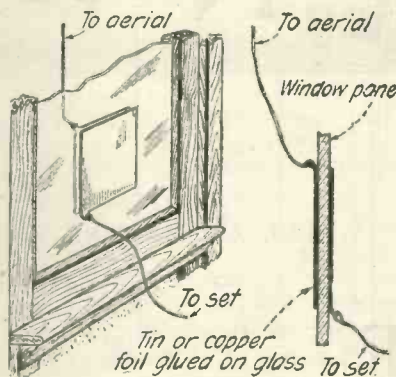

Fig. 5.—A novel arrangement in the form of an aerial lead-in. The metal sheets to which the wires are connected act as a condenser.

led from this directly to the aerial binding post of the receiving set. These two sheets of foil, with the glass window pane between them, act as a condenser in series with the aerial. It is undesirable to have these two sheets smaller than the dimensions given, otherwise considerable losses are likely to be caused, and received signals appreciably weakened, as the small capacity tends to cut down unduly the natural wavelength of the aerial proper.

F. T. S.

A CONVENIENT AERIAL LEAD-IN.

THIS idea is for those who cannot bring the lead-in wire under the window because in summer the mosquitoes get in, and in winter the cold gets in. The accompanying sketch illustrates the idea. On the outside of the upper pane of the

A FINE ADJUSTMENT FOR CONDENSERS.

ANYONE who has gone in at all for long-distance reception on wavelengths of less than 600 metres will have discovered how extremely difficult it is to accomplish the critical tuning needed to bring in weak signals. One keeps on hearing snatches of the desired transmission, but the slightest turn of the

condenser knob causes it to be lost at once.

The reason is that on the short waves a tiny increase or decrease in the capacity in a tuned circuit makes an enormous difference in the frequency of the receiving circuit. With strong signals this does not vastly matter, since they can usually be heard over a fairly wide band; but with very weak sounds, such as those of broadcast transmissions from the United States, matters are altogether different. Here it is essential to be able to tune almost exactly to the frequency of the sending station. The same thing applies, though of course in a lesser degree, to the more distant of our own broadcasting stations and to Continental telephony.

One way out of the difficulty is to use a 3-plate "vernier" condenser wired in parallel with the A.T.C. This is satisfactory up to a point, but it will probably be found necessary to use a second "vernier" in parallel with the closed circuit condenser, which means that the wireless table is apt to become chock-a-block with apparatus.

A very simple tip for obtaining fine adjustment with an ordinary 0.001  $\mu$ F or 0.0005  $\mu$ F condenser is shown in the drawing. A 3 B.A. clearance hole is drilled in the ebonite top in such a position that a screw slipped through it just makes contact with the engraved dial. We now obtain a 1 1/4 in. 3 B.A. screw with a milled head, and work on to it a piece of stout rubber tubing 1/2 in. in length. Over this is placed a thin, flat washer.

The screw is passed through the hole in the panel, a flat washer, a spring washer and a second flat washer being placed in turn over its shank. A nut is then turned down until the screw revolves easily and steadily in its hole, when a second nut is put on and screwed hard down to act as a lock.

It will be seen that as the rubber-covered upper portion of the screw is of very much less diameter than the dial with whose

edge it engages, a whole turn of its milled head will produce quite a small movement of the dial. The gear ratio will, in fact, be 12 or 15 to 1.

Rough tuning is done in the ordinary way by turning the condenser's knob. As soon as a faint signal is heard the small knob is

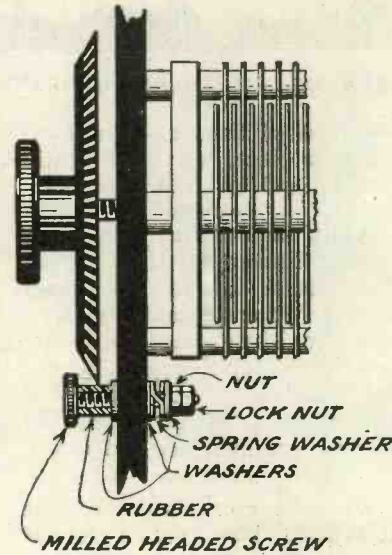

Fig. 6.—Illustrating the "micro-meter" movement.

used, and with its aid such fine adjustments can be made that there is usually no difficulty in bringing the signal up to the fullest possible strength. If the set is used for long-distance work, it is advisable to fit this form of fine adjustment not only to the A.T.C. but to the secondary condenser, as well as to those which tune transformer or tuned anodes and the reaction coil. The same idea may also be applied with excellent results to the dials of variometers and vario-couplers.

R. W. H.

#### A CHEAP SET OF GRIDLEAKS

AS all experimenters know, to get the best results out of a single or multi-valve receiving set, the gridleak must be

of the correct value. After experimenting with various kinds of variable leaks, for many weeks without having much success, I tried dipping a match stick in Indian ink. The result was amazing; the signals were louder and as clear as on a crystal set, and the filament current on the detecting valve could be cut down substantially.

Various resistances may be made by dipping one match stick completely in the ink, while another may be dipped for three-quarters of its distance only. Using an M.O. "R" type valve with the leak connected between the grid and the positive low-tension, I found the best value to be an ordinary match stick completely covered with Indian ink.

I can thoroughly recommend the above method of making a gridleak as it costs next to nothing; the leak is easy to mount and is variable, inasmuch as different leaks may be made and clipped between two small spirals of No. 22 S.W.G. bare copper wire.

E. W. B.

#### SOLDERING CONNECTIONS

THERE are four points to be remembered when making a soldered joint. The surface of the parts to be soldered should be thoroughly cleaned. The surface should be treated with a non-corrosive soldering flux. The temperature of the iron should be kept at the right value, and the point should be properly "tinned." The metal parts should be heated with the iron, and just enough solder applied to cover them.

Provided these precautions are taken, every joint will be a good one, and the apparatus connected in this manner will be silent in its operation, without any of the hissing, scratching and "frying" noises so common among poorly connected sets.

S. G. R.

# Broadcasting News



By OUR SPECIAL CORRESPONDENTS.

**LONDON.**—An attempt will probably be made to induce the President of the League of Nations to speak to 2LO on an ordinary land-line, and his speech will then be broadcast simultaneously if it is received clearly in London. This would be a spectacular demonstration of the possibilities of simultaneous broadcasting.

There is no doubt that the B.B.C. have done well with the simultaneous broadcasting. It was only in March last that the first experiments were made, and these were by no means satisfactory. In the middle of May an attempt was made to relay grand opera to all the stations, but only with partial success. The B.B.C. engineers were a bit down-hearted, and thought that it would never be practicable. However, they kept at it, and the recent tests, which were aptly described as wireless juggling, prove conclusively that simultaneous broadcasting has "arrived."

In October, the London Monday evening programme will be radiated simultaneously. It was said that an all-star symphony programme would be broadcast on these Monday evenings. To the average listener a symphony concert is anything but an all-star performance. It is to be hoped that something very much brighter than a symphony concert will be radiated, otherwise the provincial listeners will get a poor idea of a London programme.

The B.B.C. competition for the best photographs, sketches or de-

scriptions of listening-in is drawing to a close, but there is still time to send in an attempt.

Again we have had the enjoyment of listening to H.M. Grenadier Guards Band. The cornet solo in "Samson and Delilah" was exquisitely rendered; and how well Meyerbeer's "Marche aux Flambeaux" sounded! The soprano solo, "Dear Heart," by Massei, was like good old wine.

Did you ever notice how the kettledrum blots out a lot of music? This was painfully apparent the other night when Messenger's "Les Deux Pigeons" was being played by the London Orchestra. It reminded one of a good "broad" spark, working at high speed.

What an extraordinarily fine voice is that of Miss Gertrude Johnson, of the B.N.O. Co. Her version of Bishop's "Lo, hear the gentle lark" will long be remembered by listeners-in; and how well the notes in the flute obbligato blended with the singer's voice.

#### Forthcoming Events SEPTEMBER.

12th (WED.).—7.15, Dramatic Criticism. 9, Professor Ireland on "History." 10, Sir Alfred Herbert on "Machine Tools."

13th (THURS.).—7.15, Musical Criticism. 9, W. E. Wilkinson, LL.D. (London), on the "New Rent Act." Pavlova Ballet Music from Covent Garden.

14th (FRI.).—7.15, Cinema Criticism. 9, W. W. Watts, of The Victoria and Albert Museum, on "Knives, Forks and Spoons."

17th (MON.).—7.15, Literary Criticism. 9, Major H. Barnes, on "The New Regent Street."

**ABERDEEN.**—Aberdeen station will be opened on October 10th. The date has been postponed from the 2nd, as there are some big events in connection with the coming of the Colonial Premiers, which stand in the way.

**BIRMINGHAM.**—5IT made an unusual contribution to broadcasting recently. Mr. Robert Parker, the bass of the British National Opera Company, had reached one of those fine declamatory passages in the Prelude to "L'Pagliacci" when the station cat stole unobserved to the microphone and emitted a "grand howl." Evidently it appreciated the quality of the music and desired to add its own melody to that of Mr. Parker!

At the conclusion of Sir George Davies' remarks from 2LO on "Preserved Foods" the other night a London listener quickly switched over to Birmingham in time to hear again the last portion of that gentleman's talk broadcast from Birmingham. Does Birmingham Station "bottle up" lectures like this on a gramophone or similar record and turn them loose on their wavelength?

#### Forthcoming Events SEPTEMBER.

13th (THURS.).—Beatrice Evelyn, 'cellist.

15th (SAT.).—Station Military Band.

17th (MON.).—Carmen Hill, soprano, British National Opera Co.

19th (WED.).—Station Repertoire Co., in song recitals.

20th (THURS.).—Margaret Davies and Maurice Coles, of the British National Opera Co.

21st (FRI.).—Mr. Sidney Russell and Miss Russell, of the British National Opera Co., in a farce, "The Collaborators."

**BOURNEMOUTH.**—Mr. Bertram Fryer, who has done such excellent work in Newcastle, is to get the much-coveted position of Director of the Bournemouth station, which will possibly open on October 17th. Mr. Fryer made excellent use of the comparatively limited material at his disposal, and if he can mobilise all the talent which is resident in and which visits Bournemouth he will speedily make the new station one of the best in the country.

**GLASGOW.**—The Scottish play, "Rob Roy," which was broadcast by 5SC, was the most ambitious attempt of the kind yet made from any broadcasting station in the country. The piece was produced under the direction of Mr. R. E. Jeffrey. Nearly 100 performers took part in the production, which occupied a little over two hours. Reports from various quarters show that the actors and vocalists were heard clearly and distinctly throughout the Glasgow area.

On October 6 "Rob Roy" will again be broadcast from the Glasgow station and relayed from the various stations throughout the country, in order that radio enthusiasts all over Great Britain may have an opportunity of hearing it.

From September 16th Glasgow station is going to revert to "winter time," the concert programme being provided from 7.15 to 10.30, with an interval from 9.0 to 9.30.

**MANCHESTER.**—The transmissions from 2ZY have improved considerably since the new station opened. The orchestra also has made rapid strides under the guidance of the station director, Mr. Dan Godfrey, jun.,

A.R.A.M., and Manchester can now pride itself upon having one of the finest instrumental combinations of any of the British broadcast stations. The number of permanent players is 13, but on the fortnightly symphony orchestral nights the number is increased to 25. We are not sure that any improvement is made by the extra number, as the microphone appears to be swamped, so to speak, and the reproduction is confused. Doubtless there is a limit to the power of the microphone to assimilate the various sounds, but improvements in this direction may be expected in due course.

BROADCAST TRANSMISSIONS		
	Call-Sign	Wavelength
CARDIFF	5WA	353 metres
LONDON	2LO	369 "
MANCHESTER	2ZY	385 "
NEWCASTLE	5NO	400 "
GLASGOW	5SO	415 "
BIRMINGHAM	5BT	420 "
TIMES OF WORKING.		
Weekdays	... 3.30 to 4.30 p.m. and 5.0 to 10.30 p.m. B.S.T.	
*London	11.30 a.m. to 12.30 instead of 8.30 to 4.30 p.m.	
Sundays	... 8.30 to 10.30 p.m. B.S.T. 2LO 3.0 p.m. to 5.0 p.m. also.	
SILENT PERIODS.		
CARDIFF	8.0	to 8.30
LONDON	6.15	to 7.0
MANCHESTER	7.45	to 8.15
NEWCASTLE	9.0	to 9.30
GLASGOW	9.0	to 9.30
BIRMINGHAM	8.0	to 8.45

The opera series begins on September 17th with "Il Trovatore." "Carmen" will be sung on October 1st, and other works to be performed include "Lohengrin," "Faust," "Rigoletto," "The Valkyrie," "Don Giovanni," and "The Flying Dutchman."

The operatic evenings will last from 7.45 to 10.15, and usually the whole work will be given.

**Forthcoming Events**  
SEPTEMBER.

12th (WED.).—Special afternoon concert at 3.30: Miss Beatrice Eveline, solo cello; Miss Kate Winter, soprano; Mr. John Ward, tenor. Land line transmission at 8.30 of opening of British Association's Meeting at Liverpool. Sir Ernest Rutherford on "The Electrical Structure of Matter."

13th (THURS.).—Mr. Miles Hodgson, elocutionist. Miss Ealain O'Neill, soprano. Suite for flute and piano; Mr. Joseph Lingard, Miss Jessie Cormack. Miss Annie Chadwick, soprano. Mr. Joseph Markham, tenor.

14th (FRI.).—Talk by Mr. Geo. W. Thompson on "Builders of Ancient Rome." Ridgeway's Dance Band.

15th (SAT.).—2ZY Orchestra. Mr. Tom Powell, tenor. Mr. Victor Smythe as "Algy."

16th (SUN.).—Sylvian Male Voice Quartet. Mdm. Emily Hardman, soprano. Mr. Stuart Hemingway, tenor.

17th (MON.). Mr. David Openshaw, baritone. Talk by Mr. William Miller (of Millers' Fashion Service). Special operatic night, "Il Trovatore," by the 2ZY Operatic Company. Soloists: Miss Madge Taylor, Miss Olive Mackay, Mr. William Hindle, Mr. Lee Thistlethwaite. Conductor: Mr. Dan Godfrey, jun., A.R.A.M. Lecturer: Mr. Moses Baritz.

18th (TUES.).—2ZY Orchestra. Miss Carmen Hill, soprano. Talks on "Steeplejacks and their Work," by Mr. S. Bidder, who erected the aerial at the new Manchester station.

19th (WED.).—Mr. Maurice Cole, pianist. Miss Marguerite David, soprano. 2ZY Orchestra.

**SHEFFIELD.**—It is not safe to prophesy, as far as Sheffield is concerned, but we learn that this next week-end may see some land-line relay work carried out, from the Birmingham and Manchester stations, the relayed items being radiated from the new Sheffield station.

In the meantime the temporary broadcasting station at Ventnor Place is to carry on almost up to the time of the opening of the new relay station. Experiments with the latter have given great satisfaction so far, but it must be remembered that even when a practical effort is made to give the public relayed matter, great things must not be expected at first. Capt. Eckersley and Capt. West are, however, doing their utmost to make the scheme a success right from the start.

## SINGLE OR DOUBLE-WIRE AERIAL

By A. W. SPECKLEY.

*As there are divided opinions among experimenters on this subject, the following article is of interest. The views expressed are not necessarily ours, and we invite our readers' criticisms.*

WITH the advent of broadcasting on low wavelengths the question as to the best type of aerial to employ assumes an importance not previously considered. When telegraphy, with an occasional French or Dutch concert, was the goal of experimenters, the twin or double aerial was adopted without question, and the single wire was used as a result of lack of facilities to erect a double wire. As a rule the owner was of the opinion that he was handicapped thereby in comparison with his more fortunate friends.

It has always seemed strange to me that although a large amount of information as to mast construction, insulation, etc., etc., was to be found in every text-book, little or no reason was given to explain why any particular type of aerial should be erected; the respective merits were skimmed over and the beginner was left with the impression that it did not matter very much which he adopted.

My own experiences and experiments have forced me to take up a definite position with regard to this matter, and in order to promote, or provoke, some interest in the subject, I propose to give my reasons for discarding the double in favour of the single wire.

An aerial, as we know, possesses both capacity and inductance, both of which are necessary to enable us to tune to a given wavelength, but what is not generally understood is that to obtain the maximum strength and efficiency, these two factors must be present in their correct proportions, and here I would like to protest against the oft-repeated statement that a certain sized coil will tune from such a wavelength to such a wavelength with the help of a variable condenser. It will do nothing of the sort! It will certainly cover

the difference between the two figures, but it will be at efficiency at the one point on the condenser where the inductance and capacity are in agreement, and at that point only.

Most of us have noticed that although we can "get" a particular station with several combinations of coils and condenser values, there is one particular coil which gives us the best results.

In my opinion, 90 per cent. of the sets in use are tuning-in low wavelengths with too much capacity and too little inductance.

It cannot be over emphasised that it is the inductance that supplies the potential to grid and that too much capacity in the circuit has a damping effect, and we should, therefore, use as much inductance as possible.

Now the regulation twin wire aerial is of high capacity, and will not admit the introduction of sufficient inductance into the circuit to obtain the proportions necessary for best reception on low wavelengths.

This disadvantage has been felt by most experimenters, and the advice generally given is to put the condenser in series with the aerial. This permits the use of a larger coil, but is not by any means a satisfactory method, for whilst admitting that the total capacity is now less than the smaller capacity and also variable, there is a dead-end effect somewhat similar to that experienced when using a large solenoid on short wavelengths.

This then is the reason for using the single wire of low capacity, but another fault still to be found with the double wire is that it is very difficult to get the two wires identical in every respect, and unless this is done you are actually working on *two* aerials of different values, making it almost impossible to tune to the critical point so necessary for the reception of pure telephony.

### A NEW TYPE OF CRYSTAL RECEIVER—

See next week's "WIRELESS WEEKLY."



# RANDOM TECHNICALITIES

By PERCY W. HARRIS, Assistant Editor.

*Consideration of the cost of apparatus.*

**A**S *Wireless Weekly* is read by many people new to wireless, and who most probably will attempt to make their first set from purchased components in the coming dark evenings, it may be interesting to consider for a few minutes what the costs are likely to be. It is easier to arrive at a figure for the cost of such a set than is generally realised, for so many components are common to practically every kind of set and are fairly well standardised as to price.

Naturally the cheapest of all is a crystal set. If this is of the simplest single-coil slider type, it will only be necessary to buy the wire, a brass rod, a slider, four terminals, a fixed condenser to shunt across the telephones, and a crystal with its holder and cat-whisker. The cost of the baseboard can be left out, as this may generally be constructed from odd wood lying about the house.

Insulated wire for winding inductances is sold by the pound. No. 24 enamelled is quite a good wire for the beginner to use, and enough to wind an inductance to cover the wavelength range required with an ordinary aerial can be purchased for about 2/-. A slider with spring and plunger costs about 6d.; brass rods for the slider about the same, and, if you should buy it, an inductance tube of treated cardboard is also obtainable for 6d. or less. Excellent and well-made crystal holders on ebonite bases, and fitted with cat-whisker, can be bought at prices from 3/6 to 5/-, although cheaper varieties which work quite well can be purchased for as low as 2/-. A really good specimen of crystal costs about a shilling, and a good fixed condenser half a crown. First-class terminals can now be bought for 3d. each.

Of course these figures do not represent the cheapest that can be obtained, but the prices are fairly representative of good quality com-

ponents for the man who is rather fastidious. If the crystal set is to consist of an inductance withappings and fine tuning is carried out with a variable condenser, the cost will go up at once. The studs will generally need to be mounted on a panel of ebonite, although good dry wood will do, and a switch-arm with sufficient number of contacts will need to be purchased. A good switch-arm fitted with ebonite knob, washers, etc., and, say, half a dozen studs with nuts and washers can be purchased for 1/6 to 2/6. The variable condenser will cost anything from 10/6 to 25/-, according to the quality, and your ebonite panel will probably cost you 2/6.

Valve sets, of course, are more expensive, not only because the valves themselves cost money, but because of the necessary batteries that go with the set. For a one- or two-valve set a 30-ampere-hour (actual) accumulator is big enough, and this will cost about £2 to £3, according to quality. For a three-valve or four-valve set I would recommend a 40-ampere-hour (actual), which will cost 12/- or 15/- more. A 60-volt high-tension battery for any valve set, single- or multi-valve, will cost about 14/-, and the valves themselves can be put down at 15/- each, unless you choose to use the dull-emitter valves which sell at 27/6 each. Telephone headpieces for use with either crystal or valve sets run at about 20/- to 30/- a pair, and a good loud-speaker costs about £6. Standard components used in every valve set are filament resistances (2/6 upwards), grid condenser (2/6), gridleak (2/6), valve socket (1/- or 1/3). Any fixed condensers which are shunted across telephones, intervalve transformers, primaries, etc., cost about 2/6 each.

If you wish to confine yourself to reception of the broadcasting band of the British stations, a set of plug-in coils will cost you about £1. If you make your own inductances with

tappings and switches, as described on the previous page, you will save some money, of course. If you use a variable condenser for tuning, this will cost you another £1 or so.

These few indications will show that building your own apparatus is not a matter to be embarked upon under the impression that a four-valve set will cost you about £1. In the foregoing items will be found most of the essentials with approximate costs, and it will be seen that these alone, without any "fancy" fittings, will make the price mount up. If note-magnifiers are used, you will need an intervalve transformer for each stage of such magnification, and these will cost from 20/- to 30/- each.

A point to be borne in mind by the home constructor is that if he has built a one-valve set and subsequently desires to build another, the same high- and low-tension batteries, telephones, filament resistances, gridleaks and the like will probably serve just as well in the new set as in the old. In this way once one has started in the game of home building, continuance is not so expensive as might appear

at first. Most experimenters use a needless amount of ebonite in their sets, and as this is a very expensive item, much saving can be effected by leaving out all except that which is absolutely required for insulation.

Again, if you are a beginner, it is well that you should have clearly in your mind the limitations under which wireless works. Many newcomers in the *business* of wireless, as distinct from the *hobby*, have sought to revolutionise the business by stating bluntly that they want "none of this complication;" but simply a set which will have a dial on it, marked for the various stations. They imagine a set can be designed with such a dial, so that the user can turn from one station to the other "merely by twisting a knob." Unfortunately, as every serious experimenter found long ago, the design of such a set cannot yet be effected. Conditions of reception vary from day to day and from night to night, and whilst on some evenings it is quite possible to hear, say, Glasgow strongly with a two-valve set, on other nights, when conditions are not normal, it will perhaps need a three- or four-valve receiver to reach the same degree of audibility.

## "WIRELESS WEEKLY" REFLEX RECEIVER

(Continued from page 353).

The differences in potential set up across the aerial tuning variometer,  $VR_1$ , and applied to the grid and filament of the valve, set up amplified but still oscillating currents in the tuned anode circuit,  $VR_2$ ,  $C_1$ , in Fig. 3. Rectified pulses of current at audio frequency flow through the crystal detector D and the primary winding  $T_1$  of the reflex transformer  $T_1 T_2$ , and are thus passed back again into the grid circuit of the valve to undergo low-frequency amplification, the resultant audio-frequency current then actuating the telephones T connected in the positive side of the anode or high tension battery  $B_2$  (60 to 100 volts).

### Operation

To operate the set, connect up the aerial, earth, telephones, and batteries to their ap-

propriate terminals; adjust the filament rheostat until the valve is burning at correct brilliancy, and set the crystal detector, merely by guesswork, to a point where a fairly loud click is heard each time contact is made. Search for signals by swinging the aerial variometer slowly through  $180^\circ$ , changing the position of the anode variometer about  $5^\circ$  or  $6^\circ$  at each swing.

When signals are heard, adjust the two variometers to give the best results; carefully reset the crystal detector and, finally, try the effect of varying the filament brilliancy by means of the rheostat.

When purchasing the necessary components, specify that they are to be used in the assembly of a *Wireless Weekly* Reflex Receiver, and your supplier will see that you get either the identical articles specified, or satisfactory alternatives.



Conducted by A. D. COWPER, M.Sc.

#### A Vernier Variable Condenser

FROM Messrs. Gaston E. Marbaix we have received a variable condenser, for panel mounting, of approximately  $0.001 \mu\text{F}$ , provided with a three-plate vernier in the same instrument operated by a small knob in the centre of the main knob. This instrument is manufactured by a well-known American engineering firm, and really beautifully constructed and finished. A high-class bevel scale is supplied, marked from 0 to 100 divisions, and substantial stops. The instrument is designed for fixing under the panel by two screws, a card template being supplied for drilling the panel.

The rigid construction, good mechanical design, and smooth movement of the concentric spindles are particularly noticeable. Small copper soldering tags are provided for connections.

On test the insulation was found to be excellent, the maximum capacity about  $0.001 \mu\text{F}$ , and the minimum reasonably small; the electrical connections are effective and silent in operation, great care having evidently been taken to ensure this. The vernier gave very fine tuning and was extremely handy in use.

Altogether a very fine instrument indeed for the discriminating experimenter.

Also made in  $0.0003$  and  $0.0005 \mu\text{F}$  capacities.

#### An Accumulator-charging Set for Alternating Current

Messrs. Serjeant & Rose have submitted for practical test a

rotary converter, consisting of an alternating-current motor of  $\frac{1}{2}$  h.p. designed for 220 volts and 25 to 80 cycles alternating supply, and a direct-current dynamo delivering 5 amperes at 8 volts continuous, for home-charging of accumulators. The motor and dynamo are both mounted on a substantial

6-volt accumulator at an ordinary rate of 3 amperes it ran steadily, with little vibration, practically no sparking at the dynamo brushes, and minimal at the A.C. motor-brushes; also the bearings remained cool. The motor heated up quite noticeably, but apparently not dangerously. The output was steady and easily controllable.

The general impression of finish and workmanship was quite favourable; the efficiency was as high as can be expected from so small a unit. It forms a convenient and easily operated charging means for those who have A.C. mains in their homes.

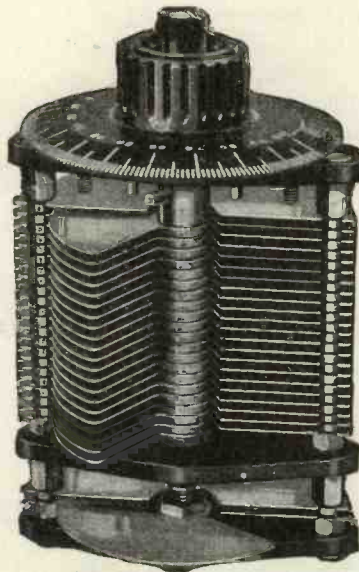

The Gaston E. Marbaix condenser.

base-board, the drive being through a flexible coupling. An adjustable resistance is also provided for regulating the speed and output.

On actual test on an A.C. supply the machine was observed to take from  $\frac{1}{2}$  to  $\frac{3}{4}$  ampere, according to load, from the A.C. supply, and delivered all of rated amount of D.C., without immediate signs of overload. On a long run in actual charging of a

#### An Enclosed Crystal Detector

Messrs. Armac have submitted for test an enclosed type of crystal detector, with a sensitised galena crystal and conventional cat-whisker, mounted on a neat ebonite base, provided with two substantial terminals. Provision is also made for the easy replacement of the crystal.

On practical test the setting of the cat-whisker was found to be convenient, the action being smooth and positive, without backlash. In actual reception, in comparison with a good standard Perikon detector, and also with proprietary galena crystals, the detecting qualities were found to be excellent. Local broadcasting, on a P.M.G. aerial, and a really efficient tuner, was clearly readable, every word being distinct, on the loud-speaker. This was in daylight, and about 13 miles from 2LO.



# Mainly about Valves

Our weekly causerie written by the Editor.

## Obtaining Negative Grid Bias

**Y**OU will remember that recently I was speaking about methods of obtaining a negative grid bias for amplifying valves. An idea which a more experienced experimenter may like to try out is shown in Fig. 1. This shows a power amplifier using two valves. The negative potential for the two grids is obtained, not from any battery, but from the drop in E.M.F. across a resistance included in the common anode circuit.

The resistance  $R$ , shunted by a capacity  $C_2$ , is included between the negative terminal of the high-tension battery  $B_2$  and positive side of the filament accumulator  $B_1$ . There is normally a steady anode current flowing round the anode circuit, and as this passes through the resistance  $R$  making the right-hand end of  $R$  negative with respect to the filament, it is possible to obtain a negative potential on the grids of the two valves by connecting the bottom end of the secondaries  $T_2$  and  $T_4$  to the right-hand side of the resistance  $R$ .

The condenser  $C_2$  is to smooth out any variation of potential across  $R$ , as it is, of course, only desired to give the grids a steady d.c. potential of, say, -10 or more volts, or in some cases perhaps only -5 volts, depending upon the high-tension voltage and the type of valve used, and the position of the valve.

As regards the values of the resistance  $R$ ,

for an ordinary amplifier using about 100 volts, a resistance of 6,000 ohms will usually be about right, while the condenser  $C_2$  has a value of not less than  $\frac{1}{2} \mu\text{F}$ , this condenser preferably being as large as possible. The ideal conditions would be to have the resistance tapped to enable different voltages to be obtained, a large condenser being also connected across the tapped portion.

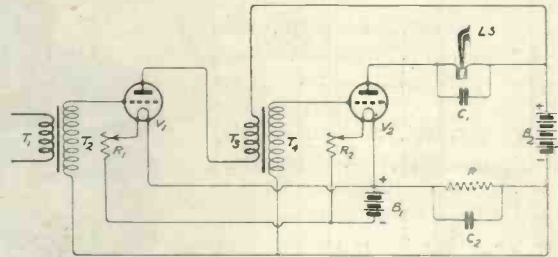

Fig. 1.—Illustrating a novel method of obtaining negative grid bias.

An advantage of the arrangement is that the negative potentials on the grids are more or less automatically regulated, no matter what high-tension voltages are applied; the greater the high-tension voltage the greater will be the current flowing in the anode circuit, and consequently the greater the potential difference across  $R$ ; it will therefore be seen that the grids will have a higher negative potential, which is what is wanted.

### SEPTEMBER.

13th (THURS.).—Ilford and District Radio Society. Informal meeting.

14th (FRI.).—The Leeds and District Radio Society. Lecture, Mr. D. Pettigrew, "Care of Brown's 'A' Type Phones."

### FORTHCOMING EVENTS

20th (THURS.).—Ilford and District Radio Society. Mr. A. J. Thompson. Lecture on "Vacuum Tubes."

20th (THURS.).—Hackney and District Radio Society. Mr. J. Skinderviken will lecture on "The Skinderviken Microphone Button and its Uses."  
27th (THURS.).—Ilford and District Radio Society. Informal meeting.

# Correspondence

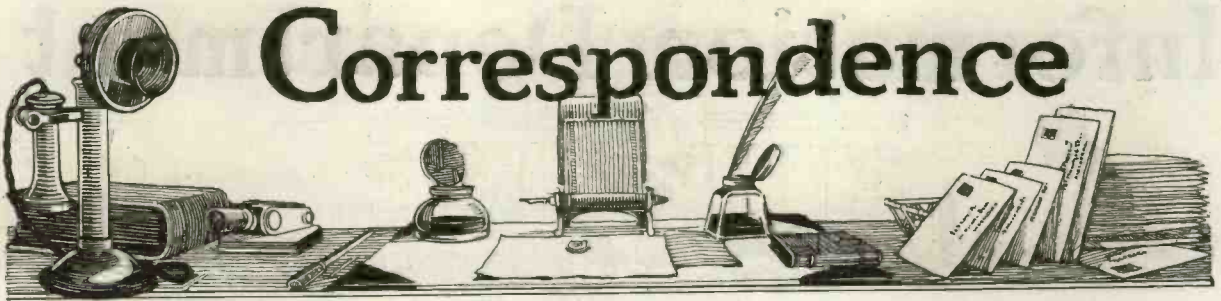

## PICTORIAL CIRCUITS

SIR,—You have often invited criticism, and I am now putting before you my personal idea *re* the following.

Latterly you have adopted pictorial diagrams, and I tried to follow one or two, but the exertion was too great during the heat wave, and as I noticed you also used the conventional diagram, have left them alone since. In my opinion this pictorial diagram would be better omitted. The conventional symbols are clear and very easily memorised, and the diagram at a glance shows what each connection is doing.

The pictorial diagram would only be useful to anyone making a slavish copy of it, without any idea of what they were doing, and its educative value would be nil. With the other type of illustration the veriest tyro could not help getting some idea of the circuit.

I hope you will not allow the newer style to oust the old one. Many good things come from U.S.A., but this is a retrograde step, to my thinking.

I am, etc.,  
ARTHUR HOBDAY.

[We shall be pleased to learn the views of other readers in this matter.—Ed.]

## ST75

SIR,—I thought your readers might be interested to learn the results from the circuit ST75 which I have made up and somewhat modified as per diagram.

*Components.*—McClellan variometer; Cossor as H.F. and Marconi "R" as detector; Ferrix

transformers by Rose, Lloyd & Co., Ltd.; 0.0002  $\mu$ F condenser for anode coil; S4 and 75 Burndept coils.

No aerial is used with this set, whilst the earth is made to a main waterpipe 10ft. away. 2LO is too loud for telephones. The results on a Claritone loud-speaker are excellent.

5IT can be tuned in but with difficulty, inasmuch as the coupling has to be so tight that the set is inclined to oscillate. 5NO

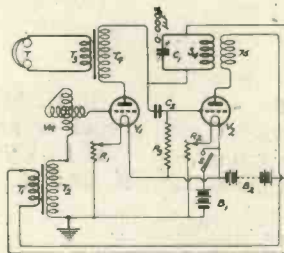

The circuit referred to by Mr. Collins.

(Newcastle) is very clear, and every word from this station can be distinctly heard. On July 28th between 10.20 and 10.30 p.m. the dance music, including the item "Play That Song of India," was received from 5NO. Subsequently I heard the News Bulletin and Weather Report, which I noticed were word for word as per 2LO.

It would seem that capacity is a great trouble with this circuit, the least movement of the body whilst tuning in 2LO causing howling. Amateurs such as 2OM, 5PU, etc., are easily tuned in and very clear.

I am, etc.,  
CHARLES COLLINS.  
London, S.W.12.

## ANOTHER OPINION

SIR,—My criticism of "C. H. S." in *Wireless Weekly* is that all he requires is a textbook to learn theory. I am sorry he cannot see the big interest *Wireless Weekly* has created solely through publication of new circuits. I am, etc.,

Devon. J. A. WEBBER.

## THE RADIO SOCIETY

We are asked to publish the following letter to The Secretary of the Radio Society of Great Britain.

DEAR SIR,—Reference your letter of July 30th giving details of a new scheme for representation on the National Committee; at our meeting on August 10th it was unanimously decided:—

"That in the matter of representation on the Committee of the Radio Society of Great Britain London should be treated as a separate group entirely and under no circumstances should any member of an affiliated society of the London group represent the provincial societies on the National Committee."

As this seems to be a matter of easy adjustment we trust that your Committee will give it immediate attention.

As there is at present no other means of communicating our ideas to other provincial societies a copy of this resolution is being forwarded to the wireless press.

Yours faithfully,  
P. SAWYER,  
Hon. Sec.

[We agree with the views of this society, and believe the Radio Society are adopting them.—Ed.]

# Information Department

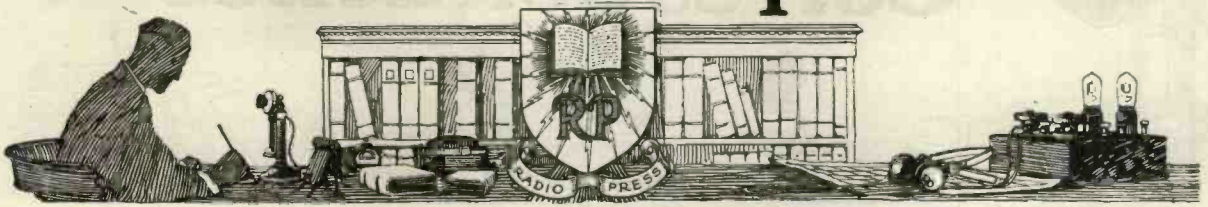

**"VALVE" (LEEDS)** wishes to construct a three-valve receiver with an inductively coupled tuner, one H.F. and one L.F. valve. He asks for switching arrangement so that he may use one, two or three valves at will.

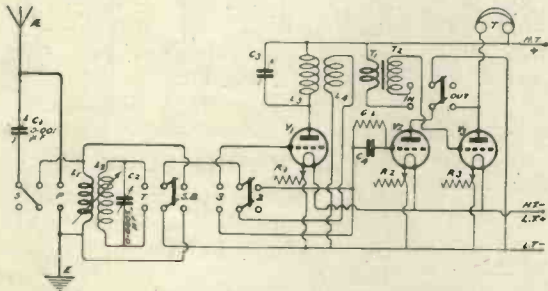

The above diagram illustrates a suitable type of receiver, and shows switches for effecting the connections you desire. The condensers  $C_3$  and  $C_4$  should each have a value of  $0.0003 \mu\text{F}$ , the former being variable. The gridleak GL is 2 megohms.

**J. O. J. (N.W.6)** wishes to construct filament rheostats for his multi-valve receiver, and asks for particulars.

To make an efficient filament rheostat suitable for controlling two valves of the high-temperature type operating from a 6-volt battery, you will require a former upon which about 15 ft. of No. 22 s.w.g. bare Eureka resistance wire may be wound. This will give the desired fine adjustment of temperature, at the same time possessing sufficient resistance to enable the valves to be worked at their most suitable point.

**J. G. (BOLTON)** wishes to construct two coils, one for a wavelength of 14,000 metres and the other for a wavelength of 23,450 metres. These are to be tuned by means of  $0.001 \mu\text{F}$  variable condensers in parallel.

For the construction of long wave coils such as those you specify, wire of about No. 36 s.w.g. should be used. If a 2 in. diameter former is employed, 1,200 turns of this wire will be required for the first coil and 1,500 turns for the second one. These coils may be wound in slab formation, and embedded in paraffin wax.

**F. R. (CHISWICK)** experiences considerable trouble from crackling noises in his set, which he is unable to trace. He has tried several different H.T. batteries, gridleaks and even filament accumulators, but the noise still persists. He asks our advice.

As you appear to have examined all the most likely sources of this trouble, and as your connections are well soldered, it is very probable that the trouble is due to a defective intervalve transformer, or, alternatively, to the insulation of your telephones being defective. In both these cases the remedy is obvious, but we suggest that, to determine from which source the noise arises, you borrow a pair of telephones which you know to be in perfect condition and test them against your own.

**T. C. M. (RETFORD)** is constructing the receiver shown on page 248 of "MODERN WIRELESS," No. 4, and asks the values of  $R_6$  and  $R_7$ ,  $C_4$  and  $C_5$ .

Employ leak resistances of 2 megohms each for  $R_6$  and  $R_7$ . The condensers,  $C_4$  and  $C_5$ , should each have a maximum of  $0.0003 \mu\text{F}$ .

**E. H. L. (LEICESTER)** wishes to construct the ST100 circuit, but desires to employ a valve in the place of the crystal. He asks where he may find particulars of such an instrument.

Details of a three-valve ST100 circuit which dispenses with the crystal rectifier appeared in *Wireless Weekly*, Vol. 2, No. 2.

**R. W. F. (MANCHESTER)** has a receiver in which both the aerial and anode circuit tuning are effected by means of variometers, and wishes to introduce reaction into the apparatus so as to strengthen signals and increase the selectivity.

Reaction can be included by connecting in series with the second variometer, namely, that in the anode circuit of the first valve a small basket coil which can be coupled to another basket coil connected in series in the plate circuit of the second valve. A two-coil holder will enable the coupling to be adjusted conveniently.

**H. H. E. (BIRMINGHAM)** has a B.B.C. crystal receiver, and asks how he may extend the wavelength range of this so that it is possible to receive Paris time signals.

In order to receive the transmissions from this station it will be necessary to connect in series with your present inductance another considerably larger variable inductance. This may be 4in. in diameter and 8in. long, wound with No. 24 s.w.g. enamelled copper wire and fitted with a slider.

**H. A. C. (E.C.4)** refers to the article on an experimental two-valve receiver by A. R. Wiskin which appeared in "WIRELESS WEEKLY," Vol. 2, No. 7, and states that he is unable to wind the number of turns specified in the article on to the formers for the basket coils. He queries the dimensions of these.

The dimensions of the formers referred to are correct. We regret, however, that, owing to an error on the author's part, the gauge of wire was incorrectly stated. This should be No. 28 s.w.g., double silk covered wire, instead of No. 24 s.w.g., as specified in the article.

**J. W. (ROCHESTER)** is making the 4-valve receiver described in "MODERN WIRELESS," No. 3, page 190, Fig. 8. He asks the values of various components for the reception of British Broadcasting, also what range he might expect on this receiver.

$C_1$  should be  $0.0003 \mu\text{F}$ ,  $C_2$ ,  $0.0002 \mu\text{F}$ , and  $C_3$ ,  $0.0003 \mu\text{F}$ .  $L_1$  should be a No. 35 or 50 Igranic coil;  $L_2$  should be a No. 75 Igranic coil. The gridleak resistance should be 2 megohms. If these values are employed in this instrument, you should expect to hear all the British Broadcasting Company's stations on telephones.

**A. Y. M. (FOREST GATE, E.7)** has made up the ST100 circuit and obtains exceedingly good results. Loud-speaker signals are clear and strong when the loud-speaker is close to the receiver, but when he attempts to take this into another room, it is found that persistent howling occurs.

The trouble in connection with the use of a loud-speaker at the end of long flexible leads could be overcome by the use of a low-resistance loud-speaker and a telephone transformer. In this instance, the usual bridging condenser of  $0.002 \mu\text{F}$  should be connected across the fine wire winding of the telephone transformer. It might also be possible to cure it by using an intervalve transformer as a step-down transformer with your present loud-speaker. In addition, try connecting various sizes of fixed condensers across the loud-speaker terminals. A condenser of about  $0.005$  or  $0.006 \mu\text{F}$  capacity would be suitable for this purpose.

**F. S. (PAISLEY)** has a cardboard tube 2½in. in diameter by 6in. long and wishes to wind it to cover the British Broadcasting Company's band of wavelengths, using No. 20 s.w.g. d.c.c. copper wire.

A suitable inductance for this purpose can be constructed by winding your tube full with a single layer of the No. 20 wire in your possession. This should be tapped at four equal intervals, after the thirtieth turn, a stud switch being made to permit selection of any number of turns as required. This, in conjunction with a variable condenser of  $0.0003 \mu\text{F}$ , will cover the broadcast range.

**T. W. (LIVERPOOL)** has a valve receiver, comprising detector valve and two low-frequency valves, which continually howls. He submits particulars of his tuning apparatus, and asks whether the values of the condensers are unsuitable, and if so whether this would cause the howl.

We do not think that the trouble which you experience from howling is due to unsuitable condensers. It is more likely to be due to reaction effects, which may be at high- or low-frequency. If the reaction is taking place at low-frequency, it may be cured by reversing the connections to one or other of the intervalve transformer primary windings. You can ascertain whether the howling is in the high- or low-frequency part of the set by varying the tuning of the aerial circuit when the set howls. This will alter the note if it is due to high-frequency reaction. Variation of the filament resistances of the low-frequency valve should alter the note if the howl is at low-frequency.

**E. T. Y. (LANCASTER GATE)** requests a circuit diagram of a loose-coupled crystal set.

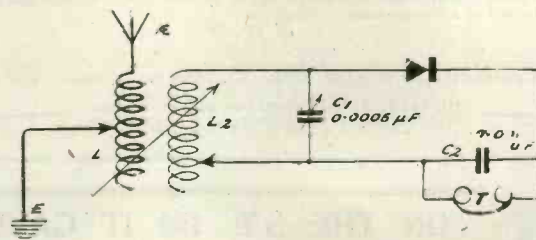

We show herewith a suitable arrangement for your purpose. For the reception of British broadcasting, the coil  $L_1$  should consist of 60 turns of No. 20 s.w.g. d.c.c. wire wound on a 3in. tube, and fitted with a slider, and coil  $L_2$  should have 100 turns of No. 26 d.c.c. wire wound on a 2½in. tube. This should be tapped at every 10 turns. The telephones T should be of high resistance, say, 2,000 ohms or more.

**GOOD TOOLS MEAN EFFICIENT WIRELESS SETS**  
 We give you Best Quality Tools with lowest prices by supplying the user direct. Send us your Postal Order or enquire to-day; you'll get our best immediate attention. None too small or too large.  
**WE PAY CARRIAGE ON ALL ORDERS.**

<b>HAND DRILL</b> , capacity 0-1". Gears cut from full metal. Complete with Three-Jaw Chuck and set of Drills, 3", 3.5", 4", 4.5", 5", 5.5", 6", 6.5", 7", 7.5", 8", 8.5", 9", 9.5", 10", 10.5", 11", 11.5", 12".	10/6
<b>ADJUSTABLE STEEL HACKSAW FRAMES</b> , 8-12", Nickel Plated, complete with 1 Blade	2/-
<b>SUPERIOR PARALLEL TABLE VICES</b> , with clamp, 2 1/2" steel jaws, accurate finish	6/6
<b>COMBINATION PLIERS</b> . Flat nose, Burner Hole, side cutting, 6"	1/9
<b>SCREWDRIVERS</b> , London Pattern, flat handles, 6"	1/3
<b>ELECTRICIANS' TURNSCREWS</b> , steel blades, hardwood handles, 4" only	8d.
<b>HAMMERS</b> , Kent Claw pattern, good quality	1/6
For light model work, tack or pin hammers.	1/6
<b>FILES</b> , Best Cast Steel, set of 3, 6" (Flat Bastard, Flat 2nd-Cut, Flat Smooth)	1/8
Half-round 6"—Bastard, each, 7d., 2nd-cut, each 8d., Smooth, each 9d.	9d.
<b>STOCKS &amp; DIES</b> , B.A. (Dies 1/8" dia.) cutting 2, 4, 6 and taps. London made.	
On card with Taper Taps	10/- per set.
with Taper and Plug Taps	12/6

**THE BILLING TOOL CO.**, 303, HIGH HOLBORN, Phone: Holborn 898. LONDON, W.C.1.

**BEWARE OF WORTHLESS IMITATIONS, SEE THE TRADE MARK *Watmel* ON EVERY GRID LEAK.**

**WATMEL VARIABLE GRID LEAK**  
 (Patent applied for.)

The Resistance is steadily Variable between 1/2 to 5 megohms. Only requires a 3/8 in. hole in panel for fitting

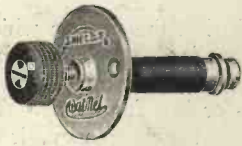

Suitable for use in any circuit, and improves the working of any valve detector. (50,000 to 100,000 ohms for the S.T.100 Circuit. Price 3/6.)

**PRICE 2/6 EACH**  
 The best Variable Grid Leak made.

**WATMEL WIRELESS CO.** Connaught House, 1a, Edgware Road, Marble Arch, W.1. Tel. 4575 Paddington.

All the advantages of experimenting with a 2-valve set are yours for half-a-crown. if you have

**PHILIPS' MODEL**  
 of  
**WIRELESS RECEIVING SET**  
 designed by  
 W. H. DERRIMAN, B.Sc., A.C.G.I., and N. COX-WALKER.

Of immense value to the amateur who desires to gain knowledge of the functioning of valves—a subject which is often so difficult to understand without the aid of expensive apparatus. The model will appeal strongly to those who hold or contemplate holding an experimental licence. The model is of stout cardboard folded to size 10x7 1/2 inches and is contained in a strong manila envelope.

Price 2/6 net  
 (post free 2/8).

Obtainable from all Booksellers, Stationers, and Apparatus Dealers or direct from **GEORGE PHILIP & SON, LTD.**, 32, Fleet St., London, E.C.4.

**NO LISTENER-IN should be without Philips' Wireless Map of Great Britain. Price 2/6 net.**



**"ON THE S.T. 100 IT GAVE A FINE ROAR WITH 2L0's DANCE MUSIC AUDIBLE AT THE END OF A LARGE SUBURBAN GARDEN."**

*Extract from test report by Mr. A. D. Cowper, B.Sc. (Lond.), in "Wireless Weekly," July 25, regarding the EEC "Xtraudion" Valve.*

**ECONOMIC ELECTRIC** Telephone: MUSEUM 1055

Head Office: 10, FITZROY SQUARE, LONDON, W.1. Showrooms: 303, EUSTON RD., N.W.1. Branch Showrooms: TWICKENHAM.

J. N. (GLASGOW) has made up a crystal receiver on the lines of the broadcast receiver described in "How to Build your own Broadcast Receiver," Radio Press Limited, but is unable to erect an outside aerial. He is two miles from 5SC and wishes to know whether he might expect results with a frame.

With very careful adjustment you might be able to hear the broadcasting from 5SC, which we understand uses the maximum power permissible. The frame is connected across the aerial and earth terminals of the set, and might be tuned by a small variable condenser having a value not greater than 0.0003 μF. You will most probably obtain better results with an indoor aerial arranged beneath the rafters of your house. Or even a number of straight lengths of wire arranged along the top floor with leads brought down the staircase to the ground floor, as described in the current issue of *Modern Wireless*.

J. B. G. (N.W.6) asks whether we consider circuit ST45, "Practical Wireless Valve Circuits," Radio Press Limited, to be a satisfactory arrangement of three valves for general receiving purposes, and if so would we give him the value of suitable components for broadcast reception.

Circuit ST45 probably represents the best way of connecting up three valves for broadcast work. The values of the various components for this purpose should be as follows:—

- Coils L<sub>1</sub>, L<sub>2</sub>, and L<sub>3</sub>, Nos. 50, 75, and 75 Igranic respectively.
- Condensers C<sub>1</sub>, C<sub>2</sub>, C<sub>3</sub>, and C<sub>4</sub>, 0.001 μF (variable), 0.00025 μF (variable), 0.0003 μF, and 0.002 μF (fixed).
- The value of the gridleak R<sub>1</sub> should be 2 megohms, and the telephones T of a resistance greater than 1,000 ohms.

G. A. P. (SOUTH LAMBETH, S.W.8) submits a circuit diagram of his high-frequency amplifier, which does not, however, produce any amplification. He asks whether it is correct, and if not could we advise him.

Your circuit is quite correctly arranged, but we do not think you are employing the proper size of intervalve coupling condenser. The small condensers marked 0.001 μF in your circuit should be about 0.0002 μF. You should, however, try high-frequency transformer coupling, as it is difficult to get this arrangement to work if extended to more than one stage.

R. K. (PENZANCE) sends us a photograph of a five-valve receiver he has recently purchased, and asks whether he could eliminate interference from the stations at Land's End, Lizard, etc., which give him great trouble.

We are afraid you will always experience interference from these stations, as the receiver the illustration of which you submit is not at all selective. If you were to remove the tuning apparatus in the existing set and substitute an inductively coupled arrangement with carefully tuned primary and secondary, you might obtain better results. We suggest as an alternative that you experiment with the interference eliminating circuits described in *Wireless Weekly*, Vol. 2, No. 5, when probably Type "C" will be found the most suitable.





# Radio Press Books give him all the information he needs

## Complete List

	Price.	Post Free
1. Wireless for All . . . . . John Scott-Taggart, F.Inst.P.	-16	-17½
2. Simplified Wireless . . . . . John Scott-Taggart, F.Inst.P.	1/-	1/1½
3. How to Make Your Broadcast Receiver . . . . . John Scott-Taggart, F.Inst.P.	1/6	1/7½
4. How to Erect Your Wireless Aerial . . . . . B. Mittell, A.M.I.E.E.	1/-	1/1½
5. The Construction of Wireless Receiving Apparatus . . . . . P. D. Tyers.	1/6	1/7½
7. How to Make a "Unit" Wireless Receiver . . . . . E. Redpath.	2/6	2/8
9. Wireless Valves Simply Explained . . . . . John Scott-Taggart, F.Inst.P.	2/6	2/8
10. Practical Wireless Valve Circuits . . . . . John Scott-Taggart, F.Inst.P.	2/6	2/8
11. Wireless Licences and How to Obtain Them . . . . . E. Redpath.	1/-	1/1½
Elementary Text-book on Wireless Vacuum Tubes . . . . . John Scott-Taggart, F.Inst.P.		10/- (Post free)

Those printed in heavy type have been published recently.

HOW many turns for a Coil to reach the Paris Wavelength—the type of circuit to operate a Loud Speaker using only an indoor Aerial—Crystal or Valve rectification in a multi-valve Set? These are a few of the questions which confront the amateur constructor.

Some will find out the correct answers by expensive experiment—others, more wisely, will benefit by the experience of those who have trodden the thorny paths of Radio before them.

The concentrated experience of some of the best known Wireless engineers and experimenters is available for all readers of Radio Press Books. You cannot do better than purchase the complete Library—one Book at a time. Each Book covers a different phase of Wireless and none overlap. Get one or two to-day and keep them by you for ready reference—they are sure to save their cost many times over. From all Booksellers.

RADIO PRESS LTD.,  
Devereux Court, STRAND, W.C.2.

**Radio Press Books**  
— a complete wireless library

Gilbert Ad.

# The Valve for perfect reception

The holiday season is over and your thoughts are turning to the pleasures of the longer nights.

Broadcasting has improved by great strides since last winter, both in quantity and quality. To enjoy it to the full, you must use Mullard Valves.

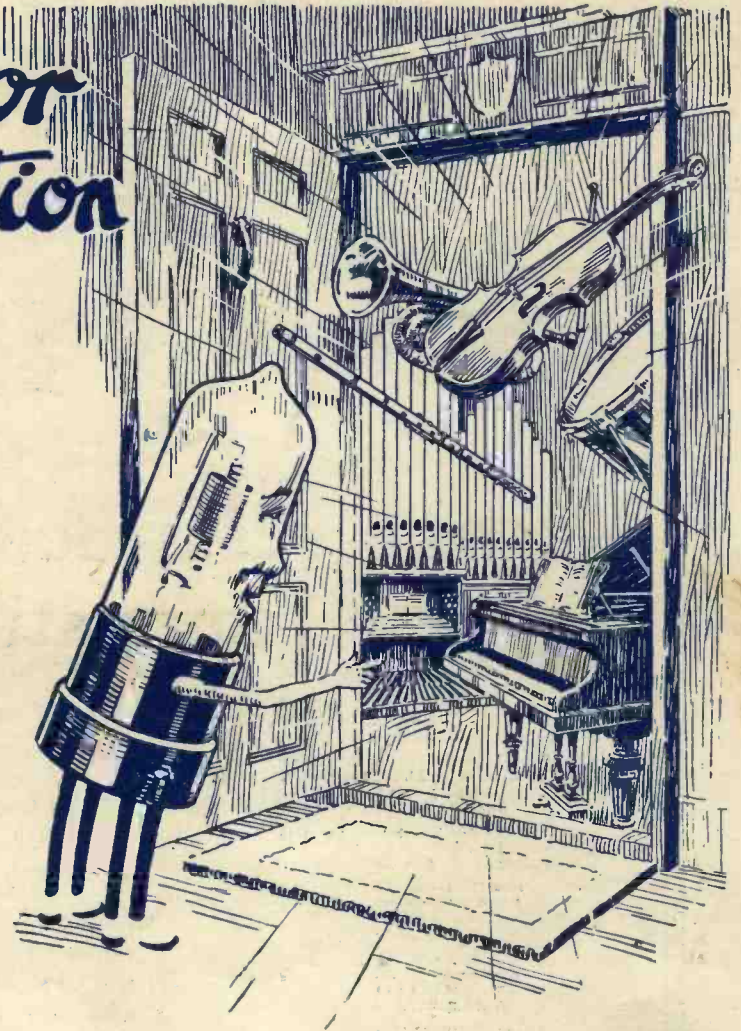

E.P.S. 58

Type "Ora" and "R" for general reception with 4-volt accumulators	15 0
Type L.F. (low filament current) for general reception with 2-volt accumulators or suitable primary batteries	£1 7 6
Type P.A. for loud speakers, giving good volume without distortion	£1 2 6 to £1 15 0

*Ask your usual dealer for them and for particulars of other Mullard products.*

# Mullard

*Obtainable from all high-class electricians, wireless dealers, etc.*

# Wireless Weekly

and The Wireless Constructor

Vol. 2.  
No. 10.

## CONTENTS

A New Type of Crystal Receiver.

Radio Shadows.

Tuning Two-Circuit Receivers.

An Easily Constructed Note Magnifier.

Some American Circuits.

Constructional Notes, Broadcasting News, Jottings by the Way, News of the Week, Apparatus we have Tested, Mainly about Valves, Correspondence, Radio Press Information Department, etc., etc.

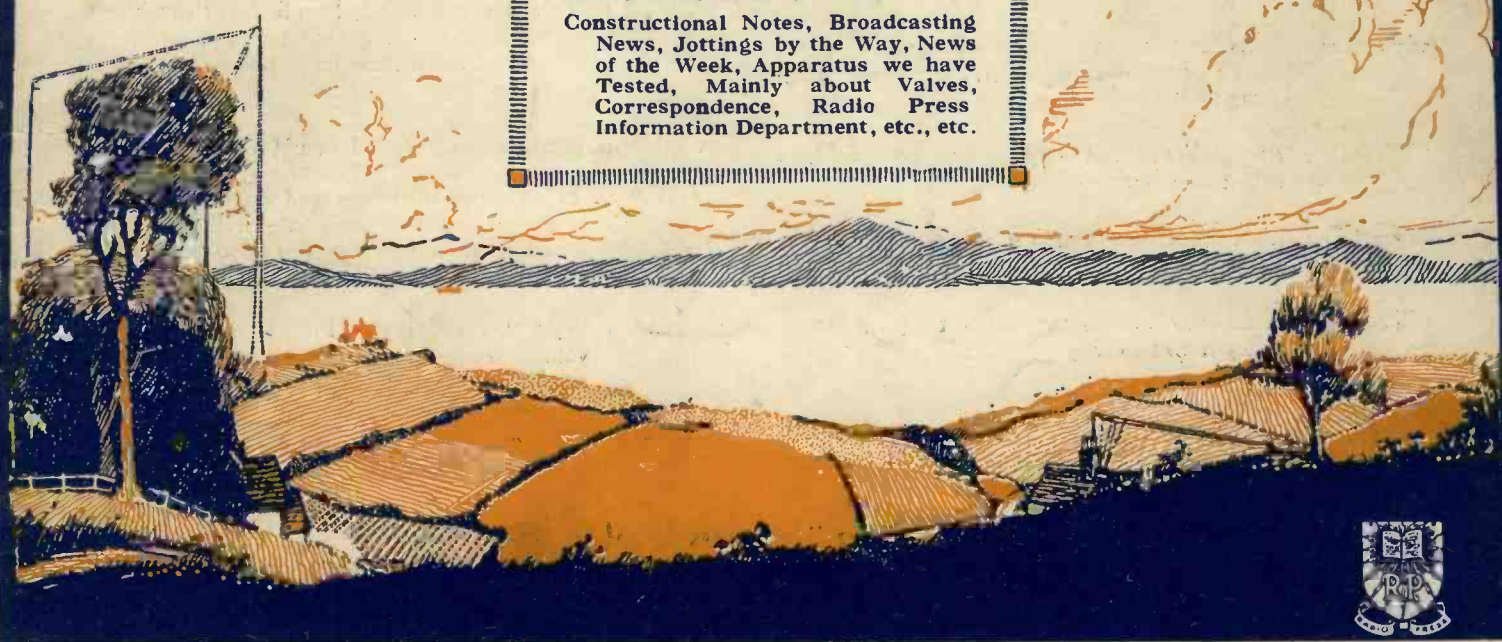

The Potentialities of Broadcasting.—By Dr. Lee de Forest



Talks with the  
Wireless  
Advertiser  
No. 9

## “Coming it” again!

**Advertiser:** I can *not* talk advertising now—

“W.W.”: Why not? Surely—

**Advertiser:** Surely because I’m getting busy, and when I’m busy I don’t need to advertise.

“W.W.”: But that’s nonsense—proved times without number.

**Advertiser:** Well, I think it’s logical to advertise when there’s no business, and when the business comes along to stop advertising.

“W.W.”: Ah! Yes! But *you* have done no advertising to get *any* business.

**Advertiser:** Maybe not; but I’m just saying what I think about it.

“W.W.”: And I must politely but finally tell you such a policy is quite wrong.

**Advertiser:** But don’t you find it’s what a lot of people think?

“W.W.”: They *try* to think it where I am concerned, but I’m proud to say I have convinced many to the contrary.

**Advertiser:** Yes?

“W.W.”: It’s a fact, and already I am finding that with the approach of the long expected wireless revival my order book is becoming “bulkier and bulkier every day.”

**Advertiser:** What do you suggest I should do?

“W.W.”: Try a series of halves and quarters alternate weeks on our £15 series rate and prove what others have done—that you always need to advertise.

**Advertiser:** Right you are, then. I’ll start at once to test your view against mine!

*All enquiries for Advertising space in “Wireless Weekly” should be addressed to —*

**Scheff Publicity Organisation, Limited, 125, Pall Mall, London, S.W.1.**

Phone—Regent 2440 (2 lines).

# Wireless Weekly

Vol. 2, No. 10,  
Sept. 19, 1923

## CONTENTS

	Page
Editorial - - - - -	370
The Potentialities of Broadcasting - - - - -	371
"Wireless Weekly" Circuits—No. 23 - - - - -	373
Tuning Two-Circuit Receivers - - - - -	374
A 1½-K.W. Valve Transmitter - - - - -	376
Jottings by the Way - - - - -	377
An Easily Constructed Note-Magnifier - - - - -	379
Broadcasting News - - - - -	381
Radio Shadows - - - - -	383
Some American Circuits - - - - -	385
A Crystal Receiver on a New Principle - - - - -	386
Constructional Notes - - - - -	388
News of the Week - - - - -	391
Random Technicalities - - - - -	392
Apparatus We Have Tested - - - - -	393
Correspondence - - - - -	394
Radio Press Information Department - - - - -	395

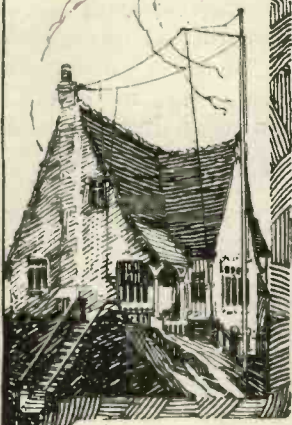

Editor: JOHN SCOTT-TAGGART, F.Inst.P.  
Assistant Editors { E. REDPATH.  
P. W. HARRIS.

Scientific Adviser:  
Prof. G. W. O. HOWE,  
D.Sc., M.I.E.E.  
Advisory Editors:  
Prof. R. WHIDDINGTON,  
M.A., D.Sc.  
Prof. C. L. FORTESCUE,  
M.A., M.I.E.E.

**Radio Press, Ltd.**  
Publishers of Authoritative Wireless Literature  
**DEVEREUX COURT, STRAND, W.C.2**  
Tel.—Central 3763.  
Advertisement Managers: { SCHEFF PUBLICITY ORGANIZATION,  
LTD., 125, Pall Mall, London, S.W.1.  
Tel.—Regent 2440.

Staff Editors:  
E. H. CHAPMAN, M.A., D.Sc.  
A. D. COWPER, M.Sc.  
G. P. KENDALL, B.Sc.  
A. L. M. DOUGLAS.  
R. W. HALLOWS, M.A.  
S. G. RATTEE.



All correspondence relating to contributions is to be addressed to the Editor of "Wireless Weekly."

Nothing contained herein is to be regarded as permission or encouragement to infringe any patent rights.

# Editorial



## Simultaneous Broadcasting

THE success attained in simultaneous broadcast transmission was exemplified on Wednesday night last when the presidential address of Sir Ernest Rutherford to the British Association at Liverpool was successfully transmitted from all the British broadcasting stations.

It was singularly appropriate that the first speech to be simultaneously transmitted should be that of the eminent scientist who specialises in the study of electrons and atoms, the present-day knowledge of which has done so much for the development of wireless.

The remarkable nature of the achievement is appreciated when it is realised that listeners as far distant as Glasgow and London heard the words of the speaker actually before members of the audience at the back of the hall in Liverpool. The time taken by the sound waves to traverse the length of the hall is about one-fifth of a second, whilst less than one-fiftieth of a second suffices for the land-line and wireless transmission to be reproduced in the telephone receivers of distant listeners.

Simultaneous broadcasting in a case where the "broadcast matter" (to quote from the P.M.G.'s licence to the Broadcasting Company) is really of national interest, is an excellent thing, and will do much to further the realisation of the potentialities of broadcasting, as so ably discussed by Dr. Lee de Forest in another page of this journal.

The method has now passed beyond the experimental stages, and we look to the B.B.C. to make full and proper use of the new development in broadcasting. We mention this because we know that many readers, particularly provincial readers, view with a certain amount of alarm the possibility of simultaneous transmission depriving them of

an undue proportion of entertainment from their local station, for which they naturally have the highest regard. Enthusiasts in Northumberland and Durham maintain that 5NO is "quite the best of the stations," whilst those in South Lancashire and Cheshire will argue stoutly in favour of 2ZY, and we feel sure the B.B.C. will appreciate and value this regard too highly to jeopardise it by an unnecessarily frequent or unjustified use of simultaneous broadcasting.

## Further Progress

Despite the continued non-appearance of the Report—the latest information at the time of going to press being that it will be published *shortly*—public interest in matters wireless continues to revive, with a consequent improvement in the conditions of the wireless industry generally, members of which appear to be gaining increased confidence and making a whole-hearted effort to overcome the ill effects of the long depression.

That wireless, and broadcasting in particular, will be extremely popular this coming winter cannot be doubted, and what is wanted more than anything at the present time is a united effort on the part of all who have the real interests of wireless at heart, firstly, to obtain a definite and final settlement of the licensing and protection questions and so put wireless once and for all above the ill fate which seems to have dogged it ever since the introduction of broadcasting; and, secondly, to make personal considerations secondary to a determination to increase the popularity of wireless in the British Isles to an extent which, a year ago, would have been considered impossible.

One opportunity for a combined effort in this direction will occur in the forthcoming All-British Wireless Exhibition and Convention, to be held in the White City, Shepherd's Bush, from November 8th to 21st.

# THE POTENTIALITIES OF BROADCASTING

By Dr. LEE DE FOREST.

*In the following article this well-known inventor expresses broad views on the possibilities of future broadcasting.*

**I**N 1909 when the idea of radio broadcasting first occurred to me, and the music of the Metropolitan Opera singers was for the first time launched upon the ether, and again in 1916 when for the first time regular radio

radio broadcast, which vision the last eighteen months has been bringing more and more into reality. But I confess that in those early pioneer days my eager imagination fell far short of picturing the astonishing hold with



*Transmitting the news bulletin.*

*Our centre picture shows the valve panel at Carnarvon, Wales, by means of which direct communication with Australia was made possible.*

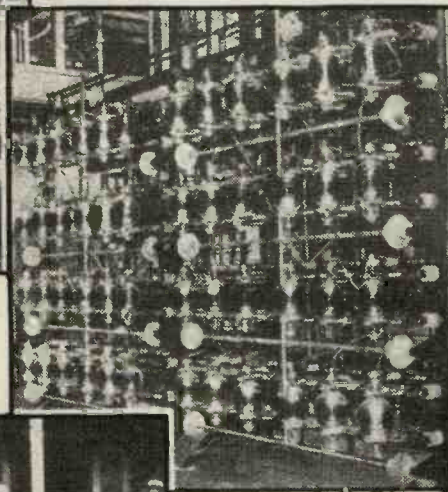

*The broadcasting of a sermon direct from the pulpit is a further reality of broadcast transmission.*

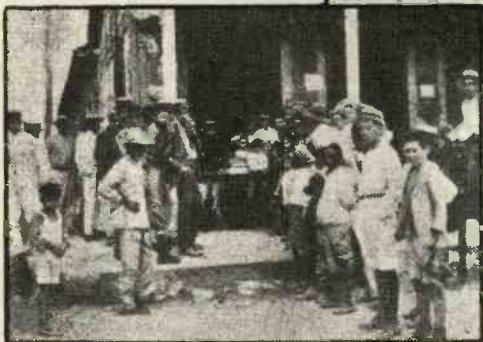

*Natives of Havana listening to broadcasting emanating from New York.*



concerts were maintained from the old station at Highbridge, when I had a small but intensely interested audience growing in numbers nightly—there began to dawn before me a vision of the astonishing potentialities of the

which this idea so suddenly gripped the entire American nation. And not alone the American people, for I have found that in England, France, Holland, and even in Germany, wherever the fame of American broadcasting

has penetrated it has enkindled to an astonishing degree the imagination of classes which one might doubt would respond so quickly. In truth, the broadcasting idea which America may be justly proud of originating is already outgrowing national boundaries. Already the radio telephone is beginning its benign work of breaking down the artificial barriers erected by politics or race. Nothing since the early days of the discoverers has so appealed to the imagination of a nation. No other medium in man's history has demonstrated its unique powers for uniting far separated sections of a great country, for causing to become acquainted dwellers in distant districts from north to south—from east to west. More than the newspaper, more than the postal service, this mighty service of hearing the spoken voice in greeting, the public address, the sermon, the lecture, the musical programme, is actively uniting us in a bond of common fellowship, common acquaintanceship, as no other conceivable instrumentality can accomplish. I predict that as an educational medium the radio telephone broadcast will in time prove second in importance only to the public school. Already we see a closer interlinkage between the people of Canada and ourselves due to the broadcasting idea; and soon these benefits will extend to Europe, between the peoples of the old world, always heretofore strangers, enemies because strangers and personally unacquainted. When night after night the citizens of foreign lands will hear the friendly words, the music and the songs from across strange frontiers, then gradually will the feelings of enmity and suspicion, based chiefly on distance and ignorance of each other, change to understanding and goodwill. Thus I maintain that radio broadcast with its irresistible educational influence is destined to prove one of the most potent powers for abolishing war.

So rapidly is this movement growing that it will not be long before the necessary high power broadcasting stations will be planted in all our cities, each covering a sufficiently wide area to enfold the entire land in a mantle of music, to breathe into every ear which cares to listen, voices of comfort, of nightly companionship with the world's doings and the world's best minds. "Just a Song at Twi-

light"—but its lovely echoes are being heard in the miner's cabin, in the rancher's hut, in the living room of the old farmhouse, over the mountain range, beyond the desert, across the silent prairie, over the wastes of sea. And who can say what minds are not awakened, what souls that were deadened, what hearts long embittered by loneliness, will not be stirred to a new life, a new outlook by that sound?

When one seriously considers the human side of this broadcasting idea and its possibilities, one must admit that it possesses potentialities for universal education, and for all the train of good which results from universal education, which can be compared only to that brought about during the past five centuries by the art of printing. Only this new revolution will grow to maturity in a decade, instead of 500 years—a graphic commentary on the acceleration of man's present progress.

I have for a long time maintained that this educational value of radio broadcasting will prove by far its greatest worth—to the people of our country—and later of all nations. No doubt just now the entertainment feature is the most striking, the phase most appealing to the popular desire, naturally enough. Unquestionably the fine programmes which are now being given by the large broadcasting stations are accountable for the astonishing spread of receiving stations during the past eighteen months.

But comparison of radio broadcasting to the introduction of the printing press is not too bold. When newspaper and press syndicates realise its full possibilities in their own field (and their leaders are rapidly coming to this realisation), this comparison will become commonplace. Editors now have a medium where antenna wires take the place of Mergenthaler type-setters, ether waves of ink and press paper, head 'phones of spectacles and ears of eyes. It is indeed gratifying to me to note the whole-hearted and enthusiastic co-operation of the American press generally to the broadcasting idea. Without this broad vision on the part of newspaper men the present popularity and astonishingly rapid growth of broadcasting would have been quite impossible.

HAVE YOU READ THE CURRENT ISSUE OF "MODERN WIRELESS"?  
DON'T HESITATE, BUY IT TO-NIGHT.





# TUNING TWO-CIRCUIT RECEIVERS

By G. P. KENDALL, B.Sc., Staff Editor.

Further simple explanations regarding the practical manipulation of receiving apparatus.

(Continued from Vol. 2, No. 9, page 342.)

WHEN we come to consider receivers containing more than one tuned circuit we find that the operations of tuning are becoming more complex and the necessity for logical methods is more than ever apparent. The method given for tuning-in with a receiver possessing two adjustments, such as described in my last article, will prove helpful in working out a method for such a receiver as that of Fig. 1 herewith, since it conveyed the idea of progressive alteration of one variable quantity and the simultaneous variation of another.

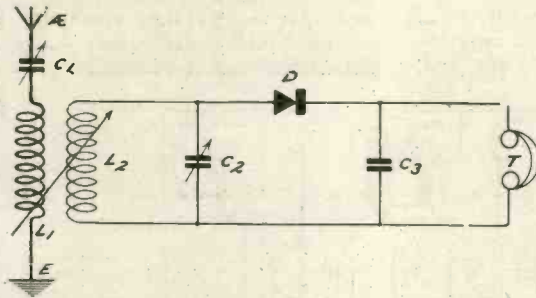

Fig. 1.—A simple two-circuit crystal receiver.

In Fig. 1 we have a receiver whose two circuits we will assume are tuned by means of interchangeable plug-in coils and the variable condensers  $C_1$  and  $C_2$ , the coils  $L_1$  and  $L_2$  being mounted in a two-coil holder so that the coupling between them is variable. The special advantage of this circuit is its selectivity, *i.e.*, its sharpness of tuning and consequent power to discriminate between waves of closely similar lengths, when the coupling between the two tuned circuits is moderately weak. Under these conditions both circuits must be tuned fairly accurately to the wavelength of the signals before they will be heard, and since there is no indication given when either of them chances to be in tune without the other, a systematic method of

making the various adjustments possible must be adopted.

First see that a suitable pair of coils are in use, referring if necessary to the chart in *Modern Wireless*, No. 6, making the various capacity allowances previously explained. Next place the two coils close together, *i.e.*, coupling tight, set the aerial tuning condenser ( $C_1$ ) to, say,  $5^\circ$  on its scale and revolve  $C_2$  between zero and maximum. If no signals are heard, increase  $C_1$  to  $10^\circ$  and again vary  $C_2$  round its whole range. Increase  $C_1$  by a further  $5^\circ$ , revolve  $C_2$ , and so

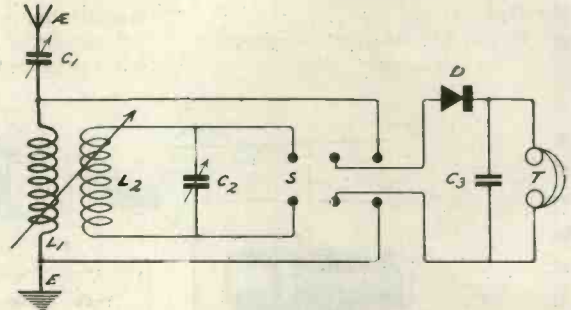

Fig. 2.—A two-circuit receiver with stand-by-tune switch.

on, proceeding by additions of  $5^\circ$  until the whole scale of  $C_1$  has been covered.

If the signals still have not been picked up it may mean that their wavelength falls outside the range covered by the pair of coils in use, or that the exact adjustment required upon the aerial tuning condenser happens to be between the various  $5^\circ$  steps which were tried. If the latter is the most probable explanation, set  $C_1$  to  $2\frac{1}{2}^\circ$  and proceed as before in  $5^\circ$  increases, thus testing a series of adjustments between those previously used.

When the signals have been picked up adjust  $C_2$  so that they are heard with maximum strength, then vary  $C_1$  slightly to check its correctness, and proceed to try various values of coupling between the coils, readjust-

ing the tuning at each alteration until you obtain the loudest signals and the greatest freedom from whatever interference may be present. It is generally best to commence with the coupling "tight," and gradually loosen it until a point is reached at which tuning is very sharp and beyond which signals begin to diminish seriously in strength. It may sometimes be necessary to weaken the coupling still further to reduce interference, since the looser the coupling the more selective the receiver.

When the signals to be picked up are strong, such as those from a near-by broadcasting station, a simpler method of tuning can be adopted. Place the coils as close together as possible, set  $C_2$  to its zero and proceed to tune-in by varying  $C_1$ . When the desired signal has been found and tuned to its loudest on  $C_1$ , separate the coils, which will cause the sounds to vanish, and vary  $C_2$  until they are heard again. Adjust the coupling to its best value as before.

Yet another easy method is to make use of a "Stand-by-Tune" switch to enable either direct or inductive coupling to be employed at will, so that the two circuits can be tuned one at a time. The connections of such an arrangement are shown in Fig. 2, from which it will be seen that the double-pole double-throw switch S connects the crystal and 'phones across either the primary or secondary coil at will.

With such a receiver the process of tuning-in is much simplified, and may be performed as follows:—Separate the coils widely, place the switch to connect the 'phones and crystal to the primary coil, and tune by varying  $C_1$ . When the signals have been found and accurately tuned-in bring the secondary coil up to an inch or so from the primary, turn the switch over to the other position and vary  $C_2$  until the signals are heard once more, subsequently adjusting the coupling.

These examples will serve as an introduction to the more difficult case of the two-valve circuit illustrated in Fig. 3. This receiver has two tuned circuits, and its adjustments are usually rather critical as a result of the inherent reaction effects present.

The best method to adopt is undoubtedly the first of those given in connection with the two-circuit crystal receiver, but since the tuning may be very sharp the aerial condenser  $C_1$  should be increased in steps of  $3^\circ$  or

$4^\circ$  only, unless, of course, the desired station is very near and so may be expected to give very strong signals without critical adjustment. In this latter case it may be possible to tune-in by setting the plate circuit condenser  $C_2$  to zero and varying  $C_1$ , until a point is found at which the signals are heard and on either side of which they diminish. This being found, tune the plate circuit and readjust the aerial circuit if necessary.

A peculiarity of this circuit, which is usually noticeable when the reaction effects are fairly strong, is that it is possible to find a pair of settings on the condensers which do not indicate that both circuits are in tune with the incoming signals, but yet which seem to be points of maximum signal strength. What this actually means is that one of the circuits is tuned a little *below* the true wavelength and the other a little *above* it, each

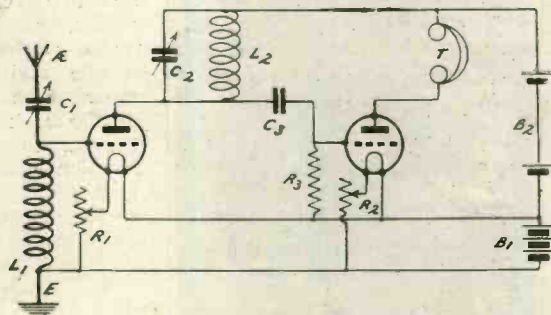

Fig. 3.—A two-valve circuit introducing two separate tuning operations.

adjustment appearing to be correct in that a variation of either reduces the signal strength. If, however, the circuit which is tuned too high is reduced in wavelength a little, a corresponding increase in that of the other will bring in the signals again with increased volume, and so one can proceed to reduce one and increase the other until the improvement gives place to a reduction, indicating that the correct setting has been passed.

Of course, one cannot tell in practice which circuit is tuned to above the true wave and which below it when a pair of settings are found which seem to be points of maximum signal strength, and one can only proceed to make alterations and determine by trial and error which should be reduced and which increased in the manner which I have indicated.

The explanation of these phenomena is somewhat abstruse and limits of space forbid my attempting it here.

# A 1½-KW. VALVE TRANSMITTER

The following article describes one of the new transmitting sets manufactured by the Marconi's Wireless Telegraph Co., Ltd.

THE apparatus herein described is generally fitted for interchangeable working in conjunction with the set referred to in *Wireless Weekly*, Vol. I., No. 5. Certain parts, therefore, are com-

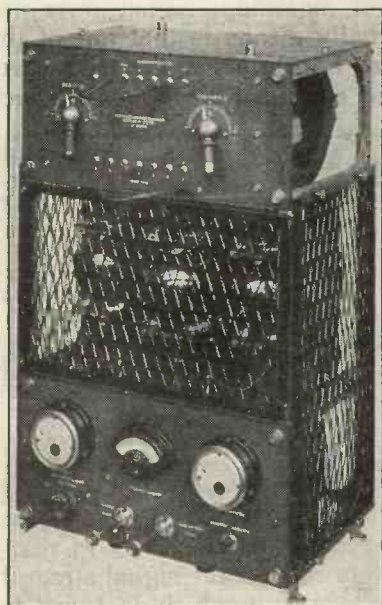

Fig. 1.—The complete apparatus.

mon to both sets, namely, aerial, earth, key, convertor or generator, transformer and D.C. and A.C. circuits.

Two switches are provided for changing over from spark to C.W. and *vice versa*. The first of these connects the power transformer

secondary to the spark or C.W. set, and for the latter makes the middle point connection to earth. This switch also connects the two primaries of the transformer in parallel for C.W., these being in series for spark transmission. The second switch controls the aerial and earth connections.

Direct coupling is used in the C.W. set, the general design being that of a panel carrying one power and two rectifying valves. Three valves, anode taps, wave range plugs, reaction handle, variometer handle and three ammeters are mounted on the panel front, while at the back of the panel there is the variometer, tuning inductance, reaction coil, grid condenser and leak, feed condenser, compensating choke, primary choke, etc. Figs. 1 and 2 show the complete instrument and the connections respectively.

A.C. at 500 cycles is rectified by the two rectifying valves (of the Fleming 2 electrode type) into pulsating unidirectional current with a frequency of 1,000, the ripples being smoothed out by means of smoothing condensers. The plate circuit of the power valve is fed by rectified A.C., while the filaments of the three valves are lighted through filament lighting transformers. These transformers are of the step-down type, the primaries being connected to the A.C. supply through two choke coils with adjustable iron cores. One of these chokes adjusts the filament brilliancy by the A.C. primary voltage. The second choke prevents fluctuation in the brilliancy of the valve

filaments when transmitting, and it is called the compensating choke. This choke, which is in series with the lighting transformer when the key is up, is shorted when the key is depressed. H.F. currents are prevented from going back to the supply circuits by means of a choke. The milliammeter indicates the amount of the H.T. feed current to the power valve, the current being controlled by the manipulat-

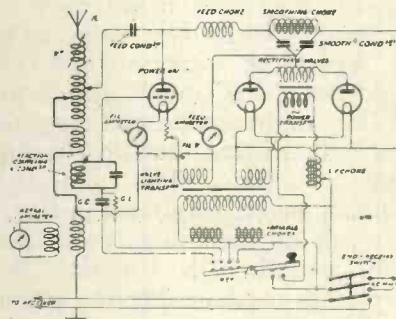

Fig. 2.—Circuit diagram of the Marconi 1½ kw. valve transmitter.

ing key, which makes and breaks the primary circuit of the transformer, and therefore controls the output of the transformer.

This type of transmitter is extremely efficient, and has a wavelength range covering most commercial wavelengths, and is capable of transmitting over a range of 1,500 miles. It radiates a pure continuous wave which reduces the possibility of interference to a minimum.

## “ WIRELESS WEEKLY ” BINDING CASES

To make the best use of such a work of reference as is provided by the first volume of “Wireless Weekly” it is essential to possess it in a compact form with a comprehensive index, and that our readers realise the fact is evident from the flow of orders for the bound volume.

Cases only 2s. 10d. (post free) and 4s. 10d. (post free) respectively. Cost of binding 5s. 6d. (post free) and 8s. 6d. (post free). These latter prices include the index, obtainable separately 1s. 1d. (post free). The volume bound complete 12s. 6d. (cloth) or 15s. 6d. (half-leather) post free.



### The Super Aerial

YOU may remember that I told you some time ago of one of our local radio-maniacs, whose enthusiasm was such that when he took unto himself a wife and had perforce to build a house he erected the aerial first and had the house built to suit it. He chose, of course, the highest point in the neighbourhood for his dwelling place. While the house was a-building the masts stood gaunt, bare and forlorn; but as soon as the young pair had moved in there was a scene of feverish activity. A bevy of ancient mariners was hired to splice wire ropes. The place was littered with insulators, pulley-blocks, coils of wire, and miscellaneous bits and pieces. Callers tripped over tent pegs hidden in the grass, or were caught sharply under the chin by unsuspected wires.

Eventually it was complete, and a very fine job too. The tapering masts with many stays, the lead-in supported on a seamanlike array of spars and rigging, the two giant earth leads supported on poles that ran to twin earth plates all combined to produce an *ensemble* that was noble and impressive.

### A Proud Moment

Proudly the owner stood surveying the fruits of his toil, and as he stood he observed three figures taking a walk up the hill. They paused for a moment by his fence. They looked at the array in stupefaction. "What's that, Ma?" asked little Tommy. "Ask yer Pa, dear," said the lady addressed, with true feminine tact (if you are a father you will understand). Paterfamilias, with

a reputation for omniscience to keep up, was not at a loss for a moment. "Oh, that's one o' them directing stations for aeroplanes," he explained. What would you not give to hear a casual stranger so describe your aerial? Those who see mine usually say, "Oh, that's only a clothes line."

### The Explosive Colonel

The latest recruit to our wireless club is a retired Gunner Colonel who served most of his time in the East, and has acquired the traditional curried liver. Need I say that his temper is not of the sunniest, and that if his profession has vouchsafed him a profound knowledge of the ways of high explosives, his long domicile on coral strands has given him a power of discharging salvos of high expletives such as few possess

### How to Deal with Rebellious Sets

At meetings of the club he is lamblike, save that he is incessantly rising on points of order. But in his own wireless room he lets himself go. He held a transmitting licence for a few days, but this was withdrawn hastily after the broadcasting display which he gave when he thought that his apparatus was not working, though really it was. The glow of his aerial was visible for miles, and dozens of receiving sets in the neighbourhood were burnt out.

He has, however, discovered the magic formula for exorcising the evil spirits that sometimes take possession of sets, and will not let them work though there is apparently nothing amiss with any part. When this happens to him

Colonel Bloodthunder simply opens his mouth and remarks . . . no, I am afraid that I cannot tell you what he says, for the printers inform me that they are out of tungsten steel type, and the ordinary kind has far too low a melting point. Possibly, however, you can imagine for yourself. Anyhow it frightens away each and all of the seven devils that have possessed the set.

### The Thirst for Knowledge

I always love the fellow who, having not the slightest knowledge of electricity, asks you to tell him in the briefest possible way exactly how wireless works. It's a funny thing how the possession of even the simplest fool-proof set gives rise to a thirst for knowledge about its "innards." People will own a gramophone for years without ever wishing to remove the top of the case beneath which the mechanism is hidden. The telephone may hang upon the wall or stand upon the desk without prompting any desire to inquire into the way in which it works. It is accepted simply as a useful accessory to business or social life, and the ordinary man's curiosity is as little excited by it as it is by, say, a chair or a coal scuttle.

But with wireless matters are very different. Your non-mechanical friends buy sets whose controls consist of one knob to be twiddled, and perhaps a switch. They laugh to scorn your own untidy-looking "hook-ups," and wonder why on earth you can be bothered with all those unnecessary levers and knobs and things. "All we desire," say they, "is to be able to hear broadcasting

when we want to, and we don't care two brass buttons how it is done." That is the first stage.

Deal Gently With Them

The second is guaranteed to occur within three calendar months. Its coming is betokened by the putting of what are apparently polite questions, asked merely for the sake of asking, about your own apparatus. Assuming at first a mask of indifference, the questioner seems not to care whether you answer or not. Little by little the queries become more and more pointed, and you can see that replies are eagerly awaited.

The light is dawning, but with

characteristic human laziness the erstwhile pooh-poothers of your enthusiasm want to find things out, not by reading, which would entail the use of their brains, but by asking more or less futile questions in order that they may use yours instead. It is flattering, no doubt, to think that they credit you with such a possession.

Be gentle with them, for they mean no harm. Lend them simple books, help them when they are puzzled. It will not be long before they forswear fool-proof sets and start upon the construction of ambitious affairs with the object of bringing in the voices of the whole world. Yes; be kind to them, for theirs is a thorny path.

The Punning Habit

If there is one habit that I deplore it is that of making puns when such serious subjects as wireless are being discussed. The pun is in any case merely a survival of what passed for wit in Victorian days. It is really beyond endurance when you get a man like Snooper, who is otherwise an intelligent being, descending to such levels. An old lady was examining his set the other day. "And can you hear the German stations?" she asked. "Oh, yes," said he, without even a blush of shame, "every Nauen then."

WIRELESS WAYFARER.

SIMULTANEOUS BROADCASTING

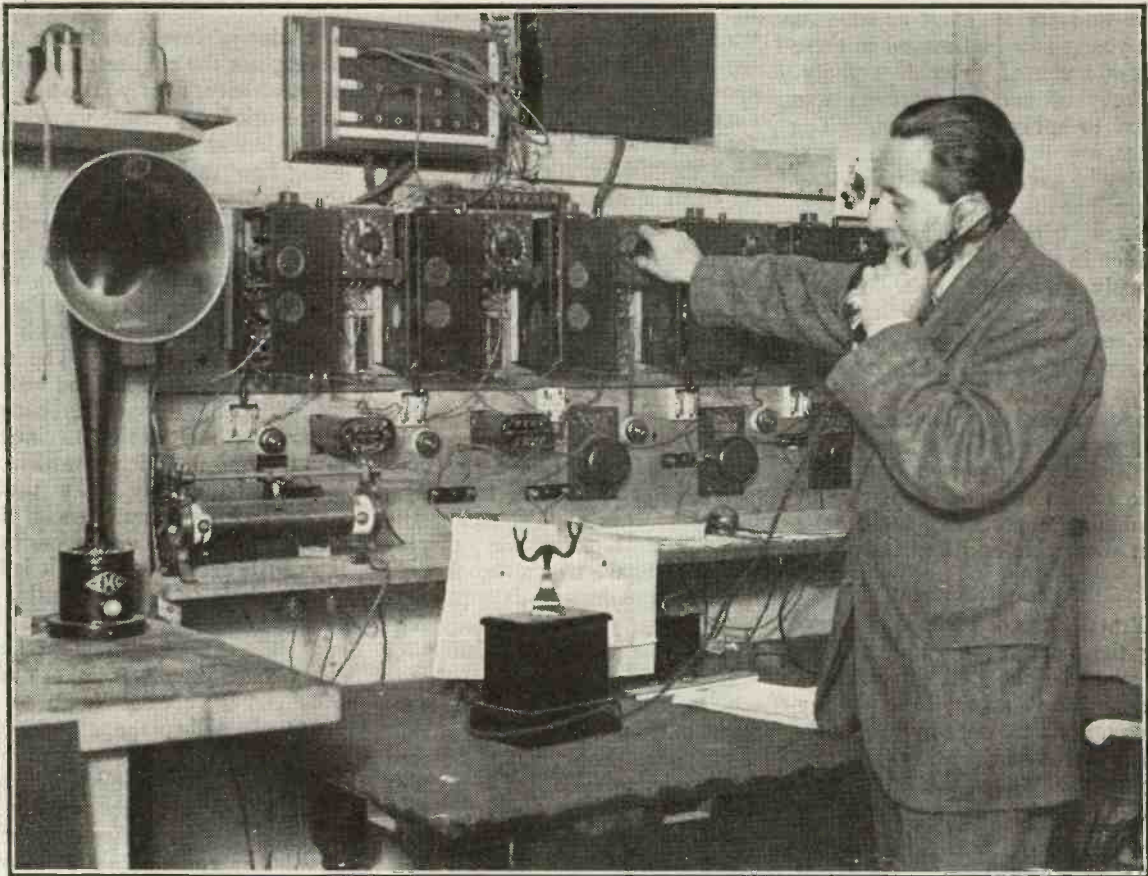

Our photograph shows the apparatus employed at 2LO for the simultaneous broadcast transmissions.

# AN EASILY CONSTRUCTED NOTE-MAGNIFIER

By STANLEY G. RATTEE, Staff Editor.

*A general purpose amplifier which will fully repay the moderate outlay and time spent upon its construction.*

**T**HE note magnifier, or low-frequency amplifier, presented in this article was designed primarily for use with the crystal receiver described on page 350 of *Wireless Weekly*, Vol. II., No. 9, but since it is a complete unit in itself, it may be used with any crystal or valve receiver with relatively equal results.

The addition of one or two stages of audio- (sometimes called low-) frequency amplification to a simple crystal or valve receiver does not introduce any special difficulties, and for that reason the construction of one of these instruments may be undertaken by even the veriest amateur constructor. In order to simplify matters, the panel and base of the apparatus to be described are made of wood, and the usual containing box dispensed with.

## The Panel and Base

If the instrument is to be used with the crystal receiver referred to above, the height of the panel and the depth of the base should be of the same dimensions as the panel and base of the crystal receiver, in order to give a neat appearance to the two units when used together. If, however, the experimenter wishes to make a general utility unit, then the

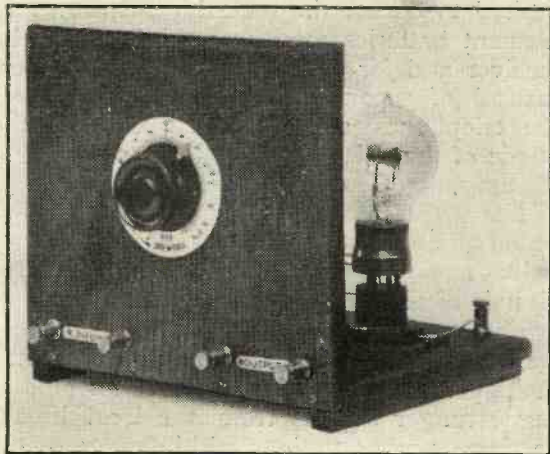

Fig. 1.—The complete instrument.

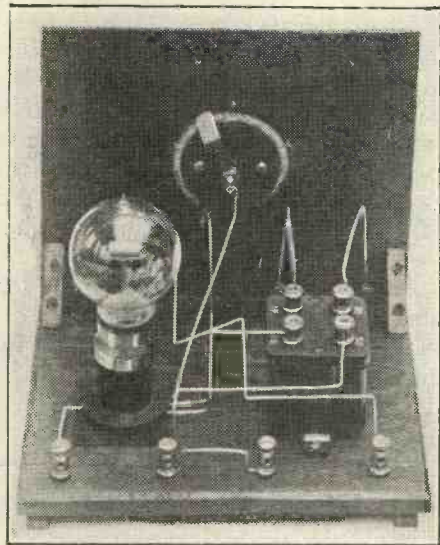

Fig. 2.—Back view of panel.

panel and base may be of  $\frac{3}{4}$  in. wood, of length and height to suit his convenience.

The panel and base are held together by two right-angle brackets which are 2 in. lengths of the same wood as the panel, screwed to both the panel and the base.

## Components Required

The necessary apparatus for the construction of the note-magnifier is as follows:—

- 1 valve socket.
- 1 filament resistance.
- 1 intervalve transformer.
- 8 terminals.

Quantity of No. 18 or No. 20 tinned copper wire for connecting purposes.

- 1 fixed condenser, any value between 0.005  $\mu$ F and 0.01  $\mu$ F.

As seen from the photographs, Figs. 1 and 2, the instrument is exceptionally compact in the arrangement of its parts, which are so placed that the leads between them are as short as possible. This not only gives the interior of the amplifier a neat appearance, but also makes the wiring a more simple operation. The "input" terminals may be seen on the left of the panel shown in Fig. 1, while the "output" or telephone terminals may be seen on the right. The L.T. and H.T. terminals are situated at the back of the base, and may be seen in Fig. 2.

Connecting the Components

The wiring of the unit is best carried out with No. 18 or No. 20 S.W.G. tinned copper wire, the leads being kept as short as possible. The arrangement of the components is so thought out that practically no two wires of the same circuit need run near to each other, and for this reason care may be taken to keep the wires perfectly straight, with a view to giving the general finish of the interior of the instrument a workmanlike appearance.

The actual connections of the receiver are illustrated in the circuit diagram, Fig. 3, and are best carried out as follows:—Before mounting the transformer complete the filament lighting circuit by connecting the L.T.

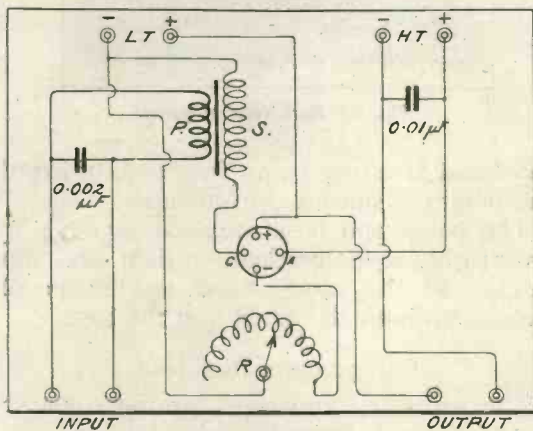

Fig. 3.—Wiring diagram of the unit.

negative terminal to the blade of the filament resistance, while the end of the resistance is connected to one of the filament legs of the valve socket. Connection is now made from the L.T. positive to the other filament leg of the valve socket.

By switching the filament resistance to its "off" position, placing a valve in the socket and then slowly switching on the resistance, this circuit may now be tested; everything being in order the valve should light. With this circuit satisfactorily completed, the transformer should be placed in its desired position. With regard to this component, any well-known make of transformer may be used, though in the actual instrument under description an Elwell "ironclad" transformer is fitted.

The primary of the transformer is con-

nected to the "input" terminals shown on the left of Figs. 1 and 3. With regard to the "input" circuit, experimenters may find that with certain makes of transformers the addition of a fixed condenser of 0.002 μF shunted across the primary will often improve results; the position of the condenser is indicated in the circuit diagram, Fig. 3, though, with the transformer used, this condenser was not found necessary.

The secondary winding of the transformer is connected to the grid leg of the valve socket at one end and to the L.T. negative at the other. Connection is now made from the anode leg of the valve socket to the H.T. positive terminal seen to the left of Fig. 2, the H.T. negative terminal being connected to one of the "output" terminals shown in Fig. 1. Across the two H.T. terminals should be connected a reservoir condenser of any capacity between 0.005 μF and 0.01 μF. The final connection before the instrument is complete is from the other "output" terminal to the L.T. positive.

Notes on Operating

The connecting of the unit for use in conjunction with a crystal or valve receiver is accomplished by removing the telephones from the receiver and connecting in their stead the "input" terminals of the amplifier, the telephones being connected to the "output" terminals of the amplifying unit.

Almost any type of valve may be used so long as the L.T. supply and H.T. voltage are consistent with the needs of the particular valve chosen.

When used with a valve receiver, if it is desired to do so, the same high-tension and filament batteries may be used for both the receiver and for the low-frequency amplifier, instead of separate batteries, provided that the telephones are connected between the anode of the valve and the H.T. positive on the amplifier, instead of as shown in Fig. 3.

The great feature of a low-frequency amplifier as an addition to the simple crystal or valve receiver is that it may be used for signals of any wavelength without alteration.

The instrument described will work equally well with a crystal or valve receiver, thus making it an ideal unit to be used for obtaining stronger signals from the local broadcasting or other stations within range of the receiver.



# Broadcasting News

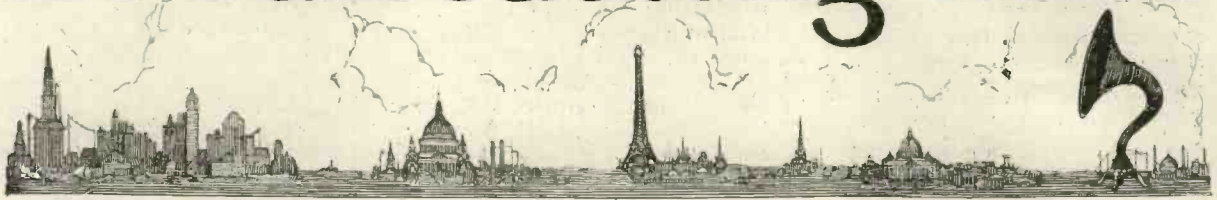

By OUR SPECIAL CORRESPONDENTS.

**LONDON**—As soon as the "report" is out of the way the B.B.C. has some developments quite as big as simultaneous broadcasting. There might, for instance, be something done in the way of portable transmitting stations. That would solve a great many problems, such as the linking up of places where a big single event is being held which it is desirable should be broadcast, but where it is not worth while putting in a land line.

Some of the listeners in the provincial areas seem to be alarmed about the simultaneous broadcasting proposals, and they seem to think that it is the beginning of the end. The argument is that if news bulletins can be relayed simultaneously, and a London concert on Monday evenings, there is no reason at all why the whole programme should not be relayed from London.

Whether it would be possible to relay a concert satisfactorily every evening remains to be seen. The B.B.C. says that it is going to do nothing to diminish the popularity and prestige of the local stations. The happy relations between the provincial stations and the listening public are great business assets to the Broadcasting Company, and they are to be maintained and strengthened.

Uncle Jeff is still the life and soul of the children's hour. His unique gifts as an improviser on the piano endear him to the kiddies. The advent of Mr. K. A. Wright, Uncle Humpty Dumpty, at 2LO, has also been

much appreciated by the children. Mr. Wright's assistance at headquarters is of the utmost value.

Uncle Arthur is also heard frequently in the children's hour these days, and, of course, he is always heard on Sunday evenings. He is usually on also for a time on Thursday evenings. The search for the man with the perfect broadcasting voice still continues.

Speaking of voices, what a revelation was "Uncle Rex's" dramatic singing one Sunday night recently. He seems to have paid a good deal of attention to voice production, and listening to his speaking voice, which is light and sparkling, one would not for a moment imagine his singing voice to be so full and rich. Congratulations "Uncle Rex," and we hope to hear you again in the "heavy stuff."

We have indeed had a week crowded with the good things of music, to wit: H.M. Grenadier Guards Band, and H.M. Irish Guards Band, although the writer thought it was somewhat of a pity that in "Three Blind Mice" the wonderfully sweet "Marche Funebre" of Chopin should have been travestied; it seemed wholly *mal à propos*.

We feel sure the popular No. 2 Hungarian Rhapsody of Liszt has never been heard to greater advantage than it was the other night as rendered by the 2LO Band, while Miss Daisy Kennedy's performance on the violin was superb; her playing of Barzycki's difficult

Mazourka was a triumph of technique, her double stopping being simply perfect.

## Forthcoming Events

### SEPTEMBER.

- 19th (WED.). — 7.15, Dramatic Critic. 9.10, Monsieur Andra on "French." 10, Mr. W. J. U. Woolcock, C.B.E., on "Applied Chemistry."
- 20th (THURS.). — 7.15, Musical Critic. 9.15, Mr. R. C. Symmonds on "How to Become an Actuary." 10, Prof. E. I. Collis on "The Importance of Psychology in Industry."
- 21st (FRI.). — 7.15, Cinema Critic. 9, Capt. R. Ramsbottom, O.B.E., Natural History Museum, on "Mushrooms and Toadstools."
- 22nd (SAT.). — 7.15, A talk on Football. 9.15, Mr. L. Oliphant on "The Secret Snake Sanctuary."
- 24th (MON.). — 7.15, Lord Mayor on "Hospital Saturday Fund." 9.15, Prof. E. W. McBride, F.R.S., LL.D., D.S., on "Are Acquired Characters Inherited?"
- 25th (TUES.). — 9, Mr. J. Humphreys, vice-chairman of the Concert Artists' Association, on "The Adair Wounded Fund." 10, Capt. Twelvemass on "Motoring."
- 26th (WED.). — 7.15, Dramatic Critic. 9.15, Mr. Anthony Bertram, official lecturer to the National Portrait Gallery, on "Literary Portraits." 10, Mr. Hugo Hirst on "Electrical Engineering."

**BIRMINGHAM**.—What was probably the first auction sale by wireless was conducted from 5IT recently. The old aerial of the Witton station was offered for sale. Apart from its "historical" value, of which, doubtless, the new owner will think with pride, the aerial was worth between £30

and £40. But 5IT's audience contains some keen bargainers, and £5 was the first bid!

Mr. Joseph Lewis, who was the salesman, addressed to the microphone a gentle admonishment. "Come, come!" he said, "surely it is worth more than that?" And promptly the telephone bell rang—an advance of one pound. Any further offers? A few minutes later another ring—and so the price advanced to £12. There, for the time being, the matter was left, in the hope that further advances would be made.

**Forthcoming Events**

**SEPTEMBER.**

- 26th (WED.).—Song recital by Miss Amy Carter, Mr. Geoffrey Wams, and Mr. Harold Casey.
- 27th (THURS.).—Miss Daisy Kennedy, solo violinist.
- 28th (FRI.).—Special Verdi and Offenbach night. Mr. W. R. Stokes, F.R.A.S., will lecture on "Canals of Mars."
- 29th (SAT.).—Station Military Band.

**GLASGOW.**—"The Merchant of Venice" is the second play to be broadcast by 5SC, and the results were as satisfactory as in the cast of the initial play "Rob Roy." For the Shakespearian play the cast numbered about a score, and the conditions in the broadcasting room were more favourable accordingly.

Since "Rob Roy" was sent out the officials of the Glasgow Station have been overwhelmed with correspondence regarding the performance. About 500 letters and postcards have been received, and of this number only half a dozen express adverse criticisms. The prevailing tone was of congratulation, and there was a general request for a "repeat" performance.

Mr. William Maley, President of the Scottish Football League, is to broadcast on Friday, September 28th, while in response to a demand by listeners, several well-known bands are to perform in the near future.

**Forthcoming Events**

**SEPTEMBER.**

- 19th (WED.).—An All-Classical Night—Coleridge Taylor. Miss Bessie Muirie (contralto) and Mr. William Gilchrist (tenor) will sing songs and duets.
- 20th (THURS.).—Special engagement of Miss Carmen Hill, of London (soprano). Mr. Jas. T. Stoddart (tenor), of Glasgow, will also sing.
- 21st (FRI.).—Miss Purvis (soprano) and Mr. Lewis Cowie (baritone) will sing, and the Scottish Co-operative Wholesale Society Band will give selections.
- 22nd (SAT.).—Mr. W. F. Cornelius (dulcimerist) will give selections, and Mr. Neil Donaldson (tenor) will sing.

soprano; Mr. Frederick Perrin, tenor; Mr. Edward Isaacs, solo pianist; Miss Florence Dunn, contralto; Mr. Carl Fuchs, solo 'cellist.

- 21st (FRI.).—Mr. Geo. Jennison, F.Z.S., M.A. (of Belle Vue), on "Elephants"; Mr. James Worsley, Lancashire dialect entertainer; Mr. W. Lee Howarth's Dance Band.
- 22nd (SAT.).—Miss Molly Gray, soprano; Mr. Victor Smythe in "Algy's Adventures"; 2ZY Orchestra.
- 23rd (SUN.).—The Armstrong-Whitworth Orchestra.
- 24th (MOX.).—Miss Frances Kendall, soprano; Radio Military Band (conductor, Mr. Harry Mortimer).
- 25th (TUES.).—Fourth Symphony Concert by 2ZY augmented Orchestra (conductor, Dan Godfrey, jun., A.R.A.M.); Mr. Dan Jones, tenor.
- 26th (WED.).—Miss Daisy Kennedy, solo violin; 2ZY Orchestra.

**SHEFFIELD.**—By the time that this appears, the Sheffield station should at last be going strong. In the meantime it will be connected up with Manchester by land line, and Manchester and London programmes will be relayed. It has been found that land lines are more economical than wireless reception. It is hoped, however, that local talent will be given a chance, and that Mr. Lloyd will continue his invaluable assistance.

The Sheffield Chamber of Commerce has written to the B.B.C. asking that Sheffield should be made the same as Newcastle and Manchester, and be a main broadcasting station. They are rather late in the day with this request. It is strange that they should allow experiments to go on which have all been openly conducted with the view to establishing a relay station, and never once give expression to their desire of having a main broadcasting station. As a matter of fact, with programmes from London, Manchester, and locally as well, Sheffield should be better served than any of the provincial stations.

**BROADCAST TRANSMISSIONS**

*Call-Sign Wavelength*

CARDIFF	..... 5WA	..... 353 metre.
*LONDON	..... 2LO	..... 389 ..
MANCHESTER	..... 2ZY	..... 385 ..
NEWCASTLE	..... 5NO	..... 400 ..
GLASGOW	..... 5SC	..... 415 ..
BIRMINGHAM	..... 5IT	..... 420 ..

**TIMES OF WORKING.**

Weekdays ... 3.30 to 4.30 p.m. and 5.0 to 10.30 p.m. G.M.T.

\*London 11.30 a.m. to 12.30 (late ad at 3.30 to 4.30 p.m.)

Sundays ... 8.30 to 10.30 p.m. G.M.T.

2LO 3.0 p.m. to 5.0 p.m. M.S.

**SILENT PERIODS.**

CARDIFF	..... 8.0 to 8.30
MANCHESTER	..... 7.45 .. 8.15
NEWCASTLE	..... 9.0 .. 9.30
GLASGOW	..... 9.0 .. 9.30
BIRMINGHAM	..... 8.0 .. 8.45

**MANCHESTER.**—Those who doubt the ability of radio to transmit humour should hear Mr. Jaye Kaye, who has been broadcasting from some of the B.B.C. stations. His turn recently from 2ZY was one of the funniest things we have heard so far by wireless: it was just the simple type of humour where the spoken word is enough, without vision or embellishment other than a little pianoforte music. It is just what is required in a popular programme.

**Forthcoming Events**

**SEPTEMBER.**

- 19th (WED.).—Mr. Maurice Cole, solo pianist; Miss Marguerite Davis, soprano; 2ZY Orchestra.
- 20th (THURS.).—No afternoon performance. Miss Phyllis Kebble,

# RADIO SHADOWS

By E. H. CHAPMAN, M.A., D.Sc. F.R.Met.Soc.. Staff Editor.

An article dealing with that troublesome phenomenon "blind spots."

THE proposed investigation of the Radio Research Board into the two phenomena known as "blind spots" and "fading of signals" reminds us that our present knowledge of the travel of wireless waves from transmitting station to receiving station is somewhat incomplete.

These two phenomena, which are to figure in the same investigation, are presumably not connected by any close relationship,

venient terms, they do not convey a very adequate idea of what is really meant. A better idea would be conveyed by the term "shaded area." "Shadow" and "shade" are words of everyday use with us. Then, again, the word shadow is frequently used in scientific work which is not connected in any way with the study of light. For example, in the extreme south of South America the Andes cause the *rain-shadow* of Patagonia. That

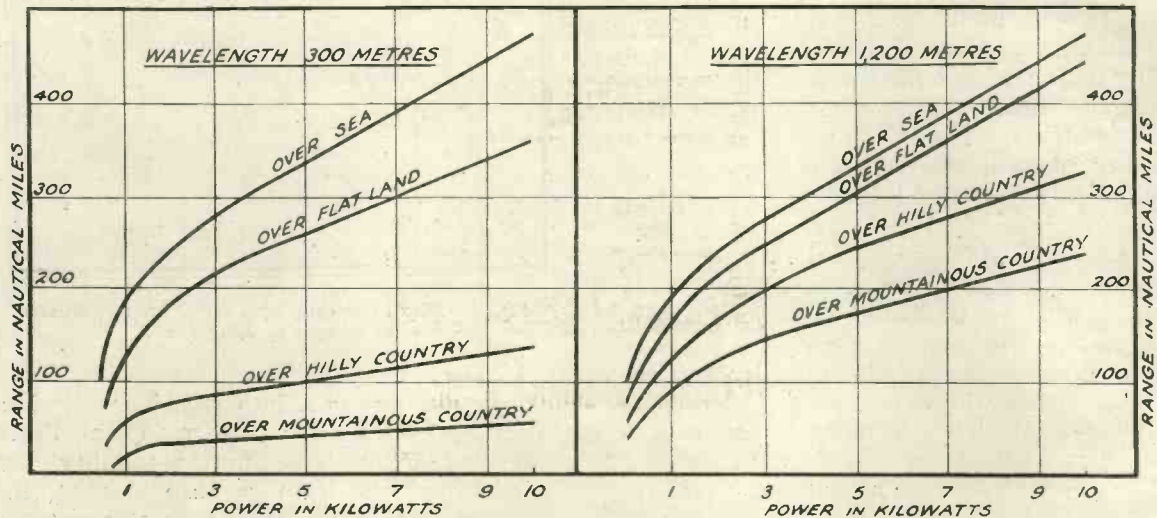

Fig. 1.—Curves showing the effect upon the transmitting range due to intervening hills.

since the former is a more or less permanent effect, whereas the chief feature of the latter is its transitory character.

By the term "blind spot" is meant an area, generally small, which is consistently shielded from the incoming waves of one or more transmitting stations. The lack of signal strength is always apparent and does not appear to vary with changes in atmospheric conditions.

Although the words "blind spot" and its American equivalent "dead spot" are con-

is to say, the Andes shield that part of the Argentine from the effects of the rainy, westerly winds, and so cause the rainfall to be only one-eighth of what it is on the other side of the mountains. From this illustration of the word shadow it will be seen that attention is of necessity drawn to the cause of the shadow.

In wireless work a mere knowledge of the existence of "blind spots" will help us little. What we want to know most of all is what causes those "blind spots," or, to put it

rather more scientifically, what we desire to know is what is it that throws a *radio shadow* and why.

Another point to be noted with regard to the use of the term "blind spot" is that it gives the idea of complete blindness, whereas the term is a purely relative one. It is doubtful if any area can be called a "blind spot" in the strict sense of the term. There may be partial absorption of the electro-magnetic waves radiated from a certain transmitting station, but that is by no means the same thing as there being total absorption. Then, again, a certain area may be well in the "radio shade" for transmissions from one broadcasting station, yet be quite "in the open" for transmissions from all the other broadcasting stations.

Because of the lack of authentic information on this subject of "blind spots" a good many stories have gained credence which would otherwise have received no attention at all. A well-known American writer recently related how there used to be mysterious yarns told by ocean travellers of a place in mid-Atlantic where no wireless signals had ever been heard, either from ships or from shore stations. There was a similar story of another place in the Atlantic where signals from all over the world were easily picked up day or night.

Since the establishment of the broadcasting stations in England there have been many cases of what are undoubtedly radio shadows. For example, in some of the deep valleys of South Wales it is very difficult to receive the Cardiff broadcasting. Here we have a distinct suggestion of the possibility of mountains casting radio shadows.

The effect of hilly or mountainous country on the range of a wireless station is well shown by the curves in Fig. 1. These curves have been constructed from the data of H. R. Sankey dealing with the range of commercial spark stations. The absorbing properties of mountains and hills with respect to wireless waves are well shown by these curves. A very noticeable feature is that mountains and hills have greater impeding effect on the shorter wavelengths. This is in accordance with what has been observed in connection with the travel of sound waves. Often enough hills have thrown a distinct *sound shadow* when houses and buildings in the direct line

of the same sound waves have thrown no such shadow.

Another important thing shown by the curves of Fig. 1 is that increase of power with the shorter wavelengths does not appear to have much effect when the transmission is over mountainous or hilly country.

In connection with the effect of a land mass on wireless signalling, it is interesting to recall an example frequently quoted by American writers. Ships to the north of Long Island often find difficulty in getting into wireless communication with ships to the south of the island, although the island is only some forty miles wide. Long Island also appears to throw a *radio shadow* in the direction of New York. Ships out at sea

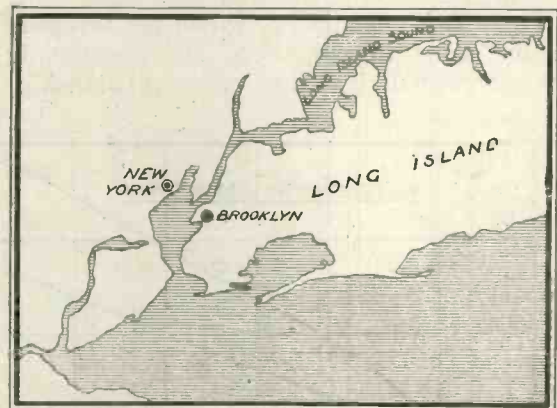

Fig. 2.—Map illustrating how New York is "shielded" to seaward by Long Island.

cannot easily get into touch with New York. Looking at the map in Fig. 2 one is struck with the possibility that wireless waves from a ship out at sea, tending to take the line of least resistance, may travel along the water of Long Island Sound rather than over the land of the island. If so, wireless waves would only be showing the same propensity for travelling over water as thunderstorms do.

The whole question of radio shadows is an extremely interesting one, and if the present investigation inspired by the Radio Research Board is carried out by a sufficiently large number of experimenters, a great deal should be added to our present rather small stock of knowledge of the way wireless waves travel through the ether.

# SOME AMERICAN CIRCUITS

The following details will afford our readers an opportunity of experimenting. It should be remembered that certain values, such as the anode voltages for instance, will require modification when British valves are used. We shall be pleased to learn of any reader's success with the arrangements shown.

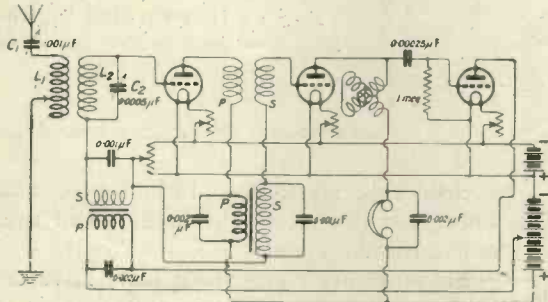

Fig. 1.—The diagram on the left illustrates a method of employing tuned high-frequency amplification in a reflex circuit. One high-frequency stage only should be tuned, namely, that next to the detecting valve. Between the first and second valve are an untuned H.F. transformer and an L.F. transformer, the respective primary and secondary windings being in series. The plate circuit of the second valve is tuned by means of a variometer, and the telephones, shunted by a fixed condenser, are also in this circuit. The complete arrangement therefore provides for two stages of H.F. amplification, valve rectification and two stages of L.F. amplification.

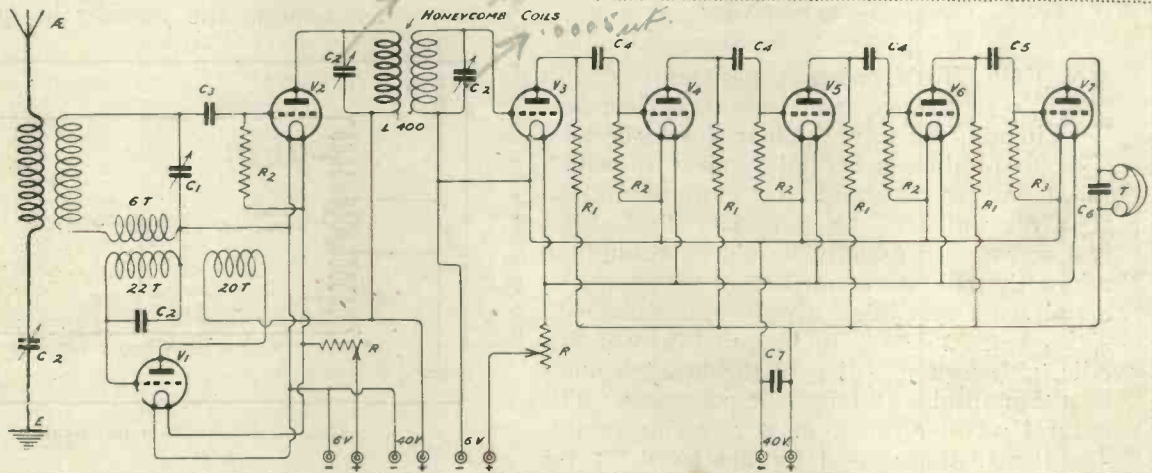
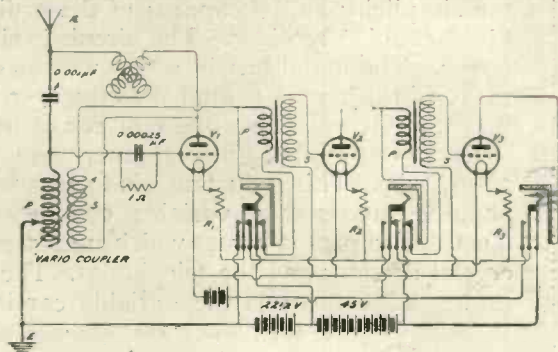
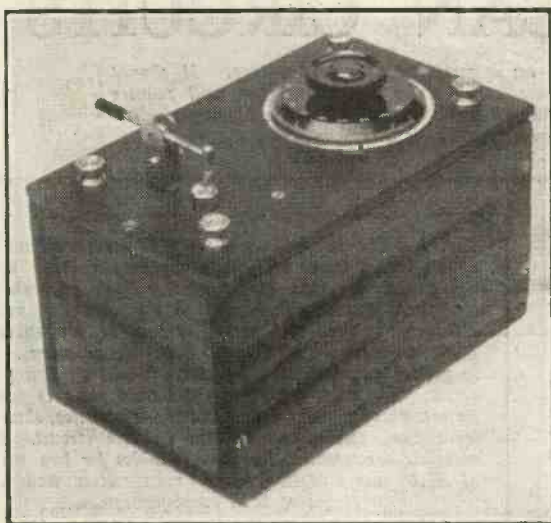

Fig. 2.—The diagram above shows the complete circuit arrangement of a super-heterodyne receiver with a five stage resistance-coupled amplifier, for which high efficiency is claimed in the reception of short waves over great distances. The values of the various components are specified as follows:—

The variable condenser  $C_1$ ,  $0.0005 \mu F$ ;  $C_2$ ,  $0.001 \mu F$ ;  $C_3$ ,  $0.00025 \mu F$ ; the three coupling condensers  $C_4$ ,  $0.0005 \mu F$ ;  $C_5$ ,  $0.0001 \mu F$ ; the telephone condenser  $C_6$ ,  $0.001 \mu F$ ; the H.T. reservoir condenser  $C_7$ ,  $2 \mu F$ . The anode resistances  $R_1$  should have values of from 50,000 to 70,000 ohms; gridleaks  $R_2$ , 3 megohms, each and the last gridleak  $R_3$ , 1 megohm.

Fig. 3.—The diagram on the right shows a single circuit receiver, the first valve being the detector followed by two stages of L.F. amplification. The telephone jacks shown enable one, two or three valves to be used as required, the filament current of any valves not in use being automatically switched off by the insertion of the telephone plug. As reaction is provided direct on to the aerial circuit by means of the vario-coupler, this arrangement is not permissible upon the broadcast wavelengths during broadcast hours. It is claimed that great selectivity is obtained by means of the variometer connected between the anode of the first valve and the upper plate of the aerial tuning condenser.





Photograph of the receiver.

**R**ECENTLY, when experimenting with a view to increasing selectivity in a set, it occurred to me that it should be possible to produce a crystal receiver in which the aerial circuit should be untuned and so tightly coupled to the secondary circuit that two or three turns only should be enough to afford the necessary transfer of energy. An aerial with very few turns of inductance in series with it seems to be practically aperiodic, although it will give the best response on the natural wavelength it possesses. The natural wavelength of most receiving aerials—at least, those used by amateurs—is far lower than the shortest wavelength it is generally desired to receive.

I have now succeeded in building a thoroughly successful crystal receiver which I think possesses most, if not all, of the advantages of the loosely coupled type, as well as the simplicity and cheapness of the ordinary direct-coupled receiver. The circuit is shown below. The aerial has in series with it eight turns of thick wire wound directly over, and in the centre of, a second coil consisting of seven turns of slightly thinner wire on a 3/4-in. tube. This inductance is fixed and has shunted across it a variable condenser of 0.0003  $\mu$ F capacity, across which are placed the crystal detector and the telephones. The sole tuning adjustment is the variable condenser

## A CRYSTAL RECEIVER

By PERCY W. HARRIS

In this receiver the selectivity of a loose coupled direct-coupled instrument, while its construction is of the ordinary type.

across this secondary inductance, and the operation is exactly the same as in the more conventional type.

Several very interesting facts have come to light while experimenting with this circuit and when making the receiver in question.

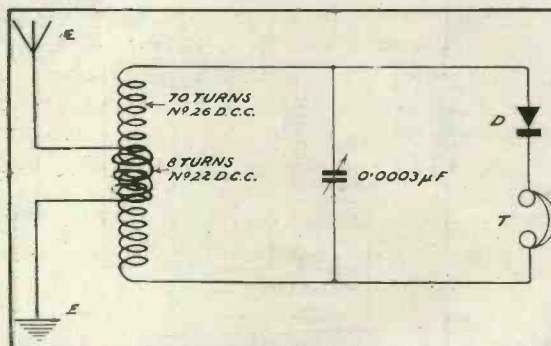

Theoretical diagram of the circuit.

It might at first appear that the coupling between the aerial and the closed circuit is so tight that the two circuits would act as one. If this were the case, however, the wavelength calibration would be the same as if the aerial and earth were connected directly to the secondary inductance. That this is not the case is proved by tests with the wavemeter and on signals, which show that if the secondary circuit is set for a particular wavelength when the aerial is connected, the wavelength does not appreciably change when the aerial and earth wires are completely removed.

With the condenser set at minimum the wavelength is about 250 metres and at a maximum 550. If the aerial and earth are

# IVER ON A NEW CIPLE

R.S., Assistant Editor.

pler is combined with the simplicity of a  
ion is no more difficult than that of the  
u-type.

connected direct to the secondary in-  
ductance the minimum wavelength is well  
over 600 metres, so that we have a much  
larger inductance and therefore higher poten-  
tial than is possible with the ordinary form  
of directly coupled receiver. To tune to  
Cardiff or London requires under  $0.0001 \mu\text{F}$   
in parallel with the inductance, and there-  
fore we get practically no reduction of signal  
strength from parallel capacity. Tuning is  
quite sharp, which should prove advantageous  
in the case of those who live near the seaside  
or close to an ordinary commercial coast  
station working on 600 metres.

There are no constructional difficulties,  
and the only point worthy of special mention  
is the method of winding the inductance.

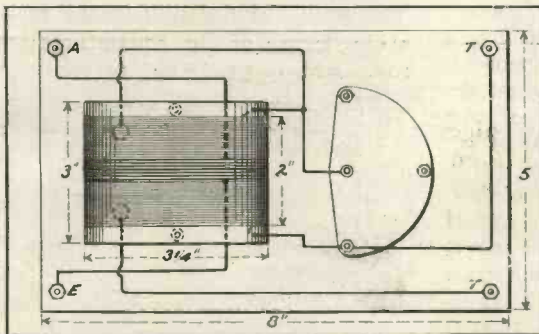

The wiring of the components as made on the underside  
of the panel.

The former, on which the coil is wound, is  
 $3\frac{1}{4}$  in. diameter and 3 in. long. Half an inch  
from one end, three holes should be bored,  
and one end of the wire with about 6 in. to  
spare should be threaded through these holes  
and secured. No. 26 double cotton covered

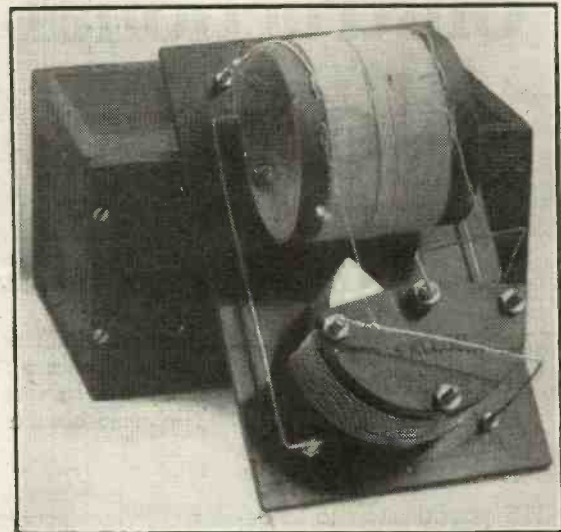

Back-of-panel view.

wire should now be wound on with all turns  
touching until half an inch from the other  
end is reached. Three similar holes are now  
made, the wire threaded through and secured,  
leaving as before about 6 in. for connection.

When this larger coil has been wound,  
take a sharp instrument, and about  $\frac{3}{8}$  in. from  
one end of the coil open the wires slightly  
and pierce a hole through the former.  
Through this hole thread the end of a piece  
of No. 22 double cotton covered wire and  
secure it by passing it through three holes  
on one end of the tube. Now wind on eight  
turns of the No. 22 d.c.c. wire, and when this  
number of turns is in position part the under-  
neath wires as before, pierce a hole through  
the former, and pass the end of the thick  
wire coil through it, securing as in the pre-  
vious case by threading the wire through  
three holes at the opposite end of the former.

The coil and variable condenser are secured  
to an ebonite panel measuring 8 in. by 5 in.,  
the panel also carrying four terminals (aerial,  
earth, and telephones) and a crystal detector.  
The tube is secured to the ebonite panel by  
two 4B.A. screws. The connecting wires be-  
tween the crystal detector, the condenser, and  
telephone terminals should be soldered in posi-  
tion before the coil is put in place, as the crystal  
detector comes underneath the coil former.

(Continued on page 392.)

# Constructional Notes



Conducted by R. W. HALLOWS, M.A., Staff Editor.

## A POTENTIOMETER OF QUALITY

THE potentiometer to be described in this note is intended to be made by those who wish to construct a really sound instrument at home. To make it up properly one must have some skill in accurate fitting, but there is nothing really difficult to anyone who is used to doing work of good amateur standard. It is designed with a view to efficiency and long life rather than compactness. Hence it is a fairly large instrument more suited to the experimenter's table than to the panels of a "boxed in" set.

The constructor can make it up

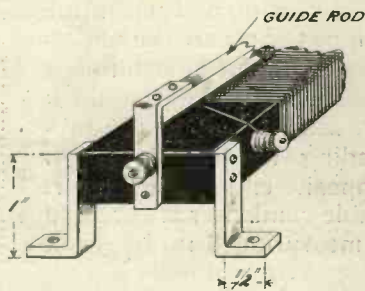

Fig. 1.—The potentiometer, former and supporting legs.

to any desired resistance without altering the dimensions given. The windings occupy 4 in. on a former measuring 2 in. in width by 1/2 in. thick. The following table shows some of the maximum resistances that can be obtained by using

wire of different gauges. The values given are for Eureka wire. They will be very much higher if Nichrome is used.

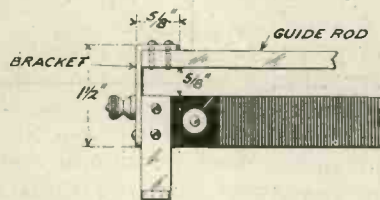

Fig. 2.—Details of the supporting legs.

No.	S.W. Gauge.	Turns.	Max. Resistance.
1	20	106	11 Ohms.
2	22	133	19 "
3	30	292	230 "
4	32	355	330 "
5	34	392	500 "

Of these, No. 1, which has a carrying capacity of 3 amperes, is especially useful as a rheostat for controlling the filaments of any number of valves up to four. It can also be employed to "tone down" the output of a 6-volt battery to suit dull emitter valves. No. 2 has similar uses, its carrying capacity being 2.3 amperes. No. 3 will act as a series resistance for controlling tuned anodes. No. 4 is excellent as a grid potentiometer, and No. 5 is suitable for placing across a dry battery to regulate the potential required by carborundum and other crystals of the same type.

The former, which is 6 in. in length and has the width and depth already mentioned, is of ebonite. The long edges should be rounded off for the four inches occupied by the windings. If this

is not done it will be impossible to get the wire as tight as it is desirable that it should be. Quite close to either end of one of these edges a 4BA hole is drilled and tapped. A terminal is screwed into each.

Enamelled wire should be used, since it is much easier to wind than bare (which has to be spaced) and occupies less room. The gauge of wire chosen is now wound on, its ends being secured to the terminals. As it is necessary to put it on under considerable tension an old leather glove should be worn on the hand through which it is fed.

The former is provided with two pairs of feet (see Fig. 1) made of angle brass, each of which is secured by a pair of 4BA screws. The guide-rod for the traveller is a 6 in. length of 1/4 in. square brass rod, which must be perfectly straight. It is supported by two

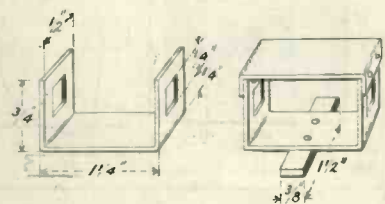

Figs. 3 and 4.—Dimensions of the "traveller."

brackets (Figs. 1 and 2), made, like the feet, of angle brass.

The most difficult part to make is the traveller, which is seen in Figs. 3, 4, 5 and 6. The body of it (Fig. 3) is made from stout sheet brass, bent as shown. A hole 1/4 in. square is cut in each of its ends, and it is provided with a



kind of lid (Fig. 4) made of the same metal and fixed in place either by rivets or small screws.

At right angles to the traveller, and fixed to it by a couple of small screws, is the bridge (Figs. 4 and 5) cut from  $\frac{3}{16}$  in. brass, and

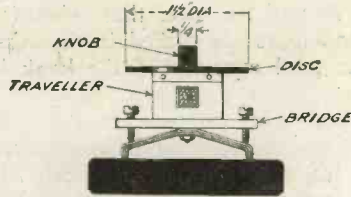

Fig. 5.—Cross section of the potentiometer.

measuring  $1\frac{1}{2}$  in. in length by  $\frac{3}{8}$  in. in breadth. To its middle point is fixed, by means of a 4BA bolt, a triple laminated contact, made of thin phosphor bronze, whose arms are  $1\frac{1}{2}$  in. apart. Two 6BA screws passing through the bridge provide a means of adjusting the pressure of the contacts upon the windings (Fig. 5).

To the "lid" of the traveller is attached a disc of  $\frac{1}{8}$  in. ebonite  $1\frac{1}{2}$  in. in diameter, which serves to prevent the fingers from coming into contact with the metal when adjustments are being made. Above this is an oval knob, which can be made by cutting out a piece of ebonite measuring  $\frac{3}{4}$  in. by  $\frac{1}{2}$  in. by  $\frac{1}{4}$  in. thick, and rounding off the  $\frac{1}{2}$  in. edges. Both knob and disc are kept in place by two 4BA screws, which are allowed to pro-

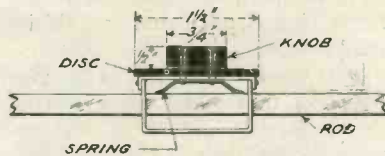

Fig. 6.—Illustrating the method of contact between "traveller" and rod.

trude a little way below the "lid" of the traveller.

The reason why they are made to protrude is that they are wanted to act as retainers for a short length of stiff phosphor bronze or clockspring, which is inserted between the "lid" and the guide-rod (Fig. 6) in order to take up

any play between it and the traveller, and to ensure that contact shall always be good.

The whole instrument may now be assembled. The traveller is run up and down two or three times on its rod, and where the contact arms make scratches the enamel is carefully cleaned off the windings with a piece of fine emery cloth folded round a strip of wood. When this process is finished the windings are given a good rub with an old toothbrush in order to remove any small fragments of metal that might pack between them and cause short circuits.

So long as care is taken to get all the parts true the potentiometer will be found to work perfectly, the action of the traveller being delightfully smooth owing to its being balanced between two springs. When the pressure on the laminated arms has been properly adjusted by means of the screws provided, the contact will be all that could be desired, and there will be none of the unevenness that occurs sometimes in potentiometers of faulty design.

R. W. H.

HINTS ON MOUNTING CRYSTALS

UPON the way in which a crystal is mounted depends very largely the efficiency of the set of which it forms a part. If the contact which it makes with its cup is poor or of varying quality reception will not be good; but if it is firmly seated in a mounting which does not allow it to move, then signals will come in at their full strength, provided always that the cat-whisker or the second crystal is properly adjusted.

The most usual method of mounting a crystal is to seat it in molten metal which on cooling sets hard and keeps it securely in position. The disadvantage of fix-

ing the crystal in this way is that the sensitivity of many kinds—particularly the various types of fused galena, such as hertzite, permanite and others of that class—is adversely affected by heat. The older text-books recommend the use of solder, whose melting point

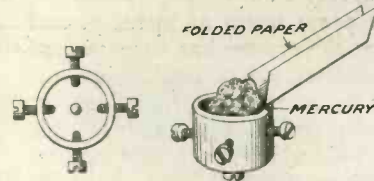

Figs. 7 and 8.—Illustrating two methods of mounting crystals.

is far too high to be good for most crystals. To-day Wood's metal is commonly used. This has a much lower melting point, but at the same time it is rather too high to agree well with delicate crystals.

An alloy with a melting point so low that it can do little harm is easily made. The constituents are:—

Tin	...	2 parts
Lead	...	3 parts
Bismuth	...	5 parts

As this combination flows at a temperature  $15^{\circ}$  Fahr. below that of boiling water, it is not likely to harm even the most delicate of crystals. If one part of mercury is added, the alloy does not solidify until it has cooled to something less than  $150^{\circ}$  Fahr. It

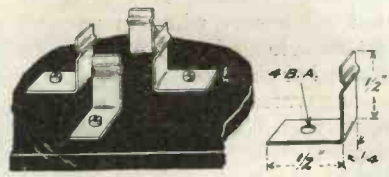

Figs. 9 and 10.—The four-clip holder and dimension of clips.

can be made to run quite easily by immersing the cup in hot water.

Another common method of fixing the crystal is to use a cup provided with set screws. There is no fault to find with this, provided that the crystal can be firmly fixed. This, however, is difficult with many of the cups now on the

market, since they have only three screws. If cups designed on the lines of that shown in Fig. 7 are made, the four screws render the task of securing an irregularly-shaped piece of crystal far easier.

One can make quite sure that the contact is all that it should be in a very simple way. Procure a few pence worth of mercury, and after the crystal has been secured by the set screws pour it into the cup by means of a folded paper, as shown in Fig. 8. If this method, which gives excellent results, is adopted, care must be taken that the detector is always kept with its right side uppermost.

Another good tip which makes cups, molten metal, mercury or set screws unnecessary and at the same time allows crystals to be changed with the utmost ease, is to make a mounting consisting of four spring clips, as shown in Fig. 9. The clips, whose dimensions are given in Fig. 10, are made of German silver or phosphor bronze. They should be mounted on the detector so that their tops are about  $\frac{1}{4}$  in. apart. R. W. H.

### A CONDENSER BANK OF ADJUSTABLE CAPACITY

**A** VERY useful piece of apparatus for the wireless man's bench is a bank of fixed condensers wired in parallel and so arranged that any can be removed or changed instantly. By making various combinations any capacity up to the total of that of the fixed condensers in one's outfit may be obtained readily. To be able to do this is a great boon when one is experimenting in order to find the best value of the condenser to be placed in shunt with telephones, loud speaker, the windings of transformers, the high tension battery, and so on. It will also be found particularly useful if one is making up low-frequency resistance capacity amplifiers as a simple means of discovering the best value for the grid condensers.

The condensers used are of the flat metal-ended type which fit into clips. Both condensers and clips can be bought quite cheaply from advertisers in this journal, but those who prefer to make their

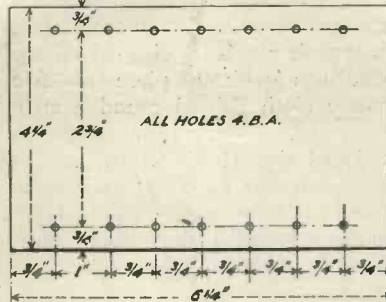

Fig. 11.—Dimensions of panel.

own are referred to the description which appeared on page 673 of *Wireless Weekly*, Vol. 1, No. 11. A very handy formula which was given there may be repeated. The capacity in microfarads equals  $O \times N \times 0.0001$ , where  $O$  is the overlap of the plates in square centimetres and  $N$  the number of dielectrics made of the best ruby mica 0.002 in. thick.

The panel for the condenser bank is a piece of  $\frac{1}{4}$  in. ebonite measuring  $4\frac{1}{4}$  in. by  $6\frac{1}{4}$  in. This is marked out and drilled as shown in Fig. 11, all of the holes being 4 B.A. clearance. Two

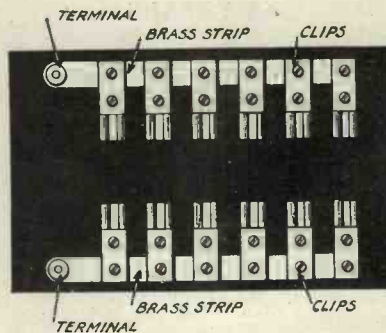

Fig. 12.—The plan of completed condenser bank.

strips of sheet brass  $5\frac{1}{4}$  in. long and  $\frac{1}{2}$  in wide are each drilled with seven 4 B.A. clearance holes to correspond exactly with those in the panel.

The strips are now laid on the panels. The terminals are passed

through the end hole of each and secured. The clips are then fixed in place by means of 4-B.A. bolts passed through the brass strips and the ebonite. All that remains is to mount the panel upon a small box about 1 in. in depth.

It will be seen that whatever condensers are placed in the clips the total capacity of the bank is the sum of their individual capacities, since all are in parallel. If, therefore, a set of condensers is made ranging from 0.0001  $\mu$ F to 0.01  $\mu$ F, as described in the note already referred to, the experimenter, by using combinations of large and small sizes, can obtain a very wide range of capacities in steps of 0.0001  $\mu$ F.

R. W. H.

### FILING SMALL WASHERS

**I**T often happens that a thin washer must be still further reduced in thickness. Difficulty is usually encountered in holding the work so that it can be filed.

A very handy method for doing this is to place the washer to be filed on a small block of wood, over which is then put a piece of flat metal. Squeeze in a vice until the washer (or other similar part is to be filed) is embedded in the block to a depth equal to half its thickness.

The block is then put in the vice with the thin metal piece resting in the cavity, where it will remain secure while it is being filed.

E. C. O.

### ERRATUM.

We are asked to inform our readers that owing to a clerical error the price of the type A.R.D.E. valve in the advertisement of the Edison Swan Electric Co., Ltd., appearing in Vol. II., No. 8, should have read 27s. 6d. instead of 27s. as stated.



# News of the Week

**T**HE Secretary of the Radio Society of Great Britain reports that the affiliation scheme is progressing favourably. Group representatives have received numerous congratulatory letters, and the Committee are taking careful note of suggestions forwarded for producing a scheme acceptable to all.

These representatives are already attending Committee meetings, and representatives of Metropolitan groups have, in the case of the Western district, appointed Mr. J. H. Reeves to represent them. The Southern and Eastern districts will also be called shortly to elect their own representatives.

On September 20th, at 6.20 p.m. (Institute of Electrical Engineers—Tea Room), an informal meeting will be held. This will take the form of a discussion on transmitting for amateurs, particularly on wavelengths of from 180 to 250 metres. Mr. Maurice Child will open the discussion, and it is hoped that a large number will be present. No tickets are necessary.

The ordinary monthly meeting will be held on September 26th as usual at the Institute of Electrical Engineers at 6 p.m. (tea at 5.30); and, in view of the forthcoming announcement of the P.M.G.'s Committee, the President, Dr. W. H. Eccles, will address the meeting on wireless topics.

Professor George W. O. Howe, D.Sc., Professor of Engineering at Glasgow University (Scientific Adviser to *Wireless Weekly*), is to

give a course of ten lectures on Wireless Telegraphy and Telephony at Glasgow Technical College. The first lecture of the series will be given on October 12th.

A telegram from Kobe has been received at Marconi House announcing the safety of Mr. A. H. Ginman, Managing Director of the Chinese National Wireless Telegraph Company, Pekin, who was in Tokio at the time of the earthquake.

The popularity of wireless during the coming winter promises to exceed all previous records. Significant among many indications in this respect is the fact that arrangements have now been made to hold an all-British wireless exhibition and Convention at the White City, Shepherd's Bush, W. 12, from November 8th to 21st.

That familiar home of many famous Exhibitions will undoubtedly provide splendid facilities for the display and demonstration of wireless on a scale worthy of its prominence in the public mind. This Exhibition is being organised in conjunction with The National Association of Radio Manufacturers, an organisation whose activities have always been so closely devoted to the maintenance of the highest standards of wireless development. As a result, all the best and most powerful wireless interests in the country will be fully represented.

It had previously been decided to hold a Wireless Exhibition at

the Horticultural Hall, Westminster, at the end of the present month; but, having regard to the more comprehensive arrangements necessitated in connection with the National Association of Radio Manufacturers, it was felt that the White City would furnish more fitting accommodation. Consequently the arrangements for the earlier Exhibition were postponed and revised so as to amalgamate with this larger Exhibition in November.

Following entirely successful experiments, says the *Evening News*, on board the *Mantua*, the P. & O. Co. proposes to install direction-finding apparatus on all its mail steamers.

For the first time in the history of the British Association, the opening speech by the President, Sir Ernest Rutherford, was broadcast by wireless on the night of September 12th.

The *Westminster Gazette* recently proclaimed that once more the superiority of wireless communication has been demonstrated. All the more important and trustworthy communications from stricken Japan have been received through the medium of wireless.

The Rochford Guardians have turned down the proposal of their house committee that a wireless apparatus should be installed at the institution for the benefit of the inmates and patients in the infirmary.

# RANDOM TECHNICALITIES

By PERCY W. HARRIS, Assistant Editor.

*Concerning untuned aerials and work-bench equipment.*

**E**XPERIMENTERS who are looking for something new to try can be recommended to investigate the possibilities of untuned aerial circuits. On another page I describe a new crystal receiver utilising this principle, and, of course, in the well-known Reinartz tuner an untuned aerial circuit is also used. The method described in my crystal receiver article can be applied equally well, in fact slightly better, to valve types of instrument, and even two turns in a regenerative receiver is quite sufficient to hand the aerial energy to the closed circuit. Shortly I hope to describe several interesting modifications of this type of circuit in these columns. Meanwhile keen amateurs should try out the general arrangement for themselves.

Wandering round the Shipping and Engineering Exhibition at Olympia the other evening, I came across, on one of the stands, some specimens of finely braided copper wire. This braid is used for connecting the brushes of dynamos to their terminals, and a few moments' thought suggested to me that there are many useful applications for this substance in wireless. Accordingly I ordered 100 yards, and have been using it in many ways the last few evenings. It is ideal for winding frame aerials, for it is perfectly flexible, of high conductivity, and makes a very neat arrangement. In connecting up experimental circuits it has all the advantages of ordinary

electric light flex, which I frequently use, with the additional advantage that when a length is cut off there is no tedious baring of the insulation to get at the wire. Temporary indoor aerials can be rapidly made up with its aid, provided we insulate it at points where it would come into contact with the walls. Very convenient short-wave receiving inductances of low resistance can also be made if we space the turns with string or other insulating substances, and, of course, there is not that irritating tendency to spring off the former characteristic of stiffer wires, such as No. 18 d.c.c., which we should otherwise need to use to get the same low resistance. The price is quite reasonable (5/6 for 100 yards), and it should prove very popular once its merits are recognised.

Another useful purchase at this same exhibition was an electric soldering iron, fitted with an adaptor and flexible cord for connection to any lamp socket. I found it on the stall of the Igranic people, who are acting as the English distributors. It is made in three sizes, but the smallest is big enough for all ordinary amateur instrument building. The consumption is only 100 watts (less than that of a couple of bright lamps in the ordinary living room), so that the expense of running it is nothing to worry about. It is perhaps rather a luxury, but in any case it is very clean to use and a great time-saver.

## A Crystal Receiver on a New Principle (concluded from page 387)

With the coil in position, solder the two thick wires to the aerial and earth terminals and the two ends of the large coil of No. 26 wire to the variable condenser. The variable condenser actually used is a Fallon, costing 6s. 9d., while the particular crystal holder costs 2s. 6d. No telephone condenser is used, as experiments on this particular receiver showed that there was no gain whatever by connecting one in the usual position.

It will thus be seen that the cost of the instrument is quite low, although its appearance is quite equal to that of many expensive commercial instruments. Square-section tinned-copper wire was used for most of the connections, the only exceptions being where the ends of the coil were taken to their respective terminals. Any other constructional points will be quite evident from the photographs.



Conducted by A. D. COWPER, M.Sc.

#### A Plug-in Basket-coil Holder

**M**ESSRS. Leigh Bros. are manufacturing a holder for basket-coils fitted with the usual plug-and-socket to plug into their single-coil or other standard fitting. This has a flat column of ebonite with the plug, etc., in the base, fitted with an ebonite knob, brass centre screw, and an ebonite disc,  $1\frac{1}{2}$  in. diameter, under which the basket-coil is to be clamped; it will take coils up to 5 in. diameter when mounted in the former holder. Small terminal screws are provided for connecting the ends of the coil.

An obvious minor criticism is that the clamping-disc is rather small for some types of basket-coils; it might with advantage be made somewhat larger in diameter.

#### A Variable Grid-leak

The "Microgrid" variable vernier gridleak unit has been submitted to us for test by The City Accumulator Company. This unit is arranged for panel mounting by means of two small screws, is 3 in. long, and occupies a space of  $1\frac{1}{2}$  in. by  $\frac{1}{2}$  in. on the panel; it is operated by a small ebonite knob at the end. It consists of a brass frame, carrying a resistance unit in an ebonite tube, with a contact in the form of a metal ball which is moved by a screw-operated carrier along a slot in the ebonite tube, thus giving steady contact and a finely adjustable resistance.

On careful measurement of the resistance values with the aid of the neon oscillator it was found to give a uniform range extending beyond the limits  $\frac{1}{2}$  megohm to 5 megohms—which is not always the case with variable gridleaks—and on trial as gridleak in a single valve set it was absolutely silent both in steady operation and during adjustment, and allowed of fine setting to the optimum point for the particular valve and con-

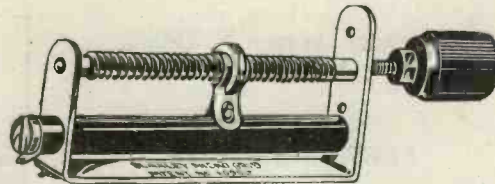

The "Microgrid" variable leak.

ditions. As the stabilising resistance in various dual circuits it operated exceedingly well, the large range of resistance proving very useful in this connection. It also performed excellently in the Flewelling circuit.

It is fitted with soldering tags for terminal connections, and is substantially made and mechanically sound.

We understand that a vernier potentiometer upon this principle is being placed on the market by the City Accumulator Company.

#### A Plug-in Crystal Detector

Messrs. S. A. Cutters have sent us for trial a crystal detector of the covered vertical type, which is arranged to plug into an ebonite base, for rapid change of crystal when required. This re-

presents a step in the right direction; for it is seldom that adequate provision is made for easy renewal of the sensitive element in crystal sets; if substantial terminals were fitted in this detector in the place of the present small screws, its utility would be considerably increased. The Hertzite supplied with the instrument is fixed with fusible alloy (in that actually submitted this had come loose, but was readily replaced, as the whole is quickly dismounted by taking out one brass screw); in so small a detector naturally it is not possible to mount a large piece crystal, which limits the available life to an appreciable extent.

On practical test, the insulation was found to be good; the adjustment convenient, the sensitive spots being easily found; the setting is not readily disturbed by mechanical vibration. Good signal-strength was obtained on local broadcasting. While lightly made, it represents good value at the moderate price quoted for the complete detector.

#### A Plug and Adapter for Terminals

Messrs. L. McMichael, Ltd., have submitted to us a neat experimenter's gadget in the form of a plug adapter for fixing on ordinary terminals, and a split plug with ebonite handle and short length of insulated flex to fit the adapter, whereby changes in connections so often required in experimental work can be made rapidly and surely, with the certainty of making good electrical contact.

# Correspondence

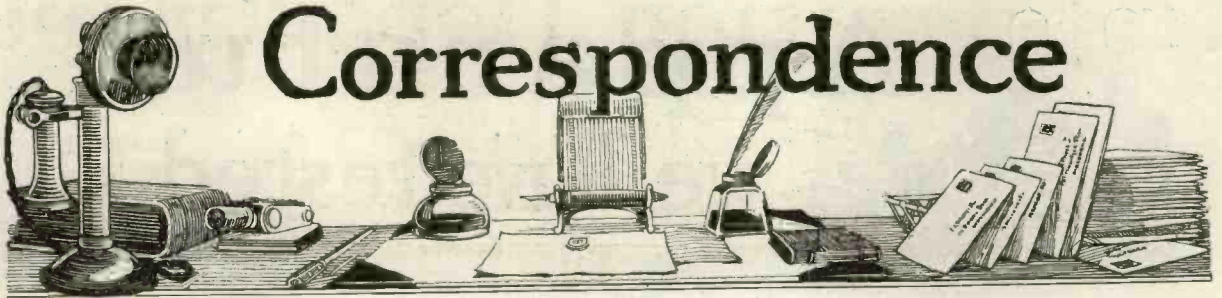

## WAVE-TRAPS

SIR,—Re Mr. Harris's article in *Wireless Weekly*, Vol. 2, No. 5, on Wave-traps. This course of experiment, together with reducing distortion of received telephony, has occupied the bulk of my time during the last three months, and, strange to say, I stumbled on the circuit as shown in Fig. 2 two nights ago.

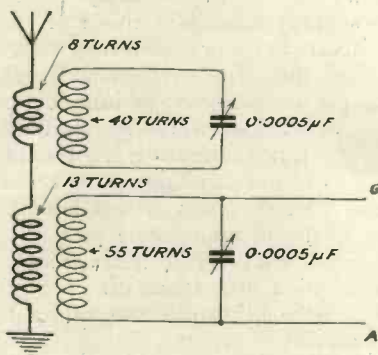

The circuit referred to by Mr. Turner.

I am enclosing a diagram of my wave-trap arrangement used with an aerial transformer which gives excellent results. If you were to try this you would, I think, agree with me that it gives excellent control over the H.F. I live 5 miles from 2ZY, and can cut him out and, using this aerial transformer, I can get all the B.B.C. stations audible 30 yards away using 4 valves.

I am, etc.,  
A. TURNER  
Ashton-on-Mersey.

## NEW CIRCUITS

SIR,—In your issue of August 8th I noticed a letter headed "A

Grouse," and cannot understand the attitude of the writer. We want to see every progressive circuit explained in your popular and efficient journal—so let us have all the "Supers" of reliability that come along, as only by experiment can we hope to progress in the science. There is no difficulty if one keeps by him separate components to wire up any circuit or dismantle it and return to the original one.

Best wishes in your progressive course.

I am, etc.,  
Hull. ALFRED E. QUICK,  
A.S.A.A., F.R.Econ.S.

## FLEWELLING CIRCUIT

SIR,—It may interest your readers to learn that I have put together the Flewelling one-valve receiver, and the results which I have had are astounding. The set works with an earth (not without), and the hiss so common with these circuits is entirely absent. I also connected one note magnifier with good loud-speaker results. Loud and clear speech is obtained, and no interference; all broadcasting stations come in strongly, also amateurs.

I am, etc.,  
Kent W. H. BAILEY.

## ST100 IN JO'BURG

SIR,—I enclose a photograph of an Essex car fitted with a wireless receiving apparatus for a motor carnival, which took place here recently.

Using ST100 circuit, local ama-

teur broadcasting could be heard very well at a distance of about 15 miles from the transmitting station and at about 4 p.m., when static is very bad here.

It, of course, attracted everyone's attention, and took the first prize for being the most original get-up.

Wireless in these parts is still in its infancy, though we have a club with over 100 members, and I think as soon as we are able to get a decent broadcasting set going, interest will soon bring in



ST100 on board an Essex car in Johannesburg.

more enthusiastic amateurs like myself.

My set is completely home-made, even the condensers and transformers, and the results obtained are marvellous.

I might add that I am a staunch advocate of your paper and *Modern Wireless*, and look forward to every issue.

I am, etc.,  
J. E. MAJOR,  
Johannesburg

[The Editor regrets that owing to the demands upon our space a number of letters are unavoidably held over.]

# Information Department



**D. F. (BLACKBURN)** asks for a circuit for a single valve transmitter using variometer tuning.

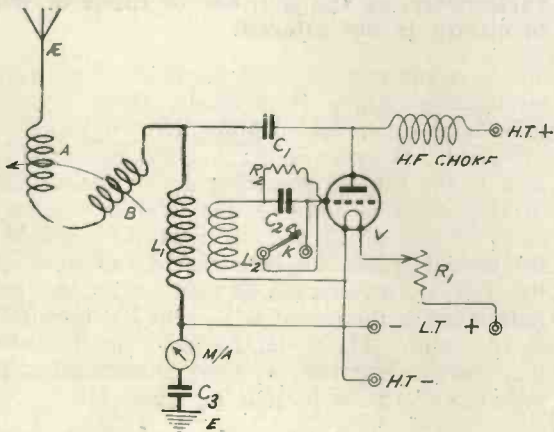

We reproduce herewith a suitable circuit.

**A. W. W. (LEICESTER)** proposes to build the circuit ST34, but finds difficulty in reconciling the wiring diagram shown in "Practical Wireless Valve Circuits," Radio Press Limited, with his ideas of the components required for this circuit. He asks if we can enlighten him on this point.

Full instructions for the assembly of a broadcast receiver embodying the circuit ST34 appeared in *Modern Wireless* for June, page 348. If you read this article carefully you will have no difficulty in assembling this receiver, which will give surprisingly good results.

**R. N. R. (KENSINGTON)** asks questions about the different methods of connecting the gridleak.

The advantages of the different methods shown in your diagrams depend largely on the type of valve in use. It is sometimes found that by connecting one side of the gridleak of an amplifying valve to the positive filament leg, the tendency to self-oscillation of the set is checked. It is advantageous to have a switch, so that the gridleak may be transferred to either the filament positive or negative leg for experimental purposes.

**E. F. (BIRMINGHAM)** wishes to wind basket coils of No. 28 s.w.g. d.c.c. copper wire upon a 2-in. former to cover from 350 to 1,780 metres.

Five coils will be required to cover this range efficiently, and they should have 35, 50, 75, 100, and 150 turns respectively. A parallel variable condenser of 0.001  $\mu$ F capacity will be necessary.

**T. E. H. (DURHAM)** enquires regarding the use and advantage, if any, of a "tune-standby" switch.

The chief advantage of a "tune-standby" switch is rapidity in adjusting to the wavelength of any required station. When the switch is placed in the "standby" position, the aerial circuit coil is connected directly across the grid and filament, and tuning is carried out on the aerial circuit only. When the station is found, the switch is put into the "tune" position, when the secondary coil is now across the grid and filament. The adjustment of the aerial circuit coil is left unaltered, and the secondary circuit is tuned and the coupling varied until strongest signals are heard. Further slight readjustment of the primary coil may then be found to improve results.

**P. G. H. (DORKING)** possesses two honeycomb coils resembling the Igranic pattern, but of which the inductance value is only specified in microhenries.

The inductance value of a 75-turn Igranic coil is approximately 37 microhenries, and that of a 50 Igranic coil 17 microhenries. The two coils in your possession are apparently identical with the Igranic coils above referred to.

**D. C. (CATFORD)** observes that if the switch arm of his tuner is placed between contact studs, a loud humming noise is heard in the receiver which vanishes when the apparatus is again tuned.

The humming noise you hear in your telephones is produced by earth currents which circulate through the apparatus when the aerial circuit is open. In your instance, the presence of an electric power main is probably the cause of the noise.



**GOOD TOOLS MEAN EFFICIENT WIRELESS SETS**

We give you Best Quality Tools with lowest prices by supplying the user direct. Send us your Postal Order or enquiries to-day; you'll get our best immediate attention.

*None too small or too large.*

**WE PAY CARRIAGE ON ALL ORDERS.**

**HAND DRILL**, capacity 0-1". Gears cut from full metal. Complete with three-jaw Chuck and Set of Drills, 1/8", 3/16", 1/4", 5/16", 3/8", 7/16", 1/2", 5/8", 3/4", 7/8", 1". **10/6**

**ADJUSTABLE STEEL HACKSAW FRAMES**, 8-12", Nickel Plated, complete with 1 Blade 2-1/2". **10/6**

**SUPERIOR PARALLEL TABLE VICES**, with clamp, 2 1/2" steel jaws, accurate finish. **6/6**

**STOCKS & DIES**, B.A. (Dies 1/4" dia.), cutting 2, 4, 6 and taps. London made.

On card with Taper Taps **10/-** per set.  
with Taper and Plug Taps **12/6**

**THE BILLING TOOL CO., LONDON, W.C.1.** *Phone Holborn 698*



**The "PERFECT" HYDROMETER**

A battery tester of precision and outstanding merit. The most reliable instrument of its kind on the market. No one who uses an accumulator should be without one; for it not only tells you when your battery is run down but shows you at a glance how much charge is left. Heavy rubber bulb and nozzle; Hydrometer scaled to indicate "full," "half," and "empty" (charge), as well as specific gravity of Electrolyte. The price is, for the first time, within the means of everyone.

**3/9** each, complete, post free.

Money back without question if not delighted with your purchase.  
*Special terms to the Trade. Travellers wanted.*

**The C. P. Co., Ltd., 12/13, Miles Lane, Monument, London, E.C.4.**  
*Phone: Central 9182.*

**BEWARE OF WORTHLESS IMITATIONS, SEE THE TRADE MARK *WatMel* ON EVERY GRID LEAK.**

**WATMEL VARIABLE GRID LEAK**  
(Patent applied for.)



The Resistance is steadily Variable between 1/2 to 5 megohms. Only requires a 3/8 in. hole in panel for fitting

Suitable for use in any circuit, and improves the working of any valve detector. (50,000 to 100,000 ohms for the S.T.100 Circuit. Price 3/6.)

**PRICE 2/6 EACH**  
The best Variable Grid Leak made.

**WATMEL WIRELESS CO.,** Connaught House, 1a, Edgware Road, Marble Arch, W.1. Tel. 4575 Paddington.

**ECONOMIC ELECTRIC L.D.**



**THE "EEC" "XTRAUDION" VALVE** is being used by the leading Radio Experimenters for detection, high and low frequency amplification, power amplifiers and low power transmission. Price 15/-

USE "RECTARITE," the synthetic crystal that makes Loud speakers talk!  
1/6 Large Specimen.

Write to-day for 40 page Radio Catalogue mailed post free, 4d.

Head Office: 10, FITZROY SQUARE, LONDON, W.1. Showrooms: 303, EUSTON RD., N.W.1. Branch and Works: TWICKENHAM.

H. A. D. (BARNES) is constructing the choke - coupled low frequency amplifier recently described in the Query Columns of "WIRELESS WEEKLY," and asks for suitable windings for the coupling choke.

The value of this is not critical, but an inductance of about 1 hy. is a suitable all-round figure. This could be made by winding 1,000 turns of No. 40 s.s.c. copper wire on a core consisting of soft iron wires 3/8 of an inch in diameter and 4in. long.

J. B. N. (NEWCASTLE) asks how such a wide range of tuning is obtainable with a variometer, as the number of turns of wire in circuit is not altered.

The best way to understand the action of the variometer is to imagine it to consist of two separate inductance coils, the coupling between which can be varied. If the coils are imagined as  $L_1$  and  $L_2$ , then if the two are so arranged that the coupling between them is additive, the total inductance is equal to that of  $L_1$  and  $L_2$  plus  $M$ , where  $M$  is the mutual inductance between the two coils. If the coils are now turned at right angles, the total inductance in the circuit is  $L_1$  plus  $L_2$ , because  $M$  is now zero. If, again, the coils are turned so that the coupling between them is subtractive, the inductance value is  $L_1$  plus  $L_2$  minus  $M$ .

E. I. W. (BARNSTAPLE) asks whether we can give him a circuit diagram of an improved Flewelling receiver which will operate successfully on an outside aerial. He wishes for an arrangement which will be very stable to operate and at the same time will give good signal strength.

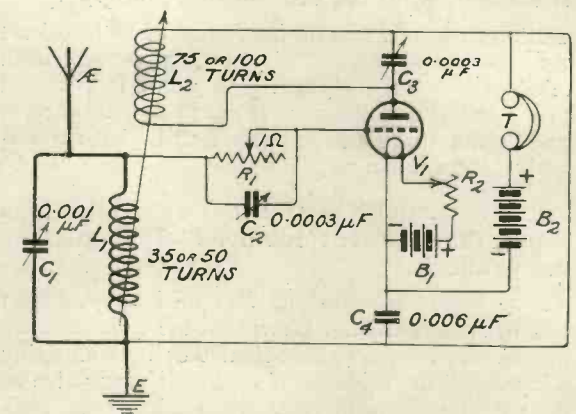

We reproduce herewith a recent modification of the Flewelling circuit which gives very good signal strength when used with an average aerial. For instance, 21.0 can be received at good loud-speaker strength 32 miles distance from the station.





# Radio Press Books give him all the information he needs

## Complete List

	Price.	Post Free
1. Wireless for All . . . . .	1/6	1/7½
John Scott-Taggart, F.Inst.P.		
2. Simplified Wireless . . . . .	1/-	1/1½
John Scott-Taggart, F.Inst.P.		
3. How to Make Your Broadcast Receiver . . . . .	1/6	1/7½
John Scott-Taggart, F.Inst.P.		
4. How to Erect Your Wireless Aerial . . . . .	1/-	1/1½
B. Mittell, A.M.I.E.E. . . . .		
5. The Construction of Wireless Receiving Apparatus . . . . .	1/6	1/7½
P. D. Tyers.		
7. How to Make a "Unit" Wireless Receiver . . . . .	2/8	2/8
E. Redpath.		
9. Wireless Valves Simply Explained . . . . .	2/6	2/8
John Scott-Taggart, F.Inst.P.		
10. Practical Wireless Valve Circuits . . . . .	2/6	2/8
John Scott-Taggart, F.Inst.P.		
11. Wireless Licences and How to Obtain Them . . . . .	1/-	1/1½
E. Redpath.		
Elementary Text-book on Wireless Vacuum Tubes . . . . .	10/-	(Post free)
John Scott-Taggart, F.Inst.P.		

Ⓞ Those printed in heavy type have been published recently.

HOW many turns for a Coil to reach the Paris Wavelength—the type of circuit to operate a Loud Speaker using only an indoor Aerial—Crystal or Valve rectification in a multi-valve Set? These are a few of the questions which confront the amateur constructor.

Some will find out the correct answers by expensive experiment—others, more wisely, will benefit by the experience of those who have trodden the thorny paths of Radio before them.

The concentrated experience of some of the best known Wireless engineers and experimenters is available for all readers of Radio Press Books. You cannot do better than purchase the complete Library—one Book at a time. Each Book covers a different phase of Wireless and none overlap. Get one or two to-day and keep them by you for ready reference—they are sure to save their cost many times over. From all Booksellers.

RADIO PRESS LTD.,  
Devereux Court, STRAND, W.C.2.

**Radio Press Books**  
— a complete wireless library

Gilbert Ad.

# STERLING

BRITISH MADE

## RADIO TELEPHONES



**NOTE REDUCED PRICES**



No. R 1260

### HIGH GRADE

with double-pole permanent magnets and stalloy diaphragms.

Headbands of coslettised steel

No. R 1260.

OHMS.	PRICE.
120	£1 2 6
2000	1 4 0
4000	1 5 0



No. R 1238

### SUPER QUALITY

with multiple permanent magnets and laminated stalloy pole pieces.

Duralumin Headbands.

No. R 1238.

OHMS	PRICE.
120	£1 17 6
2000	2 0 0
4000	2 2 0

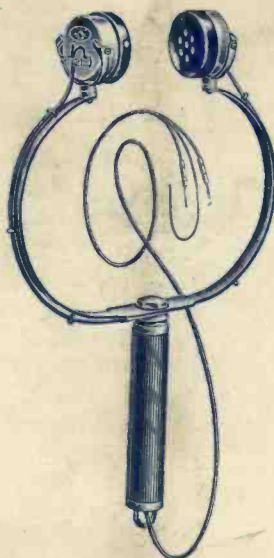

No. R 1281

### LADIES' HAND TELEPHONES

Same quality and construction as No. R 1238, with grooved ebonite handle.

No. R 1281.

OHMS.	PRICE.
120	£2 16 0
2000	2 19 0
4000	3 0 0

Obtainable from all Electrical Dealers and Stores.

## STERLING TELEPHONE & ELECTRIC Co., Ltd.,

Manufacturers of Telephones and Radio Apparatus, etc

(WHOLESALE ONLY)

Telephone House, 210-212, TOTTENHAM COURT ROAD, LONDON, W.1  
 Telephone : Museum 4144 (7 lines)      Telegrams : "Cucumis. Wesdo. London."

**BIRMINGHAM :**  
150, Edmund Street.

**CARDIFF :**  
10, Park Place.

**MANCHESTER :**  
14, St. Peter's Square.

**NEWCASTLE-ON-TYNE :**  
21, Mosley Street.

**WORKS :**  
Dagenham, Essex.

# Wireless Weekly

and The Wireless Constructor

Vol. 2.  
No. 11.

## CONTENTS

- A Single Valve Super-regenerative Receiver.
- A Carbon-Galena Loud Speaker. Regeneration and Crystal Receivers.
- The Construction of a Telephone Transformer.
- Random Technicalities.
- Early Developments in Wireless, Jottings by the Way, News of the Week, Constructional Notes, Broadcasting News, Apparatus we have Tested, Mainly about Valves, Correspondence, etc., etc.

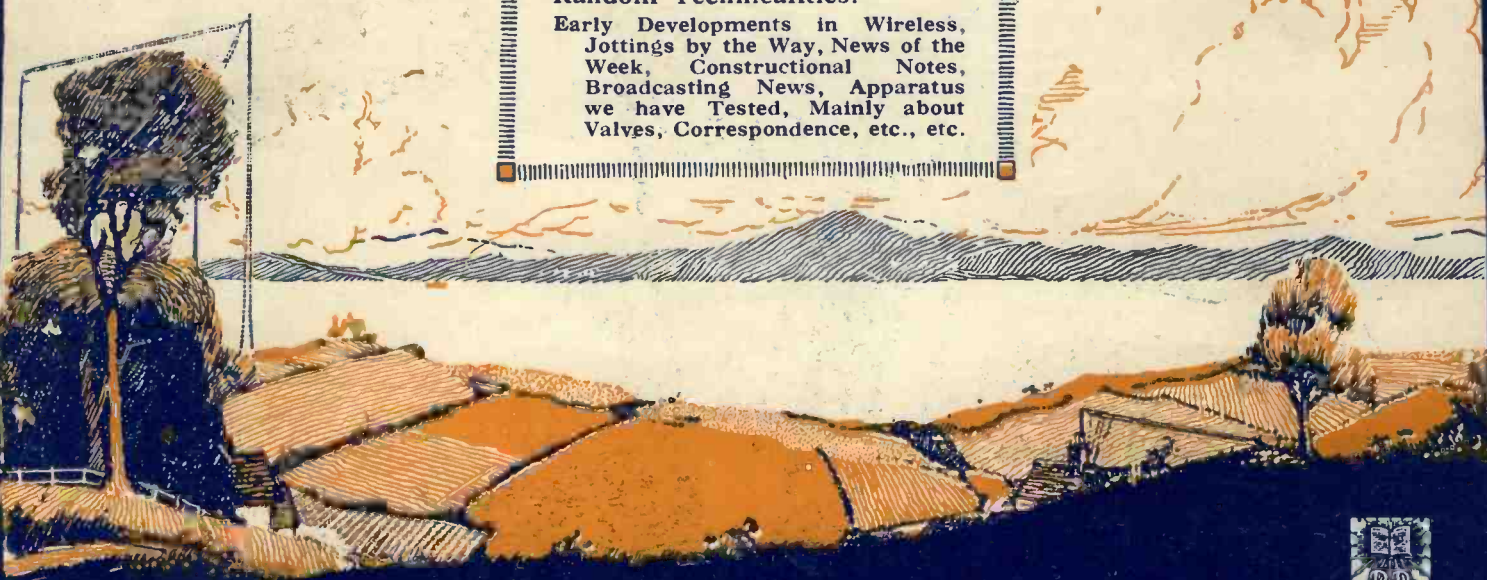

### A New Principle in Wireless Reception

By John Scott-Taggart.

# "Business Bringers"

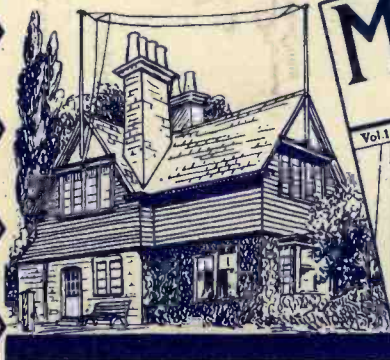
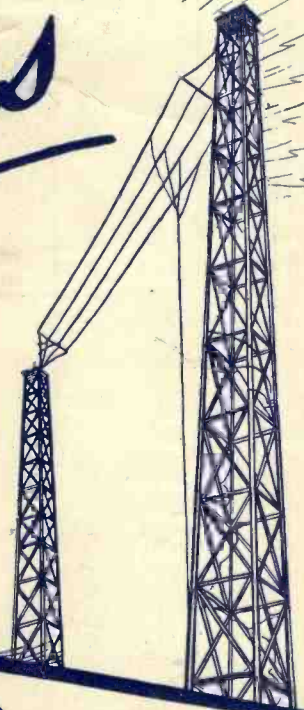

**ALWAYS  
ADVERTISE  
IN  
BOTH**

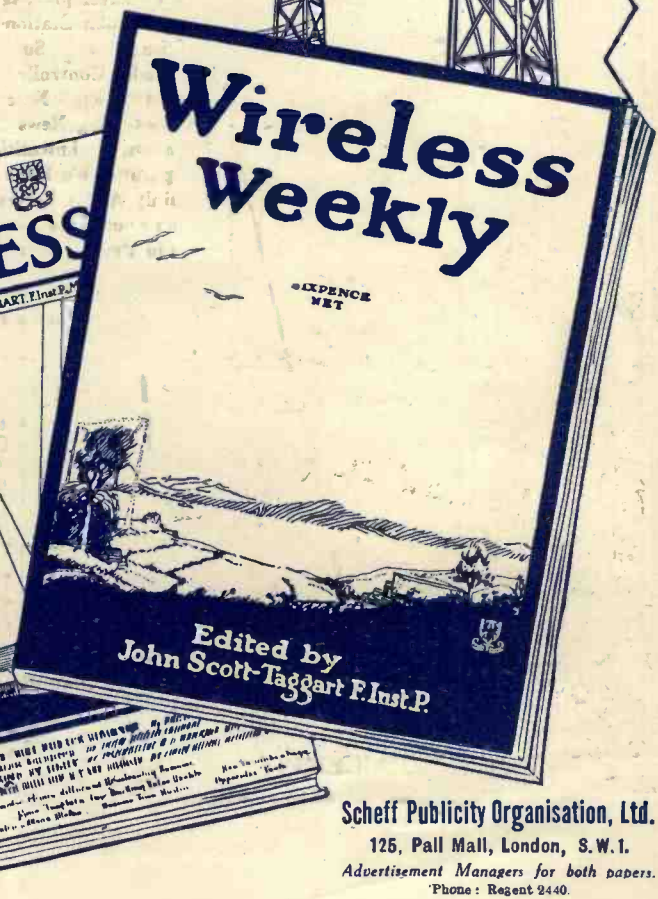
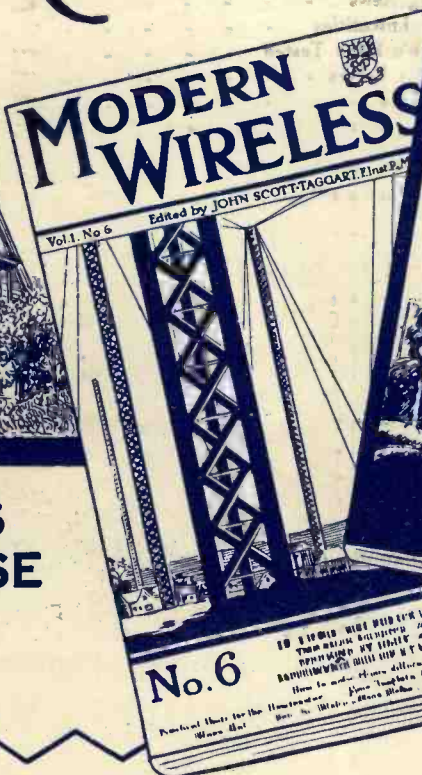

**Scheff Publicity Organisation, Ltd.**  
125, Pall Mall, London, S. W. 1.  
Advertisement Managers for both papers.  
Phone: Regent 2440.

# Wireless Weekly

Vol. 2, No. 11  
Sept. 26, 1923

## CONTENTS

	Page
Editorial - - - - -	398
A New Principle in Wireless Reception - - - - -	399
"Wireless Weekly" Circuits—No. 24 - - - - -	401
A Carbon-galena Loud-speaker - - - - -	402
Regeneration and Crystal Receivers - - - - -	404
Tree Aerials - - - - -	406
Jottings by the Way - - - - -	407
Broadcasting in Holland - - - - -	408
The Construction of a Telephone Transformer - - - - -	409
The Junior Car Club's Wireless Picnic - - - - -	410
News of the Week - - - - -	411
Early Developments in Wireless - - - - -	412
The London Station—Times of Transmission - - - - -	413
A Single-valve Super-regenerative Receiver - - - - -	414
A Model Controlled by Wireless - - - - -	417
Constructional Notes - - - - -	418
Broadcasting News - - - - -	421
Random Technicalities - - - - -	423
Apparatus We Have Tested - - - - -	424
Mainly About Valves - - - - -	425
Correspondence - - - - -	426
Radio Press Information Department - - - - -	427

Editor: JOHN SCOTT-TAGGART, F.Inst.P.  
Assistant Editors { E. REDPATH.  
                          P. W. HARRIS.

### Radio Press, Ltd.

Publishers of Authoritative Wireless Literature  
**DEVEREUX COURT, STRAND, W.C.2**  
Tel.—Central 3763.

Advertisement Managers: { SCHEFF PUBLICITY ORGANIZATION,  
                                  LTD., 125, Pall Mall, London, S.W.1.  
                                  Tel.—Regent 2440.

#### Staff Editors:

E. H. CHAPMAN, M.A., D.Sc.  
A. D. COWPER, M.Sc.  
G. P. KENDALL, B.Sc.  
R. W. HALLOWS, M.A.  
S. G. RATTEE.

Scientific Adviser:  
Prof. G. W. O. HOWE,  
D.Sc., M.I.E.E.  
Advisory Editors:  
Prof. R. WHIDDINGTON,  
M.A., D.Sc.  
Prof. C. L. FORTESCUE,  
M.A., M.I.E.E.



All correspondence relating to contributions is to be addressed to the Editor of "Wireless Weekly."

Nothing contained herein is to be regarded as permission or encouragement to infringe any patent rights.

# Editorial

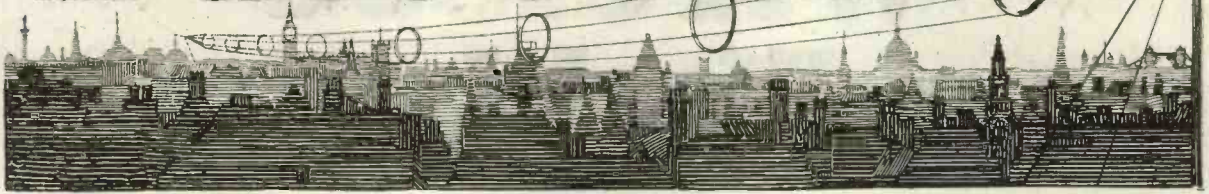

## The Report

**W**E have so often been informed that the publication of the Broadcasting Committee's report was imminent that, at this date, we merely mention, with all due reserve, that the latest information available on enquiry in official circles is that there is a decided feeling that the report will be published within a week.

It occurs to us that there are two possible explanations for the delay which has occurred. The Postmaster-General may be endeavouring to avoid a further delay following the publication of the report by getting his arrangements well advanced beforehand. The alternative may be that he intends to compensate to some extent for all the previous delay by publishing the report and his final decision in the matter simultaneously.

The continued absence of a constructional licence is holding back trade, and yet Sir L. Worthington Evans, the P.M.G., is head of the committee dealing with unemployment. The irony of it!

## Licences

We have frequently referred to the urgent necessity of hastening a settlement of the licensing question. Whilst it is all very well to blame official procrastination—which experience should have taught us to expect as a matter of course—what action, if any, has been taken by the experimenters to expedite matters?

Have they, through their societies, taken any united action to ensure that their reasonable and legal requirements shall be complied with?

What has the parent society, the Radio Society of Great Britain, been doing all these months? Nothing, as far as we are aware. Over a year ago a deputation from the society, representing the experimenters of this country, waited upon the Post Office Authorities, but

nothing appears to have come of their visit, and, in the absence of the continued vigorous action which the state of affairs warranted, we can only think that the deputation was a sheer waste of time.

A splendid opportunity for the parent society to fully justify its existence has thus been neglected. But perhaps the chance is not entirely lost. It may still be weeks before either the report is published or definite decisions announced. It is up to the Radio Society of Great Britain to use every endeavour to see that such is not the case, and by means of insistent deputations and active propaganda it should support the cause of British experimenters.

## Demonstrations

On another page we refer to a forthcoming open-air demonstration which is to take place under the auspices of the Junior Car Club. In view of our recent advocacy of publicity work in connection with wireless, and whilst agreeing that the organisation of outdoor demonstrations is a step in the right direction, we take this opportunity of mentioning the bad effect produced upon a non-technical audience by the distorted sounds emanating from overloaded loudspeakers.

## The Wavelength Problem

Those of our readers whose experiments bring them into touch with long-wave commercial transmissions will appreciate the difficulties in the way of establishing further stations on account of the congestion which at present exists, and will be particularly interested in the article "A New Principle in Wireless Reception," extracted from a paper read by our Editor before the British Association Meeting in Liverpool on September 19th. A reprint of the full paper will appear in the next issue of *Modern Wireless*.

# A NEW PRINCIPLE IN WIRELESS RECEPTION

The following is an extract from a Paper read before the British Association on September 19th by John Scott-Taggart, F.Inst.P. The full Paper will be reproduced in "Modern Wireless," No. 9, appearing October 1st.

I PROPOSE to give a very brief outline of an invention which I patented in May, 1920, but which is publicly described to-day for the first time.

The principle is of such a basic character that its application may affect the whole trend of methods of selective reception.

The invention involves the increasing, at the receiving station, of the frequency difference between desired and undesired currents. This method of solving the problem of selectivity and atmospheric elimination has never yet been attempted or suggested. The frequencies have remained the same, and the methods which have been adopted have been calculated to separate the desired from the undesired frequencies without attempting to change the actual frequency of either.

According to part of my invention, the frequency of the incoming currents is increased, with the result that the frequency difference

metres and 15,100 metres. The wavelength difference, in this case, amounts to 100 metres, a very narrow margin and one which, under ordinary circumstances, would lead to the 15,100-metre

metres difference between the two signals, but 10 metres difference on a wavelength of about 1,500 metres is ten times more valuable than a difference of 100 metres at a wavelength of 15,000 metres.

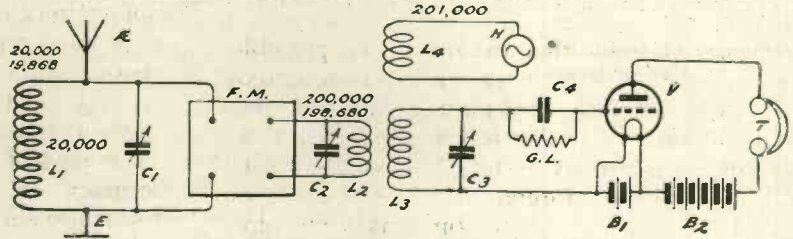

Fig. 1.—Reducing interference by frequency multiplication.

signals jamming the 15,000-metre signals. If now we apply both sets of incoming currents to a frequency multiplier giving a multiplication of, say, 10 times, currents will be delivered to the receiver proper by both sets of incoming currents. The 15,000-metre desired signals will set up

The number of cycles difference is the controlling factor in considering selective reception without interference. The example of the 15,000-metre signals being jammed by the 15,100-metre signals may be understood more clearly if we deal in cycles of frequency instead of metres. The 15,000-metre desired signal will set up oscillations having a frequency of 300,000,000 divided by 15,000, which equals 20,000. The 15,100-metre signals will correspond to oscillations having a frequency of 19,868. The frequency difference, therefore, is only 132 cycles.

If now, instead of receiving these signals in the ordinary way as, for example, by the heterodyne method, we multiply the frequencies of both signals by 10, we will increase the frequency of the signals due to the 15,000-metres station to 200,000 cycles, this corresponding to a wavelength of 1,500 metres. The 15,100-metres

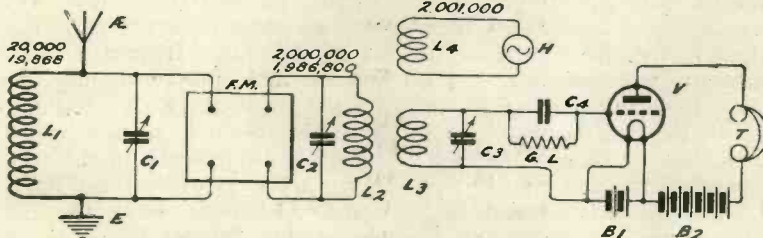

Fig. 2.—Frequency multiplication of 100 times.

between currents of different frequencies is increased.

An example will explain more readily what is meant. Let us assume that two stations are working on wavelengths of 15,000

oscillations corresponding to a wavelength of only 1,500 metres, while the 15,100-metre signals will be resolved into signals corresponding to a wavelength of 1,510 metres. There will now be 10

interfering signals will produce interfering oscillations having a frequency of 198,680 cycles.

It will be readily appreciated that the difference between the new desired and undesired currents is now ten times as great, and equals 1,320 cycles. Where before we had to differentiate between signals having a difference in frequency of only 132, we now have the considerably easier task of separating out signals having a difference of frequency of as much as 1,320 cycles. Put crudely, it is ten times as easy to separate the stations.

The new currents of multiplied frequency may be applied to selective high-frequency receiving circuits and the heterodyne method of reception may be employed.

#### Frequency Multiplication and the Use of Beats

It needs very little imagination for a student of these matters to appreciate the remarkable selectivity which is obtainable by a combination of frequency multiplication and heterodyne reception. A theoretical circuit is illustrated in Fig. 1.

In this figure it is assumed that in the aerial circuit, which contains the inductance  $L_1$  and variable condenser  $C_1$ , we have two sets of oscillations. One set has a frequency of 20,000, corresponding to the wavelength 15,000 metres of the desired signals, and the other currents have a frequency of 19,868, corresponding to the interfering signals of 15,100 metres. The circuit is tuned, of course, to the frequency of 20,000, corresponding to the desired signals. but, nevertheless, this method of selective reception is grotesquely ineffective when the frequency difference is so small. The next stage in the process is to apply the two sets of currents to a frequency multiplier which is shown, for the sake of convenience, as a box FM. This frequency multiplier may

take many forms, and might be a series of frequency-doubling devices, such as valves, or it might be an apparatus for producing harmonics, a selected harmonic being then treated as the fundamental for reception purposes. The output currents from FM pass through the oscillation circuit  $L_2 C_2$ , and even here resonance tuning may not be sufficient. Loose coupling between  $L_2$  and  $L_3$  will, however, if the primary and secondary circuits are tuned to the new 200,000-frequency signals—which are really derived from the original 20,000-frequency signals by a multiplication of 10—cause the 198,680-frequency currents, due to the interfering signal which originally had a frequency of only 19,868, to be less effective.

Oscillations are now induced into the circuit  $L_3 C_3$  from the heterodyne H, which may be, for example, a valve oscillator. This heterodyne induces local oscillations having a frequency of 201,000. The result of inducing currents of this frequency into the circuit  $L_3 C_3$  will be the production of two sets of beats. The 201,000-frequency oscillations will beat with the desired 200,000-frequency oscillations producing beats of 1,000 frequency, and these beats will be rectified and detected by the valve V, in the output circuit of which are the telephone receivers T. The 1,000-frequency beats will, of course, produce a musical note in the telephones T having a frequency of 1,000, which is a very convenient frequency for the reception of continuous wave signals. The 201,000-frequency oscillations induced by the local heterodyne will also produce beats with the oscillations having a frequency of 198,680 which, it is assumed, have not been tuned out by the use of resonance phenomena. The beats, in this case, will have a frequency of 2,300.

We now have in the telephones T two sets of signals. The desired sets have a frequency of 1,000, while the undesired ones have a frequency of 2,300, and no difficulty should be experienced in reading the desired signals without material interference from the other signals. It is important to notice that the incoming signals are not, of course, simply steady streams of continuous oscillations, but consist of dots and dashes of short duration, and that during a considerable period of time, dots and dashes of the undesired signals are received during the intervals between dots and dashes of the desired signals.

#### Hundredfold Multiplication

A far more striking example of the possibilities of this new principle in wireless reception is when we consider the frequency multiplication to be, say, 100 times. Such conditions are illustrated in Fig. 2.

The frequency multiplier FM now increases the frequency of the desired signals to 2,000,000, corresponding to 150 metres, while the interfering signals now have their frequency raised to 1,986,800. The frequency of the local oscillations of the heterodyne are adjusted to 2,001,000. With the desired currents of 2,000,000 frequency, the heterodyne currents will produce beats of 1,000 frequency which will produce a musical note of 1,000 in the telephone receivers. With the interfering signals, the local oscillations will produce beats having a frequency of 13,300. This frequency, to all intents and purposes, may be treated as above the audible limit, and the desired signals would therefore be received in the telephone receivers without any interference whatever from the undesired signals, even though in the initial aerial circuit the frequency difference amounted to such a small amount as 132 cycles.

We have recently tried most of the components made by the well-known Lissen Company and can recommend them to our readers. The results of actual tests will appear in our "Apparatus Tested" pages in due course.



“ WIRELESS WEEKLY ” CIRCUITS—No. 24

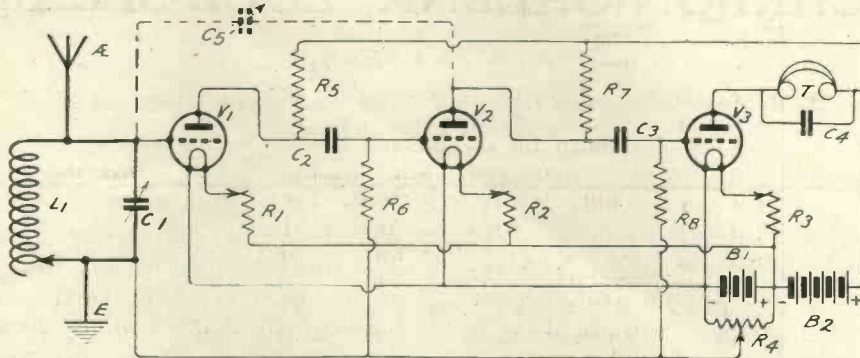

COMPONENTS REQUIRED

- L<sub>1</sub>**: A variable inductance.
- C<sub>1</sub>**: A variable condenser, capacity 0.001  $\mu$ F.
- C<sub>2</sub>**, **C<sub>3</sub>**: Fixed condensers, capacity 0.0003  $\mu$ F.
- R<sub>1</sub>**, **R<sub>2</sub>**, **R<sub>3</sub>**: Filament rheostats.
- R<sub>4</sub>**: A potentiometer, total resistance about 400 ohms.
- R<sub>5</sub>**, **R<sub>7</sub>**: Anode resistances, value about 50,000 ohms.

- R<sub>6</sub>**: Gridleak resistances, value  $1\frac{1}{2}$  to 2 megohms.

GENERAL NOTES

This is a simple, but effective, high-frequency resistance-capacity coupled receiver. The method of intervalve coupling employed is economical, and when once the values of anode resistances, coupling capacities, and gridleaks are correctly adjusted, they need no further attention.

The set is particularly effective on the wavelengths above

1,000 metres, though in some cases quite good results are obtained upon the broadcast wavelengths, if the values mentioned are carefully chosen.

Electrostatic reaction may be introduced by connecting a small variable condenser **C<sub>5</sub>**, capacity about 0.0002  $\mu$ F, as shown, but this addition is not permissible for broadcast reception. The potentiometer, **R<sub>4</sub>**, assists to prevent self-oscillation, as does the condenser **C<sub>4</sub>**, connected across the telephone receivers **T**.

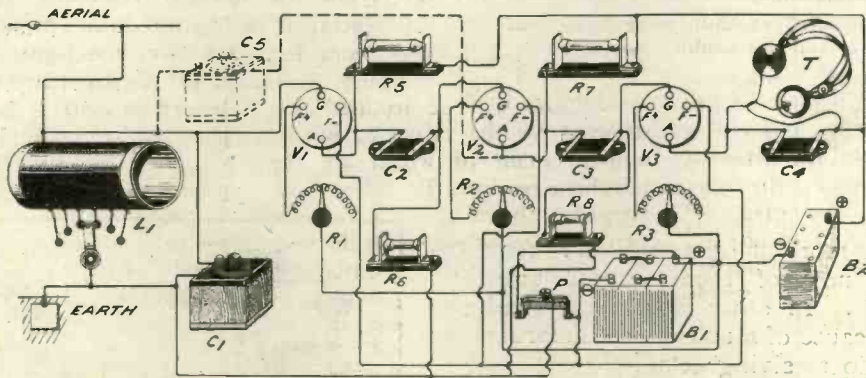

PRACTICAL WIRELESS NOTES—No. 6

GRID CONDENSERS

used with a rectifying valve usually require to have a capacity of from 0.0002 to 0.0004  $\mu$ F. The performance of the detector valve can often be considerably improved by careful adjustment of this value, and it

is a good plan to employ a variable condenser temporarily to ascertain the value which gives best signals, after which a suitable fixed condenser can be substituted.

If a home-made condenser is to be used, it should consist of

copper foils, separated by mica, assembled between two clamping pieces of ebonite. The capacity can then be adjusted slightly, either by a sliding movement of the copper foils or merely by tightening or loosening the clamping screws.

## A CARBON-GALENA LOUD-SPEAKER

By CLYDE J. FITCH.

To the mechanically inclined reader the following article suggests a large field for experiment and development.

**T**HERE are many types of loud-speakers now in use, but how many of these reproduce music and speech with all their original tones and characteristics? Take a horn from any loud-speaker and put it on another and note the difference in the sound. This is a simple test which indicates that the shape of the horn affects the quality of the reproduced sounds.

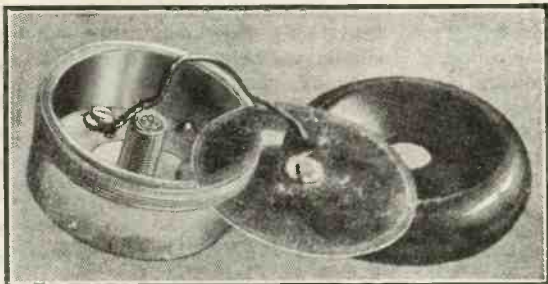

Fig. 1.—A photograph of the carbon-galena loud-speaker, dismantled.

Now take a number of loud-speakers without horns and quickly connect them, one at a time, to a receiving set, and note the difference in the quality of the reproduced concerts. All sound slightly different, but which produces the tones more like the original? As a matter of fact, none of them are perfect; all are far from it. In other words, the loud-speaker is the cause of much of the distortion in modern radio receiving sets.

The galena loud-speaker about to be described is a possible solution to the perfect loud-speaker problem. The only trouble with this type of instrument is that it does not give very loud signals. On a two-stage amplifier the received programmes from nearby radio stations are barely audible two feet from the horn, but this is remarkable, considering the simplicity of the device.

As shown in the photograph, the galena loud-speaker is nothing more than a galena crystal mounted on a mica diaphragm and

placed in an ordinary telephone receiver. The threaded rod, passing through the back of the receiver shell, carries a few carbon balls which make contact with the galena. The passage of an electric current from the galena to the carbon, or *vice versa*, heats the junction and causes expansion, thus exerting an outward pressure on the diaphragm. Therefore, if telephonic currents, corresponding to the vibrations of the human voice or music, pass through the carbon-galena contact, vibrations will be set up in the diaphragm corresponding to the original vibrations of the speech or music.

As this unit is strictly a resistance and is non-inductive, it has no electrical period of its own and will, therefore, cause no distortion due to electrical effects. The diaphragm is always pressing against the carbon balls, so that the natural vibrating period of the diaphragm is highly damped, and there will be very little, if any, mechanical distortion. There probably is a distorting effect caused by the sluggish action of the heat, but this is not noticeable; the reproduced speech is exceptionally clear.

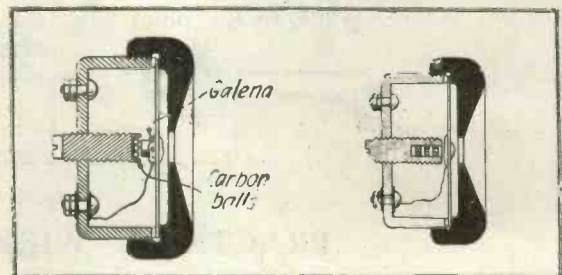

Figs. 2 and 3.—Showing, on the left, the type first used by the author, and, on the right, the more successful arrangement subsequently adopted.

A model was made with a carbon diaphragm having the galena crystal pressing against its centre. The galena was supported by the brass rod which screwed through the metal

'phone shell. The threaded rod, which was  $\frac{3}{8}$  in. in diameter, allowed for varying the contact pressure between the galena and carbon diaphragm. This 'phone was very sensitive, but had a tendency to burn out unless the current was very weak.

The next model was made as shown in the accompanying photograph and in the drawing Fig. 2. The galena is fastened to the centre of a mica diaphragm by means of a low melting-point alloy, such as is used for mounting crystals. The threaded rod carried the carbon balls, as shown, and the contact pressure was adjusted by turning the rod. From three to five balls were employed, and excellent results were obtained with the 'phone connected directly to the output terminals of a three-valve receiving set. The resistance of the galena-carbon contact was only 40 ohms, and to be efficient it should have a resistance of from 10,000 to 30,000 ohms. Hence, we should not expect good results.

To increase the resistance of the 'phone, a deep hole was drilled in the centre of the  $\frac{3}{8}$  in. brass rod, as shown in the illustration Fig. 3, and in this were placed alternately four galena crystals and four sets of carbon balls. This increased the resistance to about 200 ohms, and the expansion of the crystals and balls, acting upon each other, produced a greater effect upon the diaphragm. The signals were considerably strengthened with this arrangement.

It should be noticed in the circuit, as shown in Fig. 4, that a step-down transformer may be employed between the output of the receiving set and the 'phone. With its use, greater efficiency may be obtained. The

primary winding of the transformer should have an impedance equal to that of the valve, and the secondary should have an impedance equal to that of the 'phone. A polarising battery of two to six volts should be connected in series with the secondary winding in order to avoid the double frequency phenomenon. That is, both positive and negative halves of the current will exert an outward pressure on the diaphragm, whereas with the polarising battery only the increasing currents push out the diaphragm. Without the polar-

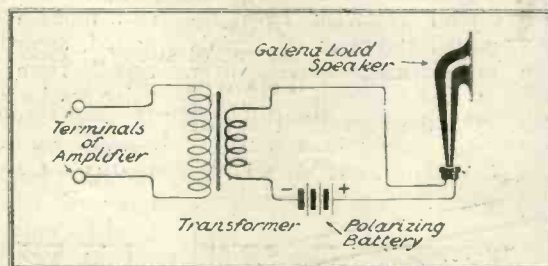

Fig. 4.—Circuit arrangement for using carbon-galena loud-speaker.

ising battery the speech is very peculiar and is entirely unintelligible.

It is well to keep in mind that the rectifying or detecting property of the galena crystal has nothing to do with its property of reproducing speech. It is the heating effect made by the electric current that causes expansion of the galena and carbon balls, and among many crystals and minerals tested galena gave the best results. An ordinary carbon ball microphone will act as a telephone receiver to a certain extent, a fact which was known as far back as 1878.

#### The Austin-Ratcliffe Trading Co.

advises us that they are in a position to supply any wireless want by post. Experimenters living in outlying districts who are unable to avail themselves of the facilities offered by the many shops of our larger towns will no doubt be interested.

**Autoveyors, Ltd.**, have published a revised leaflet describing briefly the well-known three-electrode variable condenser, which should prove of interest to many of our readers.

#### CATALOGUES RECEIVED

**Fullers United Electric, Ltd.**, have favoured us with a copy of catalogue No. 250 A., dealing with the L.S.L. plate type accumulators for lighting and ignition purposes, and the new B.J.X. and B.W.X "Block" type accumulators for wireless and ignition purposes.

**Messrs. Taylor, Taylor and Parkinson** are issuing a leaflet describing a five-valve broadcast receiver which is specially designed for long-distance reception. It is claimed that this set will receive all the B.B.C. Stations, the Hague, Berlin, and Paris telephony.

**George Palmer (Universal Cinema Supplies)** have sent to us a copy of their new catalogue of wireless accessories. This contains particulars of a large variety of parts.

# REGENERATION AND CRYSTAL RECEIVERS

By C. D.

*In view of the claims one often hears made in connection with long-distance crystal reception, the following article is of especial interest.*

At various times owners of crystal receivers have reported reception of signals from broadcasting stations over distances of several hundred miles. On the face of it a feat

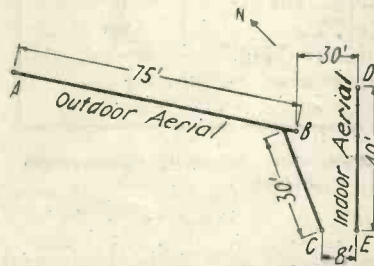

Fig. 1.—Plan showing approximate directions of the two aerials as used by the author in his tests.

now there may be hundreds or even thousands. It has been suggested, accordingly, that "radiation" from the more sensitive valve receivers, especially when in a state of oscillation, might account for some of the receiving records made with elementary types of sets normally rated as good for only 10 or 20 miles.

Other experimenters have denied the possibility of this, on the ground that signals so received would be distorted, while actually no distortion was apparent in at least some of the long-distance crystal reception reported. The writer accordingly set about making a series of tests to determine what effect, if any, a regenerative receiver might have on a nearby crystal set in the line of extending the range of the latter.

Two aerials were erected as shown in Fig. 1. One was an outdoor aerial of about the usual dimensions for broadcast reception, while the other ran indoors.

of reception on this scale is not impossible. In the pre-valve days of radio it was not unusual for amateur and commercial stations to cover several thousand miles with a sensitive crystal.

While the distribution of energy in a C.W. telephone transmitter and a spark transmitter is considerably different, the former, for example, employing energy to heat filaments which is not directly involved in the conversion of audio-frequency into radio-frequency energy, it is clear that the radiation outputs of the two types of sets are of about the same order, and that what was frequently accomplished with crystal receivers 10 or 15 years ago, in picking up distant spark telegraph signals, should still be feasible in telephone reception to-day.

In one respect, however, receiving conditions have undergone a great change. Where formerly, in urban centres, there were only a few receivers to the square mile,

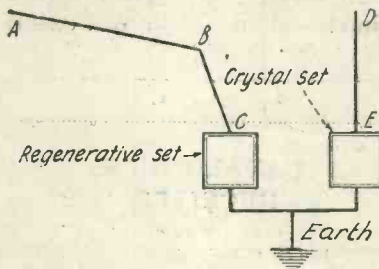

Fig. 2.—The two sets in the same room and connected to a common earth.

The indoor aerial DE was a single horizontal wire on the top floor of a six-story house, and it was so arranged that a receiving set might be connected at either end.

The outdoor aerial ABC ran from a point C indoors on the same level as DE to the roof at B, and thence horizontally about 6 ft. above the roof in a north-west direction. The indoor aerial was directed

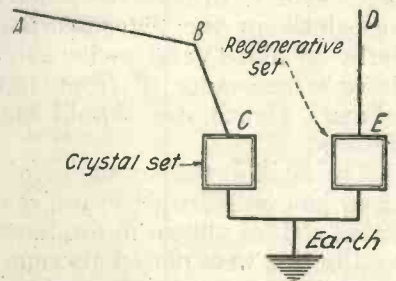

Fig. 3.—The same arrangement but position of sets reversed.

north-east, the two flat tops being at right angles. The coupling between these two aerials was no closer, it will be observed, than the valve frequently encountered in practice between aerials on the same or adjacent roofs.

The first experiments were made with a single valve regenerative set connected to the outdoor aerial, and a crystal set connected to the indoor aerial, both sets being of the single circuit type. The position of the two sets is shown in Fig. 2. The sets in this case were in the same room and connected to a common earth. Tests were first made on a local station, distant about five miles. The procedure and results are given below.

1. With the regenerative set inactive and the outdoor aerial earthed, a moderate signal was received on the crystal set and indoor aerial. This was the normal signal strength of this combination.

2. The outdoor aerial was disconnected from the earth, and, with the valve cold, the regenerative set was tuned, the operator listening on the crystal set. When the regenerative set was tuned to the wavelength of the local station the crystal signal increased about 200 per cent., or threefold. The setting of the crystal set was not changed during this test. In other words, the crystal set on the small aerial, by virtue of its electrostatic coupling to the large aerial picking up a stronger signal with higher received aerial current, was able to triple its own signal when the outdoor aerial was tuned to the same wavelength.

3. Both sets being left tuned as before, with minimum reaction on the regenerative set, the valve of the latter was lighted. No effect was observed on the crystal signal.

4. With the operator listening on the crystal set, the reaction coupling of the valve set was brought up to regenerative level, but short of oscillation. By this means the crystal signal was increased about 900 per cent. (ten-fold). The final crystal signal was therefore some 30 times what it had been without the assistance of the regenerative set and outdoor aerial. Earthing the outdoor aerial immediately cut the crystal signal to its original value. The amplified crystal signal was not distorted, inasmuch as regeneration on the valve set was not carried to the oscillation point. Although the valve set had been tuned by listening on the crystal only, it was found to be as accurately tuned as if its own telephones had been used in the normal manner.

5. Listening on the regenerative set, it was observed that tuning and detuning the crystal set altered the regenerative set signal just appreciably. When the crystal set was tuned to the local station the valve set signal was diminished very slightly—enough to be noticeable when one was looking for it. That is, the crystal set was able to get an amplification of about 30 times with only a slight diminution in the regenerative signal, an

effect due to the inherent nature of regenerative radio-frequency amplification. The energy withdrawn by the crystal set is easily compensated for by increased regeneration, and the additional load imposed by the crystal set allows a higher value of regenerative amplification short of the

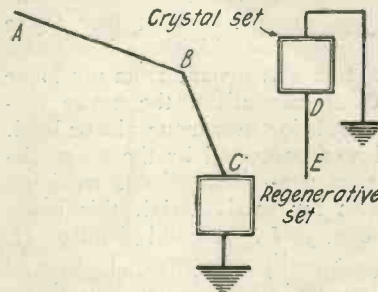

Fig. 4.—The sets separated and connected to individual earths.

squealing point than would be possible otherwise. In fact, with the valve set adjusted to maximum clear signal from the local station, the crystal set being tuned to the same wavelength, when the crystal set was detuned the regenerative set broke into oscillation.

The tuned regenerative signal was about 120 times that of the unassisted crystal signal, or about four times that of the assisted crystal signal.

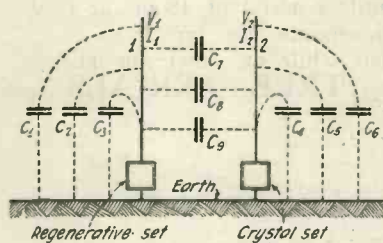

Fig. 5.—Illustrating how the effective capacity existing between two adjacent aerials is sufficient for the transference of radio-frequency energy from one aerial to the other.

The layout for the second series of experiments is shown in Fig. 3. In this case it was found that the two sets influenced each other much less. Tuning the outdoor aerial and crystal set increased the regenerative signal about 50 per cent., and the crystal signal

could be increased some 30 per cent. with the aid of the regenerative receiver and indoor aerial. When the latter was set into oscillation the beat note on either side of the local station's wavelength could be heard in the crystal receiver very plainly.

In order to eliminate the possibility of false results owing to the placing of the two sets in the same room with a common earth, the tests were repeated with the crystal set at the far end of the indoor aerial, as shown in Fig. 4, and later with the valve set in this position. An assistant made the necessary adjustments at the other end. The results were practically the same, the reaction being only slightly less owing to the somewhat looser electrostatic coupling between the two systems. It was therefore established that the effect was one occurring between the aerials, so that it may, and undoubtedly does, occur between the aerials of listeners situated near each other, although the sets may be in different houses and the listeners quite unaware of each other's existence.

The explanation of these effects may be seen from Fig. 5, which represents two aerials, 1 and 2, near each other, 1 feeding a regenerative set, 2 feeding a crystal set. Aerial 1 has a certain distributed capacity to earth along its length, represented in the figure by the separate capacities  $C_1, C_2, C_3$ . By virtue of this capacity a certain voltage, represented by  $V_1$ , is induced on the aerial by a passing electromagnetic wave. This will cause a current  $I_1$  to flow through the aerial inductance of the set connected to the aerial, and if the set is functioning properly this current will be detected and heard in the form of a signal. Similarly, aerial 2 receives a voltage  $V_2$  through its capacity to earth  $C_4, C_5, C_6$ . But if the aerials are at all near to each other, they will also have with respect to each other an appreciable distributed capacity  $C_7, C_8, C_9$ . Through this capacity radio frequency energy may be transferred from one aerial to the other.

If the current  $I_1$  is large, and  $I_2$  is small, the aeriels being tuned to the same wavelength, aerial 1 will exert a very appreciable effect on the other receiving system, but will not be noticeably affected by the action in the latter. Now, in the case of a regenerative receiver the aerial current is much greater than the current  $I_1$  originally received from the distant station, for the effect of regeneration is to greatly increase the voltages and currents in the grid circuit of the tube by reaction from the plate circuit. Thus we have an explanation for the facts experimentally noted in the above tests.

When the regenerative set is in a state of oscillation—and it must be remembered that a great many long-distance records are made with zero beat heterodyne reception—it may have still another effect on nearby crystal receivers by radiating oscillations tending to make the crystal detector more sensitive than in its normal, unassisted condition. This phenomenon was noted by Mr. Carl Ort eleven years ago, and described by him in a discussion on a paper by Mr. Edwin H. Armstrong presented before the Institute of Radio Engineers.\* Ort wrote:

\* See Armstrong: "A Study of Heterodyne Amplification by the

"It may be of interest to describe some experiments which I began in December, 1912, in a small town in Austria. At the time I was carrying on radiophone experiments, using a small Poulsen arc as a transmitting source. One day it happened that I received not only the speech from my arc station but also the noon time signals of the German Post Office station at Norddeich. The latter station was distant from my home about 380 miles, the entire distance being over mountainous land. I was impressed by the great distance over which I was receiving with my small aerial, this being about 30 ft. high and about 90 ft. long. Furthermore, I noticed that the tone of the signals received with a crystal detector was no longer musical but resembled that obtained when a tikker was used. Later I investigated the latter phenomenon, applying sustained oscillations directly to the detector, and found that the amplification was due to the increase in sensitiveness of the detector. I found that the amplification could be obtained with any frequency not audible to the

Electron Relay," *Proceedings of the Institute of Radio Engineers*, Vol. 5, No. 2, April, 1917, and discussion following.

human ear. I was able to obtain amplifications of about twenty-fold. . . . The same amplifying effect can be used at equal frequency for radio telephony." In Ort's last sentence we have, no doubt, the outline of a method of distance reception frequently and unconsciously used to-day.

The upshot of all this is that in any congested neighbourhood, using the term in the radio sense, a distance record made on a crystal receiver is worthless unless evidence is presented that no nearby regenerative receiver was picking up the same distant station at the same time. The probability in any such case is that the crystal receiver was merely being tuned to the amplified aerial currents of some valve set nearby. If one hears heterodyne squeals on a crystal receiver that is immediate evidence that a regenerative receiver is in action nearby and distant signals are apt to be relayed through it to the insensitive crystal set. While long-distance work on a crystal is possible and has actually been accomplished under conditions where assistance from valve receivers was out of the question, such *bonâ fide* long-distance crystal reception is rare, and most of the cases reported should be thrown out of court.

**A**MONG the many peculiar objects which can serve as wireless aeriels, trunks of trees can be numbered. The ac-

TREE AERIALS

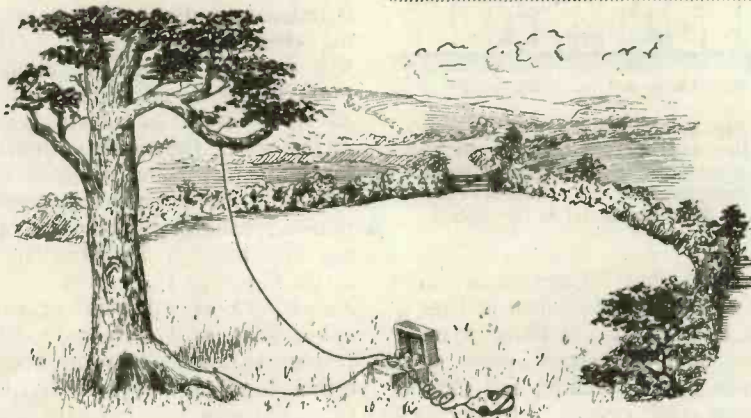

Good results are often obtained with tree aeriels as described in the accompanying note.

companying illustration shows how the apparatus may be connected, the aerial lead being taken to a nail in the upper part of the trunk and the earth lead to a point lower down. There has been some discussion as to the exact function of the tree, some people holding that the wires connected to the tree are the chief means of picking up signals. Others have held that the whole tree trunk, with its conducting sap, acts as an aerial, and that the receiver, if connected as shown, is shunted across part of the total inductance. Whatever theory should prove to be the correct one, the fact remains that good results are frequently obtainable with valve sets. Experimenters might try aperiodic aerial circuits in this way. They should prove suitable in the circumstances.—P. W. H.



### The Rivals

**I** DO not believe that any town in the country can produce as keen a pair of wireless rivals as the two who are the pride and the joy of Little Puddleton. Until about a year ago neither Bilsford nor Brogson could have put forward any sound claim to being mechanical. I doubt whether either of them possessed so much as a screwdriver. They probably knew between them less about electricity than you or I do of Papuan Demonology or of the Nebular Hypothesis. They were the closest of friends, drinking each other's whisky, smoking each other's 'baccy, and borrowing garden rollers and lawn mowers from one another in perfect amity.

To-day their skill with weird tools is nothing short of uncanny. They build huge wireless receiving sets of cunning design, and as for their familiarity with electrons and such like, well they would take the most eminent professor that you could produce and talk him to a standstill in half an hour. I admit, however, that should you take me at my word by producing a professor and bringing him down to our peaceful townlet to test the veracity of this statement I would prefer that he were a professor of law or ancient history.

You remember the tale of the fellow who posed as an all-round athlete and boasted that he had beaten both Inman and Joe Beckett? His statement was perfectly true, for he had given Tom Webster's favourite victim a sound drubbing at halma, and whacked the boxer's head off at billiards.

### Sweet Friendship

When the new hobby came along it appealed to Bilsford and Brogson as water appeals to a duckling. They dived straight in without the need of any prodding from behind. For a time all went well, save that as they burned midnight therns in one another's dens their wine merchants' and tobaccoists' bills increased so alarmingly that their better halves thought seriously of joining both the Dry England Society and the Anti-Nicotine League. They bought funny little sets and erected aerials that were a menace to themselves and to their neighbours.

Then they began to make things. Bilsford would rush round to Brogson to show him the variable condenser that he had made from two empty cigarette tins, whilst Brogson would prove his own ingenuity and the growing skill of his hands by displaying a switch contrived from a clothes peg, or a basket coil wound on a former composed of hairpins reft from his wife's dressing table. Each praised the other's efforts, or lent a hand when help was needed.

### War is Declared

The rift within the lute occurred at a meeting of our wireless club at which the burning question of high-frequency amplification was debated. Bilsford spoke in favour of transformers; Brogson, who followed, showed himself an ardent supporter of the tuned plate. They grew heated, taunts were flung, the air became thick with recriminations. Bilsford cried that Brogson might tune his plates till they turned pink, but

he would guarantee to produce better results with transformers. Brogson replied that as Bilsford never had produced any results worth talking about, it would be an excellent thing if he now put his back into it and did something at last. Had not friends seized them by the coat tails and kept them from flying at one another's throats, there would have been a most regrettable scene.

Now they are no longer friends, a fact which at first caused little pain to their wives, though the purveyors of tobacco and whisky aforementioned were most anxious to see the quarrel made up. A deadly hatred, however, has sprung up between them, and I fear that nothing will appease the wrath that smoulders in their bosoms.

### The First Skirmishes

The days when men who had developed a mutual feeling of dislike simply drew their battle axes and banged away at each other until they felt better are past and gone. Nor is it now permitted to order pistols for two and coffee for one at dawn. Bilsford and Brogson nevertheless engaged in a duel, though they did not fight with lethal weapons. It is perhaps the longest duel on record, for despite the fact that thrust and counter-thrust began ten months ago, it is still raging. Each side has got in some shrewd whacks, but neither shows any real signs yet of being beaten.

In a word they have become rivals. Each wishes to be considered a greater authority on wireless than the other, to have a bigger and more efficient set, to receive more distant signals. At

club meetings they talk at each other. If they meet on the neutral ground of another man's hearthrug they tell their host stories of scurvy fellows that they have met, the said scurvy fellows being easily identifiable as Bilsford if Brogson is doing the talking and vice versa. During our great anti-oscillation campaign they conducted an acrimonious correspondence in the *Gazette*, in the course of which "Fair Play" (Brogson) told "Pro Bono Publico" (Bilsford) exactly what he thought of him, and received in return some pretty hot ones for himself.

#### Serious Hostilities

But what we may call the practical side of the struggle provided the greater interest. If you happened to ask casually at the wireless club whether anyone had seen the latest and most expensive valve, each of the rivals was on his feet instantly telling you that he had acquired it weeks ago and offering to lend it to you to try for yourself. Sometimes one would steal a march upon the other by getting inside information about the appearance on the market of some new gadget. But as a rule they deadheaded. The competition of nations in navies

or armies was as nothing beside their frenzied struggle for supremacy in the matter of wireless gear. Their wives soon began to regret the reduction of the bills for drinks and smokes, since even at their highest these were mere drops in the ocean compared with those that flowed in from wireless shops. None of us needed to buy anything. We could always rely upon borrowing valves, rheostats, condensers, transformers, or any blessed thing from the groaning shelves of the rivals. It was indeed hardly necessary to have a wireless set, for each of them kept open house in order to demonstrate to all and sundry the superiority of his receiving set.

#### The Housing Problem

Bilsford, however, started the contest under a handicap of no mean order. Little Puddleton lies in a valley. The older houses are in the hollow, whilst those more lately built have climbed higher and higher up the hills on either side. Bilsford's home lay on the lower levels, but his rival's stood proudly further up the slope, and on its roof was raised aloft an aerial unblanketed by buildings, unscreened by his neighbours' trees.

Not to be done down in this way Bilsford purchased a plot immediately above Brogson's and let the local builder do his worst in erecting a desirable villa. He sold his comfortable old house and moved in. To him the new one's design was of little importance so long as the architect contrived, as indeed he did, so to place the house that it lay directly between Brogson's aerial and 2LO.

Brogson was furious, for his rival now obtained signals of undoubtedly greater volume. However, being of the bulldog breed he forthwith sold his house and built one on the summit of the hill. It matters not to him that he must start ten minutes earlier than he was wont to catch the 8.29; it matters not that he must pant his way home up a precipitous slope on sweltering evenings. He does not mind arriving hot and dishevelled on his return, for has he not the proud knowledge that his aerial is the highest in Little Puddleton and that he can receive stations that are names and nothing more to his rival and the rest of us?

WIRELESS WAYFARER.

## BROADCASTING IN HOLLAND

FOR the use of our readers we give below particulars of broadcasting in Holland:—

(Dutch time is 20 minutes ahead of Greenwich.)

**Sundays.**—10-11 a.m., Heussen Laboratory (valve manufacturers), the Hague PCUU 1,050 metre concert. 3-6 p.m., Neth. Radio Industry, the Hague PCGG 1,050 metre concert. 8.30-10.30 p.m., NSF Hilversum.

**Mondays.**—9-10 p.m., Neth. Radio Industry, the Hague 1,050 metre concert.

**Tuesdays.**—8-10 p.m., Heussen Laboratory, the Hague, 1,050 metres.

**Wednesdays.**—8-10 p.m., Smith & Hooghoudt, Amsterdam (wholesale retailers, manufacturers, and agents of Browns), PA5, 1,050 metre concert.

**Thursdays.**—8.30-10.30 p.m., Neth. Radio Industry, the Hague 1,050 metre concert.

**Fridays.**—9-10 p.m., Ch. Velthuisen (wholesale retailer, manufacturer) at the Hague PCKK on 1,050 metres.

**Saturdays.**—8.30-10 p.m., Mid-

delraad, Ymuiden PCMM 1,050 metre concert (amateur).

**Daily (except Sundays).**—8.15-8.30 a.m., 10-10.15 a.m., 11.30-11.35 a.m., 11.43-11.55 a.m., 12.15-12.30 p.m., 1.5-1.20 p.m., 3-3.30 p.m., 4.15-4.30 p.m., News Office, Vas Diaz, Amsterdam, PCFF, 2,000 metres, daily news and market reports. 1.30, 1.45, 2, 2.15, 2.30, 2.45 p.m., Association of Stock and Bondbrokers, Amsterdam PCFF, 2,000 metres, stock and bond quotations; Saturdays between 10.30-11.30.



# THE CONSTRUCTION OF A TELEPHONE TRANSFORMER

By H. A. C.

*This article will prove of value to the experimenter who takes pride in making his own apparatus and prefers the arrangement of low-resistance telephones and transformer.*

**M**ANY advantages may be gained by the use of a telephone transformer in conjunction with low-resistance 'phones instead of the more usual arrangement in which high resistance telephones are connected directly in the anode circuit.

An efficient telephone transformer may easily be made at the small expense of about 5s. provided care is taken in its construction.

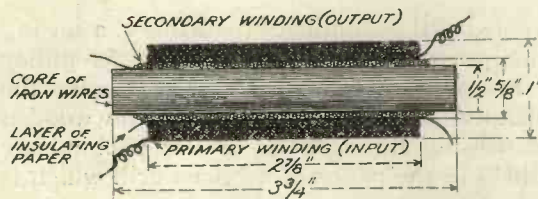

Fig. 1.—Section of completed transformer, showing dimensions.

For the primary and secondary windings  $\frac{1}{4}$  lb. of No. 42 s.w.g. enamelled copper wire and about half-an-ounce of No. 38 s.w.g. d.s.c. copper wire respectively will be required, whilst sufficient No. 22 or 24 gauge iron wire cut into lengths of  $3\frac{3}{4}$  in. to form a bundle  $\frac{1}{2}$  in. in diameter, will make an excellent core.

The iron wires should be straightened and bound very tightly with tape, especially at the ends of the core, and soaked in hot paraffin wax for about fifteen minutes. The wax is then allowed to cool until it is about to solidify, when the whole may be taken out and left until quite cold. The binding tape and any surplus wax are then removed, the iron wires and wax forming a solid core.

A strip of paper  $3\frac{1}{2}$  in. wide should be wound tightly round it two or three times and held in place by a few turns of wire, which may be taken off as the winding progresses. The end of the secondary or inner coil of fairly thick wire may then be secured to one end of

the iron core with cotton and the winding commenced, the turns being wound closely and evenly backwards and forwards as cotton is wound on a reel until five layers have been completed. The finishing end of the wire may also be bound in place with cotton and the whole immersed again in hot wax.

For the primary windings it is almost essential to use some sort of winder, which may easily be constructed from an old wire bobbin in the following manner. Select one which has a diameter of stem less than that of the finished secondary winding, and saw off one of the cheeks. If the stem is too long, cut a piece off so that the distance from the inside of the remaining cheek to the end of the stem is about three inches or just under, this being the length of the finished primary coil. The cheek which was removed should now be screwed to the stem, as in Fig. 2, so that it may be taken off when it is required to remove the finishing winding.

A few layers of about No. 28 s.w.g. enamelled wire are wound on this former

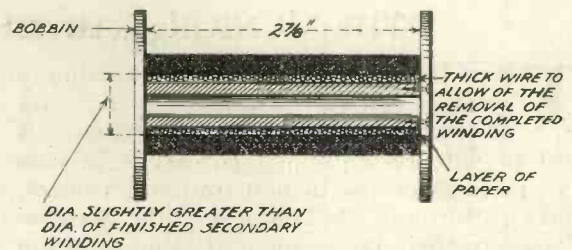

Fig. 2.—Section of the finished primary winding and former.

until the diameter over the winding slightly exceeds that of the finished secondary and core. The experimenter should note that this winding is merely for the purpose of removing the primary winding when complete, also of adjusting its internal diameter to the correct

size. After wrapping a piece of paper two or three times round this, the primary winding may be commenced, whilst the bobbin is mounted between supports, a piece of bent wire forming a handle as in Fig. 3.

It is not necessary to wind this coil in exact layers, but the turns should be wound on as evenly as possible, the wire being guided by the hand. The experimenter should also be sure that sufficient length of wire is left over

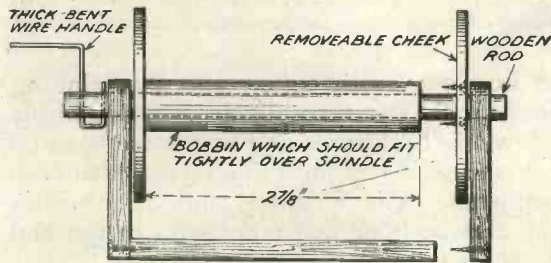

Fig. 3.—The winder.

the cheek of the bobbin for purposes of connection, and whilst winding, the bobbin from which the wire is taken may be mounted on a large nail, as in Fig. 4.

After this is completed the whole, including the former, should be soaked in fairly hot wax until it has permeated through the entire primary winding. The bobbin should then be removed from the wax and left until cold, after which the cheek may be unscrewed and the few turns of thick wire removed by pulling steadily on the end. The primary, together with the paper, may be slipped off and placed over the completed secondary and iron core.

Another immersion in fairly hot wax will serve to hold the components together and coat the whole with a layer of insulating wax, after which it may be enclosed in a box or incorporated in a receiving set as required, the ends of the windings being soldered to four terminals for purposes of making connection.

The experimenter, however, will doubtless favour a quicker method of winding the primary coil. If a small wooden pulley be

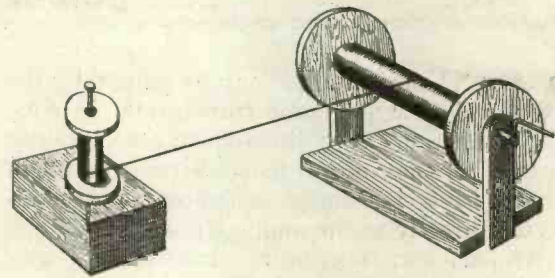

Fig. 4.—Illustrating method of winding the primary coil.

fastened to the spindle of the winder, a sewing machine treadle connected with this pulley by means of a string or belt will solve the difficulty, or, as an alternative, the wooden rod passing through the winder bobbin may be held in the chuck of a breast drill which is itself gripped in a bench vice.

The writer has made a transformer according to the description given, obtaining practically as good results with it and low-resistance 'phones as were obtained by the use of high-resistance 'phones connected directly in the anode circuit.

## THE JUNIOR CAR CLUB'S WIRELESS PICNIC

**T**HE Junior Car Club is organising a great open-air wireless picnic on Sunday afternoon, September 30th. A fleet of wireless equipped B.S.A. light cars will be present for demonstration purposes, and also through the kindness of the Marconi Company their large open-air demonstration set will be installed. This highly efficient receiving set will be in operation in conjunction with a powerful loud-speaking apparatus. The latter is a gigantic "Amplion," which the manufacturers, Alfred Graham & Co., recently demonstrated in the Midlands when 10,000 people were able to listen in the open air with perfect ease to a broadcast concert. The Junior Car Club extends a very hearty

invitation to all the members of other motoring bodies and to the motoring public in general.

The J.C.C. has pleasure in announcing that the well-known personalities of the British Broadcasting Company have accepted the Club's invitation to be present. These will include "Aunt Sophie," "Uncle Caracacus," "Uncle Arthur," "Uncle Jeff," and "Uncle Rex." Motorists are therefore invited to bring their youngsters, who no doubt will be particularly interested in seeing "Aunt Sophie" and the various "Uncles" in reality.

The venue is Burnham Beeches, and the concert commences at 3 p.m.



# News of the Week

**R**EUTER is given to understand that the Brazilian Minister of Public Works on September 6th paid a visit of inspection to the new receiving station erected by the National Wireless Company with French apparatus. While the Minister was present messages were received with perfect facility from Bordeaux.

The educational value of wireless is so apparent that we must expect the next generation to possess an all-round knowledge which we have never attained. We have talks and lectures on a great variety of subjects—music, literature, art and science—and although many of us would not take the trouble to read the written article, we are often constrained to listen when the words come uninvited to our ears. For instance, we heard the announcement recently of a talk on electricity for cooking purposes. Not being cooks, we were just about to turn off the precious juice, but lingered to catch the first few words. These aroused our interest, and we heard the talk through; in fact it proved most interesting and instructive. This has happened many times when listening-in, and as an educational medium wireless is much pleasanter than dry, laborious text-books.

We learn from a contemporary that during 1922 110,000,000 dollars were spent by the American public on wireless sets.

According to the *Leeds Mercury* one of the troubles experienced in the organisation of a road motor

transport service has been the difficulty of keeping in touch with the driver once he has left headquarters. That is now being overcome by the use of wireless installations, and, according to Mr. F. G. Bristow, General Secretary of the Commercial Motor Users Association, several large transport undertakings are considering the fitting up of receiving apparatus on their motor waggons, so that they may be able to broadcast instructions to their drivers.

Campbell Gray, Craigdhu, Kinnoth, a Perth schoolboy, whose father, Mr. William Gray, is well known in Perth law circles, has succeeded in "listening-in" to America. Young Gray has a four-valve set which he rigged up himself, and, after waiting until 3.30 a.m., he succeeded in tuning in America, and was entertained by piano solos and speeches. Although there were several interruptions by Morse, atmospheric conditions were good, and the American programme was received intermittently until 5 a.m.

Appearing in *The Times* of September 5th, the following facts make interesting reading:—

"The broadcasting position in this country, with its single organisation, contrasts strongly with the position in the United States, with its multitudinous stations. According to Government figures there were in the United States on July 2nd no fewer than 581 active broadcasting stations, but, as the result of a close survey, it was found that, in point of fact, many of these stations had, for one reason or another, ceased to

operate. The actual number of stations in working order was 450."

The article dealing with this subject concludes with a table which in point of interest we reproduce below. The various interests maintaining broadcasting stations, according to the Government returns, were:—

	Active.	Dis-continud.
Radio and electrical companies	218	121
Educational institutions	88	13
Newspapers and publishers	68	26
Department stores	36	2
Business unknown	31	26
Automobiles, batteries, cycles	26	2
Churches and Y.M.C.A.'s	20	4
Private	12	6
Hardware	11	3
Musical instruments, jewelry	10	9
Police, fire, municipal	7	2
Clubs and societies	7	5
Railroads and power companies	7	4
Telegraph and telephone companies	6	0
State bureaus	5	1
Banks and brokers	5	1
Dental, medical, drugs	5	1
Parks and amusements	4	3
Stock, poultry, and grain companies	4	1
Theatres	4	1
Mining, marble and oil companies	3	3
Real estate	2	1
Laundries	1	0
Playing card manufacturing	1	0

Although wireless telephony was first heard in Chile only last December, interest in the latest radio developments is sufficiently keen to justify the formation of the Compania Radio Chilena, which has assumed the representation of the various world-renowned manufacturers of radio equipment.

The Government has not yet taken any measures to regulate wireless activities. Everyone, we understand, is free to erect radio equipment exclusive of spark-transmitting stations.

# EARLY DEVELOPMENTS IN WIRELESS

By SIR OLIVER LODGE, D.Sc., LL.D., F.R.S.

*The conclusion of a history of the progress of wireless which began in our No. 8 issue.*

**I**N March, 1889, I lectured to the Royal Institution on "The Oscillatory Discharge of a Leyden Jar," and incidentally exhibited many of the effects of waves, both on wires and in free space, with overflow and recoil effects. But there was nothing akin to signalling exhibited in this lecture, as there was in the subsequent one of 1894.

Nevertheless Sir William Crookes, on the strength of these experiments—which he mentions—wrote a brilliant article in the *Fortnightly Review* for February, 1892 (Vol. 51, page 173), in which he foreshadows actual telegraphic accomplishment by that means, and indicates also the possibility of tuning or selective telegraphy, which was not actually born till 1897. He is evidently impressed with the experiments both of Hertz and of myself, and he quotes from my *Phil. Mag.* paper of August, 1888, in confirmation and illustration of his prevision. For he says—after speaking of choosing wavelength with which to signal to specific people—"This is no dream of a visionary philosopher. All the requisites needed to bring it within the grasp of daily life are well within the possibility of discovery, and are so reasonably and clearly in the path of researches now being actually prosecuted in every capital of Europe, that we may any day expect to hear they have emerged from the realm of speculation into that of sober fact." And then he goes on: "Even now, indeed, telegraphy without wires is possible within a restricted radius of a few hundred yards, and some years ago I assisted at experiments where messages were transmitted from one part of a house to another without any intervening wire, by almost the identical means here described."

That article appeared in 1892, and was an inspiration of genius. Too little appreciation is felt to-day for the brilliant surmises and careful and conscientious observations of a great experimental worker like William Crookes. And on some of it orthodox



*Senatore Guglielmo Marconi, G.C.V.O., D.Sc., LL.D.*

science still turns its weighty and respectable back.

### Other Methods of Detecting Waves

In 1889 I had come across the effect of cohesion under electric impetus, and employed it to ring a bell under the stimulus of the overflow of a Leyden jar, as described in my paper to the Institution of Electrical Engineers in 1890.

In 1893 I heard of Branly's filings-tube—an independent discovery of M. Branly, which really constituted an improvement on the first rough coherer idea. I think I heard of it through a lecture and demonstration by Dr. Dawson Turner of Edinburgh. What I had called a coherer was not this, but a needle point arrangement, of the end of a spiral spring touching an aluminium plate, which was and is extremely sensitive, but rather unmanageable.

With a Branly's filings-tube I made many more experiments, developing the subject;

and on the untimely death of Hertz I determined to raise a monument to his memory by a lecture at the Royal Institution on these experiments (Friday evening, June 1st, 1894), which I styled "The Work of Hertz"—meaning that it was a direct outcome and development inspired by that work. I soon found that the title was misleading, so that in the next edition I changed it into "The Work of Hertz and some of his Successors," and subsequently changed it still further into "Signalling across Space without Wires"; for that, of course, is what was being done all the time. The depression of a key in one place produced a perceptible signal in another—usually the deflection of a spot of light—and, as I showed at Oxford, also in 1894, employing a Thomson marine speaking galvanometer lent me by Alexander Muirhead, a momentary depression of the key would produce a short signal, a continued depression a long signal—thus giving an equivalent for the dots and dashes of the Morse Code—if the filings-tube were associated with an automatic tapper-back. One form of such tapper-back was then and there exhibited—a trembler or vibrator being mounted on the stand of a receiving filings-tube. This was subsequently improved into a rotating steel wheel dipping into oiled mercury. Our aim was to get signals on tape with a siphon recorder, and not be satisfied with mere telephonic detection. We succeeded; but more rapid progress would have been made had we stuck to the telephone, as wiser people did.

#### Telegraphy 1894 to 1896

My Royal Institution (1894) lecture was heard by Dr. Muirhead, who immediately conceived the desire to apply it to practical telegraphy. And when my lecture was published—as it was in *The Electrician*, with

diagrams roughly depicting the apparatus shown, drawn (some of them) skilfully but not always quite correctly, by the then editor of *The Electrician*, Mr. W. H. Snell—it excited a good deal of interest; stimulating, to the best of my belief, Captain, now Admiral, Sir Henry Jackson, Professor Righi, and Admiral Popoff, to their various experimental successes which have been elsewhere described.

To show that my work of 1894, though published, and therefore unpatentable in this country, was recognised as of value and as patentable for telegraphic purposes in the United States, I appeal to my U.S. Patent (674,846, dated May 21st, 1901—application filed December 20th, 1897), which was granted, after long discussion, on the strength of work recorded in 1894, since it could be proved to have been introduced into the United States in that year—a year mentioned in the Specification, line 100.

I was 100 busy with teaching work to take up telegraphic or any other development; nor had I the foresight to perceive, what has turned out to be, its extraordinary importance to the navy, the merchant service, and indeed land and war service, too. But fortunately in Italy there was a man of sufficient insight to perceive much of this, and with leisure to devote himself to its practical development.

In 1896 Signor Marconi brought the subject to the notice of the British telegraphic authorities, and the subject began to assume practical and commercial importance. Its further progress during the present century is known to all. My patent of May, 1897, for tuned or selective telegraphy, has been legally established by Lord Moulton as the fundamental tuning patent. It was extended in 1911 for another seven years by Lord Justice Parker, and was acquired by the Marconi Company.

### THE LONDON STATION

THE following are the winter times for 1923:—

5.0 to 5.30.—Women's Half-hour.  
 5.30 ,, 6.15.—Children's Hour.  
 6.15 ,, 7.0.—Interval.  
 7.0 ,, 7.15.—Weather Report, First News Bulletin and Notices.  
 7.15 ,, 7.30.—First General Talk.  
 7.30 ,, 8.30.—Concert.

8.30 to 8.45.—Second General Talk.  
 8.45 ,, 9.30.—Concert.  
 9.30 ,, 9.40.—Weather Report, Second News Bulletin and Notices.  
 9.40 ,, 10.0.—Concert.  
 10.0 ,, 10.15.—Men's Talk (three times a week).  
 10.15 ,, 10.30.—Concert.  
 10.30.—Close Down.

# A SINGLE-VALVE SUPER-REGENERATIVE RECEIVER.

By A. D. COWPER, M.Sc., Staff Editor.

Experimenters who are interested in the possibilities of super-regeneration—and how many are not—will welcome this practical article.

IN super-regenerative circuits a powerful high audio-frequency oscillation is permanently established by some means, in order to check periodically the radio-frequency oscillations started by excessive reaction. In the original Armstrong one-valve circuit, this was brought about by large tuned inductance and reaction coils, bridged by large tuning condensers, and themselves very closely coupled, either magnetically or (occasionally) electrostatically.

In the old and later Flewelling circuits the controlling oscillations are produced by a regulated grid-leak howl, close coupling of the radio-frequency reaction coils, to-

gether with a special feed-back from the plate-circuit above the 'phones producing this howl, which is tuned up to a high audio-frequency by means of an adjustable grid-leak—or, as the writer suggested in No. 3, Vol. 2, *Wireless Weekly*, p. 59, by using a fixed grid-leak and an adjustable grid-condenser.

Mr. J. Scott-Taggart has suggested (No. 5, p. 225) that it might be possible to obtain this "buzzing" by simply using the right values of grid-condenser, grid-leak and reaction, without even the single 0.006  $\mu$ F condenser in the grid-circuit and feed-back connection from the plate-circuit of the later Flewelling circuit.

The writer has been able to show that this can be done quite readily, giving a very *reductio ad absurdum* of super-regenerative circuits—merely a single valve with reaction, of quite ordinary equipment—and producing a circuit which at the same time is easily tuned, and possesses extraordinary sensitiveness.

### Results Obtainable

It is quite possible with this circuit to go the rounds of every British broadcasting station in rapid succession, on "capacity" aerial alone, and to read clearly each one at a signal strength comparable with that of the average B.B.C. crystal set receiving from a local station on an average suburban aerial; the curious point being that in N. London, music, etc., from 2LO and nearby amateurs come in at very little greater strength than Glasgow, 350 miles distant.

Results are a little better with an earth-connection (in a first-floor room) alone, but the improvement is rather in the direction of steadiness and ease of tuning than of greater signal-strength. An outside aerial,

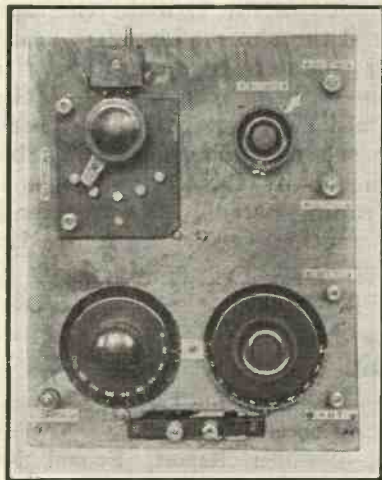
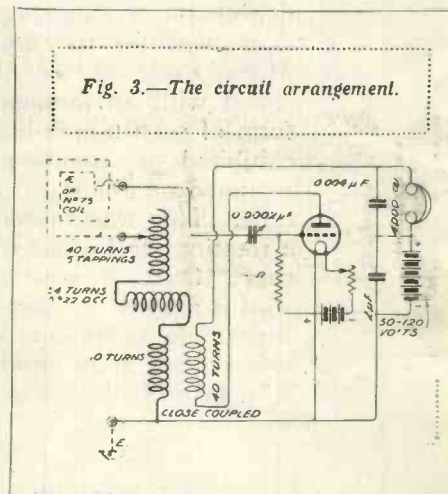

Fig. 1.—Photograph of front of panel.



and a short inside aerial, gave no improvement. Earth and aerial connections paralyse the circuit; whilst a medium-sized frame aerial is no better than earth-lead alone, though it is quieter. A very small frame-aerial gave extremely good results.

The limiting signal-strength—considerably below that of the one-valve Armstrong—rather militates against a wider use of the circuit. With two note-magnifying valves, beyond a filter-circuit to remove most of the whistle, only a moderate measure of effective loud-speaking resulted on local transmission, whilst separate

batteries, both H.T. and L.T., had to be used. Extremely loose-coupling to a aperiodic outside aerial, after the fashion of the Reinartz tuner, gave no louder signals.

However, it was quite possible to hear in London both the Newcastle and Glasgow transmissions in turn some feet away from the loud-speaker (a small Claritone), using a frame-aerial 6in. by 18in. and a D.E.R. (Marconi Osram) run off two flash-lamp batteries in parallel for L.T., and nine in series for H.T.

As with the other super-circuits, the utility lies in the direction of long-range, small portable sets and in situations where a decent aerial cannot be erected. Since the quench-

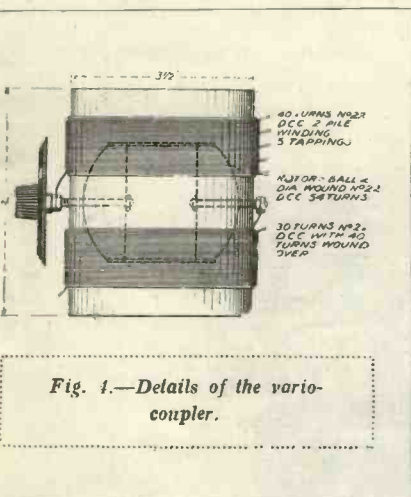

Fig. 1.—Details of the variocoupler.

ing-frequency is not fixed by a tuned circuit it cannot be filtered out so successfully as in the Armstrong circuit; but against that, and the limited signal-strength, must be set its surpassing simplicity.

**Constructional Details**

After preliminary experiments with loose components, the set was made up as in the photographs, Figs. 1 and 2. The materials required, in addition to the small frame-aerial, valve, batteries and 'phones were:—  
3-ply, 8in. by 10in.  
Ebonite:— $\frac{3}{16}$ in. : 3in. by  $3\frac{1}{2}$ in.,

for switch;  $3\frac{1}{2}$ in. by  $\frac{1}{2}$ in., for 'phone-terminals; 2in. by 1in., for grid-leak.  $\frac{1}{2}$ in. :  $2\frac{1}{4}$ in. by  $1\frac{1}{4}$ in., for valve-shelf.

- Valve-socket.
- Filament resistance.
- 0.0002  $\mu$ F variable condenser with knob for panel mounting, and scale.
- 2 megohm grid-leak.
- Switch-handle.
- 5 contact studs.
- Coil plug-mount.
- Knob and scale, for variometer.
- 9 terminals.
- Cardboard tube,  $3\frac{1}{2}$ in. diam. by 4in. long.
- Wooden variometer rotor, about  $2\frac{3}{4}$ in. diam.
- About  $\frac{1}{2}$ lb. No. 22 D.C.C. wire.
- 1oz. No. 26 D.C.C. wire.
- Length of No. 2 B.A. screwed rod; nuts; screws; No. 18 bare wire and sleeving for connections; shellac varnish, etc.
- Total cost, under £1, less valve, 'phones and batteries.

The extremely close reaction-coupling required to produce the grid-leak howl with ordinary values of grid-leak, and H.T. supply was obtained by actually winding a two-pile winding of 40 turns No. 26 D.C.C. wire on top of the first thirty turns (No. 22 D.C.C., single layer) of the A.T.I. and in the same direction, on a  $3\frac{1}{2}$ in. diam. impregnated cardboard former, separating the windings by several layers of waxed paper and insulating tape.

As shown in Fig. 3, the A.T.I. was completed with 40 turns (two-pile-wound) of the No. 22 D.C.C. wire, tapped at five points—every ten turns—and a variometer rotor in the middle gave fine tuning. An ordinary wooden-ball rotor,  $2\frac{3}{4}$ in. diam., with about  $2\frac{1}{4}$ in. winding-space, held some 54 turns of the No. 22 D.C.C. wire—the exact number is immaterial.

With the large capacity across the two windings, this sufficed to tune a small frame-aerial, in series with it, over the broadcast band of wavelengths. When using capacity aerial or earth alone, a No. 75 plug-in



Fig. 2.—Photograph of back of panel.

coil brings the wavelength up. Provision is made for this on the panel, above the tapping-switch.

A fixed grid-leak of reliable and constant value was used, mounted in clips. A standard Dubilier 2 megohm resistance suited most valves, but the value can range from 50,000 ohms to 4 megohms according to conditions, and, in particular, to the size of grid-condenser used. With the 2 megohm leak, a small variable grid-condenser is required. The writer used one of the convenient one-hole-fixing type of 0.0002  $\mu$ F nominal capacity supplied by Jackson Bros.

The five-point tapping switch and filament resistance were of ordinary type.

For convenience, the components were mounted on a vertical panel of varnished three-ply wood, about 8in. by 10in. (which has many advantages for experimental construction), the tapping switch, grid-leak, and 'phone terminals being mounted on small ebonite strips. The connections were made with No. 18 copper wire, covered as necessary by insulating sleeving, all connections being quite accessible behind the panel.

The telephone condenser was conveniently a little larger than usual (0.004  $\mu$ F), and was of the handy

"clip-in" type, supplied by the Grafton Electric Co. The valve was placed out of harm's way behind the panel, in a valve-holder mounted on a small shelf of  $\frac{1}{2}$  in. ebonite. Other details will be gathered from the photographs. To reduce the serious effects of hand-capacity, a sheet aluminium shield was fitted behind the tuning-knobs and scales, and earthed to the L.T. plus.

#### Notes on Operation

With frame aerial or a No. 75 coil connected up in the grid-circuit, the valve-filament as bright as may be safe, and maximum available H.T., the variometer should be turned to maximum wavelength position and the grid-condenser to maximum capacity,

and a loud howl or deep whistle should be heard.

By slowly decreasing the grid-condenser value this should rise to a shrill whistle. On swinging the variometer or cutting in-and-out turns on the coil by means of the switch, the note will also change, but should be kept at the high audio-frequency by adjustment of the grid-condenser (or filament temperature).

A welter of C.W. Morse and the array of heterodyne "humps" of telephone carrier-waves familiar to those who have used "supers," should now be heard; and with care one can tune into the narrow, quiet zone between two heterodyne bands where telephony is readable, adjusting the quenching-oscillation-frequency (or whistle-note) to as high a rate as the signal-

strength will permit. The adjustment of the grid-condenser for this purpose naturally slightly affects the tuning; so it must be followed up by re-adjustment of the variometer.

If any "energy collector" be used such as a short aerial or ground lead, it should be connected to the filament-side, as any load applied at the top of the A.T.I. simply "chokes" the set.

There need be no fear of producing interference with this circuit at more than a few feet, using a small frame-aerial or earth lead alone.

There are interesting possibilities in the direction of ultra-portable sets, and of short-wave work. The limited signal-strength may greatly improve on the shorter waves.

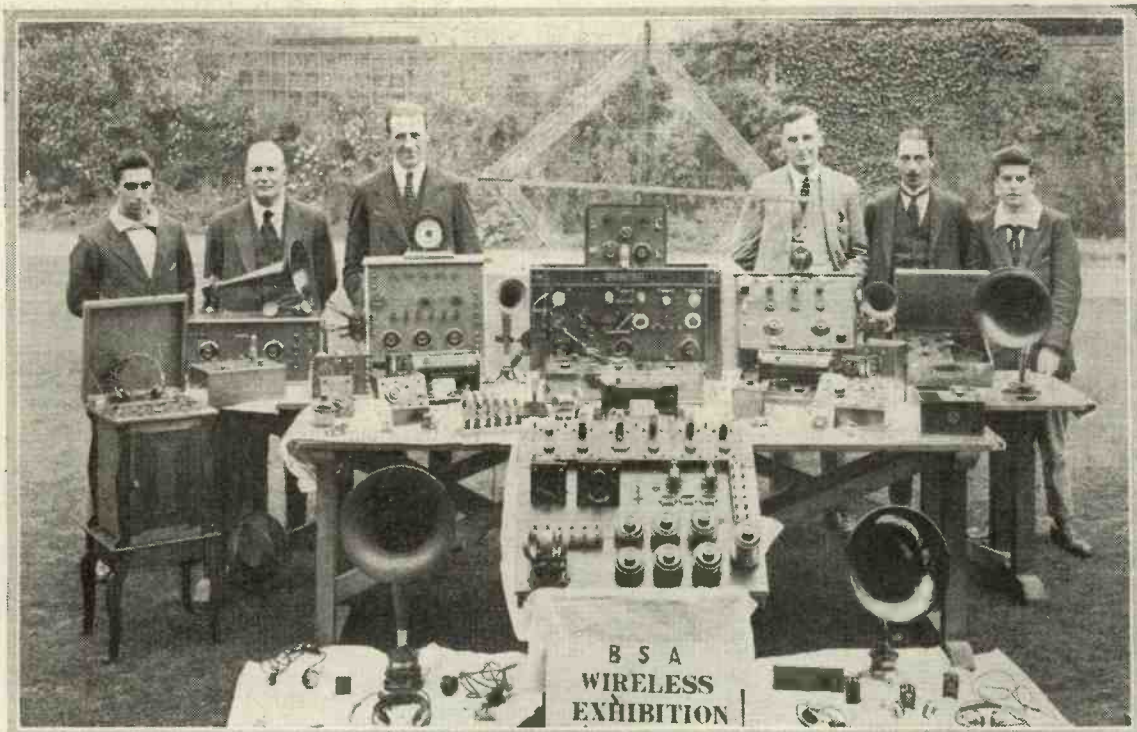

Our photograph shows some of the apparatus belonging to members of the B.S.A. Wireless Club on the occasion of the Club's first exhibition held on September 1st. The experimental apparatus of the Club is seen in the foreground. It will be noticed that all components employed in this apparatus are provided with terminals, thus allowing any circuit to be set up at will.



## MODEL CONTROLLED BY WIRELESS

*Enthusiasts will find in this branch of the hobby an interesting field for experiment.*

**M**ANY of our readers will remember the "Phillips Airship" which, demonstrated by Major Raymond Phillips, was successfully shown at the Wireless

The movements of the vessel when in the water are all controlled by wireless, and a gun fitted to the small craft can be fired by the same means; in the lower photograph the neat



*The vessel afloat, with her owner in command.*

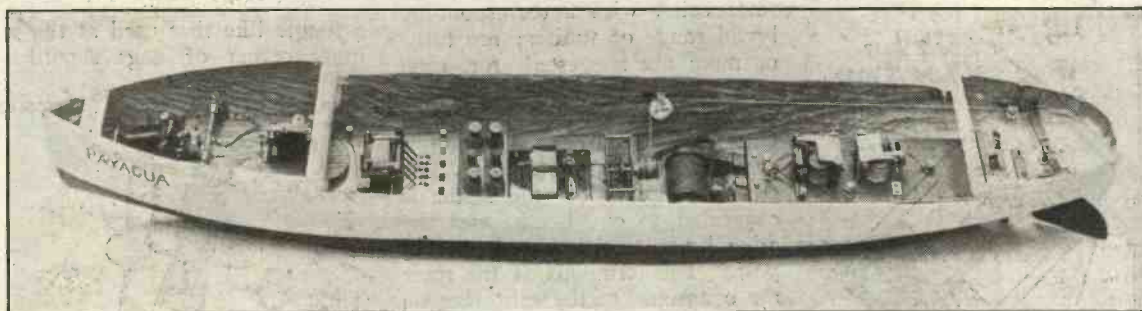

*The interior of the model.*

Exhibition held in London at the Central Hall, Westminster, during the latter part of last year.

Operated in the same way, our photographs show a model "steamship" built by Mr. Fuller, an experimental engineer and wireless enthusiast.

arrangement of the mechanism will be observed, with the step-by-step control switch, and coherer and tapper for'ard of the accumulator.

The whole vessel was built and fitted by Mr. Fuller down to the smallest detail, including the gun.

# Constructional Notes

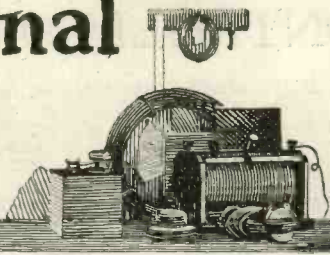
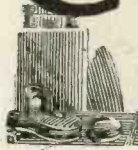

Conducted by R. W. HALLOWS, M.A., Staff Editor.

## A VARIOMETER WITH A WIDE RANGE OF INDUCTANCE

HEREWITH is a variometer which can be used to cover a wide band of wavelengths without the necessity of employing a switching arrangement. It is in reality a 360° variometer, as the coils oppose each other at one parallel setting, thus affording a lower value of inductance, providing the windings of the coils are equal. As the rotor is turned through 180°, the inductance increases, until it equals the sum of the inductances of the two coils, viz., the rotor and stator. Continuing the rotation in the same direction, the coils are connected, to assist each other. Therefore,

the coils are again parallel. This arrangement for switching the coils is accomplished by a commutating or switching arrangement that is mounted directly on the shaft of the rotor coil. This can be better

## SOME AERIAL TIPS

SO many beginners—and not a few of the older hands too!—fail to get their aerials just as they should be that the few tips which follow may be found useful. Their adoption will save a great deal of trouble.

In the first place make your halliards endless by splicing or binding together the two ends of the cord or wire. Few things are more annoying than to drop the cord and to see its end gaily sailing upwards out of reach or even right through the pulley. This cannot happen if the tip given is adopted.

When endless halliards are used a toggle like that used at the top inner corner of flags should be

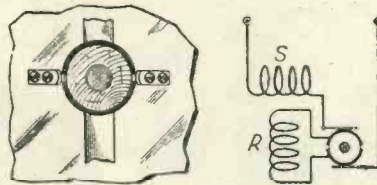

Fig. 2.—Section of the commutator arrangement. The connections are also shown.

understood by referring to the sketch, Fig. 3.

Due to this switching arrangement, a very large number of turns can be used on both the stator and rotor coils, with a corresponding broad range of tuning; 100 turns or more are suggested for each coil. Referring to Fig. 2, the variometer is connected as follows: One terminal of the stator coil is connected to a binding post. The second terminal of the stator is connected to one brush, and the other brush to the second binding post. The terminals of the rotor are connected to the split ring on the wooden washer.

The construction of this variometer is very simple, as it is made of standard parts easily obtained. The details given in the sketches are self-explanatory. Each coil has a winding of 100 turns, these being bank wound in the usual manner, to save space.

J. R. B.

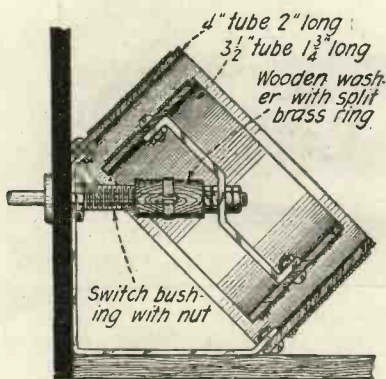

Fig. 1.—Constructional details of the variometer.

the inductance increases through another 180° until the maximum of self-inductance is reached, when

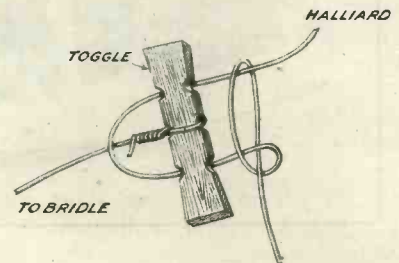

Fig. 3.—The toggle and its ropes.

fitted to a short length of wire or rope attached to the bridle. To fix on the aerial knot one of the halliards into a loop as shown in the drawing and pass the toggle through it, then pull tight.

Wire made of many strands cabled together is far better than rope for halliards. A new rope varies considerably in length according to the state of the atmosphere, and some time must elapse before it becomes weathered. For the same reason wire should be preferred to rope for aerial stays.

Many people have trouble with blocks that jam owing to the halliards slipping in between the rim of the pulley and the stopping. The best of all pulleys for wireless work is the sort used for window sash-lines, which is known as a side pulley. They can be bought from any ironmonger for 1s. or less. In these, if well made, the wheel is so close to the frame that jamming is impossible. The pulley is fastened to the side of the mast near its top by a couple of  $\frac{3}{8}$  in. bolts.

To grease a squeaking aerial pulley is quite a simple job. There is no need to scale the mast or take it down. Bind a piece of cotton waste on to one of the halliards, give it a good dose of oil and haul it up to the pulley. Work it through from side to side two or three times. Oil will be squeezed out on to the rim of the wheel, whence it will trickle down on to the axle. Again the advantage of having endless halliards is demonstrated!

It is most important that the mast should be fitted with a truck, for if it has none water will work right down into the grain of the wood and set up rot. The grain of the truck should be at right angles to that of the mast.

If your mast begins to show large cracks in hot weather do not be alarmed—all masts crack in time. Should they be very bad a good tip is to take the mast down and to force over it one or two short lengths of stove piping of different diameters, the larger, of course, being jammed down towards the bottom end of the mast. These act as ferrules and hold the wood together. Some solignum or other preservative should be worked into the cracks with a small stiff brush, or it may be squirted in with a syringe.

Don't neglect the end of the aerial that is away from the house. Some people appear to think that it does not matter much; they put three or four insulators at the lead-in end and give the other only one. This is exactly what should not be done. The free end is the point of highest potential, being generally most distant from earth, and should be well insulated.

R. W. H.

on wood, the hole through which it is to pass should be made a very tight fit. The core can then be forced through from the underside, until its shoulder rests against the wood. If the hole is a sufficiently tight fit nothing further need be done to fix it in place; but should it not be held firmly enough the brass collar method of securing should be used.

R. W. H.

### TERMINALS FROM OLD SPARKING PLUGS

**E**XCELLENT terminals of large size and heavily insulated, suitable for aerial and earth leads, can be made from porcelain cores of old sparking plugs. One of their great advantages is that they can be secured directly to a wooden mounting, even if they have to carry high-frequency or high-ten-

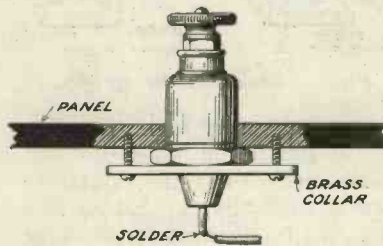

Fig. 4.—An old sparking plug terminal.

sion currents. They can thus be used in the set which has wooden panels and saves ebonite by employing the bush method of mounting valve legs and so on, or they will be found very handy for attachment to high-tension battery boxes and accumulator crates.

The drawing shows the method of fixing the plug-core terminal to an ebonite panel. A hole through which it will just pass is drilled; it is then secured in place by a brass collar, which butts against its shoulder. The lead on the underside of the panel is fixed to the electrode by means of solder.

If the terminal is to be mounted

### A NEAT PLUG-IN DETECTOR

**A** NEAT little detector which will be found very handy for reflex and other circuits employing a crystal rectifier in combination with valve amplifiers can be made up very quickly in the home workshop. It is made to plug into its mounting on the set for two reasons. In the first place this system allows detectors provided with various crystals to be interchanged in an instant; and, secondly, the effect of reversing the direction in which current flows through the detector can be tried without one's having to undo a single connection; the detector is simply pulled out, turned round, and replaced.

Fig. 5 shows the finished instrument, which is very compact indeed, measuring only 3 in. in length by  $\frac{1}{2}$  in. in breadth. The overall height including the plugs is only 2  $\frac{1}{2}$  in.

The foundation is a block of ebonite measuring 3 in. in length by  $\frac{1}{2}$  in. in width and  $\frac{3}{4}$  in. in depth. For the plugs two  $\frac{1}{4}$  in. holes are drilled in the lower side. These should be  $\frac{1}{4}$  in. deep. The solid portions of the plugs, which should be filed down to  $\frac{1}{2}$  in. in length, will be found to be a driving fit into them. When the four 4B.A. holes for the screws, which secure the uprights, have been drilled and tapped as shown in Fig. 6 in the top of the block, the plugs are inserted into their holes and driven home by gentle

tapping with a piece of hard wood. 4B.A. tapping holes are now made right through the ebonite from side to side, passing through the plugs. These are tapped, and screws are put in lightly—they will have to be re-

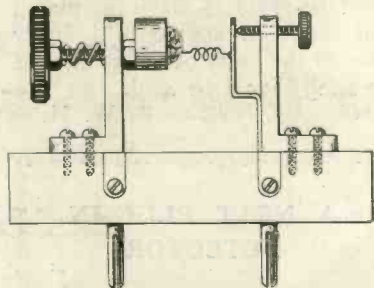

Fig. 5.—The completed detector.

moved and re-inserted later—to keep the plugs in place.

The uprights are made from angle brass. They have both the same overall dimensions. The only difference between them is that that intended to take the spindle supporting the crystal cup (A, Fig. 7) has a 2B.A. clearance hole drilled  $\frac{3}{8}$  in. from its top edge, whilst the other (B) has a 4B.A. tapped hole whose centre is  $\frac{3}{16}$  in. from the top. The cat-whisker is made of thin brass wire coiled into a spiral by being wound tightly round a knitting-needle. It is fastened by means of solder to its bracket, which is made from a piece of springy sheet brass  $\frac{1}{8}$  in. wide bent as shown in the drawing. The bracket is soldered to the face of the upright.

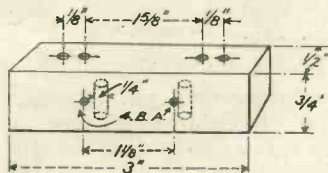

Fig. 6.—The mounting plug.

The crystal cup is made from a piece of  $\frac{3}{8}$  in. brass rod  $\frac{7}{16}$  in. in length. A 2B.A. hole for the spindle is drilled and tapped quite close to the circumference, and the hollow for the crystal, which is also placed eccentrically, is made with a  $\frac{3}{8}$  in. drill.

Reference to Fig. 5 will show

how the cup is mounted. The end of the spindle is screwed tightly into it; a nut is then put on and locked against it. The spindle is next put through the hole in its upright, when a flat washer, a spring washer, and a second flat washer are placed over it. The tension is adjusted by means of a nut—it should be such that the spindle turns rather stiffly. This nut is locked by means of a small tapped ebonite knob which is turned hard down on to it.

The uprights may now be fixed in place by means of their screws. A small brass strip is sandwiched between each and the ebonite, the other ends of the strips, in which 4B.A. clearance holes are made, being held down by the screws which pass through the plugs.

This detector is very simple to operate, and once adjusted it

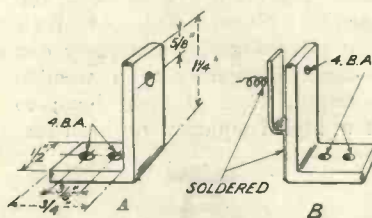

Fig. 7.—Dimensions for uprights.

“stays put” very well. Rotation of the spindle on which the cup is mounted causes the crystal to turn eccentrically, so that its surface may be searched for the most sensitive spot. Both hands are thus used in making adjustments; this will be found a great improvement on the ball-mounted cat-whisker with which one hand has to move the point over the crystal and also to adjust the pressure of the contact.

R. W. H.

### TAPPING INDUCTANCES

THOSE experimenters who are in the habit of winding their own inductances will appreciate that the general method of making tapings leaves much to be desired.

A somewhat novel and satisfactory method of tapping either a single layer or bank wound coil is illustrated in Fig. 8. As the tapping point is approached the wire is scraped bare and a narrow strip of copper foil is slipped under the bare section. The winding is then continued after the

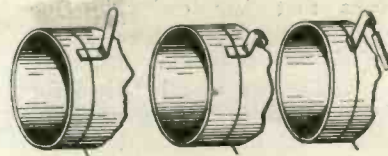

Fig. 8.—Showing how the copper foil is secured.

strip has been bent back out of the way.

When placing the strip in position only a small portion of its length should be slipped under the wire, as the majority of the strip will be required for attaching the tapping wire. By rolling the long projecting end over a 1-inch nail a tube is formed into which is inserted the tapping wire as shown in Fig. 8. The bare winding holding the strip together with the tapping wire inserted in the tube are treated with solder.

This method of tapping proves far more satisfactory than the extra turn principle in that there is no possibility of breaking the wire at the point where the wire is usually twisted for purposes of anchorage.

S. G. R.

### HEEL-BALL

VARIOUS materials have been recommended for filling-in unwanted holes in ebonite panels, but I have not yet seen a mention of one of the most valuable, namely, “heel-ball.” This substance can be obtained from shoe-makers, and can be melted into holes. Over-fill the hole, scrape it down to level of panel, and give a light rub with glass-paper.

G. P. K.

# Broadcasting News



By OUR SPECIAL CORRESPONDENTS.

**LONDON.**—The next simultaneous transmission will be on October 2nd, when some of the speeches at the banquet of welcome to the Colonial Premiers will be broadcast. The Duke of Connaught, General Smuts, the Premier of Canada and other Colonial statesmen will take part. General Smuts can be depended upon for a piece of real eloquence, and it will be interesting to hear how he "comes over."

Most of the speeches and talks which have been broadcast up to date have been of the non-exciting order, but one wonders what it would be like to listen to a real fire-eating speech by Lord Birkenhead or Mr. Lloyd George. Of course the B.B.C. have a very necessary rule that speeches to be broadcast must be submitted in manuscript and the manuscript must be adhered to. An experiment ought to be made with some eloquent speakers. Any natural exuberance which an orator might have would be considerably toned down in the studio, with its uninspiring microphone and the elimination of all sounds of appreciation (and otherwise) to which the orator is accustomed.

The B.B.C. claim to have discovered a new wireless vocal star in Mr. Romano Ciaroff, who seems likely to prove a second Caruso. A long contract has been made with him, and listeners will have the pleasure of hearing his voice shortly.

It was quite a brainwave on the part of 2LO's announcer the

other night to give us a sort of verbal "Leader" or "editorial" on the position of affairs in Spain. We hope to have more commentaries on "safe non-controversial" topics, to liven up the few items that are permitted to be broadcast.

The quality of the Pavlova Ballet Music transmission was very excellent indeed, and the little address by the Japanese Ambassador was most interesting, though a trifle difficult, perhaps, to follow.

The Sunday night address by the Bishop of Kingston-on-Thames was virile and to the point—quite a relief to the semi-intoned sermons one often listens to. Very possibly if there were more plain, forceful speakers like his Lordship, there would be fewer empty pews in our churches, chapels, etc.

## Forthcoming Events

### SEPTEMBER.

26th (WED.).—7.15, Dramatic Critic.

9.15, Mr. Anthony Bertram, on "Literary Portraits." 10.0, Mr. Hugo Hirst on "Electrical Engineering."

27th (THURS.).—7.15, Musical Critic. 9.15, Mr. Alan F. Walker on "The Mansion House." 10.0, Mr. R. J. Pilcher, on "How to Become an Analytic Chemist."

28th (FRI.).—Mr. Ernest Esdaile on "Elocution." 7.15, Cinema Critic. 9.15, A Talk on Astronomy.

29th (SAT.).—Mr. A. Wallace Jones on "How to Get Fit and Keep Fit."

30th (SUN.).—Steinway Hall Organ Recital.

### OCTOBER.

1st (MON.).—7.15, Mr. John Strachey's Literary Criticism. 9.15, Major-General Sir W. Sefton Brancker, K.C.B., on "The Future of Low-powered Aeroplanes."

2nd (TUES.).—7.15, Mr. W. Rees Jeffreys, on "Highway Administration." 9.15, Simultaneous broadcast of the speeches at the Royal Colonial Institute Dinner to the Colonial Premiers.

**ABERDEEN.**—It has now been definitely arranged that the Aberdeen station of the British Broadcasting Company will be opened on October 10th, when Sir George Adam Smith, Principal of Aberdeen University, the Marquis of Aberdeen, the Lord Provost, and others are expected to take part in the ceremony.

**BIRMINGHAM.**—If the new simultaneous transmissions from London are to be completely welcomed in the Provinces, it will be well to avoid, as far as possible, unfortunate "clashes" such as that which occurred with 5IT when Sir Ernest Rutherford's address was radiated from Liverpool. The Birmingham station had arranged for the transmission of "Maritana." The event had been keenly anticipated by listeners-in of the Midlands, and the station choir, the principals, and the orchestra had put in some painstaking rehearsals. In addition, the services of Mr. Moses Baritz as lecturer had been secured.

The prelude was radiated, but for the rest—the Liverpool trans-

mission was substituted, and until 10.20 5IT's audience had nothing to listen to but a landline transmission. At 10.30, when Mr. Percy Edgar had offered explanation and an apology, the station company nobly resolved—or so, at least, most of us thought—to go on with the opera. They did so, until nearly midnight, when the city's transport facilities had long ceased. It is to be hoped that London is not going to act arbitrarily in this way in the future.

**Forthcoming Events**

**SEPTEMBER.**

- 26th (WED.).—Song Recital by the Principals of the Station Repertoire Co.
- 27th (THURS.).—Miss Daisy Kennedy, violinist.
- 28th (FRI.).—Verdi and Offenbach night, and a lecture by Mr. W. R. Stokes, F.R.S., on the "Canals of Mars."
- 29th (SAT.).—Station Military Band.

**BOURNEMOUTH.** — The B.B.C. hope to have the new station in operation on or about October 17th next. Work is proceeding at the Studio in Holdenhurst Road, and, when completed, it will be the largest in the provinces. Two 120-ft. masts are to be erected at the transmitting station, which is to be situated in Bushey Road. The wavelength and call sign of the new station have not yet been determined.

**GLASGOW.** — The principal forthcoming events at this station are as follows:—

**SEPTEMBER.**

- 26th (WED.).—A Night with Schubert. The items of the Wireless Orchestra are confined to this composer's works for the evening. Miss Kathleen Carscadden, soprano; Mr. John Ireland Robertson, bass-baritone; Mr. P. Malcolm, M.A., F.E.I.S., on "When the Day Shortens."
- 27th (THURS.).—The Glasgow Amateur Concertina Band; Mr. Dan Jones, tenor; Miss Catherine Duncah, contralto.
- 28th (FRI.).—Address on "Football," by Mr. William Maley, President of the Scottish Football League; Mr. Allan Morton, bass,

and Miss Gertrude Simpson, in selections from their repertoire. 29th (SAT.).—An All Scotch Night. Miss Flora Blythman, contralto, and Mr. Alexander M. Allison, baritone. The programme will consist of Folk Songs, Trio for Two Violins and Piano, Cello Solo, Cornet Solo, Flute Solo, Clarinet Solo, and full orchestral items.

**MANCHESTER.**—The symphony concert from 2ZY on the 11th inst. was very enjoyable, and much improved by the skilful arrangement of the drum, which has been a disturbing factor on previous occasions.

BROADCAST TRANSMISSIONS		
	Call-Sign	Wavelength
CARDIFF	6WA	353 metres.
LONDON	2LO	365 "
MANCHESTER	2ZY	385 "
NEWCASTLE	5NO	400 "
GLASGOW	5SC	415 "
BIRMINGHAM	5IT	420 "

TIMES OF WORKING.	
Weekdays	3.30 to 4.30 p.m. and 5.0 to 10.30 p.m. G.M.T.
*London	11.30 a.m. to 12.30 instead of 3.30 to 4.30 p.m.
Sundays	8.30 to 10.30 p.m. G.M.T.
	2LO 3.0 p.m. to 5.0 p.m. also

SILENT PERIODS.	
CARDIFF	8.0 to 8.30
LONDON	6.15 .. 7.0
MANCHESTER	7.15 .. 7.45
NEWCASTLE	9.0 .. 9.30
GLASGOW	9.0 .. 9.30
BIRMINGHAM	8.0 .. 8.45

**Forthcoming Events**

**SEPTEMBER.**

- 26th (WED.).—Afternoon concert, 3.30. Miss Buckley, elocutionist. Miss Daisy Kennedy, solo violin. 2ZY Orchestra. 8.45, German Talk.
- 27th (THURS.).—Morning Concert, 11.30, by 2ZY Trio. No afternoon concert. Mr. Seth Lancaster, solo cello. Mr. Leonard Hirsch, violin, and Miss Jessie Cormack, piano. 8.45, Spanish Talk.
- 28th (FRI.).—Oxford Picture House Orchestra, 3.30. French Talk, 8.45. The Garner Schofield Orchestra.
- 29th (SAT.).—Oxford Picture House Orchestra, 3.30. Mr. Harry Hopewell, baritone. 2ZY Orchestra. Mr. Victor Smythe as "Algy." Mr. Dan Godfrey, jun., on "Rugby Football."
- 30th (SUN.).—Mr. Joseph Shore,

solo piano. Mr. Mikel Arenstein, solo violoncello. Mr. Edward Olerenshaw, baritone.

**OCTOBER.**

- 1st (MON.).—Afternoon Concert, 3.30, by 2ZY Trio. Spanish Talk, 6.30. Special Operatic Night, "Carmen" (Bizet). Principals: Miss M. Taylor, Miss N. Davies, Miss R. Hunt, Mr. W. Hindle, Mr. L. Thistlethwaite.—New Organised Chorus of 2ZY station. Lecturer, Mr. M. Baritz. Conductor, Mr. Dan Godfrey, jun., A.R.A.M.
- 2nd (TUES.).—The Band of H.M. Royal Air Force, afternoon and evening. Mr. Stephen Williams, bass-baritone. Mr. Foden Williams, entertainer. French Talk, 8.35. Relay transmission of speeches by H.R.H. Duke of Connaught and Colonial Premiers from Hotel Victoria, London.
- 3rd (WED.).—Afternoon Concert, 3.30; vocalist, Mme. Sinkinson, soprano. 2ZY Orchestra. Mr. James Worsley, dialect entertainer. Miss Catherine Aulsebrook, contralto. Signor Silvio Sideli, bass. 9.45, German Talk.

**NEWCASTLE-ON-TYNE.** —

Mr. Ernest Lynch Odhams, the new Director of the Newcastle station, has now entered upon his duties. Mr. Odhams was educated at King's College School, and was for some time assistant-editor and leader-writer of the *Bombay Oriental Review*. More recently he has been engaged in book reviewing for and as director of a well-known publishing company. Mr. Odhams has given expression to his keenness on doing his utmost for the continued success of 5NO.

We regret to announce that Newcastle listeners-in will soon miss the cheery voice of Mr. W. D. Simpson, the Senior Assistant Station Director, who is leaving to take up similar duties at Aberdeen. Mr. Simpson has been connected with 5NO from its inauguration, and its success has been in no small measure due to his indefatigable efforts. All who have been in any way associated with him regret his departure and unite in wishing him every success at Aberdeen.

# RANDOM TECHNICALITIES

By PERCY W. HARRIS, Assistant Editor.

*A useful tool—Sand-blasted ebonite—Receiving American broadcasting.*

A FURTHER useful addition to my tool kit is an expanding bit. It will bore holes in wood of any size from  $\frac{1}{2}$  in. to  $1\frac{1}{2}$  in. in diameter, the adjustment for the diameter of the whole being made by loosening a screw and resetting the cutter—quite a simple operation performed in a few seconds. Set at an inch it serves to cut the hole in wooden baseboards over which we can set the flanged type of valve socket with sufficient clearance for all four lugs; set at an inch and a quarter it makes a hole which will allow any of the tubular type of valves, such as the Ora, Cossor, Ediswan or Xtraudion, to project slightly through it—a very convenient arrangement when we want to put the valves inside the cabinet, but sufficiently projecting to show that all is well with them. The shank of the bit is very long, and thus we can bore through thick wooden frames when fitting up a lead-in tube. It is a great convenience to be able to set the cutter so as to bore a hole the exact size of the tube we desire to use, and if I had this tool earlier I should have saved myself a great deal of trouble. The smallest size ( $\frac{1}{2}$  in.) is a useful hole to bore in a baseboard when using strips of ebonite for mounting terminals, the hole being sufficiently large to allow clearance round the shank and nut of the ordinary terminals used. This expanding bit, which can be bought from any good tool shop, costs  $7/6$  with two cutters, and of course does the work of a whole collection of bits of various sizes.

My remarks in a recent issue regarding sand-blasting ebonite have brought me a letter from the Britannia Rubber Co., pointing out that they have been supplying sand-blasted ebonite for some time past to those people who desire it. This is good news, and shows that if amateurs only asked their dealers

for this ebonite it is obtainable from trade sources. The company in question sends me a small panel treated on both sides as a sample of the work, and, as I indicated in my previous article, the result is very efficient and pleasing. One of the largest firms supplying amateur requirements has now a sand-blasting apparatus installed, and will shortly be able to prepare panels to order for its customers.

Many experimenters are under the impression that reception of American broadcasting can only be effected during the winter months. That this is not the case is proved by several reports which have recently reached me regarding the reception of WJZ and other stations during the summer months.

The three-valve receiver of which I gave constructional details in the September issue of *Modern Wireless* has already proved successful for this purpose, and a reader who built one succeeded in receiving an American talk to farmers a few hours after finishing the instrument. A friend of mine who has done a great deal of experimenting with the Armstrong super-sonic receiver (not the super-regenerative instrument) has succeeded in receiving American broadcasting on a frame during the last month or so. About 3.30 in the morning seems to be the best time, as at that hour the horrible mush from Leafield has ceased. I should be very interested to hear from readers who have tried any of the wavetraps described in my recent article for the reception of American broadcasting. In many districts it should be possible to cut out this Leafield mush by one of the traps. Type C should be the best for this. In any case, now that the darker evenings are coming, every serious amateur who has a set with a high-frequency amplifying valve should try to pick up one of the American stations.

Have you given your order for the binding of Vol. I. of "Wireless Weekly"?



# Apparatus we have tested

Conducted by A. D. COWPER, M.Sc., Staff Editor.

## A Complete Crystal Set

FROM Messrs. Radio Instruments, Ltd., we have received for trial one of their B.B.C. crystal receivers, Type XLA, equipped complete with 'phones, etc.

This set is housed in a highly finished case, with convenient handle for carrying it and a padded compartment for the head-phones. The impression given by the external appearance is very favourable; the variometer control silky; and the enclosed crystal detector of the synthetic galena type, easy to adjust and sensitive. On actual trial, the signal-strength on local broadcasting at 13 miles was very fair, using two pairs of 'phones, and with a good double aerial; on the 30ft. single test aerial, low and screened badly, the signal-strength was surprisingly good. Further tests showed that reasonably good signals could be got under very unfavourable conditions, e.g., 2LO being audible on the high aerial even without any earth. The criticism might be offered that the replacement of the crystal, when worn out—as it must eventually become, even with so light a cat's whisker—would present some difficulties to the un-initiated.

## Block Accumulators

Messrs. Fuller's United Electric Works, Ltd., have given us an opportunity of making an extended trial test with two of their block type accumulators. The cells submitted were two two-volt units of 20 ampere-hour actual capacity

(40 ampere-hour by the old, and meaningless rating of "ignition capacity").

These were sent fully charged. After standing a couple of weeks the discharge characteristic was followed continuously for a rate corresponding to the filament current of a single R valve,  $\frac{3}{4}$  ampere. At this rate, and for the first discharge, the cells showed distinctly over the rated capacity, and held the voltage well, up to a late point in discharge. After a liberal recharging at a 1 ampere rate, the rather severe test was made of taking the discharge at a rate corresponding to the demands of a four-valve set; at this comparatively high rate the effective capacity fell considerably short, and the voltage rapidly decreased from just under four volts to a low figure—showing that the accumulator was overrun. After another liberal charge at the 1 ampere rate, the cells were given an extensive trial on a two-valve set using R valves. Here they retained approximately four volts for a lengthy period, and gave silent and satisfactory operation.

When used for a service within their power, the accumulators show good capacity and maintain their charge well on standing.

They are cased in substantial ebonite containers; the terminals are strong and reliable; while the acid does not splash out when the cells are carried about.

## A Coil-holder

Messrs. Leigh Bros. have sent for examination a single-coil-

holder for use on the table or panel-top, with the conventional plug-and-socket arrangement for plug-in coils. This has an ebonite base (with holes for screwing down), and two convenient terminals; connections to plug and socket are substantial, and no wires are exposed. On test the insulation was found to be excellent, and the holder convenient in use, particularly with circuits which require isolated inductances as anode coils, radio-chokes, etc. It might be suggested that the base is rather narrow for use with the larger size coils in temporary hook-ups on the experimenter's work-bench.

## A Shrouded Low-frequency Interval Transformer

Messrs. The Formo Company have submitted for test a low-frequency transformer of the enclosed type, being completely shrouded in an aluminium case, only the terminals being exposed at the top.

On test both in conventional and dual circuits the amplification was found to be satisfactory; there was freedom from distortion; and the actual ratio of signal strength magnification measured was good. The insulation resistance between windings and between winding and case was very high, and there were no signs of distress with a plate voltage over 120 V. and R. valves. The transformer was found to be quite suitable for use with the ST75 and other dual circuits, giving good loud-speaker strength in two-valve receivers.



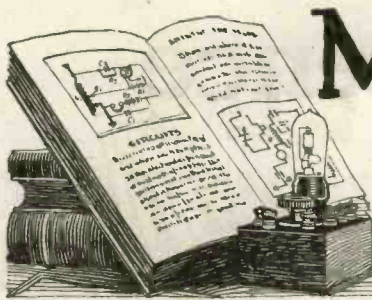

# Mainly about Valves

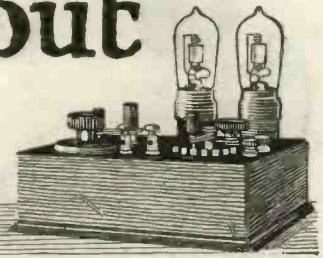

Our weekly causerle written by the Editor.

## Stopping the Self-oscillation of the First Valve

THE following idea, which is carried out on certain commercial broadcast receivers, is worth trying out if you have trouble with your first valve. The first valve of, say, a tuned anode with reaction circuit always tends to oscillate, owing to the capacity coupling between the tuned anode circuit and the grid circuit. To avoid this, we introduce damping into the grid circuit of the first valve, and one method of doing this is to connect the bottom end of the aerial circuit

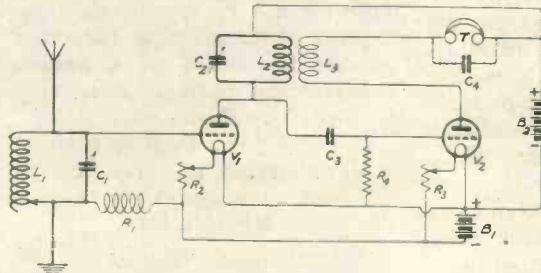

Fig. 1.—ST34 with added resistance to prevent self-oscillation of the first valve.

to a point on the filament accumulator, say, halfway along it. This introduces grid damping and often produces the desired result of stopping the first valve oscillating of its own accord.

The idea I want to mention, however, is to insert in the grid circuit a 500-ohm resistance. Fig. 1 shows this arrangement. In the grid circuit of the first valve of the ST34 circuit there is shown a coil of resistance wire  $R_1$ , having a value of 500 ohms. Any insulated resistance wire giving this resistance will do. The coil is wound inductively on a small cylindrical former, and, of course, no iron

core is used. Ten feet of No. 47 silk-covered resistance wire wound on a 1in. former will do admirably, but the reader may work out from any suitable resistance wire table the length of wire required to give about 500 ohms.

## A Principal Cause of Howling

A well-designed dual amplification circuit should not howl, even when reaction is being used. Many dual amplification circuits are perfectly well behaved until reaction is introduced, and then they tend to start howling as the reaction reaches the critical stage. This may be explained by assuming that there is a certain amount of low-frequency reaction all the time, and that the increased strength of signals caused by introducing reaction has a trigger effect which causes the valve to oscillate at low frequency.

In a dual amplification circuit, as the reaction is increased, signals become stronger, and may be sufficiently strong to start off the low-frequency oscillations. The other explanation, which is rather similar, is that when the reaction is tightened beyond the critical point, the valve oscillates at high frequency, and there is, in practically every case, a change of conditions in the valve. The anode current, for example, might increase.

I have overcome one of the commonest causes of low-frequency self-oscillation and "sensitiveness to touch," *i.e.*, tendency to howl when certain parts of the apparatus, such as the telephones or loud-speaker terminals, are touched. This is overcome by connecting the transformer in series with the aerial circuit, the secondary being shunted by a capacity, preferably variable, or, if fixed, having a value of about 0.001  $\mu$ F.

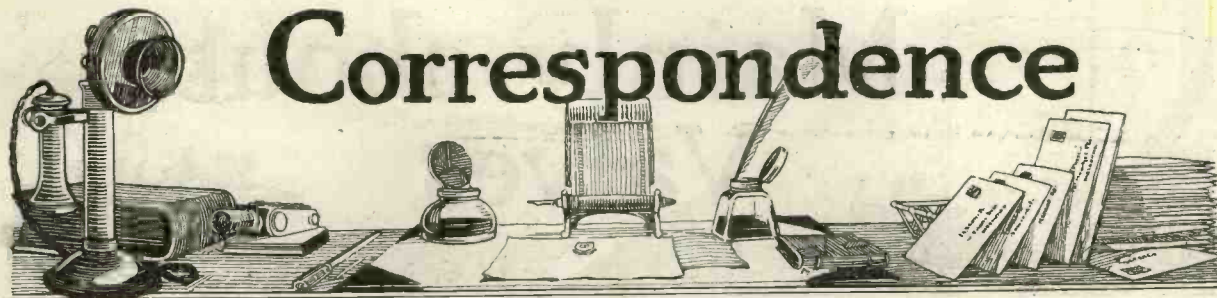

# Correspondence

## IN GENERAL

SIR,—With reference to Dr. Roberts' note on atmospheric and the possible connection of some with meteorites, I remember reading a note on earth telegraphy, etc., as practised during the war; the writer, a German, referred to the disturbances due to natural causes, similar to atmospheric in radio, and in particular instanced one sound often met with and for which he sought an explanation. The description he gave tallied somewhat with the supposed meteorite noise; he said that some idea of the sound could be got by pronouncing the word "pion" rather quickly. Might not this be due to earth currents induced by the action of meteorites?

I think your Brynmawr correspondent (Vol. 2, No. 4, p. 162/163) is rather dogmatic in assuming that because he happens to get the results mentioned, South Wales is not a "blind spot." Probably it is the same as many other districts, a collection of more or less blind spots with a few good spots here and there. I have heard all the B.B.C. stations sufficiently well to identify them—Glasgow being the only doubtful one—with crystal receivers here. Yet I could point to several places within a 2-mile radius where two valves would hardly do as much. Real blind spots are much more localised than has been supposed, but they may be grouped rather closely in certain districts, thus giving the impression on superficial examination that the whole is one big dead region. Only actual trial at the actual place where reception is desired can decide whether it is blind or not.

Valve makers supply various details of the currents, voltages, etc., of their valves, but one has usually to write specially to find out really useful details. It would not cost much to include *with each valve* a printed slip showing typical curves for the variety—individual curves would certainly not be expected—and an indication of the total emission at normal temperature.

I am, etc.,

L. J. VOSS.

Plympton, Devon.

## RECEIVING AMERICA

SIR.—Whilst listening at my station 2KW on Sunday morning, September 2nd, on a three-valve set, I was successful in hearing nineteen different American stations, the farthest being 4DL, West Palm Beach, Florida.

The reception is interesting at this time of the year, as it is really unfavourable for long-distance work, atmospheric being bad.

I am, etc.,

W. R. BURNE.

Sale, Cheshire.

## SINGLE OR DOUBLE WIRE?

SIR,—Re your article "Single or Double Aerial," *Wireless Weekly*, Vol. 2, No. 9. I find the best method of solving this difficulty is by erecting a twin aerial and balancing the natural wavelengths of the separate wires afterwards. This can be done as follows:—Bring a separate lead in from each aerial wire to the receiver; the leading-in wires must be kept at least one foot apart. Next connect one lead-in to the

receiver and tune in a distant or sharply tuned station and note the *exact* position by A.T.C. Disconnect this aerial and carry out the same procedure with the other; of course the same station must be tuned in. Now the aerial which requires the *most* capacity, or, in other words, the higher scale reading on the A.T.C. to receive this station must be increased in inductance or capacity value. This is easily done by winding a few turns of wire on a piece of  $\frac{1}{2}$  in. diameter tube and placing in series with lead-in and receiver, the number of turns being increased until the A.T.C. requires the same degrees of capacity as the other aerial. By means of a switch, either a twin or single aerial may be used.

I am, etc.,

F. BONSTEAD.

Barnsbury, N.I.

## RESULTS

SIR,—I congratulate you on producing such valuable circuits as the ST100, 75 and 76.

Having experimented with these circuits for some time, I have come to the conclusion that at last I have found the ideal "broadcast receiver"; this is the ST76.

I receive all the British stations on a loud-speaker, loud enough to be heard 30 yards from the instrument; using the type B wave trap I am able to cut out all interference.

I am, etc.,

T. W. HOLMES.

Woldingham.

[The Editor regrets that owing to the demands upon our space a number of letters are unavoidably held over.]

# Information Department

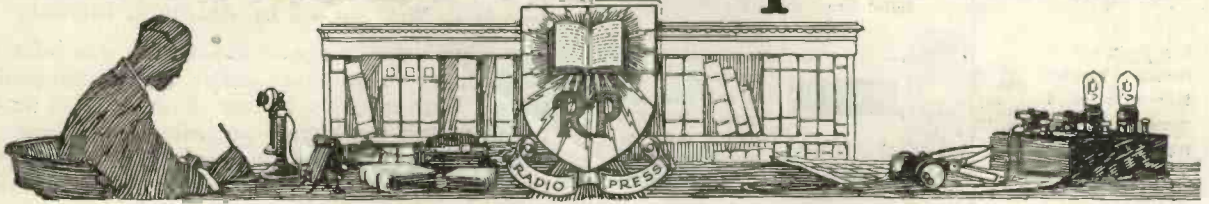

C. B. M. (CARDIFF) has a single valve receiver which will tune from 350 to 3,000 metres and wishes to know how he can increase the wavelength range. He further asks how a high-frequency valve may be added.

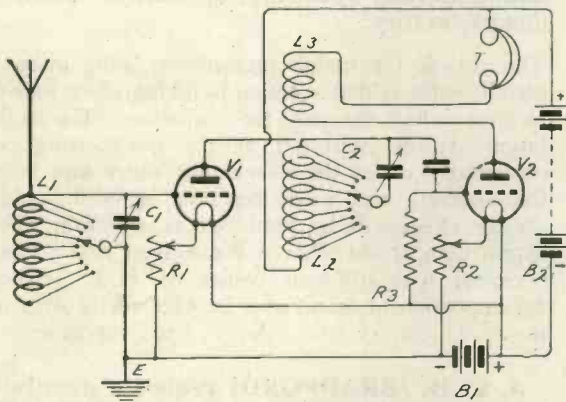

The most convenient method of increasing the wavelength range of your receiver is to add in series with your inductance one of the interchangeable types of plug-in coils. It will probably be necessary to plug-in a small coil in series with the reaction coil at the same time. We reproduce herewith a circuit showing how a high-frequency valve may be added to this receiver. We suggest that reaction should be taken to the anode circuit of the high-frequency valve, thus making the set permissible for the reception of broadcasting. The additional coil  $L_1$  provided for aerial tuning should be of the same dimensions, and wound with the same gauge wire as the coil you are at present using. With the H.F. valve added, this latter coil is used as a tuned anode coil. The condenser  $C_1$  is of the same capacity as  $C_2$ .

A. M. (BIRMINGHAM) wishes to know the best gauge and the amount of wire required for a low-frequency inter-valve transformer ratio  $2\frac{1}{2}$  to 1, and also the best type of laminations to use.

The core should consist of a number of fine iron wires not exceeding No. 28 s.w.g. It is important not to use a thicker gauge of wire where an open core is employed. This core should be  $\frac{3}{8}$  in.

in diameter and 4 in. long, and after being suitably insulated should be wound with 4,500 turns of No. 44 s.s.c. copper wire for the primary, and after further insulation again wound with 11,000 turns of the same gauge of wire for the secondary. This will give a step-up ratio of  $2\frac{1}{2}$  to 1. Half an ounce of wire will be required for the primary and  $1\frac{1}{2}$  ounces for the secondary. The resistance of the primary will be 1,100 ohms, whilst that of the secondary will be 3,600 ohms. The inductance value of the primary will be about 8 henries, whilst that of the secondary will be about 50 henries.

C. H. L. (CARDIFF) has in his possession a crystal, valve and low-frequency transformer. He asks for a circuit in which these components may be embodied.

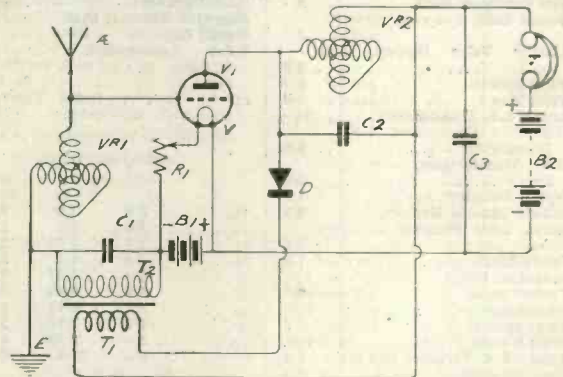

We reproduce herewith a circuit suitable for your purpose, and which should enable you to receive strong signals, provided that a good outdoor aerial is used.

The variometers may be any of the instruments advertised in this journal.

W. F. T. (BIRMINGHAM) asks for the size of former and number of turns required to tune the aerial circuit of a small telephony transmitter to 440 metres.

75 turns of No. 20 s.w.g. d.s.c. copper wire on a 3 in. diameter former will give you this wavelength if used in conjunction with a standard P.M.G. aerial. A suitable reaction coil would be 40 turns of No. 26 s.w.g. d.s.c. copper wire wound directly over the lower end of the main inductance.

**BEWARE OF WORTHLESS IMITATIONS, SEE THE TRADE MARK *Watmel* ON EVERY GRID LEAK.**

**WATMEL VARIABLE GRID LEAK**  
(Patent applied for.)

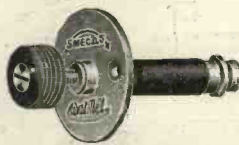

The Resistance is steadily Variable between  $\frac{1}{2}$  to 5 megohms. Only requires a  $\frac{1}{8}$  in. hole in panel for fitting.

Suitable for use in any circuit, and improves the working of any valve detector. (50,000 to 100,000 ohms for the S.T.100 Circuit. Price 3/6.)

**PRICE 2/6 EACH**  
The best Variable Grid Leak made.

**WATMEL WIRELESS CO.,** Connaught House, 1a, Edgware Road, Marble Arch, W.1. Tel. 4575 Paddington.

H. A. (DEVON) asks the approximate range of the crystal receiving set described on page 173 of "WIRELESS WEEKLY," Vol. 1, and also wishes to know the wavelength of a coil wound with 170 turns of No. 22 s.w.g. wire on a 3 in. diameter former.

The approximate range of the receiver you refer to is about 15 to 20 miles under favourable conditions. With reference to your coil, the actual wavelength of this would vary according to the type of circuit in which it was employed. The wavelength to which such a coil would tune a P.M.G. aerial would be about 800 metres.

A. L. W. (WANSTEAD) has a four-valve receiver, from which he obtains good results, but certain notes of vocal and instrumental music are more pronounced than others, and, generally speaking, orchestral music is unsatisfactory.

The reason for undue prominence being given to certain notes is that reaction is taking place in your receiver, which sharpens the resonance. The modulation system employed at the transmitting end continually varies the wavelength above and below the normal, and when reaction is taking place greater effect will be produced at a certain wavelength than at the others. We suggest that you experiment with different values of H.T. voltage. An improvement might also be effected by shunting the H.T. battery with a larger fixed condenser.

J. C. B. (BRADFORD) requests details of a high-frequency transformer suitable for the broadcast wavelengths.

An efficient H.F. transformer for wavelengths between 350 and 450 metres may consist of 2 basket coils. These should each have 110 turns of No. 44 s.s.c. copper wire wound on a former having an internal diameter of  $\frac{3}{8}$  of an inch. The two coils should be placed on a short piece of ebonite tube, and separated by a single layer of Empire cloth. To connect up, if the two coils are so placed that the direction of winding is the same throughout, then the outer end of the respective coils should be connected to anode and grid.

K. (SOUTHEND-ON-SEA) has been recommended to add the low frequency amplifier shown in circuit ST26, "Practical Wireless Valve Circuits" to his crystal receiver and asks whether we consider this a suitable arrangement.

A well-made note magnifier is a highly efficient piece of apparatus, and, when added to a crystal receiver, will result in a very satisfactory increase in signal strength.

M. P. B. (Hornsey). Please send address to this office when your queries will be answered by post.

**ROWLEY & LOUIS,**  
12, The Broadway, Muswell Hill, N.10.  
Telephone: Hornsey 668.

**COMPARE OUR PRICES!**

Headphones:  
Genuine Brunets, 4,000 ohms .. 16/6  
N. & K., best finish, very loud 14/11  
French D.L., 4,000 ohms .... 11/6

Aerial Wire, 7/22 copper, 100 ft. 2/2  
Lead-in Wire .. per yd. 2d. and 3d.  
Silk-covered Twin Flex... per yd. 0/3  
Switch Arms, complete, best only 0/9  
Filament resistances, best only.. 2/-  
Fixed Condensers .. 1/-  
Best Condenser Dials .. 2/-  
Basket Coils, 250-5,000 metres .. set of 7 3/-  
Ebonite Valve Holders, best quality .. 0/9  
Valve Sockets .. per doz. 0/9  
Valve Pins .. per doz. 0/6  
Brunet L.F. Transformers .. 14/-  
High-class Guaranteed L.F. Transformer .. 9/6  
H.F. Transformers, any wave length .. 3/6  
Crystal Detectors, in glass .. 1/6  
Shaw's Genuine Hertzite, large, 0/8  
Herbo Cat's Whisker improves results on any crystal set .. 0/6  
Phone Cords, best .. per set 1/3  
Condenser Plates .. per pair 1d.  
Contact Studs .. per doz. 0/4  
Small Spacers .. per doz. 2d.  
Large Spacers .. per doz. 0/3  
Brass Bushes .. each 1d.  
2 and 4 B.A. Threaded Rod per ft. 0/3  
Shell Insulators, large .. each 0/6  
Shell Insulators, small .. each 0/3

Reel and Egg Insulators .. each 0/2  
Insulated Hooks .. each 0/2  
Spade Terminals, threaded each 1d.  
Bushed Ebonite Knobs, best each 0/3  
Lead-in Tubes, any length, per in. 0/1  
Best Ebonite, only in sheets  $\frac{1}{2}$ ,  $\frac{3}{4}$ , 1" .. per lb. 4/6  
Systoflex, best .. per yd. 0/5  
Systoflex, cheap .. per yd. 0/3  
Best quality Coil Holders, 2-way 5/6  
Best quality Coil Holders, 3-way 6/6  
Knife Switches for panel mounting 0/8  
Engraved Rheostat Dials .. each 0/4  
Crystal Cups, with 4 screws, each 0/2  
C.A.V. Accumulator, 6 volt, 60 amp., in case with switch, fuses, etc. .... £1 19 0  
Special R type Dutch Valve, guaranteed best quality .. 8/6  
All types of valves at cut prices.

**Instrument Wires.**

No.	D.C.C.	D.S.C.	Enamelled.
18	2/6	3/9	2/3
20	2/6	3/9	2/3
22	2/8	3/11	2/6
24	3/4	4/4	2/6
26	4/-	4/11	3/-
28	4/6	5/10	3/4
30	5/4	6/10	3/9
32	7/2	7/10	3/11
34	8/-	8/10	4/4
36	8/6	11/6	4/8

All sizes in stock.  
1d. extra for reeling under 1 lb.

**All goods sent off same day as ordered.**  
Enclose sufficient for postage, extra postage will be returned.

**ECONOMIC ELECTRIC**



**THE "EEC" "XTRAUDION" VALVE**  
is being used by the leading Radio Experimenters for detection, high and low frequency amplification, power amplifiers and low power transmission. Price 15/-

USE "RECTARITE," the synthetic crystal that makes Loud speakers talk!  
1/6 Large Specimen.

Write to-day for 40 page Radio Catalogue mailed post free, 4d.

Head Office: 10, FITZROY SQUARE, LONDON, W.1. Showrooms: 303, EUSTON RD., N.W.1. Branch and Works: TWICKENHAM.

# A LINE OF *Western Electric* LOUD SPEAKERS

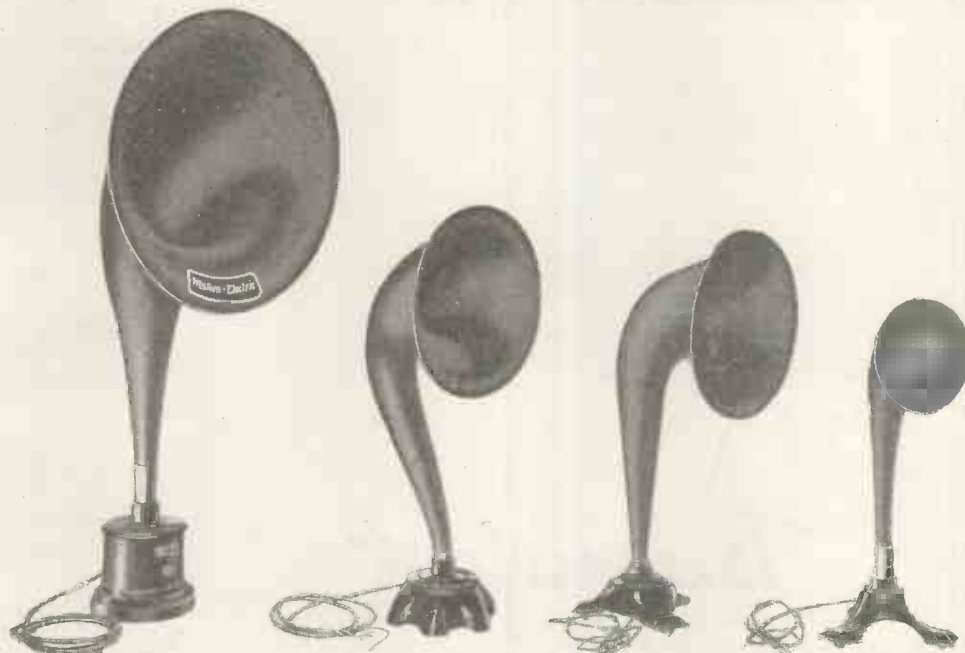

No. 44002.

No. 44005.

No. 44004.

No. 44003.

*A complete line of four Loud Speakers are now available, all of which have been most carefully designed and constructed in consideration of the needs of the public.*

No. 44003.—A small Loud Speaker operating on an ordinary magnetic diaphragm principle. The trumpet is of a non-metallic material with adequate acoustical properties. This model gives sufficient volume to enable a small audience to hear well in a quiet room.

No. 44004.—A loud Speaker of medium size operating on the standard receiver principle, but having a large diaphragm and an adjustable air-gap which enables the utmost efficiency to be obtained upon any particular current strength. This Loud Speaker gives most excellent reproduction.

No. 44005.—This model is of medium size and operates on the balanced armature principle as so successfully applied in the case of the now famous Loud Speaking equipment. More powerful than the No. 44004 model, this Loud Speaker gives adequate volume without distortion.

No. 44002.—The now familiar Loud Speaker, known universally as part of the Western Electric Loud Speaking Equipment. Operating on the balanced armature principle, this powerful model gives most faithful reproduction and purity of tone and is free from distortion.

**MADE BY THE MAKERS OF OVER HALF THE WORLD'S TELEPHONES.**

*Western Electric Company Limited:*

**CONNAUGHT HOUSE, ALDWYCH, LONDON, W.C.2.**

Telephone: Central 7345 (9 lines).

Glasgow, Leeds, Manchester, Newcastle, Cardiff, Birmingham, Southampton, Dublin. Also  
Singapore, Johannesburg, Buenos Ayres, Sydney, etc., etc.

**AN ANNOUNCEMENT OF INTEREST TO ALL WILL APPEAR IN THE NEXT ISSUE**

Demand Branded British Made Wireless Goods

# Unparalleled Results

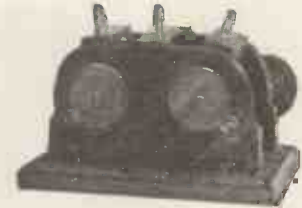
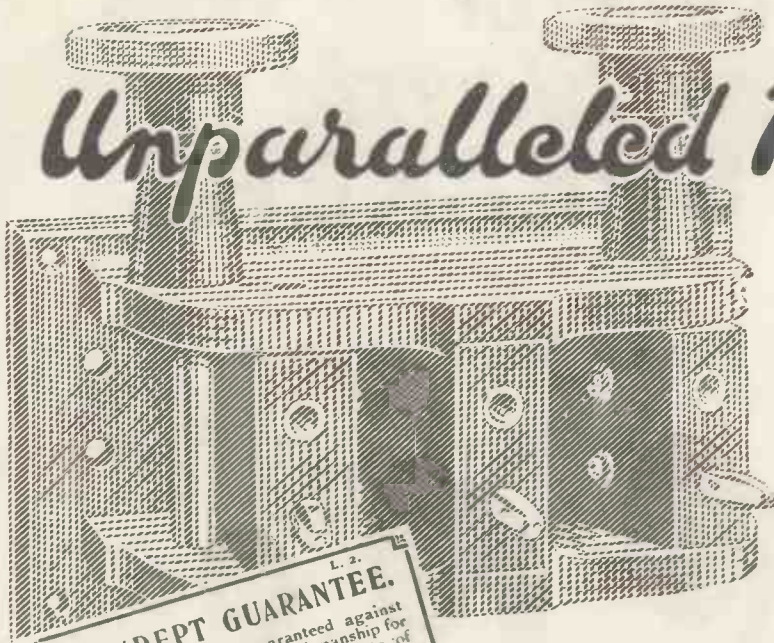

**L. 2.**  
**BURNDEPT GUARANTEE.**  
 THIS Instrument is guaranteed against defects in material and workmanship for a period of 12 MONTHS from date of purchase; if such defects develop it will be replaced or repaired free of charge upon return to factory with this tag.  
 Burndept. Ltd., Aerial Works, Blackheath, S.E. 3

## Burndept Coils and Coilholders

**BURNDEPT COILS** were the first British multi-layer coils on the market, and are known all over the world. They are patented both as regards winding and wrapping. They are dust and damp proof; self-capacity has been reduced to a minimum; each coil is attached to a non-reversible spring plug and socket fitting, which facilitates changing, and ensures perfect electrical contact at all times.

**BURNDEPT COIL HOLDERS** are of patented design and the moving arms are geared 5-1. The action is particularly smooth, making critical adjustments an easy matter. We are confident that these are the most efficient geared coil holders on the market and are essential for the most efficient use of coil inductances.

No. 135. Holder for 3 coils for panel mounting ... Price £1 1 0  
 No. 136. As 135, but on oak base with terminals ... Price £1 15 0  
 Coils for British Broadcast, each 5/-. Other prices on application.

**BURNDEPT LTD.** Head Office: Aldine House, Bedford Street, Strand, W.C.2.  
 London Showrooms: 15, Bedford Street, Strand, W.C.2.  
 Phone: Gerrard 7794, Private Branch Exchange.

**BURNDEPT**  
 WIRELESS APPARATUS

**WE** are showing at the Exhibition being held at the White City from November 8-21 under the auspices of the National Association of Radio Manufacturers.

### BRANCHES

- LEEDS:** The London Assurance House, Bond Place  
**NEWCASTLE-ON-TYNE:** 7 St. Andrew's Buildings West, Callowgate.  
**CARDIFF:** 67 Queen Street.  
**HEAD DISTRIBUTING SERVICE DEPOTS. ENGLAND.**  
**BIRMINGHAM:** C. S. Bayliss, 133 New Street  
**MANCHESTER:** W. C. Barracough, 61 Bridge Street  
**BRIGHTON:** H. J. Gallera, 32 St. James's Street  
**NOTTINGHAM:** Pearson Bros., 54 Long Row.  
**YEOVIL:** Western Counties Electrical & Engineering Co., Electricity House, Princeps Street.  
**BRISTOL:** King & Co., Western Electric Works, Park Row.  
**SCOTLAND.**  
**GLASGOW:** W. A. C. Smith Ltd., 93 Hain Street, 236 Argyle Street.  
**IRELAND.**  
**BELFAST:** R. & S. Scott, Kingston, Wellington Place.  
**DUBLIN:** Dixon & Hempstead, 17 South St.  
**CANADIAN OFFICES.**  
 192 King Street West, Toronto.  
**SERVICE DEPOTS IN ALL LOCALITIES.**

You MUST be in WIRELESS WEEKLY because it brings RESULTS.

# CHOSE GHANE

## The Crystal that ends Crystal Troubles.

In the October issue of "Modern Wireless" will be found full details of this wonderfully sensitive crystal GHANE.

- 100% sensitive surface.
- Great latitude in adjustment.
- Signals always at maximum strength.
- Stays set for weeks.

Supplied by all progressive dealers. If unobtainable locally, write to:—

**A. HINDERLICH,**  
1, LECHMERE ROAD, LONDON, N.W.2.



When you see of **MERIT** on wireless apparatus **KNOW** that it is well made, and reasonable in price.



**THE MARK** any piece of **ratus** you is efficient, and reasonable in price.

Although one of the oldest and the most efficient transformers, the MH standard transformer has only recently come into the market as a component, the whole output having previously been consumed in providing for the needs of the famous MH receiving sets.

Improved plant and extensions at our works have enabled us to increase the output of both Intervolve and Telephone Transformers, and we are now in a position to supply the MH transformer as a component. That it is MH guarantees its performance.

- MH Intervolve Transformer . . . . . 22/6 each
- MH Telephone Transformer . . . . . 17/6 each

All MH Transformers carry 1 year's guarantee.

Write for lists of MH specialities. Every wireless interest provided for.

RETAIL SHOWROOMS:

RADIO CORNER, Corner Norfolk St., 179, Strand, London, W.C.2.

**L.M. MICHAEL LTD**  
IN CONJUNCTION WITH **B. HESKETH LTD**

All correspondence to

HASTINGS HOUSE, NORFOLK ST., STRAND, LONDON, W.C.2.

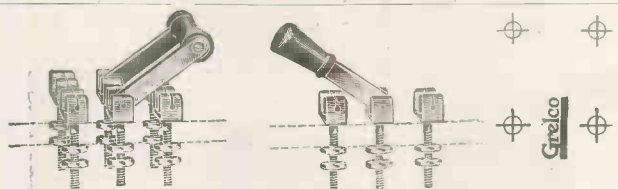

**PANEL MOUNTING KNIFE SWITCHES.**  
Neat and Perfectly Efficient. Solid Nickel.  
No. 19/20.—S.P.D.T., 1/6. No. 19/21.—D.P.D.T., 2/- Post 2d.  
CUT THIS OUT AND USE FOR DRILLING. Full Size Template.

Send for our 100 page catalogue 3d. post free,  
**TO GRAFTON ELECTRIC COMPANY,**  
54, GRAFTON STREET,  
TOTTENHAM COURT RD.,  
LONDON, W. Works: Slough.

# EDISWAN

The name which means better reception

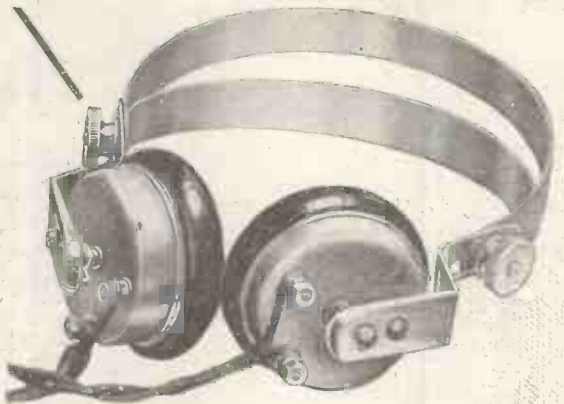

## EDISWAN Headphones

(New Design)  
Total Resistance 4,000 ohms  
**24/- per pair.**  
Adjustable, Double Headbands, Polished Pressed Aluminium Cases, Moulded Ear-pieces and six feet of flexible cord. Genuine Ediswan Headphones specially low priced at 24/- per pair.



## EDISWAN

New Low Temperature (Dull Emitter)  
**V ALVE**  
Type A.R.D.E.

**Price 27/6.**

Filament Volts	1.8-2.0
Current	30
Anode Volts	20-50
Bulb Diameter	29 mm.
Overall Length	110 mm.
including pins	max.
Cap	Standard 4-pf

Do not put more than 2 volts across the filament. Eminently suitable for reflex circuits.

The name signifies the reputation, and the Ediswan reputation means "superior productions"—superior because 40 years of research work have enabled us to discard everything but the best. Manufacturers of Complete Receiving Sets, and Accessories, also H.T. and L.T. Batteries. Ask or write for leaflets, Your Dealer holds stocks to supply you. If not, write us direct and give his name and address—a post-card will do. Have you had your FREE copy of Illustrated Booklet, "The Thermionic Valve"? If not, write us at once.

## The EDISON SWAN ELECTRIC CO., LTD.,

Contractors to H.M. Admiralty, War Office, Royal Air Force,  
123/125, Queen Victoria Street, E.C.4,  
and 71, Victoria Street, S.W.1.

Works: Ponder's End, Middlesex. Branches in all Principal Towns.

**IMPORTANT ANNOUNCEMENT.**

*A New Wireless Valve*

**MULLARD  
WECOVALVE**

FOR USE WITH A SINGLE DRY CELL.  
ECONOMICAL — LONG LIFE.

Filament current 0.25 amp.  
Filament Voltage 0.8 - 1.1 volt.  
Detector Anode Voltage 17 - 22 volts.  
Amplifier Anode Voltage 22 - 45 volts.

**STANDARD LIST PRICES:—**

Mullard Wecovalve	-	-	-	-	-	-	30/-
Sockets	-	-	-	-	-	-	1/6
4 Pin Adaptors	-	-	-	-	-	-	3/6

**MULLARD**

RADIO "A" CELL

Specially developed for use with Wecovalve - - - 2/6

**PLACE YOUR ORDER TO-DAY.**

Write for full particulars leaflet MW.1.

*Full manufacturing licence under British Patents Nos. 17580, 123126, 180090.*

**DELIVERY TO COMMENCE OCTOBER 1st.**  
ALL ORDERS in strict rotation.

**Mullard**

**45, Nightingale Lane, Balham, London, S.W.12.**

Telegrams: "Radiovalve, Wandsworth, London."

Telephone: Battersea 1068.

(B.P.S. 59.)

You **MUST** be in WIRELESS WEEKLY because it brings **RESULTS.**

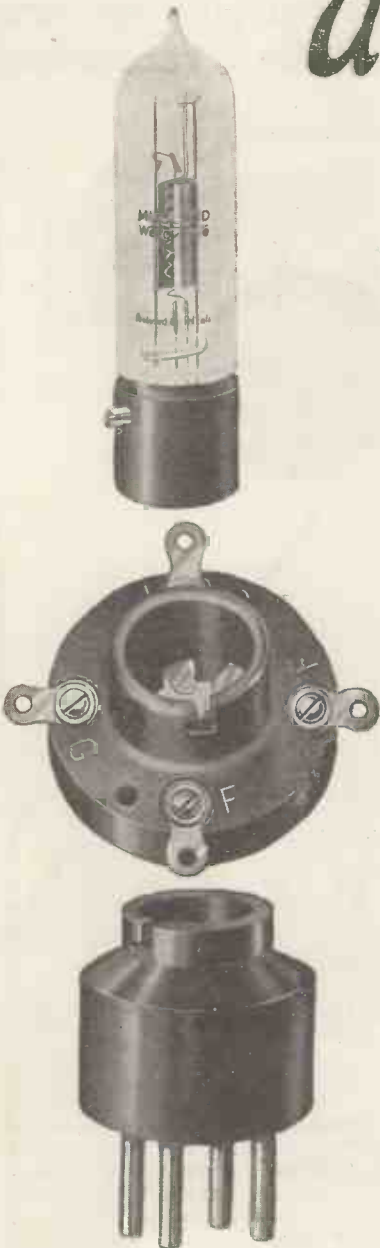



# SIEMENS

## H. T. DRY BATTERIES



Size 827, fitted with plug sockets.  
Dimensions  $6\frac{1}{2} \times 2\frac{1}{2} \times 3$  ins. high.  
E.M.F. 36 Volts.

When purchasing Dry Batteries see that they bear this trade mark.



Size 643, fitted with spring clip terminals. Dimensions  $9\frac{1}{2} \times 4 \times 2\frac{1}{2}$  ins. high. E.M.F. 15 Volts.

The prices of Siemens Dry Batteries are reasonable having regard to their high output, long life and reliable service.

*Descriptive pamphlet and prices on application.*

**SIEMENS BROTHERS & CO., LIMITED,**  
WOOLWICH, LONDON, S.E.18.

Telephone: City 6400.

Telegrams: "Siemens, Woolwich."



2 VALVE RECEIVING SET No. 520

## W. G. PYE & Co.

Scientific Instrument Makers.

**CAMBRIDGE, ENG.**

Wireless Receiving Apparatus of the  
**Highest Possible Efficiency,**  
**Greatest Selectivity,**  
**Easiest Tuning,**  
**Best Quality Workmanship,**  
**Moderate Price.**

Our Wireless Apparatus is of the same high quality as our general Scientific Apparatus, and **WE INVITE COMPARISON ON ANY AERIAL** with Receiving Apparatus of any make. Let us send you details of our 2, 3 and 4 Valve Sets.

*All our Receiving Sets are approved by the Postmaster General.*



You **MUST** be in WIRELESS WEEKLY because it brings **RESULTS.**

# Which Set Shall I buy?

Efficiency is the first consideration. Don't risk disappointment by choosing on appearance alone, which usually means *wireless deception* instead of efficient reception.

Be guided by the experience of thousands of satisfied users and buy a

## GECOPHONE

GECOPHONE "Listening-in" Sets are made by The General Electric Co., Ltd., and are the outcome of many years' experience in the manufacture of Wireless and Telephone Equipment. Listen-in with a Gecophone to ensure perfectly clear and natural reception of broadcast items.

**GECOPHONE CRYSTAL SET No. 1**      **GECOPHONE CRYSTAL SET No. 2**      **GECOPHONE 2-VALVE SET**

Complete with one set double headphones and aerial equipment. Approx. range 25 miles.      Complete with one set double headphones and aerial equipment. Approx. range 30 miles.      A mahogany cabinet set, complete with valves, all batteries and one set double headphones. Approx. range 100 miles.

Price complete - - - **£5 10 0**      Price complete - - - **£9 15 0**      Price complete - - - **£25 0 0**

Sold by principal Electricians, Stores, Wireless and Musical Dealers.

Sole Selling Agents for the Music Trades in Great Britain and Ireland:  
Columbia Graphophone Co., Ltd., 102-108, Clerkenwell Rd., London, E.C.1.

Manufacturers & Wholesale only:

**THE GENERAL ELECTRIC CO., LTD.**      **HEAD OFFICE**      **MAGNET HOUSE, KINGSWAY, LONDON, W.C.2**

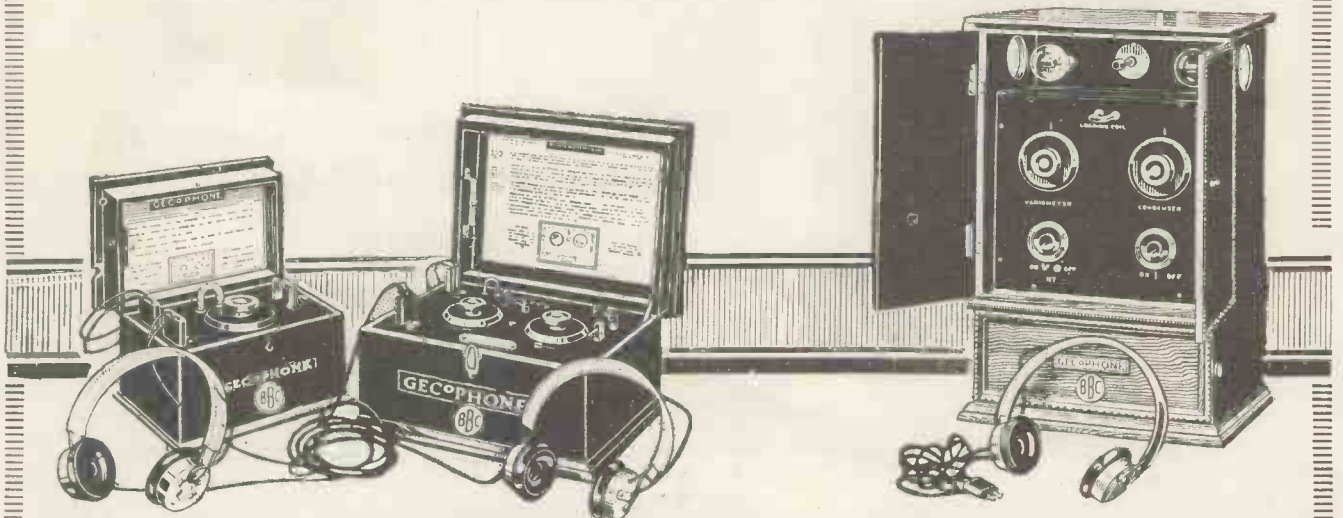

# POLAR CONDENSER

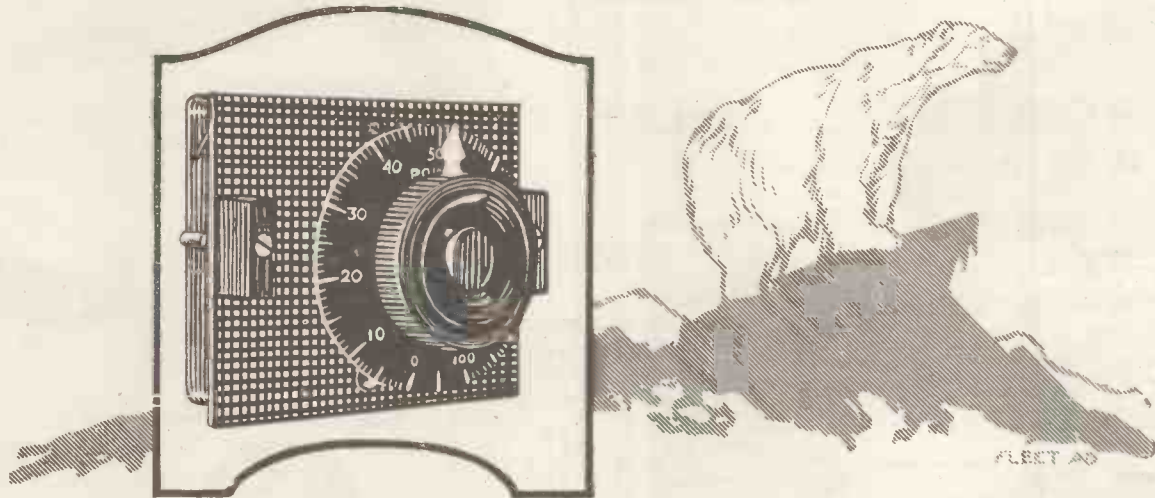

Perfect tuning dates back to the introduction of this condenser—

To-day unanimous testimony as to the superiority of "Polar" over all other types of variable condensers is available for the guidance of the amateur. "Polar"—the standard condenser employed in the great British Broadcasting and Marine Receiving Installations—is also the standard choice for Home sets.

Perfect tuning service, an open scale with ample available capacity, compactness and indefinite life are amongst the reasons for "Polar's" popularity.

### SPECIAL NOTE

Amateurs who experiment with various circuits frequently require condensers having different maximum capacities. "Polar" Condensers are so constructed that they may readily be adjusted to any of the following maximum capacities:—

'001, '0005, '0003, '0002.

Should the purchaser of a "Polar" Condenser of any of these capacities desire to have it changed to an alternative maximum capacity, he may forward it to our head office together with a remittance of one shilling to cover the cost of readjustment and return postage. We will then have the condenser adjusted to the desired capacity and returned. We do not recommend amateurs to attempt readjustment of the condensers themselves unless they have ready means for ascertaining the actual readjusted capacities.

PRICES: Unmounted, 14/-; Mounted, 20/-. Postage 6d.

Obtainable at all "Polar" stockists or direct.

**RADIO COMMUNICATION Co., Ltd.**  
34/35, NORFOLK STREET, LONDON, W.C.2.

Telephone: Central 8480 (3 lines).

Telegrams: "Radiocomco, Estrand, London."

You MUST be in WIRELESS WEEKLY because it brings RESULTS.

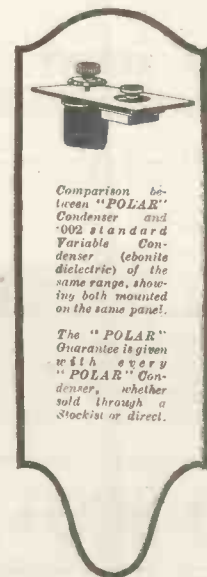

Comparison between "POLAR" Condenser and '002 standard Variable Condenser (ebonite dielectric) of the same range, showing both mounted on the same panel.

The "POLAR" Guarantee is given with every "POLAR" Condenser, whether sold through a Stockist or direct.

# Interesting?

— we should say so!

Whatever you need for your set, you'll find it listed in this new 40-page Catalogue—and illustrated too. Good, clear-cut illustrations which will give you a realistic impression of what you are buying together with full technical descriptions. Send for a copy of this encyclopædia of Wireless to-day. It will be most useful to you and its low prices will save you pounds. Postage extra on all articles shown here but paid on orders of £2 and over.



## 4d.

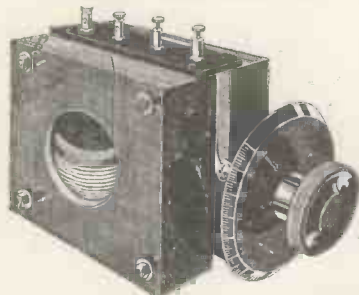

### "Variobloc" Variometer.

An internally wound Variometer of high efficiency. Permanent contacts, high inductance ratio. Fitted with terminals so that instrument can be used either as a Variometer or Variocoupler as required. Two Patterns:

- No. 1 250-720 metres ..... **17/6**
- No. 2 250-840 metres .....

Complete with ebonite dial as shown.

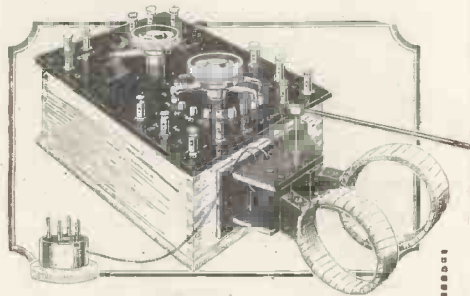

## You need this new Unit

If you are a user of Peto-Scott standardised Radio Units, you certainly need this one—the latest addition to the series and fully described on page 32 of the Catalogue. It enables dual reaction to be used simultaneously on Aerial and Anode Coils with greatly increased signal strength.

It has many other advantages which cannot be described here owing to limited space, but undoubtedly it adds 50% to the utility and interest of any existing Peto-Scott Unit Receiver.

- Complete set of parts for home assembly ..... **28/6**
- Cabinet for above ..... **3/6**
- Finished Instrument, aerial tested ..... **45/-**

### Variable Condensers.

Complete with knob scale, pointer and instructions, and TOP and BOTTOM-EBONITE PLATES ready bushed and connections made. Neatly boxed.

Parts complete.	Assembled for Panel Mounting.
.001 .....	9/-
.00075 .....	7/6
.0005 .....	6/11
.0003 .....	5/11
.0002 .....	4/11
.0001 .....	4/6
Vernier (ready assembled).	2/6

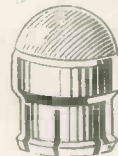
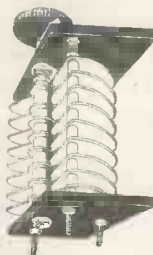

### Panel Windows.

Real opal windows for inserting in upright panels for viewing filaments of valves. Brass mounted. **9d.**



### The "Filtophone."

A special Filter to be attached across the terminals of any Loud Speaker. Improves the tone wonderfully and prevents, to a very large degree, atmospherics and other noises. In polished mahogany case. **8/6**

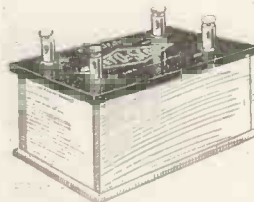

### Resistances and Grid Leaks.

Our own manufacture throughout. Each one tested for accuracy on electrical measuring instrument. Resistances: 50,000, 60,000 and 100,000 ohms, each 2/-. Clips, per pair 3d. Grid Leaks: 1, 2, 3; 4 or 5 megohms, each 1/6. Clips per pair 3d.

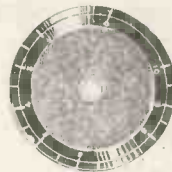
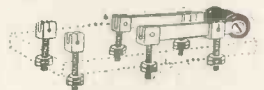

### Filament Dials.

Handsome bevelled dial zinc dia. Indicates each filament current, each **8d.**

### Nickel-plated Switches.

Superior nickel-plated D.P.D.T., without bases, ready with nuts for mounting on your own Panel. Extremely smart appearance. Take up little room. **2/6**  
Ditto, but single pole only ..... **1/9**

Series-parallel Switches.  
Complete with Brass Bush and nuts .. **2/-**  
Laminated pattern ..... **2/6**

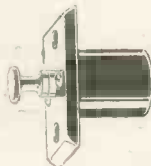

### Flush Panel Switch.

Very neat pattern takes up little room. 2-way, each .... **2/-**

### Simplex Lead-in.

The latest idea. Saves drilling the woodwork of the window frame and meets with landlord's approval. Window can be closed at any time. Fitted in one minute **1/6**



## Special Offer

### Build your own Peto-pan Super

In response to numerous requests we are now selling a complete set of parts for the famous **Peto-pan Super**—the real clear Speaker. All coils are wound (to a resistance of 4,000 ohms) every part has been accurately machined, enamelled and polished. The mahogany base has been drilled, turned and French polished. The assembling can be done in a couple of hours with only a screwdriver and a pair of pliers. Here's a unique opportunity of acquiring a well-known Loud Speaker at merely the cost of the parts. Complete set of parts including moulded horn, coils already wound, etc., etc., and full instructions ..... **40/-**  
If with straight horn ..... **35/-**  
Stamped BBC extra (when required) ..... **3/-**  
Packing case (returnable) and carriage ..... **2/6**



**SPECIAL OFFER:** To the first 50 readers of Wireless Weekly we will assemble the **Peto-pan Super** in our own workshops. Send your order at once and get a finished Loud Speaker at the cost of the parts alone.

# PETO-SCOTT CO. LTD.

Head Office - 64, High Holborn, W.C.1  
 Demonstration Lounge - 99, High Holborn, W.C.1  
 Branches - 3, Wellington Street, Strand, W.C.2  
 4, Manchester Street, Liverpool



# RADIOLA

## Wireless Apparatus

The two most important items in any wireless set are the headphones and the valves. If either or both be of inferior quality, reception will be poor — no matter how good the set may be in other respects. Use B. T-H RADIOLA telephones and valves and be *sure* of perfect reception. They can be obtained from all Wireless Dealers.



**B. T-H. RADIOLA 'PHONES** have become famous for their wonderful sensitiveness and tonal quality. They perfectly reproduce speech and music, and, moreover, give maximum amplitude of sound. Comfortable and readily adjustable, they are a worth-while addition to *any* wireless set.

#### REDUCED PRICES.

4,000 Ohms	..	25/-	per set.
120 Ohms	..	22/6	..

**B. T-H. RADIOLA VALVES** for amplifying and detecting are made in the same factory as the world-renowned *Mazda* lamp, and were supplied in large quantities to the Government during the war. These two facts, coupled with the recorded experience of many satisfied users, indicate the supreme excellence of Radiola Valves.

Price each 15/-

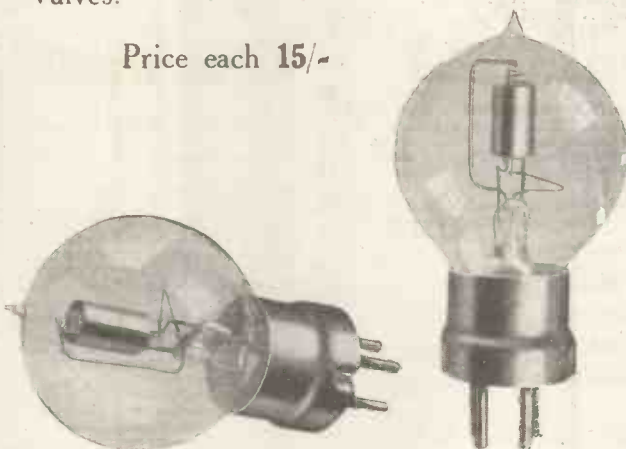

**The British Thomson-Houston Co., Ltd.,**  
Electrical Engineers and Manufacturers.

Works : RUGBY.

London Office : CROWN HOUSE, ALDWYCH, W.C.2.

Sole Agents for the Music and Gramophone Trades :—

THE MURDOCH TRADING COMPANY, 59 & 61, CLERKENWELL ROAD, LONDON.

1925

You *MUST* be in WIRELESS WEEKLY because it brings *RESULTS*.

A41

OVER QUARTER OF A MILLION SATISFIED CUSTOMERS  
 WIRELESS! WIRELESS! WIRELESS! and EVERYTHING for it.  
**DON'T PAY MORE!** Great Britain's largest  
 exclusive Wireless Stores.

**NOTE.** We are exclusively WIRELESS — NOT DABLERS!  
 Quality, Quantity and Consistency our Motto.  
 Pioneers of Cheap Prices. See our six-window display of popular bargains.

SPECIAL OFFER

**"ELKAY"** LIGHTWEIGHT HEADPHONES 12/9 (4,000 ohms). **BROWN'S** FEATHERWEIGHT HEADPHONES 19/6 (Stamped B.B.C., 4,000 ohms., our price). **D.L.** SUPER FRENCH HEADPHONES 10/11 (4,000 ohms) our price

THOMSON - HOUSTON HEADPHONES (FRENCH) 4,000 ohms, our price 14/11		EDISWAN VALVES 12/3		MULLARD "ORA" VALVES 12/9	
Bankrupt Stock and of Limited Quantity.					
N. & K. 'PHONES, the genuine article 12/9			FILAMENT RESISTANCES, smooth action, marvellous value 1/10		
SIDPE HEADPHONES, 4,000 ohms, genuine, our price 12/9			With engraved dials 2/9		
ERICSSON (genuine French 'phones, maker's name embossed) 4,000 ohms. Each pair tested and guaranteed. Don't pay 32/-, our price 16/9			VALVE LEGS, nut and washer each 1d.		
DUTCH VALVES 8/3			per doz. 10d.		
L.F. TRANSFORMERS Ratio 5 to 1. All guaranteed (postage 1/-) each 11/3			VALVE PINS, nut and washer each 1d.		
CRYSTAL DETECTORS 1/9, 1/3 and 2/6, 2/3, 1/6			per doz. 9d.		
CRYSTAL DETECTORS, enclosed in glass case, 2/6, 2/3, 1/6			1d.		
AERIAL WIRE, 7/22, guaranteed hard-drawn copper, 100 ft. (postage 1/-) 1/10			PLUNGER SPRINGS, complete each 3d.		
CONDENSER VANES, fixed or moving, per doz. 3d.			SLIDER ROD, brass, 13ins. long, 1/2in. square, drilled each 3d.		
REAL GOLD CAT'S WHISKERS each 2d.			SLIDER KNOB each 2d.		
REAL GOLD CAT'S WHISKERS per doz. 1/5			SWITCHES ON EBONITE, S.P.S.T. (quality the best) each 1/8		
SILVER CAT'S WHISKERS each 1d.			SWITCHES ON EBONITE, S.P.D.T. (quality the best) each 1/11		
SILVER CAT'S WHISKERS per doz. 7d.			SWITCHES ON EBONITE, D.P.D.T. (quality the best) each 2/9		
CONDENSER SCALES, 0 to 180 each 3d.			CONDENSER SPINDLES, all sizes in stock, from 1d. each 1d.		
IVORINE LABEL SET, 12 different titles, the set 6d.			SCREWED ROD, 2 B.A., 12ins. long each 3d.		
BATTERIES, 4 1/2 volts, best quality each 3d.			SCREWED ROD, 4 B.A., 12ins. long each 2d.		
BASKET COILS, set of 6, up to 3,000 metres... 2/4			RUBBER-INSULATED LEADING-IN WIRE per yd. 1d.		
SLEEVING, 3 yds. assorted colours, for 11d.			CHINA INSULATED SPRING CONNECTORS 3d.		
NUTS, 2 B.A. per doz. 2d.			1 way 2/4		
NUTS, 4, 5, 6 and 8 B.A. per doz. 2d.			2 way 2/4		
WASHERS, 4 B.A. per doz. 1d.			3 way 6d.		
WASHERS, 2 B.A. per doz. 1d.			INSULATORS, white reel, 2in., each 1d. per doz. 11d.		
CONTACT STUDS, with nuts and washers, per doz. 4d.			INSULATORS, white egg, each 2d... per doz. 1/8		
TERMINALS, with nut and washers, each 1d., 1 1/2d. & 2d.			WOUND INDUCTION COILS (postage 9d.):		
EBONITE KNOBS, 2 B.A. each 1 1/2d., 3d. & 4d.			12x4 9x4 8x2 6x3 6x2		
SPACING WASHERS, large per doz. 2 1/2d.			2/5 2/3 1/11 1/8 1/5		
SPACING WASHERS, small per doz. 1 1/2d.			TAPPED INDUCTANCE COILS, 20 tappings, wound to 1,600 metres each 2/6		
CRYSTAL CUPS, 2 screw each 1d.			VARIOMETERS (Tube type), complete with knob 3/11 and 2/11		
CRYSTAL CUPS, 4 screw each 2d.			DOUBLE 'PHONE CORDS, full length 11d.		
FIXED CONDENSERS, all capacities... each 10 1/2d.			HERTZITE, Genuine Large Piece 9d.		
EBONITE, cut to any size by machinery while you wait per lb. 3/6			TALITE, Genuine Large Piece 9d.		
TELEPHONE TERMINALS, nuts and washer, each 1 1/2d. per doz. 1/3			PERMANITE, Genuine Large Piece 9d.		
W.O. TERMINALS, nuts and washers per doz. 1/7			ZINCITE, Genuine Large Piece 9d.		
PANEL BUSHES, drilled each 1 1/2d.			BORNITE, Genuine Large Piece 9d.		
TOP CONDENSER, bushes each 1d.			MIXED CRYSTALS (6 kinds) 5d.		
per doz. 9d.			CARBORUNDUM 5d.		
BOTTOM CONDENSER, bushes each 1d.			ZINCITE and BORNITE, both in box 1/-		
per doz. 7d.			COIL PLUGS, real ebonite 1/3, 10 1/2d., and 9 1/2d.		
BELL WIRE, tinned copper, 12 yds. 6d.			H.F. PLUG TYPE TRANSFORMER:		
SWITCH ARMS, 4 laminations, ebonite knob, complete with panel, bush, nuts, and spring washer 8 1/2d.			1. 250 to 600 metres 3/9		
STOPS, with nuts per doz. 6d.			2. 350 to 700 " 4/-		
			3. 500 to 900 " 4/3		
			4. 800 to 1350 " 5/6		
			5. 1600 to 3200 " 4/9		
			6. 2200 to 5600 " 5/-		
			FILAMENT COMPLETE CIRCLE RESISTANCE SCALES, 0 to 300 each 6d.		
			Variable CONDENSERS of high quality. Vanes and Spacers of aluminium. Complete with knob and dial, guaranteed accurate: Vernier 4/9		
			'0002 5/9		
			'0003 6/3		
			'0005 7/-		
			'00075 8/8		
			'001 9/9		
			EBONITE CONDENSER KNOB AND DIAL 1/9		
			SUPER QUALITY 2-WAY COIL HOLDER 5/3		
			REAL EBONITE 3-WAY COIL HOLDER 7/9		
			O.B.A. NUTS per doz. 4d.		
			DETECTOR ARMS, Ball Joints, Ebonite Handle and Whisker Holder 3d.		
			WOOD SCREW TERMINALS each 1 1/2d.		
			SHELLAC per bot. 10 1/2d. and 6d.		
			AERIAL PULLEYS each 10 1/2d., 8 1/2d., 6d. and 4 1/2d.		
			TINFOIL large sheet 4d.		
			COPPER FOIL, 6in. wide per ft. 5d.		
			GRID LEAKS, 2 1/2 and 2 meg. each 10 1/2d.		
			FLEX (Twin), various colours per yd. 2d.		
			CONNECTING WIRE, tinned copper, 20 gauge 3 yds. 2d.		
			ENAMEL WIRE, in 1/2, 3/4 and 1 lb. reels:		
			22 24 28		
			per lb. 2/4 2/8 3/2 3/6		
			Note: Bobbins 2d. each extra.		
			POTENTIOMETERS, guaranteed up to 900 metres, superior make, compact size... 7/3		
			CRYSTAL DETECTOR, glass enclosed, fitted on 4x2 ebonite panel with terminals for aerial, earth and 'phones, already wired and beautifully finished 4/9		
			VALVE HOLDERS each 11 1/2d., 10 1/2d. and 9 1/2d.		
			BATTERIES, H.T., dry:		
			36 volts, including Wander Plugs 5/9		
			60 volts, including Wander Plugs 9/6		
			FILAMENT RESISTANCE DIALS 9 1/2d.		
			AMALGO-PLASTIC METAL, for fixing crystals. No Woods metal necessary 6d.		
			GOLD SEAL PLASTIC METAL, for fixing crystals 6d.		
			IVORINE NAME-PLATES, all readings each 1d. per doz. 9d.		
			EARTH CLIPS, Copper, adjustable each 5 1/2d.		
			RADIONETTE CRYSTAL SET, complete, stamped B.B.C. and including one pair 4,000 ohms 'phones, 100ft. 7/22 aerial wire, 4 insulators, lead-in tube, 6 yds. lead-in insulated wire and adjustable earth clip. Ready to listen-in. Honestly worth 3 gns... 36/6		
			RADIONETTE ONE-VALVE L.F. AMPLIFIER for above 34/6		
			CABINETS, all shapes and sizes in stock from 1/6 each		

**IMPORTANT NOTICE.** We have repeatedly said **DON'T PAY MORE**, and having served the masses well, the large return of business has made it necessary for us to acquire extensive additional premises adjoining our present address. Follow the crowd to Elkay Corner.

**"ELKAY" WIRELESS CO.,**

225 & 227, BISHOPSGATE, LONDON, E.C.2.

Open Saturday all day. (To the Trade—New Trade Counter now open. Send for NEW LIST.) We open Sundays 11 to 2.30. Special Terms to Radio Clubs. Note new Telephone No.: Central 8544

PLEASE REMIT AMPLE POSTAGE.  
**SAVE MONEY BY STUDYING OUR ADVERTS.**

# GAMAGES

THE PREMIER STORE FOR "LISTENERS-IN."

Be sure to visit Gamages Wireless Dept. next week, where there is a SPECIAL DISPLAY of all that is best in accessories, parts and complete sets. If unable to call, write for Wireless Catalogue and send your order by post.

A Splendid Morse Practice Set

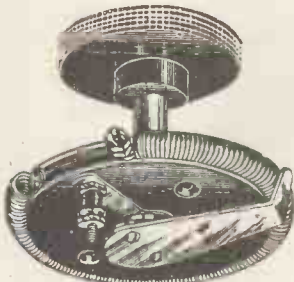

**FILAMENT RESISTANCE.**

This Resistance is similar in general design to our cheaper model, but has a superior finish throughout. Post 6d. Price **3/6**

**FULLER'S BLOCK**  
Wireless Accumulators.



SPECIAL OFFER of ex-Govt. stock, but absolutely unused. Exceptional value.

2-volts, 40 amps. Postage **10/6**

1/- 4-volts, 40 amps. Postage **21/-**

1/- 6-volts, 40 amps. Postage **31/6**

1/6 Boxes to hold 5 of these, fitted with lid & carrying strap. Each, **1/6**

Postage extra. 5 accumulators & box sent carr. free.

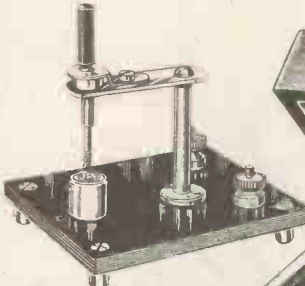

**CRYSTAL DETECTOR.**

Lacquered brass, mounted on ebonite, ball joint and "cat's whisker." Fitted with our famous "Permanite" Crystal. Post 6d. Price **4/6**

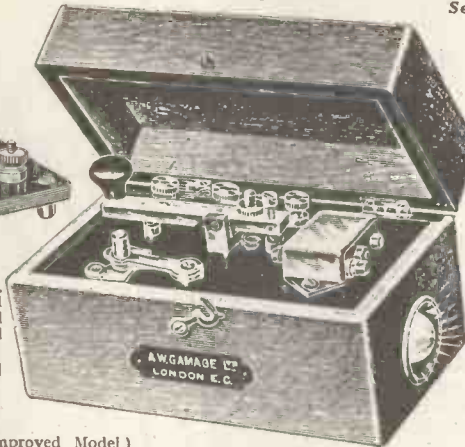

**MORSE SIGNALLING APPARATUS.** (1916 Improved Model.)

Thousands of these instruments are in use for training Naval and Military Signallers. They are efficient and handy instruments, fitted with Flashing Apparatus and High-note Buzzer, with terminals for connecting wires for Line Telegraphy.

Polished Mahogany Case, with hinged lid and sliding bottom to facilitate renewal of battery. Size 5 1/2 by 3 1/2 by 3 1/2 in. Complete with Battery ready for work. Price Weight 1 lb. 3 oz. Extra Batteries, 9d. each. Post 1d. **16/6**

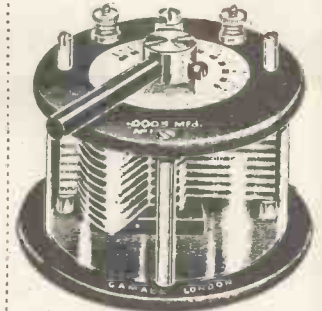

**VARIABLE CONDENSERS.** The capacity of these Condensers is '00043, being but slightly smaller than '0005 and can be used with great success where a Condenser of this capacity is required giving finer tuning. These Condensers carry the usual Gamage guarantee and every one is tested before despatch. Post 9d. Price each **7/6**



Special Offer of BROWN'S 'A' PHONES (W.D.). Every pair tested. Resistance 120 ohms. Usual price 30/-. Price **21/-** Post 6d. Cords 2/9 per pair extra.

## A. W. GAMAGE, LTD., HOLBORN, LONDON, E.C. 1

Hestavox 2 Valve, B.B.C. New. Cost £12 10. Sell £9 complete. Stuart Wireless Co. Experimenter, 3 Valve, 2 Panels. Gets Radiola here on Loud Speaker. As New. Cost £25 10 0. Sell £15. S.T. 100 complete Sets Built up R.I. Transformers. Send for full particulars. Best Ericson Head Phones, 4000 ohms. 17/6 I have best value in Crystal Sets in British Isles. 15/-. Send for particulars. ALL ABOVE ON APPROVAL WILLINGLY. NEWPORT, Westbury, SHERBORNE.

**SUCCESSFUL ASSEMBLY OF YOUR SET**

is a certainty if you get a Radiax outfit. You may adopt the unit principle of building up an Extensible Experimental system, or select a combined Set to suit your convenience and taste. Everything is planned, and our diagrams and booklets—to say nothing of our unequalled personal service to clients—are invaluable. A splendid 1-valve Set costs 32/6, a 2-valve Set 72/8. Add to these prices 12/6 per valve Marconi royalty. REACTANCE on the Anode will bring in the distant stations and double your amplification. RADIAX Regd. Variable Reactance Coil for all wavelengths 10/-. Tuned Anode Coil for same to plug into any H.F. Transformer Sockets, 350-000 metres 5/8. GET OUR COMPLETE CATALOGUE. Send 3d. Stamp. RADIAX, LTD., 50, RADIO HOUSE, PERCY STREET, TOTTENHAM COURT ROAD, LONDON, W.1. Museum 490.



RADIAX, LTD., 50, RADIO HOUSE, PERCY STREET, TOTTENHAM COURT ROAD, LONDON, W.1. Museum 490.

Radio Press  
Information Department

**QUERY COUPON**

WIRELESS WEEKLY, Vol. 2. No. II. Sept. 26, 1923

(This coupon must be accompanied by a postal order of 1/- for each question, and a stamped addressed envelope.)

**Wireless Weekly Small Advertisements**

**"A" TYPE** Brown's 120 ohm new ex Govt. headphones, 25/- post paid. Send for free complete price list of all post paid unequaled radio values. J. H. Taylor & Company, Macaulay Street, Huddersfield.

**BARGAIN £18.** Five valve receiving set including valves, tuning coils and transformers, phones, loud speaker; all new, perfect working, in compact cabinet shape. Write.—H. Jullerot, 31, Courtfield Road, S.W.5.

**CAT'S whiskers.** Pure 9-car. gold, 6d. Refined silver, 3d. Alloy, 1d. Post paid for the three, 1/. Newtonia Wireless Factory, 13/15 Whitcomb Street, W.C.2. The trade supplied.

**EXPERIMENTERS:** Don't twist wires round terminals. Be definite; use our plugs and terminal adaptors. Plugs; red, blue, or black insulation, solid brass plunger and socket, 2/6 a pair. Postage 1/4d. The Austin-Ratcliffe Trading Co., Palace Cinema Chambers, Slough.

**FOR sale:** 4 valve set, in mahogany cabinet, complete with coils to 4000 metres, 100 amp accumulator, valves, phones, etc. Receives British and Continental programmes. Trial by appointment. Price £15. 6, Hazelbourne Road, Balham, S.W.12

**G<sup>o</sup> to Mica & Micanite Supplies Ltd.,** Mica House, Offord Street, Caledonian Road, N.1, for mica and all insulating materials.

**IT will be to your advantage to write for particulars of the B.R.C./2** if you require an efficient wireless set. Bristol Radio Coy, Thomas Street, St Agnes, Bristol.

**JUST out.**—New Illustrated tool list and hundred useful lines half usual prices. Send now. Martell's, 306, Mount Pleasant Road, Tottenham, London, N.17.

**MANUFACTURERS' stock** of spacing washers, 1/10" x 1/4", 9d.; 1/10" x 7/16", 1/-; 1/8" x 1/4", 9d.—all per gross, guaranteed to size 2BA rod, 16/- per gross ft.; 4BA rod, 14/- per gross ft. three ft. lengths. Samples submitted. Cash with order. Holland & Goddard, Engineers, 128, Waterway Street, Nottingham.

**TO wireless dealers.** The Newtonia Wireless Factory, 13-15, Whitcomb St., London, W.C.2 (Tel: Regent 643) can supply dealers from stock with all the usual wireless components at the right price. You will find it cheaper in the long run to take your supplies from an established house than from Tom, Dick, or Harry

**WIRELESS uniform,** practically new, slight figure, height 5' 6", cap 6 1/2", naval warm, bargain for quick sale. W. E. Burton, 39, Ballyholme Road, Bangor, Co. Down.

You MUST be in WIRELESS WEEKLY because it brings RESULTS.

# AMPLION

## The Amplion Pedigree

- In 1887 .. Mr. Alfred Graham demonstrated the first practical Loud Speaker.
- In 1893 .. GRAHAM Loud Speakers placed upon the market.
- In 1894 .. First used in the British Navy. Transmitters applied to Phonographs for Loud Speaker reproduction. Demonstrations by Prof. McKendrick at the Royal Society.
- In 1896 .. Naval Telephones developed and adopted by the Admiralty.
- In 1898 .. Watertight Loud Speakers Patented. Fitted on board many Warships and Mercantile Vessels. Telephonic Submarine Signalling System devised.
- In 1902 .. Complete Loud Speaker installations on central battery plan erected on warships as sole means of communication.
- In 1906 .. The most extensive naval installation to date, including exchange system fitted to H.M.S. Dreadnought.
- Onwards .. Graham Loud Speakers applied to all sorts and conditions of service at home and abroad, ashore and afloat.
- To 1919 .. No less than 12,000 ship installations carried out.
- In 1920 .. "AMPLION" Loud Speakers produced for Wireless and "AMPLION" Trade Mark registered.
- In 1922 .. "AMPLION" standardised by leading manufacturers of radio apparatus

—the reason why the "AMPLION" is undeniably the finest Radio Loud Speaker and recognised as the World's Standard.

It will be seen that the "AMPLION" is not merely produced to meet a sudden demand, but is the result of years of experience in Loud Speaker design and construction.

ASK FOR FOLDER WW.

**ALFRED GRAHAM & CO.,**  
 St. Andrew's Works,  
 CROFTON PARK,  
 LONDON, S.E. 4.

'Phone: Sydenham 2820-1-2.

'Gram: "Navalhada Catgreen, London."

"BUY BRITISH GOODS ONLY."

**DEMONSTRATIONS at our Showroom:**  
 THE ALGRAPHONE SALON,  
 25/6, Savile Row, Regent St., London, W.1.  
 'Phone: Regent 1075.

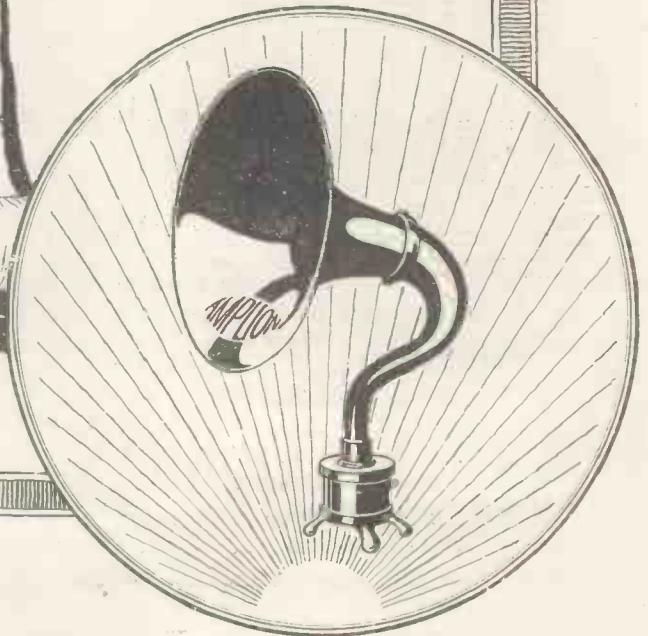



# IMPORTANT SALE

## OF Wireless Accessories and Sets

including complete ex-Government transmitting and receiving sets, loud speakers, variable condensers and Brown's reed type headphones, three valve amplifiers, complete crystal receiving sets, china insulators and miscellaneous wireless material both ex-Government and new, B. Mark II. short wave tuners, Sullivan ex-Government headphones.

WILL BE HELD AT

**STEVENS'S AUCTION ROOMS, LTD.,**  
38, King Street, Covent Garden, London, W.C.2.

(Established 1760.)

'Phone: GERRARD 1824. 'Grams: AUKS, RAND, LONDON.

**TUESDAY, OCTOBER 2nd, 1923, at 12.30 O'CLOCK.**

On view Monday prior to day of Sale, from 12.30 to 5.30, and on Morning of Sale from 9.30 to 11.30. Catalogues Free on Application.

## LOOK!! SOMETHING ABSOLUTELY NEW. A VALVE HOLDER AND FILAMENT RHEOSTAT IN ONE.

— SAVES HALF YOUR PANEL SPACE. —  
Fixed in the same way as a Valve Holder.



7/6 each.

Fix your Valve Holder and Rheostat in one operation.

Four connections only.

Also made for D.E.R. Valves  
and to plug into existing sets.

**GEO. F. WATTS & SON,**  
Radio Engineers,

131, GLOUCESTER ROAD, BRISTOL.

Finest possible adjustment  
of filament current by merely  
turning milled ring.

Full resistance 7 ohms.

Finely made in best Ebonite.

The wiring being simplified  
makes it just the thing for  
the amateur about to con-  
struct his set.

## BY THE TIME THIS IS IN PRINT:—

We hope that we shall have caught up with the extraordinary demand for the **REFTY CUP**. But we take this opportunity of apologising for the delay which that same demand has caused in deliveries this past week. Supplies can be relied on from now onwards.

\* \* \* \* \*  
Here are two pictures of the Cup (exact size). A lot of explanation is not necessary.

**THE PICTURES TELL THE STORY.**

The screws are No. 4 B.A. X 1/2" and can be used either way up.

The Cup and  
Plunger surfaces  
are ridged.

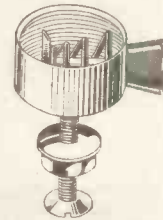

This ensures grip  
as well as  
good contact.

**PULL KNOB! INSERT CRYSTAL! LET GO!**

Prov. Pat.  
20606.

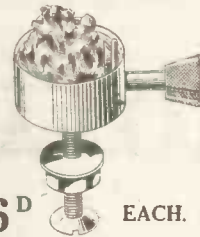

Foreign Patents  
pending.

**6<sup>D</sup> EACH.**

## \* \* \* \* \* MORE REFTY TIME-SAVERS

No. 1. Lacq.  
10 1/2d. each.  
Ebonite top.

No. 2. Lacq.  
6d. each.  
All brass.

No. 4. Lacq.  
1/- each.  
Ebonite top.



British  
Patent.



No.  
194605.



No. 1a. N. Plate.  
11 1/2d. each.

No. 2a. N.P.  
7d. each.

No. 4a. N.P.  
1/1 each.

**Depress the Knob! INSERT the WIRE! LEAVE GO!**  
**THE TERMINAL WHICH IS AS  
GOOD AS A SOLDERED JOINT**  
yet which is connected or disconnected in an instant  
**AND CANNOT POSSIBLY SHAKE LOOSE.**

*Hundreds of Dealers Stock REFTY Products. Here are  
some of them. If your dealer doesn't—send cost plus  
postage for direct delivery.*

- N.W.3. Downshire Motor Co., 28, Rosslyn Hill, Hampstead.
- N.W.6. North Western Light Supply, 40, High Road, Kilburn.
- N.7. Messrs. Pugh Bros., 95, Holloway Road.
- N.15. Savill's Planos, Ltd., High Road, Tottenham.
- S.W.1. Autoveyer's, Ltd., 84, Victoria Street.
- S.W.12. J. Jarvis, 18, Ravenwood Road, Balham.
- S.W.14. Edwards & Fordyce, Upper Richmond Road.
- S.E.14. H. J. Gordon, 395, New Cross Road.
- E.C. Spencer's Stores, 4-5, Mason's Avenue.
- E.C.2. Thos. Gunn, Ltd., 30, Fore Street.
- E.C.3. Holmes' Camera Mart, 32, Greenwich Street.
- E.C.4. W. Parton, Ltd., 94, Queen Street.
- W.1. B. Apple, 87, Tottenham Court Road.
- W.2. A. E. Person & Son, 41, Edgware Road.
- W.11. J. C. Sharp & Son, Notting Hill Gate.
- W.C.1. Service Co., 273/4, High Holborn.

## REFTY ELECTRICAL LTD.,

2, FEATHERSTONE BUILDINGS, HOLBORN, LONDON, W.C.2  
Telephone: Chancery 8264. Telegrams: "Reftinal," Holb, London

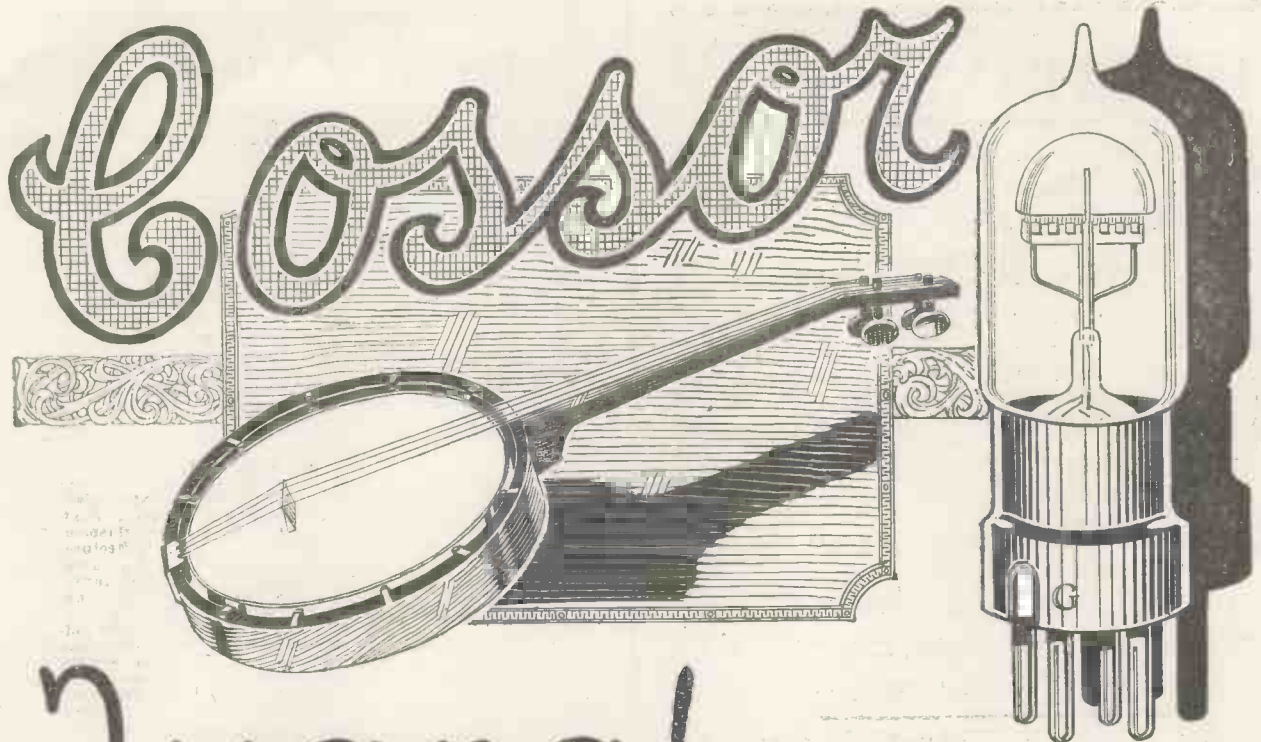

*Twang!*

—use **Cossor Valves** and cut out the Banjo accompaniment.

**Y**OU may have heard noises like the twanging of banjo strings when you have been using a Loud Speaker. Perhaps you have been unable to account for these sounds, and have imagined them to be faults in transmission. It is probably nothing of the kind! These noises are termed microphonic noises and may be actually produced by the valves in your set.

Now, owing to its unique construction, the **Cossor Valve** is singularly free from microphonic noises. Let us explain why.

The Grid of the **Cossor** is hood-shaped and wound on a stout Grid Band. The wiring is securely laced and anchored in no less than three distinct positions to every turn. The result is a Grid which is

particularly robust and rigid. Further it is electrically welded to a heavy supporting tube.

The most exacting tests have failed to show any signs of movement of the **Cossor Grid**, no matter what the working conditions are. That is the secret of its remarkable freedom from microphonic noises.

A spiral Grid, on the other hand, is much more delicate and prone to transmit the slightest vibration of the set. Such movements are so slight as to be almost unnoticeable in the ordinary way, but Radio picks them up and, magnifying them, spoils the purity of your reception.

TYPES:  
 P1. For Detector and Low Frequency use **15/-** each  
 P2 (with red top). For High Frequency use  
 From all Dealers.

When next you buy valves, make up your mind to cut out the banjo accompaniment and choose **Cossor Valves**—their greater amplification factor, freedom from distortion, and higher efficiency for long-distance work will make you regret that you had not bought them sooner.

**COSSOR VALVE Co., Ltd.—HIGHBURY GROVE, LONDON, N.5.**

*Gilbert Ad.*



**A FEW TEMPTING  
EX-GOVERNMENT  
BARGAINS**  
which cannot be repeated.



**C.W. MARK III. RECEIVER.**

This set comprises a complete two-valve receiving set with a wave-length range of 350-1,800 metres. They were manufactured to Government specification by the leading manufacturers of the day, including Marconis, A.T.M. Co., etc., and are honestly worth three times the price asked.  
Price .. .. . £9 9s.

**SYTONISERS.**

Made by S. G. Brown, Ltd., a magnificent Wavemeter of first class quality. Wave length 1,000-2,500 metres.  
Price .. .. . £3

**AERIAL MASTS.**

15 ft. Steel Masts, in Sections, each 2 ft. 8 1/2 in., complete with halyard, pulley and stays. Can be easily erected by one man. The height can be increased up to 30 feet by the use of extra stays.  
Price .. .. . 15s. each.  
30 ft. ditto in sections each 4 ft. 3 in. (without stays).  
Price .. .. . 17s. 6d. each.

**TUNING COILS.**

Brand new. As used in the Mark III. Crystal Tuner. Litzendrahdt Windings, tapped.  
Price, per pair .. .. . 10s.

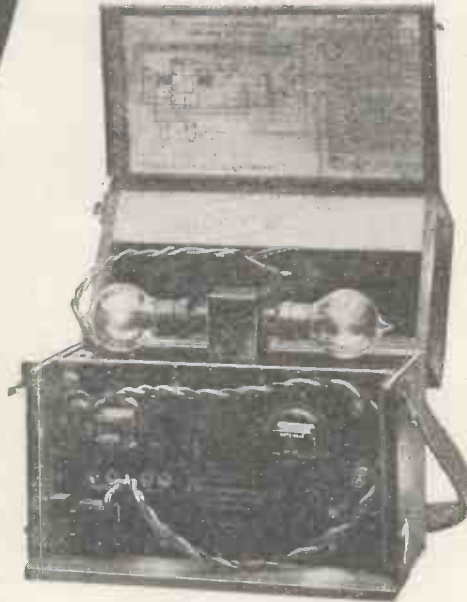

**B. MARK II. RECEIVER.**

This 2-valve receiver contains intervalve transformer, valve to phone transformer, condenser and grid leak, filament Rheostat, change-over switch, valve holder, etc. Price, including pair of Sullivan Headphones .. .. . £3 5s.  
Same, fitted with variable air condenser, .0005 mfd. £3 15s.

**AMPERE-METERS.**

O-2, Hot wire, mounted on ebonite base, on and off switch. A first-class instrument manufactured by leading makers. Limited quantity. Price .. .. . 10s. each.

**SULLIVAN HEADPHONES.**

120 ohms. Price .. .. . per pair 12s. 6d.  
Complete with our Standard Telephone Transformer, value 25s. Price .. .. . 30s.

**MORSE KEYS.**

200 only. Complete in cases. These superior instruments contain platinum contacts to the value of at least 9s. Price .. .. . 15s. each.  
Don't miss this bargain.



**C.W. MARK III, TRANSMITTER.**

Complete with Aerial Ammeter, platinum-pointed Morse Key, etc. This instrument makes a perfect telephony transmitter by simply inserting a microphone in the circuit. The quantity available is now very limited.  
Price .. .. . £3 5s.

**30-WATT H.T. UNITS.**

Designed for use with the above Transmitter.  
Price .. .. . £1

**100-WATT H.T. UNITS.**

Containing—  
2 L.F. Chokes.  
2 3 mfd. } Mansbridge Condensers.  
4 1 mfd. }  
1 1 mfd. Mica Condenser.  
Step-up Transformer, Electro-Magnetic Interrupter, Changeover Switch, 16 ohms resistance, Ebonite Panel, Terminals, etc.  
Price .. .. . £2  
A bargain for the experimenter.

**HAND GENERATORS.**

Only a few left. Hundreds sold.  
600 volts, 30 milliamps. Brand new.  
Price .. .. . £12

**INTERVALVE TRANSFORMERS.**

Tested and guaranteed. It is generally accepted that the Intervalve Transformers used by the Government cannot be excelled.  
Price .. .. . £1

We have several other bargains too numerous to advertise. Drop us a line stating your requirements, when we shall be pleased to quote our rock-bottom price.

**The CITY ACCUMULATOR Co**

79, MARK LANE, LONDON, E.C.3.  
10, RUPERT STREET, COVENTRY STREET, W.1.

'Phone: AVENUE 1316.

'Phone: GERRARD 3063.

Agents:—

**LANCASHIRE & CHESHIRE:**

Heary Hollingdrake & Son Ltd., Princes Street, Stockport.

**S. WALES:** South Wales Wireless Installation Co., Ltd., 18, West Bute Street, Cardiff, and at Cambrian Road, Newport.

**YORKSHIRE (West Riding):** Messrs. H. Wadsworth Sellers & Co., Standard Buildings, Leeds.

**FRANCE:** 33, Rue d'Hautville, Paris.

**AUSTRALIA:** 4, Teakle Street, Summer Hill, Sydney.

**GLOUCESTERSHIRE, SOMERSET & WILTS:**  
Bristol Wireless Co., 52, Cotham Hill, Bristol.

**LEICESTERSHIRE:**

Walter Rowe, Ltd., Eldon House, 97, London Road, Leicester.



# Radio Press Books give him all the information he needs

## Complete List

	Price.	Post Free
1. Wireless for All . . . . . John Scott-Taggart, F.Inst.P.	1/6	1/7½
2. Simplified Wireless . . . . . John Scott-Taggart, F.Inst.P.	1/-	1/1½
3. How to Make Your Broadcast Receiver . . . . . John Scott-Taggart, F.Inst.P.	1/6	1/7½
4. How to Erect Your Wireless Aerial . . . . . B. Mittell, A.M.I.E.E. . . . .	1/-	1/1½
5. The Construction of Wireless Receiving Apparatus . . . . . P. D. Tyers.	1/6	1/7½
7. How to Make a "Unit" Wireless Receiver . . . . . E. Redpath.	2/6	2/8
9. Wireless Valves Simply Explained . . . . . John Scott-Taggart, F.Inst.P.	2/6	2/8
10. Practical Wireless Valve Circuits . . . . . John Scott-Taggart, F.Inst.P.	2/6	2/8
11. Wireless Licences and How to Obtain Them . . . . . E. Redpath.	1/-	1/1½
Elementary Text-book on Wireless Vacuum Tubes . . . . . John Scott-Taggart, F.Inst.P.		10/- (Post free)

☐ Those printed in heavy type have been published recently.

HOW many turns for a Coil to reach the Paris Wavelength—the type of circuit to operate a Loud Speaker using only an indoor Aerial—Crystal or Valve rectification in a multi-valve Set? These are a few of the questions which confront the amateur constructor.

Some will find out the correct answers by expensive experiment—others, more wisely, will benefit by the experience of those who have trodden the thorny paths of Radio before them.

The concentrated experience of some of the best known Wireless engineers and experimenters is available for all readers of Radio Press Books. You cannot do better than purchase the complete Library—one Book at a time. Each Book covers a different phase of Wireless and none overlap. Get one or two to-day and keep them by you for ready reference—they are sure to save their cost many times over. From all Booksellers.

RADIO PRESS LTD.,  
Devereux Court, STRAND, W.C.2.

**Radio Press Books**  
— a complete wireless library

Gilbert Ad.



**Radio Frequency Transformer.**  
150 to 30,000 metres.  
Price £2 0 0

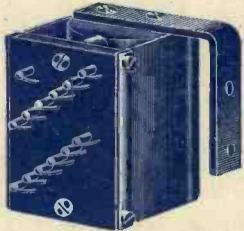

**H.F. Anode Reactance Coil.**  
150—20,000 metres. Price 25/-

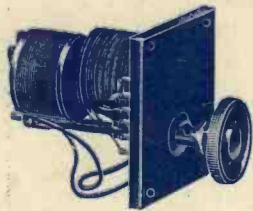

**Variable Interval Reaction and Anode Reactance.** 200—4,000 metres. Price 38/-

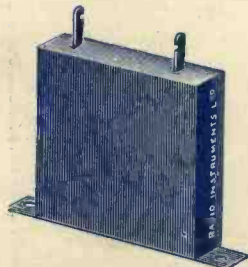

**Mounted Fixed Condenser.**  
.0002 to 2.0 mfd. 2/6—10/-

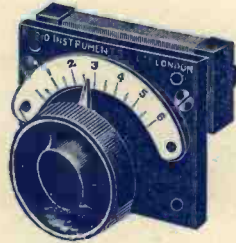

**Variable Rheostat or Potentiometer** .. 12/-  
.. 14/-

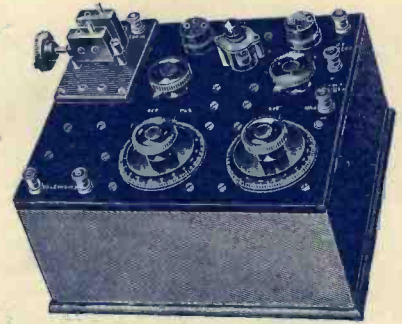

**S.T. 100.** Complete set of parts ready for mounting as illustrated.

£8 18 8

# FAMOUS R.I. PRODUCTS

The greatest success obtained by experimenters has been with the use of these products.

They are guaranteed and designed by the engineers of our company, who have received universal recognition for their work in the field of radio research.

In all new circuits **R.I.** components are employed because they represent the accepted standards of the British Wireless Industry.

Twenty-five years wireless practice is behind the manufacture of every article we put on the market.

Our new 48 page catalogue containing a full description of all our sets, components, and accessories sent free on application.

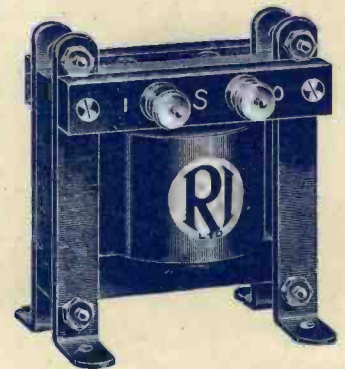

**The famous R.I. Transformer.**  
One price one quality.

25/-

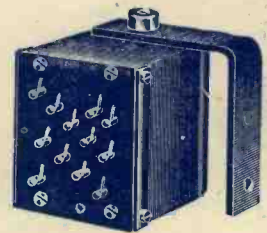

**Radio Frequency Transformer.**  
150 to 4,000 metres.

Price 25/-

# RADIO INSTRUMENTS LTD.

Managing Director : J. JOSEPH M.I.E.E.

Chief Designer : W. A. APPLETON, M.B.E. M.I.R.E. *Late Admiralty Technical Research Officer.*

ONLY ADDRESS, Works, Offices and Showrooms :—  
12, HYDE STREET, NEW OXFORD STREET, W.C.1.

Telephone : Regent 6214-6215-6216

Telegrams : "Instradio, London."

Northern Depots 19, Hopwood Avenue, Manchester, and Trinity House, Commercial Street, Leeds