

WIRELESS, incorporating "Wireless Weekly," JUNE 5, 1926.

# WIRELESS



INCORPORATING  
WIRELESS WEEKLY

2<sup>D</sup>  
WEEKLY

Vol. IV.] *JUNE 5, 1926* [No. 2

IN THIS ISSUE:

**THE 1926-1927 SEASON:**  
What Will It Bring?

By JOHN SCOTT-TAGGART, F.Inst.P.

**HOW TO BUILD A FOUR-  
VALVE SINGLE-CONTROL  
PORTABLE SET**

By JOHN UNDERDOWN

AND MANY  
OTHER IMPORTANT FEATURES

**USEFUL FREE GIFT INSIDE!**

[Registered at the G.P.O. as a Newspaper.]



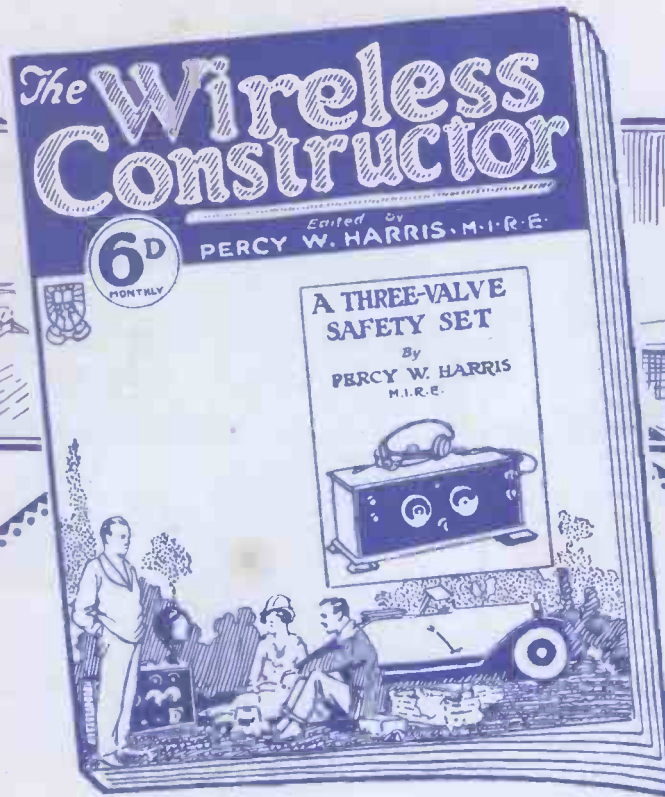

The June issue of **THE WIRELESS CONSTRUCTOR**, now on sale, is crammed with information concerning the construction of no less than 4 different popular types of receivers.

Contents include:—A new Non-Radiating Three-Valve Receiver by Percy W. Harris, M.I.R.E., which the Editor says, is "designed so that once it has received its preliminary adjustments, it cannot be made to radiate, however the tuning controls are manipulated."

Mr. Harris' third article of a series of talks to beginners appears in this issue.

Mr. J. H. Reyner, B.Sc., (Hons.), A.C.G.I., D.I.C., A.M.I.E.E., provides some valuable information on the construction and use of H.F. chokes in everyday practice.

Crystal or Valve Rectification by H. J. Barton-Chapple, Wh.Sch., B.Sc., A.C.G.I., D.I.C., A.M.I.E.E., is a feature which answers the queries of many.

**FREE BLUE PRINTS.**—In return for a coupon contained in each issue, every reader may receive One Back of Panel Blue Print of any set described in that issue.

# The Wireless Constructor

ON SALE EVERYWHERE

PRICE **6<sup>D</sup>** EVERY MONTH

8/6 per annum United Kingdom.  
7/8 per annum Canada and Newfoundland.  
8/6 per annum Other Countries.  
*Lesser periods than 12 months pro rata.*

**JUNE CONTENTS**

- A Three-Valve Safety Set** ... ..  
By PERCY W. HARRIS, M.I.R.E., Editor.
- Crystal or Valve Rectification?**  
By H. J. BARTON-CHAPPLE, Wh.Sch.,  
B.Sc., A.C.G.I., D.I.C., A.M.I.E.E.
- A Folding Frame Aerial** ... ..  
By PHILIP H. WOOD, B.Sc., F.P.S.L.
- Using H.F. Chokes**  
By J. H. REYNER, B.Sc., A.C.G.I., D.I.C.,  
A.M.I.E.E.
- Selectivity With a Single Valve** ... ..  
By JOHN W. BARBER
- Talks to Beginners—III** ... ..  
By PERCY W. HARRIS, M.I.R.E., Editor.

PUBLISHED BY

**RADIO PRESS, LTD.**  
BUSH HOUSE, :: STRAND,  
LONDON, W.C.2.

**JUNE CONTENTS**

- A Protective Unit for Your Loud-Speaker** ... ..  
By E. J. MARRIOTT.
- Mr. Gumplethorpe Gets it in the Neck "DX" With Two Valves** ... ..  
By STANLEY G. RATTEE, M.I.R.E.
- Workshop Hints** ... ..
- Two Useful Tools** ... ..
- Reducing Interference—A Loosely Coupled Crystal Set** ... ..  
By JOHN UNDERDOWN.
- The Loud-Speaker and its Problems**  
By E. H. BERRY.
- Apparatus Tested** ... ..



Use  
**THE CLARTONE**  
*Britain's Best*  
FROM ALL RADIO DEALERS

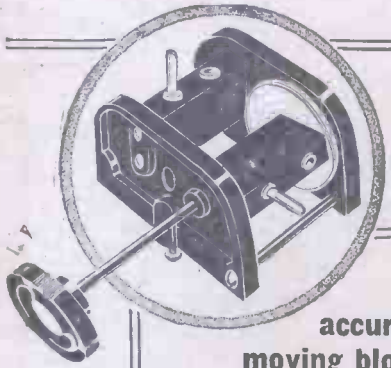

**TWO TYPES:**  
For outside panel mounting:  
Two-way .. 7/-  
Three-way .. 10/6  
For inside base-board mounting, with 6 in. handle:  
Two-way .. 8/-  
Three-way .. 12/6

**Tuning is accurate because the moving block cannot fall.**

Holds the heaviest coil securely in position and prevents the fading away of volume. The vernier movement consists of three sets of enclosed precision machine cut gears and reduces the speed of the moving coil block by eight times.  
From all Radio Dealers.

**LOTUS**  
VERNIER  
**COIL HOLDERS**

Garnett Whiteley & Co., Ltd.,  
Lotus Works, Broadgreen Road,  
LIVERPOOL.  
*Makers of the new Lotus Buoyancy Valve Holder.*

Bakelite mouldings for the side plates and knobs; heavy nickel plating for the metal parts.



This is the Glory Corner at the Bennett College. We give it that name because it contains in bundles about One Hundredweight of letters which we have received from Grateful and Successful Students. We keep all these thousands of unsolicited testimonials as a fountain of inspiration and because we are really proud of them. Having helped thousands of others to achieve success and advancement, it may be possible that we can help YOU.

I am assisted by a large and expert staff, and the advice we give is sound. If we cannot help you we will say so; if we can we will tell you how.

We have FREE booklets setting out the possibilities in connection with each of the subjects shown in the lists; send for the one in which you are interested, or ask for MY PRIVATE ADVICE which also is free. You incur no obligation.

**Have You ANY Ambition?**

- COMMERCIAL**  
Accountancy  
Advert. Writing  
Salesmanship  
Army Certific. Courses  
Auctioneering & Estate Agency  
Auditing Banking  
Book-keeping.  
Commercial Arithmetic  
Commercial Law  
Company Law  
Costing Economics  
English and French  
Executorship Law  
Foreign Exchange  
General Education  
Modern Business  
Methods

Most moderate charges, payable monthly. No extra fees.

**GOOD REASONS**  
why you should join the Bennett College

- 1 We give a written guarantee of success
- 2 We supply all the necessary books FREE
- 3 We have 20 expert tutors for every Department
- 4 We teach by post—you study in your spare time.



Yours sincerely,  
*J. Bennett*

- Police Promotion Course  
Secretaryship  
Workshop Organisation

**TECHNICAL**

- Applied mechanics  
Architectural Drawing  
Building Construction  
Clerk of Works' Duties  
Boiler Engineering  
Boiler Making  
Chemistry  
Civil Engineering  
Concrete and Steel  
Draughtsmanship  
Electricity  
Engineering  
Foundry Work  
Internal Combustion Engines  
Marine Eng., B.O.T.  
Mathematics  
Matriculation

**TECHNICAL—Cont.**

- Metallurgy Mining  
Mine Surveying  
Motor Engineering  
Naval Architecture  
Pattern Making  
Quantity Surveying  
Sanitation  
Shipbuilding  
Structural Engineering  
Surveying and Levelling  
Telegraphy and Telephony  
Town Planning  
Wireless Telegraphy  
Works Managers' Course

**ENGINEERING DICTIONARY Part One FREE.**  
To extend the name of the Bennett College we are publishing an Illustrated Encyclopaedic Dictionary of Engineering, Civil, Motor, Elect., Mech., etc. You may have Part I FREE. Send for Part I to-day. You are under no obligation.

**WE SPECIALISE IN PREPARATION FOR ALL EXAMINATIONS IN CONNECTION WITH THE ABOVE SUBJECTS.**

**WE TEACH BY POST**



Note Address:—  
The BENNETT COLLEGE,  
Dept. 111, Sheffield.

**4/11**  
2 volt 3 amp.

**Cause & Effect**

The increasing sales of Frelat valves are but the direct result of the recommendation of those who have tried them and told their friends of their wonderful value. Ask a friend who has one. The guarantee protects you.



If your dealer cannot supply, send your order direct to the distributors. Receive valves post free by return.

Continental Radio Import Co., Ltd., 8, Spital Square, London, E.1

**COUPON.**

QUESTIONS AND ANSWERS.

This coupon must be accompanied by a P.O. for 2/6 for each question, and a stamped addressed envelope when sending queries to the Radio Press Information Dept. for a postal reply. "WIRELESS."  
Vol. IV. No. 2.

# ARE YOU A PATIENT MAN?

## £200

### IF YOU ARE



"Let's see—five separate units give five capacities, taken singly. Then I can have the first two in series or parallel—total seven. Then the first three all in series or all in parallel—two more. The first and third and second and third in series, total 9. Ditto, in parallel, 11. First and second in series, and in parallel with the third—12 . . . . .  
 . . . . . And the total number of different capacities with the five units is ———?" What is it?

**If you get it right,  
 you win £200!**

Whatever your skill in counting capacities, however, the purchase of a Dubilicon will bring you one sure reward. The Dubilicon gives any capacity up to 0.011 mfd. simply by varying the connections of the eight unit capacities of which it is composed; so that by using the Dubilicon you will be able to select with unfailing certainty the best value of fixed capacity for any desired part of your circuit.

The Dubilicon is a multiple condenser containing eight separate units, the terminals of each unit being brought out to sockets on the lid. By using Clix plugs (made by Messrs. Autoveyors, Ltd., 84, Victoria Street, S.W.1) of which two are given with every Dubilicon, the units can be connected in a variety of series, parallel and combined series parallel arrangements giving a very large number of different capacities.

The uses and advantages of the Dubilicon, which we have summarised above, make it more than worth its low price of 30/-.

In addition, the purchase of a Dubilicon entitles you to enter for the £200 prize competition. All you have to do is to estimate the number of different capacities you can get by connecting up the first five units in various ways.

Ask your dealer about one to-day—and mind you enter for the £200 competition! He will tell you all about it!

*The  
 Dubilicon*



DUBILIER  
 REGISTERED TRADE MARK  
 → 477 ←

# DUBILIER

CONDENSER CO (1925) LTD

ADVERT. OF THE DUBILIER CONDENSER CO. (1925) LTD., DUCON WORKS,  
 VICTORIA ROAD, N. ACTON, W.3. TELEPHONE: CHISWICK 2241-2-3.  
 E.P.S. 193

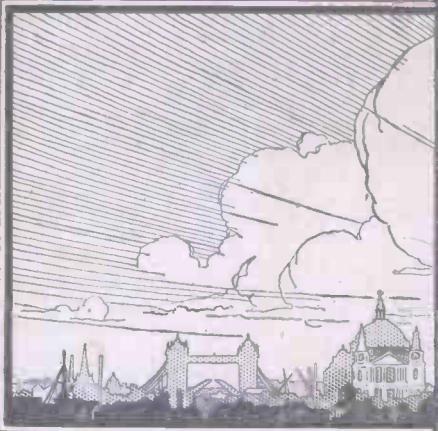

# WIRELESS

INCORPORATING

## WIRELESS WEEKLY

JOINT EDITORS

PERCY W. HARRIS

M.I.R.E.

J. H. REYNER

B.Sc.(Hons.), A.C.G.I., D.I.C., A.M.I.E.E.

ASSISTANT EDITOR

G.P. KENDALL

B.Sc.

TECHNICAL DIRECTOR

JOHN SCOTT-TAGGART

F. Inst. P., A.M.I.E.E.



## THIS WEEK'S NOTES AND NEWS

### Those "Portables"

NOW the holidays are safely over, I suppose I shall have to resign myself to the "fisherman" stories of the enthusiasts who took portable and "Portable" sets out with them. There is a subtle distinction between these two kinds of sets, as many of my readers no doubt realise by now! Actually, I look upon a holiday as a welcome opportunity to get right away from radio, so I did not take a set of any description with me. I was rewarded by seeing one party with a complete aerial up a tree, a four-valve set complete with all accessories, and three whole valves, the other being burnt out. It pays to think of such things as "spares" in other hobbies than motoring!

### Severe Critics

AS an experiment a weekly series of relays of Continental programmes will be given in June. These will take place on Tuesdays, and their continuance will depend on whether the B.B.C. considers the items broadcast by the foreign stations suitable and up to the required standard! Such is the progress of broadcasting. A little while ago Continental relays were made according to the ability of the foreign stations to pierce through the "mush" and spark interference.

### Grand Opera

THE next two operas to be relayed from Covent Garden Opera House are "The Jewels of the Madonna" (Act 2) on June 18 and "Manon" (Act 3, Scene 2) on June 28. In my opinion these relays

are steadily improving in quality, and I am really glad to see that the B.B.C. are giving us so many of them now. Each year seems to see an increase in the number of operatic performances broadcast. Is the public becoming more interested in opera?

### Co-operation

JULY 2 is "Co-operators' Day," and, if possible, a special programme

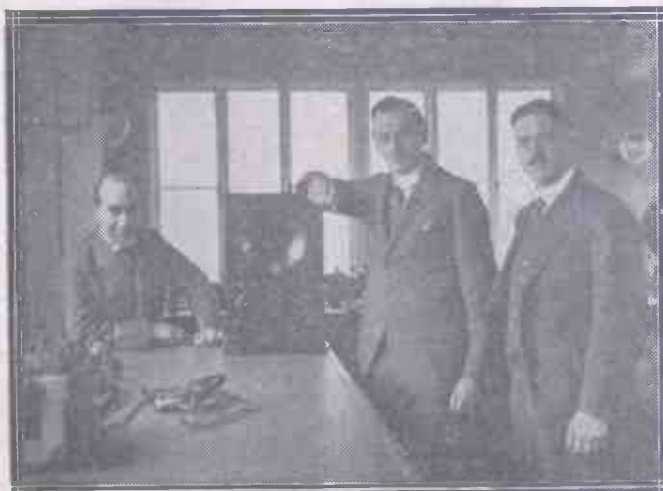

*The presentation of the first prize in Cartoonigraphs Competition No. 4, at Elstree. On the left, Mr. Josephs, Managing Director of Radio Instruments, Ltd., who provided the prize (a "Lyrianette" receiver), in the centre, the prizewinner, and on the right, Mr. Harris.*

will be broadcast from all stations. There are now four and a half million co-operators in Great Britain, and this day will be celebrated by them and their fellow co-operators in twenty different countries. Occasions like this are excellent opportunities for broadcasting to show off its "international" character to the best advantage.

### "Latest Paris Fashions"

THE latest application of the "photo-radiogram" service, I am told, is the transmission of fashion pictures to the big American "style-houses." The Americans have "dress reporters" in Paris and London constantly looking out for the appearance of new fashions, and they will now be able to "put them across" in thirty minutes or so! British advertisements have also been printed in the New York Press by radio, and a well-known dealer in autographs had an original MSS. of Browning transmitted, the copies coming back by mail for his inspection.

### The Echo Question

QUITE a little controversy is springing up about the draping of the B.B.C.'s studios. Some musicians say that it is difficult to play with true expression in a room so heavily draped, while others say that it is only in a room of that nature that the true tone of an instrument can be heard and appreciated. These say that the draping is only necessary on account of the small size of the studio, and that in a room of the size of that from which the transmissions from the Grand Hotel, Eastbourne, are made, draping is quite unnecessary.

### Messages from the Arctic

MR. FRANK R. NEILL (GI-5NJ), an Ulster transmitter, had the good fortune recently to get into communication with the s.s. *Chantier*, of the Byrd Arctic Expedition, lying in King's Bay, Spitzbergen. The operator of KEGK, which is the ship's call-sign, was anxiously awaiting news of

## This Week's Notes and News—continued

the Amundsen Arctic Expedition, with which 5NJ was, of course, able to supply him.

### Why Don't They Do It?

THE oscillator plague is now becoming so severe in some districts that the B.B.C. are mentioning names of streets in their appeals. Walthamstow is now the worst spot, and is closely followed by its neighbour, Leytonstone. Why, why don't more of the Walthamstowians and Leytonstonians read WIRELESS?

### A "Have"

THE ether never gets tired of playing practical jokes, particularly on those short-wave enthusiasts who have gone such a long way towards establishing really reliable "Trans-World" communication. Captain Wilkins, another "North Pole Adventurer," has his radio headquarters at Fairbanks, Alaska. Thousands of American and Canadian listeners have been scrutinising their condenser dials in a vain attempt to discover his signals somewhere, and have all been unsuccessful. Then comes the news that Mr. C. W. Smits (A60), of Hendrina, Trarsvaal, S. Africa, has been copying these signals ever since the transmissions commenced! One of these nights when you can't pick up Madrid's transmissions on your three-valver you will find that they have been heard in New Zealand on a crystal set!

### The Tricky Bird

THE B.B.C. are certainly unlucky with their "nightingale" broadcasts when they advertise them beforehand, but generally come off much better when they keep quiet about them and leave them as surprises for listeners. On Thursday, May 20, the attempt would have been a success had it not been for the curiosity of a motoring party who had heard the announcement and drew up to the woods without extinguishing their headlights, leaving their engine running also. This unfair competition had the effect of frightening the songsters right away from the wood. The attempt on May 22 was much more successful.

### Not the Author

WHEN the announcement was given out on Saturday, May 22, that

conductor was *not* the Arnold Bennett that they were thinking of!

### Melba's Farewell

DAME NELLIE MELBA will be remembered by most radio enthusiasts as one of the first performers at the "2-Emma-Toc-Wriddle" concerts, when listeners were counted, not by the million, but by the hundred. Her transmission was received so well in France that a phonograph record of it was made in Paris. It is therefore with doubly great regret that many will listen to her "farewell" public appearance in opera on June 8, when excerpts from her performance in "La Boheme" will be broadcast from 2LO.

### Something New

A NEW and very original broadcast is promised early next month, when the B.B.C. hope to broadcast the ceremony at the opening of the City and South London Railway extension from Clapham Common to Morden. Such intriguing noises as the throwing-in of the switches, the "right-away," and the start of the first train will probably be included. Another novelty will be the sound of the feeding of the sea-lions at the Zoo on June 12, at 6.15 p.m. The "wireless pram" will be used. This is surely only equalled by the suggestion that the soup course at the Savoy should be broadcast!

### It Might be Worse!

I HEAR that the total number of wireless licences now issued by the G.P.O. is 2,012,000. It is therefore quite true to state that the number of listeners can now be counted in millions! There are times when I curse my next-door neighbour loud and long, but I am really forced to the conclusion that things might be much worse if, for instance, I lived in Milwaukee, where 91 per cent. of the listeners use loud-speakers! American loud-speakers, too, have the reputation of being particularly raucous and unpleasing.

CALL-SIGN.

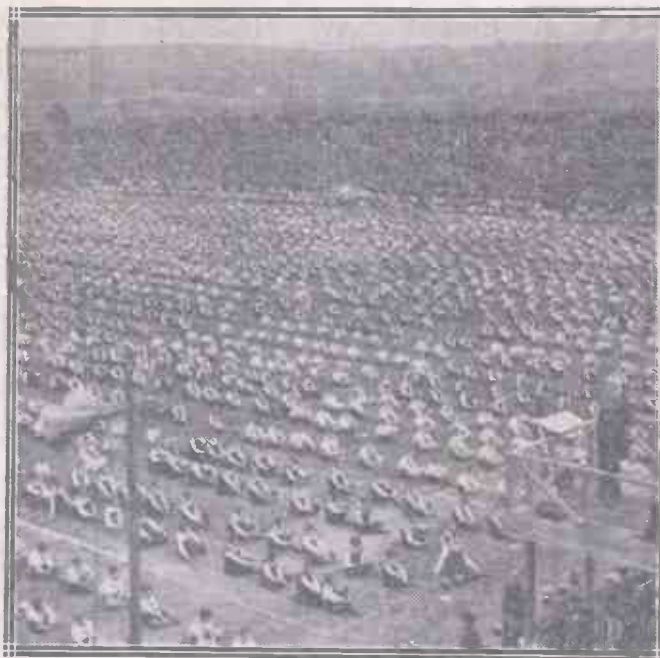

A demonstration of modern methods of physical culture was recently given by 8,500 children at Bristol. Sir Ernest Cook, D.Sc., J.P., addressed the huge audience with the assistance of Marconiphone loud-speakers.

Mr. Arnold Bennett was conducting the Minnehaha Amateur Minstrels, many admirers of the well-known

included. Another novelty will be the sound of the feeding of the sea-lions at the Zoo on June 12, at 6.15 p.m.

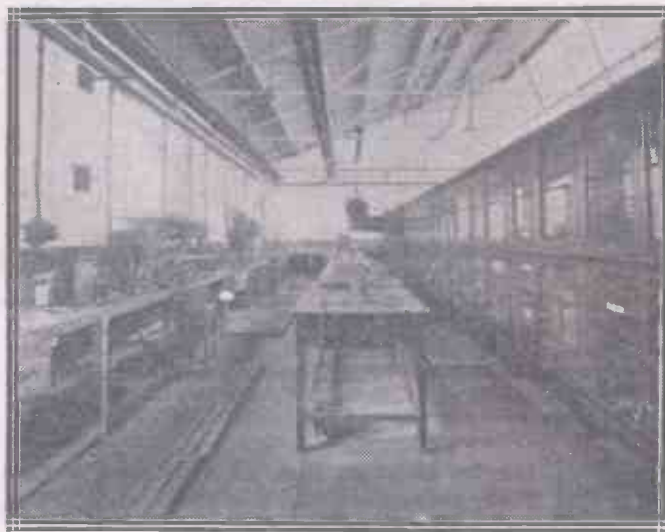

The experimental transmission section of the R.A.F. wireless establishment at Farnborough occupies very extensive premises, a part of them being seen in this view.

writer must have experienced a shock. They forgot, however, that there are probably some scores of Arnold Bennetts in this country, and that the

**NEXT WEEK.—Special Article  
by Commander Kenworthy.**

# An "All-In" Portable Set

By JOHN UNDERDOWN

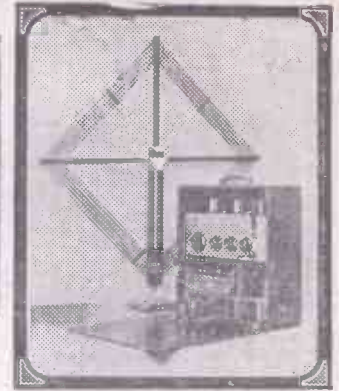

Have you yet built your portable set for this season? Here is a four-valve receiver with all the batteries inside and capable of working with a frame at moderate distances. It will receive 5XX as well as shorter wave stations.



HE receiver about to be described is a 4-valve portable one which rendered yeoman service during the recent strike, through which period it proved invaluable for receiving the latest reliable information, broadcast

there are a large number of factors which must be taken into account; firstly, should the set be self-contained? This will largely depend on the means of transport. By this I do not mean that the receiver cannot be carried, but it is certainly not an adjunct for a walking tour. Where, however, some means of transport,

## Choice of Aerials

In well-wooded country it is generally possible to erect an emergency aerial by throwing a length of insulated wire over a nearby tree, obtaining an earth connection by driving an ordinary earth tube or some substitute, such as a brass stair rod, into the soil. In open country, however, by the seaside or on the river, a frame has its advantages, and provision has been made in the receiver to utilise

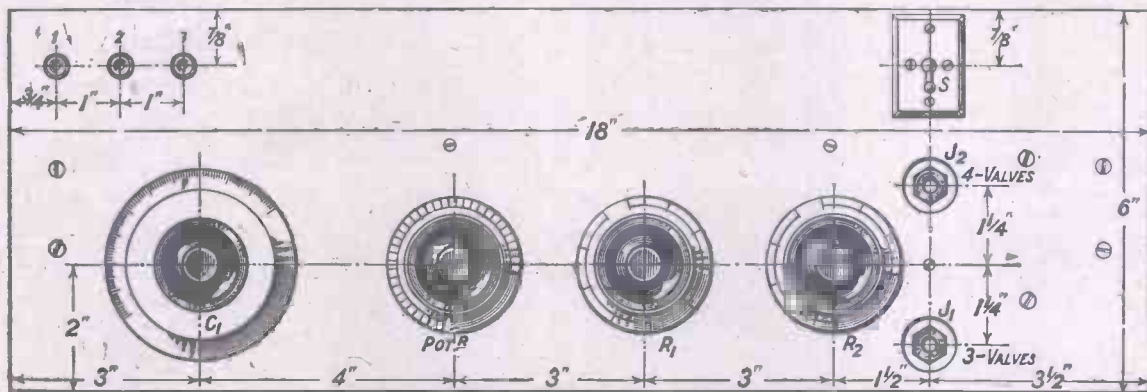

Fig. 1.—This is the lay-out of the wooden panel seen in the photo on the next page.

by the B.B.C., when otherwise nothing of the progress of events would have been known. There are a large number of people who scoff when the word "portable" is mentioned, but with the advent of dull-emitter valves,

such as a car, is available so that the receiver may be taken to within a reasonable distance from the position in which it is to be used, the set will prove a great boon.

Dull-emitter valves of the .06 ampere type, followed, perhaps, by one small-power valve taking about .12 amperes, render the employment of a comparatively small 4-volt accumulator and an H.T. battery of average size practical, and the case in which the set is housed has been designed to allow plenty of space for these accessories. It becomes possible, therefore, to connect the receiver up so that it is necessary only to connect a frame aerial, or an ordinary aerial, before the set can be put into use. This, in my opinion, is a very strong point, since I very much object to having to connect the batteries each time the programmes are required.

either a frame or an open aerial.

With frame reception the advent of the high-power broadcasting station at Daventry has made it necessary either to employ two frames, one for the 300- to 500-metre waveband and the other for 1,600 metres, or to load the smaller frame with a suitable plug-in coil. In the set it is arranged, by means of a spring clip, that the aerial coil socket into which a plug-in coil is inserted when using an open aerial provides the means of loading.

## The Circuit

The circuit of the receiver is seen in Fig. 2, and it will be observed that there are two H.F. valves, a detector and one transformer-coupled note magnifier, with provision, by means of plug and jack switching, to use only three valves if desired. Two aperiodic H.F. stages were incorporated, since their use renders it unnecessary to provide any deliberate and critically controlled means of obtaining reac-

(Continued on page 42.)

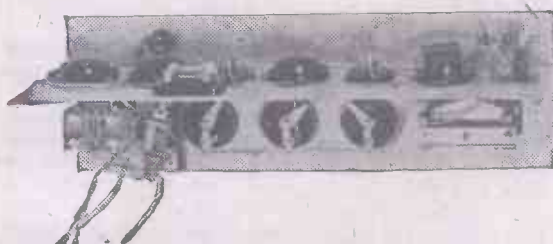

The actual set itself can be removed bodily from the cabinet.

allowing of the employment of comparatively small batteries, the proposition is a thoroughly practical one.

## Considerations in Design

When considering the "pros" and "cons" of building a portable set

tion, which would take up a large amount of much-wanted space and would render the tuning of the set somewhat more difficult than is the case with the present arrangement. All necessary reaction effects are obtained through the inherent tendency of two H.F. valves to oscillate, due to their internal self-capacity. Adequate and smooth control of reaction effects is provided by the potentiometer.

**AN "ALL-IN"  
PORTABLE SET**  
*(Continued from page 41)*

the two ends of the frame respectively to sockets 1 and 3, no coil being inserted into L1, whilst the spring clip is best left joined to socket 2.

by taking the aerial to socket 1 and utilising a suitable size of coil in the L1 position. I prefer, however, to use a Lissen X type coil here, since by so doing tuning remains largely unaltered whatever size aerial is erected.

**Overall Dimensions**

The overall dimensions of the oak case, the neat appearance of which will be appreciated from the various

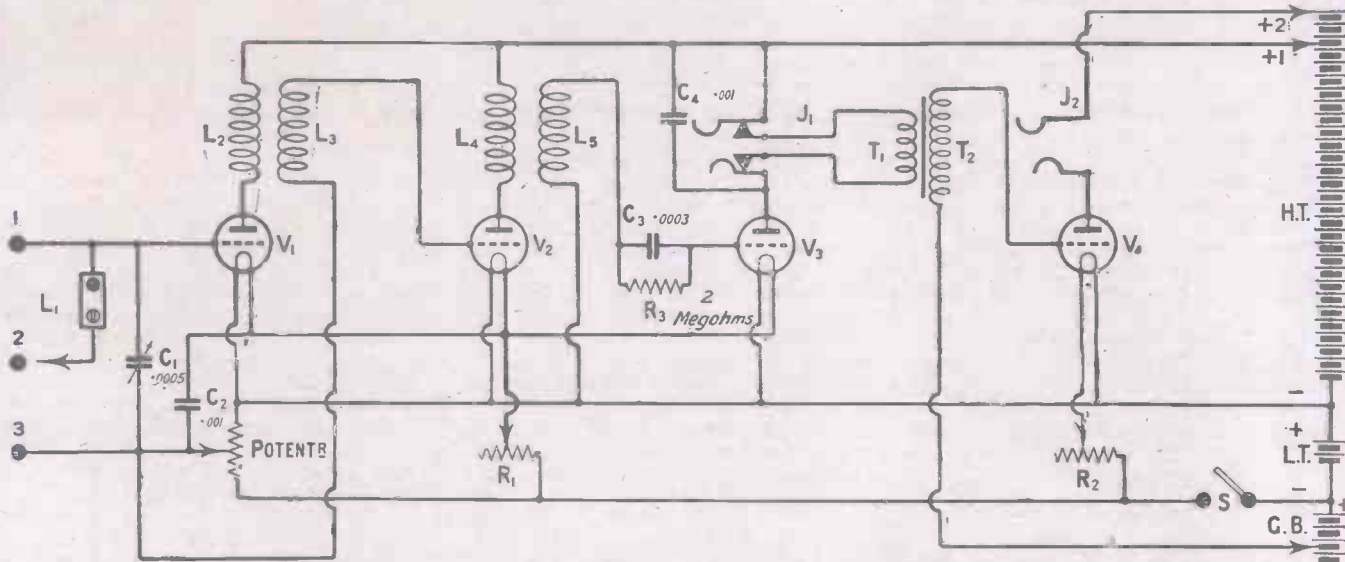

Fig. 2.—There is only one tuned circuit in the set, and it is consequently very simple to operate.

The two high-frequency valves and the detector are all run from one rheostat, necessitating that valves with similar filament rating be used here, and in practice I have found general-purpose .06 ampere valves to give most satisfactory service. A separate resistance is, however, incorporated for the note magnifier, so that a small power valve of 3- or 4-volt type and economical filament consumption can be utilised. Such valves as the Mulard P.M.4, which works on a filament voltage of 3.8, taking approximately .1 amperes, or the B.T.H. B.6, Ediswan P.V.8 D.E., etc., requiring three volts and taking .12 amperes, prove satisfactory for the note magnifier position.

**Aerial Sockets**

Three Clix sockets are arranged on the front panel of the set, numbered from 1 to 3, 2 being a blank socket. L1 is the aerial coil socket into which a Lissen X coil is inserted when using an open aerial or when loading the frame. The arrow-head from the plug of the L1 coil block (see Fig. 2) represents a spring clip, which, when an aerial coil is inserted into L1, is joined to 3, as seen in the photographs. In this case the aerial is taken directly to one of the side terminals on the Lissen X coil and the earth lead is plugged into socket 3. Frame reception, on the lower broadcast waveband, is effected by joining

**Daventry**

Daventry is received by loading the L1 coil socket with a number 250 coil, and here I use a number 250X, which



*The set can be used with an ordinary aerial and earth if desired.*

also functions with an open aerial. The frame, in this case, is plugged into sockets 2 and 3, whilst the spring clip is joined to socket 2. Plain parallel tuning may be employed, of course,

photographs, are 18 in. high, 18½ in. wide and 7 in. from back to front. The front of the cabinet opens, and the door is hinged at 8 in. from the bottom so that the tuning controls are all exposed when the set is in operation. For lightness, the panel on which the tuning controls are located, and also the platform upon which the valves, transformer, coil holders, etc., are mounted, are made of 3/16th inch oak ply-wood, the platform being fixed into position by means of two small aluminium brackets and a piece of ½-in. square section wood, which is bradded to the platform and is screwed to the front panel when the latter is fixed in position. Ample rigidity is thus obtained, whilst the weight is kept low.

The three Clix sockets seen to the left-hand side of the panel correspond to the sockets 1, 2 and 3 of the theoretical circuit diagram. Below these is located the aerial tuning condenser, which, with the exception of some adjustment of the potentiometer, is the only tuning control. Reading from left to right, and in line with the aerial condenser, will be seen the potentiometer and the rheostats for the first three and the last valves respectively. The two jacks, permitting of the employment of three or four valves at will, are placed directly under the filament "on and off" switch, to the right-hand side of the panel. The upper of the jacks is

*(Continued on page 43.)*



that in the plate circuit of the note magnifier, whilst the lower is in the plate circuit of the detector valve.

### The Components

For the benefit of the reader who wishes to construct the receiver exactly as shown in the photographs and diagrams, a list of the components used therein is given below. It is not, of course, necessary to duplicate exactly these parts, provided others of good quality are to hand, but I would not advise that any component which would make it necessary radically to alter the layout be incorporated.

One oak cabinet with carrying handle (Carrington Mfg. Co., Ltd.).

Two pieces of 3/16th-inch thick oak-ply wood 18 in. long, by 6 and 4½ in. wide respectively.

One .0005 "Popular" variable condenser (Bowyer-Lowe Co., Ltd.).

One potentiometer.

Two dual rheostats (both L. McMichael, Ltd.).

One double-circuit jack.

One single-circuit jack (both Igranie Electric Co., Ltd.).

One Connecticut "on and off" filament switch (the Rothermel Radio Corporation of Great Britain, Ltd.).

## AN "ALL-IN" PORTABLE SET

(Continued from page 42)

One .001 fixed condenser (Ingranie Electric Co., Ltd.).

One "Therla" .001 fixed condenser (the Electrical Research Laboratories).

One "Magnum" fixed coil holder.

Two small aluminium brackets (both Burne-Jones and Co., Ltd.).

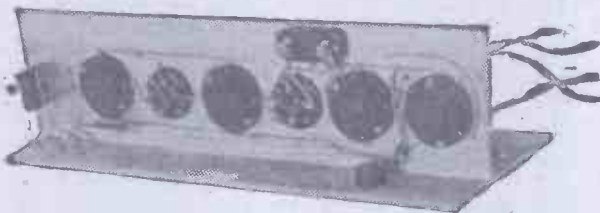

Shock-absorbing valve holders are used and all the parts are mounted on wooden panels.

One strip of ebonite, roughly 4 in. by 1 in. by ¼ in. thick.

One spring clip (Peto-Scott Co., Ltd.).

Three Clix sockets with insulating bushes (Autoveyors, Ltd.).

Two Clix plugs (Autoveyors, Ltd.).

A quantity of 18 or 20 gauge tinned copper wire, insulating sleeving,

paratively simple matter to mount the rheostats and condenser, since these are of one-hole fixing type. The valve holders, into which the valves and H.F. transformers are inserted, are fixed to the platform by means of two wood screws only. The positions in which to place these will be determined by reference to the photographs and wiring diagram. The L.F. transformer is mounted sideways, being screwed to the main panel by means of two 4BA screws and nuts. The two jacks are mounted on the small ebonite strip in the component list mentioned, and sufficiently large holes are drilled in the panel to provide adequate clearance.

### Wiring

The wiring of the set is extremely simple in nature, and is carried out mainly with 18- or 20-gauge tinned copper wire, insulated sleeving being used

where leads go through the platform to the rheostats, transformer, etc. The positions for the necessary holes through the platform should be determined when wiring is actually in progress, in order that the most convenient positions for the holes may be chosen. Little difficulty should be experienced here, but a fairly hot

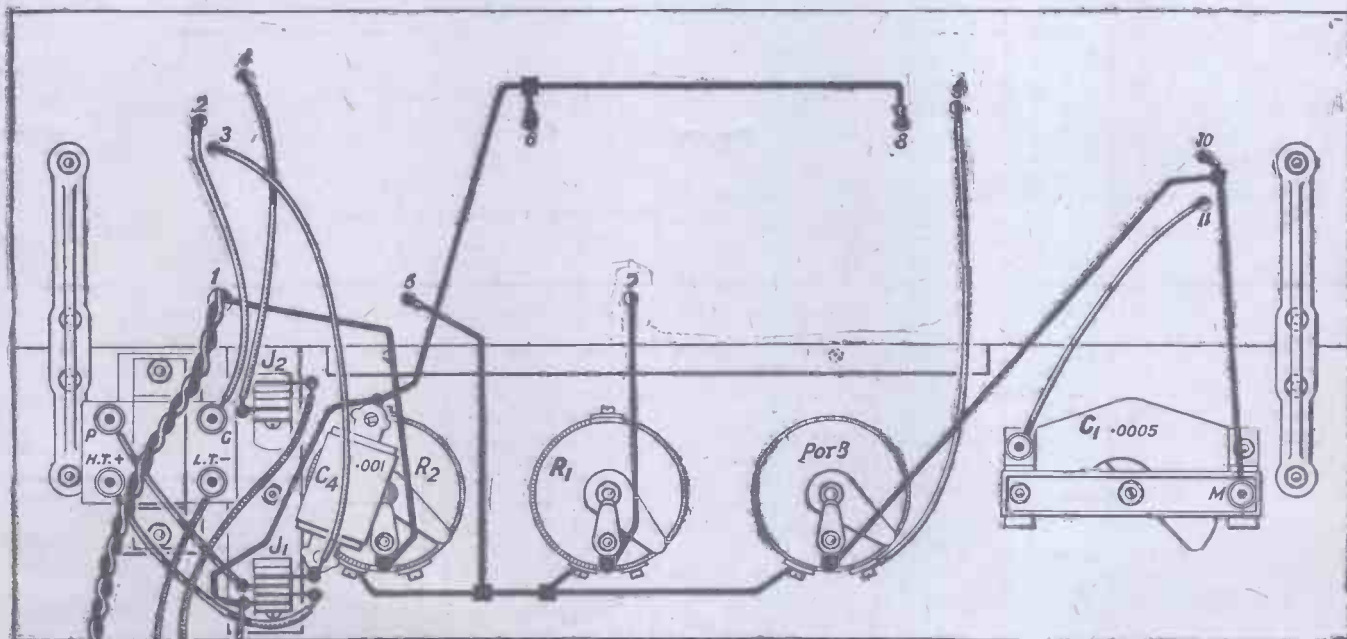

Fig. 3.—This diagram gives the wiring of the underside of the shelf and the lower part of the vertical panel.

H.T.-  
L.T.+  
L.T.-  
C.B.+ C.B.-  
H.T.+2

Four "Lotus" anti-microphonic valve holders (Garnett, Whiteley and Co., Ltd.).

Two "Magnum" ordinary valve holders (Burne-Jones and Co., Ltd.).

One 3 to 1 ratio L.F. transformer (Brandes, Ltd.).

One type 610 .0003 fixed condenser and 2 megohm grid leak (Dubilier Condenser Co., Ltd.).

rubber-covered flex, and red and black twin flex, screws, etc.

### Constructional Work

The main panel, upon which the condenser and rheostats, etc., are mounted should be drilled, by reference to the drilling diagram, before the platform is fixed in position. Once this is done it will be found a com-

soldering iron should be employed in order that sound joints may result.

It will be observed that twin flex leads are used to connect to the L.T. battery, but that there are only three ordinary rubber-covered leads from the wiring proper. These are for grid bias negative, and the two H.T. positive supplies. The leads to grid bias posi-

(Continued on page 44.)

tive and to H.T. negative are taken respectively from the negative and positive terminals of the low-tension accumulator.

### Accessories Required

If you intend to employ the receiver both for reception on the lower broadcast waveband and on 1,600 metres two sets of resistance-wound transformers will be required, and here I have used both Curtis "Constant-Tune" and Magnum "Aperiodic" types with success. With the "Constant-Tune" transformers, two for the 250- to 800-metre range and two for 800 to 3,000 metres will be required, whilst in Magnum types two Nos. 1 and two Nos. 3 are necessary. In conjunction with these transformers a Lissen '50 or 60X coil will be required for the 300- to 500-metre waveband, whilst for Daventry a number 250X is necessary. This latter coil may be employed in conjunction with a small frame, for loading purposes, in order to receive on 1,600 metres.

## AN "ALL-IN" PORTABLE SET

(Continued from page 43)

of all space available, I have arranged a sliding shelf, as seen in the heading, on which the H.T. battery stands, and under which spare coils, H.F. transformers, or a pair of telephones may be placed.

### Preliminary Tests

For a preliminary test it is best to try the receiver outside the case. With the filament switch in the "on" position and only the L.T. battery connected, a valve, preferably of bright-emitter type, should be inserted into each valve socket in turn, to observe whether the filament resistances control properly. Next insert the appropriate H.F. transformers and valves into their respective sockets, and a suitable coil in the aerial coil socket, whilst taking

aerial condenser, when the local station should be received at good strength. Bringing the potentiometer over towards its negative end should result in the set going into oscillation, and working just below this point maximum signal strength should be obtained.

If your preliminary test is carried out on a frame aerial this should be connected as previously explained, and it should be oriented so as to obtain maximum signal strength.

### Results

The receiver was first put into operation at the beginning of the strike, and has been in continual use since, both on an outside aerial of average dimensions and on a "Success" frame. On this latter, at twelve miles south-east of 2LO, both that station and 5XX give adequate loud-speaker strength for an ordinary room. On the outside aerial a large number of British and Continental stations can be obtained at loud-speaker strength,

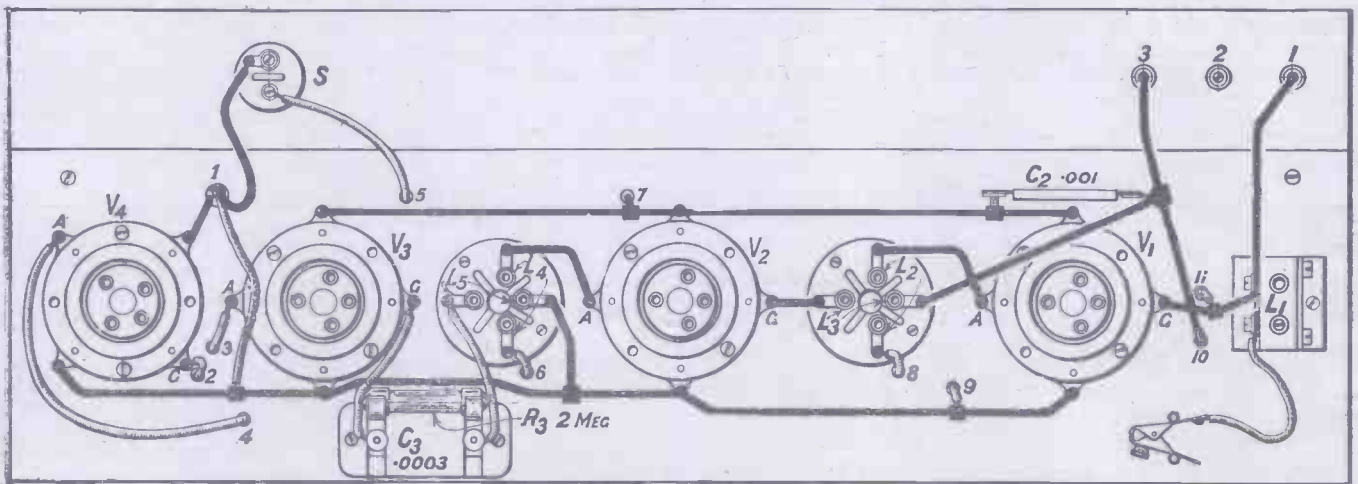

Fig. 4.—The wiring-up of the upper side of the shelf completes the set.

Where a frame aerial will be employed, one of a readily portable type is necessary, and here I have used that illustrated in the heading, which is made by Messrs. Beard and Fitch, Ltd.

### Batteries

With the types of valves previously mentioned a 72-volt or 108-volt ordinary H.T. battery proves suitable, and the H.F. and detector tapping should be taken to a voltage of the order of 60 to 70 volts, whilst on the note magnifier the full voltage of the battery should be used. A small grid-bias battery of 6 or 9 volts, tapped in  $1\frac{1}{2}$  steps, will be required for grid-bias purposes.

For the L.T. supply I prefer to use a small 4-volt accumulator such as the Oldham portable non-spill type, which has a capacity of 10 ampere hours actual. Two of these cells give a satisfactory length of service with the valves previously mentioned, and will be found to take up but little room. In order, however, to make the most

a lead from low-tension positive to the negative terminal of the H.T. battery.

Join the two positive terminals, + 1 and + 2, together, and with the telephones inserted into the upper jack, that is, the one for four valves, tap the combined H.T. leads into a low voltage socket of the H.T. battery, six volts being suitable, and if all appears correct the H.T. voltages may be correctly adjusted and the grid-bias battery may be connected up. For grid bias a 6- or 9-volt battery will be required, and its positive terminal should be joined to the negative terminal of the low-tension accumulator. Grid-bias negative, that is, the lead from the terminal of the L.F. transformer marked "L.T. —," should be taken to the  $4\frac{1}{2}$ -volt tapping in the battery.

Join the aerial to one of the side terminals on the Lissen X coil in the L1 socket and plug the earth into socket 3 on the front of the panel. With the potentiometer set at somewhere about midway between positive and negative, proceed to tune on the

when a wavetrap is employed to cut out the local station. Full operating details and a complete test report will be given next week.

## USING UP OLD SOLDER

The innumerable chips and globules of solder which collect on the work-bench due to "waste" in soldering should be carefully collected and placed in a tin for future use. When a fair quantity of this waste solder has been acquired it should be melted down in an iron pot or ladle and any dirt or scum which rises to the surface skimmed off with an old knife or other metal object.

A mould should previously have been prepared by cutting semi-circular or square-section grooves in an old piece of wood, the ends being blocked up with wooden plugs. The molten metal can be cast into sticks by pouring it into the grooves. P. H. W.

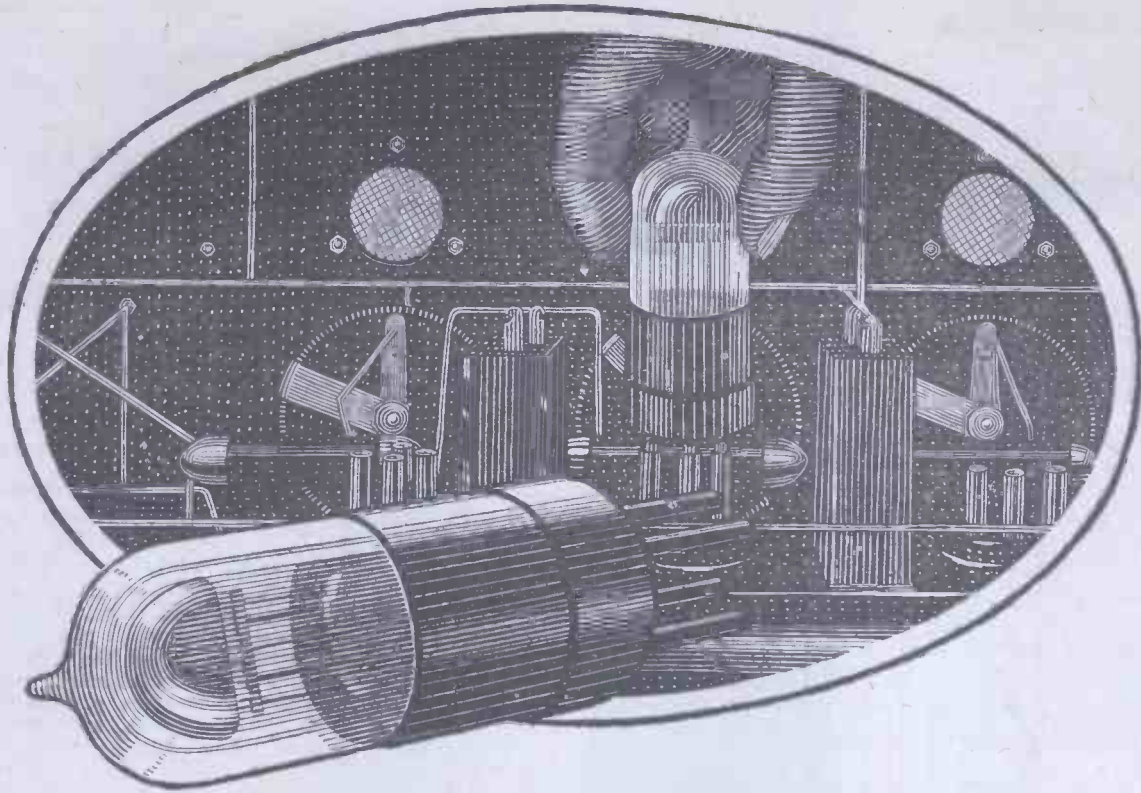

## “Mellowed by the stealing hours of Time”

**F**UNDAMENTALLY there is a great gulf between the Wuncell and other Dull Emitter valves. For in the Wuncell there is utilised a filament which actually improves with use. A filament which is built up layer upon layer until it is practically as stout as that used in a bright emitter valve. A filament, moreover, which successfully functions at a temperature glow which is almost invisible.

After all, the cost of a valve depends not merely on what you pay for it—the length of service you obtain determines whether that valve has been cheap or expensive. Measured on that basis, the Wuncell valve is by far the most economical Dull Emitter that can be bought—because it lasts longer.

Heat is the great destructive influence which brings most valves to an untimely end. In the ordinary Dull Emitter low current consumption has been obtained by whittling down the diameter of the filament almost to the point of fragility. But the

temperature at which that filament is operated is still very little less than that used in the average bright emitter. And so inevitably there is a tremendous stretching and contracting every time the current is switched on which finds the first weak spot and culminates in a fracture.

Quite apart from the technical superiority of the Cossor design—the electron-retaining Grid and Anode system—which is freely admitted, the Wuncell filament offers you three distinct advantages. An unusual robustness which precludes the possibility of early burn-out. A rigidity—due to its unique three-point suspension—which entirely eliminates microphonic noises.

And, finally, a prolific emission of electrons which tends to increase as the valve becomes mellowed by use. Truly the Wuncell sets a new and higher standard in valve economy. The moment you use one you will appreciate its outstanding merit.

### Types and Prices:

- \*W. 1. For Detector and L.F. use - 14/-  
1.8 Volts. Consumption: .3 amps.
- \*W. 2. (With red top) for H.F. use 14/-  
1.8 Volts. Consumption .3 amps.
- W. 3. The Loud Speaker Valve - 18/6  
1.8 Volts. Consumption .5 amps.

\*Also in special base with resistance to suit 2, 4- or 6-volt Accumulator 16/-

# Cossor Valves

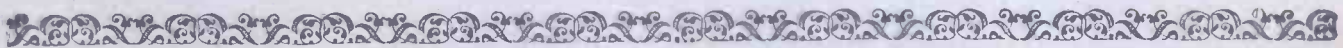



## “It was Working Perfectly Before You Came!”

By A TEST-ROOM ASSISTANT

Some very helpful instructions for dealing with a painful situation—

**T**HERE must be very few owners of wireless sets who have never had an experience of that situation which has been so exploited by the wireless humorist, in which a newly-completed set plays that low trick of refusing to work directly some friends arrive to hear it. It may have been working perfectly half-an-hour before, and yet upon being switched on once more utter silence reigns.

### A Common Misfortune

This is a misfortune which is liable to happen even to the expert, but it seems most often to fall to the lot of the comparative beginner, and it is for his benefit that these notes are being written, in the hopes of showing him the most likely faults which develop in the course of half-an-hour or so while the set is standing idle, in order that next time such a thing should happen, he may have the satisfaction of giving his friends a demonstration of successful and rapid fault-finding in addition to a proof of the powers of his set.

Now it seems probable that at least nine times out of ten it is not a real fault which has developed at all, but rather that a slip has been made in bringing the set into operation after it has been standing idle for a while, and we will just run over some of the likely things which may be forgotten or wrongly adjusted at such a time.

### The First Step

In the first place, whenever a set refuses to function for no apparent reason, go straight to the earthing switch and see that the aerial is really connected to the set and is not simply earthed. While you are about it, pull the switch out and replace it once or twice, to make sure that it is really making proper contact. At the same time, it may be wise to give the aerial and earth wires a pull to see that they are properly fastened to the switch.

Having satisfied yourself that the aerial is really attached to the set, look inside and see that each valve is lighting up to the correct brilliancy. This is a particularly tricky point in sets which are not provided with on-and-off switches, so that the valves have to be turned on and off by means of their rheostats. It is quite an easy

matter to forget what sort of valve is in use, and with a dual rheostat to turn it on just far enough for a .06 valve, when actually one of the bright-emitter type is in use. Nothing, of course, would be heard.

### Look at the H.T.

Having made sure that all the valves are lighting properly, take a look at the H.T. battery and see that none of the plugs have jumped out of their sockets. If they are all in place, pull them out one by one, replacing them in the same way, noting whether a good click is heard as each one is inserted into the battery. (In doing this, of course, the

and the next step may well be to take a spare valve and insert it in turn in each socket of the set, with a view to discovering the defective one.

### The Interchangeable Units

Having made sure that all the valves are O.K., pull all the interchangeable coils from their sockets, open out their split pins slightly and the split pins of the sockets upon which they are mounted, and replace them. The same proceeding should be adopted with any other interchangeable plug-in units, such as plug-in transformers, all through the set, and if by the time you have done all these things the set still does not work, one must regretfully conclude that some real fault has developed, and the usual systematic methods of testing should be adopted.

Just as an afterthought, make sure at this point that you have the correct sizes of coils and transformers in use for the wavelength you want.

## AT RUGBY

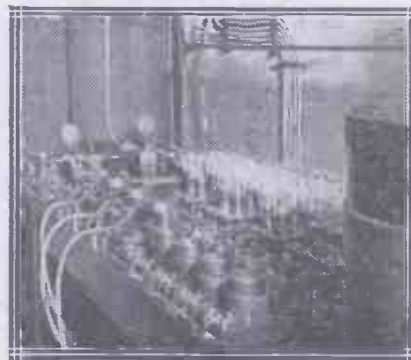

*In the old days even the most powerful stations used hand tapping keys for signalling, whereas most modern stations are equipped with automatic keys. The photograph shows the “Creed” key and pilot keys at the giant new station at Hillmorton.*

first plug to be replaced should be that which feeds the last valve, the plugs being inserted in the order of the valves in the set, counting from the last one back to the first.)

By this time you are almost certain to have found the alleged fault, but if it should continue to trouble you, there are still a number of possibilities of things which may possibly have developed while the set was standing idle. In the first place, a valve may have developed a defect, although it is not one of the most likely things,

## LACQUERING

Everyone is familiar with the tarnished appearance which the brass terminals and screwheads on a home-made set assume after even brief exposure to the conditions under which they are normally used.

This trouble is, of course, overcome in commercial receivers by subjecting all brass parts which will be visible to a process known as “lacquering.”

In effect this is to cover the metal with a thin veneer of an almost transparent varnish, giving the treated metal a yellowish brown tinge with which most of us are familiar.

Lacquering, in the ordinary sense of the word, is essentially an art, and few but professionals can obtain the desired results. Quite within the ability of the amateur, however, is the following alternative.

A very weak solution of flaked shellac in methylated spirit is procured, together with a small soft brush.

The brass to be treated is brightly polished, and the varnish previously prepared is applied rapidly and evenly, to it.

L. O'N.

# WHAT THE FUTURE HAS IN STORE

IMPORTANT ARTICLE ON THE FUTURE OF RADIO

BY JOHN SCOTT-TAGGART

## GREAT DEVELOPMENTS COMING

### AMERICAN DESIGNS ALREADY SURPASSED

These are times of rapid progress in wireless development; much has been done in the last few months, and radical changes are expected in the 1926-1927 season.

The first work undertaken at the "Wireless" laboratories at Elstree was to make a searching investigation into the problems of securing really efficient high-frequency amplification, and we are now beginning to reap the result. Parasitic oscillations are being eliminated, screened coils developed, circuits improved, and designs produced embodying the latest developments.

Mr. Scott-Taggart is strongly convinced that never before has the technical future of radio been so promising. High selectivity, a choice of stations, freedom from radiation, and volume on distant stations are now within the reach of everyone. Much interest attaches to the question of the possibilities of reflex and superheterodyne circuits, and the author commences this week the discussion of these points.

**T**O-DAY we have not merely equalled but beaten the world's best radio design. I use the word "to-day" almost literally. In the commercial world we have recently seen produced American receivers which have marked a distinct step in radio progress. This has been the result of concentrated efforts on the part of American designers on the lines of neutralised circuits (which have commonly been described as "neutrodyne" circuits, although this is a protective trade mark applying only to certain commercial products).

#### The Value of Neutralising

What have we been doing in this country? Although there are exceptions, the manufacturing trade in this country has lost sight of neutralised circuits. The great value of neutralising in wireless receivers was, however, appreciated by myself as long ago as three years back. The weakest point, as I have pointed out on numerous occasions, in the modern wireless receiver is the high-frequency amplification section. Improving detection has almost been given up as a bad job, whereas low-frequency amplification cannot well be perfected much more.

#### The First Step at Elstree

Realising the great weakness of modern methods of high-frequency amplification, the first work given to the Elstree Laboratories, situated 12 miles north of London, and established for the exclusive benefit of the journals published by Radio Press, Ltd., was the full investigation of all possible methods of high-frequency amplification, using two or more valves. The results during the last six months have

been astonishing—circuits which for the last ten years have been regarded as the best possible are relegated to the dust heap. What, then, is the future set to be like? What are we going to do in the coming year as regards radio designs?

#### What is to Come

My reply is that our whole attitude towards radio receivers is going to be altered. We are going to get real

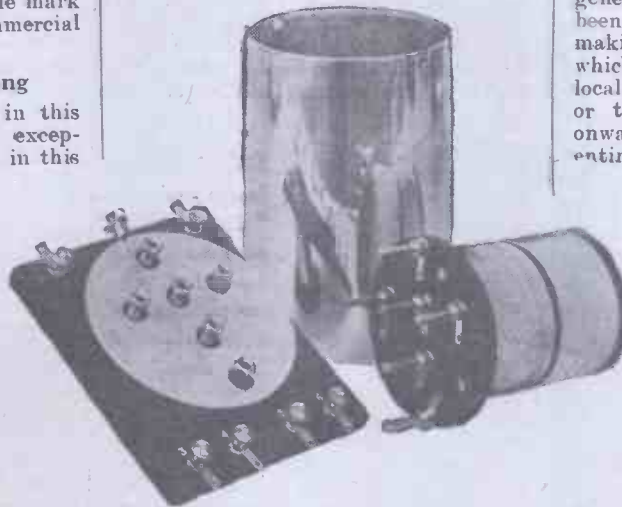

*One of the most interesting developments which is taking place concerns the use of screened coils, which permit high selectivity and stability.*

high-frequency amplification; we are going to cut out oscillation to a very large extent; we are going to bring in stations on the loud-speaker which formerly were inaudible on the telephones; we are going to be able to have a receiver almost next door to a broadcasting station and be able to pick up numerous other stations without the slightest interference. All this

will be accomplished without the erection of a series of high-power stations dotted about the country. If this programme is carried through rapidly, so that we get at least some of its advantages in the autumn, an extraordinary revival of interest is bound to occur.

#### Bright Prospects

Never was I so technically enthusiastic as I am at the present day regarding the technical future of radio. If you had asked me twelve months ago, I should have been tempted to say, "be contented with your local station, Daventry, and perhaps one other station." I admit I have been a pessimist, because I did not see how simplified designs could be made, so as to be readily handled by all. It was a very different matter producing circuits which experts could handle, and turning those same circuits into designs which the absolute beginner could build with confidence. I now feel that selectivity and long range is not the prerogative of the expert, but is within reach of every constructor, particularly the one who will build a set using from three to six valves.

#### Simplicity of Neutralising

Neutralised circuits to operate efficiently were regarded as almost a manufacturer's job. Nothing is further from the actual fact. We are simplifying these circuits (or rather the construction of them) every month, and the improvement in many components over those sold two years ago makes it as easy for a home constructor to produce a good set as a manufacturer.

A year ago the home constructor, in general, thought that a stage had not been reached when it was worth while making any alteration to a receiver which gave him good results from the local station, and if he was lucky one or two other stations. From now onwards, however, the position will be entirely changed. The new order of affairs has been demonstrated by the publication of details of the "Elstree Six" receiver in the June issue of *Modern Wireless*. This receiver uses three stages of high-frequency amplification, a detector valve and two stages of low-frequency amplification.

In my experience no receiver of such outstanding merit has yet been produced in this country—a statement which I may make with a full sense of responsibility. During a test in daylight at Elstree, over sixty stations were received within an hour,

every one of them on the loud-speaker! We all used to make statements about the number of stations which a receiver can obtain, but these results obtained in daylight conditions have been demonstrated to members of the trade, the Press and the public. For example, a lecture was given at Bradford by Mr. Barton-Chapple, a mem-

*(Continued on page 48.)*

## What the Future Has in Store—continued

ber of the staff of this paper, and results of this kind were practically demonstrated to a very large audience with the set, the Leeds-Bradford station only 200 yards away working all the time!

### A Great Demonstration

So anxious are the Radio Press to demonstrate this receiver that they are inviting 500 of their readers from different parts of the country to inspect the set in actual operation and hear the results themselves. The list of stations and dial readings has been given, and we are anxious to have the receiver compared side by side with any other apparatus in this country.

Six valves may seem to be a lot, but the vast amount of research work carried out by our engineers at Elstree has resulted in a development of a number of new circuits and a great amount of information on designs which will enable us to publish details of receivers using different numbers of valves, all giving a much greater range, volume and selectivity than a similar number of valves gave during the past year. These new receivers will be demonstrated as fully as the public may require, in order to substantiate the claims made.

### How Many Valves?

One question you will ask is: "Are we going to stop at, say, three valves?" Personally, I feel that apart from reflex circuits, the tendency will be to increase the number of valves used and also to go over to loud-speaker reception. It is a matter of

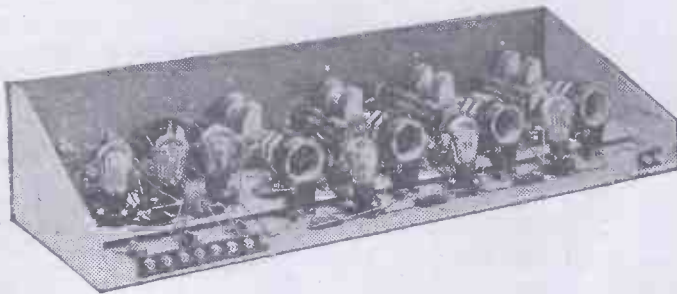

*This view of the inside of the "Elstree Six" shows the special arrangement of coils which it uses.*

considerable surprise to me that so many people still use telephone receivers with valve sets. It is almost like listening to a gramophone with telephones on your head—who would ever dream of doing such a thing? Telephones, of course, are very convenient for special cases when only certain members of the household desire to listen. Apart from such circumstances, however, there is no reason, except a financial one, why households should not go in for loud-speakers; some models are particularly cheap, and there is really no excuse why anyone should be without.

The biggest argument against build-

ing a multi-valve set in the past has been that the average multi-valve set has hitherto not given a proportionately better result than a set using, say, two or three valves. Some people still contend that you get as much on a single valve as on a five-valve set.

*Despite its wonderful capabilities the "Elstree Six" is outwardly a very simple-looking set.*

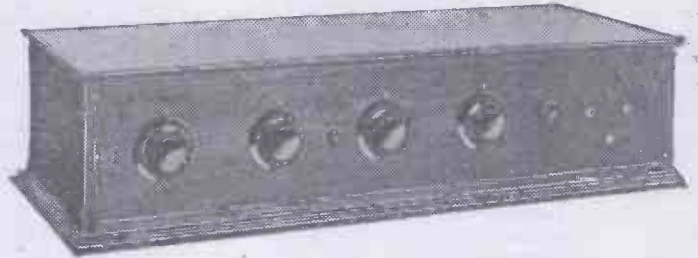

Let me assure them that although there has always been a modicum of the truth in such an assertion hitherto, yet such a statement is now completely wrong.

### The Probable Standard

We have at last learned how to get value out of each valve we employ, and as we get greater selectivity by using two or three stages of high-frequency amplification without loss of signal strength, there is every inducement to build a receiver using, say, five valves, which I believe is likely to become a very definite standard. In America, everybody uses five-valve receivers, and the idea of using a two- or three-valve set would seem ludicrous to the average citizen of the

essentially a "de luxe" receiver. It will give in broad daylight everything that is receivable, and give it on the loud-speaker. Those who are not ambitious will probably not require to receive insignificant stations working on about 100 watts in almost unknown

parts of Europe. For these, the new season will provide sets giving the utmost efficiency.

### Special Components

I would like to take this opportunity of commending to your notice those manufacturing firms who are following up the work of the Radio Press by producing coils, condensers, etc., suitable for new designs. It is our intention in the future to publish constructional designs which will enable you to use existing apparatus to the best effect, but you must not imagine that it is possible to obtain the highest pitch of efficiency by using apparatus which is becoming obsolete. Radio Press hope that more and more firms will follow up the work we are doing. The technical services of the Company are at the disposal of any firms which desire to keep in close touch with the progress we are making.

### A Warning

It is only right that I should warn you that our experiments have brought right into the open certain problems which were only rarely if ever mentioned hitherto; for example, the words "direct pick-up," were almost unknown in a wireless periodical twelve months ago. Now, hardly a Radio Press journal may be picked up without seeing some reference to this phenomenon and its effect on selectivity. Shielded coils, such as those developed as a result of some very able research work undertaken by Mr. J. H. Reyner, a joint editor of this paper, were almost unknown to the home constructor.

Who amongst the broad public had ever heard of the "parasitic oscillations" in neutralised receivers before the Radio Press announced it in their journals? Hundreds of neutralised sets have been designed in the past, and this also includes Radio Press re-

*(Continued on page 49.)*

United States. American receivers are admittedly cheap, but I think that British manufacturers will, this autumn, give the utmost encouragement to the use of multi-valve sets.

You builders of three-valve sets can get good loud-speaker results, because you are satisfied with good results from Daventry and your local station; but you will be astounded when you find that you can get perfect loud-speaker results on five valves from a large number of stations using some of the new developments which have been evolved by our Laboratories at Elstree. The "Elstree Six" is going to be extremely popular, because it is

## What the Future Has in Store—cont.

ceivers, which have included the hidden defect which produces the mysterious parasitic oscillations. These parasitic oscillations have been investigated to the full by our Elstree Laboratories, and methods of preventing it have been published in our journals. It is no exaggeration to say that the discovery and means of killing this hidden germ in high-frequency amplification has revolutionised radio reception. Screening is going to revolutionise selectivity.

### Advances to Come

Others, no doubt, will make use of some of the results obtained at Elstree, but the main thing of importance is not to permit one firm of publishers to benefit, but for the whole science and industry of radio to advance, and it is my confident opinion that we have now taken the first step towards this advance. It will, however, be necessary to prove that definite advances have been made. There has in the past been a tendency to introduce stunts into radio; irresponsible newspapers gave rubbishy descriptions of loud-speaker crystal sets. The wireless public is generally rather chary of accepting statements on their face value regarding what receivers will do. It may consequently be a little difficult to convince the public who are unaware of the biggest advances in technique which have been made, and it is for this reason that we propose to publish designs at once rather than to wait until the autumn. The building of hundreds of sets such as the "Elstree Six" will rapidly disseminate an entirely new idea of what a wireless receiver should do. Any suggestions from readers as to the demonstration of these sets, or other methods for giving convincing evidence of their efficiency, will be welcomed, I know, by the Joint Editors of this paper.

### The Place of the Superheterodyne

"What is the future of the superheterodyne?" This, I know, is a question which many would like to ask me. My impulse is to say that for the moment a "straight" circuit on an open aerial will beat a superheterodyne for absence of mush, purity of reproduction and selectivity. The "Elstree Six" is open to receive any competition from a superheterodyne. Whether this will always remain so is not certain, and for certain purposes the "super" will possess certain advantages.

It must not be forgotten, however, that a superheterodyne is never a really direct competitor of a "straight" circuit because it would be a simple matter to add a superheterodyne attachment at the end of the three high-frequency stages, which are the outstanding feature of the "Elstree Six." For the time being at any rate, I believe the superheterodyne will be eclipsed. A competition between "straight" circuits and superheterodynes is rather like that between battleship armour and the projectile which is to pierce it. An improved shell brings about an improvement in defensive armour, and this in turn usually spurs the shell manufacturer to produce a projectile which will pierce the improved armour plating.



Many of the relay stations are acquiring studios of quite a main-station standard of size and artistic finish, as this view of Nottingham attests.

### Future Articles

"What of reflex circuits?" This is an extraordinarily interesting problem entirely on its own. The third article of this series will deal entirely with the question of reflex circuits in the light of our Elstree developments. I believe that some of my views will cause a great deal of surprise in some circles.

In my article next week I propose to deal with some of the preliminary work which has culminated in the "Elstree Six," and it will be illustrated by a circuit which will help to explain some of the problems and how they were overcome.

**The "Elstree Six"**  
Have you got your copy of the June number of "Modern Wireless?"  
**One Shilling.**

## CORRESPONDENCE

### More About Short Waves

SIR,—I think the first issue of WIRELESS, incorporating WIRELESS WEEKLY, a really splendid production.

In future issues, however, I should be pleased to see more articles dealing with short-wave reception and transmission, with, perhaps, occasionally full constructional details for building receivers for these waves.—Yours faithfully,  
Belfast. L. F. CHANDLE.

### Charged Rain

SIR,—Although the effect upon reception of a shower of charged rain falling on the receiving aerial is quite well known, I do not know whether its effect upon transmission is generally realised. Recently, during a slight local storm, I was in communication with a station in Ireland, when suddenly a sharp shower of rain and hail, apparently heavily charged, caused such an enormous din in the 'phones that I had to earth the outdoor aerial and receive the other station without an aerial.

When he had finished I changed the aerial over to the transmitter and replied as usual. To my surprise the other station reported that my note, previously pure D.C., was now modulated by an irregular musical hum.

Changing the aerial over to the receiver I found that the rain was falling so violently that the effect in the 'phones, instead of the usual rattle, was very similar to a powerful spark station. Clearly the charged rain was responsible for the modulation of my C.W. signal. Has any other transmitter noticed this or a similar effect? If so, I should be glad to exchange notes with him.—Yours faithfully,

L. H. THOMAS (G-6QB).  
West Norwood, London.

### Leyton Radio Association

SIR,—There have been some remarks in the evening Press lately regarding oscillation nuisance, and Leytonstone has been mentioned. The information of our change of address may therefore be of interest to your readers in the district.

The Leyton Radio Association have now removed their headquarters to 683, High Road, Leytonstone, E.11, and will in future be known as the Leyton and Leytonstone Radio Association.

The more the public understand the working of receivers, the less the oscillation nuisance should become; therefore those in the locality interested in wireless are invited to give their support.

Prospective members should apply to the Secretary, 17, Station Road, Leyton, E.10, or any Wednesday evening at Headquarters, 8 p.m.—Yours faithfully,

R. T. KENNY, Hon. Sec.

# From my Armchair

BY EARL RUSSELL.

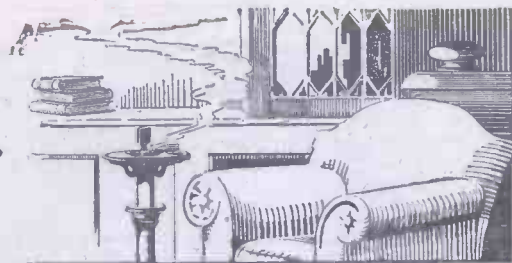

In these columns Lord Russell expresses each week his own personal views on matters of interest to "Wireless" readers.

## Wireless Diagrams

I saw a letter the other day, and I have seen others before, complaining of the difficulty of making out a diagram which uses the ordinary conventional symbols. There is really very little excuse for this complaint, for the whole of the conventional symbols can be learnt in ten minutes, and after that, deciphering a couple of diagrams will make their application quite easy. For my own part, I find the other kind, what are called pictorial diagrams, almost impossible to understand, for the connections are very much more difficult to follow.

Where the conventional shorthand is used the electrical features stand out prominently and clearly to the eye, and the general design can be seen at a glance. It is true that sometimes in reflex circuits and things of that kind a little careful following out may be

necessary before the scheme of tuning and amplification becomes quite clear. I think it must be that the unaccustomed symbols terrify people, but they are really no more difficult than saying B.B.C. instead of British Broadcasting Company.

## Woolliness

How irritating a loud-speaker can be when it insists upon being woolly, and how many things there are that can make it so. I am not sure I do not almost prefer it screaming. The woolliness may be due to too much condenser on the loud-speaker itself, sometimes caused by very long leads, to distortion due to too much reaction or to a loose contact, or to interaction between L.F. transformers or various other causes.

Whatever the reason, it is a most provoking thing, particularly in the

case of speech, when the announcer or lecturer seems to be speaking in a sort of husky growl, rather like the growl of a large, good-tempered dog, in which it is difficult to distinguish the actual words. No one ought to be satisfied with loud-speaker reception in which each word is not clearly articulated.

## Those Official Announcements

Broadcasting has been a blessing during the strike, and it was very wonderful for all England to know instantly what was happening at the centre of affairs, and the announcement at the conclusion of the General Strike, with the verbatim report, was thrilling. But how wearisome it has been to listen to. In the earlier days long lists of trains, and in the latter days yards about special constables at full length three times a day, not to mention the other official announcements "we were instructed to make." Necessary and quite proper, no doubt, but how boring. As for the elaborate statement about copyright, it now makes me scream with rage each time I hear it begin again. Still, with all that, what a blessing the wireless has been. I am astonished to read that in South Wales the official announcements of the completion of the strike by the B.B.C. were not believed, in spite of the accompanying messages from the T.U.C. Can it be that memories of the war have shaken our confidence in official announcements?

SEND FOR FREE LIST OF



## TREBLE DUTY TERMINALS AND STANDARDISED PLUG & SOCKET SYSTEM

**T**HE EELEX Treble Duty Terminal—the outcome of considerable thought and experiment—is well in advance of any other terminal.

It incorporates many special features in one terminal. THE EELEX TREBLE DUTY TERMINAL acts as a telephone or pillar terminal; takes spade, pin and eye ends as well as a plug in the top; by the provision of a slotted stem wiring is neatly and quickly done.

These terminals are heavily nickelled and are supplied with or without indicating tops, the plain type being 3d. each and the indicating terminals 4d., the name discs being in all the usual letterings engraved red or black according to polarity or in plain colours. These terminals give a professional finish to any set.

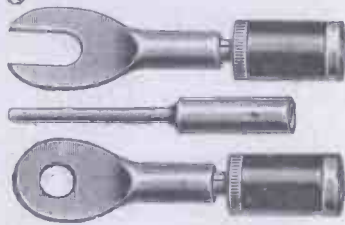

**T.14. Eye, Pin & Spade Adaptors.**

Enable plug to be converted to either pin, eye, or spade.

Price of Pin, Eye or Spade, 1d. each.

The EELEX Plugs and Sockets have been evolved after due consideration of all existing types and we have selected the standard valve pin and socket dimensions for the plug and socket respectively.

Send for our free list, it is bound to interest you. All EELEX products may be obtained through the usual trade channels, but should any difficulty be experienced we shall be pleased to supply if order is accompanied by your usual dealer's name and address.



**Plug and Socket, showing ease of wiring and constructional details.**

Price of Plug (in 6 colours) 3d. each. Socket " " " 1d. "

**T.2.S. (Small).**

Terminal only, Brass 2d. each  
" " N.P. 2½d. "

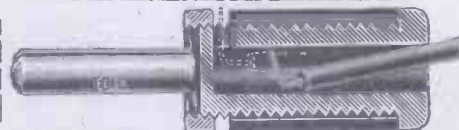

**T.2.L. Terminal, Showing various uses.**

T.2.L. (Large). Plain Brass, 2½d. each.  
" " " Plain N.P. 3d. "

Here are just a few EELEX lines. Send at once for free list to :-







# MY VIEWS ON PORTABLE SETS

By Captain H. J. ROUND  
M.C., M.I.E.E.

Captain Round has some very definite opinions on the subject of portable sets, and it is interesting to note that he considers that greater attention should be paid to "fixed-tune" sets for Daventry.



OUR recent national upheaval has had the unexpected result of producing an enormous number of wireless converts, and I am quite sure that a very good number of these converts will remain to enjoy the other good things of radio.

Modern man has a brain which while awake must be doing something; if he can't read, he wants the nearest substitute, so that when his newspapers were missing he proceeded to buy up all the radio sets, good and bad. That it was to some extent the modern restlessness, and not entirely the desire for strike news, is shown by the fact that at my bookshop nearly all the magazines were sold out, and I had to buy something like the "Boy's Own" to read myself to sleep with.

## A Boom in Portables

But I should particularly like to know why there has been a very large demand for portable sets. I cannot see any definite reason for this demand for portable as against ordinary sets. Is it merely due to flat dwellers attempting to avoid the use of an aerial (and possibly a licence), or are we really starting a new era, when those with cars, and even the remaining minority, will all carry sets about with them? More hard work is indicated for us designers if this era has really started, because the many difficulties of the problem have only been partially solved so far.

Expense, size and weight are the real difficulties in the way, but there is no doubt that for the particular purpose of the reception of news the problem is quite easy of solution, because in that case telephone reception is nearly always acceptable,

For entertainment purposes the difficulties are much greater—a loud-speaker is demanded, and this means more valves and heavy, clumsy batteries to supply the necessary power, and a loud-speaker out of doors requires even more power than one indoors for satisfactory operation.

## Aerials

I have never been entirely in favour



One of the problems of the design of portable sets is the question of whether the loud-speaker should be incorporated in the instrument or carried separately.

of a frame aerial for portable sets. Certainly, if one has a portable super, then a small one-foot frame in the lid of the set is strongly indicated, but such supers are not likely to be very common, and for the ordinary one, two or three-valve set a short aerial wire thrown over any suitable elevation is perhaps not so impressive to the on-looker, but will be found less troublesome and more portable.

A decent-sized frame is clumsy to carry, and, if collapsible, is apt to get tangled and the wires broken. The aerial wire, preferably of indiarubber-

covered wire, can be thrown over a tree branch or laid along the top of a hedge, and some remarkable work can be done by laying a wire on the ground pointing directly away from the station to be received. The earth connection can be the chassis of one's car, or a metal peg stuck into the ground, or a wire fence.

## Kite Aerials

Kite aerials are not likely to be used generally, but in combination with a crystal set great distances are possible with Daventry. Unreliability rather puts the kite out of the reckoning, but considerable amusement can be obtained by combining the two hobbies of kite flying and radio.

## Receivers

Now, what receiver is one going to choose for use with this aerial? Let us consider only telephonic reception first: I think there is one set which stands out as easily the best for the purpose, and that is the good old two-valve, reflex with reaction from the rectifier. The valves should preferably run on a 2-volt accumulator and not more than a 42-volt battery H.T. The batteries are thus comparatively light.

This set has the necessary sensitiveness due to the reaction—which reaction is more or less independent of the aerial resistance (always liable to be high with a temporary aerial and earth)—and due to the reflexing a good strength is obtainable sufficient to drown-out outdoor noises. Many such sets have been described, there are plenty on the market at very reasonable prices, and, once purchased, they will be of the greatest value. If after experience with telephonic reception you decide to launch out into loud-

(Continued on page 52.)

## MY VIEWS ON PORTABLE SETS—(continued from page 51)

speaker work you can add an L.F. amplifier as an independent unit—a distinct advantage for portables, as it splits the weight for carrying.

### In Praise of Reflexes

For pure brute sensitiveness, given a moderate aerial, this two-valve reflex has no rival, except in much higher priced receivers. Ultimate quality it may lack, but that can be foregone provided the distortion is not carried to unintelligibility. I think I should stick to a valve reflex for a portable, as adjustment of crystals in outdoor circumstances is not a nice operation. Heavy-current low-voltage valves preferably sprung with some of the modern spring sockets will be least liable to breakage of filament and will lighten the load of the L.T. battery. Those of you who do not mind chancing the damage of your super or neutrodyne, particularly if you only want to use it in a car, will, of course, have a larger thing to handle than the reflex, but the risk of damage, unless the set has been made specially for portability, will be rather great.

### Daventry

Daventry is a station which is more generally receivable everywhere than any other station, and it is transmitting a lot more than other stations, so that I rather like the idea of a set with no adjustments on it—absolutely fixed for 5XX wavelength and screwed or waxed up—it can easily be adjusted at home first—and the aerial circuit arranged so that considerable change is possible in the aerial without alteration of tune. Perhaps I will give details of such a set a bit later, but at the moment I have no particular circuit to advise on. A tuned anode two-valve set is a good way, the reaction being left slightly adjustable, or a resistance-coupled four-valve set would probably give quite good results on this longer wave, or, probably, the best way of all, a transformer-coupled arrangement, using some of those transformers which require no condenser across to tune them.

Sharpness of tuning will be of little general importance, providing one cir-

cuit, say, the input circuit, is arranged to give good tuning. The longer waves do not stand for too much tuning without distortion, anyhow. The general idea should be used in the design that one is working only to one wave, and this would cheapen things very much.

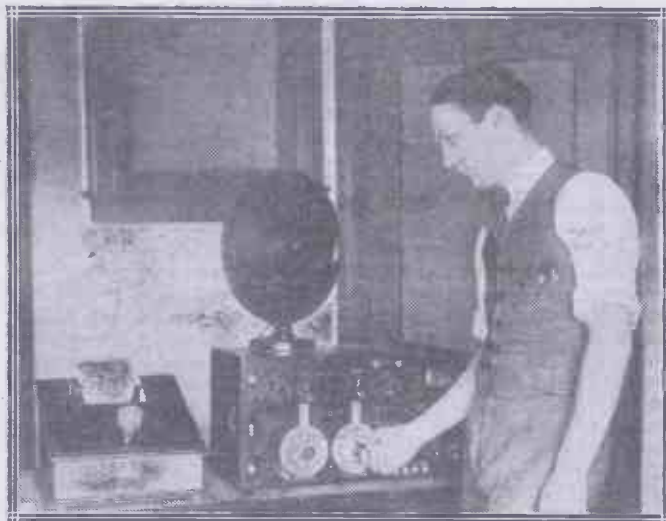

The "Radio Pen" is one of the latest variants of television. The inventor of the instrument, Mr. C. F. Jenkins, of Washington, is here seen adjusting his gear.

### Loud-Speaker Work

The most difficult problem to solve is how to work a loud-speaker. The horn of the loud-speaker will be a

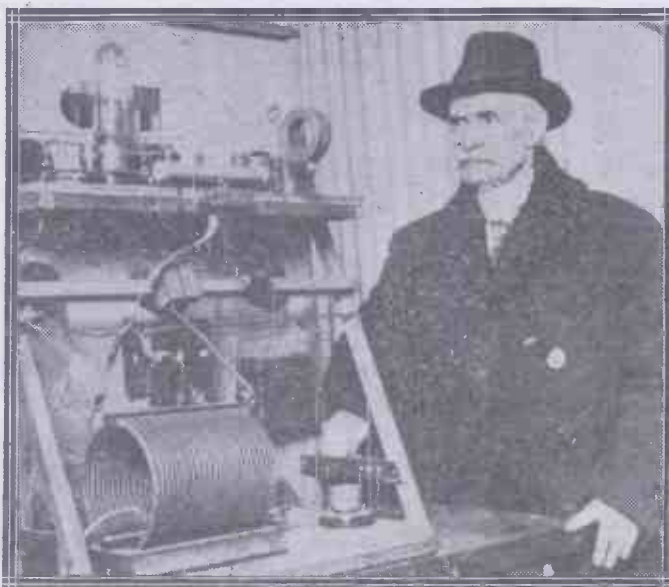

Dr. J. H. Rogers with some of the apparatus which he uses for underground wireless.

nuisance for portage; I wonder if there is one made on the principle of those collapsible drinking cups. It would be very useful, but it mustn't collapse on

its own in the middle of an important item.

A complete set for telephone reception will consist of:—

The aerial, weight say 1 lb.

Two-valve reflex set with H.T. battery.

Two-volt accumulator.

Telephones, plugs and cords.

For loud-speaker reception add:—

Two-valve amplifier.

120-volts H.T.

Loud-speaker, plug and cords.

All this will be very easy to take if your travelling is by car, but the telephone set will be quite enough if you have to do much hand carrying.

No portable set whatever will be able to do without the bigger H.T. battery if you want to work a loud-speaker, so that even if some designer gets out a light set, say, using my fixed-wave Daventry suggestion, however light it is, the weight of the complete outfit must exceed that of the aerial, H.T., and loud-speaker.

## CORRESPONDENCE

### Receivers that Will Not Interfere

SIR,—Might I express my appreciation of the good work being carried out by "Radio Press" in regard to receivers that will not interfere.

The description which appeared in the April 24 issue of WIRELESS, of the press demonstration of non-radiating receivers at the Elstree laboratories, shows what great strides have been made in this direction, by your technical staff, and I, in common with many other friends of mine, who are badly afflicted in the way of local "howlers," look forward to the time when such sets as those described by "Radio Press" are the only ones in use.

Yours faithfully,

G. W. DOWNING.

Yorkshire.

### "Monteyello"

SIR,—Referring to your issue dated April 24, page 259, "From my Armchair," last paragraph. Will you kindly inform Lord Russell that the station which he describes as calling itself "Monteyello," is San Sebastian, working on 346 metres. The call sign is "E.A.J.B.," pronounced "ay-ah-hota-otcho." The word which he takes as "Monteyello" is, I believe, "Monte Hielo."

Yours faithfully,

Brussels.

FRANK R. HAWKINS.

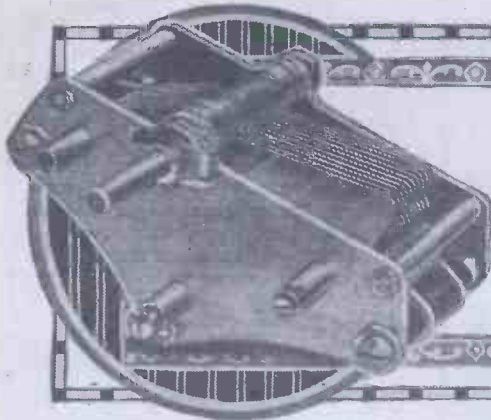

# WHY CALL IT A CONDENSER?

By H. J. BARTON-CHAPPLE,  
Wh.Sch., B.Sc. (Hons.), A.C.G.I., D.I.C., A.M.I.E.E.



LET us first make an examination of the elements which go to make a condenser. From the general standpoint a simple condenser consists of two conductors of any shape, meaning by the term conductors materials which will allow a current to flow along or through them, separated by some insulating medium, this latter being the converse of the former.

From this general statement it should be understood that the elements that make a condenser frequently occur in wireless construction. Two pieces of wire, for instance, separated by their insulated covering really form a condenser, and it is these "stray capacities" which often prove troublesome in a receiving set.

## The Elements

If we take two sheets of tinfoil, or similar substance, and arrange them, as in Fig. 1, one on top of the other with a sheet of mica, or wax-impregnated paper, etc., between them, we have a small condenser unit whose capacity in micro-microfarads depends on the area of the metal plates and the thickness of the insulating material.

## An Analogy

If we take an ordinary spiral spring, secure one end, and apply a



Fig. 1.—The elemental condenser unit referred to by the author in his discussions.

pulling force at the other, then the spring, when in this stretched condition, can be looked upon as having "stored" a certain amount of energy, which, upon releasing, can be made to do useful work. The spring was brought into a state of strain, and it was this strain which really "stored" the energy.

Now let us turn to the elemental condenser unit of Fig. 1, and see if its operation under certain conditions is at all analogous to the spiral spring

To many people the variable condenser is a rather mysterious piece of apparatus, and consequently mistakes are sometimes made in its use. This article will show that it is quite an easy matter to understand just how it works.

Our mechanical force is represented by an electromotive force (E.M.F.), which may be derived from a battery or generator, and if two leads are brought from the appropriate terminals, across which a difference of

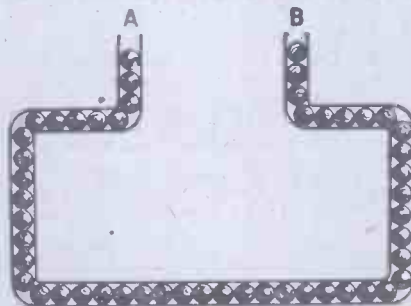

Fig. 2.—Glass tubing and lead shot are used in the construction of a helpful analogous model.

voltage exists, and touched on to the two conducting plates of the condenser, certain effects will take place.

## A Condenser When Charged

The condenser is now said to be charged, the voltage across the condenser plates being equal to the applied voltage, while a definite relation exists between the "quantity" of electricity held by the condenser, the voltage, and the condenser capacity.

Now, the difference between a conducting and a non-conducting body is that in the former there is existing a vast number of minute negative charges of electricity called electrons, which are free to move in any direction according to the applied conditions, while in the latter all the electrons are said to be fixed.

## Another Explanation

A simple analogy will perhaps make this point clearer. If we imagine a glass tube filled with small lead shot, as shown diagrammatically in Fig. 2, then, if a difference of pressure is applied across the ends A and B of this tube, so that the force at A exceeds that at B, the lead shot will

move in the direction A to B, and provided more lead shot is poured into the end A, there will be an equality existing between the amount fed in at A and the amount forced out at B.

This gives us the conception of a flow of current through a conductor, the lead shot taking the place of the "free electrons," the force being used up in causing the shot (or electrons) to move through the tube.

## The Dielectric

Fig. 3 illustrates our insulating material, the lead shot now being "anchored" to the sides of the tube by small springs, so that, although each shot can move a certain small distance, depending on the extension of the individual springs, the shot cannot travel in the same sense as in the previous case.

If a difference of pressure is now applied to the ends A and B so that the force at A exceeds that at B, as before, then all the shots will move a small distance relatively to their mean

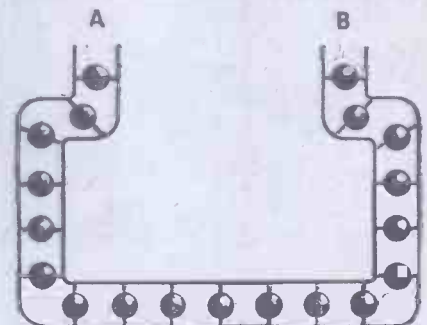

Fig. 3.—"Anchoring" the lead shot by means of small springs serves to illustrate the functions of the insulating material.

position, so that there exists a tendency to move bodily from A to B; but the effect of the force is really taken up in the extension of the springs, and the whole system is said to be in a "state of strain."

(Continued on page 54.)

**WHY CALL IT A CONDENSER ?**

(Concluded from page 53)

**The Condenser Plates**

Returning to our condenser, we shall see that much the same state exists under the conditions suggested. By making one plate positive and one plate negative, as in Fig. 4, the electrons tend to crowd towards the top

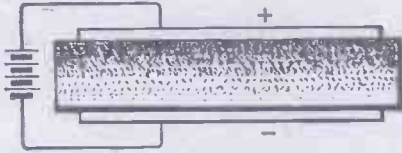

Fig. 4.—When applying a voltage across a condenser, the minute negative charges of electricity will tend to move from the negative to the positive plate.

positive plate, but the movement is not continuous, and a steady state is reached in very small time where the electrons in the insulation material are in a state of strain, the energy being "stored" in the dielectric of the condenser, due to the extension of these imaginary "anchoring springs."

If a pair of telephones is inserted in the battery leads, a click will be heard on completing the circuit, and

it is this sudden rush effect which gives the characteristic click. When this takes place, the condenser is said to be "charged."

**"Break-down"**

If the voltage across the condenser is too large the "springs" holding these electrons in position will become damaged, and the condenser dielectric is said to "break down," meaning that it has become punctured and must be replaced.

The greater the number of plates and the closer they are together, the larger will the condenser capacity become and the greater will be the amount of energy which can be usefully "stored" in one condenser.

**The Question of A.C.**

While on this subject it is, perhaps, opportune to answer another question which I find often puzzles beginners on the subject of wireless. How does an alternating current—i.e., one which rapidly pulsates first in a positive and then in a negative direction—pass through a condenser if, as we have just shown, it does not allow a direct current to pass?

Bearing in mind our previous analogies, the reason becomes easily understandable. The plates of the condenser, being made alternatively positive and negative, cause the electrons to oscillate about their mean "anchored" positions, so that the force applied alternately to the plates is transferred through the dielectric

and produces the effect, or equivalent, of a current flow.

**A Mechanical Example**

It is like knocking skittles down in an alleyway. The first skittle is given a blow, and, in falling, this imparts some of the energy to an adjacent skittle, which starts to fall, and so on, until the last skittle moves, although the original force was only applied to the first skittle.

By conjuring up these simple analogies

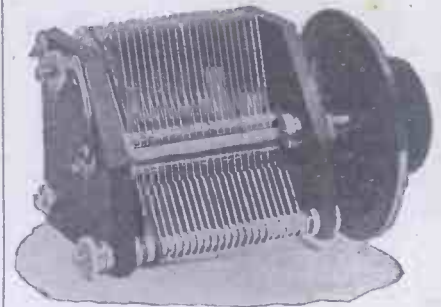

In a variable condenser of this kind, air forms the dielectric.

gies in his mind, the student of wireless will be enabled to gain a better comprehension of the subject, and a physical conception of what is actually happening in a wireless circuit always produces a sense of satisfaction, besides being an incentive and encouragement to probe a little deeper into the subject.



**Another SHORTPATH Valve  
S.P. 18/B (BLUE SPOT)**

This new S.P. 18 Valve supplements the well-known S.P. 18 Red Spot and Green Spot Valves. It is designed especially for use in resistance-capacity coupled sets and for use as a Detector and in H.F. neutrodyne tuned anode stages using 80-120 Volts H.T., so that where this H.T. is employed in the last stage, the difficulty of two H.T. supplies is avoided.

In addition, it gives still more amplification and consumes very little H.T. current.

The S.P./B (Blue Spot) is an excellent valve for anode bend detection.

Designed to work in parallel with the S.P. 18 Red Spot and Green Spot Valves, it operates for a 2-volt accumulator and consumes only 0.09 amp. filament current.

PRICES OF "COSMOS" SHORTPATH S.P. 18 VALVES.

RED SPOT.	GREEN SPOT.	BLUE SPOT.
12/6	12/6	12/6

**METRO-VICK SUPPLIES, LTD.**  
(Proprietors: Metropolitan-Vickers Electrical Co., Ltd.),  
METRO-VICK HOUSE, 145, Charing Cross Road, LONDON, W.C.2

"Cosmos" SHORTPATH S.P. 18 Valves are recommended for use as shown below with alternative H.T. values:—

Stage	Coupling	Recommended Valves H.T. 20-80 V. 80-120V.	
		Green	Blue
H.F. Amplifier	Tuned Anode (neutrodyne)	Green	Blue
	Tuned Anode (not neutrodyne)	Green	—
	Transformer (loose coupled)	Red	—
Dual or Reflex	Transformer (tight coupled)	Green	—
	All Couplings	Red	Red
Detector (Grid Leak)	Resistance Coupling	—	Blue
	L.F. Transformer or Choke	Green	Blue
Detector (Anode Bend)	All Couplings	—	Blue
L.F. Stages	Resistance	Green	Blue
	L.F. Transformer or Choke	Green	Green
Last Stage	All Couplings	Red	Red



R  
V39



**H**AVE you noticed the echo effect from the London Studio? Recently we have been treated to a number of concerts which sounded as if they were being performed in some large hall, whereas in point of fact they were broadcast from the usual studios with the aid of special echo effects. At one time the B.B.C. took steps to stamp out every possible echo, and as a result the reproduction suffered in my opinion from a "deadness" which was not at all pleasant. In particular, the sound of clapping was quite unlike itself. Now there has been rather a swing of the pendulum, and, if anything, the echo effects have been over - accentuated. Possibly the success of the broadcasting from large halls and the many letters on the subject which the B.B.C. have received are the reasons for the latest change.

**E**VERYONE seems to agree that the transmission from Covent Garden on the occasion of the "Gotterdammerung" was far below the usual standard of quality from this source. The broadcast public is becoming very critical in these days, and the remarkably good transmissions from Covent Garden have set up a high standard which will require the best endeavours of the B.B.C. engineers to maintain.

**J**UST before the war the American Government became seriously worried as to the position of the leading wireless companies and the large foreign element in their ownership. It was found on investigation that the Marconi Wireless Telegraph Co. of America had a large amount of British capital in it, and it was considered inadvisable that this should be so, having regard to the national importance of radio in times of emergency. Under the influence of the United States Government, the Radio Corporation of America was formed, and steps were taken to see

that the control of the company was fully American.

**I** SEE that under the terms of an agreement entered into between the Marconi Co., in England, and the Postmaster-General the Articles of Association of the company are being altered so that the British character of the company shall be maintained. On May 31 a meeting was held for the purpose of considering and passing a resolution altering the Articles of the company so as to make it perfectly

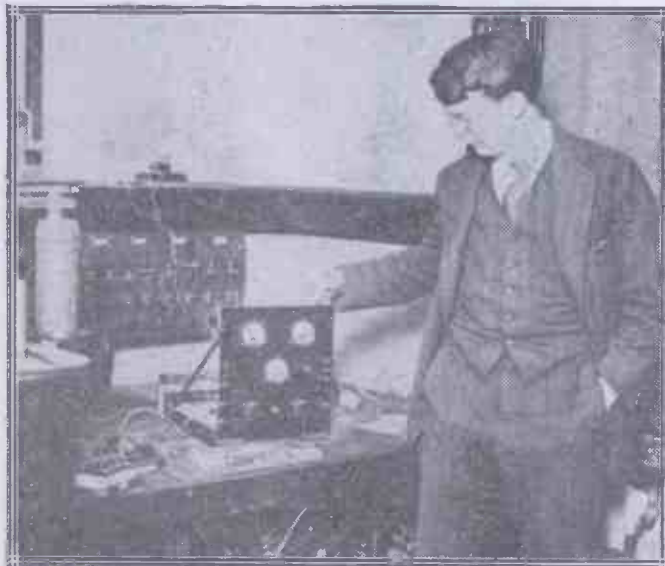

*Apparatus has been designed at the Bureau of Standards for counting tiny particles of matter by means of a Radio receiving set, the method being automatic from the time the tiny electron "races" across a wire until it is counted by an adding mechanism.*

clear, among other things, that no person other than a natural-born British subject shall be qualified to hold office as director, or other office of the company, and that not more than 25 per cent. in all of the issued capital of the company shall at any time be held by or in trust for or under control of foreigners. This is certainly a wise step.

**A**MONG the many people who have been privileged to hear the "Elstree Six" working at the Elstree Laboratories have been several im-

portant members of the wireless trade. Such people are hard to convince, and with a good knowledge of the subject, take nothing for granted and will only believe actual results they hear themselves. Without exception, they have admitted at once that the Elstree Six is more advanced than any other receiver they have heard, and I was present on one occasion when Cardiff having been tuned in on the loud-speaker (it was broad daylight at the time), a certain very well-known manufacturer turned round and said: "That is very fine, but wait till London starts, and it will be swamped out!" Capt. Tingey, who was demonstrating the set, simply smiled and turned the dial through two or three degrees, whereupon it was found that London was working all the time. The surprise of the visitor can better be imagined than described!

The same visitor was asked to name any relay station he would like to hear on the loud-speaker in daylight, and he thereupon named two or three of the more distant, and, sure enough, these were tuned in with very little delay. On one occasion recently, after dark, an attempt was made to see how many stations could be tuned in on the loud-speaker within an hour, and the total was exactly sixty, although, of course, several of them were badly heterodyned and spoiled by mush. The fact remains, however, that

the "Elstree Six" gives any listener a choice of a number of stations quite free from interference and of good quality.

**I**HAVE been very amused recently by the resurrection of some of the earliest wireless ideas, as if they were wonderful new inventions. For example, the first wireless aerial erected by Senator Marconi consisted of vertical wires with large metal plates or boxes at the top, the boxes being suspended by pulleys secured at the mast  
(Continued on page 56.)

## The Week's Diary—continued

head. For lightness, the inventor often used large sheets of perforated metal or netting. A little later he found that by extending the length of the wire horizontally he could get better results with far less trouble. Nowadays we see advertisements of all kinds of "new" aeriols, which are nothing more than the same idea as the now discarded vertical wire schemes with metal plates at the top. One of these days we may see the revived with equally extraordinary claims!

AT Whitsuntide I went to see a friend whom I have not visited for many years—certainly not since broadcasting began. I found him and two or three relations seated round a cushion on which reposed a multiple connector for telephones. In the corner of the room stood a crystal set, and the strength of signals was such that when the phones were laid on the cushion I could hear music several feet away.

He then took me outside to show me the aerial, which contained every conceivable fault I could imagine! The wire was badly insulated, the aerial was taken along a flat roof from which it was separated by not more than a couple of inches, down the front of the house at the same distance and into a front room. The total length of wire was perhaps 50 feet, of which I should imagine quite 30 feet was wasted. What was the secret of the efficiency, you may ask? A very simple one, dear readers. The aeriols of the broadcasting station were in sight!

LOOKING in the other day at the Competition Editor at work, I was very interested to find that although the "Cartoonigraph" Competition had been running for several weeks, there is not the slightest abatement in interest, and that thousands of entries still pour in for each of these interesting trials. I was privileged to see some hundreds of the entries, and was surprised to find that very many people do not trouble to do the drawing correctly, while many more fail to make the last line rhyme! Some people in their endeavour to gain a prize go to the extent of painting the figure in natural colours, while others, discarding every rule in the competition, in-

roduce the most elaborate shading and rounding off of lines. If you want to win a prize, take my tip and read the conditions carefully. They are simple enough and there are many good prizes to come yet!

LISTEN to this as an example of a letter received from a dusky inhabitant of the Gold Coast. It is addressed to Radio Press, Ltd., and is perfectly genuine.

"DEAR SIR,—I am here to animate you this few epistle to say that a certain man in our Town wants Samples of Earings, Beeds, and Handkerchieves together with catalogue for which he will order some immediately if they have a nice look.

"It was a very strange way which I gets your address from; this serves the man very happy to let me write you Because your address is very strange. Please try and present me anything that looks fine and I will send you per

thus shorting your signals to earth, or else cause that irritating intermittent contact when one moment your signals may be good and the next gone. Spiders, too, display an active interest in lead-in insulators at this time of the year, and a shower of rain on a web may easily be the cause of that mysterious disappearance of signals which annoyed you so last night.

WHEN you shunt a large condenser across your high-tension battery, you may perhaps pause to think how big it is compared with a .0003 grid condenser. I looked in the other day at the Telegraph Condenser Company's works, where there are thousands of Mansbridge condensers turned out every day, and saw what is really a giant among the pigmies. This was a Mansbridge condenser of 1,650 microfarads capacity, costing about £600, and contained in a tank large enough to hold several men. Of course, condensers of this size are not used for shunting high-tension batteries, but for electric power installations where certain corrections have to be introduced.

WAVE-TRAP.

### Short Waves: Conventional Signs

SIR,—Re your invitation to express views on short waves, I may say I also have been surprised at there being no reference to the subject in WIRELESS, and have put it down to the fact that it must be on the same plane as transmission, outside our scope, as, from what little I have gathered, it seems to require more technical skill than ordinary waves.

But as all enthusiasts wish to know every phase of the game, I certainly think that articles on short waves would prove very acceptable.

With regard to the other question of conventional signs, I think a chart explaining the signs would be quite sufficient for those people to whom the conventional signs are "double Dutch," instead of those complicated circuit diagrams with pictures of components and arrows pointing all over the place.

I cannot speak for a million people, but in my own circle of friends I am the only one who can read the conventional signs; but there is no doubt that a circuit made up from conventional signs is the easiest to follow once the chart has been mastered.—Yours faithfully,

Manchester.

W. DUMVILLE.

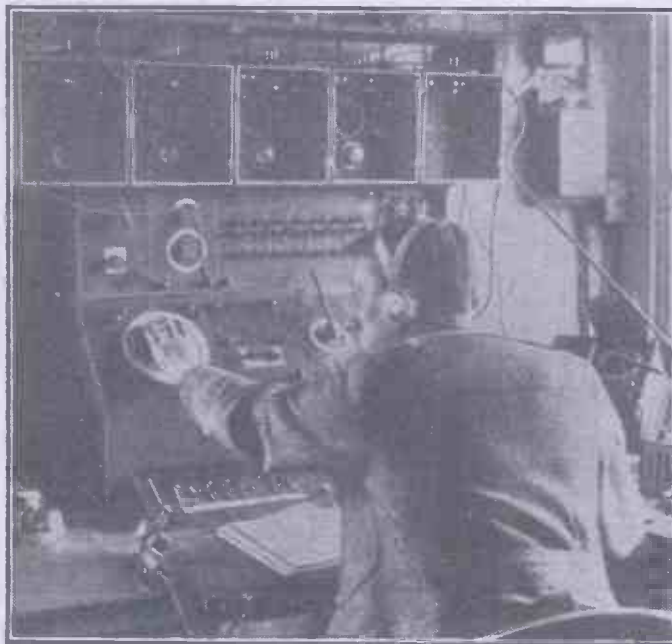

It is interesting to notice that Mr. Reynér, in his article on page 67, reports having heard a harmonic of the Croydon Station.

return Snakes-skins and Mica.—Yours faithfully,

Our Elstree Laboratories are at present engaged in trying to find some wireless use for the snakes-skins. Possibly Messrs. Dubiliers will give us an offer for the mica!

THIS is leafy June. It is also the time when wireless sets seem to play tricks with their owners, for day by day tendrils of the creeper gradually draw nearer to your aerial wire and lead-in insulator, until finally they either make a direct contact,

# AN "ALWAYS READY" CRYSTAL SET

By H. BRAMFORD

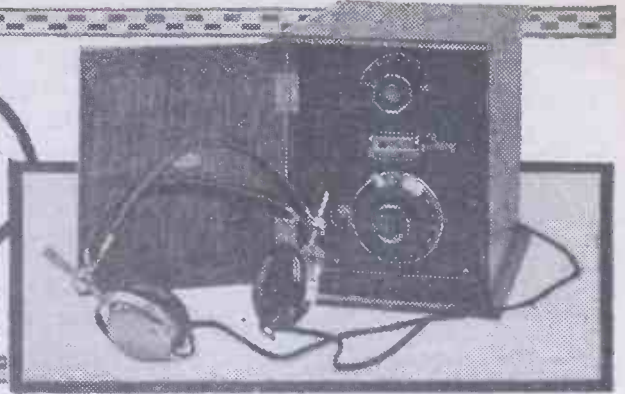

This set possesses the special attraction that, as there are no interchangeable coils to be inserted, it is always ready for use at a moment's notice.



**E**VEN those who possess multi-valve receivers have at times to fall back upon the much-despised crystal set. Others also, whose ambitions do not extend to valves, would

find it a great asset to have a crystal receiver which is always more or less ready for immediate use without coils to insert, and so on. The receiver about to be described, therefore, has been designed to suit this class of reader. The instrument once made is permanently ready for use, no plug-in coils or any additional paraphernalia being required.

The actual material used for construction, together with the names of the manufacturers are given for the

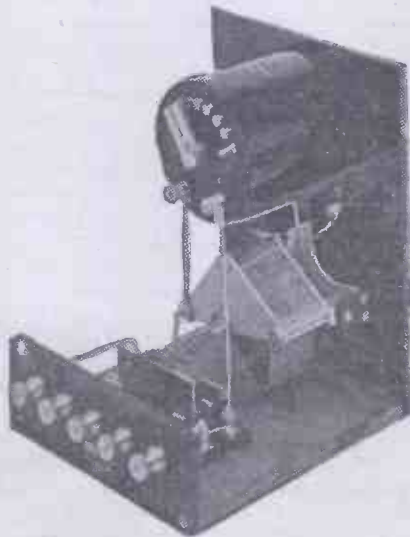

All the external leads necessary are connected to the terminal strip.

benefit of those who wish faithfully to copy the set described.

### Material Required

- One ebonite panel measuring 8 by 6 by  $\frac{1}{8}$  inch. (Camco.)
- One baseboard measuring 6 by  $5\frac{1}{2}$  by  $\frac{3}{8}$  inch. (Camco.)
- One cabinet to suit. (Camco.)

- One aerial tuning inductance. (Efesca.)
- One variable condenser, .0005 square law low-loss with vernier. (Utility.)
- One crystal detector for panel mounting. (Burndept Wireless, Ltd.)

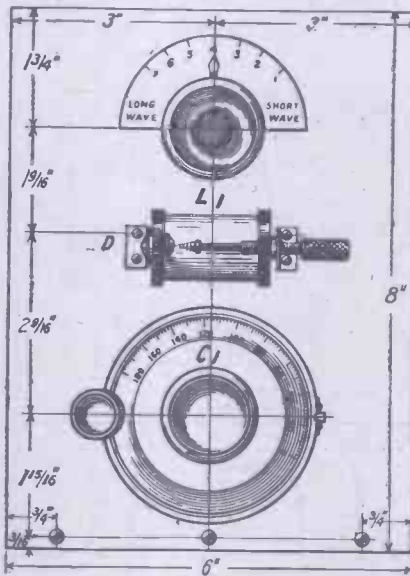

Fig. 1.—The drilling requirements on the panel are few, nine holes in all completing this operation.

- Two fixed condensers and mounts, .0005 and .002. (L. McMichael, Ltd.)
- One five-way terminal strip. (Magnum.)
- Glazite for wiring. (L. E. W. Co.)
- Radio Press panel transfers.

### Constructional Work

The first process is to drill the ebonite panel in accordance with the details and dimensions given in the front of panel diagram. A template is supplied with the type of detector specified, and the drawing is not therefore dimensioned in this respect.

When the operation of drilling is completed, the panel is secured to the baseboard by means of three  $\frac{3}{4}$ -inch wood screws, as shown. The terminal strip is next secured to the back edge of the baseboard in a similar manner.

The next process is the mounting of

the components upon the panel and baseboard respectively. This work may be easily carried out with the aid of the drilling and wiring diagrams, which represent the front and back of the panel respectively.

All that now remains is to make the various connections with Glazite. The connections made in the actual receiver were well secured between nuts and lock nuts in each case, but those who prefer to make soldered connections may, of course, do so. Little need be said relating to the actual wiring, which is extremely simple, as will be seen from the drawings.

### The Circuit

The theoretical circuit is shown in a diagram reproduced herewith. It is obvious from this that the receiver is an extremely simple one, particularly suitable for those who wish for good results without a large amount of trouble. The clip-in condenser  $C_2$  is intended for use with the object of increasing the tuning range, if necessary, for reception of 5XX on small aerials. This condenser may be of any value

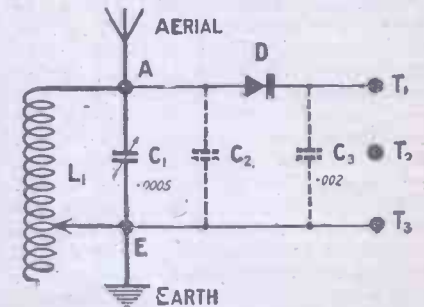

Fig. 2.—The clip-in condenser,  $C_2$ , may be used, where necessary, for increasing the tuning range when it is desired to receive 5XX on a small aerial.

found to be most suited to the occasion. It is a good idea to have in hand a series of such clip-in fixed condensers ranging in value from .0001 to .0005. A .0005 fixed condenser has been specified in the list as being the most useful if only one is obtained.

The telephone by-pass condenser,  $C_3$ , may or may not be used, as desired, but some small improvement in reception may be observed when such a con-

(Continued on page 58.)

denser is employed. This condenser may be of the value of .002.

**Operation**

Some remarks relating to the operation of the set may be desirable for the benefit of those novices who have not possessed any type of receiver before. Firstly, connect the aerial to the terminal marked A in the diagram.

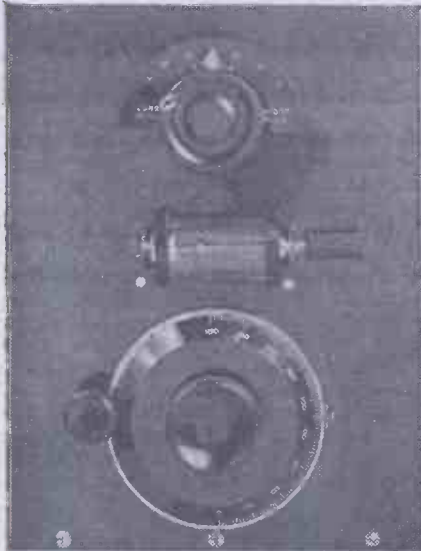

The small knob to the left of the condenser dial is the vernier control.

The earth lead is then connected to terminal E. If one pair of 'phones are used, connect them across terminals T<sub>1</sub> and T<sub>3</sub>. If two pairs of 'phones are used in parallel, connect both pairs across these two terminals. On the other hand, if two pairs of 'phones are used in series, connect one pair across terminals T<sub>1</sub> and T<sub>2</sub>, and the other pair across terminals T<sub>2</sub> and T<sub>3</sub>. Now set the aerial tuning inductance pointer at, say, No. 3 on the dial, having first adjusted the detector, and proceed to tune by means of the variable condenser, searching carefully. Proceed on these lines, trying successive numbers on the aerial tuning inductance dial until the best results are obtained, re-tuning with the variable condenser in each case. Make a final adjustment upon the crystal detector, and also, in the case of weak signals, a final adjustment with the variable condenser by means of the vernier knob provided.

**General Remarks**

When this receiver has been completed and placed in the cabinet, the aerial, earth and 'phones may be permanently connected. A permanent detector was not chosen for this design, but the type specified should, when once adjusted, stay set for a considerable period. With this object in view, the set should be placed in an out-of-the-way corner, where it is not likely to be knocked about or interfered with. It will be noticed also that the detector and tuning dials are

**AN "ALWAYS READY" CRYSTAL SET**

(Continued from page 57)

protected by reason of the fact that they are recessed into the cabinet behind the hinged door.

Once the set is adjusted, therefore, this door may be kept shut. For this purpose, the 'phones, aerial and earth are connected externally by means of the terminal strip mounted upon the baseboard, which projects at the back of the cabinet, a cut-away being made in the cabinet for this purpose. An additional refinement may be made by equipping the cabinet with anti-vibration feet. By this means the whole receiver and, incidentally, the

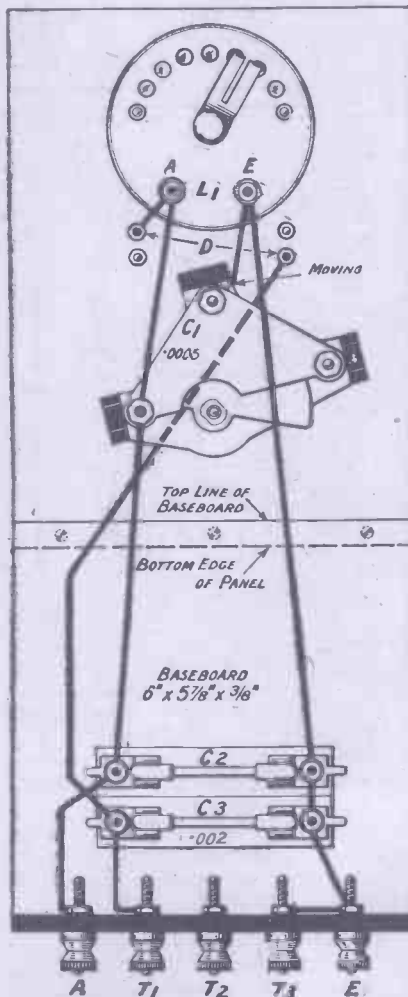

Fig. 3.—The receiver may be wired up from this diagram, which clearly shows all the connections required.

crystal detector, is rendered practically immune from any external source of vibration.

**Test Report**

The set was tried out on a very indifferent aerial, in an extremely bad

locality for reception, being situated some seven miles east of NIO. Signals were extremely good and clear, and operation proved a very simple matter. 5XX was also received, in which case a fixed condenser of a value of .0003 was inserted in the mount pro-

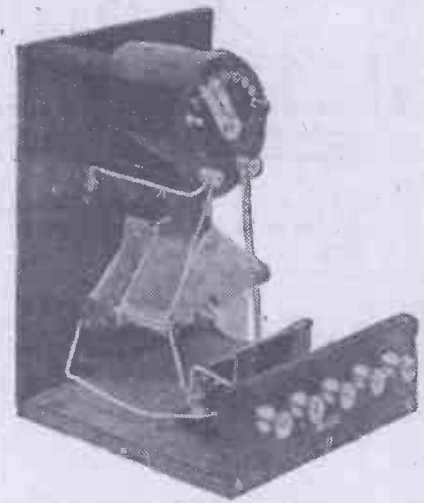

As the panel has no great weight to support, the usual panel brackets were not deemed necessary.

vided for this purpose, thus bringing the total full capacity across the aerial tuning inductance in circuit to a value of .0008, being the sum total of the maximum capacity of the variable condenser, plus the capacity of the fixed condenser in use.

**MATTING PANELS**

It is very often found necessary, for a variety of reasons, to rub down an ebonite panel. This is normally done by means of a very fine grade of emery paper, the original black colour being restored by application of oil.

This method, although fairly effective, is rarely satisfactory, as it is seldom possible to remove the scratches on the surface brought about by the emery paper becoming clogged. In addition, the finished surface seldom comes up to expectations.

**A Better Method**

A much better and less drastic method is to apply to the surface to be matted a small amount of fine grinding compound. This can be obtained from an ironmonger, or can be made by mixing fine crocus or emery powder to a stiff paste in oil. A cloth is procured and the paste is worked backwards and forwards over the panel, confining the strokes, as far as possible, to one direction. This procedure having been carried out, the superfluous paste may be washed away with turpentine and a perfect matt surface will result.

L. O'N.



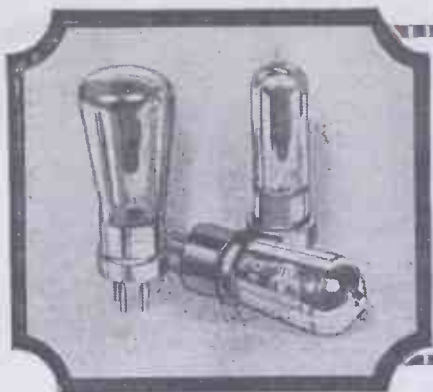

# HOW TO USE A VOLTMETER

By JOHN UNDERDOWN

**T**HE judicious use of a suitable voltmeter will throw considerable light on whether your valves are being worked at correct anode and filament potentials, and will show the actual applied grid bias voltages.

What the considerations governing the choice of a voltmeter for wireless work are, and how the instrument should be employed so as to benefit most from it will be briefly discussed in this article.

### Considerations in Choosing

To measure the voltage of a battery or any source of electrical pressure, it is necessary that the measuring instrument, or voltmeter, be connected across the two points between which it is desired to obtain the voltage, and thus current is taken by the instrument.

If this current taken by the instrument is large it may result in the battery voltage falling, so that an incorrect reading will be registered. It is of vital importance, therefore, that the meter should have a sufficiently high resistance to limit the current it will take.

This point will, perhaps, be clearer if we consider the case where two resistances,  $R_1$  and  $R_2$ , are joined in series across a battery  $B_1$ , and it is desired to measure the voltage drop across  $R_2$  (Fig. 1).

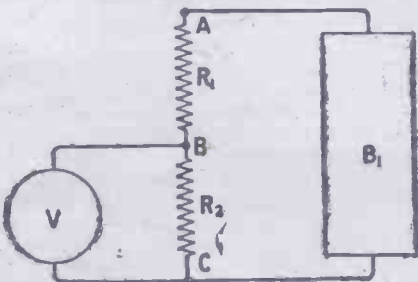

Fig. 1.—A circuit used for comparison by the author in his explanation of voltmeters and their use.

The voltage across the two resistances will be directly in proportion to the magnitude of their ohmic resistances, but on connecting the voltmeter across  $R_2$  the resistance of the coils in the instrument will be in parallel with  $R_2$ , and the resultant resistance of these two may be less than that of either the

Do you know what to look for when buying a voltmeter? The correct choice and use of this instrument is a matter of interest to all owners of valve receivers.

voltmeter or  $R_2$  alone. The reduction of resistance between B and C may result in less voltage drop across  $R_2$ , or, in other words, the reading ob-

under working conditions. To take only 10 milliamperes—i.e., .01 ampere—from a 100-volt battery, the resistance of the instrument would have to be

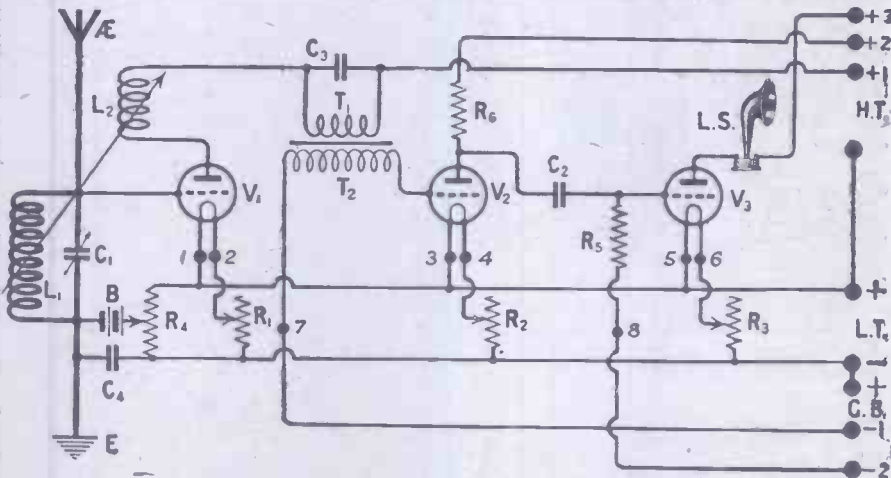

Fig. 2.—When measuring grid-bias voltages, the voltmeter should be placed across points 4 and 7 and 6 and 8 respectively.

tained may be low and erroneous. The higher the resistance of the meter the more accurate, therefore, will be the reading.

### A Practical Case

In practice,  $R_1$  and  $R_2$  may quite conveniently be a rheostat and a valve filament respectively when the importance of obtaining accurate figures will be realised, since with certain types of valves, such as the .06 ampere class, an increase in applied filament voltage above that specified by the makers will considerably reduce the useful life of the filament.

If the filament voltage of such a valve was adjusted by means of a low-resistance meter, the removal of the latter would result in the filament being overrun.

From the case considered it will be seen that the mere fact of the scale reading of a voltmeter covering voltages it is desired to read is not sufficient indication of its suitability to warrant its purchase, and its resistance should be determined.

When measuring the voltage of an ordinary small H.T. battery minimum current should be taken therefrom if its voltage is to be accurately registered

10,000 ohms, and higher resistances than this are to be preferred. The unsuitability of certain accumulator testing voltmeters whose resistances



For accurate reading, a voltmeter having a high resistance should be chosen.

may be only of 10 to 15 ohms will be at once apparent.

### Voltage Ranges

Under ordinary reception conditions filament voltages and grid bias voltages likely to be read will not exceed 10 or (Continued on page 60.)

# Capacity scooped out—

That is what we have done to this new LISSEN VALVE HOLDER—in every conceivable place capacity and loss have been literally scooped out. This new LISSEN VALVE HOLDER should find a place

in all efficient receivers, particularly those working on the low wave-lengths. (Patent pending.)



Price

1/8

Springs can be bent back for base-board use.

# Daylight in a coil mount—

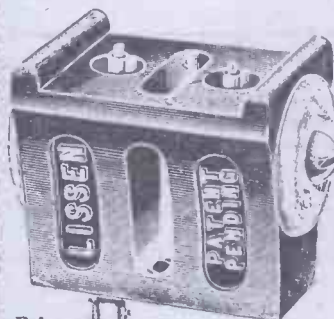

Price

1/-

Instead of capacity and loss there is daylight in the new Lissen Coil-Mount—the mount which is now being fitted to all LISSENAGON coils. You can buy this new LISSEN Coil-Mount separately—fit it to your existing coils, or any coils you wind yourself.

# LISSEN

LISSEN LIMITED,  
18-22, Friars Lane,  
Richmond, Surrey

Managing Director: Thomas N. Cole.

## HOW TO USE A VOLTMETER

(Concluded from page 59)

12 volts, whilst seldom do we need more than 120 volts for H.T. purposes.

If now a meter is obtained to read from 0 to 120 volts, it will not be easy to read with accuracy voltages, for example of the order of 2 to 3. This difficulty would necessitate the purchase of two instruments to cover the 0 to 12 and 0 to 120 volt ranges properly, but for the fact that multi-range instruments may be obtained.

### Series Resistances

It was previously explained that when two resistances are connected in series across a source of potential difference, the voltage across each is proportional to the ohmic resistances. If, now in series with a voltmeter, we connect a series resistance equal in value to that of the coil of the voltmeter, the voltage shown by the meter will have to be doubled to give the true voltage across both the meter and the series resistance. The method of reading various ranges with only one voltmeter will be understood by this example. Given for purposes of illustration, a 0 to 10-voltmeter, 0 to 100 volts may be measured by connecting in series with the voltmeter a resistance nine times that of the coils of the meter. The dial reading should then be multiplied by ten. In practice, I personally employ a double-range moving coil meter reading 0 to 10 and 0 to 100 volts, the resistances for these ranges being 1,318 and 13,180 ohms respectively, so that only 7.6 milliamps are taken when connected across a 100-volt H.T. battery. This is a reasonable current to take, since it is of the same order as that taken by a small-power valve.

### Applications

Having considered the type of meter to use, we will now deal with its practical application. The three-valve circuit of Fig. 2 shows an arrangement suitable for dealing with strong signals from the local station,  $V_1$  being a detector valve, with reaction, rectifying on the lower bend of its characteristic curve.  $V_2$  and  $V_3$  are transformer- and resistance-coupled note magnifiers respectively.

In any set it is desirable to know the applied anode voltages, filament voltage, and grid biasing voltages. Strictly speaking, the H.T. voltage applied to the anode of a valve should be measured across its negative filament leg—e.g., 2, 4 and 6,—and the positive tapping in the H.T. battery applicable to the particular valve.

In practice, however, sufficiently accurate readings may be obtained by connecting the meter across H.T. — and the three H.T. + terminals + 1, + 2, + 3 respectively. Applied H.T. voltages cannot be measured across anodes and negative filament legs, since the meter would thus be placed in series, with  $T_1$ ,  $R_1$ , and the

loud-speaker, and in parallel with the valve internal resistances, so that no useful reading would be obtained.

### Filament Voltages

The applied filament voltages must be read by connecting the voltmeter across the filament legs of each valve respectively—that is, across the points 1 and 2, 3 and 4, and 5 and 6, the first figure given being that point to which the positive terminal of the instrument should be connected.

### Grid Bias

Suitable anode and grid bias voltage will generally be given by the makers for their particular valves, and the former should not be exceeded, whilst the latter should be adjusted with some care if minimum demands are to be made on the H.T. battery, and the valves are to be worked on the correct part of their curves.

Suitable grid biasing voltages for the note magnifier should be determined from the maker's figures, and the tapings GB - 1 and - 2 should be ad-

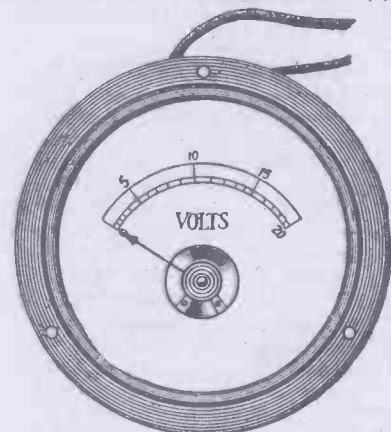

When buying a voltmeter, many more points than the suitability of the dial reading should be taken into consideration before the purchase is made.

justed to give, in conjunction with the voltages dropped across the filament resistances  $R_2$  and  $R_3$ , the required readings, the meter being connected across 4 and 7 and 6 and 8 respectively.

The reading for the detector is taken across 2 and the earth terminal.

When accumulators are used for low-tension supply, the voltage of the battery should never be allowed to drop below 1.8 volts per single cell, and when individual 2-volt cells show this figure they should at once be taken for recharging.

### Voltmeter Position

Often in practice a voltmeter is mounted on the panel of a receiver and switched in circuit to give any desired reading. This, however, is a practice which I personally do not recommend, since not only is the instrument's application to other work curtailed, but the wiring of the set is unduly complicated, from which loss of efficiency may result. It is best, therefore, to use the voltmeter as an external instrument.



# Behind the Scenes During the Strike

By Captain JACK FRÖST of the B.B.C.

THE question of the immediate future asked by our children will be not only "What did you do in the Great War, Daddy?" but "What did you do in the Great Strike, Daddy?" Some folk did one thing and some did others, but the man who carried on with his job is the one who can answer this question in the simplest way. Others may have to explain that they volunteered their services and served upon tube routes, railways, omnibuses and even carried meat from ships to lorries driven by other volunteers. Whatever may be the answer to the burning question by others, those who were in the B.B.C. during the time of national emergency can say that they carried on and provided a news source which gave the very latest reports on the position to parts of the country to which no news could possibly have penetrated other than by wireless.

## Sore Throats

Some volunteers had chalked upon a tube train that I saw, the words "We came, we saw, we conquered." The B.B.C. can hardly say they carried out very much "seeing," although when "seeing by radio" comes that will be a correct enough term, but "We heard" could fittingly form our slogan, and not only did we hear, but we spoke, at any rate the announcers did. There were, of course, many dry throats and husky voices, but the announcers were ably relieved by other members of the staff who took a turn with the long news bulletins. The news bulletins were lengthy and frequent and called heavily upon the invisible "voice." Throat tiredness did not come into consideration. Several folk who listened to the news bulletins (and who did not do that?) remarked that an enormous amount of labour must have been necessary in the preparation.

This was very much the case. At Savoy Hill the News Service staff, who were composed of the ordinary staff of the Company assisted by volunteers, received the news by telephone, whence it was typed and checked. News passed from many sources to Savoy Hill for broadcast, was collated, edited and prepared and then sent direct from the News Service room to the Studio. Some news, of course, came from Messrs. Reuter.

All information relative to Railway Services was sent to Savoy Hill from the Railway Information Bureau. There was, in addition, a special B.B.C. service of news collection.

## Impartiality

With regard to the news broadcast, the B.B.C. endeavoured to the utmost to give facilities for the treatment of the opinions of all parties, and I think all listeners will agree that the work carried out by those concerned in the preparation of the broadcasting of the news did its bit.

But how did the staff get to Savoy Hill in time? You, my reader, are not the only one who has asked that question. A number slept on the premises in their offices. Others lived close by within walking distance, and formed part of the great trek to and from business morning and evening. Others were brought to and

jugged out a pair of army boots. You know what *they* are, just shapeless, laughable lumps of leather. Although his clothing was sufficiently reminiscent of the Salient his build and finally his face completed the part which he played with his 'bus with its boarded windows and wire covered engine. It was the face of Old Bill—the whiskers and the expression complete. Upon the front of the radiator hung a board with the following cryptic remark chalked upon it:—"Tea for two when I boil." Car owners will appreciate this. This is just one small incident of the spirit of cheerfulness which was rife throughout the time of emergency.

This was the spirit which enabled everyone to carry on as usual and which, with the quietude and orderliness of the strikers themselves brought things to such an orderly and satisfactory conclusion. In my own

*A simple instrument which may be connected to an ordinary loud-speaker receiver, and will then receive wireless-transmitted photographs, is claimed to have been produced by Mr. Thorne Baker. A commercial model of this device is seen here.*

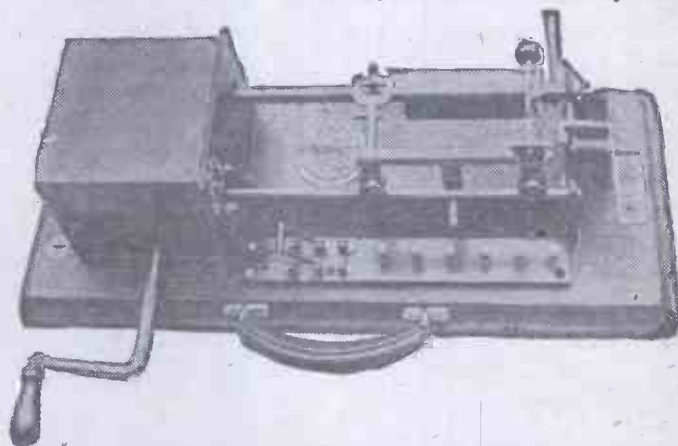

from their homes by lorries and cars. They were one with the company of lorries and cars which journeyed to and from the City from all parts of the suburbs.

## Carry On!

Those living in the country missed an interesting experience which they would most certainly have appreciated had they been town dwellers or workers. One motor-bus that I saw, with a volunteer driver and conductor, was received with cheers by the passers-by in the Strand. The driver was dressed in a well worn khaki tunic, a khaki forage cap, breeches and puttees, all relics of the War—that was quite evident. The puttees were wound around his legs just anyhow and from beneath them

district many listeners were posting the radio news on front gates and railings and in that way rendering yeoman service to the public.

## Programmes as Usual

And now a word about programmes. They were quite good during the strike, were they not? Did it occur to you that programmes which had already been arranged weeks and weeks beforehand had, of necessity, to be altered at the last moment? Artists were unable to get to the various Broadcasting Studios in London and the provinces in order to fulfil their engagements, yet you had your programme as usual. In that way, too, business was just "as usual." In fact, for the programme—  
(Continued on page 71.)

# COMPONENTS WE HAVE TRIED



Conducted by the "Wireless" Laboratories, Elstree.

## Automatic Rheostats

**A** COMPONENT received from Messrs. Rothermels is the "Amperite," described as the self-adjusting rheostat.

These components are similar to a grid-leak or anode resistance in appearance, consisting of a cartridge surrounded with black paper, and lettered in gold, with

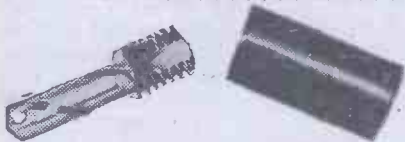

Messrs. Autoveyors' improved Wander Plug.

two metal cone ends which fit into clips, the whole being mounted on a small strip of ebonite; both nuts and soldering tags are included for making connections. They are neatly boxed in black and yellow cartons, but it would appear to be advantageous if these could be printed giving particulars of which "Amperite" is suitable for the English valves.

The cartons are marked "For use with a U.V. 199 and C. 299," and so on, which are the symbols of the different types of American valves. These are not commonly known in England, therefore the English buyer would probably find difficulty in selecting the correct "Amperite" for his own use.

## Fixed Condenser

**WE** have received from Messrs. Falk, Stadelmann some samples of their



The Igranic-Pacent filament rheostat.

new mica fixed condensers. These condensers, stated to be their new pattern, appear to be well and solidly constructed.

We were pleased to note that one was supplied in section, to show complete assembly, and another complete condenser was also sent, but minus the case, to allow of inspection of the manufacture preparatory to casing.

It is claimed that good quality mica is used, measured for thickness by a micrometer, and then for size with a steel gauge.

The method of construction is explained in a brief notice, and from the number of operations given it is apparent that every care is taken in the manufacture.

After construction in skeleton form the condensers are tested on a capacity bridge, after which it is inserted into a moulded case and filled in.

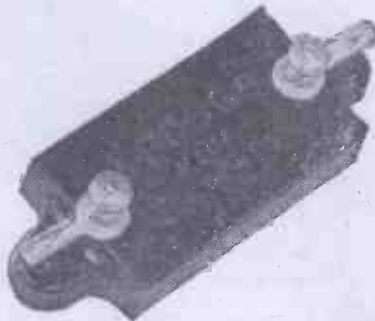

The new pattern fixed condenser produced by Messrs. Falk, Stadelmann.

Before going into stock these condensers are again tested on a capacity bridge.

The condensers are neatly and attractively boxed, always a consideration when regarding from the sales' value point of view.

## New Wander Plug

**MESSRS. AUTOVEYORS** have sent for test a sample of their new wander plug. This plug has an insulated grip, the plug itself having a double spiral cut, ensuring strength and spring. It is neatly made and finished.

## Variable Condenser

**WE** have received from Messrs. Igranic Electric Co., Ltd., of 149, Queen Victoria Street, London, a sample of



The "Amperite"—a "self-adjusting rheostat."

their Igranic-Pacent True Straight Line Frequency Condenser.

This condenser is of the conventional straight line frequency type, the plates being rather similar to the square-law type, but longer and narrower in shape. It is well constructed in brass, the moving plates being prevented from accidental warping by means of a straight bar joining them at some distance from the spindle. It is of low-loss construc-



King Quality Products, Inc., manufacture a combined rheostat and L.T. switch.

tion, porcelain being used as the insulating medium. This component shows a high class of workmanship and is well finished. Soldering lugs are provided for making connections.

## Filament Rheostat

**WE** have received from King Quality Products, Inc., a sample of their filament rheostat and low-tension switch combined. So far as the resistance element is concerned this is of the con-

(Continued on page 63.)

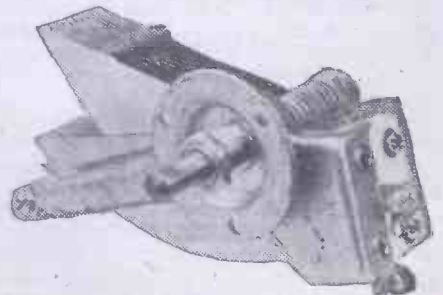

A straight-line frequency condenser—the Igranic-Pacent.

**COMPONENTS WE HAVE TRIED**

(Continued from page 62)

ventional type, a quantity of resistance wire being wound on a fibrous strip. This strip is carried on a bakelite moulding.

The centre spindle carries a circular disc with two metal contacts, these contacts being connected to a centre concentric spindle, the other end of which is joined to a small knob concentric with the main knob. Bearing on this disc is a thin spring contact, which is joined to a third terminal on the body of the rheostat. The insulating disc previously mentioned has two depressions for "off" positions. The contact arm is well shaped and tempered, and is stamped in such a way as to give it an inherent springiness. The whole component is of a very high degree of workmanship, both the construction and finish being exceptionally good. The movement of the contact finger of the resistance element is also noticeably smooth. The knobs have a high-class appearance, are of adequate size, and are engraved with arrows.

**Rheostats**

**FROM** Messrs. Igranic Electric Co., Ltd., of 149, Queen Victoria Street, London, we have a sample of their Igranic-Pacent genuine bakelite rheostat.

This rheostat is of the usual construction, the resistance element being carried on a fibrous strip, which is bent in a

circular form. This element is attached to an almost completely solid frame, which is of moulded bakelite. Both terminals and soldering tags are provided for making connections. The spring contact is well made, and moves with a smooth and even pressure over the whole surface of the element. A special knob and dial are provided, the dial being of some white metal, engraved with an arrow pointing in the "on" direction, the tail of the arrow having the word "off" imprinted on it. The knob is of hemispherical section, and is fluted to provide a firmer grip, and carries a small diamond engraved for the purpose of a visual indication of the amount of the resistance in circuit.

**SOME COMMENTS**

**Programmes**

**SIR,**—When I read the various criticisms of the B.B.C. programmes, it is difficult to restrain a smile. So many correspondents merely think of what they prefer. Individual preferences are wanted in the first place, it is true, in order that programmes which will please the majority of listeners may be compiled, but surely programmes compiled to suit the majority of over a million listeners of widely varying tastes cannot possibly please all, and they are not expected to.

The B.B.C. have obviously tackled an extremely difficult and thankless task, and credit is due to them for the very fine results obtained. Of course, some of the features are not to my taste, but

then I realise that the B.B.C. did not have me alone in mind when they arranged them.

Credit where credit is due, please.  
Yours faithfully,  
London, W. W. H. JAMES.

**Stations I Have Visited**

**SIR,**—I should like to thank you for your series of articles entitled "Stations I Have Visited," by Capt. Plugge, B.Sc., which have been appearing recently in your excellent weekly WIRELESS.

In common with several of my friends I find it of added interest to receive transmissions from foreign stations after having read a description of them, and the articles, in my estimation, are a most valuable feature.

Yours faithfully,  
Hull. J. W. HANKINS.

**Crystachoke Circuits**

**SIR,**—It appears from your Crystachoke articles that the crystal as a detector is making distinct headway.

When I read the article by Mr. A. S. Clark in the April 24 issue describing a crystal set to work with a frame aerial I was astounded.

It seems almost incredible that while three or four years ago at least four valves were supposed generally to be essential for reception with a frame, now WIRELESS steps to the front, as usual, with a crystal receiver capable of achieving this.

I look forward with great pleasure to further developments in this direction.

Yours faithfully,  
Wigan. H. L. CRINGHAM.

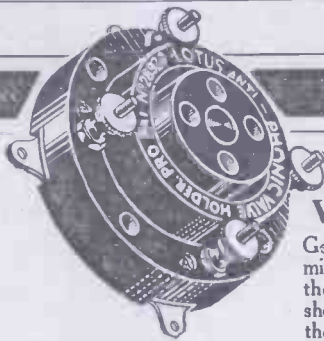

**Get Rid of Valve Trouble**

Get rid of these disturbing microphonic noises—prevent the danger of breakage from shock. Ask your dealer for the new improved Lotus Buoyancy Valve Holder, which absorbs shock and protects your valves.

Valve sockets and springs are locked together by a mechanical process, making a definite and permanent connection. Bakelite mouldings, nickel silver springs and phosphor bronze valve sockets, nickel-plated.

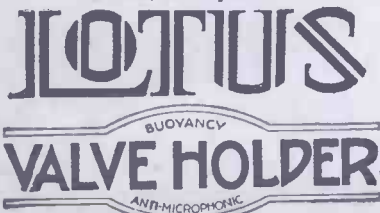

Garnett, Whiteley & Co., Ltd.,  
Lotus Works, Broadgreen Rd., Liverpool.  
Makers of the famous Lotus Vernier Coil Holder.

Without Terminals 2/3

With Terminals 2/6

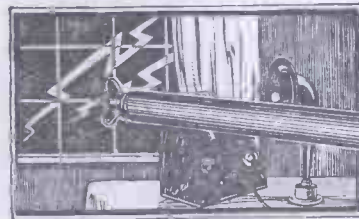

IGRANIC COMBINED EARTHING SWITCH, LIGHTNING ARRESTER AND LEAD-IN TUBE (Patent Applied for).

**Better than Insurance**

You need not fear lightning. The presence of an aerial in your garden need not constitute a danger—it can even act as a safeguard—provided it is always connected to an Igranic Combined Earthing Switch, Lightning Arrester and Lead-in Tube. It costs but 6/6, and yet consists of three essential devices in one. Be wise and fit one immediately—it is better than an insurance policy.

All reputable dealers stock this and the range of Igranic Radio Devices. Write for List S.10

Exclusive Manufacturing Licensees of



PACENT Radio Essentials

149, Queen Victoria Street, London.

Works: Elstow Road, Bedford.

# NEW NET SALES CERTIFICATE

FRANKLIN, WILD & CO.,  
CHARTERED ACCOUNTANTS.

ORIENT HOUSE,  
42-45, NEW BROAD STREET,  
LONDON, E.C.2.

26th May, 1926.

THE DIRECTORS,  
Messrs. Radio Press Limited,  
Bush House, Strand, W.C.2

Gentlemen,

WIRELESS (Incorporating "Wireless Weekly")

We have examined the accounts and records of the above publication for the period ended 31st March, 1926, and we certify that the average net sales for the twenty-eight issues of that period (after deducting all free, returned and voucher copies) amounted to

**115,536** copies per issue.

These figures only refer to WIRELESS for that period, and are exclusive of the net sales of "Wireless Weekly" (which is now incorporated with WIRELESS).

Yours faithfully,  
FRANKLIN, WILD & CO.  
Chartered Accountants.



# Some "Provincial" Circuits to Try

By J. H. REYNER, B.Sc. (Hons.),  
A.C.G.I., D.I.C., A.M.J.E.E.

**T**HERE are many people at distances of 50 to 100 miles from the nearest broadcast station, and who require, therefore, a receiver which, while being simple, must have a little more "pulling power" than the ordinary local-station receiver. It is proposed in this article to give one or two circuits suitable for these "provincial" conditions, if one may so term them for lack of a better name.

## Valve and Crystal

A useful combination in circumstances such as this is that of a high-frequency valve with a crystal detector. A circuit is shown in Fig. 1 which is a fairly straightforward arrangement of this kind. The grid circuit of the valve contains the tuned circuit  $L_1 C_1$ , the aerial being tapped across a portion of the coil  $L_1$ . The anode circuit contains the combination  $L_2 C_3$ , the coil of which is centre tapped. The high-tension connection is taken to this centre point, and the remote end of the coil is connected through the neutralising condenser  $C_2$  back to the grid of the valve. By the use of the condenser  $C_2$  the valve capacity may be neutralised, and by a slight under- or over-neutralisation a very smooth reaction effect may be obtained.

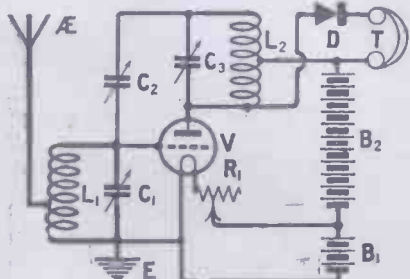

Fig. 1.—This circuit consists of a neutralised H.F. amplifying valve, with a crystal for detection.

This method of neutralising has been adopted because it enables the full voltage developed across the condenser  $C_1$  to be applied across the grid and filament of the first valve.

Many readers, no doubt, are interested in unusual circuits, and to them this article by Mr. Reyner should be of particular interest.

## Reducing Damping

It will be remembered that in a recent article I pointed out the necessity for obtaining as high a voltage as possible on the first valve of a

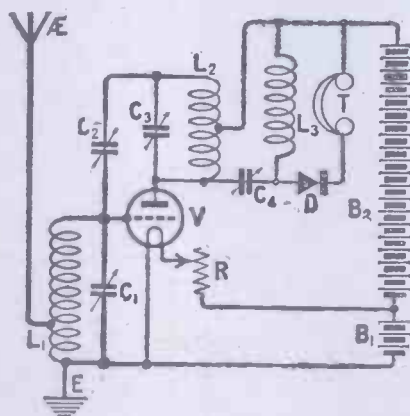

Fig. 2.—In these pages recently appeared the well-known crystachoke circuits, and in view of this the circuit shown above should be of particular interest.

high-frequency amplifier if best results were to be obtained.

The crystal circuit is connected from the half of the coil  $L_2$  in the anode circuit. The use of a centre-tapped coil here, therefore, is doubly advantageous, in that not only is the "damping" of the valve  $V_1$  removed from the circuit  $L_2 C_3$  to a large extent, but also since the crystal is tapped across half the coil only the damping from this source is appreciably reduced.

## Variable Tapping Point

The centre tapping does not necessarily give the optimum tapping as far as the crystal is concerned, and it would be better if a variable tapping could be arranged for the crystal itself, the telephones being connected to the high-tension as before.

A better method of doing this, however, enabling one to employ one of the several types of ready-made centre-tapped coils on the market is that shown in Fig. 2, which utilises

the well-known crystachoke method. Here the crystal circuit is connected to the tuned circuit  $L_2 C_3$  through a small condenser  $C_4$ , which may conveniently be made a neutralising condenser. A high-frequency choke is provided in series with the crystal circuit.

## Reducing Damping

By suitable adjustment of the condenser  $C_1$  the damping of the crystal may be reduced to the best point. As the condenser is decreased so the damping introduced into the circuit by the crystal also decreases, but at the same time the voltage applied across the crystal decreases at the same rate, so that the signal strength falls off. These two effects act in opposition, and there is an optimum point at which the signal strength reaches a maximum which may readily be found by trial.

## Effect of Damping on Signals

It may be thought that the question of reduction of damping in the circuit is not of particular importance at a

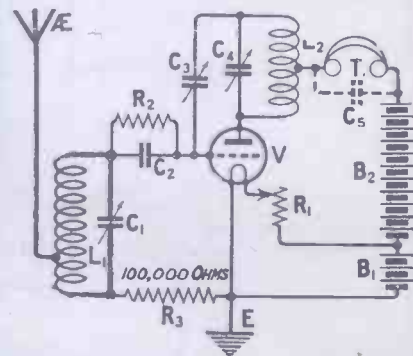

Fig. 3.—In this rather unusual circuit satisfactory results have been obtained at times with an H.F. choke in place of  $R_3$ .

distance of 70 or 80 miles from the station being received, since the selectivity of the circuit, neglecting outside interference from spark stations

(Continued on page 66.)

**SOME "PROVINCIAL" CIRCUITS TO TRY—(concluded from p. 65)**

and such like, is not of primary importance. It should be borne in mind, however, that the damping of a circuit has a direct effect on the signal strength as well as the selectivity, and if the circuit  $L_2 C_3$  is very heavily damped, then it will not tend to oscillate at all, and the control of the reaction by the neutralising condenser  $C_2$  will not be obtained.

**A Curious Circuit**

The last circuit shown is one which I came across during some experiments with high-frequency amplifiers. The grid circuit contains the circuit  $L_1 C_1$  which has an aerial tapping as before. The anode circuit of the valve contains the tuned circuit  $L_2 C_4$  with a split coil and a neutralising connection through the condenser  $C_3$  back to the grid of the valve. A condenser  $C_2$  with a leak in shunt is placed in the grid lead of the valve in order to ensure rectification, while the telephones are connected in the high-tension lead as indicated.

**Effect of the Resistance**  
The particular point about the circuit is that the return lead of the

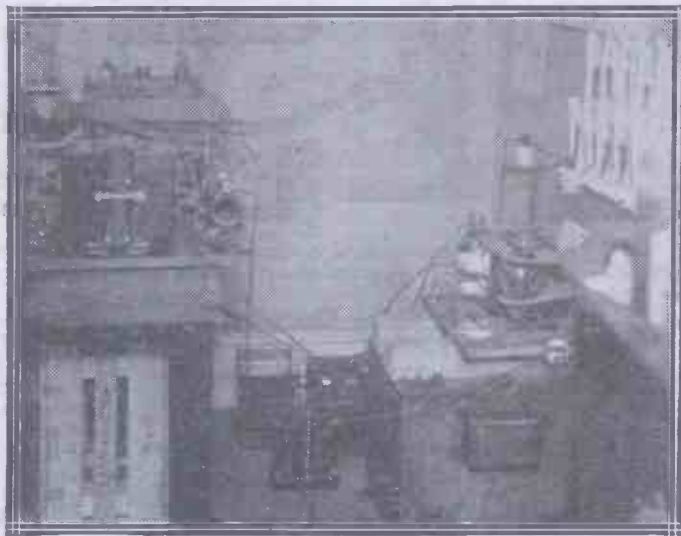

An unpleasant experience once occurred at 2WJ, an amateur station owned by Mr. R. L. Hoyle. After a conversation with a station known as HBK, in India, his station was lit up with blue electric sparks, which, it is said, flashed from point to point on his apparatus, and were believed to be due to a lightning discharge.

first circuit is not taken direct to the filament but through a 100,000 ohm

resistance. I found that this had the effect of increasing the strength on a distant station to a noticeable extent, and making the reaction control on the condenser  $C_2$  extremely smooth. It may be necessary here to connect a condenser across the telephones as shown dotted by  $C_5$ , but this is a matter for trial, and depends mainly upon the other constants in the circuit.

Suitable results have also been obtained, at times, with an ordinary high-frequency choke in place of the 100,000 ohms resistance, but this again is matter for trial, and this circuit is quite interesting in its possibilities.

**Weather Maps by Radio**

The Munich Broadcasting Station has recently taken up a scheme of transmitting not only the usual weather reports, but also actual maps, which are transmitted by the "teleautographic" system. The originals are drawn in insulating ink on metal foil at the Bavarian Central Meteorological Observatory, and may be on specially prepared

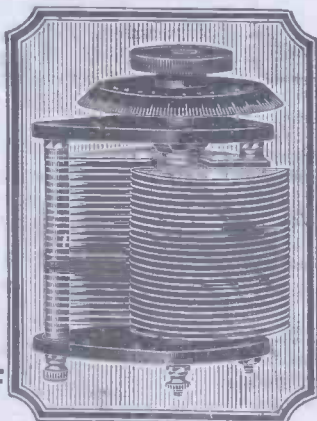

Post:  
One ... 6d.  
Two ... 9d.  
Three ... 1s.

SQUARE LAW	
.001	9/6
.00075	8/-
.0005	7/-
.0003	6/9
.00025	5/9
.0002	5/6
.0001	5/3
Vernier	4/6
STANDARD	
.001	8/6
.00075	8/-
.0005	7/-
.0003	5/9
.00025	5/6
.0002	5/-
.0001	4/9
Vernier	4/-
J.B. SQUARE LAW WITH VERNIER	
.001	14/-
.0005	12/6
.0003	11/3
.0025	11/3

**Compare its Value**

Compare the J.B. point for point with any other condenser. Consider the efficiency in action, the construction and appearance, and you will be surprised that such a really good condenser can be supplied at the price. The J.B. fulfils every requirement of a radio condenser—scientific design, rugged and compact construction, critical tuning and low losses. It is, in fact, an instrument of precision that will give you good and better service. Obtainable from your dealer.

**JACKSON BROS.**  
B. POLAND ST- OXFORD ST Telephone: GEF. RARD 7414  
LONDON - W.1 (2nd Floor)

**WIRELESS AND THE STRIKE**

The recent crisis must have proved to everyone that a RELIABLE AND EFFICIENT radio set is a NECESSITY in every home, and DUNHAM'S SETS ARE A VALVE AHEAD OF ANY OTHER MAKES. BUY YOUR DUNHAM RECEIVER TO-DAY ON OUR SPECIALLY EASY REDUCED TERMS.

Complete installations from 3/6 monthly. NO DEPOSIT REQUIRED.

Send 2d. stamps for new catalogue of our 14 different models.

Your own receiver taken in part exchange if desired.

**C. S. DUNHAM, RADIO ENGINEER**  
(Lab. of Marconi Sc. Inst. Co.)  
Easy Terms Dept., 1, 4-8, Brixton Hill, London, S.W.9

**Two in One!**

The new Dual Rheostat—a "Peerless" product in every way. Specially designed to meet the demand for a resistance equally applicable to bright or dull emitters. It has two windings—one offering a resistance of 6 ohms, whilst a continuation of this is of 30 ohms resistance. The resistance element is wound on a hard fibre strip under great tension. One hole fixing is provided and the terminals are placed in convenient positions. The contact arm has a smooth, silky action, and all metal parts are nickel-plated.

Ask your Dealer or send direct

**3/9 PEERLESS 3/9 DUAL RHEOSTAT**

**THE BEDFORD ELECTRICAL & RADIO CO., LTD.,**  
22, Campbell Road, Bedford.



# FIFTEEN STATIONS ON THE LOUD-SPEAKER IN DAYLIGHT!

By J. H. REYNER, B.Sc. (Hons.),  
A.C.G.I., D.I.C., A.M.I.E.E.,  
Joint Editor.

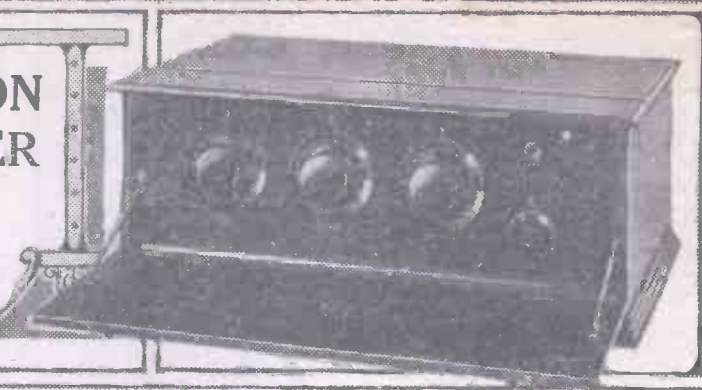

Some operating notes for the "Magic Five" receiver, full constructional details of which appeared in our last issue.

LAST week I gave the principal constructional details of the "Magic Five" receiver, and this week I propose to describe how to operate the receiver, when made, in order to obtain the best results from it. The receiver continues to give excellent results, as will be seen from the test report at the end of this article, while the large number of stations that can be received on the loud-speaker in daylight renders the set one which is well worth constructing for use during the summer months when darkness does not arrive until comparatively late in the evening.

### Neutralising

As was stated last week, the first operation in adjusting the receiver is to tune in to the local station, the neutralising condensers being placed about one-third of the way round. By this is meant one-third of the way

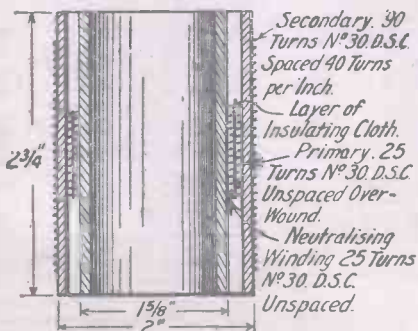

Fig. 1.—Full particulars for the construction of the special coils may be obtained from this drawing.

in, so that the capacity is about one-third of the maximum capacity obtained with the plates all in. The position shown in Fig. 2 of the description last week is two-thirds of the way round, and in this position the capacity will usually be found to be too much for normal working.

Having tuned in the local station, remove the first fixed resistor, and adjust the first neutralising condenser until no signals are heard. The variable condensers should be slightly re-

tuned at this point to make sure that the neutralising is properly effective. Now replace the first fixed resistor and remove the second, adjusting the second stabilising condenser in a similar manner. The circuit is now correctly adjusted, and searching may be carried out.

With this adjustment the circuit will remain stable from top to bottom of the range, and although better results may be obtained by a slight readjustment, as will be described shortly, it is advisable to try out the receiver in this condition first in order to obtain some idea of the handling.

### Searching

Starting with the local station, to which the receiver has already been tuned, rotate the dials a little at a time one after the other, when various other stations will be heard. In order to facilitate the testing of the receiver a test report has been drawn up giving the dial readings as expected. The actual readings will, of course, differ in individual receivers, but the log given will be of assistance. Telephones may be used at first until the operation of the tuning controls has been mastered.

### Final Adjustments

The golden rule is to move the controls a little at a time. There will be a slight rushing sound when the receiver is in tune, and this will assist in keeping the set adjusted. I have detailed the process of tuning very carefully, not because it is difficult—it is really rather easy—but because it is a little different from the usual, and no signals will be heard unless all three dials are approximately in the correct position.

Having mastered the art of tuning the set, which will not take very long, the H.F. valves may be brought to their more sensitive and final condition as follows. Increase the capacity of the first neutralising condenser very slightly, by rotating the plates towards the maximum position two or three degrees.

Now search on the receiver towards the bottom of the scale and observe

if there is any sign of oscillation. It will be found that the receiver tends to oscillate most readily when the dials are set around 60 degrees. Search in this region just as if a station were being tuned in, by adjusting to the rushing noise.

### Checking Oscillation

It may be found that at one point the set bursts into oscillation as the condensers come into tune. If this is so, reduce the neutralising condenser till the oscillation ceases. If not, the neutralising condenser may be increased until oscillation is obtained, and the condenser should finally be adjusted until it is two or three degrees below the oscillation point, so that no oscillation occurs at any point of the range. This position on my receiver occurs at about 10 degrees beyond the correct neutral position.

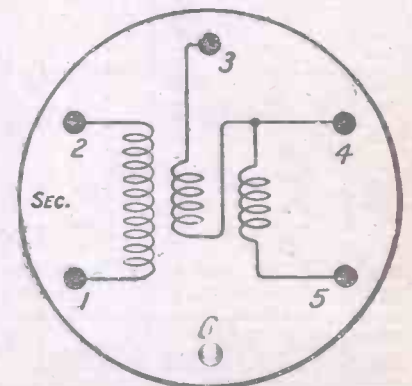

Fig. 2.—The connections from the actual coils to the pins on the ebonite mount are shown above in theoretical form.

Now repeat the process with the second neutralising condenser, adjusting it just below the oscillating position in the same manner. Do not leave these condensers just on the edge of oscillation, but two or three degrees below. The best results are obtained with the receiver in a perfectly stable condition, so be content to stop well below the oscillation point in each case.

(Continued on page 71.)

# Cōpex Shielded Coils for The Magic Five



MANY attempts have, in the past, been made to effectively deal with the problem of losses due to stray coupling. Now, however, in collaboration, with Mr. J. H. Reyner, B.Sc. (the designer of the "Magic Five"), Peto-Scott's have evolved the Cōpex Coil. This new Coil gets right to the root of the interference trouble; the metal screen which covers the coil definitely eliminates all inter-action.

Using Cōpex Coils, the "Magic Five" (described last week) is remarkably stable, and exceedingly selective and sensitive. Before building this set you would do well to write for particulars of the Pilot System of Construction—whereby you can be assured of satisfactory results. Sixpence in stamps will bring you the famous Pilot Manual.

### For the Magic Five

- Aerial Coil (B.B.C. wavelengths) 4/6
- (Prices of other ranges on application)
- Special H.F. Transformer .. 7/6

Pat. applied for.

**Build the PILOT WAY—we guarantee you good results.**

THE "MAGIC FIVE" designed by Mr. J. H. Reyner, described in "Wireless," May 29th, 1926.

- "Pilot" Type "B" Kit of Components, comprises the following:—
- 3 "Keystone" Spiral Contact Condensers, 0005 mfd., fitted with 4 in. dials .. 1 10 0
- 3 "Cōpex" Shrouds and Bases 2 5 0
- 1 "Cōpex" Aerial Coil (250-500 metres) .. 0 4 6
- 2 "Cōpex" H.F. Transformers (250-500 metres) .. 0 15 0
- 5 Benjamin Anti-phonous Valve Holders .. 0 13 9
- 2 Peto-Scott Board Mounting Neutralising Condensers .. 0 10 0
- 5 Cyldon Fixed Resistors (4 ohms) with mounts .. 1 0 0

- 1 Peto-Scott 5 ohm Rheostat .. 0 3 0
- 1 On-and-Off Switch .. 0 2 0
- 2 B.I. Multi-Ratio L.F. Transformers .. 2 15 0
- 1 T.C.C. Fixed Condenser, 2 mfd. Square Tinned Copper Wire, Screws, Nuts, etc. .... 0 1 7
- Radio Press Diagrams .. 0 3 0
- £10 7 6**

- 1 "Red Triangle" Ebonite Panel, 21 x 7 x 1/4 in., matted and drilled .. 0 12 6
- Engraving extra .. 0 1 6
- 1 Terminal Strip, 21 x 1 x 1/4 in., complete with 13 terminals .. 0 5 0
- Polished Mahogany Cabinet with Baseboard .. 2 17 6

**N.B.**—When a complete set of parts is purchased at the same time as the panel, a Marconi Royalty of 12s. 6d. per valve holder must be remitted with order.

## PETO-SCOTT CO., LTD.

Head Office, Mail Order and Works: 77, CITY ROAD, E.C.1, and at 62, High Holborn, W.C.1, Walthamstow, Liverpool and Plymouth.

## PILOT SERVICE ENSURES SATISFACTION



**CRYSTALS COME & CRYSTALS GO**

**RUSSELL'S HERTZITE**

THE FAVOURITE & UNRIVALLED

PRICE 1/6 FROM ALL FIRST CLASS WIRELESS DEALERS THE LG RUSSELL LABORATORIES 1-7 HILL ST BIRMINGHAM

# TEMPRYTES

(REGD. TRADE MARK.)

The Perfect Control for all Valve Filaments

Manufactured in values to suit all valves. From 3 to 50 ohms.

2/6

Holder Mountings for Temprytes - 1/6 each.

Full particulars with valve chart on application.



(pronounced Sil-don)

## Grounded Rotor Condensers

The absolute pinnacle of Condenser Perfection.

Square Law.		Straight Line Frequency.	
'001 Mfds.	21/- each	'0005 Mfds.	15/6 each
'0005 "	17/6 "	'0035 "	15/- "
'0003 "	16/6 "	'0025 "	14/6 "
'00025 "	16/- "		
'0002 "	15/6 "		
'0005 Dual	27/6 "		
'0003 "	25/- "		

With 4" Knob Dial.

Large 4" Knob Dial, as supplied with Square Law Condensers - 2/- "

ALL POST FREE BY RETURN ON RECEIPT OF REMITTANCE.

From the Manufacturers: **SYDNEY S. BIRD**  
 Cyldon Works, Sarnesfield Road, Enfield Town.  
 Phone: ENFIELD 672.

## SUBSCRIPTION RATES

FOR RADIO PRESS JOURNALS.

### MODERN WIRELESS

- 15/- per annum United Kingdom.
- 13/6 per annum Canada and Newfoundland.
- 15/- per annum Other Countries.
- Lesser periods than 12 months pro rata.

### THE WIRELESS CONSTRUCTOR

- 8/6 per annum United Kingdom.
- 7/6 per annum Canada and Newfoundland.
- 8/6 per annum Other Countries.
- Lesser periods than 12 months pro rata.

### WIRELESS

(Incorporating Wireless Weekly)

- 13/- per annum United Kingdom.
- 13/- per annum Canada and Newfoundland.
- 13/- per annum Other Countries.
- Lesser periods than 12 months pro rata.

### THE WIRELESS DEALER

(Available to the Trade only)

7/6 per annum (10/- abroad).

N.B.—Business letter heading or trade card must be sent with subscription.

**RADIO PRESS LIMITED,**  
 Bush House, Strand, London, W.C.2



**"BRITINOL" SELF-FLUXING WIRE SOLDER**  
 is the safe solder for Radio, easy, quick and economical too. No flux is needed, and the SKILL is IN the Wire. Right on the job, even if in an "inaccessible" spot. It cannot possibly corrode or damage the most delicate piece of work. Get a 1/2 or 66. carton from your dealer to-day, or post free from the sole makers.  
**BI-METALS LTD.** Dept. 8, SUGAR HOUSE LANE, LONDON, E.15

**WIRELESS WAREHOUSE**

THE SMALL ADVERTISEMENT WITH A WONDERFUL SERVICE.

Write for Free List.



32 Swan Street, Manchester

**06 DE'S 10/6**  
 Our Valves are admitted to be the best British made valves on the market, 3 Volt '06 L F or H.F. only 10/6 2 Volt '34 only 10/6. Power Valves from 12/6. Write at once for our FREE BOOK and get full particulars. If your dealer is "tied" we supply direct. **RADION LTD.** Radion Works, BOLLINGTON, Macclesfield, Cheshire

**WIND YOUR OWN COILS**  
 on the W.W. Coil Former, price 1/3, and get the most out of your set. Made in 3 sizes, 17, 23 and 24 pegs per side, 2-in. core. All pegs pack inside the handle. Full instructions enclosed. From your Wireless Dealer or post free 1/6 from **W. WILKINSON & Co. (Dept. W.)**, Bedford St., Nth. Halifax (state size required). Trade enquiries invited.

**PICKETTS CABINETS**  
 For every Wireless Constructor.  
 Send for Cabinet Designs and Lists free.  
 Picketts (W.L.) Cabinet Works, Bealey-Heath.

**LUSTROLOX**  
**WIRELESS VALVES**  
 THE ECONOMICAL COMBINATION.  
 2V '06 H.F. & L.F. each 9/-  
 2V '34 P.V. " 11/-  
 Obtainable from LEWIS'S LTD., Liverpool and Manchester, & LUSTROLOX LTD., West Bollington, nr. Macclesfield.

**LITTLE WIRELESS CABINETS**  
**MAP**  
 SMALL PARTS TO THE TRADE.  
**MAP Co., 246, Gt. Lister St., Birmingham.**

All communications regarding advertisements should be addressed to:  
**The Advertisement Manager,**  
**"WIRELESS,"**  
**Bush House, Strand, London, W.C.2**  
 Telephone: City 9911.

Have you a **CRYSTAL SET?**

Why not exchange it for a Loud Speaker Valve Set? We need not emphasize the advantages—you know them!

Read this:

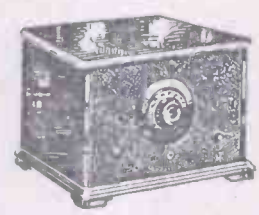

Absolutely complete, including Loud Speaker, Phones, D.E. Valves, Batteries, Leads, Aerial, etc., etc.

For a few weeks only, to quickly introduce the new, powerful General Radio Broadcast Receivers into various sections of the country, we will accept in part exchange any type of Crystal Set with phones, and allow one pound for same.

Not only that, but—

The balance is payable by twelve monthly instalments of 20/- each only.

And too—

Our Receivers will be installed by our Direct Representatives, anywhere, free!

This offer is limited to a certain number of sets. Full particulars free and without obligation—ask for booklet W. Write NOW to avoid disappointment.

**GENERAL RADIO COMPANY, LIMITED, Radio House, 235, Regent St., London, W.1**

**RESULTS OF "CARTOONIGRAFS" COMPETITION**

No. 5.—TALKS.

**FIRST PRIZE:** The B.B.C. talks may afford, A reason for some to applaud, But some pull wry faces, And we have known cases Where "dry-rot" affected the "bored."

**H. PEDDER, 3, Selby Avenue, St. Albans.**

**SECOND PRIZE:** Where "down"-cast fits better than "broad."  
**P. MEADOWS, 47, Northway, Golders Green, N.W.11.**

**THIRD PRIZE:** Of such language that ice could be thawed.  
**H. J. SHUKER, 59, Duckett Road, Harringay, N.4.**

**CONSOLATION PRIZES:**—The following fifty competitors have each been awarded a Consolation Prize, consisting of three Radio Press Handbooks or Envelopes, each book or envelope not exceeding 2s. 6d. in price. Will those readers whose names appear below, please communicate their choice by letter to the Editor, WIRELESS, Radio Press, Ltd., Bush House, London, W.C.2, marking the envelope "Consolation Prize"? Lists of Radio Press Handbooks and Envelopes were given in the issue of April 24th.

- A. D. Buckmaster, Bank of England, 5/6, Lombard Street, E.C.
- Albert Walker, 8, Osborne Villas, Hove, Brighton, Sussex.
- Walter Scott, 37, Regent Street, Hemsworth, Pontefract.
- L. Rook, 2, Marian Avenue, Woodhouse, Leeds, Yorkshire.
- K. R. Jackson, 109, Harlaxton Drive, Lenton, Nottingham.
- Henry Firth, 1, Pemberton Drive, Bradford, Yorks.
- H. C. Blyth, 120, Beecham Road, Reading.
- Bessie Cole, 66, Bertram Road, Smethwick, Birmingham.
- A. L. Boots, 21, Upton Road, Thornton Heath, Surrey.
- E. G. Clarke, 100, Eisenham Street, Southfields, S.W.18.
- J. N. Foster, 30, Croft Avenue, South Shields, Durham.
- D. Riley, 6, Acqueduct Street, Burnley, Lancs.
- H. Braithwaite, 58, St. Catherine's Road, Southbourne, Bournemouth.
- Catherine's Road, Southbourne, Bournemouth.
- T. W. Scarborough, Royston, 77, Norfolk Road, Cliftonville, Margate.
- F. W. Clabbon, 42, Callcott Road, Brondesbury, N.W.6.
- J. Lusby, 9, Dowgate Hill, Cannon Street, London, E.C.
- A. Tillyer, 6, Love Lane, Pinner, Middlesex.
- Geo. Warburton, 1, Heathbank Avenue, Liscard, Wallasey, Cheshire.
- W. Helmore, 98, Capel Road, Forest Gate, London, E.7.
- L. Swindale, 6, Brassie Avenue, E. Acton, W.3.
- D. M. Quayle, Hartshill, Ramsey,

- Isle of Man. L. V. Smee, 31, Queen Street, Market Rasen, Lincs.
- John Swarbrick, Calder Terrace, Catterall, near Garstang, N. Allanson Bailey, 3, Ferndale Road, Teignmouth S. Devon.
- R. H. Conlan, 152, Ashton Old Road, Hr. Openshaw, Manchester.
- T. Stockton, 67, King Street West, Stockport, Cheshire.
- P. Ward, 49, Karslake Road, Wavertree, Liverpool.
- Ross Smyth, Clyde Place, Perth.
- E. A. Renouf, 72, Cumberland Road, Bristol.
- Ben. D. Parkinson, 124, High Street, Worsbro' Dale, near Barnsley, Yorks.
- E. E. Jeffreys, 15, Oakwood Road, Golders Green, N.W.11.
- G. W. Breedon-Barker, 25, Alexandra Road, Rugby, Warwickshire.
- W. H. Morgan, 36, Longford Street, Regent's Park, N.W.1.
- G. L. Bishop, School House, Powick, Worcester.
- G. B. Granger, 375, Stratford Road, Sparkhill, Birmingham.
- Arthur Hughes, 163, Ladbroke Grove, North Kensington, W.11.
- W. H. Rooks, 2, Coastguard Station, Carrickfergus, N. Ireland.
- E. G. Dillaway, "Lynton," Bath Road, Maidenhead, Berks.
- B. R. Howland, 13, Hawkes Lane, Canterbury.
- Noel O'Reilly, 6, Cadogan Road, Fairview, Dublin.
- G. Granness, Meadowlea, Bradley Avenue, Thundersley, Essex.
- F. G. Minshull, 11, Park Street, Greenheys, Manchester.
- Thomas Ferguson, 50, North Junction Street, Leith.
- Arthur B. Collingwood, 5, Elmwood Road, Wallasey, Cheshire.
- James Flavell, 241, South Lambeth Road, S.W.8.
- H. Girdlestone, 4, Lulworth Avenue, Waterloo, near Liverpool.
- W. E. Baines, 11, Beaconsfield Avenue, Colchester.
- M. H. Routledge, "Newlyn," Hampton Road, Worcester Park, Surrey.
- F. W. Cook, 323, Hainault Road, Leytonstone, E.11.
- George Tabberer, Netherlea, Lythalls Lane, Coventry.



# OPERATING EVERYBODY'S WAVEMETER

By A. JOHNSON-RANDALL

Some notes of particular interest to those who have constructed the wavemeter described in the May 22 issue.

**I**N a recent issue of WIRELESS I described the construction of a simple buzzer wavemeter employing a plug-in coil. I mention this last point since the use of this type of coil makes it possible to use the instrument over a wide band of wavelengths, including that of Daventry and Radio-Paris.

### Coil Size

For the broadcast band the No. 60 "X" coil specified in the list of components in the previous article will enable a calibration to be obtained which will include the relay and main stations up to Aberdeen; in fact, it is fairly safe to say that this size of coil in conjunction with the .0005 variable condenser will cover a band from about 280-550 metres with a very good degree of accuracy. It would, provided it was calibrated against another accurate instrument, go a little lower than this, but on the bottom end of the condenser scale a number of points would have to be found in order to decide the exact shape of this portion of the tuning curve.

### Procedure for Use

We will therefore proceed on the assumption that a No. 60 coil has been placed in the socket and connected up as shown in the wiring diagram. The switch should now be placed in the "on" position and the buzzer adjusted until a high, even note is obtained. Now place the instrument

near a receiver which has previously been tuned in to a station operating on the normal broadcast band, say, the local station. Rotate the con-

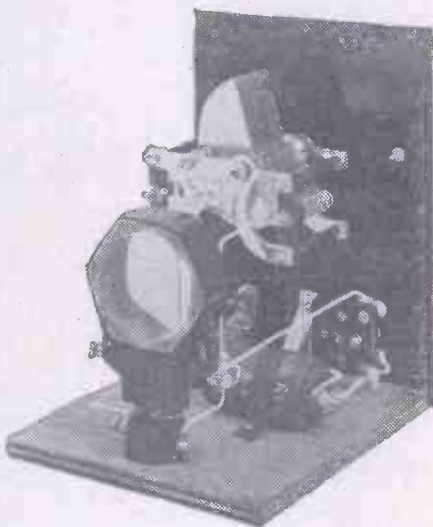

The compact, yet efficient, arrangement of the components may be seen in this back-of-panel photograph.

denser dial on the wavemeter and listen in the loud-speaker or telephones for a buzzing sound.

If the instrument is placed very

near to the set, for instance, within 1 ft. or so from the aerial coil, it is highly probable that the "buzz" will be audible over a number of degrees on the condenser dial. The point where the "buzz" is loudest indicates the setting on the condenser which corresponds to the wavelength to which the receiver is tuned. It is advisable to try the effect of moving the wavemeter to various positions relative to the receiving set until there is no doubt as to the position on the dial which produces a maximum "buzz" in the loud-speaker or telephones.

### Calibration

There are two ways of calibrating the instrument. The first method is to obtain a tuning chart by comparison with another wavemeter known to be accurate. This could be carried out with the aid of a friend in the possession of a suitable instrument or for a small charge by one of the manufacturers who undertake this class of work.

The second method may possibly appeal more to the average home constructor. The procedure is as follows:—

At fairly regular intervals readers will remember that the wavelengths of the B.B.C. stations have been determined at the WIRELESS Laboratories and published, together with the

(Continued on page 71.)

## No. 36.

## "Distorted Amplification!"

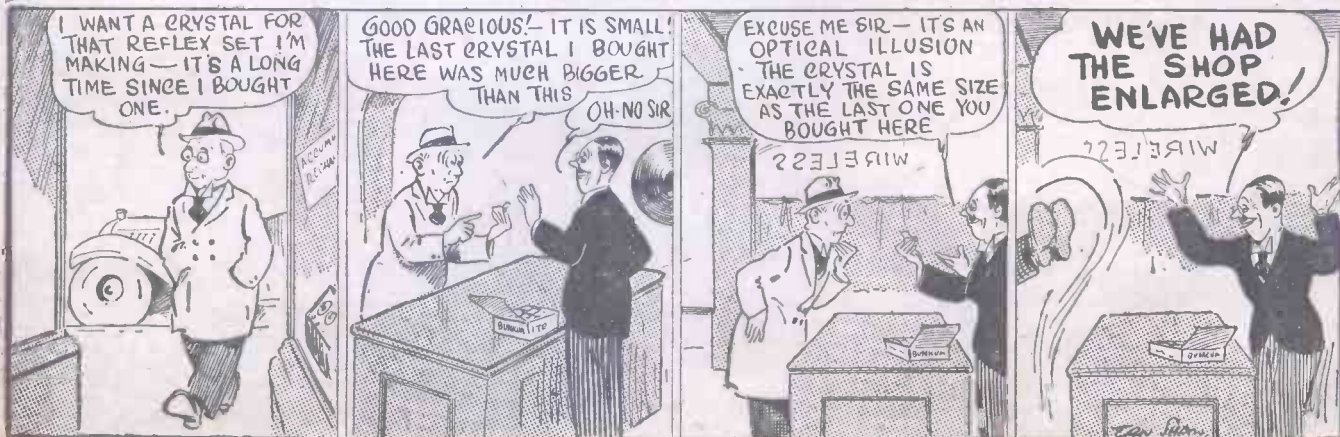

**BEHIND THE SCENES, Etc.**

(Continued from page 61)

people, business was "above par." "Quite hectic" is the correct expression. All artists who were within easy reach of the stations were called upon, and they too came up to scratch marvellously at short notice.

**Captain Eckersley Explains**

A number of listeners, too, who were using small sets which were normally out of range for reception from one or other of the stations, were able to hear the news bulletins during the strike. They, very naturally, want to know why they cannot now obtain the same strength of signals. It was decided that, during the strike, all news should be sent out with the greatest power possible. To use our Chief Engineer's own words:—

"During the strike we decided that the news bulletins must be sent out with all possible power. For once in a way we deserted our principle of sacrificing everything to quality of reproduction.

"The engineers in all the control rooms were definitely instructed to over-modulate. This is an expedient freely used on the Continent; at the cost of tonal purity, it slightly extends the audible range of a station.

"Since our object was to disseminate the news as far and wide as possible, we had recourse to this over-modulation, with the result that some small sets in remote districts were able to hear signals from a station normally out of range.

"Directly after the news bulletins the engineers reduced modulation to the normal level, so that our programmes were sent out in the usual way. On Saturday we stopped the 'extra spurt' on the news bulletins.

"Already we have received a round dozen of letters complaining that now they cannot hear the news bulletins as clearly as they did during the strike. But we have excellent reasons for not continuing to over-modulate for one day longer than the emergency demanded.

"In normal times the control of the Oxford Street transmitter (in fact all of our transmitters) is as heavy as is con-

sistent with undistorted transmission. To increase the control must result in abandoning our high standards of quality.

"Our other reason for refusing to continue this special effort is more important. We do not want to sacrifice the owners of good sets and aerials to the few listeners who have inferior apparatus. In most cases the result of the over-modulation is poor quality and 'blasting,' and there is no longer any reason why this should be inflicted on listeners, for the sake of a handful, who would not otherwise hear clearly.

"We must cater for the owners of efficient sets, who are in a big majority, and we won't give up our ideal of quality.

"It is worth noting that several of the Continental countries which have long been over-modulating are now beginning to transmit in the British way. I think it must be because Daventry has put them to shame before their listeners. Even some of the French stations, whose quality was spoilt by blasting, have considerably reduced their modulation in the past few weeks."

At the B.B.C. everyone is glad that the strike is over—we, at any rate,

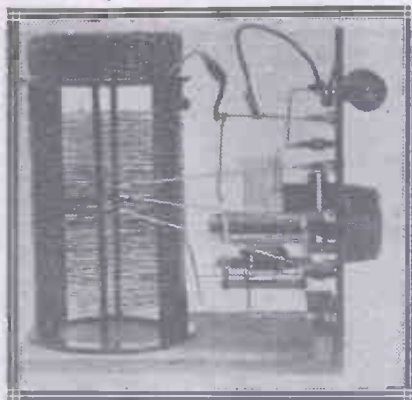

The "Three Step" coil (first described in this Journal) is being used in far lands, if one may judge by this photograph sent us by a reader in Finland.

are back to normal once again and business is "as usual."

I hope, my reader, that all is equally "up to par" with you.

**TEST REPORT ON THE "MAGIC FIVE" RECEIVER**

(Continued from page 67)

All the stations below were obtained on the loud-speaker at night. Those marked DLS gave loud-speaker signals during the daytime, while those marked DT could be heard on 'phones in daylight.

Approx. dial Setting	Station.	Remarks.
157 ..	Zurich	
150 ..	Aberdeen	DT
147 ..	Brussels	
146 ..	Swansea	
145 ..	Lyons	
144 ..	Birmingham	DLS
142 ..	Frankfurt	DT
141 ..	French Station	Unidentified
138 ..	Radio Catalana	
134 ..	Croydon	
	Harmonic	DLS
133 ..	Stuttgart	
132 ..	Belfast	DT
129 ..	Berne	
125 ..	Rome	
124 ..	Glasgow	
121 ..	Munster	DLS
119 ..	Newcastle	DLS
118 ..	Dublin	DLS
114 ..	Radio-Iberica	
112 ..	Hamburg	DLS
110 ..	Bournemouth	DLS
108 ..	Manchester	DLS
102 ..	London	DLS
98 ..	Cardiff	DLS with wave-trap
96 ..	San Sebastian	With wave-trap
94 ..	Plymouth	trap
92 ..	Hull	DLS
90 ..	Liverpool	DLS
89 ..	Leeds	DT
88 ..	Nottingham	DLS
86 ..	Barcelona	
84 ..	Bradford	
82 ..	Sheffield	DT
80 ..	Stoke-on-Trent	DLS
78 ..	Hanover	
75 ..	Dortmund	
71 ..	Radio-Toulouse	
68 ..	Cassel	
59 ..	Brussels	
56 ..	Elberfeld	DLS
53 ..	Stettin	
14 ..	Unidentified amateur working on 180 metres	

**OPERATING EVERYBODY'S WAVEMETER**

(Continued from page 70)

date and time at which the measurements were made. It will also be remembered that adequate warning was given to enable those readers who wished to calibrate their receivers or wavemeters by tuning in the various stations at the time stated and noting the adjustments required.

**Using the "Wireless" Calibration Scheme**

All that is necessary then is to watch for the next announcement as to the date and times when the measurements will be made and to tune

in as many of the stations as possible, noting carefully the adjustments necessary on the receiver. Then carry out the procedure previously explained in the example given, determining as accurately as possible the setting of the wavemeter condenser corresponding to the adjustment on the receiving set for a given B.B.C. station. Do this with every adjustment recorded, and against each wavemeter dial setting write down the equivalent wavelength published in WIRELESS. Next obtain a piece of squared paper, and proceed to make a tuning chart.

**Making the Chart**

Mark out the squared paper, writing down wavelengths vertically, say 20 metres increase for every 10 of the small squares, and dial settings hori-

zontally, this time using one small square for each degree of dial reading. Put a cross or a dot opposite each wavelength and its equivalent condenser reading. Draw a line, or a curve as it is called, through these crosses or dots, and your tuning chart is complete.

To adjust the receiving set to any given wavelength with the aid of the wavemeter, set the condenser dial to the number of degrees which represents the wavelength (obtained from the chart) and start the buzzer. Place the instrument near to the set, and adjust the receiver until the loudest "buzz" is heard in the telephones or loud-speaker. The set is then adjusted to the required wavelength. In the case of Daventry or Radio-Paris a No. 250 "X" coil will be necessary.

# PRACTICAL TOPICS

By G. P. KENDALL, B.Sc., Assistant Editor

*Those Battery Plugs—Trimming Panels—Dials for Short-wave Sets*

## Those Battery Plugs

Of all the thoroughly unsatisfactory devices with which we still have to put up in wireless, one that annoys me most is that abominable institution the plug and socket connection upon the H.T. battery. Remember that a poor connection here is certain to produce the most objectionable noises in one's ears, and then consider how very unsatisfactory an arrangement is provided on most batteries. There is a series of very small-sized sockets, and making connection with these we have small and, as a rule, very poorly made, soft brass split plugs, which, upon being inserted and withdrawn a few times, become compressed and fail to fit their sockets tightly.

Will no one give us a plug which can be depended upon to make really positive contact and not to require opening out with a knife-blade every so often? Perhaps a plug could be produced upon the same principle as the newer type of valve pin, namely, with four contact springs of a hard material which does not readily become "tired." The present type of plug is really a nuisance, and the only sort of battery I know upon which one can make a good and dependable contact is the variety with which one makes connection by inserting wires in spring clip terminals.

## Trimming Panels

The problem of what to do with an ebonite panel which proves to be a trifle too large for the cabinet for which it is intended is one which causes most people to resort to a file for the necessary reduction, but I wonder how many readers know how much better a job can be done by scraping? To take, say, one sixteenth of an inch off the edge of a panel with a file in such a way that the result is square and true is a matter calling for much greater skill than most of us possess in the use of this tool, whereas the alternative method is exceedingly simple.

Clamp the ebonite panel with the edge upon which you desire to operate upwards in the vice, taking care to cover the jaws of the vice with something soft to protect the ebonite from them, and then proceed to scrape carefully and evenly along the edge of

the panel, looking occasionally along the edge to see whether operations are proceeding correctly.

## Improvised Scrapers

The scraper can consist of a variety of improvised objects, the one which I find the most useful being a steel ruler whose edges are square and sharp. A strong knife can be used in the same way, being held with the blade at right angles to the surface which is being scraped, so that the edge does not tend to cut, but rather to scrape.

The process may sound a tedious



*Quite a number of the foreign broadcasting stations have artistic studios similar to those in this country, as is evidenced by this view of Radio-Paris.*

way, but actually it is quite quick, and a considerable quantity of material can be moved in a very short time, a special attraction of this method being that it is very easy to keep the edge of the panel square and true.

## Dials for Short-wave Work

The choice of a slow-motion dial for the tuning condenser of a short-wave receiver is a matter upon which a little advice dictated by experience may be helpful. In the first place, I should like to mention that no short-wave receiver which I have yet tried was capable of being used without a vernier dial upon waves of the order of 23 or 45 metres, so that it will be seen that the question is one affecting every user of a really short-wave set. There are alternatives to the vernier dial, of course, such as the use of a

separate small vernier condenser, a very long extension handle, and so on, but there can be little doubt that in the average set, the slow-motion dial is the best expedient.

The reader who is new to short-wave work may not perhaps realise how important this question is, but he will quickly do so when he learns that upon waves of the order of 23 metres it is no uncommon thing to find that in one of the simple types of sets it is not possible even to find a Morse signal unless some form of very slow drive is used for the condenser. The actual motion of the dial which corresponds between the station being properly tuned-in and entirely inaudible is so slight that one can quite easily go through it in one of the intervals between the dots and dashes of the Morse signals, so that it is evident that the condenser must be turned extremely slowly.

## What is Needed

Upon the short waves it is absolutely fatal to have even the slightest degree of backlash in the vernier drive and it is therefore evident that the vernier dial must be one of even higher quality than is necessary upon the broadcast band. Another point: It is very desirable in my opinion that the dial should turn in the same direction as the driving knob is turned. To me nothing is more exasperating than to turn the knob of the slow-motion device one way and to see the condenser turn in the opposite direction.

The actual ratio to choose depends upon various things, chief among them being the capacity of the condenser which is used (the larger the capacity the greater the reduction should be), the degree of skill possessed by the operator, and the actual wavelength upon which it is desired to work. The shorter the wave, of course, the greater the reduction ratio

which is desirable in the slow-motion drive. Probably a ratio of not less than 5 to 1 will serve the majority of purposes, provided that the operator possesses a fairly delicate touch. If, on the contrary, he likes to be able to dispense with any fiddling operation, so that he can turn his dial quite roughly and freely, a much greater reduction of 15 or 20 to 1 would be desirable, in which case it will be found that there is very little difficulty in tuning-in even quite weak signals. The only objection to such a large reduction, of course, is the rather tedious nature of the process of searching.

**NEXT WEEK.**

**A NOVEL SINGLE-VALVE REFLEX RECEIVER**

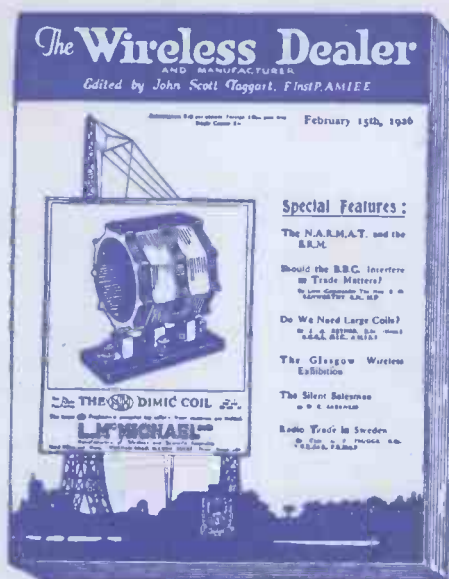

**P**UBLISHED by an organisation whose publications are solely "wireless," THE DEALER is produced by Radio People for the Radio Trade.

## The authoritative journal read by every good dealer

**A**LMOST every post brings to us appreciation of THE WIRELESS DEALER—the authoritative journal of the Wireless Industry. The rapidly growing list of subscribers is kept abreast of the times, informed of new developments in Radio Design, and is given in a very important feature, "What the Wireless Journals are doing."

Every dealer should make a point of reading this article every month ; it is invaluable for keeping up your stocks. One hundred pages full of trade information.

Fill in the attached form NOW and keep your business ahead of its competitors.

To The Sales Manager, Radio Press, Ltd.,  
Bush House, Strand, London, W.C.2.

Please enter my/our name for a year's subscription to THE WIRELESS DEALER to commence with the....., 1926 issue. Enclosed is remittance of 7/6 (10/- abroad), together with Trade Card/Official Letter Heading.

Name .....

Address .....

Use the Advertisement pages of THE WIRELESS DEALER for your business announcements.

All communications regarding "space" should be addressed to The Advertisement Manager, THE WIRELESS DEALER, Bush House, Strand, London, W.C.2.

# Don't leave it to Chance



To buy a few components, mount them up and wire them together, may give you a wireless set, but will it give you reception of broadcast programmes just as you would like it?

Some of those components may be square pegs in round holes, not quite "in tune" with the rest of the circuit—transformers especially.

That is why there is such a large sale for the R.I. Multi-Ratio Transformer. It is absolutely at home in any circuit and with any valve; it is made by a firm whose products in the Radio Industry have never been excelled, and those products give you confidence.

Many conflicting statements have been made as to whether the impedance of a transformer should match that of the valve, but it is a fact that, whatever valve you may be using, one of the impedances available in the R.I. Multi-Ratio Transformer will be absolutely suitable.

You need leave nothing to chance; the R.I. Multi-Ratio Transformer eliminates all risk of failure.

**Price 27/6**

Write for Special Leaflet W.

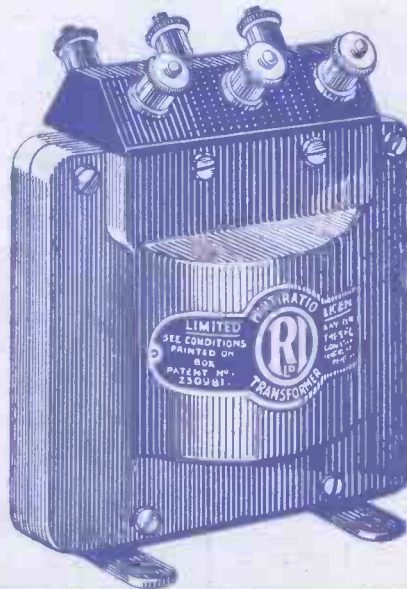

♦ THE MARK OF BETTER RADIO ♦



Advt. R.I. Ltd., 12, Hyde Street, New Oxford Street, London, W.C.1.

P.C. 32

Published by RADIO PRESS, LTD., Bush House, Strand, London, W.C.2, on Tuesday of each week, and printed for them by THE AVENUE PRESS (L. Upcott Gill & Son, Ltd.), 55-57, Drury Lane, W.C.2. Address for Subscriptions and Editorial Communications:—Bush House, Strand, London, W.C.2. Address for Advertisements:—Advertisement Manager, WIRELESS, Bush House, Strand, London, W.C.2. Registered as a newspaper and for transmission by Canadian Magazine Post. Subscription rates:—13s. per annum, 6s. 6d. for six months, post free. Sole Agents for Australasia:—GORDON & GOTCH (Australasia), LTD. For Canada:—IMPERIAL NEWS, LTD. For South Africa:—CENTRAL NEWS AGENCY, LTD.



# "WIRELESS"

INCORPORATING  
"WIRELESS WEEKLY"  
GIFT SHEET

The back of this sheet is gummed so that the Tuning Instructions and Chart can be easily fixed to the lid of your Receiver. Cut as shown by black lines.

## "WIRELESS" TUNING CHART

STATION NAME & CALL	WAVE	DIALS			REMARKS
		1st	2nd	3rd	

### HOW TO AVOID HOWLING

- (1). Always commence with the reaction control at zero.
- (2). Never advance the reaction beyond the point where a click or "plop" occurs or a rustling begins. (This means the set is oscillating).
- (3). If it is necessary to use reaction to pick up a weak station, set the control so that the receiver is safely below the oscillating condition as searching proceeds.
- (4). If reaction seems difficult to handle, adjust the high tension to the detector and high frequency valves, adjust the filament current and, if necessary, the grid leak value, until the set passes smoothly in and out of oscillation without "over-lap" in the reaction adjustment.

### HINTS ON OPERATING A BROADCAST RECEIVER

- To bring this set into use, always adopt the following procedure; it may seem a little troublesome, but it will save time in the end:—
- (1). See that the aerial, earth and batteries are properly connected. (Don't forget to look at the earthing switch).
  - (2). If interchangeable coils are used, make sure that the correct coils and transformers for the desired wavelengths are in their sockets.
  - (3). See that the telephones (or loud-speaker) are properly connected.
  - (4). If your set has a reaction control, see that it is at zero before switching on.
  - (5). Switch on, and, in the case of valves giving a visible glow, see that they all light up properly.
  - (6). If your high tension battery is of the kind with plug and socket connections, see that the plugs are in their correct places.
  - (7). Make sure by consulting the programmes that the station you want is working.