

RADIO LABORATORY HANDBOOK

THIRD EDITION

By

M.G. SCROGGIE
ESQ. M.B.E.

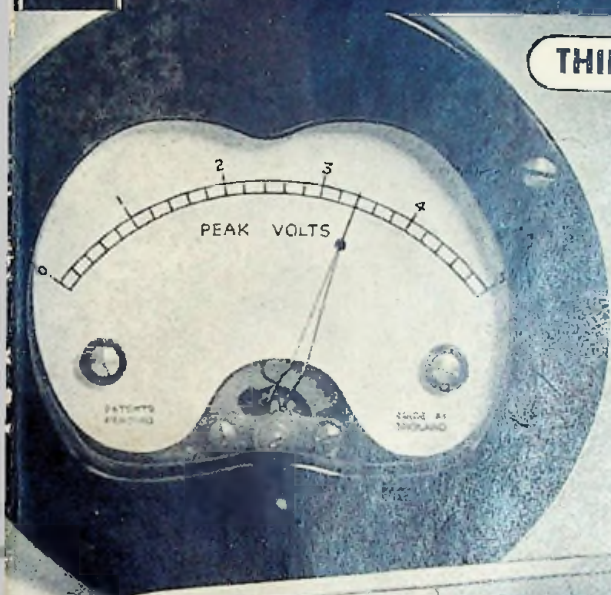

Cap	RF Volts
240	4.5
248	3.4

Historie v/d Radio

THE
FEDERATION

Issued by Wireless World

This handbook gives both the professional radio engineer and enthusiastic amateur experimenter reliable information about laboratory equipment and methods of working because it is written by a practical consulting radio engineer. The reader is assumed to have a knowledge of principles equal to that given in "Foundations of Wireless"; and space is not wasted in reiterating these fundamentals. Besides being fully descriptive of apparatus and methods, the book contains useful formulæ, symbols, abbreviations and tabular matter for day-to-day reference.

BIBLIOTHEEK
N.V.H.R.

S 39

RADIO
LABORATORY
HANDBOOK

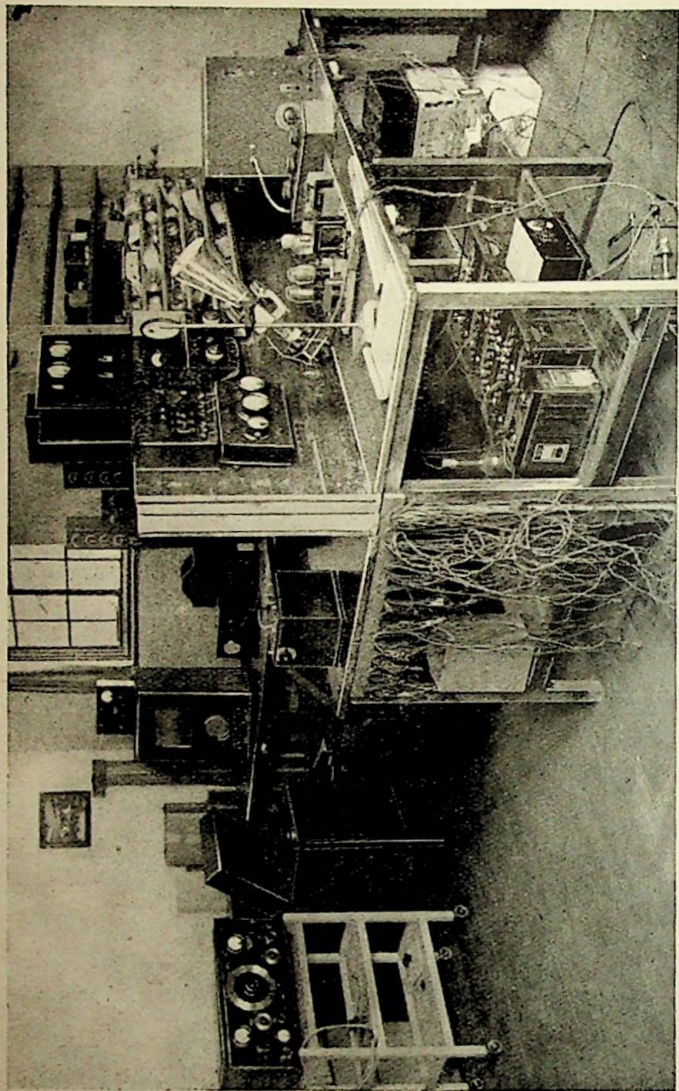

IN THE AUTHOR'S LABORATORY

Frontispiece

RADIO LABORATORY HANDBOOK

By

M. G. Scroggie, B.Sc., A.M.I.E.E.

Consulting Radio Engineer

Third Edition

(Reprinted—May, 1946)



Published by

WIRELESS WORLD

ILIFFE & SONS LTD

DORSET HOUSE, STAMFORD STREET, LONDON S.E.1

PREFACE

YOU, lifting up this book to find out whether it is for dignified engineers, like yourself, and not just for amateurs (or, alternatively, for enthusiastic home-experimenters, like yourself, and not just for dull professionals) are to be informed without delay that it is humbly dedicated to the use of both.

Though the most gifted writer may fail to interest all of the people all the time, it is the present author's hope that he may succeed in interesting some of the people (i.e., all those who experiment in radio, on however small or large a scale) some of the time. The only type of reader in this field who is definitely excluded is the one with the incurably academic mind, for he will be shocked by the frequent references to relative cost. The idea that this motive is too sordid to find a place in serious scientific investigation is a polite fiction, not only as regards the humble amateur but also the largest commercial group or Government establishment. It may generate a delightful sense of purity and loftiness of soul to pretend that expense is simply not considered, but in planning the present work the author presumed to suspect that some of the high-souled ones might not be above snatching a fearful joy by surreptitiously dipping into pages designed to aid the enthusiast in doing things on the cheap.

Then, as regards language, one must neither discourage the tender novice with unexplained technicalities, nor insult the experienced worker with diffuse baby-talk. To give some idea of what is expected of the reader, a knowledge of principles equal to that given in *Foundations of Wireless* is assumed; and space is not wasted in re-digging these foundations.

Made and Printed in England at The Chapel River Press, Andover, Hants

THIS BOOK IS PRODUCED IN COMPLETE CONFORMITY
WITH THE AUTHORIZED ECONOMY STANDARDS.

5/46

PREFACE TO THIRD EDITION

THE war has had at least three effects on this book : it has increased the number of radio technicians and therefore of potential readers ; it has rendered many instruments and components no longer readily obtainable, thus raising the value of improvisation, emphasised herein ; and it has deprived the author of opportunity for extensive revision. Nevertheless, the volume has been brought up to date and clarified in detail, and a number of new illustrations appear. To prevent the extensive sections on dynatron applications becoming void through difficulty in obtaining suitable valves, some alternative negative resistance devices are now described.

M.G.S.

CONTENTS

CHAPTER	PAGE
1 THE END AND THE MEANS	1
1 Purpose of Laboratory. 2 The Question of Equipment. 3 Selecting for Minimum Cost. 4 True Economy. 5 Making One's Own Apparatus.	
2 PREMISES AND LAYOUT	7
6 How Premises affect Results of Work. 7 Buildings to Special Order. 8 Heating and Lighting. 9 The Amateur's Laboratory. 10 Storage. 11 Layout. 12 Arrangement of Apparatus. 13 Benches. 14 Wiring. 15 Earth and Aerial. 16 Connections.	
3 FUNDAMENTAL PRINCIPLES OF MEASUREMENT	23
17 Measurement v. Guesswork. 18 False Assumptions. 19 Fundamentals of Measurement. 20 Choice of Method. 21 Avoiding Errors. 22 The "Personal Equation". 23 The Ear as an Instrument. 24 Subjective Methods. 25 Disentangling the Conclusions. 26 Disturbing Effects due to Instruments. 27 Reproducing Working Conditions.	
4 INSTRUMENTS : A—SOURCES OF POWER AND SIGNALS	33
28 "Signals". 29 "Mains" Power. 30 Batteries and Switch- boards. 31 The Gramophone Source. 32 Valve Oscillators— General Requirements. 33 Resistance Stabilisation. 34 Auto- matic Amplitude Control. 35 Advantage of A.A.C. Circuit for Modulation. 36 A complete A.A.C. Modulated Source. 37 The Dynatron Oscillator. 37a Alternatives to the Dynatron. 37b Resistance - Capacitance Oscillators. 38 "Straight" Audio Sources. 39 The Beat-Frequency Source. 40 Avoiding Pull- in. 41 Designing for Absence of Distortion. 42 Frequency Stability. 43 Commercial Audio Sources. 44 Transmitting Stations. 45 Types of Radio Sources. 46 Wavemeters. 47 Standard Signal Generators. 48 Necessity for Thorough Screening. 49 Accuracy of Signal Strength. 50 The Dummy Aerial. 51 Frequency Control. 52 Modulation. 53 Commer- cial Signal Generators.	
5 INSTRUMENTS : B—INDICATORS	67
54 Choice of Meters. 55 Multi-range Instruments. 56 Charac- teristics of Different Types of Meters. 57 The Rectifier Automatic Shunt. 58 Range Shunts and Multipliers. 59 Watt- meters. 60 Output Power Meters. 61 Ohmmeters. 62 For Low Resistance. 63 For Very High Resistance. 64 Vibration Galvanometers. 65 Valve Voltmeters. 66 Desirable Features. 67 The Square-law Valve Voltmeter. 68 Precautions for V.H.F. 69 The Auto-bias Valve Voltmeter. 70 The Slide-back Valve Voltmeter. 71 The Grid-current Valve Voltmeter. 72 Excluding Errors in Valve Voltmeters. 73 Calibration. 74 Cathode-ray Tubes—Advantages. 75 Principles of Cathode-ray Tubes. 76 Gas Focusing. 77 Electrostatic and Magnetic Focusing. 78 Deflection. 79 Characteristics of Cathode-ray Tubes. 79a Double-Beam Tubes. 80 Power Supplies. 81 Relationship between Signal and Deflection Figure. 82 Sinusoidal Time Base.	

CONTENTS

CHAPTER

PAGE

83 Linear Time Base Systems. 84 The Polar Time Base, and Some Others. 85 The Frequency Base. 86 Mechanical Frequency Modulation. 87 Electronic Frequency Modulation. 88 Deflection Amplifiers. 89 Complete Oscilloscopes. 90 Photographing Oscillograms. 91 Inexpensive Electronic Indicators. 92 Phones and Loud Speakers.

6 INSTRUMENTS : C—STANDARDS OF COMPARISON 125

93 Purpose of Standards. 94 Standards of Resistance. 95 Decade Boxes. 96 Making Standard Resistors. 97 Avoiding Errors in Comparing with Standard. 98 Difference Calibrations. 99 Standards of Capacitance—Mechanical Construction of Variable Condensers. 100 Electrical Characteristics of Condensers. 101 Multi-range Variable Condensers. 102 Fixed Condensers. 103 Standards of Inductance—The Inductometer. 104 Making Inductometers. 105 Fixed Inductances. 106 Reducing the External Field. 107 Avoidance of Eddy Currents. 108 Extending the Ranges of Standards. 109 Bridges—Their Purpose. 110 Practical Points. 111 A.C. Bridges. 112 Necessity for Simultaneous R and X Balances. 113 Ratio Arms. 114 Avoiding Stray Reactances. 115 A.C. Sources. 116 Detectors. 117 Bridge Amplifiers. 118 A General-purpose Bridge. 119 An Inductometer Bridge. 120 A Universal Bridge. 121 Maxwell and Owen Bridges. 122 A Simple Practical Maxwell Bridge. 123 Mains-frequency Bridges. 124 A Laboratory Universal Bridge. 125 Influence of Source Frequency. 126 Frequency Bridges and Meters. 127 Standard Frequency Oscillators. 128 The Absorption Wavemeter. 129 Wavelength and Frequency. 130 Calibration of A.F. Oscillators. 131 Alternative Cathode-ray Method. 132 Use of Auxiliary Oscillator. 133 The Piano as a Standard of Frequency. 134 Comparison of Radio Frequencies with Standards : Multi-vibrators. 135 The Method of Harmonics. 136 Identification of Harmonics. 137 Synchronising Non-generating Circuits. 138 Wavelength Standards. 139 Reckoning Amplification. 140 Standards of Amplification—Attenuation. 141 The Potential Divider. 142 Calculating T and H Attenuators. 143 An Example. 144 The Ladder Attenuator. 144a Other Attenuators.

7 INSTRUMENTS : D—EQUIPMENT AS A WHOLE 188

145 A Concentrate of Apparatus. 146 A Versatile Instrument. 147 Valve Testing. 148 The Dynatron Oscillator. 149 The Dynatron as a Variable Negative Resistance. 150 The Basis of Dynatron Tests. 151 Power Supply. 152 A Dynatron Oscillator Unit. 153 Accessories. 154 A Negative Resistance Bridge. 155 A "Straight" Audio Source. 156 A Slide-back Valve Voltmeter. 157 Details of Construction. 158 Output Measurement. 159 An Output-measuring Adapter. 160 Choice of a Bridge. 161 Devising Special Apparatus. 162 Preparation for an Experiment. 163 Importance of Handiness of Instruments. 164 Layout of Apparatus. 165 Need for Observing Restrictions in Applicability of Apparatus. 166 Personal Risks. 167 Avoiding Damage to Instruments.

8 MEASUREMENTS : COMPONENTS 216

168 Arrangement of this Chapter. **Resistors :** 169 Test-set Measurements. 170 Low Resistances. 171 Resistance Measurement by Voltmeter. 172 High Resistances. 173 Condenser Leakage. 174 Other Resistance Measurements. **Condensers :** 175 Simple Capacitance Testers. 176 Capacitance Bridges.

CONTENTS

CHAPTER		PAGE
	177 Measurements of Loss Factor. 178 Loss Factor of Materials. 179 Large Capacitances. Dynatron Measurements: 180 Principles of Application. 181 An Example of Dynatron Test. 182 Calibration of Small Standard Variable Condenser. 183 Measurement of Very Small Capacitances. 184 Measurement of Reactance Generally. 185 R.F. Resistance by Comparison. 186 Other R.F. Resistance Measurements. 187 Use of Negative-resistance Bridge. 188 Analysis of Results. 189 Possible Sources of Error. 190 Measurement of Inductance. 191 An Alternative Method. 192 Total Circuit Capacitance. 193 Measurement of Self-Capacitance of Coils. 194 Capacitances to Several Elements. 195 Gang Condenser Matching. 196 Measurement of Low Impedances. 197 R.F. Resistance. 197a Q-Meters. 198 Inductance Bridge Methods—Inductometer Bridge. 199 High Inductances by Dye's Shunt Method. 200 Mutual Inductance. 201 The Maxwell Bridge. 202 The Owen Bridge. 203 Other A.F. Methods of Inductance Measurement. 204 Effects of Shorted Turns. 205 Leakage Inductance. 206 Self-capacitance of A.F. Coils. 207 Linearity of Transformers. Loud Speakers: 208 Impedance. 209 Examination of Low-Frequency Defects. 210 Acoustical Measurements. Valves: 211 Nature of Valve "Constants". 212 Static Tests. 213 Cathode-ray Tests. 214 Valve Bridges—Amplification Factor. 215 Anode A.C. Resistance. 216 Mutual Conductance. 217 Input and Output Losses. Aerials: 218 Impedance Measurements.	
9	MEASUREMENTS: SETS	272
	Amplifiers: 219 Need for Using Decibels. 220 Proper Use of Decibels. 221 Measurement of A.F. Gain. 222 Frequency Characteristics. 223 Measurement of Attenuation or Loss. 224 Automatic Frequency-curve Plotting. 225 Avoiding of Overloading. 226 Determination of Overload-point. 227 Load-resistance Characteristics. 228 Detection of Non-linearity by Cathode-ray Tube. 229 Phase Shift. 230 General Usefulness of Cathode-ray Tube in Amplifier Testing. 231 Harmonic Analysis. 232 Measurement of Harmonics. 233 Intermodulation. 234 Modulation Hum. 235 Measurement of Hum. 236 "Weighting" an Amplifier. 237 R.F. Amplifiers—Measurement of Gain. 238 Selectivity Curves. 239 R.F. Non-linearity Distortion. 240 R.F. Modulation Hum. 241 Cross-modulation. Detectors: 242 Informative Characteristics. 243 Technical Procedure. Frequency-changers: 244 Measurement of Heterodyne Voltage. 245 Measurement of Conversion Conductance. Power-units: 246 Output Voltage. 247 Regulation and Cross-regulation Characteristics. 248 Consumption. Receivers: 249 Scope of Tests. 250 Conventional Assumptions. 251 Standard Signals in Frame Aerials. 252 Sensitivity. 253 Reaction Control. 254 Standard Test Frequencies. 255 Sensitivity and Image-ratio Curves. 256 Spurious Responses. 257 Noise. 258 Selectivity. 259 Instantaneous Response-curve Apparatus. 260 A.V.C. Tests. 261 Overload Curves. 262 Overall Frequency Response Curves.	
10	VERY HIGH-FREQUENCY WORK	321
	263 Bounds of V.H.F. 264 How Circuit Diagrams can Mislead. 265 Impedance Limitations. 266 Electronic Transit Time Effects. 267 Typical Circuit Design. 268 Optimum By-pass Capacitance. 269 Below One Metre. 270 Wavemeters and Receivers. 271 Valve Voltmeters at V.H.F. 272 Cathode-ray Tubes. 273 Impedance Measurement at V.H.F. 273a Use of Transmission Line "Circuits". 273b Measurement of Characteristic Impedance.	

CONTENTS

CHAPTER	PAGE
11 DEALING WITH RESULTS 274 Rearranging Formulæ. 275 What may be Neglected. 276 Deceptive Formulæ. 277 Aids to Calculation—Abacs. 278 Graphs. 279 Slide Rules. 280 False Accuracy. 281 Eliminating Errors. 282 Tabular Working. 283 Interpretation of Results. 284 Need for Caution. 285 Deducing Laws. 286 Recording Results. 287 Filing Information.	335
12 FOR REFERENCE 288 Symbols and Abbreviations. 289 Alternating Current. 290 Calculating Impedances. 291 An Example. 292 Valve Circuit Calculations. 293 Resonant Circuits. 294 The Significance of "Q". 295 Resonance Curves. 296 Calculation of Amplification and Selectivity of Tuned Circuits. 297 Coupled Circuits. 298 Resistance. 299 Skin Effect. 300 Inductance. 301 Capacitance. 302 Aerials. 303 Feeders or Transmission Lines. 304 Electro-magnetism. 305 Transformers. 306 Valves. 307 Smoothing and Decoupling Filters. 308 Decibels. 309 Relationship between Musical and Frequency Scales. 310 Standard Frequencies. 311 Wire Tables.	351
APPENDIX Constructional Information on Bridges: 1 Mains-driven Resistance and Capacitance Bridge. Power factor Calibration Table: 2 Modification for Iron Core Inductance Measurement. 3 A Modified Owen Bridge.	387
INDEX	399

LIST OF HALF-TONE ILLUSTRATIONS

IN THE AUTHOR'S LABORATORY	FRONTISPICE PAGE
FURTHER VIEW OF AUTHOR'S LABORATORY	10
THE " QUICK HOOK-UP "	15
CHASSIS FORM OF ASSEMBLY	16
PLATFORM FRAME AND RACK	16
TELEPHONE TYPE OF RACK	17
TROLLEY MOUNTING	18
GENERAL RADIO CO.'S " VARIAC "	34
MARCONI-EKCO T.F.144 SIGNAL GENERATOR	64
HUNT'S SIGNAL GENERATOR, TYPE 4002	65
" RADIOLAB " ALL-PURPOSE TESTER	68
" AVOMINOR " TEST SET	69
" UNIPIVOT " VERSATILE GALVANOMETER	71
GENERAL RADIO OUTPUT POWER METER 583-A	77
" WEE-MEGGER-TESTER "	80
BALDWIN VIBRATION GALVANOMETER	83
GENERAL RADIO VALVE VOLTMETER	91
COSSOR GAS FOCUSED CATHODE-RAY TUBE	100
COSSOR HIGH VACUUM CATHODE-RAY TUBE	101
COSSOR " DOUBLE BEAM " CATHODE-RAY TUBE	104
MOUNTING AND POWER SUPPLY FOR CATHODE-RAY TUBE	107
COSSOR CATHODE-RAY OSCILLOSCOPE	120
ELECTRONIC INDICATORS	122
CAMBRIDGE DECADE SWITCH	131
SULLIVAN-GRIFFITHS VARIABLE CONDENSER	134
MUIRHEAD TYPE 18 VARIABLE CONDENSER	136
MUIRHEAD 1-AV SLOW MOTION DIAL	137
SULLIVAN-GRIFFITHS DUAL RANGE VARIABLE CONDENSER	139
CAMPBELL INDUCTOMETER	141
SULLIVAN-GRIFFITHS STANDARD INDUCTORS	144
SELF-CONTAINED CAPACITANCE BRIDGE	162
SIMPLE ABSORPTION WAVEMETER	169
" RADIOLAB " WORKSHOP TESTING SET	190
DYNATRON TEST OSCILLATOR	197
MAINS-DRIVEN SLIDE-BACK VALVE VOLTMETER	204-205
JIG FOR MEASURING SELF-CAPACITANCE OF COILS	244
" RADIOLAB " VISUAL VALVE TESTER	264
CATHODE-RAY MODULATION FIGURES	297
EXPERIMENTAL 0.8-METRE TRANSMITTER	326
MAINS-DRIVEN C & R BRIDGE	392-393

RADIO LABORATORY HANDBOOK

CHAPTER I

THE END AND THE MEANS

THE way a laboratory is equipped and carried on depends very largely on the purpose it is meant to serve. Within the general field of radio there are a number of quite distinct purposes, which perhaps can be conveniently identified by the words

I. Purpose of a Laboratory Demonstration, Research, Design, Test, and Maintenance.

(a) **DEMONSTRATION.**—To repeat the results of others and so gain first-hand knowledge. While this suggests the technical school with its set experiments, it is a still more valuable object for private work. An ounce of practice is worth a ton of theory, we are told. While the exact numerical ratio set forth in this statement does not appear to have been rigorously proved, there is no doubt that personally confirming experiments gives one a mastery of the subject that can never be derived from books and lectures only. Moreover it may land one unexpectedly right into the middle of

(b) **RESEARCH**; or finding out more about how things work and so possibly discovering something new. Some of the most valuable discoveries have been made as a result of *not* confirming the findings of others. "Take nothing for granted" is too strict a rule to observe literally, but the spirit of it is sound. Many lines of research accidentally grow out of and perhaps utterly transcend in importance the original work. Others, again, are deliberately planned and (sometimes !)

RADIO LABORATORY HANDBOOK

carried through. Turning from these heights that are so exciting to contemplate and often so tedious to climb, we find

(c) DESIGN.—Work under this heading really falls into two divisions—obtaining data for design; and checking the designs when they have materialised. This is the main purpose of most of the laboratories in radio manufacturing concerns, and on a smaller scale the same object is pursued by keen amateurs. Although making one's set because it is cheaper than buying it is no longer a valid motive, it is fascinating and instructive to compare different methods and to try one's own ideas.

(d) TEST.—The private experimenter ought to make a practice of testing all the parts he obtains for his work—it is better to start doing this voluntarily than to be driven to it, sad but belatedly wise—and although in large organisations this work falls to the Test Room there are usually special tests that cannot or ought not to be done there. Tracing obscure faults in receivers and other apparatus may be included in this division. Lastly

(e) MAINTENANCE.—This is probably common to all laboratories, from least to greatest; for there is always plenty of work to be done in keeping the instruments and other equipment in perfect order, making and checking calibrations—valve voltmeters for example ought to be checked quite often—and setting up new apparatus. Nothing is more exasperating when carrying out an experiment, than continually having to digress in order to locate and cure faults in the apparatus, or (worse still) to take a long series of readings and then sooner or later to discover that they are invalid owing to instrumental vagaries.

This list, drawn up to help clarify ideas, is intended mainly for the experimenter who is setting up his own laboratory: the paid worker is generally not in a position to choose *à la carte*. When in process of equipping a laboratory, one may save

2. The Question of Equipment

THE END AND THE MEANS

money by first considering rather carefully what one wants to do. The most gorgeous plant without inspiration may be less truly a laboratory than the corner of a living room with a few simple home-made instruments. At the same time, one cannot set out to investigate the properties of long wave directional aerial arrays in a small flat. But it is possible to make what might prove most valuable observations with little more than an ordinary receiver. The "Luxembourg Effect" was not discovered by means of elaborate and costly apparatus, nor was it predicted as a result of intricate mathematical calculations; the equipment was a receiver and slightly more than average observation. Yet here was a discovery that gave the scientists a valuable new line of approach to the problems of the ionosphere.

There is still room for work that takes the form of systematic observations, requiring little apparatus other than a good receiver and perhaps an output meter. But the emphasis should be on the word *systematic*. With this equipment the experimenter can study such things as the influence on reception of time, season, weather, and astronomical phenomena, and how wavelength and situation of station enter into the results. This is work which is most likely to be fruitful if co-operative, and there are organisations that arrange for and collect data taken over a wide area. Although much of this work has been very thoroughly prosecuted by bodies such as the Radio Research Board, it has not been exhausted, particularly on the very short waves. These waves are especially suitable for study by the private investigator, for a number of reasons, among which may be mentioned the practicability of testing and comparing various types of resonant aerials without necessarily having at one's command enough land to make an aerodrome.

Much of this sort of experimental work can be done without making heavy demands on apparatus. In fact, it may be far cheaper than the construction of modern broadcast receivers! So far nothing very suggestive of laboratory apparatus has been mentioned. But even when the chosen experimental work can be carried on

with only a receiver it is at least desirable to have something of the nature of a laboratory, if only for ensuring the very highest degree of reliability in that receiver. Work is very restricted without some means of producing an artificial signal when required, measuring wavelengths, and checking resistances, inductances, and capacitances. Meters for checking circuits and taking experimental readings, oscillators of various types, and controllable power supplies are constantly needed whenever more general experimental work is undertaken. And so one goes on. The question is how to lay out limited funds to the best advantage.

The factor of cost will be taken into full consideration when equipment is described in detail in subsequent chapters ; but in the meanwhile it is possible to make some general observations.

3. Selecting for Minimum Cost

Assuming that experimental work is not a fleeting passion, there are certain instruments which will be practically essential now and always, and which do not quickly become obsolete. For these it is false economy to go in for the very cheapest that will just do at the time. What are loosely but very conveniently termed "meters" certainly come in this category. So do standards of resistance, capacitance, and so forth. Good workmanship now as ever costs money, and in the ordinary way a high-grade instrument by a famous firm always commands a good price. In the *ordinary* way ; but one does sometimes pick up exceptional bargains second-hand. The author was fortunate enough to be in the market when a firm with a lavishly equipped laboratory went out of business. But as bargains do not generally carry any guarantee it is obviously advisable to be able to check them against standards ; and of course such buying calls for discrimination if it is to be successful. Unless one can get something much better this way than could be afforded otherwise, it is perhaps wiser to be on the safe side and buy a new instrument. Sometimes, however, the original makers can supply used instruments that have been reconditioned and recalibrated and are practically equivalent to new, except that perhaps they are not of the latest

THE END AND THE MEANS

pattern. But of course one cannot in this way expect to save a very large proportion of the cost of a new instrument.

Decide, then, what apparatus is likely to be of permanent value, and get something of higher quality than appears to be justified, even if it means

4. True Economy postponing other purchases. In doing so do not overlook the possibility of unit instruments, consisting of a nucleus to which accessories may be added as required.

Versatility is an important feature to be considered. Careful choice may enable a few instruments to take the place of many. But do not let catalogue descriptions rush you into buying a jack of all trades and master of none. And remember, too, that one instrument, however good, cannot be in more than one place in the circuit at a time.

With regard to more specialised types of equipment of which there is now such a vast and rapidly increasing variety—oscillators, distortion meters, valve voltmeters, and so on—more caution is necessary. They are constantly changing in design, are generally expensive, and tend to become obsolete fairly rapidly. This is not to say that a good signal generator, for example, is a bad investment; it is just that one needs to exercise foresight. People who a few years ago bought expensive signal generators working only on medium and long waves find them very restricted to-day. Valve testers become obsolete almost as soon as designed. The writer remembers a magnificent example that must have cost well over £100 and legislated for everything that could be imagined; the cabinet alone cost more than it was wise to pay for a complete valve tester. To-day, this marvellous instrument would be incapable of doing anything with the more interesting types of valves! It is bad policy to spend a lot on a splendidly finished and symmetrical instrument if the development of technique makes it necessary after a short time to disfigure it with some makeshift alteration.

5. Making One's Own Apparatus It is hereabouts that we enter the field of things that it may be advisable to construct rather than buy. One should not run away with the

idea that it is necessarily much cheaper to do so. When the time spent on experimenting has been taken into account it may be quite an expensive way. But a private worker does not often rate his time very highly, and he learns all the time; and a technical department is often able to present the cost of construction to the directors in a less disturbing form than that of an outright purchase. Slack-time of mechanics can be employed, for instance; and in technical colleges the students actually pay to be allowed to perform such services. The advantage, too, of being able to suit one's own needs may amply compensate for possibly a limited standard of workmanship. As a matter of fact there are comparatively few items that really need be made up in permanent form—much of the work can be more efficiently, economically and adaptably carried out with temporary "breadboards". Then there is no grief if the specification has to be modified.

The gift of improvisation is a very valuable one, especially under war conditions. The experimenter who has to wait until he gets the correct material is not likely to go far. This is no argument for untidy, slipshod equipment. Most people, if not all, do better work with neat apparatus. But the writer has seen important research of the most refined accuracy being carried out in the box-room of a small suburban house with the most amazing collection of junk to be seen outside the Caledonian Market.

CHAPTER 2

PREMISES AND LAYOUT

THE private experimenter who perforce has to fit his "lab." somewhere into the house is apt to envy his professional brother who is allowed funds to build premises specially for the purpose. The latter, on the other hand, is apt to realise too late that his resplendent "Technical Wing" is abominably noisy, is riddled with interference, and is acoustically useless for giving a correct impression of how loud speakers sound in their natural environment. In more than one case known to the author, large manufacturing firms have eventually been driven to take over house property for laboratories.

6. How Premises Affect Results of Work

What was said in the last chapter about the nature of the work deciding the best preparation for it applies with special force to the matter of premises. For some purposes, such as pure research, an isolated hut on a moor would be ideal, because of the absence of disturbances—electrical, acoustic, or vocal—and because of the possibility of erecting aërials without complications due to adjacent buildings and other excrescences. But where the work consists in the development of receivers for the market one does not so much want conditions that are ideal as those that are ultra-real—a little *more* interference and noise than in the average dwelling; rougher mains; and a rather worse aerial even than Mr. Citizen puts up in the garden. The author once worked in a laboratory on factory premises, where a certain amount of noise and vibration was inevitable. Delicate bridge adjustment, by mirror galvanometer or phones, was exasperating in the extreme. But the sets designed there got a fine reputation for range, quality, and volume. It is incredible how much difference an unnoticed background of noise actually

makes. Taking a reproducer away from such conditions into a quiet home is like adding a stage of power amplification.

Unfortunately in this same factory the mains were of exceptionally pure waveform. So the sets also got a reputation for hum. The combined effect of good mains and bad listening conditions completely masked any imperfect smoothing, and it was essential to make all tests of this nature elsewhere.

That example is quoted to emphasise the importance of the setting for one's work. Although the requirements and facilities of private and professional workers are very diverse, it is hoped that the reader of the following discussion of the question of premises will find it possible, by means of slight mental adjustments, to adapt it to the scale of work in which he is interested. As it is the amateur who is most likely to be restricted in opportunities, it is he who is held chiefly in view, but if much of this chapter sounds rather poverty-stricken to some fortunate engineers there are always others whose material difficulties rival, if they do not exceed, those of the private individual.

Assuming first of all that funds are available for special premises, an isolated building has much in its favour provided that it is suitably constructed.

7. Buildings to Special Order This means substantial brick walls, if possible of the cavity type, and a lining throughout of some sort of building board. If there is a flat roof—of course it must never be *quite* flat—there should be an air space between it and the ceiling; and the outer surface is preferably of a white material that is self-cleansing, not a dull black which radiates heat in winter and absorbs it in summer.

The object of the lining is to help in keeping the place at an equable temperature; the usual huts hastily put up for technical staff cost a fortune to keep warm in winter, and are like ovens in summer. When a cold spell is followed by a sudden warm west wind, the resulting condensation indoors is ruinous. A building board lining

PREMISES AND LAYOUT

also provides reasonable acoustic conditions, and lends itself to serviceable decoration and to practical convenience generally.

If the technical department is to be extensive, it is generally far better that it should take the form of a number of small rooms rather than a very large one. Space can be better utilised if there are plenty of walls ; and jobs can be carried out with less mutual disturbance. So an ordinary house of suitable size may be better than a special building.

Heating is important. If the room is well heat-insulated, it is not extravagant to consider thermostatically controlled electric heating. The uniform temperature so obtained is very valuable for preserving accurate standards, to say nothing of personal comfort.

8. Heating and Lighting

Whatever the heating system, it should not produce water vapour in the room as do certain gas-heated radiators.

Lighting is also important. Strong direct sunlight is not good for apparatus, but there is difficulty in getting enough all-north natural lighting without excessive window space and loss of heat. Double windows are considered faddy in this country, though it is difficult to see why. One can hardly go too far with electric lighting. In addition to well-diffused general lighting there should be plenty of flexible arm lights, mounted clear of bench space, that can be brought right on to the job for reading meters and examining wiring and components in awkward corners.

Then there are interference suppressors. Even if it is desired at times to test receivers in the presence of interference, there should be means for cutting out severe local interference that might make certain other work difficult. An isolated building such as is being considered just now lends itself to this, by the installation of a filter where the mains enter. Where complete absence of external fields is essential it is necessary to screen the whole room with wire netting, which may conveniently be in the space behind the board lining.

Considering now the amateur, he may have no choice whatever of premises, nor perhaps even the exclusive use

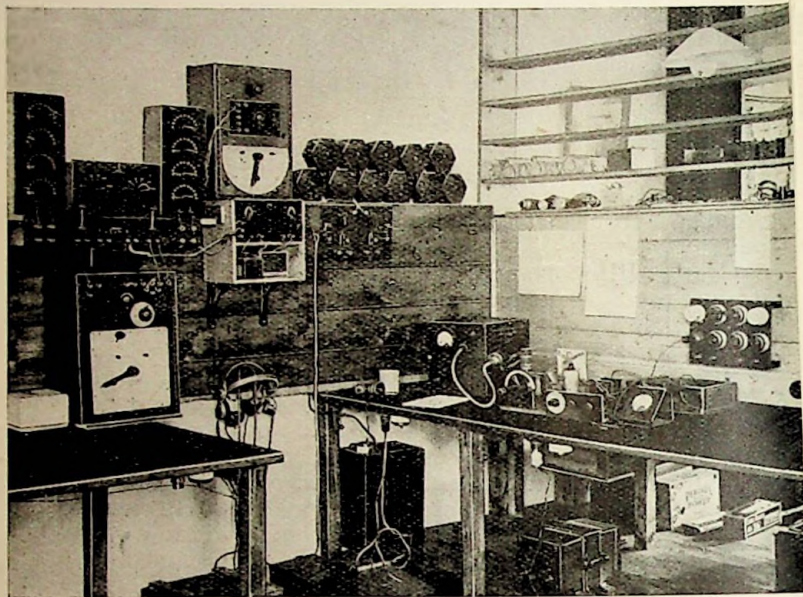

Fig.1 : Another view in the Author's laboratory. On the left is the universal bridge described on p.156. At the top is its ratio-arm box, with a decade resistance box on each side of it, all standing on the screened transformer and switch unit, below which is the low-impurity standard mutual inductometer—the standard of reactance as the decade boxes are of resistance. To the right of these is the amplifier for phones, with the frequency measuring bridge above. To the right of the amplifier is the source control box. The 800 c/s source is beneath the bench, and the beat-frequency source can be seen on the frontispiece, extreme right. To the right of the frequency bridge are a number of standard high-Q coils. On the bench can be seen the slide-back valve voltmeter (p. 203) being used in conjunction with the dynatron unit (p. 195) to investigate a tuning coil. Below is a tapped transformer for running apparatus at other voltages than the mains. For the other side of the bench, see the Frontispiece.

of a room. Where the house is old and large the chances of appropriating at least an attic or basement are quite good, but a modern house

9. The Amateur's Laboratory

is generally the next size smaller than that which will just hold the family. As regards choice, if any, between attic and basement ; in the absence of further data the author is disposed to advise the latter, because a screened transmission line can be used to make connection with a distant aerial, whereas a long earth lead has disadvantages that are not so readily overcome. This may not apply quite so decidedly to a steel-framed building, which electrically is almost a continuation of the solid earth.

One may be obliged to consider a roof loft. It has been asserted that lofts make excellent workrooms. The author's personal views do not incline in this direction, for his experience of them is that they can never for long be other than dusty ; that they enjoy what the geography books call a Continental climate, being too cold in winter and too hot in summer ; and that the trapdoor constitutes a grave danger to the preoccupied research worker. Even if the personal drawbacks are heroically overlooked, it cannot be denied that dust and extremes of temperature are particularly bad for apparatus. Nevertheless the author has seen a loft laboratory used successfully for really advanced work. Seclusion is an advantage that can hardly be overestimated, and one gets it better in a loft than in most places. An aerial lead-in can generally be arranged to come conveniently above the operating bench ; but it is worth going to the trouble of ensuring that it is truly weather-tight. Damp is the remaining chief enemy, unmentioned above, of apparatus. Another advantage of a loft is that one can string wires around, and generally damage the premises in ways that would never be tolerated downstairs—or should one say downladders ?

Sometimes an outdoor shed can be appropriated, or built. Conditions here are not unlike those just described. In winter it is difficult to make it an attractive retreat, and damp weather has disastrous effects on the equipment, unless there is the unusual luxury of permanent heating.

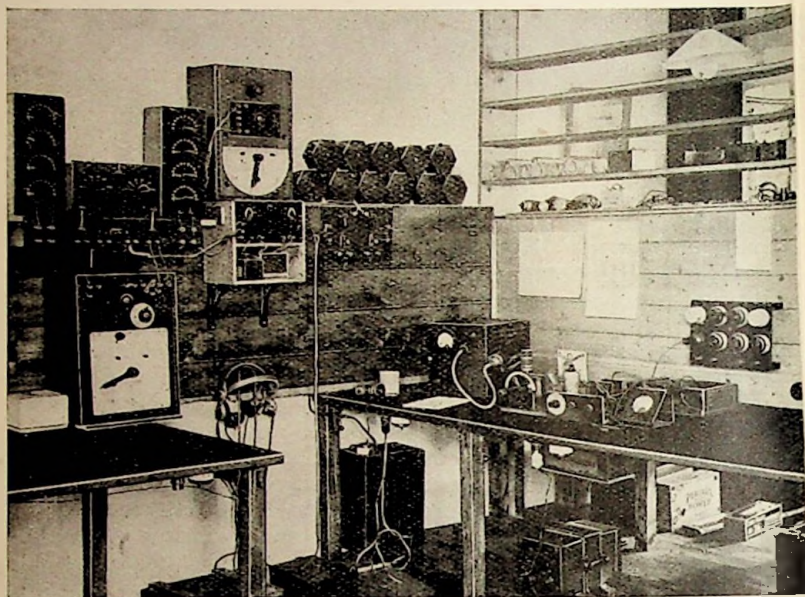

Fig.1 : Another view in the Author's laboratory. On the left is the universal bridge described on p.156. At the top is its ratio-arm box, with a decade resistance box on each side of it, all standing on the screened transformer and switch unit, below which is the low-impurity standard mutual inductometer—the standard of reactance as the decade boxes are of resistance. To the right of these is the amplifier for phones, with the frequency measuring bridge above. To the right of the amplifier is the source control box. The 800 c/s source is beneath the bench, and the beat-frequency source can be seen on the Frontispiece, extreme right. To the right of the frequency bridge are a number of standard high-Q coils. On the bench can be seen the slide-back valve voltmeter (p. 203) being used in conjunction with the dynatron unit (p. 195) to investigate a tuning coil. Below is a tapped transformer for running apparatus at other voltages than the mains. For the other side of the bench, see the Frontispiece.

PREMISES AND LAYOUT

of a room. Where the house is old and large the chances of appropriating at least an attic or basement are quite good, but a modern house is generally the next size smaller than that which will just hold the family. As regards choice, if any, between attic and basement ; in the absence of further data the author is disposed to advise the latter, because a screened transmission line can be used to make connection with a distant aerial, whereas a long earth lead has disadvantages that are not so readily overcome. This may not apply quite so decidedly to a steel-framed building, which electrically is almost a continuation of the solid earth.

One may be obliged to consider a roof loft. It has been asserted that lofts make excellent workrooms. The author's personal views do not incline in this direction, for his experience of them is that they can never for long be other than dusty ; that they enjoy what the geography books call a Continental climate, being too cold in winter and too hot in summer ; and that the trapdoor constitutes a grave danger to the preoccupied research worker. Even if the personal drawbacks are heroically overlooked, it cannot be denied that dust and extremes of temperature are particularly bad for apparatus. Nevertheless the author has seen a loft laboratory used successfully for really advanced work. Seclusion is an advantage that can hardly be overestimated, and one gets it better in a loft than in most places. An aerial lead-in can generally be arranged to come conveniently above the operating bench ; but it is worth going to the trouble of ensuring that it is truly weather-tight. Damp is the remaining chief enemy, unmentioned above, of apparatus. Another advantage of a loft is that one can string wires around, and generally damage the premises in ways that would never be tolerated downstairs—or should one say downladders ?

Sometimes an outdoor shed can be appropriated, or built. Conditions here are not unlike those just described. In winter it is difficult to make it an attractive retreat, and damp weather has disastrous effects on the equipment, unless there is the unusual luxury of permanent heating.

A concrete floor on the ground keeps the feet thoroughly cold in winter in spite of efforts to heat the place. A board floor is much to be preferred. In summer, too, both worker and apparatus may suffer from the climate in a hut or shed. But oppressive restrictions on the research worker are less likely to be enforced here than indoors.

If considerations of comfort, convenience, or necessity indicate an indoor room, and the experimenter is not in a position to exercise the rights of

10. Storage

dictatorship, it may be possible to come to terms with other interests by carrying on the more unwelcome activities—such as actual construction, and perhaps accumulator charging—out in the shed or garage. If the laboratory must, as a last resource, be shared, the guiding policy is to arrange for everything to be shut up under cover and out of sight when not in use. An old roll-top desk is an example of something that would make an excellent nucleus; the desk surfaces can be used for working, and the pigeon-holes and drawers for storing apparatus, etc. An old-fashioned wardrobe of ample proportions, with sliding shelves, makes an excellent store cupboard, and might even be adapted as a sort of work cabinet. There are other varieties of furniture that can be used for working and for storing the apparatus; a search around the house or in the local furniture market will probably suggest useful possibilities.

Whether or not a strict cover-up policy is forced on the experimenter by other members of the community, it is not a bad policy to adopt anyway. It is worth acquiring such cupboards, bureaux, filing cabinets, or nests of drawers as may be available, for storing instruments, components, tools, wire, valves, papers, and so forth. Good organisation in this respect is worth while in saved time and space, creates a favourable impression, and keeps things in good order and condition. A chest of many shallow drawers is much better for storing the smaller articles than the usual deep drawers which necessitate things being bundled on top of one another. Some drawers should be subdivided, eggbox fashion, to take valves, resistors, fixed condensers, small tools, etc., in

PREMISES AND LAYOUT

classified arrangement, so that it is not necessary to rake through the whole lot every time in order to find the right denomination. Incidentally, it is a good thing to run through one's stock of components now and then, particularly of resistors and condensers, to check the values. This may save much perplexity caused by taking them at their face values. Matchboxes are useful for screws, terminals, etc., either by using the trays to subdivide a shallow drawer, or by gluing a stack of the complete boxes together to form a nest of small drawers, with boot-buttons for knobs.

Space is nearly always at a premium ; and while it is very nice to have plenty of large tables or benches on which to set out one's work it is very seldom that there is room for this sort of layout. It is necessary then,

11. Layout

as in the city of New York and for the same reason, to resort to vertical building. A very compact arrangement consists of a wooden cupboard placed, not in the usual position against the wall, but sticking out into the room, so that the back can be used for supporting instruments, switchboards, shelves, etc., above the work bench. A space of a few inches should be left behind the back board for wiring. If there is room, one may have further benches around the working space, forming a sort of cubby-hole where everything is near at hand, except the less-used gear which is kept on the other side. Fig. 2 shows a layout of this type. At all costs the tendency to use bench top space for storage must be combated. If it is not, the actual working space soon becomes crowded out.

Methods of setting up apparatus are worth consideration ; the following types of layout can be clearly distinguished :—

12. Arrangement of Apparatus

1. *The Quick Hook-up* (Fig. 3) consists of a number of separate components—valve holders, transformers, etc.—fitted with terminals and linked up by lengths of wire. This method is the most temporary of all, and apart from students' experiments which have to be

cleared away the same afternoon has few justifiable applications. If there is to be any real saving of time the components must be fitted with good big terminals, preferably of the double or triple decker type, and there must be an ample supply of prepared leads. Inter-wiring capacitance is likely to be high, contacts poor, and short-circuits probable, owing to operating components not being firmly mounted. It is non-portable, and if the experiment drags on it may be an incubus.

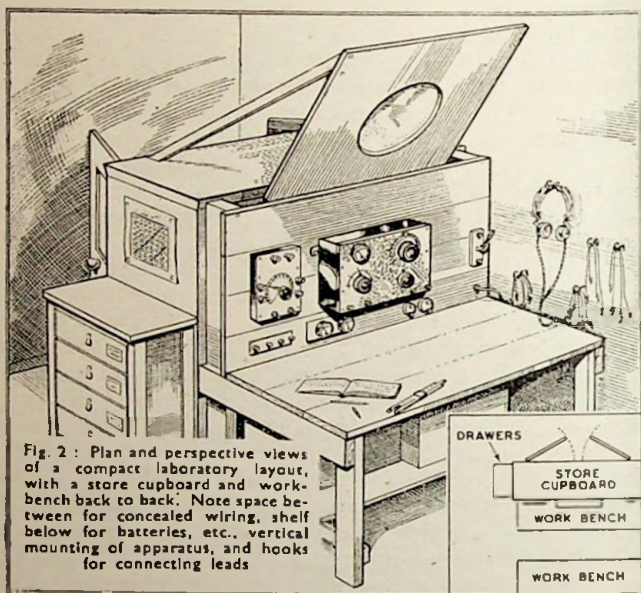

2. *The Breadboard* (Fig. 96) takes perhaps a little more time to set up, and certainly more time to dismantle; also is not definitely a horizontal space saver: but is practically indispensable for quickly assembling a circuit for temporary use, or for checking a design before irrevocably drilling holes in the permanent panel. The assembly forms a portable unit, and can be moved away

PREMISES AND LAYOUT

to make room for other things. It is superlatively cheap, and is likely to work much better for permanent use than more sightly units. But it collects dust. In the ordinary form it consists of a slab of wood, preferably ply not less than $\frac{1}{2}$ -in. thick, on which are screwed all the components. It is delightfully easy to shift components about and experiment with different wiring arrangements, and everything is accessible. Operating components—variable condensers, rheostats, etc.—and terminal strips are generally mounted on small vertical strips of wood screwed into the edge of the board; a stock of such components ready mounted is useful. C. R. Cosens recommends a modified form in which the board has $\frac{1}{2}$ -in. to $\frac{3}{4}$ -in. wood battens screwed along the edge on the lower side so as to form a hollow base

Fig. 3: The "quick hook-up"—the most temporary form of apparatus assembly



where wiring can be more neatly carried out. Certain components are more easily mounted, and the battens give better support to uprights. Metal coated plywood ("Plymax") is convenient for use when a conducting base is needed. By this time our breadboard is nearly

3. *The Chassis* (Fig. 4). This familiar mount, consisting of an inverted metal tray or shallow box, can be obtained from radio supply stores, or made up to size from metal sheet. If sloping sides are not objected to, it is also purchasable, tinned ready for soldering, from Woolworths, where it is better known as the baking tin. Aluminium is easy to work but difficult to make sound contacts with; copper is good but fairly expensive; steel is generally used for manufactured apparatus. The metal chassis is the most practical

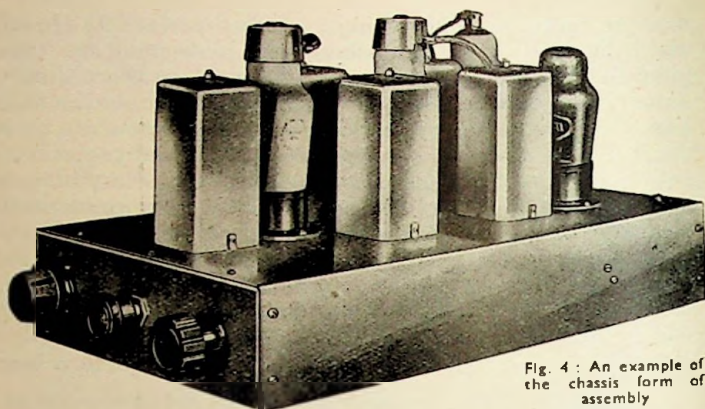

Fig. 4 : An example of the chassis form of assembly

medium for screened construction ; and, where a permanent assembly of a fairly adaptable nature is required, is preferable to the breadboard. It lends itself to incorporation in boxes and cabinets of almost any type.

4. *The Platform Frame* (Fig. 5) comes into use when several units of the breadboard or chassis type are to be combined, or when a

more compact arrangement than a single large board is desired. The frame and platforms may exist as a self-contained structure, on which any assemblies can be supported temporarily ; or the breadboards or chasses may themselves form the platforms—an arrangement more suited for permanent assemblies. If it is adopted, the construction ought to permit any one unit to be removed for inspection. If desired, the sides can be filled in with panels, dust covers, or protective wire-gauze screens. Or a popular type of tray filing cabinet may be adapted as the structure, provided that ventilation

Fig. 5 : Platform frame and rack for mounting several units in tiers (Stratton & Co., Ltd.)

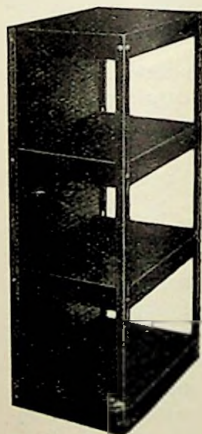

PREMISES AND LAYOUT

is introduced where necessary. This system is a cheap and flexible one, especially suited to amateur requirements and capabilities: and used to be the most popular arrangement for transmitters, but is now giving place to

5. *The Vertical, or Telephone, Rack* (Fig. 6). A substantial frame, usually of iron or steel angle or channel

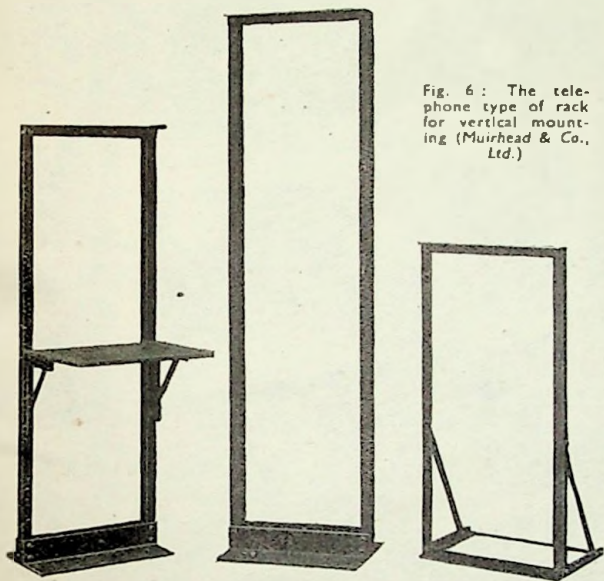

Fig. 6: The telephone type of rack for vertical mounting (Muirhead & Co., Ltd.)

section, 19 in. wide, is used to support vertical panels, to any convenient height. It is obviously the best scheme when the apparatus includes many controls, meters, jacks, and so on; but almost any unit can be accommodated—for instance a broadcast receiver chassis or a gramophone turntable. Bracing supports are needed when the unit is heavy and projects far back or forward. The most usual form of unit which includes valves, etc., that cannot

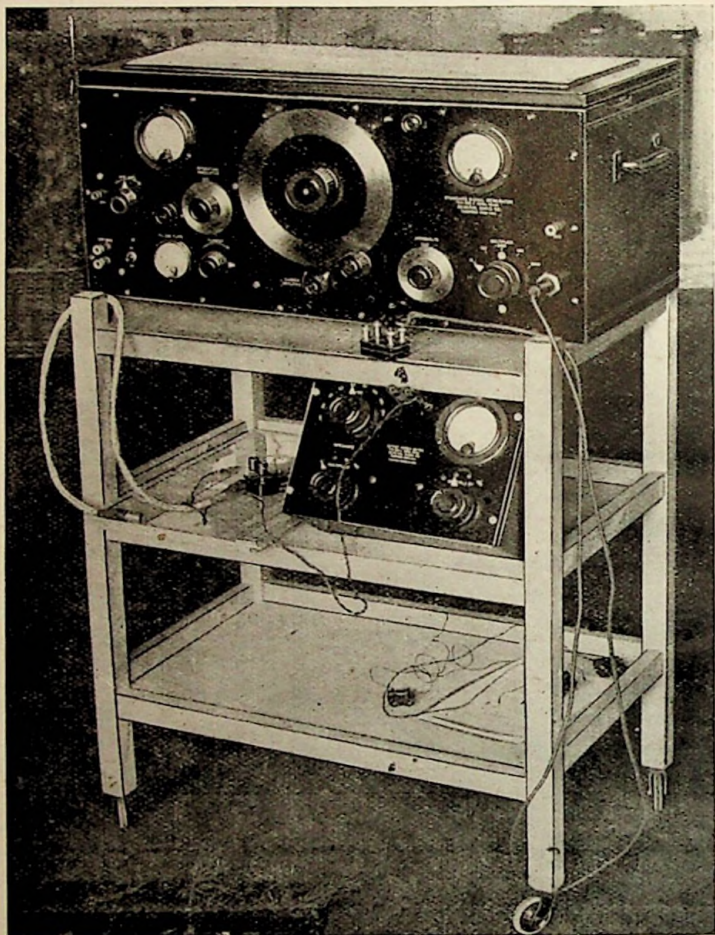

Fig. 7 : Trolley mounting is particularly suitable for much-used bulky units. The instruments shown are the General Radio Co.'s 603-A Standard Signal Generator and 583-A Output Power Meter

PREMISES AND LAYOUT

conveniently be mounted on the panel itself, is a \perp shaped structure consisting of a panel with a platform at right angles behind it. In order to avoid straining or flexing wires leading between vertical and horizontal members it is essential for the structure to be well braced. Dust-covers removable behind protect the apparatus, and the wiring between units may if necessary be led through screening conduits. The system is rather expensive to carry out properly, but makes a very neat and adaptable job for permanent use. A modification, valuable for allowing the back to be got at without leaving space behind, is to hinge the panels, enabling them to be swung open like doors.

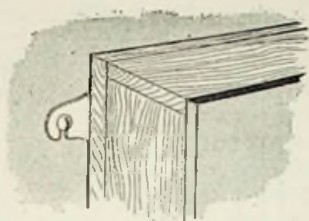
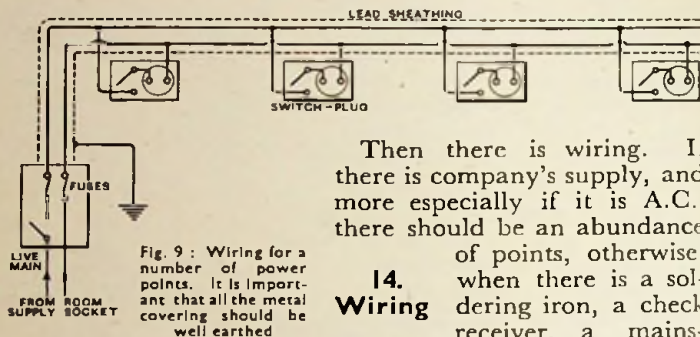

Fig. 8: Mirror plates screwed to box-form units enable them to be mounted on vertical surfaces

6. *The Trolley* (Fig. 7). Sometimes one has a bulky unit that occupies valuable space in any one position, and is difficult to lug about or apply at the most useful points. The solution is to mount it on a trolley. The large stores used to sell such trolleys unpolished for a few shillings, and they form most convenient receptacles for such things as cathode-ray tube apparatus.

Instruments as bought, and sometimes as made, take none of the forementioned forms, but consist essentially of boxes. It is a good idea to fit these with mirror plates to enable them to be hung one above another on the wall or backboard of the bench (Fig. 8).

If it is decided to construct a work bench, it is wise to see that it is strong and rigid. Boards invariably shrink and warp, leaving crevices for small screws to hide in, so a sheet of thick linoleum over the top is very pleasant for working. A shelf near the ground helps to brace the bench, and is most useful for supporting batteries, power units, and other heavy equipment.



Then there is wiring. If there is company's supply, and more especially if it is A.C., there should be an abundance

14. Wiring

of points, otherwise, when there is a soldering iron, a check receiver, a mains-

driven oscillator, and a valve heating transformer going, it may be difficult to find another point to connect a bench lamp, a heater, or a fan. Thus it is a good policy to scatter sockets about fairly freely, each separately switched in the "live" side (Fig. 9). A good place is just underneath the top surface of the bench.

A soldering iron is nearly always wanted at a moment's notice, so provision for heating it up quickly, and then keeping it on permanently at a low enough temperature to avoid burning, is valuable. Some stands incorporate a switch to cut in a resistance for stand-by; alternatively, an old alloy piston can be sliced across at gudgeon-pin level and used as an anti-burning stand (see Fig. 10).

It is necessary to decide whether to standardise pin sockets or bayonet sockets for general use: contrary, perhaps, to popular custom, the author prefers the latter, as they minimise the necessity for adapters, and the plugs do not fall out accidentally.

And here a warning must be sounded. There have been some sad examples of what the amateur and even so-called professional wireman can do. Bits of ordinary wire twisted around nails, and so forth. There are several reasons why you should make a proper job of it. One is that if you do not, the supply authority has right of action against you. Another is that shoddy wiring is a cause of fires. And another is that it leads to leakages that introduce hum and other undesirable effects, shock, and break-

PREMISES AND LAYOUT

down. So use lead-covered electric lighting cable of good quality, with all sheathing bonded together and soundly earthed—preferably by a different connection from that used for radio. Probably the whole lot of sockets will have to connect to the mains at some one original point in the room. Try to arrange matters so that, if a fuse goes because of some work being done, it does not plunge the place into darkness. For example, if the bench connections *must* be taken from the branch lighting circuit, provide fuses on the bench sub-branch of a slightly lower current rating than those protecting the whole branch. And remember that any mistrust with which the supply authorities may regard the system will be greatly intensified if they find lamps being used on a power circuit, at a lower tariff.

The need for good screening and earthing is greater where D.C. is concerned, because the high-pitched commutator ripple has a way of getting mixed with the output of amplifiers, and is particularly unhelpful in bridge work.

15. Earth and Aerial

A good "earth" is important; a main water pipe close to where it goes underground is generally satisfactory, and saves a lot of manual labour. But if a specially-made earth is needed its requirements are (1) plenty of exposed

Fig. 10: Suggestion for an anti-burning soldering iron stand, made from an old piston

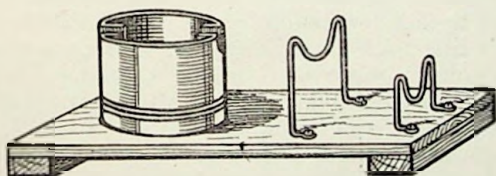

WARM UP



STAND BY

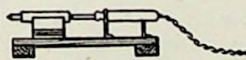

metal surface in contact with the ground, (2) burial deep enough to be in permanently moist soil, (3) no corrosion (lead tape or piping brought right into the room is good), and (4) a short run from ground to terminal. It is an excellent idea to bury the metal in two equal lots, brought out to separate terminals. Their condition can then be checked at any time by measuring the resistance from one to the other, preferably with A.C. to minimise electrolytic effects. The resistance of both in parallel cannot exceed a quarter of this figure.

Aerial and earth connections should be independent of those used for the household receiver. In fact, it is a great

mistake to attempt to do without an

16. Connections entirely separate family listening system. But it is often very convenient, when the lab. is in a different room, to have at least one pair of wires running between the two. And if, as one has a right to expect in an experimenter's house, there is loud speaker extension wiring all over the place, some way of tapping on to it in the lab. is useful. An interconnection system is valuable also if for any reason it is necessary to split up the lab., even if it is only a matter of two benches in different parts of a room. A number of wires, preferably of really heavy gauge, joining such benches and brought out to terminal strips or sockets, enable these parts to be used as a whole. If all of one space is occupied by the source of a test signal, for example, the signal can be piped through this line and used elsewhere. Or power supplies from a common source can be distributed. Even when mains power is available it is difficult to get on without batteries altogether, and some sort of switchboard for controlling them may be worth having.

Lastly ; one must not fail to lay in a good stock of flexible connecting leads of various lengths from a few inches up to a yard or two ; some with tag or tinned ends, and some with crocodile clips ; single and twin. Nobody seems yet to have entirely solved the problem of how to store them neatly so that the right type and length can be instantly selected, but perhaps a series of cup hooks serves the purpose as well as anything.

CHAPTER 3

FUNDAMENTAL PRINCIPLES OF MEASUREMENT

THE scene is a police court. The case is one of alleged dangerous driving. Witnesses are called. Some say the accused was travelling at 29 miles per hour; some 40; some 60. Some merely declare that he was travelling at a terrific speed. All

17. Measurement very inconclusive and unsatisfactory.
v. Guesswork Personal judgment, ignorance, prejudice, rather than facts, determine the evidence.

Another case. The witness this time is a mobile constable, who states that when he was driving behind accused at the same speed his speedometer read 38 miles per hour. The inference, presumably, is that this is the speed at which accused was driving. The data in this case are far more satisfactory; but not beyond challenge, as any good defending counsel would demonstrate. There would be penetrating cross-examination on how and when the police-car speedometer was checked, and how did witness know he was travelling at the same speed. Translating it from the language of the law court to that of the laboratory, what were the instrumental and personal errors? In such an important matter as legal action, affecting perhaps the liberty and reputation of a citizen, evidence ought to include not only the figures but also the limits of probable or possible error. At present that seems rather too much to expect of a law court, but it is accepted practice in a laboratory. Measurement is the basis of scientific progress; opinion, guesswork and assumption are its chief enemies.

One might suppose that in the very Temple of Science itself, the laboratory, there would be no room for these reactionary forces. But they are

18. False Assumptions constantly at hand, ready to obscure one's work. Radio itself would probably have been established much

earlier if authorities had not decided that it was impossible. Later, radio engineers noticed that as the wavelength of transmission was reduced the range apparently became less and less ; so they assumed that very short waves would be useless, and allocated them to amateurs. Subsequently they found themselves more generous than they had intended, when it turned out that these waves are the *only* ones suitable for very long ranges.

How often when carrying out experiments one observes that X steadily increases (or falls) in some sort of proportion to Y, and is tempted to miss out the last few readings and extend the curve by freehand. Or when some unexpected effect is noticed, how easy it is to make an explanation for it that will save the trouble of really finding out. It is nearly always worth while following up anything that does not work as it should, rather than dismissing it as "experimental error", or cooking the results until they come "right". It may be the key to something new. At the worst it will clear the matter up and give you a better grasp of the subject. The difficulty is that in these days work must be got through so quickly, and there is no time for exploring every little side track that appears in the course of routine. Even if there were time, few would have patience to check the obvious. But it is the ideal to aim at.

Coming now to consider actual methods and means of measurements ; if X is the object to be investigated, the measuring instruments required

19. Fundamentals of Measurement usually include a source A, an indicator B, and often a standard of comparison C. This can be illustrated by a simple functional diagram, Fig. 11, which should be observed, because it is the basis on which the next three chapters are arranged. To take a very simple

FUNDAMENTAL PRINCIPLES OF MEASUREMENT

example, the resistance of a piece of wire **X** can be measured by applying a battery **A** of known voltage and using an ammeter or milliammeter **B** to read the current passed, from which information the resistance can be worked out by applying Ohm's Law. Observe that the voltage of the battery must be assumed or measured, and that the meter **B** must be accurately calibrated over a suitable range. An error in either of these affects the result.

Fig. 11 : Functional diagram of the process of measurement

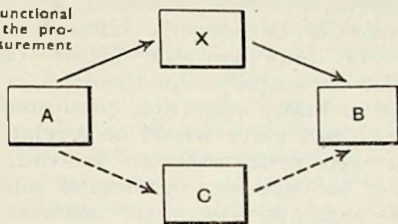

An alternative method is available if one has a standard resistance box **C**. Any battery and current indicator can be used, so long as a reasonable deflection is given. When the deflection has been read, the circuit is switched through **C** instead of **X**, and **C** is adjusted until **B** shows the same deflection. The resistance of **C** is then the same as that of **X**. Note that only one datum is needed instead of two, and that a standard resistance, being a simple fundamental element without moving parts, is more likely to maintain its original calibration, and in any case can be obtained to a greater accuracy, than deflection instruments of comparable cost and robustness.

This simple example has been described at some length because, in addition to illustrating the classification which will be adopted when discussing actual instruments, it also illustrates an important distinction among methods of measurement. When

20. Choice of Method

making any measurement there is usually a choice of methods, and in general they can be divided into these two classes, which may be called *indirect* (because the unknown is determined by deduction from other quantities), and *comparison*. In Chapter 6 it will be shown that the comparison method itself has two variations. Of course every method must be judged on its merits for each

individual job, but after considering this example it will be fairly clear that where reliability and accuracy are important the comparison method is to be preferred. The fewer data, such as calibrations, that have to be taken for granted, the better. And the simpler and more fundamental the standard with which the unknown is compared, the more likely is the result to be accurate. Resistance is a fairly fundamental quantity, depending on length, thickness, material, and temperature; and if the material is properly chosen the effect of temperature—the only variable factor—can be made negligible. But the amplification factor, μ , of a complex valve depends on so many operating conditions that comparison with a standard valve would be a relatively unreliable as well as inconvenient method. Instead, the amplification factor can be expressed in terms of something even simpler than a resistance—a mere number, the ratio between two resistances.

Always try, then, to select a method that expresses the unknown in the simplest terms. That is why bridge methods are so favoured for accurate work—the unknown is often expressed simply as a ratio, or is balanced against some fundamental standard.

In making a complicated measurement the bench may be covered with instruments, and if each of these is subject to an error that proportionately affects the result, the final accuracy may be very poor. The experienced worker devises his method so that the factors affecting the result are confined to a few well under control, and, if possible, so that unavoidable errors cancel out in the result. Take for example a valve voltmeter. One way of using it to measure R.F. resistance (described in detail later) necessitates taking two or more readings of voltage. Now the calibration of a valve voltmeter of the usual type depends on a large number of factors that may not be known to great accuracy, and may have altered to an indeterminate extent since it was last checked. So quite apart from errors elsewhere in the system, the voltage readings are subject to a number of errors difficult to

FUNDAMENTAL PRINCIPLES OF MEASUREMENT

estimate. The more widely different are the readings, the less likely are their errors to cancel out in deriving the result. But if the voltmeter is used merely to indicate equality in two tests, and the result depends only on the adjustment of a substitute resistance, the most that one assumes about the voltmeter is that its deflection due to that one particular voltage has not drifted in the short interval necessary for making the adjustment. The calibration is not used at all. The principle is to work the method around so that the factors controlling the results are the fewest and most reliable standards in the laboratory. Every reading is subject to error, but some are much less so than others. That is why the best method depends very largely on the relative reliability of the instruments available in the particular laboratory concerned.

You yourself, the observer, are one of those instruments, and (with all due respect) perhaps not among the most reliable. It is extraordinarily easy to make slips in reading scales, noting the positions of range switches, connections, and conditions generally, and in performing calculations and

22. The "Personal Equation"

drawing conclusions. Regarded simply as an indicating instrument, the human body is imperfect. We have already seen that human estimates of, say, speed, are highly unreliable. In radio, personal estimates used to be the only methods available for measuring such things as signal strength. Thus arose such units of signal strength as "Phones on table", "Audible in next room" and "R 9". The last was an attempt to put the thing on some sort of comparative basis, but obviously one person's R 9 might be another's R 6, if the receiver and its adjustment were different, the background noise greater, or the enthusiasm less.

It is now possible to measure signal strength quite conveniently and definitely on a meter; but the ear is still largely relied upon to judge the volume, tone, and distortion of reproduced sound. One may contend that as the ear is the ultimate judge

23. The Ear as an Instrument

of this, it is the most valid measuring instrument. On the same principle the eye is the ultimate judge of the proper length of a dress; but the sale of textiles would be complicated by much misunderstanding if no tape-measures or yardsticks existed. It is only by long experience that one realises how unsatisfactory aural tests really are. Individuals' ears differ more than is generally supposed. Individual tastes and ideas about how things should sound differ even more. A person who listens to a loud speaker and then goes away for a few minutes cannot on his return be relied upon to judge the relative volume within 50 per cent. of the correct amount. Still less can he judge, if the programme, the room, and the background noise have been altered. Apparent balance of tone in a reproducer depends vitally on the nature of the sound it is handling. Unless the characteristics are unmistakably pronounced, it is hopeless to try to compare loud speaker A heard last week with loud speaker B working now in a different room. Even the direct switch-over test is unexpectedly tedious and exasperating. A judgment made on one occasion may be reversed later when the programme changes. The indefiniteness of such work makes it curiously tiring and unsatisfying to perform for any length of time. And the accuracy, compared with that of laboratory work in general, is deplorably low.

Therefore persistent attempts have been made to establish precise measurement technique in this most important part of radio work. There are standard microphones, amplifiers, and so on. Sufficient to say that the whole business is appallingly complicated and difficult, largely because the sound from a loud speaker cannot be considered apart from the acoustic surroundings. So at present most of the measurements on receivers and other sound-reproducing apparatus go only so far as the electrical output; but obviously this is not a perfect guide to the ultimate result in the shape of sound.

The Bell Telephone Laboratories, which have probably done more than any other organisation to study sound reproduction, having realised the unreliability of individual judgment and the difficulties of applying instru-

FUNDAMENTAL PRINCIPLES OF MEASUREMENT

ments, have developed a technique based on the fact that random errors tend to cancel out when the average is taken of a large number. To preserve

24. Subjective Methods the desirable subjective basis of the experiment, personal judgment is used, but the independent impressions of a

large number of people are systematically taken and combined. In addition to giving an average result which is more reliable than a single one, this process also indicates how far the individual results spread around it. The persons are carefully selected, to be representative of the public generally, or to be all untrained or all trained in observation, or on some other basis as the experiment may require. The whole thing is in the highest degree systematic, and far from being a mere collection of opinions.

The important thing in this and every other method is to ensure that the quantity actually observed or measured or the fact established is the one that

25. Disentangling the Conclusions is really wanted. Make sure of one thing at a time. The books say that if you interpose a condenser of, say,

100 $\mu\mu\text{F}$ in series with a large aerial you improve the selectivity, at the cost of reduced signal strength. You try it, and the signal strength goes up. This does not prove that, in a general statement, all the books are wrong. It just shows that in this particular receiver the large aerial was too tightly coupled, and overdamped and probably mistuned the circuit; or else that the receiver tends to be unstable due to stray reaction, which was kept in check by the large aerial and released by interposing the condenser. Or perhaps a bit of both. In either case, the effect quite correctly predicted by the books is concealed by a larger effect due to the peculiarities of this receiver, and unless the experiment were rearranged it might be impossible to disentangle the required result.

It would be no good contributing a paper to a scientific society, claiming to have proved by means of experimental evidence that the accepted theory with regard to aerial series condensers is wrong. The experiments were not

conducted with sufficient attention to the possibilities of irrelevant influences acting at the same time. Sometimes it is very difficult indeed to exclude disturbing influences. It may be possible, however, to arrange the tests so that in the result they cancel out.

A particular and important sort of irrelevant influence is the testing apparatus itself. You may wish to know the

26. Disturbing Effects due to Instruments

negative bias voltage on the grid of a valve under working conditions. Fig. 12 (a) shows the circuit, with the working conditions analysed. The simplest way, one might think, is to connect an accurate and reliable voltmeter to the grid and cathode, between which points the voltage is desired to be known. Certainly the voltmeter may give a reading. But it is a fallacy to assume that that reading is what is wanted. You want to know the voltage under working conditions. What you actually read is the voltage with a voltmeter—a conducting path—between the points. And the two things may be vastly different, as may be seen by comparing *b* with *a*. A better approximation can be obtained by measuring the voltage across the comparatively low resistance bias resistor (*c*); but this does not make *quite* sure that the voltage measured is actually getting to the grid. There may be a hidden break in the grid leak. A still better method is to note the voltage from some independent supply that can be connected from grid to cathode without altering the anode current.

Or consider measuring the gain of an amplifier. A switch is used to connect a meter to measure in turn the input and output voltages. Such a method has already been discountenanced on two grounds: it is particularly undesirable to take readings which (as probably in this case) are widely different; and there is the effect of the meter on the input and output circuits. But, in addition, the switching system may introduce enough feed-back to affect the performance of the amplifier very considerably. Take great care to reproduce true working conditions, and to exclude disturbing effects due to the measuring

FUNDAMENTAL PRINCIPLES OF MEASUREMENT

apparatus. The approved method of measuring amplification is to connect in series with the amplifier an attenuator which can be adjusted to counterbalance the gain, so that the levels at the input and output of the whole are the same. The attenuation is then a measure of the gain, and no signal level measurements are necessary.

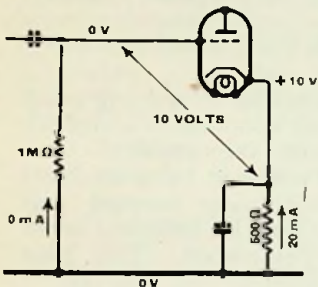

(a)

Fig. 12 : How the measuring instrument may affect the thing measured. *a* shows part of a valve circuit with the condition of current and voltage marked. If one tries to measure the voltage between cathode and grid with a voltmeter, condition *b* results, in which the quantity to be measured is reduced to one-hundredth of its proper amount. Measurement of the voltage across the biasing resistor *c* results in a comparatively small error

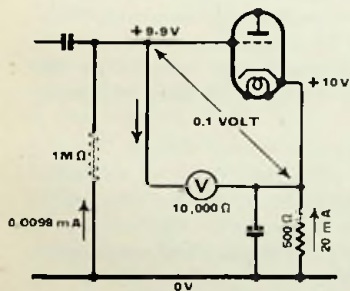

(b)

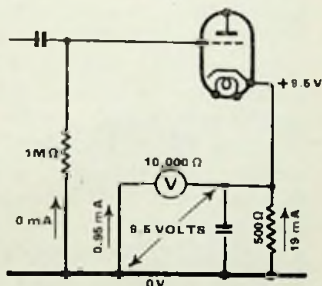

(c)

These examples are given so that when individual methods are discussed later it may be quite clear without lengthy explanation why certain methods are recommended rather than others.

The advice to reproduce, as far as possible, natural working conditions in an experiment, and again to study

27. Reproducing Working Conditions

one fact at a time, may tend to conflict. The natural working conditions of a broadcast receiver are that it is installed at a certain place, connected to a certain aerial and earth, turned on, and tuned to certain stations. During that process many influences are at work—power, locality, carrier frequency, modulation percentage and frequency of transmitter; distance and nature of ground between it and the receiver; time of day and year; nature of receiving aerial and situation; acoustics of listening room—to name a few. To draw reliable conclusions about the results it is necessary to simplify the problem. For instance, the transmitter may be replaced by a standard signal generator, with everything under control and measurable. The outside aerial may be replaced by a dummy aerial smaller than a matchbox. The loud speaker may be replaced by an artificial load and output meter. Then some definite figures of receiver performance can be obtained. But they should not blind one to the artificiality of the test, and lead to unwarrantable conclusions.

This applies with extra force to ultra-short wave tests.

Enough has been said in this chapter to emphasise the importance of care in planning tests, and also in setting up the apparatus.

Many times, however, one comes across things that go wrong; for example, a result obtained on one occasion fails to repeat itself on another occasion when the conditions are apparently similar. It may happen in the course of a single experiment, especially with complicated apparatus. It often happens when a system has been worked out experimentally, and is then put into proper shape for permanent use. This sort of difficulty is much more easily cleared up if the original apparatus has been left intact, although even then it may be very puzzling. Without it, the secret may be lost for ever. It is necessary gradually to eliminate the differences between the two, until the one responsible for the unexpected divergence in results is revealed. Often, as in detective fiction, the offender turns out to be the least suspicious character.

CHAPTER 4

INSTRUMENTS

A—Sources of Power and Signals

IN the earliest systems of electrical communication the messages were conveyed by means of make and break of current according to a prearranged code, or, in one word, *signals*. As apparatus became more complex and required to be supplied with currents

28. “**Signals**” other than those actually conveying the message, it was necessary to distinguish the latter from the former by calling them *signal currents*. The name still persists, although the original meaning of the word *signal* has had to be strained severely to make it cover such things as broadcast programmes. But it is essential to have some such concise term to distinguish the communication currents (or voltages) from those used for feeding the valves, etc. As a permanent unvarying current alone cannot be made to convey “intelligence” (to use another word whose original sense must not be taken too literally), signal currents are never strictly zero frequency (or “D.C.”), and the term “D.C. amplifier” is understood to mean an amplifier that magnifies the differences between levels of current or voltage, however slowly such differences occur. Signals are therefore usually classified according to frequency, and the broadest distinction is between audio and radio frequency. For experimental work, controllable sources of audio and radio frequency signals are among the most desirable items of equipment.

Power Sources

Sources of power for feeding valve apparatus and for incidental purposes are mainly D.C., although the raw

Fig. 13: The General Radio Co.'s "Varjac" combines the close voltage control of a sliding potential divider with the efficiency of a transformer

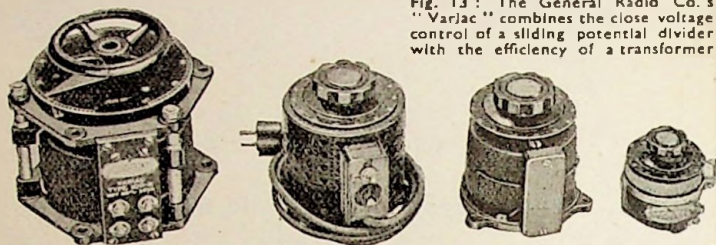

29. "Mains" Power

A.C. from the mains is used wherever practicable. Elsewhere, rectifiers and filter circuits are needed to convert to D.C. Generally it is most convenient to build a power unit into each individual piece of apparatus that requires it, rather than to try to run it from some central power unit. The requirements are so varied that it is impossible to design a power unit to anticipate them all. If it is larger than is needed not only is there waste but also in order to reduce the voltage without bad regulation (i.e., constancy of voltage for varying currents drawn) expensive stabilising devices may be necessary. And if common power supplies are used for a number of instruments, there is a probability of short-circuits and undesirable coupling. There are other obvious advantages in providing tailor-made power units. Nevertheless it is very convenient to have in addition one or two reach-me-downs for general purposes; one giving up to 120 mA at 350 volts and several amps. at 4 and 6.3 volts is very useful. Details of design need not be given here because they follow ordinary receiver practice, and can be varied to suit individual needs. Several transformers supplying A.C. at 4 and 6.3 volts are useful for heating valves connected in experimental circuits, and sometimes come in handy as a source of 50 c/s signal voltage. A larger transformer giving several hundred watts at any voltage up to 250 or 300 is a useful possession; if varied by a tapping switch (with intermediate dead studs to prevent short circuits) it may be necessary sometimes to use a heavy-current sliding

SOURCES OF POWER AND SIGNALS

potential divider across it for fine control, but the "Variac" sold by Claude Lyons Ltd. combines both functions with greater efficiency, and gives a practically continuous variation of voltage (Fig. 13). A switchboard for grouping such controls may be useful, but perhaps unnecessary if there is an abundance of mains supply points around the laboratory, as advocated in Chapter 2.

Although it simplifies matters to run as much as possible off the mains, it is hardly practicable to do without batteries altogether. For I.T., especially if

30. Batteries and Switchboards experiments demand fairly heavy current with the minimum of voltage drop, large accumulators are at least

theoretically desirable; but there are many purposes for which the small portable type is the only practicable one. The fact that they can be brought right up to the terminals of their load is likely to result in less voltage drop than by using a large stationary battery that requires long leads to connect it to the work. It is surprising how difficult it is to maintain a full 2 volts at the end of several yards of wire even when it is multi-strand cable and the current is no more than an amp. Unfortunately the type of cell that gives the least variation of voltage with current drawn is not the type that stands up best to lab. conditions—i.e., long idle periods and irregular charging. This must be considered when selecting batteries; the makers should be consulted.

A H.T. accumulator is perhaps a rather expensive luxury, bearing in mind that the very small sizes are not to be recommended for laboratory service. A useful voltage is 250; more, if one can afford it. The battery should be permanently installed in some place where it will not be in the way, but on the other hand not so much out of the way that it is too much bother to inspect it fairly frequently for acid level, creepage, or corroded terminals. It should be thoroughly insulated as a whole, and connected by well-protected cables to a distribution switchboard. Fig. 14 is a slightly modified connection diagram of a board that the author has found useful for many years. Valve or metal rectifier chargers can

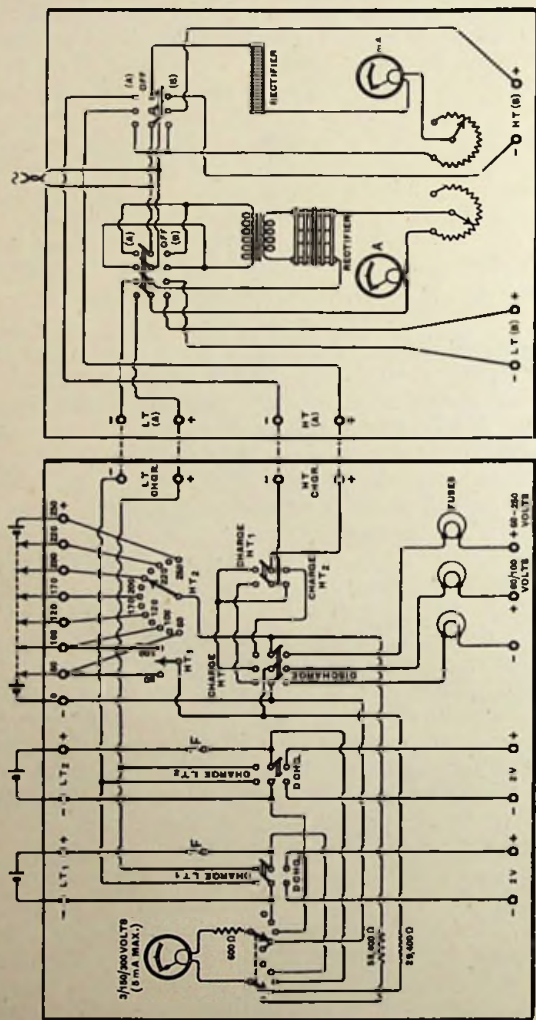

Fig. 14: Connection diagram of useful battery control and charging switchboards, for two 2-volt cells and one 250-volt battery

SOURCES OF POWER AND SIGNALS

generally be rigged up from spare components so are not specified in detail. Note that two H.T. tappings are available ; one giving a choice of two voltages (60 and 100) and the other variable up to maximum by a multi-point switch ; only alternate studs being connected, to avoid shorting sections of the battery when moving from one tap to another. The same applies to the voltmeter switch. A useful selection of voltages can be obtained by operation of the two switches :—

Connection to H.T. Terminals

(1) & (2)	(1) & (3)	(2) & (3)	
		H.T.1 = 60 volts	H.T.1 = 100 volts
60 volts	0 volts	— 60 volts	— 100 volts
100 „	60 „	0 „	— 40 „
	100 „	40 „	0 „
	120 „	60 „	20 „
	170 „	110 „	70 „
	200 „	140 „	100 „
	220 „	160 „	120 „
	250 „	190 „	150 „

One can always shift a battery tap temporarily for getting a voltage not in this list.

The switch marked “ Charge H.T.1/Charge H.T.2 ” is included because by charging the battery in two sections a saving can be effected in the charger, especially if it is of the metal rectifier type ; it is possible to charge any section of the battery according to the discharge taken from it ; and such sections can be charged more economically from a 170-volt charger than from the 340 volts that would be necessary for the whole battery at once.

Fuses are either cheap flash-lamp bulbs or the tubular sort made by Belling-Lee, who have a magnesium-fired type that avoids the usual heavy mortality of fuses due to momentary surges when first switching on any apparatus containing a large reservoir condenser or a transformer.

For the L.T. ordinary fuse wire will do, of a rating

according to requirements ; but the fusing current should not be too close to the maximum working current nor should the wire be needlessly long, or the volt drop will be excessive. For the same reason only one pole of each cell is shown fused. The cells are not interconnected on the discharge side, so can be used at different potentials in the same circuit or connected in series to provide a 4-volt supply ; they can also be charged separately, or in parallel.

A cheap but reliable moving coil voltmeter is fitted with suitable series resistors for testing both L.T. and H.T. batteries. An inaccurate voltmeter is useless for battery testing. And as a large H.T. accumulator battery is quite an expensive item it pays to give more than perfunctory attention to the maker's instructions.

Where the cost of such a battery is not practicable or justifiable, and perhaps even where it is, a few dry batteries are generally in demand. The most useful types are those with many tapings, preferably at every cell towards one end.

Audio Sources

For the amateur who cannot afford specialised and expensive instruments, the most practical audio source is a gramophone. In the first place, a

31. The Gramophone Source gramophone turntable and pick-up has its uses quite apart from experimental work, so it may not be

necessary to charge all of its cost to technical account !

At the most, it costs less than any purely electrical oscillator with comparable accuracy of frequency and waveform.

And in addition to pure tones of fixed frequency (derived from standard frequency records) one can get fancy test

signals—warble tone, gliding tone, etc.—and of course any sort of “programme” as well. A particularly useful

record for general test purposes is H.M.V. C.2492 (“Guessing the Tunes”) because it consists of various sorts of music interspersed with speech. An inexpensive technical

record is the Decca EXP.55, which provides two sets of 14 standard frequencies from 50 to 6,000 c/s. For

convenient reference here is a list of such records :—

SOURCES OF POWER AND SIGNALS

Maker	Number	Side	Recording	
Decca	EXP.55	1	Constant pure tones : 6000, 5000, 4500, 4000, 3500, 3000, 2000, 1000, 500, 250, 160, 100, 70, 50 c/s. Level constant 6000 to 250 c/s; 14 db. down at 50 c/s. Stroboscope label.	
		2	Duplicate of Side 1.	
Parlophone	P.9794	1	Gliding Tone : 6000 to 100 c/s. Level constant.	
		2	Gliding Warble Tone : as above, but frequency varied 10 times per second by ± 50 c/s.	
	P.9795	1	Constant Warble Tones : 150 ± 50 c/s ; 300 ± 50 c/s.	
		2	Constant Warble Tones : 600 ± 50 c/s ; 1200 ± 50 c/s.	
	P.9796	1	Constant Warble Tones : 4800 ± 50 c/s ; 2400 ± 50 c/s.	
		2	Constant Warble Tones : 950 ± 650 c/s ; 1800 ± 1600 c/s.	
	P.9797	1	Constant Pure Tones : * 256, 128, 64, 32 c/s.	
		2	Constant Pure Tones : 4096, 2048, 1024, 512 c/s.	
	P.9798	1	Constant Pure Tones : 6400, 3200, 1600, 800 c/s.	
		2	Constant Pure Tones : 400, 200, 100, 50 c/s.	
	H.M.V.	D.B.4033 D.B.4034	1 & 2	Special Sound Demonstrations.
			1	Constant Pure Tones : † 8500, 8000, 7500, 7000, 6500, 6000, 5500, 5000, 4500 c/s.
D.B.4035		2	Constant Pure Tones : 4000, 3750, 3500, 3250, 3000, 2750, 2500, 2250 c/s.	
		1	Constant Pure Tones : 2000, 1800, 1600, 1400, 1200, 1100, 1000, 900 c/s.	
D.B.4036		2	Constant Pure Tones : 850, 800, 750, 700, 650, 600, 550, 500 c/s.	
		1	Constant Pure Tones : 450, 425, 400, 375, 350, 325, 300, 275 c/s.	
D.B.4037		2	Constant Pure Tones : 250, 225, 200, 180, 160, 140, 120, 100 c/s.	
		1	Constant Pure Tones : 90, 80, 70, 60, 50, 40, 30, 25 c/s.	
			2	Gliding Tone : 8500 to 25 c/s. Level constant, 8500 to 300 c/s. 14.5 db. down at 25 c/s.

* Levels irregular : specified by makers.

† Levels specified by makers : practically constant 8500-250 c/s, 11.1 db. down at 25 c/s.

Level refers to R.M.S. velocity of needle point, to which the electrical output of a perfect pick-up is proportional.

Obviously the correctness of the frequency given by a standard frequency record depends on the motor speed. Assuming that the mains are frequency-controlled A.C., the speed can be accurately adjusted by means of a

stroboscope card—or the requisite number of black and white stripes painted on the edge of the turntable—illuminated by a lamp ; a neon lamp is preferable as it is extinguished completely twice each cycle of supply voltage, whereas the flicker of a metal filament lamp is very slight. The correct number of stripes for indicating 78 r.p.m. is 77 ; for 80 r.p.m. it is 75. Constancy of motor speed is naturally very desirable ; the synchronous induction type has special claims as its speed is definitely synchronised with the mains unless pulled out by an unreasonable load ; and the induction characteristic makes it self-starting.

As for the pick-up, the requirements are identical with those for first-class gramophone reproduction—level response over as wide a frequency band as possible, and a reasonably large output. The needle armature type covers a wider frequency band than most but does not give a very large output. The piezo-electric crystal type is better in this respect, but its high and capacitive impedance demands special care in circuit arrangement. While it is easy to retain the accuracy of the record's frequency calibration, the amplitude calibration is affected by the characteristic of the pick-up and of any amplifier that may be necessary for increasing the output. Although the accuracy of measurements that are made with it is not thereby upset if properly carried out (see Sec. 221) a lot of time taken over adjustments can be saved if the output is substantially uniform over the whole band of frequencies. Incidentally, it is not always realised how the amplitude at different frequencies is affected by the type of needle used. Even different samples of the same type may vary in this respect. Whatever sort is selected, the needle should be used for as short a time as possible ; on the higher frequency grooves at any rate. The top frequency calls for a brand new needle, so it is customary to begin tests at that end.

The gramophone has its limitations, of course : the records wear out or get broken ; it requires more manipulation than an all-electric source ; it is unsuitable for long runs ; the output is neither very large nor very uniform ; and the range of frequencies is limited. Some of these

SOURCES OF POWER AND SIGNALS

disadvantages are absent in the "Electrone"; the synthetic tone generator due to L. E. A. Bourn of the John Compton Organ Co. The desired waveforms are engraved along annular tracks on the surface of a revolving disc in such a manner as to separate the conducting surfaces each side of the groove. A large difference of potential is maintained across the groove by a polarising source, and the tones are picked up by stationary electrodes, which do not actually touch the disc. The output is therefore constant, continuous, and of definite amplitude. Although this system has hitherto been confined to entertainment purposes, it is possible that it may be applied as a laboratory source. The disadvantages are the extremely small output and the necessity for a suitable driving motor.

Another experimental synthetic tone source is the photo-electric, in which the waveforms are painted in black and white on a reflecting or transparent strip or film, and used to modulate the light falling on a photo-electric cell, whose output, when amplified, is the signal source.

All-electric signal sources consist of valve oscillators in more or less elaborated forms, and before describing some

32. Valve Oscillators— General Requirements

of these it will be helpful to consider the requirements of the basic valve oscillator as applied in the laboratory. One can hardly have too many oscillators, of either low or high frequency; and while any valve oscillator has its uses it is necessary or desirable for many purposes that it should conform to satisfactory standards of waveform purity, frequency stability, and uniformity of output. An ordinary oscillator circuit such as can be hooked up in a few minutes from common components is likely to be more or less defective in all of these respects. By careful design it is possible to reach almost any required standard.

Firstly waveform. It is generally at audio frequencies that it is a problem, because radio-frequency circuits are ordinarily more sharply tuned and magnify the fundamental relative to the harmonics; such harmonics as are

present may fairly easily be filtered out, but their presence is often no disadvantage and may even be very useful. The cause of harmonic distortion is that when a valve generator once starts oscillations they grow in amplitude until something limits them. Generally that something is grid current, or a bend in the valve characteristic; in other words a rectifier, which is essentially a distorter. The oscillation grows until the initial negative resistance due to the valve back-coupling is neutralised by tuned circuit resistance, and by resistance due to grid current or by reduced average valve conductance. These quantities depend on a variety of conditions that may not be very constant, especially when the frequency of the tuned circuit is adjusted or power is drawn from it; and so the amplitude of oscillation is indefinite. The same influences that result in harmonics and in variations of amplitude are also among those that cause the frequency of oscillation to depart from calibration.

If the oscillator is provided with a reaction control it is possible to prevent gross over-oscillation; but adjustment is critical and has to be done every time the frequency is changed, it is practically essential to use a valve-voltmeter or other indicator to show when the normal amplitude is reached, and when taking many readings these adjustments waste a lot of time. The best of this type, and a great improvement on ordinary variable reaction coupling, is the resistance stabilisation circuit shown in Fig. 15.* It will be seen to be a perfectly

33. Resistance Stabilisation

Fig. 15: Resistance-stabilised oscillator circuit suitable for A.F. and low R.F.

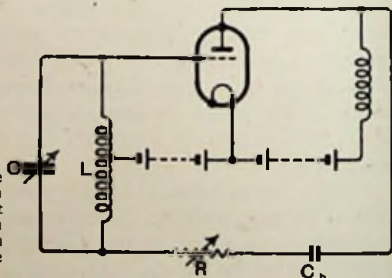

* For further information, see F. E. Terman's "Measurements in Radio Engineering." The subject of valve oscillators generally is capably presented in H. A. Thomas's "Theory and Design of Valve Oscillators."

SOURCES OF POWER AND SIGNALS

ordinary Hartley circuit, with the addition of a variable resistance R which is used to control the feed-back. The coupling between the anode and grid portions of the tuning coil is as close as possible, and the " Q " (otherwise known as magnification factor, or ratio of reactance to resistance) as large as possible. In these circumstances, if the whole output from the anode were connected direct through the high-capacitance blocking condenser C_b , oscillation would be far too fierce and would cease growing only when held by an enormous grid current. By interposing the variable resistance R , which may have a maximum of 50,000 or 100,000 ohms or more, and adjusting it until oscillation only just starts, a mere trace of grid current is enough to bring it to equilibrium, and distortion is correspondingly small. The peak amplitude across the grid portion of the coil is approximately equal to the grid bias voltage plus perhaps one volt or less if carefully adjusted. Incidentally, it is essential to use grid bias; the grid-leak-and-condenser method is inapplicable.

The object of using resistance instead of capacitance to control the feed-back is to avoid phase shifts, which tend to make the frequency less stable. Another precaution is to make the $\frac{L}{C}$ ratio not too large. This circuit provides the reader with a simple exercise in design: given μ and r_a of the valve at the grid bias selected; and L , C , R.F. resistance, and turns ratio of the tuned circuit, it is easy to calculate the required R .

This circuit works according to plan only when the stray capacitance across R is inappreciable, and as R may be fairly large this limits its use to audio and low radio frequencies—a few hundred kc/s at most.

Guiding principles in designing reaction-type oscillators for all frequencies are to avoid grid current as far as possible, to employ valves of high resistance and high mutual conductance, and to use oscillatory circuits of high Q and high ratio of $\frac{C}{L}$, with grid and anode windings as closely coupled as possible and with a high ratio of anode to grid inductance.

To avoid the possibility of over-oscillation and the trouble of having to keep reaction always adjusted, there is automatic amplitude control,*

34. Automatic Amplitude Control

which is an adaptation of our old friend A.V.C. R can be reduced to a value that ensures oscillation at every frequency to which L and C are adjusted, or alternatively it can be omitted altogether and the tapping point on L suitably chosen; and the whole or part of the grid bias is derived from separate rectification of the oscillations. Fig. 16, although not a useful practical circuit, illustrates the principle. V_2 is a diode; the grid and cathode of a disused triode or other valve will do. It is possible to combine V_1 and V_2 by using a diode-triode; but as will be shown later this limits the possibilities of the circuit. The condenser C_1 may be of any value having not more than a few thousand ohms reactance at the lowest working frequency. R_1 may be of the order of $0.5\text{ M}\Omega$. R_2 and C_2 form a simple filter to remove the oscillation component in the rectified output, and usually presents the chief difficulty because if its time constant† (R_2C_2) is made too large it causes motor-boating, and if it is too small the control fails. For this reason it is difficult

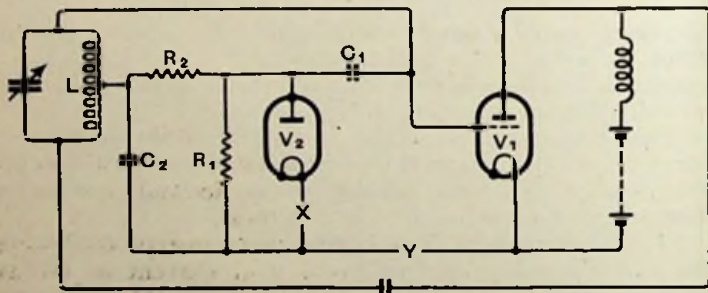

Fig. 16 : Automatic amplitude control. The grid bias for the oscillator valve V_1 is derived from the oscillation itself, rectified by V_2 . Modulation can be introduced at X or Y

* First described by L. B. Arguimbau, *Proc. I.R.E.*, Jan., 1933.

† See Sec. 301.

SOURCES OF POWER AND SIGNALS

to make the same values serve over a very wide range of frequencies. The best values must be found by experiment.

As exemplified in Fig. 16, the system presents no noticeable advantages over the simple leak-and-condenser-grid return for the oscillator. With either, suppose the oscillation frequency is altered by increasing L , or a more efficient valve is plugged in, or the anode supply voltage rises; any of these would cause the amplitude of oscillation to increase, the harmonics to increase very greatly, and the frequency to be different from that delivered under less fiercely oscillating conditions. But the circuit of Fig. 16 can be elaborated so that a very small increase in oscillation biases

Fig. 17: A.A.C. circuit with separate coupled winding for supplying the bias rectifier. Lettering corresponds with that of Fig. 16

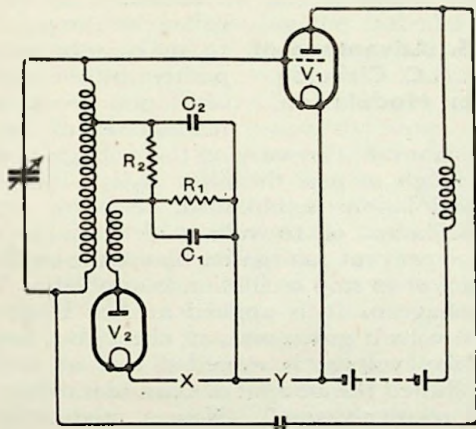

back the valve enough to restore equilibrium. Amplitude is thus kept nearly constant without manual adjustment. If the coil tap is near the grid end a closer control is obtained if C_1 is connected to the anode end of L , or alternatively a separate closely-coupled coil can be used (Fig. 17). For still closer control

and for avoiding the residual distortion due to direct connection of the rectifier to the oscillator circuit the methods of amplified A.V.C. are available, but increase the tendency to motor-boating.

This system can be worked so that the oscillation is restricted to a small portion of the best part of a valve's characteristic curves, well away from both grid current and

bottom bend, with the result that it far exceeds the uncontrolled oscillator in purity of waveform; practically the only distortion is due to the rectifier circuit, and is minimised by adopting the same design principles as apply to A.V.C. circuits. It might be supposed that the separate rectifier introduces as much distortion as a grid condenser and leak, and if badly designed this might be so; but with care it is appreciably less, and can be removed altogether by using an amplifying or buffer valve; in addition it lends itself to precise control, and causes less frequency uncertainty.

If the amplitude of oscillation restricted in this way is too small, it can be increased by introducing a delay voltage at the point X in Figs. 16 and 17, making the cathode of the rectifier positive by the amount by which the oscillation peak amplitude at the rectifier is to be increased. It is

35. Advantage of A.A.C. Circuit for Modulation

obvious that by varying this voltage at some frequency low enough to pass the filter R_2C_2 , a very perfect method of modulation is obtained. Suppose one wants a peak oscillation of 10 volts with variable modulation up to 100 per cent., a negative bias to the oscillator valve sufficient almost to stop oscillation is applied at Y. A steady delay voltage of 10 is applied at X. Until oscillation reaches 10 volts it grows without check, but beyond that limit the delay voltage is exceeded and as it has been critically adjusted the amount of extra bias demanded of the rectifier is relatively small. Now a modulating voltage variable up to 10 volts peak is applied in series with the delay voltage. If both delay and modulating voltages are fed into the cathode line through a common potentiometer, it is possible to control the amplitude of oscillation leaving the percentage modulation constant and adjustable by a separate control.

It is very easy to apply voltmeters to indicate not only the oscillation voltage but also the percentage modulation. The only drawback is the manual adjustment of oscillator bias which is necessary if these quantities are to be given correctly by such readings. According to the original

SOURCES OF POWER AND SIGNALS

method described by Arguimbau the modulation voltage is applied at Y ; the tuned circuit is loaded by the rectifier throughout the positive half-cycle, the amplitude varies with circuit conditions and it is necessary to have an A.C. voltmeter in order to read percentage modulation ; but the manual adjustment is dispensed with. In all cases it is necessary to make sure that the oscillator valve is not overloaded at maximum modulation.

The modulation voltage may of course also be generated by an automatically controlled oscillator. A circuit for a modulated oscillator is given in Fig.

36. A Complete A.A.C. Modulated Source

18, in which the slider S_1 adjusts A.F. and R.F. amplitudes simultaneously by biasing the cathodes of both control rectifiers (the voltmeter V may be calibrated directly in amplitude), and the percentage modulation is adjusted by S_2 , which may also be direct-reading. The component value markings are to give some idea of suitable magnitudes. It will be noticed that R_2 is replaced by a choke, to pass A.F. but stop R.F. It will also be noticed that

37. The Dynatron Oscillator

the triode oscillators are replaced by dynatrons, which are superior in many ways. Almost any screen-grid tetrode with the anode fed at a substantially lower voltage than the screen will work as a dynatron, but the Mazda AC/S2 excels. For detailed information there is a lengthy article on it ("Applications of the Dynatron", *Wireless Engineer*, Oct., 1933, pp. 527-540), together with 35 references to other literature on the subject. The dynatron is worth studying, because once the mode of operation has been grasped it is one of the most useful tools for experimental work. No feed-back is necessary for oscillation ; the typical curves of Fig. 19 show that when the anode voltage V_a is between the limits of about 10 to 90 per cent. of the screen voltage V_s the anode current (I_a) curve slopes the opposite way from the usual, which means that the anode A.C. resistance is negative and that any oscillatory circuit connected in series will oscillate if its dynamic resistance is numerically greater. As the curves

RADIO LABORATORY HANDBOOK

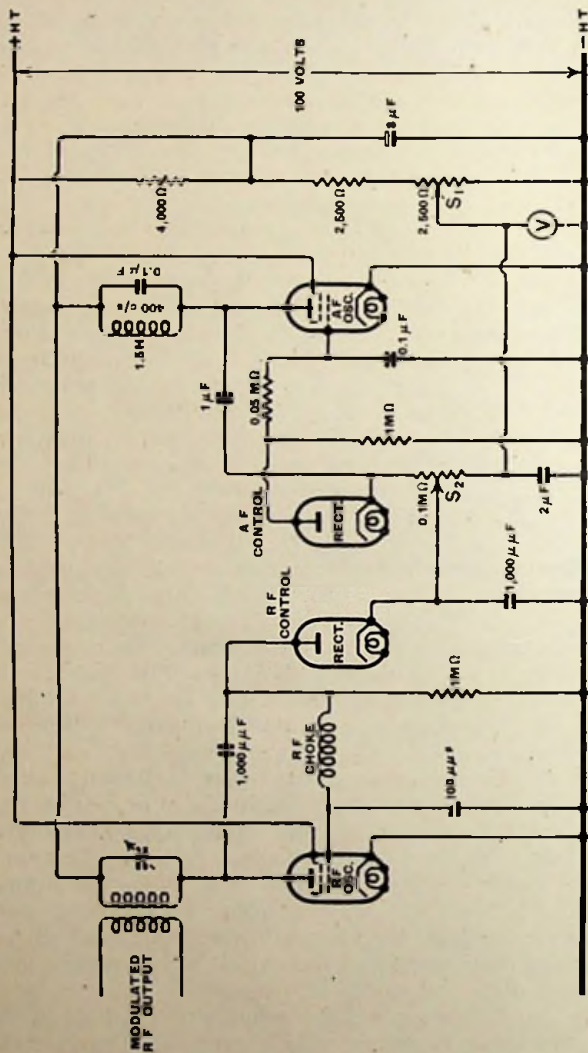
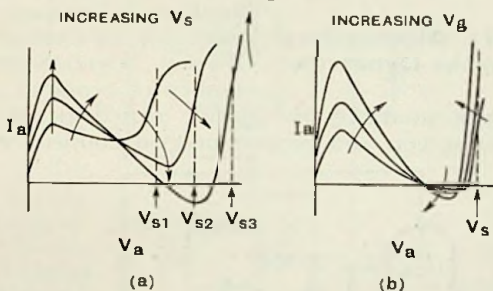

Fig. 18 : Modulated R.F. source with A.O.C. of both R.F. and A.F. oscillators. Provision for continuous variation and indication of modulated depth up to 100 per cent. by S_2 and the same for signal amplitude by S_1 and V

SOURCES OF POWER AND SIGNALS

show, the negative resistance can be varied either by V_s or by grid voltage V_g . Generally it is convenient to fix V_s at the lowest that will give the required negative resistance and sufficient amplitude of oscillation, and to use V_g for increasing the resistance until oscillation is only just maintained. Under these conditions it sweeps over the practically straight downward slope and the purity of waveform is exceedingly good. Convenient voltages are V_s 100, V_a about 20 for small amplitudes and 50 for maximum amplitude, and V_g variable to about -8 . With zero bias the anode resistance of the AC/S2 goes down to about -6000 ohms, which is capable of setting even heavily damped circuits into oscillation; but when run like this there is a risk of the dynatron properties deteriorating

Fig. 19: Typical anode current/anode voltage curves of dynatron, showing the effects of varying the screen voltage (a) and the control grid voltage (b). The screen voltage, V_s , is marked along the anode voltage scale



fairly quickly. The dynatron is therefore not advised for very high-frequency work, i.e., over 30 Mc/s, in which the impedance of the oscillatory circuit is inevitably low.

An important practical point is to make any potential divider used to tap off the anode voltage considerably lower in resistance than the negative resistance of the dynatron.

The advantages of the dynatron are its ability to set up oscillation in a simple two-terminal circuit, which may even be screened and inaccessible; the ease and precision of control; the straightness of its working characteristic; and the frequency-stability of its oscillations *provided that they do not sweep beyond this working slope*. It lends itself particularly to automatic amplitude control, because the

control element (the grid) forms no part of the oscillating circuit, and a very large control is exercised by a small grid voltage ; so much so that auxiliary manual controls are omitted in Fig. 18.

Referring once more to that diagram, the output is shown taken directly from a coil coupled to the oscillatory circuit. In practice, unless the coupling is so loose as to act by radiation rather than by induction, the output from any oscillator should be drawn from an amplifying valve so as to prevent the load from influencing the oscillator. The subject of dynatrons is continued in Chapter 7 (Sec. 148).

It may be found very difficult now to obtain AC/S2 valves, or indeed any type of tetrode suitable for use as a dynatron. Fortunately G. A. Hay has shown, in a valuable investigation (*Wireless World*, Sept. 1944), that a number of types of pentode can be substituted, by the simple expedient of "commoning" the screen and suppressor grid connections. The Osram

37a. Alternatives to the Dynatron

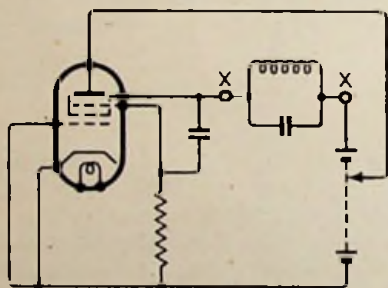

Fig. 20 : Basic transatron circuit: When suitable voltages are applied to the pentode electrodes a negative resistance is produced across the terminals XX, and continuous oscillations may be maintained in a tuned circuit connected to them

VMP.4G is shown to have the most favourable dynatron characteristics, very similar to those of the AC/S2 ; and the best working electrode voltages are little if any different. Other types having useful dynatron characteristics are Mazda SP.41, Mullard EF.50 and Brimar 6J7G.

Another pentode device capable of producing a negative resistance between a pair of terminals, and therefore an alternative to the dynatron, is the transatron, first described

SOURCES OF POWER AND SIGNALS

by E. W. Herold (*Proc. I.R.E.*, Oct. 1935) but so-called by Brunetti, whose paper on it in *Proc. I.R.I.*, Dec. 1937, is worth studying also for its explanation of "average negative resistance". The negative resistance is a feature of the screen-voltage/screen-current characteristic, so the oscillatory circuit is connected in series with the screen instead of with the anode (Fig. 20). And in order to obtain this characteristic it is necessary for the screen voltage changes to be applied to the suppressor grid. As the working suppressor voltage must be lower than that of the screen, the difference must be maintained by con-

Fig. 21 : Practical transitron circuit

necting them together through a battery, or, more conveniently, through a blocking condenser, with the suppressor tied to the required voltage (generally slightly negative) through a resistor of the grid leak type. These appendages render the circuit less ideally simple than the dynatron, and for high frequencies tend to increase losses, and stray capacitance ; but by using a physically small ceramic condenser, a resistor of the order of $1\text{ M}\Omega$, and the shortest possible connections, this drawback need not be serious. A $100\text{ }\mu\mu\text{F}$ coupling condenser is sufficient for frequencies above about 200 kc/s ; smaller may be used for VHF.

As with the dynatron, the control grid is a convenient throttle for adjusting the value of negative resistance. The screen and anode volts giving best negative resistance characteristics depend on the type of valve, but for long life should not be needlessly high. Recent articles on

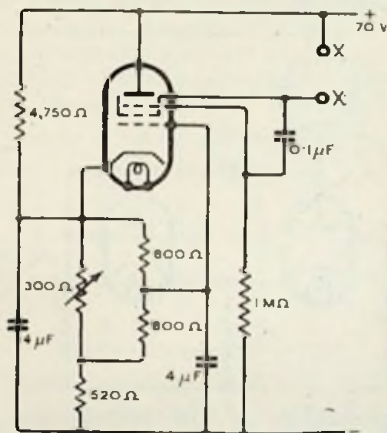

As with the dynatron, the control grid is a convenient throttle for adjusting the value of negative resistance. The screen and anode volts giving best negative resistance characteristics depend on the type of valve, but for long life should not be needlessly high. Recent articles on

the practical use of the transitron as an oscillator include those by A. G. Chambers (*Wireless World*, March and April, 1943) and F. P. Williams (*Wireless World*, Aug. 1944). In the latter it is shown that for satisfactory operation the suppressor should be provided with sufficient bias to prevent it from being swung positive by the screen, and the recommended control system is repeated at Fig. 21.

Still another two-terminal negative resistance device, especially suitable as a constant-frequency oscillator, is described by F. Butler (*Wireless Engineer*, Nov. 1944) and employs two valves, which are not necessarily tetrodes or pentodes, connected as shown in Fig. 22. For details of

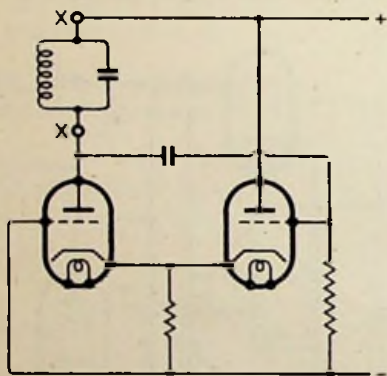

Fig. 22 : Outline circuit of cathode coupled oscillator

the principles, advantages and practical circuits, reference should be made to Butler's article ; but two additional points may be useful to note. The first is that the oscillator output can be taken from a transformer or other device—

preferably of low impedance—in the anode circuit of V_2 ; and the second is that the output across the cathode coupling may be applied through a rectifier to provide an automatic amplitude control bias, say to the suppressor grid of a suitable V_2 .

All the foregoing can be used at any frequency up to or near VHF, using appropriate coil and condenser across the negative resistance terminals. In

37b. Resistance-Capacitance Oscillators

In recent years a large variety of oscillator circuits have been devised using resistance and capacitance (RC) instead of inductance and capacitance (LC). Although some of these will work at radio frequencies, their ad-

SOURCES OF POWER AND SIGNALS

vantages increase towards the low frequency end, especially below 100 c/s, because at such frequencies air-core coils are of excessive bulk and resistance, and iron-core coils tend to cause poor waveform and inconstant frequency. The basis of most types of RC oscillator is a resistance-capacitance coupled amplifier (or amplifiers) with the output coupled back to the input. In order to maintain oscillation it is necessary for the values of resistance and capacitance and the valve characteristics to be such that if an alternating voltage is started anywhere in the amplifier loop the voltage fed back to that position is exactly equal in magnitude and phase. If a pure sine waveform is desired, the object of design is to arrange the coupling so that this condition exists at only one frequency.

In practice, with reasonably careful adjustment of the amplification, the harmonic distortion can be kept down

Fig. 23 : Outline circuit of a simple form of phase-shift oscillator. The frequency of oscillation depends on the values of R and C

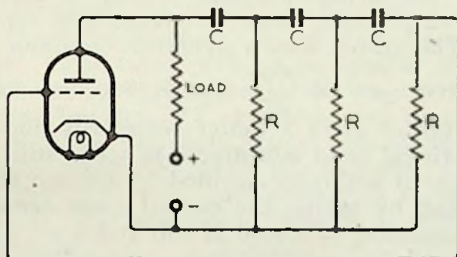

to a fraction of 1 per cent. ; but over-oscillation results in much greater deterioration

of waveform than in a comparable LC oscillator. In fact, this feature of RC oscillators is exploited when a very large range of harmonics is desired ; for example, by feeding back the whole voltage output of a 2-stage amplifier, as in the multivibrator (Fig. 84).

The subject of RC oscillators has been reviewed by J. A. B. Davidson (*Electronic Engineering*, Jan. and Feb. 1944) in an article which includes a bibliography ; so the only circuit reproduced here (Fig. 23) is one to illustrate the principle simply. Only one valve is used to provide the amplification, and the back coupling is via a 3-stage RC network which produces the required 180° phase shift at a frequency determined by the R and C values.

Coming now to actual audio-frequency sources embodying these principles, constructional details of a mains-driven oscillator giving 15 fixed frequencies from 50 to 10,000 c/s with automatic amplitude control are given in Chapter 7 (Sec. 155).

38. "Straight" Audio Sources

The output voltage varies from one frequency to another to the extent of about 1 db. owing to inequalities in the dynamic resistances of the various tuning circuits ; but it is vastly superior to the usual uncontrolled oscillator, in spite of no manual adjustment being provided. Also it cannot be claimed that the lowest frequencies, for which iron-core coils are used, are of surpassingly pure waveform. Again, they are far better in this respect than one gets from the uncontrolled triode.

For bridge purposes it may be more desirable to have exceptionally pure waveform than a range of frequencies. The author uses a dynatron oscillator tuned to the single frequency of $\frac{5000}{2\pi}$ (nearly 800 c/s). Although automatic control gives a better waveform than no control at all, critical bend adjustment is better still, so is used ; and the signal is further purified by the use of negative feed-back and by taking the output from across a rejector circuit consisting of a 0.08 H coil and a 0.5 μ F condenser. Both oscillator and filter tuning are adjustable by moving small pieces of mumetal in the fields of the coils.

Only at the topmost end of the scale is it practicable to cover any considerable band of frequency with one sweep of a condenser in any of the foregoing

39. The Beat-Frequency Source

types of oscillator ; the whole audible scale with one or even half a dozen sweeps is out of the question. But for many purposes continuous and rapid coverage of the scale is a most desirable or even essential feature. Like receiving sets, audio sources may be divided into two classes—superheterodyne and "straight". The former is better known, however, as the beat-frequency oscillator. It was probably suggested by the unlawful howl obtainable

SOURCES OF POWER AND SIGNALS

with an oscillating receiver when it beats with a received oscillation. The whole audible scale, and more, results from a very short easy movement of the tuning condenser. So in this, the B.F. oscillator has a powerful attraction, so powerful that it may sometimes obscure the difficulties involved in cultivating the original howling receiver into a laboratory instrument of precision.

A treatise on the design of the B.F. oscillator is outside the scope of this book, but it may be just as well to indicate some of the essentials if only to deter thrifty readers from too light-heartedly setting out to make one.

The first thing one notices about its prototype—the oscillating receiver—is that the very low frequencies are unobtainable because of the tendency

40. Avoiding Pull-in

of two oscillators to “pull-in” when they are very close in frequency. To avoid this the oscillators must be very completely screened from one another. Yet their outputs have to be combined. The same problem is familiar in superhet. receivers, where the two frequencies are separated by at least 110,000 c/s; but in a B.F. oscillator they must approach to 5 c/s, or preferably less, before pulling in. This does not necessarily mean that such a low frequency is wanted for testing; but if the two oscillators pull in at 5 c/s that fact implies poor waveform even at a considerably higher frequency.

Among the methods of solving this problem are the use of (a) carefully balanced output circuits connected in series with the detector; (b) screened buffer valves to prevent coupling back to the oscillator circuits; and (c) frequency-changer valves, after the manner of very-high-frequency superhets.

The matter of waveform is very important if the oscillator is intended for investigating amplifiers for small percentages of distortion, because it is obviously no good trying to do so if the test source itself is impure. Even for the important business of taking frequency response curves a pure source is necessary. If the falling off in response of some

41. Designing for Absence of Distortion

apparatus at, say, 50 c/s is being measured, and the nominal 50-cycle output of the signal put into it includes strong harmonics, to which the apparatus may be much more responsive, the result does not indicate the true 50-cycle response at all. Apart from the distortion at low frequencies due to the tendency to pull in, there is distortion due to the detector, and to the audio-frequency amplifier that follows. Detector distortion is minimised by keeping the percentage modulation low, which in turn is accomplished by making the amplitude of one oscillation relatively small ; say, a tenth of the other, which itself is made sufficiently large to sweep well beyond the curved foot of the detector characteristic. If the detector is linear* beyond this region, the amplitude of the beat oscillation is determined by the smaller and not at all by the larger of the component oscillations ; so in order to maintain a uniform output over the whole scale the smaller oscillation is made the fixed frequency, and the larger the variable. It is allowable, however, to vary the weaker oscillation over a narrow range of frequency, because the change in amplitude over such a range is generally negligible. The usefulness of doing so is that it permits a fine adjustment of frequency with a calibration that holds good at any setting of the main frequency dial. The main tuning condenser is generally shaped to give a logarithmic audio-frequency scale between 100 and 10,000 c/s, and linear outside these limits.

If *both* oscillations include harmonics, audio-frequency harmonics are produced by the detector ; so filters are usually included to make sure that at least one (the fixed, more easily) is of very pure waveform. Another reason for excluding harmonics in the component oscillations is that they are liable to cause spurious whistles at the top end of the frequency scale. Distortion in the amplifier is minimised by careful design generally, and by running the valves well below their maximum rated output.

Judicious use of negative feed-back enables an astonishingly close approach to perfect amplification to be

* There is an alternative system that requires a square-law detector and equal oscillations.

SOURCES OF POWER AND SIGNALS

achieved. In a certain 3-stage amplifier* without feed-back, the harmonics were 35 db. below the signal at full output, and the variation in gain due to a change in anode volts from 240 to 260 was 0.7 db. By the use of negative feed-back these figures were improved to 75 and 0.01 respectively.

To minimise distortion in the output stage it is necessary to ensure that the load impedance is reasonably close to the optimum for the stage. If the oscillator is used to feed a variety of loads, a well-designed multi-ratio transformer is almost essential. Triodes are far less dependent on accurate load matching than are other types, so are almost invariably used in such cases. If the oscillator is not required to feed loads of less than about 100 ohms, it is possible to dispense with the transformer and reduce risk of distortion by adopting a cathode follower output as in the type referred to in Fig. 22.

All trace of the component oscillations must be absent from the output of a B.F. oscillator, or very misleading results might occur. A filter following the detector is necessary, and it must be well designed if it is not to start "cutting" the highest audio

42. Frequency Stability

frequencies. The difficulty is that if in order to simplify this problem the component frequencies are made high, the pull-in and frequency stability problems are increased. Usually these frequencies are about 50 to 100 kc/s. Assuming 100 kc/s, it is obvious that in order to maintain a certain constancy of the output frequency at, say, 100 c/s, the component frequencies must be 1000 times as stable, unless of course, they both shift equally in the same direction.

This problem is tackled by using very stable materials for the oscillator components; designing coils and condensers so as to be unaffected by temperature; placing them well away from the heating components such as valves, or in heat-insulated compartments; arranging them symmetrically, to ensure equal changes in both oscillators; using dynatron valves as oscillators; and in other ways.

* "Stabilised Feed-back Amplifiers", M. S. Black, *Bell System Technical Journal*, Jan., 1934. See also Sec. 306.

It really is very difficult to design and make a B.F. oscillator which will give an output constant in frequency within, say, 1 c/s from the time of switching on. The worst drift can be avoided by allowing quarter of an hour or so for warming up, but this is often inconvenient.

Another necessity, if the oscillator is mains-driven, is a very high standard of supply-current smoothing and absence of stray pick-up from transformers, etc.

Altogether then, a *really* good B.F. oscillator, such as many laboratory tests require, cannot be bought cheaply or designed easily ; but a relatively simple one, if well thought out, is certainly much better than nothing.

Most radio instrument manufacturers list both audio and radio frequency oscillators of various types, but the audio range is much the less well developed, particularly in the lower price classes. Although beyond the means of most laboratories, the Sullivan-Ryall B.F. oscillator deserves mention because of the amazing standard achieved—harmonic content 0.1 per cent. over the telephonic frequency range and less than 0.3 per cent. over the whole range at 0.5 watt ; maximum output 5 watts ; output voltage constant to ± 0.1 db ; frequency stability within ± 0.5 c/s from switching on ; and a scale accuracy within 0.2 per cent. ± 1 c/s. The pre-war price was £250, rack-mounted and with power supply.

Very valuable articles by W. H. F. Griffiths on the design of B.F. oscillators, including a description of the Sullivan-Ryall type, are in *The Wireless Engineer* for May, 1934, and July, 1935.

At the other extreme, where an audio signal at only a limited number of fixed frequencies is needed for work of no great precision, it is not necessary to provide a special instrument at all, as a very cheap oscillator described in Sec. 152 will serve the purpose although it is intended primarily for radio frequencies. As already mentioned. Sec. 155 includes details of an amplitude-controlled audio-frequency dynatron oscillator.

Radio Sources

A very large number of assorted radio-frequency oscillators are available absolutely free (apart from the cost of a receiving licence), and use of them for testing purposes fulfils one of the principles laid down in Chapter 3—the desirability of carrying out tests as nearly as possible under actual working conditions. But although transmitting stations are very useful test oscillators, they have the disadvantage of not being under the control of any but exceptionally privileged workers. For most quantitative tests a signal modulated by a constantly fluctuating broadcast programme is unsuitable. The signal strength from the more distant stations cannot be counted upon to remain absolutely constant; and in wartime it is not possible to rely on constancy of either power or frequency, or even the existence of the station itself. Under more normal conditions, however, a local transmitter's carrier wave may be more reliably constant than an oscillator in the laboratory, and is certainly less likely to be influenced by stray coupling from other apparatus! But even in simple tests on receivers one very soon experiences a need for a test oscillator under one's own control.

Much of the subject of valve oscillators has already been covered in considering audio sources. From oscillators that can be assembled in a few minutes from spare parts, to standard signal generators costing hundreds of pounds, there is a continuous range of available equipment. A rough division into three classes may usefully be made, however:—

45. Types of Radio Sources

(a) "Open" oscillators, of the wavemeter class, which may be calibrated in frequency, but in which no special provision is made for controlling the signal strength to repeatable levels.

(b) Oscillators, generally described as for servicemen's use, which are entirely screened except for a definite

outlet to which the signal strength may be adjusted for comparative purposes.

(c) Standard signal generators in which the signal control is calibrated in microvolts and in which other refinements, such as variable modulation depth, may be included.

A wavemeter used at one time to be the first—and sometimes almost the only—instrument in a radio laboratory, but now that every ordinary

46. Wavemeters broadcast receiver is, according to 1920 standards, an accurate wavemeter, the original wavemeter function is expected to be included incidentally in the service oscillator or signal generator. Wavemeters as such are dealt with in Secs. 127-8. An oscillator of the *a* class, not primarily intended as a signal source, is, as already mentioned, described in Sec. 152. But where a signal source is needed, the advantage of having it under control instead of radiating indiscriminately is so great that class *a* is no longer favoured.

The status of the instrument that almost constitutes a laboratory in itself has been taken over by the standard signal generator. For receiver design

47. Standard Signal Generators and some other important purposes it is practically indispensable. Unfortunately, as with B.F. sources, a good one is expensive. In principle it is extremely simple—a valve oscillator variable over appropriate frequency ranges, and thoroughly screened to prevent uncontrolled radiation; a variable attenuator for controlling the signal output through the intended channel; and (practically always) provision for modulating at audio frequency. The extent and refinement of control varies greatly in different models, and so, of course, does the price. As details of this sort can be obtained in abundance from makers' catalogues, the most profitable thing to consider here is what features are most useful in practice. Having done that, one is better able to select the most suitable generator.

The range of output in a laboratory generator is

desirably from 1 microvolt to 1 volt. The lower figure, or even less, is necessary for measuring the more sensitive types of receiver; the higher is needed for discovering spurious responses under extreme local station conditions, or taking

48. Necessity for Thorough Screening

A.V.C. curves. An oscillator powerful enough to give an output of 1 volt in a circuit which prevents the external circuit reacting back to the oscillator must be very completely screened if the leakage field is to be imperceptible when working at one microvolt level. That is the first problem, and it involves much more than simply enclosing the apparatus in a metal-lined box. A very small current passing, say, between two "earthing" connections on the screen might be enough to set up an appreciable external field. When trying a signal generator it should be connected to a sensitive receiver at the highest signal frequency in the range, and the attenuator setting gradually reduced from a few microvolts to zero. If the receiver is sensitive enough to give an output which is substantial on one microvolt, but which steadily decreases to nil at the zero setting, then the generator screening may be considered very satisfactory.

Next, there is the design of attenuator to deal with such a large range of signal strength—120 decibels—at high frequencies. Difficult at medium

49. Accuracy of Signal Strength

broadcast frequencies, it is much more so at the very high frequencies coming into general use; a generator is now expected to go to 25 Mc/s at least. The problem is sometimes eased by providing a continuously variable output, say from 1 to 10,000 microvolts, supplemented by a "force" output of perhaps 1 volt, for testing immunity from interference, etc. At television carrier frequencies the problem is really acute, and it is generally necessary to use a reactive attenuator rather than a resistive one. With suitably modified technique it is possible to extend the range into the centimetre wavebands. But the signal voltage at the outlet of the instrument gives very little information concerning what it may be at the end of even

the shortest connection that can be used to make contact with the circuit under test. A properly designed matched-impedance connecting cable or, for centimetre waves, a wave guide, is necessary to feed the signals to the desired point.

The accuracy of the microvolt calibration, which may be within 5 or 10 per cent. at medium frequencies, usually deteriorates very considerably at the highest frequencies. Other sources of error in such work would make higher accuracy of little significance even if it could be obtained. When examining a generator, with a receiver and output meter connected so as to indicate equality of signal, some clue to attenuator accuracy can be gathered by noting whether the maximum signal at one setting of the multiplier switch is the same at one-tenth on the next higher " $\times 10$ " switch position. Another is to measure the maximum output with a valve voltmeter. But most of the accuracy must be left to the maker's reputation.

To eliminate errors due to changes in the output from the oscillator (which is bound to vary to some extent as the frequency is changed) the input to the attenuator is checked by a valve voltmeter or a thermal milliammeter. If the latter, special care must be taken as it has very little capacity to stand overload without burning out.

The aerial-earth impedance of a receiver is not infinite, and the voltage established between those terminals depends on the impedance in series with them externally.

50. The Dummy Aerial

generator measurements a compact dummy aerial is inserted between the generator and the receiver under test. It consists of 200 $\mu\mu\text{F}$ in series with 20 μH , the coil having shunted across it 400 $\mu\mu\text{F}$ in series with 400 Ω resistance. This composite impedance, which has a minimum value of 220 Ω (at about 2 Mc/s) is intended to include the resistance (looked at from outside) of the generator itself. The easiest way is to make the generator resistance small enough to be neglected, say not over 10 Ω . There is no great difficulty in making a properly designed attenuator of this resistance except at the higher ranges of output. If the internal resistance on these

ranges is higher, as it is in most generators, this must be watched, because if a comparatively low impedance circuit is connected to the outlet, the actual signal voltage supplied to the aerial may be much below the attenuator reading.

Ideally, the attenuator setting and the nature of the circuit connected to the outlet ought to have no effect whatever on the frequency, but in practice this is not always so, particularly at the highest frequencies; and unless the generator tuning is

51. Frequency Control

checked after altering the attenuator setting, results may mislead. It is quite easy to discover this defect by trial; and it is most serious when making selectivity measurements.

The frequency range has already been referred to; high frequency ranges are practically standard now, but their inclusion increases not only the attenuator problem but also the difficulty of coil switching. Plug-in coils are safe but a nuisance; switching is splendid if the switch is beyond reproach.

The tuning condenser ought to allow close adjustment, and a subsidiary control for varying the frequency slightly above and below that of the main dial is a valuable feature for selectivity tests. Direct-reading frequency scales are more pleasant, but with numerous ranges may be less accurate than calibration curves. As the instrument is expected to do duty as a wavemeter, the accuracy and stability of calibration is important.

The cheapest instruments are generally modulated to an uncertain depth; in the better sorts the modulation depth is not only accurately known but is variable at will. The depth usually assumed for general use is 30 per cent.,

52. Modulation

but for some purposes it is necessary to be able to vary it over as big a range as possible, preferably up to or very near 100 per cent. For the same purposes—tests of detector distortion, etc.—the distortion due to the generator, even at maximum depth, ought to be, but seldom is, negligible. The same remark applies to frequency modulation. These characteristics can only be thoroughly checked by cathode-ray oscillograph. The standard

fixed modulation frequency is 400 c/s and for most purposes the close accuracy of this is immaterial. Provision is generally made for external modulation for taking audio-frequency characteristics ; it is rather an advantage if too much power is not required, especially at the upper audio-frequencies. Some generators can be modulated straight from a gramophone pick-up, others require a large fraction of a watt.

A useful feature, particularly in the cheaper models, is a switch for enabling the modulation frequency signal to be used externally. And a switch for giving an unmodulated radio signal is definitely necessary.

Lastly, the power supply. Mains drive is now becoming

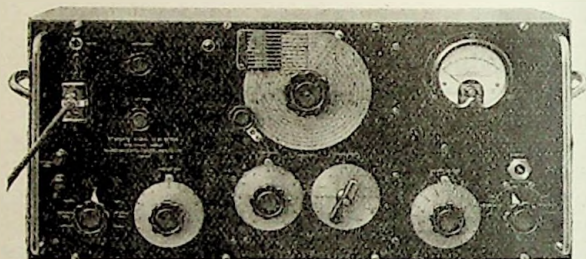

Fig. 24 : A good example of a laboratory standard signal generator—the Marconi-Ekco type TF144. The General Radio type 603A is shown in Fig. 7

general, but for some purposes—field tests for example—the battery-driven type is preferable ; so sometimes provision is made for either, as required.

An instrument embodying in full measure all the desirable features described is probably unobtainable at any price ; certainly a laboratory

53. Commercial type of standard signal generator
Signal Generators must be regarded as impracticable or at least uneconomic for any except specialist firms to produce, and the number of models to choose from has not been very large. But before the war there was on the market a very wide selection falling in

SOURCES OF POWER AND SIGNALS

class (b) ; all very useful within limits, and some of them on the borderline between mere oscillators and laboratory generators. Among the most interesting and versatile was the Lyons-Hickok type 180X, which, in addition to a radio-frequency signal tunable from 100 kc/s to 120 Mc/s and the 400 c/s modulating signal, also provided a variable audio-frequency signal by means of a heterodyne valve. And the instrument included an output meter, which usually had to be obtained separately. The signal attenuator, although it controlled the output to repeatable settings, was not definitely calibrated in microvolts.

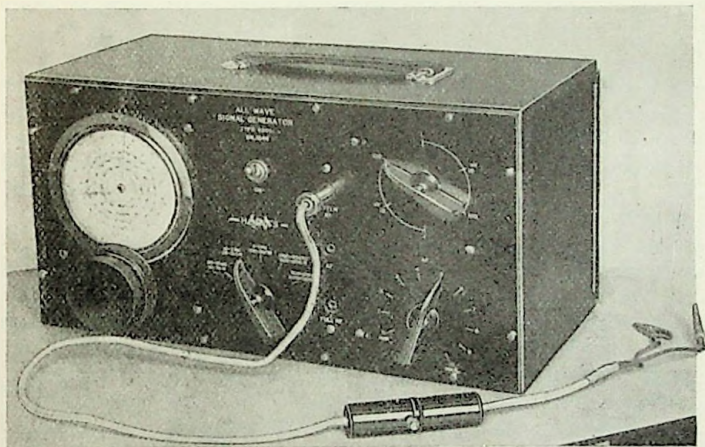

Fig. 25 : Hunt's Signal Generator, type 4002, although designed for servicing, has a semi-laboratory specification

The A. H. Hunt 4002 All-wave Signal Generator, although less versatile, gave microvolt readings, at the fixed points 1, 10, 100, 1000, 10,000 and 100,000 ; and was a good example of a low-priced instrument that could be used for serious work. The frequency scale was calibrated from 100 kc/s to 60 Mc/s, with charts for greater accuracy when required ; and a dummy aerial was

RADIO LABORATORY HANDBOOK

included. There was also a continuously-variable A.F. signal. The instrument was A.C. mains driven.

Oscillators in the "servicemen's" class, although they are not standard signal generators, are most useful in the laboratory as sources, and can be employed for comparative tests. Normally they can be obtained so cheaply that it is hardly worth trying to make one. Other things being equal, an oscillator giving a fundamental signal on all ranges is better than one relying on harmonics. This is a point to examine when making a choice.

CHAPTER 5

INSTRUMENTS

B—Indicators

HAVING applied some sort of signal to the apparatus under test, one requires an indicating instrument to give a reading of the results. The most important class of indicators can be described as

Pointer Instruments

Voltmeters and other instruments in this category have been in use ever since electrical engineering existed, but the recent growth of the radio branch has stimulated rapid development, more especially of multi-range and small portable meters. Detailed specifications are out of place here, because up-to-date information can be obtained from the excellent catalogues issued by the leading instrument manufacturers ; so the space under this heading will now be devoted to discussing the choice of meters.

54. Choice of Meters

It may be said at once that even when starting in quite a small way it is wise to spend rather a large proportion of the available funds on this department of the equipment. The reason is this : specialised *radio* engineering instruments, such as signal generators, distortion bridges, R.F. resistance apparatus, etc., are constantly changing in design. But although it cannot be denied that great developments have also taken place in volt and current meters during the last ten years or so, good instruments even thirty years old are still (assuming fair treatment) valuable possessions. In any case it is unlikely that the recent improvements in form, adaptability, and cheapness will continue to be introduced at the same rate.

One does sometimes pick up marvellous bargains,

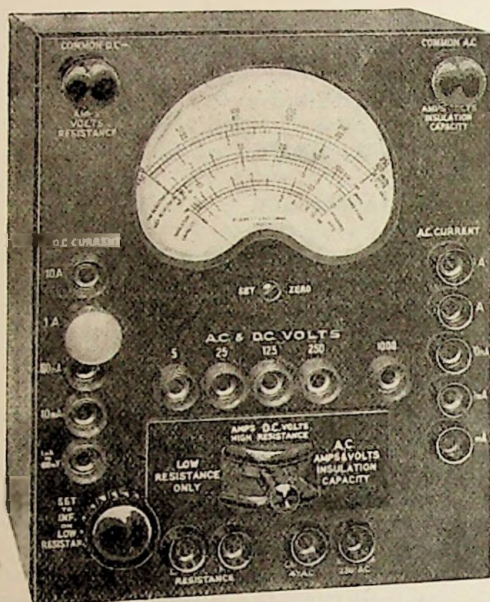

Fig. 26: "Radiolab All-Purpose Tester," reading in volts, milliamperes, ohms and microfarads over wide ranges (Everett, Edgumbe & Co., Ltd.)

perhaps by making a vulture-like attendance at the liquidation of a business, by studying advertisements in technical papers, or by examining the stocks of certain "clearance" dealers. But in doing so one must never forget the legal maxim, *caveat emptor*—"Let the buyer beware!" Unless funds are very short indeed it may be better to try those firms dealing in secondhand instruments that have been reconditioned and if necessary recalibrated; and that are fully guaranteed. But the important thing is to get hold of at least one meter of really good quality.

Recent improvements do not concern accuracy—in any given price class—so much as convenience. There is now a very wide choice of multi-range meters, giving A.C. as well as D.C. readings, voltage and current, and often some resistance, capacitance, etc., ranges too. Some means of covering all these measure-

55. Multi-range Instruments

INDICATORS

ments is almost indispensable to the experimenter or to anybody who has occasion to test radio apparatus. Whether it is the best policy to make such an instrument the primary standard of a laboratory may well be questioned, however. It is in constant demand and comes in for any rough usage that is going. Moreover, extreme accuracy is not usually needed for this sort of work. If a high-class instrument can be afforded at all, there is a lot to be said for getting a comparatively inexpensive but serviceable multi-range test set such as the Avominor, or, better still, the Avometer, and then reserving for more refined work such an instrument as a Cambridge Versatile Galvanometer. This consists of a sensitive but (for its delicate workmanship) surprisingly robust microammeter with a good long scale that can be read to a hair's breadth. To it may be added an almost unlimited variety of shunts, multipliers, thermo-junctions, etc., and for resistance measurement an accessory designed by the author; covering altogether an immense range of work. The Cambridge Instrument Co. keeps a record

Fig. 27: The "Avominor," a moderately priced and exceptionally compact multi-range test set available in D.C. and "Universal" types

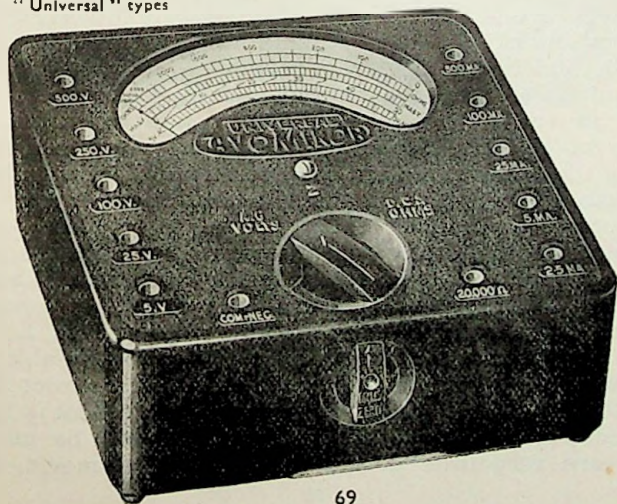

of the details of all instruments sold, and is able at any subsequent time to supply an accessory for extending its usefulness, without having to get the instrument back for adjusting resistances, etc. An advantage is that while the galvanometer is a direct-reading microammeter that is very valuable by itself—notably as the indicating part of a sensitive valve voltmeter—its applications can be gradually extended in those directions where the need is greatest. This is more economical than a completely self-contained do-everything meter of similar quality, in which some part of the high cost would probably represent unnecessary luxury.

A single meter cannot be everywhere at once, however multi-range it may be, so to supplement the meter department it is extremely useful to have a

**56. Character-
istics of Different
Types of Meters**

few miscellaneous instruments. They need not be extremely accurate, and therefore one has a good chance of picking them up on the secondhand or even the junk market. The most generally useful ranges are 5, 25 and 100 milliamps and one or two ranges of volts. Rough checks of valve feed currents and supply voltages save much confusion in experimental work. The calibration can be checked and adjusted by the good meter, and is not so very important; but it is *most* important to see that the movement is perfectly free when held in various positions, and does not stick or show different readings according to whether the current is going up or down. This, or a pointer that swings like a nervous golfer before showing a reading, is extremely exasperating. Another thing that must be looked into is the power absorbed by the instrument—voltage dropped by a milliammeter or current taken by a voltmeter. Some of the “bargains” may fail in this respect. Moving-iron meters have recently been greatly improved so far as accuracy is concerned, but are not generally suitable for radio laboratory purposes because of the large power they take. Moving-coil meters are, or can be, excellent in both respects, and in cheapness are surpassed only by meters that are very little good in either. Even moving-coil

INDICATORS

meters cannot be *assumed* to draw satisfactorily little power ; an ammeter or milliammeter should not drop more than 0.1 volt at full scale (0.075 is a standard figure), and 1 mA (1,000 ohms per volt) is a useful standard of voltmeter consumption. It is a good thing for a voltmeter to have a scale of current also, as it is then possible to read off the current taken at any voltage reading, and if necessary use it in making a correction.

By the way, some meters are marked "B.S.1" or "British Standard First Grade" or the equivalent. This

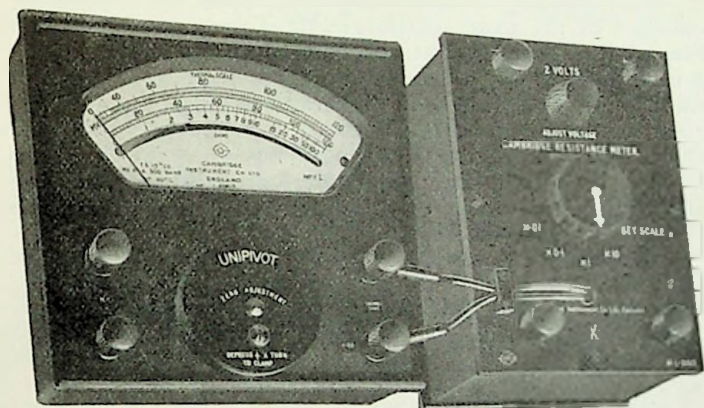

Fig. 28 : The Cambridge Instrument Co.'s "Unipivot" Versatile Galvanometer can be used for accurate work in conjunction with a great variety of accessories. A multi-range ohmmeter manufactured to the author's design is shown

sign does not mean that it is the highest possible grade of instrument, for there are better grades such as "Sub-standard" (which does not sound nearly so impressive !); it does mean that the instrument satisfies a certain defined standard of accuracy, which is good enough for any but exceptionally precise work.

The unfortunate thing about the moving-coil meter is that there is nothing quite so good for A.C. Although moving-iron meters can be made of comparable accuracy

if one pays handsomely for it, their consumption is very heavy, and they are useful only for low (power supply) frequencies. The thermal type can be used at any frequency, from zero to ultra-high, if it is suitably designed, and it gives true R.M.S. readings, but it is quickly put out of action by a slight momentary overload, and is either very expensive or power-consuming or both. The electrostatic type is totally unsuitable for all except one particular purpose, but that one ought not to be forgotten, especially in connection with television. An instrument of the ordinary current-operated types for measuring voltages of the order of thousands is very expensive, and the power consumed almost certain to be serious. But it is just where other types are least useful that the electrostatic meter is best. The higher the voltage (up to about 10,000) the cheaper it is, and the current drawn is practically nil. For general purposes, however, the true A.C. types of instrument are so far inferior to the D.C. moving-coil that in the most popular models a metal rectifier is

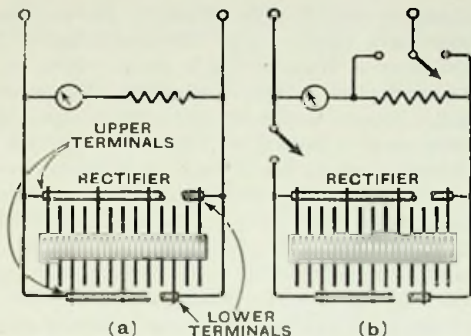

Fig. 29 : Scale of rectifier-shunted milliammeter compared with original to show the great increase in range of current measurable without shunting

incorporated to enable the latter to be used on A.C. too. There is a slight loss of accuracy in the process, and the chief disadvantage is that the reading depends to some extent on waveform ; the error due to irregular waveform may be 10 per cent. or even more. A compensating advantage over those types that read true R.M.S. values whatever the waveform is that the scale is practically linear as in a D.C. moving-coil meter, except at low voltages. There is some difficulty with voltages less than about 1, but this has so far been overcome that excellent millivoltmeters of the rectifier type are now available. The range of frequency over which the rectifier is effective is also being extended and now includes the lower radio-frequencies.

INDICATORS

Fig. 30 : (a) Method of connecting rectifier shunt. The series resistance largely determines the effective range of measurement; for the L.T.-7A rectifier it should be 130-150 ohms for a full-scale reading of 1 amp., and for the L.T.-4 rectifier about 300 ohms. (b) Addition of switch arms for reverting to the meter alone when desired



A rectifier varies in resistance according to the voltage applied, so the ordinary method of multiplying the current range by shunting the meter is ruled out. Instead, a current transformer is used, with various primary windings to provide suitable current ranges.

57. The Rectifier Automatic Shunt

But the application of a rectifier as a shunt comes into a useful dodge that is not as well known as it ought to be. Milliammeters used for general testing, even in the hands of the most careful workers, run a grave risk of bent pointers, or a worse fate, as a result of accidental excess currents. By the time that a low resistance shunt is switched across, the damage is done. What one wants is an automatic shunt that adjusts itself according to the current. A metal rectifier is such a shunt. Things can be arranged so that when the current is small its resistance is very much higher than that of the milliammeter across which it is connected, and practically the full sensitivity of the meter is preserved near the zero end of its scale. But as the current increases, the rectifier shunt resistance drops; it is possible for a 0-5 milliammeter to have the full scale current raised to 1 amp. in this way. Fig. 29 shows how the original scale is extended by the rectifier, and Fig. 30 the circuit. The components are a 0-5 milliammeter, a Westinghouse L.T.-7A rectifier; and about 130 ohms of resistance. For further information on this

scheme refer to *The Wireless World*, Jan. 11th, 1935 and June 2nd, 1938. The disadvantage of the earlier description was a high voltage drop—over a volt full scale—but with the L.T.-7A rectifier this is reduced to about a half. Apart from its protective function, this method is sometimes adopted to obtain a special scale shape—e.g., a decibel scale for signal level meters—but unfortunately the characteristics of the rectifier are dependent on temperature, and especially with such a wide-range scale the accuracy is poor. In one very useful application—bridge galvanometers—this does not matter and it is difficult to see why it is not commonly used for the purpose; the advantages are too obvious to need emphasis. Of course a rectifier appropriate to the resistance and current range of the meter must be used; a sensitive galvanometer requires a comparatively low current rectifier. The Westinghouse Brake and Signal Co. can give advice regarding any special case. It is necessary to specify the resistance and full scale reading of the instrument, without shunt, and as desired with shunt. To protect against reverse currents at least one rectifier path must be connected each way across the meter, as shown.

In theory, the construction of plain shunts and multipliers for extending the current and voltage ranges of D.C. instruments is simple; in practice it demands rather more care, for a given standard of accuracy, than the uninitiated might suppose. This work is fully dealt with in many publications,* so will not be included here, except for one valuable tip. When winding a resistance that must be adjusted to an exact amount, do it in two sections. Wind a little short of the right value with the ordinary wire, and do the adjusting on a supplementary section of much heavier gauge. Another bit of advice is never to select ranges requiring awkward scale factors such as $2\frac{1}{2}$ or even 4. Errors are sure to occur due to faulty mental arithmetic in moments of stress. With A.C. instruments, range multiplying is not so

* For example, by C. R. Cozens in *The Wireless Engineer*, Nov., 1934.

simple, even in theory, and had better not be attempted without adequate knowledge of the problems involved.

As electrical power is the product of current and voltage, one method of determining it is to measure or calculate each separately and multiply. That

59. Wattmeters is all right for D.C., and for A.C. in non-reactive circuits, but if current and voltage are not in phase an extra factor must be included—the cosine of the phase angle, otherwise known as the power factor. A wattmeter, which depends for its deflection on the force between a movable and a fixed coil, one for voltage and one for current, takes account of this and reads true watts. Although wattmeters are very important in “heavy” electrical engineering, they are not much used in radio laboratories, because they are comparatively expensive, are subject to considerable error due to their own consumption in low-power systems, and are particularly inaccurate at the low power factors common in “communication” circuits. Except perhaps in connection with the total power taken by a receiver there are other ways, to be dealt with later, of measuring power factor.

The foregoing are the fundamental “pointer” instruments; there are now many others, going under various names, in which the same meters appear thinly disguised by scales calibrated in other quantities. As wattmeters are still fresh in the mind this is perhaps a good point at which to expose the pseudo-wattmeter, which is simply a voltmeter or milliammeter calibrated in watts. Such a calibration can hold good only under certain conditions: for instance, an ammeter may be connected in a supply circuit, and assuming a certain fixed voltage and power factor it is legitimate to scale it in watts. But of course its readings are immediately invalidated if voltage or power factor alter; unlike a true wattmeter it cannot take account of these factors.

If the circuit in which the power is to be measured consists of a pure resistance the power factor need not be taken into consideration because it is equal to 1. And

by Ohm's law the power W in watts is equal to $\frac{V^2}{R}$ or I^2R (V in volts, I in amps., and R in ohms), so a volt- or ammeter can be legitimately scaled to read watts consumed in one particular resistance. This is the principle of the "output meter", which being rather important in radio work deserves more than passing mention.

When testing a receiver by applying a signal, the ear is not a very satisfactory indicator because it cannot easily distinguish small changes in intensity of sound; it gives no quantitative readings; and it cannot be relied on even for rough comparison. So for comparative work—e.g., "lining up" a receiver—an ordinary metal-rectifier A.C. voltmeter can be connected across primary or secondary of the output transformer (preferably the latter if the meter possesses a suitable range). A valve voltmeter is sometimes recommended for this purpose, but it is much less robust, portable, and convenient than the metal rectifier type.

Now a loud speaker is not a fixed pure resistance, but if its resistance as a load at the frequency of test is known at least approximately, it is possible to get some idea of the actual power in it from a voltage reading. Of course it is necessary to make sure that the resistance of the voltmeter is at least several times as great as that of the speaker!

When more accurate measurements of power are wanted, as in determining the sensitivity or maximum power output of a set, it is better to replace the loud speaker by an artificial load consisting of an accurately known pure resistance. The voltmeter can then be scaled in watts or milliwatts. While the instrument is certainly capable of reading true watts in this way, it is taken for granted in measurements of the output of valves that the load resistance is adjusted at least approximately to the optimum value, or whatever other value may be required for special tests. Not only is it necessary, then, to have a load resistance that can be varied to cover all probable requirements, but the milliwatt scale of the voltmeter has to be different

INDICATORS

for every value of resistance, which is hardly practicable if a really adequate selection of resistances is provided. The difficulty is avoided by means of a transformer with a fixed secondary across which the voltmeter and a suitable fixed load resistance are connected; and the primary is tapped, or a number of separate windings provided, so that the fixed load resistance can be made equivalent to any one of a number of different resistances, looked at from the primary side. Under these conditions a transformer to give nearly perfect characteristics at all frequencies from, say, 30 to 10,000 c/s is a difficult piece of

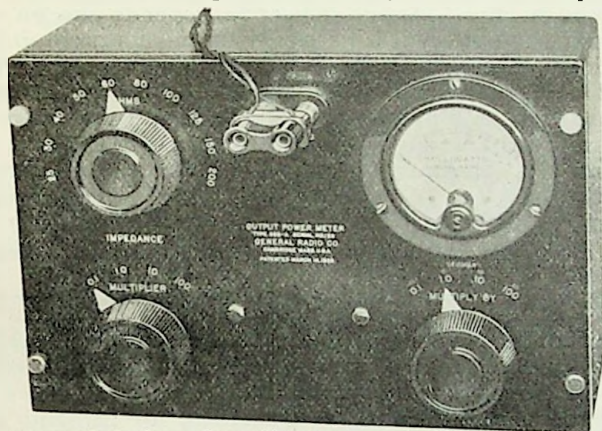

Fig.31: General Radio Output Power Meter type 583-A, giving direct readings of milliwatts with a load variable from 2.5 to 20,000 ohms

design; but for the purposes for which an output meter is generally used a very high standard of accuracy at the extreme conditions is hardly necessary. In the well-known General Radio 583-A Output Meter a special compensating system is used to equalise readings over the wide range of load resistances included, $2\frac{1}{2}$ to 20,000 ohms. Information on how to make a variable impedance output meter is given in Sec. 159. An adaptable meter of this sort is very valuable, for it enables one to see quickly how the output of a stage is affected by the load resistance.

The resistance which is found to give maximum output is not, of course, generally the "optimum" load; one has to take account of distortion too.

Another growingly popular meter which is scaled to read an indirect quantity is the ohmmeter. Many multi-range test sets are provided with a direct-reading resistance scale. The power for deflecting the pointer is obtained from a battery—usually a small one contained in the instrument—and the extent of the deflection is controlled by the resistance connected to the appropriate terminals or clips. As the deflection depends also on the voltage of the battery it is necessary to make a preliminary adjustment to compensate for this. Fig. 32 shows the circuit of one of these simple ohmmeters.*

61. Ohmmeters R is a resistance equal to the desired mid-scale reading, and the meter is adjusted by the variable shunt S to give its full deflection when the "X" terminals are short-circuited. Under these conditions I_1 , full scale current, $= \frac{E}{R}$. The resistance, X , to be measured is then connected and the current now flowing, $I_2 = \frac{E}{R+X}$. Eliminating E we get $X = R \left(\frac{I_1}{I_2} - 1 \right)$,

from which it appears that the result depends on R (which is fixed) and the ratio of the two currents. As the actual values of current are therefore immaterial it is allowable to use the variable shunt, as described, for bringing the pointer initially to full deflection (zero on the resistance scale) whatever the battery voltage may be;

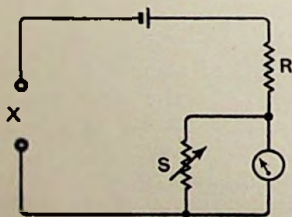

with X in circuit, is then a measure of its resistance. By selecting appropriate values for R and the shunt a variety of resistance ranges can be

Fig. 32: Circuit of simple ohmmeter. The resistance to be measured is connected to the "X" terminals

* For detailed information on how to make ohmmeters, see T. S. Dutton in *The Wireless World*, Nov. 11th, 1937, and F. L. Hogg in the Aug. and Sept. issues, 1943.

INDICATORS

provided in one instrument; but for very high ranges the current meter must either be very sensitive or the battery voltage must be raised; and for low ranges the resistance of the battery, neglected above, introduces error. The "Avo-meter", a pioneer in this field, has two preliminary adjustments—one for voltage and one for resistance of the battery.

With a trifle more trouble any voltmeter can be used to measure resistances, as described in Sec. 171. Of course, the direct application of Ohm's Law by means of voltmeter and ammeter is too obvious to be described, but besides the necessity for the two meters there is the risk of "bumping" the current meter by an unexpectedly low unknown resistance, and allowances must be made for the power consumed by one or other of the meters.

Although some ohmmeters have more than one scale, it is difficult to cover with accuracy anything like the full range of resistances encountered in radio practice. The conventional ohmmeter has seldom enough voltage to go up into the megohm ranges without additional batteries, or enough current for the very low resistance ranges. It is often very desirable to have some means of measuring the latter—switch contacts, etc. The most satisfactory method is to use the unknown resistance as a shunt to a current meter, the reduction in deflection being a measure of the resistance. The Ferranti low-reading ohmmeters depend on this principle. To cover a wide range of low resistances in one instrument the author of this book devised a multi-ranging extension of this scheme, which has been embodied in the Cambridge Resistance Meter, illustrated in Fig. 28. The same scale applies for all four ranges, covering from 0.001 to 1,000 ohms with reasonable accuracy, and the scale factors are all multiples of 10. There is no possibility of bumping the meter, even if the unknown resistance fluctuates between zero and infinity, as may approximately happen when one is joggling a switch to test its contacts. The voltage employed (2 max.) is sufficiently low not to give a false indication by breaking through surface skins.

But when testing the *absence* of a conducting path it is

usually desirable to apply a *high* voltage, to ensure that the insulation under test is capable of withstanding it. For this the "Megger" made by Evershed & Vignoles is and always has been the standard instrument.

63. For Very High Resistance

In recent years the original "Megger" has been greatly developed in two ways; in the direction of widening the range of measurements by incorporating the bridge principle for the lower values; and in the production of cheaper models. As high resistance testing at high voltage forms a relatively small part of the work of most radio laboratories, the rather large cost of the standard instruments (of the order of £50 pre-war) puts them out of reach of all except very lavish establishments, but the Wee-Megger-Tester illustrated here is worth considering. A typical machine generates 500 volts and is scaled from 10,000 ohms to 20 megohms. The reading is independent of the speed at which the generator handle is turned, provided that the capacitance of the circuit tested does not exceed about 0.25 μ F. Testing of large condensers

is impracticable with this model owing to the charge and discharge currents as the generator speed fluctuates, but the "Megger" and "Meg" ranges of instruments are



Fig. 33 : "Wee-Megger-Tester", a direct-reading ohmmeter for insulation resistance, incorporating a 500-volt hand-driven generator (Evershed & Vignoles, Ltd.)

INDICATORS

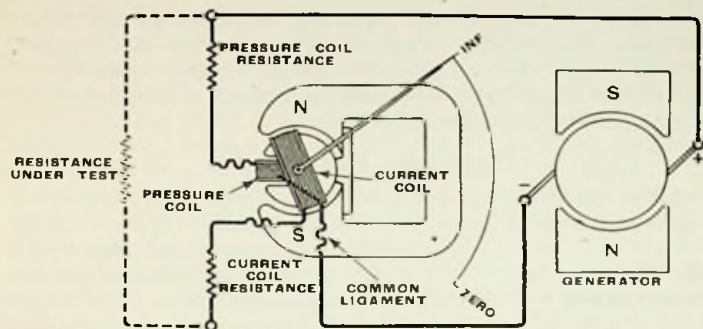

Fig. 34 : Circuit diagram of the "Wee-Megger-Tester". With Infinite resistance, current flows only through the pressure coil, causing the pointer to be held in the full-scale position. Any current flowing through the resistance under test traverses the current coil and causes a corresponding deflection (Evershed & Vignoles, Ltd.)

obtainable with a special constant output generator for high capacitance circuit tests, and a choice of scales up to 10,000 megohms at 1,000 volts, if need be. The makers supply very informative literature about these instruments and resistance testing in general.

The measurement of very high resistances will be treated in Secs. 172-3. There is also a valve-operated ohmmeter by General Radio, scaled from 0.02 to 50,000 megohms.

Although perhaps not exactly a pointer instrument, the vibration galvanometer may be mentioned here. It may

64. Vibration Galvanometers

be either of the moving coil or moving iron type ; if the former, the word "coil" must be interpreted rather broadly, as the moving element generally consists of a fine wire through which the signal current passes between the poles of a permanent magnet. If the current is alternating, the moving element vibrates, and as it is generally arranged to have a very sharp mechanical resonance the response is highly sensitive to signals of a particular frequency. The vibration is made visible by a lamp and lens system. The principal application is to bridge work at frequencies of the order of 50 c/s, at which it is extremely sensitive and has the great

advantage of practically ignoring harmonics and other currents that might tend to obscure the null point. Vibration galvanometers are usually rather expensive; one of the least costly and most practical is that made by the Baldwin Instrument Co. (Fig. 35).

Electronic Instruments

Although in principle the valve (or thermionic) voltmeter might be classed with the metal rectifier type already described, the interest concentrates on the valve portion of the instrument rather than on the meter itself, so it has been held over to this section

65. Valve Voltmeters

which is devoted to indicators that depend for their action on electronic discharge through more or less rarified space. The valve voltmeter is in general considerably more elaborate and less convenient than a straightforward meter so would not be used in preference to it; but in radio work there are very many applications where the ordinary meter is useless, either because it draws too much power or otherwise disturbs the circuit unduly, or because it does not respond to a wide enough range of frequency.

There would be no lack of material for a whole book on valve voltmeters, and what follows is by no means exhaustive. Different types have their respective advantages and disadvantages, and a single circuit cannot serve every possible purpose ideally. In essence the valve voltmeter is simply a valve operated at a curved portion of its characteristic so as to rectify the signal and give an indication on a meter, usually in the anode circuit. The detector valve in any receiver can be converted into a valve voltmeter by the addition of a meter, and often this is actually quite a sensible thing to do, because the disturbing effects of introducing measuring apparatus into the signal circuit are completely avoided. It might be objected that a calibration process would be necessary every time. True, any sort of instrument called a voltmeter ought to be calibrated in volts; and one expects a valve voltmeter to be no exception. But even when highly elaborate precautions have been taken, a valve

INDICATORS

voltmeter has not the permanence of calibration that is required of, say, a moving-coil instrument. If a lot of trouble has been taken to obtain a very accurate calibration, it is not enough to do it once and thereafter rely on it for ever; to maintain such accuracy of measurement it is necessary to check it every few months, at any rate on ranges below one or two volts. In view of this it is a good principle wherever possible to use valve voltmeters only as indicators of equal signals, because then no calibration at all is necessary. If this is not practicable, the next best thing is to make the result depend on the ratio of two readings not too widely different, so that error tends to cancel out. An example of this occurs in a certain method of measuring R.F. resistance, in which the readings are in the ratio $1 : \sqrt{2}$. For many other purposes—such as measurement of oscillator voltage in superheterodyne receivers—a very accurate voltage reading is quite unnecessary, and in certain circumstances, to be considered later, no special calibration at all is required. So the calibration difficulty may be much overestimated.

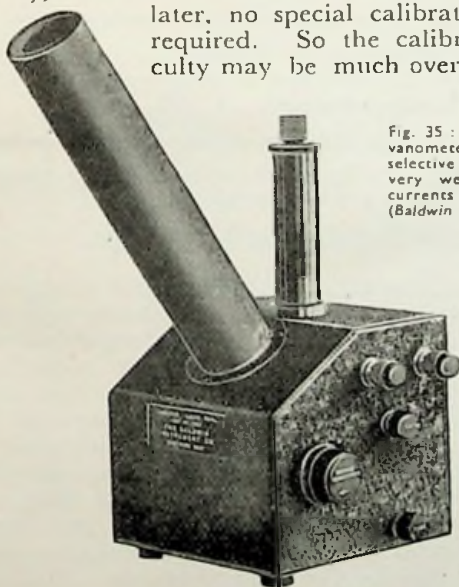

Fig. 35 : Vibration galvanometer, used for selective detection of very weak alternating currents of about 50 c/s. (Baldwin Instrument Co., Ltd.)

For general use some or all of the following features are desirable :—

- (1) As nearly as possible infinite input impedance. Disregarding wiring or other capacitances external to the valve, and " Miller effect " in the valve, the input of a valve consists of a capacitance ranging from about 1 to 20 $\mu\mu\text{F}$ according to type, and a resistance that ordinarily may be of the order of a megohm but is usually much less, and may be only a few thousands of ohms at frequencies around 100 Mc/s. On the other hand, with special valves and careful design, the impedance may be raised to many megohms.
- (2) Independence on frequency within the range concerned. The attainment of this is not likely to cause serious difficulties at frequencies less than 20 Mc/s.
- (3) Wide range of voltages measurable.
- (4) Independence on waveform ; unless discrimination between waveforms is specifically desired, as in peak and mean voltmeters.
- (5) Portability and ease of bringing into action.
- (6) Reading independent on reasonable variations of battery voltages and valve characteristics.
- (7) Simplicity of adjustment, cheapness, and robustness.

It is rather important to decide at the start how much one is interested in waveform. An instrument to read true R.M.S. voltages regardless of waveform must operate according to a square-law ; that is to say, indication proportional to square of voltage. This feature is incompatible with a linear scale. So although changes in voltage near full scale are shown up prominently, one cannot take accurate readings of widely different voltages on any one range. Whereas the ratio between full scale readings on one range and the next may be 5 or even 10 to 1 on a D.C. moving-

67. The Square-law Valve Voltmeter

INDICATORS

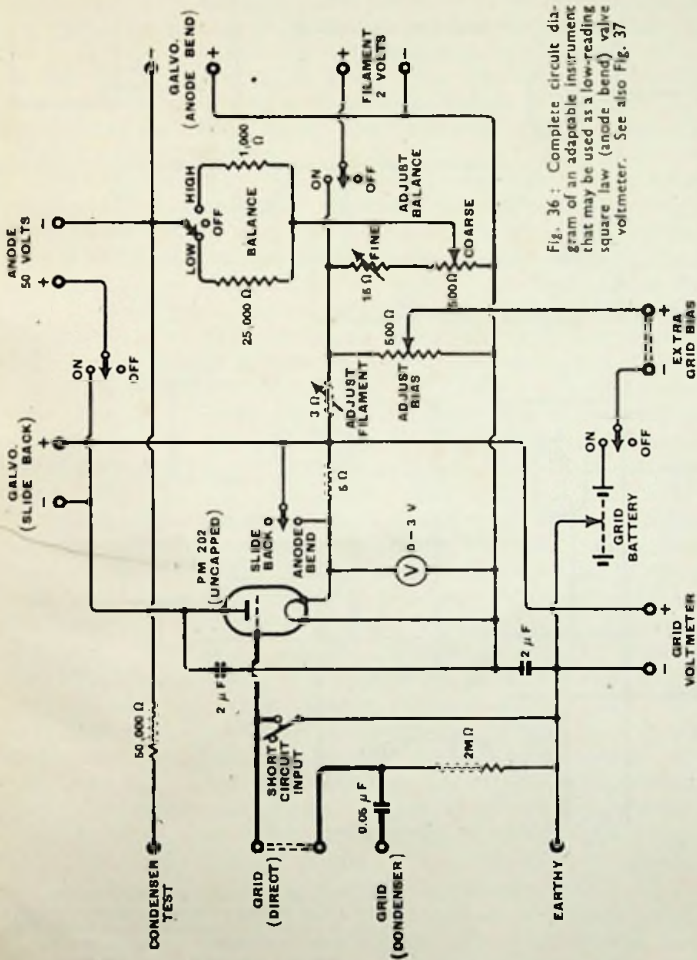
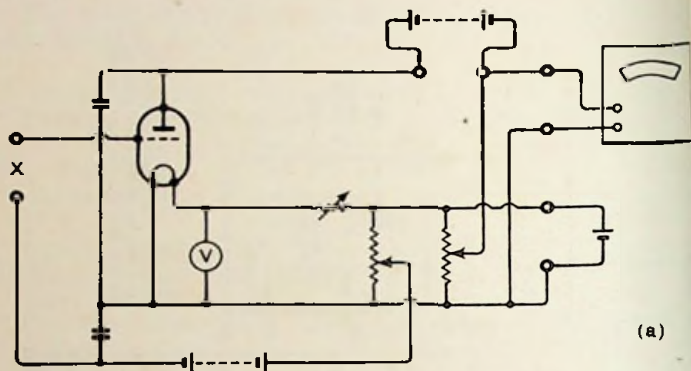
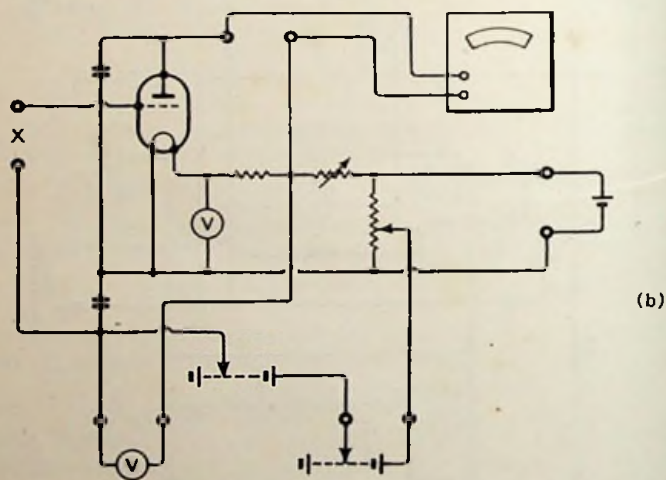

Fig. 36: Complete circuit diagram of an adaptable instrument that may be used as a low-reading square law (anode bend) valve voltmeter. See also Fig. 37



(a)



(b)

Fig. 37 : Simplified circuit diagrams
 Fig.36, showing the connections when used
 as a valve voltmeter of the (a) anode beam
 and (b) slide-back types. It can also be
 used as a condenser insulation meter. The
 positions of components correspond to
 those in Fig. 36, which provides a key to
 them

INDICATORS

coil meter with its linear scale, it should be no more than 2 or 3 to 1 on a square law meter. Moreover, although it is possible with a little care to get a close approximation to a true square law by working a suitable valve as an anode bend detector, it holds this over only a limited range, and so between these two things it is clear that absence of waveform errors and wide range of measurement do not come together.

For the more precise classes of work the square law instrument is important. A triode of the small power type is the best for the purpose, and by operating it at various initial grid and anode voltages, and in each case plotting the change in anode current against the square of the signal voltage applied to the grid, one can pick out the conditions over which square law holds sufficiently well, because the graph is then a straight line, or nearly so.

Fig. 36 shows the circuit of a voltmeter designed to read true R.M.S. values. For this purpose it is connected as shown in Fig. 37 (a). The Mullard PM.202 valve is decapped and fixed to give a short lead to a low-loss input terminal. To minimise input loss it is customary to mount this terminal on a washer of selected mica, keeping all other materials at least half an inch away. The parts indicated by heavy lines are especially short and well insulated. By-pass condensers to cathode are connected to form the shortest possible path for R.F. currents. The best anode voltage in this particular instrument was found to be about 50, and grid bias about -8 , giving an initial anode current of $60 \mu\text{A}$. The indicator is a Cambridge Unipivot instrument $24 \mu\text{A}$ full scale, with a shunt box to give additional ranges of 60, 240, 600, etc., μA . With the input short-circuiting switch closed, the filament voltage is adjusted to 1.6, the grid bias is adjusted to give full scale reading on the $60 \mu\text{A}$ range, and this anode current is then "backed off" by closing the "Balance" switch and adjusting the controls. To do this more exactly the microammeter is switched to its lowest range. Even with this sensitive instrument and the balancing out of the initial anode current, 0.1 volt R.M.S. is the lowest signal that gives a useful reading

(0.5 μ A); and the highest reading before grid current drawn is 5.5, but it is square law up to only 2.5. The "High" balance switch position is to enable a comparatively large anode current to be backed off, so that the most sensitive microammeter range can be used when a substantial signal is present; this is useful for tuning a circuit very exactly to resonance, but must be used with caution. Naturally it is at all times necessary to take great care to protect the meter from excess current. The 2-volt filament is run at 1.6 to impose at least some restriction. But with an instrument of this type it is essential to switch to a high range whenever a reading is not actually being taken, and to take particular care not to break the grid circuit when on a low range. If there is no conducting circuit externally, or the signal voltage is superimposed on a zero-frequency voltage, it is necessary to use the alternative connection through a grid condenser and leak. The input loss is then slightly greater of course. Two condensers in series are used for safety and they were very carefully selected for high insulation resistance, as a leak even through many thousands of megohms is enough to upset the readings.

Obviously in such a valve voltmeter the virtues numbered 3, 5, 7, and to some extent 6, are very heavily sacrificed to 4. 1 and 2 are very good, but so they may be in other types.

High input impedance, especially at very high frequencies, can be still further improved in this or any

other type of valve voltmeter by using an "Acorn" valve and mounting it in a "probe" at the end of a flexible cable, so that the valve

can be brought right to the point where the voltage is to be measured. Small by-pass condensers are connected close up in the probe, but for low frequency currents it is advisable to supplement them by larger capacitors in the main body. The Mazda D1 is a miniature uncapped diode specially designed for V.H.F., and its characteristics are very suitable for valve voltmeters. The heater takes 0.2 amp. at 4 volts, the maximum reverse anode voltage

is 500, and the capacitance from anode to cathode about $1.5 \mu\mu\text{F}$. For work where extremely high input impedance is essential there are special Osram valves, of which particulars are obtainable from the General Electric Co.

The inconvenience of batteries can be eliminated by mains drive, but for very sensitive instruments great care is necessary in thoroughly insulating

69. The Auto-bias and filtering the power supply. If Valve Voltmeter fractional voltage readings are not

essential, a great improvement in robustness is possible; an ordinary low-reading milliammeter can be substituted for the relatively expensive microammeter. Lastly, by sacrificing the square law feature, and using "automatic" grid bias, the voltage range can be enormously extended, because not only is the scale then almost linear, but various ranges can be obtained by providing a choice of bias resistances. This is the method usually adopted in commercial valve voltmeters, of which those by Salford Electrical Instruments, the Weston Electrical Instrument Co., and the General Radio Co. are examples. Where the work does not justify the expense of high-class instruments such as these, it is not very difficult to make up a voltmeter on the same plan. It must be remembered that this auto-bias type is necessarily less sensitive, other things being equal, because the signal causes an increase in negative grid bias and an equal reduction in anode voltage. For the same reasons, if it is desired to go up to a high reading, such as 100 volts, a large initial anode voltage must be provided, rather more than twice the maximum peak signal voltage. But it has the advantage of simplifying a wide range of measurement, and the auto-bias being of the nature of a negative feed-back system tends to stabilise the indications, rendering them less dependent on valve characteristics and supply voltages. Fig. 38 is the circuit of the Mullard valve voltmeter, arranged for easy construction from standard parts. The ranges are 4, 10, 25, and 100 volts full scale, and the indicator is a 0-300 microammeter.

The General Radio valve voltmeter (Fig. 39) employs auto-bias, but as it is supplied by the separately rectified

signal as shown in the schematic diagram Fig. 40 there are the advantages that the sensitivity is greater because the indicating valve starts working on the middle part of its characteristic instead of the foot, and the maximum meter deflection corresponds to zero signal, and therefore no damage can be caused to the meter by any signal. The rectifier is an Acorn valve mounted as a probe, and as it is connected through a condenser any super-

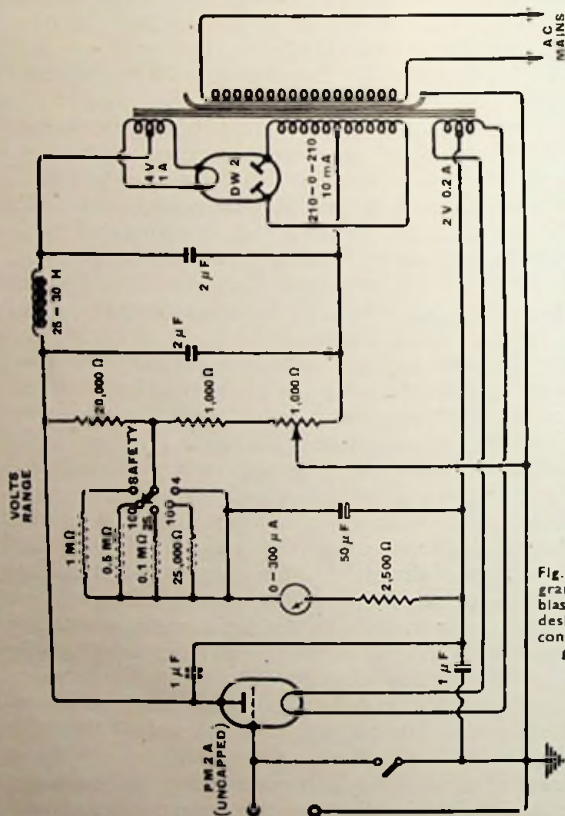

Fig. 38: Circuit diagram of Mullard self-bias valve voltmeter designed for easy construction and general utility

INDICATORS

Fig. 39: General Radio valve voltmeter giving practically linear scales from 2 to 150 volts. Note the "Acorn" valve probe. Like the preceding instrument, it is mains driven (Claude Lyons, Ltd.)

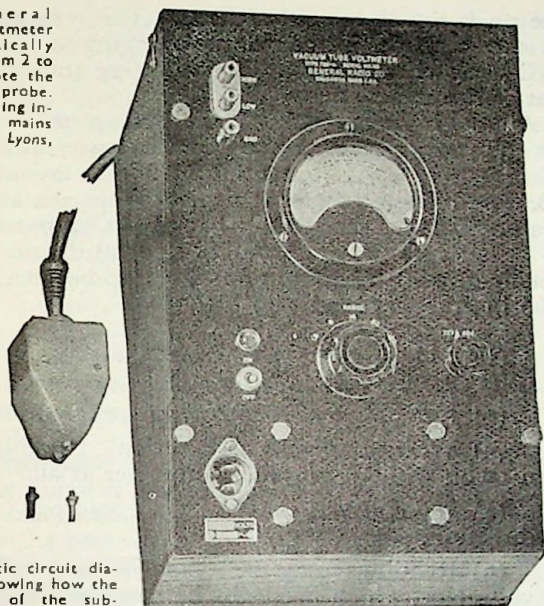
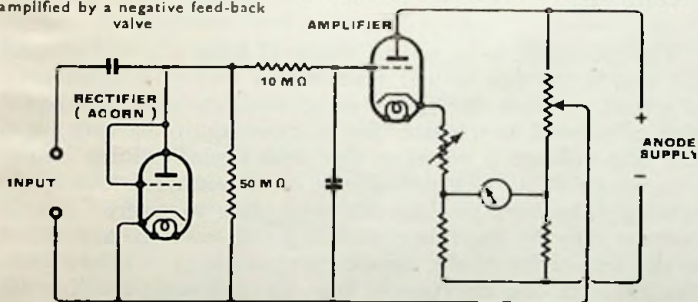

Fig. 40: Schematic circuit diagram of above, showing how the rectified voltage of the substantially linear diode rectifier is amplified by a negative feedback valve



imposed D.C. is excluded. Note the very high values of load and filter resistance with a view to maintaining a high input impedance. Except at fractions of a volt the rectified voltage applied to the second valve is equal to

the peak signal voltage applied. The resistance network in the cathode is for range changing on the negative feed-back principle, and for balancing the initial current out of the meter.

Although the auto-bias type is perhaps the most popular, for all purposes where a square law voltmeter is not essential the author favours the some-
70. The Slide-back Valve Voltmeter "slide-back". Compared with the auto-bias type, all the advantages are retained, with the exception of one to be mentioned later, and in addition there can be :—

- (1) Almost complete absence of error due to supply voltages and valve characteristics.
- (2) Avoidance of risk to sensitive instrument.
- (3) With a slight elaboration, readings down to 0.1 volt without any microammeter at all.
- (4) Indefinite extension of readings in upward direction.
- (5) Readings may be taken on any ordinary D.C. voltmeter, which need not be monopolised by the valve voltmeter.

The principle is to adjust the grid bias of a valve until the anode current is just reduced to zero in the absence of signal. When the signal is applied, an additional grid bias is needed to reduce the current again to zero, and this bias voltage is equal to the peak signal voltage and is a measure of it. In practice it does not work out quite so simply, because the bias corresponding to "zero" anode current may be anything within a volt or two, according to the sensitivity of the anode current meter. What looks like zero on one instrument may be full scale reading on another. The sensitivity of adjustment is at its very worst where the anode current curve merges imperceptibly into the base line. So it is necessary to adjust to some definite small anode current. It ought to be as small as practicable, because the greater it is, the less perfect is the valve as a

INDICATORS

rectifier. Also if a large "zero" is used, the meter on which it is indicated is not sensitive to small changes, and the adjustment cannot be made to close accuracy. The instrument illustrated in Fig. 36 can be connected in such a way as to serve alternatively as a slide-back voltmeter; see Fig. 37 (b). Because a $0.24 \mu\text{A}$ meter happened to be available the "zero" is fixed at $0.5 \mu\text{A}$ for this purpose. Even with such a small current the simple relation between signal peak voltage and added bias voltage is modified in two ways. The valve, being now an imperfect rectifier—the change in anode current due to a signal is the net result of a downward as well as an upward swing—the bias voltage needed to counteract a small signal voltage is much smaller still, so there is a curved foot in the calibration curve. With so small a "zero" as $0.5 \mu\text{A}$, the curvature is seriously noticeable only below about 0.5 volt, and about 0.2 volt peak can be measured, if the D.C. voltmeter is not a limiting factor. The other effect is that the slope of the whole curve is shifted. In the example described the peak value of voltages well above the curved foot is greater than the bias reading by less than 1 per cent., but tests show that this error increases steadily as the "zero" is increased. The reason is that the current reading of $0.5 \mu\text{A}$, when a signal is on, is the mean of a current which is zero throughout nearly all the cycle and a sharp peak at maximum positive signal. Unless the "zero" is extremely small this peak requires an appreciable excess of signal volts over bias volts to produce it, and this excess is (neglecting the foot) approximately a constant proportion of the whole signal voltage wave.

Another reason for keeping this peak small, right up to the highest voltages to be measured, is that otherwise a large amount of initial grid bias is necessary to prevent grid current at the peak. One of the advantages of the slide-back type of voltmeter is that filament and anode voltages, as well as fine adjustment of grid voltage, can all be obtained from a 2-volt battery! In the instrument illustrated, the filament voltage is adjusted to 0.8 , and part of the remainder, nearly 1 volt, is the "H.T." Apart from the object of avoiding the need for an anode battery,

this unusual arrangement ensures that the saturation current of the valve is so low as to be incapable of damaging the microammeter, whatever happens to the grid circuit. The initial grid bias is only -1.3 volts. As the excess of peak over bias volts is less than 1 per cent., this means that a signal of about 150 volts can be applied without drawing any grid current. But if the "zero" were raised even to as little as $1 \mu\text{A}$, the peak voltage would draw grid current, and in addition the anode *current* peak would be limited by the saturation current and the voltage readings could no longer be relied upon. This is particularly so if there is a high resistance in the anode circuit, for then the scanty anode voltage is dropped still further.

Lack of attention to these points may account for the relative unpopularity of the slide-back voltmeter; for if they are not sufficiently understood unsuspected errors and difficulties are likely to occur. Of course, if measurement of signal voltages less than about 1 is sacrificed, the anode current meter can be less delicate, there is less point in severely restricting the saturation current, and consequently anode voltage and grid bias; and the only thing one has to put up with is a larger correction factor.

It was mentioned that the slide-back type has one disadvantage as compared with the auto-bias anode-bend type. This is, of course, the necessity for making a manual adjustment of bias voltage before a reading can be obtained. On the other hand, a signal voltage, especially a large one, can be adjusted much more precisely to a particular level, as there is the same sensitivity of adjustment for large as well as small signals.

The variable bias can be obtained from any source greater than the peak signal voltage, and there should be coarse and fine adjustments. The fine adjustment is easily obtained from the filament battery as shown, and the coarse by single cell tappings or a potential divider capable of standing the required voltage. Alternatively, of course, the whole thing can be run from mains supply. The bias voltmeter can be incorporated, and can then conveniently be directly calibrated to read peak volts, taking account of the low-voltage bend and the correction

factor ; or it can be any suitable D.C. voltmeter connected externally. It should be noted that if the positive and negative peaks of the signal wave are unequal, as they may quite often be, the reading obviously differs according to which way round the valve voltmeter is connected. This is useful in measuring certain sorts of even-harmonic distortion. But of course it must be ensured that the different connection of the instrument does not itself influence the signal by disturbing the circuit.

A slide-back voltmeter may be calibrated in R.M.S. volts if desired, by multiplying peak values by 0.707 ; but it must be understood that such values hold good only for pure sine waves.

The only serious disadvantage of the type of voltmeter just described is the necessity for a sensitive and consequently rather expensive meter for low readings, and the desirability of it for all readings. To overcome this remaining drawback, the author has designed a practical all-round instrument in which the microammeter is replaced by a "tuning indicator", which is not only much cheaper but absolutely portable and foolproof. Working details of it will be given in Secs. 156-7.

All the voltmeters described so far depend on the curvature of the anode current/grid voltage characteristic.

71. The Grid-current Valve Voltmeter In radio receivers the "grid" type of detector, in which the grid current/grid voltage curve is used and the result amplified by the valve, is more popular because of its greater sensitivity to small signals (the valve works at a much higher mutual conductance than when it is biased nearly to cut-off) and its more linear characteristic. The sensitivity is very useful in a valve voltmeter ; the linearity *may* be a disadvantage ; the heavy anode current at the initial position, and the lowered input impedance, certainly are. And this type is about the worst for maintaining calibration conditions. Altogether it would never be considered if it were not for its sensitivity. One could, of course, increase the sensitivity of any type by using a stage of amplification, but the difficulties of maintaining stability

of adjustment and calibration tend thereby to increase beyond endurance, whether the amplification is before or after the detector.

When making a valve voltmeter for oneself, if it is intended to be at all accurate, careful tests should be made of the errors caused by departures from the normal filament, grid, and anode voltages, and anode current.

72. Excluding Errors in Valve Voltmeters

It is not necessary in the final design to make provision for reading and adjusting all of these ; generally it is possible to find by experiment which quantity controls the accuracy most, and to include a meter to check that. For instance, it may be found that, so long as the anode current is made to conform to calibration conditions by fine adjustment of grid bias, small changes in anode voltages are neutralised in their effects on accuracy. Or it may be found that filament voltage is the best adjustment ; the way it can be made to act depends on whether or not the circuit is arranged for it to affect grid bias. In a mains-driven voltmeter efforts should be made to ensure that a variation in the mains voltage causes changes in the valve voltages that tend to cancel out. It should not be forgotten that changing the range by shunting the anode current meter may alter the anode resistance and hence the shunt does not act exactly as a scale multiplier even over those parts of the ranges that overlap. The absence of grid current at the greatest working signal voltage should be checked.

Calibration of valve voltmeters depends on the means available. The usual method is to do it at 50 c/s (mains supply) ; that is why particular care

73. Calibration

is taken to make the grid coupling condensers (if any) and anode by-pass condensers sufficiently large for the error due to this low frequency to be negligible. The voltage drop in the grid condenser is less than 1 per cent. at 50 c/s if the capacity in μF multiplied by the resistance of the grid leak (and valve, if that is appreciable) is at least 0.025. In Fig. 36 it will be seen that this quantity is 0.1, giving a good margin. If a really accurate multi-range A.C. voltmeter is available,

calibration is simple enough. But if only a single accurately known voltage is available it can be subdivided by known resistances, or even lengths of eureka wire cut to the required proportions, without bothering to measure their resistances accurately. All that matters is that the resistances are neither so low that they are overheated nor so high that the valve voltmeter has an appreciable shunting effect. The subject of calibration in general is treated in the next chapter.

Finally, lest the earlier remark that accuracy of calibration is not always essential has been forgotten, it may be repeated that for many purposes a beautifully finished and calibrated instrument is quite unnecessary; more useful and reliable results may be obtained by improvising a circuit, or even by making use of part of the apparatus being tested. A milliammeter in the anode circuit of the detector valve of a receiver may tell one all that is required. The diode detector in general use to-day is even more informative, if a microammeter is available. By connecting it in the low-potential end of the load resistance or "leak", the reading in μA , multiplied by the resistance in megohms, gives something slightly less than the peak voltage applied (assuming there is no initial delay voltage).

Although it is not usually considered as a voltmeter, the cathode-ray tube is often a practical alternative to the valve voltmeter. As such and no more it is perhaps not always the most convenient choice. But whereas all the other indicating instruments that have been described in this chapter show merely the *magnitude* of the voltage or other quantity measured, the cathode-ray tube is capable of showing (simultaneously, if necessary) the magnitude, form, phase, and frequency of a wave, and its relationship to other quantities. And all that is only starting on its applications. In fact, it gives vastly more information and insight into the workings of electrical and allied apparatus than is possible by any other means. The X-ray tube is no more valuable to the surgeon than the cathode-ray tube to the radio investigator.

A very advantageous feature is that the presence of a hundred times the expected strength of signal does not leave one ruefully surveying the ruins of one's best meter. This feature may seem to be having excessive prominence here, but accidents do happen in the best regulated laboratories; and if by superhuman care and attention they are entirely avoided, such care and attention is bound to be diverted very largely from the main business in hand.

And it is not expensive. There is still a widespread idea that the acquisition by the laboratory of a cathode-ray oscillograph means firstly that the tube itself costs £10 to £15; secondly, that it cannot be worked without thousands of expensive and dangerous volts; and thirdly that even then it is not much use without one and possibly two time base units, each with from three to six unusually high-priced valves. While this may be true of television and certain special laboratory applications, it is quite a mistaken idea so far as general laboratory work is concerned.

Tubes suitable for the purpose used to cost from £2 to £6: for example, the Mullard high-vacuum E40-G3 at £2 15s.; and, at £2 5s., the GEC 4053, with $1\frac{1}{2}$ " screen, which works at 250-500 volts on the outer anode, has a 4-volt 0.8 amp heater, fits an ordinary 9-pin valve socket, and so takes its place among other "valves" in standard circuit practice; and its relatively small size and cost renders it practicable for use on panels and switchboards and in many pieces of equipment where a full-size tube would be out of the question.

The fact that the screens of the cheaper tubes are rather small need not arouse contempt, as many reproductions of oscillograms in highly esteemed technical books are smaller still. The real criterion is the ratio of effective screen diameter to spot diameter, and a small tube may actually be superior to a badly-focused large one.

A power unit, moreover, up to about 1,000 volts, can be made from scrap receiver parts at very low cost. Gas-focused tubes especially give excellent focus at a few hundred volts.

And as for a time-base unit, the one most commonly used by the author has some advantages over the more orthodox

INDICATORS

sort, not the least being that it was rigged up in a few minutes from material worth about 1s. !

The more elaborate saw-tooth time base units with variable frequency and synchronisation can be made up from receiver valves and other parts, many of which are probably in the worker's stock. Push-pull amplifiers for deflection are by no means essential with modern tubes.

Even the large tubes can be usefully worked at low voltages, and not only is the low supply voltage a convenience in itself but the deflection sensitivity is inversely proportional to the anode voltage, so that except with very strong signals it is necessary to spoil the sweet simplicity of the high voltage tubes by using signal amplifiers. The 4053, unfortunately, sacrifices a certain amount of sensitivity to its extreme shortness.

A full account of the theory and construction of the cathode-ray tube must be sought elsewhere*, but before discussing the choice of tube and

75. Principles of Cathode-Ray Tubes

equipment in greater detail it may be as well to refer very briefly to the essential features and how they differ between one type and another. It

may be considered as a specialised form of thermionic valve : there is the cathode, directly or indirectly heated, as a source of electrons ; then the anode, to which a high positive voltage is applied, holds out a very powerful attraction to them, but is tantalisingly kept out of reach by means of the counterpart of a valve's grid—a cylinder which is connected to a negative bias, constraining the electrons into a narrow stream so that they pass through a hole prepared for them in the anode, and continuing by their own momentum they strike a chemical screen at the far end of the tube with such violence as to cause a visible glow.

This narrow electron ray, after it has emerged from the anode, can be deflected from its course by either electric or magnetic fields, so causing the spot of light to move over the screen ; and the magnitude, direction, and change

* Some good books are : " The Cathode Ray Oscillograph in Radio Research ", Watson-Watt, Herd and Bainbridge-Bell (H.M. Stationery Office) ; " The Cathode-Ray Tube at Work ", John F. Rider (for American practice) ; " The Low Voltage Cathode-Ray Tube ", G. Parr (Chapman and Hall) ; " Cathode-Ray Oscillographs," J. H. Reyner (Pitman) ; " The Cathode Ray Oscilloscope," W. E. Miller (Hilff & Sons Ltd.).

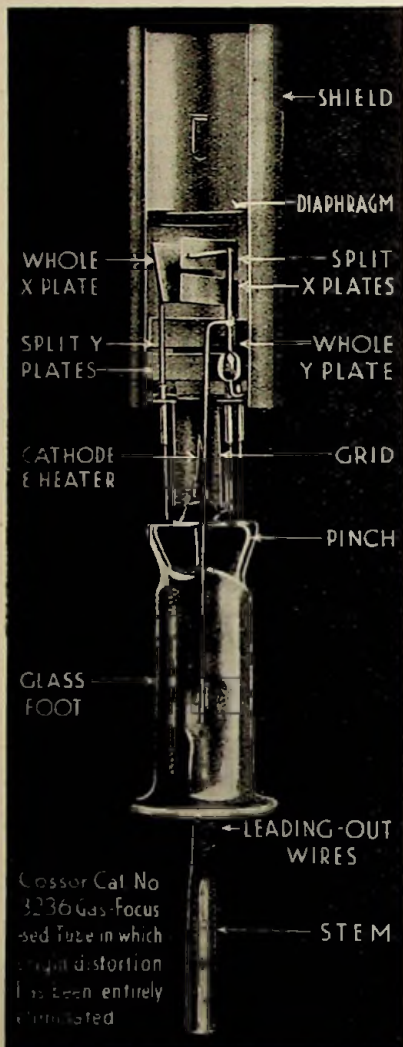

with time of such fields made plain to see. Although all sorts of elaborate patterns or figures can be caused to appear in this way, it must be clearly realised that these are optical illusions caused by the "visual persistence" of the eye, aided perhaps in some cases by a similar characteristic of the screen itself. At any one instant only a single spot of the screen is being touched by the ray.

As already mentioned, the fineness of the spot is important as determining the amount of detail that can be revealed on a screen of given size; and it is necessary to have some means of focusing, in addition to the cylinder (or *grid*, if one cares to follow valve nomenclature).

Tubes are classified principally according

Fig. 41 : A section of the electrode system in a gas-focused cathode ray tube. The split deflector plates form part of a system for avoiding origin distortion — otherwise a disadvantage of gas-focusing (A. C. Cassor, Ltd.)

Fig. 42: The electrode system in a high-vacuum cathode ray tube, in which both focusing and deflection are accomplished electrostatically (A. C. Cossor, Ltd.)

to the method of focusing, firstly into gas-focused and high vacuum

76. Gas types, and Focusing the latter into electrostatic and magnetic varieties.

In the gas-focused tubes which have now largely gone out of use (Fig. 41) there is only a partial vacuum; sufficient gas is present for the ray to cause a degree of ionisation along its path, which has the effect of drawing the scattering electrons into a narrow beam. This type of tube is simple to work; gives good results at low anode voltages; and is not defocused by unbalanced signal circuits (one side "earthy"); but begins to lose focus when the spot velocity corresponds to a frequency of deflection exceeding some hundreds of kc/s; there is a

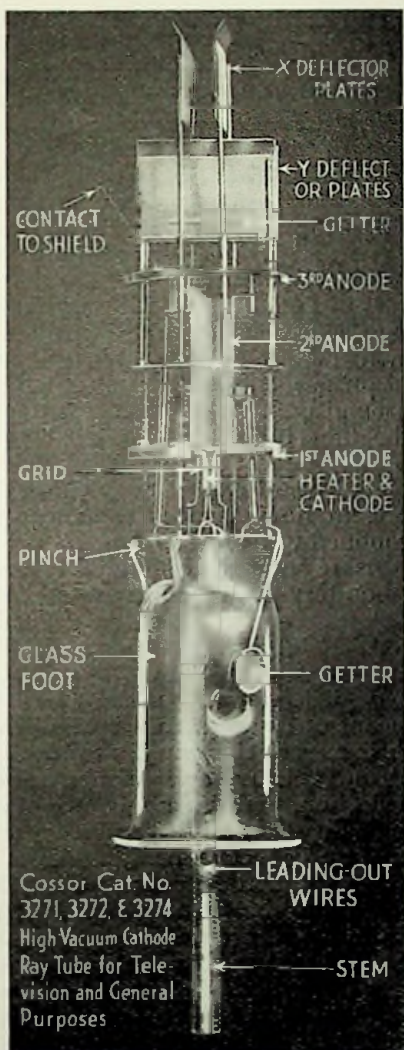

non-linearity of deflection near the centre position of the spot (known as *origin distortion*) ; modulation of the spot's brightness (as in television) is not practicable ; and only tubes with directly-heated cathodes are obtainable.

In the electrostatically focused tube (Fig. 42) there are two or even three anodes at various stages along the tube, and these are maintained at voltages so graduated as to make the beam converge on the screen.

77. Electrostatic and Magnetic Focusing

The system is often described as an electron lens, because it is in some ways analogous to an optical lens. To secure satisfactory results this rather complicated electrode system must be located with some precision ; but if the beam is magnetically focused, by means of a coil wound around the axis of the tube externally, the construction of the tube itself is simplified, and there is more scope for placing internal deflecting plates. It is also claimed that a bigger beam can be focused, giving a brighter spot. At present, however, the magnetically-focused tube is generally confined to television use.

As regards deflection of the ray, nearly all tubes for laboratory purposes are provided with two pairs of electrostatic deflecting plates, distinguished as the X and Y pairs (corresponding to X and Y axes of a graph). Magnetic deflection is possible, alternatively or additionally, by means of external coils around the neck of the tube with their axes at right angles to it. They are not so generally useful, because appreciable power is required to cause deflection, and the inductance of the coils is likely to create difficulty except at very low frequencies. To ensure a uniform deflecting field, a pair of coils is placed as shown in Fig. 43, and deflection takes place in a direction at right angles to the common axis of the coils. Electrostatic deflection, however, is in the same plane as a line joining the plates. Whereas electrostatic deflection is inversely proportional to the anode voltage, magnetic deflection is inversely proportional to the square root of the anode voltage.

INDICATORS

In selecting a tube there are quite a large number of factors to be considered. For audio and low radio frequencies the gas-focused type is suitable. It gives a better focus than the vacuum type, at least at low voltages, and does not need a symmetrical (push-pull) deflecting signal.

79. Characteristics of Cathode-Ray Tubes

The origin distortion can be removed, where necessary, by biasing the deflecting plates; and certain Cossor tubes are provided with split plates to enable this bias to be applied without deflecting the spot (Fig. 41). Incidentally, there is no origin distortion with *magnetic* deflection. If work at high radio frequencies—1 Mc/s and upwards—is to be done, the high-vacuum tube must be used. In the electrostatically focused and deflected type, the application of an asymmetrical deflecting signal (one side earthed) upsets the balance of potential and hence both the focus and deflection sensitivity, causing defocusing and “trapezium

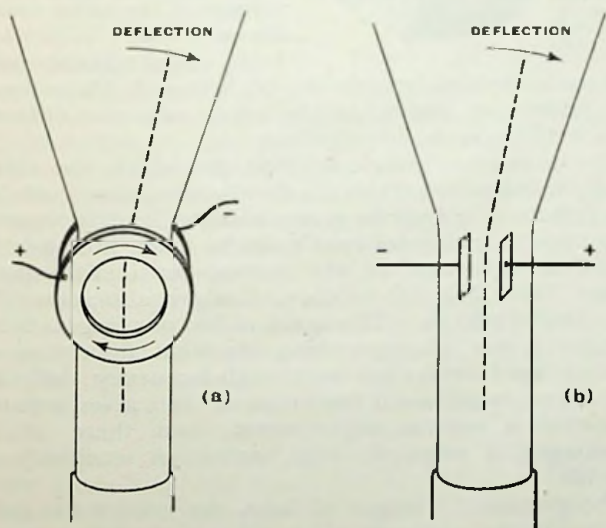

Fig. 43: Showing how (a) magnetic deflection and (b) electrostatic deflection are accomplished, and the relationship between polarity of current or voltage and the direction of deflection

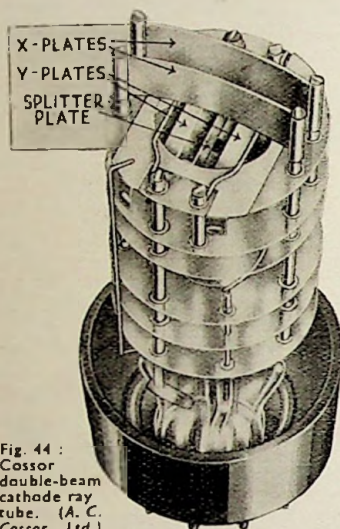

Fig. 44 :
Cossor
double-beam
cathode ray
tube. (A. C.
Cossor, Ltd.)

distortion". Provision of a push-pull amplifier, for applying equal positive and negative deflecting voltages, is not always convenient; but modern tube design has largely overcome these limitations. The deflection sensitivity of either gas or vacuum types is of the order of $\frac{400}{V}$ millimetres per

volt, where V is the anode voltage. At this figure, if 400 volts are applied to the anode, a voltage of about 25 gives a deflection of 1 inch, and a peak alternating voltage of the same amount draws a line 2 inches long.

It is important to realise that the deflection sensitivities of X and Y plates are not necessarily the same; in the 4051 tube the difference is quite appreciable.

The maximum anode voltage for which the tube is rated—usually several thousands—thus requires a considerable deflecting voltage to give a reasonable-sized figure on the screen. And great care must be taken not to let the spot rest stationary on the screen, for it will quickly "burn" it. The life of the cathode is also reduced by high anode voltage. The main object of using such high voltages is for photographing transient figures on the screen; another is for very high-frequency deflection. For more general use a few hundred volts gives a pattern visible in a not-too-bright room, and there are the advantages of relatively high deflection sensitivity and long life.

The greater the length of tube, the greater the deflection sensitivity, obviously; but to gain the full advantage of a long tube it is necessary for the focusing to be of a

INDICATORS

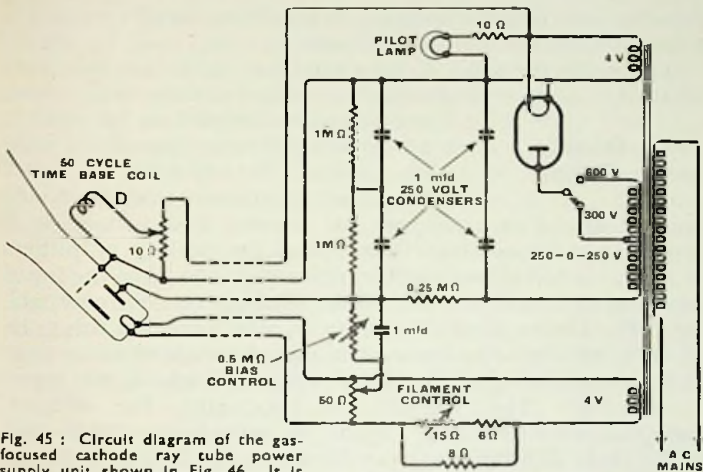

Fig. 45 : Circuit diagram of the gas-focused cathode ray tube power supply unit shown in Fig. 46. It is composed entirely of standard receiver parts

correspondingly high accuracy. There is a Cossor tube 18 inches long (Type 3277) and although the screen diameter of 2 inches seems small in proportion, extremely fine oscillograms can be taken photographically, and for a full-sized picture a peak signal of only 30 volts is needed.

An important characteristic, more especially at high frequencies, is the signal-input impedance. One of the advantages of electrostatic deflection, as of valve voltmeters, is that this impedance is so high that the effect on the signal circuit may often be neglected. The capacitance of any deflection plate to all other electrodes is similar to that of a valve—about 5–12 μF —and the resistance, even in gas focused tubes, is almost infinite.

Various types of screen are available, some being specially suitable for visual work and others for photographic; the former generally give a green light and the latter blue, but this is not invariable. The time taken for the fluorescence of the screen to disappear after the ray has moved from it may be anything from a fraction of a microsecond to half a minute or more; it is thus

possible to obtain special screens for work involving exceptionally fast or slow deflections.

The ordinary type of tube enables one to see how one quantity—say, voltage—varies with another—say, time.

79a. Double-beam Tubes

Sometimes it is helpful to be able to see how *two* different quantities vary with another ; for example, the signal voltages across primary and secondary coils of an I.F. transformer, or current and voltage in a rectifier system, against time. And for testing amplifiers with waves of various forms it is advisable to have the input signal as well as the output shown on the screen for comparison. The Cossor double-beam tube, which enables this to be done, is particularly recommendable as it costs no more than the corresponding single-beam type, with which it is interchangeable. The device for producing the second, independently-deflected beam is simplicity itself—one extra plate situated midway between the first pair of deflector plates that the cathode ray encounters (the Y plates). As at this stage the ray is undeflected and is in a diffuse condition it is split in halves by this central plate, which is internally connected to the main anode and therefore at zero or reference potential so far as the deflection system is concerned. This extra plate can be seen in Fig. 44.

When the split beam proceeds to come under the influence of the X-plates, both halves are equally deflected by them. So if, for example, a time-base voltage is applied to the X-plates, both beams are drawn horizontally across the screen ; but they can be independently deflected vertically by the Y-plates. Since the horizontal displacement is the same for both, any phase difference between the two waves is accurately depicted. It should be noted, however, that because deflection takes place each side of the plate, one of the pictures is inverted with respect to the other, and this must not be mistaken for a mysterious 180° phase shift !

The method of use is almost self-explanatory, as, apart from the separate action of the two Y-plates, everything is the same as for the conventional single-beam tube. If desired, one picture can be raised clear of the other on the screen by applying a suitable steady voltage in series with

INDICATORS

the signal voltage. Special precautions are taken in the design of the tube to avoid trapezium distortion with either symmetrical or asymmetrical deflection ; or interaction between the separate Y-plates.

Coming now to auxiliary apparatus, the one essential thing is the power source. Fig. 45 shows the circuit and Fig. 46 the appearance of a very simple unit which is in fact the one that has served the author very satisfactorily for a number of years, and can be made up from ordinary receiver parts. It is used to supply a Cossor gas-focused tube, and two anode voltages—300 and 600—are available by a change-over switch. Although the rated maximum for the tube is 3,000 volts, 600 is found to be enough for visual use and

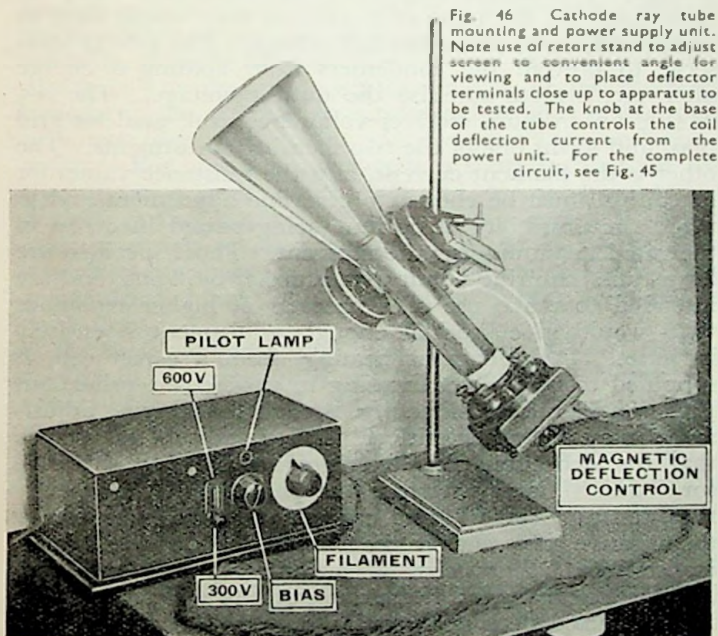

gives a very bright trace in artificial light or moderate daylight. With 300 volts it is necessary to draw the curtains when the day is bright, but as an example of the sensitivity quite a useful figure half an inch long is given by only 5 volts peak.

The smoothing circuits are simple and cheap, because the current drawn by the tube is only a few microamps.

For the same reason the rectified output voltage is very nearly the *peak* input, and an ordinary 250-0-250 volt receiver transformer (so rated at a much heavier load) gives 600 volts D.C. when connected as shown, even after allowing for the drop in the smoothing resistor. If somewhat higher voltages—about 450 and 900—are wanted, a 350-volt transformer can be substituted. The rectifier is not important, so long as it will stand the high back voltage. Obviously, single 0.5 μF condensers may be substituted for the pairs of 1 μF , but they would have to be specially ordered for the full voltage. The 1 M Ω leaks serve to prevent the condensers from holding a charge after use, and to stabilise the output voltage. The 0.5 M Ω is an ordinary receiver volume control, used for grid bias, and forms one of the two focusing adjustments. The other is the filament current, and the resistance values for its control must be chosen to give fine adjustment and to avoid the possibility of current being passed in excess of the rated maximum for the filament. Those specified are for a tube requiring about 0.75 amp. at 0.6 volts, and are intended to make use of a rheostat of higher resistance than would give gradual enough adjustment if entirely in series. D.C. filament heating, from a 2-volt cell, is supposed to give closer focusing in gas-focused tubes, but A.C. can be quite satisfactory, though the focusing adjustments may be rather critical. It is important to observe that the deflection plate voltages are relative to anode (or “gun”), and therefore the *positive* H.T. is usually regarded as “earth”, and care must be taken to render the negative parts, such as the filament leads and terminals, inaccessible. *There must be a conducting path from each deflection plate to anode*: if the apparatus to which the plates are connected does not provide one, a “leak” of about

INDICATORS

1 M Ω must be used, blocked off from the apparatus by a condenser if necessary.

The power source should be made up in a box that can be kept not less than about 5 feet away from the tube, to which it is linked by an adequately-insulated multi-way cable, so that there is no chance of the spot being drawn out into a line by unwanted magnetic deflection due to the power transformer. When working, one must remember to make sure that no other transformer—possibly in the apparatus being investigated—is causing any disturbance. Even the earth's magnetic field produces a perceptible deflection at low anode voltages, but as it is a steady one it does not matter much. If transformers *must* be close to the tube it is necessary to protect it by a mumetal shield, which, however, is fairly expensive.

Although the complete oscillographs, as sold, usually contain a cathode-ray tube built into a box along with all the auxiliary apparatus, which of course is conveniently portable, there is not only the problem of stray fields but also it may not be easy to get the deflector plates connected straight to the appropriate circuit points with a minimum of connecting leads to introduce capacitance and interaction. For bench use, therefore, it is preferable to mount the tube in a retort clamp (Fig. 46), as sold by chemical dealers, so that the base can be placed where it is wanted and the screen set at a convenient angle for observation. The diverging part of the tube can be painted black, and a cylindrical hood placed around the screen, to keep out room light.

For high-vacuum tubes, one or perhaps two focusing anodes must be supplied with appropriate voltages, and generally one of these is variable for focusing. It is quite simple to arrange a potential divider system to do this, and ordinary low wattage components can be used. But of course safety must be given due consideration; such things as live grub-screws in the control knobs must be covered up.

Sometimes the power source includes variable potentials for shifting the spot over the screen along either X or Y axes to counterbalance any voltage bias from the signal circuit that would otherwise bring the figure away from

the centre of the screen. There is a limit to the bias that may be used, in any type of tube, before defocusing results. Generally, however, such "X-shift" and "Y-shift" controls form part of a time-base unit.

When a signal is applied between a pair of plates the resulting figure is merely a straight line, which indicates the *amplitude* of the signal, but not much else. If a signal of the same frequency is applied to the other pair of plates, the straight line becomes diagonal, the angle indicating the *relative* amplitudes; or if they are applied in different phase the line opens out into an ellipse or circle from which it is possible to deduce the *phase angle*. By applying the input and output signals of an amplifier to X and Y plates, it is possible to compare amplitude, phase, and also *waveform*; for electrical distortion is shown by a visible distortion of the figure. Again, two independent signals may be applied, and (as will be explained more fully later) the *frequencies* can be compared with great accuracy. In this case, one of the signals will generally be the "unknown" and the other from a laboratory oscillator or other calibrated source. In other problems it may be desired to study some signal, or quantity that can be converted into a signal, with respect to time; and it is for this purpose that the "linear time base" is designed. This is an oscillator having a saw-tooth wave form, so that the spot is drawn across the screen at the desired rate, and then returned as rapidly as possible, to repeat the process with negligible loss of time. If the frequency of the time base is equal to the frequency of a continuously repeated signal wave or group of waves, the separate transient pictures of these always coincide and form a stationary figure which can be observed or photographed at leisure.

Although a time base is a most useful adjunct, it is necessarily not ideally simple, and very often it is possible to substitute a sinusoidal for a linear base; i.e., one produced by an ordinary sine

82. Sinusoidal Time Base

INDICATORS

wave instead of the saw-tooth variety. This is the explanation of the coil D in Fig. 45, which consists of about 200 turns of 30-gauge wire, about $2\frac{1}{2}$ -inch diameter, and can be clipped across one of the 4-volt L.T. A.C. supplies, preferably the rectifier supply for safety. The coil slides along the horizontal portion of a T-shaped piece of stiff wire, which can be swung round to give a line of any length or angle.

It is used at the start, for focusing purposes. Not only is a stationary spot bad for the screen, but focusing done on it may have to be revised when signals are on. The line gives a better idea of visibility, too; and shows if things are working properly. Then it constitutes a 50 c/s frequency standard of good accuracy (on time-controlled mains), which may be used for calibrating other sources at this frequency and many others of a simple ratio to 50. It can be used as a time base whenever a strictly linear law is not essential.

The disadvantage of a single coil is that it does not give a uniform deflecting field. A pair of suitably proportioned coils is very satisfactory in this respect, however, and can be seen fitted to the neck of the tube in Fig. 46. The amplitude of deflection is controlled electrically as shown in Fig. 45 instead of mechanically; the potentiometer is mounted at the base of the tube. Dimen-

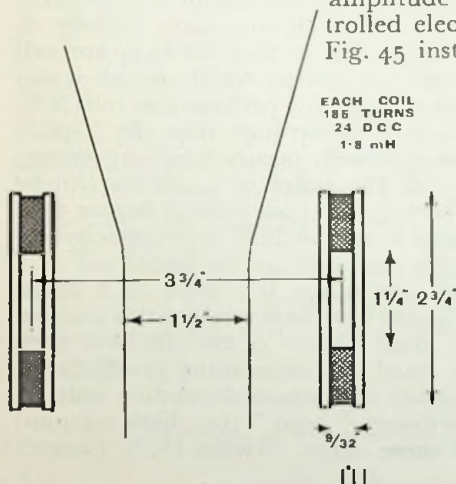

Fig. 47: Dimensions of coils suitable for providing a uniform 50-cycle deflecting field

sions of a suitable pair of coils are given in Fig. 47, but there is no necessity to adhere strictly to these. To arrive at the final adjustment of position the tube is switched on, with all deflection plates strapped to anode, and the maximum magnetic deflection, which should bring the beam well off the screen at both sides. Probably the forward and return traces fail to coincide, or the line is not straight, or both. By moving the coils carefully to a position of symmetry the figure can be reduced to a single straight line, and the coils firmly clamped in that position. In this process it is vital to have no disturbing fields; and to check this the tube and coil unit should be moved around to make sure that the line does not open out into a pair of lines part of a narrow ellipse, in any position.

As the position of these coils is fixed relative to the clamp, it can be varied relative to electrostatic deflections by twisting the tube around in its clamp, which in any case should not grip it tightly as there is some risk of breaking the tube in so doing.

The sinusoidal A.C. base can sometimes be used even when a linear deflection is wanted, because the "middle cut" of an extended sine-wave trace is quite a reasonably good approximation to it. It is necessary merely to increase the size of the base line so that the ends are well off the screen (if the coils are not powerful enough it can be done electrostatically by applying perhaps 200 volts A.C. to the X plates) and then to arrange that the Y-plate signal, which is to be observed, occurs near the centre. In this manner, waves of the order of 1,000 c/s can be examined on a 50 c/s base. An anode voltage higher than usual is necessary, because of the high spot velocity (or "writing speed") which results in less brilliance.

However, sometimes one wants the *whole* of a signal to be reproduced on a linear time base, and for this purpose

83. Linear Time Base Systems

a great variety of circuits have been worked out, some using gas-discharge valves and others depending only on ordinary "hard" (i.e., high vacuum) valves. For details of these many varieties O. S. Puckle's

INDICATORS

Time Bases (Chapman & Hall), should be consulted. The basic principle is to charge a condenser through some constant-current device, such as a high-impedance pentode, and then when it reaches a certain voltage the condenser is suddenly discharged. The voltage across the condenser therefore consists alternately of periods of uniform increase and practically instantaneous decrease; which is what is wanted for the X-plates. By altering the capacitance of the condenser and/or the anode current of the valve, the frequency of the saw-tooth wave can be varied as desired. Gas-discharge valves are capable of passing a very heavy current for rapid discharge of the condenser, and only one is required, in addition to the pentode. But they are generally limited to audio frequencies, and are not too stable in action. Although two hard valves, plus pentode, are needed, the valves are cheaper and work much more reliably, right up to about 1 Mc/s. Fig. 48 shows one form of the circuit. The condenser C is charged through the pentode V_1 , and the voltage across it rises at a uniform rate. V_2 is connected in

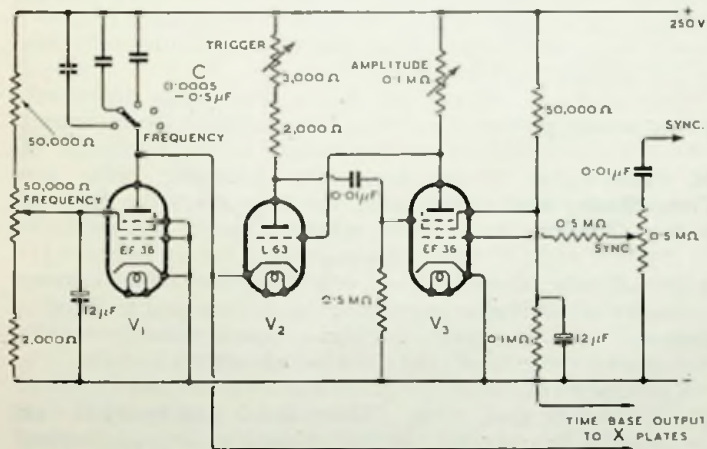

Fig. 48 : Circuit diagram of hard valve linear time base (due to O. S. Puckle)

parallel with C, but as its grid is initially biased negative by the drop across R_2 it passes no current until the voltage across C reaches a predetermined amount. Once a small anode current flows through V_2 , it causes a signal to be passed to V_3 , which makes the grid of V_2 more positive, thereby enormously accelerating the discharge. When discharge has taken place the valves return to their original condition for the next "stroke". The control grid of V_3 is connected to the "work"—the signal which is connected to the Y-plates of the oscillograph—and ensures that the frequency of the time base is held in step with it, despite small variations in supply voltages, etc.

Further elaborations provide for push-pull output, so that the voltages applied to the X-plates are balanced with respect to the cathode-ray tube anode, to avoid defocusing and distortion of the figure on the screen. And it is customary for provision to be made for shifting the spot along both X and Y axes to bring the figure central. So, by the time it is finished, the time base unit may be quite an elaborate piece of apparatus.

Some simplification is effected by B. C. Fleming-Williams in his single-valve time base; see *Wireless Engineer*, April, 1940, or Puckle's *Time Bases*. It is somewhat akin to the transitron (Sec. 37a).

One of the disadvantages of the time bases described, giving screen patterns based on the cartesian co-ordinates of mathematics, is the shortness of the base. By adopting polar co-ordinates, the base takes the form of a circle, which is longer and continuous. An example is shown in Sec. 131.

84. The Polar Time Base, and Some Others

A special tube, described by von Ardenne, the famous authority on cathode-ray tubes, in an article in *The Wireless Engineer*, January, 1937, enables a spiral time base 160 inches long to be displayed on a 4-inch screen!

There are problems in which the base should be some quantity other than time. There is no end to what can be done by translating various quantities into deflecting voltages, and so reproducing performance curves on the screen. Valve characteristic curves, for instance, can be

shown instantly on the screen instead of tracing them out laboriously by meters. Not only is there the saving in time but it is possible to investigate portions of the characteristics at which the valve could not safely be held long enough to take a meter reading. Such apparatus is described in Sec. 213.

There is one non-time base outstanding in importance—a frequency base. Suppose a frequency characteristic is required—it may be of a transformer, amplifier, loud speaker, bandpass filter, tuner, or complete receiver—to be taken at audio or radio frequency.

85. The Frequency Base

The apparatus consists of a source covering the requisite band of frequency, and an indicator to show the output at each frequency. When the output varies greatly with frequency, very many points have to be plotted each time; and in work such as “lining-up” a band-pass receiver, where there are many variable adjustments, the business becomes intolerably tedious.

But the whole curve can be displayed on the oscillograph screen by providing means for running across the frequency

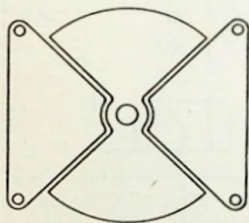

Fig. 49 : Shapes of moving and fixed vanes of a rotating condenser for providing a continuous linear variation of capacitance with time in observing frequency characteristics by cathode ray tube

band over and over again at a rate quick enough to deceive the eye, but not too quick for the circuits to follow, and arranging for the X-plate voltage to be proportional to the frequency. The Y-plate voltage, of

course, is derived from the output of the system being tested; if necessary, with additional amplification.

The mechanical method of frequency variation by means of a rotating condenser is not generally favoured now, but the author has found it successful for laboratory work, and it does allow any desired “law” of frequency variation to be provided easily. A special condenser is coupled up to

86. Mechanical Frequency Modulation

RADIO LABORATORY HANDBOOK

a small motor (one of the gramophone type will do) driving it at 200-300 r.p.m. The vanes are shaped as shown in Fig. 49, giving a linear variation of capacitance with time. One revolution gives two frequency sweeps each way, and a contact mounted on

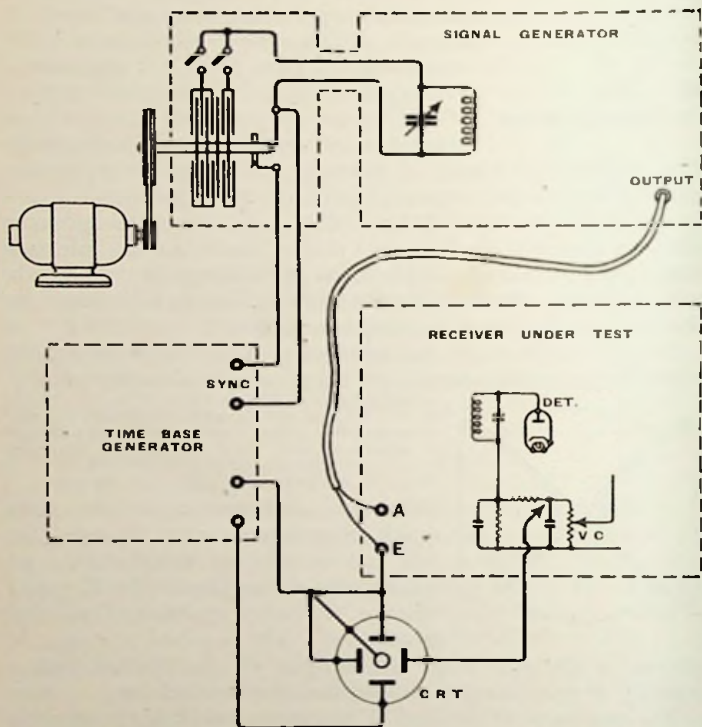

Fig. 50 : Complete system for continuous observation of receiver response characteristics. The frequency of the signal generator is continuously varied over a certain band by the motor-driven condenser, synchronized with a linear time base to provide a frequency base for the cathode ray tube. The output of the receiver under test is applied to the other pair of deflectors. In the symbol for the cathode ray tube the central spot represents the anode, which is normally connected to the "earthy" plate in each pair

INDICATORS

the spindle is used to synchronise a linear time base circuit giving about 15 sweeps per second. A 50-cycle sinusoidal sweep, together with a condenser shaped to give a corresponding rate of capacitance variation, or else a linear condenser and "middle cut" sine wave base, can be used for some circuits, but are not suitable for general use because the rate of change of frequency may be high enough to distort the response curve. The condenser fixed vanes are mounted in several sections so that the total

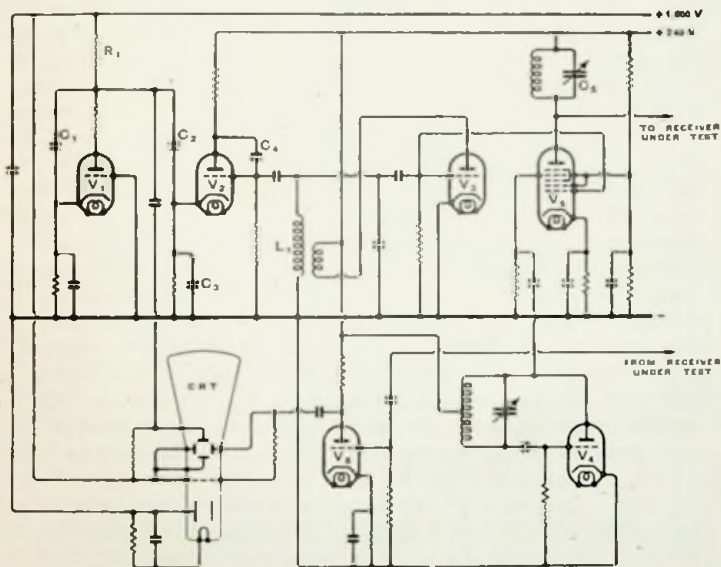

Fig. 51: All-electronic system for observing the frequency response characteristics of receivers. The valve V_2 acts as a variable reactance, altering the frequency of the oscillations generated by V_3 , which is one oscillator in a beat-frequency system. V_4 is the fixed-frequency oscillator and V_5 the mixer. V_5 amplifies the receiver response before applying it to the deflector

capacitance change can be regulated by including more or fewer vanes; and the whole is mounted in a screened box, with lead for connection in parallel with the variable condenser of a suitable oscillator. Fig. 50 shows the general

arrangement applied to the overall selectivity of a receiver.

To get the same frequency sweep at all frequencies used for test, a beat-frequency system may be employed ;

87. Electronic Frequency Modulation

in which one oscillator is used to vary the test frequency, the other is "wobbled" to give the frequency modulation, and the resulting beat note is applied to the apparatus under

test. Also a number of electronic methods of frequency modulation have been worked out, of which one depends on the Miller effect in a valve. This is described by O. S. Puckle in *The Wireless World* of August 6th, 1937, and by A. W. Barber in *Radio Engineering*, November, 1936. Another electronic system is described by D. G. Reid in the *Journal of the I.E.E.*, August, 1936, and F. L. Hill in *The Wireless Engineer*, July, 1936. A circuit derived from information by Puckle is shown in Fig. 51, where the condenser C_1 is alternately charged through R_1 and discharged by the gas-discharge valve V_1 . This generates the time base signal, which is applied to the horizontally deflecting plate of the cathode-ray tube, and also in part through the condenser C_2 to the cathode of the valve V_2 . This varies the gain of the valve and hence the capacitance reflected into the oscillator circuit $L_1 C_1$. V_4 is the second oscillator valve, and the two oscillations are mixed in V_3 and applied to the apparatus under test, the output from which is amplified by V_6 and provides the vertical deflection. In this way the response curve of a receiver can be rapidly checked at a number of points on all wavebands, for the condenser C_3 can be made to cover, say, 150 to 15,000 kc/s.

Another type of "wobbulator" employs a valve as a reactance, by feeding its control grid with oscillatory voltage 90 degrees out of phase, and varying its reactance in synchronism with the C.R.T. sweep by applying the X-plate voltage to one of the electrodes. Such methods are discussed in Reyner's *Cathode Ray Oscillographs*.

It may often happen that, as indicated in Fig. 51, a

INDICATORS

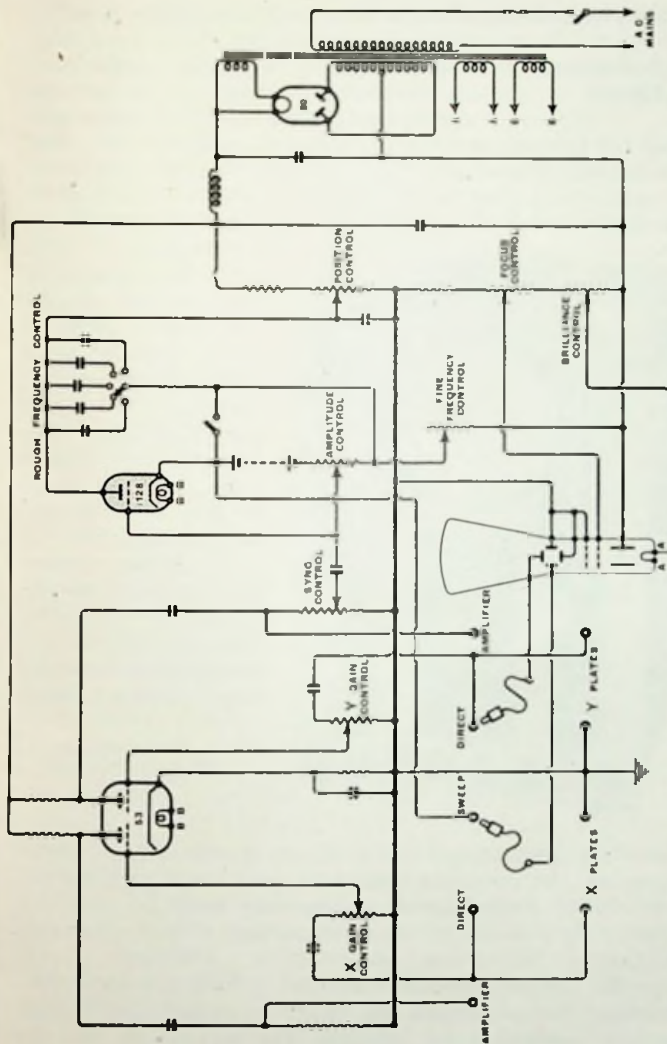

Fig. 52 : Circuit diagram of "National Union 3-5" Portable Oscillograph. The 1128-valve is a gas-discharge tube for the time base or "sweep" circuit, variable up to 20 kc/s; and the 53-valve is a twin amplifier for the two pairs of deflection plates, and covers the frequency range 20 c/s to 100 kc/s. The cathode ray tube is electrostatically focused. The whole equipment is contained in a compact carrying case with terminals as shown for connecting the deflector plates to the time base or to signal circuits, direct or through amplifiers

signal under investigation is too small to produce a useful deflection, more especially with high voltage tubes, without preliminary amplification. This is rather inconvenient, and one of the best

88. Deflection Amplifiers

reasons for keeping the tube voltage to a minimum. The inconvenience is not only that amplifiers represent so much more additional gear to provide, but also so much more to think about when considering the circumstances of the

experiment. The amplifiers must give the desired amplification, which must usually be a known quantity, and certainly must not vary with signal frequency or amplitude, or with time, or any other irrelevant quantity.

A simple resistance-coupled amplifier is usually adopted, because the amplification can be kept constant over

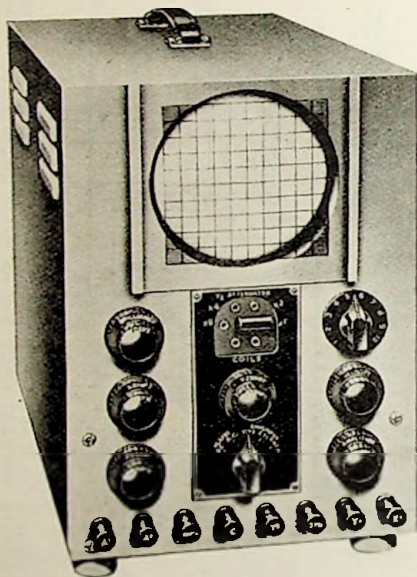

Fig. 53 : Cossor 339 Cathode-Ray Oscilloscope

a wide frequency range. If it has to go up into the radio frequencies, the coupling resistance and stage gain should be kept low. Signal-handling capacity must be carefully watched ; it is futile to study distortion if the apparatus is putting in distortion on its own. Adequate anode voltage for the amplifier is essential. And it is here that unwelcome complications are likely to occur with regard to supply potentials in bringing the signals to the de-

deflection plates without short-circuits or initial deflections being caused. Ideally every signal should be balanced, so that the algebraic sum of the voltages to either pair of plates, with respect to the final anode, is always zero. To achieve this, a push-pull system is necessary. But as one side of a signal circuit is almost invariably "earthy", one plate of each pair is usually connected to tube anode, which is earthed if practicable.

There must always be a conducting path from every deflector plate to anode. It may be a megohm or two if need be. Plates not in use should be connected straight to anode. In the 4053 tube referred to in Sec. 74 one plate of each pair is internally joined to anode, so balanced systems are impossible.

To conclude the subject of auxiliary apparatus, Fig. 52 shows the circuit of a typical American "serviceman's" portable oscilloscope, incorporating power supply, variable-frequency time base with synchronising control, separate X and Y amplifiers, each with gain controls, and spot focus and position controls. Considering its comprehensiveness it is remarkably simple. But for research purposes it might be necessary to elaborate the system very considerably.

The Cossor type 339 oscilloscope, shown in Fig. 53, incorporates a $4\frac{1}{2}$ -inch high-vacuum tube (either single or double beam) with mumetal anti-magnetic screen; A.C.-driven power unit; time base (5 c/s to 250 kc/s); synchronising, shift, and calibrating circuits, and deflector coils. A special feature is the provision of two amplifier stages which can be used separately for each Y-plate, or in cascade for one Y-plate; and they can be arranged to give a gain of 4,000 from 10 c/s to 100 kc/s, or of 400 from 10 c/s to 2 Mc/s.

Most of the work apart from rather specialised investigations on atmospheric and other uncontrollable transients can be observed visually, by causing the signal to repeat cyclically. And such effects as individual heart-beats, in medical

89. Complete Oscilloscopes

90. Photographing Oscillograms

work, can be seen by using special screens with long after-glow. But for rapid transients it is necessary to have recourse to photography, and the makers of the tube should be consulted for their recommendations regarding this. Nothing very special is necessary, however, for taking photographs of stationary figures on the screen. It is essential that they should be *quite* stationary for as long as is needed for the exposure, which must be found by experiment. Something of the order of a second may be required for a low voltage tube and a stop of about $f/6$. With a higher voltage tube, Super XX Pan. film, and $f/2$

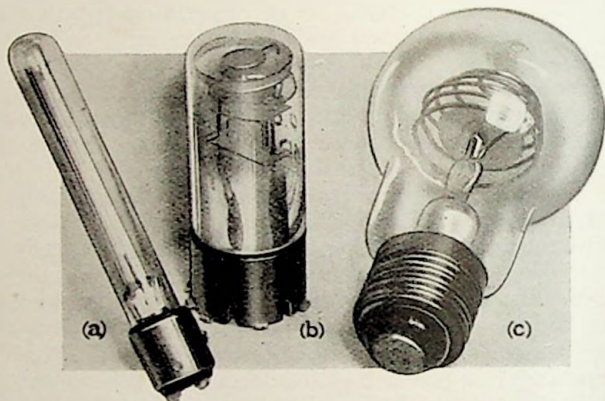

Fig. 54 : Some inexpensive and very useful electronic indicators : (a) Cossor 3180 neon tuning indicator, (b) Mullard T.V.4 cathode ray tuning indicator, and (c) General Electric "Osglim" neon lamp

aperture, exposures as brief as $\frac{1}{50}$ th sec. are possible. An exposure must not be *too* rapid or it may not include a complete cycle of movement. (This, by the way, forms the basis of a method of testing camera shutter accuracy.)

There are some purposes for which one would like to have the advantages of the cathode-ray as an indicator,

91. Inexpensive Electronic Indicators

but where a quantitative indication is not essential. A diminutive and inexpensive tube is available for this purpose—none other than the "magic eye" tuning indicator. Being com-

INDICATORS

pact, cheap, inertialess, "unbumpable", and negligible as a load, it may well be considered as a substitute for meters and other indicators in these circumstances. Certain types require only 3 or 4 volts for the full range of movement, and give a visible response on quite a small fraction of a volt. In view of the almost infinitely high input impedance, this represents a high degree of sensitiveness, which of course may be still further increased by amplification or by the still simpler expedient of connecting the cathode through a resistor of a few thousand ohms, preferably variable, in order to introduce positive feedback. It is therefore growingly popular for such purposes as indicating the balance point in bridges. An example of its use will be described in Sec. 123.

A still cheaper device, but one not quite so stable in operation, is the 3-electrode neon tube sold as a tuning indicator by the G.E. Co. and Cossor. The voltage on one of the electrodes is indicated by the height of the glow discharge in the tube. Ordinary neon lamps are almost indispensable in the laboratory, not only as indicators, but as voltage stabilisers. It should be known that they are sold with or without a resistance in the cap: for laboratory purposes they are more useful without the resistance, but as the current then rises almost indefinitely at the striking voltage care should be taken to limit it in some way to a reasonable amount.

The photo-electric cell may be classed as an electronic indicator, responsive to light. At present it is finding application mainly in industrial fields, but although it is not a general-purpose laboratory instrument its existence should be borne in mind for possible special apparatus.

Acoustic Instruments

The indicating instruments described so far in this chapter deliver their information through the eye, which is far more sensitive to changes of magnitude or form than the ear.

92. Phones and Loud Speakers They are therefore much better than acoustic indicators for such purposes as indicating maximum output from an amplifier. On

the other hand, the ear is extremely sensitive to changes in frequency, and although the cathode-ray tube may be used for synchronising frequencies with precision, when it is available, so may phones or loud speakers.

A pair of phones, especially of the adjustable type made by S. G. Brown, is a remarkably sensitive instrument for detecting very small alternating currents of the order of 1,000 c/s. An audible signal is given by power of the order of 10^{-9} microwatt! So it is generally used for indicating balance in A.C. bridges working at the middle audio frequencies. The sensitivity both of ear and phones falls off so rapidly at the very low frequencies that the same system is quite unsuitable for, say, 50 c/s. The much more expensive and tricky vibration galvanometer is officially prescribed for this purpose; but a practical alternative is an appropriately designed amplifier followed by an output meter (such as the "magic eye").

Phones have the advantage of high sensitivity and of keeping out other noises and so improving concentration, but are tiring to wear for long periods and make one feel like a dog on a chain. So an amplifier and loud speaker is sometimes preferable. An obsolete broadcast receiver, or one that is faulty on the R.F. side, may be made to serve this purpose.

An important advantage of aural indication, as compared with visual, is that the ear can discriminate between signal and noise, or between fundamental and harmonic. And whatever progress is being made in exact visual measurement, the ear remains the ultimate judge of very much that our work is concerned with.

CHAPTER 6

INSTRUMENTS

C—Standards of Comparison

It was emphasised in Sec. 20 that in general it is much easier and more accurate to measure something by direct comparison with a standard of the same sort than to try to establish it in terms of other quantities. It is quite simple to compare a length, supposed to be one yard, with a standard yardstick ; but measurement of it by observing the time taken by a standard snail to traverse the distance is likely to give the result to a substantially lower order of accuracy, and to be subject to more indeterminate influences.

93. Purpose of Standards

Among the most valuable equipment of a laboratory, particularly one where accurate measurements are performed, are standards of the various quantities concerned. Some of these, such as resistors and inductors, may be described as passive ; others, like amplifiers or generating wavemeters, are active. Passive systems are to be preferred, because they are subject to fewer influences likely to cause error and inconstancy.

In standardising laboratories, of which the N.P.L. (National Physical Laboratory, Teddington, Middlesex) is chief in this country, extreme precautions are adopted in producing and maintaining standards of the highest accuracy. Very special cells are used as standards of voltage. These rarely find a place in a practical radio laboratory, which depends on indirect measurement by means of a voltmeter, calibrated by the makers from a sub-standard instrument, which in turn was probably calibrated from a still more accurate voltmeter, itself compared with a standard cell. Although the voltmeter is an indirect method of measuring voltage (it not only

does not compare the "unknown" with a standard voltage, but actually measures current!) the direct comparison method is too inconvenient for ordinary purposes.

94. Standards of Resistance

The same is true of ammeters and milliammeters. But resistors, however calibrated, are at least the same sort of quantity as the original. They can be produced in an enormous range of values, from perhaps 0.0001 ohm, for heavy current ammeter shunts, up to many megohms. Extreme values of anything always cause the most difficulty; resistances between 10 and 1,000 ohms are the easiest to make accurately. For good quality laboratory apparatus, manganin or constantan wire is generally favoured; but for making up resistors oneself eureka is more readily obtainable, is easier to solder (an important point with very fine wires), has 29 times the resistance of copper, and for most purposes the effect of temperature is negligible (0.002 per cent. per °C.). The temperature coefficient of copper is about 0.4 per cent., so the resistance changes very appreciably within the limits of atmospheric temperature, and still more when heated by the flow of current. Although nobody is likely to be so stupid as to try to make a standard resistor of copper wire, there is just a possibility of overlooking the fact that shunting a copper-wound milliammeter with eureka is just as bad. It is necessary for the moving coil of, say, a milliammeter to have a "swamping resistance" of low-temperature-coefficient wire in series with it, preferably many times the resistance of the coil itself. If eureka is used instead of manganin it is necessary for accurate work to see that it is run at a very conservative current rating, to avoid thermo-electric generation of small misleading currents.*

The most generally useful form of calibrated resistor is the decade box, consisting of a number of groups of equal resistances (units, tens, hundreds, etc.) each controlled by an eleven-stud switch (0-10). For example, a 3-bank box would provide a total of 1,110 ohms in steps

* See also Sec. 311.

STANDARDS OF COMPARISON

of 1 ohm, or 11,100 ohms in steps of 10 ohms (Fig. 55). Apart from the accuracy and constancy of the resistances, the most important thing is the reactance, or rather the absence of it. A.C. work is now so much more important

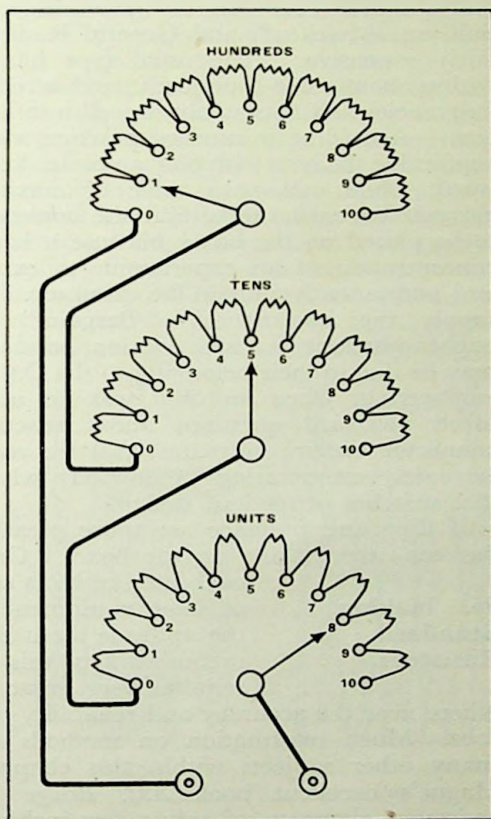

Fig. 55 : Connections of a 3-figure decade resistance box, providing 1,110 ohms in steps of 1 ohm

than D.C. that it is hardly worth buying or making resistors that are not wound non-reactively. It is not enough to be *non-inductive*, because the *capacitance* may cause more trouble at high resistances and frequencies. In one

ingenious method of winding, the residual inductive and capacitive reactances (for they can never be *entirely* absent) are arranged to cancel out.

Decade boxes, made by most of the electrical instrument manufacturers, such as the Cambridge Instrument Co., Sullivan, Muirhead, and General Radio, are necessarily fairly expensive. The usual type has an accuracy to within about 0.1-0.2 per cent., and is reliable at all audio frequencies and reasonably so well into the radio frequencies. According to modern practice, switch contacts are kept inside the box, with only a pointer-knob external. It is worth while making a table of maximum permissible currents on each range, and the corresponding voltages, to be pasted on the box; because it is very easy, in the concentration of an experiment, to exceed these limits, and permanently impair the accuracy. The makers will supply the information. "Bargain" resistance boxes ought to be accepted with caution, because their cheapness may be due to their belonging to the D.C. era in electrical engineering, when an ohm was an ohm, and nobody asked awkward questions about reactance. The plug connector system, once universal for resistance boxes, is extremely exasperating to anybody who has once used dial switches of modern design.

If time and patience are more plentiful than money, one may try making decade boxes. Or perhaps special

96. Making Standard Resistors

calibrated resistors are needed as part of some equipment. Anybody with the aptitude for it can turn out very useful work of this sort, although it requires very great care to get anywhere near the accuracy and reliability of the professional jobs. Much information on methods of winding—and many other subjects within this chapter—are given in Hague's excellent book *A.C. Bridge Methods*. Low resistance elements, of only a few inches of wire, can be made like twisted hairpins, as shown in Fig. 56 (a). Other elements, up to tens of thousands of ohms, can be wound with very thin wire on the thinnest sheets of mica capable of supporting them firmly. The object of this construction

STANDARDS OF COMPARISON

is to reduce to a minimum the cross section area enclosed by the coil ; and hence the inductance. The capacitance is quite low, too, if the wire is wound in a single layer from end to end along a small strip. Such construction, particularly if very fine wire—smaller than 40 gauge—is used, is satisfactory at quite high radio frequencies, and is often adopted in signal generator attenuators. The wire must not be allowed to bulge out from the sides, but should lie flat on the strip, and it is a good thing to give it a coat or two of very thin shellac varnish. The current-carrying capacity is low ; and for the medium resistances—1 to 100 or possibly 1,000 ohms—the Ayrton-Perry winding is more satisfactory. The procedure at first is the same as just described—a single layer from end to end on a strip of insulating material—but the resistance must be just double that required. Then another winding is put on, exactly similar except that it is in the opposite rotation. The inductances of these two windings are in

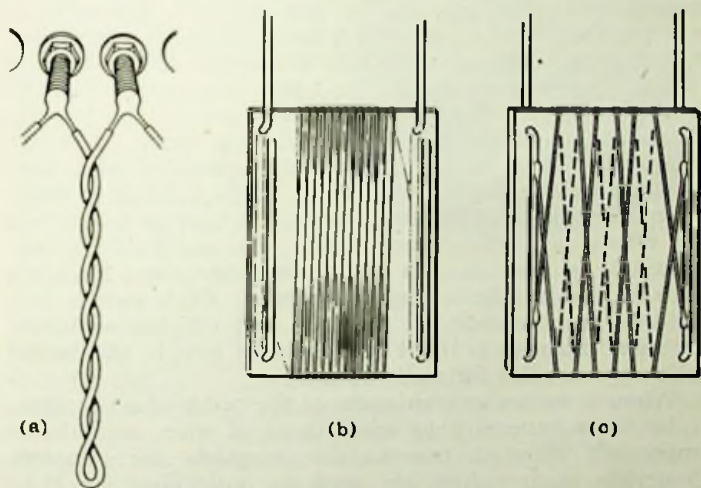

Fig. 56 : Three of the many methods of minimising reactance in elements. (a) The "twisted hairpin" is suitable for low resistance ; (b) consists of fine wire wound on a thin mica card, which is stiffened by the thick wire connecting leads. In (c) (the Ayrton-Perry method) there are two windings in parallel, in opposite rotation to neutralise self-inductance

opposition to each other, and therefore it is allowable for them to be supported on material of appreciable thickness, and hence for the wire to be of a substantial gauge. In addition to more care being needed in winding, this system is more complicated to adjust, because both wires have to be shortened simultaneously.

It has already been pointed out that if resistors are to be really accurately adjusted it is almost essential to do it on an auxiliary section wound with thicker wire, the main section being a few per cent. less than the full amount. To avoid having to keep on making adjustments, waiting for the joint to cool each time (for when hot it sets up a misleading thermo-electric current), and then measuring it carefully ; a loop of the thick adjusting wire should be slowly twisted, with the bridge or other standardising instrument in action, until it has been short-circuited to the necessary length. Then the twisted portion can be carefully soldered, making sure that the untwisted parts cannot come into contact. When it has cooled down it will probably be found to be a shade less than par, owing to creepage of the blob of solder ; a little careful thinning of the wire with a fine file will put this right. The file is used also in adjusting shunts and other very low resistances, which are often made of strip metal. Contact resistances have to be considered, especially with low-resistance elements, and it may be really difficult to make comparison with a standard in such a way as to exclude the effects of terminals and leads. An unreliable decade switch is an abomination of the worst sort, and for high-class work the Cambridge Instrument Co.'s switch unit is to be recommended. A cheap and reliable substitute for most purposes is the Yaxley type of switch, obtainable in many varieties for radio receivers.

When it comes to resistances of the order of a megohm, it becomes expensive to wind them of wire, and almost impossible if strict non-reactive methods are adopted. Generally such values are used as multipliers for D.C. voltmeters, and may be wound anyhow ; or possibly for A.C. of 50 c/s, in which case it is enough to wind on a multi-groove former, reversing every alternate section to

STANDARDS OF COMPARISON

give a fairly non-inductive result. But for high frequencies it is better to rely on "grid-leaks" although they have bad temperature coefficients and are affected by age, moisture, and voltage. If the resistances are selected on the low side, most types can be carefully scraped to a desired value and then protected from the air by insulating paint or varnish. Owing to distributed capacitance, among other effects, no known type of resistor remains accurate at very-high frequencies, and they must be specially calibrated at the required frequency. Standard resistances for radio frequencies, as used in certain methods of R.F. resistance measurement, must be made of sufficiently fine wire to keep the skin effect error within reasonable limits; a table of permissible gauges is given in Sec. 299. The use of finer gauge wire also results in lower reactance errors.

Although it is a digression from considering actual

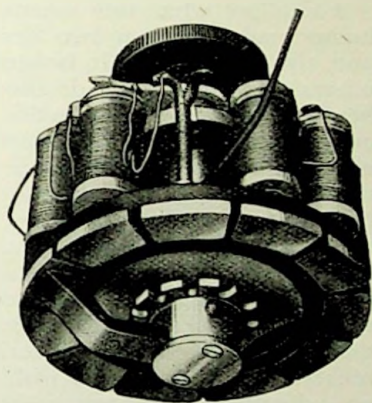

Fig. 57: Decade switch with multi-leaf contact arm to minimise resistance (Cambridge Instrument Co., Ltd.)

apparatus, this seems to be the best place to make clear an important principle where standards are concerned. Comparison of the "unknown" with a calibrated standard of its own sort, unless there is some good reason for doing otherwise, has already been advocated in preference to indirect methods. But there are two ways of using a standard in the comparison method. The standard, assuming it to be variable, can be treated as a lump of the required quantity—resistance, inductance, or whatever it may be—to the tune of the dial reading,

97. Avoiding Errors in Comparing with Standard

But however pleasantly simple it may be to think of such electrical lumps—and circuit diagrams certainly tend to encourage the habit—they are creatures of the imagination. Electrical quantities do not reside within prescribed limits, but are distributed throughout a circuit.

Connecting leads, switches, supports, and such-like humble but essential auxiliaries cannot be left out of consideration. So when you throw in a chunk of resistance you have to decide where it begins and ends. Vexatious complications of this sort can generally be wholly or partly excluded from the problem by dealing, not in absolute quantities, but in differences.

To follow what this means, suppose a comparison is being made between two decade boxes, one calibrated and the other not. It is necessary to have a meter or other device giving an indication governed by the resistance between a pair of terminals. One way of making the comparison is first to connect the unknown there, and note the reading. Then it is removed, and replaced by the calibrated box, which is adjusted to give the same reading, as nearly as possible.

To achieve the highest accuracy it is necessary to make sure that unauthorised resistances, due to switches and leads, are negligible. This may not cause anxiety in the majority of cases, but if the resistances to be measured are themselves very low it is a serious matter. The standard resistance may be known within 1 per cent., but this is of no advantage if circuit resistances amount to perhaps 10 per cent., and are not known at all.

In the alternative method, both resistance boxes are left connected all the time, and switching elements into one is balanced by cutting them out in the other. There is a possibility of switch contacts varying slightly from one to another, but this *difference* is not likely to be as much as the whole resistance of a switch, small as that ought to be if it is a good one. As for the resistances of leads and terminals, they fade out of the problem entirely.

Except for comparatively rough measurements, then, it is

STANDARDS OF COMPARISON

necessary to define exactly what the resistance in question includes, especially with low values or at high frequencies. The necessity is still greater with the other electrical quantities. In fact, the statement that a component has a capacitance of so much has little meaning unless the method of connection and other circumstances are specified in detail.

Occasions often arise when it is necessary to measure very small capacitances. Interelectrode capacitances of valves, for instance; only a few $\mu\mu\text{F}$. Or consider a tuning condenser—more strictly “capacitor”—where total capacitance is not particularly small, but which it may be important to know within a fraction of $1 \mu\mu\text{F}$, for accurate ganging. You may say, compare it directly with a standard variable condenser, calibrated to the requisite degree of accuracy. Very good; but what exactly does such a calibration mean? There are always stray capacitances. Even if one side of the condenser is earthed and extended so as to screen the other, and even if connecting leads are reduced to a minimum, how is one to know that the stray capacitance is exactly the same as in the original calibration circuit? Considering that differences of capacitance of a hundredth of $1 \mu\mu\text{F}$ can be distinguished quite easily with simple apparatus, it would be unfortunate if the accuracy of the most precise standards were wasted because of uncertainties as to strays. But whereas the *absolute* capacitance may be uncertain, the *difference* between any two readings on the scale is unaffected by whatever external capacitances may chance to be effectively in circuit. Therefore the difference method is to be preferred, at any rate when an amount as small as $1 \mu\mu\text{F}$ has any significance in the case.

Coming now to actual standards of capacitance, there are two main sorts to consider: variables, usually not much more than $1,000 \mu\mu\text{F}$ maximum; and fixed condensers, sometimes assembled into boxes and controlled by switches. Although so simple in principle, the condenser has permanently occupied the attention of some of the best scientific brains;

99. Standards of Capacitance—Mechanical Construction of Variable Condensers

and those produced by H. W. Sullivan, Ltd., for the N.P.L. are among the most remarkable examples of scientific craftsmanship. One of 1,000 $\mu\mu\text{F}$, costing upwards of £100, is shown in Fig. 58 and incidentally disposes of the idea that a direct drive is necessarily no good for fine adjustment. Although offering considerable resistance to rapid rotation, the bearings are so beautifully made and adjusted as to give the impression that if a fly leaned against the handle it would move steadily at an imperceptible rate. At least, there is no difficulty in making the most delicate adjustments by hand. Even the relatively very cheap variable condensers made by this firm, are characterised by smoothness of rotation that astonishes anybody whose experience is limited to ordinary "commercial" types. A variable condenser is, in fact, more of a mechanical job than an electrical one; such a slight movement of any of the parts in any direction other than the

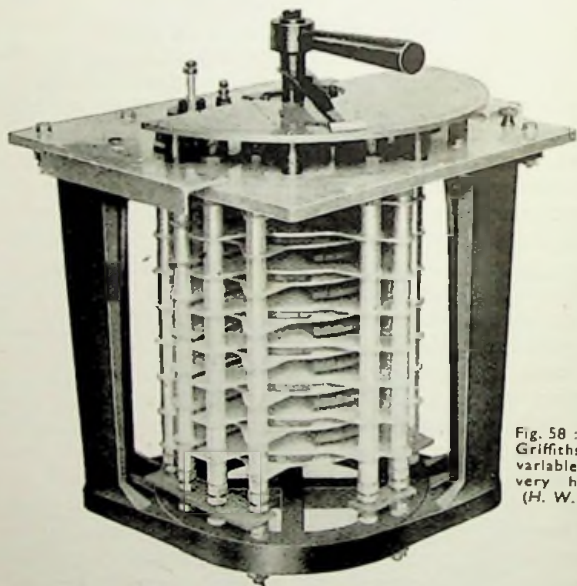

Fig. 58 : The Sullivan-Griffiths "series gap" variable condenser of very high precision (H. W. Sullivan, Ltd.)

STANDARDS OF COMPARISON

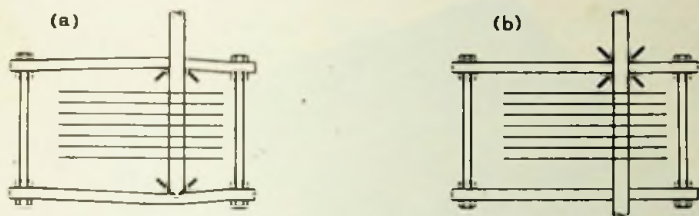

Fig. 59: Two types of condenser bearing. Type b, in which the end-plates are not under a separating stress, is to be preferred for permanence of calibration

desired rotation is liable to upset the accuracy. The worst movement is that in an axial direction, for a shift equal to one inter-vane gap—which itself may be only a fraction of a millimetre—corresponds to an increase in capacity up to infinity! In the more refined Sullivan condensers an ingenious method is adopted for putting pairs of adjacent gaps electrically in series, so that the total remains the same when the moving vanes suffer an axial shift. For a full description of these, refer to articles by the designer in *The Wireless Engineer*, January and February, 1928, and January and February, 1929. But as such types are not likely to be within the means of the smaller laboratories and individuals, a choice must be made of condensers that are well constructed mechanically, with vanes treated to prevent warping and spaced rather more widely than in ordinary uncalibrated types. Bearings that give smooth rotation and freedom from side-play, undue wear, and slackening-off, are important. The common practice of supporting the spindle by compressing it between the end-plates is open to criticism, because even the stoutest material subject to this stress is liable to acquire a set and so cause slackness and loss of calibration. It is better for the spindle to have free axial motion through one end-plate bearing, thus relieving both plates from stress, and for the other to determine the plate spacing (Fig. 59).

A straightforward scale must be very accurately engraved, and fitted with a vernier, if it is to be read to fractions of a $\mu\mu\text{F}$ when the maximum is 500 $\mu\mu\text{F}$ or more; so

(Muirhead & Co., Ltd.)

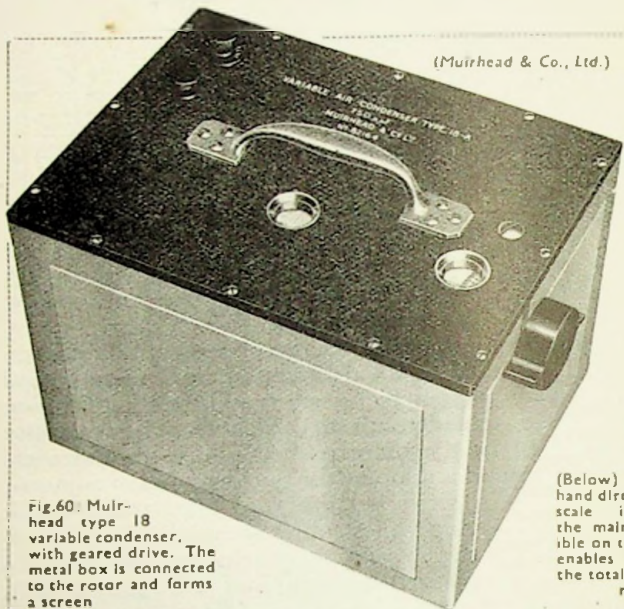
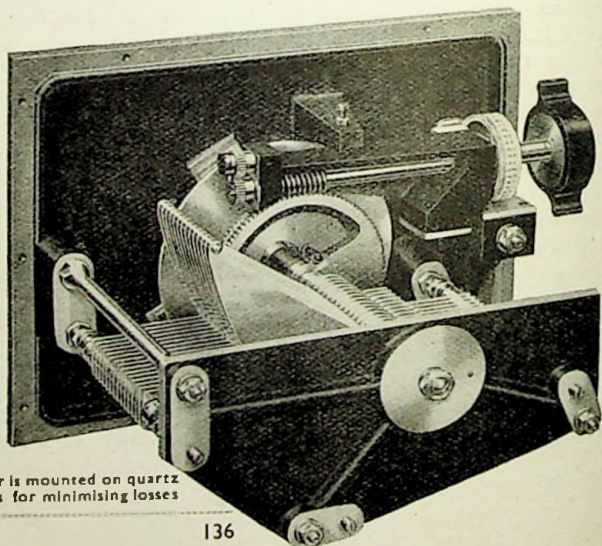

Fig.60. Muir-head type 18 variable condenser, with geared drive. The metal box is connected to the rotor and forms a screen

(Below) The right-hand directly driven scale interpolates the main scale visible on the left, and enables 1/10,000 of the total scale to be read



The stator is mounted on quartz insulators for minimising losses

STANDARDS OF COMPARISON

in the General Radio, Muirhead, and Marconi-Ekco laboratory condensers there is a geared system in which the fast-speed drive is fitted with a separate scale for interpolating between the divisions on the main scale (Fig. 60). Naturally the mechanical precision of the gearing has to be very good to avoid mechanical backlash ; and in fact for the highest accuracy the errors of the gear can be measured and taken into account. W. H. F. Griffiths has described in *Wireless Engineer*, Nov. and Dec. 1943, his technique for direct-reading frequency scales of 0.01 per cent. accuracy.

For more modest standards, the best condensers that can be afforded should be used, and fitted with a good slow-motion dial. Some dials are made by Muirhead (Fig. 61), less expensive than the highest-grade laboratory class, and much better than ordinary tuning types. The vital thing is to make sure that there is no mechanical backlash or whip between the pointer and the vanes ; and to this end the spindle should be no tighter than is necessary to avoid play.

Regarding electrical characteristics, it is usually of some importance that the losses should be very small, because

many measurements are much simplified if it is permissible to neglect them. In regardless-of-cost types, fused quartz is used for insulating supports ; but the same order of efficiency is claimed for some of the ceramic materials. In any case, the minimum solid insulation mechanically necessary should be used, and placed outside the most concentrated electrostatic fields. In the Marconi-Ekco condenser the shunt resistance at 1 Mc/s is given as 40 M Ω . Screening

100. Electrical Characteristics of Condensers

Fig. 61 : "Muirhead 1-AV" slow-motion precision dial for laboratory variable condensers and other apparatus

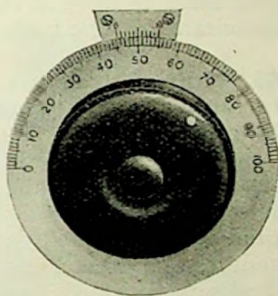

is generally adopted, for although it raises the minimum capacitance, such capacitance is at least not dependent on the positions of nearby objects. The *moving* vanes are usually connected, with the screening box, to the "earthy" terminal; that is to say the terminal which, if not actually earthed, is normally at substantially zero alternating potential. As regards vane shape, although fancy shapes—square law, log, etc.—are used for special purposes, it is more usual for laboratory condensers to be of the old-fashioned straight-line-capacitance type.

Although measurements made by "differences" do not take into account the minimum capacitance, there are other purposes—such as tuning a coil for R.F. resistance measurements—for which a low minimum is desirable. But a screened laboratory condenser giving a difference of preferably 1,000 $\mu\mu\text{F}$ is not likely to have a minimum nearly as low as ordinary tuning condensers; so it is a good thing to have at least one more condenser of smaller capacitance. The author has found it very useful to have

101. Multi-range Variable Condensers are divided electrically into two or more groups, so that the range of capacitance is variable. In the lowest range, extra spacing or a smaller vane may be used to bring the variation down to perhaps 15 $\mu\mu\text{F}$, for such measurements as of valve capacitances. Two unequal groups of fixed vanes can be arranged by supporting them from opposite end-plates; and this gives three ranges. The unused group, if any, is shorted to the moving vanes.

A simpler construction, substituting insulating fixed-vane supportingspindles, and one set of insulating spacing washers, can be adopted if the somewhat higher losses can be tolerated.

The Sullivan condensers are available in multi-range patterns, even down to the least expensive grades, and are strongly recommended (Fig. 62).

For some purposes a *very* small variable is required—say, 1 $\mu\mu\text{F}$ maximum. It is not difficult to make or adapt one suitable for the purpose, and it can be calibrated (preferably *in situ*) in terms of a known inductance by the method given in Sec. 182.

STANDARDS OF COMPARISON

As it is mechanically impracticable to build continuously variable condensers of large capacitance, the range must be extended upwards by means of fixed capacitors. Complete variation up to, say, $1 \mu\text{F}$, is obtainable by a

102. Fixed Condensers

three-switch decade box and a variable of $1,500 \mu\mu\text{F}$ maximum (to give a working overlap).

Such boxes, of first-class laboratory standard, are extremely expensive. Fortunately they are not indispensable in a radio laboratory. But it is very useful to have a box giving at least a good approximation to values up to several microfarads. Even a box of rough standards is not so very cheap if it is on the decade plan; because special switches, progressively connecting the units in parallel, are needed; and a large number of units. A box that can easily be made up, for giving a number of useful values, is one containing 0.001 , 0.002 , 0.005 , 0.01 , 0.02 , 0.05 , 0.1 , 0.2 , 0.5 , 1 , and $2 \mu\text{F}$, selected by a tapping switch.

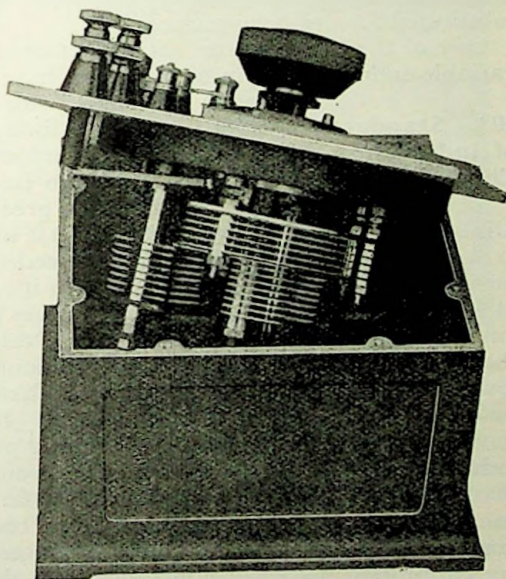

Fig. 62: Sullivan-Griffiths dual range variable condensers have many advantages for laboratory work

In any case it must be remembered that the ordinary moulded-in condensers used in broadcast receivers, even though they may be of mica, are not to be relied upon to maintain their originally measured capacitance, nor even to be particularly low-loss. Mica of good quality is certainly an excellent material for solid-dielectric condensers, but it is not the only factor. Condensers made by depositing metal on high-permittivity ceramic material are very much more constant, and are cheap. Most of the established condenser manufacturers can supply types coming between the mass-produced sort and the best laboratory grades. Sullivan offer a range of high-permanence mica condensers at quite moderate prices, so long as they are not required to be accurately adjusted to specified values. For moderate laboratory requirements a power-factor of 1 per cent. is bad ; 0.2 per cent. is fair ; and 0.05 per cent. is good. Above 0.01 μF mica condensers are costly, and good quality paper types are usually substituted for ordinary purposes.

Last of the "Big Three" is inductance. Continuously variable inductors, or inductometers, have not been very much developed for use at radio frequencies ; but for audio frequencies the Campbell inductometer, made by the Cambridge Instrument Co., is an instrument of great precision and utility. As the inductance of R.F. coils is usually measured at A.F., the Campbell inductometer need not be regarded merely as an A.F. instrument, although it can be used only at A.F. Having tried many A.C. bridges using resistance and capacitance standards, and found them fall short of the ideal, the author was fortunate in procuring a Campbell low-impurity inductometer, and found that it immediately made all this work delightfully easy. He confesses to having had something of an unreasoning prejudice against inductometers, having been under the erroneous impression that the resistance losses, being inevitably far from negligible compared with those in good variable condensers, made matters very complicated. Such inductometers, however, are calibrated in *mutual* inductance, and the resistances of

STANDARDS OF COMPARISON

the coils have only a very minor effect on the result. And although the *self* inductance cannot be varied over a large ratio of values, the mutual inductance can be adjusted to zero or even negative values. While the price of a laboratory inductometer may seem high, the extraordinary usefulness and accuracy of this instrument must be considered, and that with it one may be able to do without expensive capacitance standards. It is very surprising that cheaper types of inductometer, retaining the same

Fig. 63 : One of the types of Campbell Inductometer, for use in some of the most accurate methods of inductance measurements. Note the clear, open scale

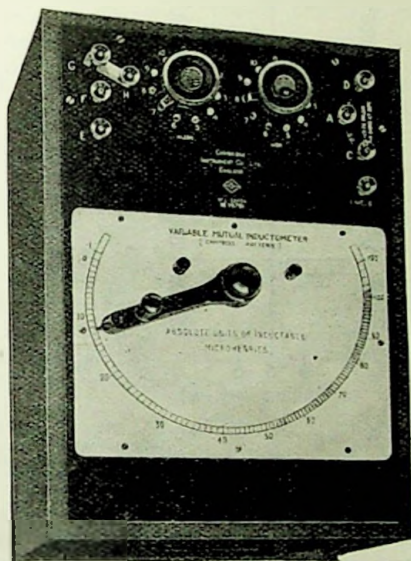

advantages in some degree, have not been put on the market; because the basic principle is simple enough. In the Campbell instrument (Fig. 63) the primary consists of a pair of fixed coils, with a small secondary coil swinging between them in such a way as to increase the coupling to both simultaneously, from a small negative value up to over $100 \mu\text{H}$. The operating arm carries a pointer swinging over a large scale which can be read to a fraction of a μH . Fixed secondary coils, consisting of ten strands of wire, coupled to both primary coils are brought out to decade tapping switches extending the range by hundreds and thousands up to $11,110 \mu\text{H}$. There are other features,

for information on which the maker's literature should be consulted, extending the range of measurement still further, both upward and downward. Some idea of the methods of use will be given a little later when bridges are considered (Secs. 119-20 and 198).

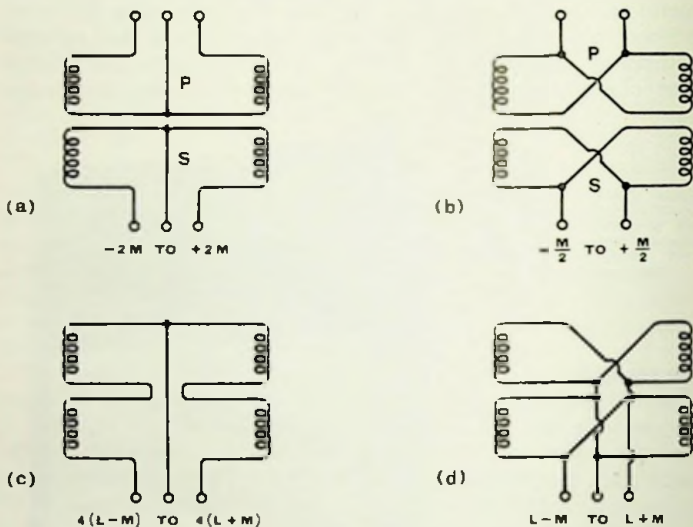

Fig. 64: Various methods of connecting a 4-coil inductometer, giving approximately the mutual and self inductances shown, where L is the self inductance of one coil and M the maximum mutual between one pair of coils

The chief difficulty in making an inductometer is the arrangement for covering a wide range of inductance.

104. Making Inductometers

But simple inductometers without tappings, for approximate measurements over a limited range, are quite easy. One method is to wind four identical coils, two fixed, and two moving on an arm pivoted midway, so that a 180° movement carries the coils from maximum coupling in one direction to maximum in the other. The two coils in each connected pair are

STANDARDS OF COMPARISON

wound in opposite rotation, which incidentally minimises stray coupling to external coils. The coils can be connected in various ways (Fig. 64): (a) As a mutual inductometer, with balanced centre-tapped primary and secondary windings; (b) Either or both pairs of coils in parallel for lower range; (c) As a self inductance, all coils in series; (d) Coils in parallel. If L is the inductance of any one coil by itself, and M is the mutual inductance between any two when they are closest, the respective ranges are— (a) $-2M$ to $+2M$; (b) $-\frac{1}{2}M$ to $+\frac{1}{2}M$; (c) $4(L-M)$ to $4(L+M)$; (d) $L-M$ to $L+M$. These are approximate, because they neglect coupling between coils that are not adjacent; but give some idea of the possible ranges. M is inevitably less than L , and, if adequate clearances are left to prevent small unavoidable sideplay causing large variations in the inductance, will be much less. So the ratio of max. to min. self inductance is much worse than in a variable condenser. However, a condenser has nothing to compare with mutual inductance, which can be swung through zero to negative values. The effect of mechanical imperfections on the calibration can be very greatly reduced by providing four primary coils, one on each side of each moving coil; this arrangement produces a nearly uniform field between them, and small axial displacements can take place without serious change in the mutual inductance.

A number of separate fixed coils of known inductance are useful in the laboratory, and as a set of them is probably required for a wavemeter or oscillator of some sort it is a good thing to have their inductances accurately measured so that they serve as standards.

105. Fixed Inductances

Obviously they should be made as mechanically rigid as possible, and preferably with the lowest practicable R.F. resistance. There are definite methods for designing coils with low R.F. resistance, and those who care to study it are referred to S. Butterworth's series of articles in Vol. 111 (1926) of *The Wireless Engineer* (then *Experimental Wireless*). One does not go very badly wrong to use single-layer coils, wound with about 1-wire spacing, on formers having

a diameter three times the winding length, up to a few hundred μH ; then multi-layer coils, so long as the number of layers is not too few, and that they are spaced properly. Standard coils in which the inductance is practically unaffected by temperature and age, made by Sullivan, have been designed on a compensating principle by W. H. F. Griffiths and described by him in *The Wireless Engineer* of October, 1929, and June, 1934. They are marketed in two grades (Fig. 65), covering all requirements, from the home experimenter to the N.P.L. The accuracy of even the second grade is of the order of 0.1 per cent.

(H. W. Sullivan, Ltd.)

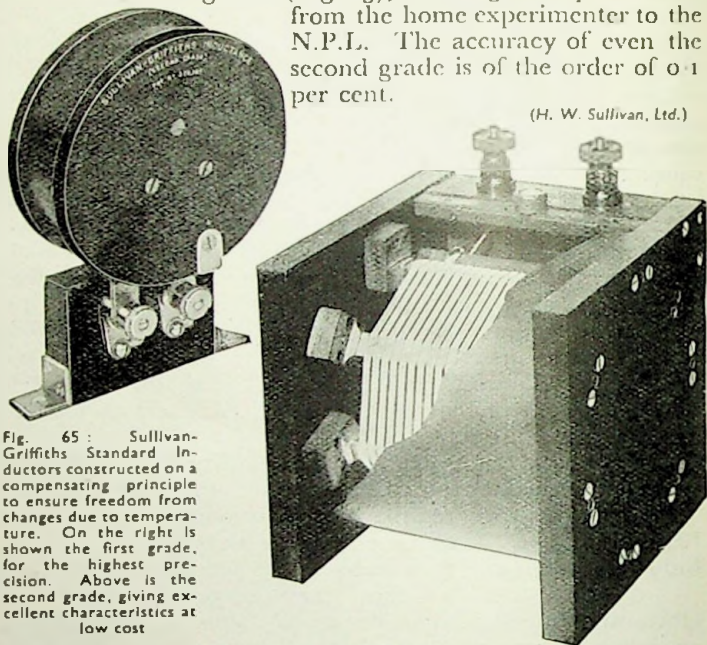

Fig. 65: Sullivan-Griffiths Standard Inductors constructed on a compensating principle to ensure freedom from changes due to temperature. On the right is shown the first grade, for the highest precision. Above is the second grade, giving excellent characteristics at low cost

The external field of an ordinary open coil causes trouble in some circumstances, and if it is impracticable to space

106. Reducing the External Field

it far enough away, or orient it, to reduce undesirable coupling sufficiently, it may be advisable to obtain the necessary inductance in the form

STANDARDS OF COMPARISON

of two opposing coils—the astatic method—or to adopt the toroidal form (Fig. 66). The toroid is awkward to wind in a rigid form, and the resistance is relatively high, but the absence of external field is very complete. Astatic coils obviously give less inductance than the sum of the separate coil inductances, so for a given total inductance the resistance is higher the closer they are together; and the stray field is higher the farther they are apart. The exact required inductance can be conveniently obtained by adjusting the separation.

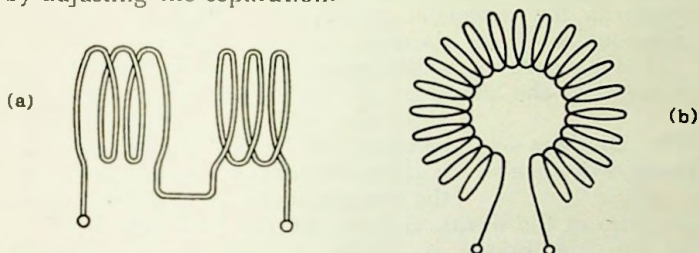

Fig. 66 : Two methods of reducing the external field of coils—(a) the astatic pair, consisting of two adjacent coils with opposite rotation, and (b) the toroid, consisting of a long solenoid bent round into a circle

It need hardly be mentioned, surely, that standard inductances, fixed or variable, ought to have no iron or steel in their construction, much less iron cores; for the permeability of iron, and hence the inductance of any coil including it in its magnetic field, varies with amplitude and frequency of the current. To avoid eddy-current effects the very minimum of any sort of metal should be in the field of the coil.

The so-called litz wire, consisting of a number of separately insulated strands can be used for reducing the A.C. resistance of coils due to eddy currents, more especially at high audio and low radio frequencies; but it must be used both intelligently and carefully, because improper application or imperfect insulation and jointing may more than throw away any of its advantages. It is also much more subject to damage than solid wire of the same total diameter.

The quantities quite ordinarily measured in a radio laboratory cover an enormous range. Taking capacitance ; there is 0.001 $\mu\mu\text{F}$ at the one extreme

108. Extending the Ranges of Standards

(the anode-grid capacitance of a R.F. valve), and 100 μF at the other (a by-pass condenser for a valve biasing resistor). They enclose a range of a hundred thousand million to one ($10^{11} : 1$). Resistance is encountered over a rather wider range ; inductance rather less. The idea of having to provide accurate standards for direct comparison covering all of these enormous ranges is alarming to contemplate.

That is where the bridge comes in. It is not practicable to measure the diameter of the sun against a standard yardstick with a pair of outside

109. Bridges— Their Purpose

calipers, but by holding the yardstick a little distance away from the eye, the sun can be measured if one knows the ratio of the distances from the eye to the stick and to the sun. A bridge is, firstly, a convenient system for comparing two electrical quantities with great precision, and secondly a sort of electrical pantograph for introducing a multiplying ratio into the comparison. The simplest bridge, the Wheatstone, is a symmetrical network of six arms, one containing a source of current such as a battery or oscillator, and another a detector, such as a galvanometer or phones ; when the impedances of the remaining four are in proportion, no current flows *via* the detector arm. In Fig. 67, showing an ordinary Wheatstone bridge circuit for D.C., balance is obtained, and the deflection

of the galvanometer G is zero, when $\frac{R_1}{R_2} = \frac{R_3}{R_4}$, which, of course, is the same as $R_1R_4 = R_2R_3$. Obviously if three of these are known, the remaining one can be calculated. It is not even necessary to know the actual values of three ; the value of one and the ratio between two is enough. Thus, if it is merely known that R_1 and R_2 are equal, balance is obtained when $R_3 = R_4$. This illustrates the bridge as a means of comparing two resistances with greater precision than could be done in a more direct

STANDARDS OF COMPARISON

fashion. Suppose they are compared directly, by noting the reading given on a meter in series with each in turn ; if the meter is a good one and has a very long scale it may be just possible to detect a difference amounting to a thousandth part of the deflection. But to get this it is necessary for the supply voltage to remain constant within still smaller limits, and for the deflection to be somewhere near full-scale. Generally, one part in a hundred would be a more likely accuracy of comparison. There is no advantage in using a very sensitive meter, because it would simply be driven off the scale. Whereas in the bridge circuit it does not matter exactly what the battery voltage is, nor need it be exactly steady ; and the higher the sensitivity of the meter the more precisely can the comparison be made. There is hardly any limit. This is the advantage of the so-called *null method*.

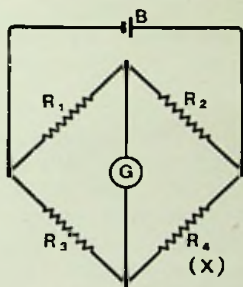

Fig. 67 : Simple Wheatstone Bridge, on which nearly all other forms of bridge are based

Now suppose that R_4 , the "unknown", is higher than the standard, R_3 , can go to. If R_2 is made, say, 10 times R_1 , then R_4 at balance is 10 times R_3 . This illustrates the second object of the bridge circuit ; to extend the range of comparison beyond that of the standard. In A.C. bridges this extension applies not only to quantity but to quality ; not only can $1,000\mu\text{H}$ be accurately compared with $100\mu\text{H}$, but it can be compared with $100\mu\text{F}$ or 1,000 ohms. Obviously all this makes it possible to cut down the number and variety of standards enormously. To give an example of this, a commercial make of bridge (the General Radio 650-A), in which everything, including D.C. and A.C. sources, is contained in a box a good deal smaller than a table radio set, covers 0.001 ohm to 1 megohm, $1\mu\text{F}$ to $100\mu\text{F}$, and $1\mu\text{H}$ to 100 H. Standards of equal accuracy, continuously variable between those

limits, would cost a small fortune and require a large part of the laboratory to house.

The D.C. bridge of Fig. 67 is simple enough, but there are a few practical points to be observed even about it.

110. Practical Points Maximum sensitiveness of balance is obtained when all four arms are equal. The nearer one can get to this condition the better. If the

arms R_1 and R_2 are in the ratio 10,000 to 1, the minimum observable deflection requires a much larger percentage unbalance than if a 1 to 1 ratio is adopted. More than that: the ratio itself is not likely to be known to great accuracy when it is large, because extreme values of resistance are not so accurate as medium values. Furthermore, a great advantage of a 1 to 1 ratio is that errors may be largely eliminated by reversing one pair of arms and taking the average of the two readings. If the resistance to be measured is very large, the sensitiveness of adjustment can be improved by increasing the battery voltage, but if R_1 and R_2 are quite low in resistance the resulting current may overheat them. So it is better for R_1 and R_2 to be the large resistances, so as to limit the current in both paths. A variable resistance in series with the battery is useful.

Although the detector G is not primarily intended as a measuring instrument, but merely to show the presence or absence of current, it is in practice used to make up for the customary absence of a continuously variable resistance standard. Having found, for example, that with $R_3 = 527$ ohms the galvanometer reads 3 divisions to the left and with 528 it reads 2 to the right, one can see that the resistance for exact balance would be 527.6 ohms.

Until balance is approached it is essential for the well-being of G to shunt it down heavily, or reduce B , or both. This is where the author's metal rectifier scheme (see Sec. 57) comes in useful, because it prevents disaster if one of the resistances is accidentally open-circuited when G is delicately adjusted to balance. It is usual to have keys in the B and G circuits, and by tapping the G key in time with the natural swing period of the pointer of G , a smaller

STANDARDS OF COMPARISON

current can be detected than if it is kept steady. The B key must be closed before the G key, because if any of the resistances is reactive, as for example when the resistance of a transformer or loud speaker coil is being measured, the different impedance of such an arm to a current that is varying causes a momentary detector current even when the bridge is perfectly balanced for steady currents.

Which is the obvious cue to go on to A.C. bridges, a vastly more complex subject. Readers who may want to

know a good deal more about it than there is room for here should refer to Hague's *A.C. Bridge*

Methods. A smaller but useful and practical book is *A.C. Measurements* by David Owen. There is also a useful section on bridges in Terman's *Measurements in Radio Engineering*. The reason why it may be wise to look up a detailed treatment of the subject is that there are many more bridges than can be described here, and one of them may most nearly fit in with requirements and available apparatus. It is proposed here to describe certain types that experience has shown to be most generally useful.

If the four impedance arms are pure resistances (i.e., free from reactance) there is no reason why A.C. should not be used instead of D.C. In fact, if the frequency is about 1,000 c/s, the detector can be a pair of phones, which is more sensitive, robust, and cheap than a galvanometer. But the resistance measured is the resistance to A.C. at the frequency of the source, which may not be the same as the Z.F. resistance. However, it is often desirable to know the A.C. resistance.

Next, suppose the arms are all occupied by condensers or by inductors. The same law for balance applies to their reactances; but it is necessary for them all either to be pure reactances, or to have the same power factors or ratios of resistances to impedance;

otherwise the unbalanced resistances obscure the reactance balance. In practice it is highly unlikely that four reactive arms would balance

for reactance and resistances simultaneously, unless special provision is made for adjusting these quantities independently. In certain types of bridge, more especially those including self inductance, these adjustments are not independent, and one may work away at them, first one and then the other, for a considerable while before reaching a balance. Capacitance arms are generally better, because a good condenser is a fair approximation to a pure reactance. The advantage of mutual inductance, as distinct from self inductance, is that it can be injected into an arm as a practically pure reactance, and at audio frequencies it has the advantage over a condenser of being a relatively low impedance, more in keeping with resistance arms of such values as can be accurately and non-reactively constructed.

An essential part of the great majority of useful bridges is a pair of ratio arms. They may conveniently be controlled by switches, of the low-

113. Ratio Arms contact-resistance type used for decade boxes, to give values of 1, 10, 100, 1,000, and 10,000 ohms. More important even than getting these values correct is the accuracy of ratio. And as the most accurate measurements are those made with equal ratio arms, it is especially important that corresponding resistances on each side should be equal. Fortunately it is possible to check equality by getting a balance with a pair of equal impedances—preferably of approximately the same values as the ratio arms—in the other two arms, and then reversing one pair of arms. The ratio arms should also be as symmetrical as possible—to equalise any stray reactances—and enclosed in screened boxes, as indicated in Fig. 68. If preferred, the resistances can be multiples of 10, one end of every one being connected to the centre terminal. This arrangement has the advantage of enabling them to be adjusted independently of one another. If an accurate resistance box is possessed or can be borrowed, it is not a difficult matter to make a ratio arm box, using a pair of equal resistances to form a temporary bridge circuit for comparison with the standard. Now, with a source and detector (which will be considered shortly), any single

STANDARDS OF COMPARISON

unknown quantity can be compared with a standard of the same sort. At least one decade resistance box is almost indispensable in even a small laboratory, and assuming it to be variable up to 11,110 in steps of 1 ohm, one has right away a bridge for measurement of D.C. or A.C. resistances from about 0.0001 ohm to 100 megohms. In practice it will be found that the extreme values are not measurable, at any rate to reasonable accuracy, because of connection resistances and insufficient detector sensitiveness. In any case, the range over which the decade box gives adjustment to four figures does not go below 0.1 ohm. With A.C., residual reactances introduce further difficulties.

If it is merely a question of getting a sharp balance adjustment, any inequality of residual reactance can be neutralised by shunting a variable condenser across one or other of the arms, as may be required.

114. Avoiding Stray Reactances

The range of measurement of inductance and capaci-

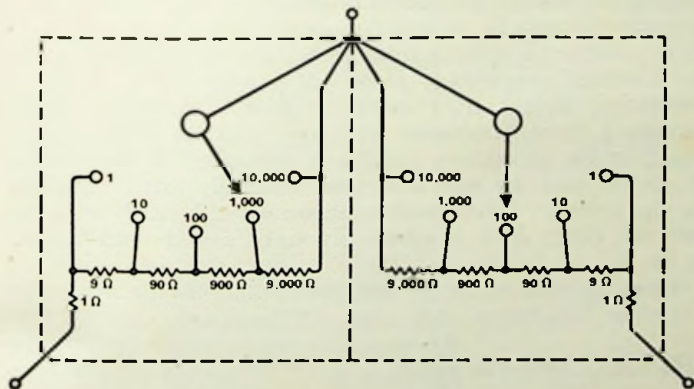

Fig. 68 : Diagram of a pair of switched ratio arms for A.C. bridges

tance does not effectively extend so far above and below the limits between which the standard can be varied as in the case of D.C. resistances. Directly unity ratio is

departed from in an A.C. bridge the accuracy and ease of handling fall off, and unless suitable precautions are taken they may fall off very seriously. Even when working with equal ratio arms it is necessary to take reasonable steps to avoid stray capacitance and inductance, or at least to ensure that the strays are equal. Capacitance to earth of the source does not affect the balance, so long as it is earthed. The same is true of the detector, but it is not possible to earth both simultaneously, and as the detector usually consists of phones and is therefore subject to fluctuating capacitance effects it is the more in need of earthing. The other diagonal arm, the source in this case, must then be symmetrical with respect to earth, which is achieved by connecting it through a special balanced and screened transformer. Such transformers are purchasable, and should be chosen of such a ratio as to match the impedance of the source to that which the bridge is intended to measure with best accuracy. For example, it may well be 10 to 100 ohms for low and medium inductance measurements, 1,000 ohms as an average for resistance, and 10,000 ohms or more for capacitance. The detector, similarly, is most sensitive when it is matched. It is possible to make a suitable transformer by interposing an earthed screen—a piece of copper sheet with an insulating lining to prevent it from forming a short-circuited turn—between primary and secondary, and winding the secondary (which is connected to the bridge) in halves side by side and symmetrically with reference to the screen. The usual transformer coil, with an inner and an outer end, is obviously unbalanced with respect to earth.

Coming now to the source itself, this may be a fixed or variable frequency oscillator. Although a variable frequency is necessary for some purposes, a fixed frequency is sufficient for the majority of measurements, and 1,000 c/s is a common choice. In calculations it is ω , equal to $2\pi f$, that is usually required; and if the frequency is nearly 800 c/s (actually 796) ω works out at 5,000, which is a more convenient figure than 6,283. Either is easily

STANDARDS OF COMPARISON

audible in phones, but if 50 c/s is used (as may be necessary to measure large inductances without being overmuch troubled by self-capacitance) phones are almost useless.

116. Detectors A vibration galvanometer (Sec. 64) is the officially approved detector at low frequencies, but is an expensive instrument for occasional use. An amplifier with metal rectifier voltmeter gives uniform response at all frequencies and is favoured for industrial use, where quiet listening cannot be guaranteed, but, unlike the vibration galvanometer, is unable to discriminate against harmonics. The "Magic Eye" tuning indicator is a particularly useful

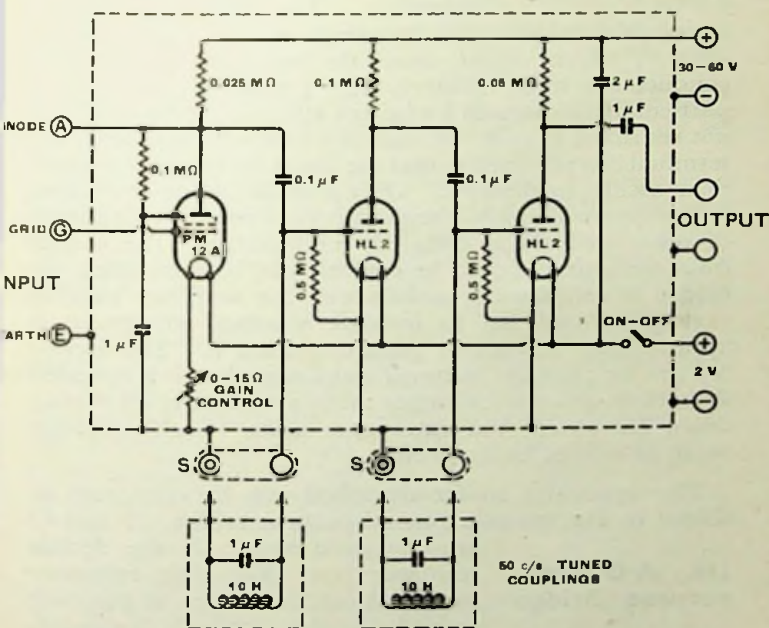

Fig. 69 : Circuit diagram of amplifier, mainly for use in conjunction with bridges

detector of either alternating or Z.F. voltages, and has come into common use in portable bridges. In certain types of bridge, such as those containing inductance and capacitance in opposite arms, the balance depends on frequency, and is consequently obscured by the presence of harmonics from the source. With a little practice one can ignore these in phone tests, if the fundamental frequency is not too low.

As it is risky to put much power into a bridge from the source, a very valuable accessory is an amplifier for increasing the sensitiveness of balance.

117. Bridge Amplifiers

Fig. 69 is the circuit of such an amplifier, built into a metal box for screening. The object of using a screen-grid valve in the first stage is to obviate "Miller effect", which would cause the input capacitance and conductance to be relatively large; while this may not be particularly important for bridge purposes, the amplifier is not restricted to such use, and as a further convenience the terminal A is provided so that the first stage can be converted to an oscillating detector. Only a small output is provided for, as the possibility of a large amount of power in the phones or other detector is definitely undesirable. The output from the source should be controllable, because when the bridge is considerably unbalanced the amplifier may be overloaded and fail to indicate whether adjustment is approaching balance or departing from it. The sockets S S are for plugging in tuned couplings when it is intended to work on any one frequency; they are effective for cutting down harmonics and extraneous noise. Such couplings must, of course, be screened.

The apparatus so far described can be connected as shown in Fig. 70 as a general-purpose bridge. P and Q are the ratio arms; R the decade resistance box.

118. A General-purpose Bridge

For plain resistance measurement the switch is put over towards X, the terminals S shorted, and the unknown connected to the X terminals. For capacitance measurements, the standard condenser is

STANDARDS OF COMPARISON

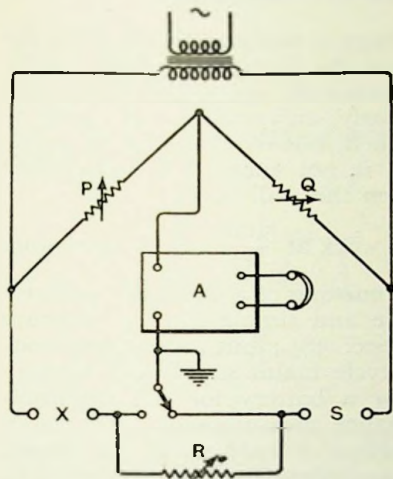

Fig. 70 : Diagram of a general purpose A.C. bridge, for which external standards of reactance must be provided

connected to S, the unknown to X, and the switch towards whichever condenser has the greater resistance—probably X. R is then used to balance the resistances. Such a bridge must be used with caution at ratios other than unity, because the oscillator transformer is then not balanced in the right ratio. To get over this difficulty the “Wagner earth” is sometimes used, for information on which the larger works should be consulted.

Although this type of bridge can be used for comparing self inductances, it is far from satisfactory for the purpose, because of the difficulty of finding balance. The ideal instrument is the

119. An Inductometer Bridge

inductometer, which is connected as shown diagrammatically in Fig. 71.

P and Q are the ratio arms as before; the unknown impedance is connected at X and its resistance balanced by a standard resistance at R. The reactance is balanced by the mutual inductance introduced by the coils of the inductometer; and as this may be positive or negative, either inductance or capacitance reactances can be measured. In the Campbell inductometer a slide wire SW is included to give continuous adjustment of resistance to the extent of rather more than one ohm, so that R need not be varied in smaller steps. To extend the range of this instrument provision is made for two other ratios, and to take advantage of these the ratio arms should include the values 10, 90 and 990 ohms. At the same time the slide wire is out of action and a continuously variable resistance at R is necessary.

Fig. 72 shows the layout of a bridge system which the author has designed around the Campbell Low-Impurity Inductometer, and which is not only as nearly universal as can well be imagined, but over most of this wide range is not excelled by specialised bridges. It can be seen on the wall in Fig. 1.

It is intended primarily to work at $\frac{5,000}{2\pi}$ c/s, derived from

a fixed frequency source consisting of a dynatron oscillator with a triode output stage and simple filter to improve purity of waveform (see Sec. 38); but a beat-frequency oscillator or even the 50-cycle mains supply can be connected when required; or a battery for Z.F. measurements. Apart from resistance measurement; inductance is measurable from a fraction of $1\mu\text{H}$. up to the largest iron-core inductances encountered, if necessary with D.C.

flowing — a measurement that cannot be so satisfactorily performed by any other type of bridge; and the capacitance range goes from a fraction of $1\mu\mu\text{F}$ to the largest electrolytic condensers made. With all these reactances, the A.C. resistance is also given. Fig. 73 shows the connections of the bridge network itself, which is arranged to form a sort of platform, supporting the ratio arm box in the centre and the lower resistance arms at its ends.

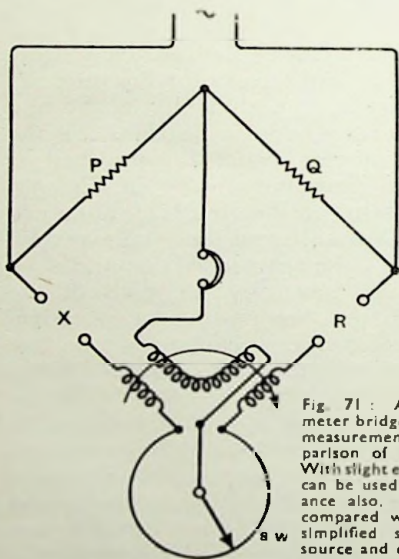

Fig. 71: An inductometer bridge circuit, for measurement or comparison of inductances. With slight elaboration it can be used for capacitance also. Note that, compared with Fig. 70, simplified symbols for source and detector are used

STANDARDS OF COMPARISON

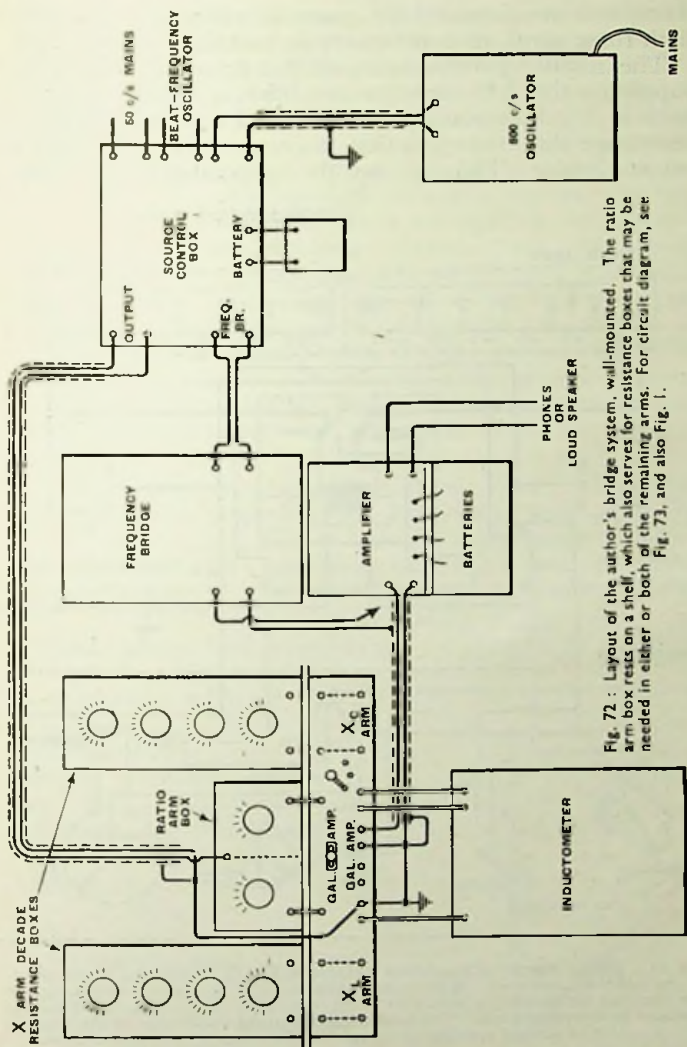

Fig. 72 : Layout of the author's bridge system, wall-mounted. The ratio arm box rests on a shelf, which also serves for resistance boxes that may be needed in either or both of the remaining arms. For circuit diagram, see Fig. 73, and also Fig. 1.

RADIO LABORATORY HANDBOOK

Terminals are provided for connecting anything in parallel with these arms, as is necessary in certain measurements.

The middle portion contains the screened transformer supplying the A.C. detector-amplifier, a switch to change over to a galvanometer for D.C., and a switch (BGH) to rearrange the lower junction to convert from an inductometer bridge (Fig. 71) to the general-purpose bridge

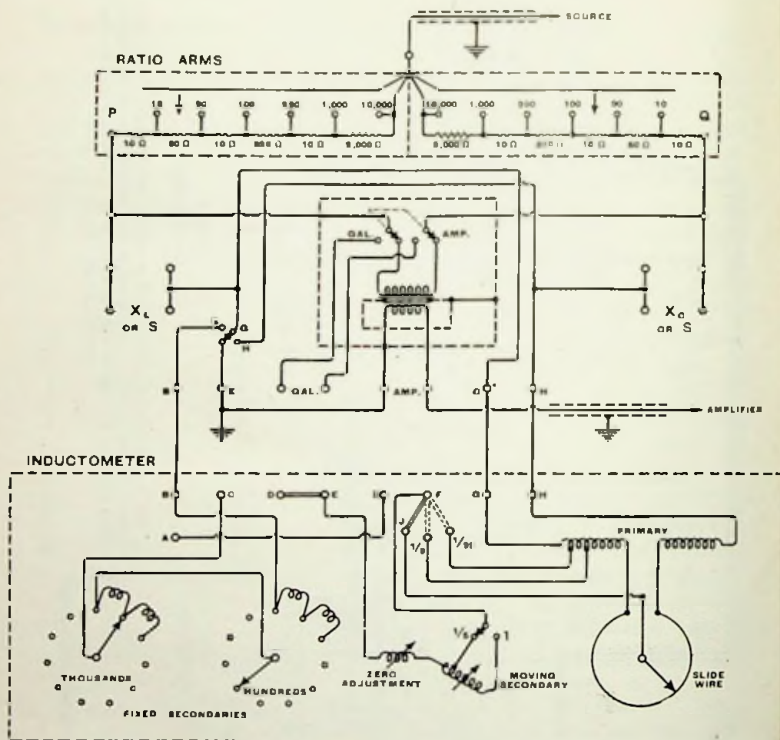

Fig. 73 : Circuit diagram of the bridge included in Fig. 72. According to the nature of the test the "unknown" is connected to terminals X_1 or X_2 , and extra terminals are provided for connecting resistance boxes in parallel. The inductometer may be replaced by a resistance box. The screened and balanced transformer in the centre is so enable an earthed amplifier to be connected across the unearthed diagonal

STANDARDS OF COMPARISON

(Fig. 70). For the former, the switch is set to B; for the latter a decade resistance box is substituted for the inductometer at the GH terminals, and according to the switch position is placed in series with the unknown for difference measurements or on the opposite side for comparison measurements. A diagram of the amplifier has already been given (Fig. 69), and the ratio arm box is similar to Fig. 68 but with values of 10, 90, 100, 990, 1,000, and 10,000 ohms. It is essential to use screened (lead-covered) leads where shown, both to prevent undesirable stray couplings, and to prevent hum being picked up by the amplifier. A Campbell frequency bridge is conveniently associated with the system for measuring the frequency of the source, but is rather of the nature of a luxury. Details of some of the methods available with this bridge, and particularly those for large inductances and iron-core coils with D.C., are given in Chapter 8.

The inductometer is unfortunately rather costly, and when it is not available the most usual form of bridge makes use of a capacitance standard, which can be made to balance against an inductance in the opposite arm, as in Maxwell's bridge (Fig. 74).

Another bridge with capacitance and resistance standards is Owen's (Fig. 75).

It is possible to cover a wide range of both inductance and capacitance with a compact and inexpensive self-contained system, but, in general, such bridges are rather

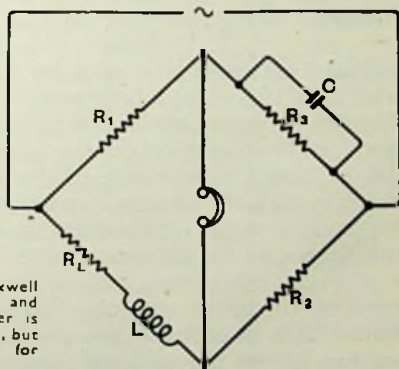

Fig. 74 : Theoretical diagram of Maxwell bridge for comparing inductance and capacitance. If a standard of either is available, the other can be measured, but certain precautions are necessary for practical success

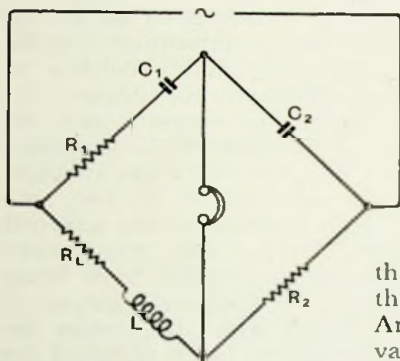

Fig. 75: The Owen bridge is more convenient than the Maxwell for inductance measurement with a fixed condenser

troublesome to adjust to balance, because they include two or more inter-dependent variable adjustments.

One method of avoiding this disadvantage is to gang the resistance arm controls. Another way is to use a variable condenser arm as the standard; the only

disadvantage is that because the capacitance is generally limited to about 1,000 $\mu\mu\text{F}$ the effect of stray capacitances is liable to be felt, more especially as a fairly high ratio is necessary for some measurements. Nevertheless, a variable condenser standard can be used successfully, either by being content with moderate accuracy or by taking special precautions against stray errors. Constructional details of an improved Owen bridge are given in the Appendix, p. 397.

122. A Simple Practical Maxwell Bridge

Fig. 76 shows the circuit of a bridge suitable for home or laboratory construction, for measuring capacitance from 50 $\mu\mu\text{F}$ to 1 μF and inductance from 10 μH to 0.1 H. Actually,

different networks are used for C and L, as shown in the subsidiary diagrams where switching is omitted for clarity. A variable condenser is used as the standard, and it should therefore be of as good quality as possible. As its screening case is joined to one side of the source, the other side of which is earthed, its stray capacitance to earth comes across the source and in moderation is harmless. Also the unknown can be measured with one side earthed, which is a great convenience in examining components of a receiver or other assembly without disconnecting each item. It is important that the capacitance of the phasing resistors across the variable condenser should be negligible

STANDARDS OF COMPARISON

as otherwise of course the calibration of the condenser is upset. The inductance of the resistors in series in the X arm, if appreciable, can of course be allowed for by a preliminary test with the X terminals shorted. A buzzer source is shown, because it lends itself to self-

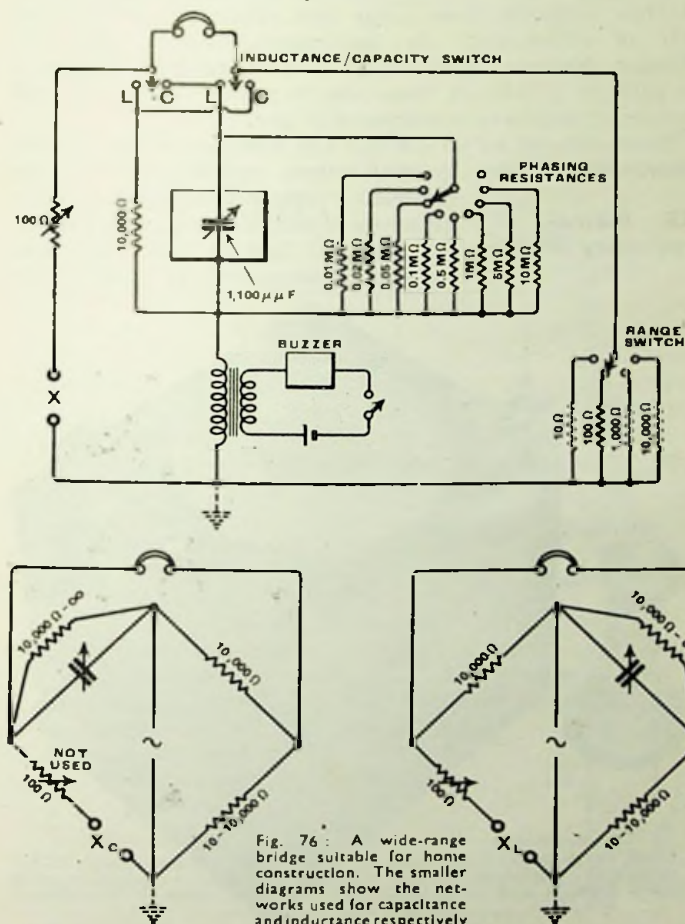

Fig. 76: A wide-range bridge suitable for home construction. The smaller diagrams show the networks used for capacitance and inductance respectively

contained construction and, as balance in this bridge is independent of frequency, it is allowable; but the silence of a valve or neon tube oscillator is a favourable point.

An inexpensive capacitance bridge by Sullivan, also employing a buzzer (Fig. 77) is unusual and ingenious in that variable ratio arms are composed of a ganged pair of differential air condensers. For details, see *Wireless Engineer*, Jan., 1931. The range covered is $50 \mu\mu\text{F}$ to $5 \mu\text{F}$ in two ranges; the bridge is self-contained and very convenient to use.

Measurement at 50 c/s has the advantage that a very adequate oscillator is maintained continuously by the electricity supply authority, and the influence of stray capacitances is much less than at 800 or 1,000 c/s, also resistances measured at such a low

123. Mains-frequency Bridges

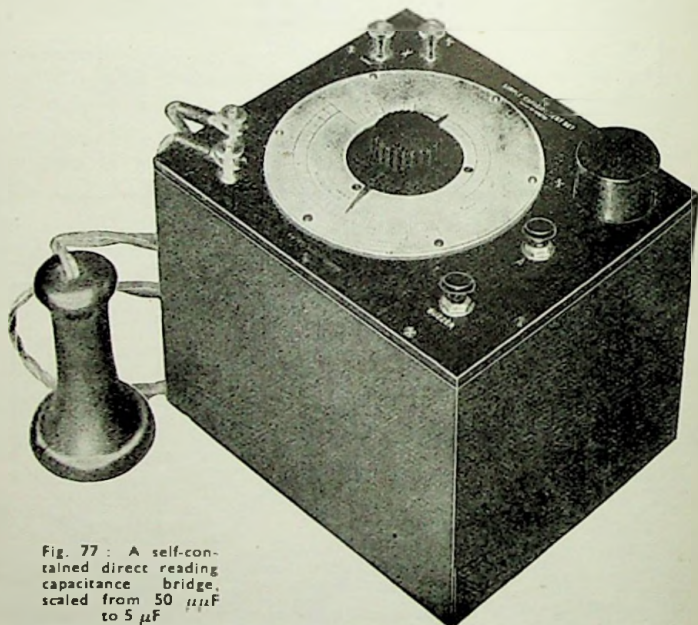

Fig. 77 : A self-contained direct reading capacitance bridge, scaled from $50 \mu\mu\text{F}$ to $5 \mu\text{F}$

STANDARDS OF COMPARISON

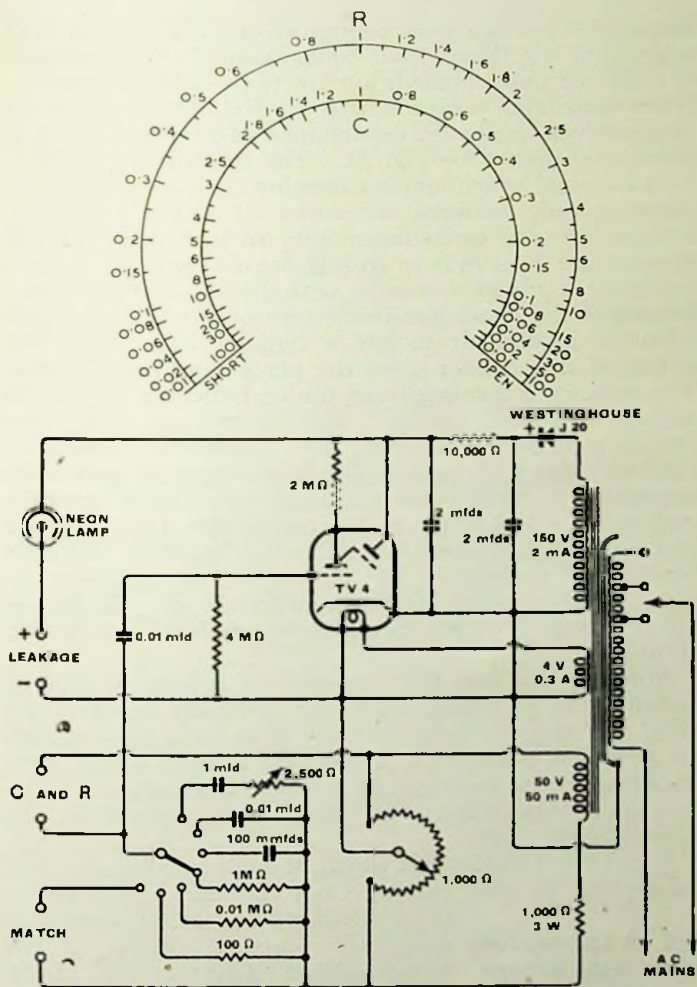

Fig. 78 : Diagram with values of a self-contained mains-driven resistance and capacitance bridge employing a "magic eye" as amplifier-detector. For constructional details and pictures refer to Appendix, p. 384. The nature of the scale, assuming a uniform resistance element, is shown above

frequency are often near enough to the Z.F. values to be substituted for them; but unfortunately the impedance of radio coil inductances is too low to be easily measurable. If low inductance measurements are excluded, a very useful mains-driven bridge for capacitance and resistance can be made as suggested by Fig. 78. The calibrated element is a wire-wound potentiometer forming the ratio arms, and, counting only between the ratios of 10 : 1 and 1 : 10, measurements of capacitance from 10 $\mu\mu\text{F}$ to 10 μF and of resistance from 10 Ω to 10 $\text{M}\Omega$ are covered. A variable resistance is provided in series with the highest capacitance because if the condenser being measured has a large loss factor it is difficult to get a balance otherwise. The setting of this resistor gives the percentage power factor. The detector is a cathode-ray tuning indicator, and as the cathode is fairly "earthy", and the ratio arms are conveniently of low impedance, the "unknown" cannot be earthed. But if the earthy side is connected to source the impedance to earth is low and stray capacitance generally inoffensive. The scale at the top of this Fig. 78 shows how a linear potentiometer calibration appears; the scale reading is multiplied by the value of resistance or capacitance to which the range switch is set. Bridges of this type, mainly for service engineers, are listed by a number of makers.

Although the last few examples of bridges cannot be described as precision types, the accuracy being of the order of 1 to 5 per cent., they are often quite good enough for practical purposes and give the answer before more elaborate instruments can be brought into action. Constructional information on them is contained in the Appendix (p. 387).

A marketed instrument which, though extreme accuracy throughout its wide ranges is not claimed, is of a rather more advanced and at the same time

124. A Laboratory eminently practical design, is the **Universal Bridge** Marconi-Ekco TF.373. It covers D.C. resistance from 0.05 Ω to 1 $\text{M}\Omega$, inductance from 5 μH to 100 H, capacitance from 5 $\mu\mu\text{F}$ to 100 μF , and loss factor of both coils and condensers

STANDARDS OF COMPARISON

is directly readable. D.C. and A.C. sources, amplifier, and D.C. and A.C. detectors (both meters) are included.

There are many specialised precision bridges offered by the well-known instrument makers, but description of them is outside the scope of this book.

Bridges in which the balance is independent of the

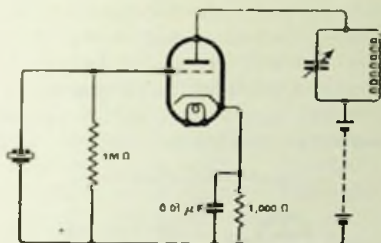

Fig. 79 : Simple crystal oscillator for frequency checking

frequency of the source (except in so far as the constants of the arms vary with frequency) are

125. Influence of Source Frequency generally preferable, because bad waveform of the source does not greatly matter, and in fact buzzers

or neon-tube oscillators can be used. Those bridges in which balance is obtainable at only one frequency require a very pure source, especially if the indicator is a valve or metal rectifier voltmeter. With practice the ear can discriminate between fundamental and harmonics, but is never so sensitive in such conditions. What is a drawback for general purposes forms the essential principle of special classes of bridge, such as those for frequency measurement. Frequency-discriminating bridges are also used as filters for suppressing one particular frequency very completely, as in the measurement of distortion (see Sec. 232). Other specialised types of bridge are devised for measuring valve characteristics; and will be referred to in that connection (Sec. 214).

The Campbell frequency bridge includes a variable

mutual inductance, constructed on the lines of the inductometer already described. The

126. Frequency Bridges and Meters

General Radio instrument employs the Wien bridge containing only resistances and capacitances. The chief disadvantage of a frequency bridge is that there is no one detector capable of covering the full audio frequency range with adequate sensitivity, and of rejecting the harmonics that are more than likely to be present. It has the advantage of being direct-reading; but can be dispensed with by having a variable-frequency oscillator (a more generally useful possession) as a comparison source, calibrated from some standard.

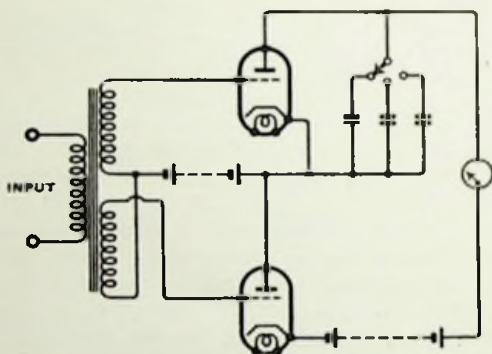

Fig. 80 : The principle of an electronic frequency meter. The signal is caused to charge and discharge a condenser (selected according to the desired range of frequency) unidirectionally through a milliammeter which is calibrated to read frequency directly

Direct-reading frequency meters are sometimes constructed on the principle of applying the signal, whose frequency is to be measured, in push-pull to the biased-back grids of two valves, which are thereby made alternately conducting and caused to charge and discharge a condenser unidirectionally through a milliammeter: the current reading is proportional to the frequency. An example of this system is described by Guarnaschelli and Vecchiacchi in the *Proc. I.R.E.*, April, 1931, and the general idea can be gathered from the circuit diagram Fig. 80. The range of frequency covered is 20 to 10,000 c/s.

Oscillators have already been considered in Chapter 4,

STANDARDS OF COMPARISON

and any of these, if calibrated, can be regarded as a standard of frequency, provided that it is designed to retain its calibration accurately. The beat-frequency oscillator, unless very elaborately devised, does not do this ; but if by means of

127. Standard Frequency Oscillators

the trimmer condenser in parallel with one of the oscillator tuned circuits the scale is brought correct at any one point by comparison with a single standard frequency, the scale as a whole is unlikely to depart seriously from calibration.

In the radio frequency range, a signal generator is generally designed to hold its frequency calibration and therefore to serve for measuring frequency, in addition to its primary function as a signal source. Wavemeters, formerly much used for measuring wavelength or frequency, are therefore almost superseded, except in work where the necessity for the utmost accuracy and permanence of calibration justifies setting aside costly apparatus for this purpose alone. The finest examples of wavemeter design and construction are those by H. W. Sullivan Ltd. Even in the high-precision field there is a tendency for the continuously-calibrated types of wavemeter to give place to elaborate rack-mounted assemblies arranged for comparing any frequency with a single standard such as a crystal oscillator, on which all the precautions for ensuring constancy of frequency are concentrated, and which is therefore capable of accuracy within one part in several millions.

For more modest standards even the simplest crystal oscillator enables wavemeters, signal generators, etc., to be checked with a high order of accuracy ; and one can be quite confident that the frequency will remain constant to within closer limits than can be observed on a wave-meter scale, regardless of coupling to external circuits. This is particularly valuable in the reactance-variation methods of measuring tuned circuit resistance. Fig. 81 shows the simplest circuit, in which the anode circuit is tuned to the fundamental frequency of the crystal. Together with other circuit values, it is adjusted to cause reliable oscillation ; and generally emits enough harmonics

to provide checks over a wide frequency band. The unit can be made much more useful by adding a stage of amplification, preferably using a screen-grid valve, and adjusting its bias and/or screen voltages to provide numerous strong harmonics. The details of the design can easily be adapted to suit requirements and available components.

Although a heterodyne oscillator is practically essential in the laboratory, there are some purposes better served by

**128. The
Absorption
Wavemeter**

the much simpler absorption wavemeter, consisting merely of a tuned circuit, sometimes with the addition of some form of detector—lamp, thermocouple, or neon tube — to

indicate resonance.

As one of the desirable features of an absorption wavemeter is sharpness of resonance, most such detectors are undesirable ; but a small neon tube is useful for transmitters and power oscillators, if the coupling is reduced to the point where only a slight glow is just maintained at exact resonance. The most usual method of detecting agreement between an absorption wavemeter and an oscillator of any power is to note the slight kick given to the pointer of a milliammeter connected to show anode current to the oscillator. Besides its simplicity and absence of feeding requirements, advantages of the absorption wavemeter are that there are fewer factors to upset the calibration ; there is no wondering whether or not it has stopped oscillating ; indication is usually a simpler matter ; and it has no harmonics to cause confusion or uncertainty. It is particularly useful for the higher frequencies, more especially very-high frequencies, at which it is difficult to " find the place " quickly with the heterodyne wavemeter when the frequency of the oscillator to be checked is quite unknown.

Apart from the obvious requirements that the coil or coils and variable condenser should be constant and reliable and also loss-free, there is not much to be said about the design. To keep the operator's hands well out of the field of both wavemeter and " unknown " circuit it is usual for the condenser and coil to be mounted at the

STANDARDS OF COMPARISON

end of a stick a foot or more long, with an extension control. At frequencies of hundreds of Mc/s (decimetre wavelengths) the absorption wavemeter may consist of a tiny condenser with a little loop of wire connecting the terminals. Fig. 81 shows an example of this rigged up in a few moments, but adequate for rough comparisons; and also one covering all frequencies from 2 to 100 Mc/s with 4 coils.

Wavelength and frequency are fundamentally quite different quantities, as different as the length of a journey and the time spent on it; they are only interchangeable on the assumption that the speed of travel is the same in each case. While this is not

even approximately true for journeys in general, it is true for electric waves in free space, and so a standard of wavelength is also a standard of frequency, and *vice versa*; either is calculable by dividing 300,000,000 by the other, assuming wavelength to be in metres and frequency in cycles per second. But the assumption "*in free space*"

129. Wavelength and Frequency

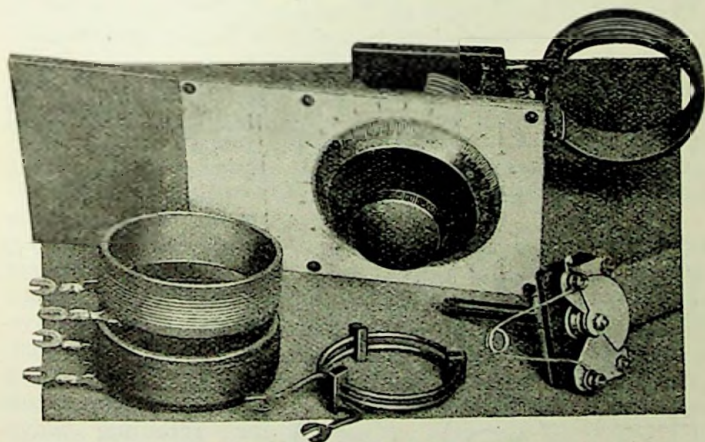

Fig. 81 : Simple absorption wavemeter and coils ; the larger covers 2 to 100 Mc/s and the smaller is for quick checking of decimetre waves

must not be entirely overlooked ; in certain practical cases, to be referred to later, it does not exactly hold.

Frequency is a more important quantity than wavelength in nearly all electrical communication work, and although the fundamental standard of frequency is the very low figure of one cycle per day, observed astronomically, by successive multiplying devices it, is used for measuring frequencies of many millions of cycles per second. The tendency, then, is to oust the term *wavelength* ; but it is rather difficult to do so altogether at the very high frequencies—hundreds of Mc/s—because then it appears as a directly observed quantity, which is constantly having

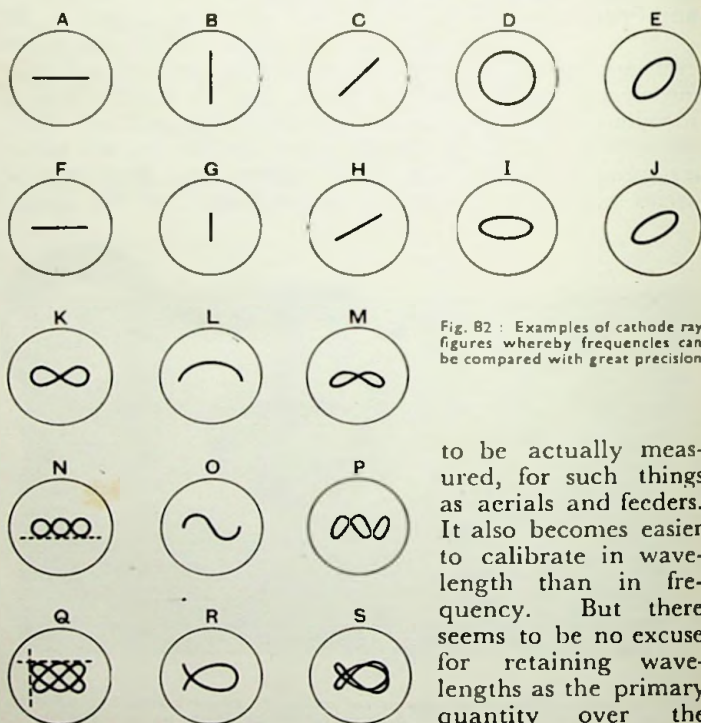

Fig. B2 : Examples of cathode ray figures whereby frequencies can be compared with great precision

to be actually measured, for such things as aerials and feeders. It also becomes easier to calibrate in wavelength than in frequency. But there seems to be no excuse for retaining wavelengths as the primary quantity over the

STANDARDS OF COMPARISON

ordinary broadcasting bands, which *must* be divided up according to frequency in order to allow for sidebands.

Beginning with audible frequencies, a very accurate 1,000 c/s standard is available in peace time to all within range of the N.P.L. station 5HW. The American standard frequency station WWV can be received in Europe on some of its channels. Particulars are given in Sec. 310.

A more generally available standard, correct over a period of hours to very high accuracy (because adjusted by comparison with Greenwich time) is

130. Calibration of A.F. Oscillators time-controlled 50 c/s A.C. mains. It is liable to fluctuate slightly from this average, but not often more than about 0.1 per cent. During the war the accuracy has tended to decrease.

Given a single accurately-known frequency, it is possible to fix a whole series of points on the scale of an oscillator. By far the best way of doing this is with the cathode-ray tube. The source of the known frequency is applied to one pair of deflection plates and the signal to be calibrated to the other. Either separately produces a straight line on the screen, at right angles to the other (Fig. 82, A and B). Both together give a diagonal straight line (C), if they are in phase, and of the same waveform; a circle (D) if they are equal in magnitude and 90° out of phase, or an ellipse (I) if they are unequal; and an inclined distortion of an ellipse (E and J) at intermediate phase angles. If the frequency of one is very slightly less or more than the other, the pattern is seen to pass through these forms continuously.

If now the frequency of the signal producing the vertical deflection is twice that of the other, the patterns assume forms such as K-M; if three times, as N-P; and so on.

These are examples of Lissajous figures, which are discussed in detail in a series of articles by Hilary Moss beginning in the June, 1944, issue of *Electronic Engineering*. The number of loops meeting a horizontal tangent indicates the order of multiple, but it should be noted that if the loops are superimposed, as at L, O, R, the count would be wrong; it is necessary for it to be done when

they are spaced out, as at E, K, N, Q. Simple fractional ratios can be distinguished by counting the loops meeting tangential lines drawn both vertically and horizontally, as $3/2$ in Q. When the number of loops along either edge of the pattern is large, it may not be possible to distinguish them clearly; and a better method is to connect the lower frequency signal to both pairs of plates across a phase-splitting circuit, as in Fig. 83.

131. Alternative Cathode-ray Method

The reactance of C at that frequency should be equal to R ohms to produce a circle; for 50 c/s they might be $0.1 \mu\text{F}$ and 30,000 ohms respectively. The other signal is then connected in series with the anode supply to produce a toothed wheel pattern, as at A*. If F is the higher frequency, f the lower, and N the number of teeth, then of course $f = F/N$. For instance, in checking

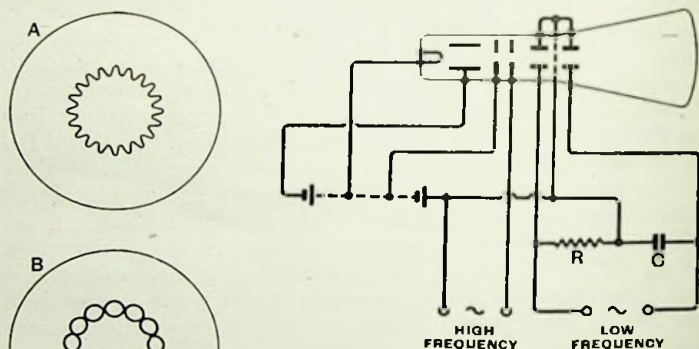

Fig. 83 : Circuit for comparing frequencies related by a larger ratio than is easy to distinguish from the figures of Fig. 82. The ratio is found by counting the "teeth" in the figure A, or half the number of loops in figure B. Intermediate ratios are determined by speeds of rotation as described

the 50-cycle mains frequency by the N.P.L. 1,000-cycle signal, a 20-tooth wheel would appear and remain stationary if the mains were correct by the N.P.L. But

• If the available signal voltage is insufficient to show teeth, it may be connected to the grid instead, and the bias adjusted to give a dotted line effect. But one must beware of possible ambiguity with fractional frequency ratios—e.g. 3 and $1\frac{1}{2}$ times the low frequency may give similar pictures.

STANDARDS OF COMPARISON

if the frequencies depart slightly from an integral ratio, the wheel appears to rotate. Denote the time in seconds for one complete revolution by T ; then $f = F/N \pm 1/T$. Suppose it takes one second for the wheel to move one tooth's breadth, then in the example considered T would be 20 and the mains frequency would be 50 ± 0.05 c/s. Whether it is plus or minus is revealed by the latter part of the N.P.L. test; a slowing down of the rotation denotes minus, and vice versa.

A simple fractional ratio is distinguishable by this method too, as shown in Fig. 83 B, where the ratio is $\frac{13}{2}$.

With a known 50 c/s only, it is possible to calibrate an oscillator at fractions of this frequency—25, $16\frac{2}{3}$, $12\frac{1}{2}$, etc.—and multiples—100, 150, 200, etc. As about twenty teeth can readily be distinguished for each centimetre circle diameter, the whole audio frequency band can be included with a tube of moderate size; but unless the frequencies are phenomenally steady at the exact multiple, or the pattern is photographed, the only way of counting the

132. Use of Auxiliary Oscillator

highest numbers is to increase the frequency very gradually from some easily countable number and note every time the pattern "pulls in". Even this requires some care, and a more reliable method is to have an auxiliary oscillator tuned to, say, 1,000 c/s by the 50 c/s; and then use this to form the circular base for the higher frequencies. Another advantage is that many new points are obtainable; from 1,000 c/s— $333\frac{1}{3}$, $166\frac{2}{3}$, $142\frac{0}{7}$, $111\frac{1}{9}$, and so on. Then the auxiliary oscillator can be shifted up another 50 c/s by the standard, and still another series obtained. There is no limit except patience to the number of points that can be derived from one fixed standard frequency for drawing a curve and so obtaining a continuous calibration.

Incidentally, this method of auxiliary oscillator and cathode-ray tube is very helpful for using a frequency bridge beyond the limits of its range, or the probably narrower limits within which the ordinarily available detector (i.e., phones) is effective.

Working by ear is much less satisfactory; it is easy enough to synchronise two oscillations when they are nearly equal, by reducing the frequency of the slow beats to zero, but

133. The Piano as a Standard of Frequency

a certain amount of musical skill is necessary in order to proceed further. One may run up or down the musical scale from the known frequency, filling in the frequencies from the particulars given in the table in Sec. 309. Having reached an octave, an auxiliary oscillator is desirable for using it as a fresh starting point. If no more reliable standard is available, an ordinary piano is of some use, but comparison is not as easy as might be supposed, especially at the lowest frequencies, because harmonics are stronger than the fundamental. Pianos are usually tuned to a rather different pitch from the physicist's tuning fork; and as the correct version is seldom given it appears here

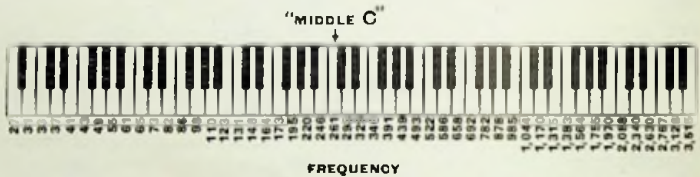

Fig. 84 : Piano scale showing the frequencies to which the keys are tuned. The usually-published scales based on C=256, are misleading. Frequencies of black keys can be obtained by multiplying the frequency of the white key below it by 1.059

as Fig. 84. Only the white keys are numbered; but the frequencies of the black keys can be got by interpolation.

It is possible to use a standard audio frequency, such as that broadcast by 5HW or WWV, for accurate radio frequency calibrations; and in fact

134. Comparison of Radio Frequencies with Standards : Multivibrators

that is just what is done in the refined apparatus previously mentioned. A multivibrator—an oscillator consisting of two resistance-coupled amplifying stages connected in cascade with one another—is synchronised with the known frequency, and produces such an enormous number of detectable harmonics that it

STANDARDS OF COMPARISON

establishes a series of known points right up into quite high radio frequencies. The range can be extended still farther by repeating the process with another multivibrator working at a higher fundamental frequency. The multivibrator circuit is shown in its simplest form in Fig. 85. The fundamental frequency of the oscillation

Fig. 85 : Basic circuit of multivibrator, for generating oscillations rich in harmonics

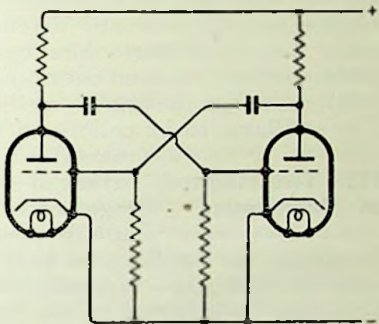

depends mainly on the values of the condensers and grid leaks, being higher the smaller they are. It is easy to achieve frequencies from less than 1 c/s up to 1 Mc/s and higher, using almost any type of valve; but for retaining high radio frequency harmonics it is advantageous to use special valves such as "acorns" and to minimise stray capacitances everywhere. The anode resistors should also be reduced from the more usual values of about 50,000 ohms to perhaps 1,000 ohms or so for harmonic frequencies in the region of 30 Mc/s.

The output can be drawn from either anode, preferably tapped off the anode resistor if the full amplitude is not needed. The synchronising signal can be fed in at a tapping on either of the grid leaks. If the components connected to one valve equal the corresponding components for the other valve, positive and negative half-cycles are of equal duration: they can be made unequal by using unequal components. Generally one or both grid leaks are made variable to the extent necessary to adjust the frequency as required.

In normal times all reputable broadcasting stations maintain the frequency of their carrier waves within very close limits—a few cycles per second. There is therefore

no shortage of standard radio frequencies. The method of using any one or more of these to fix an unlimited number of other known points on the frequency scale of an oscillator or wavemeter is similar to that already described for audio frequencies. A cathode-ray tube may be used for comparison of frequencies having a simple ratio to one another, in exactly the same way; but it is unnecessary, because the heterodyne beat notes between radio frequency harmonics can be listened to without being confused by even enormously stronger fundamentals.

Suppose that the known oscillation is exactly 1,000 kc/s. The oscillator to be calibrated is tuned so that its fundamental is nearly the same. A receiver arranged to receive both of them together renders a beat note audible, at a frequency equal to the difference.

135. The Method of Harmonics

By tuning the oscillator so that the frequency of the beat note becomes zero—generally described as “tuning to zero beat note”—it is exactly synchronised with the standard. That is well known; but to do it successfully certain precautions must be observed. The coupling between oscillators and/or receiver should be very small, so as to prevent the frequency of either being “pulled”. It is best for one of the received oscillations not to be so enormously stronger than the other as to “wipe out” the receiver, or to pull the weaker in step with it and so prevent zero beat note being accurately set. It is for this reason that a screened oscillator, with output control, is preferable to an “open” wavemeter.

Although it is quite easy to synchronise two oscillations within about 0.01 per cent. in this way, a far better method is to use an oscillating receiver (or a third oscillator) tuned to any convenient beat frequency with respect to the standard. As the oscillator to be calibrated is tuned near synchronism the two nearly-equal beat notes produce an easily noticeable trill, which becomes a slow beat when equality is very near. In this way it is possible actually to count the difference in cycles; in the example considered (1,000 kc/s standard), one beat every second would indicate a difference of one part in a million. The only important

STANDARDS OF COMPARISON

precaution is to make sure that both frequencies are on the same side of that of the receiver. It is very easy to settle this by very slightly altering the receiver oscillation frequency ; if correct, the slow beats will continue around a different audible beat note ; if wrong, the two beat notes will diverge and destroy the slow beats.

Because of the extreme precision of this method, without elaborate apparatus or strict conditions, one tries to make use of it in as many sorts of test as possible. Even the simpler zero beat method is much more precise than most forms of indication, such as pointer readings ; and examples of use are given in later chapters.

In the section on oscillators (32) it was pointed out that extreme stability of frequency (such as is needed in a wavemeter or other standard) and copious harmonics do not generally go together. For wide-range calibration it is therefore usually helpful to set up a transfer oscillator with plenty of harmonics, any one of which (or the fundamental) can be synchronised with the standard and used to establish other fixed points. The multivibrator is the extreme example ; but an ordinary back-coupled oscillator run with such tight coupling as to overload the valve badly yields detectable harmonics up to twenty or more.

Sometimes it may be difficult to tell exactly what harmonics are responsible for the audible beat note. If the receiver reaction is variable,

136. Identification of Harmonics tightening it generally causes the note to increase in strength if a receiver harmonic is involved, and to weaken if it is the fundamental. The harmonics produced by a dynatron oscillator are almost imperceptible if the grid bias is adjusted so as barely to maintain oscillation ; but they may be strong if the bias is much reduced, and this enables one to tell whether fundamental or harmonics are being received. Of course it is necessary to synchronise with the standard *after* any such reaction or bias adjustments have been made, as the frequency is slightly shifted thereby.

Suppose one is listening on a fixed frequency—the standard—and an oscillator is to be calibrated over lower frequency ranges, it is tuned so that each of its harmonics

in turn is received. Assuming again a 1,000 kc/s standard for illustration, the oscillator can be calibrated at 500, 333 $\frac{1}{3}$, 250, 200, etc. By halting at any of these, the receiver can be shifted to another harmonic—higher or lower—and a fresh start made for filling in intermediate points. To calibrate higher frequency ranges, the fundamental of the oscillator is caused to beat with harmonics of the receiver, giving points at 2,000, 3,000, 4,000, etc., and intermediate points can be filled in as before. A slide-rule is often useful for identifying the fundamental when a number of high-order harmonics are heard; if one harmonic comes in at 4,400 kc/s, and the next at 4,950, the moving scale is slid along until two consecutive whole numbers bridge the gap between these two numbers on the fixed scale. The only numbers that do so are 8 and 9, so these are the harmonics, and the fundamental (read below "1") is 550 kc/s.

An absorption wavemeter gives no beat notes or harmonics, so must be calibrated from the *fundamentals* of a calibrated oscillator, by holding it as

137. Synchronising Non-generating Circuits

far away as one can still see a slight "kick" of the pointer of a milliammeter in the oscillator anode circuit when the wavemeter is tuned through resonance. A circuit with a grid leak of rather high resistance is best for showing such an indication.

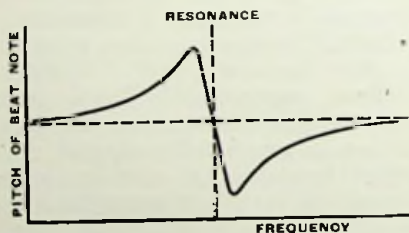

Fig. 86: The "N-curve", showing the disturbing effect of a loosely-coupled circuit tuned through resonance; a phenomenon that is helpful in synchronising circuits very exactly

A much more precise method is to listen to a beat note due to either fundamental or harmonic of the oscillator; even when the wavemeter is coupled too loosely to show

STANDARDS OF COMPARISON

any meter kick the beat note can be heard to rise gradually, then fall rather suddenly, and then rise again, as shown in Fig. 86. Exact resonance takes place on the steep slope at the point where the beat note is unaffected by removing the coupled circuit entirely, short-circuiting it, or setting it right off tune. Still more exact synchronisation is possible if a third oscillator is used to cause slow beats to be produced when the frequency of the oscillator to which the wavemeter is coupled alters very slightly. In this way a non-generating oscillatory circuit can be adjusted to resonance with as great precision as an oscillator. For detailed information on the procedure for the most exact results the reader should refer to a paper by F. M. Colebrook and R. M. Wilmotte in the *Journal of the I.E.E. (Wireless Section)*, Vol. 6 (1931), p. 49.

Having established a sufficient number of calibration points, one proceeds to plot them carefully on a large sheet of graph paper. Isolated errors, caused perhaps by mistaking the number of a harmonic, are shown up. In case a whole series of harmonics is wrong, it is advisable to have cross checks from some other standard.

By the use of harmonics it is possible to calibrate well up into the V.H.F. bands, but at frequencies still higher it becomes almost impracticable to

138. Wavelength Standards

continue the frequency calibration. Just as this difficulty increases, wavelength calibration becomes relatively easy, making use of the principles of standing waves along parallel wires. There are several variants of the method; the most compact is the quarter-wave resonator, which is only a little over 8 feet long for 10 metre wavelength. For wavelengths of 1 metre and less the method is particularly convenient. A pair of parallel bare wires is strung across the room or mounted on a wooden frame. As the presence of material (other than air) between the wires is a source of error, it is best to do without any spacers, stretching the wires tightly between supports and taking very great care to get them exactly parallel. The farther apart, the less the probable error in parallelism, but the greater the distance material—

conducting or otherwise—must be kept away. About two inches separation is suitable for waves of the order of 5 metres ; one inch for shorter waves. Except for the insulators at the ends there should be nothing but air within at least several inches of the wires.

One pair of ends is left unconnected, and the other is short-circuited. If an oscillator coil is brought near the short-circuited end in such a position as to couple magnetically (see Fig. 87) there is the usual meter "kick" at resonance, which takes place when the oscillator wavelength is four times the length of wire from the short-circuit to the open end. It also takes place if it is four-thirds, four-fifths, four-sevenths, etc., of the wire length. Actually waves do not travel *quite* so fast along such lines as in free space, and the wavelengths thus measured are less by a small amount, but if the suggested precautions are taken the error should not be more than about 1 per cent.

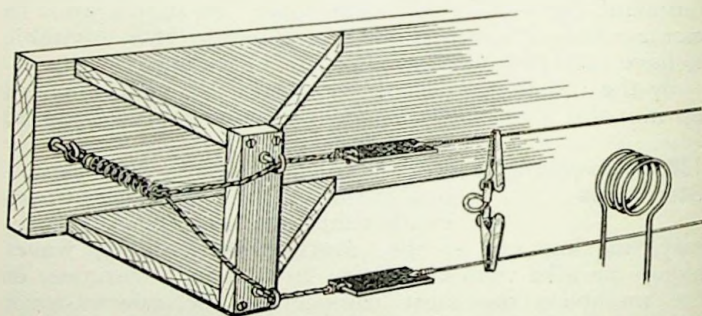

Fig. 87 : Position of an oscillator coil for coupling to a parallel-wire resonator in wavelength measurement

Unless the oscillator frequency is approximately known beforehand, it may be difficult to find the indication of resonance within the tuning range of the oscillator. If it is found, it should be confirmed that it is due to the wire and not to an internal absorption, by bringing the oscillator away from the wire. Alternatively the oscillator frequency can be left alone, and the resonator tuned to it by

STANDARDS OF COMPARISON

shifting the bridge piece along. The awkward thing about this is that the oscillator coil must be shifted along with it. It is quicker to adopt the half-wave resonator by leaving the oscillator and the bridge at one end, and moving another bridge, made of a short piece of stiff wire pushed through the end of an insulating handle to form a T-piece, away from it along the wire. At certain points the oscillator meter will probably jump about a bit ; these points are half wavelengths apart.

An important quantity in radio work is amplification or gain. The most obvious way of specifying gain is by the ratio of output voltage, current,

139. Reckoning or power, to input. An amplifier
Amplification may give a voltage amplification of
25 (to 1) ; at some extreme frequency

it may give an amplification less than one, say 0.2, which may be described as a loss of 5. *If the impedances across which input and output voltages (or currents) are measured are equal* the power amplification is equal to the square of the voltage (or current) amplification.

Gain or loss is practically always expressed in decibels (db). Plus 1 db. is equal to a power gain of 1.259 or a voltage (or current) gain of 1.122 ; minus 1 db. a loss of the same ratio. One may consider not only the gain or loss between two pairs of terminals, such as the input and output of an amplifier, but across one pair of terminals when some change or adjustment is made. For further information on this subject see Secs. 219-20. A table of db. appears in Sec. 308, but the most convenient method of arriving at db. from a pair of readings is to refer the ratio of them to the uniformly divided scale of a slide-rule. A power ratio of 1 is 0 db., and a power ratio of 10 is 10 db. These are the ends of the scale. The corresponding point on the " db. scale " to 4 on the main slide-rule scale is 6 ; a power ratio of 4 is 6 db. A power ratio of 40 is 4×10 ; equal to 6 + 10 or 16 db. Note that gains or losses in db. are *added*. A voltage (or current) ratio is equivalent to twice as many db. as the same power ratio.

There are such things as standard amplifiers, used to

provide a known gain when measuring voltages too small to be read by valve voltmeter, cathode-ray tube, or other instrument. Their gain depends on so many things that they cannot reasonably be depended upon to

high accuracy, so wherever possible a standard of loss—an attenuator—is preferred, because it consists of a passive network of resistors. While an attenuator cannot serve the purpose of an amplifier, it can be used to calibrate an amplifier. The method is simple; it is connected in cascade with the amplifier (i.e., one leading into the other) between an appropriate signal and an indicator; the attenuator or amplifier is adjusted until the indicator reads the same through them as when it connects straight to the signal. The gain and loss are then obviously equal. Which comes first in the line depends on circumstances; if the attenuator comes first, the amplifier is worked at a low signal level and is not likely to be overloaded. That is therefore usually the better order. For details, see Sec. 221.

If the attenuator works into a circuit that can be reckoned to be of infinite impedance—a voltage-operated device, such as a valve—it can take the simple form of a potentiometer.

141. The Potential Divider

This name is commonly but wrongly applied to the ordinary volume control, which however can earn some title to the name by being calibrated. But to be more definite the step-by-step type is preferred. The total resistance is made large enough not to be overheated by the current due to any voltage likely to exist across the input terminals, nor to load the input circuit excessively. With these conditions fulfilled, the lower the resistance the better, in order to minimise the effect of any finite impedance it may work into, and also to reduce the chance of interference from stray fields. On the infinite output impedance assumption, the voltage attenuation is decided solely by the ratio $\frac{R_0}{R_1}$ (Fig. 88). It is often convenient to divide the resistance

STANDARDS OF COMPARISON

Fig. 88 : The simple potential divider can be used as an attenuator within certain restrictions

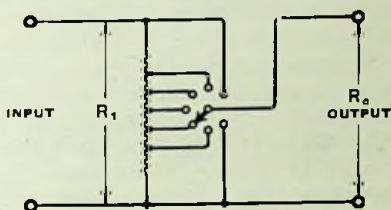

so as to give an equal number of decibels loss per stud. The values of R_0 for a given R_1 can be calculated

on a slide-rule as just described, or from the formula $db. = 20 \log_{10} \frac{R_1}{R_0}$. For convenience, a potentiometer giving a total of 40 db. loss in steps of 2 db. is tabulated for a R_1 of 100,000 Ω . The values for any other R_1 can easily be found by multiplying everything by the ratio of the

No. of stud, counting from lower end	db. loss	Resistance to next lower stud
1	∞	0 ohms
2	40	1,000
3	38	259
4	36	326
5	34	410
6	32	517
7	30	649
8	28	819
9	26	1,031
10	24	1,298
11	22	1,633
12	20	2,058
13	18	2,590
14	16	3,260
15	14	4,100
16	12	5,170
17	10	6,490
18	8	8,190
19	6	10,900
20	4	12,400
21	2	16,110
22	0	20,790
		Total 100,000 ohms

actual R_1 to 100,000. The resistances specified are for the individual steps, not for total R_0 .

The potentiometer type of attenuator has two limitations : if the impedance into which it works is not infinite, the amount of attenuation is altered, and so is the input impedance of the attenuator. For working out of and into finite resistances a more elaborate network is necessary, requiring complex switching.

142. Calculating T and H Attenuators

Fig. 89 (a) shows the form of the T attenuator. The attenuation is controlled either by simultaneously varying all three resistances by ganged switches or using a set of double-pole change-over key switches to cut in or out the desired number of stages of fixed attenuation ; the latter method is slightly less rapid to manipulate but is easier to construct and is more suitable for high-frequency use because sections can be separately screened and points of widely different potential kept apart. By selecting suitable values for the resistance arms the input and output resistances—that is to say, the resistance of the attenuator measured at either end and connected to a circuit of its rated resistance at the other—can be kept always the same.

To illustrate this a 3-stage attenuator is shown in Fig. 90. When all the switches are in the upper position obviously there is no attenuation, and the

143. An Example

resistance of the far end, looked at from either end, is 6,000 ohms. When the first (left-hand) pair of switch arms—which form one switch—is depressed, there is no change in the resistance, but 1 db. attenuation is introduced. Similarly with the other stages. A total of 7 db., variable in steps of 1 db., can be inserted.

To calculate the series and parallel resistances, S and P, for an input and output resistance R and voltage ratio

$$\frac{V_1}{V_2} = r$$

$$S = R \left(\frac{r-1}{r+1} \right)$$

$$P = R \left(\frac{2r}{r^2-1} \right)$$

STANDARDS OF COMPARISON

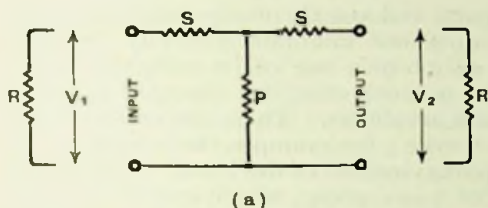

(a)

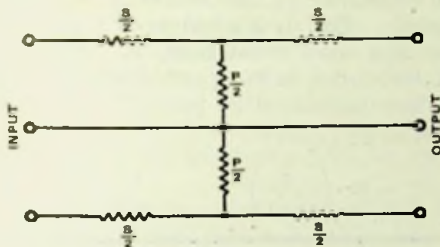

(b)

Fig. 89: Form of attenuator necessary to preserve constant input and output impedances at all attenuations. (a) is the T-type, and (b) the H for use in push-pull and other systems balanced to earth. Certain relationships between the series and parallel resistances S and P must be observed

From this it is clear that both resistance arms are proportional to R, so that if the dimensions of an attenuator for, say, 10 ohms load resistance is known, those for a 1,000 ohm load are obtained simply by multiplying everything by 100.

For systems which must be balanced with respect to earth, the still more complex H attenuator (Fig. 89 b) is used, and requires a set of 4-pole-switches. In radio equipment, both audio- and radio-frequency, something

Fig. 90 (below): Worked-out example of a 3-stage T attenuator giving a maximum of 7 db in steps of 1 db

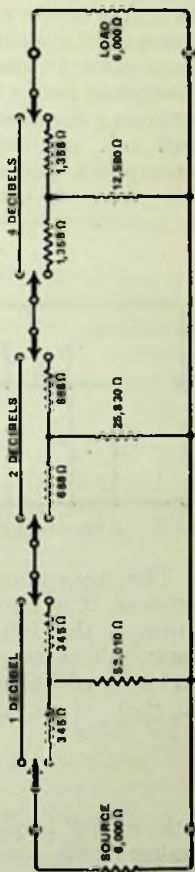

more simple, compact, and quickly manipulated is wanted, and, although it does not maintain perfectly constant resistance with the switch near one of its ends, the ladder attenuator (Fig. 91) is much used, for example in signal generators and audio amplifiers. There are various slight modifications of this type; for example, the output can be switched to the tappings instead of the input. The ladder consists of a series of Γ or Γ stages, which can be arranged to present a constant resistance to one end only. It is best illustrated by an example. Fig. 91 is a series of Γ stages, and assuming that source and load resistances, R , are equal, and that a constant resistance is required from the *input* standpoint, the arms are calculated by:—

$$S = R (r - 1)$$

$$P = R \left(\frac{r}{r - 1} \right)$$

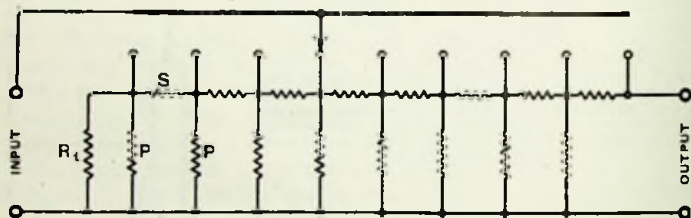

Fig. 91 : A convenient type of attenuator much used in radio work—the "Ladder"

The resistance R_i is called the iterative resistance, because it is equivalent to an infinite repetition of stages towards the left. In this type of attenuator, with the assumptions stated, $R_i = rR$. For example, suppose source and load resistances are 10 ohms and each step is to be 5 db. R , then, is 10, and r is 1.778; from which:—

$$S = 7.78 \text{ ohms}$$

$$P = 23 \text{ ,,}$$

$$R_i = 17.78 \text{ ,,}$$

R_i and P in parallel are 10 ohms, which in series with S makes 17.78, equal to R_i . So R_i and the first stage together have the same resistance as R_i . This is true of any number

STANDARDS OF COMPARISON

of stages ; their resistance towards the left is equal to R_1 . What about the right ? The load is 10, and in series with S and in parallel with P makes 10 again. So the resistance through all paths from any stud to which the source is switched (excluding the path through the source itself) is 17.78 in parallel with 10, or 6.4 ohms. This, though not equal to 10, is at least constant at all switch positions. Because it is not 10 the system is less efficient than one in which the impedances are perfectly matched, and even when the source is tapped right across the load there is a loss in the attenuator, called the insertion loss.

The attenuation per stage, working from the load end, can easily be found to be 5 db., but the output resistance is 6.4 ohms at the end stud, 12.75 at the next, 16.0 at the next, and tends towards 17.78 at an infinite number of steps away.

Nevertheless, where strict matching is not essential, it is a useful type of attenuator, and can be made quite cheaply.

For more detailed treatment of attenuators, including the effects of incorrect, unequal, or reactive terminal impedances, an advanced work such

144a. Other Attenuators.

as A. T. Starr's *Electric Circuits and Wave Filters* should be referred to.

F. E. Terman gives data on the more practical types in his *Measurements in Radio Engineering*, and there is a very valuable paper by McElroy in *Proc. I.R.E.*, March, 1935, giving tables for rapid calculation of resistance elements in all the usual types of attenuators. In particular, the bridged-T type may appeal to home constructors because only two resistors have to be adjusted for each step. It is similar to the T attenuator already described, but with a fourth element, B, joining the input and output terminals on the SS side. The S resistors are both made equal to R, so may be permanently connected, and

$$P=R \left(\frac{L}{r-1} \right)$$

$$B=R (r-1)$$

The switching can be done by a 2-pole switch of the Yaxley type in which the arms are not electrically connected.

CHAPTER 7

INSTRUMENTS

D—Equipment as a Whole

THE three previous chapters, if read straight off, may have had a slightly bewildering effect on anyone faced with the task of equipping a laboratory with limited means, in spite of the fact that elaborate and expensive apparatus has either been omitted or,

145. A Concentrate of Apparatus

if of general importance, described quite briefly. There is a vast amount of equipment that might have been mentioned, but has been left out

because too highly specialised or likely to be available only in lavishly appointed laboratories. Even so, much more has been included than most people are likely to be able to acquire personally. The purpose of this chapter is to help the reader to boil things down to a concentrated residue consisting of a moderate amount of apparatus selected for maximum utility without unnecessary expense, overlapping, or obsolescence. What that residue is depends very much on individual requirements, but the apparatus contained in the following list, though few in number, enables a very large proportion of the enormous range of zero-, audio- and radio-frequency tests to be carried out with reasonable accuracy and convenience. The items are entered in parallel columns; those on the left hand are of a more strictly practical nature; they would not be inappropriate for a service laboratory aiming at being capable of clearing up the obscurest of faults: those on the right hand may be substituted or added if funds permit or if the object is work of a more ambitious character.

EQUIPMENT AS A WHOLE

	B	Ref. Section	A	Ref. Section
1	Multi-range meter, such as "Radiolab All-Purpose", Universal Avomitor or Avometer.	55 61	High-grade laboratory meter, such as Cambridge Versatile Galvanometer with accessories	55
2	Modulated oscillator.	53	Standard signal generator.	47-52
3	Dynatron oscillator.	37 148-153	Same, including negative resistance bridge.	See 3B also 154
4	"Straight" A.F. oscillator.	38 155	Beat-frequency A.F. oscillator.	30-43
5	Cathode-ray tube with power unit and mains-frequency time base, and preferably also frequency-modulation device.	74-82 89 85-7	Same, with more elaborate specification, including variable-frequency linear time base and deflection amplifier.	See 5B also 83 88
6	Mains-driven slide-back valve voltmeter (or auto-bias type).	70 156-7 146	In addition, square-law valve voltmeter.	67
7	Variable-ratio transformer, for matching receiver to A.C. voltmeter.	159	Multi-range multi-impedance output meter.	60 158
8	Decibel potential divider.	141	Same.	141
9	Mains-driven "Magic Eye" C & R bridge and Owen bridge for L	123, 146 Appendix	Universal bridge with standards of L, C & R	117-20 124 160 94-107

Under the modest name of the "Radiolab Workshop Testing Set" hides a piece of apparatus of exceptional versatility and value for laboratory use as well as for servicing (Fig. 92).

146. A Versatile Instrument It combines items 6 and 9B above, and also includes a high voltage insulation test set. The ranges are 10 $\mu\mu\text{F}$ to 60 μF ; 100 Ω to 10 $\text{M}\Omega$; power factor of electrolytic condensers 0-50 per cent., leakage of electrolytic condensers, or of anything else, 0.08 to 4 mA from 10 to 400 volts, or 0.1 to 5 $\text{M}\Omega$ at the highest voltage; and the valve voltmeter, which employs a top-grid valve "probe", introducing exceptionally small circuit disturbance and usable up to 40 Mc/s, reads 0.2 to 100, and has an input impedance of 5 $\text{M}\Omega$ and capacitance of 9 $\mu\mu\text{F}$.

Some readers may be surprised to see no valve tester on the list. The difficulty is that either the latest sort of valve that one wants to test seems somehow to be outside

the scope of the instrument; or else, to avoid this possibility, the designer has made the

147. Valve Testing apparatus so flexible that it is almost as much trouble to make all the appropriate connections and switchings as to rig up a test for oneself from the appropriate valve socket and meters. This being so, the author's practice when setting up an experimental circuit involving valves is to check the valves in their own circuits, and, on the comparatively rare occasions when a valve is being investigated as such, to hook up a suitable circuit.

Admittedly this is not likely to suit workers such as service engineers handling many valves; and they must have one of the many valve checkers offered for service purposes, provided with innumerable sockets for coping with all the types our enterprising valve industry has turned out. A simple routine valve checker that the author designed some years ago makes use of a principle that is often overlooked—"automatic grid bias"—for measuring mutual conductance. It is described in detail in *Experimental Wireless* (now *Wireless Engineer*), September, 1928, and briefly in the next chapter (Sec. 216).

Considering the listed items in detail; the choice of

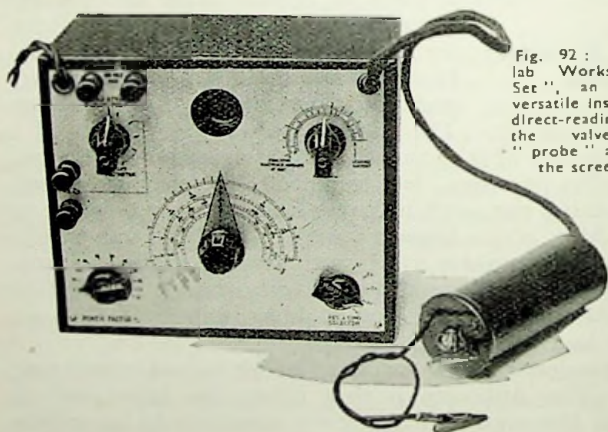

Fig. 92: The "Radio-lab Workshop Testing Set", an exceptionally versatile instrument with direct-reading scales. Note the valve voltmeter "probe" at the end of the screened cable

meters has already been dealt with fairly fully in Secs. 54-56. There are very many excellent makes and types other than those referred to ; the author mentions the above on the ground of personal experience.

There is also such a large choice of excellent modulated oscillators at low prices that it hardly pays to think of making one ; and standard signal generators are rather beyond the capabilities of the amateur instrument designer and maker.

The dynatron "substitution" oscillator, on the other hand, is not a recognised commercial product, and is easily constructed to suit individual

148. The Dynatron Oscillator needs. The unit now to be described is an "open" oscillator, not primarily

intended as a signal source because

item 2 is assumed to be available for that purpose. Although it would be possible to screen it in and fit it

with an output valve and attenuator, it would thereby become less suitable for certain tests such as R.F. resistance

measurement ; and it cannot be substituted for No. 2 because for some purposes both are needed. For the same

reason it is not relied upon as a standard of frequency, although it is quite useful for it to be calibrated. Even

excluding these uses, it is hard to equal for versatility. Examples of its use are : matching coils and condensers

to high accuracy for ganged circuits ; measuring or comparing the dynamic resistances of tuned circuits ;

testing R.F. chokes for mistuning and absorption over the band of working frequencies ; testing samples of insulating

materials for R.F. loss ; and measuring the characteristics of aerials.

For many of these purposes an ordinary valve oscillator could be used, but the dynatron has the advantages :

(1) that a reaction coil or tapping is unnecessary and therefore oscillation can be set going in any coil, even

though it may be totally screened and inaccessible except for its two end connections ; (2) that the resistance against

which oscillation can be maintained is under easy and precise control by varying the grid bias ; and (3) that the

frequency of oscillation is remarkably independent of

operating voltages, etc. Disadvantages are not serious and consist chiefly of the fact that unless one happens to acquire an exceptionally good valve (and they vary rather unpredictably) it may not be possible to get very "difficult" circuits (such as V.H.F.) to oscillate. The Mazda AC/S2 has exceptionally powerful dynatron properties; most samples of this type are amply effective. For low-loss circuits, which are easy to set into oscillation, the Mullard S4VA is preferable because of its small interelectrode capacitance and good power-factor. Both of these are now obsolete, but a number of alternatives are described in Sec. 37a.

To understand how the dynatron can be used for the various purposes suggested, it is necessary to visualise it in the circuit as a negative resistance,

149. The Dynatron as a Variable Negative Resistance the amount of which can be conveniently controlled by varying the grid bias. The control grid is not subjected to any oscillatory voltage but is kept at a steady bias voltage

that acts as a throttle. When coils and condensers are put together to form a tuned circuit they are equivalent to a very high positive resistance at the frequency to which they are tuned (Sec. 293). The lower the resistance due to losses in the components, the higher is this so-called "dynamic resistance". Using very efficient components it is possible to make it several hundred thousand ohms, while with poor components it may be only tens of thousands. If there were no losses at all the dynamic resistance would be infinity, but this can be achieved only by neutralising them by means of negative resistance, of which valve reaction is the most familiar example. The dynatron is actually a rather simpler form of negative resistance, as the amount depends on the valve itself and not on external coil couplings or adjustments.

Now this is where it is easy to get confused. When asked whether a resistance of $-100,000$ ohms or $-10,000$ would be the more effective for neutralising losses, it is natural for one to say " $-100,000$ ", and perhaps "of course!" But bearing in mind that a resistance of

EQUIPMENT AS A WHOLE

10,000 ohms represents much heavier losses than 100,000 ohms, one can see that $-10,000$ must be a correspondingly more effective negative resistance to neutralise it. When calculating one must use the rule for adding resistances in parallel,* by which a combination

$$\bullet \frac{R_1 \times R_2}{R_1 + R_2}$$

of $+10,000$ and $-100,000$ gives $+11,111$ ohms—only a slight improvement on the original 10,000.

The negative resistance of a dynatron when it is given such a large negative bias as nearly to cut off its current is nearly infinity; so it is capable of neutralising only those circuits which are already extremely low-loss. As the bias is reduced, the negative resistance falls, giving correspondingly greater neutralising ability; but one has to be careful not to allow the screen current to rise excessively, or the valve may lose some of its valuable dynatron properties. When neutralising "bad" circuits, then, do so for as brief a time as possible; preferably just a "spot reading". The AC/S2 will go to $-10,000$ or even $-5,000$ ohms, but be careful about letting the screen current exceed about 7 mA.

When the positive resistance of a tuned circuit is fully neutralised, oscillations set up in it continue indefinitely. If the grid bias of the dynatron is further reduced, so that the resistance is more than neutralised, the amplitude of oscillation increases until it sweeps round the bends of the valve characteristic curves, so bringing the negative resistance to a balance once more. This has at least three bad results: (1) it causes the valve to take an unnecessarily high current, (2) it produces strong harmonics in the oscillation, and (3) it causes the frequency of oscillation to depart from that which is determined by the capacitance and inductance of the components. It is important, then, to work with the grid bias *just* on the right side of the oscillation point.

Any increase in the losses of the circuit necessitates reduced negative grid bias to bring the valve to the oscillation point. The bias vol-

150. The Basis of Dynatron Tests

tage (taking care to keep all other working voltages constant) is therefore a measure of the circuit losses or resistance. Secondly, the frequency at which the circuit oscillates depends, of course, on the capacitance and inductance, and any change due to an added connection necessitates retuning to restore the original frequency. *These two facts form the basis of substitution tests with the dynatron.*

The method in all cases is to compare one circuit or component with others. If the actual values of some are known, therefore, they can be used as standards to measure the unknown. Fig. 93 shows the simplest dynatron oscillator circuit, X being the terminals to which standard and unknown condensers, coils, etc., are connected. Corresponding terminals for alternative types of oscillator are shown in Figs. 20, 21 and 22. An important constructional feature must be a smooth control of grid bias and provision for indicating small changes in its voltage. Although the negative resistance does not depend very much on anode voltage over the working range it is convenient to be able to adjust it, so as to avoid any part of the curve that (greatly exaggerated) looks like Fig. 94 (a) and to

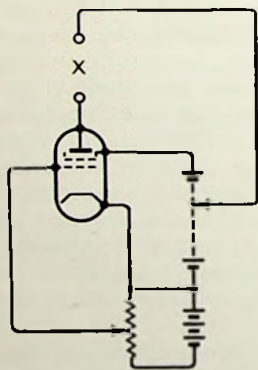
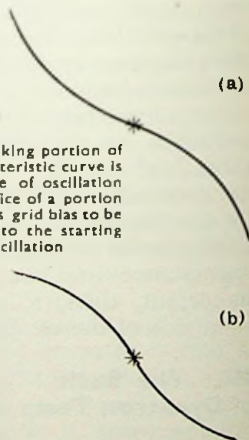

Fig. 93 : Simple dynatron circuit, illustrating the principle of its uses for testing

Fig. 94 : If the working portion of a dynatron characteristic curve is like a, amplitude of oscillation is unstable. Choice of a portion such as b enables grid bias to be set very exactly to the starting point of oscillation



select part that is more like *b*. The difference is that with *a* the negative resistance falls as the amplitude increases and so oscillation once started jumps to a large amplitude, and there is electrical backlash in adjustment to the threshold of oscillation.

As regards power supply, the heater of the AC/S2 or other indirectly heated valve is most economically fed from

A.C., but where there is none it may
151. Power Supply not be unreasonable to devote a largish 4-volt or 6-volt accumulator to the job. Two-volt battery tetrodes *can* be used, but their dynatron properties are generally not very good. Some battery pentodes make fairly good transitrons. Where A.C. is available there is a choice between running the heater from a small transformer and the other supplies from batteries, or an all-A.C. drive. If the A.C. is rectified and smoothed it makes rather a big affair of it. Semi-battery operation is cheap, because of the low current consumption; and the supply is steady. But if the apparatus is used infrequently it is likely that when it is needed the battery is run down, and decidedly *not* steady.

A useful and adaptable compromise will now be described in detail, with a switch for changing between battery and
raw A.C. The latter requires no
152. A Dynatron Oscillator Unit rectifier or smoothing circuits, is always ready for use, enables lower negative resistances to be obtained without risk to the valve, and can be heard with a non-oscillating receiver. But it gives a rough note which is not so euphonious, and comparison of bias is not so accurate or convenient. Readers who wish A.C. only or battery only can omit the parts that do not interest them. The description can easily be adapted to pentode dynatron or to transitron (Sec. 37*a*).

The full circuit is given in Fig. 95, and the photographs (Figs. 96 and 97) should make clear the construction, which however leaves considerable scope for individual taste or facilities, for it is a mere "breadboard".

The transformer is a special one supplied by Sound Sales Ltd., giving 4 volts 1 amp. and 100 volts 40 mA.

RADIO LABORATORY HANDBOOK

The by-pass condensers should be non-inductive and mounted close up to the valve with short leads.

In series with the grid is a 5,000-ohm resistor to prevent excessive grid current on the positive swings when running on raw A.C. The grid potentiometer should be wire-

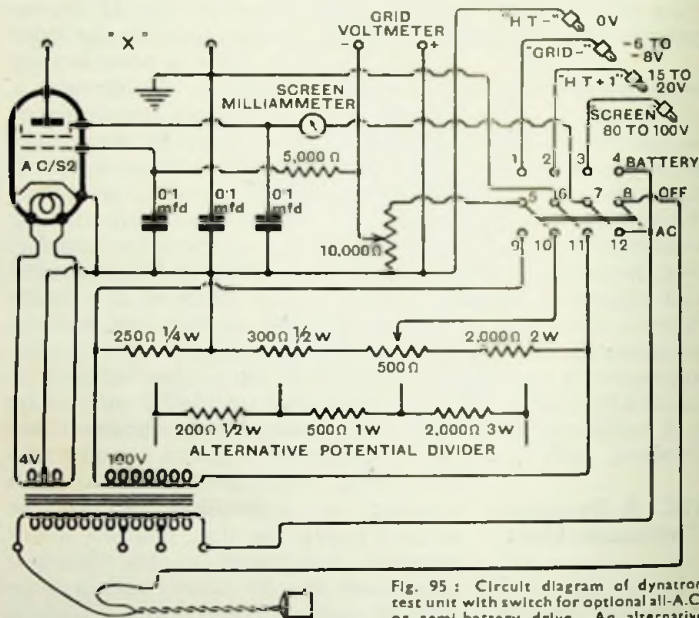

Fig. 95: Circuit diagram of dynatron test unit with switch for optional all-A.C. or semi-battery drive. An alternative fixed potential divider is shown

wound and give consistent wiper contact so that close adjustment may be made. If the control is a sound one, pointer-knob settings may be used for comparative tests; but voltmeter readings are more reliable, and terminals are indicated for the purpose. But remember that when the voltmeter is withdrawn the bias rises. It is wise to withdraw a D.C. voltmeter when A.C. is being used; as, apart from no proper reading being obtainable, the "movement" is liable to be damaged by the vibration. An anode voltage control is shown on the A.C. side, but

EQUIPMENT AS A WHOLE

this (and also the tapings on the battery side) must be regarded as semi-fixed adjustments to obtain the best conditions in the first place, as of course grid bias comparisons are upset if the other voltages are shifted. The anode voltage control is not absolutely essential, and an optional potential divider network for fixed anode voltage is illustrated. It is quite futile to attempt to derive the anode voltage—about 20 is usually suitable—from a high-resistance network, because the working point will not stay

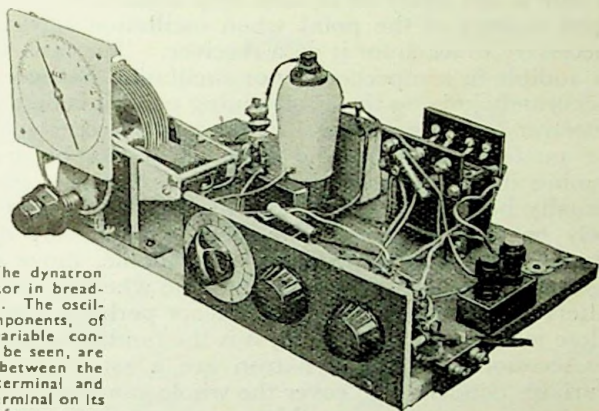

Fig. 96 : The dynatron test oscillator in bread-board form. The oscillatory components, of which a variable condenser can be seen, are connected between the valve top terminal and the large terminal on its left

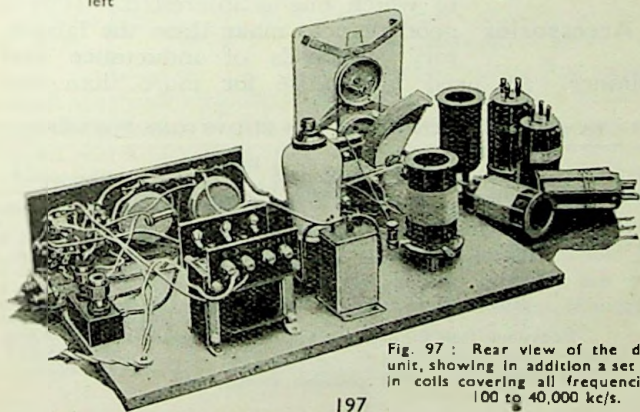

Fig. 97 : Rear view of the dynatron unit, showing in addition a set of plug-in coils covering all frequencies from 100 to 40,000 kc/s.

RADIO LABORATORY HANDBOOK

on the negative resistance slope. A milliammeter in the screen circuit is useful for indicating when the unit is working and to give warning when the grid bias is reduced too far.

For a preliminary test, connect a coil and condenser to the tuned circuit terminals, switch to either A.C. or batteries, and when the valve has warmed up check that the screen current varies as the grid bias control is rotated. As regards anode current, there is no need to be dismayed if it is zero or even a milliamp or so in the reverse direction. There is not likely to be any very noticeable jump in the feed current at the point when oscillation starts, so it is necessary to listen for it on a receiver. The raw A.C. note is audible in a superhet or non-oscillating receiver, but for accurately judging the exact tuning point it is better for the receiver to be oscillating. If there is no receiver that can be made to oscillate, the same effect can be gained by tuning it to a not-too-strong station carrier wave. It is usually best to disconnect the aerial for this purpose and rely on stray pick-up. To check whether the dynatron signal is the fundamental or a harmonic, move the grid control some distance round and note whether the strength alters greatly. If it does not, except perhaps a jump very close to the oscillation point, it is the fundamental.

Accessories to the dynatron are a set of coils and a variable condenser to cover the whole gamut of frequencies in which one is interested. It is a good plan to make these the laboratory standards of inductance and capacitance. As need may arise for more than one

INDUCTANCES OF COILS WOUND ON EDDYSTONE FORMERS

Type of Former.	Wire.	Turns.	Spacing (turns per in.)	Inductance (Micro- henries).	Waveband.*	
					Metres.	Frequency.
Threaded, Type 936	No. 22	3	7	0.6	8.1-29.1	10.3-37 Mc s.
" "	" 22	4	14	1.1	10.7-37.5	8.0-28 "
" "	" 22	6	14	2.0	14.6-50	6.0-20.5 "
" "	" 22	16	14	8.0	29.7-102	2.95-10.1 "
Plain, Type 935	" 22 DSC	30	Close wound	31.5	58-200	1.5-5.18 "
" "	" 30	100	" "	255	166-580	516-1,800 kc/s
" "	Eddystone Type	BR	main winding.	1,760	446-1,500	200-672 "
Slotted	"	GY	" "	7,240	910-3,060	98-330 "

* With Cylidon B35 condenser, 0.00035 mfd.

EQUIPMENT AS A WHOLE

variable condenser, it is helpful to mount them on plugs, or on small panels fitted with slotted metal strips for screwing down to the baseboard.

The coils shown in Fig. 97 are wound on formers made by Stratton & Co. Ltd. ("Eddystone") with plugs to fit into a low-loss 4-pin valve holder. The table gives winding data for a set of coils covering 100 to 37,000 kc/s (3,000 to 8 metres). For greater precision one would use the Sullivan temperature-compensated coils referred to in Sec. 105.

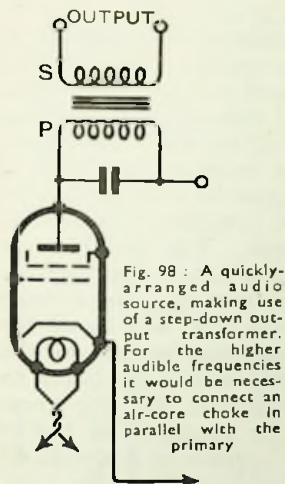

Fig. 98: A quickly-arranged audio source, making use of a step-down output transformer. For the higher audible frequencies it would be necessary to connect an air-core choke in parallel with the primary

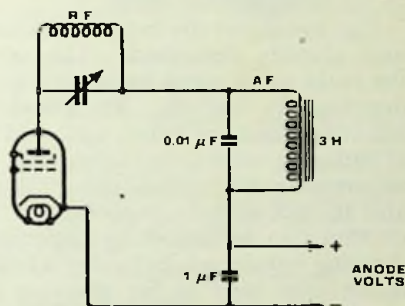

Fig. 99: Modulated R.F. is obtained by connecting audio and radio sources in series. The values shown are for modulation at about 1,000 c/s

The same unit can be used for audio frequencies as well as radio, and if no occasions it is desired to

use it as an extra signal source, it can be arranged by connecting the primary of an output transformer in place of the usual coil and tuning it to the desired audio frequency by a condenser in parallel (Fig. 98). The signal voltage depends on the anode voltage, reaching a maximum at half the screen voltage. Or a modulated radio-frequency signal is obtained by connecting in series with the usual tuned circuit, on the side away from the anode, an audio-frequency circuit (Fig. 99). A 3H choke shunted by $0.01 \mu\text{F}$ modulates at about 1,000 c/s.

The procedure for using the dynatron in substitution

and comparison tests will be described in the next chapter.

It will be found that its scope as a measuring instrument will be greatly increased if means are provided for measuring its negative resistance at any adjustment. There are various ways of doing this, such as deducing the slope of the anode current/anode voltage curve by plotting points each side of the working point ; but the best method is by means of a special bridge circuit, which it is suggested may form a valuable addition to the unit just described.

Fig. 100 shows the extra circuit in relation to the dynatron unit already described. The two resistors, which form the ratio arms, must be accurate, and can be made up as described in Sec. 96. The coupled coils are for balancing out capacitance of valve, etc., and Fig. 101 gives dimensions of suitable ones ; by arranging a scissors-like coupling adjustment, the mutual inductance can be brought to zero and in fact slightly negative. The best direction of connecting can be found by experiment. The switch is for shorting out the whole bridge when it is not needed, and the flying clip lead is for shorting it through the by-pass condenser (to maintain the Z.F. resistance, and hence the anode voltage, constant) and alternatively shorting out the oscillatory "X" circuit. A switch would be likely to introduce too much circuit disturbance for the most

precise work. The use of this apparatus is described in Sec. 187.

Fig. 102 shows the circuit of the "straight" A.F. source with automatic amplitude control that was promised in

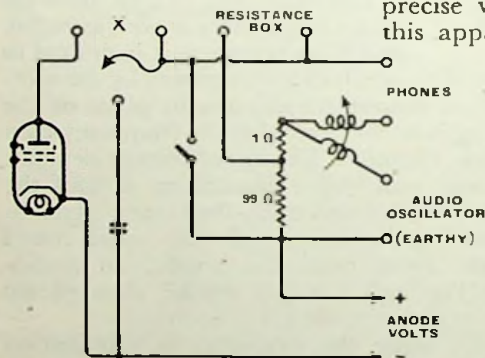

Fig. 100: Bridge circuit for measuring the negative resistance of a dynatron at any adjustment

EQUIPMENT AS A WHOLE

Chapter 4. Details are given of the components in case it is desired to follow this design exactly; but

155. A "Straight" Audio Source

there is no special significance in the specified values of smoothing condensers—they just

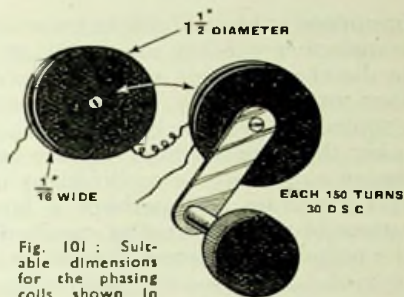

Fig. 101: Sizable dimensions for the phasing coils shown in Fig. 100

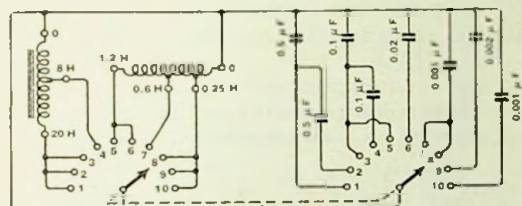
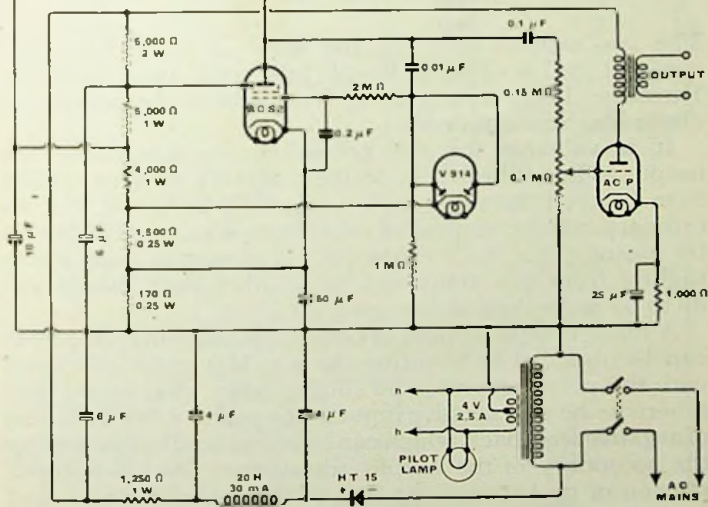

Fig. 102: Quantitative circuit diagram of a "straight" dynatron audio source, with A.C., providing ten fixed frequencies from 50 to 10,000 c/s



happened to be available in a standard block. As there is no transformer winding for supplying anode volts the circuit is in direct connection with the mains and the precautions that usually apply to D.C. mains apparatus should be adopted to prevent contact with any part of the circuit other than the secondary of the output transformer. The design can easily be modified by using a transformer with H.T. winding and perhaps a larger output stage. The output of the oscillator as specified is about 150 mW ; and the output transformer should be selected to suit the work in view—a multi-ratio type is very useful. If particular frequencies are required with any exactitude it may be necessary to try a number of condensers of the same nominal capacitance, or to supplement them with padding condensers.

The approximate frequencies given in the different switch positions with the components specified are :—

Switch position.	Frequency, c/s.	Switch position.	Frequency, c/s.
1	50	6	1,000
2	70	7	3,000
3	115	8	4,500
4	250	9	7,000
5	450	10	10,000

The two tapped coils are the same as those originally specified in *The Wireless World*, July 20th, 1934, made by Partridge Transformers Ltd., from whom the smoothing choke also was obtained.

It is valuable for the potentiometer controlling the output to be calibrated in decibels, and if a stepped control is to be used the table in Sec. 141 will be useful, but an ordinary volume control of reliable type can be calibrated by means of an A.C. voltmeter. The output level varies slightly from one frequency to another, but should not do so by more than about ± 0.5 db.

A further improvement in constancy and purity of output can be obtained by omitting the $0.15\text{M}\Omega$ resistor in series with this potentiometer, and cutting down what would then otherwise be an excessive input to the power valve by means of negative feed-back, which can be introduced by interposing the secondary of the output transformer (or a tapped-off portion of it) between the foot of the potentiometer and

RADIO LABORATORY HANDBOOK

bins nearly all of the desirable characteristics of a valve voltmeter. The circuit diagram, Fig. 103, suggests that it is rather complicated. Part of this is due to the inclusion of two detector valves—one inside the cabinet, for general use, including voltages up to 250 peak and with superimposed steady potential; the other an “acorn” probe for V.H.F. use. If the acorn valve is omitted and its place at the end of the probe occupied by the HL4g (which, incidentally, was selected because the grid is brought to a top cap connection, giving an exceptionally high input impedance) the instrument is simplified and cheapened, at the sacrifice of more accurate results beyond the 30 Mc/s region.

With the arrangement shown, either the probe or the

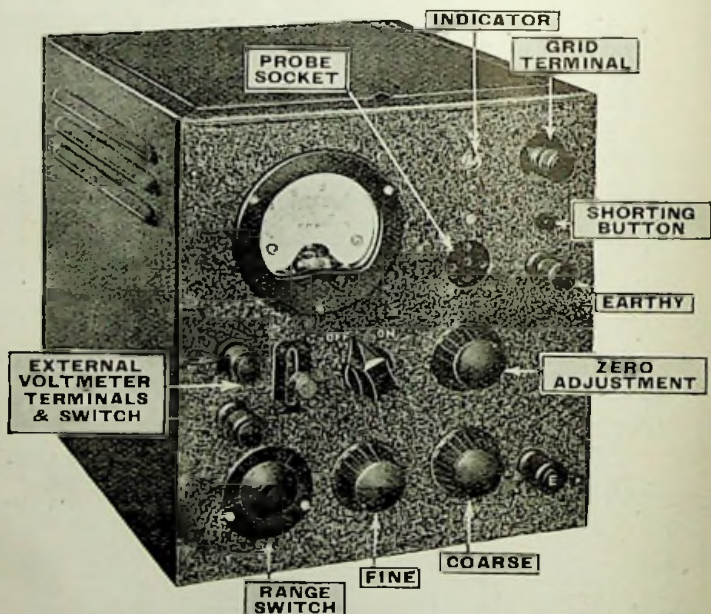

Fig. 104 : Home-made mains-driven slide-back valve voltmeter. It is completely self-contained, but an optional acorn valve probe for V.H.F. use can be plugged in as shown. The cathode-ray indicator window is immediately above this socket

EQUIPMENT AS A WHOLE

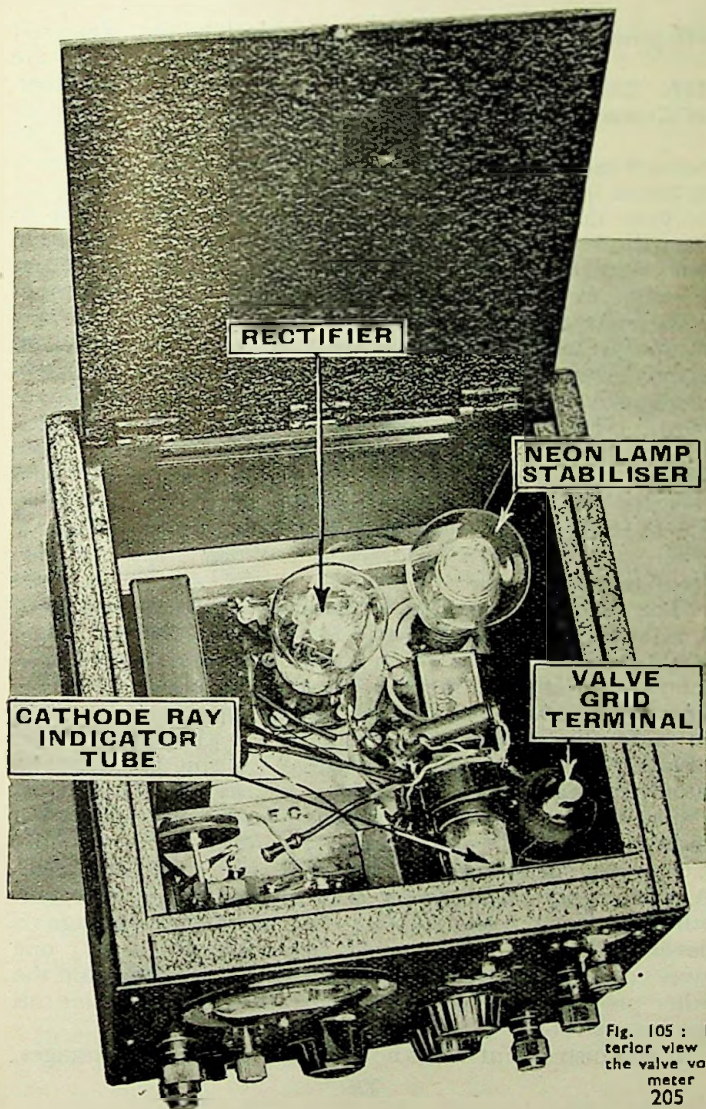

Fig. 105 : Interior view of the valve voltmeter 205

HL4g must be unplugged when the other is in use. The good input characteristics of the HL4g are preserved by a mica-bushed terminal,

157. Details of Construction

a good mica condenser, short leads to grid, and the shorting-switch contact mounted on the condenser to avoid bringing extra material into the system for support. The earth is joined only to the case, so a direct connection from earth to "earthy" is optional; a useful feature when measuring volts across a valve coupling in an anode circuit. It is essential for the valves to be "hard", as at maximum peak volts the grid goes 500 volts negative and a very minute leakage through the $4\text{ M}\Omega$ resistance would cause error. Owing to the small clearances in the acorn valve it is hardly wise to use it at more than about half maximum volts. The two $500\ \mu\text{F}$ by-pass condensers are connected to give the shortest possible paths in the head of the probe. The screening sheath is at the same potential as the "earthy" terminal, but if a 5-wire cable and a 6-pin plug are used the screen can, of course, be taken to "earth". The $25,000\Omega$ resistor is for removing any trace of ripple from the bias.

The anode current of either valve passes through a $1\text{ M}\Omega$ resistance between grid and cathode of the "magic eye", which has a 4-volt grid base and therefore 4 microamps covers the full range of indication. Two lines can be marked on the glass for reference, corresponding to the outline of the moving shadow at about half a volt negative, which is about as sensitive a setting as any. The supply potentials for the valves are stabilised at about 160 volts by a neon tube, which must be *without* internal resistance. The "BIAS ADJUST" control is for initially setting the shadow to its standard width with no signal. A readjustment is necessary after changing the valve, but otherwise it is very stable. The slide-back voltage is developed across two ganged potentiometer units; one gives coarse adjustment on all but the lowest range, and the other provides fine adjustment for these and also controls the lowest range.

If the instrument were not to be used for low voltages,

EQUIPMENT AS A WHOLE

the peak signal voltage is so nearly equal to the slide-back voltage that any D.C. voltmeter could be used without special calibration. It is even possible to dispense with a meter entirely and calibrate the slide-back control. But for convenience, and to cover readings from 0.1 volt upwards, a meter is incorporated. There is no need for it to be a highly sensitive one; that illustrated is actually 0.5 mA. By using a gang range switch it is impossible to drive the pointer far off the scale even by the grossest neglect. It is therefore an exceptionally practical instrument. Terminals are provided for connecting an external voltmeter in parallel with or instead of the internal one. In the original specimen a switch for changing over is fitted, but as the range switch has an "off" position it is not really necessary.

For the higher readings the greatest possible error due to a change of valve is practically negligible; thus, the scale calibrated for a HL4g valve was found to depart from the calibration for such a different valve as an HA1 by only 0.1 volt, to be added to the reading. Above about half a volt the scale is linear. Mains variations have no appreciable effect on the calibration, though they may cause some drifting of the slide-back voltage, but as that is read at the appropriate time it does not matter very much.

This type of instrument is particularly sensitive for setting a signal of any but a fractional voltage to a specified level, or for adjusting two signals to equality, which is the recommended purpose of valve voltmeters. Generally this sensitivity of adjustment far exceeds that of a meter scale of even much larger dimensions than the one illustrated.

Although there is a good deal of latitude in most of the components used, the following list of some of them may be helpful:—

Bias control	Reliance type TW	500Ω	
Fine slide-back control	" " "	200Ω	} double gang
		200Ω	
Coarse slide-back control	" " "	2000Ω	} triple gang
		10,000Ω	
		50,000Ω	
Meter	Ferranti	0.5 mA.	
Range switch	" "	type 6	

Case	Eddystone 1033	
Power transformer	N. Partridge	4 v. 1 A
	Special	4 v. 1 A
		380 v. 20 mA
Smoothing condensers	Dubilier 0288	
5-way cable plug	Bulgin P36	

The two limitations of the valve voltmeter just described are that readings much below a volt are rather cramped and accuracy relatively poor, and that it cannot be used to read R.M.S. values. For serious experimental work it is desirable to supplement it by a low-reading square-law instrument. Sec. 67 indicates the requirements of this, and the one illustrated in Fig. 37 (a), or a modification of it, is suggested.

A valve voltmeter can be used to measure receiver output; but a simpler, robusiter, and more convenient instrument for the purpose is a metal rectifier voltmeter shunted by a suitable load resistance. Besides, it is very likely that the valve voltmeter may be needed elsewhere in the set-up.

158. Output Measurement

Generally one is more interested in output power than in voltage. The output power can be calculated from the voltage if the load resistance is known (Milliwatts = $\frac{(\text{Volts})^2}{\text{Thousands of ohms}}$). The effective resistance of a load

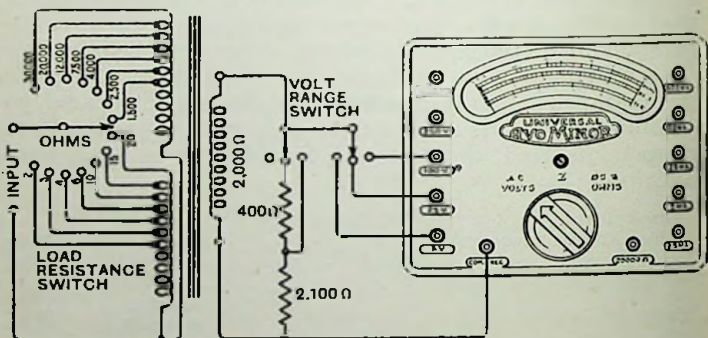

Fig. 106: Circuit of unit for adding to multi-range test set to convert it into an output meter

EQUIPMENT AS A WHOLE

speaker is somewhat uncertain and variable, so unless a mere relative indication is needed it is better to substitute a known artificial load matched to the valve. The value of having a load resistance adjustable over a wide range, from about 2 to 20,000 ohms, cannot be stressed too much. Unfortunately if the output meter consisted merely of a voltmeter across a variable resistance the milliwatt scale would have to be different for every value of resistance provided, which would be impracticable if a really useful selection were provided; or the power would have to be derived by calculation each time, the voltmeter resistance being duly taken into account. So the output meter consists of an output transformer with a fixed secondary winding across which the voltmeter and additional load resistance are connected, and a large number of primary tappings for matching. To ensure satisfactory transformer characteristics on all taps and at all audio frequencies, special compensating networks are used in the better instruments, which with multi-range switches are quite complex, but enormously useful.

159. An Output-measuring Adapter Although such a good standard of accuracy at all resistances and frequencies is not given, a relatively simple accessory for attaching to a

rectifier-type A.C. voltmeter is a great improvement on the single-resistance output meter; and Fig. 106 shows a circuit based on the Universal Avominor. The multi-range transformer is specially made by Sound Sales Ltd. for the purpose.

The selection of seven low and seven high resistance ratios is enough to enable output characteristics to be plotted. The average loss due to the transformer is 1 db., increasing somewhat above 6,000 c/s. The secondary winding is designed for the resistance of the Avominor at its lowest range—2,000 ohms. On the other ranges the resistance is higher, so extra shunt resistors are needed to maintain the load constant. The meter reads as low as 0.1 milliwatt; and, as 5,000 milliwatts is about as high as is needed in most work, only the first three ranges of the Avominor are utilised. It should be noted that on the 5-volt range the resistance of the meter rises much above 2,000 ohms at

small deflections, so tests in which this matters should be run at not less than 5 mW. The transformer, resistors, and range switches can be built into any compact form that suits the experimenter. The resistors call for some comment, though. They should be non-inductive, and the composition type is good enough if selected and checked for correct resistance within a few per cent. The 2,100 Ω one has to dissipate up to 5 watts, so it may be necessary to use several of lower rating connected in series or parallel. An alternative is to use the wire-on-mica type described in Sec. 96. To make the instrument read power directly without interfering with the existing scale one can cut a piece of stiff Bristol board into a shape to fit snugly over the glass without sliding about. A curved slot is cut to reveal the position of the pointer over the whole of its movement, and the milliwatt scales marked above and below. Fig. 107 is useful for deriving the milliwatt scales from the volt scales.

The decibel potential divider, No. 8 on the list, useful for amplification measurements and other purposes, can be made up according to the specification in Sec. 141, or a modification of it as required. Apart from the necessity for reasonably non-reactive resistors, this item calls for no special comment.

Lastly in the list, the bridge. If inductance is left out of account, there is no doubt that the potentiometer ratio arm type described in Sec. 123 is the

160. Choice of a Bridge

most practical and useful where great accuracy is not demanded, and it is easy either to buy or make. Inductance is the difficulty. If strictly practical methods are not insisted upon, radio-frequency coils can be measured at R.F. by the dynatron unit (Sec. 190), and A.F. coils with the valve voltmeter and resistance box (Sec. 203). But if this is considered to involve too much setting-up of apparatus and working-out of results, the alternative is a bridge. The Owen bridge is perhaps the most practicable where great expense cannot be lavished on this department. An inductometer bridge is delightful if means can be found of acquiring one. The construction of bridges covering most of the ranges in R, C & L is dealt with in the Appendix.

EQUIPMENT AS A WHOLE

And finally, if one wants to get results, without having to bother about planning the apparatus, and there is enough work to be done to justify the cost, the Marconi-Ekco Universal bridge (Sec. 124) or a similar type should be given due consideration.

That completes our present review of the sort of equipment that is most practical for general purposes; there is endless scope for individual ingenuity in adapting such means as **161. Devising Special Apparatus** are available to meet the task in hand.

The more one follows the line of original research the more it becomes necessary to devise special instruments for carrying it on. The keen experimenter should take every opportunity of studying the scientific papers and experiments of experienced workers, noting the ways in which investigations of great beauty and precision are sometimes made with very simple means. Many of the fundamental laws of electricity were established in this way. The work has become so highly developed that nowadays very great instrumental resources are necessary to carry on much of it, but simple methods directed by genius are not yet ineffective.

Before going on to consider methods of tackling specific problems, it may be well to emphasise once again the im-

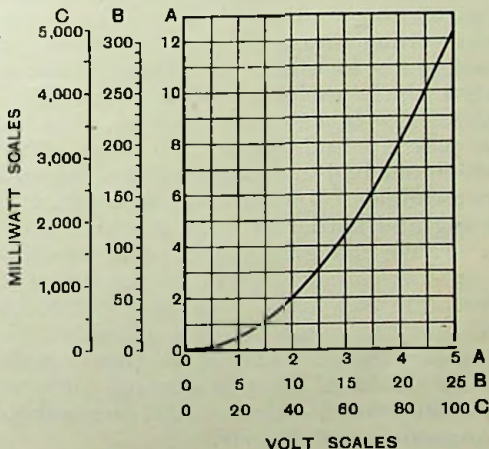

Fig. 107 : Curve for converting volt scales to milliwatt scales, based on a load resistance of 2,000 ohms

portance of system. In setting up what may perhaps be an elaborate assembly of apparatus for certain tests, the result of hurrying over the pre-

162. Preparation for an Experiment preparations to get down to the work itself is likely to be the same as that of rushing straight into an examination paper without calmly pausing to study the questions—misdirected energy and irrelevant answers. Do the readings that it is proposed to take really supply the required information? Is the apparatus arranged so that they can be taken with the minimum alterations and adjustments, such as are liable to introduce errors? The business of thinking out and arranging the apparatus should be separated as far as possible from the business of using it, so that one can concentrate on each in turn.

If much work or thought are required to bring certain apparatus into use there is a tendency not to bother to make the measurement at all. Incon-

163. Importance of Handiness of Instruments convenient instruments are simply not used. On the contrary, if instruments are chosen and arranged to be really *handy*, it is easy to develop the habit

of checking everything and thus avoiding much subsequent loss of time and perplexity. The author found that he was getting into a habit of using one particular meter in preference to others, not entirely because it included a particularly useful selection of ranges *but just because it happened to be fitted with clip leads*, thus requiring less effort to pick up and apply than those other instruments for which one had to look about for a pair of leads and connect to terminals. Incidentally, it is easier to see what one is doing and harder to make mistakes with a plug-in system of range-changing than with switches. Too much emphasis cannot be laid on the value of a good stock of crocodile clip leads, preferably painted with some sort of enamel to minimise risk of short circuits. In some laboratories one knows, whenever anything is taken in to be examined there is a search for wretched bits of wire to twist around soldering tags, giving thoroughly unreliable connections everywhere.

EQUIPMENT AS A WHOLE

Then the lay-out of the apparatus is often important. There are some connecting leads that could be taken

round the town and back without impairing results, and others where every inch is vital. In an experiment* carried out by the author the

standard of impedance used was an inch or so of wire! By giving thought to the placing of the instruments the leads likely to cause stray couplings or undesired distributed impedances are reduced to a minimum, and so are couplings between such coils as it may not be possible to screen effectively. Some parts of the circuit ought, perhaps, to be kept as far away from material substances as possible, or from other parts in which currents of the same frequency but a very different power level are flowing.

It is very important to be fully aware of what is inside each built-up unit. Failure to do this may result in

164. Layout of Apparatus

165. Need for Observing Restrictions in Applicability of Apparatus

short-circuits (because terminals thought to be unconnected are "commoned" or earthed), or omission of connections (because terminals thought to be linked are actually unconnected), or overloading some instrument, or exceeding the

conditions within which calibration holds good. For example, an output meter, sold to keep within a small limit of error, may be subject to much larger errors if an excessive standing current is passed through the transformer. Or a circuit may be effectively bypassed for a certain range of frequency, and error caused by using it outside this range; or the stray reactances may be greater than is allowable for the work intended. These risks are greatest with apparatus of neat "commercial" appearance, in which the convenience of operation and the engraved wording may deceive one into thinking it must give the correct results regardless of the many assumptions that are tacit unless a detailed book of conditions and exceptions is provided and consulted. A breadboard is at least easy to follow, and a sizzling coil

* "Fixed Condensers for 5-metre Work", *Wireless World*, September 29th, 1933.

is sooner spotted than if it is in a substantial mahogany cabinet. All apparatus, particularly of the more specialised types, should have a circuit diagram and a summary of conditions of use pasted in or on it.

Some technicians seem to consider it smart to affect a contempt for electric shock. One wonders how many of

166. Personal Risks

the fatalities are pure accidents and how many arise from carelessness. Sometimes a shock of thousands of volts causes only minor discomfort, and sometimes a hundred volts or even less is fatal. Even an ordinary domestic receiver gives 1,000 volts peak across its H.T. transformer secondary. It is difficult to get a dangerous shock when standing on an insulating mat with one hand in the pocket, even when poking about among high tension apparatus ; not that it is wise to do so in any circumstances, but the one-hand habit is a prudent one to acquire. Of course one ought never to touch conductors for the purpose of ascertaining whether or not they are " live ", but in an emergency when no instrument is available, the rule goes by the board. When it does, at least make sure that you use the *back* of your finger so that any resulting muscular twitch breaks the circuit instead of increasing the contact pressure.

Serious personal harm is fortunately rare, but the involuntary jerk resulting from even a slight " packet "

167. Avoiding Damage to Instruments

often damages some delicate instrument or causes short-circuits. This is only one of very many possible causes of damage to apparatus. It is so very easy to ruin a valuable instrument by a moment's inattention or lack of foresight ; and when a whole assembly of them is being used in one experiment it is like sailing on a dark night through a minefield. It is possible to do damage without being aware of it ; for example, in the preoccupation of carrying out a series of readings one may not realise that the current passing through a decade resistance box has risen so high as to produce a permanent loss of accuracy. It is therefore particularly important that the standards which are

ultimately relied upon and which there may be no means of checking are exposed as little as possible to such risks. Though an instrument may appear to have recovered from an overload, one always has uncomfortable doubts about the accuracy. Thermocouple meters are the most vulnerable to comparatively small overloads, and replacement and recalibration is expensive. Protective devices for meters have been given a good deal of attention lately, but the presence of fuses or cut-outs should not be made an excuse for carelessness. In this book strong preference is given to instruments and methods that relieve one of all anxiety concerning safety. An example of a method that is *not* recommended is the measurement of the leakage of a condenser by connecting it in series with a delicate microammeter and a high voltage. Even if one takes the essential precaution of short-circuiting the microammeter until the charging current has passed, the certainty of its demise in the event of condenser breakdown puts the method out of consideration. Sometimes accidental short-circuits do the damage; sometimes open-circuits, as when the bias comes off the grid of a valve in the anode circuit of which is a delicate instrument with the standing current carefully balanced out. These balances are especially risky. The method of resistance measurement recommended in Sec. 62 has the great merit that although a sensitive instrument is used, no resistance from zero to infinity inclusive can drive it off the scale on any of its ranges. The same applies to the author's slide-back valve voltmeter.

When such fool-proof devices cannot be used, make a calculation beforehand of the maximum current that can flow anywhere it might do harm (the chart referred to in Sec. 277 facilitates this); make all connections secure; avoid exposed leads or connections that might fall or be drawn into contact; and before operating switches make quite certain that they are going to do what you expect. It is an excellent habit to leave all multi-range meters connected for the highest volt range when they are not otherwise being used. This should be done immediately after a reading is taken, even if it is wanted again in half a minute. It might happen to be wanted to read volts instead of milliamps!

CHAPTER 8

MEASUREMENTS: COMPONENTS

It is regretted that an entirely logical arrangement of this chapter has not been found possible. Grouping all methods of measuring each quantity under its own heading would make reference easier, but would necessitate repeating whole pages devoted to the

168. Arrangement of this Chapter technique of measuring, say, inductance, in other sections such as capacitance, where the procedure is sometimes very similar. Also it is more in accordance with reality to treat all tests relating to one component in the same section instead of scattering them here and there according to the characteristic measured. But here again such questions arise as whether measurement of inter-electrode capacitances of valves should appear under "Condensers" or "Valves". Actually it appears under "Dynatron Measurements", where are included tests on a number of components that are given separate headings. So these headings must be very broadly interpreted, and full use made of the index.

Resistors

For checking the correctness of resistors within a few per cent. the direct-reading scales generally included in multi-range test sets are the most convenient. The usual procedure is to short-circuit the "X" terminals (as the terminals or clips to which the component to be measured will hereafter be known) and manipulate the adjustment provided until the instrument reads zero ohms, and then connect the resistor and take the reading. For more accurate results some meters

MEASUREMENTS : COMPONENTS

are provided with *two* preliminary adjustments, one for compensating for the battery voltage, and the other for its internal resistance. The highest resistance that can be measured can be increased by using an external battery.

Fig. 108 : Scheme for measuring low resistances

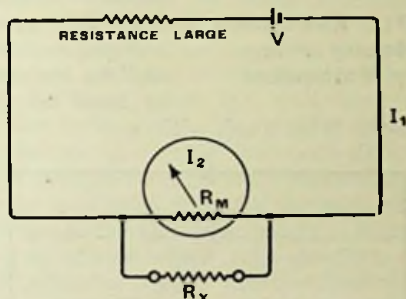

The multi-range instrument described in Sec. 62 is the most convenient for the low values for which the ordinary test set does not provide ; but essentially the same method can be adopted with any milliammeter or ammeter whose resistance is known (Fig. 108). A deflection, I_1 , preferably at or near full-scale, is produced by a current from any source whose resistance is at least a hundred times that of the meter, R_M . The unknown resistance R_X is then shunted across the meter and the deflection I_2 read.

Then

$$R_X = R_M \left(\frac{I_2}{I_1 - I_2} \right)$$

The greatest accuracy is when the connection of R_X halves the deflection, i.e., when $R_X = R_M$. Infinity corresponds to the initial deflection and zero to zero deflection, whatever the range ; so the method is particularly good when uncertain resistances such as switch contacts are to be measured. Another advantage for this purpose is that the test is made at very low voltage, and shows up poor contacts that might be broken down by a higher test voltage. For comparing switches there is no need to know

R_M accurately. The value can usually be learnt on applying to the makers.

If no ohmmeter is available, a voltmeter can be used for measuring resistances of a medium or high order in a manner rather similar to that just described, except that the resistance is connected in series with the meter, and the resistance of the supply must be *small* compared with that of the meter (Fig. 109). Then

171. Resistance Measurement by Voltmeter

$$R_X = R_M \left(\frac{V_1 - V_2}{V_2} \right)$$

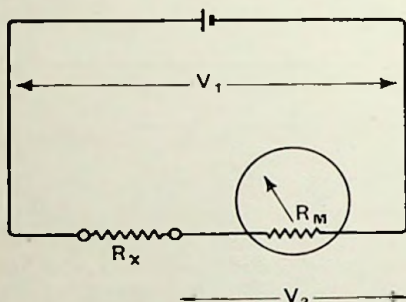

Fig. 109 : Measurement of resistance by voltmeter

As in most voltmeters the ohms-per-volt (full scale) is specified, there is not likely to be much difficulty about R_M .

For measuring very high resistances, such as insulation, the "Megger" or one of its offspring made by Messrs.

172. High Resistances Evershed and Vignoles is the generally accepted instrument (see Sec. 63). Some models are suitable for measuring condenser insulation. The

alternative, of using a sensitive meter to measure the current passed through R_X by a high voltage, ought only to be used with suitable precautions, such as a sufficiently high added resistance in series to protect the instrument in the event of total breakdown of R_X . A high-reading high-resistance voltmeter, say one of 1,000 ohms per volt and 500 volts full-scale, reads approximately 1 per cent. full-scale through 50 megohms when full-scale voltage is applied, and so detects a leakage of this order, but can

hardly be said to measure it. Various neon tube and valve devices have been evolved for such measurements (e.g., the G. R. Co. 437-A megohmmeter, scaled up to 50,000 megohms).

A simple and convenient device, primarily intended for measuring the leakage of condensers but applicable to other high resistances, is shown in Fig. 110. Almost any ordinary valve can be used, and the grid bias is chosen so that with the switch closed the pointer of the meter comes to a mark not much above zero on the scale. The condenser under test, meanwhile, is charged by both anode and grid voltages through the safety resistance R , which may be about $50,000 \Omega$. When the switch is opened the condenser discharges through its own leakage; the grid potential rises; and so does the anode current. The time taken for the pointer to reach a second mark is noted and when multiplied by a certain constant it gives megohm-microfarads. For example, if it takes 6 seconds, if the constant is 100, and the condenser is $0.1 \mu F$, its leakage is $6,000 M\Omega$.

173. Condenser Leakage

Fig. 110: Circuit for measuring condenser leakage and other very high resistances

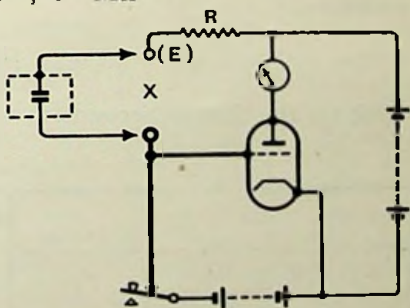

The leakage to +H.T. of the part of the circuit indicated by heavy lines is in parallel, and is the limiting factor as regards the resistance that can be measured. If necessary the valve must be selected for low leakage, and perhaps decapped. Quite an ordinary valve with bakelite base was found to have a leakage of the order of $50,000 M\Omega$ in dry weather. It can be measured by connecting an exceptionally good condenser and comparing the rate of leakage in the ordinary way (resistance R_1) with that (R_2) when the condenser is disconnected and the reading taken

by making the connection on the grid side momentarily after a lapse of time. Knowing the total resistance under both conditions, the apparatus resistance R_3 can be calculated:—

$$R_3 = \frac{R_1 R_2}{R_2 - R_1}$$

In the same way a high resistance other than that of a condenser can be measured by connecting it in parallel with a known condenser. But it should be realised that the measured leakage of most condensers varies for some time after application of the charging voltage, so the test should be repeated until consistent results are obtained.

Condensers smaller than about $0.005 \mu\text{F}$ discharge so quickly that they may be difficult to measure unless their leakage and that of the apparatus are exceptionally small.

For most purposes it is enough to see whether the pointer flicks rapidly across the scale, moves at a pace that is easily followed, or remains almost stationary; corresponding to bad, average, and exceptionally good condensers respectively. But the actual value of RC can be derived from the formula for the discharge of a condenser:—

$$RC = - \frac{t}{2.3 \log_{10} \left(\frac{V_2}{V_1} \right)}$$

where t is the time in seconds to discharge from V_1 to V_2 .

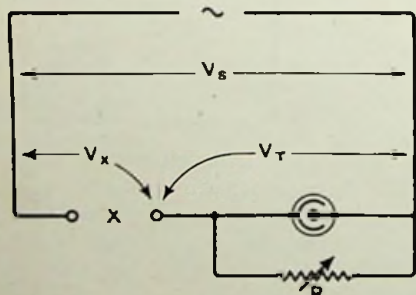

Fig. 111 : Simple neon-lamp impedance checker

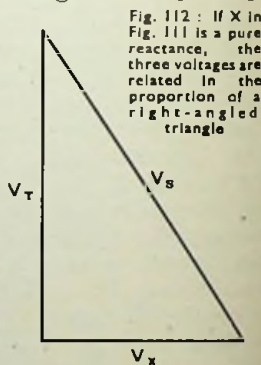

Fig. 112 : If X in Fig. 111 is a pure reactance, the three voltages are related in the proportion of a right-angled triangle

MEASUREMENTS : COMPONENTS

Suppose the anode voltage is 100, and the grid bias corresponding to the first mark on the scale is 10, and to the second 5. Then $V_1 = 110$ and $V_2 = 105$, and $RC = 21.5 t$. Having got so far, one would calculate the second mark to make the constant a round 20. It is a good thing to have alternative second marks so as to provide ranges suitable for low and high leakages.

The valve voltmeter described in Sec. 67 includes provision for this form of leakage test.

The most accurate measurements of resistance over a wide range are those performed with a bridge (Secs. 109-10), and if the bridge is suitably designed it is available for measurements with A.C. as well as D.C. Although bridges can be used at radio frequencies, the technique necessary puts them in a specialised field; the system chiefly considered here will be the dynatron (Sec. 185). The same method serves for measuring the reactance of resistors at any frequency with which one is concerned.

174. Other Resistance Measurements

and if the bridge is suitably designed it is available for measurements with A.C. as well as D.C. Although bridges can be used at radio frequencies, the technique necessary puts them in a

Condensers

Some multi-range test sets have capacitance scales, which are calibrated for use with the 50 c/s mains as source and enable components to be checked more or less approximately. A rough component checker can easily be made, using a neon tube as indicator (Fig. 111). The 50 c/s mains are used as source, and denoting the *peak* voltage by V_S , the "striking" voltage of the tube by V_T , and the voltage across the condenser by V_X , the three may be represented by a right-angled triangle as in Fig. 112, assuming the loss factor* of the condenser to be zero. V_S is known—it is

* As the term *power factor* ($\cos \phi$ or R/Z) suggests something that one desires to make as large as possible (as indeed one does in electrical power distribution systems), it is proposed that in connection with such things as condensers and tuning coils, the term *loss factor* (sometimes called *dissipation factor*) be used. It is more convenient to define it as R/X or $\cot \theta$, but unless losses are abnormally large R/Z and R/X are practically the same. In low-loss circuits, ϕ is nearly 90° , and the angle $90^\circ - \phi$, called the loss angle, δ , is sometimes specified. The loss factor is $\tan \delta$, and when small is practically equal to δ in radians.

$\sqrt{2} \times$ the R.M.S. mains voltage--and V_T is about 160 with the usual "beehive" or similar type of tube fitted for lighting socket. The reactance of the condenser, X_C , when R is adjusted so that the tube just lights, is

$$\frac{R V_X}{V_T}$$

So it is possible to work out the values of R that cause the tube to light when any given condenser is connected. This is perhaps most useful for checking that condensers come within certain limits, as might be needed in a Test Room. Assuming that the mains are 200 volts and V_T is 150, values of R at which the tube would light, but be extinguished by the next lower R , work out like this:—

R	C in μF
2 M Ω	0.001–0.002
1 M Ω	0.002–0.004
0.5 M Ω	0.004–0.008
and so on, down to	
1,000 Ω	2–4
500 Ω	over 4

Lower values of R are not recommended, as they would pass an excessive current, and condensers (other than electrolytic, which cannot be tested with this circuit), seldom exceed 4 μF . As it is, one has to take care not to get a shock from the "X" terminals.

The foregoing devices do not measure capacitance as such, but only impedance: and so cannot distinguish

between a condenser, a resistor, and a choke. *Measurement of capacitance, as distinguished from rough checking, is best done with some sort of bridge,*

176. Capacitance Bridges of which there is a great variety ranging from cheap portable instruments to equipment of great precision and, of course, cost. No condenser is pure capacitance, but some simple forms of bridge hopefully assume that it is

MEASUREMENTS : COMPONENTS

near enough for the resistance, or loss factor, to be ignored ; others make provision for the resistive component to be balanced out but not to be measured quantitatively ; and others again provide for more or less precise measurement of loss factor. Often the loss factor may be a matter of greater interest than the capacitance.

The very simple form of bridge shown in Fig. 113 is

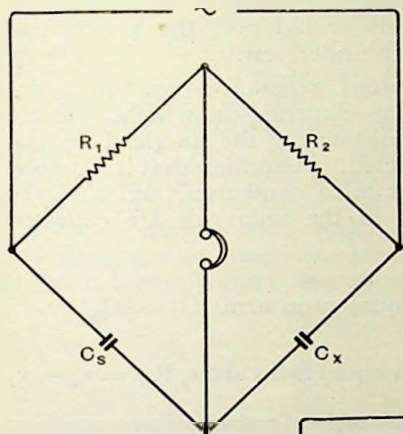

is in the first class mentioned. When the capacitance is small the effects of stray capacitance have to be considered. Preferably the ratio arms are equal, but as that means having a large continuously variable condenser, it is more

Fig. 113 (left): The simplest capacitance bridge, in which no account is taken of the resistive properties of the condenser

Fig. 114 (right): Capacitance bridge with phasing control to obtain sharper balance by equalising the loss factors of the condenser arms

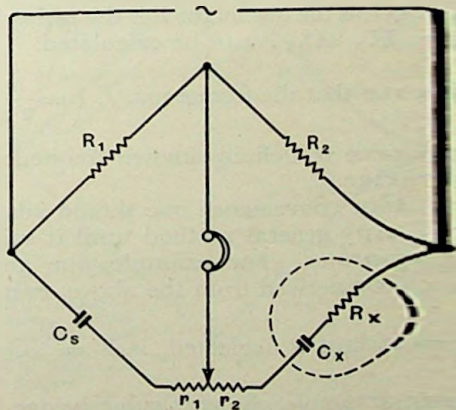

usual for simple bridges to use a potentiometer as the ratio arms (Sec. 123). Although phones are shown, they will be understood to represent any form of detector. At balance

$$C_x = C_s \frac{R_1}{R_2}$$

Frequency does not enter into this equation.

Fig. 114 shows a simple bridge with provision for balancing the resistive component. If it is done as shown (with a potentiometer), and $R_1 = R_2$, it must be remembered that the number of ohms over which the slider moves is effectively doubled because it is not only cut out of one arm but is put into the other. Condensers of the same capacitance may be compared for resistance by substituting one for the other at the "X" terminals; the nearer the slider is to these terminals at balance, the greater the resistance of the condenser under test.

Calculation of the actual resistance—or, more informatively, the loss factor—depends on whether or not the resistance of the standard may be

177. Measurement of Loss Factor neglected. Assuming that it is a good air or mica condenser, and that the losses in the unknown are expected to be relatively large :—

$$C_X = C_S \frac{R_1}{R_2} \text{ or with equal ratio arms } C_X = C_S$$

$$R_X = r_1 \frac{R_2}{R_1} - r_2 \text{ or, with equal ratio arms, } R_X = r_1 - r_2$$

And as the loss factor F is the ratio of resistance to reactance, or $R_X \omega C_X$, it can be calculated.

Note that the frequency, f , $\left(= \frac{\omega}{2\pi} \right)$, enters into this, so a

source of definite known frequency must be used for the bridge.

For convenience one should adapt the formulæ relating to any general method until it suits one's own particular apparatus. For example, the general formulæ for loss factor derived from the above, even if the loss factor of the

standard is neglected, is $F = \omega C_S \left(r_1 - \frac{R_1 r_2}{R_2} \right)$. But if,

for example, the particular bridge has equal ratio arms, is run at 800 c/s, and the resistance is adjusted entirely on the

MEASUREMENTS : COMPONENTS

standard side, then the formula can be simplified to

$$F = \frac{C_s r_1}{2} \text{ per cent., } C_s \text{ being in } \mu\text{F.}$$

It is of course essential that r_1 should itself be non-reactive; and for really accurate work there are other requirements, for details of which Hague* should be consulted. An alternative adjustment for loss factor is by means of a variable condenser across the ratio arm opposite the "X" arm, as in the Schering bridge (Fig. 115). One advantage of this is that if the source and detector are interchanged (as they may be in nearly all bridges), and the junction of the ratio arms is earthed, adjustment of C_1 can be made quite safely even when very high voltages are applied to C_x , and for this reason the method is very important in cable and insulator testing.

It is a bridge well worth considering for accurate measurements of condenser losses. Full descriptions are given in larger books; the equations are very simple:—

$$C_x = C_s \frac{R_1}{R_2}$$

$$R_x = \frac{C_1}{C_s} R_2$$

$$F = \omega C_1 R_1$$

The effect of stray capacitances across the ratio arms can be ignored if the arms are equal and if the *difference* in C_1 , due to the presence of R_x as compared with a condenser having negligible resistance, is taken.

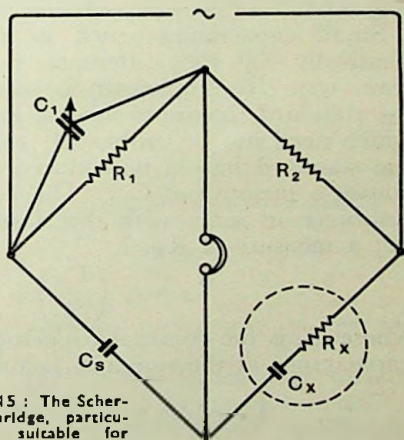

Fig. 115 : The Schering bridge, particularly suitable for measuring the loss factors of small condensers

The usual method of comparing or measuring the loss

* See Sec. 111.

factor of materials, such as paper, bakelite, etc., is to cut a sample in the form of a flat sheet

178. Loss Factor of Materials

and hold it between a pair of metal plates in such a way as to exclude air gaps as far as possible. To ensure this, mercury is recommended as the metal. Assuming that substantially the whole of the losses in the rudimentary condenser thus formed are due to the dielectric material, the loss factor of the condenser may be regarded as the loss factor of the material. The loss factor is not the same at all frequencies (though *dielectric* loss is far more constant than the resistance), but tests made, say, at audio frequencies generally give some idea of how the same materials compare at radio frequencies. To make accurate quantitative measurements, the technique has to be far more elaborate, in order to minimise contact and fringe errors. Obviously it is easier to measure thin sheets of 10 sq. ins. and upwards in area than small, thick chunks; if the capacitance of the sample is very small it is difficult to distinguish it from stray capacitance through other dielectrics.

Small capacitances such as these qualify very emphatically for the difference method of measurement (Sec. 97). The unknown is connected in parallel with the standard (balanced against any convenient condenser which need not be calibrated) and the amount by which the standard has to be reduced to restore balance is of course a measure of C_x . The amount, r_1 , by which the resistance in series with the standard must be altered is not a measure of R_x .

$$R_x \approx r_1 \left(\frac{C_s}{C_x} \right)^2$$

where C_s is the constant capacitance of the arm, i.e., the capacitance of the standard before C_x is connected.

$$\text{Therefore } F \approx \frac{\omega r_1 C_s^2}{C_x}$$

and if the same ω and C_s are used for all tests the formula can be further simplified.

If the dimensions of the sample are known, the dielectric constant can be measured at the same time; it is the

ratio between the capacitance with the dielectric in position to that with air only, or it can be calculated from $\kappa = \frac{11.3 TC}{A}$, where C is the capacitance in $\mu\mu\text{F}$, T the thickness in cms. and A the area in sq. cms.

Unless a bridge of really good quality is available, it is better to measure small capacitances (below about 1,000 $\mu\mu\text{F}$) and their loss factors at radio frequencies by means of the dynatron, as will be described in Secs. 180-8. Quite apart from convenience, it is better that condensers and materials should be tested at the working frequency.

There are various ways in which a capacitance much larger than the standard can be measured. One is to connect it in series with some condenser that can be measured directly. If C_1 is the capacitance of this condenser by itself, and C_2 with C_x

179. Large Capacitances

in series, then

$$C_x = \frac{C_1 C_2}{C_1 - C_2}$$

Fig. 116 : Method of testing electrolytic and other high-capacitance condensers by cathode ray tube

In other methods a capacitance in parallel with a resistance is balanced against one in series, and use made of the appropriate circuit equation. This will be referred to again in Sec. 199. A disadvantage is that the balance depends on frequency, so a pure waveform is essential.

A method of measurement particularly suitable for large capacitances utilises the cathode ray tube. Fig. 116 shows the connections. The 50 c/s mains may conveniently be used as the A.C. source, and if the condenser is electrolytic a battery or other Z.F. source B exceeding the

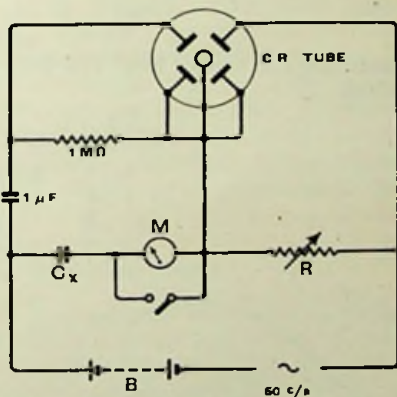

peak alternating voltage, must be included. It may be desirable to measure the leakage current at the same time; M is a multi-range—or better still, a rectifier-shunted—milliammeter which ought to be short-circuited when the capacitance test is being made. The deflection-plate condenser and leak are necessary for electrolytics, to prevent the battery from deflecting the ray off the centre of the screen. The objection to connecting the battery directly in series with the condenser across its pairs of deflection plates is that its resistance may not be negligible. The resistance R is adjusted until the deflection due to it is equal to that due to C_x . Actually in most tubes the deflection sensitivities of the two pairs of plates are not quite equal, and this must be allowed for; but disregarding this correction, and assuming the A.C. source is free from harmonics, a perfect condenser would show a perfect circle on the screen, and as resistance and reactance would be equal

$$C_x = \frac{I}{\omega R}$$

Assuming the source is 50 c/s, here are a few representative values :—

C_x	R
1 μF	3183 Ω
8 μF	398 Ω
25 μF	127 Ω
100 μF	31.3 Ω

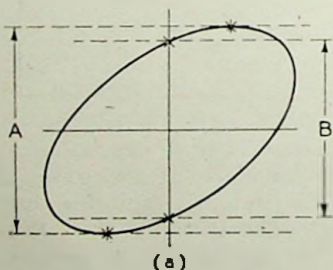

Fig. 117a : Analysis of the cathode ray tube figure for calculating the phase angle of a condenser

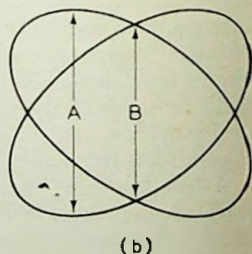

Fig. 117b : Double ellipse obtainable with a double-beam C.R.T.

MEASUREMENTS : COMPONENTS

If the loss factor of C_x is very bad it causes an appreciable departure from the circular form ; the dimensions A and B (Fig. 117a) enable the phase angle and hence the loss factor to be calculated, for $\sin \phi = B/A$.

The loss factor is therefore

$$\sqrt{\left(\frac{A}{B}\right)^2 - 1}$$

The dimensions A and B are difficult to measure accurately, even when the phase angle is exceptionally large, because the axes and parallel lines are not present on the screen. G. N. Patchett has shown (in *Electronic Engineering*, April, 1944) how this difficulty can be overcome with a double-beam cathode-ray tube, by connecting the second Y-plate to the first instead of to the anode. The result is to produce two ellipses, as in Fig. 117b, from which B can be measured between intersections and A directly across the figure without reference to axes. Another method for electrolytic condensers is by the bridge shown in Fig. 78, for in practice no polarising voltage is necessary, and the resistance of the condenser under test is given by the resistance in the standard arm multiplied by the scale factor. Resistance of an electrolytic condenser, being fairly constant with frequency, is better to measure than the loss factor.

Dynatron Measurements

It is appropriate at this stage to describe in some detail the use of the dynatron oscillator, as measurement of both condensers and coils are included.

180. Principles of Application As already mentioned, the dynatron does all the tests that an oscillator of the more usual feedback type will do (V.H.F. excepted), and many others ; and although R.F. measurements will be particularly described, it is applicable at A.F. too. The principles of the dynatron were discussed in the last chapter, and will now be assumed.

Every impedance, however complex, can be represented

at any one frequency as a pure resistance and a pure reactance, either positive (inductive) or negative (capacitive). It is a matter of convenience whether they are reckoned as being in series or parallel; formulæ are given in Chapter 12, (Sec. 290) for changing from one to the other. If the actual arrangement of the electrical quantities in the circuit is known, it is possible (but sometimes excessively laborious) to calculate the impedance of the whole at any other frequency, as also illustrated in Chapter 12. When the system is very complex, for example if it cannot be regarded either as "lumps" of resistance and reactance or of uniform distributions of them, the only practicable way of finding out is actually to measure them at all the frequencies concerned, and, if desired, to express the results in the form of curves. Generally it is necessary to plot the points very closely together or sharp peaks or dips may be missed.

It has been shown how one of these quantities—resistance—determines the amount of negative resistance that a dynatron must be adjusted to give in order to maintain oscillation; it is easy to detect the starting and stoppage points of oscillation by means of a suitable receiver, and so the negative resistance adjustment—usually grid bias—can be calibrated in terms of that quantity, or alternatively it can be measured on the spot by means of the negative-resistance bridge (Sec. 187). The other fundamental quantity—reactance—affects the frequency, which also can be observed to any desired precision. An increased frequency shows a decreased total reactance, such as would be caused by an inductance in parallel or a capacitance in series with the oscillatory circuit; and vice versa.

As equality is an easier condition to observe accurately than a specified change, the usual object is to work on the substitution plan, compensating for the introduction of the unknown by an equal and opposite amount of the standard, and so keeping the observed frequency constant. The two chief cases are (1) the circuit being investigated is also the main oscillatory circuit, or (2) it is connected in parallel with another oscillatory circuit.

As an example of the second of these the measurement

of a R.F. choke will now be considered. The ideal R.F. choke is effectively an infinite impedance.

181. An Example of Dynatron Test

The writer once devoted a lot of time to the design of such a choke, and succeeded in producing one equivalent over a very wide band of frequencies to a resistance of over a megohm shunted by a capacitance of about $1 \mu\mu\text{F}$ or less. It is common for the average values in commercial chokes to be under a quarter of a megohm and over $8 \mu\mu\text{F}$, and at certain frequencies for such results as $10,000 \Omega$ and $25 \mu\mu\text{F}$ to occur ! The effects, as regards damping and mistuning, on a tuned circuit with which the choke is virtually in parallel can be imagined. Measurement of a choke at frequencies other than those

at which it is intended to work are unable to give the required information. Measurement by dynatron fulfils all the conditions that have been laid down as desirable in any method (Secs. 20-1).

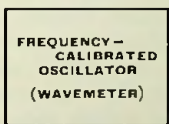
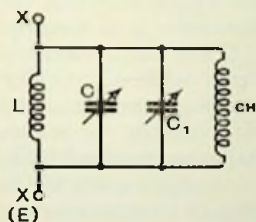

Fig. 118: Apparatus used for measuring the resistance and reactance at working frequencies of a R.F. choke, CH. This is typical of many measurements that can be made by means of a dynatron oscillator

The dynatron apparatus itself has been described in detail (Secs. 148-153) so need not be repeated in theoretical diagrams. All that it is necessary to show is the "X" terminals (Fig. 118). The terminal on the supply side is distinguished by "E" denoting "earthy". The other one should of course be close to the anode and joined to it by a short straight link ; or may even consist of the valve top terminal itself. The four components shown should

also be connected as directly as possible in order to put them all effectually in parallel, with no appreciable lead inductances intervening. It is desirable for clips to be provided so that the choke Ch can be clipped in and out without any alteration to the circuit other than its presence or absence. Of course it is necessary for the leads to be long enough to prevent Ch from being affected by proximity to any other components, particularly L, which may be screened provided that this is not incompatible with low R.F. resistance of the oscillatory circuit as a whole. Generally L will be one of a set of low-loss plug-in coils covering all the useful wavebands. C is the main tuning condenser, required to tune L to approximately the desired frequency. It need not be calibrated. C₁ is a condenser of about 25 μμF maximum.

If C₁ is not already calibrated, the apparatus can be used to do so, provided that the inductance L is known.

182. Calibration of Small Standard Variable Condenser For this purpose C should preferably be large compared with C₁. The dynatron oscillator is synchronised with a calibrated oscillator (or wave-meter) by the beat note method (Sec. 135). Call the frequency with C₁ at

zero f . Any setting of the small condenser can be marked as zero; for the present purpose it is convenient to make it about half the maximum capacitance so as to read increase and decrease as positive and negative. Now alter the setting of C₁ until an audible beat note is produced, of a frequency f' that can be compared with some standard. Then move the condenser the other way until the same beat note is produced the other side of zero, shifting the frequency by an amount $2f'$. The corresponding *change* in capacitance, C', is

$$C' = 2C \left(\frac{f^2}{(f-f')^2} - 1 \right)$$

but as C is the whole capacitance of the circuit prior to the adjustment of the small condenser, and is therefore unknown even if the condenser C is calibrated, it is more useful to have the formula in terms of L :—

MEASUREMENTS : COMPONENTS

$$C' = \frac{10^{12} f' (2f - f')}{2\pi^2 f^2 L (f - f')^2}$$

in which the units are μH , $\mu\mu\text{F}$, and kc/s . The wave-meter frequency is then brought to give f' once more on the far side of zero beat, and the process is repeated several times, giving a number of closely-spaced points for drawing a calibration curve of C_1 .

As f' is generally less than 1 per cent. of f , and therefore practically negligible in comparison with it, the formula simplifies to

$$C' \approx \frac{4 C f'}{f}; \quad \text{or} \quad \frac{10^{12} f'}{\pi^2 L f^2}$$

with the same units as before, and it need not be worked out afresh each time if C_1 is small compared with C , and equal $2f'$ steps are taken, as f can be regarded as practically constant.

This method, incidentally, is the most accurate for measuring very small capacitances. For example, suppose f is 1000 kc/s and L is 250 μH ; if f'

183. Measurement of Very Small Capacitances is 50 c/s , the corresponding C' is 0.02 $\mu\mu\text{F}$. The object of tuning from $f + f'$ to $f - f'$ rather than f (zero beat) is that there is always a tendency

for even loosely coupled oscillators to pull in to synchronism; alternatively one can observe the change from, say 250 to 300 c/s , as may very precisely be done by a cathode-ray tube with one pair of plates supplied from the 50 c/s mains.

Larger capacitances, of the order of 10 $\mu\mu\text{F}$, may be measured by comparison with the variable condenser just calibrated. This is what is done with

184. Measurement of Reactance Generally our R.F. choke. It is clipped in position, and alters the frequency of oscillation, as observed by the receiver. It will also probably stop it

oscillating altogether until the grid bias is readjusted; for it must be re-emphasised that the dynatron must always be set to the only-just-oscillating condition, and that this

can be done satisfactorily only when the anode voltage is adjusted to a point on the curve where there is no backlash (Fig. 94). The frequency is brought back again by adjustment of C_1 , and the capacitance change read off. At frequencies above the natural resonant frequency a choke, or any other coil, is effectively a capacitance, and necessitates a reduction in C_1 . At its resonant frequency it is a pure resistance and there is no frequency shift to be compensated. Below its resonance it is an inductance, which is equivalent to a negative capacitance, and C_1 must be increased. Any capacitance can be represented by a negative inductance, and vice versa, but the equivalence holds good numerically at only one frequency.

$L = -\frac{1}{\omega^2 C}$, and $C = -\frac{1}{\omega^2 L}$, where ω as usual is $2\pi f$. Thus, if the frequency is known, L can be measured in terms of C . But one cannot measure the *true* inductance of a coil in this way, because any actual coil is mixed up with internal capacitance, and so would give a different answer at every frequency.

The reactance, positive or negative, of the choke has been found. To find the effective resistance at any

185. R.F. Resistance by Comparison

frequency, it must be compared with known resistances. A continuously-variable calibrated high-frequency resistor from about 0.01 to 5 $M\Omega$ is not obtainable, so it is necessary to clip in a number of measured grid leaks, which are fairly reliable up to a few Mc/s. By connecting in turn values of 0.01, 0.025, 0.05, 0.1, etc., megohms, calibration curves can be drawn as in Fig. 119, relating added shunt resistance to critical grid bias, and from these the approximate resistive component of the choke's impedance determined, at any rate approximately, by observing the critical grid bias with the choke connected.

The same method is followed in measuring the losses in condensers, coils, insulating materials, etc. It is most informative to analyse the circuits of a receiver in this way, connecting or removing each item in turn. One can find out the relative amounts of damping introduced by tuning

MEASUREMENTS : COMPONENTS

coil and condenser, coil screen, terminal plates, connecting leads, valve sockets, detector valve, AVC diode, screened lead, etc., and take steps to remedy those that are excessive, and not waste time reducing those that are relatively

Fig. 119 : Calibration curve of critical grid bias for a dynatron oscillator when various resistances are shunted across the oscillatory circuit. With the help of this, unknown resistances can be approximately determined at any frequency included in the calibration

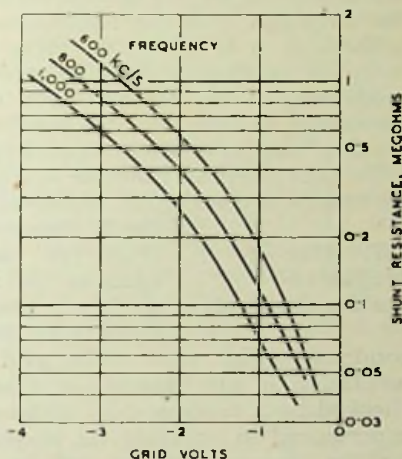

negligible. It may even be possible to use the valve in the receiver itself as the dynatron, temporarily connecting screen and suppressor grid together, as in Sec. 37a. Artificial conditions of measurement are thereby almost entirely excluded.

The method of resistance measurement by shunt resistance calibration may appear a trifle crude, though it is good enough for most practical purposes. However, for greater precision a direct measurement of the negative resistance of the dynatron can be made. In such tests as that of the

186. Other R.F. Resistance Measurements R.F. choke, which is put in parallel with an oscillatory circuit, it is necessary first to measure the resistance R_1 without choke and then with it, R_2 , and derive the resistance R_c of the choke above in the usual manner for resistances in parallel :—

$$R_c = \frac{R_1 R_2}{R_1 - R_2}$$

but when the resistance of an oscillatory circuit itself is to be measured, it can be done direct. The resistance of a coil may also be measured directly if a condenser with negligible losses is used for tuning it. Of course, if one wants to avoid having to measure the negative resistance of the dynatron and the resistance-substitution method of calibrating it is adequate, there is no reason why one complete oscillatory circuit should not be measured by connecting it in parallel with another. There is the advantage, in fact, that it is possible to measure the circuit at other than its resonant frequency, if that is wanted.

To take a typical example again, suppose it is desired to investigate a certain I.F. transformer. It is connected to

**187. Use of
Negative-
resistance Bridge**

the X terminals of the dynatron unit (Fig. 120) and tuned by its own trimmer to the desired frequency; the bridge circuit being cut out by the flying lead clipped on to the by-pass condenser (Fig. 100). The grid bias is adjusted until oscillation is just started, so that the frequency can be checked by a receiver near at hand. Difficulty would be experienced in applying the methods commonly specified for the measurement of coil losses, because the screen prevents a very loosely coupled external oscillator from developing enough potential across the coil to be measured accurately by a valve voltmeter. But by simply connecting it to the dynatron, the oscillation can easily be detected by a receiver of quite moderate sensitivity even when situated a yard or more away, and the threshold adjustment observed. It is advisable to have a very fine grid bias control, in addition to the coarse one for preliminary adjustment. When it has been carefully set so as to be right on the division between oscillation and no-oscillation, the clip lead is moved over to the anode terminal, short-circuiting the X terminals, and the resistance box adjusted to give exact balance, R ohms. By adjusting the bridge coil coupling at the same time, a very sharp balance is possible.

But for two reasons it is generally necessary to use an amplifier for detecting the exact balance. The first is

MEASUREMENTS : COMPONENTS

that the whole of the oscillator signal comes across the valve, and to measure the slope of (as nearly as possible) a tangent to the valve characteristic curve, the signal voltage should be kept as small as possible—not more than about one volt for preference. As the resistance of the bridge to the oscillator is not more than $100\ \Omega$, a step-down transformer from the oscillator is indicated. The second reason why a particularly sensitive detector is needed is that the resistance of the ratio arms of the bridge is necessarily low and the ratio itself is high, in order to avoid complications owing to an unduly high resistance in the anode circuit of the valve. In measuring "good" coils and circuits, the negative resistance of the valve may be several hundred thousand ohms, and amplification before the phones is almost essential. A step-up transformer such as a fairly high-impedance microphone-to-valve transformer, ratio between 40 and 100 to 1, may be used to advantage, and arranged so that the stray capacitance to earth is as little as possible.

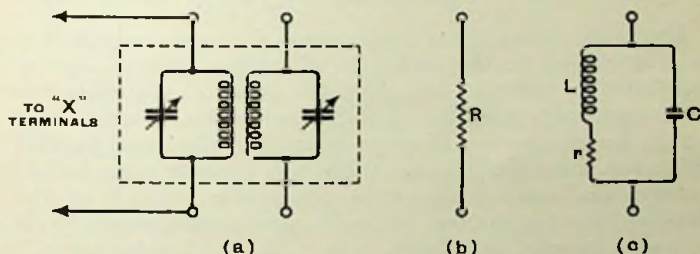

Fig. 120: An I.F. transformer represented by the diagram *a* or any other tuned circuit, however complex, is equivalent at resonance to a high resistance *R* (*b*) which is the quantity measured by the dynatron apparatus. Alternatively it can be represented in the form *c*.

Although the resistance of the bridge to anode current is small, for the utmost precision the process of setting the grid bias to the exact threshold of oscillation, and then balancing the bridge, should be repeated one or more times, in case adjustment of *R* has slightly shifted the critical bias adjustment. All this

188. Analysis of Results

may sound a long business, but actually can be done very easily and quickly. Then the negative resistance of the valve is $100R + 99$, numerically equal to the dynamic resistance (sometimes called anti-resonant impedance) of the transformer including its own trimmer. If it is desired to find out how much loss is due to the coil and how much to the trimmer, the latter must be replaced by a high-grade variable condenser, whose loss is either negligible or known, adjusted to the same frequency. Suppose the first measurement gives a figure of $125,000 \Omega$ for the dynamic resistance, R . For design purposes that is the most important quantity to know, but if the inductance L is known (and it can be measured with the same apparatus, as will shortly be described), and also the frequency, the loss resistance follows ;

$$R = \frac{L}{rC} = \frac{\omega^2 L^2}{r}$$

If L is $500 \mu\text{H}$ and the frequency is 470 kc/s , r works out at 17.5Ω . The "magnification", Q , is $\frac{\omega L}{R}$, which is 84.5 .

Fig. 120 shows these equivalents ; r is shown as if it were confined to the coil, but of course part of it may represent condenser loss. If R with a negligible-loss condenser is $170,000$, the Q of the coil and its surroundings is 115 , and that of the trimmer is 320 ; by the usual parallel resistance formula. If one prefers to express these in loss factors, the reciprocals of Q are taken ; the F of the trimmer is thus 0.0031 or 0.31 per cent. (which, incidentally, is none too good).

If the experiment is done carefully there is only one correction to make ; the damping caused by the terminal and anode of the valve may not be

189. Possible Sources of Error

the same at the radio frequency of oscillation as it is at the audio frequency used for measuring the negative resistance of the valve. Generally the A.F. loss is completely negligible, and the R.F. loss can be measured by means of a second dynatron. Suppose it is found to be equivalent to a resistance of $1.5 \text{ M}\Omega$ in parallel, the true R of the coil is $192,000$ instead of $170,000$ as found before.

There is also a possible error in assuming that the negative resistance of the valve is the same at all frequencies. The assumption is probably quite justifiable except perhaps at ultra-high frequencies, at which the time taken by electrons to cross from one electrode to another becomes an appreciable fraction of one cycle of oscillation (Sec. 266).

Even when every precaution is taken the dynatron method is quite within the capabilities of modestly equipped laboratories, and the author believes it to be superior in accuracy to any other method of comparable practicability, if not to any known method however elaborate. As mentioned in *The Wireless Engineer* of October, 1933, by inserting a small piece of fine resistance wire in series with the coil, measuring with the dynatron the difference in radio-frequency resistance of the coil caused by this introduction, and comparing it with the results of more precise direct determination of the wire resistance, it was found that results were consistent within less than 1 per cent. over a wide band of frequencies, and a quarter of 1 per cent. if special care was taken. The accuracy of measuring r , and still more R , is of course better still. The method also has the advantage of requiring no corrections for the self-capacitance of the coil (Sec. 197), which is itself a rather troublesome thing to measure.

Measurement of inductance has yet to be dealt with. It is not possible to get accurate results by tuning the coil with a single known capacitance and

190. Measurement of Inductance observing the frequency, because the coil itself has a certain self-capacitance, usually of the order of

$5 \mu\mu\text{F}$, and there are other initial capacitances that are not known precisely, if at all. But if the two frequencies with and without an added known capacitance are noted,

the inductance $L = \frac{\omega_2^2 - \omega_1^2}{\omega_1^2 \omega_2^2 C'}$ where C' is the reduction in capacitance required to bring the frequency from $\frac{\omega_1}{2\pi}$

to $\frac{\omega_2}{2\pi}$. A single known fixed capacitance will do, but for the best accuracy a difference-calibrated variable condenser

should be used, and there is then no question about minimum capacitance of the condenser, or stray capacitance of leads, etc. Obviously the ratio of final to initial capacitance should preferably be large. The most convenient and accurate method is to note the reduction in capacitance required to tune from the fundamental to the second harmonic, or from second to fourth harmonics (because they are more comparable in strength than fundamental and harmonic), of a fixed oscillator. In that

case $\omega_2 = 2\omega_1$ and $L = \frac{3}{\omega_2^2 C'}$ or $\frac{3}{4\omega_1^2 C'}$

If L is in μH , C in $\mu\mu\text{F}$, f in kc/s , and λ in metres,

$$L = \frac{19 \times 10^9}{f_1^2 C'} \quad \text{or} \quad \frac{0.211 \lambda_1^2}{C'}$$

The coil to be tested is connected in parallel with a calibrated variable condenser across the dynatron "X" terminals, and with the condenser somewhere near its maximum (but preferably not too near, for the calibration may not be at its best over the top and bottom 5 per cent. of the scale), the fundamental oscillation is picked up on a receiver, which should be oscillating rather strongly, and is tuned to zero beat after the dynatron grid bias has been adjusted to threshold oscillation. The frequency, f_1 , is noted by bringing a calibrated oscillator also to zero beat. The capacitance of the standard condenser is then reduced until the dynatron beats with the second harmonic of the receiver, at which, incidentally, the *total* circuit capacitance is a quarter of its initial amount. The difference between the capacitance readings gives C' , from which L is calculated as above.

The method usually described for measuring inductance at radio frequency consists in tuning it by a calibrated condenser and plotting the results of a number of readings of capacitance and the corresponding wavelengths squared (λ^2), as in Fig. 121. Although the readings, being subject to some error however small, may give points that do not lie exactly on a straight line, the best line drawn through them is likely to average out

MEASUREMENTS : COMPONENTS

the errors to some extent, and the extent to which they do fall on a line is a useful check on the probable accuracy of the readings. The length OB, on the negative side of the scale, represents capacitance additional to that of the calibrated condenser ; that is to say, the self-capacitance C_L of the coil, and that of any apparatus such as the dynatron, and associated leads. By adding this in, the total capacitance required to tune the coil to any wavelength or frequency is given, and L follows from whatever formula the worker finds most convenient ; for example

$$\lambda = 1885 \sqrt{LC} \quad \left(\begin{array}{l} L \text{ in } \mu\text{H} \\ C \text{ in } \mu\text{F} \end{array} \right)$$

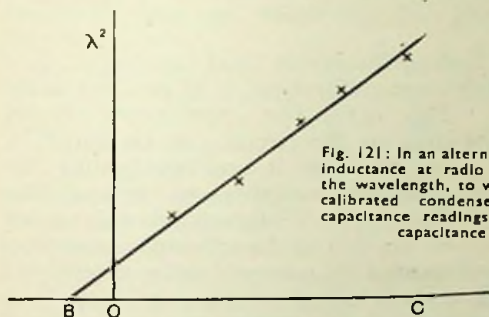

See also Sec. 293.

The previous method, although based on this one,

Fig. 121: In an alternative method of measuring inductance at radio frequency the square of the wavelength, to which the coil is tuned by a calibrated condenser, is plotted against capacitance readings, and the total circuit capacitance thus determined

is more likely to be accurate, because only one known frequency is needed, and generally it is possible to make that coincide with an accurately known point such as a reliable transmitter or a quartz crystal standard. However, if there is any risk that the wrong harmonics might have been used, it is wise to make quite sure by plotting several readings as in Fig. 121 as a check.

For reasons explained elsewhere, preference is given throughout this book to methods depending only on the *difference* calibrations, especially of variable condensers.* Two points on the condenser scale may be marked 100 $\mu\mu\text{F}$ and 300 $\mu\mu\text{F}$ respectively, and

* A valuable article on this is "The Measurement of Small Variable Capacities at Radio Frequencies", by W. H. F. Griffiths, *The Wireless Engineer*, August, 1928.

assuming the condenser was accurately calibrated and has not altered since, the difference is really $200 \mu\mu\text{F}$ no matter what sort of circuit the condenser is in. But the actual capacitance in the circuit when the condenser is set to $100 \mu\mu\text{F}$ is certainly *not* $100 \mu\mu\text{F}$. It is $100 \mu\mu\text{F}$ plus certain other amounts which may or may not have been there when the condenser was calibrated, and although they may be measured separately the results are bound to be of a lower degree of accuracy than the difference between two settings of the standard. So if, say, $200 \mu\mu\text{F}$ is to be added to a circuit it is better to do so by turning the standard from 100 to 300 (or any points giving the required difference) than by connecting the condenser in and setting it to 200.

The method of finding the actual total capacitance in a circuit, given a difference calibration, is to proceed as for

193. Measurement of Self-Capacitance of Coils

Fig. 121. The capacitance of any item in the circuit can be found by withdrawing it and readjusting the standard variable to restore the frequency. Unfortunately this cannot be applied to the self-capacitance of a coil (C_L), because it cannot be removed independently of the coil. Neither does it serve to measure any item essential to the test, such as the minimum capacitance of the standard, unless another is available for a separate test. So although the method of Fig. 121 is the one usually specified for measuring the self-capacitance of a coil, in practice it becomes quite a long business. It is also a good example of a method that looks perfectly all right until one has experience of it. To determine the position and inclination of the line with accuracy it is necessary for the extreme plotted points to be separated by not less than probably several hundred $\mu\mu\text{F}$. Even when the readings are taken very carefully and accurately, one finds that the drawing of the line can lead to an uncertainty of several $\mu\mu\text{F}$ in the position of B, and as C_L is only a part of BO the error in it after allowing for the various items in the remainder is probably of quite the same order as C_L itself. Two lines which may look equally well drawn among the

MEASUREMENTS : COMPONENTS

points on the graph might give C_L values of 0 and $6 \mu\mu\text{F}$ respectively, or even a small negative value.

What is believed to be the only published method of measuring C_L with high precision was described by the author in *The Wireless Engineer*, September, 1933. The required result is one-third of the *difference* between two readings on the standard, and the precision of reading is therefore actually three times higher than that of the standard. Against this must be set a certain loss in accuracy due to the necessity for deducting the capacitance of the dynatron valve and of the special measurement jig ; but provision is made for doing this *in situ* with exceptional ease and accuracy. The inductance also is calculable from the results.

Fig. 122 : Connections used in an accurate method of measuring the self-capacitance of coils

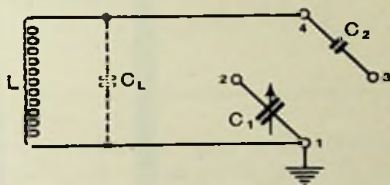

The method makes use of a difference-calibrated condenser C_1 (Fig. 122) and any fixed condenser C_2 of a capacitance within the range of C_1 . Terminals 3-1 are first joined and an oscillator (which need not even be calibrated) set to resonance. Next 2-4 are joined instead, and C_1 adjusted to resonate with the oscillator. C_1 and C_2 are then equal. Then 2-3 only are joined and the oscillator frequency shifted so that its second harmonic resonates. Lastly 1-3 and 2-4 are both joined, 2-3 being open, and C_1 is increased to resonate to the oscillator fundamental. This increase is $3(C_L + C_0)$ where C_0 is the capacitance of the valve and jig. The method is a good example of deriving the result from the minimum number and maximum accuracy of data.

The jig (Fig. 123) consisting of screens and special contact devices, described in the article referred to, is designed to facilitate the test and to reduce to negligible amounts any stray capacitances resulting from the various connections that would affect the result.

While dealing with measurement of small capacitances

it may be as well to consider those between valve electrodes, or any systems (such as a piece of twin cable in an earthing sheath) in which one wants to know the capacitance between two elements that both have capacitance to some third party or parties. For example, take a triode, where there are three capacitances, shown diagrammatically in Fig. 124. It might be supposed that all one has to do is to connect the two electrodes concerned to the measuring

194. Capacitances to Several Elements

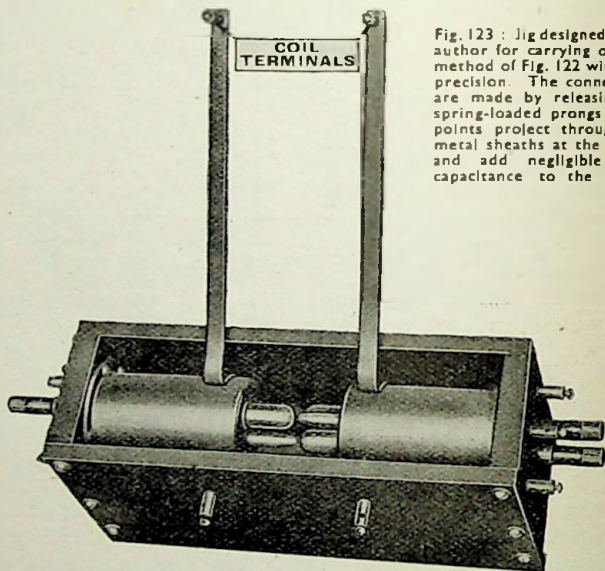

Fig. 123 : Jig designed by the author for carrying out the method of Fig. 122 with high precision. The connections are made by releasing the spring-loaded prongs whose points project through the metal sheaths at the centre and add negligible stray capacitance to the circuit

apparatus and leave the other unconnected ; but this would not give the correct result. The proper procedure is to measure in turn the capacitance from each electrode to the other two joined together. For instance, the grid and anode are tied together and the capacitance C_1 from them to cathode is measured :—

MEASUREMENTS : COMPONENTS

$$\begin{aligned} C_1 &= C_{GO} + C_{AO} \\ \text{also } C_2 &= C_{AG} + C_{AO} \\ \text{and } C_3 &= C_{GC} + C_{AG} \end{aligned}$$

From these results the required capacitances are calculated.

Here are the required solutions of the simultaneous equations just stated :--

$$C_{GO} = \frac{C_1 + C_3 - C_2}{2}$$

$$C_{AG} = \frac{C_2 + C_3 - C_1}{2}$$

$$C_{AC} = \frac{C_1 + C_2 - C_3}{2}$$

Fig. 124 : Diagrammatic representation of the three inter-electrode capacitances in a triode

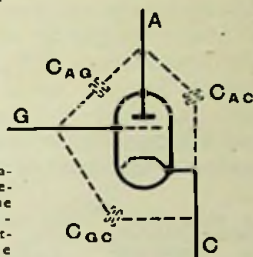

The actual measurement process is the same as that for the R F. choke, described in Sec. 184.

So many dynatron measurements having been described, it is unnecessary to go into detail about such matters as matching the sections of a gang condenser. Each section in turn is used to tune a suitable coil, and even very small differences in capacitance can be detected by the change in beat note. At the first (minimum capacitance) setting the sections are equalised by means of the trimmers. Some idea of the seriousness or otherwise of mismatching at other settings can be judged without actual measurement ; a beat note of a few hundred c/s, compared with zero for the section taken as the standard of reference, would generally be acceptable ; but if the note goes beyond audibility altogether the mistuning effect in a receiver can be imagined. The only precaution to be observed is to see that the clip lead or other means of switching from one section of the gang to another inserts the same amount of stray each time it is moved to a given section. Actual calibration can, of course, be done at the same time if desired.

If an impedance is too low to be measured directly

across the "X" terminals of the dynatron it should be "tapped down" the coil. Suppose

196. Measurement of Low Impedances a resistance of the order of $100\ \Omega$ is to be measured. It would of course render oscillation impossible if connected across the whole coil, but if tapped across one-twenty-fifth of the turns it is equivalent to about $62,500\ \Omega$ across the whole coil (see Fig. 194). Unfortunately a R.F. coil is not a perfect enough transformer for the usual square-of-the-ratio relationship to hold accurately for comparison between such a resistance and a larger one across the whole coil, so it must be tested against a standard of its own magnitude.

Fig. 125: Circuit diagram explaining the resistance-variation method of measuring R.F. resistance

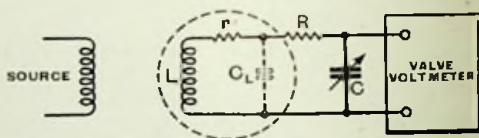

Although the dynatron method has marked advantages for R.F. resistance measurement, two others will now be briefly described. The first, well-

197. R.F. Resistance

known as the resistance-variation method, is illustrated in Fig. 125. The coil is very loosely coupled to a powerful oscillator of the desired frequency, and is tuned by a good variable condenser C until the voltage read by the valve voltmeter VV is a maximum. The losses due to C and VV ought to be negligible, or known from the results of a separate test. At first the resistance R is zero, and the oscillator is adjusted to give a large voltage across C . Thereafter the oscillator is untouched, because it is assumed that the voltage actually induced in the coil is constant for all readings. Several resistors R , the R.F. resistance of which are known, are in turn inserted, and the corresponding voltages read on VV . It is necessary for the reactance of R to be either negligible or small and constant throughout; and so it usually takes the form of short lengths of fine resistance wire (see Sec. 299), a copper wire of the same length being substituted as a "zero".

MEASUREMENTS : COMPONENTS

By plotting R against the reciprocals of the corresponding voltages V , the results should fall on a straight line, as in Fig. 126, and the apparent R.F. resistance, r' , of the coil is given by OB . The graph reminds one of Fig. 121, and the method is even more disadvantageous, because the accuracy of reading V and R over a wide range is generally not high, and the accuracy of r' is lower still. It is also necessary to measure C_L in order to apply the correction

$$r = r' \left(\frac{C}{C_L + C} \right)^2,$$

where r is the true resistance. This correction is not needed in the dynatron method, nor in the next to be described, which is a good one if means are available for measur-

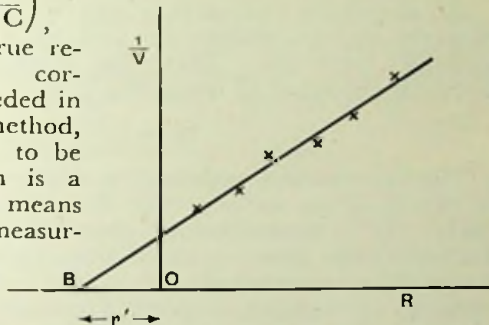
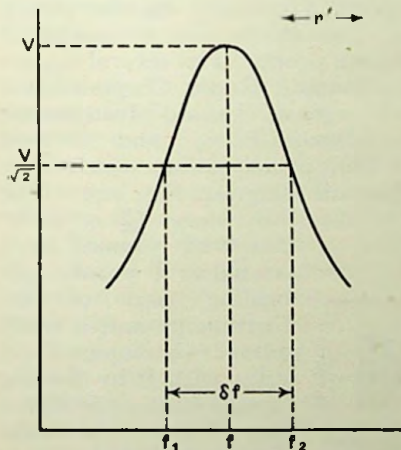

Fig. 126: Method of plotting the results derived from the system of Fig. 125 to get r' , the R.F. resistance, neglecting the self-capacitance, C_s , of the coil. Knowing C_s , the true resistance r can be calculated



ingsmall frequency differences accurately. The circuit is the same as for the previous method, except that no added resistance is needed. The voltage V at resonance

Fig. 127: Resonance-curve method of measuring R.F. resistance

is noted, and this reading is then reduced to $\frac{V}{\sqrt{2}}$ by adjusting the oscillator frequency each side of resonance (Fig. 127).

Call $f_1 - f_2$, the total frequency swing between these two points, δf .

Then
$$r = 2\pi L \delta f.$$

For an accurate method of measuring δf refer back to Sec. 182. If the magnification, Q , of the coil is required, the formula is even simpler

$$Q = \frac{f}{\delta f}$$

An alternative method is to keep the oscillator frequency constant and to mistune the coil by a small calibrated variable condenser. Then the approximate formula, accurate enough if Q is not small, is

$$Q \approx \frac{2C}{\delta C}$$

The experimental technique is similar to that described in the dynatron section. For the reader who wishes to study R.F. measurements more closely, Hartshorn's *Radio-Frequency Measurements by Bridge and Resonance Methods* is strongly recommended.

As Q is such an important quantity in the design laboratory, direct-reading instruments for measuring it

197A. Q Meters

have been produced by several makers (e.g., Boonton Radio Corporation—British agents, Leland Instruments Ltd.—Marconi-Ekco, and Salford Electrical Instruments). The principle on which they

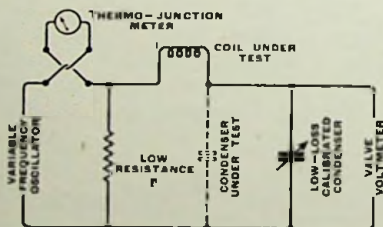

Fig. 128 : Schematic diagram of Q meter

work is shown in the schematic diagram Fig. 128. The coil whose Q is to be measured is tuned by a standard condenser forming part of the instrument, and a small voltage is injected in series with it by passing current from an oscillator through a low resistance. The magnified voltage across the tuned circuit is measured by a valve voltmeter. As the current is

MEASUREMENTS : COMPONENTS

brought to a mark on the thermo-junction meter, and the low resistance is fixed, the injected voltage is definite and therefore the voltmeter reading can be calibrated directly in Q values. For example, if the injected voltage is 0.01, a deflection of 1 volt on the voltmeter when the circuit is brought into resonance corresponds to a Q of 100. The resistance must, of course, be low compared with that of the coil.

The tuning condenser loss is generally small enough to be neglected. But by using a standard coil of known loss, the instrument can be used to measure the capacitance and loss of a condenser, or of a high resistance. Low resistances or reactances, on the other hand, can be measured by connecting them in series. The instrument is therefore exceptionally versatile and convenient to use.

Any inductance can be measured at low frequency by bridge methods, which are more convenient for R.F. coils than R.F. methods, but the bridge must be a good one. Probably the best of any for all-round work is one employing an inductometer ; and the procedure for various types of coil will now be described, referring particularly to the universal bridge of which a full circuit diagram is given in Fig. 73 ; but simplified diagrams will illustrate each method of use.

The coil under test should in all cases be kept at a distance of a foot or two from the inductometer to avoid coupling thereto. The length of the leads does not cause error, because the *difference* is taken between the inductance with the coil in circuit and with its terminals short-circuited.

For straightforward measurement of any inductance within the range of the inductometer the circuit is that of Fig. 129. Equal ratio arms PQ are used ; 10 Ω is a suitable value for R.F. tuning coils. The Campbell instrument is provided with a slide wire S for continuous adjustment of the resistive component up to 1 Ω ; any greater resistance must be balanced out by the decade box or other form of resistance R . If phones are used, as shown, it would be better to interchange them with the source to

avoid variable stray capacitance ; but in the actual bridge described a balanced transformer feeding an amplifier is used. The coil is first short-circuited, and M and S adjusted to balance. There is a zero adjustment so that the inductance of the leads can be balanced with the main pointer set to zero, but of course this is merely for the convenience of direct reading and is not essential. The coil is then unshorted and M , S , and R readjusted for balance. L is *twice* the reading on M (after allowing for the "zero" reading, if any) because reactance is not only added to one arm but removed by an equal amount from the other by the operation of the mutual inductance. R_L is of course the difference in the readings of $R + S$.

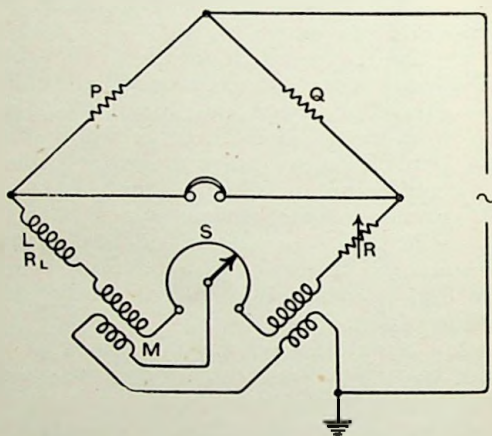

Fig. 129 : Straight-forward method of using inductometer bridge

For inductances not exceeding $42 \mu\text{H}$ the Campbell inductometer is provided with a switch that divides readings on the main scale

(which is calibrated up to $105 \mu\text{H}$) by 5.

With the switch in the normal position the hundreds and thousands dials extend the main scale up to $11,105 \mu\text{H}$, giving direct readings of L up to $22,210 \mu\text{H}$. For still higher inductances, a ratio switch is set to $\frac{1}{10}$ and the ratio arms PQ is altered to $90 : 10$. The slide wire is out of action, so a continuously variable R is necessary ; and $R_L = 9R$ and $L = 10 M$, so the maximum is $111,050 \mu\text{H}$. Finally, for a maximum of 1.1105 H , the ratio switch is

MEASUREMENTS : COMPONENTS

set to $\frac{1}{100}$, the ratio arms to 990 : 10, and $R_L = 99R$ and $L = 100 M$.

Fig. 130 : Dye's method of using Inductometer (or other) bridge to measure Inductances above the calibrated range. This is a very useful scheme but requires a source of accurate frequency and pure wave form

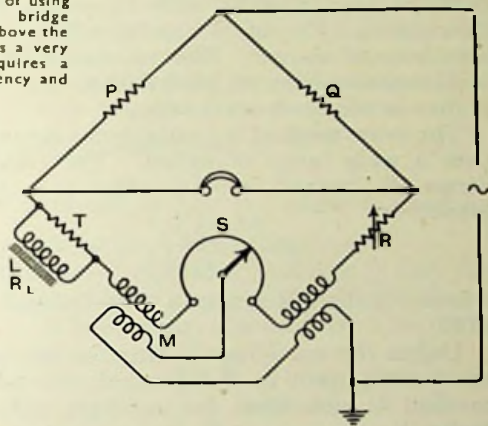

Higher inductances still, with practically no top limit, are measurable by shunting the coil with a non-reactive resistance T (Fig. 130). The arm thus formed is equivalent to a comparatively low inductance in series with a resistance, and by this device is brought within the equal-ratio range. T is in general equal to the initial value of R, and having made the preliminary zero adjustment with L disconnected, balance is obtained with L in position.

199. High Inductances by Dye's Shunt Method

Then $L = \frac{2 T^2 M}{r^2 + 4 \omega^2 M^2}$ and $R_L = \frac{T^2 r}{r^2 + 4 \omega^2 M^2} - T$ where r is the difference in R due to connection of the coil (see Sec. 282).

As balance depends on the square of the frequency, a pure waveform must be used, and the frequency must be accurately known. If the reading M turns out to be too small to be made accurately, the measurement should be repeated with a higher value of T.

A valuable feature of this method is that it is available for iron-core coils carrying D.C., which are usually something of a problem. All that is required is a battery and milliammeter in series with L , and a T that will stand the current. Part of the current will flow through the other arm too, of course. The resistance of the battery and milliammeter have to be deducted from the apparent R_L , if that is required accurately.

The same method is available for measuring capacitance over a wide range of values. The condenser is shunted across R instead of T ; otherwise the procedure is identical.

$$C = \frac{2M}{R^2} \left(1 + \frac{t^2}{4\omega^2 M^2} \right)$$

where t is the difference in T to balance the introduction of C .

Unless the condenser is large or has a large loss factor the second term in the bracket can be neglected. The method is not ideal for accurate measurement of loss factor F .

$$F = \frac{t \left(1 - \frac{t}{R} \right)}{2\omega M} - \frac{2\omega M}{R}$$

Fig. 131: Measurement of mutual inductance by direct balancing against mutual inductometer

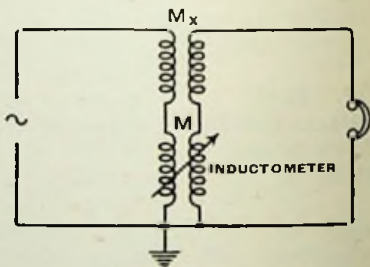

The same bridge, incidentally, can be used for direct measurement or comparison of condensers, and although it is not generally good practice to have the two high-impedance arms on the earth side it works satisfactorily with the apparatus described, thanks, no doubt, to the balanced transformer, screening, and symmetrical ratio arms. For a method of measuring iron-core coils with the C and R bridge, see Appendix.

Finally, mutual inductance is, of course, measurable

MEASUREMENTS : COMPONENTS

directly by the appropriately connected inductometer in the simple manner shown in Fig. 131,

200. Mutual Inductance which needs no comment. Or it can be done by measuring the self-inductance of the primary and secondary coils connected in series (i) when the mutual inductance between them increases the self-inductances of the whole, and (ii) with one coil reversed. Then, calling

these two values L_1 and L_2 respectively, $M = \frac{L_1 - L_2}{4}$, and K (the coefficient of coupling) $= \frac{M}{\sqrt{L_P L_S}}$ where L_P and L_S are the primary and secondary coil inductances.

The formula for the Maxwell bridge described in Sec. 121 is quite simple. Referring to Fig. 74, in which balance is preferably obtained by a variable condenser,

201. The Maxwell Bridge $L = CR_1R_2$ where L can be in μH and C in μF ,

$$\text{and } R_L = \frac{R_1 R_2}{R_3}.$$

The resistance balance is best got by a variable resistance in series with the coil; the coil resistance itself is then $\frac{R_1 R_2}{R_3}$ less this added resistance.

The advantage of the Owen bridge (Fig. 75) is that the condensers are fixed and can therefore conveniently be of fairly large capacitance, matching the impedance of the inductance arm better and making high ratios unnecessary.

202. The Owen Bridge They can be of about equal value, say $0.25 \mu F$; and only C_2 need be accurately known for inductance measurement. Neglecting the resistance of C_1 and C_2 ,

$$L = R_1 R_2 C_2$$

$$R_L = \frac{R_2 C_2}{C_1}$$

Preferably the bridge is again balanced with the coil short-circuited, R_1 having to be reduced to r_1 to do this.

Then more accurately

$$L = (R_1 - r_1)R_2C_2$$

Again, it is an advantage to have a variable resistance in series with the coil; and the units can be μH and μF . Both of these bridges can be used over a range of a few μH up to about 0.1 H or more; and of course the range can be extended indefinitely in the upward direction by using the shunted coil device just described. Except with this, both bridges are independent of frequency and waveform.

When measuring a coil of high inductance, such as an intervalve transformer winding, it must be remembered that what is measured is not the true inductance but the resultant of the true inductance and the self-capacitance. If the measurement is made at a low frequency such as 50 c/s the effect of the latter may be negligible; but at 1,000 c/s it may even swamp the inductance entirely; in

Fig. 132: If a condenser box is available, this is a convenient method of measuring large inductances. Provision is shown in this diagram for making the measurement with D.C. flowing

other words, the natural resonance may be at or below that frequency.

There are other A.F. methods of measuring inductance than bridge methods, though in general they are less

203. Other A.F. Methods of Inductance Measurement

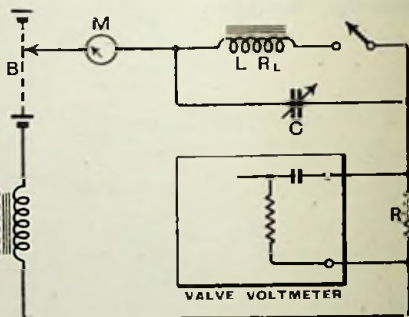

accurate. One of them is illustrated by Fig. 132. The condenser C is adjusted until the current is the same whether the coil under test is switched in or not. When this condition exists,

$$L = \frac{1}{2\omega^2 C}$$

or in another form, $X_L = \frac{1}{2}X_C$. This result is unaffected

MEASUREMENTS : COMPONENTS

by the resistance of L. To give some idea of magnitudes, here is an approximate table based on a frequency of 50 c/s.

C in μF	L in H
0.02	250
0.05	100
0.1	50
0.2	25
0.5	10
1	5
2	2.5
5	1

As a low-reading A.C. milliammeter may not be available, the drop across a resistance R may be observed by a valve or metal rectifier voltmeter. Assuming the source to be 50 c/s, R should be anything up to a few thousand ohms to give a drop of the order of one volt. The source voltage might be about 20; more or less, according to the magnitude of L. The diagram shows the method applied with D.C. flowing, supplied by the battery B and measured by the moving-coil milliammeter M. It is then essential for the valve voltmeter to have a grid condenser and leak, or for the metal rectifier to have a large condenser in series, to render it unaffected by the D.C. component. The only disadvantages of this method are that it requires a decade condenser box or the equivalent, and a reasonably pure A.C. source. Given these, it is probably the most convenient method for iron core coils with and without D.C.

Another method, which needs no condenser box but does require an accurately calibrated valve voltmeter and a known resistance, is shown in Fig. 133 (a). R should be of the same order as the impedance of the coil; for the usual smoothing choke of about 25-40 H it may conveniently be 10,000 Ω , and must of course be capable of carrying the D.C. When A.C. and D.C., if any, are adjusted, the voltmeter is connected in turn across R, across the coil, and across both. Call the readings V_1 , V_2 and V_3 respectively. Then as R is known, the impedance of the coil with and without R in series is known. The quickest

way of finding the result is to draw the impedance diagram, of which Fig. 133 (b) is an example. Resistance is measured off horizontally and reactance vertically. R is a pure resistance, so can be represented, to any convenient scale, by the horizontal line AB . The two impedances are known in magnitude but not in phase. With centre B and radius $\frac{RV_2}{V_1}$, and with centre A and radius $\frac{RV_3}{V_1}$ draw arcs cutting at C . The vertical CD represents to scale the

Fig. 133 (a) (right): The "three-voltages" method of measuring resistance and effective resistance of a coil

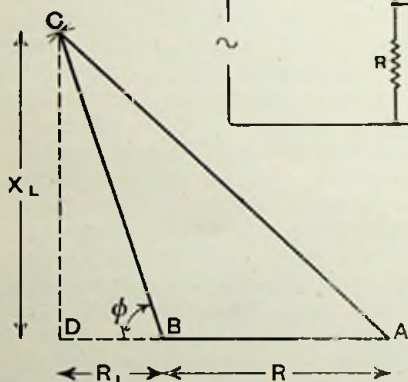
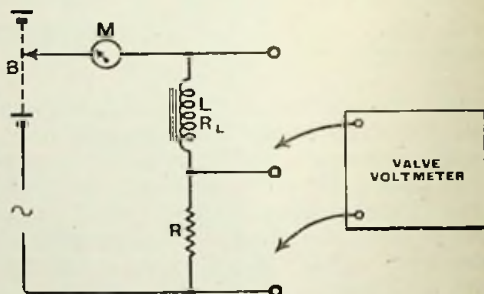

Fig. 133(b): Right-angled triangle diagram for working out the results obtained with the circuit of Fig. 133(a). The sides AB , BC and AC are respectively proportional to the voltages measured across resistance, coil, and both in series

reactance of the coil, and DB its resistance, while ϕ is the angle of lag. $L = \frac{X_L}{\omega}$. Unless the readings are accurate the error in R_L and ϕ may be large, but X_L is reliable so long as V_1 and V_2 are somewhere about the same magnitude, and the frequency is low enough for the effect of self-capacitance to be negligible. Even at 50 c/s the common instruction to assume that R_L is the same as or not much more than the Z.F. resistance is often surprisingly wrong.

MEASUREMENTS : COMPONENTS

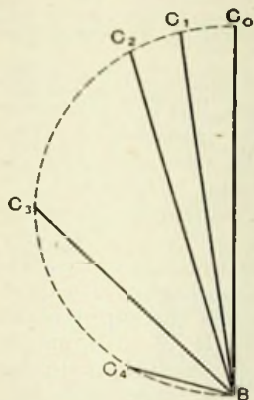

Fig. 134 : If the vector BC in the preceding figure, representing the impedance of the coil, is drawn for varying numbers of short-circuited turns, the points C lie on a semi-circle. Where the shorted turns are few, the effect on resistance is much more pronounced than on the impedance or reactance

204. Effects of Shorted Turns

The effect of short-circuited turns is interesting (Fig. 134). A perfect coil, with no resistance, would give a line like BC_0 —a pure reactance. In practice there is a small resistance, and the impedance of the coil is represented by BC_1 . Now if a single turn is shorted the reactance is not greatly affected, but the A.C. resistance is increased, as shown by BC_2 . It is just as if the coil were the primary of a transformer with a small current being drawn from the secondary. As more turns are shorted the resistance reaches a maximum and the reactance drops off rapidly (BC_3); then as a large proportion of the whole coil is shorted both decrease (BC_4) until finally the whole coil is cut out (B , a point, which by definition has no magnitude). The interesting thing is that all the C s lie on a semi-circle.

An important quantity in A.F. transformers, because it ultimately determines their "fidelity" or band of frequencies handled without loss, is the leakage inductance. This is measured on the primary side with the secondary short-circuited. Suppose an output transformer is being investigated. The cause of a droop in the output/frequency curve at the low-frequency end is the shunting effect of primary inductance, which should be measured at a low enough frequency (usually 50 c/s) for the self-capacitance effect to be unimportant. At the other end of the scale the leakage inductance is the

205. Leakage Inductance

The cause of a droop in the output/frequency curve at the low-frequency end is the shunting effect of primary inductance, which should be measured at a low enough frequency (usually 50 c/s) for the self-capacitance effect to be unimportant. At the other end of the scale the leakage inductance is the

limiting factor, and it can be measured at the same frequency.

The self-capacitance of an output transformer is generally not a major influence in its performance, but it is otherwise with an intervalve transformer. The capacitance of the secondary can be measured by joining it to the "X" terminals of the dynatron and shorting the primary (Fig. 135). A resistance of a few ohms is a good enough approximation to a short-circuit for this purpose, but has the advantage over a dead short-circuit that if it is connected across the input of an amplifier (e.g., the "Gram" terminals of a domestic receiver) it enables the frequency of oscillation to be observed. Such a resistance should be no larger than will just serve the purpose. The dynatron is adjusted to oscillation threshold, and the frequency measured (Secs. 131-2). As the frequency is usually near the upper limit of hearing, if not above it, the cathode-ray tube method is almost essential. The anode voltage of most dynatron valves can be adjusted to zero anode current, so avoiding D.C. effects on the transformer. The leakage inductance L_L is then measured from the secondary side at 50 c/s.

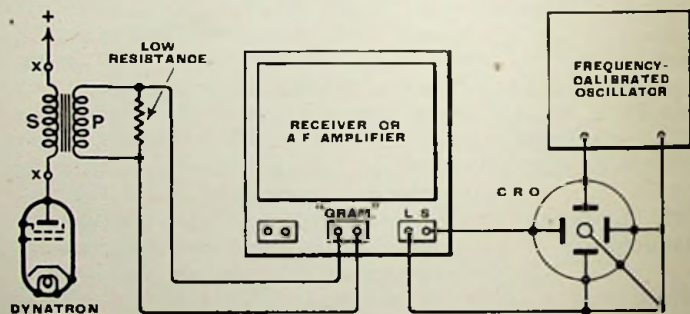

Fig. 135 : Apparatus used for measuring the natural frequency of oscillation of a transformer secondary winding with the primary virtually short-circuited. By measuring also the inductance of the secondary in this condition, the self-capacitance can be derived

$$C_S = \frac{10^{12}}{\omega^2 L_L}, \text{ where } \frac{\omega}{2\pi} \text{ is the frequency of oscillation,}$$

MEASUREMENTS : COMPONENTS

L_L is in henries, and C_S in $\mu\mu F$. This includes the capacitance of the dynatron, which may of course be deducted for greater accuracy, and replaced by the capacitance of the valve into which the transformer normally works.

By comparison the primary capacitance is generally negligible, unless the step-up ratio is very low. It can be added in, however, if it is remembered that when transferring a capacitance to the higher voltage winding it must be divided by the square of the step-up ratio. The opposite applies to inductance.

Other methods of measuring the self-capacitances of iron-core coils generally are dealt with in detail by M. Reed in *The Wireless Engineer*, May, 1937, p. 252.

An important characteristic of an intervalve or output transformer is linearity of output against amplitude. When

207. Linearity of Transformers the output ceases to be in direct proportion to the input, harmonic distortion is caused. This may be very easily tested by connecting one pair of cathode-ray tube plates across the primary and the other pair across the secondary, and applying a signal of controllable amplitude. Needless to say, in this as in all other transformer tests, the conditions should be the same as those under which its performance is desired to be known—if it works with a certain D.C. passing through the primary, or with a certain valve and circuit capacitance across the secondary, these conditions or their equivalents should be imposed during the test.

If a straight line is produced on the screen, as in Fig. 136 (a), there is no non-linearity distortion, nor is there any phase shift, and the step-up ratio is $\frac{OB}{OA}$, where OA is the

line along which the ray moves when only the primary plates are connected, the other pair being shorted. In general there is zero phase shift at some middle frequency, and the line opens out into an ellipse at low frequencies due to primary inductance and at high frequencies due to leakage inductance. The actual angle can be measured as explained by Fig. 117. Unfortunately it is not so easy to detect distortion of an ellipse as it is of a straight line,

but once it starts it usually develops rapidly as the amplitude increases and so becomes very obvious. Fig. 136 (b) shows what would produce mainly third-harmonic distortion, due perhaps to transformer iron saturation, *c* shows distortion due to valve grid current, which causes even harmonics, and *d* is an example of simultaneous third-harmonic distortion and phase shift. Phase shift without distortion is shown dotted.

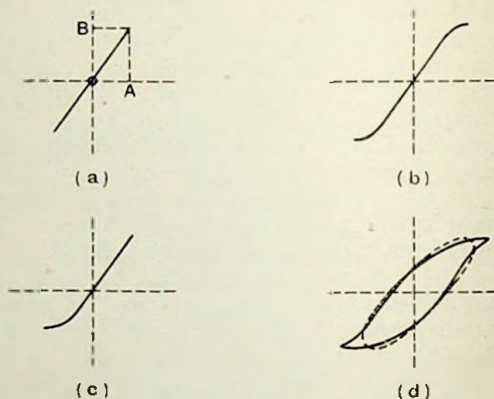

Fig. 136 : Representative cathode-ray figures from which non-linearity distortion (harmonics and intermodulation) and phase shift can be deduced

Loud Speakers

For many purposes a loud speaker and its transformer can be considered as a single unit, and measurements of its impedance referred to the primary

208. Impedance of the transformer. Theoretically with a perfect transformer of ratio $S : 1$ the impedance regarded from the primary side is S^2 times the impedance of the speaker itself, but in practice there are slight divergencies due to transformer characteristics, such as leakage inductance.

A distinction must be drawn between the purely electrical impedance of the speaker and the working impedance, which includes what is known as the motional impedance

MEASUREMENTS : COMPONENTS

due to the back-voltage induced by the movement of the coil in the magnetic field. The difference is hardly noticeable in the upper parts of the frequency scale, but at the mechanical resonance of the cone and coil the motional impedance is the main part. It can be determined by measuring the total impedance first with the coil free and then firmly clamped in the normal position in the gap, and taking the vectorial difference (Sec. 290.) The methods of measurement are exactly the same as those described in the preceding pages for reactance and resistance of coils, particularly those with iron cores.

The behaviour of a moving-coil speaker is especially important in the frequency range which includes its main resonance, usually in the region of 80 c/s. The severity of the resonance itself; the amplitude of coil movement at which it goes outside the uniform magnetic field, causing modulation of the upper frequencies simultaneously present; the possibility of mechanical rattle at the large amplitudes associated with low frequencies; and the production of sub-harmonic tones due to flexing of the cone at certain frequencies—all these can be investigated by an oscillator capable of giving a practically undistorted output of several watts. The mechanical movements of the coil and cone can be seen in "slow motion" by examining it by the light of a neon lamp fed from another oscillator differing from half the frequency of the first by only about 1 c/s, or alternatively by an oscillator working at nearly the same frequency and with D.C. superimposed so as to provide a pulsating instead of an alternating supply.

The existence of the modulation effect mentioned above can be tested by superimposing a relatively high frequency, such as 1,000 c/s, on the bass frequency signal (which may conveniently be 50 c/s mains), picking up the output at the high frequency by means of a microphone and amplifier with filter to exclude the low frequency, and connecting this output to a cathode-ray tube, to the other pair of plates of which the low-frequency source is connected. A rectangular figure is formed so long as there is no

modulation. If the sides of the figure corresponding to the high-frequency plates are not parallel, it indicates undesirable modulation due to the amplitude produced by the low frequency signal at the strength applied. Apart from the necessity for a high-quality microphone to translate the acoustical output into electrical form, the technique is the same as for amplifiers, and further information is given under that heading (Sec. 233).

The acoustic characteristics of a loud speaker are much more important than the electrical ones, but unfortunately measurement of them is not only

210. Acoustical Measurements extremely difficult but there is a good deal of controversy as to their interpretation. It is pointed out, for example, that a speaker which rattles abominably may show up better according to its measured results than another which is undoubtedly far pleasanter to listen to. Nevertheless, performance curves are informative when they are used on a basis of experience. The subject of their technique is outside the scope of this book, but here are a few references to sources of information:—

Applied Acoustics. (2nd ed.) Olson and Massa (an excellent 494-page volume by two R.C.A. engineers).

Loud Speakers. (2nd ed.) N. W. McLachlan (advanced treatise by an outstanding authority).

Elements of Engineering Acoustics. L. E. C. Hughes.

Loud Speaker Response Curves. *Wireless World*, March 29th, 1935, pp. 306-310 (description of apparatus used in *Wireless World* laboratory for taking frequency characteristics).

Valves

In valve data lists the three quantities—A.C. anode resistance (r_a), Amplification factor (μ), Mutual conductance (g_m), are generally tabulated.

211. Nature of Valve "Constants" Because they are often specified without qualification, and also perhaps because they are sometimes referred to as "constants", it may not always be fully appreciated that the figures given have very little meaning unless the conditions under which the valves were measured is also specified. Commercially it is the

MEASUREMENTS : COMPONENTS

understanding that they are taken with an anode voltage of 100 and a grid voltage of 0, unless the contrary is stated. The more complex valves must be more fully specified, of course. Now these are not at all typical of *working* conditions, under which the characteristics may be quite different. This must always be borne in mind when estimating, say, the amplification given by a stage.

Given two of the above three, the third follows, for $\mu = r_a g_m$; or, if all three are measured, this relationship affords a check on the results.

Another thing that is not always realised is that the above three are only a few of many that might be taken. For instance, in a tetrode there is the screen/anode mutual conductance, and the grid/screen mutual conductance, and others.

There are two chief methods of measurement—known as the static and dynamic (or D.C. and A.C.) methods respectively:—

(1) to plot the characteristic curves point by point and measure the slopes of tangents to the curves at the points concerned. g_m is the slope of the anode current/grid voltage curve, and r_a the reciprocal of the slope of the anode current/anode voltage curve. μ is got by multiplying these, or by noting on the curve the ratio of the change in anode voltage to the grid voltage required to keep the anode current constant

(2) to measure them directly by means of a suitable A.C. bridge.

The former has the advantage of enabling the properties of the valve to be visualised as a whole, and the latter gives more rapid and accurate results at individual points.

Taking characteristic curves is a straightforward process, given a sufficient number of meters of the appropriate ranges. As there will probably not

212. Static Tests be enough meters to read the current and voltage of every electrode at once, it may be necessary either to switch a meter from one place to another, or to assume that the voltages applied to electrodes not immediately concerned are constant. Care must then be taken to avoid error due to putting meters in and out of circuit, or to variations in "constant" voltages due to changing load. The voltage dropped in

milliammeters should be allowed for. Particular care must be taken over readings that are above the normal safe working conditions, such as those with positive grid bias. If the power is kept on for more than a second or so the characteristics may be observed to drift and perhaps to alter permanently. When the anode current in a directly-heated valve is very heavy it alters the current distribution in the filament and results differ appreciably from those taken under A.C. conditions, which do not allow the fila-

ment time to cool during the peaks of anode current.

Fig. 137 shows the "Radiolab" valve tester for laboratories, of the meter type as distinct from the bridge type. It is arranged for applying tests to almost any imaginable valve.

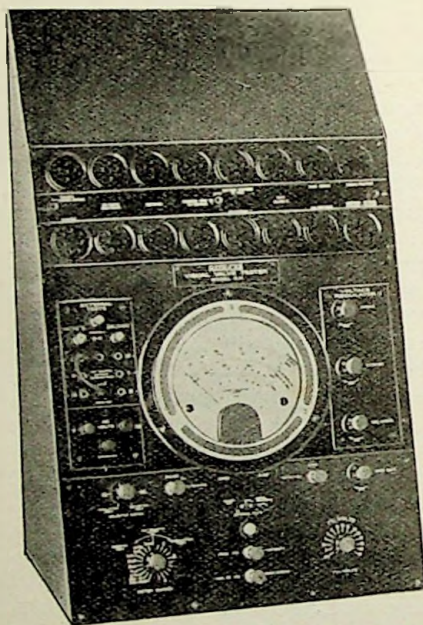

Fig. 137: Radiolab Visual Valve Tester, providing for a wide range of tests on valves of many types (Everett Edgcomb & Co. Ltd.)

The difficulty about taking readings that would over-run the valve can be got over by projecting curves on the

213. Cathode-ray Tests

cathode-ray tube. The 50 c/s supply is very suitable for the purpose, as it is plentiful, is high enough in frequency to prevent the valve from being damaged in the duration of a half-cycle, and low enough not to complicate matters by capacitance currents. Fig. 138

MEASUREMENTS : COMPONENTS

shows a circuit arranged for taking anode current/grid voltage curves. V_x is the valve under test. A suitable 50 c/s voltage is applied to the grid, and also to the horizontal pair of deflection plates of the cathode-ray tube. It is very likely that the voltage sweep required for the valve is not the same as is needed to produce a well-proportioned trace on the screen, so in practice a potential

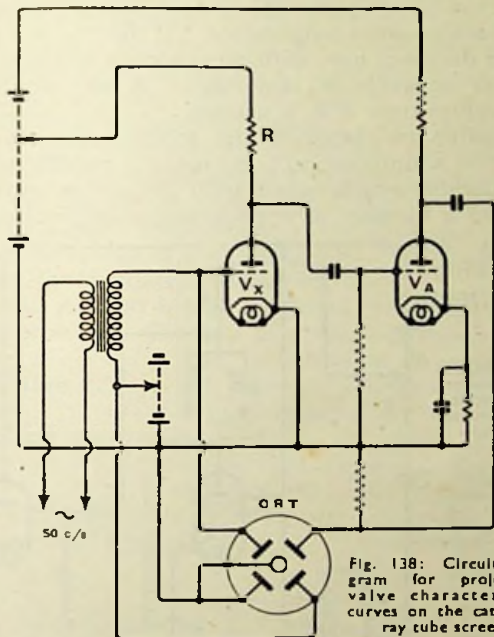

Fig. 138: Circuit diagram for projecting valve characteristic curves on the cathode-ray tube screen

divider would be used and preferably adjusted to give a convenient scale of volts per inch or centimetre. It is not practicable to produce a vertical deflection by means of coils directly in the anode circuit, because if the number of turns were sufficient to give an adequate deflection the impedance of the coils would constitute a very appreciable anode circuit load. The same is true of a resistance large enough to set up a deflecting potential. So it is necessary

to use amplification. The resistance R is as small as possible—not enough to affect the anode voltage to a serious extent—and is followed by an amplifier that is practically distortionless at 50 c/s. It should therefore be worked well within its power, and with coupling condensers of adequate capacitance— $1 \mu\text{F}$ or so. It is very easy to check it by removing the input lead from R and taking it to a point on the 50 c/s potential divider that gives approximately the same signal amplitudes. If the resulting figure is a straight diagonal line, with no tendency to form a loop, there is no appreciable distortion. A similar method serves for calibration, if R is known.

It is possible to elaborate the scheme so as to show several curves simultaneously, by using a rapidly rotating switch, preferably synchronised with the mains, to connect the anode to a number of appropriate anode voltages.

Although all this is quite interesting, the most

Fig. 139 : Scheme of Fig. 138 modified for studying the oscillation characteristics of a dynatron

Fig. 140 (below) : Example of results obtained with the system of Fig. 139, showing over-oscillation due to insufficient negative grid bias

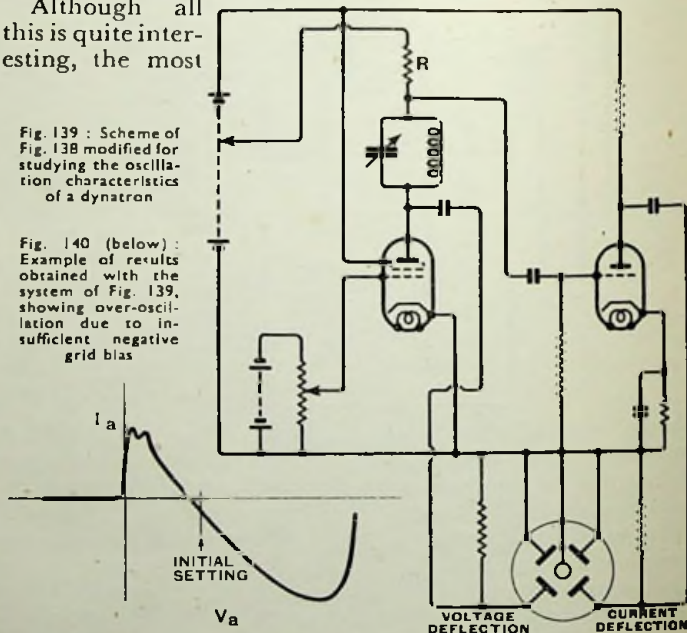

valuable purpose of the cathode-ray apparatus is to show the behaviour of the valve under dynamic conditions. If R in Fig. 138 is replaced by an actual amplifier coupling, then the dynamic characteristic curves can be displayed, and the effects of altering the frequency or the nature of the coupling studied. Probably there will be enough signal developed across the coupling to make an amplifier unnecessary. A still more interesting study is self-oscillation. Suppose it is desired to see what part of the characteristic curve is swept over during oscillation ; the anode current deflection is obtained as in Fig. 138, and either anode or grid voltage is applied to the other pair of plates. The anode oscillatory circuit is of course connected between the anode and R. Fig. 139 shows a circuit used for finding out the extent of the anode current/anode voltage curve of a dynatron over which oscillation takes place as the grid bias is adjusted, and Fig. 140 is one of the results when the bias is very much less than the oscillation threshold value.

Coming now to bridge methods, the simplest quantity to measure is μ . If the μ of a valve is, say, 20, it means that the increase in anode current due to 1 volt more on the anode can be counteracted by an extra $\frac{1}{20}$ -volt negative on the grid. So the very simple arrangement of Fig. 141 serves the purpose. The tapping point, or the resistances each side of it, are adjusted until there is silence in the phones ;

$$\text{then } \mu = \frac{R}{r}$$

The impedance in the anode circuit does not matter, as

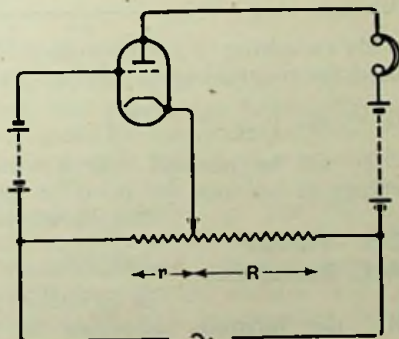
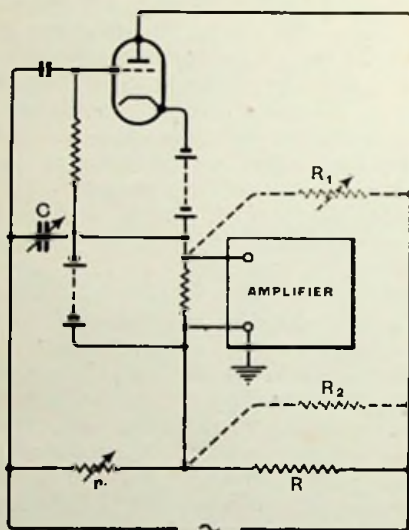

Fig. 141: Simple bridge circuit for measuring μ . For more accurate work especially with high- μ valves, it is necessary to balance out stray capacitances as shown in the next figure

there is no A.C. component at balance ; but any voltage drop due to D.C. must, of course, be allowed for in adjusting the anode voltage. The chief practical difficulty, especially with high- μ valves, is to avoid excessive stray capacitance due to batteries and phones. Fig. 142 shows how this can be done, and also an amplifier as an alternative to phones. As R is generally much larger than r ,



there is likely to be a preponderance of valve capacitance current via the anode, so a condenser C is shown for balancing it out. This preliminary balance is carried out with the valve cold. If R is fixed at some value such as 1000Ω , r can be direct-reading in μ .

Fig. 142 : Elaborated valve bridge, showing capacitance balance amplifier for increasing sensitiveness of detecting balance, and additional arms for measuring r_a as well

By switching in the resistance R_1 , the same circuit can be used for measuring r_a . When balance is again achieved,

$$r_a = R_1 \left(\frac{r}{R} \mu - 1 \right).$$

It will be noticed that if r and R are of the correct values to balance for μ , it is impossible to balance r_a .

But if, when r and R are right for μ

215. Anode A.C. Resistance

balance, a resistance $R_2 = \frac{R}{101}$

is switched in at the same time as R_1 , the formula simplifies to $r_a = 100R_1$, and this

MEASUREMENTS : COMPONENTS

is very convenient for making R_1 a direct-reading control.

The circuit for measurement of g_m is delightfully simple (Fig. 143) and so is the calculation ($g_m = \frac{I}{R}$). If the result

216. Mutual Conductance

is wanted in milliamps per volt, or millimhos, multiply by 1000; if in microamps per volt, or micromhos, by 1,000,000. It would be possible,

without unduly complicated switching, to adapt the arrangement of Fig. 142 to include this test also.

Note that in this method any screen or other electrode to be kept at a steady voltage with regard to the cathode must be supplied by a battery separate from the one used for the anode. P. D. Tyers describes in *The Wireless World*, Aug. 13th, 1937, an equivalent D.C. method of measurement which is arranged to avoid separate batteries.

Of the three quantities, g_m is the one that most usefully expresses the "goodness" of the valve, and so is often the one to be measured—more or less—in commercial valve checkers. A very simple method is to note the reduction in anode current on switching in a cathode-biasing resistor (Fig. 144). A full account of this was given in *Experimental Wireless* (now *The Wireless Engineer*), Sept., 1928. The anode current meter is adjusted to full scale, I_1 , with R short-circuited; the switch is then opened, and the new reading, I_2 , noted. Then

$$g_m = \frac{I_1 - I_2}{I_2 R} - \frac{1}{r_a}$$

and if r_a is not very low the second term can be neglected in approximate tests, and the instrument made direct-reading. In any case it is useful for comparative tests.

Another suggestion by the author for a simple g_m -meter for service or routine tests is illustrated by Fig. 145 taken from an article "The Hartley Circuit" in *The Wireless World*, May 21st and 28th, 1937, in which the underlying principles and calibration are explained. It makes use of a close-coupled Hartley oscillating circuit, such as a 1 : 3 ratio iron core transformer of 3H in parallel with

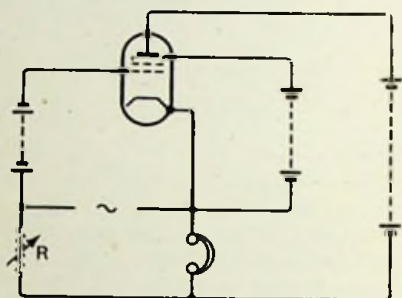

Fig. 143: Circuit for measurement of mutual conductance

$0.005 \mu\text{F}$; r is a rheostat of about $25,000 \Omega$ maximum, which can be calibrated directly in g_m . It is adjusted until the meter indicates the start of oscillation. The existence of oscillation

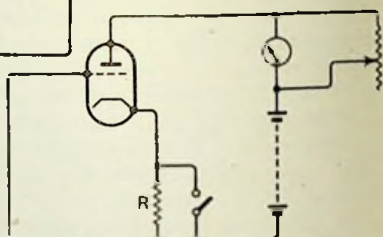

Fig. 144: A simple D.C. method of mutual conductance testing

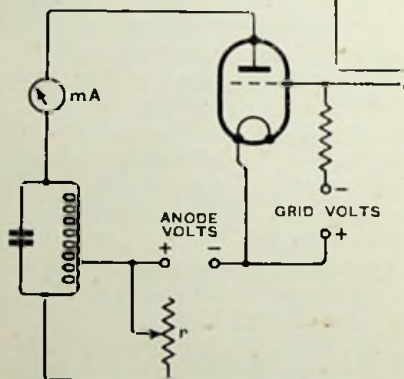

Fig. 145: Another mutual conductance meter, depending on the ability of the valve under test to set up oscillation

is, perhaps, more convincing evidence of the soundness of a valve than tests of a more academic nature.

Apart from the usual characteristics already discussed, one of the most important is the effect of the valve on the circuits to which it is connected. A tuned coupling circuit, for example, is affected by the output impedance of the preceding valve and the input impedance of the succeeding valve. The former consists

217. Input and Output Losses

mainly of r_a , and with negative bias the latter ought to be infinite, but actually both valves have a certain amount of capacitance which, with its resistive component, introduces some loss as well as change in tuning. These effects are present when the valve is cold, but when it is working there are additional effects that can be lumped in with them. For example, at very high frequencies the apparent input shunt resistance falls off very seriously due to a phase change caused by the finite time taken by electrons to cross the inter-electrode spaces. Then there is the celebrated Miller effect, caused by amplified potentials on the anode working back to the grid via the anode-to-grid capacitance. The resistance and reactance thus reflected may be either positive or negative, according to the nature of the anode circuit.

The transit-time effect is rather difficult to investigate*; but all the others can be measured by the dynatron, in exactly the same manner as for R.F. chokes (see Secs. 184-5), and the value expressed as an equivalent resistance and reactance (or capacitance, if more convenient). As both may be very high, and the shunting effect therefore small, it is desirable for the oscillatory circuit itself to have a very high Q in order to show up the effect measurably.

Aerials

The resistance and reactance of an aerial, whether of open or frame type, can also be measured by the dynatron, and calls for no further

218. Impedance Measurements comment except to point out that the impedance may be too low to be measured comfortably straight across the "X" terminals and may have to be connected across a section of the coil as described in Sec. 196. And, strictly speaking, one ought to hold a transmitting licence before making such tests!

* For information see "Input Resistance of Vacuum Tubes as Ultra-High Frequency Amplifiers", W. R. Ferris, *Proc. I.R.E.*, January, 1936, p. 82. "Grid Loss at Ultra-High-Frequencies", M. G. Scroggie, *Wireless World*, Oct. 23rd, 1936. "Characteristic Constants of H.F. Pentodes", M. J. O. Strutt, *Wireless Engineer*, September, 1937.

CHAPTER 9

MEASUREMENTS : SETS

IN this chapter we progress from individual components to combinations of components, of which receivers are the most plentiful examples. But a receiver is two steps upward in complexity, for even the simplest includes several departments, each of which is a distinct combination ; and the performance of a receiver cannot be analysed unless measurements are made on these separately. So firstly there are

Amplifiers

Presumably the most important thing to know about an amplifier is its amplification or gain, and how this depends on frequency and amplitude of the signal. The relationship to amplitude leads on to consideration of output power and distortion.

As the usual practice is to express gain in decibels it may be as well to digress for a moment in order to be quite clear about what this unit means. It appears that sometimes its use causes a certain amount of confusion, particularly when the input to an amplifier is measured in volts and the output in watts.

219. Need for using Decibels

The most obvious way of specifying gain is as the ratio between input and output. If an input signal of 2 volts is applied and the resulting output is 100 volts, the gain is $\frac{100}{2}$ or 50. Of course, this is not necessarily the same as the gain when a signal of 1 volt is applied, for the signal level must be taken into account if it is not within the range of substantially linear amplification.

A 1 : 1 output transformer added to this amplifier may perhaps reduce the 100 volts to 85 volts, giving a "gain" of 0.85 (any gain less than 1 is, of course, a loss). The overall gain is thus 50×0.85 , or 42.5.

MEASUREMENTS : SETS

A disadvantage of this method of reckoning is that if the relationship between gain and, say, frequency is expressed by means of a curve on such a basis, it is very difficult to get a fair idea of the performance of the amplifier by looking at the shape of the curve. Fig. 146 shows three frequency characteristic curves. The only thing that can be reliably learnt from a glance at them is that amplifier A gives a greater gain than B, which in turn gives more than C. But whereas it appears at first sight that the difference between A and B is wider than that between B and C, reference to the scale of gain shows that while A is $2\frac{1}{2}$ times B, B is 4 times C. This way of plotting amplification curves is therefore misleading, even if one is interested in comparing merely the general level of gain. But in considering a frequency characteristic the actual gain is of less consequence than the relative gain at different frequencies. Curve C is nearly flat compared with curve A, and one might jump to the conclusion that

Fig. 146 : Three characteristic curves plotted on an ordinary magnification or gain scale. The general appearance of the curves leads to quite wrong conclusions

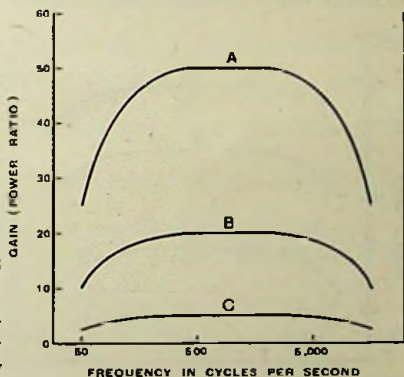

the amplifier it represents gives more uniform amplification. But in actual fact all three curves indicate identical frequency characteristics.

As a plotted curve has little purpose if it does not succeed in saving one from having to make numerical calculations in order to draw fair conclusions, there is obviously a need for some system of reckoning gain which will make things that actually are equal look equal. This object is attained if gain is plotted on logarithmically-divided paper.

Frequency scales already are, or should be, plotted in this way, for similar reasons. Fig. 147 shows the same three curves transferred to such a sheet, and even if the gain scale were omitted altogether one could depend upon the shapes and respective levels of the three curves to present a fair comparison. A given distance along the vertical scale represents a certain increase in gain, wherever along the scale it may be : so it is an obvious step to divide the scale into equal divisions and call them units of gain. A tenfold increase is divided into ten equal steps called decibels, and as a gain of 1 on the

220. Proper use of Decibels

original scale is really neither a gain nor a loss, it may be made 0 on the decibel scale. 10 on the gain ratio

scale therefore corresponds to 20 on the db scale, 100 to 40, and so on. Because the db scale is uniformly divided, one is free to put the zero wherever it is convenient. For instance, in studying one of the amplifiers whose characteristics are shown in Fig. 147 it might be convenient to

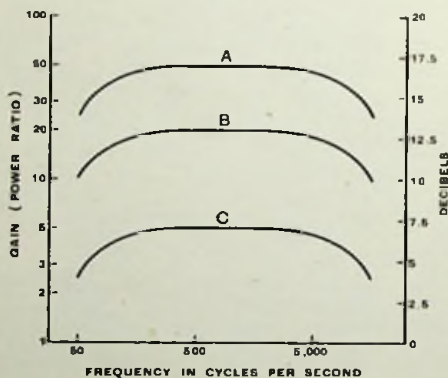

Fig. 147 : When the curves of Fig. 146 are replotted on a logarithmic gain scale, which is the same as a linear decibel scale, the true proportions appear

fix the zero level by the flat portion of the curve, or by its level at some standard frequency such as 400 or

1,000 c/s. The graph would then read directly db below or above normal. And for curves of such things as gramophone pick-ups, where gain is meaningless, the choice of zero db level is similarly open.

For this reason there is no sense in referring to a power or signal strength of so many decibels, unless some starting

MEASUREMENTS : SETS

point is specified or understood. It is correct to refer to an output of half a watt as +10 db if it has been agreed to call 50 mW "zero".

Mathematically the gain in db = $10 \log_{10} \frac{P_2}{P_1}$, where P_1 and P_2 are input and output power, or alternatively the power before and after some change has been made in the operating condition.

In radio practice it is usual to measure the signal at one or both ends of the amplifier in volts. In line telephone work, where decibels originated, signals are usually established across some definite impedance such as 600 ohms, and as power is proportional to V^2 , the gain in db = $20 \log_{10} \frac{V_2}{V_1}$, assuming that the impedance is the same in both cases. If V_1 and V_2 are "before and after" figures, being measured at the same place each time, there is obviously no difficulty about impedance. But if the impedances, Z_1 and Z_2 , are different the proper formula is $20 \log_{10} \frac{V_2}{V_1} + 10 \log_{10} \frac{Z_1}{Z_2} + 10 \log_{10} \frac{K_1}{K_2}$, where K_1 and K_2 are the power factors of the impedances; or if currents I_1 and I_2 are measured, the gain in db is $20 \log_{10} \frac{I_2}{I_1} + 10 \log_{10} \frac{Z_2}{Z_1} + 10 \log_{10} \frac{K_2}{K_1}$; otherwise one gets absurdities such as a high-gain amplifier with a low impedance output apparently giving a decibel loss, or a transformer by itself giving a gain.

In valve amplifiers the impedance at the input to a valve may sometimes be practically infinity, which leads to a result almost as absurd as the previous one, and considerably more useless; so, as the actual gain or loss at any particular point on the curve is generally of minor importance compared with the relative level under various conditions, it is customary to leave impedance out of account. But the prevalence of this practice must not be allowed to obscure the true principle, or confusion sooner or later is certain.

Tables connecting decibels with voltage (or current) and power ratios are given in Sec. 308, but the best way is to read them off a slide rule. Suppose the output power of a receiver is observed to rise from 46 to 58 mW as the result of a change in frequency. The ratio found on the slide rule in the ordinary way is 1.26; but if instead of bothering to look for this the log scale is read—nearly 0.1—the gain in db is obtained by the simple process of multiplying by 10, and is therefore 1. This works only when the ratio is not over 10. For every additional figure to the left of the decimal point in the ratio it is necessary to add 10 db to the result; or to subtract 10 for each place to the right. With practice the process becomes as rapid as ordinary slide rule calculation. If the readings in the above example were taken in volts they would be in the ratio of 1.12 (i.e., $\sqrt{1.26}$), or 0.05 on the log scale, and must be multiplied by 20, giving 1 db again. Incidentally, 1 db is about the least change in signal strength that can be noticed by ear when it is made rapidly.

Coming now to work on amplifiers, the technique differs according to the frequency, so first will be considered audio-frequency amplifiers, either as separate units or departments of a receiver or other apparatus.

221. Measurement of A.F. Gain

Gain or loss can be measured by applying a suitable signal and observing its strength at input and output. As already explained, a better method, and one that is standard in telecommunication practice, is to insert a calibrated attenuator and adjust it until the net gain of the combination is nil. Fig. 148 is a diagram of the scheme. Of course, it is necessary to consider the proper terminations to the units: the amplifier will ordinarily be working into its proper load, such as a loudspeaker, or a resistance representing its normal load.

A single meter can be switched from end to end, as shown, in which case it need not be calibrated, nor even be particularly free from "drift" or frequency error, so long as it does not take enough current to alter the signal when it is switched in. A valve voltmeter, even of extemporised type, is the obvious type of indicator for

MEASUREMENTS : SETS

this ; and a cathode-ray tube is also suitable, especially for large signals. A metal rectifier meter or even a pair of headphones may be used if their impedance is high enough relative to the signal circuits. It is merely a matter of adjusting to equality, not of actual measurement. It need hardly be mentioned that a sensitive valve voltmeter should not be switched in such a manner as to open-circuit its grid between the two positions, and that precautions must be taken to exclude non-signal potentials such as H.T. voltages. Both objects are achieved by using a grid condenser and leak circuit, but even then there is a possibility of momentary violent surges on switching over, which might injure a sensitive instrument unless it is temporarily desensitised. As a matter of fact there is rarely any need for sensitive instruments in this type of test.

The alternative is to use two indicators and no switching,

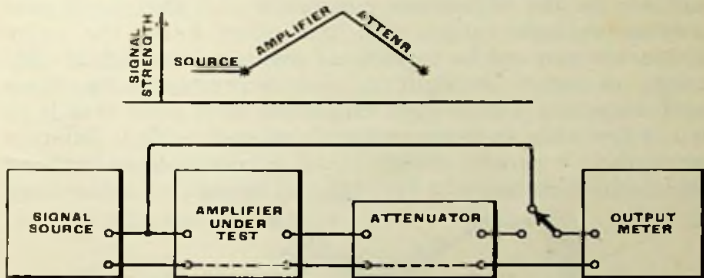

Fig. 148 : Block diagram of the arrangement of apparatus when measuring the gain of an amplifier by comparing it with the loss introduced by a calibrated attenuator. If the attenuator is continuously variable over the range concerned, the only purpose of the meter is to adjust the signal level at the two points shown by the stars in the signal strength diagram to equality ; no meter calibration is needed. Note that both source and meter are at relatively low signal levels

so that their impedance does not so much matter ; but it is necessary to check their readings against one another at all frequencies if the actual gain is to be measured accurately. Neither meter need be calibrated, unless the "zero" gain and the signal level are to be measured at the same time. One ought, however, to have at least some idea of the signal level, in order to avoid overloading the amplifier or perhaps even the attenuator. The method of connection shown tends to result in a high signal strength,

and is suitable for use with a low-output source. If the position of amplifier and attenuator were reversed, the signal level with a weak source might be so low as not to be clear of noise, hum, etc. ; but it is quite satisfactory if the output of the source is comparable with the normal output of the amplifier.

It is when taking a frequency characteristic that one realises the immense advantage of having a constant-output source. If the input signal can be

222. Frequency Characteristics relied upon to be constant at all frequencies, all that one has to do on shifting to a new frequency is to adjust the attenuator to keep the output meter reading constant and then to read the attenuator. Switching and input adjustment are avoided.

The amateur laboratory may not possess an attenuator suitable for the impedance concerned and calibrated over a wide enough range. On the other hand the valve voltmeter may not be capable of reading over such a wide range of signal strength as that represented by input and output of a high-gain amplifier, and, even if it is, it is not desirable to measure signals of such widely different strength if it can be avoided ; so a compromise between the methods is shown in Fig. 149. The signal is attenuated

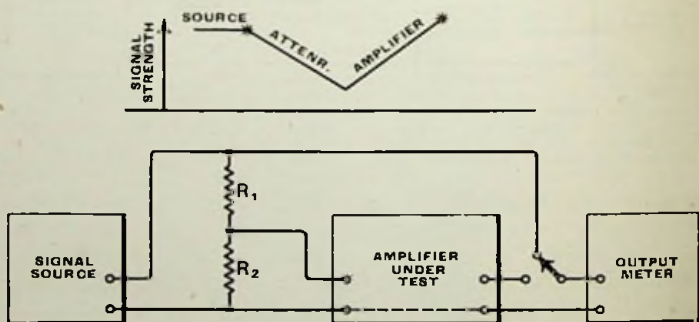

Fig. 149 : It may be better in some cases for the amplifier and attenuator to be at low signal levels, source and meter being high. This is done by putting the attenuator ahead. This diagram also shows the use of a simple fixed or semi-variable attenuator to bring the meter points to approximate equality. A meter calibration is then needed as well as the attenuator calibration, but the need for wide range is avoided, as are some other disadvantages

MEASUREMENTS : SETS

to a known extent by the potential divider R_1 , R_2 , so as to make the input and output signals at the voltmeter of the same order of strength. There is then little risk of feed-back due to switching and the input signal can be read on the same voltmeter range as the output. If the gain of the amplifier is very variable, as when a tone-control system is being tested, it is desirable for the attenuation to be semi-adjustable; and special care must be taken to ensure that overloading does not take place at any frequency. Fig. 149, incidentally, illustrates the use of the attenuator ahead of the amplifier, but the same method may be adopted with the circuit of Fig. 148.

The simple switching shown assumes that the "earthly" side of each instrument is common; if not, a double-pole switch is of course needed.

If the unit to be measured introduces a loss, the attenuator with which it is compared must be connected in parallel with it, instead of in cascade;

223. Measurement of Attenuation or Loss

Fig. 150 illustrates the connections when the known attenuator is of the simple type shown in Fig. 149. To take an example, suppose the voltmeter reading in position 1 is 1.3 and in position 2 is 1.5, and that R_1 and R_2 are 900 and 100 ohms respectively. Then the "gain" is

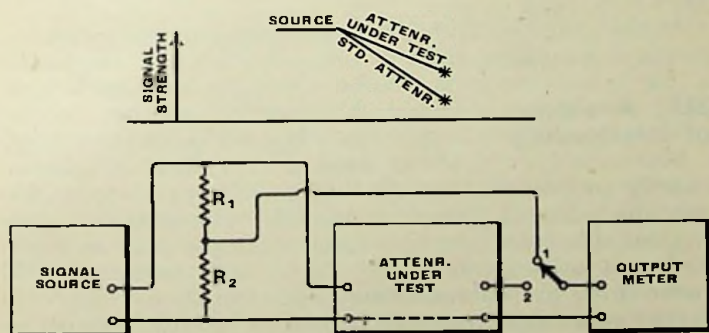

Fig. 150 : Here two attenuators are being compared and the only difference in method is that they are connected in parallel instead of in series. If possible the standard is adjusted to make the two stars coincide

$$\frac{1.5}{1.3} \times \frac{100}{900+100} \text{ or } 0.115, \text{ which is } -18.8 \text{ db.}$$

The procedure in measuring a multi-stage amplifier stage by stage is obvious, but it is necessary to take particular care when instruments are connected across a valve grid circuit, for even the capacitance of a valve voltmeter may have an appreciable effect on the secondary of a high-ratio step-up transformer, or the leads may introduce undesirable feed-back in a very high-gain amplifier.

If much work is to be done on the testing and design of A.F. transformers, tone controls, etc., the continual plotting of frequency curves becomes very tedious. It may pay to set up special apparatus for tracing curves automatically or semi-automatically.

224. Automatic Frequency-curve Plotting

Various methods have been devised, some depending on mechanical operation of the oscillator frequency control linked with the frequency base of the recorder or oscilloscope, and some entirely electrical in action. It is important that the frequency sweep is not *too* rapid for the apparatus under test to follow. An example of a rapid curve-tracing system is described by W. N. Weeden, in *The Wireless World*, August 13th, 1937, p. 137, and by the present author in the same journal, May 11th, 1939, p. 435.

In describing gain- and frequency-characteristic measurements on amplifiers, the only references to signal amplitude have been warnings to keep it well within the handling capacity of the apparatus. Up to a point the output of a normal amplifier is almost exactly proportional to the input—in other words, the amplifier has a linear amplitude characteristic—but beyond this point the characteristic bends over in some such way as is shown in Fig. 151. It is evident that if curve 1 is the characteristic of an amplifier it does not matter what signal strength is used to measure its gain so long as the input does not exceed A' (or the output exceed A"). The need for caution occurs when the gain is

225. Avoidance of Overloading

measured at other frequencies or conditions, because if at some other frequency the gain is higher, as shown by curve 2, the original maximum allowable input voltage A' might go beyond the new overload point B . It happens that a constant output voltage would have avoided this error, but it is possible for the characteristic to change to curve 3, when neither input nor output voltages previously certified to be safe could be allowed.

The position of the overload point is not absolutely definite, because if an apparently straight portion of characteristic is accurately plotted on a sufficiently large scale it is found to

226. Determination of Overload-point

be not quite straight. Any curvature causes some harmonic distortion, and it is just a question of how much is allowable. A customary allowance is 5 per cent., but sometimes this reckons in all harmonics,

Fig. 151 : Showing that a signal level that is within the capabilities of an amplifier in one set of conditions may overload it in another

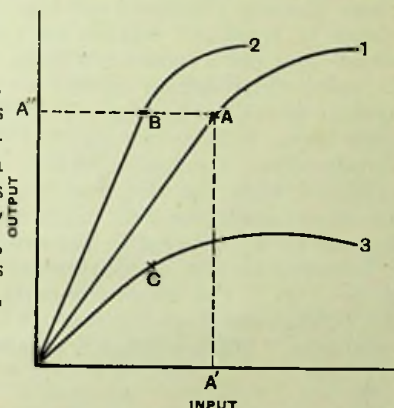

and sometimes it includes only the strongest—2nd or 3rd, as the case may be. There are other more complicated methods of reckoning harmonic distortion, in the effort to make it a fair measure of the objectionableness of what one hears.

In testing amplifiers it is desirable to be able to measure (a) the maximum output that does not contain more than a specified percentage of specified harmonics, or (b) the harmonics present when a specified output is being given. Unfortunately there is no entirely satisfactory method of getting either of these strictly definite results without more or less elaborate or costly apparatus: but if some margin is allowed to cover individual judgment

it is a simple matter to discover a practical overload point. A gain-measuring circuit, such as that of Fig. 149 is used, and the signal increased until the gain shows decided signs of falling off. An elaboration of this method that is particularly useful for rapid production tests is a pair of ganged attenuators, one ahead of the amplifier and the other behind, so arranged as to keep the total attenuation constant. So long as the amplifier is linear, therefore, the final output is steady, but beyond the overload point it changes. The attenuator can be calibrated in output power.

For occasional tests one would plot a curve such as those already discussed in Fig. 151. It can be plotted either in terms of voltage or power—the latter is more usual—but not a mixture of both. If the input is measured in volts, the readings should be squared in order to plot against watts, as in Fig. 152. This curve appears to be quite linear only as far as 1, but that is a rather excessively conservative overload point. Good quality may be expected with the very moderate curvature up to 2, but an output corresponding to the third point would probably be marred by noticeable distortion.

Instruments for measuring output power are discussed in Sec. 60. The usual methods involve measurement of the voltage developed across a known resistance—the load resistance. If the voltage is measured across a loud speaker

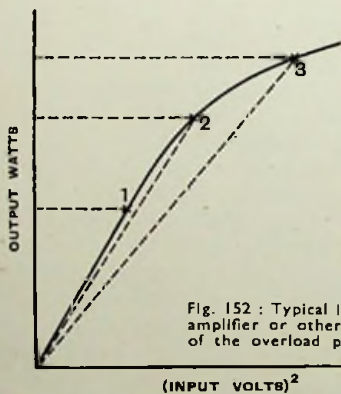

Fig. 152 : Typical input/output characteristic of an amplifier or other unit, showing how estimation of the overload point is a matter for judgment

or similar load, it must be remembered that it is neither constant at all frequencies nor non-reactive, and the nominal resistance of the loud speaker multiplied by the square of the voltage may be considerably different from the actual watts.

MEASUREMENTS : SETS

It is often instructive to take a load resistance characteristic, which is a curve of output watts against load resistance. There are two varieties, which must not be confused. In each case the load resistance is varied and the corresponding watts in it observed, but in one the signal voltage to the

227. Load-resistance Characteristics

grid of the valve is kept constant at some level comfortably below the overload point, and in the other the signal voltage is adjusted for each load resistance until a specified limit of distortion is reached. In the first case the maximum output is obtained when the load resistance equals the effective internal resistance of the valve feeding it (and is a convenient method of measuring that quantity) ; in the other, the load resistance giving the greatest *useful* output, and the amount of that output, are found ; the optimum resistance depends on a number of conditions, but is usually at least twice a triode valve resistance and only a fraction of a pentode resistance. Note the *effective* internal resistance is mentioned above ; if negative feedback is used, such resistance may be quite different from the actual valve resistance.

A curve such as Fig. 152 does not give much idea of the nature of the distortion. A much better and actually easier test is by means of the cathode-ray tube as described

228. Detection of Non-linearity by Cathode-ray Tube

in Sec. 207 in connection with transformers, except that, in an amplifier, OA (indicating the input voltage) may be so small compared with OB (the output) as to make the line almost vertical, whereas for examining distortion it is better for it to be at about 45° to the vertical ; and the expedient described in connection with Fig. 149 is adopted to bring input and output voltages at the tube approximately equal, either by applying more than the amplifier input or stepping down its output. As a cathode-ray tube requires a fairly large deflection voltage (compared with the usual valve voltmeter), and deflection amplifiers are obviously undesirable for the present purpose, the former method is shown in Fig. 153.

Fig. 153: Detection of amplifier distortion and phase shift by applying input and output signals (with suitable equalisation) to cathode-ray deflector plates. An advantage of this simple method is that a perfectly undistorted signal is unnecessary

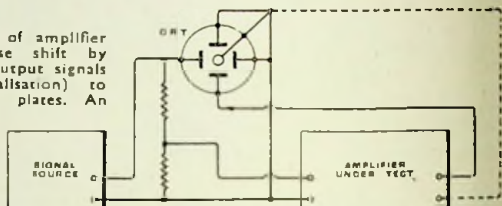

Phase shift is not considered to be a distortion so far as continuous tones are concerned, but is important in television amplifiers and in negative

229. Phase Shift feed-back amplifiers. Even when not important in itself, it is usually a symptom of frequency distortion. Zero phase shift (or a multiple of 180° shift) is indicated by a diagonal line enclosing no area. As the shift increases to 90° the line opens out into a circle (or ellipse, if OA and OB are unequal), and then contracts to a diagonal with the opposite slope at 180° . Of course 180° shift can always be produced by reversing one pair of connections. An inductive load or coupling-impedance, or capacitance reactance in series with either (both occur in amplifiers at the lowest frequencies) causes a phase *lead*; the reverse (both occur at the

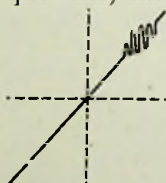

Fig. 154: If oscillation in an amplifier occurs at some part of the signal cycle, it is shown up like this when the arrangement of Fig. 153 is used

highest frequencies), a *lag*. If, therefore, an inductance is shunted across the output and the phase shift is seen on the screen to increase, the original shift must have been a lead; and *vice versa*.

Non-linearity distortion is detected in the same way as described for transformers, and illustrated in Fig. 136 *b* to *d*. When there is no phase

230. General Usefulness of Cathode-ray Tube in Amplifier Testing difference, this is a fairly delicate test for such distortion—much more so than throwing the waveform of the output on the screen on a linear time base, and is much easier to carry out because no time base is needed, *nor*

need the test signal itself be undistorted. An exception is when

the amplification of the unit under test discriminates considerably between the frequency of the test signal and its harmonics. When designing or investigating an amplifier a cathode-ray tube across input and output is an indispensable aid. One can learn more about it in half an hour than by days of testing with meters. It is particularly valuable for detecting spurious oscillation of an amplifier (and, incidentally, establishing its frequency), not only when the amplifier is at rest but also when working under various conditions. It is a possibility for spurious oscillation to occur at only one part of the cycle of a signal (indicated by such as Fig. 154), and only within certain limits of amplitude and frequency. This would cause an unpleasant buzz or blast on certain notes, but what chance would there be of detecting the cause with anything than a cathode-ray tube!

A cathode-ray figure can also be used for measuring the actual proportions of the harmonics, provided that the input/output figure is a line and

231. Harmonic Analysis

encloses no area (a condition that exists in the majority of cases at some medium frequency, even when the load is not a resistor), and that there is no cathode-ray origin-distortion.

The following method is adapted from that described by J. A. Hutcheson,* who demonstrates it for all harmonics up to and including the seventh; and it involves only the simplest arithmetic. Fig. 155 shows how the requisite data are derived from the cathode-ray figure. The total output swing, a , is measured, as it conveniently can be by cutting off the input (horizontal) deflection. The other quantities, b to g , are the distances, measured vertically (in the direction of the output deflection), from a straight line drawn between the ends of the curve to selected points on the curve. The relative horizontal distribution of these points is shown. Distances measured *downwards* from the straight line are called *negative*, those upwards are positive. These signs must be carefully observed throughout the calculation, but the signs of the final answers are

* *Electronics*, January, 1936, p. 76.

of no great significance. The distances can either be measured in volts if the screen is calibrated, in which case the amplitudes of the harmonics are given in volts; or in any arbitrary units such as millimetres, for the units make no difference to the harmonic percentages.

If the amplitudes of the various harmonics are denoted by V_2, V_3 , etc., they are given by

$$V_2 = \frac{f+c}{3} + \frac{d-b-g}{4}$$

$$V_3 = \frac{f-c}{3}$$

$$V_4 = \frac{d-b-g}{4}$$

$$V_5 = \frac{f-c}{3} + \frac{b-g}{2.828}$$

$$V_6 = \frac{d}{2} - V_2$$

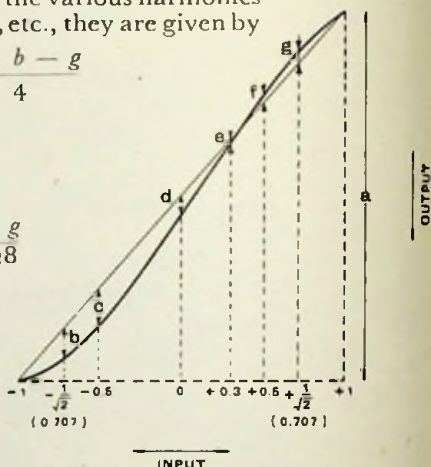

Fig. 155: From the cathode-ray figure the approximate proportions of the harmonics can be worked out as described

$$V_7 = \frac{(e - 1.82V_2 - 1.092V_3 + 0.655V_4 - 0.699V_5 - 0.751V_6)}{1.146}$$

The seventh is the only one that takes more than a moment or two to work out, and it can be omitted unless there is reason to believe that the upper odd harmonics are appreciable.

The amplitude of the fundamental, V_1 , differs from the amplitude of deflection only by the odd harmonics:—

$$V_1 = \frac{a}{2} + V_3 - V_5 + V_7$$

The percentage of any harmonic is $\frac{100}{V_1} V_n$ and the percentage total harmonics is

$$\frac{100}{V_1} \sqrt{V_2^2 + V_3^2 + V_4^2 \dots}$$

MEASUREMENTS : SETS

It is essential to measure the figure accurately and to avoid distortion of it, for unless the electrical distortion is very bad the harmonics are relatively small. Also, because they are calculated as differences between probably larger quantities, the working must be done to at least one more significant figure than is expected in the answers. Generally two significant figures are satisfactory in the answers, and only the first is likely to be at all reliable even if the work has been done very carefully.

As an example, suppose that in Fig. 155

$$\begin{aligned} a &= 120 \\ b &= -10 \\ c &= -12 \\ d &= -7 \\ e &= -2 \\ f &= 2 \\ g &= 3 \end{aligned}$$

Then

$$V_2 = \frac{2 - 12}{3} + \frac{-7 + 10 - 3}{4} = -3.33$$

$$V_3 = \frac{14}{3} = 4.67$$

$$V_4 = 0$$

$$V_5 = 4.67 + \frac{-10 - 3}{2.828} = 4.67 - 4.60 = 0.07$$

$$V_6 = \frac{-7}{2} + 3.33 = -0.17$$

$$V_7 = \frac{-2 + (1.82 \times 3.33) - (1.092 \times 4.67) - (0.699 \times 0.07) + (0.751 \times 0.17)}{1.146}$$

$$= \frac{-2 + 6.07 - 5.10 - 0.05 + 0.13}{1.146} = -0.83$$

$$V_1 = 60 + 4.67 - 0.07 - 0.83 = 63.77$$

Percentage 2nd harmonic = 5.2

" 3rd " = 7.3

" 4th " = 0

" 5th " = 0.1

" 6th " = 0.3

" 7th " = 1.3

" total " = 9.1

For measuring harmonics more accurately and under more general conditions the methods commonly used make use of a filter or bridge to balance out

232. Measurement of Harmonics

the fundamental, and an attenuator to compare what is left—i.e., the total harmonics—with the fundamental. The filter method, exemplified by the General Radio 732-B Distortion and Noise Meter, is satisfactory at any one fixed frequency; but it is impracticable to vary the cut-off frequency of the filter widely. The Marconi-Ekco TF-142 Distortion Factor Meter makes use of a bridge to balance out the fundamental, which may be anything from 100 to 8,000 c/s. It is therefore much more useful, because harmonic distortion negligible at one frequency may be serious at another, but naturally the apparatus is more costly and complex. Neither of these gives the order and proportions of the separate harmonics; to get these a still more elaborate instrument must be used, such as the General Radio 736-A Wave Analyser. Various methods have been described for analysing harmonics, such as the production of slow beats by applying an analysing oscillation at each harmonic frequency in turn,* but the author's experience is that unless harmonic analysers are designed and used with great care, or are very restricted in scope, the results are not satisfactory or easy to obtain. For example, an oscillator is required whose own harmonics are entirely negligible. The cathode-ray method at least avoids this serious difficulty.

Amplifier tests so far described involve the application of only one test signal at a time. Considering that

233. Inter-modulation

amplifiers are seldom actually used under such a restricted condition it is surprising that these tests are generally regarded as adequate. It is most informative to apply two signals simultaneously, and is another line of attack on the type of distortion—non-linearity—that causes harmonics. If an amplifier, gramophone pick-up, microphone, loud speaker, or other link in the chain has a non-linear characteristic—i.e., output not

* e.g., W. Greenwood in *The Wireless Engineer*, June, 1932, p. 310.

MEASUREMENTS : SETS

in exact proportion to input—not only are harmonics produced on top of any single tone being handled but two or more tones being handled simultaneously modulate one another and produce a whole range of new tones not present in the original. Harmonics at least harmonise with the fundamental (though not necessarily with one another) but modulation products are generally bad discords.* If one tone carries the amplifier to a portion of its characteristic where the amplification is appreciably different from that to smaller signals, any weaker tone simultaneously present is mutilated. A very low frequency may not be conspicuous, owing to the insensitiveness of the ear to low tones, but yet may have by far the greatest amplitude present, enough to cut up the more audible middle and top frequencies. This was mentioned in connection with loud speakers (Sec. 209) and a method of test briefly described. Amplifiers, because their output is in electrical instead of acoustical form, are easier to test in this way,† and Fig. 156 shows the scheme.

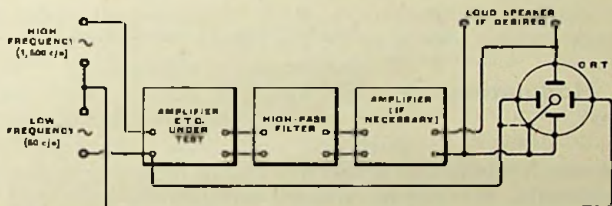

Fig. 156 : Apparatus for testing amplifiers for Intermodulation, due to non-linearity

A convenient source of the low frequency is the ever-useful A.C. mains, while the high frequency may be 1,000–2,000 c/s and is kept far within the handling ability of the amplifier or other apparatus under test. The low

* In a paper which deserves careful study (*Wireless Engineer*, February, 1937, p. 63), J. M. O. Harries arrives at the conclusion that the objectionableness of non-linearity distortion can be reliably estimated by analysing the side-tones in a certain way, whereas the usual estimations on the basis of harmonic percentages is very misleading. This substantiates our feeling that pentodes do not sound so good as harmonic data make them out to be. There seems to be no doubt that for estimating tolerable output the present harmonic distortion tests ought to be replaced by intermodulation tests.

† For more information refer to A. C. Bartlett, *The Wireless Engineer*, February, 1935, p. 70.

frequency is adjustable up to the overload point. A filter with a cut-off at, say, 400 c/s, removes the low frequency, and the high frequency can be examined for modulation by loud speaker or cathode-ray tube. If the latter, the filter makes a very delicate test possible, because the removal of the strong signal enables the weak to be amplified and the damage examined, as it were, through a microscope. If the amplifier is perfect within the limits of the strong signal, the weak appears on the screen at uniform amplitude; but if there is non-linearity its nature is revealed by the contour of the wave. In this connection, the low-frequency base shown in Fig. 156 is simpler to supply and easier to interpret than the linear base shown by Bartlett. A pentode or other element that flattens both positive and negative peaks will obviously produce a result such as Fig. 157 (a); while a partial rectifier such as a triode shows up as at b. If the distortion is taking place at some stage differing in phase from the signal at the input, the envelope of the wave shows loops as at c.

In certain circumstances, such as push-pull operation, the modulating tone may be the ripple left over as a result of inadequate smoothing.

234. Modulation Hum

In a straight amplifier such a ripple would show up as excessive hum, but in push-pull such hum is cancelled out.

If too much advantage is taken of this in reducing smoothing components, the ripple, though sufficiently balanced out to be inoffensive with no signal, may nevertheless swing each valve over so much of its characteristic as to modulate a signal. This *modulation hum* can be identified by examining the output of the amplifier with the cathode-ray tube on a base of the A.C. supply feeding the amplifier power unit. A single test signal, of a relatively high frequency, is applied; and a filter is not essential, so the apparatus is very simple. Modulation hum shows up as an irregularity in the envelope of the signal wave, and its seriousness can be gauged by comparison with the mean amplitude of the signal.

The measurement of straight hum might seem relatively

MEASUREMENTS : SETS

simple, but it is not. The results of using an output power meter or an A.C. voltmeter across the

235. Measurement of Hum output of the amplifier are almost entirely useless. Owing to the enormous dependence of the sensitivity of the ear on frequency (the expression "frequency distortion due to the ear" sounds a bit hard on Nature), and such complications as speaker resonances, a barely audible low-pitched hum may give a pronounced reading on a meter which fails to show any response at all to an

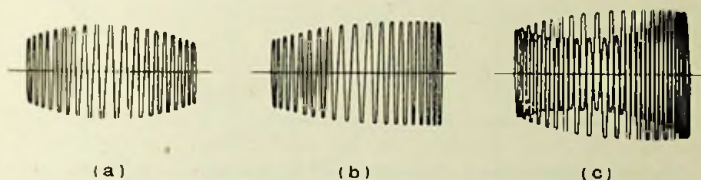

Fig. 157 : Typical cathode-ray figures displaying intermodulation

aurally poisonous high-pitched ripple. One partial solution is to interpose a "weighted network"—a filter designed to attenuate frequencies in proportion to the sensitivity of the ear—followed by or combined with an amplifier. The slope of the average aural characteristic (Fig. 158) is about 12 db per octave up to 800 c/s in the region of 20 phons loudness (which may be regarded as typical of unobjectionable hum). An increase of 6 db per octave can be obtained by taking the potentials developed across an inductance in a constant-current circuit, such as a pentode whose internal resistance is very much greater than the maximum load impedance.

236. "Weighting" an Amplifier The required characteristic can therefore be obtained by employing two stages in cascade. The inductance is selected by considering the frequency at which no gain is necessary. Assuming a pentode with a working mutual conductance of 2 mA/V, an inductance of $1\frac{1}{4}$ H gives a small gain at 100 c/s, which is the lowest main component in a full wave rectifier system, and a slight loss at 50 c/s,

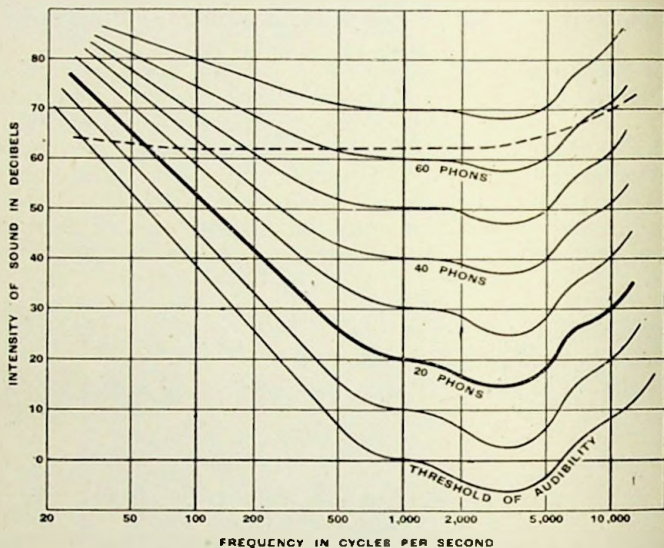

Fig. 158 : Average characteristics of the human ear. The curves of equal loudness (measured in phons) are very different from the horizontal straight lines corresponding to equal intensities of sound. By using the "weighted" amplifier specified in Fig. 159 the 20-phon line is brought up to the almost level dotted line, enabling an ordinary meter to read proportionately to loudness

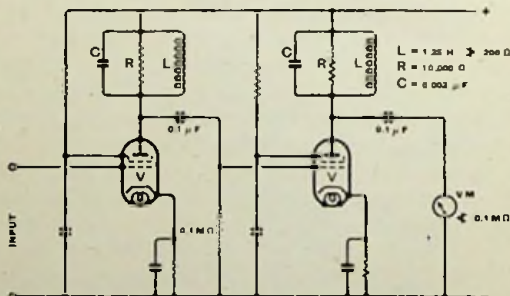

Fig. 159 Circuit of a weighted amplifier to compensate for the characteristics of the average ear, as shown in Fig. 158

which is prominent in a half-wave system. The resistance of the coil should not exceed about 200 Ω at the most. To limit the gain at the upper frequencies and bring the compensation into accord with the remainder of the aural

MEASUREMENTS : SETS

characteristic, the coil is shunted by 10,000 Ω resistance and 0.002 μF capacitance. Fig. 159 shows the circuit of a proposed weighted amplifier on these lines. The approximate overall gain is

c/s	30	100	300	1,000	3,000	10,000
Gain, db	-10	8	28	42	48	42

and the resultant of this and the 20-phon aural characteristic is shown as a dotted line in Fig. 158. The output voltmeter should either have an impedance not less than about 0.1 $\text{M}\Omega$, or be driven from a stage of power amplification, and is preferably of the R.M.S. variety. When connected across the output load, R_L , of an amplifier under test, the voltmeter reading divided by $\sqrt{R_L}$ gives a comparative indication of the sound that would be produced by a perfect loud speaker substituted for R_L . Note that the weighting amplifier gives a nearly level aural characteristic over the whole audible frequency band, and any hiss or other noise present is also indicated; if only hum is to be included, a filter cutting off above about 1,000 c/s should be interposed.

Passing now to radio-frequency amplifiers, the differences are more in emphasis than in basic principle. The method of measuring A.F. gain (Sec. 221) is applicable, if proper precautions are taken to avoid stray reactances in the attenuator and in the indicator. Unless the frequency and the total gain are comparatively low it is generally impracticable to bring the signal from the high-level end of the attenuator out into the open, and therefore to get an absolute measurement of gain both attenuator and output meter must be calibrated. The attenuator is almost invariably ahead of the amplifier and incorporated in the source, which thus becomes a standard signal generator. Metal-rectifier meters at best are available only at the lowest radio frequencies, and the valve voltmeter is the standard form of indicator. Even its effect

RADIO LABORATORY HANDBOOK

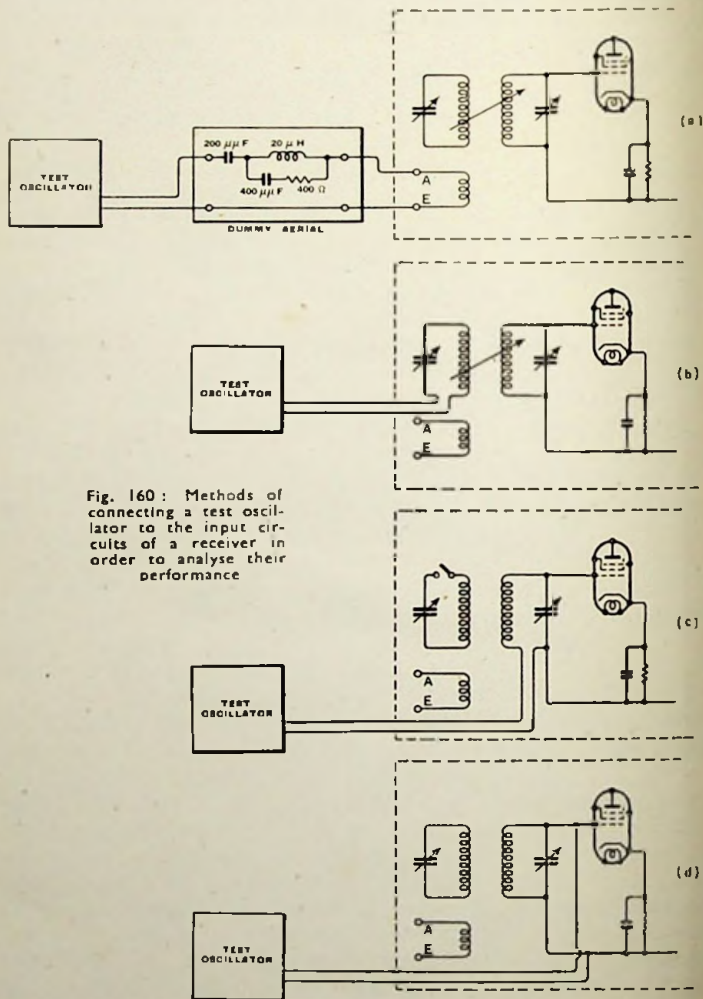

Fig. 160: Methods of connecting a test oscillator to the input circuits of a receiver in order to analyse their performance

MEASUREMENTS : SETS

on the circuit must be considered and allowed for. Such effects can be avoided if the system to be measured includes a detector valve, for there is little difficulty in adapting it to serve as a temporary valve voltmeter by inserting a suitable meter in the anode circuit. The rectified current in a diode detector is only a few microamps, but if a low-reading microammeter is not available an alternative is to observe the anode current in an added valve used as a Z.F. amplifier (Fig. 40). The popular double-diode-triode can usually be slightly modified to respond to the Z.F. component of the diode's output.

The method of connecting the test oscillator or signal generator varies according to the nature of the test, as shown in Fig. 160, where a "band-pass" tuned input is selected as an example. If the test is meant to start from the aerial terminals and to allow for the external loss in the aerial, the oscillator is joined to the aerial terminals via the dummy aerial (*a*). Next the signal is shown injected in the first tuned circuit, to leave the aerial coupling out of account (*b*). Next it is similarly connected in the secondary, and the loading of the primary may be included, or not, by switching, or better still by removing it entirely (*c*). Lastly the oscillator is connected straight to the grid, short-circuiting the tuned circuit, which, if in tune, shunts the generator negligibly (*d*). It is assumed in all cases that the oscillator impedance is no more than a few ohms. In practice it may be enough to cause appreciable flattening of a sharp circuit when connected in series.

By adopting these connections in turn it is possible to analyse the tuning system and determine the gain or loss due to each element. For example, with a fixed signal the output (measured in the anode circuit or farther on in the system), might be 0.5, 5, 10, and 0.125 volts respectively, showing a tenfold loss due to the aerial and coupling, and a magnification or "Q" of 80 for the tuned circuits.

In view of the generator-resistance error in measuring Q—especially if large—in this way it is generally better to arrive at it by the resonance curve method (Sec. 197).

Relative measurements, such as frequency characteristic

curves, can be made if the instrument at only one end is calibrated, the other merely serving

238. Selectivity Curves to keep the level constant. Radio-frequency characteristic curves can be taken either with the amplifier

retuned for each reading, or with the tuning left alone, and in the latter case are better known as resonance or selectivity curves. The variation of gain over the band of frequencies covered by a selectivity curve may be so great as to make the choice between constant-input and constant-output methods a matter of some importance. The choice is usually settled more by practicability of measurement than by a consideration of which corresponds the more closely to actual working conditions. With a constant input the output meter would not only have to cover an exceptionally wide range but probably be called upon to read impracticably low voltages. Measurement of selectivity will be more fully treated in the section on signal generator tests of receivers; without a standard signal generator one is limited to measurements of low gain, and moderate selectivity such as that due to a single tuned circuit or the upper portion of a highly selective characteristic; in other words, it is possible to study side-band cutting but not adjacent channel selectivity of modern systems. If a single unscreened circuit is to be examined it may be energised by a fairly powerful unscreened oscillator placed near enough to give a good reading on the valve voltmeter connected in parallel, but not near enough to load or "pull" the circuit appreciably. If the circuit under test is very selective the loading due to the voltmeter must either be allowed for (see Sec. 188), the voltmeter tapped down the coil, or the associated valve, if any, adapted as a voltmeter.

The frequency of either the oscillator or the circuit or amplifier under test (usually the former) is varied over a band of perhaps ± 10 kc/s, and the variation in output noted. It is very helpful if the oscillator is provided with a fine control for frequency. Unless a rather complicated system is used it is hardly practicable to calibrate this selectivity tuning control accurately in frequency, to be

direct-reading at all settings of the mains tuning control. The most accurate method of measuring the frequency displacement over a narrow band is by means of the audible beat-frequency set up between it and a fixed-frequency oscillator.

The frequency-modulated oscillator system referred to in Secs. 85-87 for depicting response curves continuously on the screen of a cathode-ray tube is worth its complexity when very much work is to be done on selective systems, more especially those involving more than one tuned circuit between valves—the so-called band-pass tuners. Further reference to this will be made in connection with receivers.

Non-linearity distortion of a carrier wave as such is not of prime importance ; one is concerned with distortion of the modulated envelope. The

**239. R.F.
Non-linearity
Distortion**

likelihood of such distortion increases with the depth of modulation. For measuring it, a modulated oscillator is of course needed, and the modulating

signal should be accessible for connecting across one

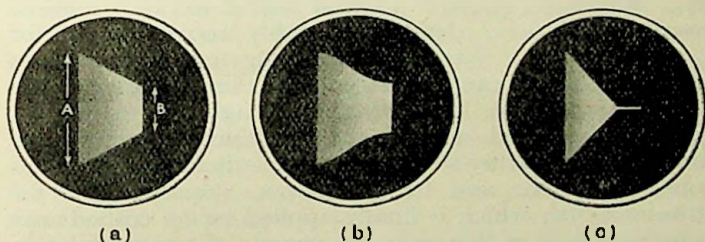

Fig. 161 : Cathode-ray figures from which the purity and depth of modulation can be determined

pair of deflection plates of the cathode-ray tube. The depth and purity of modulation of the oscillator can be observed by connecting the modulated output through an amplifier known to be reasonably distortionless to the other pair of plates. The result is a figure such as

Fig. 161 (a). The depth of modulation is $\frac{100 (A - B)}{(A + B)}$

per cent., and the absence of distortion is indicated by the straightness of the sloping sides. Fig. 161 (b) is an example of distorted modulation, and *c* of over-modulation. Having ascertained that the oscillator itself is beyond reproach, its output can then be applied to the amplifier under test, and the output of the latter similarly examined. Note that purity of the modulating signal is not essential in making this test.

If the amplifier is followed by a detector, modulation hum due to inadequately smoothed valve supply current can be heard by applying an un-

240. R.F. Modulation Hum modulated carrier wave over a range of strength up to the maximum for which the amplifier is intended. The cathode-ray system just described can be used for the same purpose to make a more searching investigation, the procedure being the same as for A.F. amplifiers, except, of course, for the frequency of the signal.

Cross-modulation is another non-linearity effect that can be studied in a similar manner. The signal to which the amplifier is tuned is unmodulated,

241. Cross-modulation and a signal modulated to a suitable depth (preferably 100 per cent. for the most exacting test) by an audio frequency, which can be derived from the mains, is applied at some off-tune frequency. Although this signal is presumably tuned out by the selectivity of the whole amplifier, the earlier stages may be overloaded by it under some conditions and its modulation impressed on the in-tune signal, which is finally applied to the cathode-ray tube on a base of the audio frequency. Cross-modulation appears as a non-uniformity in the amplitude of the signal on this base, in the same manner as for modulation hum.

Detectors

Apart from the effective load imposed by the detector on the preceding tuned circuit (which can be measured with the dynatron as described for

242. Informative Characteristics R.F. resistances generally), there are a number of characteristics that may be taken, such as :—

MEASUREMENTS : SETS

(1) Z.F. output current or voltage against unmodulated R.F. input amplitude.

(2) A.F. output against modulated R.F. input amplitude.

(2a) Percentage A.F. harmonics against modulated R.F. input amplitude.

(3) A.F. output against modulated R.F. input modulation depth.

(3a) Percentage A.F. harmonics against modulated R.F. input modulation depth.

(4) A.F. output against modulated R.F. input modulation frequency.

The first of these is instructive if the detector is to supply A.V.C. bias, but gives only a partial idea of the performance of a signal detector. It shows up overloading or saturation of the valve, but a linear Z.F. characteristic does not necessarily mean absence of harmonic distortion.

If the A.F. load is less than the Z.F. load, as happens when the former is fed through a condenser, there may be severe distortion, which test (3a) is necessary to evaluate. (4) is seldom really necessary, because the imperfections can usually be calculated fairly easily. (2) or (2a) are very important with the "grid" type of detector, to show overloading; are slightly less important with the "anode bend" type, to show over- and under-loading; and are less important still with the diode type, which normally runs no risk of being overloaded. (3) or (3a) are useful with any type, because none is perfect at 100 per cent. modulation. The (a) tests are to be preferred, because they show directly what can be got at from the others only by indirect means, but they demand greater instrumental resources.

The technique generally is very similar to that for corresponding tests of amplifiers, but a few notes follow for each.

(1) (Z.F. output against modulated R.F. input).

Unless the behaviour of the detector is being studied at exceptionally low signal strength the

243. Technical Procedure R.F. input amplitude is normally within the scope of a multi-range valve voltmeter, or at worst can be

brought within it by some simple form of potential divider; so an uncalibrated oscillator can be used as a source, and the output read on a D.C. milliammeter or microammeter in the anode circuit, at a number of input amplitudes covering the desired range. Then a curve is drawn connecting them, and inspected for any bending over, showing overloading. The foot of the curve is bound to exhibit a bend, but rectifiers differ in the lower limit of the straight portion. If no suitable microammeter is available for a diode detector, the drop across its load resistance can be measured by a slide-back voltmeter with direct connection (i.e., no grid condenser).

(2) (A.F. output against modulated R.F. input). A modulated oscillator is needed as a source, and the percentage modulation should be known. A modulation frequency of 400 c/s is customary. In measuring the output (usually with a valve voltmeter) it is necessary to make sure that the R.F. component has been thoroughly filtered away or it will complicate the readings. This can easily be checked by shutting off the modulation and seeing whether the reading is zero.

The dynamic input/output curve obtained by this test is much nearer reality than the result of the previous test. The harmonic distortion can be estimated by applying the original modulation voltage to one pair of cathode-ray tube plates, and the A.F. output to the other, and proceeding as for amplifiers; but of course any distortion due to the modulation process is included. For this reason it is best to work with a moderate modulation depth—e.g., 30 per cent.—if it is R.F. amplitude overloading that is being primarily studied.

(2a) (A.F. output harmonics against modulated R.F. input). If the A.F. source is distortionless and a harmonic bridge or analyser is available, by all means use them to measure the distortion direct.

(3) (A.F. output against input modulation depth). The difficulty about this most valuable test, which, like (2), can be observed by meter or cathode-ray tube or both, is that most modulated oscillators fail just where the test is most interesting—at the modulation depths approaching 100 per cent. If they can be modulated at all up to this point or near it, the distortion is usually impossibly bad. The modulation system described in Sec. 35 is one of the best, but a certain amount of distortion is introduced by the control rectifier. For full information tests (2) and (3) ought to be combined.

(3a) (A.F. output harmonics against input modulation depth). This is even more valuable, but very few people are blessed with the means of carrying it out properly.

(4) (A.F. output against input modulation frequency). There is no very great difficulty about this, if a suitable variable A.F. oscillator is available for modulating purposes. One usually suspects a falling-off in output at the highest modulation frequencies, due to condenser-and-leak time constant; or a drop at the lowest frequencies, due to inadequate coupling condenser; but the range of output to be measured is normally quite small.

Frequency Changers

The problem is very similar to the last, but is complicated by the presence of the heterodyne oscillator, adjustment of which influences the performance.

244. Measurement of Heterodyne Voltage The most practical test is to measure the heterodyne voltage over the whole of its frequency range to make sure that it nowhere departs too drastically from that recommended for the type of valve. The valve voltmeter range ought to include 2 to 30 volts.

Measurement of conversion conductance can be tackled in the straightforward way of applying a known signal voltage to the control grid and measuring

245. Measurement of Conversion Conductance the I.F. output under actual working conditions, but the latter part of it presents some difficulties. The I.F. must be separated as well

as possible from the components of other frequencies, by choosing an I.F. widely different from the others and measuring the output voltage with a low-loss valve voltmeter across a sharply-tuned resonant circuit, but the result is still not known unless the resonant impedance of this circuit is known. However, the *conversion gain*—the ratio of I.F. voltage output to signal-frequency voltage input—is sometimes more interesting than the conversion conductance. Or the ratio of conversion conductance to mutual conductance, which in a good system approaches 0.5, can be measured by finding the ratio of signal-frequency voltage to intermediate-frequency voltage at the input, other things being equal, required to give equal output.

Fig. 162: Circuit used for measuring the conversion conductance of a frequency-changer valve, employing one low-frequency source only

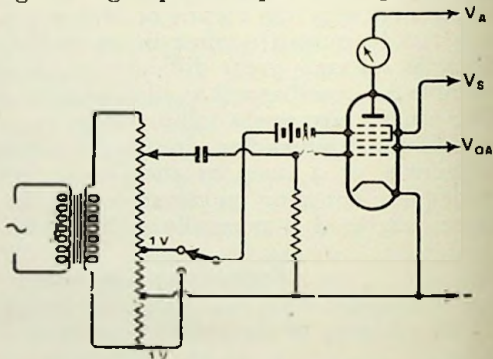

Although it is open to the objection that it does not represent working conditions, a method described by Benjamin, Cosgrove and Warren, in the *Journal of the I.E.E. (Wireless Section)*, June, 1937, and embodied in the Radiolab Visual Valve Tester (Fig. 137) is delightfully simple to carry out, as both signal and oscillator voltages can be derived from the 50 c/s supply and the indicator is a D.C. milliammeter. Fig. 162 shows the arrangement. The electrodes are fed with their appropriate voltages, and the oscillator grid receives the normal oscillator voltage—say 10 volts—from the low-frequency source through a grid condenser of correspondingly larger capaci-

tance ; $0.1 \mu\text{F}$ would do. The control grid receives a relatively small signal, say 1 volt, from the same source. The Z.F. anode current is read first with this signal in one phase and then with phase reversed by means of the switch shown. The difference in mA between the two readings, divided by twice the peak signal voltage, is the conversion conductance in mA/V.

Power Units

In measuring the output of a power unit it is hardly necessary at this stage to remind the reader of the importance of using a low-current voltmeter to measure the no-load voltage ;

246. Output Voltage

more especially from sources with a high internal resistance, due perhaps to potential dividers or series-connected resistors. If the output is to be measured under load—i.e., when supplying current—then the current drawn by the voltmeter, if appreciable, can be added to that drawn by the load. Sometimes the voltmeter itself constitutes an adequate load. Or, what comes to the same thing, if the load current is measured by a milliammeter and the load resistance is known, the voltage follows from Ohm's Law.

The output voltage from power units for television cathode-ray tubes or other loads taking a small current at high potential can most conveniently be measured by an electrostatic voltmeter.

If the output voltage is measured at several currents it is possible to draw a curve connecting output current and voltage, known as a *regulation curve*.

247. Regulation and Cross-regulation Characteristics

There is no need for many points, because the "curve" is usually indistinguishable from a straight line. Voltages at full, half, and no load are generally enough, except with "choke input" smoothing systems, whose characteristic curves take a sharp upward turn near zero load.

When a number of outputs are available in one unit it may be desirable to obtain *cross-regulation* data, to show

the effect of varying load across one output on the voltage supplied to another. If there are numerous outputs one can amuse oneself for quite a long time over this.

The consumption, reckoned in terms of money, of ordinary receivers, oscillators and most laboratory gear, is so small that anxiety to know the

248. Consumption exact amount is seldom felt. But whether or not the power of the apparatus is a considerable mains load, measuring the input is often an informative check on design or a help in tracing the cause of overheating. As wattmeters are seldom available, or, if available, complicate matters by their own consumption, it is useful to remember that a power-measuring instrument of good accuracy has been installed by the persons responsible for supplying electricity. The supply meter actually measures kilowatt-hours, integrating the power with time. If the apparatus under test is switched on for a definite time, everything else served by the meter being off, the average power consumed is found. It is not necessary to run the test for a long period, even though the power be small. A.C. supply meters usually contain a revolving disc visible through a window ; and the number of revolutions per KWH may be specified, or if not can be derived by observing how a revolution is related to the movement of the $\frac{1}{100}$ dial (10 revolutions of which indicate 1 KWH). To make sure that decimal points are not put in the wrong places, and to establish confidence generally, the consumption of a lamp of known wattage should be tested as a preliminary experiment.

Receivers

This section, in spite of its importance, need not be dealt with at vast length, partly because the procedure in receiver testing is more widely known

249. Scope of Tests than that of most other radio measurements, and partly because much has been included in the preceding

sections.

The nature and extent of tests performed on a receiver

MEASUREMENTS : SETS

naturally depend on whether they constitute a routine check or a detailed analysis ; whether, in other words, they are service or production tests, or laboratory tests. The latter are kept mainly in view here.

In tests performed on a receiver as a whole, the use of an artificial source of signals is generally free from objection, and standard signal generators are available ; but at the other end the technique is not in quite such a satisfactory position. Ideally the output should be measured in terms of sound (assuming that sound is the product the apparatus is designed to supply). Unfortunately the equipment required for measuring sound intensity over the whole A.F. band, free from complications due to surroundings, is not only extremely elaborate, expensive and difficult to operate, but even when the utmost resources at present known are available the correct procedure and the interpretation of results are alike still the subject of dispute.

Reluctantly, then, the loud speaker is here excluded from the system, and the output is assumed to be measured in electrical form. In interpreting the measured sensitivity and frequency characteristics, therefore, it must never be forgotten that they are subject to this omitted factor, which is liable to smooth out or accentuate frequency-curve irregularities, or upset comparison of sensitivity.

Although receiver measurements can be pursued to any degree of elaboration and exhaustiveness to supply desired information, certain conditions have become generally accepted for use whenever there is no special and specified reason for departing from them.

The standard dummy aerial for all waves is specified in Chapter 4 (Sec. 50) and shown in Fig. 160. The modulation frequency and depth, unless otherwise required, are 400 c/s and 30 per cent. respectively. This will be referred to hereafter as the standard signal. The author's custom is to make all measurements at a signal frequency of 1 Mc/s unless otherwise required. The standard output is 50 mW in a resistive

load matched to suit the output stage. One reason for a comparatively low power is that at 50 mW the signal is usually below the A.V.C. delay voltage. Whether the output transformer is regarded as part of the receiver or part of the load (loud speaker) is a matter for judgment—generally the former is preferable—but the distinction should be drawn, for commercial output transformer efficiency is sometimes very low. Incidentally, it is useful to know that when the output meter is adjusted to present the same load resistance as the loud speaker and is connected in parallel with it, either because there is no convenient means of cutting the latter out, or in order to listen to what is going on, the equivalent of the normal standard test output of 50 mW is approximately 15 mW reading when the output valve is a pentode and about 22 with a triode. Not only is there an equal division of power between meter and speaker, but the total power available falls owing to the lowering of load impedance, and this loss is more noticeable in the case of the pentode, assuming both are worked under tolerably normal conditions. The use of negative feed-back upsets this condition. The simultaneous use of both loads should not, of course, be used when taking audio-frequency characteristics, for the loud speaker impedance varies with frequency.

The standard test conditions are open to criticism; for example, it may reasonably be argued that a standard output level proportional to the maximum rated output—say, a quarter of it—should be adopted. The British Radio Manufacturers' Association has drawn up tentative specifications* for receiver performance tests which in a number of particulars aim at improving on the schedule drawn up some years ago by the corresponding body in America. While the bringing of the conventional conditions of test as far as possible into line with typical working conditions is a desirable object it may be said that *general acceptance* of some standard, whereby results taken in different places can be compared, may be even more important than the nature of that standard.

* *Proc. I. E. E. (Wireless Section)*, Sept., 1937, p. 170.

MEASUREMENTS : SETS

The connection of a signal generator to an open-aerial type of receiver is simple enough, as Fig. 160 (a) shows.

251. Standard Signals in Frame Aerials

Injection of the signal into a frame aerial is possible by connecting the generator directly in series with the aerial; but this has the disadvantages of necessitating a break into the aerial wire, and of putting probably 10 ohms or more into the aerial and so altering its characteristics materially. The alternative is to couple it inductively by means of a coil connected straight to the signal generator (Fig. 163).

Fig. 163 : One method of introducing a known signal into a frame aerial. The signal strength is calculated from the quantities shown

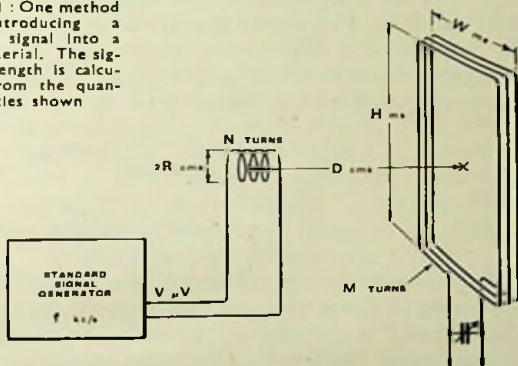

If this coil has N turns of radius R cms. and an inductive reactance X ohms, and is situated on the same axis as the frame aerial and D cms. away from it along that axis, then the field strength in microvolts per metre at the frame aerial when the signal generator output is V microvolts is

$$\frac{18,800 N R^2 V}{(R^2 + D^2)^{3/2} X}$$

The British R.M.A. suggests that the coil should be 10 cms. in diameter and 6 cms. long, wound with 20 turns to an inductance of $40 \mu\text{H}$ and shielded by a wire cage arranged so that there are no closed conducting loops in planes at right angles to the axis of the coil. The

connecting leads are also to be screened, but the shunt capacitive reactance should be large compared with the inductive reactance, which itself should be so large compared with the impedance of the source that its output should not be seriously lowered by the load imposed by the coil. If the distance, D , between centres of this coil and the frame aerial, is 2 metres, as recommended, the above equation reduces to

$$\text{Field strength} = \frac{4.67 V}{f} \text{ microvolts per metre,}$$

where f is the frequency of the signal in kc/s.

If it is desired to know the actual voltage induced in the frame aerial, the field strength obtained as above must be multiplied by the effective height of the aerial, which for a rectangular frame is approximately

$$2 M H \sin \frac{\pi f w}{300,000} \text{ metres}$$

where

M is the number of turns

H the height in metres

w the width in metres.

The voltage developed across the aerial at resonance is, of course, Q times the voltage induced as described.

Sensitivity is defined as the number of microvolts from the generator required to produce standard output. The greater the sensitivity, the smaller the number, which is rather unfortunate as it tends to ambiguity of statement

252. Sensitivity

unless when mentioning that the sensitivity is, say, greater, it is made clear whether it is sensitivity in its verbal or its numerical sense that is meant. One way of doing this is to describe the sensitivity as *better*, which is understood to mean greater sensitivity and fewer microvolts. For domestic broadcast receivers, a sensitivity of $1 \mu\text{V}$ is almost too much to be manageable; $10 \mu\text{V}$ is fairly sensitive and self-generated background noise is not dominant; $100 \mu\text{V}$ is rather poor for any superheterodyne receiver, and is bettered in sets with only two valves before the second detector; $1,000 \mu\text{V}$ sensitivity is enough only for local

MEASUREMENTS : SETS

stations or powerful foreign stations under favourable conditions.

Beginners are sometimes perturbed by the thought that the microvoltage actually across aerial and earth terminals is less than that delivered at the output of the generator, the balance being lost in the dummy aerial ; and that the net signal depends on the impedance between aerial and earth terminals. But it must be realised that this condition is less artificial than would be the measurement of the microvoltage at the A and E terminals. The receiver designer may, if he likes, use a low-impedance aerial coupling coil which gets only a small proportion of the generator output : but as it presumably gives a high step-up ratio to the tuned coil the signal at the grid of the first valve may be just as high as if a high-impedance coupling coil were used. Of course, receivers must never be compared by connecting their A and E inputs in parallel !

Difficulties arise when there is variable reaction. Fortunately, reaction controls are now the exception rather than the rule. At best, sensitivity figures with reaction are roughly approximate ; the only thing to do is to adopt standard adjustments and duplicate them as much as possible each time. One obvious adjustment is "zero" reaction. Even this is quite indefinite, because zero on the scale may be very different from zero reaction. A receiver in which some fault makes it almost unstable will show a much better sensitivity than one which is normal. The other setting, which may be described as "critical reaction", is the most advanced that permits the receiver to be tuned through resonance without breaking into oscillation. Different operators will get widely different readings, but an intelligent operator can repeat his own results with fair consistency.

Both in Britain and America it is agreed that 600, 1,000, and 1,400 kc/s are suitable standard frequencies at which to measure sensitivity in the medium-wave band. For drawing a curve these are hardly enough, and 800 and 1,200 should be included.

253. Reaction Control

254. Standard Test Frequencies

The British R.M.A. suggests 160, 200, and 300 kc/s for the long-wave band, but the author considers 200 kc/s unsuitable because unless the measurements are made in a screened room even a well-screened receiver picks up enough from Droitwich to interfere with the test. He personally adopts 175, 225 and 275 kc/s. As for the short-wave broadcast bands, they are comparatively narrow, and a single frequency in each should be enough; say, 6, 9.5, 11.8, 15.2, 17.8, 21.5, and 26 Mc/s.

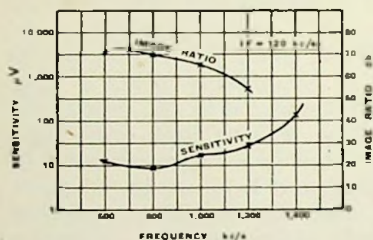

Fig. 164: Typical medium-wave sensitivity and image ratio curves for a domestic superheterodyne receiver

Microvolt scales for sensitivity and other characteristic curves are logarithmic in order to accommodate the wide

255. Sensitivity and Image-ratio Curves

range of microvolts from 1 up to 100,000 or 1,000,000 (1 volt), and a uniform scale of decibels is therefore optional. Fig. 164 shows a typical sensitivity curve. If the receiver is a superheterodyne, the image (or second channel) ratio should be measured at the same time. Suppose the receiver is tuned to 1,000 kc/s and the sensitivity is 16 μ V. Then if the I.F. is 120 kc/s the image frequency is 1,240 kc/s. The generator is therefore tuned to this frequency and the signal increased until standard output is once more obtained from the receiver. Suppose the signal is now 28,500 μ V. Then the ratio of this to the first channel sensitivity is $\frac{28,500}{16}$ or 1,780. The best way of expressing this is as

65 db. If the I.F. is in the neighbourhood of 470 kc/s, the image frequencies are largely outside the broadcast bands and the ratio is so high as to render serious interference from even a local station unlikely in the medium

MEASUREMENTS : SETS

band, but the ratio should be measured on the long-wave band as there is a possibility of interference from a very powerful station of 1,100–1,200 kc/s. And whatever the I.F., the image ratio should be measured on all short-wave bands. With a low I.F. and a badly lined-up receiver the ratio may be less than 1.

As any detailed treatise on the superheterodyne explains, there are many other possible spurious responses, which

256. Spurious Responses

can be investigated by the signal generator as required. For example, there are the whistles due to harmonics of the I.F. being picked up by the

R.F. circuits and beating with the signal. With an I.F. of 120 kc/s, signals close to frequencies of 240, 360, 480, 600, 720, etc., kc/s, are liable to interference if the receiver is badly designed. Similarly, 930 and 1,395 kc/s are the danger points with a 465 kc/s I.F. The greatest interference usually occurs at a signal strength which just falls short of overcoming the A.V.C. delay voltage. Suppose the maximum whistle—found by swinging generator and receiver tuning alternately over about 5 kc/s, and then adjusting signal strength—is an output of 12 mW with an *unmodulated* signal of 60 μ V, and the output when the modulation is switched on is 300 mW. The modulated signal to give 12 mW is next found to be 10 μ V. The ratio $\frac{60}{10}$, or 6, may be regarded as a measure of the I.F.

harmonic interference. The greater this ratio, the less the liability to interference.

Measurement of the undesirable response to I.F. signals ought, of course, to be made ; especially at the ends of the wavebands nearest in frequency to the I.F.

In the more sensitive receivers the measurements are complicated by noise. It is usually impossible to measure a sensitivity of the order of 1 μ V because the output with no generator modulation at all may actually exceed

50 mW. As such sensitivity is useless, there is no need to go to great trouble to find a measure of it ; even if found

it ought not to count to the credit of the receiver. The standard output can be raised, say, to 500 mW, and a note made to that effect.

If the output meter is of a square-law type (which a metal rectifier is not) the output power due to two simultaneous signals, or to signal plus noise, is directly added. The sum of a number of simultaneous voltages, v_1 , v_2 , etc. is $\sqrt{v_1^2 + v_2^2 + \dots}$. The British R.M.A. define noise level as the unmodulated R.F. signal microvoltage for which the R.M.S. noise output from the receiver is equal to the output given by a 10 per cent. modulation of that carrier at 1,500 c/s. The signal modulated in this way is applied to the receiver and adjusted to such a strength that when the modulation is switched off the output in watts is halved. A square-law meter is necessary to do this properly, but doubtless the results given by other common types of meter are sufficient for local comparison. The meter should be responsive up to 8,000 c/s without more than 2 db loss. The higher modulation frequency, 1,500 c/s, is specified in order to make the result more independent of tone control than if the usual 400 c/s were used; but if the tone control setting—normally the one giving flattest response—is specified there seems to be no objection to 400 c/s.

It is necessary to consider what is included in the term "noise". As it is self-generated noise that is being considered, anything from external sources, arriving via either aerial or mains, should be excluded; and so also is hum, because a measurement of electrical output due to it is so far from representing the aural effect. In the R.M.A. specification referred to, hum is definitely excluded by a filter, and the remaining noise, generated within the receiver, assumed to be between 500 and 8,000 c/s. Measurement of hum is dealt with in Sec. 235.

There are two methods of measuring *selectivity*. In the first, one signal generator is used. After it has been adjusted to give standard output from the receiver carefully tuned, its frequency is varied each side of resonance and the corresponding signal strengths to maintain standard

258. Selectivity

MEASUREMENTS : SETS

output are noted. They can be plotted as a curve, which appears as an inverted resonance curve (Fig. 165). It is, of course, essential either for the signal to be too weak to bring the A.V.C. into operation, or for the A.V.C. to be temporarily put out of action.

If the response is of the flat-topped or two-peaked variety, the receiver should be tuned to the centre or trough, which may mean that a greater sensitivity is shown a few kc/s off tune. For rapid testing, when the drawing of a curve is not justified, the author takes readings at ± 3 kc/s and ± 9 kc/s. The former gives some idea of whether side-band cutting is serious, and the latter indicates adjacent channel selectivity. But a curve is desirable because it shows more clearly asymmetrical response (as in Fig. 165), twin peak separation, and the steepness of the "skirts" of the curve for exclusion of powerful signals several channels away. Curves are particularly valuable in presenting the performance data for variable selectivity controls.

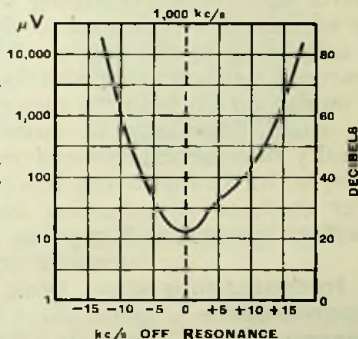

Fig. 165 : Typical selectivity curve (slightly asymmetrical) by the single-generator method

The foregoing method has the advantage of simplicity, but it is very far from representing working conditions, where there is not only the interfering signal or signals but also the one to which the receiver is tuned. So the approved modern methods require two signal generators in series. The procedure recommended by the R.M.A., with an open aerial receiver, is first to tune it to the generator providing the interfering signal, which is modulated in the standard manner and set to a strength of 1 mV ($1,000\ \mu\text{V}$). The receiver volume control is then adjusted so that the receiver gives a quarter of its rated power output.

The second generator, giving an unmodulated signal of 1 mV, is then switched on and its frequency adjusted to that of the first by the zero beat note method. If the modulation of the first generator tends to confuse this it may be temporarily switched off. The first generator is then detuned above and below the receiver frequency, beginning at ± 5 kc/s, and its signal strength adjusted so that the receiver output due to the modulation of this interfering signal is at all points 40 db below the original power (i.e., a quarter the rated output). To prevent the beat-note of 5 kc/s and upwards, or hum voltage, affecting the output meter, a filter is inserted between it and the receiver to remove everything except the 400 c/s signal. The selectivity is expressed as the strength in millivolts of the interfering carrier wave. The presentation of results as curves is similar to that with the single-generator method. An output 40 db below a quarter of the rated wattage is very small, especially in battery-driven receivers, and difficulty may be experienced in reading it on the usual meter, or in distinguishing it from small disturbances.

For studying or adjusting band-pass tuners, variable selectivity systems, and response curves generally, plotting curves is tedious—intolerably so in

259. Instantaneous Response-curve Apparatus some work. The cathode-ray response curve apparatus that is generally used in the factory for lining up receivers quickly is helpful also in the

laboratory. The apparatus is described in Secs. 85-7. In applying it to receivers, the signal source should be in effect a properly-screened signal generator ; an unscreened or ordinarily-screened oscillator with the rotating condenser or electronic frequency modulator attached, which is serviceable for testing filters or systems with comparatively small amplification, is liable to let out too much stray signal for tests at low microvoltages.

With regard to connection of the cathode-ray tube to the output of the receiver, there are two possible methods. The deflection plates can be supplied with either the unrectified signal from the final tuned circuit, in which case a filled-in figure appears, like Fig. 166 (a) ; or the

rectified and smoothed product, giving a line diagram, as at *b*. A disadvantage of the former is that it is quite the exception for the signal to be strong enough to produce a reasonably large diagram when connected straight to the deflection plates; and amplification presents obvious difficulties. A minor disadvantage is that the light is much less intense than when it is concentrated into one line. But as there are no A.F. circuits the frequency of curve repetition need not be very low—the 50 c/s supply can be used—and that makes it possible to operate in the

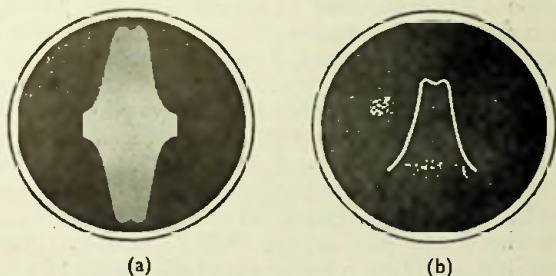

Fig. 166 : How selectivity curves appear on the cathode-ray screen when (a) the R.F. or I.F. signal, and (b) the rectified and filtered Z.F. output are used

A.V.C. region of signal strength without risk of the bias varying appreciably during the cycle. Obviously an unmodulated R.F. signal is used.

If the rectified-signal method is adopted—and it is the more popular—the use of A.F. modulation is impracticable because the curve repetition frequency must be kept lower than any audio frequency—10 to 20 c/s—to avoid distortion of steep curves. It is very desirable to use the rectifier (detector) in the receiver, so as not to introduce conditions that would alter the performance. The filtering following the detector should not be more than is needed to eliminate R.F. ripple. Unless exceptionally high-level detection is a feature of the receiver, a stage of Z.F. amplification between it and the cathode-ray tube is necessary.

For considerable information on such apparatus, and the precautions to be adopted, the reader should refer to

an article by R. F. Proctor and M. O'C. Horgan in *The Wireless Engineer*, July and August, 1935.

Two tests of importance deal with the relationship between input signal strength and output power.

260. A.V.C. Tests To show A.V.C. action it is desirable that the output stage should not be overloaded, so it is necessary to use the volume control to restrict the output to, say, a quarter of the rated maximum. The R.M.A. method of beginning with the strongest signal (1,000,000 μV), controlled to give this output power, and then reducing the signal strength, is subject to the objection that it entirely fails to give the most important information about the A.V.C.—the output level to which it tends to bring signals that overcome the delay voltage. If that level is too high, a large proportion of the volume control range, corresponding to gross overloading, is wasted, and the remainder is consequently overcrowded. Also the method involves measurement of very small output powers towards the lower part of the A.V.C. curve. And it is not possible to conform universally to the standard specified, because the majority of signal generators are incapable of an output of 1 volt.

Fig. 167 : Examples of A.V.C. curves. A is taken with no muting system in operation. At the extreme left a noise output of 2mW with no signal is shown; then there is the steep rise during which A.V.C. is inoperative owing to the delay voltage not having been overcome. When it is, A.V.C. restricts further rise. Owing to excessive delay voltage in this case, the "flat top" is rather too high. When a muting or Q.A.V.C. system is in use, the curve B results

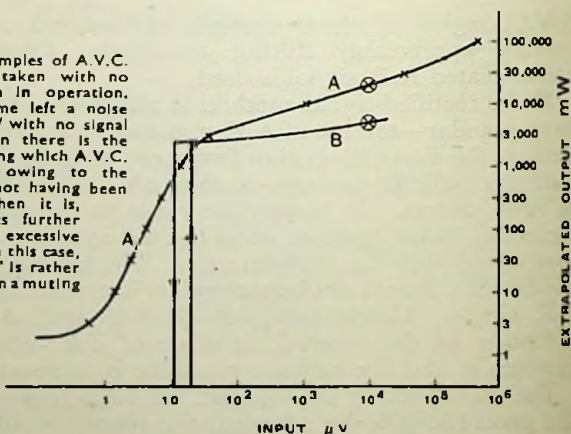

MEASUREMENTS : SETS

The writer advocates a procedure that avoids all these disadvantages. The volume control is set at its maximum. If with no signal there is appreciable receiver noise output, its amount is noted. Then a standard signal of increasing strength is applied and the corresponding output observed. A convenient series of points is 1, 3, 10, 30, 100, etc. mW ; 3 is near enough to $\sqrt{10}$ to be placed half-way between 1 and 10 on a logarithmic scale without serious error. When the next step in output would exceed about a quarter of the rated maximum, the volume control is adjusted until the output is reduced to one-tenth (in watts), and the next two output meter readings are multiplied by 10. If necessary this process is repeated, until the maximum generator signal is reached.

The following is a typical example (Fig. 167 (A)) for a receiver with a nominal output of $3\frac{1}{2}$ watts :—

Output, mW Measured	Output Plotted, mW	Input, μ V
2	2	0
3	3	0.6
10	10	1.3
30	30	2.5
100	100	4.2
300 } * 30	300	7.7
100	1,000	12.5
300 } * 30	3,000	44
100	10,000	1,130
300 } * 30	30,000	33,000
100	100,000	400,000

* Volume control adjusted.

The A.V.C. curve is plotted as *extrapolated output watts* against R.F. microvolts, and shows the output that would be given if the audio stages were unlimited in power-handling capacity. A receiver with an excessive delay voltage or too much audio gain can produce theoretical kilowatts in this way ! Faulty design is thus revealed.

If a briefer test is required, the extrapolated output watts at $10^4 \mu\text{V}$ is perhaps the most useful single datum. Experience shows that with 30 per cent. modulation this should normally be slightly greater than the rated maximum output. In Fig. 167 (A), for example, it is excessive.

When a noise suppression system (Q.A.V.C.) is incorporated, the lower reaches of the curve are especially interesting. If an appreciable range of signal strength is occupied in overcoming the suppression, so that the first part of the curve is similar to that of ordinary delayed A.V.C. but steeper, one result is more or less noticeable distortion of transmissions in this region of signal strength. To make sure that this does not take place, designers usually try to obtain a slight backlash effect, so that by however small a margin the suppression bias is exceeded, it is completely thrown off with a jerk (take care of the output meter !) and the signal can be carried appreciably below this critical value before suppression again takes charge. The increasing and decreasing characteristics should be distinguished by arrows (Fig. 167 (B)).

The object of the other input/output characteristic is not to avoid overloading but to show it up. If the R.F. signal strength is varied slowly, the result is obscured by A.V.C. R.F. overloading must therefore be studied in terms of distortion of the

261. Overload Curves modulation. The methods are dealt with in Sec. 226, under Amplifiers, which also includes similar tests on the A.F. department. In tests on the receiver as a whole, in which the A.F. output is measured, it is necessary to have the depth of modulation under control, and the signal generator itself should be free from distortion.

In a "static" test of linearity, the signal modulated at 5 or 10 per cent. is adjusted to give an output comfortably within the capabilities of the receiver. The modulation depth is then increased to the maximum possible, in suitable steps ; and the output watts plotted against the square of the modulation percentage. In a perfect amplifier the result is a straight line passing through the

origin. The output power at which a serious departure from perfection is made can be seen. Of course the modulation system of the generator must be above reproach, or the test will be vitiated. To test it, the whole modulation range should be run through *within* the capabilities of an amplifier. Unless it is desired to include possible A.V.C. effects it may be desirable to cut out the A.V.C. action, as some systems are affected by the depth of modulation.

A dynamic test of non-linearity is more reliable, using the cathode-ray tube method described in Secs. 228-231. The adaptation to a complete receiver is too obvious to need description.

Lastly, there is frequency distortion. Here again, there is no need for detailed description of the method of test.

**262. Overall
Frequency
Response Curves**

The signal generator is modulated by an oscillator of variable frequency, and the output noted over the A.F. band. The signal strength, depth of modulation, and output power, within

reasonable limits, have little or no bearing on the results, and standard conditions can conveniently be assumed.

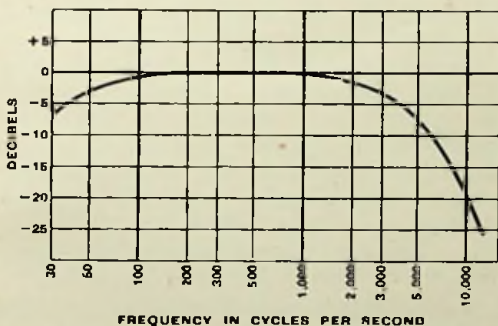

Fig. 168 : Typical overall modulation-frequency response curve of a receiver. The fall at the high-frequency end is influenced partly by selectivity of the tuning circuits and partly by detector and A.F. circuit characteristics, tone control, etc.

On the other hand, carrier wave frequency may have a pronounced effect; the settings of tone control and selectivity control obviously have, and separate tests are necessary to show them.

RADIO LABORATORY HANDBOOK

The results should be plotted on a logarithmic frequency scale, and the response is usually indicated in decibels, with that at 400 c/s as zero level (Fig. 168).

The need for intelligent interpretation of results must be re-emphasised in connection with these frequency characteristic curves. The loud speaker characteristics may alter the overall result very greatly. A severe falling-off in response at the upper frequencies may be largely filled up by speaker resonance. The impedance of the speaker rises, too, and with a pentode output stage this tends to increased acoustical output, whereas with a triode the opposite obtains. If this is fully kept in mind, however, frequency characteristics can be valuably informative.

CHAPTER 10

VERY-HIGH-FREQUENCY WORK

ALTHOUGH references to the suitability or unsuitability of methods or apparatus at very high frequencies have been included in the preceding chapters, notes devoted specifically to such work may be

263. Bounds of V.H.F.

helpful to readers who are unaccustomed to it. Generally there is no sharply-defined frequency at which a particular form of technique becomes inapplicable. It is necessary to use judgment based on common sense, experience and estimation of the relative quantities affected by frequency. Effects negligible at, say, 1 Mc/s, become appreciable in accurate work at 10 Mc/s, and dominant at 100 Mc/s. Most of the methods described in this book for radio frequencies present no special difficulty due to frequency as far as one or two Mc/s, and with sometimes a little extra care can be used satisfactorily up to 10-20 Mc/s. Above 30 Mc/s one enters the field of "very high" frequencies (which are defined as those between 30 and 300 Mc/s, corresponding to wavelengths between 1 and 10 metres), and in it a fairly large number of modifications have to be made to the ordinary technique. Above 300 Mc/s, in the region of ultra-high frequencies or decimetre waves, still more drastic changes in method are necessary, and the same applies again to the super-high frequencies, or centimetre waves (sometimes called microwaves). The technique of U.H.F. and S.H.F. requires a book to itself, and this chapter is confined mainly to V.H.F.

One thing that the experimenter has to get used to, even at moderately high frequencies, is not thinking too much in terms of circuit diagrams,

264. How Circuit Diagrams can Mislead

with their localised inductances and capacitances. Whereas the quantities not shown on the diagram are "strays" at moderate radio frequencies, they often usurp control at very high frequencies

and become more important in the operation of the circuit than the legitimate components. For example, it would be quite impossible to explain the action of the V.H.F. oscillator circuit of Fig. 169 (a) by taking account only of the primary characteristics of the components shown. But when the interelectrode capacitances of the valve are marked in as condensers, the circuit is immediately recognisable as the Colpitts (Fig. 169 (b)). Incidentally, this particular circuit is quite a good one for general use in the V.H.F. band. Even more obscure is the manner of action of an oscillator in which both condensers and coils are absent, and the capacitance and inductance reside in parallel wires or coaxial tubes.

One must have some idea of the stray quantities present, and decide whether they make the proposed work invalid.

Generally a very *high* impedance is impossible, because stray capacitances are in shunt with everything. It is like performing electrical experiments

at the bottom of the sea, with everything more or less short-circuited by the salt water. On the other hand, it is impossible to get a very *low* impedance between two separated points, because the inductance of even an inch of straight wire may be responsible for quite a large number of ohms. So for both reasons wiring should be as short and direct as possible if it is to play the part of a mere connector.

Because of the irreducible minimum capacitance due to wiring, valve electrodes, and so forth, the inductance

that can be used for tuning is very small; and instead of an impedance at resonance approaching a megohm, as is possible at medium frequencies, one may be reduced to a few thousands

of ohms. Consequently the dynatron is practically ruled out. Even if it were not so on this account, another difficulty would intervene. An effect that is negligible at 1 Mc/s, appreciable at 10 Mc/s, of major importance at 100 Mc/s, and renders ordinary methods quite impossible at 1,000 Mc/s, is the time taken by electrons to move from

VERY-HIGH-FREQUENCY WORK

one electrode to another in a valve. Without going into the theory of the thing,* one can say that the most important result is that the effective cathode-grid impedance is reduced to an alarming extent (Fig. 181). The input impedance of a screen-grid valve can be regarded at medium frequencies as consisting almost entirely of a few $\mu\mu\text{F}$ of capacitance. But in the V.H.F. band it is found to be shunted by a resistance of only a few thousands of ohms. In addition to the references just given, there is a very interesting article by M. J. O. Strutt in *The Wireless Engineer*, Sept. 1937, giving a large amount of data on this deterioration of valves at V.H.F., and on methods used in investigating it. So far as the author is aware, no data on this phenomenon in relation to the dynatron have been published; but as the dynatron is in any event unsuitable at V.H.F. they would be of only academic interest.

Fig. 169 : Due to the major influence at V.H.F. of valve inter-electrode capacitance, the circuit which according to the components actually visible would appear as (a) is better understood when drawn as (b)

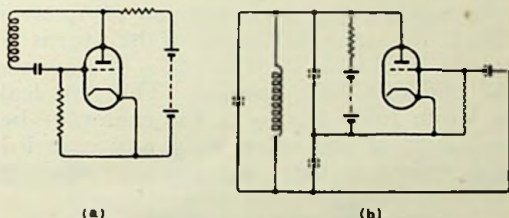

In setting up V.H.F. apparatus these various influences should be taken into account. Suppose, for example,

267. Typical Circuit Design

an oscillator is required, to provide a signal covering a band in the region of 60 Mc/s (5 metres). To get the close coupling necessary to ensure oscillation when the impedance of the circuit is unavoidably so low and is further lowered by the shunting effect of the valve, and to make the system as rigid as possible so as to prevent vibration affecting the frequency of oscillation, single coil circuits such as the Hartley or Colpitts are preferred to "reaction coil" arrangements. To ensure

* But see W. R. Ferris in *Proc. I.R.E.*, January, 1936; and a simplified explanation by the present author in *The Wireless World*, October 23rd, 1936.

ready oscillation over the whole of the band, the effective position of the tapping must be considered. At lower frequencies the cathode can be tapped near one end (usually the grid end) of the coil with complete success. But at V.H.F. the tap should be near the centre. If stray capacitance comes across a portion of the coil the effective tapping point may thereby be shifted along to an unfavourable position.

For rigidity and low capacitance the coil should be wound of thick bare wire—say about 14 S.W.G.—shaped on a rod $\frac{3}{4}$ -inch diameter and mounted as directly as possible to the valve holder, which should be of special low capacitance shape and material and mounted an inch or more clear of the baseboard. The variable condenser, also of compact design and with maximum and minimum capacitances of perhaps 25 and 3 $\mu\mu\text{F}$ respectively, is mounted so as to make wiring practically non-existent, and especially so as to avoid what are, in effect, unauthorised turns or half-turns of coil; and, of course, it should be rotated by a slow motion control at the end of a long spindle. The grid leak resistance can be quite low—25,000 Ω for example—because the input resistance of the valve is in any case low; and with a high resistance there is a risk of “squegging”.

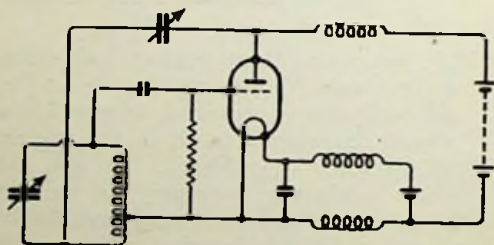

Fig. 170 : Typical oscillator circuit for V.H.F. as described in the text

The oscillation can be controlled by a small trimmer slung in the wiring. Three chokes are shown (Fig. 170) for isolating the batteries in case it is desired to put them at some distance. In any case it is a good thing to keep the R.F. currents in their own quarters. The filament chokes must be of reasonably low resistance, and assuming

VERY-HIGH-FREQUENCY WORK

a filament consumption of about 0.1A they can be made by winding 50 turns of 26 S.W.G. wire on a half-inch tube. Where the resistance restriction does not apply, the same or a rather greater number of turns of fine wire on a quarter-inch former is to be preferred.

If by-pass condensers are needed anywhere in a circuit there is no advantage, but rather a disadvantage, in using a large capacitance. As the author showed in an article in *The Wireless World* (September 29th, 1933) there is an optimum capacitance for every frequency, being that required to neutralise the inductance of the connections. Assuming the distance between the terminals of the condenser to be about an inch, and no additional wiring, the optimum capacitance is given in Fig. 171.

268. Optimum By-pass Capacitance

showed in an article in *The Wireless World* (September 29th, 1933) there is an optimum capacitance for every frequency, being that required to

neutralise the inductance of the connections. Assuming the distance between the terminals of the condenser to be about an inch, and no additional wiring, the optimum capacitance is given in Fig. 171.

Fig. 171: Optimum capacitance of by-pass condensers, assuming the total length of connections (including the condenser itself) is about one inch

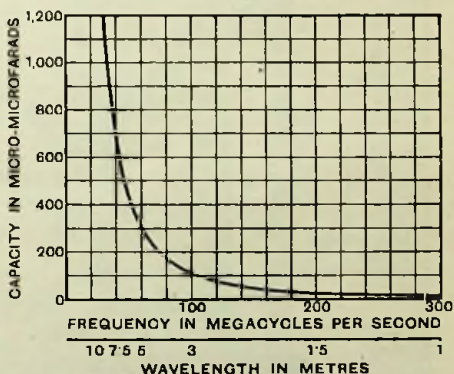

It is not implied that all of the foregoing precautions are essential to success, and each experimenter has his pet methods, but they indicate the general idea of how to go to work.

269. Below One Metre

As the input conductance of a valve rises in proportion to the square of the frequency it is almost impossible to use a conventional valve above about 125 Mc/s, but the "acorn" valve,

RADIO LABORATORY HANDBOOK

specially designed to reduce the transit time effect to a minimum, is workable at several hundred Mc/s. Fig. 172 shows the construction and Fig. 173 the circuit of a 375 Mc/s (80 centimetre) oscillator. The whole thing is mounted on a small piece of $\frac{1}{8}$ -inch copper sheet held at the end of a wooden stick. The dark square is a background to show up the detail, and is not any part of the apparatus. An aerial, consisting of a piece of wire cut to a half-wavelength, can be excited either as shown (current excitation) or by bringing one end near a high potential part of the coil (voltage excitation). It is very instructive to play about with such pieces of wire used as aerials or reflectors.

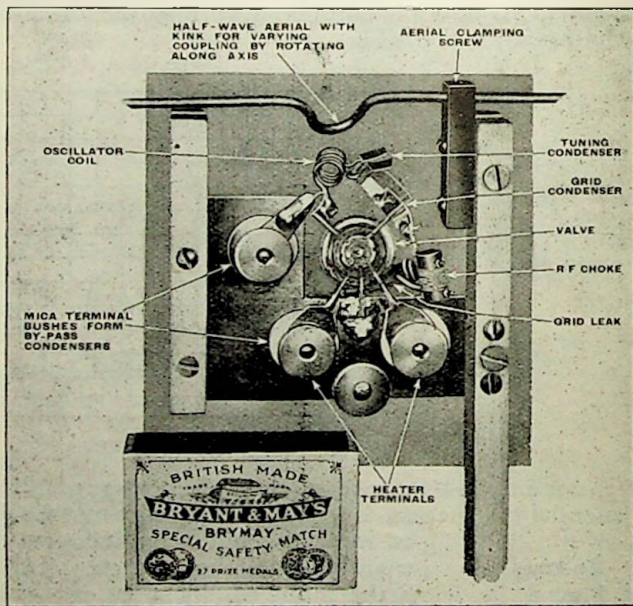

Fig. 172 : An experimental 0.8-metre transmitter using an "acorn" valve. The matchbox, half actual size, indicates the compactness of the apparatus

VERY-HIGH-FREQUENCY WORK

The heterodyne wavemeters and receivers, so useful at medium frequencies, become increasingly unworkable as the frequency is increased. When a change of frequency of 0.0005 per cent. sends the beat note completely beyond audibility, the effort to find a beat note, and having found it to hold it, is too great. So the absorption wavemeter, described in Chapter 6 (Sec. 128), relying on a movement of the oscillator anode-feed milliammeter at resonance, is the usual device for finding the frequency. Actual measurement of frequency, or rather wavelength, by means of parallel wires, is described in Sec. 138. As for receivers, the type that

270. Wavemeters and Receivers

Fig. 173: Circuit diagram of the oscillator shown in Fig. 172

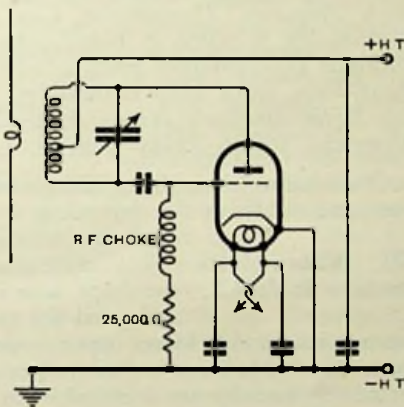

qualifies for general use in the laboratory, by reason of its flat tuning and great sensitivity, is the super-regenerative. The higher the frequency the more workable it is. For

the oscillator shown in Fig. 172 the corresponding receiver is practically the same except for a high-resistance grid leak to induce "squegging", which provides a super-regenerative effect. A general article on the super-regenerative receiver, written from the practical standpoint, was published in *The Wireless Engineer*, November, 1936.

Apart from the possibility of "squegging" (i.e., stopping and starting of H.F. oscillation at some audible or super-audible frequency due to inability of negative charge to

leak off rapidly enough from the grid) to confuse the unwary, V.H.F. apparatus is especially liable to spurious oscillation, or perhaps it should be said that such oscillation is especially difficult to detect or distinguish from the legitimate or expected mode of oscillation. Absorption wavemeters help to clarify the situation by not generating harmonics, and this is a further point in their favour.

It is difficult to get far with experimental work at the higher frequencies without some knowledge of the theory and practice of "transmission lines", "characteristic impedance", and standing waves. Most of the advanced textbooks cover this subject; a concise and up-to-date treatise devoted exclusively to it is Willis Jackson's *High Frequency Transmission Lines*; a non-mathematical explanation is given in *Foundations of Wireless*; while the amateur experimenter particularly can find all aspects of short-wave work ably expounded from his standpoint in the *Radio Amateur's Handbook*, published annually by the American Radio Relay League.

Considering now the applicability of various measuring instruments, from the foregoing it will readily be judged that the triode valve voltmeter is not very satisfactory at V.H.F., except perhaps when an "acorn" valve is adopted for the purpose. Even that has a considerably lower input impedance at, say, 60 Mc/s, than at 1 Mc/s; but as impedances generally at the former frequency are inevitably so low it does not matter very much. But for voltage measurement at V.H.F. the diode is the best, and its use and limitations have been closely studied by a number of workers, e.g., E. C. S. Megaw, in *The Wireless Engineer*, 1936, pp. 65-72, 135-146, and 201-204. Diode voltmeters, using a special miniature diode with small clearances, have been used up to 1,000 Mc/s, but at that frequency only very rough indications of voltage are to be expected. However, for comparison—which, according to the exhortations of this book, is all that is really necessary for most measurements if they are properly planned—they are quite satisfactory. Fig. 174

VERY-HIGH-FREQUENCY WORK

shows the simple circuit of a diode voltmeter. To avoid the need for a sensitive microammeter the rectified voltage can be applied to the input of a valve, in the

Fig. 174 : Circuit of diode valve voltmeter for V.H.F.

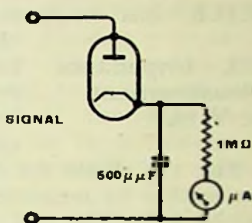

anode circuit of which is a suitable meter. A suitable type of diode for V.H.F. use is the Mazda D.1 (Sec. 68).

The gas-focused cathode-ray tube begins to lose definition at very moderate frequencies—a few hundred kc/s—but at V.H.F. it stages an unexpected

272. Cathode-ray Tubes

come-back, and gives results of some utility even at 1,350 Mc/s*—22 cm. wavelength. The focusing of the high-vacuum tube is unaffected by frequency; but the deflection sensitivity alters, whatever the type, when the period of a cycle of the signal is comparable with the time taken by the ray to traverse the deflecting field. Suppose, for example, that these two periods are equal. Then the deflection due to the negative half-cycle neutralises that due to the positive half, and the sensitivity is nil. Moreover a phase difference is introduced in electrostatic deflection tubes, in which the ray comes successively under the influence of the X and Y pairs. These effects decrease as the anode voltage on the tube is increased, but ordinarily become noticeable at about 100 Mc/s. For detailed information on these and other V.H.F. effects refer to the paper by Piggott, just mentioned, or to a textbook on C.R. tubes.

The standard measuring instrument for V.H.F. current is the thermo-junction instrument. It is expensive, and very easily burned out, but is less affected by frequency than any other type.

The failure of the dynatron for practical purposes at

* L. S. Piggott, *Journal I.E.E. (Wireless Section)*, September, 1936.

V.H.F. has been mentioned. The large number of measurements for which the dynatron has been specified are not thereby rendered impossible; most of them can be performed with the aid of a triode oscillator.

273. Impedance Measurement at V.H.F.

Fig. 175 shows the circuit of such an oscillator used by the author to measure the input impedance of valves at 54 Mc/s.* The coil consists of six turns of 16 S.W.G. copper half-inch diameter, tapped at turns as numbered. The grid bias at which oscillation starts—indicated by a sudden change in anode current—is read on a voltmeter having a large open scale. The anode voltage must be kept very constant. The tuning condenser can be calibrated and used to measure capacitance at R.F., as in the dynatron apparatus, but it must be realised that the inductance of even the shortest leads modifies the results to an appreciable extent. The principal object is the measurement of resistance. The oscillator is calibrated by connecting to the X terminals a variety of resistors of the non-wire wound type, and noting the critical grid bias in each case. A curve is drawn relating the two. The weak point of this method is that even the little $\frac{1}{4}$ -watt composition resistors depart from their measured

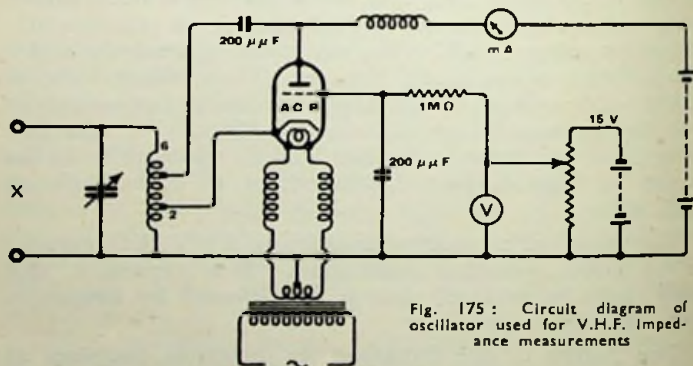

Fig. 175: Circuit diagram of oscillator used for V.H.F. impedance measurements

* *Wireless World*, October 23rd, 1936.

VERY-HIGH-FREQUENCY WORK

resistances if the frequency is very high. One object of using a large variety of resistors and drawing a curve is to minimise the chances of serious errors, by averaging them out. It is the high resistances that are affected first as the frequency is raised, and at about 60 Mc/s anything above 50,000 Ω is likely to be considerably wrong. From about this figure downwards the results given by the apparatus just described are in very satisfactory agreement with similar measurements performed by a more accurate method.*

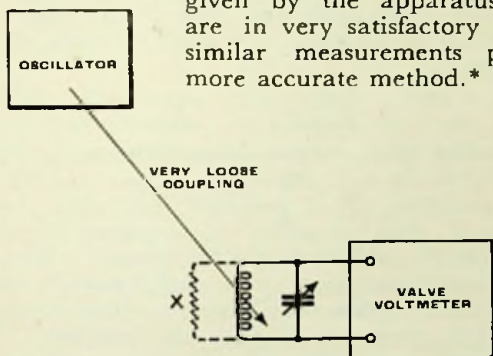

Fig. 176: Alternative arrangements for V.H.F. impedance measurement

That method, briefly, is the $\sqrt{\frac{1}{2}}$ scheme described here in Sec. 197. The apparatus required is a fairly powerful V.H.F. oscillator, coupled to a tuned circuit, the voltage across which is measured by a valve voltmeter—for the present purpose of the diode variety (Fig. 176). The condenser of the tuned circuit is accurately calibrated in small capacitance differences, so as to measure the capacitance required to tune from one to the other of the points each side of the resonant peak at which the voltage is $\sqrt{\frac{1}{2}}$ of this maximum. Assuming that this capacitance, δC , is a small proportion of the whole circuit capacitance, and ω is 2π times the resonant frequency, then the dynamic resistance of the tuned circuit, R_1 , is $\frac{2}{\omega\delta C}$.

* M. J. O. Strutt, *Wireless Engineer*, September, 1937.

Turning this into a strictly practical formula—

$$R_1 \approx \frac{318,000}{(\text{Mc/s})(\mu\mu\text{F})} \text{ ohms.}$$

Having thus determined the equivalent resistance of the tuned circuit (including valve voltmeter), one next connects in parallel with it the component or circuit to be tested, repeating the test and getting the resistance, R_2 , of the combination. The resistance, R , of the added part is, of course, derived from the usual formula for parallel resistances—

$$R = \frac{R_1 R_2}{R_1 - R_2}$$

The approximation given above is good enough for V.H.F. purposes if δC is not more than about one-fifth of the total capacitance. It is assumed, too, that the connection of R to R_1 does not affect the frequency of the oscillator or the voltage induced in the test circuit. With this in view, the oscillator must be powerful enough to give a noticeable reading when very loosely coupled; and great care must be taken not to alter the positions of anything, for a slight movement of an adjacent object that has no connection with either oscillator or test circuit may alter the coupling appreciably. And of course all leads in the test circuit must be reduced, so far as possible, to nil.

When the frequency is very high it is advisable to abandon the attempt to use orthodox "lumped" circuit elements and instead to go in for distributed circuits. These usually take the form either of parallel or coaxial rods or tubes. For example, if they are quarter of a wavelength long and short-circuited at one end, they form a tuned circuit having the advantage of higher Q than could be obtained by using lumped L and C , and are more easily constructed and applied. One has not the feeling of groping in the dark in making a circuit for a desired wavelength, because the only measuring instrument required is a centimetre scale. Oscillators can be made

VERY-HIGH-FREQUENCY WORK

to "go down" to much shorter waves by the use of "lines" than with conventional tuned circuits. And it is possible to dodge the difficulties due to the impedance of leads in measurement circuits by making the leads and the circuits one and the same. The technique is dealt with the last chapter of Hartshorn's *Radio-frequency Measurements*, and will no doubt be developed to an increasing extent as centimetre waves come into use.

The characteristic impedance (or surge impedance) of a transmission line is the resistance of the load that can be fed by it with complete absorption of the power. This is the most efficient condition, because, if a greater or less load resistance is supplied with power through the transmission line, it is unmatched and part of the energy is reflected up and down the line and is ultimately lost.

Mismatching can be detected by the presence of standing waves on the line; that is to say, instead of a constant or gradually diminishing R.F. voltage as one moves along the line from supply to load, the voltage is alternately greater and less. The points of maximum voltage can be detected by a neon lamp (if there is enough power present) or a valve voltmeter, and are situated at intervals of practically half a wavelength if the line is air-spaced. The characteristic impedance of such a line is more easily calculated than measured (see Sec. 303), and the losses are generally small; but cables having solid dielectric between the conductors are a different matter. One method of measuring the characteristic impedance (generally denoted by Z_0) is to feed one end of the line from an appropriate oscillator and adjust a load resistance at the other end until there is no trace of standing waves. The Z_0 of the line is then equal to this resistance. The feeder loss can also be measured, by noting the voltages at each end and expressing the ratio in db. per 100 ft. or other unit of length. As the resistance of most lines lies between 30 and 600 ohms, it is a difficult matter to provide a variable that is non-reactive at very high frequencies. Another practical difficulty is the detection of standing waves when the line is of the coaxial type.

An alternative method is to adjust the frequency, or the length of line, so that when the load end is either open- or short-circuited the line is resonant and therefore behaves as a pure resistance. If it is an odd number of quarter-wavelengths long and open, or an even number and closed, this resistance is very low; and if an even number and open or an odd number and closed the resistance is high.

Measure the resistances with the load end open and closed, and call them Z_1 and Z_2 . Then $Z_0 = \sqrt{Z_1 Z_2}$

The attenuation of the length of line is $8.686 \sqrt{\frac{Z_1}{Z_2}}$ decibels, assuming Z_1 is the low resistance and Z_2 the high.

The impedance of the line is measured in the same way as that of anything else (see Sec. 273). When the line has been adjusted to resonance, it affects only the damping and not the tuning of any tuned circuit to which it is connected. Z_2 , being large, can be tapped across the whole of a tuned circuit; but Z_1 would probably be more easily measured by connecting in series. Although it may still be measured as an equivalent shunt resistance, the corresponding series resistance is obtained as in Sec. 290. For example, if Z_2 were found to be $1,600 \Omega$ and $Z_1 4 \Omega$, then

$Z_0 = \sqrt{4 \times 1,600} = 80 \Omega$, and the

$$\text{attenuation} = 8.686 \sqrt{\frac{4}{1,600}} = 0.43 \text{ db.}$$

CHAPTER II

DEALING WITH RESULTS

THE ultimate value of laboratory work on the bench often depends largely on what is done with it at the desk. Instrument readings may prove too much or not enough if they are improperly or inadequately handled.

And it is remarkable how apparently scanty data can sometimes be made to yield information of great value if put through a scientific "third degree" examination.

274. Rearranging Formulæ

One of the considerations when devising a method of measurement should be, if possible, the direct presentation of the results ; but notwithstanding this it is often necessary to derive them by computation, and sometimes this may be very laborious. So the aim of whoever produces a formula should be to manipulate it into a form that minimises the task of computation. The more results there are to be worked out, the more trouble is justified in prearranging the formula.

Take a simple example. The equation connecting the inductance, capacitance, and resonant frequency of a tuned circuit can be written in many ways. Of these,

$$\omega^2 LC = 1$$

is probably the tidiest looking. But it is not at all well adapted for practical purposes. Suppose that one is working out the capacitances in a circuit of known inductance that is found to resonate at certain frequencies. Suppose, too, that the inductance happens to be $16 \mu\text{H}$, that the frequency is measured in Mc/s , and that the capacitance is desired to be in $\mu\mu\text{F}$.

Unless the contrary is stated, it is assumed that formulæ are in "fundamental" units—amperes, henries, farads, centimetres, cycles per second, and others listed in Sec. 288—which (as in the case of farads) are sometimes very

clumsy for practical use. Who would choose to substitute 0.000016 H and 7,500,000 c/s in a formula to get 0.000000000028 F?

So assuming now that the symbols f , L , and C stand for the quantities in the practical units mentioned, the original formula can be transformed, remembering that ω is $2\pi \times$ (frequency)—

$$(2\pi f \times 10^6)^2 (L \times 10^{-9}) (C \times 10^{-12}) = 1$$

$$\text{whence } C = \frac{10^6}{4\pi^2 f^2 L} = \frac{25,330}{f^2 L}$$

This form is retained for filling in various inductances, but if a number of readings are taken for $L = 16$, the work is facilitated still more by reducing the equation to

$$C(\mu\mu F) = \frac{1,583}{f^2(\text{Mc/s})} \quad (L = 16 \mu H)$$

When formulæ are adapted for special units this should be made clear, either by a note to the effect or by subscripts as suggested above. Confusion is caused if the limitations of a formula are not made clear.

Often a formula can be greatly simplified by neglecting a difference that is too small to be serious within the scope of the work. Suppose the capacitance, **275. What may be Neglected** C , of a circuit that oscillates at a frequency, f , is increased by the small amount C' , causing a corresponding small reduction, f' , in frequency. Then

$$C' = \frac{Cf'(2f - f')}{(f - f')^2}$$

This can be used as a method for measuring small capacitance changes (see Sec. 182). The formula is a most awkward one to calculate, however, for subtractions cannot be done on a slide-rule but have to be worked out beforehand. But because f' is very small compared with f , it can be neglected in terms containing both, so

$$C' \approx \frac{2Cf'}{f} \quad (f' \ll f)$$

a delightfully easy piece of work.

DEALING WITH RESULTS

Very often these approximate formulæ are written with the sign of equality ($=$), and no doubt it is sometimes pedantic to use the sign of approximate equality as above, but it is another of the little things that help to prevent mistakes; and so is the note seen on the right, signifying that f' is *much* less than f .

The above example illustrates another point, that elimination of "negligible" terms must not be done indiscriminately. Because f' is small it might be thought allowable to simplify the equation still further to

$$C' \approx \frac{0}{f}$$

a ridiculous result. It is only as part of a much larger quantity that it can be neglected.

There is a rather more subtle pitfall. It can be illustrated by a somewhat similar example. Suppose one possesses an accurately calibrated condenser,

276. Deceptive

Formulæ

but no suitable standard inductance. As there are inevitably certain unknown capacitances (such as that of the coil) in shunt with the standard condenser, the total circuit capacitance is unknown in spite of the calibration, and one is not much further forward. But if the condenser readings, C_1 and C_2 , required to tune to two known frequencies, f_1 and f_2 respectively, are noted, the extra circuit capacitance, C_0 , can be calculated without a knowledge of the inductance:—

$$C_0 = \frac{C_1 f_1^2 - C_2 f_2^2}{f_2^2 - f_1^2}$$

This looks quite harmless, but it is a type of formula to beware of. It involves the differences between relatively far larger quantities. Consequently, unless these quantities are known and calculated with extreme accuracy, the answer is not accurately given. The small error due to slide-rule calculation of the large quantities might exceed the final answer! In other formulæ there is sometimes a temptation to eliminate a "negligible" term,

only to find that, because the formula involves relatively small differences between larger quantities, the despised term was vital after all.

Subject to these precautions, it is usually worth while doing something to adapt a formula to the particular work in hand. It is a good thing to keep a special notebook of pet formulæ that have proved their value. Chapter 12 may provide a nucleus of this.

It is not always necessary to work out results from formulæ; to a moderate accuracy the results can be derived quickly from alignment diagrams or "abacs". Most of those used in radio work are available in a book *Radio Data Charts*, by

**277. Aids to
Calculation—
Abacs**

J. McG. Sowerby, obtainable from the same publishers as of this volume. By laying a straight-edge across the diagrams to intersect scales of the known quantities at the appropriate points, the desired quantity can be read off another scale. By far the most useful diagrams of this type are those due to the late W. A. Barclay and first published in *The Wireless World* in the issue of February 17th, 1932, and several times afterwards by request, the latest being September 10th, 1937. One of them, connecting volts, ohms, milliamps (and amps), and watts, enables the remaining quantities to be read off when any two are known. Besides covering Ohm's Law, it shows whether a proposed resistor is likely to be overheated, the least resistance that is safe for a resistor of given wattage rating and voltage drop, and many other everyday problems. But still more valuable is the other diagram, connecting ohms (reactance), henries (and μH), c/s (and kc/s and metres), and microfarads. The full usefulness of this can hardly be imagined without trial, nor is there space for a selection of the problems that can be answered by it. The author got reprints of the two on good paper, and dry-mounted them on each side of a photo-mount; a piece of strong thread attached provides a convenient straight-edge always at hand. Even when not accurate enough for the work in hand, the chart is valuable for rough checking of calculations.

DEALING WITH RESULTS

The ordinary graph is another form of diagram that can be very useful as an aid to calculation. Ordinarily

278. Graphs

a single curve serves to relate only two quantities, and a "family" of curves is needed for three; and then one of them is represented only by a series of isolated values. Sometimes a single curve can be made more general by scaling the ordinates in quantities that include two or more factors. Some examples of this are given in Chapter 12.

Whatever is available in the form of quick-reckoning diagrams, there are always plenty of things to be worked out; and for this purpose no engineer

279. Slide Rules

could possibly go through life without a slide rule. There are a number of publications giving instructions on the multitudinous uses of the slide rule. For radio purposes an easily accessible uniformly divided scale (usually marked "L" or "LOG") is very helpful for converting ratios to decibels and *vice versa* (see Sec. 220). It is with slide-rule working in mind that the first formula given for C' , a few paragraphs earlier, was viewed with distaste. The simplified formula, on the other hand, can be worked out with one setting.

The accuracy, of course (assuming adequate workmanship), depends on the length of scale, and there are various devices for getting a long scale in compact form. The ordinary straight rule still retains its popularity, but a circular rule has certain advantages, one being that the scales are continuous.

If a number of factors are multiplied in the ordinary long arithmetical manner, the answer appears with a great many more figures than any of the

280. False Accuracy

factors. To the unthinking, it might appear that the answer is known to more decimal places than any of the data used to find it. This, of course, is absurd; and, to avoid implying greater accuracy than is justified, the surplus figures should be cut off or replaced by noughts, or the shortened methods of multiplication that waste no time finding these meaningless figures should be used. An

advantage of the slide rule is that it automatically gives a uniform standard of accuracy. If it can be read accurately to three figures, then the answer is given with that number, no matter how many factors compose it. For most engineering purposes, the degree of accuracy given by properly effected slide-rule calculations is rather better than the accuracy of the data, or the accuracy with which the answer need be known. Where this is not the case, and data of high precision are available for giving an answer that must be known to the same order of accuracy, either the calculation must be done laboriously by arithmetic, or log tables of the appropriate number of figures used. Incidentally, a book of seven-figure tables is much quicker to use to five figures than a book of five-figure tables.

It is helpful to make a habit of writing down figures in such a manner as to indicate the order of accuracy. For example, although 1.3 and 1.300 are numerically equal, they convey a different meaning. The first means anything from 1.25 to 1.349; the second indicates that it is known to greater accuracy, and lies between the narrower limits 1.2995 and 1.30049. This does not avail for very large numbers; but the method used by the N.P.L. does. It consists in dropping to a slightly lower level the first figure that is not known with certainty, as, for example, $10,2_{50}$ which indicates that the greatest possible error to which this result is subject would not affect the first three figures but might affect the fourth.

At any rate, one must take care not to mislead or be misled by *false accuracy*. Even quite experienced students or technical assistants are sometimes guilty of recording such readings of B.S.I. 1st Grade meters (reading, say, up to 100) as 86.75 and using them as if the instrument really were accurate to 0.01 per cent. instead of 1 per cent. of full scale. Or, having performed a measurement of R.F. resistance by a method that can be depended upon within perhaps 5 per cent., they state the result as 34.22 ohms.

There is inevitably a margin of error due to the instru-

ments used for making a measurement, and there are mathematical methods for combining data in such a way as to get the most probably accurate result. For these, a book dealing with the theory of errors should be consulted. Some instrumental error, as has just been said, is inevitable. But there is no excuse for increasing it by faulty working out. One cannot take too much care about this. It is at least an immense waste of time to spoil good work by mistakes in recording or working out. And if one intends to earn a living by technical work it is important to know that reliability is a far more rewarded virtue than careless brilliance. To this end, columns of figures should be inspected for obvious inconsistencies, rough checks should be made of calculations to ensure that the decimal point is right, and cross-checks devised to arrive at the same results by other routes.

In general the soundest method of recording and working out results is in tabular form. By taking the calculation a step at a time the chance of mistakes is reduced, tracing miscalculations is much easier and quicker, and the intermediate steps may show up useful and perhaps unexpected relationships. The alternative of writing down only the final answers, or of working them out on odd scraps of paper that are lost or destroyed, is most exasperating when it is found or suspected that something has gone wrong. Moreover, when work is being referred to by somebody else, or at a much later date, it can be accepted more confidently if the details of how the results have been arrived at are clearly shown.

As an example of tabulation, suppose that a number of measurements have been made by the method described in Sec. 199 of the effect of Z.F. current on the inductance and resistance of an iron-core coil. The formulæ are

$$L = \frac{2T^2M}{r^2 + 4\omega^2M^2} \quad \text{and} \quad R_L = \frac{T^2r}{r^2 + 4\omega^2M^2} - T$$

where $\omega = 2\pi f$ as usual. Suppose $T = 1,000$, $\omega = 5,000$, and the readings, M , of the inductances are in μH . Then

RADIO LABORATORY HANDBOOK

first the formulæ are simplified on these assumptions to

$$L = \frac{2M}{r^2 + \left(\frac{M}{100}\right)^2} \text{ henries and } R_L = \frac{10^6 r}{r^2 + \left(\frac{M}{100}\right)^2} - 1,000 \text{ ohms.}$$

The working out of the readings is then arranged thus—

READINGS								
I (mA)	M (μH)	r (Ω)	r ²	$\left(\frac{M}{100}\right)^2$	$r^2 + \left(\frac{M}{100}\right)^2$ = A	$\frac{2M}{A}$ = L(H)	$\frac{10^6 r}{A}$ = R _L + 1,000	R _L (Ω)
0	4,740	2.8	8	2,245	2,253	4.2	1,242	242
10	5,120	3.2	10.3	2,630	2,640	3.9	1,210	210
20	5,680	3.9	15.3	3,220	3,235	3.5	1,205	205
30	6,400	4.9	24	4,100	4,124	3.1	1,188	188
40	8,550	8.6	74	7,300	7,374	2.3	1,180	180
50	12,200	17.2	296	14,900	15,196	1.6	1,132	132

The next thing is to draw a graph of L and R_L against the Z.F. current I (Fig. 177).

The points referring to the A.C. resistance of the coil are rather irregular, and it will have been noticed in the working out that a small error in data or calculation causes a relatively large error in the derived value of R_L. If it is important to know with accuracy the variation of R_L with Z.F. current it will be necessary to repeat the observations of r and the calculations more carefully.

In the above tabulation use has been made of an abbreviation "A" for one part of the formula. This method is especially helpful in a complicated formula where the same "sub-assembly" occurs more than once, or where it has to be repeated frequently in some working.

The whole of any work coming within the scope of this book is in vain if it does not enable some interesting conclusion to be drawn. Generally a

283. Interpretation of Results measurement is not an end in itself, but is made with the object of deducing something from it about the apparatus tested, and has to be *interpreted*.

Looking at the example just given, it seems clear that the inductance falls off considerably as the Z.F. current is

DEALING WITH RESULTS

increased. As it happens, that is such a well-authenticated phenomenon that it causes no surprise and there is no

Fig. 177: Example of experimental results plotted to aid interpretation

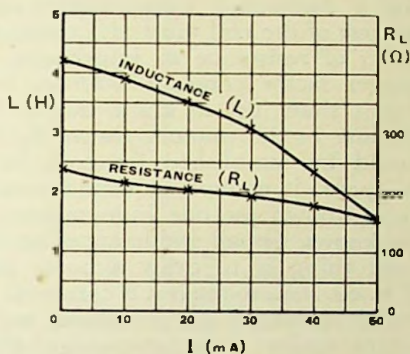

reason to doubt the validity of the conclusion. But in general one should be extremely cautious in coming even to such a simple conclusion as this. What about the 800 c/s signal current? Was its strength measured, or arrangements made to keep it constant or governed by some simple relationship? If the inductance depended very critically on the A.C., an indefiniteness in this factor might lead to very wrong conclusions quantitatively and perhaps even qualitatively about the relationship between inductance and Z.F. current. Has the experiment been carried out in such a way as to introduce no other factor into the results? What about the resistance of the battery used for supplying the Z.F. current, and the impedance of the milliammeter used for measuring it? Was the frequency of the A.C. *quite* steady throughout? (The results depend on the *square* of the frequency, so this is important). Such questions as these have to be considered and answered satisfactorily before conclusions can safely be drawn. Suspect everything. The genuine experimenter has a permanently suspicious mind.

He has already suspected that the curious wavelike distribution of the R_L readings may not represent a physical phenomenon but merely insufficient accuracy; and on this assumption a smooth curve has been drawn

through them. If the experiment is repeated more accurately and the curve found to droop in a manner similar to that for inductance, the interpreter at once looks for a connection between the two. Obviously the *impedance* of the coil must also droop in the same way. The ratio of resistance to impedance is *power factor*. Is the power factor constant? If so, it is a more interesting result than just to know that inductance and resistance decline in the manner shown by a pair of curves. If it could be established for coils in general (which, as it happens, it cannot) it would mean that if the resistance were known for one inductance and frequency it would be known for all inductances at that frequency. So the next thing is to draw a curve of power factor against Z.F. current, to see if it is constant. If not, and no obvious relationship can be perceived, perhaps a curve of power factor against inductance might show one? And so on.

While a graph or table connecting two or more variables may be useful and instructive, it is much more valuable to be able to deduce from it some law expressing the relationship in simpler terms. In doing this one must be aware of the fallacy of enunciating a

284. Need for Caution

law that All Negroes Have Curly Hair, when the only statement that is justified is that all the negroes that one can remember having seen had curly hair. Refrain from the temptation to extend a curve beyond the known points (extrapolation), however surely it may seem to tend in a certain direction. Even filling in the curve between the known points (interpolation) is not justifiable without due consideration. The curve shown in Fig.

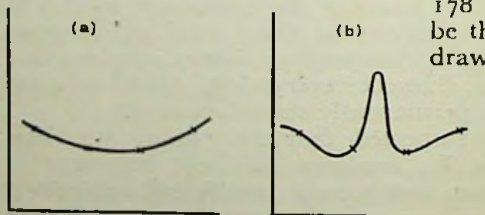

178 (a) may seem to be the obvious one to draw through the

Fig. 178: Two ways of drawing a curve through a series of plotted points. Which is right?

DEALING WITH RESULTS

points given, whereas closer investigation might show it to be of the form of Fig. 178 (b). How about Fig. 179? Is the odd point an error in reading, or is it a genuine irregularity in the relationship between the two quantities graphed? The answer must be sought by repeating that particular reading, and preferably also by taking a few extra readings in its neighbourhood. One of the values of a graph is the way it discloses errors, or (alternatively) unexpected phenomena, in this way.

Another purpose of a graph is as a means to establish laws of behaviour. Having confirmed that the odd point

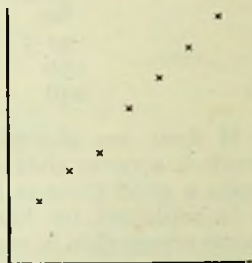

Fig. 179: If it were not for one point, a straight line could be drawn through them all. Is the odd reading an error, or does it point out a fact?

285. Deducing Laws

in Fig. 179 is a mistake, one would draw a straight line through the others and deduce a simple linear equation connecting the two variables, so that additional values of one quantity could be derived from the other without measurement. This process is explained in school mathematics. If the "curve" really is curved, it is probably not obvious what the relationship is; so the next thing is to try replotting on paper ruled logarithmically in one or both co-ordinates, which may reduce it to a straight line from which a law can be deduced. Alternatively, one of the quantities can be squared or raised to some other power using plain graph paper; or a curve plotted of *differences* between values of y at equal intervals of x . These are some of the many ways of manipulating data to extract some sense out of them.

The following data on the input resistance of "acorn" pentodes are quoted from an article by M. J. O. Strutt.*

* *Wireless Engineer*, September, 1937, p. 483.

RADIO LABORATORY HANDBOOK

Frequency : Mc/s	Resistance : Ohms
37.5	140,000
60	49,000
91.5	23,000
150	7,700
238	2,800

If these are plotted as a graph with linear scales the result is a curve that anybody familiar with graphs might make a good guess at (Fig. 180). But to cut out guessing, it is replotted on logarithmic paper (Fig. 181), and it seems reasonable to regard the points as lying on a straight line. It can then be seen that for every 10 : 1 ratio unit of frequency (say 30 to 300), the resistance covers two (2,000 to 200,000); and that as the one increases the other decreases, so it can be deduced that the reciprocal of the resistance (i.e., the conductance) of the valve is proportional to the *square* of the frequency. To make

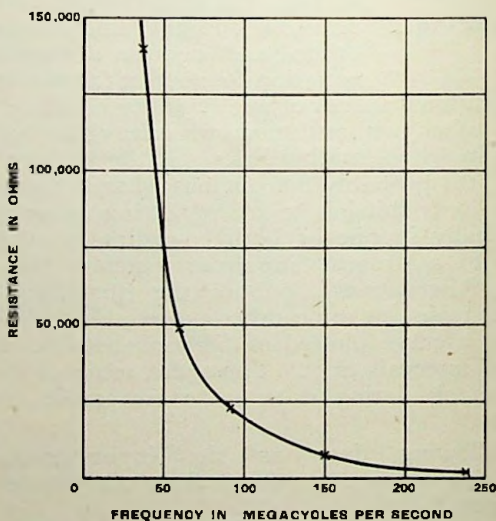

Fig. 180: The general law connecting Input resistance of a valve with frequency is not obvious from a curve plotted in this way—

DEALING WITH RESULTS

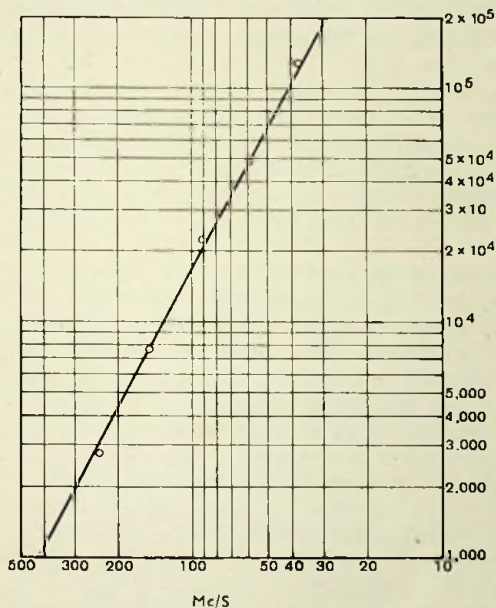
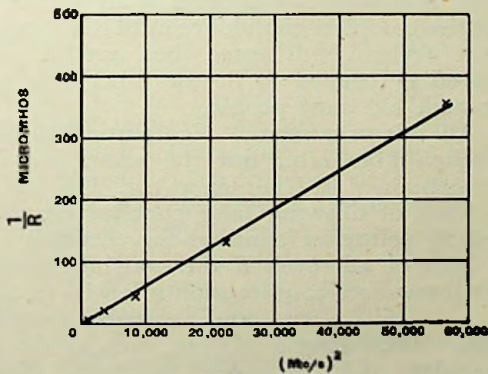

Fig. 181:

—but by plotting it to logarithmic scales it is reduced to a straight line, from which a definite relationship can be deduced—

Fig. 182:
—and can be decided by plotting $\frac{1}{R}$ against f^2



quite sure of this, Fig. 182 shows $\frac{I}{R}$ plotted against f^3 (and incidentally shows the superiority of the log curves for well-distributed plotting).

One can say, therefore, that within the limits of accuracy of the experiment, and within the limits of frequency covered, the above-mentioned law applies for this valve. If it is found experimentally to apply to all valves tested, then one may perhaps venture to work on the hypothesis that it applies to all valves, until evidence to the contrary is forthcoming.

This is an example of an *empirical* law (i.e., established by experiment rather than reasoning). A "law" is chiefly useful in so far as it enables the results of untried experiments to be predicted. For example, having taken the five readings plotted in Fig. 181 one may with some confidence predict the results of measurements made at intermediate frequencies. But so long as the law is only empirical one always takes a chance in using it, and the further its use is extended the more risky that chance becomes. But an empirical law often points the way to establishing a theoretical proof, which shows how far the law applies—whether it is general or restricted. Until the proof is forthcoming, confidence in general use of the law is more or less lacking. Sometimes the theory comes first, and as theory is often badly founded it, too, fails to inspire complete confidence until it is supported by practical test. When both agree (but not because one has been forced or coaxed to fit the other) the position is secure enough for most people.

All this may seem "highfalutin" to the owner of the kitchen-table lab., but the same principles hold good. As explained in Chapter 3 (e.g., Fig. 12), it is essential to beware of drawing false conclusions, even when merely taking voltmeter readings for checking over a set.

Last of all, even if the conclusions or deductions are for immediate consumption it is wise to make a permanent and accessible record of them. This is true even if the answer is, so to speak, a lemon. Negative results are as important as positive, however

286. Recording Results

DEALING WITH RESULTS

unsatisfactory they may seem at the time. Results that do not turn out as predicted by theory or previous experiment may show the way to new discovery. If a thing "doesn't work" there is a temptation to throw the job up in disgust; but perseverance with the object of finding the cause of the failure is nearly always worth it, if the time can possibly be spared. But however disappointing the result, it is worth recording with full particulars, if only to show at some future date how not to attempt it. There is often a tendency to suppose that work can be remembered and that there is no need to go to the trouble of recording it minutely. Or, if recorded at all, that rough abbreviated notes will be understood when referred to later. Of course, some people may have entirely different memories, but the author has often looked up notes of work done several years ago and found them either unintelligible altogether or demanding a good deal of study before the threads can be sorted out and the results and the conditions under which they were obtained made clear. Graphs there may be, without explanations; symbols used with no definitions.

The best way is to write out an unabbreviated "fair copy" of the original work; but if that is too much, a few marginal notes explaining what it is all about, and picking out the results prominently so that one has not to wade through a lot of working to make sure which really are the results, is worth while. Unless an experiment is very brief, it must be recorded as it proceeds, and very often some of the earlier parts are later found to be wrong. In such cases a marginal note to that effect should be made, so that when coming to it a long time later the mind does not take on board material only to have to throw it away again when the later results are disclosed.

Another thing; make a careful note of the condition of the experiment—circuits and instruments used. Though some detail among these may seem unimportant at the time, later on it may be realised to have been vital.

The actual form of the records depends on individual circumstances. Loose leaf books, preferably large enough to take graphs without folding, are generally better than

plain notebooks and enable leaflets and data from various sources to be filed in appropriate places. For large quantities of material, foolscap folders in cabinets may be more suitable. There are various more or less elaborate systems of filing by subject, but the author has found that the system may tend to become a master instead of a servant, and that the entirely unscientific alphabetical arrangement is more effective for practical purposes. The difficulty about subject filing is that subjects overlap and much mental effort is expended firstly in deciding what subject certain notes should be filed under, and later what part of the system should be searched for these notes.

Information on what other people have been doing is a problem. Much time is certain to be wasted in "discovering" what has already been published, or in preliminary work that would be unnecessary if one were informed about the methods and results of others; on the other hand, it is impossible to read all the world's technical publications, and time is wasted in searching through even a small portion of them. The most helpful contribution to the solution of this problem is the "Abstracts and References" section of *The Wireless Engineer*, and especially the indexes to them published annually.

287. Filing Information

CHAPTER 12

FOR REFERENCE

MOST technical matter would be tedious and clumsy in the extreme if use were not made of symbols and abbreviations. But to get the full benefit of these it is most important that everybody should use the same system of symbols, and that that system should be easy to use and understand, and be free from ambiguities. As a result of a great deal of work devoted to standardisation, there is remarkably good agreement throughout the world, but individuals do not always conform to the accepted standards. The symbols used throughout this book agree with those of the British Standards Institution. The list that follows is not exhaustive, but it includes most of those in common use. It is important to grasp the distinction between the symbol for a property, such as *inductance*, and the abbreviation of the unit in which quantities of that property are reckoned, such as *henries*. The latter is correctly used only after a number specifying a particular quantity, as $160\mu\text{H}$, standing for 160 microhenries. If the same thing were used in an equation it would mean 160 multiplied by the permeability of magnetic material multiplied by magnetising force.

<i>Property</i>	<i>Symbol</i>	<i>Unit</i>	<i>Abbreviation for Unit</i>
Time	<i>t</i>	second	s
Length	<i>l</i>	centimetre	cm
Wavelength	λ	metre	m
Frequency	<i>f</i>	cycle per second	c/s
Angular velocity (or Pulsatance)	ω	radian per second	
Electromotive force, e.m.f., or voltage	E	volt	V
Current	I	ampere	A
Power	P	watt	W

RADIO LABORATORY HANDBOOK

<i>Property</i>	<i>Symbol</i>	<i>Unit</i>	<i>Abbreviation for Unit</i>
Self inductance	L	henry	H
Mutual inductance	M	henry	H
Capacitance	C	farad	F
Resistance	R	ohm	Ω
Reactance	X	{ inductive XL	Ω
		{ capacitive XC	Ω
Impedance	Z	ohm	Ω
Magnetising force	H	oersted	
Flux density	B	gauss (or line per sq. cm.)	
Total flux	Φ	maxwell (or line)	

Standard Prefixes for Unit Abbreviations

M	mega-	signifies one million	($\times 10^6$)
k	kilo-	signifies one thousand	($\times 10^3$)
m	milli-	signifies one thousandth	($\times 10^{-3}$)
μ	micro-	signifies one millionth	($\times 10^{-6}$)
$\mu\mu$ or p	micromicro- pica-	} signifies one billionth	($\times 10^{-12}$)

It has recently become customary in circuit diagrams to omit the symbols Ω and μF when specifying the numerical values of resistors and capacitors, adding k, M or p alone where applicable.

The following terms when met haphazardly are particularly liable to bewilder the novice, but can easily be distinguished when their relationships are grasped:—

Resistance, R
(resistivity, ρ)

Conductance, G, = $\frac{R}{R^2 + X^2}$
or g

Reactance, X, = $\omega L - \frac{1}{\omega C}$
(inductance, L)
(capacitance, C)

Susceptance, B, = $\frac{X}{R^2 + X^2}$
(not often used)

Impedance, Z, = $\sqrt{R^2 + X^2}$

Admittance, Y, = $\frac{1}{Z} = \sqrt{G^2 + B^2}$

Alternative endings—

- ance* — an abstract electrical (or magnetic) property
- or* — a component embodying the above
- ive* — denotes the adjective corresponding to —*ance*
- ivity* — the amount of —*ance* possessed by unit quantity of material

For example—

Resistance is the property of materials that causes electrical energy to be dissipated as heat

A Resistor is a piece of equipment designed to embody resistance

Resistive—possessing resistance

Resistivity is the relative resistance of materials: the resistivity of copper at 20° C. is 1.7 $\mu\Omega$ per cm. cube (not per cu. cm. !)

FOR REFERENCE

Not all of the above items are fully inflected in this way, and where it is sensible to do so it is still sometimes rather pedantic; it is more common to refer to a *coil* and *condenser* than an *inductor* and *capacitor*. What might be called *capacivity* is actually named *permittivity* (κ); and instead of *inductivity* there is *permeability* (μ).

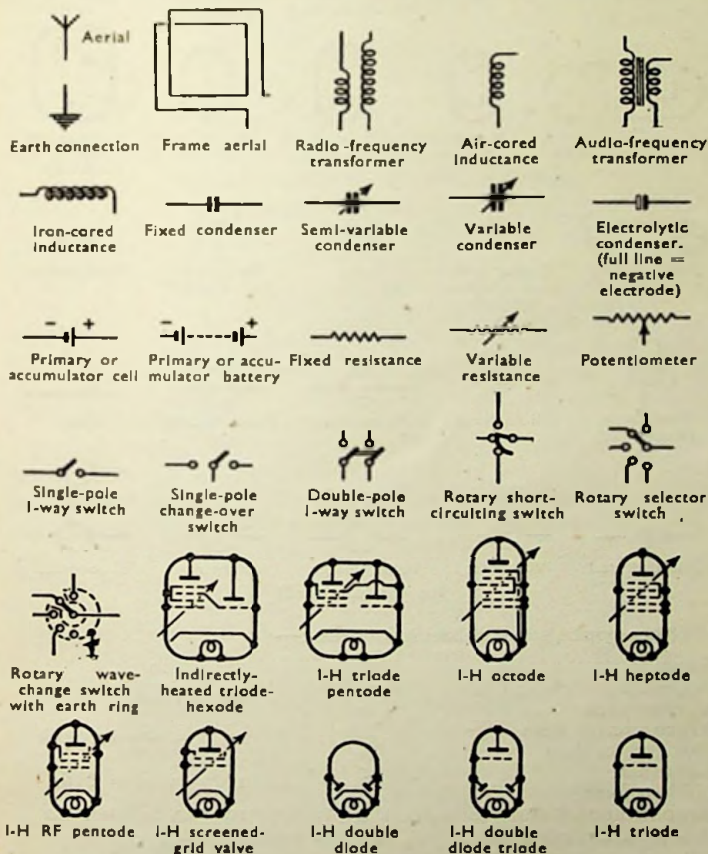
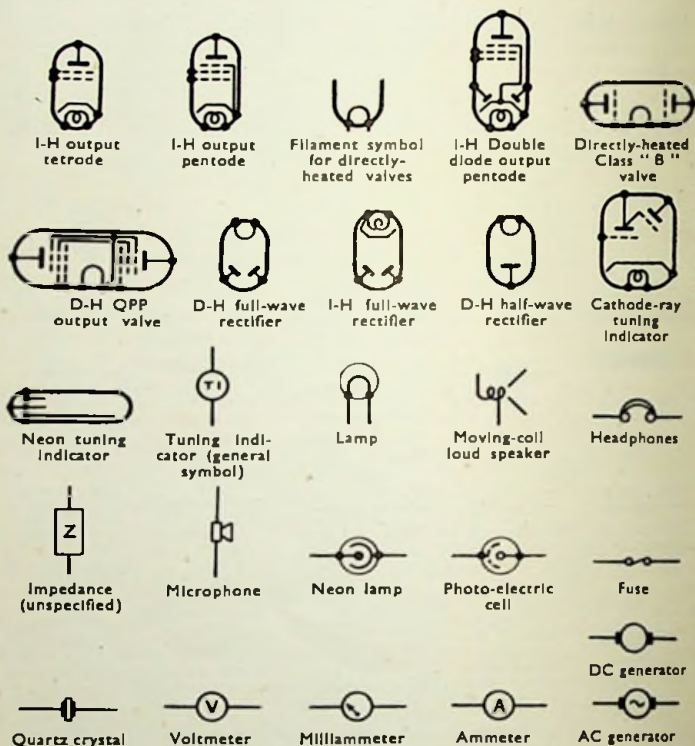

Fig. 183 : Symbols used in circuit diagrams

RADIO LABORATORY HANDBOOK



Other symbols and abbreviations are :-

Equal to	=
Approximately equal to	≈
Greater than	>
Much greater than	≫
Not greater than	≲
Less than	<
(and so forth)	≪
Amplification factor (of valves) μ	=
Anode A.C. resistance " " r_a	=
Mutual conductance " " g_m	=
(or transconductance)	=

$10^2 = 100$
$10^3 = 1000$
$10^{-3} = \frac{1}{1000}$ or 0'001
$10^{\frac{1}{2}} = \sqrt{10} = 3'162$
$10^{\frac{3}{2}} = \sqrt{10^3} = 31'62$
$\pi = 3'14159 \dots$
$e = 2'71828 \dots$

FOR REFERENCE

Angle between vectors representing alternating current and voltage ϕ

Power factor $\cos \phi, = R/Z$

Loss factor or dissipation factor, $\cot \phi, = R/X$

Magnification factor, Q , is variously defined as Z/R (reciprocal of power factor) or X/R (reciprocal of loss factor), but in normal circuits where $Q >$ about 10 they are practically the same thing.

Loss angle, δ , is $90^\circ - \phi$, and $R/X = \tan \delta$

Root-mean-square R.M.S.

Decibel = db or more correctly dB

Alternating current A.C.

Direct current D.C.

Owing to the prevalent misuse of the abbreviations A.C. and D.C., more especially as adjectives, the author suggests that where applicable the following should be substituted:—

Zero-frequency	Z.F.	(instead of D.C., where "D.C." would be used to distinguish from "alternating")
Audio-frequency	A.F.	(frequencies from about 30 to 15,000 c/s)
Radio-frequency	R.F.	(frequencies above audibility)
Video- (or visio-) frequency	V.F.	(frequencies, due to television scanning, from 0 to about 3 Mc/s)
Intermediate-frequency	I.F.	(the frequency selected from the output of a super-heterodyne frequency-changer)

"L.F." and "H.F." are still sometimes used to mean "A.F." and "R.F." respectively; but the latter are to be preferred as being less ambiguous. Although "R.F." includes "I.F.", where both are used together "R.F." is understood to refer to the frequency of the received carrier wave. This is sometimes referred to as "S.F." (signal frequency), whereas others understand "signal-frequency" to mean the modulation frequency.

The following is the official nomenclature for radio frequencies:—

Description	Abbrevn.	Frequencies	Wavelengths
Very Low	V.L.F.	Below 30 kc/s	Over 10,000 metres
Low	L.F.	30-300 kc/s	1,000-10,000 metres
Medium	M.F.	300-3,000 kc/s	100-1,000 metres
High	H.F.	3-30 Mc/s	10-100 metres
Very High	V.H.F.	30-300 Mc/s	1-10 metres
Ultra High	U.H.F.	300-3,000 Mc/s	10-100 cms
Super High	S.H.F.	3,000-30,000 Mc/s	1-10 cms

Harmonics. The practice of referring to the harmonic that is twice the frequency of the fundamental as the *first* harmonic, although doubtless true, is deprecated, because it is much less confusing to consider the fundamental as the first harmonic, the second harmonic being twice the frequency, the third three times, and so on.

Alternating current and voltage, and any quantities that can correspond to them, such as magnetic flux, can be expressed as instantaneous values,

289. Alternating Current peak values, mean values or R.M.S. (or effective) values. The instantaneous value is constantly changing during the cycle, and is specified by a small letter, e.g., "*i*". The peak value is the greatest (positive or negative) during a cycle, and is denoted, e.g., by " I_{\max} " or " \hat{i} ". The R.M.S. value is simply "*I*".

For a sine waveform
$$I = \frac{I_{\max}}{\sqrt{2}} = 0.707\dots I_{\max}$$

$$I_{\max} = 1.414\dots I$$

$$\text{and } I_{\text{mean}} = \frac{2 I_{\max}}{\pi} = 0.636\dots I_{\max}$$

When the waveform is *not* sinusoidal the ratio is different, and this causes differences in meter readings according to whether they depend on the R.M.S. value (thermal meters) or the mean value (most metal rectifier meters) or the peak value (slide-back valve voltmeters).

A thorough mastery of A.C. circuits is one of the most essential things in radio work. Here are the most-used relationships. The symbols are those given in the preceding pages, except where noted.

$$\omega = 2\pi f = 6.28318\dots f$$

$$X_L = \omega L$$

$$X_C = \frac{1}{\omega C}$$

$$Z = \sqrt{R^2 + (X_L - X_C)^2}$$

$$I = \frac{E}{Z}$$

Complex circuits are equivalent, at any one frequency, to simple circuits consisting of R and X in series or in parallel, whichever is the more convenient. It must always be remembered that R and X must not be added arithmetically, but *vectorially*, as is often indicated by the symbol *j*, meaning that a vector representing the quantity to which it is prefixed is displaced by an angle of 90°. The vectors of R, X, and Z therefore form a right-angled triangle, so

$$Z = R + jX = \sqrt{R^2 + X^2}$$

Algebraically $j = \sqrt{-1}$

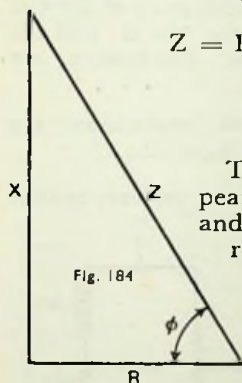

To simplify calculations in which *j* appears, the following are useful (*p* and *r*, and *q* and *s* stand for any resistive and reactive quantities respectively) :—

$$\begin{aligned} \text{When } Z &= \frac{1}{p + jq}, & R &= \frac{p}{p^2 + q^2} \text{ and } X = -\frac{q}{p^2 + q^2} \\ Z &= \frac{p + jq}{r + js}, & R &= \frac{pr + qs}{r^2 + s^2} \text{ and } X = \frac{qr - ps}{r^2 + s^2} \\ Z &= (p + jq)(r + js), & R &= pr - qs \text{ and } X = qr + ps \\ Z &= \sqrt{p + jq}, & R &= \sqrt{\frac{\sqrt{p^2 + q^2} + p}{2}} \text{ and } X = \sqrt{\frac{\sqrt{p^2 + q^2} - p}{2}} \end{aligned}$$

To translate parallel circuit elements into their series equivalents, and *vice versa*, these relationships are very useful :—

$$\begin{aligned} R_s &= \frac{R_p X_p^2}{R_p^2 + X_p^2} & X_s &= \frac{R_p^2 X_p}{R_p^2 + X_p^2} \\ R_p &= \frac{R_s^2 + X_s^2}{R_s} & X_p &= \frac{R_s^2 + X_s^2}{X_s} \end{aligned}$$

Separate resistances or reactances in series can be combined by simple addition (remembering that capacitive reactance is negative), and the reciprocals of resistances or reactances in parallel can likewise be added. For adding reciprocals it is convenient to remember that

$$\frac{I}{\frac{1}{A} + \frac{1}{B}} = \frac{A B}{A + B} \quad \text{and} \quad \frac{I}{\frac{1}{A} - \frac{1}{B}} = \frac{A B}{B - A}$$

291. An Example *Example.*—Reduce the circuit shown to its simplest equivalent at 400 c/s. (The resistance of the coil is represented by the 360 Ω, and the resistances of the condensers are assumed to be negligible).

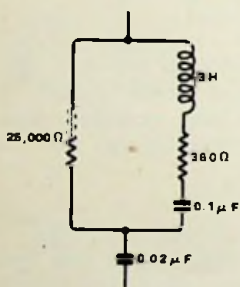

Fig. 185

This immediately reduces to

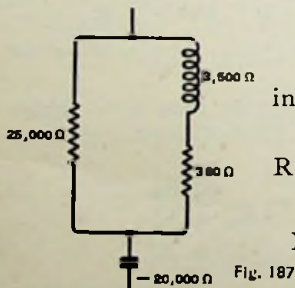

Fig. 187

The equivalent reactances are worked out from $X_L = \omega L$,

$$X_C = \frac{I}{\omega C}, \quad \omega = 2,500 \text{ very nearly.}$$

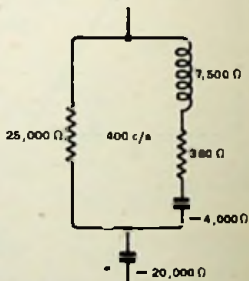

Fig. 186

Converting the series elements into parallel equivalents

$$R_p = \frac{360^2 + 3,500^2}{360} = 34,500 \Omega$$

$$X_p = \frac{360^2 + 3,500^2}{3,500} = 3,550 \Omega$$

Combining the resistances by adding the reciprocals

$$R = \frac{25,000 \times 34,500}{25,000 + 34,500} = 14,500 \Omega$$

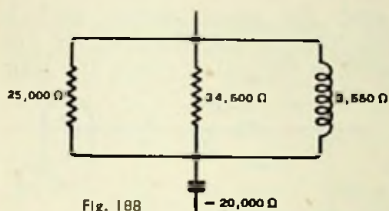

Converting the parallel elements into series equivalents

$$R_s = \frac{14,500 \times 3,550^2}{14,500^2 + 3,550^2} = 820 \Omega$$

$$X_s = \frac{14,500^2 \times 3,550}{14,500^2 + 3,550^2} = 3,350 \Omega$$

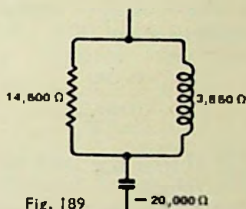

Combining reactances, the simplest series equivalent is the result ; and this is easily changed into the parallel equivalent if desired.

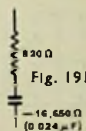
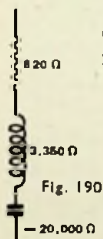

Examples of this sort of thing constantly occur in valve amplifiers, where there are intervalve couplings, tone control circuits, valve anode resistances and capacitances, etc., and it is desired to calculate the performance at some frequency or frequencies.

When the equivalent simple circuit is required at many frequencies the work becomes laborious, and is best carried out in tabular form, as explained in Sec. 282.

It must be remembered that the voltages across R and X in series (or the currents through R and X in parallel) must be added vectorially. For example, if a valve grid condenser has a reactance of 50,000 Ω, and the grid leak

resistance is $0.25 \text{ M}\Omega$, and the signal across both is 12 volts, it does not mean that 2 are dropped in the condenser and 10 are applied to the valve across the leak.

The total impedance is

$$\sqrt{0.25^2 + 0.05^2} = 0.255 \text{ M}\Omega,$$

so the voltage across the condenser is

$$12 \times \frac{0.05}{0.255} = 2.35,$$

and across the leak is $12 \times \frac{0.25}{0.255} = 11.76.$

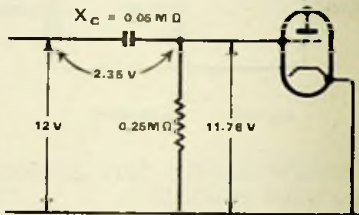

Fig. 192: A typical example of vectorial addition of voltages and impedances

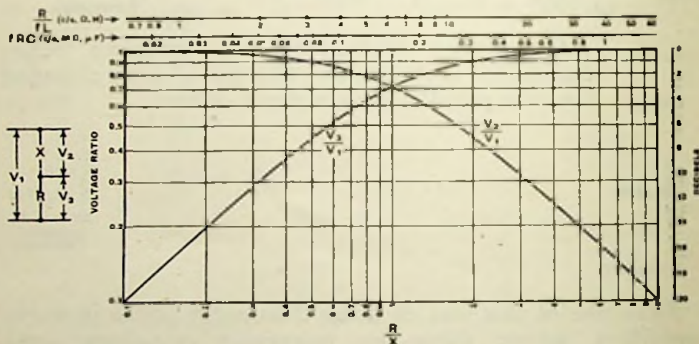

Fig. 193: Universal curves whereby the division of voltage between a resistance and a reactance can be read off. This is particularly useful in estimating the performance, at different frequencies, of valve amplifier circuits

As this type of calculation is rather common, here (Fig. 193) is a universal curve which is useful for finding the loss at any frequency due to a coupling condenser, or the cut-off given by a tone-control condenser or choke. The action of complex circuits can be determined by first reducing them to simple circuits. In the above numerical example the ratio $\frac{R}{X}$ is $\frac{0.25}{0.05} = 5$. From the curve, the

FOR REFERENCE

voltage across the resistance is seen to be 0.98 of the total, and across the reactance (condenser) 0.196. Multiplying these by the total voltage, 12, the answers are 11.26 and 2.35 as before. To render calculations of reactances unnecessary, scales of inductance and capacitance are also included.

Resonance takes place when $X_L = X_C$, which in a circuit with X_L , X_C , and R in series makes $Z = R$ and simplifies matters greatly. If f_r denotes resonant frequency—

$$\omega_r L = \frac{1}{\omega_r C} \qquad \omega_r^2 = \frac{1}{LC} \qquad f_r = \frac{1}{2\pi \sqrt{LC}}$$

This can be put into various convenient forms to suit the most workable units of L and C . Where not stated it is always assumed that the units are those in the first table in Sec. 288. For example:—

$$f_r = \frac{159.2}{\sqrt{LC}} \quad (C \text{ in } \mu\text{F}) \text{ or } \begin{pmatrix} L \text{ in } \mu\text{H} \\ C \text{ in } \mu\text{F} \\ f_r \text{ in kc/s} \end{pmatrix}$$

Or, if wavelengths are preferred to frequencies; as $\lambda = \frac{300,000,000}{f}$

$$\lambda_r = 1.885 \sqrt{LC} \quad \begin{pmatrix} L \text{ in } \mu\text{H} \\ C \text{ in } \mu\mu\text{F} \end{pmatrix}$$

The *parallel* (or rejector) resistance of a resonant circuit, when R (in either X_L or X_C arm, or part in each) is small, is known as the dynamic resistance, or anti-resonant resistance, R_D .

$$R_D \approx \frac{L}{RC} = \omega_r L Q \quad (Q \text{ assumed } \ll \text{ about } 10)$$

$$Q = \frac{X}{R} \text{ (either } L \text{ or } C)$$

If $Q \nless 0.5$, the circuit is non-oscillatory.

If either reactance is tapped, the impedance at resonance across the tapped-off portion is still resistive, but is proportional to the square of the tapping ratio. So across half of the coil R_D is one-quarter its value across the whole coil.

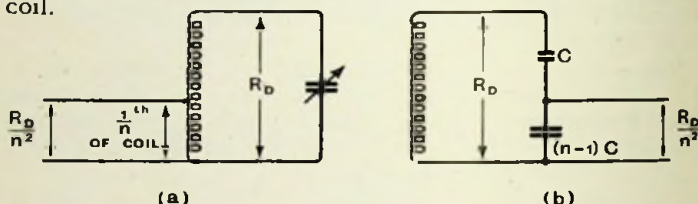
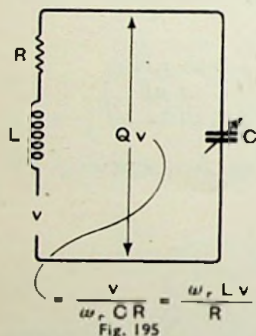

Fig. 194: How the dynamic resistance, R_D , of a tuned circuit is reduced by "tapping down," either on inductance (a) or capacitance (b) side. The impedance across the tapping points still remains a resistance

294. The Significance of "Q"



Q is a measure of the "response" of a tuned circuit at resonance, and of its selectivity; and is sometimes known as the *magnification* because it is equal to the ratio of the voltage developed across the circuit to the voltage injected into it.

An average value of Q for tuned circuits is about 100. If a resonant circuit includes various items in parallel—coil, tuning condenser, valve holder, wiring, etc.—each with its own Q and C , then the Q of the whole circuit is given by

$$\frac{1}{Q} = \frac{1}{Q_L} + \frac{C_1}{Q_1 C} + \frac{C_2}{Q_2 C} + \text{etc.}, \text{ where}$$

C is the total capacitance of the circuit, Q_L is the magnification of the coil as such, and the numbered quantities refer to each separate item having capacitance (including the self-capacitance of the coil regarded as a separate entity).

The response curve around the resonant frequency is of special practical interest; and fortunately its shape for a

295. Resonance Curves

single tuned circuit, or a number of similar tuned circuits, is the same for all circuits, differing only in scale, so can be shown as a universal curve

FOR REFERENCE

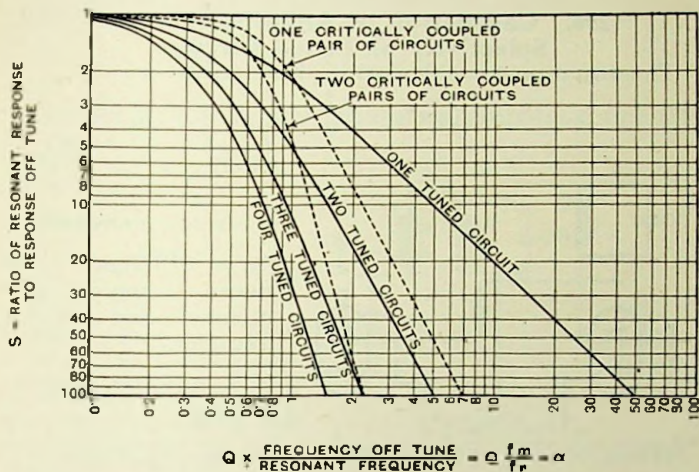

Fig. 196 : Universal response curves, showing the extent to which the response falls off as the resonant frequency is departed from. Comparing one critically-coupled pair of circuits with two single circuits, it can be seen that the steepness of the slope well away from resonance is the same, but the coupled pair gives much more level response near resonance

(Fig. 196) from which the behaviour of any particular circuit can be quickly judged. For example, suppose Q is 80, and the resonant frequency is 500 kc/s. Then by multiplying the scale by $\frac{500}{80}$ it becomes a scale of "kc/s off tune" for that particular circuit. To find the adjacent-channel (9 kc/s off tune) selectivity, the scale reading is $\frac{80 \times 9}{500} = 1.44$, and the response ratio, S , read from the curve for one tuned circuit, is 3, meaning that when the circuit is detuned by 9 kc/s the signal strength required to provoke a given response is three times as great as if it were right in tune; or that the adjacent-channel response is one-third that at resonance. Two circuits entirely uncoupled except by a perfectly screened valve give a ratio of 9; three, of 27; and so forth.

296. Calculation of Amplification and Selectivity of Tuned Circuits

The equation for calculating these curves is

$$S \approx (4\alpha^2 + 1)^{\frac{N}{2}} \quad (f_m \ll f_r)$$

where $\alpha = \frac{Qf_m}{f_r}$

f_r = resonant frequency

f_m = difference between resonant frequency and actual frequency

N = number of tuned circuits

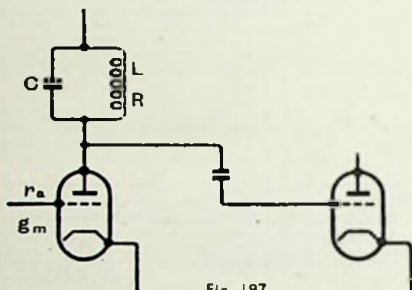

Fig. 197

When $N = 1$, the formula of course is $\sqrt{4\alpha^2 + 1}$

Maximum response (at resonance), $m_{max} = Q$

If in a stage of amplification $r_a \gg R_D (= \omega LQ)$, the gain of the stage, $A, \approx Qg_m\omega L$ or $\frac{Qg_m}{\omega C}$ or Q^2g_mR or R_Dg_m

297. Coupled Circuits

Coefficient of coupling, $K, = \frac{X_m}{\sqrt{X_1X_2}}$, where X_1 and X_2

are the reactances of the two circuits and X_m is the mutual reactance. For inductive coupling

$$K = \frac{M}{\sqrt{L_1L_2}}$$

If the total inductance of a pair of coils connected in series is measured before and after the leads to one coil are reversed, L_a and L_b being the two readings, then

$$M = \frac{L_a - L_b}{4}$$

General formula for calculating secondary resonance curve for one pair of similar coupled circuits

$$S \approx \frac{2}{+1\beta^2} \sqrt{4\alpha^4 + 2(1 - \beta^2)\alpha^2 + \frac{(1 + \beta^2)^2}{4}}$$

FOR REFERENCE

where $\beta = Q K = \frac{X_m}{R}$
 $= \frac{QM}{L}$ when coupling is wholly inductive.

Condition (1). $\beta = 1$ (critical or optimum coupling)
 $X_m = R$

Then $m_{\max} = \frac{Q}{2}$, at

resonance

and $A \approx \frac{Q g_m \omega L}{2}$

($r_a \gg R_D$)

$S \approx \sqrt{4\alpha^4 + 1}$

or of course, for N pairs

of circuits, $(4\alpha^4 + 1)^{\frac{1}{2}}$,

from which universal re-

sonance curves can be worked out (see dotted curves in Fig. 196).

Condition (2). $\beta < 1$ (under-coupling)

$$m_{\max} < \frac{Q}{2}$$

Condition (3). $\beta > 1$ (over-coupling)

$M_{\max} = \frac{Q}{2}$, but not at resonance

Response at resonance, $m_r = \frac{Q\beta}{1 + \beta^2}$

$$\frac{m_{\max}}{m_r} = \frac{1 + \beta^2}{2\beta}$$

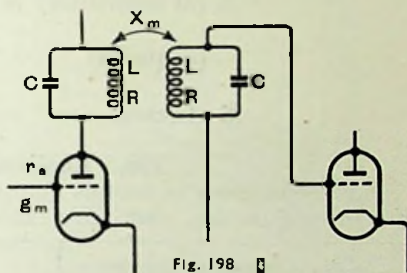

Fig. 198

$\leftarrow (f_r - f_m)$ f_r $(f_r + f_m) \rightarrow$

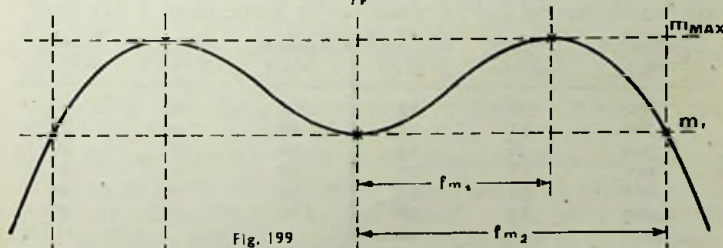

Fig. 199

RADIO LABORATORY HANDBOOK

$$f_{m_1} \text{ (i.e., half-peak separation)} = \pm \frac{f_r \sqrt{\beta^2 - 1}}{2Q}$$

$$f_{m_2} = \sqrt{2} f_{m_1}$$

So five important points can easily be calculated.

$$A \text{ (at resonance)} \approx \frac{Q g_m \omega L \beta}{1 + \beta^2}$$

$$\text{(at peaks)} \quad \frac{Q g_m \omega L}{2}$$

$$S \text{ at resonance} = \frac{1 + \beta^2}{2\beta}$$

298. Resistance

Z.F. resistances of metals compared with copper. For use in conjunction with wire tables, Sec. 311.

Metal	Comparative Resistance	Temperature Coefficient	Metal	Comparative Resistance	Temperature Coefficient
Advance	28	0.0018	Mercury	59	0.088
Aluminium	1.6	0.34	Nichrome	55	0.04
Brass	4.4	0.15	Nickel	4.4	0.41
Concordin	60	0.17	Nickelin	27	0.031
Constantan	30	0.00072	Phosphor bronze	4.4	0.097
Copper (annealed)	1	0.40	Platinoid	21	0.031
Eureka	29	0.0022	Platinum	6.3	0.36
German silver	12-18	0.018-0.072	Silver	0.94	0.31
Gold	1.5	0.36	Steel (hard)	12	0.31
Iron (soft)	6.1	0.50	Tin	6.7	0.45
Lead	12	0.41	Tungsten	3	0.51
Manganin	27	0.00054	Zinc	3.7	0.40

Temperature coefficients above are in *percentage* rise in resistance per °C.

299. Skin Effect

Maximum gauge of straight wire of which R.F. resistance does not exceed Z.F. resistance by more than 1 per cent.

Frequency, kc/s	Copper, S.W.G.	Eureka,* S.W.G.	Frequency, Mc/s	Copper, S.W.G.	Eureka,* S.W.G.
100	30	15	5	47	33
200	34	18	10	49	37
300	36	19	20	50	40
500	38	21	30	—	42
1,000	42	24	50	—	44
2,000	45	28	100	—	47
3,000	46	30			

* Sufficiently correct for manganin.

FOR REFERENCE

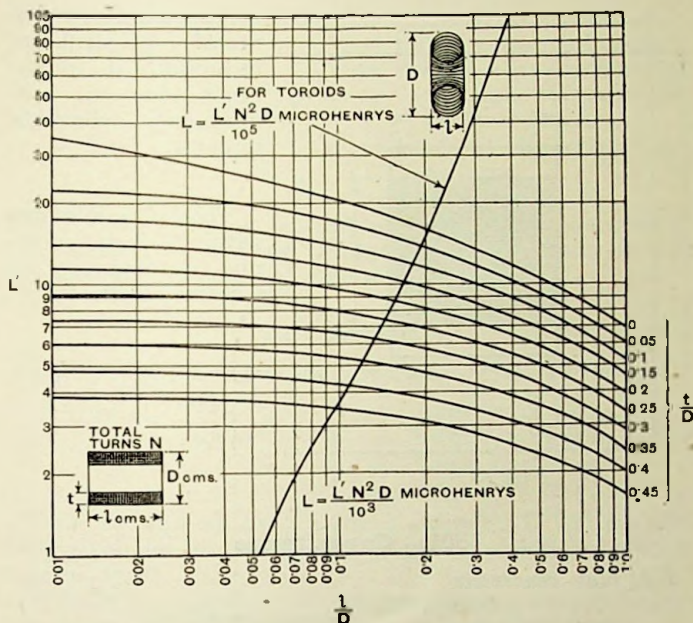

Fig. 200 : Data sheet compiled from standard formulæ by Mr. F. Charman, by which the inductance of coils of all shapes can easily be found

The universal curve sheet, Fig. 200, covers the calculation not only of single-layer solenoids, but of multi-layer coils of most shapes, including flat "pies", and even toroids. From the curve and ordinate corresponding most closely to the dimensions of the particular coil, read off the factor L' , which is then to be substituted in the formula given. A special curve is included for toroids, for which the dimensions have different meanings, as shown; and it should be noted that the formula differs by a factor of 0.01. The curve sheet enables the correct number of turns of wire on a former of given shape for a required inductance to be calculated. The wire tables in Sec. 311 then enable a suitable gauge of wire to be selected.

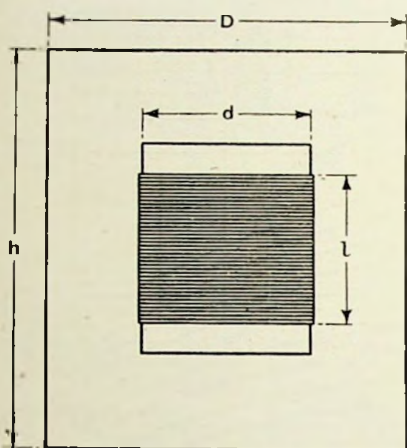

Fig. 201

Approximate formula* for calculating reduction in inductance due to non-magnetic cylindrical screening can :—

To get inductance within screen, multiply inductance unshielded by the factor.

$$\frac{D^2 - d^2}{D^2} \left(1 - \frac{l}{2h} \right)^2$$

301. Capacitance

Flat plate condensers

$$C = \frac{0.0885 AN\kappa}{t} \text{ micromicrofarads :}$$

where A = area of each plate, sq. cms.

N = number of plate separations.

κ = permittivity or dielectric constant, of separating material (for vacuum and air, $\kappa = 1.00$).

t = thickness of each separation.

Edge effect is neglected. A 2-plate condenser has one separation ; a 3-plate, two ; and so on.

Coaxial cylinders, or screened wires.

$$C = \frac{0.2416 \kappa l}{\log_{10} \frac{r_1}{r_2}} \text{ mmfds.}$$

l = length in cms.
 r_1 = radius of outer cylinder, in cms.
 r_2 = radius of inner cylinder, in cms.
 κ = permittivity.

See Fig. 202b.

*Due to W. G. Hayman (*Wireless Engineer*, April, 1934, p. 189).

FOR REFERENCE

Condenser discharge.

$$V_2 = V_1 e^{-\frac{t}{RC}}$$

V_1 = initial voltage of charge.

V_2 = voltage after discharging through resistance R for time t secs.

e = base of Napierian logarithms.

$$= 2.718 \dots$$

The quantity RC is known as the *time constant*, and is equal to the time for the voltage of the condenser to fall to $1/e$ or 0.368 of its initial amount.

302. Aerials

Effective height of rectangular frame aerial, in metres

$$= 2Nh \sin \left(\frac{\pi fw}{300,000} \right)$$

N = number of turns.
 h = height in metres.
 w = width in metres.
 f = frequency in kc/s.

When multiplied by the field strength in $\mu V/m$ the above gives the microvoltage induced in the frame aerial (see Sec. 251).

Formulae for open aerials are not given, because only ideal forms can be calculated with reasonable accuracy.

303. Feeders or Transmission Lines

Characteristic (or surge) impedance, $Z_0 \approx \sqrt{\frac{L}{C}}$ (losses neglected).

l = inductance per unit length. c = capacitance per unit length.

Air spacing.

Parallel wire feeder.

$$l \approx 0.0092 \log_{10} \frac{D}{r} \text{ microhenries per cm.}$$

$$c \approx \frac{0.121}{\log_{10} \frac{D}{r}} \text{ mmfds. per cm.}$$

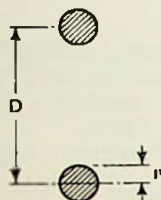

Fig. 202a.

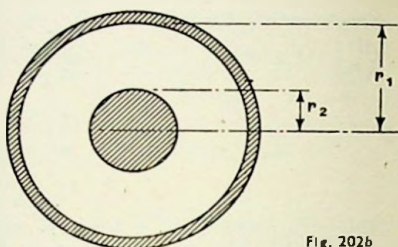

Fig. 202b

$$Z_0 \approx 276 \log_{10} \frac{D}{r} \text{ ohms.}$$

Coaxial feeder.

$$l \approx 0.0046 \log_{10} \frac{r_1}{r_2} \text{ microhenries per cm.}$$

$$c \approx \frac{0.242}{\log_{10} \frac{r_1}{r_2}} \text{ mmfds. per cm.}$$

$$Z_0 \approx 138 \log_{10} \frac{r_1}{r_2} \text{ ohms.}$$

Quarter-wave Transformer.

A line of surge impedance Z_1 can be matched to another of Z_2 by linking them with a quarter wave length of line of impedance $\sqrt{Z_1 Z_2}$

Impedance of Loaded Line.

The impedance Z_1 of a line of characteristic impedance Z_0 and length d (in wavelengths) terminated by an impedance Z is:—

$$Z_1 = Z_0 \frac{Z_2 + jZ_0 \tan 2\pi d}{Z_0 + jZ_2 \tan 2\pi d} \quad \text{See Fig. 203.}$$

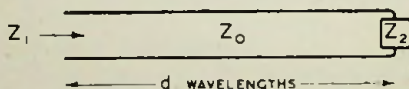

Fig. 203

304. Electromagnetism

$$\text{Magnetising force, } H = \frac{1.257 \text{ IN}}{l}$$

$$\text{Flux density, } B = \mu H$$

$$\text{Total flux, } \Phi = BA$$

FOR REFERENCE

$$L = \frac{\Phi N}{I \times 10^9} = \frac{1.257 \mu AN^2}{l \times 10^9} \text{ henries}$$

N = number of turns

l = length of magnetic path, cms.

μ = permeability of magnetic path

A = cross section area of magnetic path sq. cms.

E.m.f. generated by sinusoidally varying magnetic field

$$E_{\text{rms}} = 4.44 B_{\text{max}} ANf \times 10^{-9} \text{ volts.}$$

305. Transformers

$$\text{Turns per volt, } \frac{N}{E} = \frac{10^9}{4.44 B_{\text{max}} Af}$$

Resistance in secondary circuit, R_s , is equivalent to $\frac{R_s T_p^2}{T_s^2}$ in the primary circuit, where T_p and T_s are the numbers of primary and secondary turns respectively. Similarly for reactance or impedance.

Leakage inductance, $L_L = L_p(1 - K^2)$ (K = coefficient of coupling ; see Sec. 297).

An audio transformer in a valve anode circuit is approximately equivalent to the following circuits at various frequencies :—

At low frequencies. (Fig. 204).

L_p is the primary inductance.

$$\text{Gain of stage } = \frac{v}{v_0} = \frac{\mu n}{\sqrt{\left(\frac{r_a + r_L}{r_L}\right)^2 + \frac{r_a^2}{\omega^2 L_p^2}}}$$

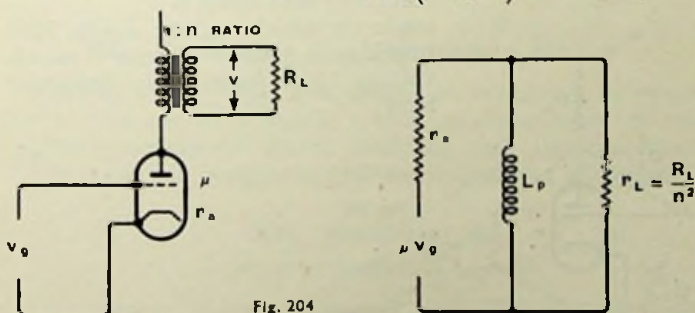
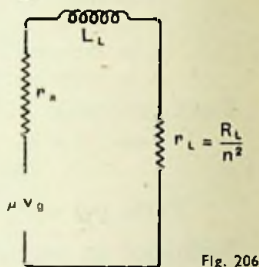
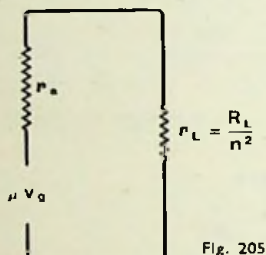

Fig. 204

At medium frequencies. (Fig. 205).

$$\text{Gain of stage} = \frac{\mu n r_L}{r_a + r_L}$$



At high frequencies. (Fig. 206).

(Taking account of effect of leakage inductance, but not of capacitance.)

$$\text{Gain of stage} = \frac{\mu n r_L}{\sqrt{(r_a + r_L)^2 + \omega^2 L_L^2}}$$

306. Valves

Fundamental formula $\mu = g_m r_a$

Velocity of an electron due to potential of V volts ($V < 15,000$) = $5.94 + 10^7 \sqrt{V}$ cms./sec.

Input capacitance = $C_{gc} + C_{ga} (1 + A \cos \theta)$

where A = amplification of valve (ratio of voltage developed across load impedance in anode circuit to grid signal voltage); maximum is μ .

θ = angle by which voltage across load impedance leads anode circuit voltage (θ is positive for inductive load).

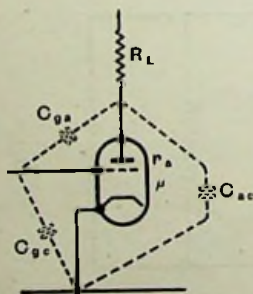

FOR REFERENCE

With resistive load (neglecting, or including in the load the capacitance C_{ac})—

$$\text{Input capacitance} = C_{gc} + C_{ga} \left(1 + \frac{\mu R_L}{r_a + R_L} \right)$$

$$\text{Input resistance} = - \frac{1}{\omega C_{ga} A \sin \theta}$$

With inductive anode load circuits the input resistance is negative; with capacitive loads, positive.

Negative feed-back.

If a proportion, B , of the output voltage of an amplifier giving an amplification, A , is fed back to the input in opposition to the signal, the amplification is reduced to

$$A' = \frac{A}{1 + AB}$$

In general, distortion and noise arising in the amplifier are reduced in the same ratio.

Suppose the voltage amplification is 500, and 6 per cent. of the output is fed back in opposition ($B = 0.06$). Then

$$A' = \frac{500}{1 + 30} = 16.$$

If $AB \gg 1$, $A' \approx \frac{1}{B}$; that is to say, the amplification is unaffected by minor changes in the amplifier itself and depends only on B , the feed-back circuit.

307. Smoothing and Decoupling Filters

The curve sheet, Fig. 208, shows the reduction in ripple due to the use of a single resistance-capacitance or inductance-capacitance filter, assuming that the reactance of C is negligible compared with the impedance of the load.

308. Decibels

(See also Secs. 219-20)

The number of db corresponding to the ratio between

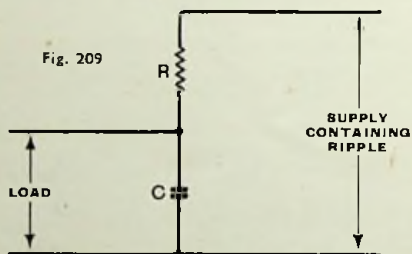
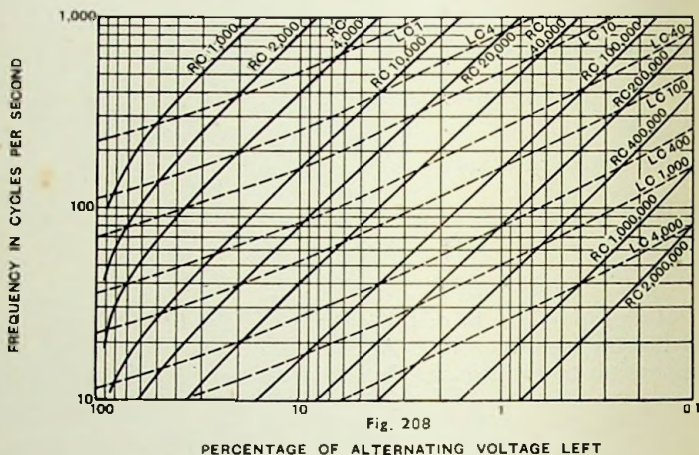

Fig. 208: Curves showing the effectiveness of the simple type of decoupler or filter (Fig. 209) represent C in microfarads multiplied by R in ohms (or L in henries, if a choke is used instead of a resistance). It is assumed that the impedance of the load is much higher than that of C.

two amounts of power, P_1 and P_2 , is

$$db = 10 \log_{10} \frac{P_2}{P_1}$$

When the voltage or current ratio is known, and the impedances across or in which they act are the same or equal,

$$db = 20 \log_{10} \frac{V_2}{V_1} \text{ or } 20 \log_{10} \frac{I_2}{I_1}$$

If impedances are unequal,

FOR REFERENCE

$$\begin{aligned}
 \text{db} &= 10 \log_{10} \frac{V_2^2 Z_1 \cos \phi_1}{V_1^2 Z_2 \cos \phi_2} \text{ or } 10 \log_{10} \frac{I_2^2 Z_2 \cos \phi_2}{I_1^2 Z_1 \cos \phi_1} \\
 &= 20 \log_{10} \frac{V_2}{V_1} + 10 \log_{10} \frac{Z_1}{Z_2} + 10 \log_{10} \frac{\cos \phi_1}{\cos \phi_2} \\
 &\text{ or } 20 \log_{10} \frac{I_2}{I_1} + 10 \log_{10} \frac{Z_2}{Z_1} + 10 \log_{10} \frac{\cos \phi_2}{\cos \phi_1}
 \end{aligned}$$

where $\cos \phi$ is the power factor of the impedance.

DECIBEL TABLE

Voltage ratio (equal impedance)	Power ratio	← — db + →	Voltage ratio (equal impedance)	Power ratio
1.000	1.000	0	1.000	1.000
0.989	0.977	0.1	1.012	1.023
0.977	0.955	0.2	1.023	1.047
0.966	0.933	0.3	1.035	1.072
0.955	0.912	0.4	1.047	1.096
0.944	0.891	0.5	1.059	1.122
0.933	0.871	0.6	1.072	1.148
0.923	0.851	0.7	1.084	1.175
0.912	0.832	0.8	1.096	1.202
0.902	0.813	0.9	1.109	1.230
0.891	0.794	1.0	1.122	1.259
0.841	0.708	1.5	1.189	1.413
0.794	0.631	2.0	1.259	1.585
0.750	0.562	2.5	1.334	1.778
0.708	0.501	3.0	1.413	1.995
0.668	0.447	3.5	1.496	2.239
0.631	0.398	4.0	1.585	2.512
0.596	0.355	4.5	1.679	2.818
0.562	0.316	5.0	1.778	3.162
0.531	0.282	5.5	1.884	3.548
0.501	0.251	6.0	1.995	3.981
0.473	0.224	6.5	2.113	4.467
0.447	0.200	7.0	2.239	5.012
0.422	0.178	7.5	2.371	5.623
0.398	0.159	8.0	2.512	6.310
0.376	0.141	8.5	2.661	7.079
0.355	0.126	9.0	2.818	7.943
0.335	0.112	9.5	2.985	8.913
0.316	0.100	10	3.162	10.00
0.282	0.0794	11	3.55	12.6
0.251	0.0631	12	3.98	15.9
0.224	0.0501	13	4.47	20.0

RADIO LABORATORY HANDBOOK

DECIBEL TABLE—*continued.*

Voltage ratio (equal impedance)	Power ratio	← — db + →	Voltage ratio (equal impedance)	Power ratio
0.200	0.0398	14	5.01	25.1
0.178	0.0316	15	5.62	31.6
0.159	0.0251	16	6.31	39.8
0.141	0.0200	17	7.08	50.1
0.126	0.0159	18	7.94	63.1
0.112	0.0126	19	8.91	79.4
0.100	0.0100	20	10.00	100.0
3.16×10^{-2}	10^{-3}	30	3.16×10	10^3
10^{-2}	10^{-4}	40	10^2	10^4
3.16×10^{-3}	10^{-5}	50	3.16×10^2	10^5
10^{-3}	10^{-6}	60	10^3	10^6
3.16×10^{-4}	10^{-7}	70	3.16×10^3	10^7
10^{-4}	10^{-8}	80	10^4	10^8
3.16×10^{-5}	10^{-9}	90	3.16×10^4	10^9
10^{-5}	10^{-10}	100	10^5	10^{10}
3.16×10^{-6}	10^{-11}	110	3.16×10^5	10^{11}
10^{-6}	10^{-12}	120	10^6	10^{12}

309. Relationship between Musical and Frequency Scales

Note*	Interval from lowest	Fractional Ratios	Frequency Ratio†
C ¹ Doh	Octave	48 to 24, or 2	2.000
B Te	Seventh	45 " " $\frac{1}{5}$	1.888
A Lah	Sixth	40 " " $\frac{2}{5}$	1.682
G Soh	Fifth	36 " " $\frac{3}{5}$	1.498
F Fah	Fourth	32 " " $\frac{4}{5}$	1.335
E Me	Third	30 " " $\frac{5}{6}$	1.260
D Ray	Second	27 " " $\frac{2}{3}$	1.122
C Doh	Unison	24 " " 1	1.000
	Tone		1.122
	Semitone		1.059

See also piano scale (Fig. 85).

* This begins at C so as to accommodate the whole major scale on the white keys of the piano.

† Calculated on the "equal temperament" scale, to which keyboard instruments are tuned in order to allow changes of key without retuning; as can be seen, it does not agree *exactly* with the fractional ratios, which are correct as judged by ear.

It is interesting to note that the ratio of a whole tone is practically the same as the voltage (or current) ratio equal to one decibel; a semitone corresponds to half a decibel.

310. Standard Frequencies

*N.P.L. Standard Modulation Frequency Transmissions . 1,000 c/s**

This transmission takes place on the second Tuesday of each month on a nominal carrier frequency of 396 kc/s (758 metres) to the following schedule:—

- 10.40 G.M.T. Announcement in morse—"CQ de G₅HW (3 times). Standard Frequency Emission at 1,000 cycles per second".
- 10.45 Transmission of modulation frequency for one hour.
- 11.45 Modulation frequency reduced by 25 parts in ten million (to enable observers to decide whether their own frequency is above or below that of the N.P.L. standard).
- 11.55 Announcement in morse—"CQ de G₅HW. The correct frequency was .999x (or .000y)" (3 times).

In this announcement of the correct value, the figures before the decimal point are omitted. Thus, .999x indicates a frequency of 999.999x c/s, and .000y a frequency of 1,000.000y c/s.

In the London and Surrey district, at least, there is no necessity for a special receiver, as the second harmonic can be picked up on an ordinary broadcast receiver, on 792 kc/s (379 metres).

American Bureau of Standards Standard Frequency Transmissions.

This service comprises the broadcasting of standard frequencies and standard time intervals from the Bureau's radio station WWV near Washington, D.C. It is continuous at all times day and night, from 10-kilowatt radio transmitters except on 2.5 megacycles per second where 1 kilowatt is used.

At least three radio carrier frequencies are radiating at all times. The radio frequencies are:—

2.5 Mc/s	2300 to 1300 G.M.T.
5	"continuously day and night
10	"" " " "
15	"1100 to 2300 G.M.T.

* Suspended since 1939. Resumption under consideration at time of writing (1946).

RADIO LABORATORY HANDBOOK

Two standard audio frequencies, 440 c/s and 4,000 cycles per second, are broadcast on the radio carrier frequencies. Both are broadcast continuously on 10 and 15 Mc/s. Both are on the 5 Mc/s in the daytime, but only the 440 is on the 5 Mc/s from 2300-1100 G.M.T. Only 440 is on the 2.5 Mc/s. It is, of course, quite easy to separate such diverse audio frequencies by means of a simple filter; but for the frequency comparison methods of Secs. 130 and 131 it is not essential to do so, because only one of the patterns can be made stationary on the screen at a time.

In addition there is on all carrier frequencies a pulse of 0.005-second duration which occurs at intervals of precisely one second. The pulse consists of five cycles, each of 0.001-second duration, and is heard as a faint tick when listening to the broadcast; it provides a useful standard of time interval, for purposes of physical measurements, and may be used as an accurate time signal. On the 59th second of every minute the pulse is omitted.

The audio frequencies are interrupted precisely on the hour and each five minutes thereafter; after an interval of precisely one minute they are resumed. This one-minute interval is provided in order to give the station announcement and to afford an interval for the checking of radio-frequency measurements free from the presence of the audio frequencies. The announcement is the station call letters (WWV) in morse, except at the hour and half hour when a detailed announcement is given by voice.

The accuracy of all frequencies, radio and audio, as transmitted, is better than one part in 10,000,000. Transmission effects in the medium (Doppler effect, etc.) may result at times in slight fluctuations in the audio frequencies as received; the average frequency received is, however, as accurate as that transmitted. The time interval marked by the pulse every second is accurate to 0.00001 second. The 1-minute, 4-minute and 5-minute intervals, synchronised with the second pulses and marked by the beginning or ending of the periods when the audio frequencies are off, are accurate to a part in 10,000,000.

FOR REFERENCE

The beginnings of the periods when the audio frequencies are off are so synchronised with the basic time service of the U.S. Naval Observatory that they mark accurately the hour and the successive 5-minute periods.

Of the radio frequencies, the lowest provides service to short distances, and the highest to great distances. Reliable reception is in general possible at all times throughout the United States and the North Atlantic Ocean, and fair reception throughout the world.

The accompanying wire tables, which cover almost every practical need, are published by kind permission of the compiler, Mr. C. R. Cosens, M.A.,

311. Wire Tables and of the Editor of *The Journal of Scientific Instruments*, in the April, 1937, issue of which they first appeared. They have been extended by the present author to include the last three gauges, which, however, because of their extreme fragility, are not highly recommended.

The following are some extracts from Mr. Cosens's explanatory remarks.

"The results given are fair averages, and different samples should not vary therefrom by more than a few per cent. In practical use, any apparent improvement on 'slide-rule accuracy' is illusory; for example, a change of temperature of 4° C. alters the resistance of a copper wire by about 1 per cent., and although resistance materials have much smaller temperature coefficients of resistance, they vary from sample to sample with unavoidable small changes of composition and of wire diameter, due to wear of the drawing dies. If great accuracy is required, it is advisable to determine the relation between length of wire and resistance by experiment, and then to mark the result on the reel.

"The resistance of a known length of copper wire is often required, and for transformer work, etc., this length will invariably have been calculated in centimetres, so that the usual 'ohms per 1,000 yards' is inconvenient. Ohms per cm. length would be best, but to avoid zeros after the decimal point, ohms per kilometre of copper wire are given. For resistance wires the length needed to give a

specified resistance is usually required, and this is given in the tables as centimetres of wire per ohm, for both constantan and manganin.

“Since wire is sold by the pound or ounce, it is desirable to know the length contained on a reel of stock weight. The usual tables give the weight in pounds of 1,000 yards of bare wire, no allowance being made for the weight of the covering, although this may amount to more than a 60 per cent. increase for very fine wires. Since silk-covered wire is more expensive than cotton, it is often bought in small reels of an ounce or two, while the cheaper cotton covering is used for thicker wires, and is seldom bought on reels of less than a half or quarter pound. The tables therefore give the length of D.C.C. wire of each size that will be found on a 1 lb. reel, and the length of D.S.C. on a 1 oz. reel. These have been calculated for copper wire, with allowance made for the weight of the covering; but the densities of constantan and manganin differ from that of copper by so small a proportion (say 1 per cent.) that this column can be used for these materials also without appreciable error.

“For constantan and manganin, the number of ohms that may be expected on a 1 lb. reel of D.C.C. and on a 1 oz. reel of D.S.C. are given. As stated above, these are average values and considerable differences occur from sample to sample, especially in the case of manganin. The deviation should not exceed 5 per cent., and is unlikely to be more than half this, but it should be remembered that this is the resistance as supplied, and that when manganin is annealed after winding there will be an appreciable drop of resistance, so that a coil should be wound about 1 or 2 per cent. high and adjusted after annealing. Annealing is not necessary for constantan; though desirable for very accurate work, the change in resistance is very small.

“The columns for D.S.C. wire can also be used for finding the length on a reel of enamel and single silk covered wire, and the error will be small and on the safe side.

“The tables also give: (a) the number of turns of wire that will occupy a length of 1 cm. of a single-layer coil, if wound with turns touching, and (b) the number of turns

FOR REFERENCE

that can be wound in a square cm. of a multi-layer coil such as a transformer coil. This has been calculated with no allowance for 'bedding', i.e., on the assumption that the wires will lie as shown in Fig. 210, not as in Fig. 211.



Fig. 210

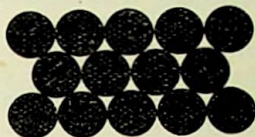

Fig. 211

Although Fig. 211 is possibly nearer the truth when a wire winding machine is used, experience shows that when wire is wound by hand in a lathe, without winding absolutely even layers for the finer sizes (which is incredibly tedious), but with reasonable care to keep the winding as level as possible, the values given in the table do fairly represent the number of turns that can be got into the available space. Additional space must of course be allowed for the insulating bobbin, or for the tape if former-wound.

“This information is given for five different wire coverings. A single layer of insulation, whether silk, cotton, or enamel, is not recommended for hand winding; enamel alone is very satisfactory when used on a winding machine, but when wound by hand there is risk of scratching the enamel or pinching the wire and causing a short-circuited turn. Enamel and single silk (E. & s.s.) or enamel and single cotton (E. & s.c.) are very satisfactory; E. & s.s. can be specially recommended for small transformers, it takes up no more space than double silk (sometimes less), and it is cheaper. For thicker wires, E. & s.c. takes up much less space than double cotton, and is no more expensive. Both these coverings are excellent from the point of view of insulation, the cotton or silk makes a soft bed for the turns of wire so that the enamel is not easily injured, while the enamel gives high insulation resistance even if a 'dry' coil without varnish is used in a damp place. Copper and constantan wires can be bought enamelled, but enamel covering is not obtainable with manganin wires.

“ Of resistance wires, constantan (copper 60 per cent., nickel 40 per cent.)- is sold under various trade names, such as ' Eureka '.

“ Where the errors due to thermal e.m.f.'s cannot be neglected, it is necessary to use manganin (copper 84 per cent., manganese 12 per cent., nickel 4 per cent.), but some little experience is needed to work this material, so that, apart from the expense, one does not use it if it can be avoided. Manganin cannot be soft-soldered, but must be silver-soldered at a red heat with a blowpipe, a process requiring some dexterity with a fine wire. It is also necessary to have some form of annealing oven, preferably electric, which must have thermostatic control to keep the temperature correct to within a degree or two, as it is necessary after winding to coat the wire with shellac varnish to protect it from oxidization, and then to anneal for at least twenty-four hours at a temperature not below 130° C. If the temperature does not exceed 130° C., the manganin does not anneal; if it exceeds 140° C., the silk insulation will be charred. If the shellac coat does not completely cover the wire, oxidization takes place and the resulting coil will have a large temperature coefficient (when annealed properly without access of oxygen the temperature coefficient is very small, sometimes even zero or negative).

“ The cross-section in square millimetres is convenient for determining the current-capacity. Drysdale and Jolley give the current-density employed in instrument work as between 1 and 4 amperes per square mm. For small mains transformers of 100 W. or so, higher current densities could be employed without dangerous overheating, but the determining factor is usually the voltage drop allowable on full load, and this results in demanding a current density of from 1 to 2 amperes per square mm. only.

“ The even-numbered gauges are more frequently used than the odd numbers, but all can usually be obtained from stock, and intermediate sizes are also made by some makers, especially in copper wire ”.

FOR REFERENCE

S.W.G.	Copper		Constantan (or "Eureka")			Manganin			S.W.G.	
	Ohms per km.	*Metres per 1 lb. reel D.S.C.	*Metres per 1 lb. reel D.C.C.	Cm. per ohm	Ohms per 1 oz. reel D.S.C.	Ohms per 1 lb. reel D.C.C.	Cm. per ohm	Ohms per 1 oz. reel D.S.C.		Ohms per 1 lb. reel D.C.C.
12	3.00	0.57	0.1	1.140	0.050	0.80	1.300	0.044	0.70	12
13	3.95	0.73	11.5	890	0.082	1.31	1.020	0.072	1.15	13
14	5.22	0.97	15.2	680	0.144	2.3	770	0.126	2.0	14
15	6.45	1.20	18.7	550	0.22	3.5	630	0.192	3.1	15
16	8.16	1.52	24	430	0.35	5.6	400	0.31	4.9	16
17	10.66	1.98	30	330	0.60	9.6	380	0.52	8.4	17
18	14.51	2.7	41	240	1.10	17.7	280	0.97	15.4	18
19	20.0	3.8	58	169	2.3	30	193	1.99	32	19
20	25.8	4.7	71	137	3.5	55	156	3.0	48	20
21	32.6	6.0	90	108	5.5	88	124	4.8	77	21
22	42.6	7.8	115	83	9.4	150	95	8.2	131	22
23	58.0	10.5	156	61	17.3	260	70	15.1	240	23
24	69.1	12.6	183	51	25	400	58	22	350	24
25	83.6	15.3	220	42	30	580	48	32	510	25
26	103.2	18.7	260	34	55	880	39	48	770	26
27	124.3	22	310	28	79	1,270	33	69	1,110	27
28	152.6	28	380	23	110	1,900	26	104	1,670	28
29	180.8	32	430	19.5	167	2,700	22	146	2,300	29
30	217	39	500	16.2	240	3,800	18.6	210	3,400	30

RADIO LABORATORY HANDBOOK

S.W.G.	Copper			Constantan (or "Eureka")			Manganin			S.W.G.
	Ohms per km.	*Metres per 1 oz. reel D.S.C.	*Metres per 1 lb. reel D.C.C.	Cm. per ohm	Ohms per 1 oz. reel D.S.C.	Ohms per 1 lb. reel D.C.C.	Cm. per ohm	Ohms per 1 oz. reel D.S.C.	Ohms per 1 lb. reel D.C.C.	
31	240	44	560	14.2	310	5,000	16.2	270	4,440	31
32	287	51	640	12.3	410	6,660	14.1	360	5,800	32
33	334	59	730	10.6	560	9,000	12.1	490	7,900	33
34	395	69	830	8.9	780	12,400	10.2	680	10,900	34
35	474	83	1,010	7.5	1,100	17,800	8.5	970	15,600	35
36	579	100	1,210	6.1	1,640	26,200	7.6	1,430	23,000	36
37	723	123	1,400	4.9	2,500	40,000	5.6	2,220	35,000	37
38	929	158	1,740	3.8	4,100	66,000	4.3	3,600	58,000	38
39	1,236	210	2,200	2.9	7,200	115,000	3.3	6,300	101,000	39
40	1,451	240	2,400	2.4	9,800	157,000	2.8	8,600	137,000	40
41	1,727	280	—	2.0	13,600	—	2.3	11,900	—	41
42	2,000	330	—	1.69	19,600	—	1.93	17,100	—	42
43	2,580	390	—	1.37	29,000	—	1.56	25,000	—	43
44	3,270	480	—	1.08	44,000	—	1.24	39,000	—	44
45	4,260	570	—	0.83	60,000	—	0.95	60,000	—	45
46	5,800	730	—	0.61	120,000	—	0.70	105,000	—	46
47	8,360	1,020	—	0.42	220,000	—	0.48	196,000	—	47
48	13,050	1,480	—	0.27	550,000	—	0.31	480,000	—	48
49	23,200	2,380	—	0.15	1,550,000	—	0.17	1,350,000	—	49
50	33,400	3,200	—	0.105	3,000,000	—	0.12	2,650,000	—	50

* These columns may also be used for Constantan and Manganin.

FOR REFERENCE

S.W.G.	Turns per cm. length of single-layer coil				Turns per sq. cm. section of solid coil				Dia- meter in. (bare)	Cross- section mm. ²	Dia- meter mm. (bare)	S.W.G.		
	D.S.C.	D.C.C.	E. & S.S.	E. & S.C.	Enamel	D.S.C.	D.C.C.	E. & S.S.					E. & S.C.	Enamel
12	—	3.3	3.4	3.6	—	11.1	—	—	11.7	13.3	5.48	12		
13	—	3.7	3.8	4.1	—	13.8	—	—	14.6	16.8	4.39	13		
14	—	4.2	4.3	4.7	—	17.5	—	—	18.7	22	3.24	14		
15	—	4.7	4.7	5.2	—	22	—	—	21	27	2.63	15		
16	5.8	5.2	5.3	5.8	3.3	27	3.2	3.2	28	34	2.07	16		
17	6.6	5.8	6.0	6.7	4.3	33	4.1	4.1	36	45	1.59	17		
18	7.7	6.7	6.8	7.8	6.0	44	5.6	5.6	46	60	1.167	18		
19	9.2	7.7	7.9	9.2	8.4	60	7.8	7.8	62	85	0.811	19		
20	10.1	8.4	8.6	10.2	10.2	70	9.4	9.4	73	103	0.657	20		
21	11.3	9.2	9.4	11.4	12.7	84	11.6	11.6	88	130	0.519	21		
22	12.7	10.1	10.4	12.9	16.1	102	14.7	14.7	107	167	0.397	22		
23	14.6	11.6	12.5	15.0	21.0	134	19.3	19.3	156	220	0.292	23		
24	15.7	12.3	13.3	16.2	25.0	151	23.0	23.0	178	260	0.245	24		
25	17.1	13.1	14.6	18.1	29.0	172	28.0	28.0	210	330	0.203	25		
26	19.2	14.1	15.7	19.9	37.0	198	35.0	35.0	250	400	0.1642	26		
27	21	14.9	17.2	22	43.0	220	42.0	42.0	300	480	0.1363	27		
28	23	15.9	18.5	24	52.0	250	50.0	50.0	340	580	0.1110	28		
29	24	16.7	19.6	25	60.0	280	58.0	58.0	380	670	0.0937	29		
30	26	17.6	21	29	70.0	310	70.0	70.0	450	840	0.0779	30		

RADIO LABORATORY HANDBOOK

S.W.G.	Turns per cm. length of single-layer coil				Turns per sq. cm. section of solid coil				Dia- meter in. (bare)	Cross- section mm. ²	Dia- meter mm. (bare)	S.W.G.		
	D.S.C.	D.C.C.	E. & S.S.	E. & S.C.	Enamel	D.S.C.	D.C.C.	E. & S.S.					E. & S.C.	Enamel
31	28	18.2	28	22	31	780	330	780	400	940	0.0116	0.0682	31	
32	30	18.9	30	23	33	880	360	880	540	1,080	0.0108	0.0501	32	
33	31	19.7	32	24	35	990	390	990	590	1,240	0.0100	0.0507	33	
34	34	21	35	26	39	1,170	420	1,100	670	1,490	0.0092	0.0429	34	
35	36	23	37	20	42	1,300	510	1,380	860	1,750	0.0084	0.0358	35	
36	39	24	40	31	46	1,520	560	1,610	980	2,100	0.0076	0.0293	36	
37	42	25	44	—	51	1,790	620	1,910	—	2,500	0.0068	0.0234	37	
38	46	26	49	—	56	2,100	690	2,400	—	3,200	0.0060	0.01824	38	
39	51	28	55	—	66	2,600	770	3,000	—	4,300	0.0052	0.01370	39	
40	54	29	58	—	72	2,900	810	3,400	—	5,100	0.0048	0.01167	40	
41	60	—	62	—	79	3,600	—	3,800	—	6,200	0.0044	0.00981	41	
42	64	—	66	—	86	4,000	—	4,300	—	7,300	0.0040	0.00811	42	
43	68	—	73	—	96	4,600	—	5,300	—	9,200	0.0036	0.00657	43	
44	73	—	79	—	106	5,300	—	6,200	—	11,300	0.0032	0.00519	44	
45	79	—	86	—	119	6,200	—	7,300	—	14,200	0.0028	0.00397	45	
46	86	—	96	—	141	7,300	—	9,200	—	19,800	0.0024	0.00292	46	
47	94	—	109	—	171	8,800	—	12,000	—	29,000	0.0020	0.00203	47	
48	108	—	—	—	206	10,800	—	—	—	43,000	0.0016	0.00130	48	
49	—	—	—	—	280	—	—	—	—	79,000	0.0012	0.00073	49	
50	—	—	—	—	328	—	—	—	—	107,000	0.0010	0.000507	50	

APPENDIX

CONSTRUCTIONAL INFORMATION ON BRIDGES

THE circuit diagram is given in Fig. 78, and by stripping it of details, as in Fig. 212, the basic principle can be seen clearly. The component to be tested, connected at X, is compared with any one of a number of standards, S,

I. Mains-driven Resistance and Capacitance Bridge (Sec. 123)

selected by a range switch. To avoid the need for continuously variable standards, the ratio arms are made variable, and are composed of an ordinary potentiometer, which is calibrated to read ratios directly. It is supplied with a 50-cycle voltage, and balance

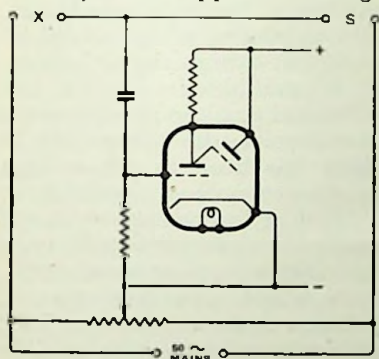

is shown by the cathode-ray tuning indicator. The reading of the potentiometer at balance, multiplied by the value of the standard in circuit, gives the value of X directly; and as in the present example the standards are all multiples of 10 this

Fig. 212. Showing how a "magic eye" is employed in a bridge as detector. For circuit details see Fig. 78.

process demands no appreciable amount of mental arithmetic. For instance, if the potentiometer reading when balance is obtained is 0.65 and the range switch is set to 100 ohms, the required result is 65 ohms.

When made up as described here, the bridge :

Measures resistance from about 10Ω to $10M\Omega$.

Measures capacitance from about $10\mu\mu F$ to $10\mu F$, including electrolytics.

Gives rough checks over ranges 100-fold greater than above.

Measures power factor, up to 60 per cent., of "bad" condensers from $0.1 \mu\text{F}$ upwards.

Compares components, including large inductances, with any standard of similar sort.

Detects leakages, from about $100 \text{ M}\Omega$ downwards.

Gives a continuously variable 50-c/s signal up to 25 volts.

Is portable, self-contained (except for mains connection), direct reading, and requires no earth connection.

Turning now to the full circuit diagram, Fig. 78, some of the other features can be seen. The special mains transformer supplies 4 volts for the heater of the TV₄ indicator, 150 volts through a small metal rectifier and simple smoothing circuits for the anode of the TV₄, and 50 volts to the bridge itself. The bridge voltage should be graduated to suit the impedance being measured, and this is done automatically by the 1000-ohm 3-watt resistor in series with the transformer winding. For high impedances, such as grid leaks and small condensers, which would be difficult to balance sharply without a high signal voltage, half of the full 50 volts is available; but for low impedances which at 25 volts would pass too much current for themselves and for the transformer, the voltage falls to a suitable value. The resistor has been chosen so that even if the test terminals are shorted no harm will follow. And electrolytic condensers rated at low voltages will not be damaged. The 1000-ohm potentiometer should be a reliable one with a smooth and uniform resistance element, for it is the component with which measurements are actually carried out. The input resistance of the TV₄ indicator is kept high, otherwise it would not be possible to get results with such high impedances as $10 \mu\mu\text{F}$, which at 50 cycles is no less than 300 megohms.

The accuracy of measurement is, of course, no better than that of the standards used. And here there is room for wide differences according to individual requirements and opportunities. If one is tied for cost, and has no chance of getting standards checked, condensers and resistors of the ordinary receiver type can be bought within 5 per cent. limits at little if any increase in price. That is good enough for rough checking. At somewhat higher prices, resistors

APPENDIX

are sold correct within 0.5 per cent., which is quite good enough for most purposes, and approaches the maximum closeness of adjustment of the potentiometer. Or, if another bridge is available, resistors can be wound with Eureka wire to the right values, taking care that approximately half the turns are wound in opposite rotation to minimise inductance. Enthusiasm probably falls short of wire-winding the megohm; a selected grid leak type of resistor is more practicable.

Standard condensers are more difficult. Apart from the question of measuring their capacitances, the sorts commonly used are liable to vary with temperature, age, etc. The smallest should preferably be one of the ceramic or plated mica types; the middle size a good quality mica; and, as mica is prohibitive for the largest, a good quality paper specimen is suggested. If facilities for accurate capacitance measurements can be begged, borrowed, or hired, an attempt should be made to bring up the condensers to their exact ratings by shunting small ones across them. So, if those selected are not dead right (an unlikely stroke of luck) it is convenient for them to be slightly low. If one is prepared to spend a pound or two on accuracy, some firms, such as H. W. Sullivan, can supply accurate condensers.

It is very desirable for the standards to be as nearly as possible exactly multiples of 10, for convenience in reading; but, of course, it is not inconsistent with high accuracy for them to be somewhat different *so long as the exact values are known*. For instance, if a condenser is 1.04 μF , within 0.5 per cent., it can be assumed to be 1.0 μF for direct reading within an accuracy of, say, 5 per cent.; while on occasions when greater accuracy is wanted the actual value can be worked out. The point is that the cost of a condenser whose capacitance is guaranteed to a given accuracy is much greater if it is required to an exact round number rather than to a nominal value.

No provision is made for balancing the resistance of the smaller condensers. It is generally enough to observe whether the sample under test gives a reasonably sharp balance; if not, it is a bad one. But in the largest sizes most of those now used are electrolytic, and at low fre-

quencies a relatively large power factor is not necessarily a ground for rejection. At the same time it should not be too large. Some electrolytic condensers show a power factor of less than 5 per cent. and are quite acceptable; others show 30 per cent. or more and should be rejected. The adjustment to exact balance when the power factor is appreciable is done by the 2,500-ohm rheostat, which can be of the same type as the 1,000-ohm potentiometer. Calibration of this control will be described later.

In use, the component to be measured is connected to the "C and R" terminals, and the range switch set to what is believed to be the nearest value. In all probability the screen of the TV₄ is nearly covered with illumination. But if the potentiometer is turned, a point should be reached at which the light shrinks into a clearly defined cross. If by careful adjustment the edges of this pattern cannot be made dead sharp, the power factor of the component must be different from that of the standard. On the largest capacitance range this can be cleared up by alternate adjustment of the power factor and potentiometer knobs.

If balance falls outside the readings 0.1 to 10 on the ratio scale a better result will be obtained on another range. If balance is obtained only at one extreme limit of the potentiometer adjustment, the component must be open-circuited or short-circuited, or at any rate substantially so in relation to the range in use. A 10 μF condenser would appear as a dead short if tested on the 100 $\mu\mu\text{F}$ range.

When measuring condensers on the 100 $\mu\mu\text{F}$ range, the same sharpness of balance must not be expected as on the higher capacitance ranges. It is not that balance is blurred; assuming that the power factor of the sample is not exceptionally bad, balance is quite good; but a larger movement of the ratio control is required in order to show an appreciable change in the indicator pattern. The best way is to swing the knob to and fro between positions each side of balance, until the exact balance point can be judged. With the particular bridge illustrated here, it is possible to observe a capacitance as low as 5 $\mu\mu\text{F}$, and the readings around 100 $\mu\mu\text{F}$ are surprisingly accurate.

A useful feature is a seventh position on the range

APPENDIX

switch, whereby an external standard can be connected to the "Match" terminals. For example, it might be necessary to adjust a number of components to the same value, or their departures from a certain standard. This is available for inductances of not less than about 1 henry. Push-pull transformers can be tested for balance of windings. And other uses will readily occur.

For calibrating the potentiometer it is an enormous help if one can use a laboratory resistance box, and at least one accurate known resistance. These are connected to "C and R" and "Match", and their ratios set to various values. If the fixed resistance connected to "Match" is 100 ohms, the other is set to 100, giving the ratio "1" to mark on the scale. Increasing to 110 ohms gives 1.1, and so on. There should be two scales, because the capacitance or "C" scale increases in the opposite rotation to the "R" scale. The "1" marks coincide, of course, and each setting on one scale is the reciprocal of the corresponding point on the other. The result is shown in Fig. 78.

If no resistance box is available, a quantity of Eureka wire can be used for calibrating in ratios, on the assumption that its resistance is proportional to length. But of course it becomes rather tedious, cutting lengths of wire, if a large number of scale points are to be found.

To calibrate the power factor adjustment, the 1 μ F is temporarily shorted, and the 2500-ohm rheostat balanced against a fixed or variable standard in the "C and R" arm. A table is given showing the relationship between power factor and resistance in series with 1 μ F at 50 c/s.

POWER FACTOR CALIBRATION TABLE

Power factor : per cent.	Resistance : ohms
5	160
10	320
15	485
20	650
25	820
30	1000
35	1190
40	1400
45	1610
50	1830
55	2080
60	2370

RADIO LABORATORY HANDBOOK

The leakage test is an optional extra, requiring only a neon lamp. The most suitable type is that supplied for indicator purposes. The lowest available voltage lamp should be chosen, but it may be noted that a 230-volt lamp lights up on the 175 volts available. Though it can be used for detecting DC leakage anywhere, its main use is for condensers. When any condenser is connected the lamp flashes momentarily, due to charging and in a dim light this should be perceptible with capacitances down to about $0.005 \mu\text{F}$. If the condenser is a good one it may be necessary to wait quite a long time for the next flash. But a poor condenser flashes like a police road beacon, while a downright bad one shows a continuous light. This judgment must not be applied too literally to electrolytic condensers (which, incidentally, must always be connected the right way round), because they always leak to some

extent, but whether that extent is reasonable can be gauged by watching the lamp. A light that remains bright continuously after the condenser has been connected for a minute or two shows excessive leakage. Frequency of flashing depends not on megohms, but on megohm-microfarads, a quantity that is a truer measure of the condenser's quality. A microfarad condenser with a leakage of 50 megohms is proportionately

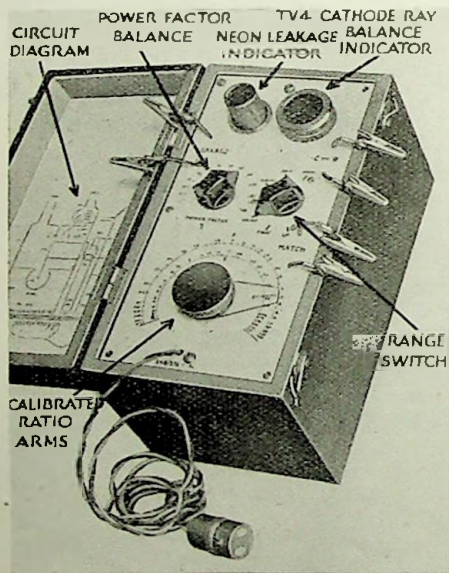

Fig. 213. Mains-driven C & R bridge

APPENDIX

similar to a 0.25 microfarad condenser with a leakage of 200 megohms.

The variable 50-cycle signal, mentioned in the list of advantages, can, of course, be derived from the "LEAKAGE -" terminal and one of either of the other pairs. And, of course, a 25-volt signal with a centre tap (or any other ratio) is available by using three terminals.

With regard to construction, there is scope for individuality. The photographs (Figs. 213 and 214) give some idea of how it can be done. It was wanted to get it into a

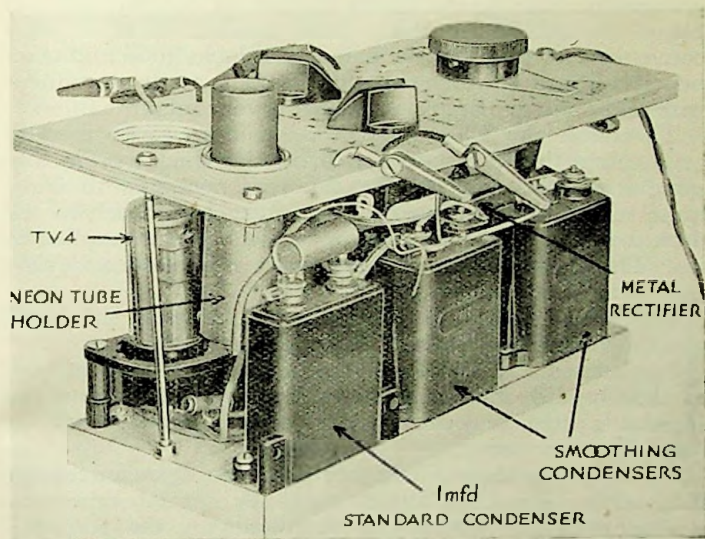

Fig. 214. Bridge with case removed

handy ex-Navy wavemeter box, hence the crowded appearance. It would be much easier to make if done on a less compact scale. The disposition of the components is of some importance; the leads connecting the parts of the bridge proper should be short, and the $1\text{M}\Omega$ and $100\ \mu\text{F}$ standards particularly should be joined close to the switch and have minimum capacitance to other parts. The 50-volt

RADIO LABORATORY HANDBOOK

leads from the transformer need not be particularly short. But all AC leads must be kept as far as possible from the grid of the TV₄, the connections to which should be well insulated. The cathode of the TV₄ is connected to heater, — HT, transformer screen, and metal lining of box, if any. The last precaution does not seem to be essential, nor does an earth connection, but if there is difficulty in getting balance with very high impedances one can be tried. "LEAKAGE—" is available for the purpose.

Crocodile clips are quicker to use and generally more convenient than screw terminals but, of course, one can please oneself about this. Matt ivory sheet is very convenient for covering the panel, as it looks good and takes pencil calibration which can afterwards be made permanent with Indian ink. But remember it is very inflammable!

To enable the TV₄ and the neon lamp to be used in bright light they are shown with tubular shields projecting some way above the panel. But it is necessary to make quite sure that the neon tube is not kept so much in the dark that it cannot start to glow on the voltage supplied to it. The flash voltage is sometimes raised considerably by darkness.

If the box has a lid, a detailed circuit diagram should be gummed inside it—a sound practice with all lab. gear.

For reference a list of suitable components follows, but, as already said, there are alternatives so far as at least the standards are concerned. *The required accuracy must be specified when ordering.*

There is also scope for higher precision of measurement if a larger potentiometer is used. A special type was produced to the author's requirements by the Reliance Manufacturing Co. (Southwark) Ltd., Sutherland Road, London, E.17, having a 2 $\frac{3}{4}$ in. diameter and wound with nickel wire to enable a finer gauge to be used and hence a more nearly continuous variation.

Transformer	Special	N. Partridge, Dean Stanley St., London, S.W.1
Rectifier	J-20	Westinghouse
Ratio arms	M 1 Clarostat	Claude Lyons
Power factor control	M 2 $\frac{1}{2}$	"
Range switch	Type 5 (or a Yaxley Ferranti switch)	"

APPENDIX

	1-mfd. standard	Type BB (selected)	Dubilier
	0.01 " "	" 770 (special) ± 2 p.c.) "	" "
	100 mmfd. " "	" CTS(" ± 1 p.c.) "	" "
	100 ohm " "	R.20 (± 0.5 p.c.)	Bulgin
	0.01 megohm " "	R.26 (± 0.5 p.c.)	" "
	1 " "	± 5 p.c. selected	Claude Lyons
	1000 ohm 3-watt resistor		" "
	10000 " " "		" "
	4 megohm " " "		" "
	2 " " " "		" "
	0.01 mfd. condenser	Type 4601/S	Dubilier
Two	2 " "	BB	" "
Six	Crocodile clips	CR. 6	Bulgin
	Panel surfacing	$\frac{1}{4}$ -in matt ivoryine	Reliance (Nameplates) Ltd., Twickenham
Two	small knobs	K.58 or K.92	Bulgin
	Large knob	K.70	" "
	Cursor	K.72	" "
	Cathode ray indicator	TV4	Mullard
	" " " holder	VH 24	Bulgin
	Neon indicator	17 x 52 mm. S.E.S.	Philips
	" " holder	D.18	Bulgin

With a very few additional components the preceding C and R bridge can be modified to deal with inductances also, from about 1 to 1000 henries, provided that the power factor is not too large. Air-core coils are practically ruled out by this proviso. Measurement can be made with polarising current, up to 100 mA if not kept on too long. And the scale can be calibrated from the main bridge. The modification may be either incorporated or connected externally as an attachment. Assuming the latter, Fig. 215 is the circuit and method of connection.

The transformer is a Bulgin LF45, ratio 1 : 25 for stepping up to the TV4 for increasing the sharpness of indication. A 0.02 μ F condenser shunts the secondary in order to reduce the effect of harmonics. The standard is the 0.25 μ F condenser, which ought therefore to be of reasonably good quality. The end-to-end resistance of the 500 Ω potentiometer is not critical (nor is that of the fixed 500 Ω) but it must not vary more than 1 Ω as the slider is moved; and a Morganite type "P" carbon potentiometer has been found the best solution.

The 25 μ F condenser is to prevent current from the polarising battery from passing through the transformer.

The 500 Ω slider is first set to short-circuit the 0.25 μ F, and the main bridge is then balanced. The "unknown"

is then connected to the terminals L, in series with a battery and milliammeter if polarising current is required. (Note that the polarity of the battery must be as marked in Fig. 215). The 500 Ω potentiometer is then adjusted for

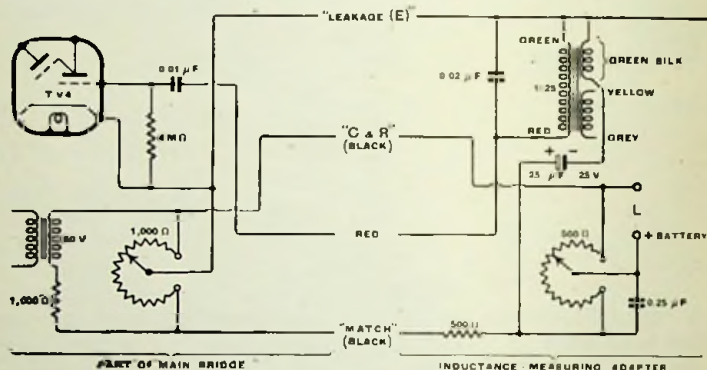

Fig. 215. Circuit of auxiliary bridge for measuring iron-core coils

balance. To obtain it sharply, it may be necessary to adjust the main potentiometer, but if such adjustment exceeds 2 or 3 per cent. it is a sign that the resistance of the coil is higher than normal in iron-core types, and the reading cannot be relied upon.

At balance the inductance L in henries is $\left(\frac{a}{b}\right)^2 \frac{1}{4\pi^2 f^2 C}$ where f is 50 c/s, C is in this case $0.25 \mu\text{F}$, and $\frac{a}{b}$ is the ratio of the resistance across L to that across C and can be calibrated from the main bridge, which, of course, is itself scaled in ratios. The formula simplifies to $L = 40 \left(\frac{a}{b}\right)^2$, so the 500 Ω potentiometer can be calibrated in henries by connecting the slide to "red" terminal (grid of TV₄) on the main bridge and the ends to the "black" terminals (ends of main potentiometer).

APPENDIX

Ratio on main bridge R scale	Corresponding calibration in henries
0·16	1
0·22	2
0·32	4
0·50	10
0·71	20
1·00	40
1·58	100
2·24	200
3·16	400
5·0	1000

The components are all small, so can be mounted in a box a few inches each way which can be provided with short leads for clipping to the main bridge (or, as already suggested, incorporated in it with a double-pole switch for disconnecting the inductance section when not in use).

Further details, and derivation of formula, were given in *The Wireless World*, January 12th, 1939.

The two preceding divisions of this Appendix between them cover most values of resistance and capacitance, and the "iron-core" or A.F. range of inductance. There only remain inductances below 1 henry—the R.F. range.

3. A Modified Owen Bridge

The 50 c/s bridge fails here, chiefly because the reactance of a few μH at that frequency is so minute as to be negligible in comparison with its resistance. The inductometer bridge is good but expensive. In the Maxwell there is a wide disparity between the reactance to be measured and that of the standard—a calibrated variable condenser, whereas for accuracy the arms of a bridge should be of the same order of impedance. So the Owen, in which the standard is a fixed condenser, deserves consideration.

An easily and inexpensively made bridge, modified from the usual Owen, is due to L. B. Turner. The circuit (which should be compared with Fig. 75) is shown in Fig. 216. R_2 and R_3 are varied simultaneously by what is in effect a range switch, to give values of 1, 10, 100 and 1,000 ohms. If the "X" terminals are shorted, then for balance the variable C_1 equals the fixed standard C_2 , and $R_1 = 0$. The effect of a pure inductance connected to X is to make it necessary to introduce a proportionate value of R_1 ; and to balance the resistance of the coil, R_2 , the

reactance of C_1 , must be increased and therefore its capacitance reduced. The maximum value required is equal to C_2 .

C_2 is a $0.01 \mu\text{F}$ condenser of low power factor, but its opposite number, C_1 , need not be particularly good, and consists of any variable of at least $0.001 \mu\text{F}$, supplemented by switched steps of the same value totalling $0.01 \mu\text{F}$. As they may be cheap "receiver" condensers they are not a formidable item; and if a 2-pole 11-way Yaxley switch is used only five condensers are needed—1, 2, 3, 4 and 6 times $0.001 \mu\text{F}$. R_1 is also not necessarily very "pure", and may consist of a $1,000\text{-}\Omega$ rheostat supplemented by 10 fixed steps of $1,000 \Omega$. No elaborate inductive winding is needed. R_2

and R_3 , however, ought to be reasonably non-inductive, as described in Sec. 96.

Fig. 216.
Circuit of
Turner-Owen
Bridge

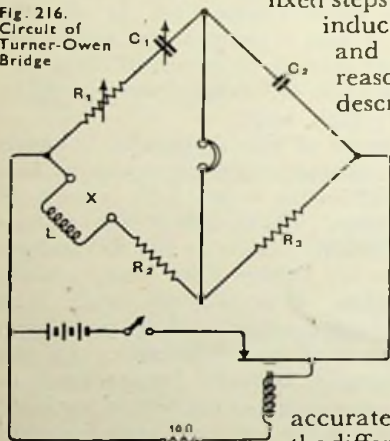

As in the Owen bridge $L = R_1 R_2 C_2$, the maximum values in the four ranges are 0.1 , 1 , 10 , and 100 mH ; so the total range covered is from a few μH to 0.1 H . The arrangement is not well adapted for measuring R_1 , however.

It should be noted that if C_2 , although known accurately, is not exactly $0.01 \mu\text{F}$, the difference may be allowed for by adjusting the values of R_2 and R_3 so that $R_2 C_2$ is exactly 0.01 , 0.1 , 1 , and 10 ; and the bridge will be direct reading in terms of these factors and R_1 .

A special feature is the method of connecting the battery, enabling a current of the order of 1 amp. to be passed through L on the lowest range. The impedance of the bridge being low, that of the phones should be likewise.

The author has made a successful bridge on similar lines but using a valve oscillator of about 2000 c/s. , with range arms 5 , 50 , and 500Ω , and R_1 consisting of a good 500Ω "potentiometer" and 10 steps of 500Ω each. It gives the useful ranges of 0.25 , 2.5 , and 25 mH , and a coil of $1 \mu\text{H}$ is definitely measurable.

INDEX

(Items in italics are names of persons, firms, books, etc.)

	PAGE		PAGE
ABACS	338	Box form units, Vertical mounting	
AC Bridges	149	of	19
<i>AC Bridge Methods</i>	228	Breadboard layout	14
— Measurements	149	Bridge amplifiers	154
— Formulæ	356	—, Campbell Frequency	159, 165
Accuracy, False	330	—, Choice of	210
Acorn probe for VHF	88, 204	—, Construction of	164, 387
— Valve	325	—, Galvanometer	74, 81, 148
Acoustic indicators	123	—, General purpose	154
— Measurements	262, 305	—, General Radio Co.	147
Aerial and earth connections	21	—, Inductometer	155, 210, 249
Aerials, Formulæ	369	— measurements 26, 146, 222, 236, 249	
—, Measurements on	271	—, Marconi-Ekco	164, 211
AF Gain Measurement	276	—, Maxwell	159, 253
— Standards	169	—, Negative resistance	200, 236
— Sources. (<i>See Audio Sources</i>)		—, Owen	159, 253, 397
Amplification factor	262	—, Schering	225
—, Units of	181	—, Universal	156, 164
Amplifier Measurements	272	—, Wien	166
— Gain, Measurement of	276	Bridges, AC	149 & Appendix
Amplifiers, Bridge	154	—, Capacitance	222
—, Deflection	120	—, DC	146
—, Standard	182	—, Frequency	166
Amplitude control, Automatic	44, 201	—, Mains-frequency	162
Anode AC resistance	262, 268	—, Valve	264
— bend Valve Voltmeter	87, 94	British Standard First Grade	
— Voltage, Cathode-ray	104	Meters	71
Apparatus layout	13	Brown Adjustable Phone	124
<i>Ardenne, von</i>	114	<i>Brown, S. G.</i>	124
Astatic winding	145	<i>Brunetti, C.</i>	51
Attenuation	182	Building, Special Laboratory	8
—, Measurement of	279, 334	<i>Butler, F.</i>	52
Attenuator	182	<i>Butterworth, S.</i>	143
— Calculation	184	By-pass condensers for VHF	325
—, Ladder	185	CALIBRATIONS, Difference 132, 241	
—, Variable	61	<i>Cambridge Instrument Co.</i>	
Attenuators, Ganged	282	69, 71, 128, 130, 140	
Audio Sources	38	Cambridge Resistance Meter	79
—, Beat-frequency	54	— Versatile Galvanometer	69, 189
—, Calibration of	171	Campbell Frequency Bridge	159, 165
—, Gramophone	38	— Inductometer	140, 155, 250
— "Straight"	54, 201	Capacitance bridges	222
Aural Tests	28	— Formulæ	368
"Autobias" Valve Voltmeter	89	— of circuit, Measurement of	241
Automatic amplitude control	44	— Standards of	133
— shunt	73	Capacitances, Inter-electrode	244
AVC Curves	316	—, Loss factor measurements of	224
— Tests	316	—, Measurement of large	227, 252
Avometer	69, 79, 189	— small	233, 243
Avominor	69	Care of instruments	214
—, Universal	69, 189, 209	Cathode follower	57
Ayrton-Perry Winding	129	Cathode-ray figures	170, 260
BALANCES IN BRIDGE WORK	149	— Tube	
<i>Baldwin Instrument Co.</i>	89	97, 227, 277, 283, 285, 297, 314, 329	
Band-pass circuits	295	—, Advantages of	97, 285
<i>Barber, A. W.</i>	118	—, at VHF	329
<i>Barclay, W. A.</i>	338	—, Auxiliary apparatus	107
<i>Bartlett, A. C.</i>	289	—, Characteristics of	103
Beat-frequency source	54	—, Double Beam	106, 229
— note harmonics, Identification of	177	—, Principles of	99
<i>Bell Telephone Laboratory</i>	28	—, theory, Books on	99
Benches	19	—, valve testing	264
<i>Black, M. S.</i>	57	<i>Chambers, A. G.</i>	52

INDEX

	PAGE		PAGE
Characteristic curves, Taking	263	Dynatron accessories	198
— Impedance	369	—, Advantages of	49, 91
— —, Measurement of	333	— characteristics by cathode-ray tube	267
Charging switchboard, Battery	36	— measurements	229
<i>Charman, F.</i>	367	— oscillator	47, 57, 191
Chassis construction	15	—, Substitutes for	50
Choke, RF, Measurement of	231	— test example	231
Circuit calculations	356	— unit, Illustrated	195
— diagram at VHF, Misleading	321		
<i>Claude Lyons Ltd.</i>	35, 91	" EARTH ", Importance of	21
Coaxial lines	322, 332, 370	Economy	4
<i>Colebrook, F. M.</i>	179	Eddy currents in coils	145
Colpitts Oscillator	322	Eddystone formers, Coil induc-	
Commutator ripple	21	tances on	198
Comparison in measurement	25, 131, 194	<i>Electric Circuits and Wave Filters</i>	187
Condenser bearing	135	— shocks	214
— calibration, Variable	232, 245	Electromagnetism formulæ	370
—, Laboratory type	137	" Electrone " Tone Generator	41
— leakage, Measurement of	219	Electrostatic meter	72
—, Marconi-Ekco	137	Empirical law	348
—, Matching of ganged	245	Equipment, Choice of	2
—, Multi-range	138	Errors, Eliminating	131, 341
Condensers, Standard fixed	139	Eureka wire	26, 126, 366, 382
—, — variable	133	<i>Everett Edgcombe & Co. Ltd.</i>	68, 264
—, Testing	221	<i>Evershed & Vignoles</i>	80, 218
Conductance, Conversion	301	Extrapolation	344
—, Measuring mutual	269		
Constantan wire	126, 366, 380	FEEDERS	369
Consumption, Measurement of power	304	Ferranti ohmmeter	79
Conversion gain	302	<i>Ferris, W. R.</i>	271, 323
<i>Cosens, C. R.</i>	15, 379	Field of coil, External	145
Cossor Cathode-ray Tube	100	— strength in frame aerial	308
Coupled circuits, Formulæ for	364	Filing cabinets	12, 350
Crocodile clip leads	212	Filters, Efficiency of smoothing	373
Cross modulation	298	<i>Fleming-Williams, B. C.</i>	114
— regulation	303	Focusing, Electrostatic.	102
Crystal oscillators	167	— Magnetic	102
Curves, Plotting	339, 344	Formulæ, Pitfalls in	235
		—, Rearranging	335
DECADE resistance box	126	Frame aerial	307, 369
— switch	131	Frequency abbreviations	355
Decibels	272, 375	— Base	115
Deflecting coils	111	— Bridges	166
— plates	102	— Calibration	171
— —, Cossor split	103	— Changers	301
Design, Data and checking of	2	— Characteristics	278
Detector characteristics, Measure-		—, Classification of	355
ment of	298	— Curves	273, 319
— distortion in BF oscillators	55	—, Plotting	280
Dielectric losses, Measurement of	226	— Distortion	278, 319
Difference method of measure-		— Meter, Electronic	166
ment	132, 241	— Modulation, Electronic	118
Dissipation factor	221, 355	— —, Mechanical	115
Distortion, Frequency	278, 319	—, Standards of	169
—, Harmonic	42, 259, 281	Fundamental and harmonics,	
—, Intermodulation	261, 288	Amplitude of	287
—, Measurement of	285		
—, Non-linearity	259, 284, 297	Fuses, Belling-Lee magnesium	37
—, Phase	260, 284	— in laboratory supply circuits	21
Dummy Aerial	62, 295	GAIN	272
<i>Dutton, T. S.</i>	78	Galvanometer, Vibration	81, 153
<i>Drysdale & Jolley</i>	382	Gang condenser matching	245
Dye's Bridge Method	251	G.E.C. cathode-ray tube	98
Dynamic resistance	192	— neon tube	122

INDEX

	PAGE		PAGE
General Radio Bridge	147	Interpolation	344
— Co.	18, 89, 128	Interpretation of results	342
— Distortion Meter	288	Ionisation in cathode-ray tubes	101
— Ohmmeter	81	<i>JOURNAL of Scientific Instru-</i>	
— Output Power Meter	18, 77	<i>ments, The</i>	379
— Wave Analyser	288	LABORATORY layout	10
Gramophone source	38	— plan	14
Graphs, Use of	339, 344	—, purpose of a	1
Greenwood, W.	288	Ladder attenuator	185
Grid current valve voltmeter	95	Laws, Deduction of	345
Griffiths, W. H. F.	58, 144, 241	Layout, Importance of experi-	
Guarnaschelli	166	mental	213
HAGUE, B.	128, 149	Leakage inductance	257
"Hard" Valve Time bases	112	Lecher wires	179
Harmonic method of frequency		Lighting of laboratory	9
calibration	174	Lissajous figures	171
Harmonics, Analysis of (<i>See also</i>		Litz wire	145
Distortion)	285	Load-resistance characteristic	283
—, Identification of	177	Logarithmic scale for audio source	56
Harmonics, Nomenclature of	356	— scales, Advantages of	274
Harries, J. H. O.	289	Logarithms, Use of	340
Hartley circuit	43, 269, 323	Loss factor, Measurement of	221, 224
Hartshorn, L.	248, 313	Losses, Measurement of	235
Hay, G. A.	50	Loud speaker measurements	260
Heating of laboratory	9	—, Books on	262
Herold, E. W.	51	Low frequency (<i>See AF</i>)	
Heterodyne voltage measurement	301	L.T. Equipment	35
High frequency. (<i>See RF</i>)		Luxembourg Effect	3
Hill, F. L.	118	Lyons-Hickok Modulated Oscil-	
Hogg, F. L.	78	lator	65
Home-made apparatus	5	McLACHLAN, N. W.	262
Hook-up, The quick	13	"Magic Eye" indicator	122, 153, 205
Horgan, M. O'C.	316	Mains-driven bridge, Diagram of	163
H.T. Accumulators	35	— frequency bridge	162
Hughes, L. E. C.	262	— power	34
Hum, Measurement of	291	Maintenance of equipment	2
—, Modulation	291, 298	Manganin wire	126, 380
Hunt's Signal Generator	65	Marconi-Ekco Distortion Meter	288
Hutcheson, J.	285	— Signal Generator	64
<i>I.E.E. Journal</i>	118, 179, 302, 329	— Universal Bridge	164, 211
Image-ratio Curve	310	Matching feeders	370
Impedance, Characteristic	333, 369	Materials, Loss factor of	226
— of loaded lines	370	Maxwell bridge	159, 253
— of speaker	260	Mazda dynatron valve	192
— Measurement	222, 229, 246	Measurements, Acoustic	262
— of aeriels	271	—, Importance of	23
— at VHF	28	<i>Measurements in Radio Engineering</i>	
Impedances, Calculation of		149, 187
Indicators, Miscellaneous elec-		Megaw, E. C. S.	328
tronic	122	"Megger"	80, 218
Indirect measurement	25	Megohmmeter	219
Inductance at VHF	322	Metal rectifier meter	72, 76, 208, 277
— Calculation Curves	367	Metals, ZF resistances of	366
— Leakage	257	Meters, Choice of	67
— Measurement, AF	249, 254	Method of measurement, Choosing	25
—, RF	239, 249	"Miller Effect"	84, 118, 154, 271
—, Standards of	140	Miller, W. E.	99
Inductances, Standard fixed	143, 199	Milliammeters	70
Inductometer bridge	155, 210, 249	Modulation	63
—, Making an	142	— by AAC	46
Inductometers	140	— hum, AF	291
Instruments, List of recommended	180	—, RF	298
—, Pointer	67	Moss, Hulory	171
Intermodulation	261, 288		

INDEX

	PAGE		PAGE
Motor-boating due to AAC	45	Permittivity	226, 353
Moving coil meters	70	" Personal Equation "	27, 341
— iron meters	70, 72	Phase angle, Measurement of	110, 228, 260
<i>Muirhead & Co.</i>	128, 136	— distortion	260, 284
Mullard cathode-ray tube	98	Phones	123
— dynatron valve	102	Photo-electric cell	122
— Self-bias valve voltmeter	80	— tone source	41
Multi-range Meters	68	Photographing oscillograms	121
— variable condensers	138	Piano as frequency standard	174
Multivibrator	174	Pick-up, Suitable type of	40
Mumetal shield	109	<i>Piggott, L. S.</i>	329
Mutual conductance	262, 269	Platform frame	16
— inductance measurements	253	" Plymax " metal-coated plywood	15
— standards	140	Potential divider	182
<i>NATIONAL Physical Laboratory</i>	125, 171, 377	Power consumed by apparatus, Measurement of	304
— Union 3-5 portable oscillograph	110	— factor	75, 355
N-Curve	178	— Meters, Output	76, 208
Negative bias voltage, Ascertaining	30	— points, Layout of	30
— feed-back	56, 202, 373	— ratio and decibels	275, 375
— resistance	47, 102	— sources	33
— resistance bridge	200, 236	— unit output	303
Neon tube indicator	122, 221	Premises, Effect on work of	7
Noise	311	Precautions, Safety	214
Non-reactive winding	127	<i>Proctor, R. F.</i>	316
N.P.L. Standard AF	174, 377	<i>Puckle, O. S.</i>	112, 118
Null method, Wheatstone bridge	147	Pull-in, Avoidance of	55
OBSERVATION, System in	3	Push-pull output for time bases	114
Ohmmeters	78	" Q "	238, 295, 362
<i>Olson & Massa.</i>	262	Q-meters	248
Oscillator, Calibration of AF	171	QAVC characteristics	316
—, — RF	174	Quarter-wave transformer	370
— circuit, Dynatron	195	Quartz insulation	137
— crystal controlled	167	<i>RADIO Amateurs' Handbook</i>	328
—, Dynatron	47, 58, 191, 229	<i>Radio Data Charts</i>	338
—, General requirements of	41	<i>Radio Engineering</i>	118
—, 80cm.	326	" Radiolab All-Purpose Tester "	68
—, " Open "	59	" Radiolab Valve Tester "	264, 302
—, Radio frequency	59	— Workshop Testing Set "	189
—, Reaction type	43	<i>Radio Research Board</i>	3
—, Resistance-Capacitance	52	Range shunts and multipliers	74
—, Standard frequency	167	Ratio arms	150
—, Transitron	50	Reactance, Measurement of	233
—, VHF, Design of	323	Reaction in receivers, Variable	300
Oscillators, Valve	41	Receiver testing	304
Oscillograms, Photography of	121	Records, Keeping	348
Oscillograph, Cathode-ray. (See also Cathode-ray Tube)	109	—, Standard-frequency	39
Oscilloscope, Cossor portable	120	Rectifier automatic shunt	73
—, National Union	119	—, Westinghouse	73
Osram voltmeter valves	80	<i>Reed, M.</i>	250
Output circuits of AF sources	57	Regulation Curves	301
— Measurements	208, 281, 305	<i>Reid, D. G.</i>	118
— of Power Units	303	Research	1
— Measuring adaptor	209	Residuals	151
— Power Meters	76	Resistance boxes	126
Overload curves of receivers	318	—, Measurement of RF	234, 246
— point of amplifiers, Determination of	281	— measuring apparatus	78
Owen bridge	159, 253, 397	— stabilisation	42
<i>Owen, David</i>	149	— standards	126
<i>PARR, G.</i>	90	Resistance-Capacitance oscillators	52
<i>Patchett, G. N.</i>	229	Resistors, Measurements on	216
		Resonance curves	296, 314, 362
		Resonances of loud speakers	261

INDEX

	PAGE		PAGE
Response curve by cathode-ray	314	Storage of apparatus	12
<i>Reyner, J. H.</i>	99, 118	<i>Stratton & Co. Ltd.</i>	16, 199
RF amplifier, Measurements on	293	Stroboscope	40
— choke, Measurement of	231	<i>Strutt, M. J. O.</i>	271, 323, 331, 345
— resistance by resonance curve	247	Subjective methods	29
— — — comparison	234	Sullivan capacitance bridge	162
— — — dynatron	235	— coils	144, 199
— — — resistance-variation	246	<i>Sullivan, H. W. Ltd.</i>	134, 167
— — — at VHF	331	Sullivan-Ryall BF Oscillator	58
<i>Rider, John F.</i>	99	Superheterodyne, Spurious responses in	311
Risks, Personal	214	Surge impedance (Characteristic impedance)	369
R.M.A. receiver test specification	306	Switchboards	35
R.M.S. values	87, 95, 356	Switches for instruments	130
Roof loft as laboratory	11	Symbols	351
<i>SALFORD Electrical Instruments</i>	89	—, Circuit	353
Saw-tooth wave, Production of	113	Synchronising circuits	174, 178
Scales, Relationship of musical and frequency	174, 376	TABULAR working	341
—, Plotting frequency	274	Telephone rack	17
Schering Bridge	225	<i>Terman, F. E.</i>	149, 187
Screened oscillators	59	<i>Theory and Design of Valve Oscillators</i>	42
Screening of field-strength coils	308	Thermal meters	62, 72, 215, 329
— — — laboratory	0	Thermionic voltmeter. (See Valve Voltmeter)	
— — — Reduction in inductance due to	368	Thermo-electric currents	130, 382
Selectivity, Calculation of	363	<i>Thomas, H. A.</i>	42
—, Measurement of	206, 312	Time base circuits, Linear	112
Self-capacitance of AF coils, Measurement of	258	—, Polar	114
— — — RF coils, Measurement of	242	—, Sinusoidal	110
Sensitivity curves	310	— constant	369
—, Measurement of	308	<i>Time Bases</i>	113, 114
Shoddy wiring, Danger of	20	Toroidal winding	145
Shunt method for large capacitances	252	Transformer formulæ	371
— — — inductances	251	—, IF, Dynamic resistance of	237
Shunts, Automatic	73	Transformers, AF, Inductance of	251
—, Range-changing	74	—, Leakage Inductance	257
Signal and deflection figure relationship	110	—, Linearity	259
— generators, Standard	60	—, self-capacitance	258
"Signals", Meaning of	33	—, Shorted turns	257
Sine wave AC values	356	Transit-time effect	271, 322
Skin effect	131, 366	Transitron	50
Slide-back valve voltmeter	92	Transmission lines	332, 369
— — — Construction of	203	Trapezium distortion	103
Slide rule, Circular	330	Trolley mounting	18
Slow-motion dial	137	Tuned circuits, Formulæ and graphs of	361
Small parts, Storage of	12	Tuning indicator	122
Soldering iron stand	20	<i>Tyers, P. D.</i>	269
<i>Sound Sales Ltd.</i>	195, 209	"UNIPIVOT" Galvanometer	69, 71
Sources, AF	38, 54	VALVE amplification factor	262, 267
—, —, Distortion in	55	— Bridges	267
— for AC Bridges	152	—, Circuit losses due to	270, 372
—, Mains	34	— "Constants"	262
—, RF	59	— inter-electrode capacitances	243
<i>Souerby, J. M.</i>	338	— Formulæ	372
Specialised equipment	5, 211	— Voltmeters, Anode bend	87
"Squegging"	324	— — Auto-bias	89
Stability, Frequency	57	— — Calibration of	96
Standard-frequency oscillators	167	— — Commercial	89
— records	39	— — Construction of	203
Standard signal generators	60	— —, Diode	328
— test frequencies	171, 310	— — Errors in	96
<i>Starr, A. T.</i>	187		

INDEX

	PAGE		PAGE
Valve, voltmeters, General	82	Wavelength standards	179
— — Grid current	95	Wavemeters	59, 167
— — Slide-back	92, 203	—, Absorption	168
— — Square law	84	—, for VHF	179, 327
— — VHF	88, 328	W'eeden, W. N.	280
"Variac" Transformer, General		"Wee-Megger-Tester"	80
Radio	34	Weighted network for hum	
Vecchiacchi	166	measurement	202
Vertical layout	13	Westinghouse Brake & Signal Co.	74
VHF (Very High-Frequency).		Weston Electrical Instrument Co.	89
Measurements of	88, 179, 321	Wheatstone Bridge	146
Vibration galvanometers	81	Wien Bridge	166
Voltmeters, Electrostatic	72, 303	Williams, F. P.	52
—, Metal rectifier	72, 208	Wilmotte, R. M.	179
—, Moving coil	70	Wire tables	379
—, Valve or thermionic. (See)		Wiring, AC	20
Valve Voltmeters)		"Wobbulator"	118
"WAGNER" Earth	155	Workbench	19
Watson-Watt, R. A.	99	Working conditions, Reproducing	
Wattmeter	75	X-SHIFT	110
—, Substitute for	304	Y-SHIFT	110
Waveform. (See Harmonics, Dis-)		"ZERO beat note"	176
tortion, etc.)		ZF resistances of metals	366

The quality of
Walter Switches and Walter
Condensers is not to be judged by
looking at the price. The low cost is due
to high-speed modern equipment and
labour-saving plant. The high quality is
the result of fine design and immense care
in manufacture and test. + + + +



WALTER
INSTRUMENTS LTD.

GARTH ROAD, LOWER MORDEN,
SURREY. Telephone: DERWENT 4421-2-3

C.R.C.11.

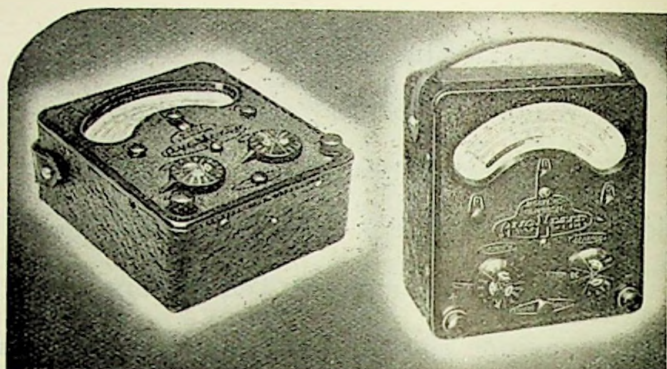

50-range Model 7
Universal Avometer

40-range Model 40
Universal Avometer

The UNIVERSAL AVOMETER

THE Model 7 Universal Avometer is a multi-range A.C. D.C. Measuring Instrument of B.S. 1st grade accuracy, providing 50 ranges of readings on a 5" hand calibrated scale. Range selection is by means of two rotary switches, for A.C. and D.C. respectively. A press button provides an additional range for each value of current and voltage shown on the switch knobs.

Current consumption is 1mA. or 2mA. at full scale deflection according to whether the press button is used or not. The total resistance of the Meter is 500,000 ohms. The meter is protected by an automatic cut-out against damage through severe overload, and compensation is provided for variations in ambient temperature.

Current		Voltage		Resistance	Capacity	
1mA D.C. only		50mV D.C. only			10,000 ohms	0.01—20 mfd.
2 " " "		100 " " "		100,000 "	Impedances of P. & dB. ranges	
5 " A.C. & D.C.		500 " " "		1 Megohm		
10 " " "		IV " " "		(Using Internal Batteries)	500 ohms	
50 " " "		5 " A.C. & D.C.			5,000 "	
100 " " "		10 " " "			50,000 "	
500 " " "		50 " " "		10 Megohms		
1A " " "		100 " " "		40 "	Power 200mW 2W 200mW	Decibel 0 = 50mW - 25 to + 6 - 15 to + 16 - 25 to + 6
5 " " "		200 " " "		(Using A.C. or D.C. Mains)		
10 " " "		400 " " "				
		500 " " "				
		1000 " " "				

Various accessories are available for extending the above ranges. Also available, the 40-range Universal Avometer (without Power and Decibel ranges).

'AVO'

Registered Trade Mark

Precision ELECTRICAL TESTING INSTRUMENTS

The "AVO" ALL-WAVE OSCILLATOR

An inexpensive, accurate modulated oscillator covering a continuous fundamental frequency band from 95 Kc. to 40 Mc. by means of 6 separate coils mounted on a rotary turret selector. A harmonic calibration extends the range to 80 Mc. A large, clearly marked dial is directly calibrated throughout, accuracy being within 1%. Externally modulated, internally modulated, or R.F. signals obtainable at will. Internal modulation 30% at 400 c/s, the L.F. signal being available for external use. Calibrated double attenuator enables signal to be varied from a few microvolts to 50 millivolts, with a force output of 1 v. Self-contained, fully shielded. Shielded output lead and interchangeable dummy aerials. A.C. Mains and Battery Models.



The "AVO" TEST BRIDGE

A portable self-contained 50-cycles bridge of exceptional accuracy and utility for direct measurement of all normal values of condensers and resistances. Except at the extreme ends of the scale, accuracy is within 5%.

CAPACITY
:000005—:005 mFd.
:0005 —:5 mFd.
:05 —50 mFd.

RESISTANCE
5—5,000 ohms
500—500,000 ohms
50,000 ohms to
50 Megohms.

Facilities also provided for condenser power factor measurements and leakage tests by the flashing neon method; resistance, capacity and large inductance measurements against external standards. May also be used as a highly efficient valve voltmeter indicator for measurement of both audio and radio frequency voltages.

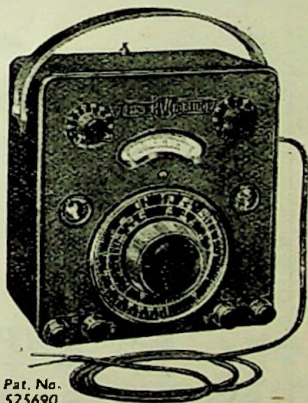

Pat. No.
525690

Sole Proprietors and Manufacturers :

THE AUTOMATIC COIL WINDER & ELECTRICAL EQUIPMENT CO. LTD.
Winder House, Douglas Street, London, S.W.1.

Telephone : VICTORIA 3404-8

"Cyldon" Variable Capacitors

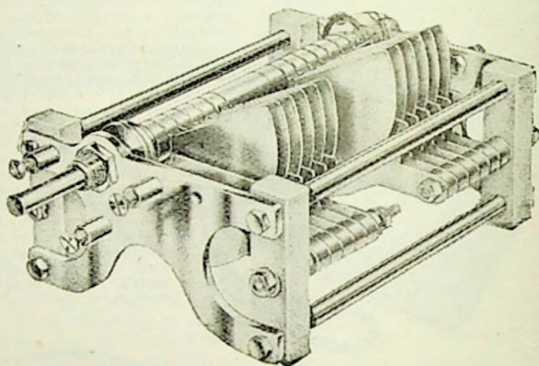

TYPE SSTR. SQUARE LAW. TRANSMITTING

One of the Cyldon range
From
Miniature Air Trimmers
to
High Voltage Transmitting
CAPACITORS

SYDNEY S. BIRD & SONS LTD.

CAMBRIDGE ARTERIAL ROAD, ENFIELD, MIDDX.

Telephone : Enfield 2071.

Telegrams : "Capacity, Enfield"



Silvered Mica & Ceramic
CAPACITORS

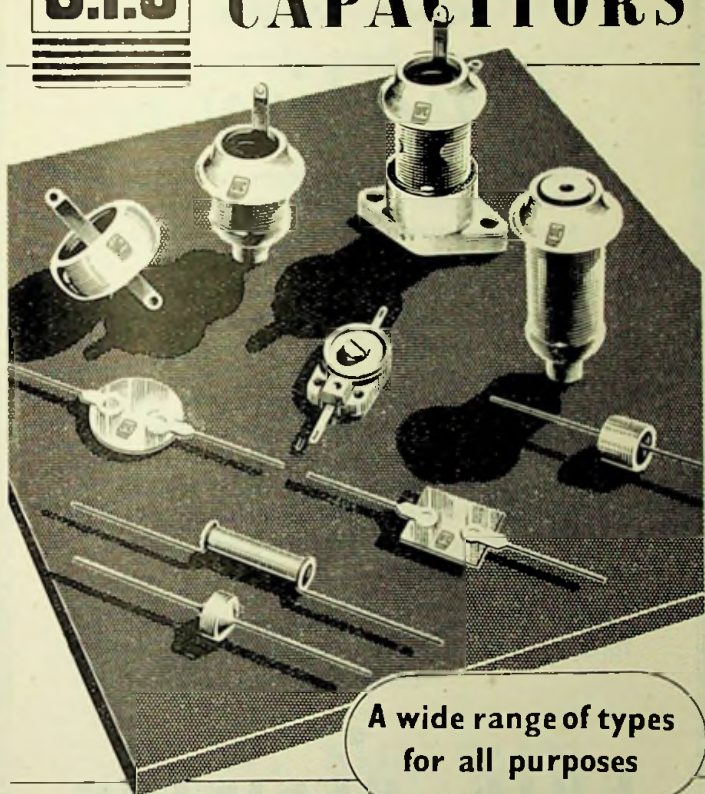

A wide range of types
for all purposes

UNITED INSULATOR CO. LTD.

Oakcroft Road, Tolworth, Surbiton, Surrey

Telephone : Elmbridge 5241 (6 lines)

Telegrams : " Calanel, Surbiton "

Unsurpassed In Ceramics

IT ALL SUMS UP TO
ONE WORD

Quality!

Nothing has been skimped in the manufacture of Erie high-grade resistance products. Only the finest raw materials that are so essential for efficient operation are used. Even in the face of rising production costs cheap substitutes that are "almost as good" do not find their way into Erie products.

That is why their performance has been steadily improved through the years. That is why today they give unparalleled all-round balanced performance. That is why you will find them used by those manufacturers who recognise the advantages of using only quality component parts.

CARBON RESISTORS
TONE CONTROLS

WIREWOUND RESISTORS
VOLUME CONTROLS

SUPPRESSORS

**ERIE RESISTOR
LIMITED**

Carlisle Rd., The Hyde, Hendon, N.W.9

Telephone : Colindale 8011

Electrical Standards for Research and Industry

Testing and Measuring Apparatus
for Communication Engineering

ALL TYPES

ALL
FREQUENCIES

ALL
ACCURACIES

WAVEMETERS

OSCILLATORS

CONDENSERS

INDUCTANCES

RESISTANCES

BRIDGES Capacitance
 Inductance
 Resistance

H. W. SULLIVAN

— LIMITED —

LONDON, S.E.15

Telephone : New Cross 3225 (Private Branch Exchange)

The design and making of Radio metal parts—chassis, screens, brackets, escutcheons, etc.—has many *pit-falls* for the unwary.

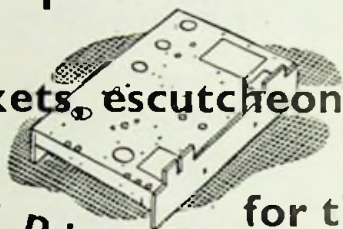

It is our special pride that leading radio engineers constantly use us in the solving of these and similar problems

Walter
J E H
CHASSIS STAMPINGS PRESSINGS
RADIO

PARM LANE, FULHAM, S.W.6. TELEPHONE. FULHAM 5234
C.R.C.10

POINTERS FOR DESIGNERS



CATHODE RAY TUBES

The G.E.C. range of electrostatic industrial cathode ray tubes includes four screen sizes down to $1\frac{1}{2}$ " diameter. Widely used in measuring and similar instruments, their outstanding features include:—

- Brilliant screen traces and undistorted frequency response over a wide range.
- Screens for photographic recording or for producing sustained images, when specially ordered.

Other types of tubes, including those suitable for television receivers with black and white screens will shortly be available.

Detailed technical data sheets are available on request.

Osram
PHOTO CELLS

G.E.C.
CATHODE RAY TUBES

Osram
VALVES

Advt. of The General Electric Co. Ltd., Magnet House, Kingsway, London, W.C.2.



PRODUCTS for the RADIO ENGINEER

CABLES

An extensive range of TELCON high-frequency cables is available to meet all requirements. In many of these **Telcothene** insulation is used. This material is the latest development in thermoplastic insulants. It has a dielectric constant of 2.3 and a power factor of not exceeding 0.0005, is chemically inert, unaffected by sunlight, and highly resistant to moisture and dilute acids and alkalis.

METALS

TELCON metals include the high permeability, low loss alloys **Mumetal**, **Rhometal**, **Radiometal** and 2129 Alloy for transformers, chokes and shields. High Resistance metals comprise the nickel-chromium alloys **Pyromic** and **Calomic**, the low temperature-coefficient copper-manganese alloy **Telcuman**, and the nickel-copper alloy **Telconstan**. Beryllium-Copper (CuBe 250) Age Hardening Alloys and **Telcoseal** Glass Sealing Alloys are also produced.

Full details furnished on request

THE TELEGRAPH] CONSTRUCTION & MAINTENANCE CO. LTD.

Founded 1864

Head Office :

22 OLD BROAD ST., LONDON, E.C.2.

Tel. : London Wall 3141

Enquiries to :

TELCON WORKS, GREENWICH, S.E.10.

Tel. : Greenwich 1040

1 2 3 inches

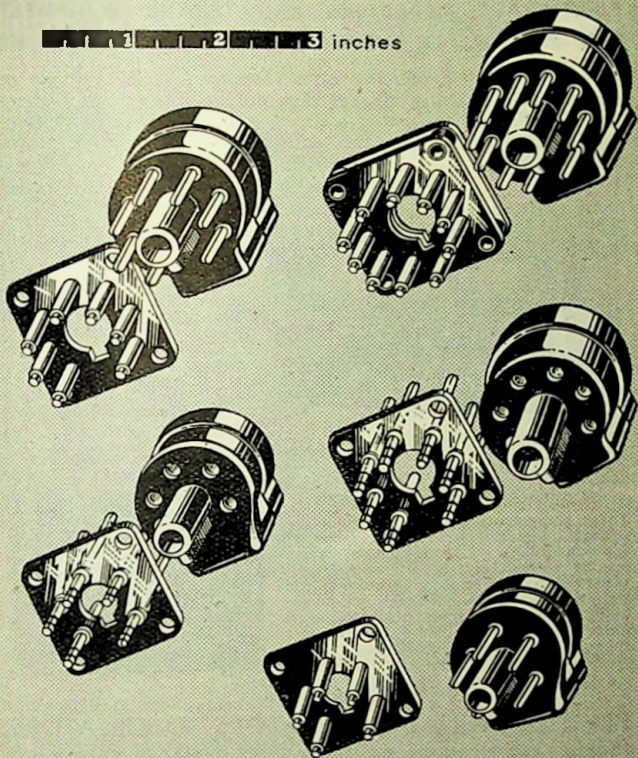

BELLING & LEE LTD
CAMBRIDGE ARTERIAL ROAD, ENFIELD, MIDDX

LABORATORY INSTRUMENTS

FIRST-GRADE MEASURING AND TESTING EQUIPMENT FOR PHYSICAL AND COMMUNICATIONS LABORATORIES

This Company is producing, on a restricted scale, a range of specialised Measuring and Test Equipment of the very highest quality. Special apparatus is also manufactured to customers' specifications. If you are equipping a Laboratory please consult us.

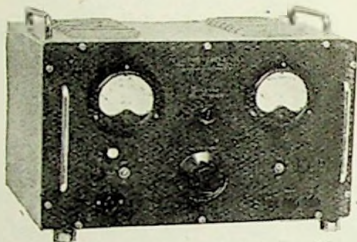

CONSTANT-VOLTAGE POWER SUPPLIES

A range of standard models is available, of various output voltages and current ratings. The output voltage is substantially independent of Mains voltage or load current, within the specified limits. Illustrated is the Model 101-A, which provides an output voltage from 250 to 400 volts at up to 250 mA, with a Stabilisation Ratio greater than 100 and an Internal Resistance less than 1 ohm.

HIGH-VOLTAGE TEST SETS

These equipments are designed for high-voltage insulation tests on all types of components, including capacitors. Tests may be made either with DC or AC. All models include a large scale Electrostatic Voltmeter which is also available, independently, for the measurement of high voltages. Illustrated is the Model 301-A, which covers the range from 1,000 to 5,000 volts.



BRIDGES, SIGNAL GENERATORS, OSCILLATORS,
OSCILLOSCOPES. REGULATED POWER SUPPLIES.
PRECISION WOUND TRANSFORMERS & CHOKES

PRECISION, QUALITY AND RELIABILITY

ALL-POWER TRANSFORMERS L^{TD}.

WIMBLEDON, S.W.19

Telephone : LIBerty 3303

COSSOR

Electronic INSTRUMENTS

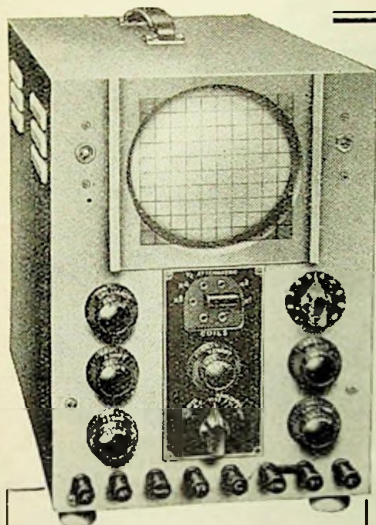

A Cossor Radio Service Instrument designed for use with the Oscilloscope for visual testing:—

GANGING OSCILLATOR
Model 343.

A Frequency Modulated Signal Generator for visual aligning and testing Radio Receivers.

High Vacuum Double Beam OSCILLOGRAPH Model 339

This unique Cossor Oscilloscope is, irrespective of price, the most comprehensive instrument of its type so far produced. In addition to the Double Beam Tube (4½ in. diam.) it uses the original Cossor Hard Valve Time Base, the frequency range of which extends to 250,000 c.p.s. Two amplifier valves operate independently on each Y plate, or in cascade with either a high gain (900) or a wide bandwidth (2,500,000 c.p.s.).

Instruction Manuals are supplied with each instrument and copies are available at 3/6 each net, postage 3d.

A. C. COSSOR LTD.
LONDON, N.5

VORTEXION

"SUPER FIFTY WATT"

AMPLIFIER



This **AMPLIFIER** has a response of 30 cps. to 15,000 cps., within $\frac{1}{2}$ db., under 2 per cent. distortion at 40 watts and 1 per cent. at 15 watts, including noise and distortion of pre-amplifier and microphone transformer. Electronic mixing for microphone and gramophone of either high or low impedance with top and bass controls. Output for 15/250 ohms with generous voice coil feedback to minimise speaker distortion. New style easy access steel case gives recessed controls, making transport safe and easy. Exceedingly well ventilated for long life.

Amplifier complete in steel case, with built-in 15 ohm mu-metal shielded microphone transformer, tropical finish price 29½ Gns.

C-P.20A 15-WATT AMPLIFIER for 12 volt Battery and A.C. Mains operation. This improved version of the old C.P.20 has switch change-over from A.C. to D.C. and "stand by" positions and only consumes 5½ amperes from 12 volt battery.

Fitted mu-metal shielded microphone transformer for 15 ohm microphone, and provision for crystal or moving iron pick-up with tone control for bass and top and outputs for 7.5 and 15 ohms. Complete in steel case with valves £22 10 0

VORTEXION LTD.

257-261 THE BROADWAY, WIMBLEDON, LONDON, S.W.19

Telephone : LIBerty 2814 & 6128. Telegrams : "VORTEXION, WIMBLE., LONDON"

NEW OSCILLOGRAPH

Usable up to 5 Mc/s

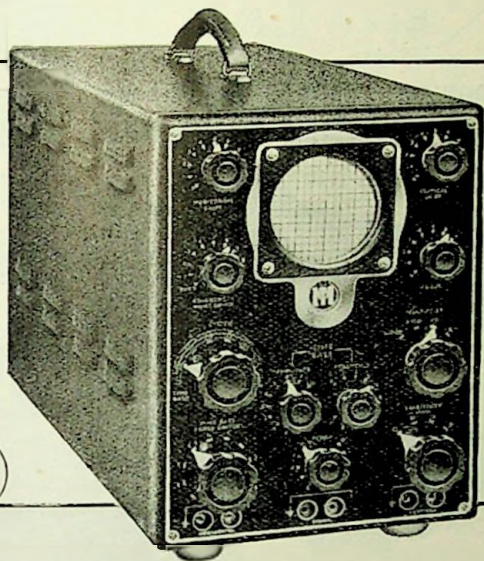

PRICE
£75



The Mullard High Frequency Cathode Ray Oscilloscope type E.805 sets a new standard for portable instruments, and embodies many features previously found only in instruments twice its size and price. Special features include: High impedance Input Circuit. High gain, wide band Vertical Amplifier (Sensitivity 5 mV/cm, frequency range 2 c/s - 5 Mc/s). Electronically stabilised power supply. Write for leaflet M.503 to:—THE MULLARD WIRELESS SERVICE CO. LTD., Measuring Apparatus Section, Century House, Shaftesbury Avenue, W.C.2.

Mullard

MEASURING
APPARATUS

(134H)

IF this handbook has given you
W R I T E **FOOD for THOUGHT**
further *UNRATED* assistance
is offered by your contacting

LABGEAR -

for

ELECTRONIC LABORATORY EQUIPMENT
RECEIVING & TRANSMITTING COMPONENTS

ELECTRONIC VIEWING UNIT

B:RLH,2014

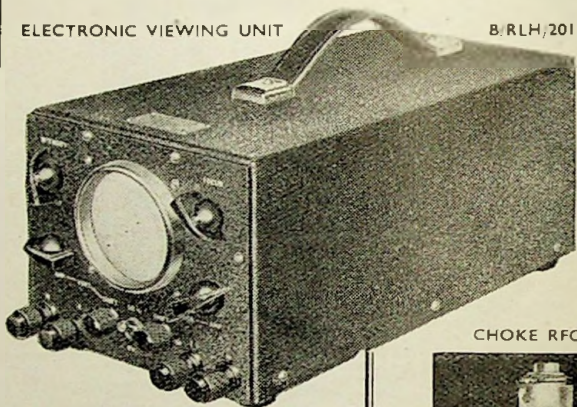

NO

CHOKE RFC1/RLH

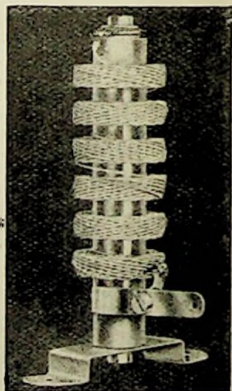

No matter whether your
present or future needs are for
single instruments of this nature
or quantity production of small
components similar to this

Submit your requirements or write for lists to :

Labgear WILLOW PLACE,
CAMBRIDGE, ENG.

Phone : Cambridge 2494 (2 lines)

MANUFACTURERS OF HIGH-CLASS
TEST EQUIPMENT

TAYLOR UNIVERSAL METER 1,000 OHMS PER VOLT

MODEL
90A

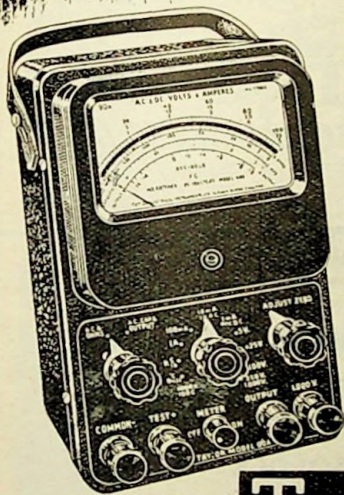

1. 40 Ranges.
2. 1,000 Ohms per Volt.
3. First Grade Accuracy.
4. Four-inch meter scale.
5. Mirror and Knife-edge pointer.
6. Buzzer for Continuity Tests.
7. Automatic overload protection.
8. Self-contained Resistance measurements from 1 Ohm up to 1 Megohm.
9. Three Self-contained Capacity ranges with external A.C. supply.

Price £15 : 15 : 0

Taylor
electrical instruments

TAYLOR ELECTRICAL INSTRUMENTS LTD.,
419-424 MONTROSE AV., SLOUGH, BUCKS. TEL.: SLOUGH 21381 (4 lines)
GRAMS: "TAYLINS, SLOUGH"



PARTRIDGE TRANSFORMERS

FOR LABORATORY USE & EXPERIMENTAL WORK

Specially wound to customers' requirements
Prompt Delivery - - Economical Prices

AS SUPPLIED TO

National Physical Laboratory, British
Electrical and Allied Industries Research
Association, Medical Research Council,
Radium Beam Therapy Research, etc., etc.

and

THE AUTHOR OF "The Radio Laboratory Handbook"

Telephone:



Abbey 2244

PARTRIDGE TRANSFORMERS LTD

76-8, PETTY FRANCE, LONDON, S.W. 1

MELTON METALLURGICAL LABORATORIES LTD

Liquid Silver, Platinum and Gold

for metallising CERAMIC,
MICA, QUARTZ or GLASS

Low Melting-point **SOLDER** from 70°C.

Non-corrosive liquid **FLUX** for all electrical
purposes. A.I.D. Approved.

Agents for Australia :

A. S. HARRISON & CO. PTY. LTD.
85 CLARENCE STREET, SYDNEY

**IPSWICH RD., TRADING ESTATE
SLOUGH, BUCKS. Phone: SLOUGH 20992**

RADIO CAREERS

AN IMPORTANT GUIDE



This modern guide indicates clearly how all engaged in the Wireless industry can equip themselves for safe and highly-paid posts despite the keener competition which will come with a return to peacetime conditions.

"ENGINEERING OPPORTUNITIES" contains 112 pages of highly useful information. It gives full details of our very comprehensive series of modern WIRELESS COURSES, including General Wireless Engineering, Advanced Wireless and High Frequency Engineering, Short Wave Wireless, Talking Picture Engineering, Television, Radio Servicing, Mathematics, Acoustics, Electrotechnics, etc., etc.

TELEVISION

Radio Engineers who are thinking ahead are giving close consideration to the study of Television. There is no doubt about it that there will shortly be an enormous boom in Television, and the man who is equipped with the most up-to-date knowledge of Television practice and principles will find himself in a position to skim the cream of this new market. Our Television course covers all stages of the subject thoroughly, both from the technical and purely practical aspects. It is fully described in our handbook.

"ENGINEERING OPPORTUNITIES" also explains the most efficient way of preparing candidates for such recognised Examinations as B.Sc., A.M.I.E.E., A.M.Brit.I.R.E., City and Guilds, etc.

**WE DEFINITELY GUARANTEE
"NO PASS—NO FEE"**

The Wireless industry is alive with possibilities. In your own interests you should write for your copy of "ENGINEERING OPPORTUNITIES" without delay—FREE of cost or obligation. The book is bound to indicate many opportunities which otherwise you might miss.

BRITISH INSTITUTE OF ENGINEERING TECHNOLOGY

51 SHAKESPEARE HOUSE, 17-19 STRATFORD PLACE, LONDON, W.1

THE B.I.E.T. IS THE LEADING INSTITUTE OF ITS KIND IN THE WORLD

*The choice of
every good
Radio
Engineer*



SPEAKERS & COMPONENTS

Limited supplies
are
again available

TRANSFORMERS . STENTORIAN
SPEAKERS . FACTORY SPEAKERS
VALVE HOLDERS . SWITCHES
CHOKES

WHITELEY ELECTRICAL RADIO CO. LTD., MANSFIELD, NOTTS

Q5/100

A NEW 100 kcs. Quartz
Crystal Unit for Secondary
Frequency Standards, with 5
star features.

- * Accuracy better than 0.01%.
- * New angles of cut give a temperature coefficient of 2 parts in a million per degree Centigrade temperature change.
- * Vitreous silver electrodes fired direct on to the faces of the crystal itself, give permanence of calibration.
- * Simple single valve circuit gives strong harmonics at 100 kcs intervals over the range 100 kcs. to 20,000 kcs.
- * Octal based mount of compact dimensions. Full details of the Q5/100, including circuit, are contained in our leaflet Q1. Send stamp to-day for your copy.

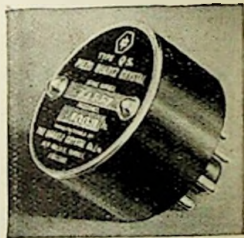

Q5/100 Price 45/-

THE QUARTZ CRYSTAL CO. LTD.
63-71 KINGSTON ROAD, NEW MALDEN, SURREY

Phone: Malden 0334

THE ANSWER TO *Resistor Muddle*

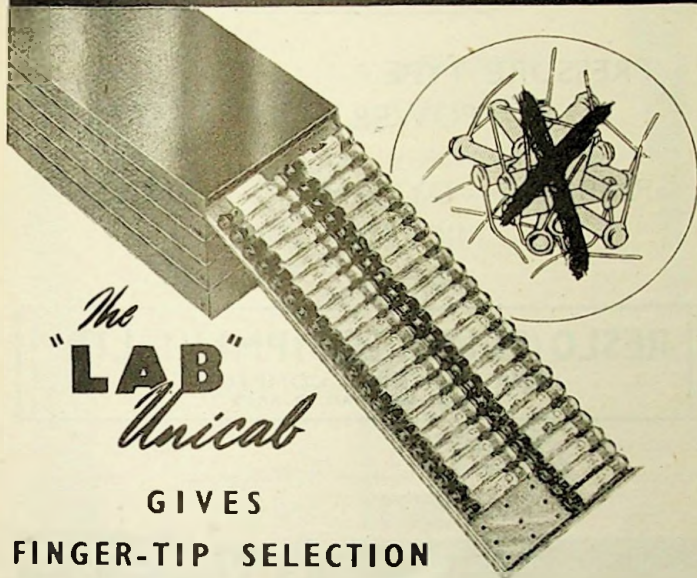

The
"LAB"
Unicab

GIVES FINGER-TIP SELECTION

No more groping about for that elusive Resistor (why is it that just the value you want is always missing?) when you install the 'LAB' unicab and give yourself finger-tip selection. 48 popular values in 1-watt or $\frac{1}{2}$ -watt 'LAB' Resistors are contained in a slider drawer case, 10" x 3", finished in Olive Green, with each Resistor firmly held yet easily withdrawn or replaced, and each value identified at a glance. Have done with that persistent Resistor Muddle get 'LAB' Unicabs to-day. Drawers are pierced to accommodate both $\frac{1}{2}$ and 1 watt resistors

PRICES

Single Unit complete with 48 one-watt resistors 48s. RETAIL

Single Unit complete with 48 half-watt resistors 24s. RETAIL

Prices subject to the usual Trade Discounts

RADIO RESISTOR COMPANY LIMITED
CUMBERLAND ROAD, STANMORE, MIDDLESEX
TELEPHONE : WORDSWORTH 1138

RESLO

PRESSURE TYPE

POWER LOUDSPEAKERS

RIBBON — DYNAMIC — CARBON
MICROPHONES

RESLO (SOUND EQUIPMENT) LTD.

THE POTTERIES, COMPTON
Nr. GUILDFORD, SURREY

ADVANCE B.3.

*a
Signal
Generator
of
unusual
design*

RANGE : 100 Kc. to 30 mc/s.

R.F. OUTPUT : $1\mu\text{V.}$ to 100 mV.

Full details sent upon application.

ADVANCE COMPONENTS LTD.

BACK RD. SHERNHALL ST. LONDON E.17. Tel: LARKSWOOD 4366 7

- *Continuously Variable Potentiometers*
- *Miniature Wire Wound Resistors*
- *Vitreous Wire Wound Resistors*
- *Tubular Wire Resistors*
- *Preset Resistors*
- *Instrument Stud Switches*
- *Stud Potentiometers*
- *Variable Attenuators*
- *Fixed Attenuators*
- *Plugs and Sockets*
- *Faders*
- *Knobs Etc.*

Products from the House

Telephone:
Northampton 2820

Telegrams:
"Ceil Northampton"



PAINTON & COMPANY LIMITED
KINGSTHORPE NORTHAMPTON



RADIO HANDBOOKS

Issued in conjunction with
Wireless World

FOUNDATIONS OF WIRELESS

By M. G. Scroggie, B.Sc., A.M.I.E.E.

(Fourth Edition)

Price 7/6 net. By post 7/10

WIRELESS SERVICING MANUAL

By W.T. Cocking, M.I.E.E., Editor of "Wireless Engineer"

(Seventh Edition)

Price 10/6 net. By post 10/10

BASIC MATHEMATICS FOR RADIO STUDENTS

By F. M. Colebrook, B.Sc., D.I.C., A.C.G.I.

Price 10/6 net. By post 10/11

TELEVISION RECEIVING EQUIPMENT

By W.T. Cocking, M.I.E.E., Editor of "Wireless Engineer"

Price 10/6 net. By post 10/10

RADIO DATA CHARTS

By R. T. Beatty, M.A., B.E., D.Sc. Revised by J. McG. Sowerby, B.A., Grad.I.E.E.

(Fourth Edition)

Price 7/6 net. By post 7/10

RADIO DESIGNER'S HANDBOOK

Edited by F. Langford Smith, B.Sc., B.E.

(Fifth Impression)

Price 10/6 net. By post 11/1

Another recommended book

RADIO CIRCUITS : STEP BY STEP SURVEY OF SUPER-HET RECEIVERS

By W. E. Miller, M.A. (Cantab.), M.Brit.I.R.E., Editor of "The Wireless and Electrical Trader"

(Second Edition, Sixth Impression)

Price 3/6 net. By post 3/9



Full particulars of any of the above books
will be sent on application to the publishers:

ILIFFE & SONS LTD.

Dorset House, Stamford Street, London, S.E.1

BRITAIN'S FOREMOST JOURNAL ON RADIO, TELEVISION and ELECTRONICS

"Wireless World" is recognised throughout the radio, television and electronics industry as the foremost publication for manufacturers, designers and service engineers, and it is also studied by all the keenest experimenters. Every new theory and development is discussed and analysed by leading experts, and much data is provided on the latest designs and circuits. Whether your interest is in radio, television or electronics, "Wireless World" will keep you accurately informed on the latest developments from all over the world.

*Published
Monthly
(26th preceding
month)
Price 1/6*



One of the 29 Associated Iliffe Publications

blitheek Ne