

Flame, smoke and gas detectors

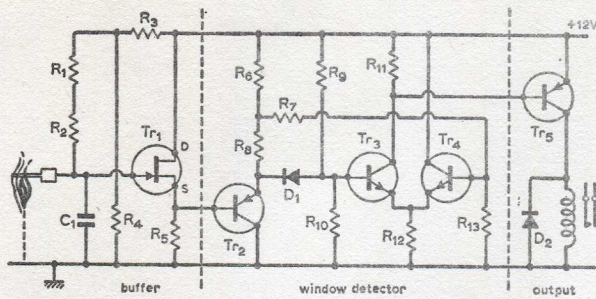

Flame detector

A flame offers a low conductance path to ground. In series with R_1 , R_2 , that conductance defines a range of potentials on the gate of Tr_1 , that leaves the emitter of Tr_2 at a high enough potential to keep D_1 out of conduction, but not so high as to bring Tr_4 into conduction via R_7 . Hence Tr_3 , Tr_5 conduct holding on the relay—interlocked with the supply for fail-safe operation. If the flame is extinguished Tr_1 gate goes high, driving Tr_4 on via Tr_2 , R_7 . This removes the drive from Tr_3 , and the relay. A short circuit to ground at the input reduces the base potential of Tr_2 bringing D_1 into conduction and cutting of Tr_3 and hence the output.

The mid-section of the circuit offers a window action with the relay being held on for a restricted range of flame resistances, higher and lower values giving drop-out. The resistance

Component values

Tr_1 : TIS34
 Tr_2 : BC126
 Tr_3 : BC125
 Tr_4 : BC125
 Tr_5 : BC126
 D_1 : 1N914
 D_2 : 1N4002
 C_1 : 1nF
 R_1, R_2 : $15M\Omega$
 R_3 : $2.2k\Omega$
 R_4 : $12k\Omega$

R_5 : $6.8k\Omega$
 R_6 : $1.5k\Omega$
 R_7, R_9 : $12k\Omega$
 R_8 : 820Ω
 R_{10} : $15k\Omega$
 R_{11} : $2.7k\Omega$
 R_{12} : $4.7k\Omega$
 R_{13} : $22k\Omega$

Semiconductors not critical but TIS34 may need selection because of parameter spread.

is high requiring a high input resistance buffer; the output is conventional.

Smoke detector

When detecting the interruption of light by smoke, to avoid the effects of ambient illumination etc., the light beam may be chopped at source and the resulting a.c. from Tr_1 (see over) used via buffer Tr_2 to trigger the monostable circuit around Tr_3 , Tr_4 . This prevents the potential applied to R_{10} from rising sufficiently to fire the thyristor. If the load is a horn having an interrupter switch in series with its coil, the thyristor can cease conduction on removal of the gate drive (alternatively a.c. drive to the load would be required).

Time delay and generator circuits

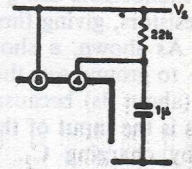
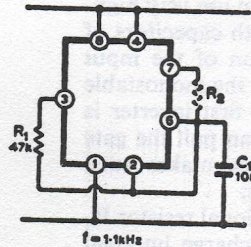
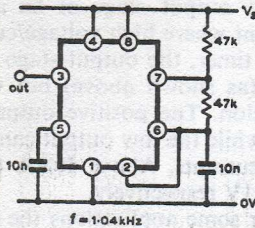
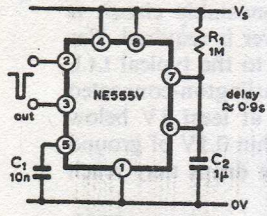

Circuit description

An i.c. such as the 555, with internal comparators driving a set-reset flip-flop offers great flexibility in the design of alarm systems. With pin 2 high, the capacitor is held low via pin 7. A negative-going edge on 2 allows R_1 to charge C_2 until the potential on 6 passes $2V_s/3$, when the original state is restored.

● Linking the inputs of the two comparators (2 and 6) to the discharge path (7) causes the potential at the common point to cycle between $V_s/3$ and $2V_s/3$, set by an internal potential-divider. For both circuits the output has switching characteristics comparable to a t.t.l. gate because of a similar totem-pole output stage. An audible alarm is available by connecting a loudspeaker (3-25Ω) between V_s and pin 3. If V_s is +5V, the on/off condition of the alarm may be controlled by

driving pin 4 from the output of a t.t.l. gate.

● An astable can also be constructed by feedback from the output to the paralleled comparator inputs. When the output is high, C_1 is charged positively through R_1 until the upper threshold is passed; the output switches low and C_1 is discharged until the trigger value set by pin 2 is passed. Timing is set by the less well-defined output amplitude, and the frequency is less stable than the basic circuit. Addition of R_2 varies mark-space ratio.

● If the reset terminal 4 is coupled to an RC network as shown, then a time-delay can be introduced at switch-on, before which firing of the circuit as a monostable can be achieved.

Wireless World Circard Series 13:

Alarm Circuits—2

Bridge circuits

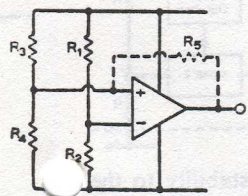

Components

ICs: 741, $V_s \pm 15V$
 R_1 to R_4 : 10kΩ, R_5 : 1MΩ
 Bridge voltage: 1.5V (Fig. 2)

Circuit description

Three bridge configurations are shown. In each case the bridge is composed of four resistors, R_1 to R_4 , and the circuits are basically Wheatstone bridges with balance occurring for $R_1/R_2 = R_3/R_4$. Substitution of impedances Z_1 to Z_4 would leave the balance requirements unchanged, and other variants such as the Wien bridge can be produced. For resistive elements it may be possible to supply the bridge and amplifier from a common d.c. supply and a high-gain op-amp detects departure from balance. A small amount of positive feedback via R_5 helps reduce jitter in the output when close to balance, but gives hysteresis to the balance sensing.

● If a separate supply is required for the bridge, one bridge balance point may be grounded, removing the need for high common-mode rejection for the amplifier. The errors in all these circuits include voltage offset of the amplifier, 1-5mV for untrimmed general-purpose op-amps, and input currents/offset, 10nA to 1μA for conditions as before. For balance detection to within 0.1% this implies bridge voltages in excess

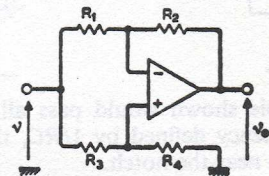
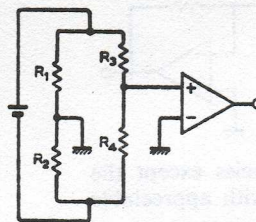

of 1V and currents of up to 1mA.

● By opening the bridge and embedding the amplifier in the network as shown, balance is achieved for the same relationship between the resistances, but with input and output both with respect to ground. This circuit has an output that is a linear function of the departure of R_2 from the balance condition (R_1, R_3, R_4 assumed constant as reference resistors). For d.c. applications the input may be one or other of the supply voltages. In all cases best sensitivity is achieved for $R_1/R_2 \rightarrow 1$. If the resistor whose value is being sensed has to have a low resistance, power wastage is avoided by keeping the other pairs of resistances high.

● Another method of achieving input and output as ground-referred signals, is to use an amplifier with push-pull outputs and single-ended input. A simple case is the single transistor as shown where the power supply, if properly by-passed, closes the bridge when used for a.c. measurement/sensing.

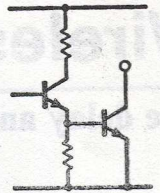
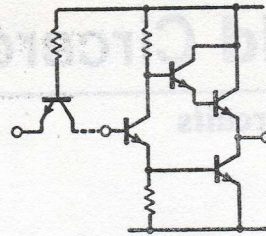
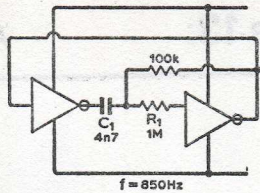
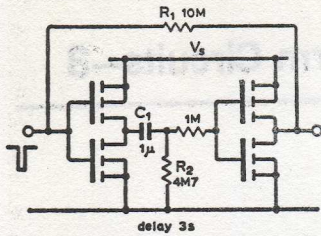

● A monostable using c.m.o.s. inverters can use very high-value resistors, giving time delays of $>1s$ with capacitors of $<1\mu F$. As shown, a short-duration excursion of the input from + to ground sets the output to zero for the monostable period (about 3s) because the output of the first inverter is high, as is the input of the second until R_2 can pull the gate down by charging C_1 . The high impedance makes such monostables useful as touch-operated circuits.

● A related astable circuit shows an additional resistor R_1 which isolates C_1 from the rapid charge/discharge imposed by the gate protection diodes in both these circuits. The resistor improves the timing stability.

● The output stage of an astable/monostable circuit is important where high voltage/current/power is required. For the 555 timer, the output stage is similar to the typical t.t.l. output (as shown above) but with a Darlington-connected top section. The positive output is thus at least 1V below supply while the low output can be to within 0.1V of ground at low currents. Above 50mA the voltage drops may reach 2V and 1V respectively.

● For some applications the open-collector output of t.t.l. devices such as SN7401 gives convenient driving of loads, while other devices such as SN7406 will withstand collector-emitter voltages of up to 30V.

Further reading

Three articles, by Robbins, Orrel and De Kold, in *Electronics*, 21 June, 1973, pp.128-32.
Application note for XR-2556 timing circuit, Exar, 1973.

Cross references

Series 3, card 9.
Series 13, card 5.

© 1974 IPC Business Press Ltd.

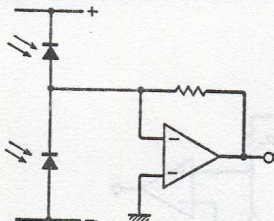
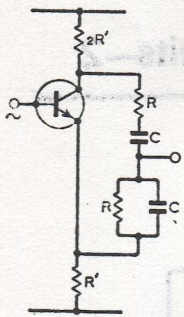

The example shown would pass all frequencies except the notch frequency defined by $1/RC$, though with appreciable attenuation near the notch.

● For many purposes, the availability of a centre-tapped supply provides a "phantom-bridge" action. If the ratio of positive to negative supplies remains constant then taking one input of the sense amplifier to the centre-tap leaves only a half-bridge externally. Used for example with photodiodes, the output voltage is proportional to the unbalance currents in the diodes i.e. to the degree of unbalance in the illumination of the diodes. Because the diodes act as constant-current devices the circuit is much more tolerant of drift in the centre-tap than for purely resistive elements. The negative feedback gives a linear output-unbalance characteristic. Reversal of the amplifier input terminals would give positive feedback, introducing a switching action and hysteresis as in the first diagram.

● Some i.c.s have internal potential dividers which can effectively form part of a bridge. The 555 timer, for example, has its two comparators tapped at $\frac{1}{3}$ and $\frac{2}{3}$ of the supply

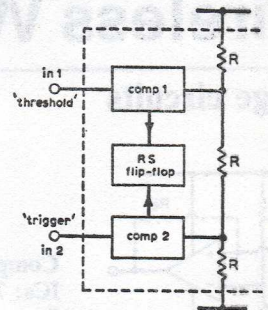

voltage via a resistor chain with very good stability to the ratio of their values; the absolute values are not important for such an application. The lower-threshold detector ("trigger") when held high prevents any output change (input 1 is assumed high) regardless of the status of the reset terminal. The reset terminal regains control only when the trigger input falls below the level accurately defined by the potential divider. With the trigger taken from an external potential divider containing the required sensing element the bridge—balance sensing can be obtained.

Further reading

Markus, J. (ed.), Bridge circuits, in *Electronics Circuits Manual*, McGraw-Hill, 1971, pp.84-9.
Graeme, Tobey & Huelsman, *Operational Amplifiers*, McGraw-Hill, 1971.

Cross references

Series 1, cards 9 & 10, series 9, cards 1 & 11.
Series 13, cards 1 & 3.

© 1974 IPC Business Press Ltd.

Level sensing and load driving

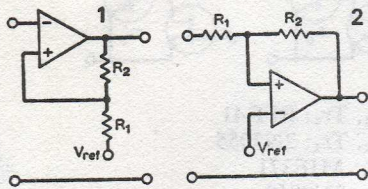

$R_1: 1k\Omega$
 $R_2: 100k\Omega$
 ICs: 741
 $V_s \pm 15V$

Circuit description

The basic level-sensing circuits shown may be used with or without positive feedback, to obtain an output change as the input passes a defined level or levels. For $R_2 \rightarrow \infty$, $R_1 \rightarrow 0$, amplifier gain determines the range of input voltages for which the output is not switched hard to one or other extreme. (Typically 1 to 20mV for comparators, required to operate at high speeds; 0.1 to 5mV for op-amps where accuracy of level-sensing makes their slower operation an acceptable penalty.) Hysteresis introduced by positive feedback allows the circuit to latch into a final state after the first excursion through a given level, provided the input cannot reverse its sense sufficiently to pass back through the other switching level. These circuits can thus perform the combined functions of level-sensing and set-reset action required in many alarms if for example the signal is a positive-going voltage initiating the set action, while the reset action is a negative-going pulse over-riding the former e.g. a resistor taken from the non-inverting input to the negative rail.

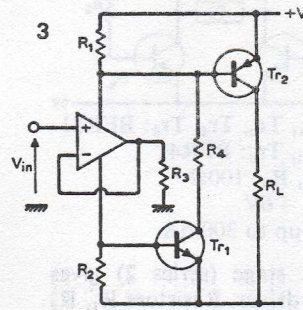

$Tr_1: BFR41, Tr_2: BFR81$
 $V_s \pm 6V, R_L: 200\Omega$
 $R_1 \text{ to } R_3: 100\Omega, R_4: 1.2k\Omega$

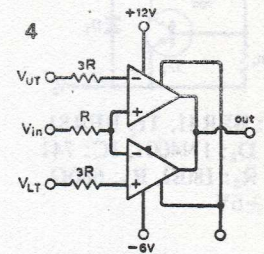

$R: 1k\Omega$
 IC: 711

- An adaptation of the output stage shown in Fig. 5 gives an output when the p.d. across either R_1 or R_2 exceeds about 0.6V. In the former case this corresponds to a positive input voltage defining sufficient positive supply current via R_3 i.e. $V_{in}R_1/R_3 \approx 0.6V$. Similarly a negative input voltage switches the output via Tr_1 . The switching action is not particularly sharp as it uses only the gains of the transistors.
- A standard window comparator gives sharper switching but requires two amplifiers/comparators and still requires an additional transistor if an output swing comparable to supply voltage is required e.g. for efficient switching of lamps relays etc., particularly at higher currents.

Applications of 555 timer

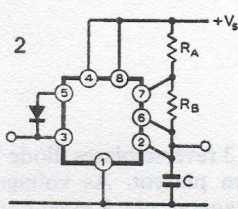
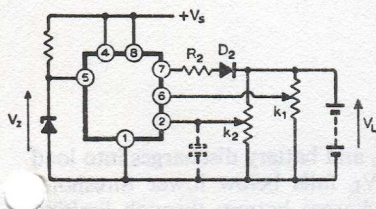

Circuit description

The 555, designed as a timing circuit with either monostable or astable operation, has internal circuit functions that allow it to be used for many other purposes. In alarm systems, the power output stage that permits currents of either polarity of up to 200mA (though 50mA minimizes voltage losses) means that lamps and relays can be driven quite readily. When used as an astable circuit the output square wave can be applied to a loudspeaker to give an audible alarm, while a voltage fed to the control terminal modulates the frequency for warble or two-tone effects. As a monostable circuit it can be used to provide delays from microseconds to minutes, allowing, for example, a warning alarm to be held for a defined period of time after the appearance of the condition being detected. In such cases the condition (closure of a switch in a burglar alarm for example) is converted into a negative-going pulse, applied to the trigger input. A further application for the device involves the controlled hysteresis

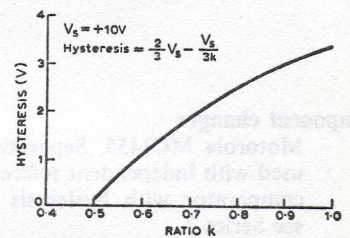
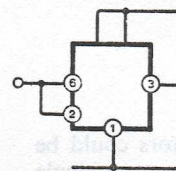

provided by the two comparators biased from an internal potential divider. With $V_1 > V_{ref1}$ the output is driven negative via the flip-flop which ignores any further excursions of V_1 about V_{ref1} in either sense. When V_2 falls below V_{ref2} the flip-flop is reset, the output going positive. In the astable circuit $V_1 = V_2$, $V_{ref1} = 2V_s/3$, $V_{ref2} = V_s/3$ and the capacitor is charged and discharged between $V_s/3$ and $2V_s/3$.

Typical performance

IC: NE555V (Signetics), $V_s + 10V$
 $R_1: 2.2k\Omega, R_2: 10k\Omega$
 $k = 0.6, D_1: 5.6-V$ Zener diode
 Upper set point: 5.7V (V_z)
 Lower set point: 4.75V ($V_z/2k$)
 Output swing: 9V for $R_L \geq 250\Omega$
 If R_1, D_2 omitted, $V_{ref1} = 2V, V_{ref2} = V$ and set points become 2V and V/k .

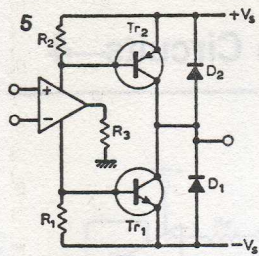

Tr₁: BFR41, Tr₂: BFR81
 D₁, D₂: 1N4001, IC: 741
 R₁, R₂: 180Ω, R₃: 680Ω
 V_s ±6V

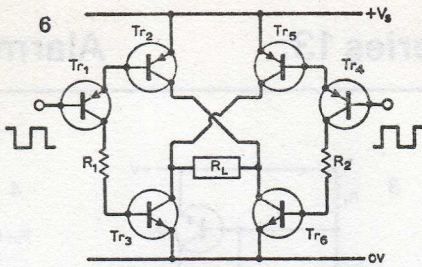

Tr₁, Tr₂, Tr₄, Tr₅: BFR81
 Tr₃, Tr₆: BFR41
 R₁, R₂: 100Ω
 V_s ±6V
 I_L up to 300mA

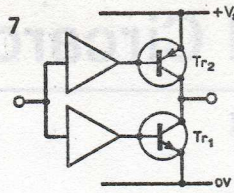

IC: 1/3 CD4049
 or CD4050
 Tr₁: BFR41
 Tr₂: BFR81

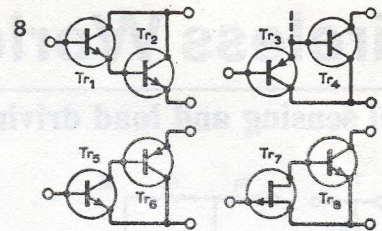

Tr₁, Tr₅: BFR41
 Tr₂, Tr₄: 2N3055
 Tr₆: MJE371
 Tr₇: 2N3819

● A previously-described output stage (series 2) gives push-pull drive using one op-amp as driver. Resistors R₁, R₂ are selected to keep Tr₁, Tr₂ out of conduction in quiescent state. The op-amp is used in any of the sensing/oscillating modes that result in p.d.s across R₃ sufficient to drive Tr₁, Tr₂ into conduction. Either may be used alone for driving lamps, relays, or the circuit as shown may be capacitively coupled to a loudspeaker for a.c. power drive.

● An output stage using a bridge configuration requires antiphase switching at the inputs, but gives a load voltage whose peak-peak value is twice the supply voltage. This is equally applicable to audio alarms or to driving of servo systems for which it was designed.

● Complementary m.o.s. buffers may be used to drive complementary output transistors as shown and with the aid of an additional inverter a similar stage provides a bridge output. The transistor base current is limited to a few milli-

amperes but in all these output stages, short-duration current spikes may occur during the output transitions. Diode protection against inductive voltage spikes as in Fig. 5 should be used for loudspeaker, relay and solenoid loads.

● Any of the output transistors may in principle be replaced by the compound transistor pairs if higher peak currents are needed. To reduce the above requirements it is worth considering the use of f.e.t. devices as the input transistor of the pair.

Further reading

Electronic Circuits Manual (Markus, McGraw-Hill 1971):
 Main circuits—pp.1-6; lamp control circuits—pp.344-9;
 trigger circuits—pp.889-907.
 Linear Integrated Circuits Handbook, Marconi-Elliot,
 pp.165-170.
 Industrial Circuits Handbook, SGS-Fairchild, pp.6-13.

© 1974 IPC Business Press Ltd.

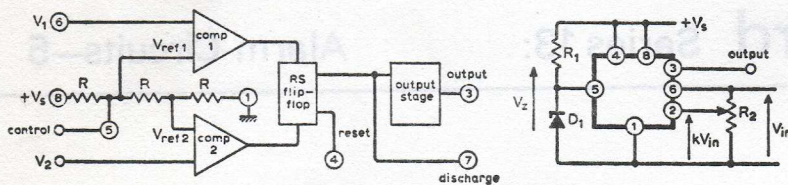

Component changes

IC: Motorola MC1455. Separate comparators could be used with independent reference voltages or a single comparator with hysteresis defined by feedback—see Series 2.

V_s: 4.5 to 18V. At low voltages the saturation voltages at the output may not allow adequate drive to electromechanical/filament lamp loads.

R₁, D₁: Any network to provide constant voltage at control input. Voltage may be to within 1V of common line or positive supply, but for optimum performance should be close to 2V_s/3.

R₂: 1k to 1MΩ. At low values, excessive loading of source; at high values inaccuracies due to threshold current of up to 0.25μA.

Circuit modifications

● Use as battery charger illustrates method well (above). Upper threshold when $k_1 V_L = V_z$; lower threshold when $k_2 V_L = V_z/2$. When upper threshold is exceeded output at

pin 3 reverse-biases diode D₂ and battery discharges into load when present. As voltage V_L falls below lower threshold voltage at pin 3 rises and charges battery through limiting resistor R₂. Hysteresis may be reduced towards zero for $V_z/k_1 \rightarrow V_z/2k_2$.

● To increase hysteresis, the potential at pin 5 may be reduced following a transition through the upper threshold. This may be done as in Fig. 2 by using output pin 3 via a diode—both thresholds are varied if the diode is replaced by a resistor.

● The increased swing simplifies the triggering of a following 555 used as a Schmitt trigger, as the capacitor voltage in Fig. 2 can approach zero. Complete alarm systems can be based on such circuits combining level sensing, time delays and waveform generation, as well as audible alarms.

Further reading

Four articles, by De Kold, McGowan, Harvey & Pate, in *Electronics*, 21 June 1973, pp.128-32.

© 1974 IPC Business Press Ltd.

Frequency sensing alarm

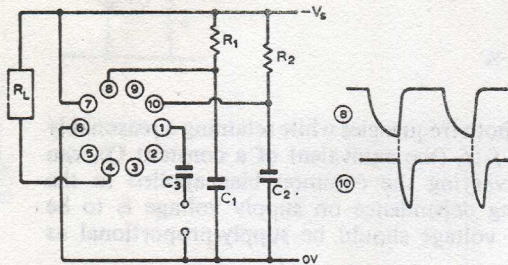

Circuit description

The circuit is a monolithic m.o.s. i.c. which uses external RC elements to fix the frequencies at which the circuit provides a switching action. It does so via two separate switching times defined by C_1R_1 and C_2R_2 , as from a pair of monostable circuits with the second time interval being initiated at the end of the first. The input may be a repetitive signal of arbitrary waveform, provided the amplitude is in excess of 100mV pk-pk (though it should not exceed 20V pk-pk). Internally this is presumably squared by a Schmitt type of circuit to trigger the monostables. Three distinct conditions may exist; if the period of the received signal is $t = 1/f$ and the two delays are $t_1 = k/C_1R_1$, $t_2 = k/C_2R_2$, then $t < t_1$, $t_1 < t < t_1 + t_2$, $t > t_1 + t_2$. These conditions are distinguished by additional internal circuitry that allows sensing of frequencies above a given datum or within a given band with a switched output that can be made to latch on or off, toggle

at a lower frequency ($f/20$), and hold on during signal failure or for temporary interruptions of the signal.

The upper frequency in the band mode or the datum in the datum mode is set by t_1 and the lower band-frequency by $t_1 + t_2$. The circuit provides frequency-sensing function similar to comparators Schmitt-triggers and window-comparators.

Typical performance

IC: FX101 (Consumer Microcircuits)
-12V supply, -3mA + load current

V_{in} : 250mV pk-pk to pin 1

R_1, R_2 : 470k Ω

C_1 : 22nF, C_2 : 10nF, C_3 : 0.1 μ F

Ground pins: 2, 3, 9.

Output on for: $f > 150\text{Hz}$ ($f \approx 1/0.6C_1R_1$).

Pin 1 signal input.

- 2 grounded, holds switch state during signal loss. open, switch off. ground via 'C', switch off after signal break of 200ms/ μ F for 'C'.
- 3 ground, circuit automatically resets on change off. open, switch latches when turned off.
- 5 link to 8, switch latches when turned on. Ground 3. link to 8 via 'C', hysteresis in datum point of 'C'/ $C_1 \times 100\%$.
- 9 ground, datum mode, switches on for $f > f_1$. open, band mode, on for $f_1 > f > f_2$. link to pin 5, output toggles at $f/20$ when in band.

Wireless World Circard Series 13: Alarm Circuits—7

Digital alarm annunciators

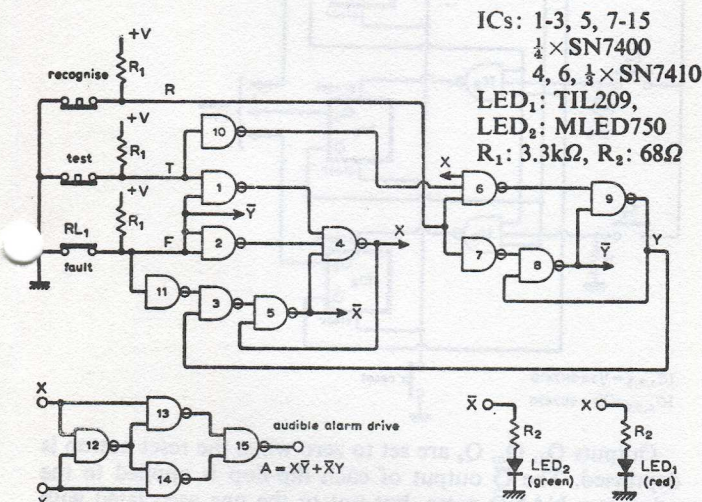

ICs: 1-3, 5, 7-15
 $\frac{1}{2} \times \text{SN7400}$
4, 6, $\frac{1}{2} \times \text{SN7410}$
LED₁: TIL209,
LED₂: MLED750
 R_1 : 3.3k Ω , R_2 : 68 Ω

Circuit function

It is assumed that a fault condition is the opening of relay contact RL_1 , though any other sensor that maintains the NAND-gate input terminal at a low ('0') level is adequate. A fault will turn off a "safe" green light and illuminate a "danger" red light, and operate an audible alarm. When the "recognise" push-button is depressed, the red light stays on, but the alarm is silenced. When the fault clears, the alarm is restarted, the green light comes on and the red light goes off.

The "recognise" button is again pushed to reset circuit to its normal state.

Circuit operation

Consider the circuit in its normal state where inputs R, T and F are at zero volts (or binary zero) i.e. $R=T=F=0$. This makes $X=0$ ($\bar{X}=1$), $Y=0$ ($\bar{Y}=1$) and hence LED₁ is energised (green) and LED₂ (red) is off.

If a fault occurs, RL_1 opens, F goes high (or binary one) i.e. $F=1$, causing $X=0$ ($\bar{X}=1$), but the state of Y (and \bar{Y}) remains as before. Hence $A=1$, and triggers audible alarm. Pushing the recognise button causes $R=1$, and as $F=1$, $T=0$, then $Y=1$ ($\bar{Y}=0$), but X does not change. LED₁ remains on, but $A=0$, and alarm stops. This state will be maintained until the fault is cleared.

When the fault is cleared, $R=F=T=0$, Y does not change, but $X=0$ ($Y=\bar{X}=1$, $X=\bar{Y}=0$). Hence LED₂ is illuminated, $A=1$, and the alarm operates.

Final recognition of the fault clearance is obtained from $R=1$, which will return circuit to its normal state i.e. for $R=1$, $F=T=0$, $Y=0$ and $X=0$.

Depression of the test button will check LED₁ and the alarm, when started from normal state with LED₂ on.

Circuit modification

As X, \bar{X} , Y, \bar{Y} are available, the exclusive-OR function of A can be obtained as shown.

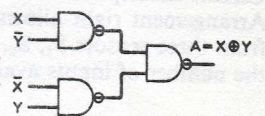

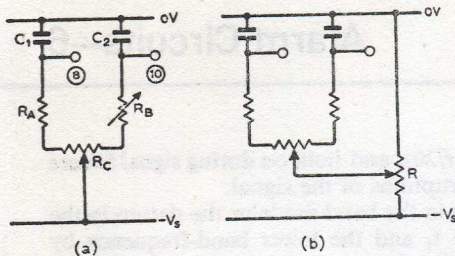

Component changes

- V_s : -12 to -22V some samples operate with reduced accuracy down to -8V.
- V_{in} : 0.1 to 20V pk-pk
 freq. set points: 0.01Hz to 50kHz.
 response time: within 5 to 10 cycles of receipt of correct frequency.
- R_1, R_2 : 100k to 1M Ω
 C_1, C_2 : 250pF to 1 μ F
 C_3 : 10nF to 1 μ F (not critical)

Circuit modifications

As the lower frequency in the band mode is affected by time constant C_2R_2 in the original circuit while the upper frequency is not, variation of R_2 increases the band by variation of its lower bound only. For $C_1=C_2=C$, variation in the tapping point of RC in (a) at left leaves the sum of the time constants unchanged at $(R_A+R_B+R_C)C$ i.e. it is the lower frequency that remains constant while the upper frequency is changed.

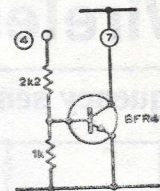
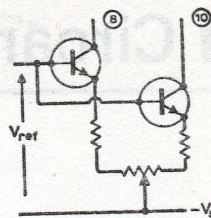

- Variation in both frequencies while retaining a reasonably constant ratio of $f_2:f_1$ (the equivalent of a constant Q), can be achieved by varying the common bias applied to the resistors. If strong dependence on supply voltage is to be avoided the bias voltage should be supply-proportional as in (b).
- Constant-current sources allow linear control of period against a separate reference voltage, which may be supply-proportional.
- Filament lamps may be driven via an additional transistor, currents up to 100mA or so being provided by circuit on right. Direct drive of reed relays, i.e. ds is possible though current is marginal.

Further reading

Volk, A. M. Two i.c. digital filter varies passband easily, *Electronics*, 15 Feb. 1973, p.106.
 McKinley, R. J., Versatile digital circuit filters highs, lows or bands. *Electronics*, 21 June 1971, p.66.
 FX101: Consumer Microcircuits data sheet D/026.

Cross references

Series 1, cards 6 & 7.

© 1974 IPC Business Press Ltd.

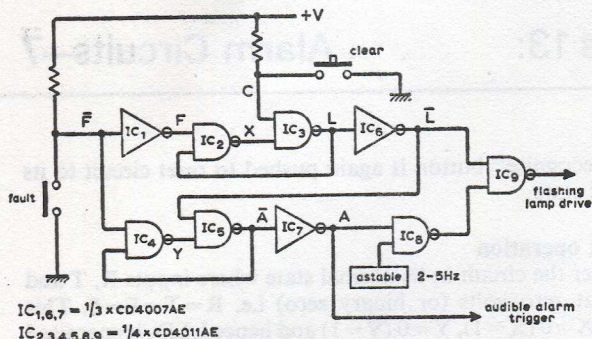

IC_{1,6,7} = 1/3 x CD4007AE
 IC_{2,3,4,5,8,9} = 1/4 x CD4011AE

Circuit description

Complementary-m.o.s. devices may be used in the circuit above to minimize stand-by power consumption.

Normal safe condition obtains with $\bar{L}=A=0, \bar{F}=1$. When the fault-switch closes, $F \rightarrow 1$ and since L is already high, $X \rightarrow 0$. Hence $L=0, \bar{L}=1$, opening gate IC₉. Also since $\bar{F}=0, Y \rightarrow 0$, and hence \bar{A} is forced to zero, therefore $A=1$. This transition may be used to switch an audible alarm. Simultaneously the oscillator gate is opened which will cause lamp flashing at a rate determined by the astable frequency.

If the fault is rectified, the alarm condition is maintained until the clear button is pressed causing C to be low. Hence $L \rightarrow 1$, and will latch in this condition via memory circuit IC₂ and IC₃. Also $\bar{L}=0$, thus $\bar{A}=0$, this condition being maintained via IC₄ and IC₅, and the alarm is silenced.

Circuit description

Arrangement right allows detection of first-fault occurrence from three sensors S₁, S₂, S₃, this number being restricted by the number of inputs available per NAND-gate.

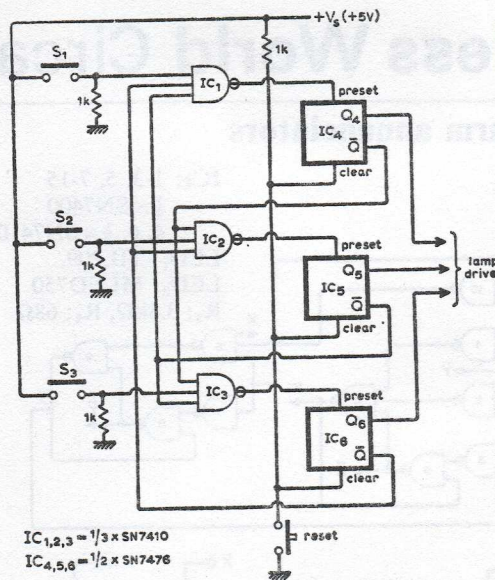

IC_{1,2,3} = 1/3 x SN7410
 IC_{4,5,6} = 1/2 x SN7476

Outputs Q₄, Q₅, Q₆ are set to zero when the reset button is depressed. The Q output of each flip-flop is applied to the other two NAND gates, but not to the one associated with itself. Hence two of the three inputs of each gate are high. If S₂ closes, for example, IC₂ output goes low, and this negative-going edge being applied to IC₅ preset terminal sets Q₅=1 (and hence Q=0). Therefore IC₁ and IC₃ are now inhibited and cannot respond to a fault condition.

Further reading

Zissos, D., Logic design algorithms, Oxford 1972.

© 1974 IPC Business Press Ltd.

Filament lamps and relays

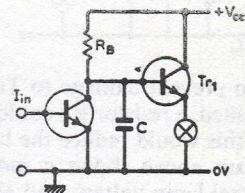
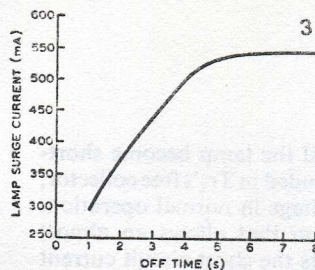
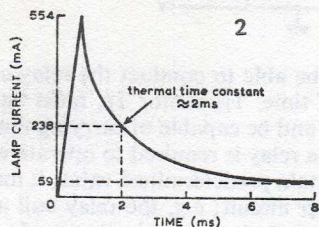
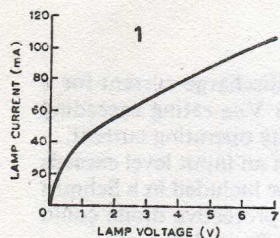

Filament lamps are widely used as visual alarm indicators and often connected in the collector-emitter circuit of a bipolar transistor that is switched on and saturated under alarm conditions. These lamps have a positive temperature coefficient of resistance with a large difference of resistance between the cold and hot states—see Graph 1 which is typical for a 6-V, 100-mA panel lamp. When switched on across a voltage source, a large current surge flows in the lamp, and switching transistor, which then decays exponentially to its normal or rated value in the hot state. This surge may be 5 times the rated current, or even higher, shortens the life of the lamp, may destroy the switching transistor or blow the power supply fuse. Graph 2 shows the typical initial surge current characteristic of a 6-V, 60-mA panel lamp having a thermal time constant of about 2ms.

When lamps are used as flashing alarms, the initial surge current is as shown in Graph 2 but the surge current on successive pulses depends on the thermal time constant and the time between flashes. Graph 3 shows the typical variation in surge current when a 6-V, 60-mA panel lamp is switched on for 5 s then off for t_{off} seconds.

If the p.d. applied to the lamp is gradually increased the current rises in a controlled manner to its normal operating value, prolonging the life of the lamp and reducing the probability of transistor damage. A simple arrangement is shown above where Tr_2 is normally held on and saturated with a low value of $V_{CE(sat)}$ holding Tr_1 and the lamp off. Under alarm conditions, the base drive to Tr_2 is removed and the capacitor charges through R_B . The base voltage of Tr_1 rises exponentially so that the lamp surge current is avoided.

Signal domain conversion

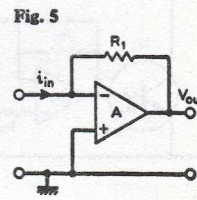
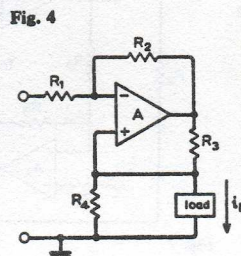
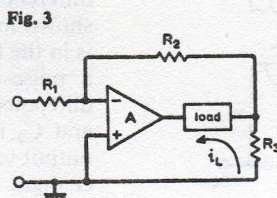
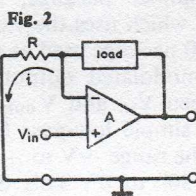
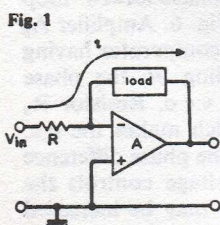

Voltage-to-current conversion

It is often required to supply signals to relatively long transmission lines in which case the signal is more convenient in current form rather than as a voltage. Thus, voltage-to-current converters are useful and may be realized using operational amplifiers especially if the load is floating. Figs. 1 & 2 show the more common forms the former being an inverting type and the latter non-inverting. In both Figs. $i = V_{in}/R$ and is independent of the load impedance, but the source and operational amplifier must be able to supply this load current in Fig. 1, whereas little source current is needed in Fig. 2 due to the high input impedance of the amplifier. Fig. 3 shows another floating-load V-to-I converter which requires little source current if R_1 is large and allows i_L to be scaled with R_3 , the operational amplifier supplying the whole of the load current; $i_L = V_{in}(1/R_1 + R_2/R_1R_3)$. The circuit of Fig. 4 is suitable for V-to-I conversion when the load is

grounded. When $R_1R_3 = R_2R_4$ the load current is $i_L = -V_{in}/R_4$ and the current source impedance seen by the load very high.

Current-to-voltage conversion

If a device is best operated when fed from a voltage source but the available signal is in the form of a current, a current-to-voltage converter will be required, one example being shown in Fig. 5. Current is fed to the summing junction of the operational amplifier which is a virtual earth so that current source sees an almost-zero load impedance. Input current flows through R_1 producing an output voltage of $V_{out} = -R_1$ volts/amp. The only conversion error is due to the bias current of the operational amplifier which is algebraically summed with i_{in} . The output impedance is very low due to the use of almost 100% feedback.

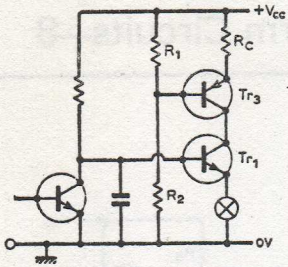

To prevent damage to Tr_1 should the lamp become short-circuited, a resistor R_C could be included in Tr_1 's free collector, but this would reduce the lamp voltage in normal operation. Circuit above shows a modification that allows an almost normal lamp voltage and also limits the short-circuit current to the desired value by using only a small R_C value and a saturating transistor Tr_3 .

Relays are used to actuate alarm devices that need to be isolated from their control circuitry for various reasons such as their current, voltage or power requirements being incompatible with the electronic circuitry. Circuit right, a commonly-used relay drive circuit which takes into account both the resistive and inductive properties of the relay coil. When actuated, the steady-state coil current is fixed by the coil resistance and supply voltage, but when Tr_1 is turned off the inductance of the coil causes the collector voltage to rise towards a level greatly exceeding V_{CC} if the protective diode D_1 were omitted. Diode D_1 allows V_{CE} to rise only slightly above V_{CC} before the diode conducts to dissipate the energy stored in the relay coil. When Tr_1 turns on D_1 is reverse-biased and does not affect the operation. The diode must be able to withstand a reverse voltage slightly greater than V_{CC}

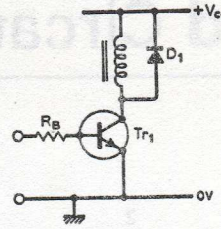

and be able to conduct the relay-coil discharge current for a brief time. Transistor Tr_1 must have a V_{CE} rating exceeding V_{CC} and be capable of carrying the relay operating current.

If a relay is required to operate when an input level exceeds a certain predetermined value, it may be included in a Schmitt trigger circuit; e.g. the relay coil and protective diode could replace R_4 in the basic circuit of series 2, card 2.

If the alarm indication uses a l.e.d. or alpha-numeric array of l.e.ds consult series 9, cards 2, 5 & 6.

Further reading

Shea, R. F. (Ed), *Amplifier Handbook*, section 3106, McGraw-Hill 1966.

Egan, F. (Ed), *400 ideas for design*, vol. 2, pp.18/9, Hayden, 1971.

Cleary, J. F. (Ed), *Transistor Manual*, pp.202, General Electric Co. of New York, 1964.

Industrial Circuit Handbook, section 2, SGS-Fairchild, 1967.

Cross references

Series 2, card 2.

Series 9, cards 2, 5 & 6.

Series 13, cards 4 & 7.

© 1974 IPC Business Press Ltd.

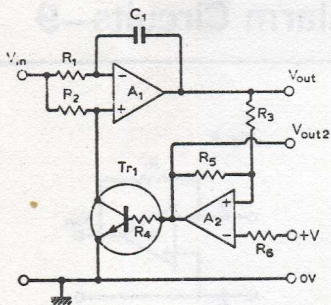

Fig. 6

Voltage-to-frequency conversion

Many voltage-to-frequency converters exist, the circuit complexity often being a guide to the degree of linearity and maximum operating frequency. Fig. 6 shows one form of V-to-f converter (a v.c.o.) suitable for use at frequencies below about 10kHz, each amplifier being of the current-differencing LM3900 type. Amplifier A_1 is connected as an integrator with A_2 acting as a Schmitt trigger which senses the output from A_1 and controls the state of Tr_1 which either shunts the input current through R_2 to ground, making V_{out1} run down linearly, or allows it to enter A_1 causing V_{out1} to rise linearly with $R_1 = 2R_2$. So V_{out1} is a triangular wave and V_{out2} a square wave having a frequency that is linearly dependent on R_1 , C_1 and the threshold levels selected for the Schmitt trigger.

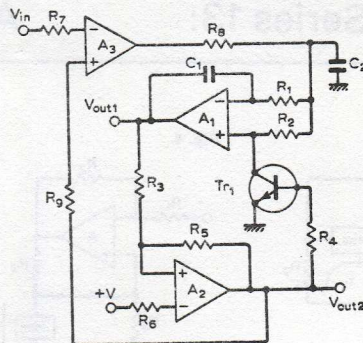

Fig. 7

Frequency-to-voltage conversion

Diode-pump, transistor-pump and op-amp pump circuits are widely used for low-cost frequency to voltage conversion. Another circuit, using a single LM3900 quad current-differencing amplifier package, is the phase-locked loop shown in Fig. 7 which uses the v.c.o. of Fig. 6. Amplifier A_3 is in the LM3900 package used as a phase comparator having a pulse-width modulated output depending on the phase difference between V_{in} and V_{out2} of the v.c.o. Resistor R_8 and C_2 form a simple low-pass filter which makes the d.c. output vary in the range $+V$ to $+V/2$ as the phase difference changes from 180° to 0° . This direct voltage controls the frequency of the v.c.o. and its lock range may be increased by using the fourth amplifier in the package as a d.c. amplifier between the filter and the integrator. Centre-frequency of the p.l.l. is about 3kHz with: R_1, R_3 1M Ω ; R_2 510k Ω ; R_4, R_6, R_9 , 30k Ω ; R_5, R_8 1.2M Ω ; R_7 62k Ω ; C_1 1nF; C_2 100nF; $V = +4$ to $+36V$.

Further reading

Graeme, J. G. & Tobey, G. E. *Operational Amplifiers*, chapter 6, McGraw-Hill 1971.

Linear Applications—Application notes AN20 and AN72, National Semiconductor 1973.

Cross references

Series 3, cards 3, 5 & 10.

Series 13, cards 1 & 6.

© 1974 IPC Business Press Ltd.

Pressure, temperature and moisture-sensitive alarms

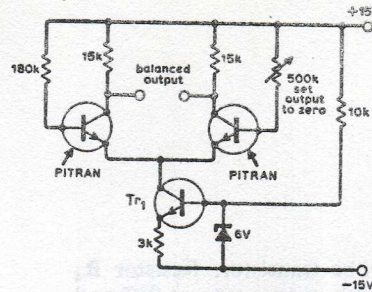
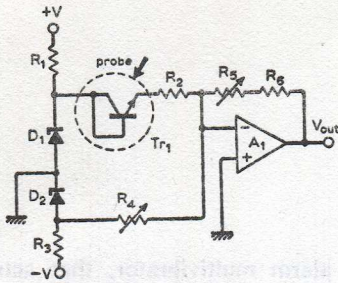
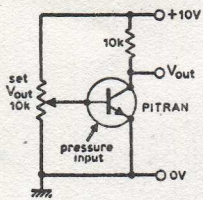

Pressure-sensitive alarm

A pressure-sensitive alarm may be made using a specially-modified transistor known as the Pitran. It is a planar n-p-n transistor having a diaphragm mounted in the top of its metal can which is mechanically coupled to its base-emitter junction. When a pressure is applied to the diaphragm a reversible change is produced in the transistor characteristics. The mechanical pressure input can be used to directly modulate the electrical output of the transistor which may be fed to the alarm circuitry e.g. via a comparator or Schmitt trigger which switches state when the input pressure to the Pitran exceeds or falls below some critical level. The Pitran may be connected as a single-ended-input single-ended-output stage, as shown left or as a differential-input balanced-output stage, as shown middle. Conventional transistor circuit design techniques may be used for the Pitran stages. Linear

output voltages of up to one-fifth of the total supply voltage are obtainable.

Temperature-sensitive alarm

Circuit above shows the input circuitry of an alarm which may be operated by the output signal from the operational amplifier when the temperature monitored by the probe transistor exceeds a pre-determined value. The temperature-sensing transistor is a low-cost n-p-n type that can produce a resolution of less than 1 deg C in a temperature range of 100 deg C. If the operating current of the probe transistor is made proportional to temperature, the non-linearity of its base-emitter voltage may be minimized, being less than 2mV in the temperature range -55 to $+125^{\circ}\text{C}$. Zener diodes set the input voltage to 1.2V and this is applied through R_1 to fix

Security, water level and automobile alarms

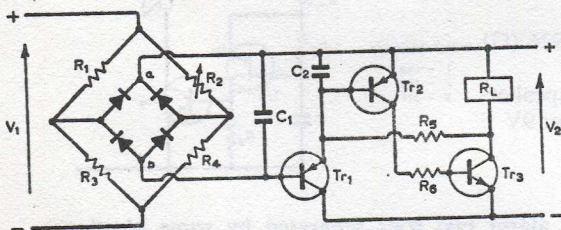

Circuit description

Component R_3 is the resistance in the search loop which if obtained using two $100\text{k}\Omega$ resistors allows one to include switches either in series with the loop or in parallel with either resistor, or both. In the latter case changing a switch condition from open to closed in the parallel case and from closed to open in the series case can give rise to either a positive voltage or a negative voltage being applied to the diode bridge; the bridge is, of course, balanced initially. The diode bridge being a full wave rectifier will apply a negative V_{ba} to the following circuit in either case.

The bridge resistors are large valued to minimize current drain from the battery but requires that the following circuit have a large input resistance. Hence the Darlington pair Tr_1 and Tr_2 is employed.

When V_{ba} goes negative, Tr_1 and with it Tr_2 , conducts. Transistor Tr_2 then drives Tr_3 , which is a higher power device

capable of drawing a relay coil to produce the warning signal. At the same time when Tr_3 conducts, the collector of Tr_3 goes negative and hence via positive feedback through R_5 the base of Tr_3 remains negative, even if V_{ba} is set back to zero. Hence, a latching action is obtained, which keeps the warning signal on. The warning signal will only be removed if the power supply is removed.

Capacitors C_1 and C_2 are required to prevent spurious pulses from triggering the alarm, in the case of C_1 , and to prevent switching transients from triggering the alarm when the alarm is being reset, in the case of C_2 .

Component values

R_1, R_4 : $150\text{k}\Omega$

R_3 : $200\text{k}\Omega$

R_2 : $250\text{k}\Omega$ variable

R_5 : $27\text{k}\Omega$

R_6 : 470Ω

C_1, C_2 : $0.33\mu\text{F}$

Tr_1, Tr_2 : BC126

Tr_3 : BFR41 or BFY52

Diodes 0A81

V_1 : 18V

V_2 : 9V

Brake light monitor (circuit over)

Both of the identical counter-wound coils are wound round the reed relay. Hence the relay switch will only close, giving a dashboard warning, if either of the brake lights fails either with an open circuit or short circuit.

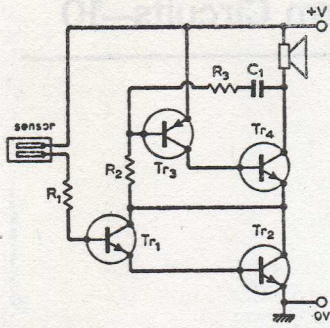

the operating current of the probe transistor. Resistor R_4 may be adjusted to make amplifier's output zero at 0°C and R_5 is used to calibrate the output voltage to $100\text{mV}/\text{deg C}$, or any other scaling factor, independently of the $V_{\text{out}} = 0$ condition. $R_1, R_3, 12\text{k}\Omega$; $R_2, 3\text{k}\Omega$; $R_4, 5\text{k}\Omega$; $R_5, R_6, 100\text{k}\Omega$; $D_1, D_2, \text{LM113}$; $\text{Tr}_1, \text{Tr}_2, 2\text{N2222}$; $\text{A}_1, \text{LM112}$; $V \pm 15\text{V}$.

Moisture-sensitive alarm

A low-cost audible alarm which operates when the electrodes of the input sensor become damp due to increase in humidity, direct contact with water, rain or snow is shown above. The sensor is conveniently made from parallel-strip printed circuit board or commercial equivalent, so that increase in moisture at the strips produces a very small current to Tr_1 base via R_1 which forms a high-gain compound pair with Tr_2 which switches hard on. Transistors Tr_3 and Tr_4 form the

audible alarm multivibrator, that acts as a load on the compound pair, having a repetition rate determined by the C_1R_3 time constant. A piercing note at about 2.5kHz is produced with $R_1, R_2, 100\text{k}\Omega$; $R_3, 1\text{k}\Omega$; $C_1, 10\text{nF}$; $\text{Tr}_1, \text{Tr}_2, \text{Tr}_3, \text{OC71}$; $\text{LS}, 8\text{-}\Omega$ loudspeaker; $V, +9\text{V}$.

A flashing display with a rate of about 2Hz may be obtained by replacing the loudspeaker with a 6-V, 60-mA panel lamp and changing the values of R_2 to $470\text{k}\Omega$ and C_1 to $2.2\mu\text{F}$.

Further reading

Tingay, E. The Pitran—a new concept in pressure measurement, *International Marketing News*, p.8, 1970.
Linear Applications—application notes AN31, AN56 and AN72, National Semiconductor, 1973.
Brown, F. Rain warning alarm, *Everyday Electronics*, pp.208-11, 1972.

© 1974 IPC Business Press Ltd.

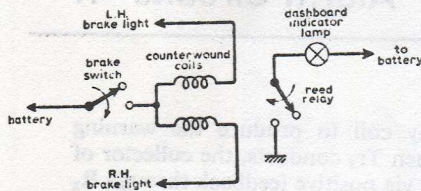

Water level alarm

This circuit is designed to produce a note from the loudspeaker when the sensor input terminals are shorted. As such it can be used for many applications apart from suggested water level/rain alarm. When the input terminals are shorted base drive to Tr_1 via R_1 is obtained, and the supply voltage is switched to the unijunction relaxation oscillator comprising Tr_2, R_2, R_3 and C (card 4, series 3). A train of pulses of period mainly determined by the product R_2C is then presented to the base of Tr_3 , thereby producing pulses of current through the loudspeaker. The loudspeaker alarm note can be altered by altering the product R_2C . Considerable effective output can be obtained by selecting the note to correspond to the resonant frequency of speaker. In practice the alarm will sound for any resistance between zero and five megohms.

The quiescent current of the unit is of the order of nanoamps so that battery life is many months even if the unit is switched off. Provision to test the battery condition is made by switch position 2 which should cause Tr_1 to switch on the oscillator provided the battery is in good condition.

For water level sensing two conducting rods spaced an inch, or less, apart and positioned at the required level is all that is required.

Component values

$R_1: 100\text{k}\Omega$
 $R_2: 3.3\text{k}\Omega$
 $R_3: 270\Omega$
 $C: 0.5\mu\text{F}$
 $\text{Tr}_1, \text{Tr}_3: 2\text{N2926 (G)}$
 $\text{Tr}_2: 2\text{N2646}$
 $\text{LS}: 8\text{-}\Omega$ loudspeaker
Supply voltage: 9V

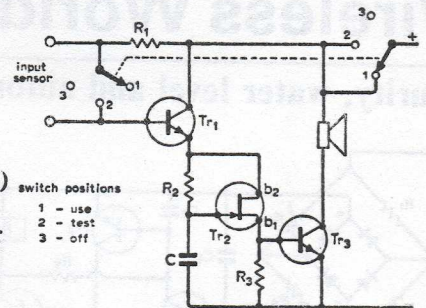

For a rain alarm two rods separated by some blotting paper will suffice. When the blotting paper becomes wet contact between the rods is made, the alarm sounds and the washing is saved once more (provided the missus isn't away shopping).

Component changes

Resistor R_1 may be any value up to $5\text{M}\Omega$ provided a true shorting of the sensor input terminals is obtainable. The R_2C product is dictated by the pitch of the note required. Resistor R_3 should be much less than R_2 e.g. $R_2/10$.

Further reading

Andrews, J. Security Alarm, *Practical Electronics*, 1973, p.338.
Moorshead, H. Rain & Water Level Alarm, *Practical Electronics*, 1971, p.820.
Morum, S. W. F., Brake Light Monitor, *Practical Electronics* 1973, p.588.

© 1974 IPC Business Press Ltd.

Electromechanical alarms

Electromechanical transducers are obtainable in a wide variety of types: they may be d.c. or a.c., resistive, relative or capacitive, contacting or non-contacting, analogue or digital, linear or angular, etc. Insofar as most alarm systems use a comparator (cross ref. 1) to compare the signal with a reference and as d.c. signals are easily compared we shall assume here that any a.c. systems are followed by signal conditioning equipment which includes a rectifier (cross ref. 2) of some sort so that the effective output is d.c.

Displacement alarm

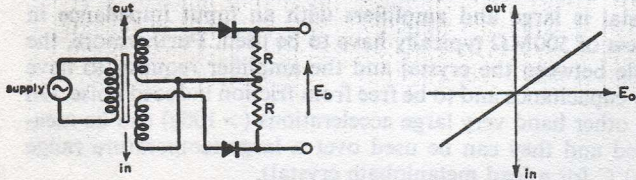

Circuit shows a relative displacement transducer, of the differential transformer type, followed by a demodulator to provide the d.c. output shown in graph. The core, which is shown in its zero output position, is attached to the member whose displacement is required. The core is generally made from high permeability ferromagnetic material so that flux linkages with and hence the e.m.f.s of the secondary coils are highly dependent on the position of the core relative to the coils. Relative transducers generally have a displacement span of between 0.01 and 120in, in rectilinear form, and

between 0.05 and 90° in angular form. As the induced e.m.f.s are proportional to frequency, very sensitive system can be made at high frequencies.

Capacitive transducers are used in situations where very small displacements have to be measured and/or non-contacting measurement has to be performed. Photoelectric/digital measurements (again non-contacting) are used when high accuracy is required, although fairly low cost versions can be constructed if accuracy is not essential.

Velocity alarm

Linear velocity transducers are most commonly used in the vibrations field where the displacement of the member whose velocity is required is small. Essentially, they consist of a coil moving in a permanent magnetic field, the coil e.m.f. being proportional to the speed. As a large proportion of the speed producing systems are driven by motors one can generally obtain information on linear speed from a knowledge of angular speed. This can be obtained by various types of a.c. or d.c. tachometers, but with the increasing use of digital instrumentation, toothed rotor, photoelectric and similar systems are becoming increasingly common. Diagram shows basis of operation of the toothed rotor tachometer and the

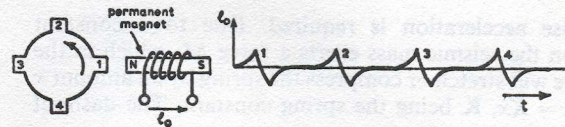

corresponding output when the rotor is rotated by the shaft of a motor. The output waveform is obtained because of the changing flux pattern caused by the changing magnetic circuit. If the output signal is fed to a zero crossing comparator (cross refs. 1, 3) or to a Schmitt trigger (cross ref. 1) one will then obtain a train of pulses, each pulse representing the passage of a rotor tooth past the permanent magnet. Obviously the pulse frequency is proportional to the shaft speed. If the train of pulses is then fed to a frequency-to-voltage converter a direct voltage proportional to shaft speed is obtained and this can be fed to a comparator to give an alarm if it exceeds a predetermined level. Because the number of teeth on the toothed rotor can easily be varied, the range of speeds measurable by this technique is extremely large. Further, the rotor can easily be constructed in any workshop, no great precision being required for many applications. Both heads on a coupling between two shafts often suffice as the toothed rotor.

Acceleration alarm

Acceleration transducers all have one feature in common viz the seismic mass, M . The basic acceleration transducer is shown below. The case of the system is attached to the

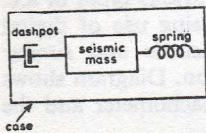

body whose acceleration is required. Due to a constant acceleration the seismic mass exerts a force $M\alpha$ which in the steady state will stretch or compress the spring by an amount x where $M\alpha = Kx$, K being the spring constant. The dashpot

simply provides damping whilst the mass is moving. If we know M and K then a measure of x gives a signal proportional to the acceleration. This can be done by any displacement transducer of suitable dimensions and sensitivity. Frequently, however, the spring arrangement is a leaf spring arrangement with strain gauges attached. The spring deflection gives rise to changes in resistance in the strain gauges which if connected in a Wheatstone bridge circuit gives a voltage proportional to the deflection and, hence, to the acceleration. As the Wheatstone bridge can be supplied from a d.c. source there is no need for rectifiers before feeding to a comparator. Strain gauge bridges usable up to 750Hz have been built.

For higher frequencies piezoelectric crystals replace the spring. The crystal produces a charge or voltage across its terminals when subjected to the stress of the seismic mass under acceleration. However, the output impedance of the crystal is large and amplifiers with an input impedance in excess of $500M\Omega$ typically have to be used. Furthermore, the cable between the crystal and the amplifier requires to have low capacitance and to be free from friction induced noise. On the other hand very large accelerations ($>100g$) can be measured and they can be used over a large temperature range ($570^\circ C$ for a lead metaniobate crystal).

Further reading

H. N. Norton, Handbook of Transducers for Electronic Measuring Systems, Prentice-Hall.
 Considine, Encyclopedia of Instrumentation and Control McGraw-Hill.

Cross references

Series 2, Comparators and Schmitts.
 Series 4, A.C. Measurements. Series 13, card 4.