

ELECTRONICS WORLD

Denmark Dkr. 63.00
Germany DM 12.00
Greece Dra 680
Holland Dfl. £2.50
Italy L 5500
IR £2.97
Spain Pts. 700.00
Singapore S\$ 11.25
USA \$5.95

+ WIRELESS WORLD

NOVEMBER 1990 £1.95

BROADCAST

Battle for the sky

DESIGN

Direct conversion FM

SYSTEMS ENGINEERING

ALL IN THE CARDS

REVIEW

£340 spectrum analyser: just a toy?



*Fast,
Accurate,
Versatile...*



Model ME 4050 £139.00

Packed with high performance features for tough performance requirements, the superb new 4000 series from SOAR offers exceptional value for money.

SOAR Digital multimeters provide a wide range of capabilities, covering general purpose applications in research and development, production line service and maintenance use. The 4000 series up to the high accuracy 4½ digit DMM's is complemented with some economic models which include hand held as well as bench-type multimeters.

- 0.3% basic D.C.V. accuracy.
 - Relative and data hold functions.
 - Custom 4000 A/D convertor.
 - Frequency test.
 - 40 segment analog Bar Graph.
 - Impact resistant case.
 - Vibration, dust, grime and splash proof.
 - Auto power down.
 - High speed auto ranging and sampling.
- Plus (ME-4050)
- Unrivalled accuracy of 0.1% D.C.V.
 - Direct temperature test facility.
 - Min/max. memories.

FREE CATALOGUE

- Over 220 full colour pages.
- All prices listed.
- Complete technical data included.

For further details and full colour test and measurement equipment catalogue, contact the sole U.K. distributors:-

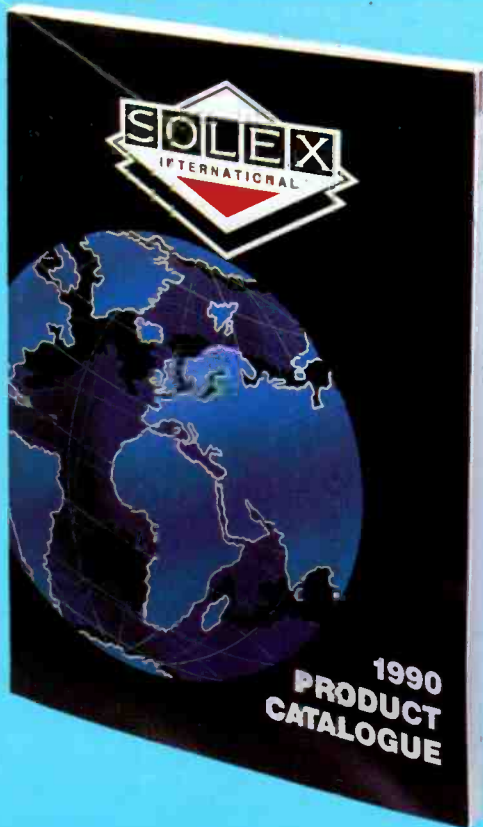

Unit 25, Swannington Road, Cottage Lane Industrial Estate, Broughton Astley, Leicestershire LE9 6TU

Tel: (0455) 283486.

Fax: (0455) 283912.



SOLEX

an analog & numeric devices Ltd. company

CONTENTS

FEATURES

WORKING THE SYSTEM 940

Estimates put the number of PC card species in the tens of thousands. If the application exists, someone, somewhere has probably built a card to support it.

REVIEW — RF SPECTRUM PROBE 952

Can a £340 oscilloscope add-on provide the facilities of a 100MHz spectrum analyser?

THE FUTURE VIEW 957

Sky has gained most by being first although BSB seems set for a long term victory taking the MAC standard with it says Peter Willis.

DIRECT CONVERSION FM 962

Direct conversion detection is as old as the hills. Digital signal processing has given the technique a new lease of life.

UPDATE SPECIAL..... 973

The missing life of Alan Blumlein. Britain's greatest electronics inventor has had his place in history deliberately denied.

INTERFACING WITH C 978

Most filter poles possess real values. Digital filters may have poles at zero resulting in analogue impossible — and surprising — characteristics.

REVIEW — PCB EAGLE 983

PCB Eagle is a layout and schematic capture package for professionals. Does it live up to its promise? Martin Cummings gives the verdict.

REVIEW — CRACKER..... 994

A spreadsheet for the engineer? Peter Williams finds out if Cracker 4 adds up.

EMC AND 1992..... 1002

Why small firms must plan for the new euro-EMC rules.

ARCHIMEDES FOR R&D 1005

Acorn's Archimedes represents a much better platform for systems development argues David Reid.

LOUD AND CLEAR..... 1008

Radio played a crucial role in the Battle of Britain. A J Martin reviews the technology of the day.

INDEX 1989

The index for 1989 is now available, free of charge, to anybody who wants one. Please send in a stamped, addressed envelope — preferably A4 — to Index 1989, Electronics World+Wireless World, Room L333, Quadrant House, The Quadrant, Sutton, Surrey SM2 5AS. We regret that we cannot accept telephone index requests.

REGULARS



Laptop computing for space shuttle p938

COMMENT 931

Blowing the whistle

RESEARCH NOTES 933

Switching with half an electron, word processor headaches, power line leukaemia and silicon visible light emitting diodes.

UPDATE 938

Euro-VLSI gets boost, laptops in Space, cheaper teletext, new biophysics studies and other news from around the industry.

LETTERS 949

NEW PRODUCT CLASSIFIED 968

New products at-a-glance.

CIRCUIT IDEAS..... 988

Tone burst gate, latching switch array, PC programmable power supply.

APPLICATIONS..... 992

Zero error low pass filter, precision rectifier and op-amp temperature transducer.

PIONEERS 998

What do anti-submarine warfare, birds and piezo-electricity have in common? They were all the subject of study by Walter Cady and George Pierce, inventors of the crystal oscillator.

RF CONNECTIONS..... 1015

Explosives and RF, low noise microwave oscillators and VDU flicker.

In next month's issue. The connection between transient intermodulation distortion and power supply impedance in audio amplifiers seems, at first sight, remote. However, a falling power supply rejection ratio with frequency is a matter of known fact. A new audio design hypothesis may hold the key to better Class AB amplifiers.

NEURAL NETWORKS

Application areas include:

- Modelling & Forecasting
- Process Control
- Signal Analysis & Classification
- Complex Scheduling
- Financial & Economic Modelling

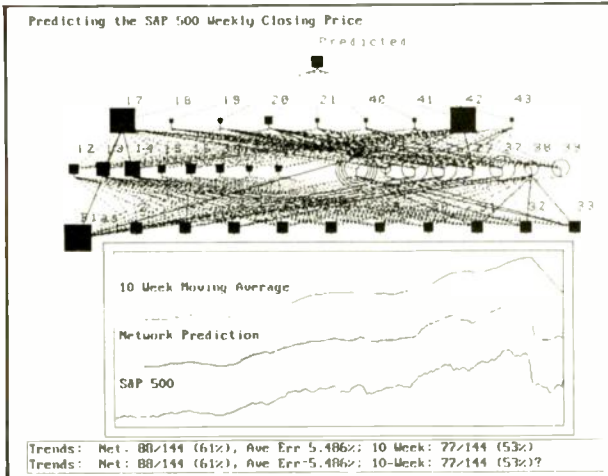

Scientific Computers — a company having more than 30 year's experience in the fields of simulation and parallel processing — is *the* European Distributor on behalf of NeuralWare Inc.

We supply the complete range of **Neural Network** development tools

Our service includes:

- On-line technical support
- Authorised NeuralWare Inc. training courses
- Consultancy

Find out how you can maintain your competitive edge by calling:

KNOWLEDGE TECHNOLOGY GROUP

Scientific Computers Ltd.,

Victoria Road,
Burgess Hill,
West Sussex
RH15 9LW

TEL: (0444) 235101

FAX: (0444) 242921

CIRCLE NO. 125 ON REPLY CARD

Our very simple offer to craftsmen

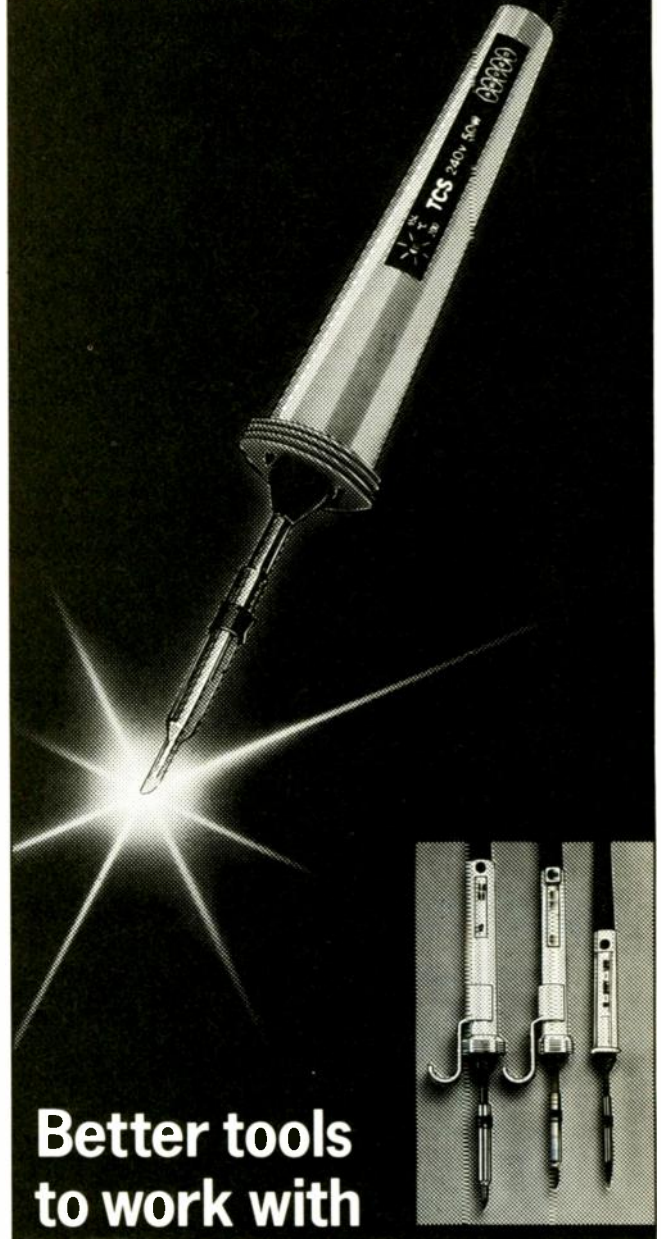

Better tools to work with

● **Antex TCS 240 V 50 W and TCS 24 V 50 W.**

● Temperature Controlled Soldering Irons for electronic and electrical applications — especially field maintenance and repair.

● Temperature range 200° to 450° C. Analogue proportional control \pm 1%. Max. temperature achieved within 60 seconds.

PLUS

● **Antex M-12W; CS-17W; and XS-25W. Available in 240 or 24 volt.**

● Tools specially designed for fine precision soldering. **Ideal for all electronics craftsmen and hobbyists.**

For full information on the comprehensive Antex range of soldering irons, power supply units and accessories, please clip the coupon.



Antex (Electronics) Limited, 2 Westbridge Industrial Estate, Tavistock, Devon PL19 8DE. Tel: 0822 613565. Fax: 0822 617598. Telex: 9312110595 AE G. Please send me full details of the full range of Antex soldering products.

Name _____

Address _____

Postcode _____ (EWW4)

CIRCLE NO. 126 ON REPLY CARD

CONSULTING EDITOR

Philip Darrington
081-661 8632

EDITOR

Frank Ogden
081-661 3128

DEPUTY EDITOR

Jonathan Campbell
081-661 8638

ILLUSTRATION

Roger Goodman

DESIGN & PRODUCTION

Alan Kerr

EDITORIAL ADMINISTRATION

Lindsey Gardner
081-661 3614

ADVERTISEMENT MANAGER

Jan Thorpe
081-661 3130

DISPLAY SALES MANAGER

Shona Finnie
081-661 8640

ADVERTISEMENT ADMINISTRATION

Karen Baines
081-661 8649

ADVERTISING PRODUCTION

Melanie Green
081-661 8469

PUBLISHER

Susan Downey
081-661 8452

FACSIMILE

081-661 8939



**REED BUSINESS
PUBLISHING
GROUP**

Electronics World & Wireless World is published monthly USPS687540. By post, current issue £2.25, back issues (if available) £2.50. Order and payments to 333 *Electronics World & Wireless World*, Quadrant House, The Quadrant, Sutton, Surrey SM2 5AS. Cheques should be made payable to Reed Business Publishing Group. Editorial & Advertising offices: *EW/W* Quadrant House, The Quadrant, Sutton, Surrey SM2 5AS. Telephone: Editorial 081-661 3614, Advertising 081-661 3130, 081-661 8469. Telex: 892084 REED BP G (EEP). Facsimile 081-661 8939 (Groups II & III). *Newstrade* - Quadrant Publishing Services No 081-661 3240. Subscription rates: 1 year (normal rate) £30 UK and £35 outside UK. Subscriptions: Quadrant Subscription Services, Oakfield House, Perrymount Road, Haysards Heath, Sussex RH16 3DH. Telephone 0444 441212. Please notify a change of address. USA \$116.00 airmail. Reed Business Publishing (USA), Subscriptions Office, 205 E. 42nd Street, NY 10117. **Overseas advertising agents: France and Belgium** Pierre Mussard, 18-20 Place de la Madeleine, Paris 75008. **United States of America** Jay Feinman, Reed Business Publishing Ltd, 205 E. 42nd Street, NY 10117. Telephone (212) 867-2080. Telex 23827. **USA mailing agents:** Mercury Airfreight International Ltd Inc, 10(b) Englehard Ave, Avenel NJ 07001. 2nd class postage paid at Rahway NJ. Postmaster - send address to the above.

© Reed Business Publishing Ltd 1989. ISSN 0266-3244

Blowing the whistle

"What did you do in the Gulf war, Daddy?"

"I fought alongside everybody else."

"Yes, but on which side?"

I sit here writing this in the week of the parliamentary debate on the Gulf crisis. The Prime Minister is being resolute. The Leader of the Opposition is statesmanlike. The House unites in its surprise and condemnation. "Aggression" already sounds like a cliché.

Two years earlier, the subject of this pompous and hypocritical rhetoric was happily gassing friends and enemies alike. At around the same time the junior Foreign Minister was taking tea on the lawn at the Iraqi Embassy equally happily, presumably on the advice of his civil servants.

Also happy were the DTI. They authorised the export control documents for the high speed Transputer modem links used in missiles, the curiously-shaped high precision machined castings, control computer equipment. And industrial chemical plant.

Politicians espouse grand purposes yet seldom pursue anything weightier than short-term objectives. They certainly can't be relied on for applied

morality unless found out in public.

Civil servants are, by and large, amoral. They simply pursue their index-linked careers, immune from the consequences of either their mistakes or self-interest. They are denied morality: those who express it in public lose their jobs and risk imprisonment. Clive Ponting (The Belgrano affair), Sarah Tisdall (US nuclear Tomahawk missiles in Britain) and Cathy Massiter (M15 dirty tricks) were such people denied.

Much of what has happened in the Gulf couldn't have occurred without the compliance of scientists and engineers working in Western industries. Designing a guidance system which controls the trajectory of a missile is one thing. Knowingly working on a guidance system which will control the flight of an Iraqi missile is quite another. Those engaged on suspect projects - in research, development or sales - must have the courage to blow the whistle. A few brave people did but many more didn't.

Scientists have a duty to question both technology's end purpose and its morality; they alone may be in a position to short-circuit the civil servants and moralise the politicians.

Frank Ogden

EASY-PC

PCB and SCHEMATIC CAD

For Super Schematics....

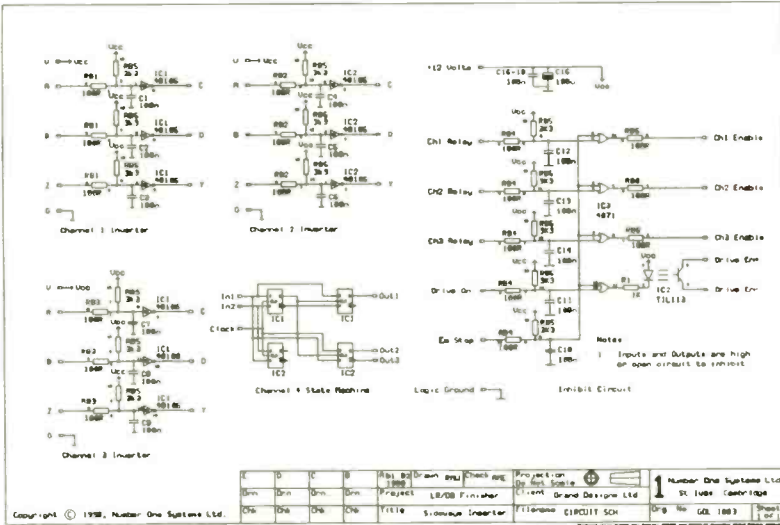

**Still
Only
£98!!**

**BRITISH
DESIGN
AWARD
1989**

- **Runs on:-
PC/XT/AT/386
CGA EGA VGA.**
- **Design:-
Single sided, Double
sided and Multilayer
boards.**
- **Provides Surface
Mount support.**
- **Standard output
includes Dot Matrix
printer, Pen Plotter,
Photo-plotter and
N.C. Drill.**

....and Perfect PCB's

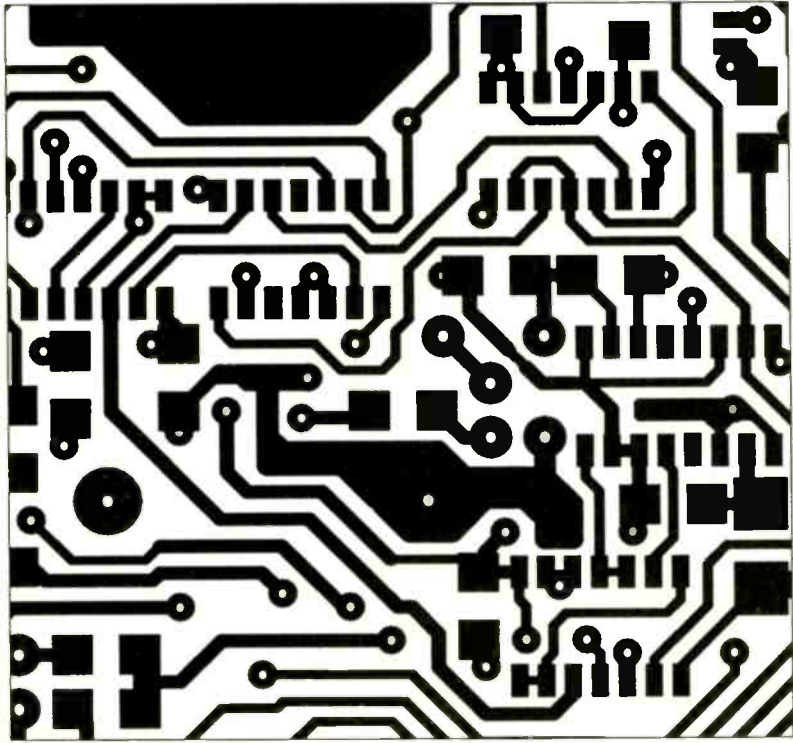

Use Award Winning EASY-PC

- **Over 4000
installations in
over 50 countries
worldwide.**
- **Over 500
installations in
Universities,
Colleges etc. (Aug '90)**

Fast Professional Quality Output - Affordable Price

Write ,Phone or Fax for full details:-
Number One Systems Ltd. **I** See us at **DESKTOP CAD Stand 1216**
 REF: WW, HARDING WAY, SOMERSHAM ROAD, ST.IVES, HUNTINGDON, CAMBS, PE17 4WR, ENGLAND.
 Telephone: 0480 61778 (6 lines) Fax: 0480 494042 ACCESS, AMEX, MASTERCARD, VISA Welcome.

CIRCLE NO. 127 ON REPLY CARD

Word processing could be real office headache

Why do we complain about VDUs but happily watch hours of TV? The answer, more complex than we might imagine, was one of the subjects tackled in a summary of health progress on VDUs and fluorescent lights given at the Swansea meeting of the British Association for the Advancement of Science by Arnold Wilkins of the Medical Research Council Applied Psychology Unit.

First, fluorescent lights: although we are not always consciously aware of the 100Hz flicker, our eyes and optic nerves certainly respond up to that frequency. Wilkins' own research shows that this neural burden affects everything from eyeball muscle control through to the incidence of headaches, panic attacks and agoraphobia.

Just-published research in Cambridge compared a group of agoraphobics under normal fluorescent lighting, with those under fluorescent lighting

having high frequency ballasts and no measurable flicker. Although the subjects were unaware of the nature of the experiments heart rates were measurably higher under mains-frequency lighting.

Wilkins says that if the cost of HF ballasts is unacceptably high, flicker can be minimised by careful choice of lamp phosphors. Unfortunately lamps with a good colour rendering flicker most while the old, less efficient, "warm white" lamps have a somewhat longer persistence. No one yet knows whether a reduction afforded by such a change is sufficient to be clinically beneficial. Research is currently going on to try to answer that and also whether wearing red spectacles (!) would allow the office worker to benefit from the fact that phosphor persistence is greater at the red end of the spectrum.

VDUs and why, subjectively, they

seem worse than TV sets is also a subject Arnold Wilkins and his colleagues have been addressing. Contrary to the obvious deduction, the difference is not just a matter of what most of us would prefer to be doing. In fact watching TV ought to be infinitely *less* pleasant than watching a VDU screen because in general the degree of flicker is much greater. Not only is the refresh rate usually slower, but the persistence is shorter. Wilkins says that the real answer has to do with the spatial structure of the displayed material and the demands it makes on the viewer's brain (processing, not intellectual).

The big difference between TVs and VDUs is the often-overlooked one that TVs usually display pictures whilst VDUs usually display text. Pictures are easy for the eye/brain combination to analyse because there are plenty of unambiguous cues. The eye therefore moves easily and effortlessly to the area of interest.

Text, on the other hand, is spatially confusing because of its repetitive stripy character. When words are closely spaced horizontally as well as vertically there is little unambiguous "global" information to guide the eye. Arnold Wilkins says that machine-generated text is far worse than hand-generated typography of the past because appropriate spacing has yet to be formalised in computer algorithms.

Wilkins' research has also shown that the patterns created by screen text are very close to the spatial patterns that are known to disturb the brain. Such patterns cause eye-strain, headaches and even seizures, presumably because of the extra demands they place on the brain in resolving ambiguous visual material.

Arnold Wilkins believes that we should not over-estimate the brain's capacity to adapt to visual difficulties. Text-books, for example, are fond of reminding us that we can see almost single photons, perform automatic colour balances and even eventually adapt to spectacles that invert the scene. Such adaptation, remarkable as it is may, in the long term, exact a toll in the form of minor health problems and lost production.

Computer designers and lighting consultants take note.

Electronics stops one for the road

Palladium, which enjoyed a meteoric if somewhat short-lived rise from obscurity during the "cold fusion" saga, is now back in the news for its potential value in a much less glamorous role. *Platinum Metals Review* (1990, 34, 3) reports Japanese research into a new and highly specific form of breathalyser.

Until now detection of alcohol vapour in breath has mostly been performed by a sort of miniature fuel cell where alcohol is oxidised catalytically to generate a current which can then be measured and read out in the usual way. The only problem with this sort of device is that fuel cells will oxidise virtually any reducing substance such as hydrogen, methane or even petrol. So expect no mercy from the Law if you have just returned from a fire-eating session.

To overcome this specificity problem, J. Tamaki *et al* have developed

a semiconductor detector that will respond only to alcohol vapour. It is based on a porous substrate onto which has been deposited a 50µm layer of lanthanum oxide, indium oxide and palladium. Gold lead-out wires then complete the assembly.

Indium oxide should keep the electrical resistance down, while the lanthanum oxide increases the sensitivity sevenfold compared with previous semiconductor alcohol detectors. Palladium also increases the sensitivity but more especially is said to reduce the 90% response time to about 35s for 1000ppm alcohol in air at 300°C.

As for the device characteristics, the output is said to be approximately linear from 0 to 100ppm and the response to other gases small.

It could be the end of the excuse: "Sorry officer, I've got this inexplicable craving for menthol cough sweets . . ."

Switching with half an electron

Half an electron is all that is needed to switch a novel electronic device from one state to another. That is the implication of some intriguing work done by U. Meirov *et al* of the MIT Department of Physics and Research Laboratory of Electronics (*Phys. Rev. Lett.* Vol. 65 No 6).

The device (**Fig. 1**) looks not unlike a conventional fet with the addition of two gates, each with a pair of constrictions reducing the channel width to around 100nm.

Putting restrictions on the channel through which electrons can flow is well established as a means of exploiting the quantum effects that occur in what are effectively one-dimensional structures. But until this latest work no-one had experimented with additional constrictions to isolate electrons in a sort of "box".

Inspiration to pursue this line of research came almost two years ago when Marc Kastner, also of MIT, was experimenting with a transistor similar to that shown in Fig. 1, but without the tiny restrictions. When plotting the characteristic curve of the device, he found that the output current did not, as expected, vary smoothly with the applied control voltage. Instead it varied up and down in a periodic fashion.

After months of head-scratching, Kastner concluded that there must be a pair of impurities along the channel that were somehow boxing in the electron flow and introducing unexpected quantum effects. The only explanation must be that the output current was varying according to the actual number of electrons in the box thus created.

To test this hypothesis, Kastner and Meirov, with S.J. Wind of IBM, constructed a device with the electron box created deliberately rather than by chance impurities. This meant the dimensions were precisely known and the device was more amenable to rigorous experimentation. In particular the team could make accurate calculations of electron numbers. Kastner estimates that under typical experimental condi-

tions the device has fewer than 100 electrons in the box at any one time.

When curves were plotted (**Fig.2**) and compared with calculations on electron population, the MIT team concluded that the current through the channel goes through a complete cycle each time the number of electrons in the restricted segment goes up or down by one.

In other words one electron causes the transistor to turn on, off and on again, and by applying logic, a single change of state should come about from addition of half an electron!

Disappointingly perhaps, the curves do not demonstrate the existence of half electrons; the single change of state comes about when the average

number in the box is something-and-a-half. This in turn is controlled by adjusting the voltage applied to the gate electrodes. A voltage change equivalent to an increase of 0.1 electrons in the box can change the output current by two orders of magnitude — an extraordinary sensitivity.

As yet there is no detailed theory to explain exactly what is happening, especially the non-cyclic variations in the characteristic curves. Nevertheless the possibility of a multi-state transistor that turns on and off dozens of times as the input voltage is varied is an intriguing one. So are the variety of possible commercial applications, not least frequency multipliers. Sadly, so far, the device will only work below 1k.

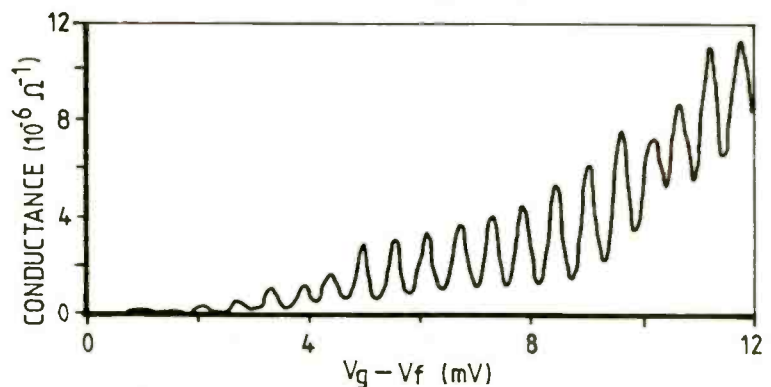
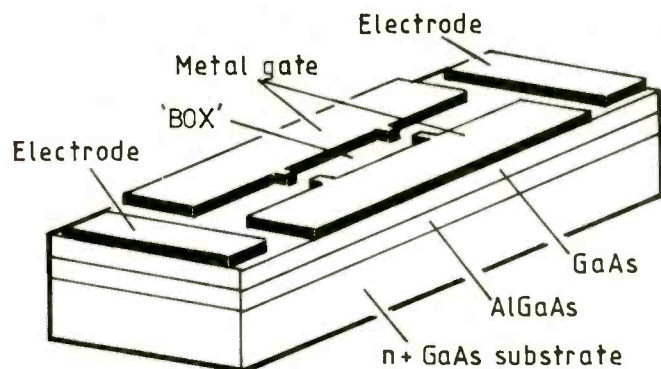

UNBEATABLE PRICES



GREAT OFFERS ON TRIED AND TESTED USED EQUIPMENT

SWEEP GENERATORS

HP 8350B Sweep Generator Mainframe	£ 1,750
HP 83590A Plug In 2-20 GHz	£ 5,250
HP 83592B Plug In 0.01-20GHz	£ 9,950

LOGIC ANALYSERS

HP 1630G 65 Channel Logic Analyser	£ 1,950
HP 1630D 43 Channel Logic Analyser	£ 1,750
HP 1631D Logic Analyser/Digitising Scope	£ 2,900
HP 1651A Logic Analyser	£ 1,950
TEK 1240 Logic Analyser	£ 895

SPECTRUM ANALYSERS

HP 8568A/B Spectrum Analyser 100MHz -1.5GHz	£16,000
HP 3582A Spectrum Analyser 0.02Hz -25.5KHz	£ 4,250
HP 3585A Spectrum Analyser 20Hz -40MHz	£ 8,750
HP 3585B Spectrum Analyser	£13,500
HP 8562A Spectrum Analyser	£18,000
HP 3562A Dynamic Signal Analyser	£10,950
HP 3561A/1001 Dynamic Signal Analyser	£ 6,650
MAR 2382 Spectrum Analyser 100Hz - 400MHz	£11,500

PROTOCOL ANALYSERS

Atlantic Research 4600 Protocol Analyser	£ 1,950
Atlantic Research Protocol Convertors (various)	£ 150
HP 4953A Protocol Analyser	£ 2,000
HP 4955A Protocol Analyser	£ 2,150

OSCILLOSCOPES

HP 1740A Oscilloscope	£ 974
HIT V209 20MHz Oscilloscope	£ 425
PHI PM3256 75MHz Oscilloscope C/W Battery Pack	£ 1,025
PHI PM3055 60MHz Oscilloscope	£ 641
TEK 2445 150MHz Oscilloscope	£ 1,640
TEK 7880 Plug In Timebase	£ 225
TEK 7A19 Plug In Amplifier	£ 656
TEK 7613 100MHz Mainframe	£ 513
TEK 7A29 Plug In Amplifier	£ 974
TEK 2465ACT 350MHz Oscilloscope	£ 2,950
TEK 7A24 Plug In Amplifier	£ 700
TEK 2225 50MHz Dual Channel Oscilloscope	£ 564
TEK 2215A 60MHz Dual Channel Oscilloscope	£ 400
TEK 2235 100MHz Dual Channel Oscilloscope	£ 850
TEK 2236 100MHz Dual Channel Oscilloscope	£ 1,538
TEK 2445A 150MHz Quad Channel Oscilloscope	£ 2,050
TEK 2465A 350MHz Quad Channel Oscilloscope	£ 2,870

TEK2465A - OPT10 350MHz Oscilloscope	£ 3,331
PHI PM3350 50MHz Dual Channel D.S.O.	£ 1,750
TEK 7S11 Plug In Sampler	£ 666
TEK 2201 20MHz Dual Channel Oscilloscope	£ 794
GOU 1604 20MHz D.S.O.	£ 1,538

HP 54501A 100MHz Quad Channel Digitising Scope	£ 1,845
PHI PM3320 Digital Oscilloscope	£ 4,049
TEK 2230 100MHz D.S.O.	£ 1,850
TEK 2430A 150MHz Dual Channel D.S.O.	£ 3,844

PULSE GENERATORS

HP 8112A Pulse Generator	£ 2,306
TEK PG508 Generator Plug In	£ 461
TEK TG501 Time Mark Generator	£ 359
TEK PG506 Pulse Generator	£ 1,281

FUNCTION GENERATORS

HP 8111A Pulse/Function Generator	£ 1,179
HP 3200B 500MHz Oscillator	£ 641
TEK SG503 Generator	£ 871
TEK SG504 Generator	£ 1,281

RF GENERATORS

ADR 742A Signal Generator	£ 3,500
MAR 2017 Signal Generator	£ 2,250

DIGITAL MULTIMETERS

FLU 8021B Digital Multimeter	£ 95
FLU 8050A/01 4.5 Digit Bench Multimeter	£ 300
FLU JF25 Analogue/Digital Hand Held Multimeter	£ 145
FLU JF37 Digital Multimeter	£ 145

EX-DEMO EQUIPMENT (AS NEW)

Byrans 84 IEEE A4 7 Pen Plotter	£ 700
Byrans 83 RS232 A4 10 Pen Plotter	£ 850
HIT V222 20 MHz Oscilloscope	£ 250
LLOYD 2002 2 Channel Chart Recorder	£ 250
MAR 2018A AM/FM Signal Generator	£ 1,750
MAR 6960 Power Meter	£ 750
PHI PM2519-514 4.5 Digit D.M.M. (inc GPIB)	£ 200
PHI PM3305-40 35MHz 4 Channel D.S.O.	£ 1,500
PHI PM5193 Synthesised Function Generator	£ 2,000
PHI PM6668-02 1GHz Counter	£ 200
RACAL 1998 1.3 GHz Universal Counter	£ 400
TEK 2335 100MHz Field Service Oscilloscope	£ 1,500
TEK 2336 AS 2335 +Timer/Counter/D.M.M.	£ 1,750
THA TA2500 72 Channel Logic Analyser	£ 1,850

All prices advertised are exclusive of carriage and VAT. All equipment sold subject to availability.
Warranty period 12 months on all equipment (except computers MDS - 3 months).

**WE BUY TOP QUALITY
TEST EQUIPMENT**

**For further information telephone
LONDON 0753 580000**

LONDON OFFICE & HEADQUARTERS
Dorcan House, Meadfield Road, Langley Berks, SL3 8AL, Tel: 0753 44878.

CIRCLE NO. 128 ON REPLY CARD



Red light from warm silicon

Ever since technologists first produced GaAs/GaAlAs light emitting diodes, the search has been on to find a silicon device structure which will operate in the visible spectrum at room temperature. Leds in silicon would have the significant advantage of integrating directly into standard integrated circuits.

Scientists at RSRE, Malvern may have made the necessary breakthrough. By fabricating extremely thin

structures in crystalline silicon, it appears that the band structure can be modified substantially to permit efficient visible light emission. Using a special dissolution method, free standing "quantum wires" less than 5nm in thickness have been produced on standard silicon wafers.

At this thickness — about 15 000 times thinner than a human hair — injected holes and carriers recombine to produce red light at efficiencies

comparable to those achieved with GaAs. RSRE used an unfocused 10mW green laser beam shining on the structure as the excitation source. The electron-hole pairs thus created produce strong, red emission easily visible to the naked eye. This is the first time that silicon photoluminescence has been observed at room temperature.

The researchers see excitation by current injection as the next step.

Case builds against power line leukaemia

Two independent research teams, one British and the other Russian, have come up with a possible mechanism showing how AC fields could cause childhood leukaemia. Though still far from conclusive, the theory is sufficiently plausible for other scientists to be taking it seriously. It is also the only explanation to take account of evidence suggesting that effects are restricted to certain specific AC frequencies.

Various suggestions have been made that AC magnetic fields can have harmful effects on the human body (Killing Fields, *EW+WW*, Feb 1990). In particular there's been a weak associative link in some studies between the incidence of childhood leukaemia and the proximity of overhead power lines. But as with so many epidemiological studies, there has been no absolute proof of any causal connection. Moreover no single plausible theory has explained how extremely weak non-ionising fields could affect biological processes.

However, according to Donald Edmonds of the Clarendon Laboratory at Oxford and John Male of National Grid Research and Development, a weak oscillating magnetic field together with a fixed field (such as the

earth's magnetic field) can act to weaken the chemical bonds that hold metal ions to complex protein molecules. Such metal-protein complexes are at the heart of many of the enzymes that regulate much of the body's biochemistry.

Behind the new theory, discussed recently at a meeting of Bioelectromagnetics Society in San Antonio, is the concept of cyclotron resonance frequency; the rate at which a charged particle circulates as it accelerates in a constant magnetic field. This is dependent on the charge and mass of the particle and the strength of the field. If a varying field (such as that from an AC power line) is then added, the particle accelerates further leading, in the case of an ion, to possible chemical effects.

What is now proposed by the British group, and independently by a Soviet scientist, Valeri Lednev, of the Institute of Biological Physics in Puschino is that the enhanced cyclotron oscillation at power line frequencies is sufficient to dislodge a calcium ion from a protein called calmodulin.

As may be deduced from its name, calmodulin is a substance which modulates the movement of calcium in and

out of cells and which is thus central to cellular functioning. Disturb such a system and, according to both groups of scientists, there is a perfectly adequate basis for explaining the way in which AC fields could cause childhood leukaemia.

Lednev has already demonstrated the effects on individual cells in the laboratory in a reproducible way. Power utilities in the UK, USA, Australia and Sweden are now taking the theory sufficiently seriously to fund more research into human subjects.

On the positive side, Edmonds believes that AC fields could be used beneficially for therapeutic purposes. If such fields can have direct and fundamental effects on cells, then it is conceivable that precisely measured, localised fields could be used to restore deficiencies in ionic transport. There are, for example, heart conditions in which calcium ions play a key role and for which magnetic fields might be used as a form of non-invasive therapy. Other metal ions might similarly be stimulated by AC fields of different frequencies. It certainly lends a new meaning to giving your body a tune-up! *Research Notes* is by John Wilson of the BBC World Service Science unit ■

A 20MHz top quality oscilloscope for £270?

This special offer, only available through Electronics World + Wireless World, represents unbelievable value.

We have assured ourselves that the Model 1021 oscilloscope from Japanese instrument manufacturer, Leader Electronics, more than meets its published specification and is of an exceptionally high build quality. Our judgement is backed by an unequivocal guarantee.

At £270 (inclusive of test probes, packaging and delivery but excluding VAT) the instrument is an absolute bargain.

- 20 MHz dual channel operation
- Variable trigger hold-off
- 5mV/div Y1/Y2 sensitivity at 20MHz
- 1mV/div Y1/Y2 x 5mag at 7MHz
- 200ns/div to 0.2s/div sweep rate
- DC to 500kHz X bandw dth
- X/Y operation using Y channels
- X/Y phase shift $<3^\circ$ at 20kHz
- 8 cm x 10 cm display area
- Calibration accuracy better than 3%
- 1kHz internal calibrator
- Special video signal trigger modes
- Rise-time <17.5 ns
- Graticule illumination
- Two x 10 probe kits included
- Unequivocal guarantee

To place your order please send in a cheque for £310.50 (which includes VAT) to the address shown. Alternatively complete the coupon with your credit card details or phone in your credit card order on 081-661 3614 (mornings only).

Oscilloscope offer, Room L333, Electronics World + Wireless World, Quadrant House, The Quadrant, Sutton SM2 5AS

LEADER OSCILLOSCOPE 1021 ORDER FORM

Please send me the special offer instrument

I enclose a cheque for £310.50 (inc VAT) payable to Reed Business Publishing Group

Please debit my credit card

Expiry date

Access Visa American Express Diners Club

To the sum of £310.50

Name: Mr. Mrs (with initials)

Address

Signature

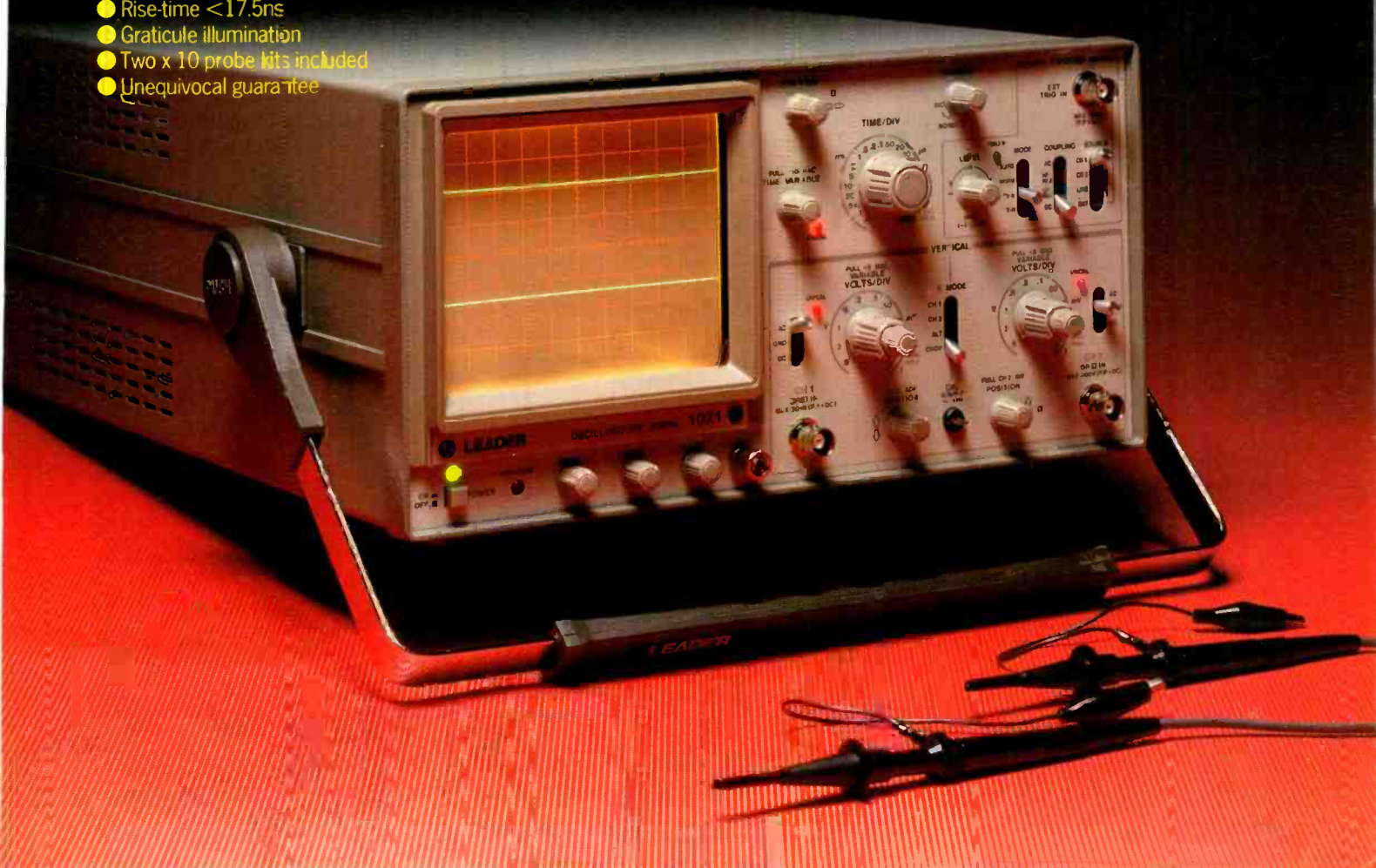

Euro-VLSI programme on target for expansion

Latest news from the VLSI Design Action, part of the EC Esprit programme to increase very large scale integration engineers in Europe by 3000 per year, is that ES2 is to supply design tools and silicon processing facilities for the Eurochip project.

Eurochip is a consortium of leading research institutions and academic institutes who are providing Europe's educational establishments with access to chip manufacture, IC design systems test equipment and training. Five members of the consortium are CMP (France), DTH (Denmark), GMD (W.

Germany), IMEC (Belgium) and RAL (UK).

On the design software part of the programme, ES2 submitted a joint proposal with Cadence Design Systems to supply a "General Release Package" – bundled software which includes Cadence's Opus software, Verilog tools, and ES2's Solo 1400 ASIC software. A further 60 Associated Institutions, selected by the CEC are also to be offered the package.

ES2 has been selected by Eurochip as the first choice vendor for chip prototypes. These will be

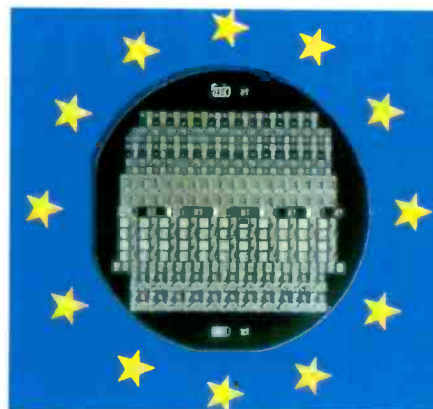

manufactured using ES2's double metal CMOS processes in 1.5 micron (1.1 effective channel length), with further reductions to sub-micron level over the life of the programme.

Help from above for jammed drivers

Observant motorists, or those who find being stuck in rush hour traffic jams gives them plenty of time to look around, may have been curious to note the appearance on bridges of what looks like new lighting units. In fact these are the sensor parts of the Trafficmaster traffic monitoring system designed to improve traffic flow on overcrowded motorways.

motorway has a hold up and consider taking an alternative route.

The sensors mounted on bridges at approximately two mile intervals log the speed of traffic passing below. If the speed drops below a pre-set threshold of 25mph, the sensors relay that information over a radio link to the General Logistics Control Centre at Luton. From there data is transmitted, using the Air Call Paging radio paging network, to a receiver unit mounted on the dashboard of the vehicle.

The receiver displays the information on a screen in map form,

giving the driver an audible and a visual signal when updated information is received. It can then zoom in to a close-up map of the problem area with a flashing block showing location, speed and direction of the hold-up- and length of tail-back. Information is updated every three minutes.

Since the system already uses paging technology, integral personal message paging is incorporated into the system.

The first phase of Trafficmaster will cover the M25 and motorways within a 35 mile radius of central London. Nationwide coverage is expected by Spring 1993.



Secretary of State for Transport Cecil Parkinson samples the latest information on blocked motorways.

In the system – claimed by makers General Logistics to be the first of its kind in the world – traffic information picked up from the sensors is interpreted by a central control station then relayed to a receiver unit mounted in a car, lorry or bus. Drivers are able to see whether a particular section of

PC Space saver

As of its next launch – whenever that's going to be – NASA's space shuttle will take up a GRiD lap-top fitted with a portable CD-ROM drive to replace the 230kg of paperwork which astronauts are forced to take with them. Since each kilogram costs \$2200 to place in orbit, the computer saves \$500,000 on each launch.



New biophysics studies

The National Grid Company has outlined six independent research projects on the biological effects of electric and magnetic fields.

According to the National Grid Research and Development Centre, 'the aim of the new work is to select those effects which appear to be biologically significant, to ensure that, where necessary, they are replicated and to develop studies which test the hypotheses raised by previous investigations.'

An independent Steering Committee, headed by Dr C Suckling, FRS, decided on the research topics and contracts have been placed for two or three years. The programmes will cost £600 000.

The projects are part of the National Grid's continuing research in this area. Last year it announced other projects, including a survey of personal exposure at home and at work among 200 electricity industry volunteers, and monitoring background levels in homes using specially fitted mobile vans.

The former research is expected to be completed next year. The NGC is also hoping to be involved in a new large-scale study into the causes of childhood cancer in the UK organised by the UK Co-ordinating Committee on Cancer Research.

The six funded studies are:

Metcalf JC, Hesketh TR. Dept of Biochemistry, University of Cambridge. 'Rapid biochemical responses in cultured cells to power-frequency electric and magnetic fields';

Hladky SB. Dept of Pharmacology, University of Cambridge. 'Effects of low-frequency magnetic fields on single ion channels';

Dexter TM, Dale RE. Paterson Institute for Cancer Research, Manchester. 'Effects of low-frequency, alternating magnetic fields on short-term responses of haemopoietic stem and progenitor cells to specific growth factors';

Anderson M, Birley AJ. School of Biological Sciences, University of Birmingham. 'The effects of low-frequency electro-magnetic fields on cellular transcription in *Sciara* and *Drosophila* salivary glands';

Dixey R. St Bartholomew's Hospital, London; Green JC. Plymouth Marine Laboratory. 'The uptake of Ca^{++} in a frequency-dependent or 'resonant' manner as indicated by changes in the mobility of diatom strains sensitive to the Ca^{++} concentration in their support medium';

Pethig R, Morgan H. Institute of Molecular and Biomolecular Electronics, University College of North Wales, Bangor. 'Influence of low-frequency electromagnetic fields on ion flux through reconstituted membrane channels'.

Finally, it is awaiting the results of two studies: one of childhood cancer and possible links to the magnetic fields from overhead pylons, to be published in the British Journal of Cancer by the end of the year; the other, of possible connections between adult cancer and exposure to environmental EMFs. Both are being carried out by researchers at the University of Leeds.

Chip promises cheaper teletext

Philips Components is to use a single chip in its teletext decoders for analogue TVs, removing the need for up to 40 peripheral components. At the same time the chip has been designed to allow viewers to set VCRs using teletext facilities, simplifying programming. It will also cut power consumption by 2W.

The ITV1 combines the previous ECCT (enhanced computer controlled teletext) and VIP-2 (video input processor) chip set in a single chip working from a 5V supply.

The SAA5246 (IVT1.0) can acquire four teletext pages simultaneously, storing them in external 8k-by-8-bit ram. The SAA5244 (IVT1.1) is primarily aimed at small-screen TVs; it provides one acquisition channel, and can store the acquired page in on-chip ram.

Philips is developing an IC which will store the full teletext data base in off-chip ram, and so will display any page instantaneously. Typically only 22 peripheral components are needed instead of the previous 60, to construct a complete World System Teletext decoder.

Each IC extracts teletext data from the video signal, regenerates the teletext clock, and synchronises the

text display to the TV sync. circuits. Analogue data slicing used by the ECC/VIP2 chip set is replaced with digital data slicing, incorporating analogue circuits and A-to-D converters.

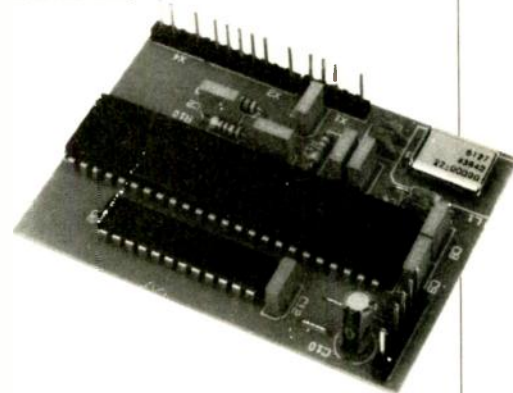

Single chip teletext solution.

The ICs support both video and scan-related synchronisation modes, and have a display clock phase locked-loop circuit. They connect to a microcontroller across the industry-standard serial, two-wire I²C-bus. There is an RGB interface to standard colour decoder ICs, with a push-pull output drive.

University aided in DSP research

Bristol University's Centre for Communications Research has been given a boost in its design of advanced signal processing functions by donation of a floating point DSP emulator from Texas Instruments.

Professor Joe McGeehan and Dr Andrew Bateman of the Centre took delivery of TI's TMS320C30 in-circuit emulator from Craig Marven, Higher Education Programme Manager at Texas Instruments.

Professor McGeehan, Director of the Centre said the development system would give undergraduate and postgraduate students access to the latest signal processing technology, "providing them with an insight into the many and diverse applications that this technology can support throughout the engineering disciplines."

The Centre for Communications Research was established by the University of Bristol in 1987 with the purpose to provide a broad-based, high-calibre research capability in the field of mobile communications networks and systems.



Professor Joe McGeehan and Dr Andrew Bateman take delivery of the in-circuit emulator from TI's Craig Marven (standing).

The PC was not designed to be an industrial computer. In many ways, the design considerations which IBM applied when inventing its desktop go completely against the needs of the industrial market. The way the XT, AT, and to a lesser extent, MCA buses function contradicts the needs of systems integration. There is no formal bus standard, bus I/O space is limited and a standard PC system can't cope with an environment any harsher than a desktop.

Despite all this, the trend towards using PC architectures in such environments continues as quickly as the equipment makers can manage. In most cases the reasons for this are non-technical. This is a market-driven tendency. The vast majority of computer applications do not lend themselves to the use of standard hardware. Users need more or less processing power, special types of input and output, varying data speeds. No-one wants to pay for useless features, but, if a computer needs to, say, drive a servo, then that facility has to be incorporated.

The alternatives

The IBM market provides the answer through a mix of commercial/custom software and a standard base unit stuffed with off-the-shelf add-in cards. Everything slots together to make the final system which can be a factory controller, a video graphics paintbox or a cash register. IBM cards enjoy a diversity not found in VME, STE or any other bus system.

There are, of course, established bus alternatives at a cost. The 8-bit STE bus is popular in industrial environments where its physical strength and ability to accommodate many cards in a single rack are essential. VME and Multibus are 32-bit architectures, and offer higher performance. VME, for instance, has a quoted maximum data rate of 40Mbyte/s and, being 32-bit, can live with the more powerful microprocessors. These are just three of many. So why should anyone want to attempt a similar trick with the PC architectures?

The first reason is familiarity. Users feel comfortable with their PCs, and want something that will at least look

Working the system



Some estimates put the number of obtainable PC card species in the tens of thousands. If the application exists, someone, somewhere has probably built a card to support it. Andrew Gothard reports on technical PC flora and fauna.

familiar. But that is not the whole story. After all, there are now several vendors offering single-card PCs or ATs which will plug into an STE backplane providing familiar PC facilities in STE. This allows the bus to run all the usual PC applications software, another reason often cited for taking the PC route.

PC systems also have the advantage of compatibility. Getting data from the acquisition stage to, say, statistical analysis, then moving it back as some kind of control signal is best done in a single environment. And if you want lots of small computers to talk to each other (think of the supermarket point of sale terminals), it really is an advantage to give them a common language.

Even on a smaller scale, compatibility is important. An engineer may buy a single expansion card to perform a single control or monitoring function. The chances are that another card, another function, will follow at some time afterwards. If that happens a number of times, the end result tends towards a fully configured system with all the development done.

Another factor driving PC systems integration is simply that it is possible. PCs have expansion slots, and cards to go in the slots are available. From graphics acceleration, through co-processors, and on to I/O and control cards, the hardware is there. Creating the final system becomes almost as simple as building Lego. In short, it is possible to build a backplane-based system just like any other.

That the process is so simple leads to low cost. In the words of Alan Turner, of systems integration company Chip-tech, "the whole thing rests on the fact you've got extremely low cost hardware. And by association with a high volume thing like the PC, all the bugs

get driven out. You're tapping into a safety factor associated with numbers."

This assertion is backed up by Louis Prtak, formerly with PC and subsystem supplier Blue Chip Technology. He says that the sheer number of different products now available brings the final system price down. "I can't think of any facility you can't find off the shelf," he says. Development, too, is cheaper, because the PC design keeps the non-expert in mind. "Although the PC isn't ideal," he explains, "you've got off the shelf development tools."

Controlling software

The availability of development software is one of the main driving forces behind the whole market, particularly in the field of data acquisition. Programs like National Instruments' LabWindows, Adept's Workbench, or Keithley's Asyst, can be used to control the companies' plug-in instrumentation and data acquisition products, as well as external GPIB or RS-232 controlled modules. The screen, mouse and keyboard of the PC can even be made

to look and function like a traditional standalone instrument. Such programs determine what the operator sees on the screen, allow statistical analysis, and control peripherals such as printers.

This type of engineering software also enables passing of data to and from other standard PC packages like Lotus, and to more specialised software like Data Translation's Global Lab, or Adept's DADiSP. The last two bring in digital signal processing functions such as infinite/finite impulse response filtering and fast Fourier transforms.

For developers, having such programs also means that it is not necessary to know all about the vicissitudes of the PC-bus simply to get a basic system up and running. Often, configuring the system can be merely a matter of connecting up a number of icons on the PC screen.

In industrial rather than laboratory applications, PCs find their way into production test and SCADA (supervisory control and data acquisition). There is still a feeling that business

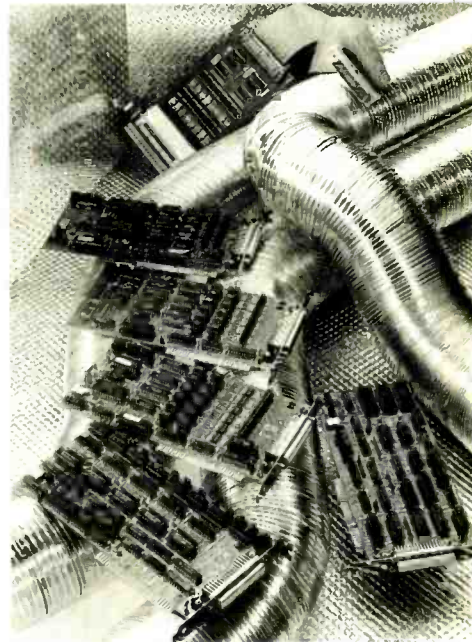

Grudging acceptance of IBM architecture: STE supplier Arcom now offers PC cards.

machines are not sufficiently robust, either physically or in terms of software and operating systems to cope with

ARTISTIC LICENCE

PRESENT THEIR NEW RANGE OF

PC-BUS I/O CARDS

Whatever your application - industrial control, laboratory data acquisition or simple digital I/O - our new range of PC-Bus I/O cards provide the solution.

The cards are all "Port Mapped", and can be driven by any programming language. On board address selection ensures simple configuration for existing software packages.

All cards are supplied with a detailed manual, example programs, diagnostic and driver software.

We also offer design services for both custom software and application specific hardware.

DIB	24 opto-isolated digital inputs. 5V DC-DC converter.	£ 125
DOB	24 opto-isolated darlington outputs. 400mA per channel.	£ 125
DIO	16 opto-isolated inputs, 8 opto-isolated darlington outputs. 5V DC-DC converter.	£ 125
PIO	48 channel programmable TTL input/output.	£ 85
ROC	16 relays, available in form A, B, C and unpopulated.	£ 135

Prices exclude VAT and delivery.

Contact ARTISTIC LICENCE (UK) LTD. on 081-904-2803
61 The Avenue Preston Road Wembley Middlesex HA9 9PH

All products designed and manufactured in the U.K.
OEM & Distributor enquiries welcome

CIRCLE NO. 129 ON REPLY CARD

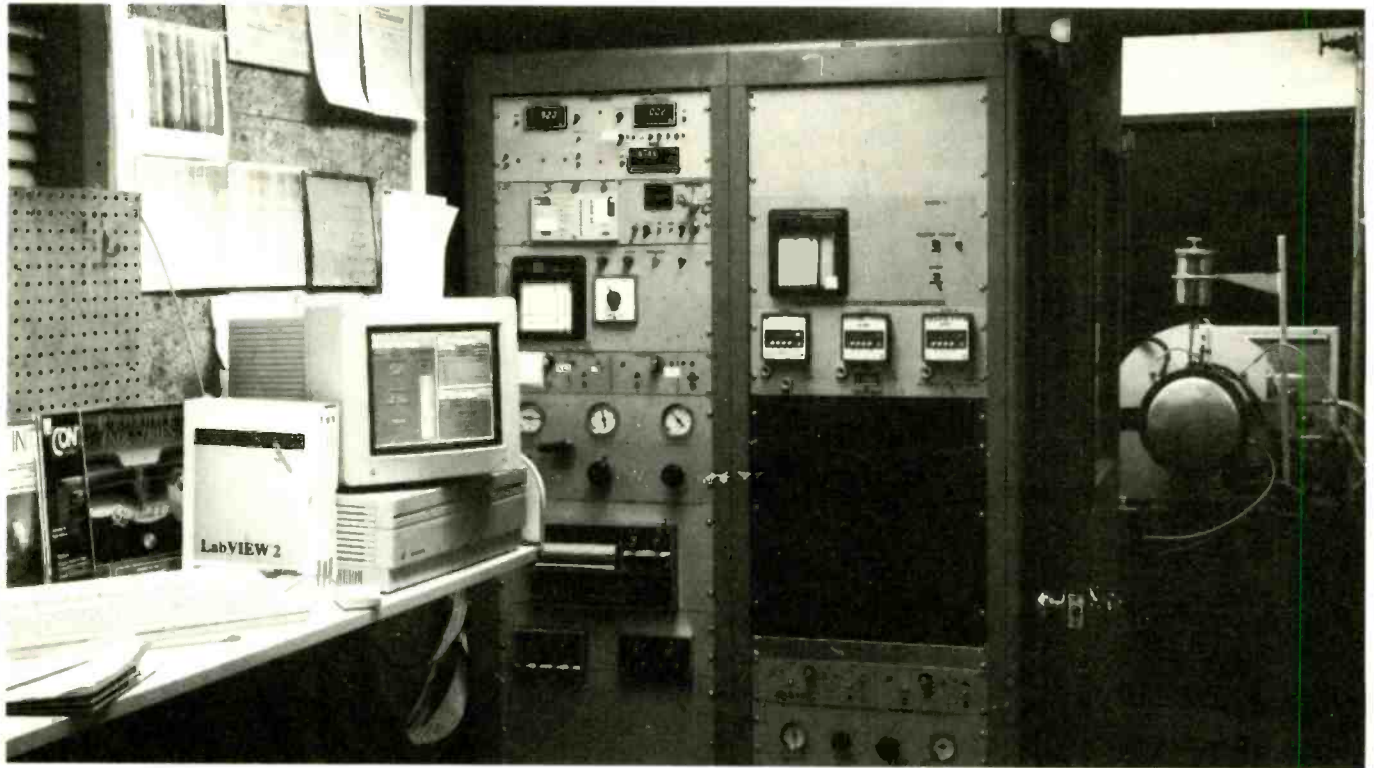

ultimate control. According to Dick Haycock, of systems and software house Hexatec, "If PCs are used in control there should be protection behind them." Hexatec produces an off-the-shelf SCADA software package called Scan 1000, which Haycock says provides an economical way of giving operators process information, and allowing them to change process settings.

Haycock cites applications as diverse as monitoring the boilers of a 1200MW power station, collecting data from environmental tests, and monitoring the malting of barley, as areas where PCs have been used. "The industrial and laboratory situations are entirely different.

"Cards in the back of a PC tend to be in fairly small applications, where you're not going beyond tens of channels" he comments.

In contrast, a large industrial application will involve signal conditioning and A/D conversion outside the PC box, with control vested in programmable logic. Hundreds of channels of data can then be sent via multiplexer and serial link to a PC or PC network. This provides the user interface, datalogging and statistical analysis facilities, perhaps along with some supervisory control. This is where software like Scan1000 comes in. The package is written in C, and runs under Microsoft Windows. Haycock claims that a GUI (graphic user interface) is a distinct advantage when it comes to

Taking the pain out of system software development: IEEE systems integration with LabWindows.

adapting to changes in, for instance, display types.

An incomplete answer

Louis Prtak maintains that the PC has often entered the industrial arena by replacing the PLC. Blue Chip, he says, spotted the possibilities relatively early, and started selling Olivetti PCs, modified to cope with the harsher industrial environment before moving on to a range of data acquisition and control cards. He says that there are good reasons for choosing PC-based systems, rather than STE. "There are very few things you can do with STE that you can't do with a PC," he says.

Of course, not everybody agrees with that statement, vendors of STE-bus cards and systems in particular. An interesting perspective on this is provided by Arcom, and its distributor Dean Microsystems. Both companies have, until recently, been firmly wedded to the STE idea, but recently found market pressure too much, and jointly launched a range of PC-type cards. The two companies insist that both technologies will live happily side by side in the catalogue, STE remaining the system of choice for applications which need its more extensive I/O space (that basically means that you can have more cards in a system), ease of packaging, and resistance to harsh environments.

Catching the bus

Launching the PC products, Arcom's Anthony Winter pointed to six primary areas of difficulty in configuring PC systems, the first being the lack of experience of many PC-bus vendors in the industrial market place. This, he said, is exacerbated by the desire of customers to do things as cheaply as possible, "fighting their real needs," as he put it. Lack of support, he argued, is a further problem, stemming mainly from a tendency to sell a board and leave the user to work it into the system.

On the technical front, he pointed to a lack of panel space and I/O addresses, as well as a connector system and card size not intended for systems integration, as major difficulties. Dean and Arcom say that their approach solves these problems. But before looking at just how this is done, it is worth taking a step back to consider one fundamental of choosing a PC-type system — the bus itself.

PCbus is not a single product type. Besides the original 8-bit PC-type, there are now XT, AT, MCA, ISA and EISA variants. MCA and EISA stay temporarily out of the picture for two reasons. First, there are very few processor cards available for these two architectures, either in motherboard or expansion card form. So relatively few peripheral boards are commercially

Continued on page 946

Who Said You Can't Have It All?



16 & 32-bit PROCESSORS

- Intel 8088
- Intel 80186
- Intel 80286
- Intel 80386SX
- Motorola 68000
- Motorola 68010
- Motorola 68020
- Motorola 68030

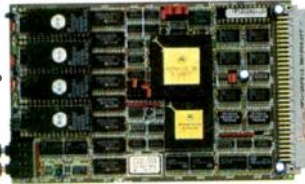

STATIC & DYNAMIC MEMORIES

- 512K to 8 Mbytes Dynamic Memory Boards
- Universal EPROM/RAM Static Memory Boards
- System Expandable to 32Mb

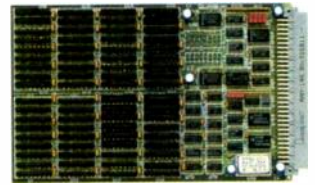

COLOR GRAPHICS

- 640x480x256 Colors
- 800x600x256 Colors
- EGA
- VGA
- Touch Screen EL Display

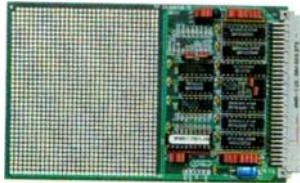

ACCESSORIES

- Predecoded Prototyping Boards
- Terminal Strip Adapters
- Power Supplies
- Bus Extenders
- Packaging Products



MASS STORAGE

- 3.5" & 5.25" Floppy Disk Controllers and Drives
- ST506 Winchester Controller and Drives (up to 70 Mb)
- Intelligent SCSI Controller (up to 1 Gb)
- Tape Streamer



MOTION CONTROL

- DC Servo controllers
- Stepper Motor Controllers
- Shaft Encoder

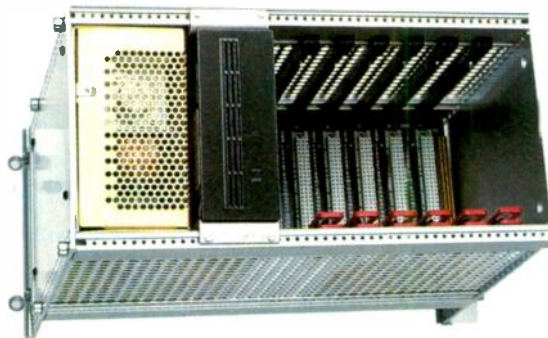

MS-DOS®

- Popular and User Friendly Single Task, Single User Operating System
- Runs on Intel Processor Based Systems
- Allows the Use of Any of Thousands of PC Software Products
- ROMed Version Available for Applications in Harsh Environment



OS-9®

- Real-Time Multitasking, Multi-User Operating System for Motorola Processors
- UNIX-like Syntax and UNIX Compatible C Library
- Modular and Totally ROMable Software Architecture
- Editor, Assembler and C Compilers Allows Self Hosted Software Development
- Cross Development Tools Available for PC and UNIX Workstations



VISION SUBSYSTEMS

- 256 to 2048 Elements Linear CCD Cameras
- Matrix CCD Cameras Interfaces
- Real-Time Image Processing Hardware



NETWORKING

- 10 Mb/s Ethernet*
- 10 Mb/s X25
- 1 Mb/s GESNET*
- 1 Mb/s Arcnet*
- 1 Mb/s IEEE 488
- 375 Kb/s Bitbus*



INPUT/OUTPUT INTERFACES

- RS 232 / 442 / 485 SIOs
- Parallel TTL I/Os
- 10, 12 and 16-bit A/D & D/A
- Thermocouple, RTD, Resolver Interfaces
- Opto Isolated I/Os
- Mechanical & Solid State Relays

Whoever said that obviously doesn't know about GESPAC. With GESPAC, you get nearly 200 boards designed to **work together**, available from under a single roof and backed by a team dedicated to your success. What's more, all of these boards are supported with two operating systems (MS-DOS® and OS-9®) a choice of Real-Time kernels, a choice of IBM PC or UNIX® based cross development tools, and virtually one

software driver for every board we make.

Call us today to receive the industry's most comprehensive catalog of microsystem solutions. See how GESPAC can help you build the system that best meet your unique specifications, in the shortest amount of time.

DISTRIBUTED IN THE U.K. BY:
ALTEK Microcomponents Ltd.
Lifetrend House, Heyes Lane
Alderley Edge, Cheshire SK9 7LW
Tel. 0625/582 637 - Fax 0625/584 804



AD014E-8934

INTERNATIONAL

18, ch. des Aulx
CH-1228 Geneva
Tel. (22) 794 34 00
Fax (22) 794 64 77
Telex 429 989

FRANCE

Z.I. Les Playes
83500 La Seyne s/Mer
Tel. 94 30 34 34
Fax 94 87 35 52
Telex 430 457

USA

50 West Hoover
Mesa, AZ 85210
Tel. (602) 962-5550
Fax (602) 962-5750
Telex 386 575

CIRCLE NO. 157 ON REPLY CARD

Professional Solutions Limited

18 Dalston Gardens, Stanmore, Middlesex HA7 1DA

Tel:(081)-206-2095 Fax:(081)-206-2096



**COMPLETE SYSTEMS - MOTHERBOARDS - DISC & TAPE DRIVES + CONTROLLERS
MONITORS & ADAPTORS - DRAM/SIMM/SIP MEMORY - I/O CARDS - KEYBOARDS
DTP/CAD - ETHERNET/ARCNET - NOVELL - TCP/NFS - DOS/C-DOS - XENIX/UNIX**



RAM, SIP, SIMM

All 80ns speed:-

256Kbit (256Kx1) DIP	£2.39
256Kbit (64Kx4) DIP	£2.39
1Mbit (1Mx1) DIP	£7.39
1Mbit (256Kx4) DIP	£7.39
256Kbyte SIMM or SIP	£21
1Mbyte SIMM or SIP	£75
4Mbyte SIMM or SIP	£475

*All prices exclude VAT and Delivery and are based upon payment with order
*Mail orders accepted with ACCESS/VISA
*1 year warranty is given on all goods
*Prices and specifications are subject to change without notice.
*PSL is a licenced credit broker and can offer 1 - 5 year Lease/Purchase agreements to business purchasers.
*OEM, S/W House and Dealer enquiries welcome.

HARD DISC DRIVES

SIZE (Mb)	ACCESS (ms)	MODE	PEAK (byte/s)	DIM	PRICE
21	40	MFM	625K	3.5"	£169
21	28	MFM	625K	3.5"	£209
32	28	MFM	625K	3.5"	£235
32	40	RLL	940K	3.5"	£195
32	28	RLL	940K	3.5"	£229
42	24	MFM	625K	3.5"	£275
42	28	IDE	1.2M	3.5"	£269
49	28	RLL	940K	3.5"	£265
68	24	RLL	940K	3.5"	£305
115	19	ESDI	1.2M	3.5"	£535
150	16	ESDI	1.2M	5.25"	£645
320	18	ESDI	1.2M	5.25"	£1259
640	16	ESDI	1.8M	5.25"	£1699
1050	14	SCSI	4M	5.25"	£3469
Single drive cable set					£10
Dual drive cable set					£15
5.25" tray for 3.5" drives					£9

COM/LPT AND SUPER I/O CARDS

All cards are for PC/XT/AT, 8-bit:

2 Serial, 1 Parallel, 1 Games	£29
As above plus clock/cal/batt. & Dual 360K/720K/1.2M/1.44M Floppy Disc Controller	£49

KEYBOARDS, MOUSE, TRACKERBALL

102 key UK AT kbd	£44
102 key French kbd	£68
Hi-Res Serial Mouse, Microsoft Compatible, 3-Button, s/w	£35
Serial Trackerball, Microsoft Compatible, 3-Button, s/w	£55

FLOPPY DRIVES

360 Kbyte, 5.25 inch	£64
1.2 Mbyte, 5.25 inch	£78
720 Kbyte, 3.5 inch	£58
1.44 Mbyte, 3.5 inch	£73
5.25" tray for 3.5" drives	£9
Cable for 1 or 2 drives	£6

MONITORS

Hercules Mono 720x348: Amber or Paper-White 12" - £75 14" - £85	
VGA Mono Paper-White: 14" 640x480 £95 17" 1024x768 £669 21" 1280x1024 £999	
Colour VGA, PGC, 8514A, and Multisync: 14" 640x480, VGA, .31mm £269 14" 1024x768, VGA, .28mm £349 14" 800x600, Msync, .31mm £389 14" 1024x768, Msync, .28mm £419 16" 1024x768, Msync, .28mm £779 20" 1280x1024, Msync, .31mm £1699	

DISC CONTROLLERS

Combined Floppy (360/720K+1.2/1.44M) and 16-bit Hard disc controller with:

1:1 interleave MFM 450Kbyte/sec	£77
1:1 interleave RLL 690Kbyte/sec	£93
1:1 interleave RLL 1.2Mbyte/sec	£115
1:1 interleave ESDI 800Kbyte/sec	£169
1:1 interleave ESDI 1.2Mbyte/sec	£186
IDE/AT-BUS 690Kbyte/sec	£33
SCSI "Future Domain" 2Mbyte/sec	£89

XT 8-bit hard disc controller 1:1
MFM - £43 RLL - £54

FLOPPY ADAPTORS

All cards are for PC/XT/AT, 8-bit and support 360K/720K/1.2M/1.44M

Internal, 1 or 2 drives (A:,B:)	£29
Int/Ext, 1 or 2 drives (A:->G:)	£49
Int/Ext, 1 to 4 drives (A:->G:)	£65

Cache Disc Controllers:

Ultra High Performance CACHE disc controllers, good for NOVELL, UNIX etc... (All are SCSI interface)

16-bit, 2Mbyte Cache, 2.5Mbyte/sec	£1189
16-bit, 8Mbyte Cache, 2.5Mbyte/sec	£1889
32-bit, 2Mbyte Cache, 7.5Mbyte/sec	£1189
32-bit, 4Mbyte Cache, 7.5Mbyte/sec	£1319
32-bit, 8Mbyte Cache, 7.5Mbyte/sec	£1889

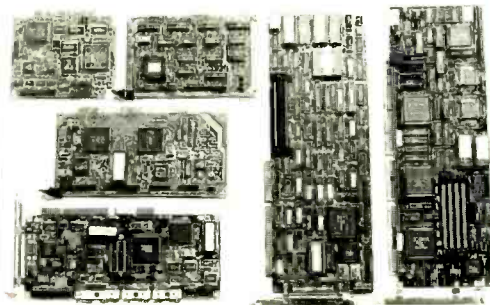

BELL VGA MONITOR CONTROLLERS

Columns	640	640	800	800	1024	1024	RAM SIZE	VGA CHIP TYPE	HIGH SPEED CACHE	PRICE £
Rows	480	480	600	600	768	768				
Colours	16	256	16	256	16	256				
	Y		Y				256	OAK		89
	Y	Y	Y		Y		512	PARADISE		135
	Y	Y	Y	Y	Y		512	TSENG		159
	Y	Y	Y	Y	Y	Y	1024	TSENG	Y	219

All VGA controllers support: * 8 bit and 16 bit bus.
* VGA Mono with 64 grey scales.
* Hercules, MDA, CGA and EGA software.

Mono/Colour Graphic/Hercules/Printer Port adaptor, 64Kb £29

TIGA/DGIS/8514A MONITOR CONTROLLERS:

Texas Instruments TI34010 and TI34020 based Graphic Processor Controllers from £549 — High-Res, High-Speed, High-Colour.

CALL OUR SALES DEPARTMENT FOR DETAILS OF:

- * Single and Multi-User UNIX/XENIX systems.
- * On-site hardware maintenance contracts.
- * Complete system integration of hardware and software.
- * Export Department for foreign orders.

Professional Solutions Limited

18 Dalston Gardens, Stanmore, Middlesex HA7 1DA

Tel:(081)-206-2095 Fax:(081)-206-2096

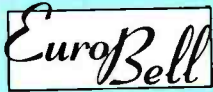

**COMPLETE SYSTEMS - MOTHERBOARDS - DISC & TAPE DRIVES + CONTROLLERS
MONITORS & ADAPTORS - DRAM/SIMM/SIP MEMORY - I/O CARDS - KEYBOARDS
DTP/CAD - ETHERNET/ARCNET - NOVELL - TCP/NFS - DOS/C-DOS - XENIX/UNIX**

BELL RANGE OF IBM COMPATIBLE COMPUTER SYSTEMS

BELL 80x86 Motherboards: Technical Information						Prices (£): Motherboards				Prices (£): Complete Systems						
CPU	Clock Speed MHz	Land -mark MHz	Max. RAM Mb	Cache RAM Kb	Slots 8/16/32 bits	Installed RAM (Mbyte):				Disc Capacity (Mbyte):						
						0	1	2	4	0	21	32	49	68	115	150
8088	12	2.8	1	-	8/0/0	42	102	-	-	395	615	649	715	759	-	-
80286	10	13.5	4	-	2/5/0	89	149	235	389	455	675	715	785	829	-	-
80286	12	16.5	8	-	2/6/0	119	179	239	359	545	765	805	875	919	-	-
80286	16	21.5	8	-	2/6/0	159	219	315	399	595	815	855	925	969	-	-
80286	20	27.0	8	-	3/4/0	229	329	389	549	679	-	935	999	1049	1379	1489
80386SX	16	21.0	8	-	2/6/0	299	369	419	539	725	-	985	1049	1095	1419	1529
80386	20	27.5	16	-	2/6/0	499	579	659	789	839	-	1139	1169	1215	1539	1649
80386	25	34.0	16	-	2/6/0	575	665	745	875	925	-	1225	1255	1299	1625	1735
80386	25	43.0	16	64	2/6/0	765	849	935	1065	* 1359	-	-	1689	1735	2059	2169
80386	33	58.0	16	32	2/6/0	1019	1099	1189	1319	* 1615	-	-	1945	1989	2315	2425
80386	33	59.0	32	128	0/6/2	1439	1529	1599	1739	* -	-	-	2405	2449	2769	2885
80486	25	114.0	16	64	2/6/0	2039	2125	2209	2399	* 2639	-	-	3009	3239	3335	3445
80486	25	114.0	32	128	0/0/8	3569	-	-	3869	** -	-	-	4659	4699	5025	5135

All systems include: 1Mb RAM, 3.5" or 5.25" Floppy Disc Drive, Case, Power Supply and Mains Lead, 102-key AT Compatible Keyboard, 14" Mono Monitor, 2 Serial Ports, 1 Parallel Port, 1 Games Port.
*2Mb RAM included **4Mb RAM included

ADD £79 for Mono VGA; £259 for Colour VGA; £69 for MS-DOS 4.01; £49 for MS-DOS 3.3; £69 for DR-DOS 5; £29 for Mouse.

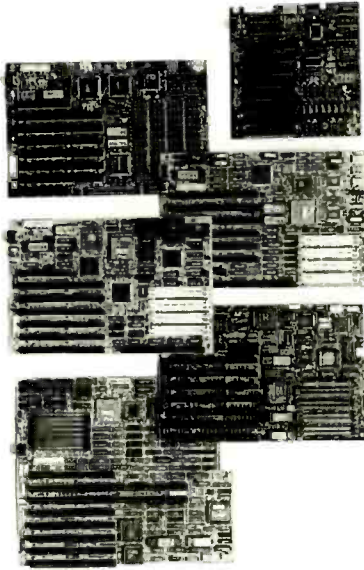

Flip-Top Compact, 200W £99
Table top low profile, 200W £109
Table top compact, 200W £119
Mini Tower XT table top, 200W £149
Mini Tower AT table top, 230W £199
Std. Tower AT floor stdg, 230W £229
Maxi Tower AT floor stdg, 400W £899

SYSTEM CASES

System Enclosures include Front Panel controls and wiring, PSU and Fan(s)

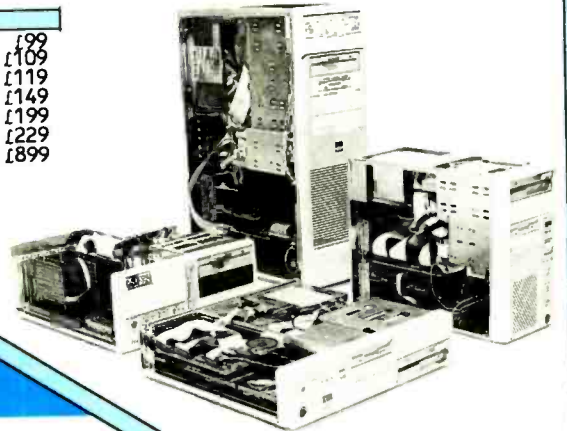

NETWORK STARTER KITS

Complete package of LAN software and LAN controllers, cables, T-pieces, terminators and boot PROMs.

	ArcNet	Ethernet
1 Server, 3 Workstations:		
Novell ELS I	£635	£880
APX LAN O/S	£540	£785
1 Server, 7 Workstations:		
Novell ELS II	£1800	£2285
APX LAN O/S	£800	£1284
1 Server, 15 Workstations:		
Novell AdvNet	£3330	£4205
APX LAN O/S	£1760	£2635

ARCNET

IEEE 802.4 - 2.5Mbit/sec
Low Cost Network:

LAN card - BUS, STAR or Twisted Pair	£59
4-port Active Hub card, coaxial or Twisted Pair	£109
Stand-alone Hubs:	
4-port Passive	£85
8-port Active	£129

ETHERNET

IEEE 802.3 - 10Mbit/sec
High Performance Network:

Boot PROMs: NOVELL £10; TCP/IP £20

8-bit W/S card "NE1000"	£125
16-bit Server card "NE2000"	£159
8-bit W/S for TCP/IP	£169
16-bit Server for TCP/IP	£239
32-bit EISA high-speed "NE2000" server card	£299

Terminal Servers for TCP/IP-NFS networks, full functionality, includes fan-out cables and s/w:
16 serial ports, 1 parallel £2695
32 serial ports, 1 parallel £3995

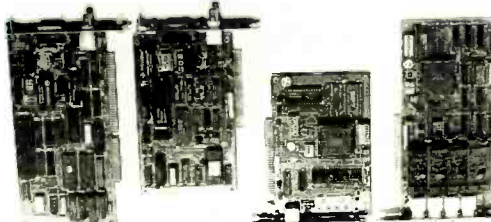

TOKEN RING

IEEE 802.5 - 4Mbit/sec
IBM Compatible Network:

8-bit Workstation Card	£299
16-bit Server Card	£469

***Call for 16Mbit/sec Controllers

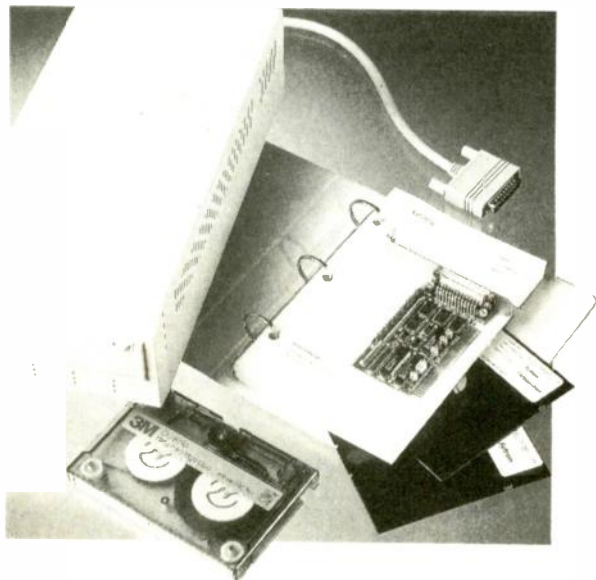

TAPE BACKUP SYSTEM FOR YOUR PC

Protect the valuable data on your PC's hard disk. Make a copy on a DC600 tape cartridge with Panther – the new tape backup system from Tandberg Data.

Panther is for use with IBM PC/XT/AT (or compatible) computers, or the IBM PS/2 range. There are versions to mount inside your computer or to stand alongside it. Backup storage capacities range from 60 to 525Mbyte. QIC-02 or SCSI interface is provided together with SY-TOS operating software.

Panther is for networks and multiuser environments as well as single users. Operating systems supported include PC-DOS, MS-DOS, OS/2, Novell, 10-Net, LAN Manager and Token Ring. Connectability with Xenix, Prologue, UNIX and Pick is also offered.

Contact us now for details and we will put you in touch with your local distributor/dealer. OEM enquiries for build-in systems invited.

FARNELL
TANDBERG
DATA
 COMPUTER PERIPHERALS

FARNELL TANDBERG DATA
 DAVENPORT HOUSE · BOWERS WAY · HARPENDEN
 HERTS · AL5 4HX · TEL (0582) 769071 · FAX (0582) 769025

CIRCLE NO. 130 ON REPLY CARD

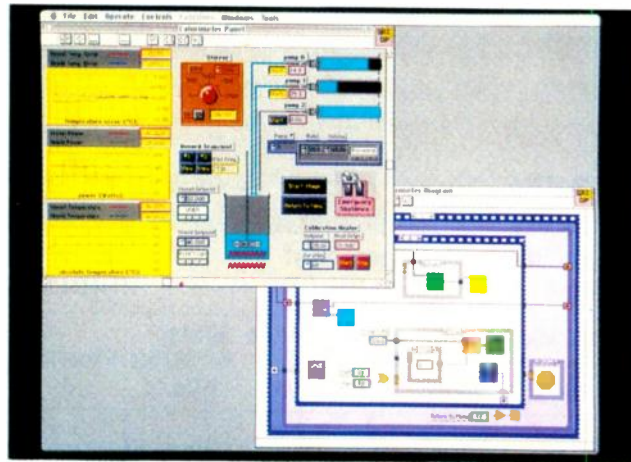

Macintosh has made little impact in systems integration even though NuBus is technically superior to the AT bus.

available. Without the availability factor, MCA and EISA will not get off the ground.

The second reason is the nature of the market itself. Engineers are unlikely to choose a system simply because they want the very latest machine. Prtak: "The factors which affect the business market don't affect the engineering market. Engineering is very down to earth." Alan Turner agrees: "Very few of our customers ask for a 386 when they don't need it," he says. "They're not into PC hype, very often they survive with an 8088."

Aces

Aces House
 St Georges Avenue
 Poole
 Dorset
 BH12 4ND
 0202 723373

Adept Scientific

6, Business Centre West
 Avenue One
 Letchworth
 Herts
 SG6 2HB
 0462 480055

Arcom

Unit 8
 Clifton Road
 Cambridge
 CB1 4WH
 0223 411200

BICC Vero Circuit Boards

Flanders Road
 Hedge End
 Southampton
 SO3 3LG
 0703 266300

Blue Chip Technology

Hawarden Industrial Park
 Manor Lane
 Deeside
 Clwyd
 CH5 3PP
 0244 520222

Burr Brown

1, Millfield House
 Woodshots Meadow
 Watford
 Dorset
 WD1 6YX
 0923 33837

Chiptech

Unit 1
 Tewin Court
 Welwyn Garden City
 AL7 1AU
 0707 335390

Fairchild

East Point Burgoyne Rd
 Thornhill
 Southampton
 SO2 6PB
 042121 6527

Data Translation

The Mulberry Business Park RG3 1BR

Wokingham

Berks

RG11 2QJ

Dean Microsystems

11, Horseshoe Park
 Pangbourne
 Reading
 RG8 7JW
 0734 845155

Diamond Point International

Unit 9
 North Point Business Estate
 Enterprise Close
 Medway City Estate
 Rochester-upon-Medway
 Kent

ME2 4LY
 0634 722390

Hexatec

The Courtyard
 Ochre Lands
 Hexham
 Northumberland
 NE43 1SB
 0434 605575

Keithley

The Minster
 58, Portman Road
 Reading
 Berks

Loughborough Sound Images

Epinal Way
 Loughborough
 Leicestershire
 LE11 0QE
 0509 231843

National Instruments

21, Kingfisher Court
 Hambridge Road
 Newbury
 RG14 5SJ
 0635 523545

The 8-bit XT bus rapidly runs out of available pins and has no DMA facilities. Nor can a peripheral card take over the bus. The AT bus has a 16-bit data path using an additional, smaller connector, and also has facilities which allow DMA transfers between cards and main memory, although not direct between two cards. There are extra interrupt lines for flexible control and, under certain circumstances, processors other than the central processor can take control of the bus, using the "bus master" line. This, however, has to be used with care. Simply asserting bus master will crash the CPU. The processor requesting control has to issue an interrupt, asking the CPU to finish its current task, and store any necessary information. Only then can bus master be used to transfer control.

The AT bus is where the real technical fun begins because AT is designed to make use of the 80286 (32-bit internal, 16-bit external) and 80386 processor chips, as well as being backward compatible with earlier 8-bit devices. A simple task like moving a 32-bit data word across the bus can become a nightmare: you need to know when each 16-bit chunk moves across the bus, where it is, and, when it gets to the other end, which half-word is which. Not a job for the faint-hearted.

Start using 8-bit devices, too, and the problems quickly multiply. These worries are tied up both with the original PC-bus design and the way IBM upgraded it, all the time trying to maintain software compatibility. The fact that there was no formal specification in the first place makes it worse. Many PC systems integrators seem to build systems despite, rather than with the help of, the bus itself. It's rather like a battered old Ford Cortina which never starts first time, but commands its owner's love and respect because of its imperfections, not its good points.

Raw power

The lack of a spec means that it is impossible to guarantee absolutely that any two boards will work together. Says Alan Turner, "Boards are unprovable under all circumstances. We all live with the fact that the products we sell are effectively unproven."

According to him, the huge number of PC cards available, and the history of the product, fixes problems via a kind of evolution. "Not all VME boards will interchange anything like as well as PC boards.

"PC is a brutally simple system that most people can understand. So many

people have worked for so long, it's getting good despite its conceptual weaknesses. If you started with a blank sheet, you couldn't make a case that you would do it this way, but it will work for you if you know the folklore," he adds.

The physical limitations of PC type cards have not escaped the attention of developers over the years. To accompany the Arcom I/O cards, Dean has taken on a range of backplanes, CPU boards, and racks, from US manufacturer I-Bus. One of the problems in increasing the processing power of PC systems is the ability of the bus itself to supply sufficient electrical power. I-Bus can drive up to 40A on the +5V supply line, which should be adequate for most needs. Many of the acceleration boards now available count their power consumption in tens of watts.

There are occasions when power requirements are actually increased by the relatively low PC-bus bandwidth; any fast processor will probably need a fair amount of memory on-board just to keep it fed with data.

Keeping the cards physically clamped in the enclosure also deserves attention: the connector and form factor were not designed to withstand the shock and vibration conditions often found in industrial environments.

In the cards

Selecting the component parts of a system is one thing, making it all hang together is quite another. Alan Turner says that success really depends on how much software you're writing yourself, "because you involve yourself in porting." The answer to most problems, he says, is to stick to as few suppliers as possible so that when problems do occur, there is a fair chance that the vendor can help solve them. "People try to debug by resorting to a logic analyser. "It's very hard to break into them that way, there are so many quirky things," he says. There are less than 512 spare I/O locations on the PC bus which may seem a lot, but can be quickly eaten up by single expansion cards which use a range of addresses.

Arcom's solution to this involves using only two or four address bytes, no matter how complex the board's function. This address decodes to a bank of 256 registers, 128 of which are used to serve the I/O devices themselves. The remaining 128 are used for special functions, one of which includes a board type identifier letting the CPU know that it is actually looking at the expected board. Another controls an

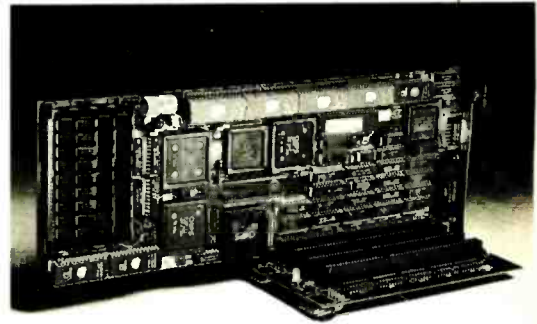

(PC)²: 286 card running on an industrialised AT bus, I-Bus.

on-board LED which, along with some simple software, can be used to provide a visual indication of whether CPU and board are communicating. Hopefully, this makes it relatively easy to configure a system using dos, and routines written in a high-level language.

Arcom has used the same signal conditioning scheme on the PC range as on its existing STE equipment saying that analogue signals need to be kept out of the PC box, both for safety's sake and to allow the maximum number of input channels. The diversity of cards now available for all PC types is bewildering. In the Arcom range, digital I/O cards with up to 40 channels are available, at a cost of between £125 and £185 depending on isolation requirements. A/D conversion weighs in at £325 for a 16-channel 12-bit card, whilst a 4-channel D/A comes in at under £250.

For those who really do have to deal with lots of digital channels, Poole-based company Aces has come up with a 192-channel I/O card priced just over £250. In the field of motion control, Diamond Point International distributes boards from US-based Technology Inc, which can control up to three stepper motors with C-coded software routines supplied as standard.

Burr-Brown produces boards that will accept analogue inputs and digitise them to 16-bit resolution at up to 500ksample/s, fast enough for real-time operation. The company provides a range of associated development tools, including DSPlay XL, which allows users to draw a flow diagram of the desired application and then produces executable code for the board.

Motherboards and CPU cards are equally common, but if anything more difficult to assess. Prices range from less than £100 to well over £2000, reflecting the range of processors from the most basic 6MHz 8088-type chipset to a full-blown 25MHz 80486 with coprocessor support. ■

NEW

**UP to 1 Megabit
DOWN to 45 nano Second**

ROM EMULATOR

from only

£99

- Emulates CMOS, NMOS and Bipolar PROMs, as well as 24, 28 and 32 pin devices
- All sizes from 16k to 1 Meg
- Bus widths up to 32 bits
- Loads 27512 in under 10 seconds
- Battery backed

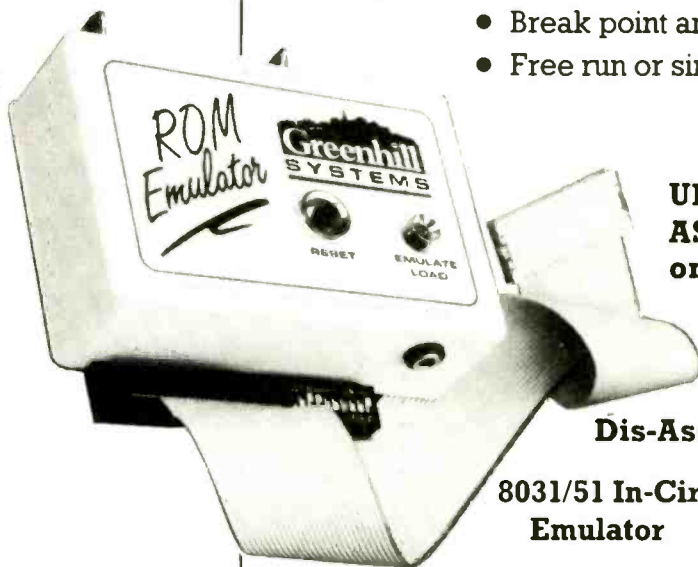

SIMULATOR

only £99

- Debug microprocessor software on your PC
- Break point and trace
- Free run or single step

UNIVERSAL ASSEMBLER only

£69

Dis-Assemblers

£99

8031/51 In-Circuit Emulator

from £499

**2 Mbit EPROM Programmer
Universal Memory/PLD/PAL
Programmer**

£139

£749

SMART COMMUNICATIONS

2 Field End, Arkley, Barnet, Herts EN5 3EZ. Telephone 081-441 3890

CIRCLE NO. 153 ON REPLY CARD

R.S.T.

LANGREX SUPPLIES LTD

R.S.T.

One of the largest stockists and distributors of electronic valves, tubes and semiconductors in this country.

Over 5 million items in stock covering more than 6,000 different types, including CRT's, camera tubes, diodes, ignitrons, image intensifiers, IC's, klystrons, magnetrons, microwave devices, opto electronics, photomultipliers, receiving tubes, rectifiers, tetrodes, thyratons, transistors, transmitting tubes, triodes, vidicons.

All from major UK & USA manufacturers.

Where still available.

Obsolete items a speciality. Quotations by return. Telephone/telex or fax despatch within 24 hours on stock items. Accounts to approved customers. Mail order service available.

LANGREX SUPPLIES LTD

1 Mayo Road, Croydon, Surrey CR0 2QP.

Tel: 081-684 1166

Telex: 946708

Fax: 081-684 3056

CIRCLE NO. 151 ON REPLY CARD

FIBRE-OPTICS EDUCATOR

Versatile training equipment for education and industry.

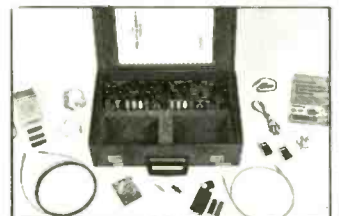

FIBRE-OPTICS POWER METER



dBm and μ W scale; battery life 500 hours.

FIBRE-OPTICS MONITOR

For continuity testing and voice comms.



For further details contact:

ELLMAX ELECTRONICS LTD.,
Unit 29, Leyton Business Centre,
Etloe Road, Leyton, London, E10 7BT.
Telephone: (081) 539 0136.

ELLMAX ELECTRONICS

CIRCLE NO. 152 ON REPLY CARD

Smoking CFCs

Your excellent editorial on the choice of refrigerants supports the use of propane but misses one important point with regard to safety. Leakage can easily be detected by fuel gas sensors: the sensor in the Maplin catalogue can detect propane at 2000 ppm. With suitable associated circuitry such sensors can initiate alarm signals (a kit is available) and could even be arranged to disconnect power to a refrigerator.

Pre-war domestic refrigerators were sold containing sulphur dioxide which is more hazardous than propane due to its high toxicity and more likely to leak due to its corrosive action in the presence of moisture. (I do not know of any household casualties but I do remember having to evacuate my father's house when attempting to salvage the compressor from a discarded refrigerator; there was a formidable cloud of gas when my hacksaw cut the piping.)

CFCs are far from innocuous to those who smoke. Refrigeration units on military radar sets used to carry dire warnings to smokers in the event of a leakage. Pyrolysis of CFCs occurs when drawn through the burning portion of a cigarette forming phosgene, hydrogen chloride, hydrogen fluoride and other highly toxic products such as those mentioned in your editorial. Domestic refrigerators do not seem to carry this warning.
Guy Selby-Lowndes
Plaistow
West Sussex

Back to basics

Several articles in your August issue could have been combined in order to demonstrate the existence, indeed the foundations, of natural mathematics. The convolution procedures described by Howard Hutchings can be used to design four-dimensional (i.e., spatiotemporal) fractals (see Keith Wood's article) under conditions in which the complex components become phase-

Computer cop-out

In computer applications, designers can rarely resist the temptation to extend the application of their cleverness beyond solving the immediate problem in hand, changing modes of operation from those used in non-computer-based systems and increasing the role of the machine relative to its human operator. In some cases, the computer effectively runs the show in most situations, handing over to the operator only in unforeseen emergencies. Where new control logic has been applied, this may still have to give way to more traditional logic in particular situations.

Both of these traits are apparent in the Airbus A320 systems outlined in the article: in normal flight, the joystick controls 'g' rather than the traditional nose up pitch and an "alpha-floor" system controls the flaps, rudder and engine thrust for best effect – the pilot only pulls the joystick for the result he wants and the computers do the rest. However, at low speeds and altitudes, all this changes: 'g' control gives way to conventional pitch control and the "alpha-floor" switches over

locked loops (see Michael Payne's article, Loran or Decca?). Sierpinski's triangle (p.704) is one way in which Pascal's triangle can be represented, and this particular fractal is therefore the origin of families of number systems. By inspection, these articles contain all the elements of time, distance, orientation, phase and number sufficient and necessary for the definition of a universal, holographic geometry.

The means for detecting the patterns produced by such a geometry are defined in my UK Patent (No 2199976), which was published on July 18. Although couched in terms of simple electronics, the underlying principle of the specification is that of a generalized

to "alpha" protection, which leaves throttle control to the pilot (otherwise the aeroplane would never land).

The problem with this is twofold: the pilot becomes used to "leaving it all to the computer" and can be unexpectedly projected into the hot seat, and the switches in control logic may lead to dangerous confusion. With an eight-second response lag in the engines, the switch from alpha-floor to alpha could leave the pilot for critical seconds assuming that the computers are controlling engine power while the computers have handed control over to him. I know it is a mistake to prejudge the outcome of the technical investigations into the French Airbus crash, but it is difficult to avoid associating the fact that the changes in control logic are altitude-controlled and occur at 100 feet with the fact that the manoeuvre the pilot was attempting involved a slow flypast at 100 feet.

Alasdair Keel
Chapel Allerton
Leeds
West Yorkshire

mathematical procedure for the determination of time-series, auto- and cross-correlations in real time. It is therefore capable of optimising the operations of an entire industry (such as electricity generation and supply) if executed on a sufficiently large, distributed scale. As the late Professor Waldron said in his letter in the same issue: "We must go back to basics and build up physics again . . ."

B. E. P. Clement
Crickhowell
Powys

Iron Curtain call

Jeffrey Burton (September Letters) has raised an important issue regarding 'old' equipment.

Tons of good-quality gear, often with low hours, is being junked all the time or is in storage. Some time ago, we offered 20 Commodore computers to a university in Czechoslovakia. Since this was before the relaxation in Europe, there were problems getting the Czech trade delegation to help with transport, but eventually an unmarked van pulled up in the early hours and loaded up. I thought the PET computers would disappear into the Black Market en route, but they all turned up, to the great joy of the staff of the department of psychology, and they tell me they now have the best-equipped classrooms in their country.

Would the editor consider running a list for our friends abroad to see? The universities of Britain could surely help, as could industry.

The main proviso is that the new owners realise that the gear will probably not have the blessing or services of the manufacturer and that they will be 'on their own', but they do have resourceful technicians willing to cannibalise for spares.
Jim Chambers
Dept. of Psychology
University College
London

If anyone is able to help in the way suggested by Messrs Burton and Chambers, a list of equipment to be disposed of would be most helpful. But please do not send equipment to this office – Ed.

Electronic tagging

Can anyone tell me whether work is being carried out on the use of electronic "tagging" devices for patients suffering from dementing complaints such as Alzheimer's Disease?

At a recent meeting of our local support group of the Alzheimer's Disease Society it was generally agreed that a major problem for carers looking after Alzheimer's sufferers was their tendency to wander away and become lost, putting themselves at risk and causing severe distress to the carer, who sometimes needs to

call in the police to help.

It was suggested that sufferers might carry a small, unobtrusive transmitting device which could be activated remotely by the carer, by which the sufferer could be located. (Alternatively, the police could be equipped with the appropriate tracking equipment.)

I would be very grateful if you could point me in the right direction to follow up this idea.
J.J. Trot
6, Matthewsgreen Road
Wokingham
Berkshire RG11 1JU

Golden-eared gullibility

The correspondence in the September issue, including that headed "Critical Ear", must surely rank as a new nadir of obtuseness and descent to personalities. Am I alone in hoping that the Editor will eventually add that welcome suffix (perhaps after this one?) that "this correspondence is now closed" and confine the pages of *EW+WW* to matters of real audio engineering interest? Leave this nonsense to the hi-fi comics, where it apparently finds a supine, gullible audience. Anyone seeking evidence of the genuine contributions to audio techniques over the past 50 years need go no further than the Patent Office.

There is one factor that, surprisingly, no one appears to be ready to identify. The present breed of hi-fi equipment reviewer is a parasitic appendage on a willing host – the hi-fi manufacturers (with a few honourable exceptions). They are wined, dined and courted as part of the promotional technique, often at considerable expense; even to the extent of being appointed "consultants". When products are subsequently reviewed, no one can convince me that the appraisal can ever be completely detached and with the consumer's interests 100% dominant. The system cannot but result in the erosion of integrity in the most subtle way. It is not without significance that one manufacturer, highly

respected world-wide and winner of the Queen's Award for industry, with many patents attributed to its founder and designer, consistently gets poor review ratings by a certain section of the review faction. Why? Could it be because they refuse to play the "game"?

What I find particularly disturbing is that the hi-fi magazine establishment does not regard this situation as in any way ethically questionable, as it most certainly would have been in my day as a reviewer. It has now become the established norm. The simple truth is that, if the hi-fi magazines were to fold overnight, then the reviewing industry would disappear without trace. Its value would be nil.

Reg Williamson
Kidsgrove
Staffordshire

Is convolution fundamental?

I used to believe that convolution was an unnatural operation, hard to believe, difficult to understand and unique. This is not so; I was wrong. We have all been using the concept for years – perhaps without realising it.

Convolution is one aspect of combinational mathematics, identified by a "multiply, summate and shift" structure. This much is not new, as readers of *EW+WW* will have guessed from a casual perusal of my August 1990 article on C. To make the point more simply and to remind you of the all-pervasive nature of the algorithm, reconsider the structure of the two-times table (or a small fragment of it)

- 0 times 2 = 0
- 1 times 2 = 2
- 2 times 2 = 4
- 3 times 2 = 6
- 4 times 2 = 8
- 5 times 2 = 10

This structure is created using convolution. Examining the anatomy more closely, the system under test is characterised by {2,2,2,2,2,2} and the input to the system is the data set {0,1,1,1,1,1}. To convince yourself of the validity

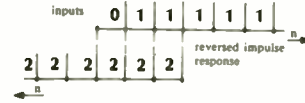

of the model, evaluate $3 \times 2 = 6$ using convolution. Reverse the system data set and align it with the input sample of current interest. The convoluted output $1 \times 2 + 1 \times 2 + 1 \times 2 = 6$ follows quite naturally. My thanks to Chris Dillon of the Open University, who drew my attention to the obvious.
Howard Hutchings
Willerby
Hull

Misrepresentation

My apologies to R. Harrowell for misrepresenting his views (*EW+WW* July and September, 1990). His suggestion, to set up a panel of engineers to study and report on heterodox theories, is very commendable. May I put it to the test by submitting the following heretical theory?

Suppose that an onlooker on Earth sees two space-ships flying side-by-side at a velocity V , relative to Earth.

One of the astronauts wishes to check the separation of the space-ships so he transmits a laser pulse and times the return of the echo on his range-finder. As far as he is aware, the pulse goes to the sister-ship by the shortest route and the echo returns as shown below:

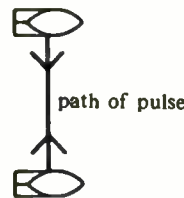

Astronaut's view

But that is not how it looks to the Earth-bound onlooker. During the short time that the pulse is crossing space, the second ship continues to move forward, so the pulse has to travel at a forward-slanting angle. Similarly, the echo has to slant forward to return to the first ship, as shown below:

If the pulse returns to the

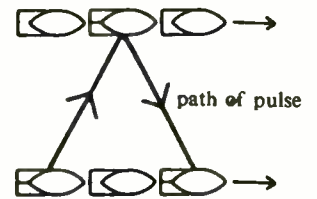

Onlooker's view

So the onlooker thinks that the pulse has further to travel than the astronaut has assumed.

According to SR theory, the speed of light c is independent of the source and observer. If this is correct, then the astronaut and the onlooker would assume that the speed of the laser pulse was c and they would obtain different answers if they computed the time of travel of the pulse.

If the space-ships travelled slowly the difference is small. But if they travelled at, say, half the speed of light, the onlooker's computation of path length would be 15% longer than the astronaut's!

Relativists explain this in terms of 'time dilation' and they assume that 'speed' causes the astronaut's 'clock' to run slower than the onlooker's.

An alternative theory is that the speed of the pulse is c , relative to the laser source. But the onlooker moving with velocity V , relative to the source, would measure the pulse velocity to be the vector sum of $c+V$, as shown below:

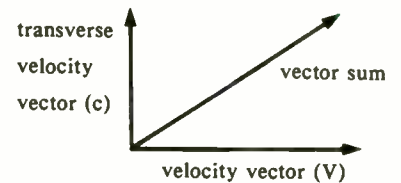

range-finder after time 2τ , both the astronaut and the onlooker would compute the distance of separation to be $(c\tau)$. The computation is independent of V and there is no need to invoke 'time dilation'.

John Ferguson
Camberley
Surrey

DON'T TRADE—

In times like these we understand that Corporates and Individuals simply cannot afford to "write-off" their investments. It pays to upgrade at less cost for greater specification. That's the idea behind the range featured here. All goods are backed by a full one year warranty, and pre and post sales support from our technical department. Call us for more details.

UPGRADE!

MAINBOARDS:

Why buy a 'speed up' board when, with less investment (in many cases) you can have the advantage of full 32/64 bit BUS architecture extended/expanded RAM, real/virtual mode?

DT286-12V (LXA-12) 80286 10/12MHz, socketed for 80287 VLSI chipset AT bus, 2x8 bit 6x16 bit slots, XT size, AMI bios 1-4Mb on board using 256k/1Mb DRAM.
£119

DT NEAT 16 (NEAT-16) 80286 16MHz, socketed for 80287, NEAT chipset AT bus, 3x8 bit 5x16 bit slots, XT size, AMI bios 1-4Mb on board using 256k/1Mb DRAM.
£169

DT NEAT SX 16 (NEATSX-16) 80386SX 16MHz, socketed for 80387SX NEATSX chipset, 32 bit bus, 3x8 bit 5x16 bit slots, XT size, AMI bios 1-4Mb on board using 256k/1Mb DRAM.
£289

DT NEAT SX 20 (NEATSX-20) 80386SX 20MHz, socketed for 80387SX, NEATSX chipset, 32 bit bus, 3x8 bit 5x16 bit slots, XT size, AMI bios 1-4Mb on board using 256k/1Mb DRAM.
£339

DT Cache 33 (Cache 33) 80386 33MHz, socketed for 80387 or 3167, C&T chipset, 32 bit bus, 3x8 bit 4x16 bit 1x32 bit slot, XT size, AMI bios 1-8Mb on Ramcard using 256k/1Mb DRAM.
£879

DT386-33 Cache 80386 33MHz, socketed for 80387, 32 bit bus, 2x8 bit 6x16 bit slots, full size USA made, Phoenix bios, 1-32Mb on board using 256k/1Mb/4Mb SIMMS.
£989

DT 486-25 Cache 80486 25MHz, socketed for Weitek 4167, 32 bit bus 7x EISA slots 1x8 bit, full size, USA made, Award bios, up to 64Mb on board.
£2494

DT 486-33 Cache 80486 33MHz, socketed for Weitek 4167, 32 bit bus, 7x EISA 1x8 bit slots, full size, USA made, Award bios, up to 64Mb on board.
£2994

ENCLOSURES (INC PSU)

DESKTOP TYPE (200W PSU) **89.00**
LOW PROFILE DESKTOP (200 PSU) **105.00**
MINI TOWER FOR BABY MAINBOARDS (200W PSU) **135.00**
MINI TOWER FOR FULL SIZE MAINBOARDS (200W PSU) **139.00**
FULL SIZE TOWER SYSTEM (220W PSU) **209.00**

NETWORK ADAPTERS:

ARC PCN001 (8 bit NOVELL NE1000 equiv) **129.00**
PCN006 (16 bit NE2000 compatible, card) **149.00**
ARC PCN002S (STAR TOPOLOGIES, NOVELL equiv) **89.00**
PCN002B (LINEAR BUS TOPOLOGY 2.5Mb/sec) **96.00**
PCN003 (8 PORT ACTIVE HUB, 2000FT at 25 Mb/sec) **169.00**

COMPATIBLE MEMORY

IBM
IBM PS/2 30 286 2Mb **139.00**
IBM PS/2 50Z-55SX-65SX-65SX-P70 2Mb **135.00**
IBM PS/2 70 2Mb **135.00**
IBM PS/2 55SX-65SX 4Mb **395.00**
AST
PREMIUM 386/25 1Mb **65.00**
PREMIUM 386/33 1Mb **65.00**
PREMIUM 386SX 1Mb **65.00**

COMPAQ

DESKPRO 386/33 2Mb **154.00**
DESKPRO 386/25 1Mb **81.00**
DESKPRO 386/25 4Mb **285.00**
DESKPRO 386/20 1Mb **81.00**
DESKPRO 386/20 4Mb **285.00**
DESKPRO 386S 1Mb **119.00**
DESKPRO 386S 4Mb **325.00**

HEWLETT PACKARD

LASERJET II 2Mb **169.00**
LASERJET II 4Mb **309.00**
LASERJET IID 2Mb **169.00**
LASERJET IID 4Mb **309.00**
LASERJET IIP 1Mb **110.00**
LASERJET IIP 2Mb **170.00**
LASERJET III 1Mb **110.00**
LASERJET III 2Mb **170.00**

MATHS CO-PROCESSORS

INTEL 8087 **64.00**
INTEL 8087-2 **92.00**
INTEL 80287-XL **165.00**
INTEL 80387-16 **255.00**
INTEL 80387-20 **275.00**
INTEL 80387-25 **339.00**
INTEL 80387-33 **419.00**

HARD DRIVES

SEAGATE ST124-0 21.4Mb MFM 40ms **159.00**
SEAGATE ST125-1 21.4Mb MFM 28ms **169.00**
SEAGATE ST138-1 32.1Mb MFM 28ms **199.00**
SEAGATE ST138R 32.7Mb RLL 40ms **179.00**
SEAGATE ST138R-1 32.7Mb RLL 28ms **199.00**
SEAGATE ST157A 44.7Mb IDE 28ms **225.00**
SEAGATE ST157R-1 491.1Mb RLL 28ms **209.00**
SEAGATE ST41200N 1050.0Mb SCSI 17ms **2875.00**
SINGLE DRIVE CABLE SET **8.00**
DOUBLE DRIVE CABLE SET **12.00**
5.25" FITTING KIT FOR 3.5" DRIVES **5.00**

FLOPPY DRIVES

TEAC 5.25" (360K) **60.00**
5.25" (1.2Mb) **75.00**
3.5" (720K) **55.00**
3.5" (1.44Mb) **70.00**
FLOPPY DRIVE CABLE SET **5.00**

RAM:

41256 (256K x 1) 80ns **1.70**
44256 (256K x 4) 80ns **5.45**
41000 (1Mb x 1) 80ns **5.25**
4164 (64K x 1) 100ns **1.30**
41256 (256K x 1) 100ns **1.85**
41464 (64K x 4) 100ns **2.25**

Teach your Old Drive some New tricks ...

Achieve nearly TWICE the capacity while almost doubling the speed!

ADRC - 9008 Hard Disk Controller
8-bit—Suitable for 8088/80286 based systems running at 6 to 12Mhz. Just **£139**

ADRC PS180-16FN Hard Disk Controller
16-bit—Suitable for IBM AT/286 and /386 compatibles and PS/2 Model-30. This controller also handles two 5.25" or 3.5" floppy drives. Just **£266**.

NOVELL AUTHORISED RE-SELLER

DIGITASK

Digitask Business Systems Ltd, Unit 2, Gatwick Metro Centre
Balcombe Road, Horley, Surrey RH6 9GA
Telephone (0293) 776688 Fax: (0293) 786902 Telex: 873761 DIGIT G
CIRCLE NO. 154 ON REPLY CARD



PRICES AND MANUFACTURERS' SPECIFICATIONS
SUBJECT TO CHANGE WITHOUT NOTICE
PRICES DO NOT INCLUDE CARRIAGE AND VAT

Authorised Dealer
Personal Computers

100MHz spectrum analysis on a 10MHz oscilloscope

When used with a standard oscilloscope, the Type 107 Spectrum Probe from Laplace Instruments offers the power of a spectrum analyser at a fraction of the cost. Mike Tooley investigates

Probe in use on a CB radio output stage

Type 107 Spectrum Probe allows any standard oscilloscope to be used as a 100MHz spectrum analyser; the vertical deflection indicates amplitude on a logarithmic scale and the horizontal scale gives a linear indication of frequency. Furthermore, unlike most conventional spectrum analysers which invariably provide input having a nominal 50Ω impedance, the Spectrum Probe offers a non-constant but very much higher input impedance and therefore does not load the majority of circuits to which it is connected. The 500V DC isolation capacitor fitted in series with the probe tip has a value of 10pF.

Hence, within the frequency range concerned, the probe can be used in much the same manner as a conventional oscilloscope probe, a separate ground connection normally being needed to maintain earth continuity with the equipment under test.

A single cable carries the output of the probe to the oscilloscope and the power supply and a phono-to-BNC adapter is provided to connect the output of the probe to the BNC input of a standard oscilloscope. The power unit, which is fitted into a 13A mains plug enclosure is connected by means of a 3.5mm jack. A metal sleeve may be fitted to the probe tip to mate directly with a coaxial connector, such as the output from an RF signal generator. Alternatively, the probe tip can be grounded via a short RF pick-up loop using the ground clip provided, thus providing a current-sensitive, rather than voltage-sensitive pick-up arrangement.

Oscilloscope adjustment

The oscilloscope should be set to provide a vertical sensitivity of 50mV/division (DC-coupled) and a horizontal time scale of 0.5ms/div. Trigger controls should be set for negative edge triggering.

Small adjustments to the vertical shift and horizontal gain may be needed to centre the spectrum display on the oscilloscope screen. Positioning the display is straightforward; the zero-frequency reference line should appear at the extreme left-hand side of the display. Thereafter, the display should read horizontally from 0 to about 100MHz and vertically from zero to 50/60dB above the base line, the maximum amplitude corresponding to an input of about 0.25V.

At this point, it is perhaps worth mentioning that the Spectrum Probe should only be relied upon to produce relative indications. It should not normally be used to make absolute measurements of either amplitude or frequency. In fairness, it is possible to calibrate the instrument by means of signals from an external RF signal generator; it would then be possible to



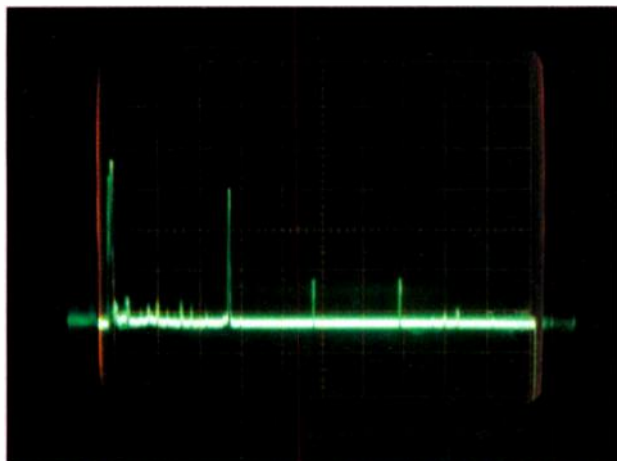

Recorded spectrum from CB radio. Note the relative levels of 2nd and 3rd harmonics.

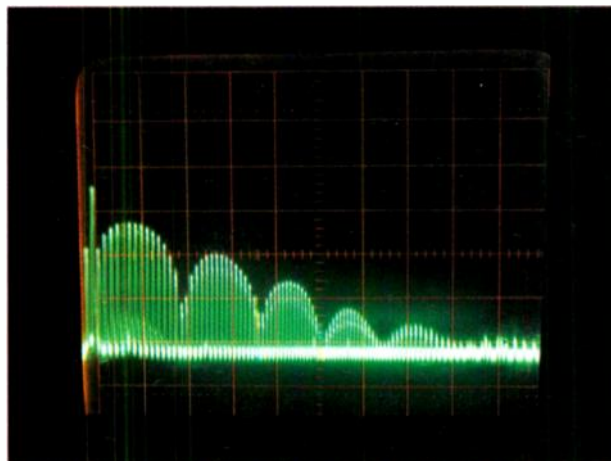

Display obtained by connecting spectrum probe to pulse generator via BNC adaptor and dummy load. Generator was delivering 70ns pulses with a PRF of 1MHz.

ascertain the approximate frequency and amplitude of an applied signal. Indeed, measurements to within 200kHz and 5dB can be made by using this somewhat cumbersome technique.

With the oscilloscope settings mentioned earlier, each vertical division on the screen of the oscilloscope corresponds to an input change of approximately 10dB. The total dynamic range of 50 to 60dB may, however, be reduced to about 40dB in some applications as a result of spurious responses. Furthermore, if the oscilloscope has a "×10" horizontal and/or a delayed sweep facility, they may be used to reduce the horizontal scale and permit closer examination of frequency spectra to within a few hundred kHz.

Specifications

frequency range	<1MHz to >100MHz
dynamic range	50dB min.
vertical output	5mV/dB typical
vertical log. linearity	±3dB
tangential sensitivity	100µV ±3dB at 50MHz
flatness	±2dB, 5MHz to 100MHz
LF degradation	about -5dB below 1MHz
spurious responses	generally -40dB
IF bandwidth	180kHz at -3dB
max. CW input	+15dBm, 1V at 100MHz
sweep rate	6ms/100MHz typical
horizontal linearity	±10%
radiation (from probe tip)	
	-40dBm at 150MHz into 50 ohm
	-50dBm at 250MHz into 50 ohm
power source	220V ±10% 50Hz, 4W
size	190 × 25mm diameter (probe)
weight	56gm (probe)

Manual

A neatly produced, eight-page, A5 format, spiral-bound manual provides full information concerning oscilloscope adjustment, operation of the Spectrum Probe and on the method of calibrating signals against an external standard. It suggests a number of rather vague applications for the instrument and several of these could have been usefully expanded to include some representative displays as well as recommended test points. The manual is neither better nor worse than normal for this type of instrument.

Operation

Using the Spectrum Probe is delightfully simple. I used it in a number of practical applications, including checking the spectrum of a local oscillator in an HF receiver, measuring the spurious output from a 28MHz transceiver (with and without a low-pass antenna filter present) and monitoring the spectral distribution of supply-rail noise in a switched-mode power supply. None of these tasks could have been performed very easily using a conventional oscilloscope time-domain display.

Indeed, the probe produced some interesting findings. In the case of the HF receiver, the level of the fifth harmonic of the local oscillator was excessively high due to a broadly resonant collector load in the buffer stage (damping the collector choke with a 1kΩ resistor reduced the level of the harmonic by more than 10dB).

In the 28MHz transceiver, the low-pass antenna filter had no effect at all upon a spurious signal at 9MHz, which

was little more than 35dB down relative to the full-carrier. Subsequent replacement of the low-pass filter with a band-pass unit has virtually eliminated this spurious signal from the output.

The level of supply-borne noise in the switched-mode power supply was found to be considerable at certain points along the printed circuit tracks (notably those remote from the main decoupling components). Noise was then effectively reduced to the base line level by means of judiciously placed ceramic disc capacitors between ground plane and supply rail.

During testing, the Spectrum Probe was used in conjunction with a variety of oscilloscopes, including a Gould OS-300, Hameg HM-203, and my trusty Tektronix 549. In no case was there any problem with adjustment of the oscilloscope controls, and triggering was achieved in a simple and straightforward manner.

The full kit.



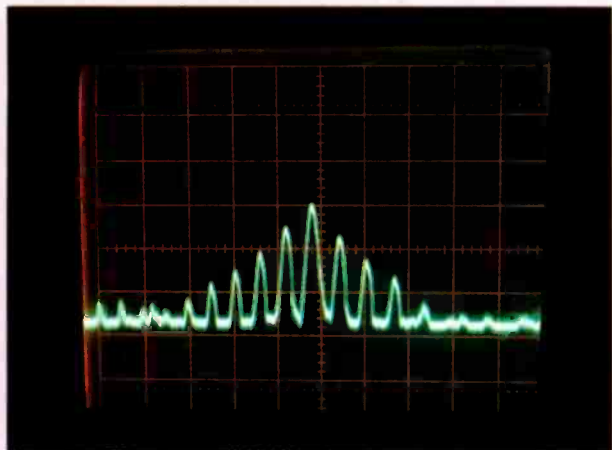

Spectrum from 1 to 100MHz showing emissions up to 40MHz from computer equipment. Note the feature at 85MHz expanded in the righthand picture.

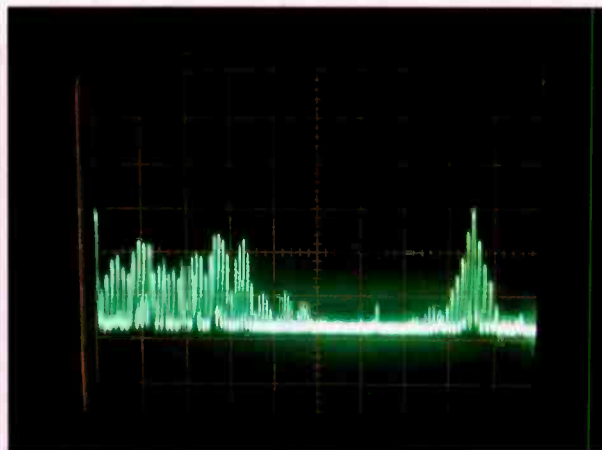

Expanded view of the spectrum at 85MHz depicting a fundamental plus sideband series at 1.5MHz offset.

Conclusion

This is an ingenious and highly versatile test instrument which will undoubtedly prove to be an invaluable aid to anyone wishing to make a rapid assessment of the spectral distribution of signals. Its ability to display signals in the frequency domain on a conventional low-

cost oscilloscope should not be underestimated; indeed, it should be stressed that the instrument can display signals at 100MHz far outside the bandwidth of, for example, a 10MHz oscilloscope. Like me, I suspect that you will be loth to part with it.

The Type 107 Spectrum Probe costs £345, plus VAT. Laplace Instruments is at Masters House, Bexton Road, Knutsford, Cheshire WA16 0BU. Telephone: 0565 50268. Fax: 0565 53519.

AN RF SPECTRUM ANALYSER FOR ONLY £345? (+VAT)



The 107 SPECTRUM PROBE converts a standard 1MHz scope into a 100MHz spectrum analyser.

- 70dB dynamic range
- 40dB spurious rejection
- 50µV sensitivity, +/- 2dB flatness
- 1kV DC, 1v/+15dBm @ 100MHz Max signal
- ±5% frequency axis linearity

APPLICATIONS

- *RF Radiation.* When used with a short antenna, the local RF field can be monitored. Check for emission from computers, switching PSU's etc.
- *Servicing.* The low capacity input of the Spectrum Probe allows circuit probing without affecting circuit operation, allowing rapid evaluation of performance and problems.
- *Mains-borne RF.* The high voltage input rating of the Spectrum Probe allows direct measurement of RF noise. Signal lines and ground lines can equally be checked.
- *Education.* This low-cost, easy-to-use probe is ideal for teaching RF techniques and the frequency domain.

Available only from Laplace Instruments Ltd at £345 plus VAT (£396.75) including mains adaptor, manual, equipment case, BNC adaptor and postage. Full unconditional refund if returned within 15 days undamaged.



LAPLACE INSTRUMENTS LTD

Masters House, Bexton Road, Knutsford, Cheshire WA16 0BU. Tel: 0565 50268

CIRCLE NO. 134 ON REPLY CARD

Take the Sensible Route!

BoardMaker is a powerful software tool which provides a convenient and fast method of designing printed circuit boards. Engineers worldwide have discovered that it provides an unparalleled price performance advantage over other PC-based and dedicated design systems by integrating sophisticated graphical editors and CAM outputs at an affordable price.

NEW VERSION

In the new version V2.23, full consideration has been given to allow designers to continue using their existing schematic capture package as a front end to BoardMaker. Even powerful facilities such as Top Down Modification, Component renumber and Back Annotation have been accommodated to provide overall design integrity between your schematic package and BoardMaker. Equally, powerful features are included to ensure that users who do not have schematic capture software can still take full advantage of BoardMaker's net capabilities.

£295

BoardMaker V2.23 is still a remarkable £295.00 and includes 3 months FREE software updates and full telephone technical support.

NEW AUTOROUTER

BoardRouter is a new integrated gridless autoroute module which overcomes the limitations normally associated with autorouting. **YOU** specify the track width, via size and design rules for individual nets, BoardRouter then routes the board based on these settings in the same way you would route it yourself manually.

This ability allows you to autoroute mixed technology designs (SMD, analogue, digital, power switching etc) in **ONE PASS** while respecting **ALL** design rules.

GRIDLESS ROUTING

No worrying about whether tracks will fit between pins. If the track widths and clearances allow, BoardRouter will automatically place 1, 2 or even 3 tracks between pins.

FULLY RE-ENTRANT

You can freely pre-route any tracks manually using BoardMaker prior to autorouting. Whilst autorouting you can pan and zoom to inspect the routes placed, interrupt it, manually modify the layout and resume autorouting.

£495

BoardRouter is priced at £295.00, which includes 3 months free software updates and full telephone technical support. As a special introductory offer, BoardMaker and BoardRouter can be bought together for only £495.00.

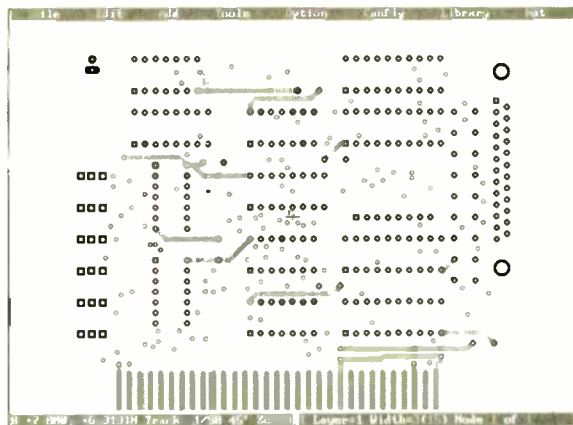

Full analogue, digital and SM support - ground and power planes - 45 degree, arced and any angle tracks with full net-based Design Rule Checking.

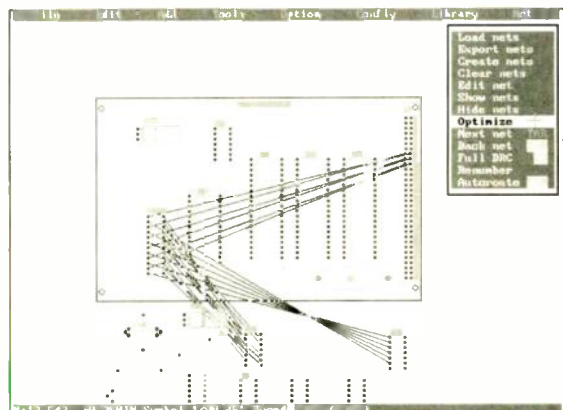

Optimized placement by displaying ratsnest per component. Lines indicate the unrouted nets.

HIGHLIGHTS

- Net list input from OrCAD, Schema etc.
- Top down modification
- Forward and back annotation
- Component renumber
- Fully re-entrant gridless autorouting
- Simultaneously routes up to eight layers
- Powerful component placement tools
- Extensive Design Rule Checking
- Full complement of CAM outputs
- Full support and update service
- Reports generator
- PostScript output
- SMD support
- Effortless manual routing

Don't just take our word for it. Call us today for a FREE Evaluation Pack and judge for yourself.



Tsien (UK) Limited
Cambridge Research Laboratories
181A Huntingdon Road
Cambridge CB3 0DJ
Tel 0223 277777
Fax 0223 277747

All trademarks acknowledged



RAEDEK ELECTRONICS

SERVING THE COMMUNICATIONS AND ELECTRONICS INDUSTRIES

BANNERLY ROAD, GARRETT'S GREEN, BIRMINGHAM B33 0SL, ENGLAND

Tel 021-784 8655

Fax 021-789 7128

TRANSISTORS

TYPE	LIST	TYPE	LIST	TYPE	LIST
MRF134	26.00	MRF485	6.75	2N3553	2.75
MRF136	27.00	MRF492	25.00	2N3632	13.90
MRF137	29.00	MRF497	17.50	2N3733	14.00
MRF138	35.00	MRF504	2.95	2N3866	1.75
MRF208	15.00	MRF507	3.00	2N4416	1.75
MRF212	11.00	MRF618	24.00	2N4427	1.75
MRF221	9.75	MRF630	5.50	2N5090	13.00
MRF222	18.00	MRF641	17.00	2N5109	2.50
MRF223	11.50	MRF644	27.00	2N5589	8.75
MRF224	16.75	MRF645	22.00		
MRF229	4.00	MRF648	31.00	2N5590	9.75
MRF232	13.50	MRF1946	14.00	2N5591	10.75
		MRF941	3.00	2N5641	8.50
		MRF944	20.00	2N5642	11.00
MRF233	14.50			2N5643	12.75
MRF234	18.00			2N5913	2.75
MRF237	3.00			2N5915	15.00
MRF238	11.00	SD1012	10.75	2N5944	9.75
MRF239	16.00	SD1013/3	10.75	2N5945	11.80
MRF240	23.00	SD1019	29.00	2N5946	12.75
MRF245	29.00	SD1019/5	29.00	2N6080	8.00
MRF247	26.00	SD1098	25.00		
MRF260	0.75	SD1127	3.00		
MRF262	15.00	SD1133	10.00	2N6081	9.75
MRF264	15.50	SD1134/1	2.90	2N6082	10.90
		SD1135	11.50	2N6083	12.50
MRF313	11.75	SD1136	8.90	2N6084	13.75
MRF314	22.00	SD1143	11.50		
MRF315	37.00			2SC1729	12.50
MRF317	57.00	SD1219	17.75	2SC1945	6.00
MRF321	16.50	SD1224	13.00	2SC1946	14.00
MRF323	26.00	SD1272	12.50	2SC1947	6.00
MRF326	50.00	SD1274	13.00	2SC1968	26.00
MRF327	60.00	SD1278	16.50	2SC1970	2.00
MRF401	12.50	SD1410	25.00	2SC1971	3.50
MRF422	39.00	SD1411	65.00	2SC2053	1.00
MRF428	65.00	SD1416	26.00	2SC2075	3.00
		SD1428	27.00	2SC2078	1.00
MRF433	11.00	SD1433	13.00		
MRF448	69.00	SD1434	36.00	2SC2166	1.50
MRF449A	15.00			2SC2237	7.00
MRF450/A	12.60	SD1441	52.00	2SC2283	10.50
MRF454/A	17.50	SD1444	3.50	2SC2290	25.00
MRF455	16.50	SD1488	19.00	2SC2395	16.00
MRF458	17.50	SD1574	9.75	2SC2495	20.00
MRF475	2.75	SD1407	21.50	2SC2630	25.00
MRF476	2.75	SD1477	21.50	2SC2905	25.00
MRF477	17.00			2SC2642	22.00
				2SC2695	19.00
		2N3055	0.75		
		2N3375	14.00		

VALVES

TYPE	LIST	TYPE	LIST	TYPE	LIST	TYPE	LIST	TYPE	LIST	TYPE	LIST	TYPE	LIST	TYPE	LIST	TYPE	LIST
A2134	14.00	ECH81	1.25	ME1400	2.00	4X150A eimac		6GW8	2.00	807	5.00						
A2426	25.00	ECH83	1.25	N78	6.00	6H6GT	2.00	811A	5.00								
				OA2	1.20	5B255M	10.00	6J4	2.00	812A	12.00						
				OA2WA	2.00	5C22RcA	100.00	6J6	2.00	813	15.00						
				OB2	1.00	5R4GY	4.00	6J7 GT	3.50	813 RCA	30.00						
C1149/1	155.00	ECL80	0.50	OOE03-12	6.00	5U46A	2.50	6J86A GE	9.00	833A	45.00						
				QV02-6	15.00	5Y3GT	3.00	6J9C GE	11.25	866A	7.00						
				QV03-10	5.00	5Z3	4.00	6J56C GE	10.50	872A	17.00						
				QV03-20	20.00	5Z4	2.20	6K06 GE	10.95	8654	1.00						
				QY4-400	105.00	6AK5	2.00	6L6 GE	9.00	8670	3.00						
						6AK6	1.50	6SJ7GT	1.50	8687	3.90						
						6AK6	2.00	6SQ7 GT	1.50	8692	2.00						
						6AL5	0.50	6SK7	2.20	8696	3.90						
						6AM4	3.00	6SL7GT	3.90	8725	2.00						
						6AM5	3.50	6V6 GT	1.50	8726	2.00						
						6AM6	1.50	6X4	1.00	8727	2.00						
						6AQ5	1.25	6X5 GT	0.75	8750	1.00						
						6AS7G	3.50	7Y4	2.00	8751	2.25						
						6AT6	1.50	12A6	2.90	8763	5.90						
						1824A	40.00	12AH7	3.00	8984	25.00						
						2C39A	25.00	6AW6A	2.90	12AU6	1.00						
						2021	2.00	6BA6	1.00	12AX7	1.00						
						2E26	6.90	6BA7	3.50	12BE6	1.50						
						2X2A	4.00	6BH6	1.50	12BH7A	6.00						
						3C45	32.00	6BU6	1.25	12BL6	1.25						
								6BN6	1.50	12BY7A	6.00						
								6BQ5	1.00	12OQ6B	3.00						
								6BQ7	1.00	25L6GT	1.00						
								6BR7	3.00	50C5	0.75						
								6BZ6	2.00	75B1	3.00						
										6C6B	2.00						
										6CD6 GA	3.00						
										6CW4 RCA	9.50						
										6DQ5	10.00						
										572B CET							
										6EA8	2.00						
										6F17	2.50						
										725A	150.00						
										805	11.00						
										7486	145.00						
										7643	5.00						
										8013	50.00						

WE ALSO SUPPLY EIMAC TUBES AND ACCESSORIES

1000's of VALVES/TRANSISTORS/IC's IN STOCK. PLEASE ENQUIRE ON TYPES NOT LISTED.

BACKWARD WAVE OSCILL CRT's IGNITRONS KLYSTRONS MAGNETRONS RECEIVING TUBES SOLID STATE REPLACEMENTS THYRATRONS TRANSMITTING TUBES

PRICES - CORRECT AT TIME OF GOING TO PRESS. TERMS - PLEASE ADD £1.00 P & P AND VAT @ 15% to orders

CIRCLE NO. 133 ON REPLY CARD

FULL SPECTRUM MONITORING

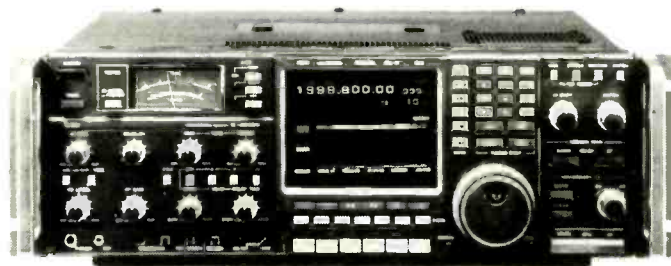

The world is at your fingertips with ICOM's new IC-R9000 radio communications receiver with continuous all mode, super wideband range of 100kHz to 1999.8MHz and a unique CRT display that shows frequencies, modes, memory contents, operator-entered notes and function menus. The revolutionary IC-R9000 features IF Shift, IF Notch, a fully adjustable noise blander and more. The Direct Digital Synthesiser assures the widest range, lowest noise and rapid scanning. 1000 multi-function memories store frequencies, modes, tuning steps and operator notes. Eight scanning modes include programmable limits, automatic frequency and time-mark storage of scanned signals, full, restricted or mode-selected memory scanning priority channel watch, voice-sense scanning and a selectable width around your tuned frequency.



Icom (UK) Ltd. Tel: 0227 363859. Telex: 965179 ICOM G N.B. For Wales and the West contact: M.R.S. Communications Ltd. Cardiff. Tel: 0222 224167.

Please send information on Icom products & my nearest Icom dealer. 7

Name/address/postcode: _____

Job Title: _____ Tel: _____ Post to Icom (UK) Ltd Dept.WW, FREEPOST, Herne Bay, Kent CT6 8BR

CIRCLE NO. 131 ON REPLY CARD

Custom metalwork - good and quick!

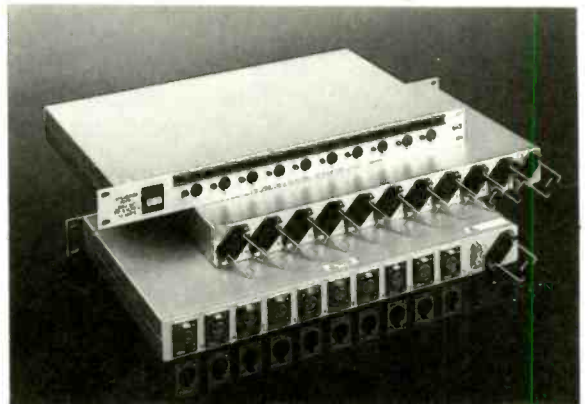

Plus a wide range of off-the-shelf products including:

- Nine sizes of standard 19" rack cases
- New "clam" case in any depth
- Eight-card 1U Eurocard case
- Audio, video and data patch panels
- Rack blanking and ventilation panels

All use the unique IPK extrusion, giving strength and rigidity with no fixing screws in the front panel; cases can be tailored to your requirements. Rack mounting strips, cable trays etc. from stock.



IPK Broadcast Systems 3 Darwin Close Reading Berks RG2 0TB Tel: (0734) 311030 Fax: (0734) 313836

CIRCLE NO. 132 ON REPLY CARD

There are two main views on satellite television. One is that it is part of a grand design to bring in a wondrous new transmission technology which will (a) consign the pathetic PAL system to the dustbin of technological history and (b) give the European consumer electronics industry the wherewithal to counter the irresistible advance of the Japanese. The other is that, by a combination of pay channels and low-cost programming, it is a good way of making money.

These two camps are not absolutely mutually exclusive. BSB, for instance, uses new-technology D-MAC to broadcast old (or old-ish, usually at least a year) movies and rerun sitcoms and drama series, in much the same way as Sky does in PAL.

Sky's owner, Rupert Murdoch, recognises the purpose of the MAC initiative – he recently described it as “a racket being put together for the European manufacturers to keep the Japanese out”. Being a PAL man, however, he wants nothing to do with it.

Sticking with PAL has enabled Sky, which was first onto the UK direct-to-home (DTH) scene, to be relatively successful at keeping receiver costs below £200 for the most basic model and getting audience figures up. Over a million UK households now receive Sky and, in those homes, viewing figures for Sky's four channels, at 29.7% taken together, now exceed ITV/Channel 4 (29%) and BBC 1/2 (27.5%).

BSB, slowed down by development difficulties with one of the three receiver chipsets necessitated by the new transmission standard and its associated decryption system, only came on-air in April this year, six months behind schedule and 15 behind Sky.

The irony is that some 95-98% of British TV sets cannot receive the D-MAC signals, since they lack Scart sockets with separate RGB connections. Of those which could, many probably don't, since BSB receivers do not come equipped with Scart connectors.

THE FUTURE VIEW

Recent surveys indicate that satellite TV has taken a sizeable chunk out of television advertising revenue. Sky was first and has gained most, although BSB seems set for long term victory taking the MAC standard with it, writes Peter Willis.

Although a comparison of the test card in PAL and D-MAC reveals elimination of colour bleed and Moiré patterning in D-MAC, the picture quality of TV sets with full Scart sockets is often so high anyway that little, if any, difference is visible in normal viewing. In fact, the composite video PAL signal which, together with the stereo audio is fed to the Scart output for the benefit of sets with “restricted” Scart (no separate RGB), can give a considerably brighter picture than the D-MAC/RGB.

The price of BSB's receivers, which not only have to carry the specialised chipsets, but also a system for re-encoding the D-MAC signal into PAL for the benefit of the majority of TV sets, has crept up to around £375 from the £250 originally announced.

This is despite BSB's limiting production rights to four manufacturers in an attempt to achieve mature-market economies of scale from the outset.

Sky, incidentally, seems to have achieved the same objective more informally. By setting up its own direct-rental operation, it effectively handed over the supply of over 70% of “its” receivers to Amstrad. The receivers were general-purpose PAL satellite receivers, pre-tuned to the Astra satellite, on which Sky occupies four out of 16 channels. Sky encrypted its movie channel after a year of operation and began by giving away add-on decryption units (universally called decoders, to the annoyance of purists). These are gradually being supplanted by IRDs (integrated receiver-decoders, again from Amstrad, though other makes will follow), specific to Sky unless any other broadcaster adopts the smartcard Videocrypt system. At around £325 for

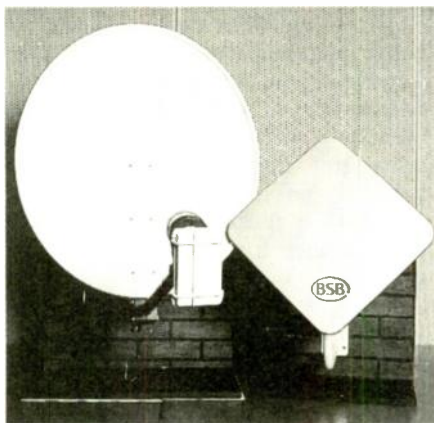



a remote-control model, these have considerably narrowed the price gap with BSB.

It remains to be seen whether BSB, after some initial receiver supply problems (though nowhere near as bad as those which afflicted Sky at its launch) and the counter-attractions of the hottest summer on record, can achieve its target of 400 000 direct-to-home installations by Christmas.

This figure has already been whittled down from half-a-million which, together with cable, was supposed to give BSB a million households this year. Cable connections, which clearly require fewer individual decisions, except over the all-important pay channel, look to be on target.

It is another of the numerous ironies of the satellite industry that BSB, intended as a high-power, small-dish direct broadcasting system, should find its first success on cable.

Cable has gained from the arrival of Astra and four-channel Sky (plus MTV, Screensport, Lifestyle and Children's Channel on the same satellite), with some serious advertising. The rate of franchise awards has increased, to 85 in the year to March 1990, from 33 the previous year. The number of bidders for each franchise has increased, too,

“ . . . a racket put together for the European manufacturers to keep the Japanese out ”

Make mine a big MAC, but the odds against are no better than the aspect ratio when it comes to selling HDTV to the euro-public.

from an average of 1.3 in 1988/9 to 2.6 in 1989/90.

Over two-thirds of UK homes – 14.6 million – are now covered by franchises, although at present well under one million of them are passed by installed broadband networks. Further expansion would obviously be slower and dependent on likely uptake, but the Cable Authority has identified 48 further towns of potentially suitable size. Recent research indicates that 38% of UK homes would subscribe to cable TV, were it available. Furthermore, 39% of dish-owners would switch.

Figures like this, while encouraging to satellite programme providers, do not suggest that the satellite receiver is destined to become a standard item of domestic equipment alongside the TV set and video recorder. It will enjoy a few years' growth, alongside satellite TV itself and while cable networks are being installed. Indeed, some cable franchisees are selling dishes to potential customers with a promise to buy them back when the network passes the door. But, once cable is established, the dish on the roof could become strictly a rural option, as oil-fired central heating is for those not served by a gas main.

It may be that not all cable networks will be buried underground, or consist of a fixed, physical link. Instead, particularly in densely-populated areas, they may depend on microwave dis-

tribution. These signals require clear line-of-sight and operate over short distances, Aerials used to capture them are considerably less obtrusive than even the smallest of satellite dishes. They are short and cylindrical, looking rather like porchlights, and at present about 100mm in diameter and a little more in depth. By the time they are in production, they are expected to be about a quarter of this size.

What will be received on microwave aerials, once they are established in five or six years' time, or by any other means, is a matter of much conjecture.

The pessimism school of prognosis has it that there is simply not enough advertising revenue around to support both Sky and BSB, particularly since they bid the price of movies up against each other, and especially so in the present economic climate. Therefore, they will merge, or the weaker operation will be taken over by the stronger.

There are two objections to this proposition. One is that, even if advertising budgets are spread more thinly to encompass satellite channels, it may not be they who will suffer. Indeed, starting from zero, they can only gain, at the expense of more established media.

Both channels also have a second source of revenue in pay-TV. This will not always be confined to the movie channels; it will, for instance, certainly be extended to major concerts and sports events on a pay-per-view basis, once the audience base is judged to be large enough.

The other obstacle to any sort of merger is the fact that, although the

“the picture quality of scart TV sets is so high that there is little difference in normal viewing”

programme packages have more similarities than differences to the untrained viewer, the two broadcasters are corporately, culturally and philosophically about as far apart as are their satellites in the geostationary orbit.

BSB (31°W) is owned by a consortium of other companies, including Reed International, Granada, and Pearson (owners of Penguin Books and the Financial Times). It is Britain's "official" DBS (Direct Broadcast by Satellite) project, with WARC-allocated frequencies and orbital posi-

Continued over page

The Programmer that fits your Pocket - £495

S3 is a product which has shaken the industry. It is in all the big-name catalogues. It is used by all the big-name companies. That's because S3 has an elegance and fitness-for-purpose that puts it in a different league from old fashioned bench programmers. But you don't have take our word for it. You can get an S3 on NO-RISK APPROVAL and find out for yourself.

S3 doesn't only program EPROMS

S3 programs any (E)EPROM you can put in the socket. Choose manufacturer and device from a menu and S3 will select one of 80-odd algorithms. But programming memory devices is only a part of S3's repertoire. It's not the be-all and end-all. If you need to program EPLDs, CMOS PALS, NOVRAMS, SINGLE-CHIP MICROS and the like, S3 is still the best tool for the job. Dataman provides dedicated modules and software, which are much cheaper than any other solution because the S3 you already own acts as a "mainframe". These products don't just exist in our imagination. We have them on the shelf, ready to ship.

Software upgrades are FREE

When new programmable parts are released, Dataman provides new software to program them. This software is FREE. It is also easy to install. The original program comes in a ROM. You place it in the socket (see picture) and press the HELP button. It loads in a few seconds. And you only have to do it once. S3 retains its program - and your data - in non-volatile memory, even when switched off. We post the new program on our Bulletin Board. If you have a modem, you can download it. There are lots of other useful programs available too. Give our BB a call on 0305-251786.

Terminal Program with S3 Driver

We offer a TERMINAL PROGRAM which supports four COM ports simultaneously at speeds up to the 115,200 baud. This program is useful in its own right. It also has a FRONT-END DRIVER for S3, with MENUS and HELP screens. This gives you Remote Control of all S3's functions. You can Upload and Download files, change configuration and do everything remotely that you can do with S3's keyboard. Some companies make a song-and-dance about their software drivers, - and charge you at least £100. Ours is free. Not 'free' when you buy something, but FREE to any Company requesting literature.



Universal Assembler & Editor

S3 is also a MEMORY-EMULATOR. Use it with an Assembler and you have a complete Microprocessor Development System. It happens that Dataman sells a fast full-featured Editor/Assembler, called SDE, for use with S3 (or without).

RS232 socket (DB25) on the back, for remote control.

Emulator lead (supplied) plugs in beneath.

S3 programs and emulates 25 and 27 series EPROMS up to 27512.

The 80 character LCD shows ASCII and HEX.

Quality keyboard for fast data entry.

S3 will program hundreds of PROMS without recharging.

Charger unit (supplied) recharges S3 in 3 hours.

A single keypress will Assemble and Link the source file(s), download to S3 and start the program running on your target system. SDE has some amazing features. If it finds an error when assembling, it puts you back in the source-file at the error line. It will tell you the absolute address of any line of source code. That saves the chore of printing listings when debugging. SDE comes in single or multiple processor versions. Do try it. You will like it.

Socket is used to program PROMS and load software.

Money-back Guarantee

Our aim is to get a product into your hands. Our products sell themselves. We promise to hand your money back without question if you're not mightily pleased. Dataman products are so well thought out and downright useful - and such good value for money - that we hardly ever get any returns.

What to do next

Send your business-card or letterhead quoting where you saw this ad. That gets you LITERATURE and YOUR FREE TERMINAL PROGRAM (not just a demo - it really works!) If you're in a hurry, phone and speak to Debbie, Emma, Chris or Nigel. Some formalities are necessary, but we will waste no time in getting the goods to you. Tomorrow morning is quite possible.

Specifications and Price List

S3 has a 64 kbytes CMOS RAM buffer for storing USER programs and ROM/RAM EMULATION - access time is about 120ns. There are also 8K bytes of program RAM, a serial interface at 300, 600, 1200, 2400 4800 and 9600 baud for remote control and uploading and downloading files. S3 comes complete with Manual, Mains-charger unit, ROM emulator lead, write-lead and software to program and emulate (E)EPROMS and FLASH EPROMS. Re-charging takes 3 hours and does not prevent normal use. Typically one charge per week is enough. S3 measures 7.3 x 4.4 x 1.8 ins and weighs just over 1lb.

S3 Developer's Package Reveals all S3's secrets. Contains Circuit Diagrams, Source Code, BIOS calls and Editor/Assembler (as SDE above) for NEC7806 processor in S3. Lets you write your own custom software - even make S3 into a something completely different.	£395.00
MCS48 module for 8741/42/48/49	£195.00
MCS51 module for 8751/52/53	£125.00
32 pin module for EPROMS (inc FLASH) over 1m	£75.00
40 pin module for EPROMS over 1meg	£75.00
EPLD (CMOS PAL) modules (set of 2) for Erasable Programmable Logic Devices. Works with manufacturer's compilers to provide self-contained system. Receives, translates, creates and transmits JEDEC files. Loads, burns and copies parts such as 22V10, 20G10, 16R4, 16R6, 16L8, 16L8, PEEL18CV8, EP300 to EP900, 50C30 to 50C90 from Cypress, AMD, AMI, Altera, Gould, Texas, Intel, ICT	£295.00
S3 IS GUARANTEED FOR 3 YRS, OTHER PRODUCTS 1 YR, BOTH PARTS AND LABOUR. VAT MUST BE ADDED TO ALL PRICES, IN UK ONLY BUT POSTAGE IS FREE. SPECIAL OR FOREIGN DELIVERY COSTS EXTRA.	



Lombard House, Cornwall Rd,
DORCHESTER, Dorset DT1 1RX,
Phone 0305-268066
Fax 0305-264997 Telex 418442
Bulletin Board 0305 251786
300/1200/2400,N,8,1 (24hr)

CIRCLE NO. 159 ON REPLY CARD

tion. It is regulated, for the time being, by the IBA. Like other national DBS projects within the EC, it is covered by a directive requiring the use of some form of MAC as its transmission standard.

Sky, on the other hand, is an entrepreneurial project ultimately under the control of one man, Rupert Murdoch. It rents transponders on the Astra satellite (19.2°E), which is a privately-owned, Luxembourg-based operation. Astra is not in the least official, and is comparatively unregulated. Its frequencies were not originally allocated as broadcast frequencies; indeed, the whole concept of "medium power" (direct to home) was undreamt-of at the time of the 1977 WARC (World Administrative Radio Conference). And it was not covered by the 1986 EC directive, which imposed MAC on the DBS broadcasters.

This could change soon. That directive expires at the end of next year and an EC discussion document is currently circulating which looks at transmission standards, the "next generation" of DBS and compatibility with HDTV. A green paper setting out proposals is due for publication at the end of October, leading to a further directive next year. It will certainly encompass medium-power satellites. Astra plans two more, co-located at 19.2°W, and Eutelsat is about to launch the first of a series, to be strung out between 7°E and 30°E.

Logically, the new directive should extend the MAC requirement to these satellites, and there has been intense lobbying for this from companies such as Philips and Thomson with an interest in the Eureka HDTV project, for which they regard MAC as a stepping-stone.

Sky, however, believes that such a restriction, even if it applies only to new satellites and is not extended retrospectively to its own channels, would be an unreasonable interference with consumer choice. It would mean, for instance, that existing receivers would not be able to pick up channels on Astra's new satellite, 1B, due for launch in December.

Given that Sky has already established a strong precedent for PAL and that Germany has indicated a willingness to flout the existing directive and use some of its DBS channels to broadcast PAL (mainly for the benefit of the DDR-as-was), the directive is not expected to be too stringent. Smart money is currently on some soft-pedal recommendations — which broadcasters will be free to ignore — about the use of MAC.

This would leave MAC to make its way by its own merits, which include extremely secure encryption and the capacity to address individual receivers. Both are of value to pay-TV, the latter particularly so when pay-per-view gets started. Already, 22 out of the 73 satellite channels in Europe use MAC, including two on Astra.

Sky, which professes to look forward to HDTV — eventually — and in the meantime uses a cumbersome Smart-card subscriber system, takes the view that MAC is an unnecessary intermediate step, promoted by manufacturers just to gain more TV sales. This has some truth, at least in the context of an enforced adoption.

Benefits offered by MAC to the viewer are, after all, of debatable value. It is easy for professionals and other interested parties to get carried away by the improvement in picture quality, but one has to maintain a sense of proportion and allow that, for most viewers, this is pretty marginal.

The other great benefit is the ability to show wide-screen pictures. The down side of this is that sets on which to view them (those with 16:9 ratio screens) will cost around £3000 when they come on the market next year and the only material available for showing in the format will be old movies.

This is where the "MAC-first-then-HDTV" lobby scores a point by arguing that the existence of wide-screen reception facilities will encourage the adoption of appropriate studio equipment (and particularly OB cameras for sports events) and the production of wide-screen material.

The benefit offered by high-definition television — over and above those conferred by MAC — is an improvement in picture quality derived from doubling the number of horizontal lines, from 625 to 1250. This, however, will only come into its own on really big screens. Even on a 30in tube there is very little difference.

Since tubes any bigger than 30in are heavy and, being built around a vacuum, dangerous, the fate of HDTV is closely linked to alternatives, of

which the only promising one is LCD. This is stuck at around 14in in direct-view at present, but has been demonstrated to good effect as a projection medium. The promise held out to viewers, in around 10 years' time, is of flat, wall-hanging screens, 6ft wide or more, providing an intensity of experience comparable to being in a cinema.

The prize for the European consumer electronics industry, if it can pull this off, is threefold.

In the first place, it consists of protecting its own market against inroads from the Japanese, who have already developed their own version, called Hi-Vision, which uses 1125 lines and, unlike the European system, has no reverse compatibility.

Secondly, while there is little prospect of forcing the Japanese to accept it as a world standard, there is a good chance of seeing the system adopted in American and other NTSC countries. The European system is NTSC-adaptable and much of the US TV manufacturing industry is European-owned.

"Germany has indicated a willingness to flout the existing directive and use some of its DBS channels for PAL"

Finally, and perhaps most important of all is the interaction with the computer industry. The one thing computers cannot yet manage economically is good-quality dynamic video, i.e. moving pictures. HDTV could provide this, which is why, according to Philips, the Japanese have targeted it as a key strategic technology and Europe must do likewise.

Europe's HDTV project is less than four years old. It has moved fast in that time, and has developed sufficient credibility to gain the support of member-countries, and *de facto* recognition by the CCIR at its most recent meeting in Dusseldorf, in May this year.

In the context of the race for high-tech global supremacy, Sky's developing economic muscle could mean that the battle between it and BSB will prove to be a turning-point. However, given the forces mustered behind the MAC/HDTV banner, there is at least an equal chance that Sky, if it chooses to remain with PAL, will be left on the sidelines as an interesting anomaly. ■

"the two broadcasters are culturally and philosophically as far apart as are their satellites in geostationary orbit"

RENT OR BUY - NEW GENERATION DEVELOPMENT TOOLS. RENT OR BUY NEW

NEW GENERATION ICE

REAL TIME HIGH LEVEL DEBUG
WITH THE COMPILER
OF YOUR
CHOICE



DEVELOPMENT TOOLS. RENT OR BUY NEW GENERATION DEVELOPMENT TOOLS. RENT OR BUY NEW GENERATION

GENERATION DEVELOPMENT TOOLS. RENT OR BUY NEW GENERATION DEVELOPMENT TOOLS. RENT OR BUY NEW

▶ **EXCLUSIVE ON-THE-FLY FACILITY**

Set breakpoints, display trace data, and display memory with the target system running at full speed. Essential for debugging Real-Time systems.

▶ **256K TO 1M STATIC RAM OVERLAY**

Expandable to 1mb. Overlay your target system EPROM and develop in RAM.

▶ **EASY TO USE**

With on line help and Auto help facility.

▶ **HIGH SPEED PARALLEL INTERFACE**

Down loads 64K of code in 15 seconds. Supports BINARY-OMF-OBJ-HEX-S-ABS files.

▶ **REAL-TIME TRACE 72 BIT WIDE BY 8K**

4 Operating modes

- 1. Start/Stop
- 2. Trace Area
- 3. Trace All
- 4. Selective Trace

▶ **8 BIT SUPPORT ALSO AVAILABLE**

All major 8 & 16 bit CPU's

▶ **HARDWARE BREAKPOINTS**

Supports Address, data, Status and external events. 8 Levels of nesting 256 points per level.

▶ **MULTI CPU SUPPORT**

Change microprocessor support by exchanging the CPU module. We have support for: **8 BIT** Z80-8085-NSC800-8048/49/50-6301-6809-6309-8051/52-64180-647180-Z180-68HC11. **16 BIT** 8086/88-80186/88-80C186/88-80286-V20/V30-V40/V50-V25/V35-68000/10-68020-H8/500-H16

▶ **PERFORMANCE AND COVERAGE FULLY TEST, OPTIMISE AND PROVE YOUR CODE**

▶ **MACRO FACILITY**

Use 'C' commands to define your own commands.

▶ **MULTI-TASKING CAPABILITY ON PC**

Single Key change from ICE to DOS task and back to ICE.

dux [uk] Tel: (0420) 63724

GENERATION DEVELOPMENT TOOLS. RENT OR BUY NEW GENERATION

Direct – conversion FM design

Homodyne or direct-conversion reception has always attracted a good deal of attention, especially in amateur circles¹. It has the attraction of simplicity, both in principle and in hardware terms. The first figure shows a simple homodyne receiver which could in principle be simplified even further by the omission of the RF amplifier (at the expense of a poorer noise figure) and even of the input tuned circuit or band-pass filter – some filtering might be provided by the aerial, if for example it were a half-wave dipole.

The homodyne has something in common with the superhet, but whereas the latter produces a super-sonic intermediate frequency (hence SUPERsonic HETerodyne receiver), in the homodyne the local-oscillator frequency is the same as the signal's carrier frequency, giving an IF of 0Hz.

It is well known that a homodyne receiver can be used for reception of SSB, although in a simple homodyne there is no protection against signals in the unwanted sideband on the other side of the carrier. A small offset between the frequency of the local carrier and that of the SSB signal can, however, be tolerated, at least on speech signals.

Homodyne reception can also be used for the reception of AM, but no frequency offset is permissible and the phase of the local carrier must be identical to that of the incoming carrier, otherwise all the modulation "washes out". This means in practice that the local oscillator must be phase-locked to the carrier of the incoming signal. If the local oscillator circuit is undercoupled so that it barely oscillates, if at all, the incoming signal energy can readily synchronise it, an arrangement universally employed

Direct-conversion detection is as old as the hills. Digital electronics has given the technique a new lease of life. By Ian Hickman.



under the name of "reaction" in the days of battery-powered "straight" wireless sets using 2V directly heated valves.

FSK and the homodyne

CW is readily received by a homodyne receiver, but it is not immediately obvious how it could be successfully employed for FM reception. However, it can, as will shortly appear.

The simplicity of the homodyne means that it is potentially a very economical system of reception and, for this reason, there has always been an active interest in the subject on the part of commercial concerns; a number of homodyne receivers has appeared on the market². This paging receiver is actually a data receiver using FSK modulation, which is a type of FM where the information is conveyed by changing the signal frequency rather than its amplitude. One could in principle receive the signal by tuning the local carrier just below (or above) the two tones and picking them out with two appropriate audio frequency filters, but this would be a very poor solution, since there would be no protection from unwanted signals on the other side of the carrier.

The solution adopted was much more elegant, with the local oscillator tuned midway between the two tones, so that both ended up at the same audio frequency, equal to half the separation of the two tones at RF. Now in a simple homodyne receiver, this would simply render the two tones indistinguishable; in a practical system it is necessary to have some way of sorting them out. This is entirely feasible, but it does involve just a little more kit than in a basic Fig. 1 type simple homodyne receiver. Before looking at how it is done, some basic theory is needed, which I have chosen to illus-

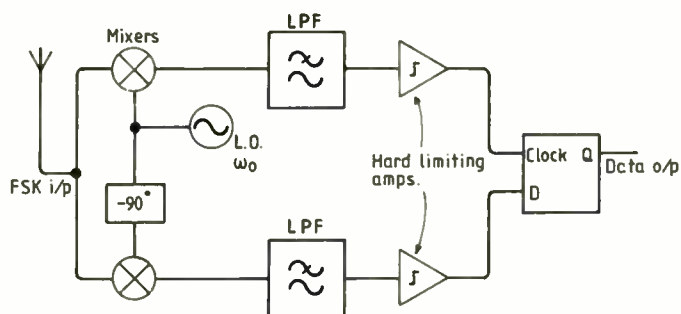

Fig. 1. Principle of the homodyne, in which the received signal is converted directly to audio by setting the local-oscillator frequency equal to that of the signal.

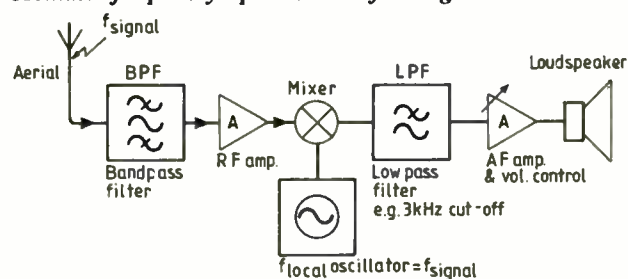

Fig. 3. Homodyne receiver for frequency-shift keyed transmission.

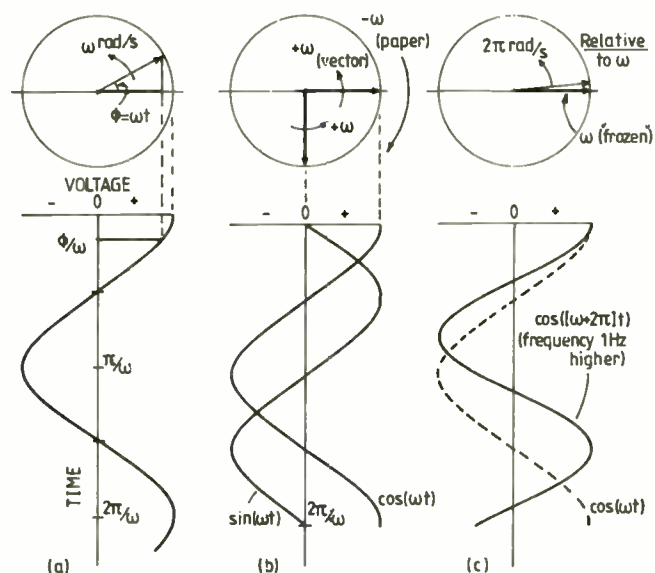

Fig. 2. Vector representation of sinusoidal waveforms. Waveform at (a) is derived from projection of rotating vector onto horizontal axis, while at (b) two such vectors are shown in quadrature, producing sine and cosine waves. Slightly different frequencies produce the effect seen at (c).

trate graphically rather than with algebra and trigonometry, though the results are of course the same.

Figure 2(a) shows a sinusoidal waveform and illustrates how its instantaneous value is equal to the projection onto the horizontal axis of a vector of fixed length, rotating (by convention) anticlockwise. Figure 2(b) carries the idea a little further and shows two such vectors, representing a sinewave and a cosine wave. As in (a), both vectors should be imagined as rotating at an angular speed of ω rad/s, that is $(\omega/2\pi)$ Hz. If they really were, there would be a blur at anything above a few tens of Hertz, so further imagine the paper they are drawn on to be rotating in the opposite direction, i.e. clockwise, at ω rad/s, thus freezing the motion and enabling us to see what is going on.

Furthermore, with this convention one can picture what happens when a slightly different-frequency sinewave is also present, say at a frequency of $(\omega + 2\pi)$ rad/s or 1Hz higher. This can be represented on the vector diagram as a vector rotating anticlockwise at a velocity of 2π radians, or one complete revolution, per second relative to the frozen ω vector, Figure 2(c). Had the frequency of the second sinewave been $(\omega - 2\pi)$ rad/s, that is to say 1Hz lower than ω , then its relative rotation would have been clockwise.

The method used by the paging

receiver mentioned earlier to distinguish between the equal-frequency baseband tones produced when the homodyne receiver is tuned midway between the two radio frequencies is shown in Fig. 3, a block diagram of the receiver. Incoming signal is applied to two mixers, each supplied with a local oscillator drive at a frequency of f_o , but the drive to one mixer is phase shifted by 90° relative to the other.

Referring back to Fig.2(c), a vector rotating anticlockwise at $f_{sh}/2$ relative to f_o (where f_{sh} is the frequency shift between the two FSK tones) will come into phase with the sine component of the local oscillator, $\sin(\omega_o t)$, a quarter of a cycle before coming into phase with $\cos(\omega_o t)$. On the other hand, when the incoming signal is $f_{sh}/2$ lower in frequency than f_o , then the clockwise rotation of the vector in Fig. 2(c) indicates that it will come into phase with $\cos(\omega_o t)$ a quarter of a cycle before $\sin(\omega_o t)$.

Now relative phases are preserved through a frequency changer or mixer, so the audio signal in the Q channel will be in quadrature with that in the I channel. Furthermore, one channel will lead the other or vice versa, according as the incoming RF tone is above or below f_o . The two audio paths include filters to suppress frequencies much above $f_{sh}/2$ (these filters must be reasonably well phase-matched,

obviously) after which the signals are amplified and then turned into square waves by comparators. As the square waves are in quadrature, the edges of the I channel waveform occur midway between those in the Q channel, so the D input of the flip-flop will be either positive or negative when the clock edge occurs, depending upon whether the RF tone is currently higher or lower in frequency than f_o , i.e. whether the signal represents a logical 1 or a 0.

The frequencies of the two RF tones are $f_o + f_{sh}/2$ and $f_o - f_{sh}/2$ and the resultant frequencies out of the mixers are the difference frequencies between these radio frequencies and the local oscillator frequency, or $(f_o + f_{sh}/2) - f_o$ and $(f_o - f_{sh}/2) - f_o$. The first of these audio tones is at a frequency of $f_{sh}/2$, while the second is at $-f_{sh}/2$ and of course by the very nature of an FSK signal, only one is present at any instant. Played through a loudspeaker, they would sound indistinguishable – as indeed they are in themselves. It is only by deriving two versions of, say, $+f_{sh}/2$ using quadrature related local oscillators and comparing them that it can be distinguished from $-f_{sh}/2$.

The ability of the receiver to distinguish between two audio tones of identical frequency, one positive and one negative, indicates that negative frequencies are “for real”, in the sense that a negative frequency has a demon-

strable significance different from that of its positive counterpart. This can only be observed, however, if both the P and Q (in-phase and quadrature versions) are available; the signal is then said to be a "complex" signal. A complex signal cannot be conveyed on a single wire, unlike an ordinary or "real" signal.

FM reception

In the case of more general FM signals, including analogue voice, more extensive processing of the baseband (i.e. zero-frequency IF) signals is required. Whilst this could, in principle, be carried out in analogue circuitry, it is often nowadays performed with digital signal-processing (DSP). The great attraction here is that one set of digital hardware can provide any required bandwidth and any type of demodulation (rather than having separate hardware filters and detectors for AM, FM, PM etc.) in, say, a professional or military communications or surveillance receiver (at present the arrangement would be unnecessarily expensive in a broadcast FM set). The signals must first be digitised, which in the present state of the art cannot be done economically at RF with enough bits to provide sufficient resolution. A super-het front end translates the signal to a low IF. There it can be conveniently digitised directly, or alternatively it is translated to zero Hz and then digitised.

There are several examples of receivers using this approach. The STC model STR 8212 is a general-coverage HF receiver with a DSP back end which includes FM in its operating modes. In such a receiver, a non-standard IF bandwidth is easily implemented, requiring only a different filter algorithm in prom, rather than a special design of crystal filter, with the associated time and cost penalties; a rather similar receiver is available from one of the large American communications manufacturers.

Another implementation of a high-performance HF-band receiver with a zero-frequency final IF is described in ref.3. (This did not list FM as one of its modes, but discussion with the authors afterwards confirmed that this mode is indeed included.) At the same venue, a paper⁴ from Siemens Plessey Defence Systems described their PV3800 range of broadband ESM receivers covering 0.5 —1000MHz. These include an FM demodulation mode and use a DSP back end; from the brief details given it would seem likely that again a zero-

frequency IF is used.

To understand the reception of conventional analogue FM signals by a homodyne receiver, it is time to introduce the general expression for a narrow-band signal centred about a frequency ω_0 ; this is

$$V(t) = P(t) \cos \omega_0 t - Q(t) \sin \omega_0 t \quad (1)$$

where P(t) and Q(t) are called the in-phase and quadrature components. It is important to realise that equation (1) is only useful to describe narrow-band systems, such as could pass through a band-pass filter with a bandwidth of not more than a few percent of the centre frequency; for very wide band system it would become mathematically untractable. So bear in mind that the functions of time P(t) and Q(t) are relatively slowly varying functions, that is to say a very large number of cycles of the carrier frequency ω_0 will have elapsed by the time there has been a significant change in the values of P(t) and Q(t).

With this proviso, equation (1) can, with suitable values of P and Q, represent any sort of steady state signal, including FM. I am using this expression, following the development in ref. 5, rather than the possibly more usual approach (see box) followed by other writers, e.g. in ref. 6, because it seems to fit in better with the explanation which follows.

Now FSK is a very specific and rather unrepresentative type of frequency modulation, resulting when a discrete waveform representing a digital data stream is used to modulate the frequency of a transmitter, but I introduced it first for the sole purpose of clearing up the question of the existence of negative frequencies. In the more general case, an FM signal results when a continuous waveform representing a voltage varying with time, for example speech or music, is used to modulate the frequency of a transmitter. The resultant RF spectrum is in general very complex, even for modulation with a single sinusoidal tone,

unless the m, the "modulation index", is small.

This is defined as the peak frequency deviation of the frequency-modulated wave above or below the centre frequency (the unmodulated carrier frequency), divided by the modulating frequency. Thus, if the amplitude of a 1kHz modulating frequency at the input of the transmitter were adjusted for a peak frequency deviation of ± 2 kHz, then $m=2$. It is fairly easy to show that, in the case of modulation by a single sinusoidal tone, the peak phase deviation from the phase of the unmodulated carrier is simply equal to m radians. For any modulating waveform, there will be a peak frequency deviation and a corresponding peak phase deviation, but the term modulation index is only really meaningful when talking about a single sinusoidal modulating tone.

Before pursuing the niceties of the FM signal, however, I must explain the significance of P(t) and Q(t). If P is a constant (say unity) and Q is zero or vice versa, the result is a unit-amplitude cosine or sine waveform of angular frequency ω_0 (the centre frequency), the only difference being that one is at its positive peak voltage, the other at zero but increasing, at the instant $t=0$, respectively.

Looking at the effect of other values for the constants, if $P=Q=0.707$ (I have written just P rather than P(t) here, since P(t) indicates a function of time, i.e. a variable, whereas just at the moment I am considering constants) then, as Fig. 4 shows, the phase of the sinusoidal waveform is 45° at $t=0$ and its amplitude (courtesy of Pythagoras) is unity. Note that the phase at $t=0$ (or at any other time, relative to an undisturbed carrier wave $\cos \omega_0 t$) is given by $\tan^{-1}(Q/P)$ and the amplitude by $(P^2+Q^2)^{1/2}$.

If one insists that even if P and Q are allowed to vary, i.e. are functions of time, they shall always vary in such a way that at every instant (P^2+Q^2) is constant, then there will be a wave of constant amplitude. In this case, since the amplitude modulation index is zero, any information the signal carries is due to its variation of frequency and it can be described by the values of P and Q.

To start with a very simple example, suppose $P(t) = \cos \omega_d t$ and $Q(t) = \sin \omega_d t$, where $\omega_d = 2\pi$ rad/s (say). Since $\cos^2 x + \sin^2 x = 1$ for all possible values of x (including therefore $\omega_d t$), the result is a constant amplitude signal. Further, its phase relative to ω_0 is $\tan^{-1}(Q(t)/P(t)) = \tan^{-1}(\tan \omega_d t)$ or ω_d times t. In

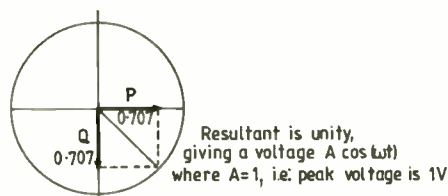

Fig. 4. In-phase and quadrature components. If P^2+Q^2 is constant, the wave is of constant amplitude.

other words, since the phase of the signal is advancing by $\omega_d = 2\pi$ rad/s relative to ω_c , the signal frequency is 1Hz higher than ω_c - a (constant) deviation of +1Hz from the centre frequency. Now if ω_d had been -2π rad/s, then the deviation would have been -1Hz, since $\cos(-x) = \cos x$, whereas $\sin(-x) = -\sin x$. Thus the deviation is simply the rate of change of phase of the modulated signal with respect to the unmodulated carrier.

If now ω_d itself varies sinusoidally at an audio frequency ω_a , then the result is a frequency modulated wave. But if, like me, you start to get confused as the algebraic symbols go on piling up, take heart; some waveforms are coming in just a moment. However, there is one more expression to look at first, since it forms the basis of the particular form of FM demodulation to be examined.

In FM, the transmitted information is contained in the deviation of the instantaneous frequency from the unmodulated carrier - indeed, the deviation is the transmitted information. But the deviation is simply the rate of change of the phase angle of the signal relative to the unmodulated carrier; this phase angle is equal to $\tan^{-1}(Q(t)/P(t))$, or ϕ , say. So the instantaneous frequency of the signal ω_i is

$$\omega_i = \omega_c + d\phi/dt.$$

Now ω_c is a constant and so conveys no information: to demodulate the signal evaluate $d\phi/dt$, that is $d\{\tan^{-1}(Q(t)/P(t))\}/dt$. After a few lines of algebraic manipulation (which aren't given in Ref. 3, but which I have checked out and can vouch for) this turns out to be

$$\frac{d\phi}{dt} = \frac{P(t) \cdot dQ(t)/dt - Q(t) \cdot dP(t)/dt}{P^2(t) + Q^2(t)} \quad (3)$$

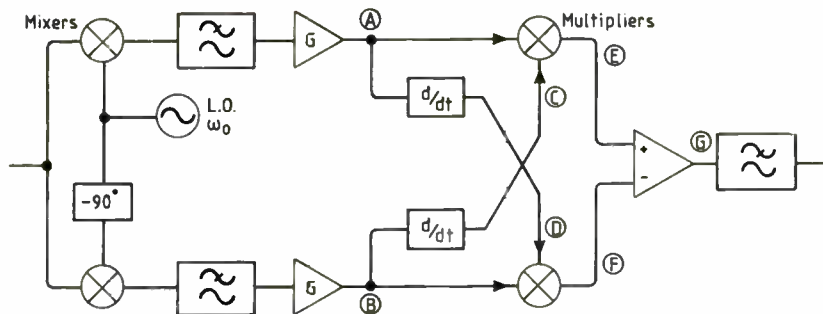
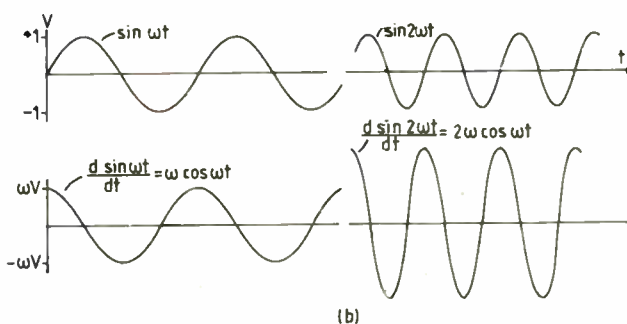
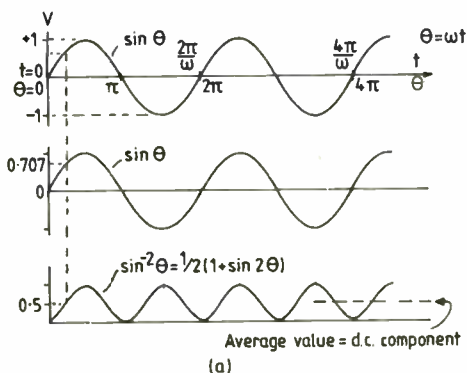

Fig. 5. Sin/cosine demodulator, which produces the numerator of equation (3) at G.

Now as seen earlier, if $P^2(t) + Q^2(t)$ is constant, the result is a constant-envelope wave. For an FM signal, this condition is fulfilled (ignoring fading, for the moment) so, to recover the modulation, a circuit which implements the numerator of the right hand side of equation (3) is needed.

Such a circuit is shown, in block diagram form, in Fig. 5. Taking it in easy stages, start with Fig. 6(a), which recaps on the basic trig. identity $\sin^2 \phi = 1/2(1 + \sin 2\phi)$, as can be seen by multiplying $\sin \phi$ by itself, point by point. Figure 6(b) recalls how $d(\sin \omega t)/dt = \omega \cos \omega t$, i.e. when you differentiate a sine wave, it suffers a 90° phase advance and the amplitude of the resultant is proportional to the frequency of the original.

In Fig. 5, assume that $P(t)$ is fixed at $+2000\pi$ rad/s, and Q likewise. There is thus a fixed frequency offset of 1kHz (2000π rad/s) above the carrier frequency ω_c . In Fig. 5, the frequency of the incoming signal is first changed from being centred on ω_c to being centred on zero by mixing it with a local oscillator signal which is also at ω_c . The two quadrature-related versions of the LO give the in-phase and quadrature baseband versions, P and Q , of the incoming signal. In the upper branch of Fig. 5, the P or in-phase (cosine) component of the signal (now

at the original deviation frequency of +1kHz) is multiplied by a differentiated version of the Q or quadrature component. Since these are in phase with each other, the result is a waveform at twice the frequency, and with an offset equal to half its peak-to-peak value, i.e. always positive, as in Fig. 6(a).

Figure 7 shows this and also the waveforms corresponding to the lower branch of the Fig. 5 circuit. Here, the resultant waveform is again at twice the frequency, but in this case, always negative, since $d(\cos \omega_d t)/dt = -\omega_d \sin \omega_d t$. Finally, subtracting $Q(t) \cdot dP(t)/dt$ from $P(t) \cdot dQ(t)/dt$, as in Fig. 7, gives a pure DC level. All traces of waveforms at $2\omega_d$ wash out entirely, since when $Q(t) \cdot dP(t)/dt$ is zero $P(t) \cdot dQ(t)/dt$ is at its maximum and vice versa - provided that the two LO components are exactly in quadrature, that there are no differences in the phase responses of the upper and lower channel of the Fig. 5 circuit and that their gains also match.

Fig. 6. Effects of squaring and differentiating sine waves. Squaring the wave, as at (a), doubles its frequency and produces a DC component. Differentiating, shown at (b), gives a cosine wave with an amplitude proportional to frequency.

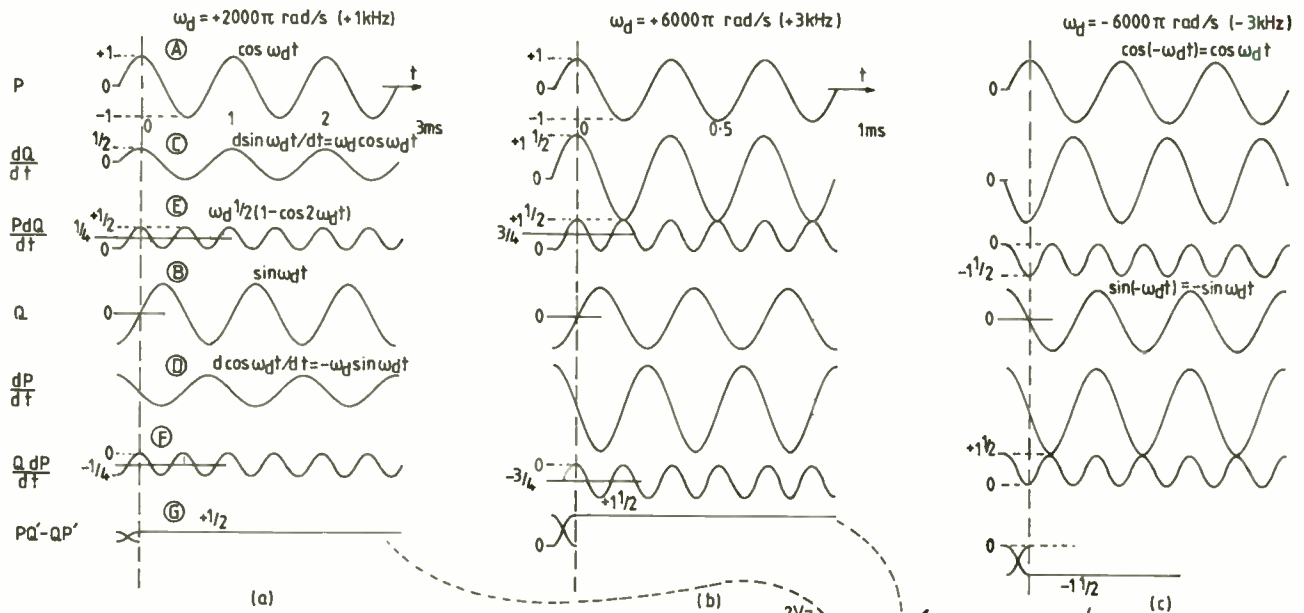

Figure 7 also shows the results when the deviation is +3kHz -3kHz, giving three points on the discriminator curve, which is a straight line passing through the origin. If ω_d , instead of being constant, varies in sympathy with the instantaneous voltage of the programme material, then the output of the circuit will simply be a recovered version of the original modulating signal as broadcast. This is illustrated for modulation by a single sinusoidal tone in Fig.8.

Note that, if the LO frequency is not exactly equal to the carrier frequency of the received signal, then the output of the circuit will contain an offset voltage, proportional to the mistuning, but this will not in any way affect the operation of the circuit as described. Indeed, in principle the offset could be equal to the peak output voltage at full modulation, so that the recovered audio would always be of one polarity, providing that the low-pass filters in Fig. 5 had a high enough cut-off frequency to pass twice the maximum deviation frequency.

The offset could be even greater; one could in theory apply expression (3) directly to a received broadcast FM signal at 100MHz, using the signal direct for the P(t) input and a version delayed by a quarter wavelength of coaxial cable for the Q(t) input. However, with the broadcast standard peak deviation limited to ± 75 kHz, the peak recovered audio would amount to only 0.075% of the standing DC offset, giving a rather poor signal-to-noise ratio.

Fig. 7. Sine-wave demodulator operation with a constant frequency offset. As seen in Fig. 5., subtracting QdP/dt from PdQ/dt gives a DC level proportional to frequency.

Homodyne in practice

The circuit of Fig. 5 could be implemented entirely in analogue circuitry, using double balanced mixers, low-pass filters and op-amps. Differentiation is very simply performed with an op-amp circuit, with none of the drift problems that beset integrators, while the multipliers could be implemented very cheaply using operational transconductance amplifiers (OTAs). An application note in the Motorola Linear handbook explains how to connect the LM13600 as a four-quadrant multiplier. However, as the denominator of (3) was ignored, the output of the circuit will vary in amplitude in sympathy with the square of the strength of the incoming signal; there is no AM suppression. The amplifiers G in Fig. 5 cannot be made into limiting amplifiers since, for the circuit to work, the baseband P and Q signals need to remain sinusoidal. In

principle, the amplifiers could be provided with AGC loops, but these would need to track exactly in gain: not very practical.

Alternatively, the whole of the processing following the mixer low-pass filters in Fig. 5 can be performed by digital signal-processing circuitry; the P and Q baseband signal would be popped into A-to-D converters and digitized at a suitable sample rate. This would have to be at least twice the frequency of the highest audio modulation frequency, even for narrow-band FM. For wide-band FM, the sampling frequency would have to be at least twice the highest frequency deviation to cope with the P and Q signals at points A and B in Fig. 5. In practice, it would need to be higher still to allow for some mistuning of the LO, resulting in the positive peak deviation being greater than the negative or vice versa, and also to allow for practical rather than "brick-wall" low-pass filters following the mixers.

All the mathematical operations indicated in (3) can be performed by a digital signal processor, resulting in a digital output data stream which only needs popping into a D-to-A converter

to recover the final audio. In addition to evaluating the numerator of (3) on a sample by sample basis, the DSP can also calculate $P^2(t)+Q^2(t)$ likewise. By dividing each sample by this value, the amplitude of the value of the final data samples is normalised; that is, the amplitude is now independent of variations of the incoming RF signal amplitude - AM suppression has been achieved. Naturally, this only works satisfactorily if the signals going into the A-to-D converters are large enough to provide a reasonable number of bits in the samples, or excessive quantisation noise will result.

I do not know of any homodyne FM receivers working on the principles outlined in this article, in either an analogue or digital implementation, other than the special case of the FSK paging receiver described earlier. Here I am limiting the term "homodyne" to receivers which translate the received signal directly from the incoming RF to baseband, that is to an IF of 0Hz. In this sense, a homodyne is a heterodyne receiver, though not a "superhet".

However, the homodyne principle as described can be and is used as the final IF stage in a double or triple superhet, the penultimate IF being translated

down to the final IF of 0Hz, and there digitised. The following DSP section provides all the usual demodulation modes, including narrow band FM implemented as indicated using expression (3) in full. ■

References

1. P. Hawker. Keep it simple - direct-conversion HF receivers. Proc. Conf. on radio receivers, IERE, July 1978, p.137.
2. I.A.W. Vance and B.A. Bidwell. A new radio pager with monolithic receiver. Proc. Conf. on communications equipment, IEE, April 1982, p.138.
3. Coy, Smith and Smith. Use of DSP within a high-performance HFband receiver. Proc. Fifth International Conference on Radio Receivers and Associated Systems, Cambridge, July 1990. Conference Publication No. 325.
4. Dawson and Wayland. A broadband radio receiver designed for ESM applications. *Ibid.*
5. J.H. Roberts. Angle Modulation. Peter Peregrinus Ltd, 1977.
6. Tibbs and Johnstone. Frequency Modulation Engineering, 2nd edn. Chapman and Hall, 1956.

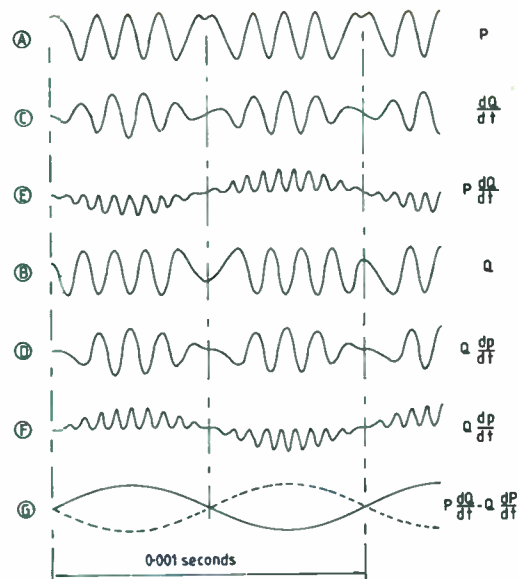
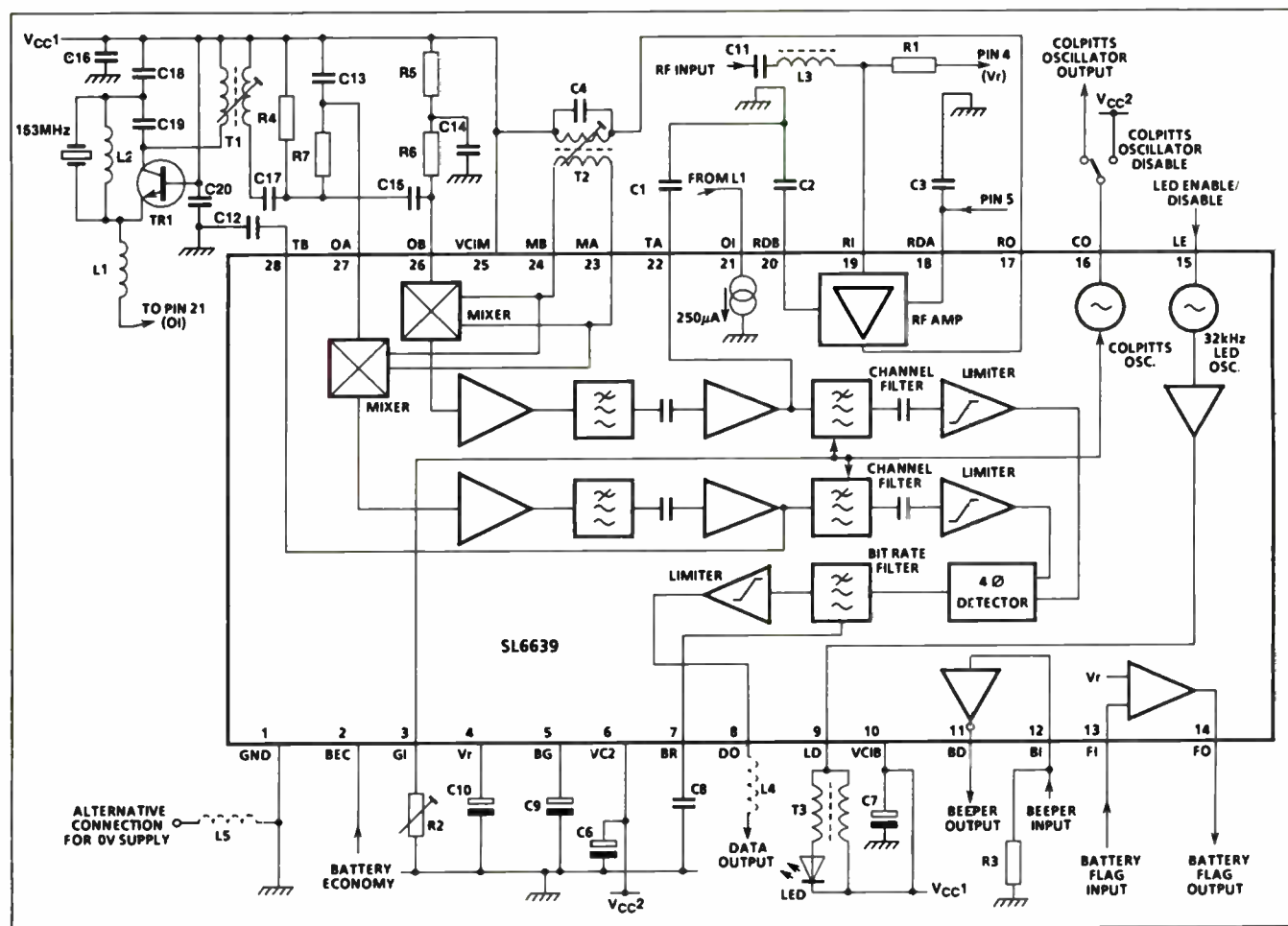

Fig. 8. Waveforms seen in the demodulator of Fig. 5. with a 1kHz FM signal of peak deviation 7kHz.

Fig. 9. Practical application of the SL6639 direct-conversion FSK data receiver chip from Plessey - a 153MHz receiver for a data rate of 512b/s.



ACTIVE

Discrete active devices

High-power mosfets. Highest power, highest frequency second generation RF power mosfets from Motorola are the 28V MRF175GV/GU and 50V MRF176GV/GU. GV models (225MHz) supply 200W at up to 17dB gain; GU models (400MHz) deliver 150W up to 14dB gain. The devices offer low thermal resistance, low C_{rss} guaranteed performance at either VHF or UHF frequencies. Motorola Ltd, 0296 395252.

Ultra-low-series-resistance variable diode. Suitable for UHF/VHF trimming applications, the 1SV229 variable capacitance diode has a series resistance of 0.2 Ω typically and comes in matched pairs, triples or quads in a surface-mount package. Maximum reverse voltage is 15V with a current of 3nA. Capacitance ranges from 14 and 16pF at 2V. Toshiba Electronics (UK) Ltd, 0276 694600.

High voltage low resistance mosfet. The ZVNL110A combines a 100V drain-source voltage with an on-resistance of 3 Ω at 0.5A. Handling a peak of 6A maximum, its threshold voltage is 1.5V. At ambient temperatures it can take continuous current of 320mA and its drain current given zero gate voltage is 10 μ A maximum. Less than 15ns to turn on and 25ns to turn off when carrying 1A drain current. Input capacitance is 75pF. Rise and fall times are both

A hammer driver circuit developed under the Power Asic system from Harris Semiconductor

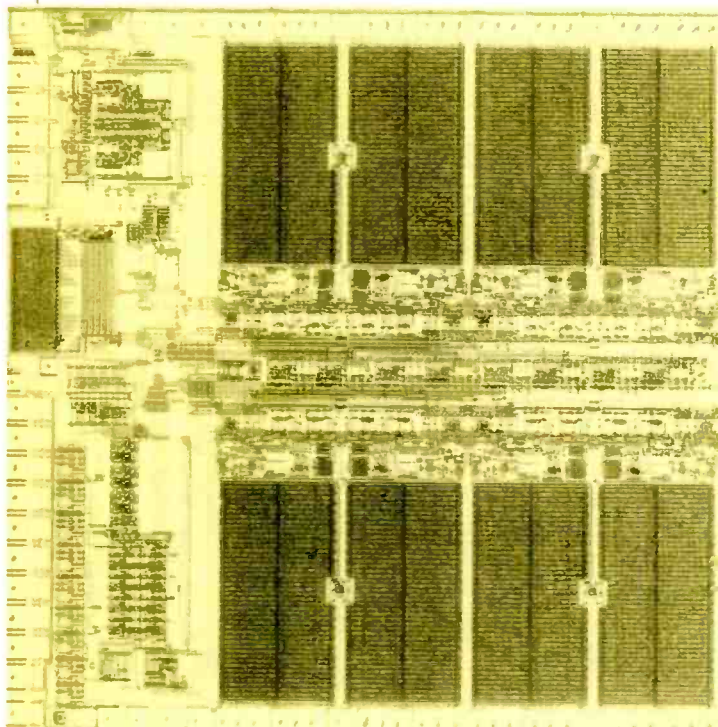

under 14ns. 4 by 2.5 by 4.8mm. It can dissipate 0.7W at -55 to 150°C. Zetex plc, 061 627 4963.

200V transistor. Collector-emitter rating of 200V, maximum saturation of 0.5V at 1A and a gain of 50 at 500mA. At ambient temperature the ZTX776 dissipates 1W; on a 1-in PCB this rises to 1.5W. Mounted on a PCB, thermal resistance of the junction to ambient is 116°C/W. Under pulsed conditions, the device handles 2A. 30MHz transition frequency and an output capacitance of 20pF, with a collector-base figure of -20V and a frequency of 1MHz. Zetex plc, 061 627 4963.

1A SOT23 transistors. Two surface-mount transistors from Zetex have a maximum collector-emitter voltage of 30V, a continuous current rating of 1A, and a gain of at least 40 when running at peak-current rating of 2A. The NPN (FMNT449) and PNP (FMNT549) devices have collector-emitter saturation voltages of 0.3V at 1A, and when carrying 0.5A, minimum gain of the devices is 100. Transition frequencies of the 449/549 are 150MHz and 100MHz respectively and output capacitances are 15pF and 25pF. Zetex plc, 061 627 4963.

Linear integrated circuits

Dual video amplifier. Elantec EL2224 is a dual monolithic amplifier capable of 60MHz open loop bandwidth, with only 10mA of supply current. Open loop gain is 75dB. It will operate from ± 5 to ± 15 V. Full power bandwidth is 3.0MHz when driving a 10V differential signal into 2000 Ω . METL, 0844 278781.

Low power comparator. MAX900 and MAX901 quad TTL comparators have propagation delays of 8ns with 5mV overdrive, an input common mode voltage range which includes the negative supply, and power consumption of 18mW. Both have differential inputs and TTL compatible outputs with internal active pull-ups. The MAX900 has output latches. Devices can be powered from separate analogue and digital supplies, or from a single +5V supply. Maxim Integrated Products Ltd, 0734 845255.

Octal sample-and-hold. The SMP-08, combines eight sample-and-holds on a single chip. Internal capacitors hold the input signal. Output amplifiers buffer the signal held on each of the hold capacitors. A TTL/cmos-compatible/one-of-eight decoder controls internal switches connecting the analogue input to the selected sample-and-hold. Each channel can be addressed to program a different output voltage. +5 to +15V or dual supplies of ± 3 V to ± 7 V. Droop rate is less than 1mV/s. Price in 100-piece quantities is \$6.25.

Logic building blocks

Mosfet with undervoltage lockout. Developed by Motorola is a series of high speed dual inverting mosfet driver ICs. MC34151 devices have low input current, input hysteresis for fast output switching independent of input transition time, and two high current totem pole outputs. Undervoltage lockout has hysteresis to prevent erratic operation at low power supply. Pin-compatible with MMH0026 and DS0026 dual mos clock drivers. Motorola Inc, 0101 602 897 3615.

Memory chips

Intelligent cache. Intel's 386 "smart" cache 82395DX integrates cache control logic, 16k of sram and 1000 cache tags. It expands the architecture of the i486 CPU on-chip cache into a stand alone device designed for 386 DX CPU-based systems. In a Power Meter Mips (Version 1.5) benchmark run on a 33-MHz 386 CPU-based EISA system, the cache operated at 8.3Mips. 1000-unit quantities £60.48 and £73.25 for 25- and 33-MHz versions. Intel Corporation (UK) Ltd, 0793 696000.

Very fast 1Mbit eeprom. 120ns maximum access time. The 28C010 eeprom boasts 80mA active and 350 μ A standby current requirements. Extended chip select facility eliminates the x4 decoder required for multi-part system applications; reverse bias generator; software write protection; and false write and erase protection. £3.80 each for 100. Seeq International Ltd, 0793 694999.

Data cache ram. The VT62A168/188 is a high-speed 128K static ram with 25ns access time, for use as a data cache ram, with the Intel 82385 cache controller in 386-based systems. It can be organised as 8k x 16 or two 4k x 16 memories. Two devices provide the complete 32k data cache supported by

the 82385 cache controller while the device will accommodate 33MHz versions of the 80386. VLSI Technology GmbH, 089 926905 0

Microprocessors and controllers

Control microcomputer. MEG's control microcomputer has its operating system on-board, allowing programming in Basic and data logging, programming, editing and selective erasing of eeprom, flash eeprom or battery-backed ram. Standard specification includes A-to-D conversion, relay drivers and 8-bit input and output. A PLD allows hardware structure to be modified for special requirements. Basic firmware routines, which can be incorporated in programs, are included in memory to simplify I/O and memory management. Basic controller can be supplied for under £200. MEG Instrumentation Ltd, 0742 669887.

68HC000 embedded processors. The TMP68301F architecture includes a standard 68HC000 CPU core running at 12MHz or 16MHz, three separate uarts each with baud rate generator, three channel 16-bit timers, 16-bit parallel I/O (configurable as Centronix I/F), interrupt controller, address decoder and bus error detection. The TMP68303F adds a three channel DMA controller, on-chip dram controller, watchdog timer and direct stepper motor drive. Toshiba Electronics (UK) Ltd, 0276 694600.

Optical devices

Visible laser diode. AlGaInP laser diode operating in the visible spectrum at 670nm, boasts a radiant output of 100mW. Threshold current is 70mA. It is a gain-guided double-hetero visible laser diode housed in a V package. Key features include fundamental transverse mode; correction of astigmatism using slanted glass cap; reverse voltages of 2/15V for LD/PD versions. Operating current is 85mA; operating voltage is 2.6V; monitor current is 0.1mA. Sony Europa GmbH, 0784 466660.

Bright LEDs. Panasonic's ultra-bright GaAlAs LED, uses high-efficiency chips to provide two candelas at a forward current of 20mA. Dished and polished lead frame and a 5mm diameter lens made from water-clear material, which focuses the light into a narrow ($\pm 10^\circ$) viewing cone. Forward voltage is typically 1.8V. Trident Microsystems Ltd, 0737 765900.

Power semiconductors

Power mosfets. Devices rated at 60V output with a typical on resistance of 160m Ω incorporate short-circuit-current limit, thermal shutdown and overvoltage/open load. TPD1000S has a maximum on resistance of 220m Ω , operating current of 2mA typical (at 12V), and a maximum power dissipation of 30W. The TPD1001S has a maximum on resistance of 200m Ω . Toshiba Electronics (UK) Ltd, 0276 694600.

PASSIVE

Oscillators

VCO with on-board filtering. Harmonic suppression of -30dBc and low phase noise are characteristics of the L100 series. Packaged on a miniature hybrid PCB 50.8 x 37.08 x 8.89mm, the tuning range is 50 to 175MHz, with phase noise specification better than -110dBc, measured at 10kHz from carrier. Tuning voltage is 0 to 12V DC with a sensitivity of 5MHz/V. Output is 5dBm, ± 1 dBm into 50 Ω . Chronos Technology Ltd, 0989 85471.

Connectors and cabling

Decoupling capacitor socket. Samtec's CIC series capacitor/IC sockets combine a precision screw machined IC socket with a decoupling capacitor between the power and ground contacts. Lead counts include 12 through 24 pins on 0.30in row spacing and 24 through 40 pins on 0.60in centres. Samtec Electronics Ltd, 0236 739292.

Crystals

Ceramic resonator. The MGA, MTA and MXA series, operating at -40 to +125°C, is suitable for use with either CMOS, HCMOS or TTL circuits and could provide a low-cost, compact and rugged alternative to quartz crystals or LC oscillators. Frequency range is 2-32MHz. 10.0 x 7.0 x 0.5mm. The device's two leads are on a 5mm pitch. Murata Electronics (UK) Ltd, 0252 811666.

Displays

16-grey scale plasma display. The PFP8060HRUS AC gas discharge plasma display provides a display matrix of 640 x 480 dots of 0.2mm diameter and 0.33 x 0.33mm pitch. The neon orange display, against a black face gives a minimum contrast ratio of 20:1. Brightness is 110cd/m² over 211 x 158mm. Viewing angle is 160°. 95V (plasma display) and 5V (logic) are required. Enclosure measures 279 x 213 x 19mm. Fujitsu Microelectronics, 0628 76100.

40 x 4 LCD. Varitronix 40 character by 4 line LCD range, with LED back light, has an effective viewing area of 154.0 x 27.6mm. Displays are available in TN, S-TN and SBE formats. 4.1V backlight supply, drawing 324mA. Module size is 196 x 56 x 11mm. Character height with cursor is 5.5mm. Trident Microsystems Ltd, 0737 765900.

Filters

Hex filter. Designed to consolidate filtering requirements in the DC to 8kHz range in multi-channel analogue signal systems, the MA6882 hex-filter offers six filters on one CMOS chip. Each chip contains two 7th order lowpass filters, two 6th order bandpass filters and two

6th order notch filters. All notch and bandpass filter centre frequencies can be individually selected. Marconi Electronic Devices, 0522 500500.

Instrumentation

Four in one measurement. DOA 141 combines a digital multimeter, function generator, frequency counter and power supply. The auto ranging 3 1/2 digit LCD multimeter DC accuracy of 0.5% is enhanced by measured data hold and memory mode for relative measurements. Measuring from 1Hz to 100MHz, the eight-digit frequency counter has a resolution of 0.1Hz and a sensitivity of 15mV. The function generator covers 0.02Hz to 2MHz with up to 20Vp-p output. Price (exc. VAT) is £395 Alpha Electronics Ltd, 0942 873434.

DSO and timing analyser. Model 1600 logic oscilloscope from Outlook Technology is a 16-channel digital storage unit with logic timing analyser triggering. It can be used as a multi-channel oscilloscope and also a 200MHz logic timing analyser with 1.5ns glitch detection and 5ns triggering across all 16 channels. Instrumatic UK Ltd, 0628 476741.

Low price oscilloscope. LeCroy's 10 digital oscilloscope captures up to 150MHz signals and automatically measures waveform parameters. The intelligent trigger system offers pulse width, interval width, logic pattern, state, time/event qualified, bi-level, and TV triggering. Two independent channels, each with 150MHz bandwidth, 4Gsamples/s for repetitive signals, 100Msamples/s for transients, 8-bit A-to-D converters, and 10ksamples of acquisition memory. LeCroy, 0235 33114.

Portable timing receiver. The TrueTime OM-PCB synchronised clock (less than 36in²) offers accuracy to 1ms to universal co-ordinated time. Selectable board outputs are RS-232, IRIG B, E and H and 1Hz. Further options. Consumption is 200mW. It derives time from the very low frequency Omega navigational system signals. Measurement Ltd, 0926 335411.

Sensitive trigger oscilloscope. The Tektronix 2205 is a dual-channel 20MHz instrument. In addition to auto- and single-sweep triggering, it provides independent selection of TV line and TV field triggering at any sweep speed. 80 x 100mm CRT. Horizontal sweep speeds range from 0.5s to 100ns per division; x10 magnifier. Vertical deflection varies from 5mV to 5V per division. RS Components Ltd, 0536 201234.

Fast transient generator. The NSG 1025 is a fast transient/burst generator with a solid-state high-voltage switch.



16-channel storage scope and timing analyser from Instrumatic

Test voltages up to 4.4kV and burst frequencies up to 10kHz single-pulse capability. A switch can select fixed settings for pulse parameters or continuous setting of the test voltage and free choice of burst frequency. Fast single pulses (5/50ns transients). 10kg, 18.3 x 44.9 x 36.1 cm. 25W. <£5000. Schaffner EMC Ltd, 0734 697179.

High sensitivity oscilloscope. Kenwood's CS4025 has a full 8 x 10div. screen (1div. —10mm). Sensitivity between 5mV/div. and 5V/div. over the full bandwidth and high sensitivity of 1mV/div. and 2mV/div. up to 5MHz. Sweep variable from 0.5 μ s/div. using the x10 magnifier. Crosstalk -40dB for a 1kHz sine-wave. £299 plus VAT including two probes. Thurlby-Thandar Ltd, 0480 412451.

High performance multimeter with increased scale length. The 1503 is a 3/4-digit digital multimeter measuring AC/DC volts, AC/DC current, and resistance, frequencies up to 4MHz with a resolution of 0.1kHz. Basic resolutions are 10 μ V, 10m Ω and 1nA. It can measure up to 1200V DC and 750V AC; 10A AC or DC continuously, or 25A for 10s. Resistance up to 32M Ω . Price £169 plus VAT including mains adaptor and test leads. Thurlby-Thandar Ltd, 0480 412451.

Interfaces

EISA host bus adaptor. Barracuda SCSI host bus adaptor can transfer data over the 32-bit EISA bus at 33Mbyte/s. Interphase International says this is the first high performance SCSI host bus adaptor for EISA-based machines. Speed relies on the BusPacket Interface and its large ram buffer coupled to a fast, deep FIFO memory. Barracuda can be configured as a single or dual host bus adaptor. Interphase International Inc, 0869 321222.

Literature

PMI data book. Volume 10, 1800-page text is intended for those involved in analogue IC design. Technical data

on nearly 200 devices, including operational amplifiers and D-to-A converters, is given; together with an applications index and industry cross reference section. The edition also contains a section on the expanded range of SSM audio products. Free. Arrow Electronics UK Ltd, 0234 270777.

Materials

Insulation pen. The 3300 circuit overcoat pen insulates, protects and repairs circuit boards, components and delicate electronics. The overcoat material is a polymer coating available in several colours. Dries in minutes. The over-coating is safe for gold, silver, copper and solder alloys. Traces as narrow as 1/16-in are possible. Price \$9.95 plus \$1.00 mail or \$2.50 UPS. Planned Products, (408) 459-8088.

Power supplies

External supplies. The Elpac CMI range of linear, external power supplies with input voltages of 200-250V AC, 50Hz, are now available in the UK. Two single-output models (+5V and +12V) and three triple-output models (+5V, +12V and -12V) are in the series. All outputs are regulated. Output 7.5 to 14W. £27 to £43 each in 100-unit quantities. Dowty Power Electronics Ltd, 0722 413080.

DC/DC converter. FC020A power module is a 20W isolated unit.

Regulated output voltage varies by no more than 0.16% of nominal 5V level. The unit measures 9.1 x 4.8 x 1.3cm. Nominal input voltage is 24V DC, but it will handle 18 to 36V DC. Short-circuit protection, remote sensing, synchronisation to an external clock, output overvoltage clamping. Powerline Electronics Ltd, 0734 868567.

DC supplies. Pennine DC power supplies' standard range includes unregulated and unsmoothed, and unregulated with smoothing. Inputs are 110 or 240 v.c.t.s AC, outputs are 24 or 12 volts DC, but alternative voltages are available. DC current values are

from 1A to 10A but current ratings available up to 100A. TSS (Saddleworth) Ltd, 0457 876131.

Programmable power supply. The TSP3222 125W dual-output half-rack programmable DC power supply has a GPIB interface and every function can be controlled via the IEEE Bus. Voltage and current can be read back via the GPIB to a resolution of 12 bits. The two 0-32V, 0-2A outputs are independent, isolated to 300V, and can operate in constant-voltage or constant-current mode. Output 2 can track output 1 when in isolated mode. £995 (plus VAT). Thurlby-Thander Ltd, 0480 412451.

DC-DC converter. The 10500 series 10W DC-DC converters provides 5V, $\pm 12V$ or $\pm 15V$ outputs from nominal 24 or 48V inputs. Input tolerance is 18 to 36V or 36 to 72V; high density, $>6.5W/in^3$, and efficiency $>80\%$ are achieved through 150kHz switching frequencies and surface mount technology. Vero Electronics, 0489 780078.

Power supplies. Verospeed's BVM110 110W supply has a 12V output capable of supplying the high peak currents demanded by disk drives during start-up. For larger digital systems, the BVM350NFS 350W universal input switcher has a floating fourth output, adjustable between 4.5V and 16V. Verospeed, 0703 461111.

Production test equipment

Fault finding. Simpler fault finding at component level by comparing pictures of device characteristics is the aim of T3000. Test clips are connected to the device and a 40-pin scanner displays and compares the signature of each pin. Built in pulse-generator allow testing of three-terminal devices. Fault finding on un-powered boards. Polar Instruments Ltd, 0481 53081.

Programmiers

Eprom programmer. Lloyd Research's L9000 eprom programmer, awarded formal type approval by Texas Instruments, can program 1Mbit T1 parts such as 27C010 and 27C1024 without adaptors. It is modular with the option to fit one or two modules. A module can have one, two or four copy sockets. Lloyd Research Ltd, 0389 885515.

Transducers and sensors

Rugged keyboards. Touch sensitive, vandal-proof keyboards with no contacts, movable mechanical parts or membrane are impervious to most hostile environments. Rust proof keys. Switches operate on change of a high frequency signal level. Resistant up to 15kV. output can be matrix, coded parallel or RS232C serial. Requires 5 or 12V DC at 50mA maximum. Digitran Ltd, 0763 261600.

COMPUTER

Computer board level products

Digital PCB testing. A low-cost PC-based package offers 192 individually programmable digital test channels, backed by a method of generating and executing go/no-go test programs. Locate-192 has a full-length card that plugs into a spare I/O expansion bus slot. Software language is based on English-style commands. Cost £936. ACES Ltd, 0202 723373.

Thermocouple driver package. PC73 amplifier and A-to-D conversion card plugs into an expansion slot to measure and display temperature. Eight differential signals from the external connection unit are multiplexed by reed relays through a high stability instrumentation amplifier. They are digitised by a 12-bit integrating A-to-D converter, at up to 30 conversions per second. Can measure down to $-2760^{\circ}C$. Amplicon Liveline Ltd, 0273 608331.

High-integrity PCbus expansion boards. Arcrom has developed a range of control and monitoring I/O expansion boards. Transparent offset-addressing is used where each board occupies two or four address bytes regardless of complexity of function. Range includes nine I/O choices spanning digital I/O, timing/counting, serial comms, A-to-D and D-to-A functions. Arcrom Control Systems Ltd, 0223 411200.

Digital multimeter. DMM-VIP plug-in board reproduces the functions of a digital multimeter, data logger and chart recorder. AC or DC up to 300V can be measured with four ranges. Input impedance is 11M Ω on DC. Other ranges include AC/DC current to 2A, resistance to 20M Ω , capacitance up to 2 μf and decibels up to $\pm 55dB$. Chart recorder emulation. Data may be logged to disk. External scanning units

Development system board produced by ERA Technology for the Plessey convolver PDSP16350 and PDSP16256



allow 32 channels. £399. Blue Chip Technology, 0244 520222.

Logic analysers. A five-unit series of PC-based logic analysers ranges from the CLK-2450 and CLK-12100 for education applications to the CLK-27100 and CLK-27200 for professional laboratories. The 27100 and 27200 units offer sample rates up to 200MHz, 16 level sequential triggering, variable threshold capability, and 16k memory depth. Flight Electronics, 0703 227721.

PC comms board. Emulex's DCP-88i (developed from the DCP-88), with up to 512kbyte of dual ported memory and octopus cabling, is built round a 7.16MHz NEC V20 microprocessor powering four synchronous or asynchronous serial ports plus optional parallel printer port. Can run all software supporting X.25, IBM 3270 and 3780 emulations and LU6.2 protocols. Emulex Ltd, 0734 772929.

Scan converter. A broadcast-quality pal version of Magni Systems VGA Producer computer-image scan converter card with a suitable VGA card, provides a video output that can be viewed on a television screen, mixed or recorded. A control box which, with a video camera or recorder allows overlaying captions, mixing, keying (cut-outs), borders, cross-fades and cuts. F W O Bauch Ltd, 081 953 0091.

Continuous period counter. The CTM-PER is a 28-bit board able to measure TTL signals from DC to 80kHz. Two BNC type connectors are gate and signal inputs. The gate enables measurements and can be programmed with polarities of either positive, negative or none. Signal can measure from positive, negative, or both edges. Keithley Instruments Ltd, 0734 575666.

Single board computer. SBC-XT and SBC-AT miniature single-board computers provide functionality of an AT/XT on a 5.75 by 7.75in board. Integrated control of hard disk, floppy disk and VGA graphics. Powered from a 5V rail. Monitor, drives and keyboard are needed to run MS-Dos or Unix applications. 4Mbytes of on-board memory and an 80287 maths co-processor can be accommodated. Nevin Developments Ltd, 0264 332122.

Optimising power amp design. Fast design and optimisation of single-ended switching-mode (Class E) RF power amplifiers is the goal of Hepa-opt (high efficiency power amplifier — optimiser). It uses adaptive step size and direction, receiving from its companion simulation program Hepa-sim, the computed DC input power, RF output power, and total power dissipation. \$355 to \$595. Design Automation Inc, (617) 862 8998.

Digital filter development system. ERA Technology's PC compatible development system is built around the PDSP16350 (modulator) and PDSP16256 (filter) digital signal processing chips. Supplied with digital filter design software, optimised for Plessey chips. Available with 12-bit resolution, 1MHz A-to-D converter; or an 8-bit 20MHz A-to-D. On board oscillators provide sample rates from 1kHz to 1MHz or 20MHz. Plessey Semiconductors Ltd, 0793 518000.

Cell-based semicustom intelligent power program. Process innovation, cell library development and cad tool integration have been combined by Harris Semiconductor in a package for designingasic power supplies. "Power Asic" has been developed for intelligent power applications — defined by Harris as combining analogue, logic and power in monolithic or multi-chip implementations, providing self-protection and feedback diagnostics and greater than 50V (and/or) greater than 2A (and/or) greater than 2W.

Entire boards can be replaced. Applications for Power Asic include power supplies (DC-DC converters), printers (print head drivers, hammer drivers), motor control (Class D power amplifiers, linear power amplifiers), and automotive-specific (high side and low side switches).

Macro library, HPA2000, is used with a junction-isolated, double-layer metal, 60-volt BiCmos process. The library includes logic, I/O functions, and analogue macro functions.

The Fastrack Power Asic design system includes menu-driven interface, a hierarchical schematic capture environment, user variable component values and geometries, back annotation support, and statistical simulation support for best, typical and worst case analysis. Harris Semiconductor (UK), 0276 686886.

With 48 years' experience in the design and manufacture of several hundred thousand transformers we can supply:

AUDIO FREQUENCY TRANSFORMERS OF EVERY TYPE

YOU NAME IT! WE MAKE IT!

OUR RANGE INCLUDES:

Microphone transformers (all types). Microphone Splitter/Combiner transformers. Input and Output transformers. Direct Injection transformers for Guitars. Multi-Secondary output transformers. Bridging transformers. Line transformers. Line transformers to B.T. Isolating Test Specification. Tapped impedance matching transformers. Gramophone Pickup transformers. Audio Mixing Desk transformers (all types). Miniature transformers. Microminiature transformers for PCB mounting. Experimental transformers. Ultra low frequency transformers. Ultra linear and other transformers for Valve Amplifiers up to 500 watts. Inductive Loop transformers. Smoothing Chokes. Filter. Inductors. Amplifiers to 100 volt line transformers (from a few watts up to 1,000 watts). 100 volt line transformers to speakers. Speaker matching transformers (all powers). Column Loud-speaker transformers up to 300 watts or more.

We can design for RECORDING QUALITY, STUDIO QUALITY, HI-FI QUALITY OR P.A. QUALITY. OUR PRICES ARE HIGHLY COMPETITIVE AND WE SUPPLY LARGE OR SMALL QUANTITIES AND EVEN SINGLE TRANSFORMERS. Many standard types are in stock and normal dispatch times are short and sensible.

OUR CLIENTS COVER A LARGE NUMBER OF BROADCASTING AUTHORITIES, MIXING DESK MANUFACTURERS, RECORDING STUDIOS, HI-FI ENTHUSIASTS, BAND GROUPS AND PUBLIC ADDRESS FIRMS. Export is a speciality and we have overseas clients in the COMMONWEALTH, EEC, USA, MIDDLE EAST, etc.

Send for our questionnaire which, when completed, enables us to post quotations by return.



PO Box 36, Ipswich IP1 2EL, England.
 Phone: 0473 252794 & 0473 219390 –
 Telex: 987703G Fax: 0473 236188

CIRCLE NO. 108 ON REPLY CARD

KESTREL ELECTRONIC COMPONENTS LTD.

- ☆ All items guaranteed to manufacturers' spec.
- ☆ Many other items available.
- 'Exclusive of V.A.T. and post and package'

	1+	100+		1+	100+
Z8530	1.00	0.50	2732A	2.00	1.50
Z80A CPU	0.80	0.65	2764A.25	2.00	1.35
Z80B CPU	0.90	0.70	27C128.25	2.40	1.95
Z80A CTC	0.50	0.35	27128A.25	2.10	1.60
Z80B CTC	0.75	0.55	27256.25	2.20	1.70
Z80A P10	0.60	0.50	27C256.25	2.10	1.60
Z80B (CMOS) CTC	1.00	0.80	27C512.25	3.00	2.60
74LS02	0.13	0.06	6116LP.150	1.00	0.70
74LS32	0.13	0.07	6264LP.150	2.00	1.55
74LS83	0.16	0.10	62256LP.120	3.60	3.10
74LS123	0.18	0.12	6821P	0.70	0.50
74LS125	0.14	0.10	6850P	0.68	0.48
74LS138	0.14	0.09	8251A	1.10	0.80
74LS148	0.30	0.20	8255A	1.20	0.95
74LS154	0.28	0.15	82C55A	1.30	0.95
74LS174	0.16	0.10	6502P	2.20	1.56
74LS244	0.22	0.14	6522P	2.00	1.45
74HC32	0.12	0.09	6551A	2.80	1.75
74HC86	0.16	0.12	LM324	0.16	0.10
74HC132	0.20	0.14	74HCT125	0.18	0.13
74HC153	0.18	0.12	74HCT373	0.30	0.18

All memory prices are fluctuating daily, please phone to confirm prices

**178 Brighton Road,
 Purley, Surrey CR2 4HA
 Tel: 081-668 7522. Fax: 081-668 4190**

CIRCLE NO. 107 ON REPLY CARD

HENRY'S Edgware Road, London, W2

ELECTRONICS DISTRIBUTORS

METEX AND TEST LAB INSTRUMENTS YOU PAY TRADE PRICES

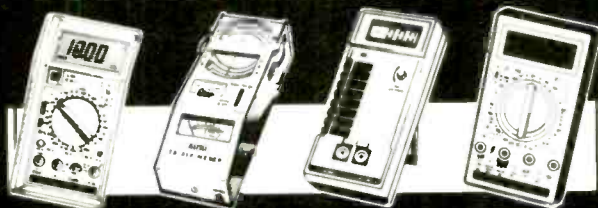

3 1/2 AND 4 1/2 DIGIT Dmms

ALL MODEL'S WITH CONTINUITY TEST (★ With Capacitance + Hic test 0 with 200KHZ Frequency counter)

METEX PROFESSIONAL

3 1/2 and 4 1/2 digit Dmm's with hard carry case.

Large LCD Displays with leads battery and instructions. 20A AC/DC.

BARGRAPH SERIES

M36108 3 1/2 Digit 30 Range 0.3% (-) £50.25

M36508 3 1/2 Digit 30 Range 0.3% (-+o) £61.25

M4650 4 1/2 Digit 30 Range 0.05% with Data Hold (+o) £87.10

M4600 30 Range 4 1/2 Digit 0.05% with Data Hold (+) £67.00

M4360 30 Range 4 1/2 Digit 0.05% with Data Hold (+o) £71.00

ALSO STOCKED

M3610 M3650 M4650 M3630B M4630B

AUTO RANGE SERIES

3 1/2 Digit with Data Hold and Freq. Counter

M80 21mm Display 20KHZ Counter £50.92

M818 17mm Display True Rms. 400 KHZ Counter £56.28

M818B Bargraph Version £64.32

NON-BARGRAPH

M3800 32 Range 3 1/2 Digit 0.5% (-) £31.50

M3630 30 Range 3 1/2 Digit 0.3% (+o) £47.57

STANDARD SERIES

- with soft carry case 3 1/2 digit 12mm Displays

M23158 17 Range 10 ADC £20.00

M23188 23 Range 10 ADC (+) £23.72

M2335 31 Range 10A AC/DC (+) £27.74

M2325 32 Range 10A AC/DC (+) £30.42

M2355 32 Range 10A AC/DC (+o) £34.57

M2365 38 Range 10A AC/DC (+o) £37.25

ALT216 Low cost 3 1/2 digit £12.13

INSTRUMENTS & POWER SUPPLIES

3000 LCR AC Bridge	£102.20	TE220 1 MHz Audio Generator	£81.75
M3002A AC Millivolt Meter 1MHZ	£82.80	3300 Autorange Digital Cap. Meter	£64.00
2020 500 KHZ Function Generator	£94.50	6100 Signal Tracer/Injector	£52.30
4182A0 150 MHZ Fr Gen. Plus 6 Digit Counter	£181.00	5250 150 MHZ 7 Digit Freq Counter	£64.50
2603A0 1 MHZ Af Gen. plus 6 Digit Counter	£164.16	243 0/24V 0/3A Variable PSU	£56.00
TE200 150 MHZ Rf Gen.	£84.00	245 0/24V 0/5A Variable PSU	£69.55
PS500 350 MHZ Harmonic	£84.00	154 4/15V 0/4A Variable PSU	£40.00
		303 0/30V 0/3A Variable PSU	£78.22
		PS3030 0/30V 0/3A Variable PSU	£108.40
		PS3030 Digital Version	£213.00

"POCKET" TEST INSTRUMENTS

YF20 Dual Scale Sound Level Meter 120dB	£32.85	3900TD LCD Dmm With Dwell And Tach Ranges 20A AC/DC	£49.58
225V VHS Video Head Tester	£30.69	KT50 LCD 8 Range Capacitance Meter	£36.20
1065 Digital Lux Meter - 3 Ranges	£44.83	6060 LCD Digital True Power Meter	£64.00
07 Logic Probe	£1.65	6KW 19	£64.00
M625 Logic Probe/Pulsar	£14.74	2070 19 Range Multimeter 10ADC + Buzz	£12.60
300 AC C amp Meter 600A/300V/Resis	£33.50	2030ET 27 Range 10A AC/DC. Cap. Buzz	£29.30
M265 Add on AC Clamp Probe for Dmm's	£16.48	5050E 41 Range FET mm	£26.77
501 Electronic Insulation Tester 500V	£53.25	0M5 Wallet Autorange Dmm	£18.70
504 Electronic Insulation Tester 1000V	£70.88	921 Pen Type Autorange Dmm	£24.78
K0M6 TR Dip Meter 1.5 to 250 MHZ	£41.88	850 Mains Phase Tester	£21.70
1082 LCD Temperature & data hold	£36.72	260 1000A AC Digital clamp meter	£40.25
302K LCD Temperature Two 1/P	£32.00	261 Add on insulation tester for 260	£29.35

Henry's are also instrument distributors for HAMEG, FLIGHT, ALTAI, BLACKSTAR, THURLBY, HITACHI, CROTECH, THANDAR. Phone for best prices.

Also stocked Tools, components, CB, public address, CCTV, security, communications, TV, video, audio, computer accessories.

Prices correct at July 90
TELEPHONE YOUR ORDER WITH VISA/ACCESS OPEN 6 DAYS A WEEK FOR CALLERS

ADD 15% VAT (UK ONLY)

HENRY'S AUDIO ELECTRONICS

404 Edgware Road, London W2 1ED
 Instruments/Audio 071-724 3564
 Security/Communications/CCTV 071-724 0323
 Components 071-723 1008 Fax: 071-724 0322
 Trade/Education/Export 071-258 1831
 Account Facilities Available for: Education and Trade/Industry

CATALOGUES IN COLOUR

- Instruments
 - Security
 - Supplements
 - Components
- Ask Henry's first
 £1 for callers: large SAE £2 stamp UK by post, (Export £3.00) Free to Education with Trade Prices

CIRCLE NO. 106 ON REPLY CARD

Beginner or advanced hobbyist EBBO® is the right system for you



Once hobbyists had to buy "professional" Solderless Breadboards paying "professional" prices, but now there is EBBO, a total Breadboarding System at a hobbyist's price. EBBO can be as simple or as ambitious as you want it to be, the only limit is your own imagination or skill.



Send for detailed colour catalogue and price list—

AP Products Ltd

Barclays Bank Chambers, Market Place,
Saffron Walden, Essex CB10 1HR
Tel. 0799 26602 Fax 0799 21408

CIRCLE NO. 109 ON REPLY CARD

Universal μ P Development STATION

DATA I/O
STAG
ELAN
MQP
CITADEL
DATAMAN
SUNSHINE
etc



**ANY
TARGET
SYSTEM
WITH
EPROM,
SRAM,
OR
EEPROM.**

256K VER FROM £199 ex.V.A.T & P.P.

RING FOR A COPY OF OUR DEVELOPMENT TOOLS CATALOGUE...

MEMORY EMULATOR FEATURES.....

- * MEMORY EMULATOR WITH TRACE/BKPT EXPANSION CAPABILITY
- * PORTABLE MEMORY RETAIN VERSION AVAILABLE
- * 256K AND 1 MEG VERSIONS EMULATE ALL 27XXX EPROMS, 28XXX EEPROMS & 6XXX SRAMS.
- * DOWNLOAD YOUR CODE FASTER THAN BLOWING EPROMS 8K BYTES PER SECOND ON STAG STRATOS...

8K TRACE/BREAKPOINT FEATURES.....

- * 2 STAGE HARDWARE BREAKPOINT ADDRESS
- * 4 * LOGIC PROBE INPUTS + INTERRUPT OUTPUT PROBE
- * FIVE STANDARD USER PROGRAMMABLE BREAK CONDITIONS
Break on addr 1, trace from addr 1 to addr 2 or until buffer full.
Break on logic & addr 1, trace " " " " " "
Break on write & addr 1, trace " " " " " "
" " " " " " , trace every write and address 1
Trace continuous until address 1 reached.
- * TRACE MEMORY read-in using READ command of PROM PROG

FLASH DESIGNS: ST ANDREWS HOUSE, P.O. BOX 167, CRAWLEY,
SALES: 0293-611722 W. SUSSEX. RH119YE. TECH: 0293-551229

CIRCLE NO. 110 ON REPLY CARD

Mains Signalling Evaluation Kit

Across all industry sectors great interest is being shown in mains signalling, and there are many applications and market opportunities. This kit, complete with user manual, offers a cost effective way to gain rapid familiarity with the technique.

MODEMS

- * Modular solution to digital mains communication
- * Half-Duplex operation
- * Impulse noise resistant FSK modulation
- * Sinusoidal output for low R.F.I.
- * U.K. rated signal isolation transformer

FILTER

- * Attenuates signals by up to 40 dB
- * Clamps around cables for ease of installation

Kit comprises: 2 x Modems, 1 x Filter

Order Code: MS5001 Contact: Vicky Warner on Tel: 0993 841574 Fax: 0993 843186

PRICE £125 + P.&P.

EXCLUDING V.A.T.

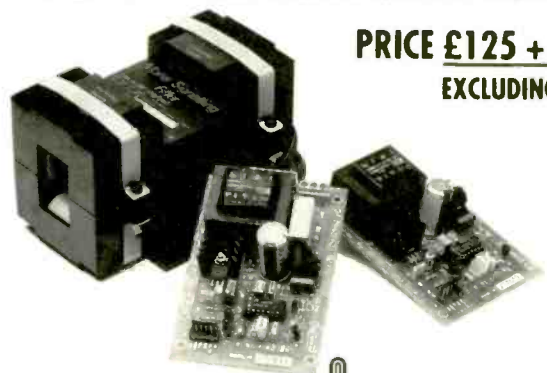

emlux
The Power to Control

Emlux Limited

Industrial Estate, Black Bourton Road, Carterton, Oxford. OX8 3EZ

CIRCLE NO. 111 ON REPLY CARD

THE MISSING LIFE OF ALAN BLUMLEIN

For eighteen years, a biographer has promised a biography of Alan Dower Blumlein, but has so far not published it and has kept the material to himself. Will it ever surface, asks Barry Fox.

Ask anyone on the street in North America, or the local equivalent of the Clapham bus, to name a "great inventor", and they will probably quote you Thomas Alva Edison. Ask the same question in Britain and the most likely names to come up will be Sir Clive Sinclair or Alan Sugar. Put the same question to an electronics engineer and (unless you have chanced on one of the stalwarts who see John Logie Baird as the unsung hero of the secret war) chances are that they will quote you Alan Blumlein.

Many readers of *EW+WW* will need no education on Blumlein's achievements and genius, although they may not know of some fascinating sides to the man's character which came out in a BBC radio documentary on Blumlein, broadcast earlier this year.

Sterling work by BBC researchers showed how Alan Dower Blumlein's life story is the stuff that Hollywood movies are made of. An absent-minded genius who died in mysterious circumstances, he could not read until he was twelve years old and would not read complete books until after his marriage.

He invented stereo sound recording in the early 1930s, became the driving force behind the first all-electronic TV system which made Britain a world leader in the late 1930s and then moved on to work on the radar systems which helped Britain win the war against Germany. He died when a Halifax bomber, which was testing H2S, the first radar to give air crews an electronic map image of the ground below, crashed when an engine caught fire near Ross-on-Wye. Sabotage was suspected, but never proved.

The government postponed even a brief announcement for three years, fearing that the news of his death would give solace to Hitler, who was complaining at the time that British radar was the ruin of his U-boat campaign.

Obviously, this brief insight into Blumlein's character and achievements struck a chord with the public. After the BBC broadcast, the producer's office in Bristol was inundated with calls and letters from listeners wanting to know where they could learn more about the man of whom they had previously heard nothing. Was there a biography to read? they asked.

The BBC could only answer No. And thereby hangs a most curious tale which may concern *EW+WW* readers.

It now looks likely that even the fiftieth anniversary of Alan Blumlein's death, in June 1992, will pass without publication of a full biography. This stems from the fact that vital biographical material relating to the inventor has passed into the hands of one man, Francis Paul Thomson of Watford, who has not yet produced the book he has been promising for nearly eighteen years.

The inventor's son, Simon Blumlein, has waited patiently but now says he is "very concerned". Francis Thomson began making private and public calls for biographical material, in 1972, using Simon Blumlein's name and with the Blumlein family's blessing. Because no book has appeared Thomson still, in



Alan Dower Blumlein

1990, holds all the material collected.

Early this year the biographer was blaming an unnamed publisher for the delay on his Blumlein biography. Soon after, he explained that unification of the EC in 1992 will "so completely turn the public's attention away" as to make publication of a biography in 1992 "a wasted effort". He then promised a "bang" in "virtually every country globally at a time suitable". Next he claimed to have written "five biographies of Blumlein" and that "Mark IV went to the publishers months ago".

Most recently (June 1990) Francis Thomson said he would publish an "abridged autobiography" (whatever that may mean) "internationally in 1991/92".

Simon Blumlein is especially worried because he has seen the biographer go off at a tangent, which distresses Simon Blumlein and distressed his mother, the inventor's widow, who died recently. By delving deep into Alan Blumlein's ancestry, Francis Thomson

has unearthed distant and tenuous links between the two families and is now drawing parallels at great-grandfather and junior-school level which, as Thomson puts it, "has enabled me to piece together an important basis to account for his genius".

Simon Blumlein is also concerned that he does not know what biographical material has been supplied to Thomson, and by whom, and what will happen to it in the future. This is because the Blumlein family agreed in 1972 that material received from those who knew Alan Blumlein should for convenience all be sent to, and held on behalf of the Blumlein family by, Francis Thomson. Some of the people who supplied material for the book are believed now to be dead.

While the book remains unfinished, other researchers are unable to access whatever historical material Thomson was supplied. As the BBC researchers found, every year first-hand memories of the man fade further into the mists of time. In blunt terms, sources die.

"I hold the world copyright of very many of the photos and illustrations of Blumlein from circa the early 1900s (and) I hold the negatives of very many Blumleinalia materials" confirmed Francis Thomson recently, warning that anyone thinking about publishing their own biography "should ensure . . . copyright clearance of both illustrations and text".

At the time of his death, in June 1942, Blumlein was less than forty years old, but had secured 128 patents, one for every six weeks of his working life. Patents are legal documents and, by definition, dull to read. Blumlein wrote little else for public consumption, and certainly nothing in lay language. This is hardly surprising; he was far too busy inventing to write anything that was not strictly necessary. In any case, although an electronics wizard, he was never at home with books and was an appalling speller. Probably he would now be diagnosed as word-blind or dyslexic.

Even after the belated announcement of Blumlein's death, there were security and secrecy restrictions, and Blumlein's colleagues were too busy re-building their own lives to think about fighting to de-classify documents and writing books. Even Blumlein's wife had not known what he was working on when he died.

The fact that Blumlein's work spread over such a wide field, crossing the boundaries of sound, film, television, electrical engineering, telephone and military technologies, deterred pot-

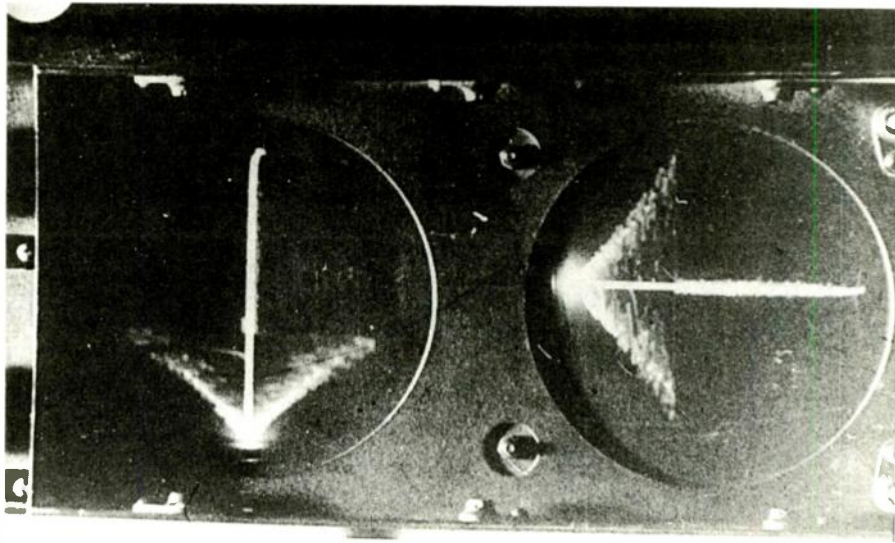

Blumlein's radar: Mk IV AI set in operation, 1940

ential biographers, too.

The first man to take on the job was an engineer, B.J. Benzimra. In 1967 he wrote a superb article¹ which called for reminiscences from those who knew Alan Blumlein to be sent to his son Simon. Benzimra said at the time that his dream was to "raise this forgotten man from the dead".

The next year, in May 1968, at a seminar on Blumlein's life organised by the British Kinematograph Sound and Television Society (BKSTS), Simon Blumlein spoke about his father and said he hoped with Benzimra to write a biography "even if it never gets published".

Unfortunately, Benzimra had to abandon the project through ill health (he later died) and it was taken over by Francis Paul Thomson of Watford. In September 1972 Francis Thomson sent out standard letters for publication to electronics magazines, for instance to the editor of the *Journal of the British Kinematograph, Sound and TV Society*, explaining that a biography of Alan Blumlein was "in preparation". The letter was an "urgent request" for "all who had personal contact with him (Blumlein), however slight, or who would like to give an assessment of his position in the history of technology" to write to Thomson at his Watford address.

Francis Thomson also wrote personally to those who he thought might be able to provide either written or tape-recorded notes. "Rather hesitantly" he wrote "I decided to attempt a biography". The letter included a questionnaire in the form of "notes for the guidance of contributors" and asked for any letters, memos, photographs, voice records or movie film to be sent

as well. The biography, explained Thomson, would be written so that 85% was acceptable to the technically interested with the remaining 15% aimed at the more technically oriented reader. The book, he added, "may be made the foundation of a documentary film".

The letters were on notepaper headed "Alan Dower Blumlein, a biography by F.P. Thomson in association with Simon Blumlein". Simon Blumlein had agreed that Francis Thomson should hold all material submitted on Simon's behalf. The guidance notes were referred to as a "formal request" in addition to more general requests published by magazines. Please respond by 30 November, 1972, recipients of the letter were asked, and given eighteen points on which to respond.

In December 1972 Francis Thomson told one correspondent that "a large number" of people had responded and there were already "unexpected surprises of great historical interest".

In September 1973, *Wireless World* carried a letter from Rex Baldock, organiser of the watershed BKSTS seminar in 1968, suggesting that anyone with information on Alan Blumlein should send it to Mr Thomson at his Watford address. R.W. Burns, then a graduate student at Leicester University, found it necessary to abandon a year's work on a Ph.D. thesis on Blumlein when he heard from Francis Thomson of his plans to produce a biography.

At the 1977 unveiling of a plaque on the house in Ealing where Blumlein once lived, Mr Thomson gave a speech in which he told how he had been "persuaded to write a biography". By

1981 he said he had accumulated about one and a half hundredweight of material and traced Blumlein's ancestry back to the early 15th century.

In 1982, in the fortieth anniversary year of Blumlein's death, *Wireless World* reported Mr Thomson as saying that he expected his biography on Blumlein to be published in mid-1984 and had "found some very interesting material about Blumlein's father and maternal grandfather who had much influence on him" and that "research into the family has taken him into such fields as mediaeval tapestry when he found the coat of arms of the Blumlein family of Strasbourg in a 500-year-old tapestry."

But 1984 passed without any sign of a biography. Anyone seeking guidance from *Who's Who* on the whereabouts of Thomson's biography is likely to end up very puzzled.

In the 1982 edition, the entry for Francis Thomson lists books on banking and tapestry, and a biography (with Simon Blumlein) entitled "A.D. Blumlein, Inventor Extraordinary". Publication date was given as 1977. But when I contacted the British Library it could find no trace of any biography on Blumlein, by anyone, and Francis Thomson has declined to identify any published work.

The next edition of *Who's Who* referred to "Engineer Extraordinary: a Biography of Alan Dower Blumlein", omitted any mention of Simon Blumlein and gave the publication date as 1983. By the 1984 edition all reference to Blumlein had disappeared. Even the most recent issue remains silent.

One of the books cited by *Who's Who*, *Money in the computer age*, contains an interesting account of Francis Thomson's campaign to persuade the British Government to adopt the Post Office Giro system of banking. He writes how he "soon grew accustomed to being on the receiving end of personal abuse and worse; after two physical attacks and threats against my wife's safety, I began to wonder what would come next . . . influential bodies were starting to take notice and reactionary elements were obviously starting to be apprehensive . . . it was no secret I was preparing a book that would be hard-hitting and several attempts were made to get a sight of some of its pages before publication; for example the dustbin at my home was searched several times by visitors who came by night and removed all the torn scraps of my rejected copy".

History seems now to be repeating itself. Francis Thomson recently de-

To Thomson from Fox

Is there any firm news to report on your promised biography of Alan Blumlein?

Do you for instance have a firm publication date yet? If you have abandoned the project I would be interested to hear what has, or will, become of the original source reference material.

I know that many people have been hoping to see a Blumlein biography for many years.

From Thomson

Reference: Your letter dated December 19 1989.

5 YEARS AGO, Mr. F.P. THOMSON O.B.E., C.ENG., M.I.E.E., Hon.F.I.S.T.C. was offered a minimum of one-and-three quarter million United States Dollars by an American organization for the Blumlein Archives and in addition free residence in Boston Mass. if, for 4 years in the 1990s he would host Science Seminars at no cost to himself.

Mr. Thomson's part American ancestry made this hardheaded approach to his long and painstaking Blumlein researches (at great expense to himself) a MUCH MORE FAIR attitude than the MANY approaches he has received from British people who have treated him as a sort of charity which OUGHT TO DISGORGE at his own expense the Blumlein memorabilia he has acquired and the research notes he has made when exploring accuracy of some of the people who have claimed association etc. with A.D. Blumlein.

Can you make Mr. Thomson a better offer?

Yours etc.,

p.p. F.P. THOMSON

From Thomson

Dear Sir,

Reference: Your letter of 02.01.1990.

You have REPEATEDLY attempted to persuade Mr. Thomson to give you information for your various articles and broadcasts, but have NEVER PROMISED HIM anything in return. Your above-noted letter now requests him to catalogue the archives and merely suggests in return that you "...might know of others who would be interested" in purchasing the archives". Mr. Thomson is not so dim-witted as not realise that your request for "what the archives comprise" is but another way of your gaining a comprehensive idea of detailed information about the entire Blumlein Family and Ancestral story, for which in return you are merely prepared to "consider the matter". Some years ago a member of the Blumlein Family communicated to him the information that you were accusing Mr. Thomson of having communicated IRRITATINGLY with your wife, but had

scribed a strange incident in which a messenger came to his house with a fraudulent letter "demanding" that he hand over "a large quantity of photographs, original documents and notes". The mysterious messenger then "used force" and "threatened" Mr Thomson, but apparently left empty-handed.

Recently the biographer revealed that he is researching "the probable meeting and changes made in South African native policy as a result of a meeting between A.D. Blumlein's maternal grandfather and the brother of a SA Prime Minister Sir Leander Starr Jameson, when both were in King William's Town, the former for a great conference of SA's principal ministers of religion, and where he was detained as a result of contracting crippling cellulitis (erysipelas - in those days often fatal)". Thomson notes that his mother, before marriage, was governess to the Jameson family in SA.

Says Simon Blumlein: "I just want to see my father's achievements more widely recognised, which was the original aim of the biography. One of the last things my mother told me was that she wanted that too. We want to be sure that material submitted in good faith to Francis Thomson and myself by people who knew my father is safe and

secure and that bona fide researchers can eventually be guaranteed access to it. We do not want to see the Blumlein and Thomson families tenuously linked by ancestral coincidences. Apart from anything else, it's hard to see who, other than the biographer, could possibly be interested in such matters."

If the biographer does as he now promises and publishes something in 1991/92, it will come a full twenty years after his original call for material. But the prospect of an "abridged" work is not reassuring. Neither is the biographer's talk of his plans for the material he has collected.

"Five years ago," reveals a recent letter headed as from the 'F.P. Thomson Archives for the Alan Dower Blumlein (1903-42) Biography and Family History', "Mr F.P. Thomson, OBE, C.Eng, MIEE, Hon. FISTC, was offered a minimum of one and three quarter million US dollars by an American organisation for the Blumlein archives and in addition free residence in Boston, Massachusetts if, for four years in the 1990s, he would host science seminars at no cost to himself. Mr Thomson's part American ancestry made this hardheaded approach to his long and painstaking Blumlein researches (at great expense to himself) a much more fair attitude than the many approaches he has received from British people who have treated him as a sort of charity which ought to disgorge at his own expense the Blumlein memorabilia he has acquired and the research notes he has made when exploring accuracy of some of the people who have claimed association with A.D. Blumlein".

References

1. B.J. Benzimra. A.D. Blumlein - an electronics genius. *IEE Electronics and Power*, June 1967, pp.218-224.

Further reading

M.G. Scroggie. The genius of A.D. Blumlein. *Wireless World*, September 1960, pp.2-7.

The world of Alan Blumlein. *BKSTS Journal*, July 1968, pp.206-218. (Seminar report.)

P.B. Vanderlyn. In search of Blumlein: the inventor incognito. *Journal of the Audio Engineering Society*, September 1978, pp.660-670..

B. Fox listed publications on Blumlein in *HiFi for Pleasure*, January 1984, pp.29-37.

W.A. Atherton. Pioneers 14: Alan Dower Blumlein - the Edison of Electronics. *Electronics and Wireless World*, February 1988, pp.184-186.

Information and the Internal Structure of the Universe, by Tom Stonier. A title hinting at a key to unlock the hidden secrets of the universe, and a cover linking a DNA molecule with the mysteries of space, means it takes a little time for the reader to adjust to Tom Stonier's real aim in this book.

Because this is not a book offering answers, philosophical or physical. It is in fact a collection of suppositions laying the ground-work for an all-embracing general theory of information which Stonier hopes will show "information" is one of the fundamental building blocks of the universe.

But that comes later. Here we have what in effect is the first in a trilogy - *After Chaos and After Information* yet to be published - and a manifesto for "information physics".

The aim of the book is to show how information can have a physical dimension. Whether a reader allows such an assumption largely rests on whether it is accepted that information exists independently of our ability to understand or decode it.

Stonier's contention is that information exists and does not need to be perceived to exist. It does not need to be understood, no intelligence is needed to interpret it, and it does not have to have meaning. A popular metaphor adopted to explain the physical existence of information is the example of the book which contains information, whether or not it is read or understood.

The book begins with a review of how information is carried in the organic and inorganic world and looks at how different measures can be reinterpreted in terms of their information content.

Communications engineers familiar with the work of Claude Shannon may have already considered some of the ideas behind Stonier's work. But Shannon was more concerned with a mathematical theory of communication, relating the idea of entropy to the transmission of information.

Tom Stonier is obviously aware of the controversial nature of his hypotheses and that his book represents an introduction to "an alternative view of physical phenomena" with a reinterpretation of well-established analyses.

As he says: "Some of it makes intuitive sense; some of it may prove to be wrong. Nevertheless, it is a beginning".

Springer-Verlag, 155 pages, hard back £13.50.

Postscript

After I had written this article, a reader drew my attention to a notice published ten years ago in *Wireless World* (January 1980, p.72). This notice reminded that, at the time of his death shortly after the end of WWII, Sidney George Brown, FRS, had more than 1000 patents on inventions including the gyrocompass, sensitive headphones and loudspeakers.

Wireless World reported that a biography of S.G. Brown was in preparation and that the biographer would like to hear from people who knew the Brown family in the USA or worked for S.G. Brown or his company in Britain and could give or lend papers, notes, photographs, etc.

The biographer? F.P. Thomson, "biographer of A.D. Blumlein".

It is now ten years on and the reader can find no reference to any biography of either Blumlein or Brown by F.P. Thomson.

"Is there any way in which our senior institutions of engineering and sciences," he asks, "could come to the rescue and honour the memory of these great and interesting figures in a fitting manner. Not to do so should be a matter of reproach to us all". ■

EPROM PROGRAMMERS

MODEL 200 – £295 (other models from £195)

- Includes MSDOS driver software, serial cable, comprehensive manual, 32 pin ZIF socket and universal object file editor/converter.
- Programs virtually all EPROM devices currently available including micro-controllers (nearly 600!).
- Emulation capability with our E512 or the Greenwich Instrument emulators.
- Easy to set up – *not* a plug in board.
- 12 Month Guarantee. Money back if not completely satisfied.
- Designed, manufactured and supported in the UK.



Z8 ADAPTER FOR MODEL 200

- Programs Zilog and SGS parts
- All Security Functions Programmable

£75

Increasingly popular 8 bit microcomputer available in CMOS versions.

PIC 16C5x ADAPTER FOR MODEL 200

- Available for DIL or SOIC parts
- Manufacturer approved algorithms

From £75

The 16C54/7 is a range of low cost, low power, high speed microcontrollers ideally suited to low or high volume developments

8 PIN SERIAL EEPROM ADAPTER FOR MODEL 200

- Reads & programs over 50 devices
- 1°C (M8571, X2402), 9306, 2506 etc.

£75

As used for security devices in many car radios, mobile radios, cellular phones & security systems.

Adapters available also include

- 8748/41 family £75
- 8751 family £75
- 40 pin EPROMs up to 4 Mbit £75
- 63701/5 from £75
- 32 pin PLCC EPROMs £85
- 647180 £125

Other families in development – please enquire.

We also sell Bipolar and Gang Programmers, EPROM Emulators and Erasers and a universal cross-assembler for IBM PCs and compatibles.

Write or phone today for Free Information Pack

Tel: (0666) 825146

Fax: (0666) 825141



MQP ELECTRONICS, PARK ROAD CENTRE
MALMESBURY, WILTSHIRE, SN16 0BX UK

Norwegian customers please contact:
Digitron A/S, Phone number: 071-45 890
Norway Fax number: 071-45 453

CIRCLE NO. 114 ON REPLY CARD

HALCYON ELECTRONICS

Computers, test equipment, video monitors, amateur radio gear, oscilloscopes, scientific instruments, connectors, printers, power supplies, communications, disk drives, multimeters, component bridges, frequency counters, signal generators, semi-conductors, integrated circuits, etc.

GOULD K100 D LOGIC ANALYSER	£1250	H.P. 3825B DESKTOP COMPUTER WITH 15263A	
DATA PRECISION 600C WAVEFORM ANALYSER	£3000	CARD READER	£195
WITH TWIN DISK DRIVE UNIT FOR ABOVE		UDI 2026 SONAR SCANNER, SURFACE UNIT	£995
LEADER LCG 396 NTSC PATT. GENERATOR	£395	SAILOR 66TS MF MARINE RECEIVER	£149
DECCA VOYAGER (MARINE), PSU, HANDSET	£80	ZX81, 16K RAMPACK, PSU, HANDBOOK	£59
LEADER LBO-9C ALIGNMENT SCOPE	£249	PRINCETON HX9 9" COL MON IBM/APPLE, ETC	£125
QUBEX QA 200 DISK DRIVE TEST UNIT	£2000	MUIRHEAD M100 COMMS RX 100KHZ-30MHZ	POA
HITACHI CM2073A/301 20" RGB LIN	£495	FARNELL E350, STABILISED PSU'S VAR OP	
14" MICROVITEC 1456/DGB CGA NEW	£159	0-350V 100MA & 2x6.3V (TAPPED)	£45
14" MICROVITEC 1456 TTL/LIN BBC, etc. NEW	£159	LINSTEAD M2B AC/DC ELECTRONIC METER BATT	£20
MEGGER'S MEGGER BRIDGES From		SCHLUMBERGER 4000 F/M/C/W 300HZ-520MHZ	POA
SERVOGOR 281, 8-PEN PLOTTER, A3	£69	PERIFILE DATA LOGGERS From	£45
KW VESPA Mk2, PSU, HBOOK	£85	NEWBURY TERMINALS 9509L NEW	£125
P4000 & EP4000 EPROM PROGRAMMERS EA	£95	NEWBURY TERMINAL 800Z NEW	£55
RACAL 1772B/S2/RB3/F/O a/c RECEIVER	£1950	GETRONICS VISA 95 TERMINALS	£75
CONRAC 7211 HI-RES RGB MONITOR	£395	OTHER TERMINALS From	£20
12" GREEN SCREEN MONITORS From	£39	EQUINOX COMPUTERS	£125
24" VIDEO MONITORS B&W, SOUND. From	£49	DEC RX02M-MD TWIN DISK DRIVES	£175
B41 RECEIVER 15KHZ-700KHZ	£69	TEKTRONIX 834 PROG DATACOMMS TESTER	£495
OSCILLOSCOPES DUAL TRACE From	£75	GOERZ RECORDING MULTIMETER BATT OP	£69

HANDHELD MONITOR TESTER FOR IBM MONO, CGA, EGA, VGA & OTHERS. TRADE ENQUIRIES WELCOME

OSCILLOSCOPES SINGLE TRACE From	£69	POLAROID/IBM PALETTE IMAGE RECORDER 72-10	£595
CREED 2300, PUNCH/READER/DIAL	£39	AVO 8'S Mk2, 5 & 6 From	£59
SIGNAL GENERATORS AF TO 5GHZ From	£25	VARIABLE OUTPUT PSU'S From	£48
LCR BRIDGES From	£35	TEKTRONIX 520 PAL OR NTSC VECTORSCOPES	£475
GALLENKAMP MAGNETIC STIRRER	£29	FREQUENCY COUNTERS From	£35
9" B&W MONITOR WITH PULSE/CROSS, ETC	£85	UPA CAVIDERM CD6 PTH TESTER	£995
PLESSEY INVERTERS 50V DC TO 240V SINE 375W	£85	BT OCTARA 32, TX23, TX21'S	£595
SONY UMATIC VT2030 + RF	£95	CHART RECORDER RS610-528	£95

1000'S OF UNLISTED BARGAINS FOR CALLERS
QUALITY ELECTRONIC EQUIPMENT BOUGHT. ALL PRICES EXC. OF P&P AND VAT

423, KINGSTON ROAD, LONDON SW20 8JR

SHOP HOURS 9-5.30 MON-SAT TEL 081-542 6383

CIRCLE NO. 113 ON REPLY CARD

Quality Toroidal Transformers

A large, standard range of (15-2000VA) high quality products are available conforming to BS415 (EC65) class 2 requirements.

Custom design options include –

- Audio grade – low noise
- Autotransformers
- Inverter transformers
- Current transformers
- Metal banding
- Potted centres
- Tape screens

We also manufacture other standards including:

EC742, EC601 (BS5724), UL506, UL544, CSA222

Agents wanted worldwide

Contact or tel 08494 28734
fax 08494 68745

Antrim Transformers Ltd
25 Randalstown Road,
Antrim, Co. Antrim,
N. Ireland BT41 4LD

CIRCLE NO. 112 ON REPLY CARD

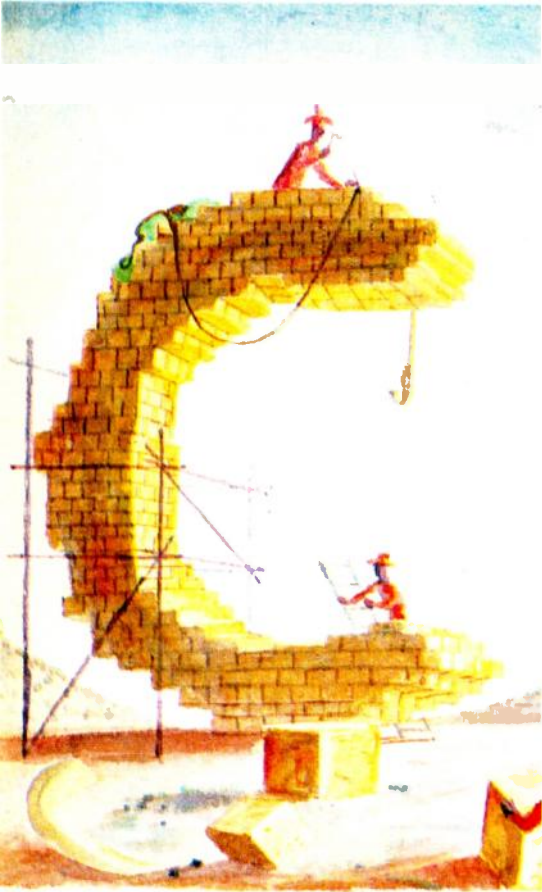

Interfacing with C

An accompanying set of 57 source code C listings presented with this series is now available on disk, price £25.50+VAT. We will shortly be publishing a book 'Interfacing with C' written by Howard Hutchings and based on the series, but containing additional information on advanced processing techniques. We are now accepting advance orders, price £14.95.

Prices include post and packaging. Please make cheque or company order payable to Reed Business Publishing Group and send to Lindsey Gardner, room L301, Quadrant House, The Quadrant, Sutton, Surrey SM2 5AS. Credit card orders can be phoned through on 081-661 3614 (mornings only).

INTERFACING WITH C

PART 7

Most filter poles possess real values. Digital filters may have poles at zero resulting in analogue impossible – and surprising – characteristics. Howard Hutchings explains FIR filters.

The previous examples have been restricted to establishing a correspondence between analogue and digital filters. Expressed most simply the problem reduced to mapping s-plane poles on to the z-plane. We shall now abandon all subtlety and demonstrate how it is possible to achieve results which are completely impractical using analogue circuits.

A fundamental feature of the moving averager is the ability to store input data and output it later through the D-to-A converter. This characteristic is sufficiently interesting for us to investigate it further and to produce some unusual digital signal processing effects. As we have already explained, no real analogue system can have more zeros than poles, yet the behaviour of the moving averager is characterised exclusively by zeros. If any poles are included for real-time realization, they will be located at the origin and will have no effect on the magnitude of the frequency response.

Generating echo and reverberation. Most low-pass filters exist expressly for the purpose of removing noise and improving the quality of the audio signal. Undoubtedly, all the digital filters discussed so far could be realised using combinations of R, L and C or the equivalent active filter design. But certain signal-processing operations are notoriously difficult to implement using analogue circuits: in particular, computations which require the accumulation of data over a long period.

Classical methods, that is, pre-digital, relied on analogue delay lines or tape loops to look back in time and record the signal's history. One of the fundamental advantages of digital com-

putation is the ease with which data can be stored and manipulated. For example, a digital signal processor can easily manipulate data captured substantially before the current sample, without any loss of accuracy.

To generate an echo, it is necessary to record or store a signal before releasing it a fraction of a second later, together with the current input. Because the poles included for real-time realisation are at the origin, the filter may be characterised as a finite impulse-response (FIR) type.

As a realistic application we intend to use the personal computer system shown in Fig. 5.1 to generate a weighted time delay or echo. The effect of this signal processing will be to make music sound as though it is being played in a large auditorium; the sound rebounds from wall to wall, progressively fading away into silence. Reverberation or generating multiple artificial echos is a combination of the original input signal plus suitably weighted delays. The effect on speech is quite dramatic, making it appear as though two people were speaking simultaneously in synchronism; six-string guitars sound like twelve-string instruments and concert pianos like honky-tonks.

Initially, I shall assume the interval between samples to be $250\mu\text{s}$, which is a reasonable estimate in terms of the complexity of the real-time algorithm written using C. The intention is simultaneously to output the current input, together with the input signal captured ten samples previously. To avoid exceeding the dynamic range of the D-to-A, both signals will be weighted; the sum of the weighting coefficients must be less than, or equal to one. In

keeping with our assertion regarding speed and simplicity, both coefficients will be 0.5. In other words, the current input will be added to the delayed input and the sum divided by two, before outputting through the D-to-A.

The weighted impulse response may be described by the sequence

$$h(n) = \{0.5, 0, 0, 0, 0, 0, 0, 0, 0, 0.5\}$$

Our objective is to design a computer program which will model this characteristic. Using z-transform notation, we write the transfer function directly as

$$H(z) = \frac{Y(z)}{X(z)} = \frac{1+z^{-10}}{2}$$

Recognising that X(z) and Y(z) are the transforms of the input and output signals, we cross-multiply and obtain

$$Y(z) = X(z)(1+z^{-10})/2.$$

Converting from transforms to sequences gives the recurrence relationship

$$y(n) = 0.5x(n) + 0.5x(n-10).$$

The pole-zero diagram, weighting function and frequency response characteristic are shown in Fig. 5.29.

Observe how the magnitude of the frequency spectrum varies over the

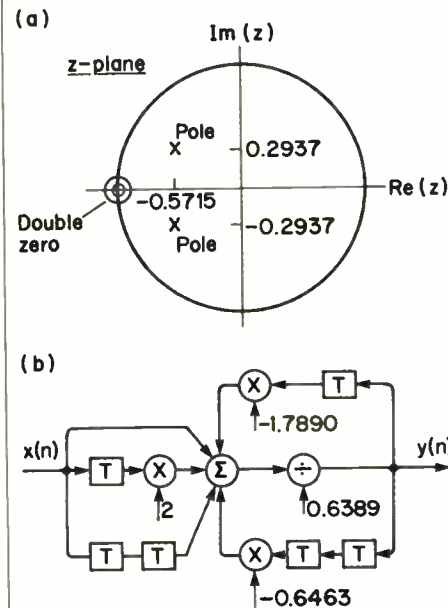

Fig. 5.27. Pole/zero diagram (a) and block diagram (b) of second-order Butterworth filter. Effect of double zero at $z=1$ in (a) reduces magnitude of frequency response to zero at Nyquist frequency. Recurrence formula indicates three forward paths in (b) and two feedback paths.

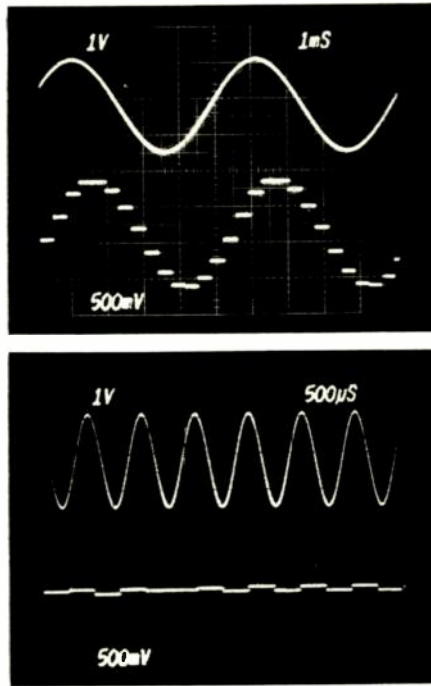
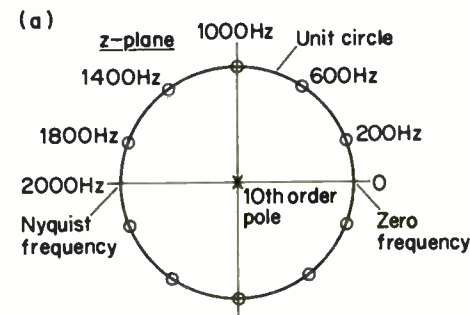

Fig. 5.28. Oscilloscope display of 200Hz (a) sine wave input and D-to-A output, after passing through Butterworth filter of Listing 5.5. Trace at (b) shows effect of double zero at half sampling frequency on 1250Hz input.

range of interest (DC to the Nyquist frequency), producing a comb-filter characteristic. The effect of the zeros has been to completely attenuate each frequency whose period is an integral multiple of the twice the time delay. Maximum output is obtained at those frequencies whose period is an integral multiple of the time delay. You can easily confirm this by running the program, Listing 5.6. On my system the

Fig. 5.29. Pole/zero diagram (a), weighting function (b) and frequency spectrum resulting from all-pole echo-generating program of Listing 5.6. Frequencies whose period is multiple of twice time delay are eliminated.



sampling frequency was 4kHz, and the designed delay 2.5ms. Consequently, the amplitude of the filtered output fell to zero at 200, 600, 1000, 1400 and 1800Hz.

Listing 5.6

```

/*****
/*  GENERATING ECHO 2.5ms DELAY  */
/*          FS = 4000Hz          */
/*****
#include<stdio.h>
#include<conio.h>
#define BASE 768
main()
{
float a,b,c,d,e,f,g,h,i,j,k,y;
/*****
NOTATION
a=x(n) b=x(n-1) c=x(n-2) d=x(n-3)
e=x(n-4) f=x(n-5) g=x(n-6) h=x(n-7)
i=x(n-8) j=x(n-9) k=x(n-10) y(n)=y
/*****
unsigned int contents;
outp(BASE,1);
/*****
SELECT I/P CHANNEL
/*****
for(;;)
{
outp(BASE + 2,0);
/*****
START CONVERSION
/*****
contents = inp(BASE + 2);
a = 0.00392 * contents;
/*****
NORMALISE INPUT
/*****
y = 0.5 * (a + k);
outp(BASE + 4,(int)128 * (1 + y));
k = j;
j = i;
i = h;
h = g;
g = f;
f = e;
e = d;
d = c;
c = b;
b = a;
/*****
SHUFFLE DATA FOR DIFFERENCE EQN.
/*****
}
}
    
```

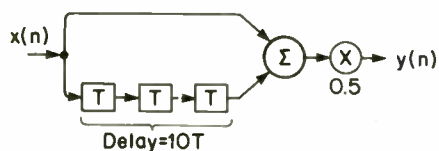

Fig. 5.30. In Listing 5.6, delay elements hold input for 10 sampling periods. Delayed input is then summed with current input.

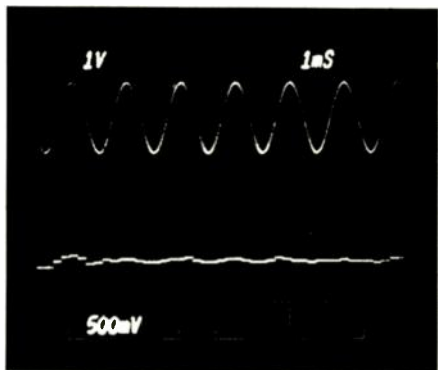
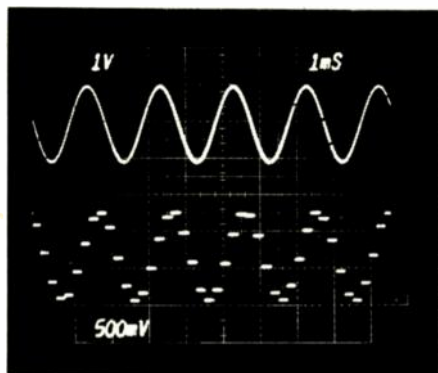

Fig. 5.31. Display of 500Hz (a) input and D-to-A output after passing through comb filter of Fig. 29 with 2.5ms delay. Trace at (b) shows effect of zero at $\omega T = 3\pi/10$ rad on 600Hz input.

Reverberation

Rather than using the computer and associated peripherals to generate a single delay, we choose to modify our design to generate multiple echos or reverberation. By adding the current, non-delayed input to weighted previous inputs, the signal will cycle through the processor until it becomes too soft to be heard. Mathematically, this signal-processing operation may be represented in the time domain by the expression

$$y(t) = x(t + \alpha x(t-T) + \alpha^2 x(t-2T) + \dots + \alpha^k x(t-kT)$$

Commuting from the time domain to the complex-frequency domain using Laplace transforms, we may write

$$\dots \alpha^k e^{-ksT} X(s)$$

Before expressing the signal in terms of z-transforms,

$$Y(z) = X(z) + \alpha z^{-1} X(z) + \alpha^2 z^{-2} X(z) + \dots + \alpha^k z^{-k} X(z)$$

Inspection of the mathematical model indicates that the transfer function of the filter is a truncated version of the infinite impulse response, already identified with the first-order low-pass digital filter. The required weighting function may be formed by subtracting the delayed, but weighted impulse response from the infinite impulse response as shown in Fig. 5.32.

$$H(z) = \frac{z}{z-\alpha} - \alpha^k z^{-k} \frac{z}{z-\alpha}$$

$$= \frac{z}{z-\alpha} (1 - \alpha^k z^{-k})$$

When a computer is programmed to behave a real-time filter, the amount of computation needed to achieve a particular impulse response is often an important consideration. Software-based multiplication is likely to impose



Fig. 5.32. Computational efficiency is achieved by expressing the truncated impulse response (a) as the difference between the IIR (b) and weighted/delayed IIR (c).

Fig. 5.33. Z-plane pole/zero diagram (a), weighting function (b) and spectrum of reverberation filter of Listing 5.7.

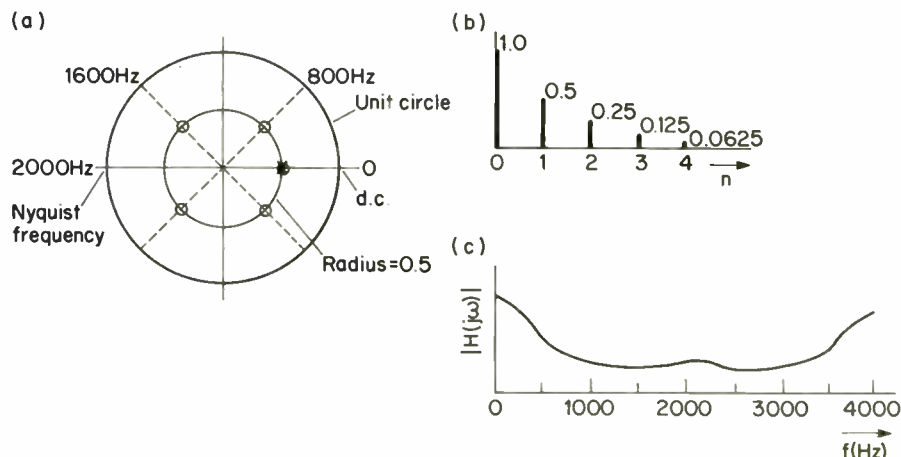

the greatest time overhead. In the quest for greater speed, considerable computational advantage can be gained by minimising the number of multiplications, if possible by expressing the transfer function recursively. As we have already seen, this is one of the critical parameters of any digital signal-processing system, because the amount of real-time processing limits on the sampling frequency.

Converting from transforms to sequences, we may express the processed output $y(n)$ as

$$y(n) = \alpha y(n-1) + x(n) - \alpha^k x(n-k)$$

This recursive expression offers exciting possibilities for the real-time computation of certain F.I.R. filters. Summing the current non-delayed input, with progressively weighted previous inputs, produces multiple echos or reverberation. For example the weighting function

$$h(n) = \{1, 0.5, 0.25, 0.125, 0.0625\}$$

simulates the effect of adding the current input $x(n)$ to weighted versions of the four previous inputs $0.5x(n-1)$, $0.25x(n-2)$, $0.125x(n-3)$ and $0.0625x(n-4)$ respectively. Expressing the processed output recursively, we may write

$$y(n) = 0.5y(n) + x(n) - 0.03125x(n-5).$$

Recognise that only three operations are required to implement a weighting function containing five coefficients. Obviously, the greater the number of terms in the impulse response, the more efficient the recursive algorithm becomes, minimising the number of computations to three. The pole-zero configuration, impulse response and frequency spectrum of this filter are illustrated in Fig. 5.33. Observe the

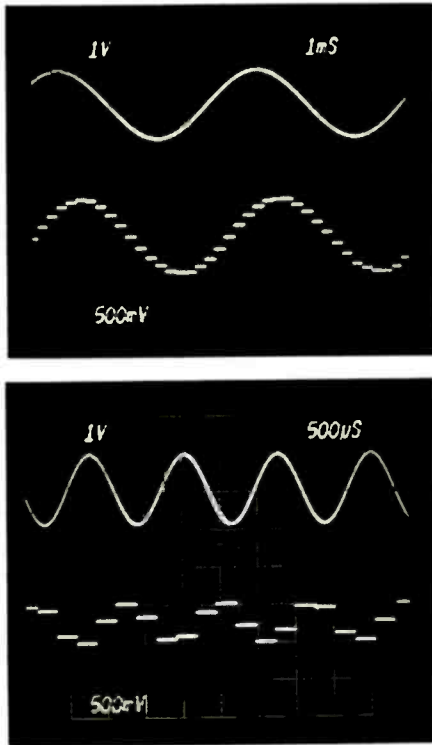

Fig. 5.34. Display of 200Hz (a) input and D-to-A output after reverberation filter of Listing 5.7. At (b), 800Hz input shows limited attenuation of zero.

effect of the pole-zero cancellation (where z equals $+0.5$); this interesting result characterises the behaviour of the filter in terms of $(k-1)$ zeros, excluding the coincident pole/zero cancellation where $z=a$.

Inspection of the frequency response shows the partial amplitude attenuation introduced by the remaining zeros. Geometrically, it is not hard to see the reason for the shape of this frequency spectrum; the magnitude is characterised completely by the radial displacement of the zeros. Remember that locating a zero on the circumference of the unit circle guarantees complete attenuation at that frequency, as previously demonstrated by the digital delay/comb filter. As usual, the poles at the origin make no contribution to the shape of the spectrum amplitude.

Listing 5.7

```

/*****
/*  GENERATING REVERBERATION
/*  RECURSIVELY FS=4000Hz
*****/
#include<stdio.h>
#include<math.h>
#define BASE 768
main()
{
float a,b,c,d,e,f,y;
/*****

```

```

NOTATION
a=x(n) b=x(n-1) c=x(n-2)
d=x(n-3) e=x(n-4) f=x(n-5)
y=y(n) z=y(n-1)
-----*/
unsigned int contents;
outp(BASE, 1);
/*-----*/
SELECT I/P CHANNEL
-----*/
for(;;)
{
outp(BASE + 2, 0);
/*-----*/
START CONVERSION
-----*/
contents = inp(BASE + 2);
a=0.000392 * contents;
/*-----*/
NORMALISE INPUT
-----*/
y=0.5 * z + a - 0.03125 * f;
outp(BASE + 4, (int)128*(1 + 0.516229 * y));
/*-----*/
WEIGHT AND SCALE: OFFSET CODING
AVOID OVERDRIVING D-TO-A (0.516229)
-----*/
f = e;
e = d;
d = c;
c = b;
b = a;
z = y;
/*-----*/
SHUFFLE DATA INTO
RECURRENCE FORM
-----*/
}
}

```

Further reading

1. R. E. Bogner A. G. Constantinides. Introduction to Digital Filtering. John Wiley, 1975.
2. B. M. G. Cheetham P. Hughes. Digital filter design. *Wireless World*. May 1982.
3. J. T. R. Sylvester Bradley. Digital filter design. *Wireless World*. May 1983.
4. Electronic Signal Processing, T 326. O. U. Press 1984.
5. H. J. Hutchings. Digital filters explained. *Wireless World*. December 1985.
6. T. O'Haver. Audio processing with a microprocessor. *Byte*. June 1978.
7. H. Chamberlin. A Sampling of techniques for computer performance of music. *Byte*. September 1977.
8. C. C. Bissell. A Phasor approach to digital filters. *Int. J. Engineering Education*. Vol. 24 1987.

Next month: practical programming for Fourier transforms.

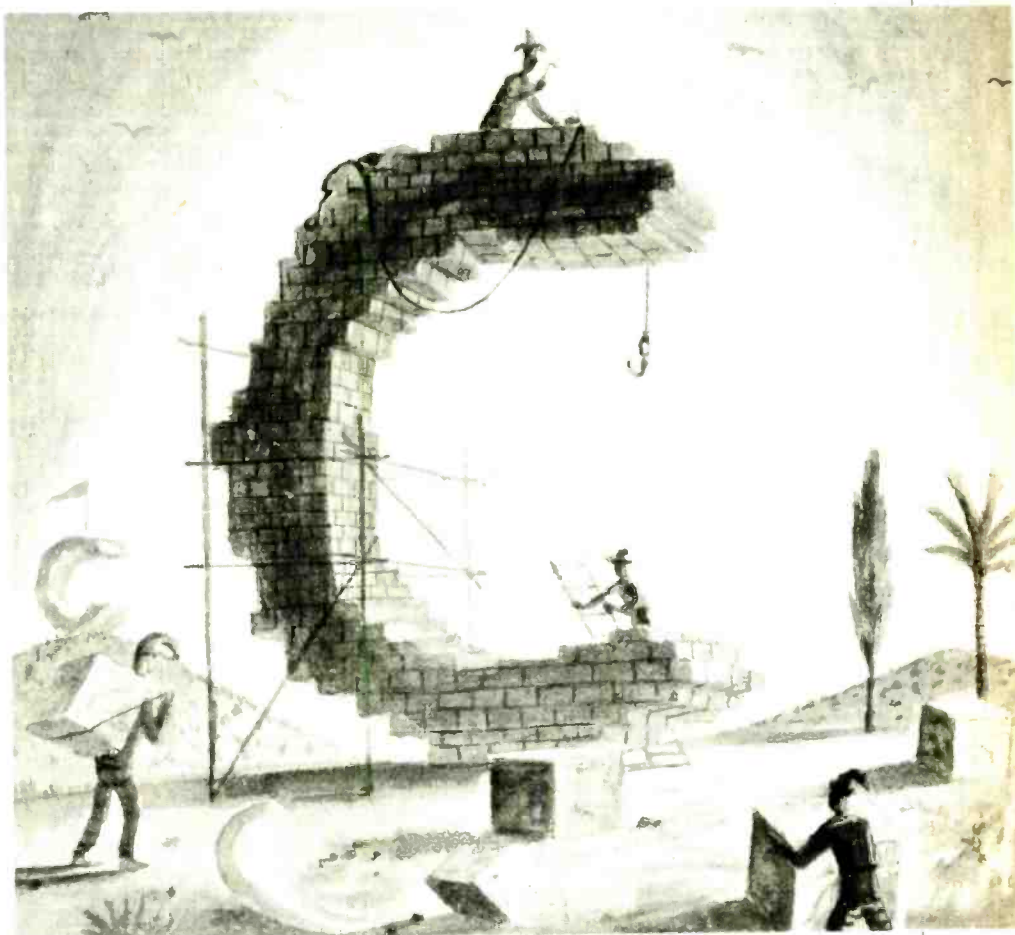

THE ORIGINAL SURPLUS WONDERLAND!

MONITORS

MONOCHROME MONITORS

THIS MONTH'S SPECIAL!

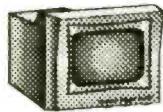

There has never been a deal like this one! Brand spanking new & boxed monitors from NEC, normally selling at about £140! These are over-engineered for ultra reliability. 9" green screen composite input with etched non-glare screen plus switchable high/low impedance input and output for daisy-chaining. 3 front controls and 6 at rear. Standard BNC sockets. Beautiful high contrast screen and attractive case with carrying ledge. Perfect as a main or backup monitor and for quantity users! **£39.95 each (D) or 5 for £185 (G)**

CALL FOR DISCOUNTS ON HIGHER QUANTITIES!

Zenith ZVM-1240-EA brand new & boxed 12" amber flat screen with optional swivel and tilt base. Sunflex filter with dark tint. Standard TTL PC compatible. 18 mhz bandwidth. Very attractive "state of the art" tapered grey case. Standard 9 pin D plug (supplied) on 1 metre cord and mains cord terminated with IEC connector. 240 volts complete with operations manual. An absolute gift at: **£59 (D) 10/£500 (G). Swivel/tilt base £4.95.** Wang green screen 12" chassis monitor with composite video input. Adjustable for tilt. Requires 12 vdc. Brand new and boxed in perfect condition. **Only £39 each or 2 for £75 (F)**

Motorola M1000-100 5" black & white compact chassis measuring only 11.6H x 12W x 2.2D. Ideal for CCTV or computer applications. Accepts standard composite or Individual H & V syncs. Needs 12vdc at only 0.8a. Some units may have minor screen blemishes. Fully tested with 30 day guarantee and full data. **£29.00 (C)**

Fully cased as above in attractive moulded desk standing swivel. Dim 12 x 14.5 x 26cm. **£39.00 (C)**

JVC 751 ultra compact chassis monitor for 12vdc 0.7a. Dim 11 x 14 x 18cm. Simple DIY data included to convert to composite video input. Full data. **BRAND NEW £65.00 (B)**

20" Black & white monitors by Aztek, Cotron & National. All solid state, fully cased monitors ideal for all types of AV or CCTV applications. Standard composite video inputs with integral audio amp and speaker. Sold in good used condition - fully tested with 90 day guarantee. **£85.00 (F)**

COLOUR MONITORS

Decca 16" 80 budget range colour monitor. Features a PIL tube, beautiful leak style case and guaranteed 80 column resolution, features usually seen only on colour monitors costing 3 times our price! Ready to connect to most computers or video outputs. 75cl composite input with integral audio amp & speaker. Fully tested surplus, sold in little or hardly used condition with 90 day full RTB guarantee. Ideal for use with video recorder or our Telexbox ST, and other audio visual uses. **£99 (E) 3/£275 (G)**

HI-DEFINITION COLOUR MONITORS

Brand new Centronic 14" monitor for IBM PC and compatibles at a lower than ever price! Completely CGA equivalent. Hi-res Mitsubishi 0.42 dot pitch giving 669 x 507 pixels. Big 28 Mhz bandwidth. A super monitor in attractive style moulded case. Full 90 day guarantee. **Only £149 (E)**

20", 22" and 26" AV SPECIALS

Superbly made UK manufacture. PIL all solid state colour monitors, complete with composite video & sound inputs. Attractive leak style case. Perfect for Schools, Shops, Disco, Clubs. In EXCELLENT little used condition with full 90 day guarantee. **20"....£135 22"....£155 26"....£185 (F)**

LIQUID CRYSTAL DISPLAYS

Hitachi LM052L 16 chars by 2 lines. Integral ASCII controller. 5vdc. Register for external instructions. 3" x 1". **£19.95. 3/£49.95 (A)**
Epson EG-2801 large capacity. 2801A uses normal LCD technology. 2801S uses Super Twist. Both have enormous 32,768 dots. 512x64 and use multiplexing. Display area 9-3/4" x 1-1/2". Uses +5vdc. Contrast controlled by -4 to -17vdc. Perfect for graphics or chars. **EG-2801A £69 (A) 3/£199 (B) 10/£595 (C) Regular £136. EG-2801S £95 (A) 3/£275 (B) 10/£850 (C)**

COMPUTER SYSTEMS

TATUNG PC2000. Big brother of the famous Einstein. The TPC2000 Professional 3 piece system comprises: Quality high resolution Green 12" monitor. Sculptured 92 key keyboard and plinth unit containing Z80A CPU and all control circuits. PLUS 2 integral TEAC 5.25 80 track double sided disk drives. Generous other features include dual 8" IBM format disk drive support. Serial and parallel outputs, full expansion port, 64K ram and ready to run software. Supplied complete with CP/M, Wordstar and Basic. Brand new and covered by our famous 90 day guarantee and backup. Normal price of this unit is over £1400! **Our price only£299 (E)**

V22 1200 BAUD MODEMS

We got a tremendous buy on further stocks of this popular Master Systems 2/12 microprocessor controlled V22 full duplex 1200 baud modem - we can now bring them to you at **half last advertised price!** Fully BT approved unit, provides standard V22 high speed data comm, which at 120 cps, can save your phone bill and connect time by a staggering 75%! Ultra slim 45 mm high. Full featured with LED status indicators and remote error diagnostics. Sync or Async use; speech or data switching; built in 240v mains supply and 2 wire connection to BT. Units are in used but good condition. Fully tested prior despatch, with data and a full 90 day guarantee. What more can you ask for - and at this price! **ONLY £69 (D)**

LARGE QUANTITIES OF OSCILLOSCOPES AND TEST GEAR ALWAYS AVAILABLE - CALL NOW!

IBM KEYBOARD DEALS

A replacement or backup keyboard, switchable for IBM PC, PC-XT or PC-AT. LED's for Caps, Scroll & Num Locks. Standard 84 keyboard layout. Made by NCR for the English & US markets. Absolutely standard. Brand new & boxed with manual and key template for user slogans on the function keys. Attractive beige, grey and cream finish, with the usual retractable legs underneath. A generous length of curly cord, terminating in the standard 5 pin DIN plug. A beautiful clean piece of manufacturers surplus. What a deal! **£39 (B) 5/£175 (D)**

Brand new and boxed 84 key PC/XT type keyboards in standard IBM grey with very attractive mottled finish and "clacky" solid feel keys. 10 function keys on side. English layout and £ sign. Green LEDs for Caps, Scroll & Num locks. **£29.95 (B) 5/£135 (D)**

CALL FOR DISCOUNTS ON HIGHER QUANTITIES!

FLOPPY DISK DRIVES BARGAINS GALORE!

NEW 5 1/4 Inch from £29.95!

Massive purchases of standard 5 1/4" drives enables us to present prime product at industry beating low prices! All units (unless stated) are removed from often brand new equipment and are fully tested, aligned and shipped to you with a 90 day guarantee and operate from +5 & +12vdc, are of standard size and accept the standard 34 way connector.

SHUGART SA405. BRAND NEW **£29.95 (C)**
TANDON TM100-2A IBM compatible DS **£39.95 (C)**
TANDON TM101-4 80 Track DS **£49.95 (C)**
CANON, TEC etc. DS half height. State 40 or 80T **£79.00 (C)**
TEAC FD-55-F. 40-80 DS half height. BRAND NEW **£79.00 (C)**

3 1/2 INCH BRAND NEW AT £19.95!!

Never before seen price for a 3 1/2" drive. Standard size believed to be by Canon. Brand new and packaged - mint condition! 40 track SS, run from +5 & +12vdc with standard power connector.....Only..... **£19.95 or 2 for £34.50 (B)**

CHOOSE YOUR 8 INCH!

Shugart 800/801 SS refurbished & tested **£150.00 (E)**
Shugart 851 double sided refurbished & tested **£225.00 (E)**
Mitsubishi M2894-63 double sided switchable hard or soft sectors. BRAND NEW **£250.00 (E)**

SPECIAL OFFERS!!

Dual 8" drives with 2 megabyte capacity housed in a smart case with built in power supply! **Only £499.00 (F)**

Ideal as exterior drives!
End of line purchase scoop! Brand new NEC D2246 8" 85 megabyte of hard disk storage! Full CPU control and industry standard SMD interface. Ultra Hi speed transfer and access time leaves the good old ST506 interface standing. In mint condition and comes complete with manual. Only..... **£399 (E)**

MAINS SUPPRESSORS & FILTERS

Roxburgh SDC 021 2 amp mains RFI filter. Has an extra wide frequency range of 150 khz to 30 mhz. Can type, solder lug connection. Quality manufactured to BS 613 standards. Dims 1-1/2"D x 1-3/4"H..... **£3.95 or 3 for £10 (A) 10 for £29 (B)**
Roxburgh SDA 01325. Similar to above rated at 1-1/2 amps. Dims 1-1/2"D x 1-3/4"H..... **£3.25 or 3 for £8.50 (A) 10 for £25 (B)**

Suppression Devices SD5 A10. Extra compact general purpose suppressor. Plastic moulded case with single bolt fixing and snap connectors. Rated at 230 vac 5 amps. Dims 1-3/4"L x 1-1/8"W x 5/8"H..... **£3.95 or 3 for £10 (A) 10 for £29 (B)**

Belling-Lee type L2127 3 amp mains RFI filters. Has a built in mains cable (English coding), and a three pin miniature non-reversible socket and a mating plug, to go to the equipment. Ideal for those who are bugged by RF interference. Very compact. Dims 3-1/8" x 2.5" x 1.5"..... **£3.95 each or 3 for £10 (A)**

RECHARGEABLE BATTERIES

LEAD ACID

Maintenance free sealed long life. Type A300.

12 volts 12 volts 3 amp/hours **£13.95 (A)**
6 volts 6 volts 3 amp/hours **£ 9.95 (A)**
12 volts Centre tapped 1.8 amp hours. RFE. **£ 5.95 (A)**
12 volts 12 volts 24 amp hours. A200. RFE. **£29.00 (B)**

NICKEL CADMIUM

Quality 12v 4ah cell pack. Originally made for the Technicolor video company. Contains 10 GE top quality D nicad cells in a smart robust case with a DC output connector. Ideal for portable equipment. Brand new. **£19.95 (B)**
Ex-equipment NICAD cells by GE. Removed from equipment and in good, used condition: D size 4ah **4 for £5 (B)**
F size 7ah **6 for £9 (B)**

SPECIAL INTEREST

Tektronix 1751 Waveform/Vector monitor **£2750**
Trio 0-18 vdc bench PSU. 30 amps. New **£ 470**
DEC VAX11/750 Inc. 2 Meg Ram DZ and full documentation, in brand new condition
DEC VAX Station 100
DEC LS/02 CPU board
Calcomp 1036 large drum 3 pen plotter
Turby LA 160B logic analyser
1.5kw 115v 60hz power source
Tektronix R140 NTSC TV test signal standard. **£ 875**
Sony KTX 1000 Videotex system - brand new **£ 790**
ADDS 2020 VDU terminals - brand new **£ 225**
Sekonic SD 150H 18 channel Hybrid recorder **£2000**
Trend 1-0-1 Data transmission test set **£ 525**
Kenwood CA-3501 CD tester, laser pickup simulator **£ 350**

ANALOG to DIGITAL and DIGITAL to ANALOG CONVERTERS

Brand new and boxed Amdek ADA-200 analog to digital and digital to analog converter packed with features: Interfaces to most popular PC's; 2 channel input & output by software selection; Integral I/O filters and address decoder; Input pre-amp; over-level detector; trigger signal detector circuit and more. Input level 25mv to 50v p-p. Max. sampling frequency is 44khz and input gain variable to 200 times. Designed for use with almost any personal computer, allowing conversion of analog signals to digital data for processing by the computer plus conversion back to analog signals. 26 page manual supplied has data on the correct connection to many CPU's including 8080, Z-80, 6800, 6502 and 6809 families plus data and schematics for user modification of I/O filter cut-off frequencies. With 50 way ribbon cable, edge connector and power cord. At a fraction of the regular price! **Brand new & boxed.....£49.95 (C)**



POWER SUPPLIES

All PSUs 220-240vac input and are BRAND NEW unless stated. Many types ranging from 3v to 10kv always in stock.
Power One SPL130. 130 watts. Link selectable for 12v (4A) or 24 v (2A). 5v @ 20A. ± 12v @ 1.5A. Switch mode. **£59.95 (B)**
Astec AC-8151 40 watts. Switch mode. +5v @ 2.5a. +12v @ 2a. -12v @ 0.1a. 6-1/4" x 4" x 1-3/4". **£19.95 (B)**
Greendale 19A80E 60 watts switch mode. +5v @ 6a. ±12v @ 1a. ±15v @ 1a. RFE and fully tested. 11 x 20 x 5.5cm. **£24.95 (C)**
Conver AC130. 130 watt hi-grade VDE spec. Switch mode. +5v @ 15a. -5v @ 1a. ±12v @ 6a. 7-1/2 x 12.5 x 6.5cm. **£49.95 (C)**
Boatert 13090. Switch mode. Ideal for drives & system. +5v @ 6a. +12v @ 2.5a. -12v @ 0.5a. -5v @ 0.5a. **£29.95 (B)**
Farnell G6/40A. Switch mode. 5v @ 40a. Encased **£95.00 (C)**
Farnell G24/5S. As above but 24v @ 5a. **£65.00 (C)**

COOLING FANS

Please specify 110 or 240 volts for AC fans.
3 inch AC 112" thick **£ 8.50 (B)**
3 1/2 inch AC ETRI slimline. Only 1" thick. **£ 9.95 (B)**
4 inch AC 110/240v 1 1/2" thick. **£10.95 (B)**
4 inch AC 112" thick **£ 9.95 (B)**
10 inch AC round. 3 1/2" thick. Rotron 110v **£10.95 (B)**
10 inch As above but 230 volts **£24.95 (B)**
62 mm DC 1" thick. No. 812 for 6/12v. 814 24v. **£15.95 (A)**
90 mm DC 5 v. Papt8105G 4w. 38mm. RFE. **£19.95 (A)**
92 mm DC 12v. 18 mm thick. **£14.95 (A)**
4 inch DC 12v. 12w 1 1/2" thick **£12.50 (B)**
4 inch DC 24v 8w. 1" thick. **£14.50 (B)**

THE AMAZING TELEBOX!

Converts your colour monitor into a QUALITY COLOUR TV!!
TV SOUND & VIDEO TUNER!



Brand new high quality, fully cased, 7 channel UHF PAL TV tuner system. Unit simply connects to your TV aerial socket and colour video monitor turning same into a fabulous colour TV. Dont worry if your monitor doesnt have sound, the TELEBOX even has an integral audio amp for driving a speaker plus an auxiliary output for headphones or Hi Fi system etc. Many other features: LED Status Indicator, Smart moulded case, Mains powered, Built to BS safety specs. Many other uses for TV sound or video etc. Supplied BRAND NEW with full 1 year guarantee.
Telebox ST for composite video input monitors..... **£29.95 (B)**
Telebox STL as ST but with integral speaker..... **£34.95 (B)**
Telebox RGB for analogue RGB monitors..... **£65.95 (B)**
NOT suitable for IBM or Clone type colour monitors. PAL overseas version please call. SECAM / NTSC not available.

BRAND NEW PRINTERS

TEC Starwriter Model FP1500-25 daisywheel printer renowned for its reliability. Diablo type print mechanism gives superb registration and quality. On board microprocessor gives full Diablo/Orme command capability. Serial RS-232C with full handshake. Bidirectional 25 cps, switchable 10 or 12 pitch, 136 cpl in Pica, 163 in Elite. Friction or tractor feed. Full ASCII including £ sign. Fort and ribbon Diablo compatible..... **£199 (E)**
DED DP-G21 miniature ball point pen printer plotter mechanism with full 40 characters per line. Complete with data sheet which includes circuit diagrams for simple driver electronics..... **£49 (B)**
Centronics 150 series. Always known for their reliability in continuous use - real workhorses in any environment. Fast 150 cps with 4 fonts and choice of interfaces at a fantastic price!
£ 295 150-4 Serial up to 9.5" paper, fan fold tractor..... **£ 99.00 (E)**
£ 150 150-4 Serial up to 9.5" paper, tractor, roll or s/sheet..... **£129.00 (E)**
£ 650 152-2 parallel up to 14.5" paper, tractor or s/sheet..... **£149.00 (E)**

CALL FOR THE MANY OTHERS IN STOCK.

Visit our Shop - Technical help always on hand plus many un-advertised specials. You can buy a colour television for as little as £29! Come and join the gang at 215 Whitehorse Lane!

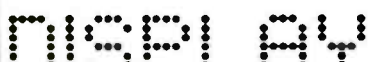

MAIL ORDER & OFFICES
Open Mon-Fri 9.00-5.30
Dept WW, 32 Biggin Way,
Upper Norwood,
London SE19 3XF.

LONDON SHOP
100's of bargains!
Open Mon-Sat 9-5.30
215 Whitehorse Lane,
South Norwood,
London, SE25.

DISTEL © The Original
Free dial-up database!
1000's of Items+Info On Line
300 bd 081-679-1888.
1200/75 bd 081-679-6183,
200/1200 bd 081-679-876

ALL ENQUIRIES
081-679-4414
Fax: 081-679-1927
Tel: 081-679-4502



All prices for UK Mainland. UK customers add 15% VAT to TOTAL order amount. Minimum order £10. PO orders from Government, Universities, Schools & Local Authorities welcome-minimum account order £25. Carriage charges (A)=£2.00, (B)=£4.50, (C)=£8.50, (D)=£10.00, (E)=£17.00 (F)=£17.00 (G)=Call. All goods supplied subject to our standard Conditions of Sale and unless otherwise stated guaranteed for 90 days. All guarantees on a return to base basis. We reserve the right to change prices & specifications without prior notice. Orders accepted subject to stock. Quotations willingly given for higher quantities than those stated. Bulk surplus always required for cash.

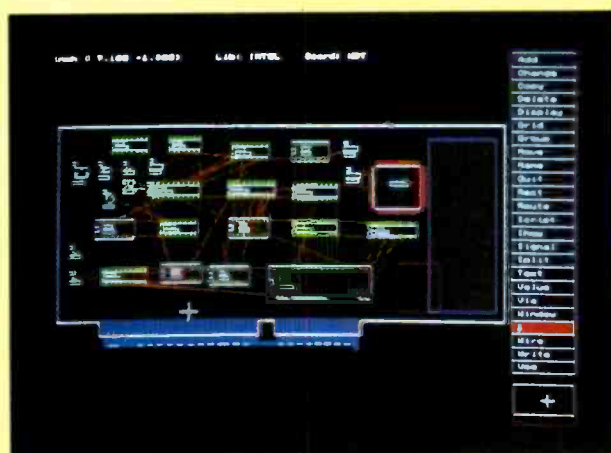

Fig. 1. "Airwire" connections on a PCB, which are pulled after a component when it is moved.

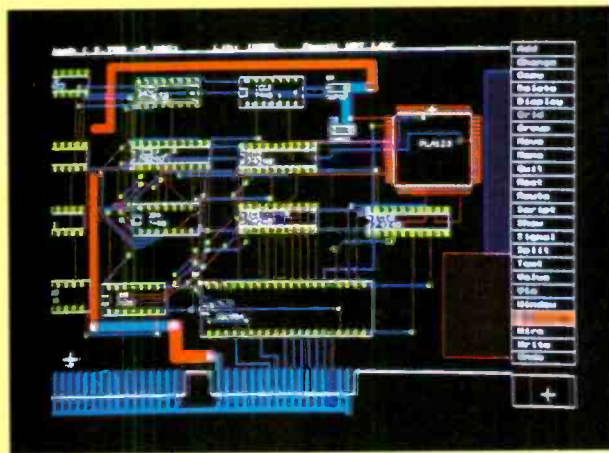

Fig. 2. Right-hand section of the board of Fig. 1 after autorouting. Board outline must be decided first.

Eagle is primarily a PCB layout editor and, in its simplest form, simply provides computerised draughting of the artwork. Important add-ons are the autorouter module, which automatically places tracks to rules previously specified and a schematic-capture module, which allows designers to draw the circuit diagram on computer before moving on to layout. Surprisingly, the schematic-capture module is not available on its own and must be used in conjunction with the layout module.

What will it do?

Eagle runs on machines compatible with IBM XT, AT and PS2, with a minimum of 540kbyte of ram. It needs either EGA or VGA graphics adapters and will not work with monochrome or Hercules screens, since this level of resolution and colour are necessary to make sense of the information presented on the screen. A mouse is required, as is a parallel port to take the software protection key or "dongle", which is a feed-through device still allowing the printer to be operated from this port if required. The manual explains that most calculations are in integer form, so a maths co-processor is of little help, but a hard disk is essential, since Eagle and its libraries occupy in the region of 2Mbyte of storage.

Eagle's specifications are more than adequate; boards of up to 64in square and 255 layers would satisfy even the most obscure applications. It will draw schematics up to A0 and in both layout and schematic the component count

PCB Eagle

PCB Eagle is a layout and schematic capture package for professionals. Does it live up to its promise? Martin Cummings gives his verdict.

will be limited by the memory available, not the software. Both modules come complete with a library of components, which covers all the obvious devices, and fresh ones can be created and stored for future use.

Output is possible to simple dot-matrix printers, laser printers, plotters or photoplotters. Most people will use their printer for checking and send a file to a bureau for photoplotting and manufacture. Output drivers are not dependent on the dongle and CadSoft encourages users to distribute them as required to obtain the desired result.

This software originated in Germany, where it has been available for a couple of years. An occasional hint of its Teutonic background comes to light in the libraries where, for example, electrolytic capacitors are abbreviated

to ELK and sheet outlines have unpronounceable headings. CadSoft is continuing to anglicise the package and commands such as SMASH and RIP-UP show that the German authors have an idiomatic grasp of the English language.

It comes in a boxed ring binder with 5.25in or 3.5in disks as required. Installation is as simple as it can be made; you just plug in the disks and type INSTALL; in most cases, the type of graphics adapter is automatically detected and away you go within minutes of opening the box. There is a temptation to play before reading the manual; coloured lines can readily be drawn, but they will be nothing more than modern art unless you take the plunge into the documentation.

Both layout and schematic editors involve similar activities — placing parts, making connections and adding labels. Hence, commands are very similar and if you know one you can use both; the rules are different but they should be common sense to most users. A Help feature exists, but is limited to listing the commands that are available, removing the drawing from the screen while they are there.

Although the menu is always present on the right of the screen, sub-menus popping up as required, commands can be typed as an alternative to mouse pointing and can be abbreviated as

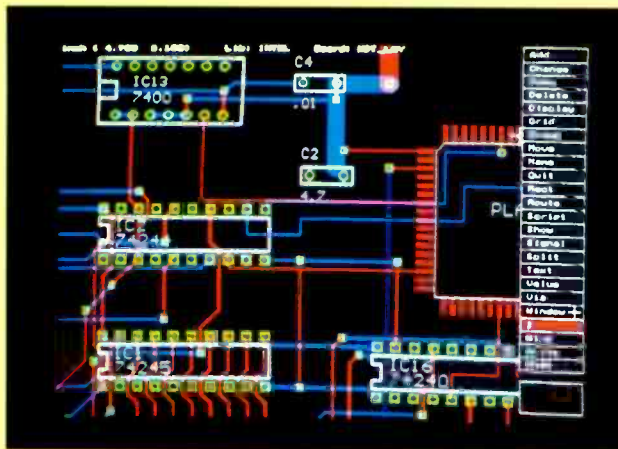

Fig. 3. Close-up of board showing conventional and SMD components. Connections to SMDs are not autorouted.

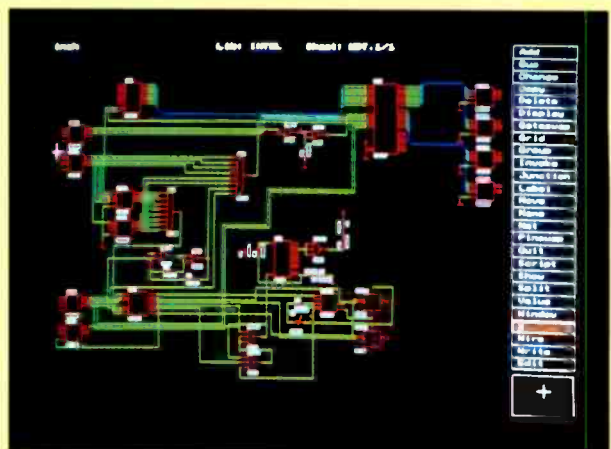

Fig. 4. Full-sheet schematic diagram. Eagle does not provide a hierarchy of drawings.

much as you like. Unfortunately, the menu does not have room for all possible commands, so the novice must refer to the manual frequently or forfeit his drawing for the command list, using the Help feature. Part of the menu changes to display the most recently used command but, inevitably, this is not the command that is needed next and causes confusion rather than assistance. A saving grace is that the menu content can be completely reconfigured to show commands that are frequently used or perhaps those that are difficult to remember. Menu operation becomes second nature after a short time.

You can customise the keyboard to a limited extent by assigning sequences of commands to function keys. This usually appeals to the lazy or well organised amongst us, but in this case the former are unlikely to make the effort to create the text strings and this feature would benefit from a "learn" mode. Some function keys are already assigned to useful functions like redraw, zoom and grid on/off and most people will live amicably with this default configuration. UNDO and REDO commands are particularly helpful, avoiding many self-inflicted frustrations and encouraging the user to be adventurous, in the knowledge that everything is retrievable if mistakes are made.

Speed of redraw on a 12MHz AT is two or three seconds for a complexity that is comfortable to work with and zooming is easily achieved to any magnification required. Redraw and zoom out (to the full sheet) are single key-strokes and the experienced user in full swing will be working his graphics card so hard he will be able to fry eggs on it.

Colours differentiate between devices, connections, labels and other layers and you can change them if you take a dislike to the default selection.

A grid, displayed or suppressed as required, provides various resolutions down to 0.001in. When set to a metric grid, Eagle converts its internal imperial calculations to millimetres; the coordinate displays are therefore not quite whole numbers, although the errors are not cumulative over the grid and in practice can be ignored. In any case, this is unlikely to pose problems in a world of imperial components.

Libraries

There is a comprehensive set of pre-defined components. Inevitably, even the first layout will need extra components to be defined, but in most cases there is enough variety to allow you to adapt rather than start from scratch.

Some libraries come with the schematic module and contain several hundred components, including a

reasonable spread of TTL and c-mos packages. Parts can be added or new libraries created but, although this is painless, it is fairly time consuming to define shapes, pin labels, pin numbers and pin functions for the electrical rule checker.

Surface-mount devices (SMDs) are available to the layout editor and the library provides a fair selection of chips and discrete components, although the autorouter has not yet been told about SMDs; connections to these devices must be routed manually.

Schematic editor

Competence with the schematic editor comes quickly and it is easy to forget the speed with which you are documenting the circuit; simply select and connect. Eagle automatically numbers and labels devices as they are drawn, taking into account multi-device packages, and component values can be added where appropriate. It gives signals unique identities,

Specifications

Layout editor

Board size up to 64in square
255 layers
Single or double sided or multilayer
grid resolution down to 0.001in
Track width down to 0.01in
Continuous zoom, autopanning, rubber-banding
Cut, rotate and paste
Supports surface-mount devices
"No-go" areas can be declared
Output drivers for
printers
laser printers
plotters (incl. HPGL)
photoplotters (Gerber)

Autorouter

Max routing area 50 square inches
Max x or y dimension 15 inches
Automatically routes two signal layers
Handles any number of power-supply layers
Operates on 0.05in grid

Schematic capture

Up to 99 sheets per schematic
Automatic component numbering
Continuous zoom, autopanning, rubber-banding
Cut, rotate and paste
Automatic parts listing

which can be changed to more meaningful names to help readability. When re-organising a drawing, you can move devices around, dragging their connections with them, although a lot of tidying up is necessary after a move.

Drawing a bus saves a lot of clutter and prevents the engineer going cross-eyed when reading the circuit. Using a bus within Eagle is simple and the results so pleasing that the user will find himself using a bus where previously he would not have bothered. The show command quickly becomes a favourite, highlighting a signal wherever it permeates the drawing and helping to confirm connections.

More prolific designers can spread their circuits over several sheets, but Eagle does not provide for a hierarchy of circuits.

Subjecting the completed schematic to the electrical rule checker (ERC) is a bit like having it checked by a methodical, experienced engineer who has no idea what the circuit should do; it will detect errors like two outputs connected together or a net with all inputs and no output. It will do a better job than the most thorough human and prevents a lot of those small but frustrating errors that need layout changes.

You can make hard copy of the schematic on dot matrix printers, large sheets being printed in sections and put together to form the complete drawing. Even low-cost printers produce presentable quality, but most professional users will want plots for the drawing office and a respectable selection of plotters is supported.

Any mention of accurate documentation is likely to send engineers to the aspirin bottle, but help is at hand, since Eagle will produce a comprehensive parts list from the schematic at the press of a key. The format, whilst very presentable and informative, is rigid and unlikely to meet the needs of every drawing office, but a little manipulation with a text editor will work wonders.

It is also possible to export a netlist in the form of a text file, although it is difficult to see the purpose in this because the document, again presentable and informative, is not in the form required by the layout editor.

Creating the layout

Schematics are convertible with one command into a collection of physical components connected, as the crow flies, by "airwires" and this is by far the most convenient way to make the transition from circuit diagram to lay-

Fig. 5. Zoomed section of bottom right of Fig. 4.

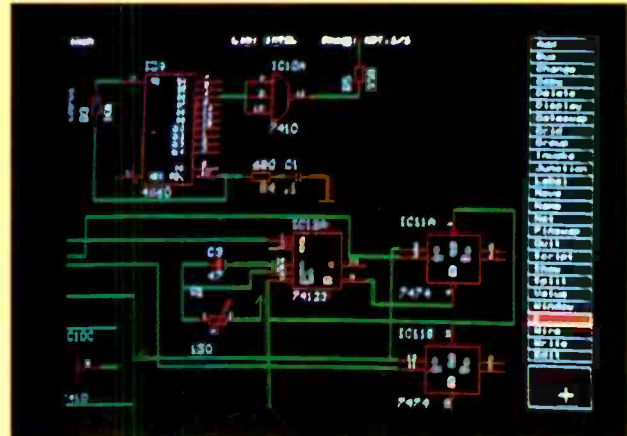
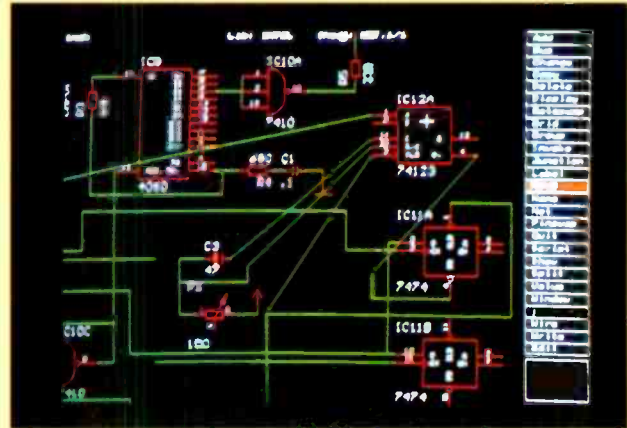

Fig. 6. Result of moving IC_{12A}, connections "rubber-banded" after it. Tidying up is often needed after this operation.



out. When using the layout editor alone, there are several ways of telling the computer what to connect: the simplest method is to lay the track manually, but to make use of the autorouter one must define the electrical connections.

The Eagle file format for netlists is documented, easily understood and readable by operators so it can be created on any ASCII text editor, although it would only be a tolerable experience on simple boards or those with repetitive sections. Probably the best method is to click the mouse on the points to be interconnected once component placement is done, the connections being drawn as airwires. Eagle

includes a program to take Orcad netlists and convert them to Eagle format.

Creating the initial board outline is tedious but, in time, most users will build up a library of outlines which can be called up to bypass this step. Component placement is made as easy as possible, packages are moved around under mouse control, pulling their airwires with them until the engineer is ready to connect up.

Autorouter

Any combination of manual and autorouting is possible and, once it is invoked, you can stop the autorouter at any time for a manual intervention and then resume. In practice, before unleashing the autorouter, power supplies and critical signals will be routed manually with the appropriate track width. Depending on space and complexity, the autorouter may not be able to complete the routing of all signals and human inspiration must be applied to complete the board.

For multilayer boards, the autorouter is limited to the most popular configuration of two signal layers and

System requirements

IBM XT, AT or PS2 compatible
640kbyte ram
EGA or VGA graphics adaptor
Floppy-disk drive
Hard-disk drive
Microsoft-compatible mouse
Parallel printer port
Printer or plottter

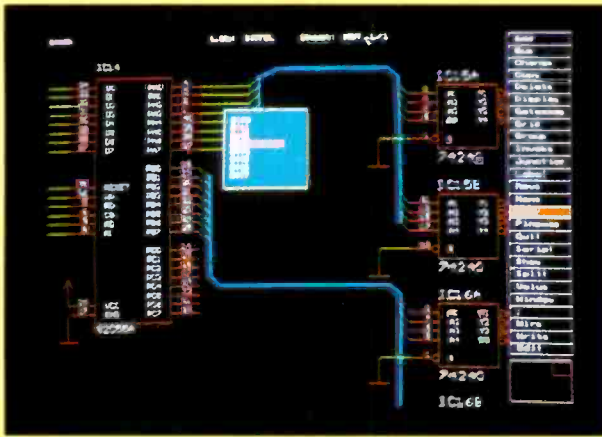

Fig. 7. Bus connection sub-menu. Entries to and exits from a bus are checked by SHOW command.

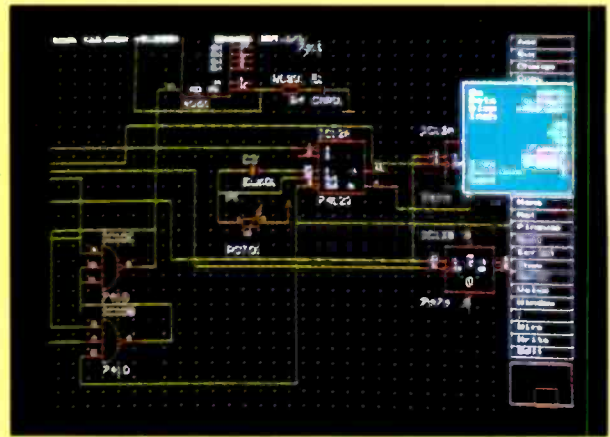

Fig. 8. Schematic with grid, which can be set to resolve 0.001in for layouts.

several internal power supply planes. Further signal layers are possible, but they must be routed by hand.

Time taken to autoroute depends on several factors, but can range from under a minute for small boards to five or ten minutes for more complicated and densely populated boards. As the algorithm steams along, tracks appear on the screen and you can monitor progress. At first, tracks appear too quickly for the eye to follow, but the computer slows as more work is needed. When it eventually stops, the program reports the proportion of signals it has routed, the remainder being shown as airwires. Autorouted tracks can be removed, replaced, bent or re-routed with ease to help the user shoehorn the final tracks onto the board.

The manual does not give many details about the algorithm used by the autorouter and the strategies are not adjustable or selectable in any way. It can only deal with tracks and objects on a 0.05in grid, which limits the track density and prevents it achieving the current benchmark of two tracks between adjacent pads on a 0.1in pitch. These limitations, together with its inability to deal with surface-mount components, can be overcome manually.

Like the schematic, the layout can be subjected to the eagle eye of the design rule checker. In addition to identifying short circuits, the DRC checks the layout against specifications for such things as track spacing, drill sizes and oversized pad drilling. Specifications are adjustable to suit domestic, industrial and military uses. Check programs halt after a preset number of errors and patiently point them out.

Hard copy

Eagle provides an easy to use and comprehensive output program to transfer the layout to paper or film. Even the simplest of boards needs several artwork sheets, but supplementary sheets such as drilling templates, solder masks and silk screens are all generated automatically from the work that has gone before. You simply need to decide which layers or combination of layers you want to plot and what device you are going to use.

Final hard copy must have all lines drawn and filled to the correct width; however, for checking, Eagle can produce simplified prints where wires are reduced to a single pixel width or are represented by unfilled outlines.

Manuals

When taking delivery of software it is often necessary to plough through the manual with the perseverance of a marathon runner; however, the documentation supplied with Eagle is a pleasant exception. Its pace is fast, a brief introduction and definition of terms being followed by a worked example using files supplied on the disks. There are helpful hints, things to watch out for and useful sections to educate readers fresh to computerised PCB layout.

Eagle has evolved primarily as a layout tool, the schematic editor being added later, and unfortunately this is evident in chapters that describe laying out the board before creating the schematic. This conflicts with patterns of behaviour burnt into the brains of engineers, who find the flow of valuable information disrupted.

There is no doubt that Eagle is a

suitable product for the professional environment and that it comes from many man-years experience in the electronics industry. Learning to drive Eagle is painless, but the user must be committed and persevere to get the benefits. Initially, progress will be slow as library components are built up, but it will quickly become the sort of tool that you cannot live without. Technical managers will find that control and maintenance of the libraries becomes an important issue in a multi-user design office. Everything you would want to configure, such as colours and default settings, can be adjusted, usually by creating a text file which is interpreted by the software.

The autorouter is fast, competent and impressive within its limitations, but would leave a lot of manual work to clear up if applied to complicated designs. However, this comment must be judged against the price of the module and the fact that, not many years ago, purchasing software like this required a research grant and hardware the size of a wardrobe to run on.

Potential users need have no anxiety about the performance and flexibility of Eagle. ■

Prices and supplier	
Layout editor	£335
Autorouter	£260
Schematic editor	£350
Demo kit	£8.70
(includes full documentation)	
(all prices exclude VAT)	
CadSoft (UK), P.O. Box 5, Kilmacollm, PA13 4JZ, Scotland. Telephone: 0505 872338. Fax: 0505 874149	

PROGRAMMERS

EPROM,
EEPROM
PALs,
GAL etc
Micro,
Bipolar

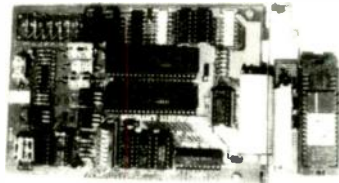

- Extensive device support
- Up to 1Mbit devices and larger
- Simple menu operation
- Intelligent programming algorithm
- Split and shuffle
- Support all common file formats
- From only £139

- SCN10** Low cost E(E)PROM programmer
Options for micros and 4 gang
- UP600** Universal Device programmer with editor
E(E)PROM, PAL, GAL, PEEL, Micro, Bipolar
- SA10** Standalone E(E)PROM programmer with editor
- SA20** 8 gang version of SA10

SMART COMMUNICATIONS

2 Field End, Arkley, Barnet, Herts. EN5 3EZ
Telephone: 081-441 3890

CIRCLE NO. 116 ON REPLY CARD

IN VIEW OF THE EXTREMELY
RAPID CHANGE TAKING PLACE
IN THE ELECTRONICS
INDUSTRY, LARGE QUANTITIES
OF COMPONENTS BECOME
REDUNDANT. WE ARE CASH
PURCHASERS OF SUCH
MATERIALS AND WOULD
APPRECIATE A TELEPHONE
CALL OR A LIST IF AVAILABLE.
WE PAY TOP PRICES AND
COLLECT.

R. Henson Ltd.

21 Lodge Lane, N. Finchley,
London, N12 8JG.
5 mins from Tally Ho Corner

Telephone:
081-445 2713/0749

CIRCLE NO. 117 ON REPLY CARD

Feedback TELECOMMUNICATIONS TRAINING

Feedback offer an extensive range of
Telecommunications equipment.

From basic introduction to Analogue
systems . . . to advanced Digital and
Microwave techniques.

Each equipment is supplied with a
comprehensive training manual.



NEW

The
complete

NEW Microstrip Trainer

The Feedback MST532 is designed to train
the microwave engineers industry and
education so desperately need.

The system is geared to industrial
application and can also be used for testing
and systems development.

No sophisticated test equipment is required.

For further information on the Microstrip Trainer
and the Feedback Telecommunications range
contact:

Feedback

Feedback Instruments Limited

Park Rd, Crowborough, E. Sussex, TN6 2QR, England.
Tel: 0892 653322, Telex: 95255, Fax: 0892 663719.

CIRCLE NO. 118 ON REPLY CARD

Tone-Burst Gate

This circuit was developed after my interest had been aroused by T.G. Barnett's circuit (September, 1989) and my suggestion for an alternative in the August 1990 issue. In the simplified diagram, a zero-crossing detector produces clock pulses from the (external) audio oscillator. Assuming that the SR flip-flop is in its reset state, counter 2 is inhibited and the fet is on, allowing the input waveform to pass. Counter 1 counts the input periods until the selected Q output goes high, whereupon the flip-flop is set. This inhibits counter 1, switches off the fet and enables counter 2. The input periods are now counted by counter 2 until its selected Q goes high, resetting the flip-flop. The action then repeats.

The circuit works well from 20Hz to 20kHz with input amplitudes from

20mV to 4V p-p. Filtering on the input of the comparator was found necessary to overcome pick-up of transients, which more sanitary lay-out would no doubt eliminate. A sniff of positive

feedback applied to one of the offset pins gives a small amount of hysteresis.

D. Bridgen
Santiago
Chile.

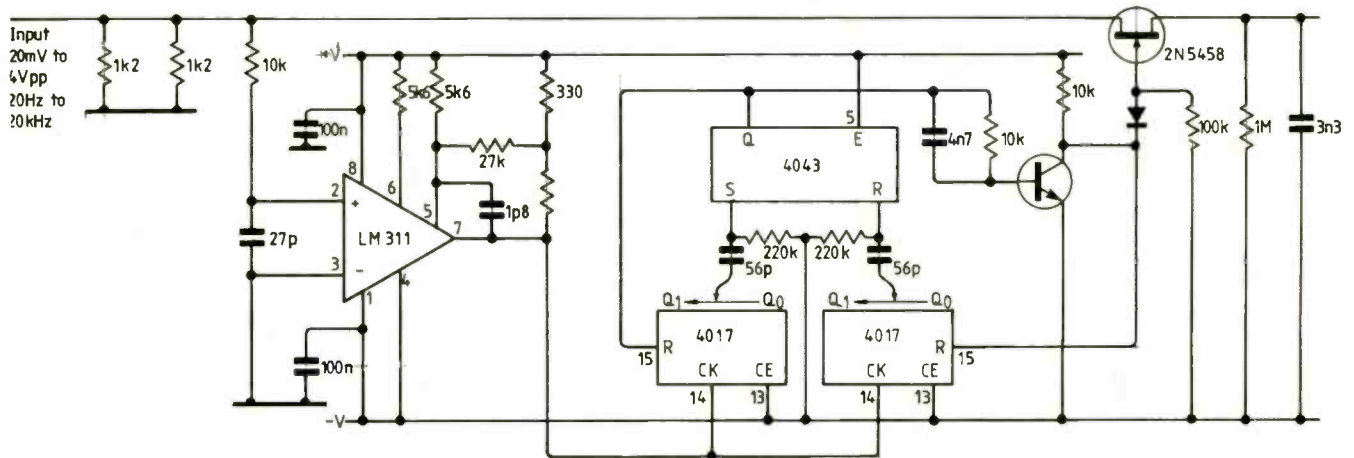
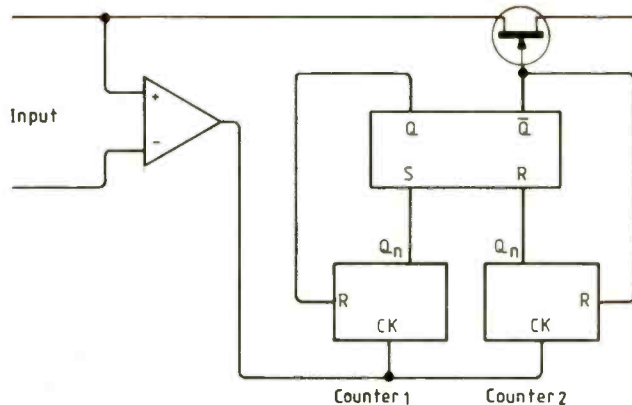

Latching switch array

In a simple electronic version of the type latching selector switch found in amplifiers and television receivers,

pressing one switch causes its corresponding output to go high and latch until another switch is activated.

A 4532 8-bit priority encoder produces a 3-bit binary code and a gate signal. When a button is pressed, the 4532 produces the equivalent binary code, the gate signal going high. This rising edge is delayed by the RC network to give the lines time to settle and then latches the code into the binary decoder, an HC237 (HC137 for inverted outputs). The output is therefore a latched version of the input, only one line being high at any time.

Richard Green
Winscombe
Avon

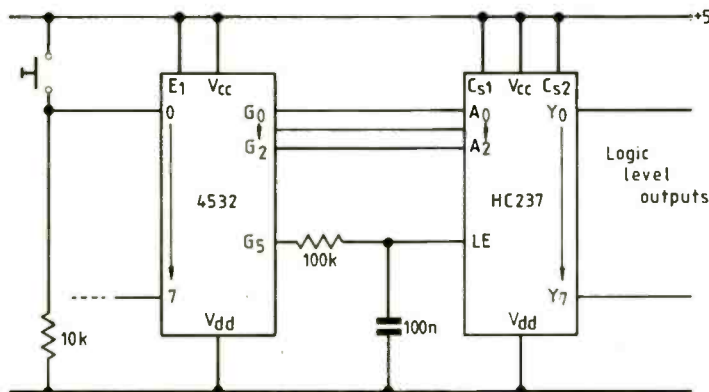

DON'T MISS THESE BARGAINS!

110 WATT POWER SUPPLY ASTEC switch mode, 230V mains input, 38V at 2½A & 3A outputs, encased and fitted on panel mounting plate with mains input socket and on/off switch, made for use with computers or other top grade equipment. You can have it at a fraction of its proper price. Brand new and guaranteed. Sample £12.00 post paid - 3000 available & good discount to quantity buyers.

BRUSHLESS D.C. 12V FAN tiny, only 60mm square, good air mover but causes no interference £8.00.

2MW LASER Helium Neon by PHILIPS, full spec, £30, power supply for this in kit form is £16.00, or in larger case to house tube as well £17.00.

MAINS 230V FAN best make "PAPST" 4½" square, metal blades £8.00.

BATTERY MOTORS 12 models in stock in large quantities ranging from tiny model aircraft one at 25p each to ½hp made to drive the famous Sinclair C5 car, you can have this at £17.50.

SOLAR MOTORS 1½-9V precision made to operate from low current off solar cells £1.50, solar generator to drive this £7.00, has provision for battery back up when sun is not shining!

ELECTRONIC MEGGER & MULTITESTER the megger indicates insulation value to inf. Multitester has 4 ranges AC/DC volts, 3 ranges DC milliamps, 3 ranges resistance and 5 amp range. These instruments are Ex British Telecom, but in very good condition, tested and gndd. OK, probably cost at least £50 each, yours for only £7.50 with leads, carrying case £2.00 extra.

COPPER BOARD for making you pcb 174 x 100mm x 2mm thick double sided and brand new, 50p each, £40 per hundred, £350 per thousand.

AIR SPACED TRIMMER CAPS 2-20 pf ideal for precision tuning uhf circuits 25p each, 10 for £2. 100 for £15.

1Khz. TONE GENERATOR this is PP3 battery operated and has a 1Khz output that can be continuous or interrupted at a rate variable by a panel mounted control. Also on the front panel are separate output sockets for monitor or headphones, and a battery condition indicator. Constructed on a pcb and front panel size approx 105 x 50mm ex equipment but in as new condition £2 each.

OSCILLOSCOPE 301B developed for testing transmission lines, it makes and displays pulse echoes to find shorts and breaks in cable networks, this uses a 3" CRT to display the type of fault and a LCD to read out the distance from the fault. The instrument is powered by 12V of rechargeable nicads located in base, and it generates 1.5kv internally. It is housed in a high impact plastic case size approx 9½" x 9½" x 5". Ex British Telecom in very good condition and working order, £49.50 plus £5 insured delivery.

FIELD TELEPHONES just right for building sites, rallies, horse shows etc. just join two by twin wire and you have two way calling and talking, and you can join into regular phone lines if you want to. Ex British Telecom in very good condition, powered by batteries (not included) complete in shoulder slung carrying case, £12.50 each.

MAINS ISOLATION TRANSFORMER stops you getting "to earth" shocks. 230V in and 230V out. 150 watt upright mounting £7.50.

HANG UP PHONE won't clutter up your desk or workbench, current model, has push button dialling, last number recall, internal alarm etc.. Ex B.T. in good condition and fully working ready to plug in. £5

HIGH VOLTAGE CAPS if you use these ask for our 1-10 Kv Capacitor list, we have over ¼ million in stock and might save you a lot of money.

Prices include V.A.T. Send cheque/postal order or ring and quote credit card number. Add £3 post and packing. Orders over £25 post free, unless postage quoted separately.

M&B ELECTRICAL (WW Circle No. 119)
12 Boundary Road, Hove, Sussex BN3 4EH
Telephone (0273) 430380 Fax (0273) 410142

SOIL HEATING germinates and brings on the young plants without having to heat the whole greenhouse. Now is the time to install it, the main items, a 750 watt transformer and 100 metres of heating cable will cost you only £29 including carriage.

CEILING LIGHTS COULD COME DOWN if the water pipes above freeze and burst, you can guard against this by winding our waterproof heating cable around them. Costs only about the same as a 40 watt lamp to run. Cable resistance is approx. 90 ohms per metre, 15 metre length suits the average house price is £5 or cut to your specification 40p metre.

INSTANT HEAT is what you want for your workshop etc. and you will get it with one of our tangential blow heaters, can be mounted under the bench or in a simple enclosure, three models available all have full or half heat plus cold blow. 3Kw has 12" element £8, 2½Kw & 2Kw both have 8" elements and are £6 each.

POWER CUTS OR FAILURES cause inconvenience or worse, our emergency fluorescent lighting unit keeps itself charged, comes on automatically and stays on for at least 3 hours, is neatly cased and ready to instal price £25 includes its ni-cad batteries.

500V BRIDGE MEGGER developed for G.P.O. technicians the Ohmter 188 is the modern equivalent of the bridge megger. 9V battery operated it incorporates a 500V generation for insulation testing and a null balance bridge for very accurate resistance measurement. On the front panel there is a 3" x 3" panel meter calibrated in megohms to inf. and a small scale to indicate balance showing the exact setting of the four controls in the variable arm of the resistance bridge. Ex B.T. in quite good condition with data & tested. Yours for a fraction of original cost £45 + £5 insured delivery.

WHY STAY/BLACK & WHITE We can supply a RGB input, IBM compatible, high resolution colour monitor with power supply and in a black metal case for only £89.50 + £5 insured delivery.

TRAVEL MECHANISM goes backwards and forwards, could be used to animate a display or position a device, battery or p.s.u operated, distance of travel 4" and speed of travel depends on applied voltage 1½V very slow 12V max is quite fast. £5.00.

SOUND SWITCH has countless uses, one could be to control the above travel mech. Signals of 10 Hz to 20kHz picked up by its electret mike and FET amplifier and further amplified to be able to control relay motor etc up to ½ amp. supplied ready to work from 6V. Price only £2.

EXPERIMENTING WITH VALVES don't spend a fortune on a mains transformer we can supply one with standard mains input and secs. of 250-0-250V at 75 mA and 6.3V at 3 A. price £5.

15Watt Bohm 8" SPEAKER & 3" TWEETER made for a discontinued high quality music centre, give real hi.fi. and for only £4 pair

MANY EXPERIMENTS NEED RELAYS here's your chance to stock up at a bargain price. 10 relays all with different coil voltages: 3V 5V 6V 12V 24V & 48V DC, 230V 110V 48V 24V AC yours for £5 the lot.

230V AC from 12V DC inverter kit with transformers gives 60 watts £16 without transformers gives 15 watts £12.

WANT TO EXPERIMENT WITH DISC DRIVE You can have a double sided JAP made model, brand new for only £10! Why, because it was made for a very compact unit and consequently uses a small non standard disc. (We stock these at £2 each) it requires 5V 300mA power supply (we can supply). The drive is nicely cased and has output and input leads, originally listed at over £100, so it's a real bargain.

TIMES TEN IONISER using transformers and novel circuitry, our ioniser emits at least ten times as many ions as does any other kit or offer, nor do we know of a ready built model that is as good, you don't need a tester to see if it is working just bring your hand close to it and feel the stream of neg ions. It's a kit complete with case, nothing else to buy yours for £14.50.

TWIN 5½ DISC DRIVE cased and with internal power supply. Product of a famous Jap maker this is IBM XT compatible 360k double sided - brand new £59.00.

ULTRASONIC TRANSMITTER/RECEIVER with Piezo alarm, built into preformed case, is triggered by movement disturbing reflected signal, intended for burglar alarm, car alarm etc. has many extras, time delay, auto reset, secret off device etc. £40 instrument yours for £10.

CIRCLE NO. 119 ON REPLY CARD



HITACHI 50MHz Laboratory Oscilloscopes

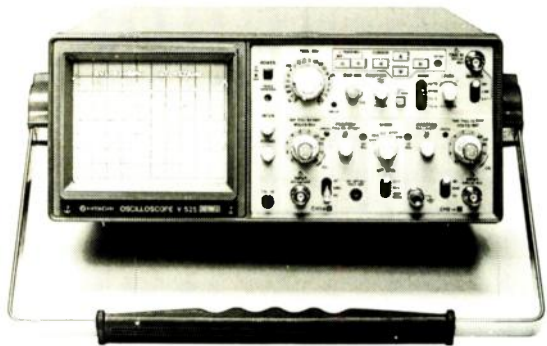

from £639!

These new low-cost 50MHz oscilloscopes provide the quality and performance you expect from Hitachi at a surprisingly low price.

There are three models offering a choice of delayed sweep or cursor measurement and all offering exceptional value for money.

Our sales engineers can provide on-site demonstrations and immediate delivery. Ask for more details of these new 50MHz models and the full 26 model Hitachi range:

Thurlby

Thurlby-Thandar Ltd., Glebe Road, Huntingdon, Cambs. Tel: (0480) 412451

CIRCLE NO. 120 ON REPLY CARD

The PC 'Scope

The DS-PC Link package connects a Thurlby Digital Storage Adaptor to an IBM compatible PC, creating a flexible digital storage oscilloscope with the sophistication and performance of instruments costing many times more.

DSA511	2 channel adaptor, 20MHz, 10MS/s	£445
DSA524	2 channel adaptor, 35MHz, 20MS/s	£595
DS-PC Link	Interface software and cable	£139

Alternatively an oscilloscope can be used as the display device in place of a PC. Contact us now for the full technical details:

Thurlby

Thurlby-Thandar Ltd., Glebe Road, Huntingdon, Cambs. Tel: (0480) 412451

from Thurlby

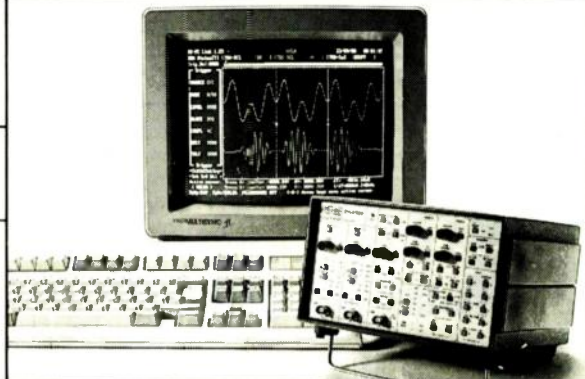

CIRCLE NO. 121 ON REPLY CARD

Centronics-compatible 12 bit programmable power supply

The circuit shown was designed to provide a glitch-free 12-bit programmable power supply from an 8-bit port. Its output voltage was used to control a piezo electric transducer via a 0-1500V DC-to-DC converter. To allow compatibility with a wide range of computers, the supply is controlled via the eight data lines on a universal Centronics printer port. The present design provides an output voltage of $0-V_{ref}$ (at 0-500mA) with 12-bit resolution where V_{ref} may be set by VR1 to between 6 and 12V.

Six data lines (D0-D5) on the port are used to provide both the six low- and high-order bits as input to a 12-bit DAC (DAC-312). Connecting pins 11,12, and 15 to ground allows the supply to be programmed using the usual line printer routine. To ensure a 12-bit simultaneous parallel input to the DAC, two transparent latches (373s) are used to demultiplex both the low- and high-order input bit sequence. These 12 bits are then strobed into a second pair of 373s, where data lines D6 and D7 are used to provide the

necessary strobe logic to enable latch input (see logic table). OP-amp OP27 is used on the output of the DAC as a current-to-voltage converter and a Darlington pair comprising 2N3053 and TIP120 provides the necessary current gain.

W. Lanigan and F. McLysaght
Maynooth
Kildare
Eire

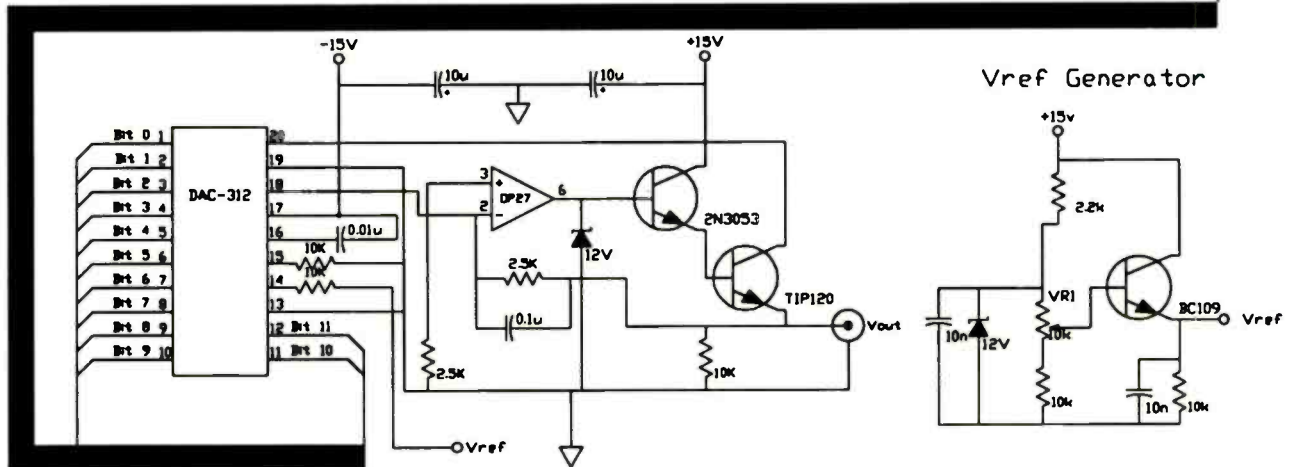
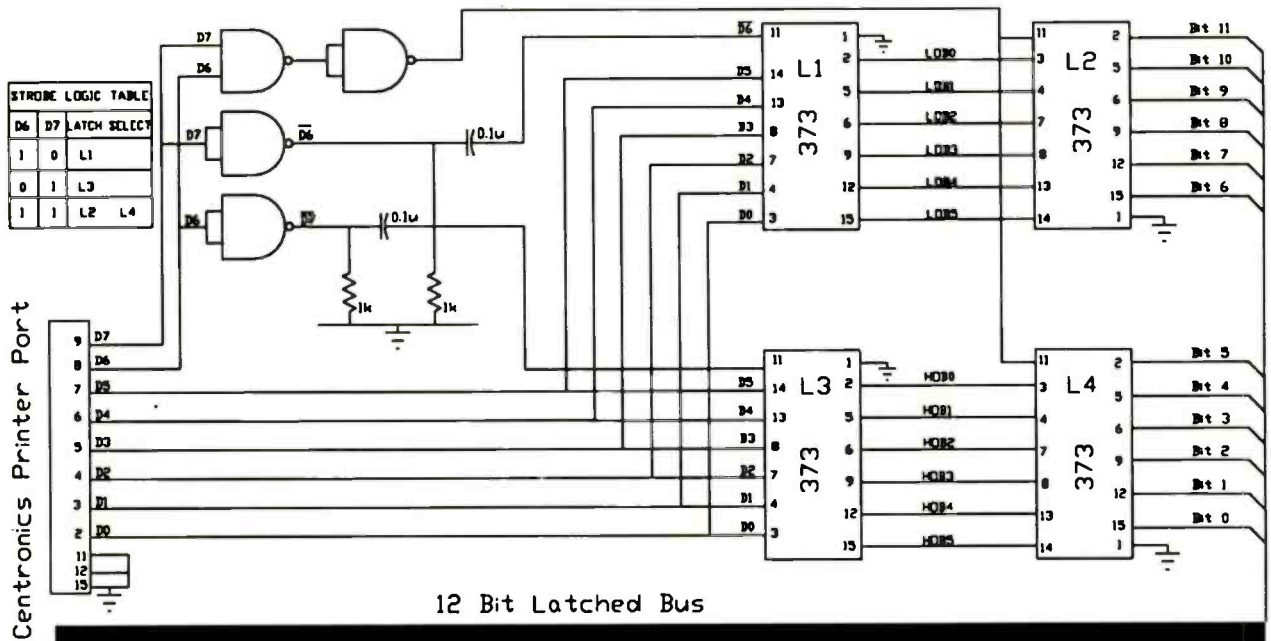

SPICE•AGE

Non-Linear Analogue Circuit Simulator £245 complete or £70 per Module

Those Engineers have a reputation for supplying the best value-for-money in microcomputer-based circuit simulation software. Just look at what the latest fully-integrated SPICE Advanced Graphics Environment (AGE) package offers in ease-of-use, performance, and facilities:

- SPICE•AGE performs four types of analysis simply, speedily, and accurately:
- Module 1 - Frequency response
 - Module 2 - DC quiescent analysis
 - Module 3 - Transient analysis
 - Module 4 - Fourier analysis

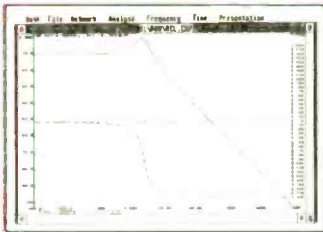

Frequency response of a low pass filter circuit

2 DC Quiescent analysis

SPICE•AGE analyses DC voltages in any network and is useful, for example, for setting transistor bias. Non-linear components such as transistors and diodes are catered for. (The disk library of network models contains many commonly-used components - see below). This type of analysis is ideal for confirming bias conditions and establishing clipping margin prior to performing a transient analysis. Tabular results are given for each node; the reference node is user-selectable.

1 Frequency response

SPICE•AGE provides a clever hidden benefit. It first solves for circuit quiescence and only when the operating point is established does it release the correct small-signal results. This essential concept is featured in all Those Engineers' software. Numerical and graphical (log & lin) impedance, gain and phase results can be generated. A 'probe node' feature allows the output nodes to be changed. Output may be either dB or volts; the zero dB reference can be defined in six different ways.

DC conditions within model of 741 circuit

LATEST FEATURES: define up to four independent signals with time vs voltage co-ordinates on text files and use the FFT functions to make a spectrum analyser or chain outputs to simulate circuits of unlimited size!

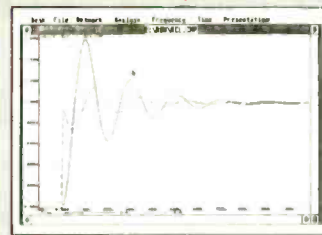

Impulse response of low pass filter (transient analysis)

4 Fourier analyses now with Hanning window option

SPICE•AGE performs Fourier transforms on transient analysis data. This allows users to examine transient analysis waveforms for the most prevalent frequency components (amplitude is plotted against frequency). Functions as a simple spectrum analyser for snapshot of transients. Automatically interpolates from transient analysis data and handles up to 512 data values. Allows examination of waveform through different windows. Powerful analytical function is extremely easy to use.

3 Transient analysis

The transient response arising from a wide range of inputs can be examined. 7 types of excitation are offered (impulse, sine wave, step, triangle, ramp, square, and pulse train); the parameters of each are user-definable. Reactive components may be pre-charged to steady-state condition. Up to 13 voltage generators and current generators may be connected. Sweep time is adjustable. Up to 4 probe nodes are allowed, and simultaneous plots permit easy comparison of results.

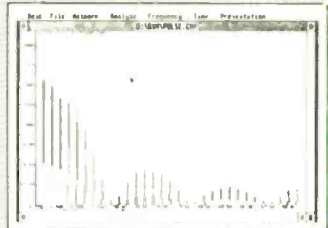

Spectrum of rectangular pulse train (Fourier analysis)

If your work involves designing, developing or verifying analogue or digital circuits, you will wonder how you ever managed without Those Engineers circuit Simulation Software.

A good range of properly supported and proven programs is available and our expert staff are at your service.

Telephone: Charles Clarke on 071-435 2771 for a demonstration disk.

Those Engineers LTD

106a Fortune Green Road West Hampstead
London NW6 1DS

Tel: 071-435 2771 Fax: 071-435 3757

CIRCLE NO. 122 ON REPLY CARD

WE HAVE THE WIDEST CHOICE OF USED OSCILLOSCOPES IN THE COUNTRY

TEKTRONIX 2445 Four Trace 150MHz Dual TB	£1200
TEKTRONIX 2245A Four Trace 100MHz Dual TB	£1000
TEKTRONIX 2235 Dual Trace 100MHz Delay Sweep	£650
TEKTRONIX 2215 Dual Trace 50MHz Delay Sweep	£450
TEKTRONIX 475 Dual Trace 200MHz Delay Sweep	£850
TEKTRONIX 465 Dual Trace 100MHz Delay Sweep	£450
HP 1722B Dual Trace 275MHz Delay Sweep, 5 Function LED Display for Real Time Measurement	£750
HP 1740A Dual Trace 100MHz Delay Sweep Trig	£350
PHILIPS PM 3217 Dual Trace 50MHz Delay Sweep	£400
TELEQUIPMENT D83 Dual Trace 50MHz Delay Sweep	£300
TELEQUIPMENT D755 Dual Trace 50MHz Delay Sweep	£250
GOULD OS3000 Dual Trace 40MHz Delay Sweep TV Trig	£250
GOULD OS1100 Dual Trace 30MHz TV Trig	£180
GOULD OS300 Dual Trace 20MHz	£250
GOULD OS2560 Dual Trace 35MHz TV Trig	£160
COSSOR CD1150 Dual Trace 35MHz Delay Sweep	from £100
S.E. Labs SM111 Dual Trace 10MHz	£130
TEKTRONIX 2210 Digital Storage Dual Trace 50MHz (20MS/s Sampling Rate) As New	£1150
GOULD 4035 Digital Storage Dual Trace 20MHz	£750
GOULD OS4020 Digital Storage Dual Trace 10MHz	£450
GOULD OS4000 Digital Storage Dual Trace 10MHz	£300

THIS IS JUST A SAMPLE - MANY OTHERS AVAILABLE

HP 8112A Programmable Pulse Generator 50MHz	£1500
BRADLEY Oscilloscope Calibrator 192 with Cal Cert.	£800
QATARON 1061 Auto Cal DMM True RMS etc	£650
SOLARTRON 7075 DVM µg Gen 5-200MHz	£700
R & S SW184 (Sweep Gen with display) 0.1-1000MHz	£750
MARCONI TF2008 AM/FM 10MHz-510MHz Sig Gen	£450
MARCONI TF2015 AM/FM 10-520MHz Sig Gen with TF2171	£400
MARCONI TF2015 without Synchroniser TF2171	£250
MARCONI TF2016 AM/FM 10MHz-120MHz Sig Gen with TF2173	£350
MARCONI TF2016 without Synchroniser TF2173	£175
MARCONI TF2356/2357 Level Osc/Meter 20MHz	the pair £950
HP 8620C Sweeper Main Frame (Plug-ins available)	£1000
LEADER VSS5851A Vectorscope	£600

TEKTRONIX 491 SPEC ANALYSER 1.5-12.4GHz from £1000	£1400
SYSTRON DONNER 1702 Sig Gen 100kHz-1GHz	£950
POLARAD Sig Gen type 1105B 0.8-2.4GHz	£500
POLARAD Sig Gen type 1106B 1.8-4.6GHz	£500
POLARAD Sig Gen type 1207A 3-7.8GHz	£500
POLARAD Sig Gen 1207A with 1509 Freq Doubler	£750
POLARAD Sig Gen 1208A 6-951GHz	£500
POLARAD Sig Gen 1208A with 1510 Freq Doubler	£750

TEKTRONIX TM504 with PG506/SG503/FG501	£2250
RACAL STORE 14DS 14 Channel Magnetic Tape Recorder	£2000
RACAL 9081 Synthesised Sig Gen 5-200MHz	£650
RACAL 9009 Mod Meter 10MHz-1.5GHz	£350
RACAL 9301 RMS Voltmeter 10kHz-1.5GHz	£250
TIME 2004 DC Voltage Standard 0.005%	£450
SOLARTRON 7150 Digital Multimeter 6 1/2 digit	£300
AVO Valve Characteristic Meter VCM163	from £250-£350
FERRUGRAPH R152 Recorder Test Set from	£200
THURBY PL3200MC Two 30V 2A Quad Mod Digital	£200

TELEQUIPMENT C771 Curve Tracer £250
MARCONI TF2700 Universal LCR Bridge Battery from £125
MARCONI TF2337A Automatic Distortion Meter 400Hz/1MHz £100
MARCONI MOD Meters TF2300, TF2300B, TF2303 from £100
MARCONI TF2603 RF Millivoltmeter 50kHz-1.5GHz £75
MARCONI TF2430 Digital Freq Counter 10Hz-80MHz £60
MARCONI TF1152/1 RF Power Meter 500MHz-10.25W, 500mW £25
MARCONI TF833A RF Power Meter 20MHz-35MHz 20mW-10W £20
RACAL 9915 Freq Counter 10520MHz Crystal Oven £150
FARNELL PSU HD/100 030V 0100A £750
UNINTERRUPTED Power Supply type RBSCAC 500VA £150

AVO 8 MULTIMETERS
GOOD WORKING ORDER - PHYSICALLY NOT BRILLIANT
SUPPLIED WITH BATTERIES & LEADS ONLY £30
ALL OTHER MODELS AVAILABLE

LEADER 1M186A Two Ch MvMeter 5Hz/500kHz, 1mV-300V £100
KIKUSUI AVM23 AC Voltmeter Dual Ch 10Hz-500kHz £100
300uV-100V £75
SOLARTRON 7045 Multimeter 4 1/2 digit 30 ranges Auto Man £95
FARNELL Pulse Gen System 1Hz-10MHz Single/Double £40
LOGIC PROBE type 3300RA THYOMOS (P&P £3) £10
 Large range of BENCH POWER SUPPLIES available from £40
 XY PLOTTERS Various models from £25-£400

SOME BRUEL & KJER EQUIPMENT ALWAYS AVAILABLE. PLEASE ENQUIRE

LEVELL TM38 AC Millivoltmeter 1Hz/3MHz 5uV-500V £60
LEVELL TM3A AC Millivoltmeter 1Hz/3MHz 5uV/500V £40
LEVELL Oscillator TC152 2Hz-300kHz Sine Sq from £55
LEVELL Oscillator TC150M 1.5Hz-150kHz sine Wave £20
LEVELL Decade Osc TF66A 0.2Hz-1.22MHz Low dist from £35

NEW EQUIPMENT

HAMEG OSCILLOSCOPE HM1005 Triple Trace 100MHz £792
Delay Timebase
HAMEG OSCILLOSCOPE HM604 Dual Trace 60MHz £610
Delay Sweep
HAMEG OSCILLOSCOPE HM205 7 Dual Trace 20MHz £338
Component Tester
HAMEG OSCILLOSCOPE HM205 3 Dual Trace 20MHz £610
 Digital Storage
 All other models available - all oscilloscopes supplied with 2 probes

BLACK STAR EQUIPMENT (P&P all units £5)
APOLLO 10 100MHz (As above with more functions) £295
METEOR 100 FREQUENCY COUNTER 100MHz £109
METEOR 600 FREQUENCY COUNTER 600MHz £135
METEOR 1000 FREQUENCY COUNTER 10Hz £176
JUPITOR 500 FUNCTION GEN 0.1Hz-500kHz Sine Sq In £109
ORION COLOUR BAR GENERATOR Pal TV Video £200
 All other Black Star Equipment available

HUNG CHANG DMM 7030 3 digit Hand held 28 ranges £39.50
 including 10 amp AC/DC 0.1% ACC (P&P £4)
 As above DMM6110 2 1/2% £33.50 ea
 Carrying cases for above £3.00 ea

OSCILLOSCOPE PROBES Switched X1X10 (P&P £3) £11

TELEQUIPMENT C771 Curve Tracer £250
MARCONI TF2700 Universal LCR Bridge Battery from £125
MARCONI TF2337A Automatic Distortion Meter 400Hz/1MHz £100
MARCONI MOD Meters TF2300, TF2300B, TF2303 from £100
MARCONI TF2603 RF Millivoltmeter 50kHz-1.5GHz £75
MARCONI TF2430 Digital Freq Counter 10Hz-80MHz £60
MARCONI TF1152/1 RF Power Meter 500MHz-10.25W, 500mW £25
MARCONI TF833A RF Power Meter 20MHz-35MHz 20mW-10W £20
RACAL 9915 Freq Counter 10520MHz Crystal Oven £150
FARNELL PSU HD/100 030V 0100A £750
UNINTERRUPTED Power Supply type RBSCAC 500VA £150

Versatower:

A range of telescopic towers in static and mobile models from 7.5 to 36 metres with tilt-over facility enabling all maintenance to be at ground level.

Designed in accordance with CP3 Chapter V, part 2. 1972 for a minimum wind speed of 140 kph in conditions of maximum exposure and specified by professionals world-wide where hostile environments demand the ultimate in design, quality and reliability.

Suitable for mounting equipment in the fields of:

- Communications
- Security surveillance - CCTV
- Meteorology
- Environmental monitoring
- Geographical survey
- Defence range-finding
- Marine and aero navigation
- Floodlighting
- Airport approach lighting

Further details available on request.

STRUMECH ENGINEERING LIMITED
 Portland House, Coppice Side, Brownhills
 Walsall, West Midlands WS8 7EX, England
 Telephone: Brownhills (0543) 452321
 Telex: 335243 SEL G
 Fax: 0543 36 1050

Zero-error low-pass filter

Fifth-order, low-pass filters by Maxim, the MAX280 family, provide accurate cut-off frequency setting and eliminate DC offset errors completely. They are well suited to the removal of noise on transducer signals when DC is present.

The 281 is a Bessel filter which offers

external R and C should be chosen so that $(1/2\pi RC)=1.2737$. Figures 3 and 4 show the frequency response in pass-band and stop-band.

Two MAX281 can be cascaded either with or without buffers. The circuit of Fig. 5 shows an arrangement

which corrects for the loading of the output of the first stage; there is a maximum DC error in this arrangement of 2mV at V_{out} .

Maxim Integrated Products (UK) Ltd, 21C Horseshoe Park, Pangbourne, Reading RG8 7JW.

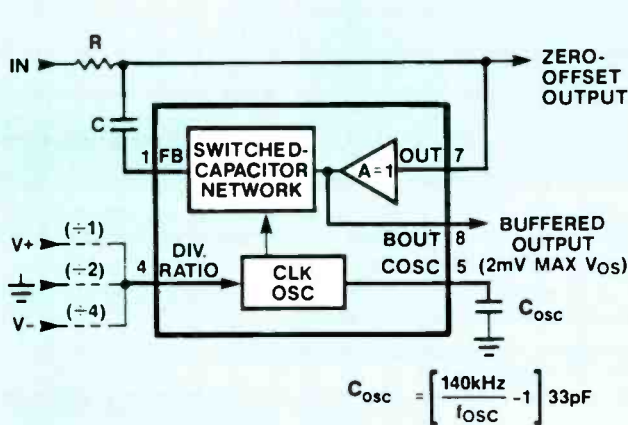

Fig. 1. MAX281 architecture. Clock and divider ratio are set to provide desired cut-off frequency.

$$C_{osc} = \left[\frac{140\text{kHz}}{f_{osc}} - 1 \right] 33\text{pF}$$

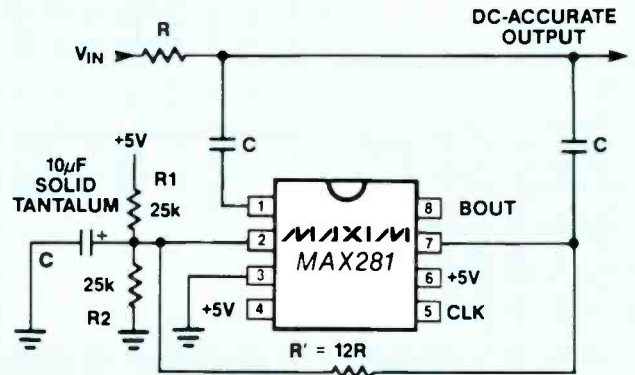

Fig. 2. Single-supply operation. C and R are not needed if input is around 0.5 supply voltage.

FOR A 1kHz FILTER $R = 20.272\text{k}\Omega$ $C = .01\mu\text{F}$, $f_{CLK} = 101\text{kHz}$
 THE FILTER IS BESSEL FOR $\frac{1}{2\pi RC} = \frac{f_c}{1.2737}$

constant group delay to give minimum pulse distortion, a small overshoot and a short settling time and is intended for use where transient response is critical.

Figure 1 shows the architecture of the circuit. Output voltage is sensed by the internal c-mos buffer and applied to an internal switched-capacitor network, which drives the bottom plate of an external capacitor to form a fifth-order, low pass filter. Input and output appear across R and IC itself only sees the AC part of the signal. DC offsets of the buffer and switched-capacitor network are blocked and do not appear at the output pin.

Resistor R and the capacitor C automatically provide anti-aliasing filtering for the sampled filter and LF noise in the IC is attenuated by C, since noise at FB goes through a high-pass path to the filter output.

There is also an on-chip 140kHz oscillator, which is variable by means of an external C and series variable resistor of 50kΩ at pin 5. Figure 2 is the circuit diagram of a single-supply (5V) filter. Output and ground, pins 7 and 2, are biased to half the supply voltage, the biasing resistors being selected to pass 100µA or more. The 12Ω resistor biases the buffer and the capacitor on pin 7 isolates the buffer from DC. The

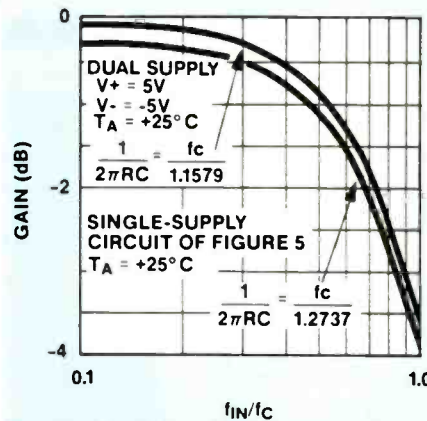

Fig. 3. Pass-band frequency response of single or dual supply filter.

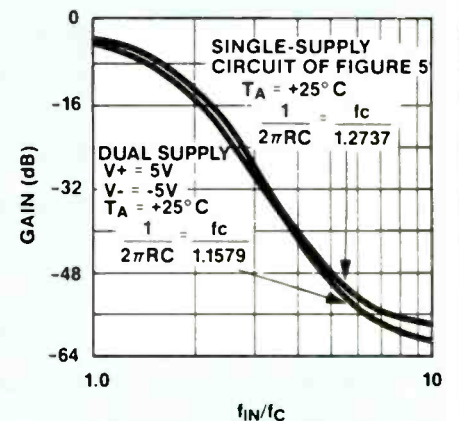

Fig. 4. Frequency response in stop-band.

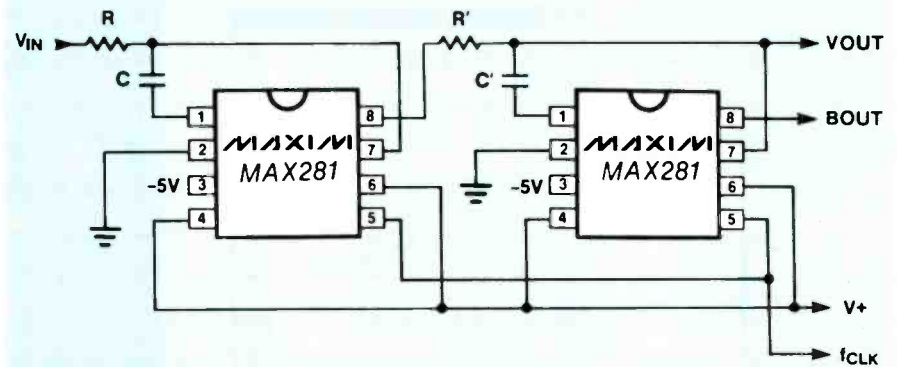

Fig. 5. Cascading two MAX281 filters. Second stage driven by first stage buffered output.

Op-amp full-wave rectifier/temperature transducer

NE5230 is very low-voltage operational amplifier that will work from split or single supplies as low as 1.8V or up to 15V, the output swinging to ground on a single supply. Power consumption is adjustable, at $\pm 0.9V$ the current required being only $110\mu A$. Unity-gain bandwidth is 180kHz, adjustable up to 600kHz. Input arrangements are claimed to be unique, in that the common-mode input range can exceed positive and negative rails by 250mV. The device is intended for use in instrumentation, transducer amplification, comparators, audio work and precision rectification.

Since the common-mode range includes both supply rails and since the output will swing to within 100mV of either rail, obtaining half-wave rectification in either direction is simple, only needing two resistors and no diodes. Internal saturation detectors keep the device out of "hard" saturation, so that it is possible to use the biasing circuits in Fig.1, which produce both positive and negative-going outputs.

In its half-wave configuration, the circuit does not respond to half the incoming wave since the output would exceed one or the other supply rail, depending on biasing. During the other half cycle, however, the output is able to reach the rail voltage if input and gain are so adjusted. This, moreover, occurs over the full audio range.

If a second NE5230 is used in an inverting, summing configuration as shown in Fig.2, the input is combined with the half-wave output, the result being a full-wave rectifier. Input and feedback resistors must be chosen to give equal peak amplitudes.

Figure 3 shows the device used as a temperature transducer. The bias adjustment pin, which is normally used to control supply current and, therefore, power, is at a voltage proportional to temperature, since it is produced by amplifier bias current. If this pin is connected to the input pin, the NE5230 itself becomes a temperature transducer. The potentiometer will provide variable temperature/output current conditions. Thermal considerations to be borne in mind for this application are described in detail in the application note.

Philips Components Ltd, Mullard House, Torrington Place, London WC1E 7HD. Telephone: 071-580 6633.

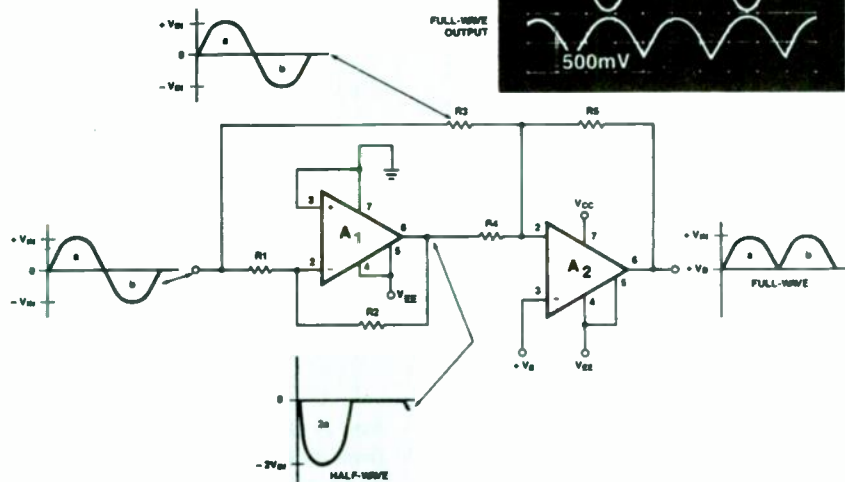
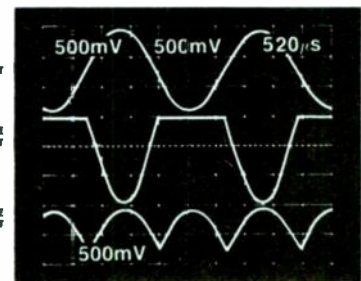
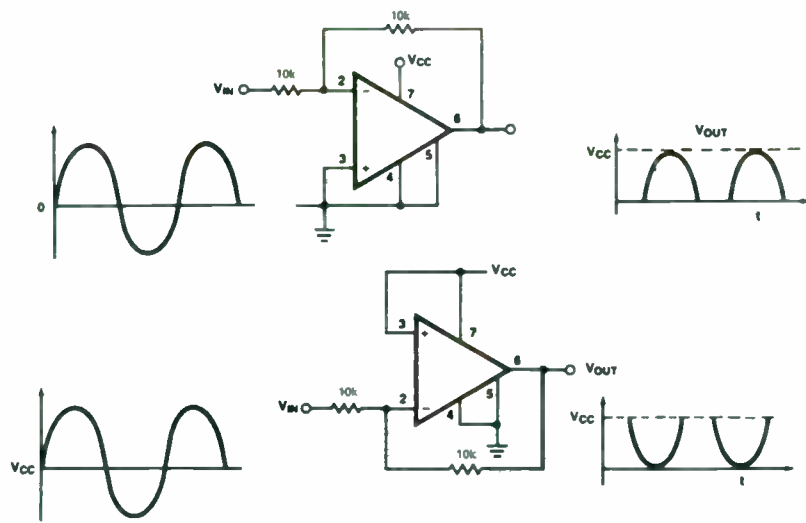
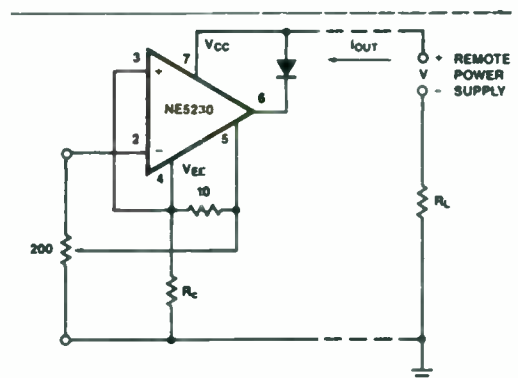

Fig. 1 (top) half wave rectifier

Fig. 2 (Above) Full wave rectifier

Fig. 3 Temperature transducer circuit



In commerce the spreadsheet has become indispensable, both as a thinking "what-if" tool and as a means of automating routine tasks. But in electronics and other engineering and scientific disciplines it still thought of as an optional extra.

This is perhaps because Visicalc and its successors such as Supercalc and Lotus were all (primarily) targeted at the business community. Cracker 4 could change all that as it has been designed by engineer Ian Searle of Software Technology Ltd specifically to tackle industrial problems.

All the usual features for manipulating data and text, with mathematical, logical and statistical functions in abundance are included. But in addition are features that make it equally at home in the laboratory.

Graphs

Most spreadsheets now can tackle straightforward XY graphs—though earlier versions were restricted to business charts where the X axis could take up only a fixed number of values.

As with most modern spreadsheets Cracker will produce output from a table of sine and cosine functions (Fig. 1). But the package also offers the option of linear or logarithmic scales automatically on either or both axes. For example in a plot of series resonance, the horizontal scale could be changed from linear to logarithmic (Figs. 2a and 2b) simply by altering a single digit to select one of the 12 scientific graph options. Log plots can extend over many decades (Fig. 2c).

Graphs can be X:Y, X:logY, logX:Y and logX:logY. In any one option data can be plotted as separate points, as lines joining points or as a best straight line fit (least squares approximation).

Hercules, CGA, EGA and VGA screens including high resolution modes can all be handled, with hard copy output to Epson-compatible printers or HP-compatible plotters. Files can be saved in HPGL (Hewlett-Packard Graphics Language) format for high resolution plotting or import into DTP systems.

Spreading the work-load

A spreadsheet for the engineer not the accountant? Peter Williams finds out if Cracker 4 adds up.

Graphics

A unique feature of Cracker, as far as engineers are concerned, is that embedded in the package is a graphics language which specifies the size, shape and location of text and drawings.

Values can be entered directly into cells while the graphics image is being specified, or values can be taken from calculations elsewhere in the spreadsheet.

Text can be printed at any location (Fig. 3.) with different sizes and alignments such as rotation through 90°, print in bold and so on. Circles, segments and arcs can be drawn by specifying co-ordinates of the centre, the radius and, where required, start and finish angles. Single or polylines can be handled.

Fig. 1. Output from table of sine and cosine functions

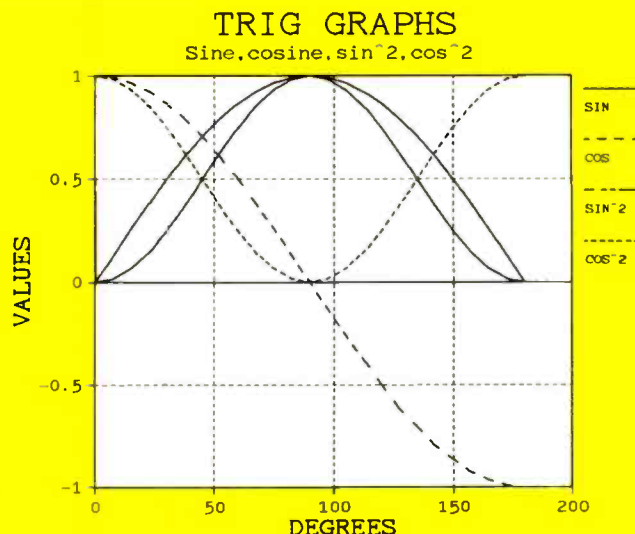

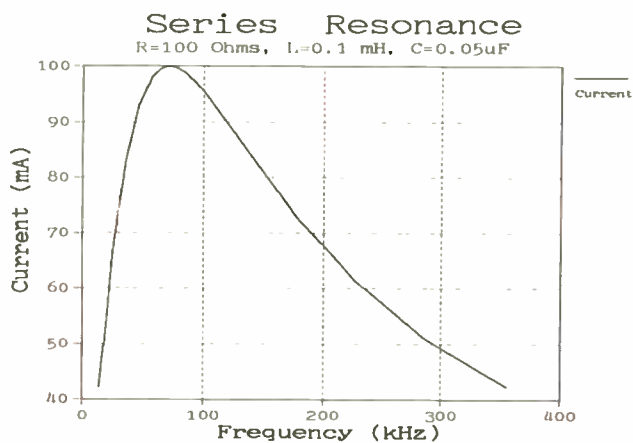

Fig. 2a. Series resonance plotted on a linear scale.

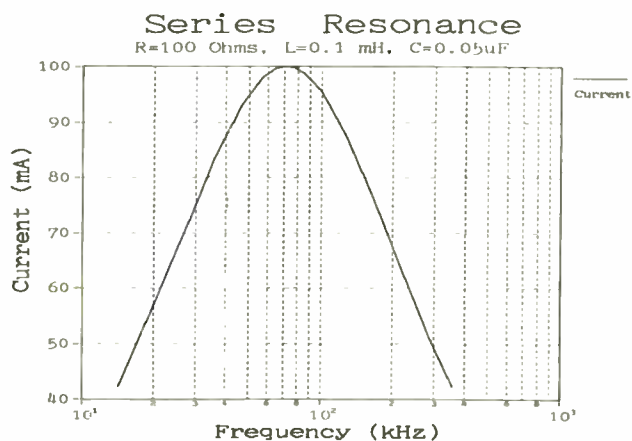

Fig. 2b. Changing scales from linear to log is simple.

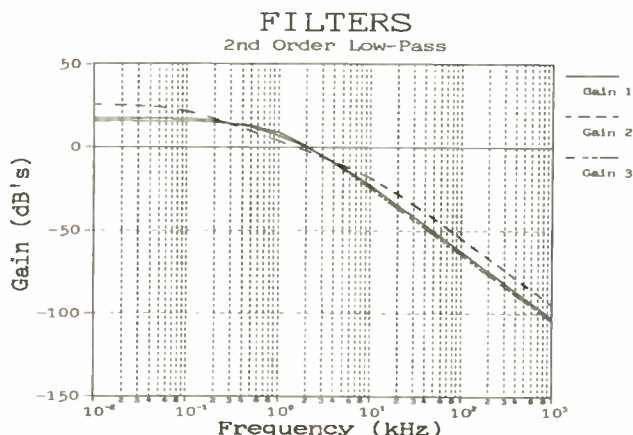

Fig. 2c. Log plots can extend over many decades.

Cracker 4 specifications.

The spreadsheet will run on PC compatibles with 512K in any standard screen mode. It is available at £99.95+VAT from: Paperback Software (UK) Ltd, The Widford Old Rectory, London Road, Chelmsford, Essex CM2 8TE.

Site licenses are available for educational use. MEDC (Microelectronics Educational Development Centre) has licensed the package for use in Scottish Colleges and Universities and a sample pack of educational examples, cost £10 (CWO) is available from: Dr Peter Williams, Director of MEDC, 8/14 Storie Street, Paisley, PA1 2BX.

A teaching example in trigonometry (Fig. 4.) demonstrates how triangles are drawn to scale, with any change in an unknown resulting in the triangle being redrawn to the new dimensions. In a Civil Engineering example, a scale drawing of a T-beam is derived from spreadsheet calculations (Fig. 5.). But the idea could be extended to producing scale drawings of a transistor die, varying as the equations are adjusted to change device parameters.

Cracker can also collect multiple images from existing files and combine, scale and locate them on a single screen or printout (Fig. 6.)—very useful for Desk Top Publishing.

I/O in the lab

Two new functions, IN and OUT, were introduced by Software Technology Ltd in response to users' requests for

CRACKER GRAPHICS LANGUAGE

<p>TEXT 7 185 Hello world!</p> <p>TEXT-ANGLE 0 TEXT-ANGLE 90 TEXT-ANGLE 270 TEXT-ANGLE 180</p> <p>ALIGN-LEFT ALIGN-CENTRE ALIGN-RIGHT</p> <p>TEXT-HEIGHT 2 TEXT-HEIGHT 4 TEXT-HEIGHT 6</p> <p>TEXT-LINE-WIDTH 1 TEXT-LINE-WIDTH 2</p> <p>CIRCLE 20 35 10</p> <p>SEGMENT 55 35 10 0 230</p>	<p>POLYLINE 4 80 160 90 180 100 160 80 160</p> <p>FILL-AREA-ON</p> <p>FILL-STYLE 1</p> <p>FILL-STYLE 2</p> <p>FILL-STYLE 3</p> <p>FILL-STYLE 4</p> <p>FILL-STYLE 5</p> <p>FILL-STYLE 6</p> <p>FILL-STYLE 7</p> <p>LINE-STYLE 1</p> <p>LINE-STYLE 2</p> <p>LINE-STYLE 3</p> <p>LINE-STYLE 4</p> <p>LINE-STYLE 5</p> <p>LINE-STYLE 6</p>	<p>DIMENSION 160</p> <p>VECTORS</p> <p>ARROW-LOCATION 0</p> <p>ARROW-LOCATION 1</p> <p>ARROW-LOCATION 2</p> <p>ARROW-FORM 1</p> <p>ARROW-FORM 2</p> <p>ARROW-FORM 3</p>
--	--	---

Fig. 3. A range of print options is available.

REVIEW

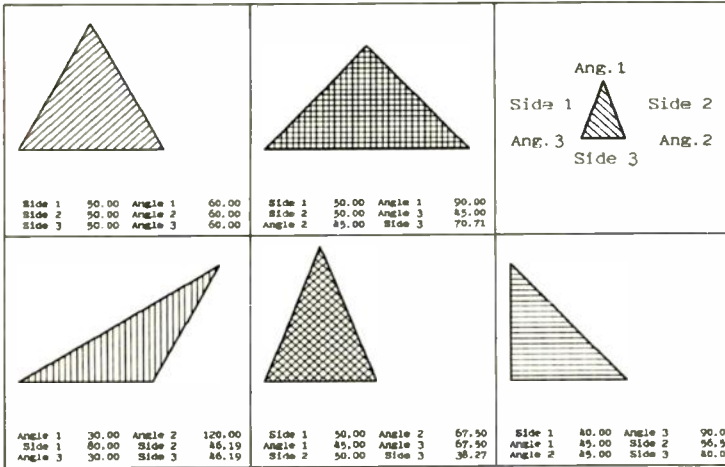

Fig. 4. Triangles can be drawn to scale from data.

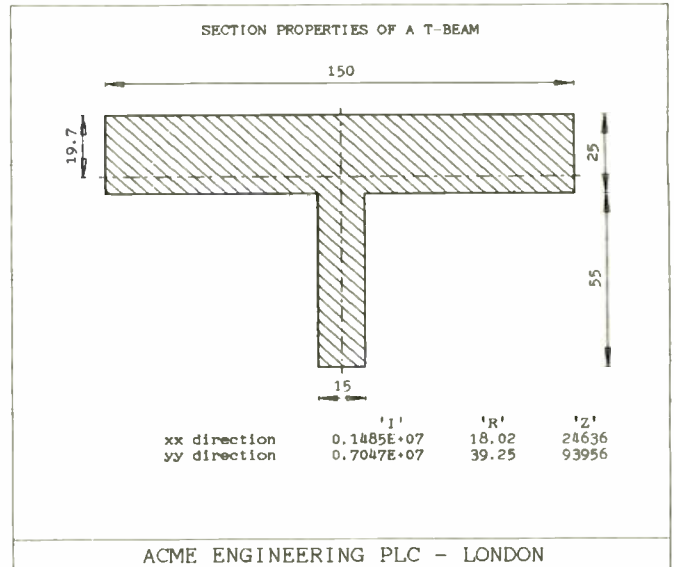

Fig. 5. Scale drawings can be produced from spreadsheet calculations.

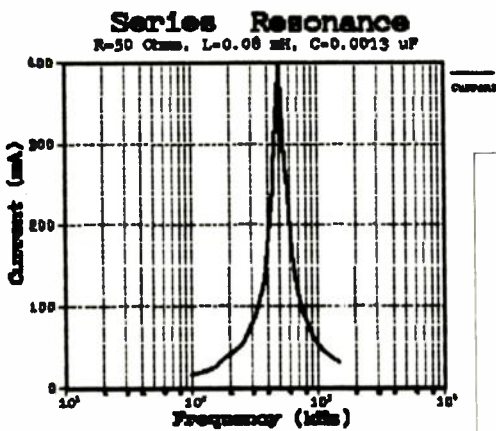
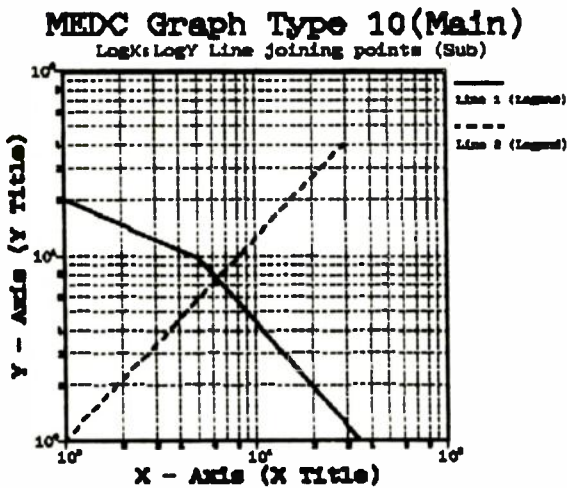
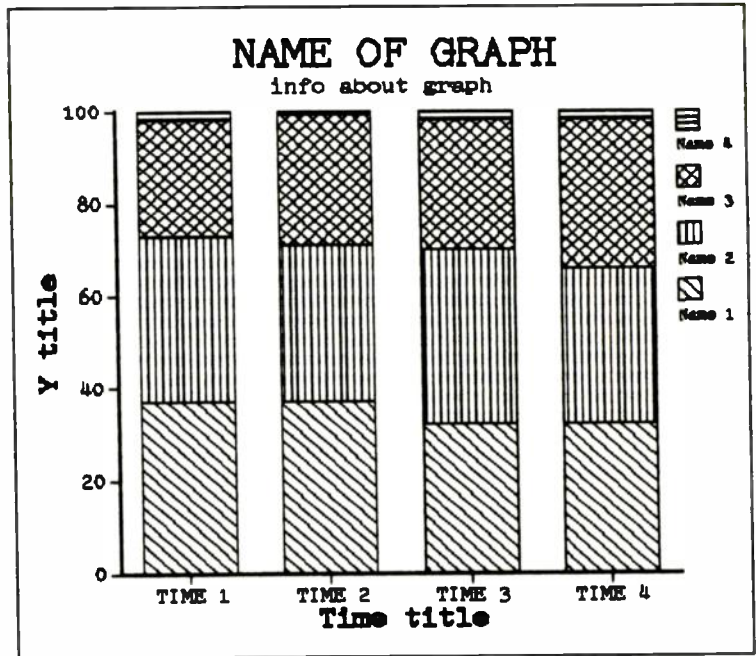

Fig. 6. Multiple images can be combined. Here a bar graph has been drawn from current data with pre-stored images pulled in.



an extra feature for laboratory use.

The first, when entered into a cell in the spreadsheet, identifies the port address from which data is to be collected. Entering IN(956) causes that cell to show the decimal value of the 8-bit number on port 956. Cells can be periodically updated using internal timing functions, with the data prepared for eventual graphing.

Similarly the output function directs data in a cell to a specified output port. OUT (957,99) causes the binary number corresponding to decimal 99 to be sent to port 957 each time that cell is reactivated. The ports themselves have

8-bit values, so that the decimal values for data should lie between 0 and 255.

Simple life

Almost any spreadsheet can be useful in processing data for science and engineering applications. But some spreadsheets have extra features that make the life of the electronics engineer easier. Cracker is an example of software designed by an engineer for engineering applications, bringing with it specialist graphics and I/O functions that allow the 'what-if' approach to practical problems. ■

RTC52
Serial port, 64kB, 12 bits I/O, 80C52-BASIC Processor

RTC-V25
2 Serial ports, A/D, EEPROM, 384kB, Clock, 40 bits I/O, V25 Processor

RTC180
2 Serial ports, 96kB, A/D, EEPROM, 24 bits I/O, 64180 Processor

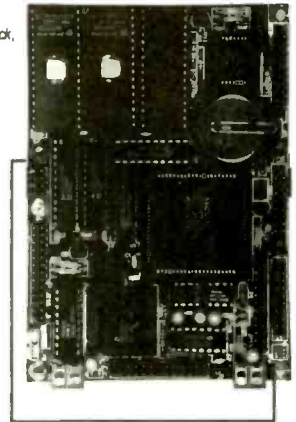

COMING SOON

RTC31
Serial port, 64kB, 12 bits I/O, 8031 Processor

RTC-HC11
Serial port, A/D, EEPROM, 64kB, Clock, 15 bit I/O, 64HC11 Processor

Micromint's RTC

The Biggest Little Controller Family in the World!

Micromint's RTC series of compact controllers gives you the **BIGGEST** list of usable features available in **LITTLE** controller packages.

RTC controllers and peripherals let you match the processor to the job: 8031, 80C52BASIC, 64180, 68HC11, or V25. Next, you add the optional I/O you need: serial (RS-232 or RS-485), parallel, A/D, D/A, optoisolated, high voltage, IR, and more!

With the RTC Stacking Bus, all this power comes with a footprint ranging from 3.5" x 3.5" to 3.5" x 5" (depending on the processor board required). No other controller series gives you the **BIG** power of RTC controllers in the same **LITTLE** space.

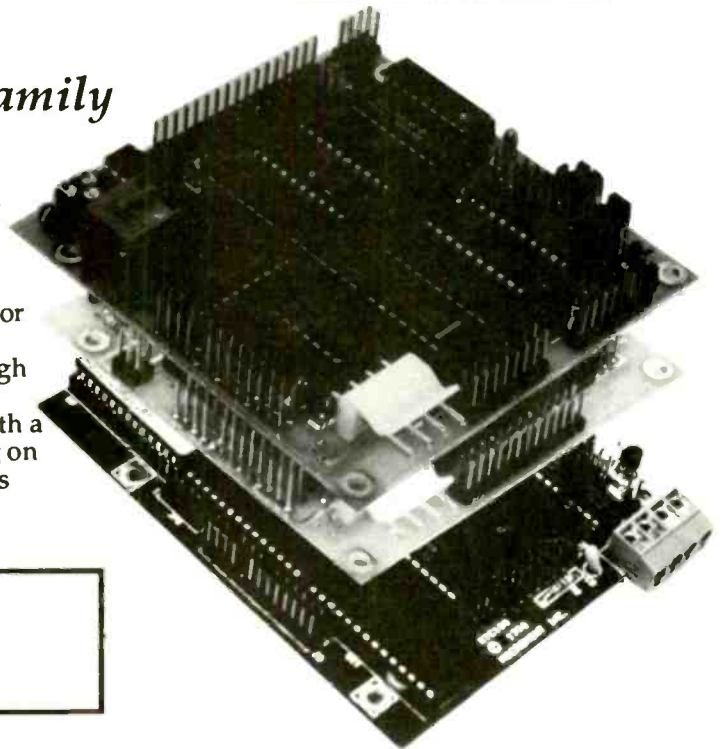

Manufactured by:



MICROMINT, INC.
4 Park St., Vernon, Connecticut 06066
(203) 871-6170 • Fax (203) 872-2204

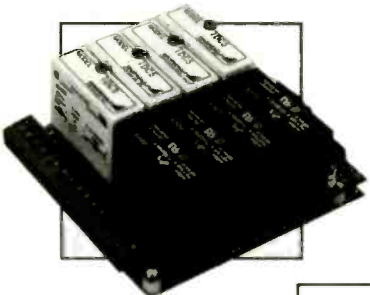

RTC-OPTO
Optically Isolated I/O Exp. Board

RTC-LCD
Display, Keyboard, and X-10 I/O Exp. Board

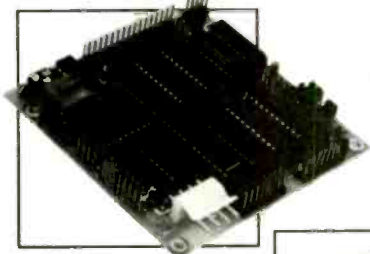

RTC-IO
A/D, D/A, Clock, Parallel I/O Exp. Board

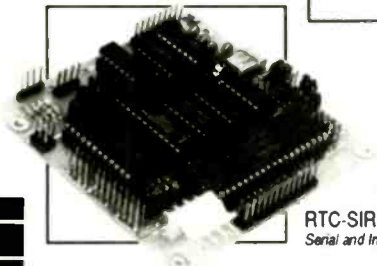
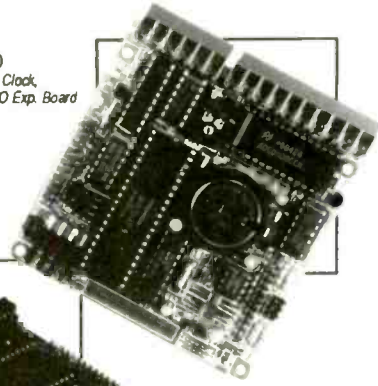

RTC-SIR
Serial and Infrared I/O Exp. Board

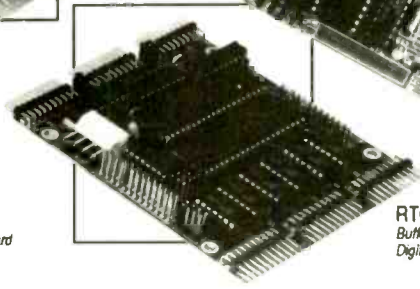

RTC-BUFIO
Buffered, High-Voltage, Digital I/O Exp. Board

In Europe Call:



J. B. DESIGNS & TECHNOLOGIES LTD. • 15 Market Place • Cirencester, Glos. GL7 2PB England

Tel: 0285-658122 • Fax: 0285-658859

Descriptions above include all populated options.

CIRCLE NO. 155 ON REPLY CARD

PIONEERS

Walter Guyton Cady
and George
Washington Pierce
Crystal-controlled
oscillator

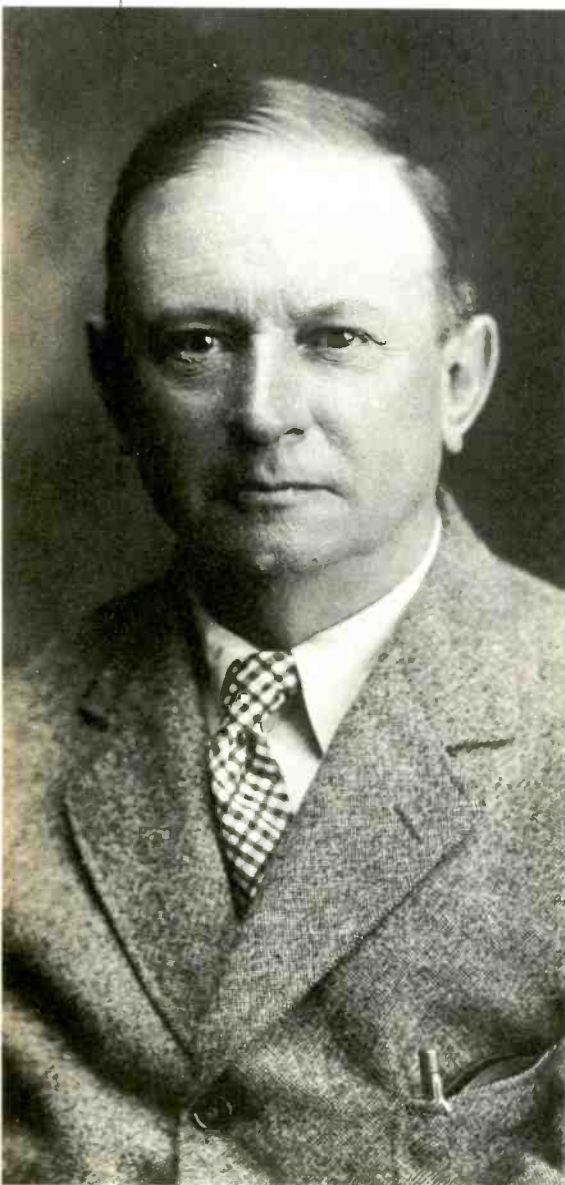

G.W. Pierce, Harvard University Archives.

What do piezoelectricity, anti-submarine warfare and birds have in common? Answer: They were all studied by the inventors of the quartz crystal oscillator, W.G. Cady and G.W. Pierce. Whilst the men's names are no longer instantly recognised by many electronics engineers, the quartz oscillator is a widely used and fundamental piece of modern electronics. Probably its most widespread use today, and the only one well known to the public, is in wrist watches and clocks. As a frequency regulator, it has a vast number of applications. Before its invention it was difficult, for example, to maintain a stable frequency at a radio transmitter.

Sometimes, the crystal-controlled oscillator is known simply as the Pierce oscillator after George Washington Pierce. The Pierce oscillator made its debut in 1923 and followed the pioneering work on piezoelectricity and crystal oscillators performed by Walter Guyton Cady during and after the First World War.

Walter G. Cady

Cady was a professor of physics at the Wesleyan University, Middletown, Connecticut, from 1902 to 1946, and was renowned internationally for his work on piezoelectricity. In 1946 he published what became the standard textbook on the subject, called simply "Piezoelectricity". It was still in print nearly 20 years later.

Piezoelectricity is electricity produced by mechanical stress on a non-conducting crystal. It was discovered by Pierre Curie and his brother Jacques in 1880 and named by W.G. Hankel

from the Greek word "to press". For the next few decades it remained little more than a scientific curiosity with no real engineering application but, like so many things, all that was changed by the First World War. By the end of the 1920s, piezoelectric crystals had been used for record player pickups, loudspeakers, earthquake measurement, water pressure measurement – and for stabilising the frequency of radio transmitters.

It was in June, 1917 that Cady became interested in piezoelectricity. He attended a meeting in Washington DC where engineers and scientists from various Allied nations discussed how to detect enemy submarines. About 40 people, including Lord Rutherford, threw ideas around and the one that appealed to Cady was to transmit an underwater beam of sound and pick up the reflections. Paul Langevin in France, the meeting was told, was proposing to make a 'sandwich' of little pieces of quartz between two pieces of metal and use the piezoelectric effect to generate a beam of ultrasonic sound. This was the origin of sonar, though the war was over before Langevin got his device working.

Cady liked the idea and was invited to work with the General Electric Laboratories at Schenectady and with Columbia University but, as with Langevin, the war was over before the work was completed. However, the foundations for future work on ultrasonics and sonar had been laid, and Cady had become fascinated by piezoelectric crystals. As he put it himself, "I found that when I connected a crystal into an electric circuit it behaved in certain peculiar ways."

The reverse effect to piezoelectricity, whereby the crystal is stressed by applying an electric field, was already well known. Cady found that if a crystal was included in the circuit of a variable-frequency electronic oscillator, then there was one particular frequency at which the crystal vibrated particularly strongly, so strongly that in some cases it broke under the strain. "If the frequency varied by the tiniest amount one way or the other from that, the crystal practically didn't vibrate at all," he recalled.

The Hollywood-style breakthrough came one evening. "I think that one of the biggest thrills that I ever had was one evening when I happened to think that right here in that vibrating crystal was something that might be valuable and useful in the electrical industry, because just as a tuning fork is used, for instance, to set the pitch of notes on the piano for example, so these little crystals, when they got to vibrating, acted like a tuning fork. They would vibrate at one frequency, but not at any other."¹

For the next few years, Cady followed up his work. "In the course of time I found that not only would one of these crystals respond when you excited it electrically, but that there was a way of connecting it into an electric circuit, a radio circuit to be specific, such that the circuit itself became controlled by the quartz. The quartz acted like sort of a little governor and controlled exactly the frequency of the circuit."¹

It was in 1921 that Cady and his associates at Wesleyan University made the first piezoelectric crystal resonator. The idea was Cady's, but it was subsequently developed by others, especially Pierce. Speaking in 1964, Cady could proudly say that the idea "is now universally used in radio everywhere."

Pierce oscillator

George Washington Pierce was greatly impressed by Cady's work and he began to study the design of electronic circuits which could use the controlling influence of the vibrating crystals. In 1923 he introduced three circuit configurations, each using only one valve and one set of contacts to the crystal. In Cady's earliest circuit a three-stage amplifier had been used with two sets of contacts to the crystal.³ J. M. Miller produced a widely used variation in 1925. The Pierce oscillator was patented and subsequently vigorously defended.

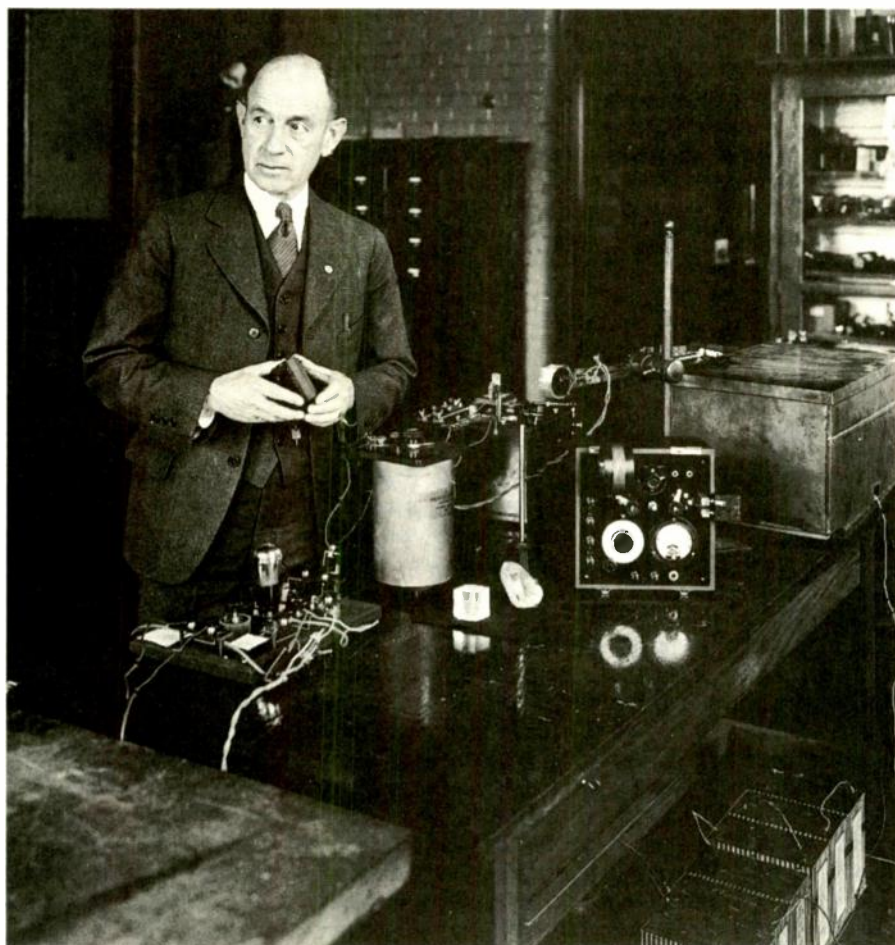

W.G. Cady, Wesleyan University Archives.

By the time America entered World War I, Pierce had already established his reputation as an applied physicist working in the new field we know as electronics. He had published his first book, "Principles of Wireless Telegraphy" in 1910 and in 1914 he became the first Director of Harvard University's Croft Laboratory. So it is no surprise that he too was one of America's scientists pulled in during 1917-18 to examine the problems of detecting enemy submarines. Like Cady he spent some of his time at the US naval base at New London and, presumably, the two men met. In 1920 he put his wartime learning to good use by publishing a widely-used book "Electric Oscillations and Electric Waves," and he offered the first university course on the use of sound for underwater signalling. It was supported by the US Navy.

Texan 'cowboy'

Pierce was born on January 11, 1872 near Austin, Texas, the son of G.W. Pierce Sen. and Mary Gill Pierce. He was the middle of three brothers. His

father was a farmer and cattleman, what we might romantically – and probably inaccurately – call a cowboy. The association with cattle was to have an unexpected influence on Pierce's academic career.

After attending rural schools Pierce entered the University of Texas in 1890 and graduated with a BSc in 1893. By that time he had enjoyed seeing his work in print for the first time, a joint publication with his professor. The following year he obtained a master's degree and then taught in secondary schools and took odd jobs to increase his income. Physicists were not in great demand. One of his jobs, as clerk of a Texas court, gave him a feel for legal matters which was to prove useful.

In 1897 Pierce set off for Harvard University. Years later, with a reputation for an "inexhaustible supply of salty anecdotes," he loved to tell the tale of how he came to go there. Having meagre funds, he worked his way on a cattle train to the railway junction at St Louis, en route for the University of Chicago. At St Louis, the only train for Chicago in the next few days was a sheep train, whereas a cattle train was about to leave for the East Coast. For a cattle man there was no

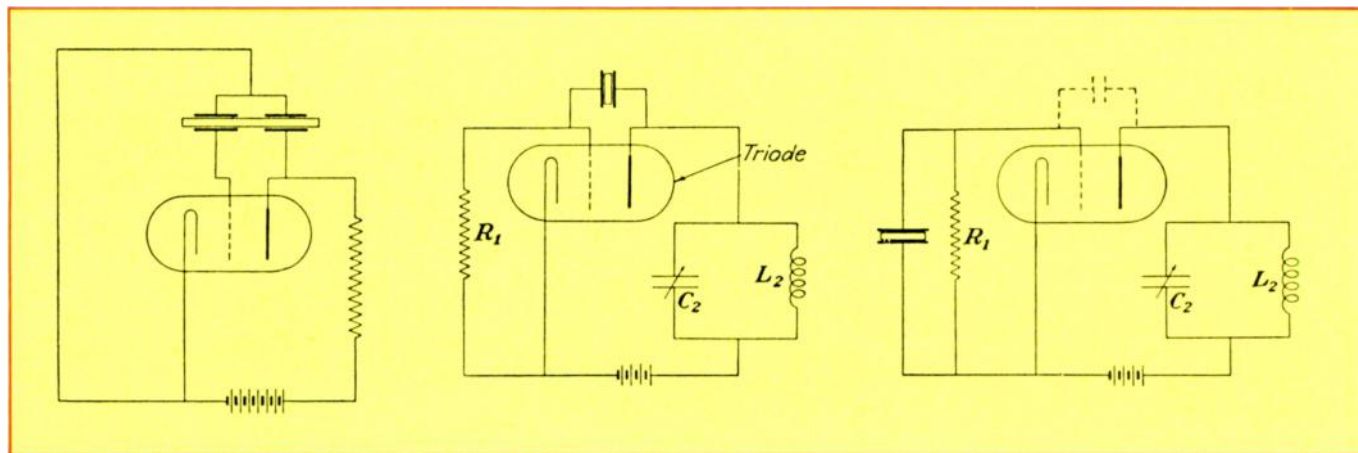

Fig.1. Early piezoelectric crystal oscillators.

(a) Single valve modification of Cady's circuit (1921/22) using neither coil nor capacitor. The original X-cut quartz crystal (0.15 x 3.9 x 0.7cm) had a fundamental frequency of about 70kHz but, with two pairs of electrodes, the circuit could oscillate at about 140kHz.

(b) Pierce circuit (1924).

(c) Pierce-Miller circuit (1925).

choice to make; Chicago's loss was Harvard's gain. His career there was to be spectacular.

After gaining his PhD in 1900, he spent a year at the University of Leipzig before returning to give Harvard the next 39 years of his life. He rose through the academic ranks from assistant in the Physics Department to full professorship in 1917. In that time, he introduced new courses in electrical theory and brought Harvard to the leading edge of electrical communications research. In 1914, as we have seen, he became the first Director of the new Cruft Laboratory, a post he held for 26 years. He was appointed as the Rumford Professor of Physics in 1921 and the Gordon McKay Professor of Physics and Communication Engineering in 1935. He retired in 1940. After his retirement he continued his love for ultrasound by studying the sounds made by bats and insects, something he had become interested in earlier. At 76 he published his third book: "The Songs of Insects."

Pierce has given his name to one version of the piezoelectric crystal oscillator, but he is also well known for his 1928 magnetostriction oscillator. Other areas of his work included the study of crystal rectifiers (1907), the measurement of the electrical characteristics of telephone receivers and the idea of motional impedance (with A.E. Kennelly, 1912). He also covered a range of work in radio, resonant circuits and electroacoustics.

He was a man known for his droll humour and was well liked by his students. His hobbies included painting, fishing and writing poetry. He married twice, first in 1904 to Florence Goodwin. They had no children and when she died in 1945 "G.W." was left alone with no close relatives. The following year he married Helen Russell, a friend of the family.

Like most noted pioneers, Pierce

received many honours from professional institutions and the like, and was President of the Institute of Radio Engineers (now the IEEE). Unlike many other pioneers he also became wealthy from his patents and was pleased to be able to help young students who were short of funds, as he had once been. He died at Franklin, New Hampshire, on the 25th August 1956, aged 84.

Cady

Cady too received his share of honours, including a Prize from the Institute of Radio Engineers in the USA and the Duddell Medal from the Physical Society in London. He was born in Providence, Rhode Island, on December 10, 1874 and received his bachelor's and master's degrees from Brown's University and his PhD from Berlin University in 1900. He was in Germany at about the same time as Pierce, who was two years older than he. Whilst in Berlin, Cady met a young lady: Kathrin Olive Miller. They married in 1903 but she died only six years later. Their only son died in 1952.

On returning from Berlin, and after a couple of years in the US Coast and Geodetic Survey, Cady joined Wesleyan University in Connecticut in 1902 and became a full professor in 1907. As Pierce stayed at Harvard, so Cady stayed at Wesleyan until he retired from teaching in 1946, at the age of 72.

to become Professor Emeritus.

Cady and Pierce had many similarities. They were born within two years of each other, attended their local university, did postgraduate work in Germany, became university professors, worked on submarine detection in World War One, studied piezoelectricity and crystal oscillators – and late in life became interested in birds: Cady studied their song and Pierce their migratory patterns.

After retiring from teaching, Cady continued his research work at Wesleyan under contract from the US Navy until 1950. In 1951 he moved to California, but was still very active as a consultant and as a research associate at the California Institute of Technology until 1955 – good going for someone in his eighth decade. Even then he was not finished, for he returned to Providence (to live in the house where he was born), re-established links with physicists at Brown's University and continued to do his own work.

Holder of over 50 patents, he was granted one for an accelerometer in 1973 when he was 93 years old. David Rines, his attorney, who had represented him since the 1920s was a mere 89 years old. And they say you are too old at 40!

As Cady's 100th birthday approached, Brown's University made plans to celebrate and honour him. A reception was arranged and press and photographers notified, but it wasn't to be. Walter Cady died one day before his 100th birthday.

References

1. W.G. Cady, "Recollections of Physics at Wesleyan." Address at Wesleyan University, May 19, 1964.
2. W.G. Cady, "Piezoelectricity", McGraw-Hill, 1946, and Dover 1964.
3. George Washington Pierce, Obit., Harvard University Gazette, January 26, 1957.
4. Dictionary of Scientific Biography, Vol X, Scribner's, NY.

A two year guarantee on all our second-hand Test and Measurement equipment!

To give you the confidence that you really did save money by buying second-hand, we are the only company to offer you the protection of a two year parts and labour guarantee on all the Test and Measurement equipment we supply.

Dealing in equipment from the leading manufacturers such as Hewlett Packard, Tektronix, Marconi, Philips, Gould, etc., we can offer you the best in test. Call us now for more information.



0800 521231

International Callers No. 44 344 869 226

Capella-Technos, Park House, The Pavilions, Downmill Road, Bracknell, Berkshire, RG12 1QS. Fax 0344 869230

11A

CIRCLE NO. 136 ON REPLY CARD

Field Electric Ltd. Tel: 081-953 6009. 3 Shenley Road, Borehamwood, Herts. WD6 1AA. Fax: 081-207 6375, 0836 640328

SPECIAL OFFERS

Philips CM7000 monitor. Composite video input: RGB (mono) + audio 240vac 12" green screen new & boxed £85.00 c/p 8.75
Micropolis hard disk drive full height including PSU & Rack slides. 5 1/4" model 1325br. ST 506 51MB MFM. £200.00 c/p 9.00
9" Nec monitor, 240 vac input, composite video input, £29.95 c/p 6.80
19" colour monitor, 240 Vac input, R.G.B. composite video input, ex-equipment tested with no screen burns, case size 18 1/2 x 17 1/2 x 17 1/4, £150.00 c/p please ring
Teac 1/2 height floppy disk drive FD 55 FV 96 TPI 500/1000 kbytes 80 track 300 rpm SA400 interface new. £49.95 c/p 4.50
Teac FO 55 GFR Multi Format Drive BBC Micro IBM/AT or compatible ex-equipment no guarantee £24.00 inc c/p
Tandon (Winchester) hard disk drive 1/2 height TM 252 10 Mb new ex-equipment, £57.50 c/p 6.50
360K 1/2 height Floppy Disk Drives IBM compatible ex-equipment. No guarantee £16.50 inc c/p.
Plantronics acoustics communications headsets new & boxed (Auralite) type headset, model star set II complete with ear tips instructions etc. £50.00 c/p 3.50 qty. discounts
Sola Mini Ups + Inverter and Line Conditioner. Sinusoidal output wave shape. 600VA 240VAC £250 + VAT c/p details please ring.
Torin TA450 5 V.D.C. Fans 120x120x40 £5.75
Torin TA450 12 V.D.C. Fans 120x120x40 £5.75
Torin TA450 24 V.D.C. Fans 120x120x40 £5.75
All Fans New c/p 1.50 qty. discount
PC, XT, AT Type Cards
Super EGA, KP900 or 4850 chip No.s Genoa GN006002-B. GN006001-A. TMS 27PC128. V53C464P80LX8. £22.
B475. PEGA1A. TC21SC160AT. 27C128-2JL. M41464-12X8 £22.
Graphmaster plus. Gemini TAS8746 KM41464AP-12x8. M27256-2E1 £22.
Hega/printer. KM41464AP-12x8 UA89C002x2. UA89C001. UA89C000. UA89C003. M27256-2F1.
Twinhead 8190G10x2. £32.
VGA. No.1 Video seven CL-GD410-40PC-BD CL-GD420-40PC-BC. KM41464AJ-15x8 IMSC176P-40 £32.
No.2 IMSG171S/50. ET3000AF (11051AG-0015) MB81464-10x8. M27256ZB. £32.
No.3 TRGC1710-66XXA. MMC27C256Q MMC 27CP128Q. VIDEO SEVEN 4560023. D41464-12x8 £32.
Disk controller's. No.1 16bit. WD11C00C-JU WD16C92A-PL. WD2010B-PL. WD10C20B-PH WD1015-PL37A-02-M. D765AC. GM76C28-10 £10.
No.2 16bit disk adpt. CXK5816PN-10Lx2 WD1010A-PL. C35024AE. C1C8236E. Z0765A08PSC. PAL20LBACNS. PAL16R6ANC £10.
8 bit No.1. UM8272A. HY27C64D-15. DM74LS245N. SN74LS191N. HD74LS04P. PAL16RANG £5.
No.2. WD11C00-JT. WD2010B-PL. WD1015A-PL WD10C20B-PH. WDC62-000128-000. HY 6116AP-10 £6.
H1-RES=Graphics No.1. L1A2099. HY27C64D-15 MB81464-12x2. UM6845B. PAL16LBANC. PAL20LBANC. PAL16LBANC. Switchable colour mono £10.
No.2 23C07 SIS. SIS82CII. SN74LS44N. Yamaha V6363. Light pen opp. £8.
Comms cards. No.1. CXK5816PN-15L. UM2301. C1C 86458E. HYB4164x8. £10.
No.2 C1C86458E. UM2300. CF58206FT. MSM4416P-15x2 £8.
We cannot list complete No.s of chips per card. Some info on cards. Manufacturers surplus stock. C/P per card £1.00
Please send SAE for complete list. Please ring for EGA/VGA/Network Cards - too many to list.
Test & measurement/audio/communications/computer equipment always in stock, power supplies transformers plugs/sockets & connectors, components fans panel meters cables etc.

We would like the opportunity to tender for surplus equipment

Official orders credit card telephone orders accepted with Access, Amex, Diners, Visa cards. Overseas enquiries welcome c/p rates U.K. mainland only. Please ring for c/p rates not shown.

All prices inc. V.A.T. unless stated. Stock list available.



CIRCLE NO. 137 ON REPLY CARD

EMC TESTING

Ready for 1992?

- NAMAS accredited
- FCC listed
- BS 5750 Pt 1 approval
- AQAP 1 & 13
- 3, 10 and 30 metre ranges
- Open-field, all-weather site
- Totally independent
- Remedial laboratory
- EMC design consultancy
- Guidance through regulations

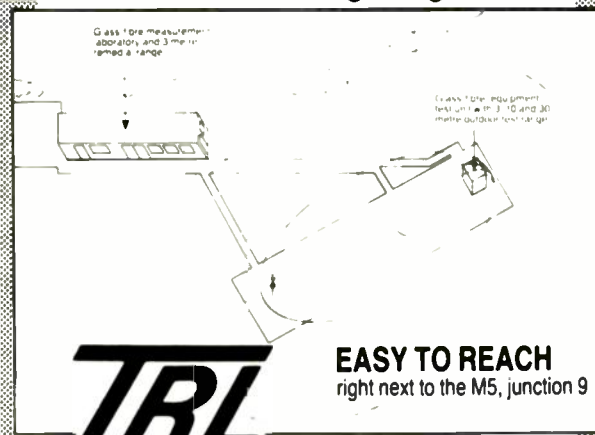

TRL

EASY TO REACH
right next to the M5, junction 9

TRL Technology Ltd EMC/RFI Division

Alexandra Way, Ashchurch, Tewkesbury,

Gloucestershire GL20 8NB

Telephone (0684) 850438

Fax (0684) 850406 Telex 437444

CIRCLE NO. 138 ON REPLY CARD

Why small firms must plan for EMC

The forthcoming EC Directive on electromagnetic compatibility (EMC) has serious implications for manufacturers of electrical and electronic equipment. On the one hand it offers an expanded market where unified standards will allow easier movement of products across borders.

But it could also mean expensive redesign of current equipment to meet the new standards, and planning ahead for EMC design of new products.

In the US, where EMC legislation based on similar principles to the European Directive is already in operation, one of the major causes of recent computer products missing their scheduled launch dates has been EMC problems.

Here in Europe manufacturers are in the awkward position of having no finalised standards to work to, yet having to produce goods now which can be sold on the market after the Directive comes into force. For large companies, a failure to provide adequately for EMC may be very costly; for small companies it could be fatal.

The scope of the Directive (number 89/336/EEC) includes all electrical and electronic equipment, systems and installations (with a few specific exceptions, such as amateur radio set-ups) and deals with both electromagnetic emissions from equipment and immunity to incoming signals. It applies to all equipment sold or installed after January 1 1992, including products already in existence.

As a result, all electronics manufacturers should currently be preparing – if they have not already done so – an EMC plan, particularly smaller companies having fewer resources and less margin for error.

Unfortunately the temptation is to do nothing until the standards are finalised then face having to undertake urgent product redesign. Even if the modification costs themselves are not prohibitive there will be little chance of quick testing of products.

A better approach is for manufacturers to look at products now and identify

Unprecedented access to new markets; or an unbearable burden for small companies? Early planning for the 1992 European EMC Directive could make all the difference.

those which will need to comply. Resources should be allocated for the EMC plan and costs should be estimated for design and redesign, extra components, prototype and production testing, and for progressing the paperwork to achieve compliance.

After the costing procedure, it may even become apparent that some products should be scrapped, because achieving EMC compliance will be too expensive.

For small companies, much expertise will have to be bought in, as setting up an EMC design and test facility is expensive. But because the number of existing EMC consultancies and test laboratories is unlikely to meet demand, becoming fully booked long before 1992, it may be wise to sort one out well in advance.

Design for EMC

It is almost always cheaper to build in EMC early in the design phase than to modify a finished design. EMC should be considered from the outset, as it is governed as much by the physical parameters of the equipment as by the actual circuit configurations.

Given that most products under development will still be on sale after

1992, and the shortage of EMC standards, it is vital for companies to plan ahead and produce an EMC strategy.

For example tests can be devised built around existing standards (eg the IEC 801 series) giving a good idea of a product's relative EMC performance. The information obtained should also give a manufacturer a good idea how much additional design work will be needed before products will comply with the likely standards.

Companies not EMC testing their products at the moment, are likely to face severe problems in two or three years time.

When looking at the design for a new product, time and resources must be allocated for analysis, prototyping, testing and modification for EMC, before the final prototype stage. In particular, EMC should be considered before the equipment casing, interface types and board layouts are defined. But EMC design must also take account of the product as a whole, not just as a sum of parts.

If a product fails EMC requirements, only when it has been tested thoroughly to assess how bad the problem is, is it possible to decide whether to opt for "add-on" EMC (by modifying the case, screening cables, etc) or whether complete redesign is needed. In the long term, the add-on approach is usually the more expensive.

Where a project has reached production without adequate consideration, it may be necessary to retrofit EMC into an established product. Even under these circumstances, it is worth studying manufacturing costs in detail before deciding. While it is quicker to go to the extremities of equipment and make modifications, in the long term this approach often proves more costly. Going back to the root of the problem can take longer but, in the end, may prove less expensive.

Standards of compliance

No hard and fast regulations to ensure compliance are contained in the Directive. Instead it makes general statements regarding acceptable levels of

emissions and adequate levels of immunity.

Clearly these are insufficiently precise to be a basis for designing and testing equipment, and so a series of harmonised European standards is being created. Compliance with the Directive can be demonstrated either by manufacturing to the relevant standards or by production of a "technical construction file" which must include a technical report or certificate from a "competent body". The technical file route becomes applicable principally where there are no relevant standards, but can also be used where the manufacturer chooses not to apply the European standards.

In practice, the onus is on manufacturers to ensure their products comply with the Directive. For example, if two products differ only minimally (such as a computer fitted with either a 20Mbyte or 40Mbyte hard disk) then it is for the manufacturer to decide whether or not the variants need to be tested separately.

Similarly, component parts are unlikely to require separate testing. PC cards, for instance, need not be tested with each and every PC to which they can be connected, but only as part of a typical system.

The harmonised standards are being produced by Cenelec, with a mandate from the European Commission. Work is proceeding rapidly, concentrated in two areas; production of a series of generic standards covering all types of equipment, and a series of separate product-oriented standards. Foremost among the latter will be the standards for information technology equipment (ITE).

For emissions, a number of European standards already exist, based on the equivalent Cispr publications.

Harmonised European standards will generally have the prefix EN (for European Norm), and will be translated by member states into equivalent (and theoretically identical) national standards. While these documents give a good idea of the likely requirements of the Directive, they are likely to change significantly over the coming months.

The situation for immunity is far less clear, and for most products (including ITE) there are no standards. While Cenelec is making rapid progress, most standards are unlikely to be available until late 1991, leaving little time to test, redesign or modify products to ensure they comply. This will be particularly true for telecommunications equipment as it will have to be tested



Equipment and test methods must comply with the relevant test standards.

by a notified body

Expensive testing

Having chosen the relevant technical standards, the next stage is to test equipment to ensure it complies. Once compliance has been established, a manufacturer can then certify it and, providing it complies with other relevant European Directives, label it with the CE mark.

For telecommunications equipment, the situation is complicated by the requirement that equipment must be type-approved by a notified body. The DTI has indicated that it will be looking to Namas (the National Measurement Accreditation Service) to provide assessment of competence of both "competent" and "notified" bodies.

Provided a manufacturer can show its in-house laboratory has sufficient independence, there would seem to be no reason why it cannot be accredited, and there are many advantages to doing this. But to perform the tests accurately and in full, requires significant capital investment. As an example, to cover just emissions tests, expenditure would include a calibrated open-area test site of appropriate size; test receivers covering at least the range 9kHz to 1GHz; antennae and other transducers, and ideally a screened room in which to perform the tests.

For all but the largest companies the cost is likely to be prohibitive, especially when the running costs (such as additional staff and training) are considered.

The Directive also applies to impor-

ters and distributors of foreign-built equipment in that it is the responsibility of whoever puts a product on the UK or European market to ensure compliance. However, costs may be lessened, or even eliminated, if products are brought in from a country which operates a similar EMC testing system.

The alternative to setting up an in-house facility is to contract out work. One advantage is that staff at independent test laboratories, because of the volumes handled, should have a more detailed knowledge of specifications and their implications, as well as the relevant test methods and procedures.

Inevitably, manufacturers will have problems getting some of their equipment to comply with the regulations. It is here that an independent test facility can perform a second role – advising on practical aspects of EMC design, and diagnosing sources of EMC problems and identifying solutions.

If manufacturers are to have confidence in their products, tests must be performed according to the method stated in the specification. But much diagnosis and solution of known problems may not require a full test facility, and medium-sized companies should be able to establish some form of EMC test bench at relatively low cost.

A major advantage of this approach is early appreciation of the EMC problem before too many design parameters have been fixed.

Easier exporting

The most important benefit of the new

LEGISLATION

regulations to manufacturers will be access to a unified market. If equipment complies with the EMC regulations in one EC country, it will by definition be legal in all the others, eliminating expensive redesigns on products to gain access to certain markets. In addition, as the approvals process is one of self-certification, equipment only needs to be tested against one requirement, eliminating time-consuming multiple applications and trips to type-approval laboratories.

Products complying with the European specifications will almost certainly comply with most civilian EMC specifications worldwide and may also be suitable for non-critical military applications.

But self-certification can put an increased burden on manufacturers as not only must prototype units comply with regulations, but units in volume production must continue to comply. However, makers of one-off or special items or systems may not need to demonstrate compliance with the Directive. If their products are made to special order, and not put on the open

market, then the Directive does not apply.

Manufacturers whose products comply with current regulations (eg VDE specifications in Germany) should not have too many problems dealing with the emissions requirements, although it should be noted that some of the proposed limits for radiated emissions (eg EN 55022 for information technology equipment) are quite tough, particularly between 30 and 230MHz. Where products do not currently comply, new products will almost inevitably suffer increased design, manufacturing and testing costs and existing products will probably have to be redesigned.

The new regulations will pose considerable technical challenges for all manufacturers though for those already considering EMC in their designs the challenges should be greatly reduced.

However, for all but the smallest companies, benefits from access to the wider European market should greatly outweigh the problems. As a result manufacturers aware of the regulations stand to prosper; those who ignore may find it impossible to survive. ■

The complete text of the Directive has been published in the official journal of the European Communities (No L139 of 23.05.89, pp 19-26). Copies are available from Caroline Beech, Alan Armstrong Ltd, 2 Arkwright Road, Reading, Berks. RG2 0SQ. Tel: 0734 751771.

The DTI has booklets available, and also operates a mailing list. Contact Laurence Green, Radiocommunications Agency, Dept. of Trade and Industry, RM 106, Waterloo Bridge House, Waterloo Road, London SE1 8UA. Tel: 071 215 2162.

The BSI contact for EMC matters is J Childs, British Standards Institution, 2 Park Street, London W1A 2BS.

A videotape on the subject (running time 10 minutes) is available on free loan from Oxley Developments Co Ltd, Priory Park, Ulverston, Cumbria LA12 9QG. Tel: 0229 52621.

Antennae and accessories for testing are sold by Chase EMC Ltd, St Leonard's House, St Leonard's Road, Mortlake, London SW14 7LY. Tel: 081 878 7447.

Testing will be carried out by Radio Frequency Investigation Ltd, Ewhurst Park, Ramsdell, Basingstoke, Hants RG26 5RQ. Tel: 0256 851192.

BUILD YOUR OWN FILM-NET DECODER

CITY SATELLITE SYSTEMS LTD & MONTIQUE CONSUMER ELECTRONICS UK LTD OFFERS YOU THE OPPORTUNITY TO BUILD YOUR OWN HQ MONTIQUE DA100 SIGNAL ANALYSER FOR ASTRA SATELLITE TRANSPONDER No. 11.

THIS EXCITING PROJECT INCLUDES:

- ★ FILM-NET MAIN DECODER P.C.B.
- ★ VIDEO PROCESSING VIDEO P.C.B.
- ★ PARTS LIST
- ★ WORKING THEORY AND DETAILED TEST PROCEDURE
- ★ HQ P.C.B. THROUGH PLATED, SOLDER RESIST, DOUBLE SIDED, COMP IDENT
- ★ DIMENSIONS MAIN P.C.B. 250mm×125mm, VIDEO P.C.B. 110mm×125mm

ONLY £34.99 + P&P POWER SUPPLY EXTRA £7.99, 12V 1 AMP REGULATED. CONTACT CITY SATELLITE SYSTEMS LTD ON 081-503 5326 OR SEND CHEQUES TO 272 BARKING ROAD, EAST HAM, LONDON E6 1LB. ACCESS, VISA, AMEX AND SHOP CALLERS WELCOME.

No. 1 IN SATELLITE TV.



CITY SATELLITE SYSTEMS LTD

081-503 5326

272 Barking Road, East Ham, London E6 1LB

CIRCLE NO. 139 ON REPLY CARD

As a senior R & D engineer with a large company developing image processing systems for archiving paper documents I was involved in locating a development system which would offer high speed access and considerable in-built I/O. Other needs were a good prototyping base, which was easy to use, and access to a 32-bit risc (Reduced Instruction Set Computer) bus. It was these requirements which led to Acorn Computers' Archimedes and R140 machines.

The Archimedes is based on the Arm (Acorn's risc machine) VL86C010 risc chip supported by the related chip set, VIDC, MEMC, and IOC. With ram, rom, a screen and a keyboard this essentially composes the machine.

The Arm chip in itself is a powerful microprocessor which can be easily built into a self-contained single card micro. Acorn's Springboard is a PC card with an Arm chip, either 1Mbyte or 4Mbyte of ram and a 32-bit podule bus. The result is a simple and cheap multiprocessor system on a PC base, with some basic software and an extensive hardware interfacing manual.

We used Springboard as a high speed data acquisition card to capture 8-bit streaming data, without burdening the host PC, convert it to 32 bits to be read by the Arm support chips and then placed in the Springboard's ram.

Data was processed and re-directed to another peripheral card or to the host PC. A small piece of machine code, written by our software department, extracted data from the Springboard's ram and put it into the PC ram for transfer to disc or further analysis.

Acorn also produces the R140, a more professional system, which is an Archimedes with an implementation of Berkeley 4.3 Unix designed to work with the Arm processor. The plug-in peripheral expansion card (Acorn call this the "podule") bus on the R140 is the same as on the Archimedes and so podules are exchangeable. We used it

Arch rival to PC-based R&D

Every development lab needs an Archimedes, says David Reid, to reduce time – and costs.

Model range

There is a number of different models in the Archimedes range, suitable for R & D.

The A3000 is a cut-down Archimedes, but still suitable for development. Its podule expansion connector is external to the system box and the 32-bit databus is not available. It comes with a Mbyte of ram and a floppy disc drive for under £700.00.

The 410/1 is a 1Mbyte version of the 440, but includes the new Memc running 10% faster than the original. (An upgrade kit from Acorn will fit this chip to a 440.)

The 440 is the Archimedes flagship with 4Mbyte of ram, a 20Mbyte hard disc and a four-slot podule expansion.

Acorn's own Econet interface can be fitted to the machines, and systems can be linked together to form an Archimedes network. More systems can be added as the need arises. The cost of an Econet board is only a fraction of the cost of a similar product for the PC.

and its Risc-iX operating system to develop software written in C and hardware for a Sun workstation system to run under Sun-OS.

The R140 also has an Ethernet board and a SCSI card, both of which are supported by the Risc-iX operating system.

Development software

For a development system, Archimedes offers quite a few options when it comes to software. The operating system is Risc-OS multi-tasking windows, controlled from a desktop-type environment, containing many routines for controlling programs running in the desktop and through the podules installed.

BBC Basic version 5 is included and there is also a built in assembler which I have used to write hardware test programs.

The machine is easy to program and a few hours spent with a good Arm book^{1,2} helps with familiarisation. Proficient programmers can make use of Ansi-C, Pascal and Modula-2 packages, all of which have been around for over a year and cost a fraction of the price of similar dos packages.

PC users who are sceptical about changing because of loss of a favourite database, can spend £90 on Acorn's PC emulator which will run from Risc-OS and give a 5.2MHz PC running MS-Dos.

The number of development languages is growing every day as more companies take advantage of the 32-bit risc architecture, expanding the

Archimedes into a rapid development system. There is even said to be an emulator for the Apple Mac, though I have not seen it.

From my own experience of development on the Archimedes for just over two years, with the variety of signals available at the 96-way Din41612 connector and the standard Eurocard podules, the time required for development and testing of prototypes can be significantly reduced.

Development tools

Many companies specialise in development tools for the Archimedes, with such products as a transputer development kit and software providing a front end to the development system based on the Inmos transputer and programmable in Occam.

A simple podule development card called the Apec (Archimedes Prototype Expansion Card) provides all the Archimedes decoding and some firmware to enable quick building and testing of circuits. The card, costing about £35, has a buffered data bus, four separate read lines, four separate write lines, some latching and control signals.

In prototyping it is re-usable simply by fitting a row of pins to the Apec board and a socket to the prototype board.

Another optional plug-in board allows the new Arm 3 chip to be fitted

to an Archimedes, replacing the existing Arm 2 chip and increasing the processing power to nearly 12Mips for about £600. Arm 3 is fully compatible with Arm 2 so no software changes are required to make existing code run with the new board. There is also a podule to increase ram capacity to 8Mbyte.

Overall, cards for the development environment range from high resolution video digitisers for medical applications to low cost video digitisers.

As far as data acquisition is concerned, the Archimedes is well supported with very fast 12-bit 8-channel A-to-D podules; high speed links between two machines for passing data between Archimedes or between an Archimedes and a PC; IEEE cards for running scientific test equipment; flat-bed 24-bit colour scanners; postscript turbo laser boards; SCSI driver boards; video overlay and gen-lock boards.

Graphics tablets and cad/cae software are also available and a particularly useful package is a PCB layout program which can auto-route up to eight layer boards and produce camera ready artwork output from a plotter, dot matrix or laser printer.

Verospeed and Radio Spares do a wire-wrap Eurocard with a 41612 connector fitted, for plugging into any of the four Archimedes podule expansion ports. Fitted with a few buffer chips

Latest machines

At the Unix Users Show 90 in London, Acorn announced the R260 machine, having an Arm 3 microprocessor, a 100Mbyte hard disc drive and eight or 16Mbyte of ram on board. The target for this machine is health-care, image processing, research and development and universities/polytechnics.

There is also a cut-down version, called the R225, which only has 4Mbyte of ram (expandable to 8Mbyte) and no hard drive. This is intended as a workstation terminal on a network or as a development base for specialist applications.

this will allow access to all the bus signals.

The podule bus has two main clock frequencies on board, an 8MHz reference clock and a 2MHz clock. The Arm clock signal runs at approx. 8MHz but can not be relied upon as the processor sometimes slows this down.

One of the podule slots on the four-port backplane is configured for a co-processor with access to the Arm data lines (D0-D32) directly through row B of the Din41612 connector, as well as the necessary control signals to detect the co-processor and its data control lines. (These appear on the reserved pins of row C Fig. 3.)

Rapid conclusion

The speed of I/O on the Archimedes means it can be used to simulate, through software, some of the more

Archimedes chip set

The Arm 86C010 32-bit microprocessor with a full 32-bit data-bus and a 26-bit address-bus gives a uniform 64Mbyte of address space, and is pipelined. Its instruction set consists of 44 basic instructions, each having a condition code causing the processor to skip the instruction if the condition is not met – highly desirable when multiple test-and-compares are required.

The Arm has 27 32-bit registers, some of which overlap giving instant retention of key registers for context switching and servicing of interrupts.

Of the four distinct modes available, the most important to developers is "supervisor" allowing access to the memory mapped plug-in peripheral expansion card (podule). Next most useful are the interrupt modes; normal and fast. When an interrupt is serviced the machine changes into the appropriate mode, switching the shadow registers if necessary.

User mode allows use of the desktop and programs from within the operating system.

Memory controller Memc interfaces the Arm to slow dynamic rams, Vidc and the

IOC chip. Version 1 of the Memc controller can access 4Mbyte of ram. In effect the Memc chip can be thought of as a physical-to-logical address translator providing a three level protection system. This allows efficient virtual memory, necessary to obtain a multi-tasking environment without all the associated hardware required by most other processors.

It has some DMA in order to keep Vidc refreshed with screen data, and keyboard and sound systems updated without having to rely on the Arm for constant information.

Memc also has a memory mapped allocation within the podule area (Fig. 3) for fast transfers between the podule I/O and ram in the Archimedes. 32-bit word aligned data transfer can take place.

Vidc can generate video at a large number of different resolutions and depth of colour bits. It can produce 1280 X 960pixels in monochrome, and colour displays of 640 X 512pixels of 4bits/pixel. Vidc also contains a colour mapping palette with 4096 different hues.

IOC provides peripheral support and

handles interrupt control signals which have flexible and easy-to-program timing parameters. Four independent 16-bit programmable counters are configured as two timers and two baud-rate generators (for RS-423 and the keyboard comms). IOC ensures interrupt latency is low, well under 1µs, even when running at only 8MHz.

The plug-in peripheral expansion card bus timing is controlled by IOC and has four different access speeds; slow, medium, fast and sync. Control signals – some bi-directional – allow access to many different types of peripherals. IOC controls these different speeds by stretching the access timing of the bus-latch signal, thus slowing all transfers through the I/O area.

Speed is determined by which I/O memory address is accessed, so that, for example, when testing a circuit to see how fast it could go before falling over, all that is required is to change the plug-in peripheral expansion card base address and run the test program again.

More information and full specification of the Arm chip-set, is available from VLSI Technology.*

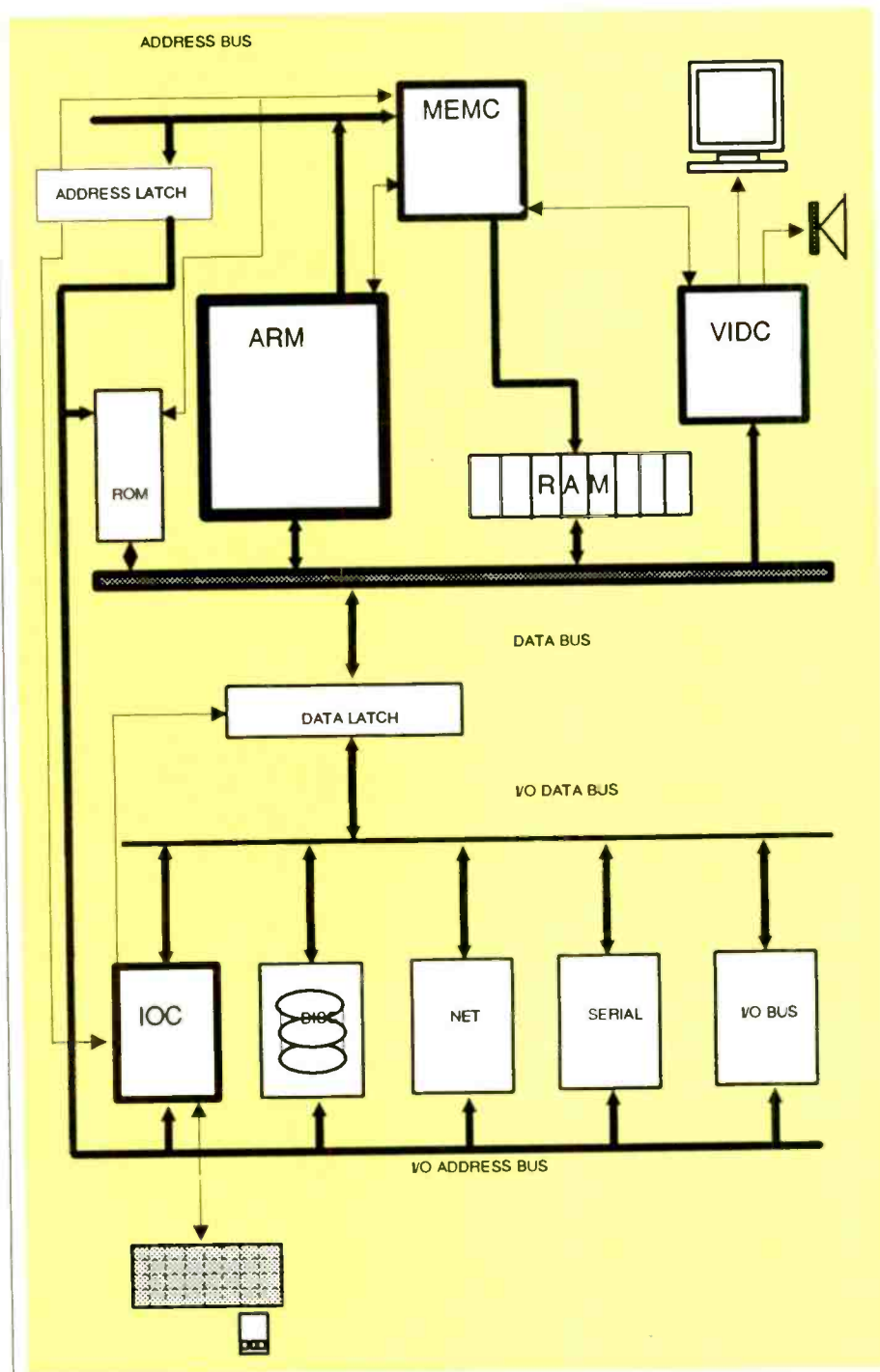

Archimedes block diagram

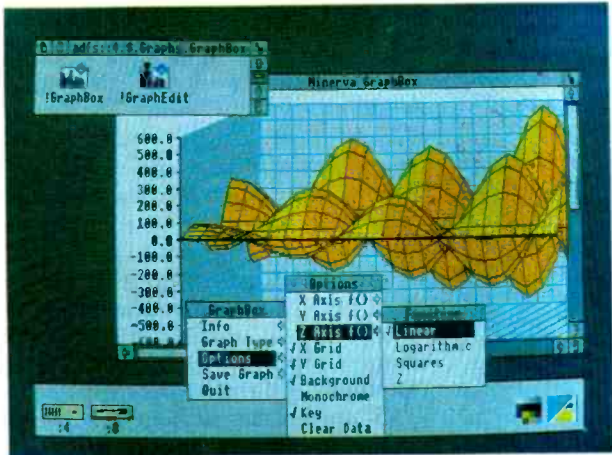

Risc-OS is the Archimedes multi-tasking operating system shown here running Graphbox



Acorn's R260 - with Arm 3 risc processor, 100Mbyte disc drive and up to 16Mbyte ram.

complicated hardware bus configurations, storing and analysing results while testing the card in question.

For instance, while debugging a card built for PC AT architecture it was possible to control all the bus signals, isolating the problem by simply running a test pattern at the bus and then analysing the results in real time. Simple alteration of the board timing chips, and a few more tests, produced a solution in about an hour instead of the probable half a day without the Archimedes.

Its quickness means research and development departments can get new products out much faster, and integrate new peripherals into existing systems quickly and painlessly (almost...).

Initially, when we proposed the acquisition of an Archimedes for the R & D lab, we had to convince management that it would speed development and was really essential to keep up with competitors.

But the Arm has certainly proved itself and the company now uses eight or nine Archimedes and one R140 Unix-based system, for development.

My belief is that with the Archimedes firmly bolted to my development bench, I have been able to complete more projects in less time with fewer problems and at lower cost than I would otherwise have ever been able to do.

David A. Reid has now started a company providing peripheral hardware solutions for the Archimedes.

References

1. Archimedes Operating System. Alex and Nic Van Someren, Dabs Press, Dec 1988.
2. Arm Assembly Language Programming. Peter Cockerell, MTC. £12.95. (ISBN 0-9512579-0-0)
3. Technical notes on the VL86C010 Arm chipset. Acorn Computers Ltd, Cambridge Technopark, 645 Newmarket Road, Cambridge CB5 8PD.
4. VLSI Technology Inc. 486-488 Midsummer Blvd., Saxon Gate West, Central Milton Keynes MK9 2EQ. Tel: (0908 667595)

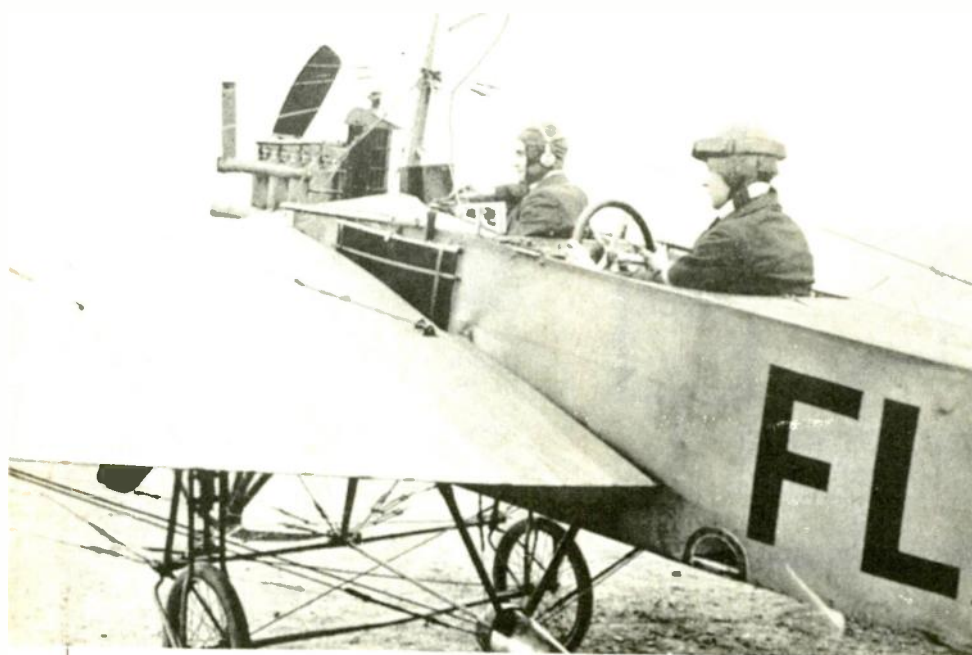

Flanders monoplane equipped for WT transmission in 1911. The four wires running above the fuselage from the mast behind the engine formed the antenna.

radio transmission in July 1912 with a routine Morse message beginning, "We are off the water, going ahead full speed..." rasping out from a spark transmitter aboard a Wright floatplane. The equipment weighed 40 lb and was powered from a 250W generator driven from the engine flywheel by a leather belt. The initial transmission was made over a distance of three miles, but ranges up to 15 miles were later achieved.

These first attempts mark the start of a long and difficult association between the emerging technologies of radio and aviation. It was not to be an easy association, for aircraft imposed such a tremendously hostile environment on the equipment, with the attendant

Loud and Clear

Fifty years ago, in the late summer of 1940, the Battle of Britain was being fought. Radar is recognised by historians as being a key factor in that conflict, but it is less well known that the battle also marks a significant point in the development of aircraft radio equipment. Such an anniversary is perhaps a fitting point from which to look back at what happened prior to 1940 and to see how aircraft radio had developed into what was state-of-the-art in 1940.

The first tentative steps were made from 1910 onwards, with both aircraft and radio still very much in their infancies. The first transmissions to and from an aircraft were made in the United States by McCurdy, from a Curtiss aeroplane on 12 August 1910, soon followed in England by Dorrington Bangay, from a Flanders monoplane, over Brooklands, in 1911.

But progress was not without setbacks, as many of the early experiments were carried out independently. For instance, the U.S. Navy, an early exponent of radio communication, achieved its first successful aircraft

J. A. D. McCurdy, who made the first transmissions to and from an aeroplane, a Curtiss, on 12 August 1910.

A Review of Aircraft Radio to 1940

A.J. Martin



vibration and electrical noise, plus the added penalty of weight restriction.

On 4 August 1914 Britain entered World War I with only one or two (out of some 60 aircraft fitted with wireless. The first artillery report from an aircraft equipped with wireless was sent on 22 September, in the opening months before trench warfare had set in. By 1915 wireless had completely taken over for the reporting of artillery fire from the air, with the early transmitters having limited ranges of about seven miles. A typical World War I reconnaissance aircraft would have carried a primitive CW transmitter only. Following take-off, the aircraft would circle the aerodrome, making a transmission, and await a visual signal from the ground to confirm the transmitter was working before departing on its mission.

Multi-stage receivers before 1917 invariably consisted of a series of wooden boxes, each housing a separate stage and the whole lot connected together by wiring between external terminals. Also, the early triode valves often became unstable when attempts were made to produce sensitive and selective receivers. A Professor Hazeltine developed the Neutrodyne circuit, which solved the problem by feeding back out-of-phase energy from the

anode circuit of a valve to neutralise unwanted oscillation. This, together with more compact construction, meant that useful aircraft receivers became practicable.

By the end of World War I, some progress had been made in the airborne radio's capability. A typical installation would be some 100 lb in weight, and use a wind-driven generator to drive a rotary spark gap transmitter. It would

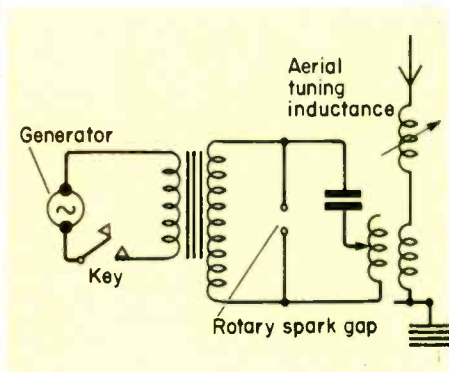

Circuit diagram of a typical spark transmitter.

work in the medium frequency band with a trailing aerial and have a valve receiver. Over the period of the war, valve life expectancy had increased from a figure of tens of hours to some thousand hours or more. Ranges achieved with such equipment were determined by the aerials used: 10 miles for one strung on the aircraft, 15 to 30 miles for a 50ft trailing wire, and 75 to 100 miles for a 400ft trailing wire. Range for one of the early valve telephony transmitters would have

been less than half that of a spark transmitter.

Reliable two-way radio telephony contact with aircraft was much more difficult to achieve. Although voice transmissions had been received in an aircraft as early as 1911, it was not until 1915 that Prince and Round, two engineers working at Brooklands for the Royal Flying Corps, achieved successful two-way contact. This was not immediately followed up and it was not until late 1917 that a squadron of Bristol Fighters equipped with radio telephony operated in France briefly before being withdrawn. In 1918 a Home Defence squadron for protecting London was likewise equipped (Fig. 4).

Although the techniques of shielding and plug suppression were understood, they were often ruled out because of their serious effects on weight and engine performance. Indeed, the problem of ignition noise was so bad that it led to the development of a separate technique for taking direction-finding bearings from aircraft. This technique, devised by Dr. James Robinson, involved the operator in adjusting for constant signal level, thus avoiding the difficulty of establishing a null against a background of ignition noise.

Many tests and trials took place during this period, both here and in the United States, where the U.S. Navy became particularly interested in aircraft radio development. For instance, on both sides of the Atlantic there was a search for a flying helmet which

The first public demonstration of air-to-ground wireless telephony, by 141 Squadron, Sutton's Farm, 1918.

incorporated microphone and ear-phones and could be worn for long periods without causing severe headache. One can well imagine that the testing of helmet designs was not a popular task. In the United States, B. F. Meissner conceived the idea of a microphone diaphragm which allowed speech vibration to act on one side only but was exposed to background noise on both sides, thus balancing it out.

British development work on military aircraft radio was carried out at the Wireless Testing Park at Biggin Hill, where a Royal Flying Corps officer, Hugh Dowding (later Air Chief Marshal Sir Hugh Dowding, of the R.A.F.), took an interest. His involvement thus spanned over 20 years. Research continued at Biggin Hill until 1922, when the engineers and scientists moved to Farnborough. After the war, both Round and Prince worked for the Marconi Company on civil aircraft radio development.

In the 1920s perhaps one of the most significant influences was the arrival of broadcasting, for without this it is probable that research into valves and components would have slowed down. In 1929 the invention of the screen grid valve led to tetrodes and pentodes becoming available, to be followed by the metallised valve, all of which helped to improve the stability of radio frequency amplifiers.

Until the 1930s aircraft radios worked in the medium frequency band, but in 1933 the Air Ministry, which had authorised testing of high frequency equipment since 1928, decided that fighter direction and control would use high-frequency radio telephony in con-



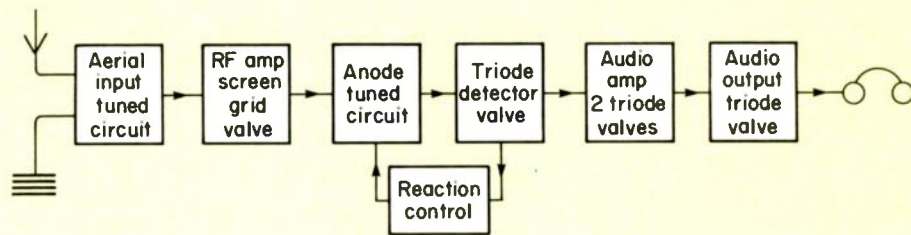

Block diagram of R1082 receiver.

junction with ground direction-finding stations. It was a far-sighted decision.

But not all RAF aircraft had been equipped with radio. In the inter-war years there were many biplanes in service in which CW radio was an optional fitting in the rear cockpit. These aircraft were called upon to undertake many tasks, often in remote areas of the Empire. The provision of radio equipment could then be quite comprehensive: a separate receiver and transmitter, a motor-generator for in-flight power, a winch for a trailing aerial, a stowed frame aerial and base in bags, a 30ft aerial mast stowed in sections, and an emergency hand-driven generator fixed in the rear fuselage, these latter items being for use if the aircraft was forced down through engine failure.

Often though, only one aircraft in a flight would be so equipped and, anyway, air-to-air signalling was usually visual. No doubt everyone has heard of the Aldis lamp, but how many know what "zogging" was? It was the pilots' term for transmitting Morse code by arm signals from an open cockpit — a short down stroke was a dot, and a long one a dash.

At the outbreak of World War II, standard RAF equipment for bomber aircraft was the transmitter T1083 and receiver R1082 combination, while

fighters were equipped with the transmitter/receiver TR9. The T1083/R1082 was already overdue for replacement in 1939, the original specification for the Marconi T1154/R1155 having been issued by 1936.

The R1082 was a receiver which required considerable skill to use, for the design was a tuned radio frequency-detector with reaction-audio amplifier combination. An operator could not simply tune such a receiver casually across a waveband, for there were two tuned circuits to adjust (they were not ganged) and there was also a reaction control — in effect you needed three hands to tune at maximum sensitivity. The receiver did cover a very wide frequency range, from 111kHz to 15MHz, with 14 pairs of plug-in coils to cover this range, but actual frequency had to be determined from calibration charts for each receiver. As an aid, the operator was provided with an OTP ("oscillator test point") — he stuck his finger on this and put the receiver into oscillation (presumably thus reassuring himself that it was indeed working).

The accompanying T1083 transmitter was a two-valve master-oscillator transmitter, the oscillator being a Hartley, Colpitts (see "Pioneers", p814) or tuned anode/tuned grid according to the band in use. The frequency range was covered by four pairs of plug-in coils. A limited facility was provided for radio telephony operation, but HT power supply from a generator caused speech to have a superimposed ripple.

A complete T1083/R1082 installation included an intercom system, a loop aerial for taking bearings from ground stations and a winch for use if a trailing aerial was fitted. A "listening-through condenser" and limiter valve enabled the receiver to be used alongside the transmitter. Power supplies to the installation were of necessity elaborate: the receiver was powered from a 120V dry battery and one 2V 20AH accumulator, the transmitters needed four 2V 20AH accumulators in series for valve heaters, with an 80W motor generator,

running off an engine, to provide the HT at 1000V.

The T1083/R1082, in terms of component count, was a relatively simple piece of equipment, with a mean time between failures of around 10,000 hours. But this would be misleading, for vibration in propellor-driven aircraft was considerable, even though attempts were being made to design shock absorbing mountings. However, the inadequacy of these early systems really lay in the difficulty of their operation. Maximum range with this equipment would have been on CW, of course, dependent on the operator's skill, and very marginal for bomber operations against Germany.

Some idea of the difficulty of operating such equipment as this can be gathered from the fact that 18 adjustments to the transmitter were recommended when the operator simply wanted to back tune the transmitter to the receiver frequency, and even a well-trained operator would take several minutes to change frequency. On the other hand the equipment did have simplicity, which meant that in the event of a part failing, both the receiver and transmitter could be made to work in some slightly different configuration. It is interesting to note the alternatives that could be resorted to in such an emergency. If the RF amplifier valve failed, the valve could be removed and the aerial connected to the disconnected anode lead. If the detector valve failed, and a spare was not available, an audio valve could be used. A spare RF amplifier valve (screen-grid type) could be used as a replacement for any of the triodes provided that the screen grid was connected as the anode. If there were no spare valves or the fault was in another component, the R1082 could be run as a four-, three-, two- or single-valve receiver, provided that the detector stage could be made to work.

The T1083 transmitter could also supposedly be run as a single-valve transmitter by setting the PA neutralising capacitor to full and forcing some output through a defunct PA stage. In

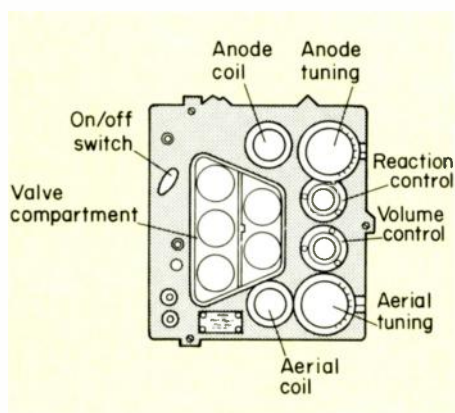

Diagram of front panel of R1082 receiver, showing the four controls at right.



reality, for a wireless operator/air gunner in the turret of a Blenheim aircraft of that period, most of this must have been academic.

Finally as regards the T1083/R1082, I think the story told me by a friend neatly sums up conditions during the early part of the war. My friend was doing his training as a WT operator and was shown the T1083/R1082 with the comment, "You'll probably never see one of these again." He later spent a considerable time abroad in some remote spot operating the pair as a ground station. Indeed, they were still in use in operational aircraft as late as 1943.

There were several variations of the

Routine inspection of an aircraft wireless by ground staff.

TR9, denoted by suffix letters, but the basic design was for a radio telephone transmitter/receiver operating between 4.3 and 6.6MHz with nominal ranges of five miles between aircraft and 35 miles to ground stations. DC power input was about 4W and the installation weighed some 60 lb.

The transmitter (from TR9B onwards) was a two-valve, crystal-controlled oscillator/PA arrangement, the PA being anode modulated and the receiver being a tuned radio frequency-detector and audio-amplifier configuration. The set could be operated by the

pilot, remote controls giving mechanical control of send/receive and receiver fine-tuning functions, and potentiometer control of receiver volume. The equipment was powered by a 2V 20AH accumulator and dry batteries; a battery tray in the equipment contained a 120V HT battery and a 15V grid bias battery for the transmitter. A separate 4½V grid bias battery was located in the receiver section.

The TR9 was not restricted to use in single-seater fighter aircraft and so was also provided with an intercom amplifier, A1134. This also gave further amplification when a moving coil microphone was used with the transmitter.

In fighter aircraft, such as the Spitfire and Hurricane, the TR9 was installed behind the pilot's seat, a wire aerial from the tail fin being brought in via a stub mast just behind the cockpit. This, in the main, was the equipment with which the Battle of Britain was fought. The high-frequency radios were not fully effective and at least one famous fighter pilot's memoirs contain references to swapping insults with German opponents.

From 1936 onwards exercises took place with fighter aircraft being



British radio amateurs G5CV (Douglas Walters, top of steps, with transmitter) and G6JP (George Jessop, right, with filament battery) were the first amateurs in Europe to establish two-way SW radio communication between aircraft. It was achieved on 18 June 1933, using 56MHz equipment fitted to De Havilland Dragon-Moths.

HISTORY

Block diagrams for TR1143 transmitter and receiver, used by many fighter squadrons in the Battle of Britain.

directed by ground stations via HF radio, and the limitations of the existing equipment became evident. In early 1937 the specification for a VHF radio was issued. It is interesting to note that already, in 1933, British amateurs G5CV and G6JP had demonstrated VHF two-way contact between aircraft using low power equipment in the 5m band and this had been widely publicised.

The Royal Aircraft Establishment, with a background of research into VHF since 1935, was tasked with the production of a suitable design. However, in early 1939 it became clear that the specification would have to be revised if VHF equipment was to become available with a minimum of delay. The first VHF sets, TR1133, were available just before war broke out, and almost immediately replaced by an improved design, the TR1143 but VHF equipment was not in universal

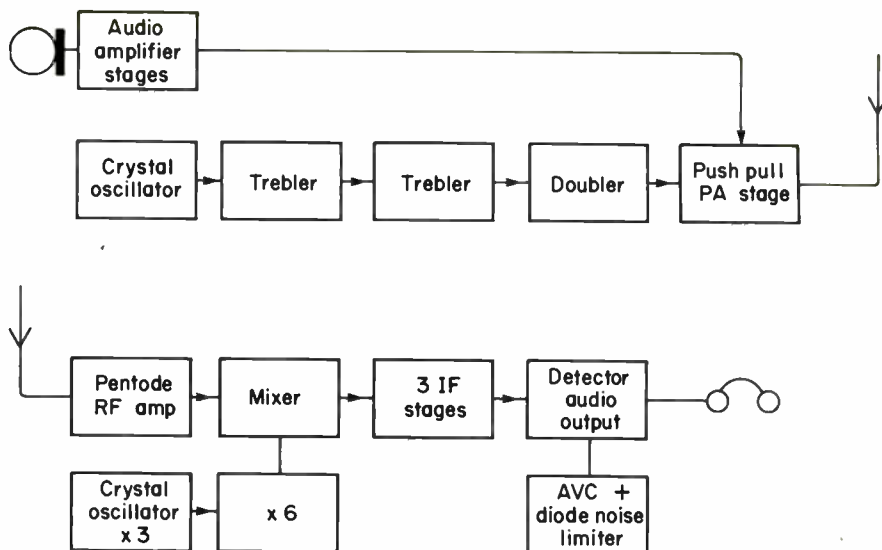

use in fighter squadrons by the time the Battle of Britain had broken out.

Fifty years ago, then, aircraft radio communications were suddenly of vital importance. Comparison with today's equipment does make it all seem a very

long time ago, but it was only recently that someone demonstrated to me that, after all those years, his flying helmet, with the R/T connector intact, still fitted him perfectly. ■

PORTABLE OSCILLOSCOPE

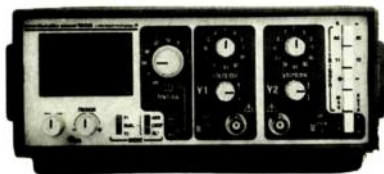

1502

- 15MHz dual trace
- Battery/mains
- Highly portable
- Weighs under 3kg
- Full function

only £375
inc. Probes

Black★Star



All products designed and
manufactured in U.K.

I/O INTERFACE RS-232



2308

Intelligent microprocessor based I/O Measurement and Control Interface. Analog & Digital Inputs, Analog Outputs, Mains Relays.

only £315

FREQUENCY COUNTERS
COUNTER/TIMERS
PAL PATTERN GENERATOR
FUNCTION GENERATORS
PASSIVE PROBES

A full range of professional test instruments, manufactured in the UK by Black Star. Phone or write for full set of illustrated data sheets or for a product demonstration.

BLACK STAR LTD

4 Harding Way
St.Ives, Huntingdon
Cambs. PE17 4WR, UK. Tel: (0480) 62440
Telex: 32762
Fax: (0480) 495172

SYSTEMS MULTIMETER

IEEE-488/RS-232
FULL TALK/LISTEN



4503

THE WORLDS MOST SOPHISTICATED LOW COST SYSTEMS MULTIMETER.

- Autoranging
- 0.03% Basic accuracy
- True RMS
- AC/DC volts/current
- Resistance
- Null, Hold, Continuity, Diode, Filter, dB, Data Logger, % Deviation, Ax+b, Rel.
- Rack Mounting available.

only £365
inc. Interfaces

CIRCLE NO. 140 ON REPLY CARD

Assembly Programmers!

Lets face it. If you write in Assembler the odds are already stacked against you. You have enough problems getting clean code out without having to deal with low-wattage development software that's determined to get in your way.

Crash Barrier's METAi Development System knows its job - and its place. Having a proper retargetable linking assembler means it's faster and does more processors (several hundred variants) - and has sold more - than any other Development System in the world. UK Designed, Manufactured and Supported, full system £395; ring, fax or circle enquiry number for full data on new V5 release. Ring/fax us now and we'll fax you back full data in minutes!

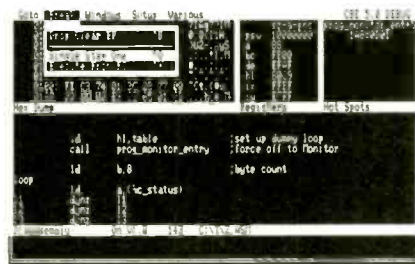
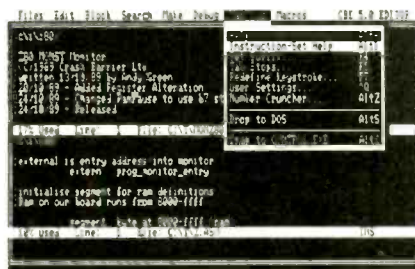

Crash Barrier Ltd,
18 Oxford Street, Wellingborough, Northants, NN8 4HY
Tel: (0933) 224366, Fax: (0933) 441877, BB: (0933) 224377

CIRCLE NO. 158 ON REPLY CARD

EX-STOCK

MEMORIES

FUJITSU DRAM

81464	64Kx4	120ns	DIP	£2.85
81256	256Kx1	100ns	DIP	£2.95
81C1000	1Mx1	80ns	DIP/ZIP	£3.95
81C4256	256Kx4	80ns	DIP/ZIP	£3.95
814100	4Mx1	80ns	DIP/ZIP	£33.00
814400	1Mx4	80ns	DIP/ZIP	£33.00
85235	1Mx9 SIMM MODULE	80ns		£39.50
	SIMM MODULE SOCKET 250 DEG ANGLE			£1.50

SRAM

6116	2Kx8	150ns	DIP	£1.40
8464 (6264)	8Kx8	100ns	DIP	£2.15
84256 (62256)	32Kx8	100ns	DIP	£3.80

FUJITSU EPROM

2764	NMOS	200ns	£2.20	27C128	CMOS	200ns	£2.70
27128	NMOS	250ns	£3.10	27C256	CMOS	200ns	£2.91
27256	NMOS	200ns	£3.40	27C512	CMOS	200ns	£3.81
27C64	CMOS	200ns	£2.62	27C1000/1	CMOS	200ns	£6.42
1772 2MHZ FLOPPY DISC CONTROLLER £4.90							

WE HAVE MANY OTHER ICs IN STOCK INCLUDING FAST SRAMS, PC/AT CHIP SETS, MODEMS AND U ARTS. WE ARE THE LEADING DISTRIBUTOR FOR FUJITSU SEMI CONDUCTORS. PLEASE CALL FOR OUR SHORT FORM CATALOGUE.

Please add 15% VAT on all orders after £0.50 P&P

HAWKE

Hawke Components Limited

UNIT 26, CAMPBELL COURT
BRAMLEY, NR BASINGSTOKE
HANTS RG26 5EG

TEL: 0256 880800
FAX: 0256 880325

CIRCLE NO. 149 ON REPLY CARD

HAPPY MEMORIES

4164 100ns 64Kx1	1.65	2716 450ns 5volt	3.20
41256 80ns 256Kx1	2.25	2532 450ns Only pulls	3.50
41256 100ns 256Kx1	1.95	2732 450ns	2.15
41464 100ns 64Kx4	2.45	2764 250ns	1.85
44256 80ns 256Kx4	5.95	27128 250ns	2.25
41000 80ns 1 Megx1	5.50	27256 250ns	2.45
6116 150ns Low Power	1.45	27C256 250ns	2.45
6264 120ns Low Power	2.45	27512 250ns	3.45
62256 100ns Low Power	4.95	27C512 250ns	3.75
SIMMS 80ns 1Megx9	57.50	SIPPS 80ns 1 Megx9	59.00

Please call for prices of other chips, same chips but different speeds, quantity discounts etc. Second-hand (Pulled) chips available for many of the above devices at substantially lower cost. Call for availability and price of these and other items. Full list available upon request.

Low profile IC sockets:

Pins	8	14	16	18	20	24	28	40
Pence	5	9	10	11	12	15	17	24

We always have a large quantity of both new and secondhand computer equipment in stock and will be pleased to quote you on your requirements for hardware and software. If you would like to receive our (infrequently!) published lists please write your name and address down and post it to us. Thank you.

Please add 50p post & packaging to orders under £15. VAT to be added to total. Credit card orders by phone or mail welcome. Plc, Government & Educational orders welcome for minimum invoice value of £15 net.



Happy Memories (WW),
FREEPOST, Kington,
Herefordshire. HR5 3BR.
Tel: (054 422) 618 Sales,
628 Fax

(No stamp needed unless first-class required)



CIRCLE NO. 150 ON REPLY CARD

1991 CATALOGUE

The new 1991 Greenweld Catalogue, published on 1st October is the best yet, with many substantial reductions and quantity pricing for bulk buyers. Included in the price of the catalogue are the current Bargain List as well as the next 6 updates and lists, all supplied with reply paid envelopes.

Price £2.50 UK £5.00 Overseas
(Catalogue only £1.50 UK £3.00 Overseas)
Free to Education & Bone Fide companies.

COMPONENT OFFERS:

Type	1+	100+1k+	Type	1+	100+1k+
LOGIC CHIPS					
74LS00	.10	.06	04		
74LS04	.14	.08	06		
74HC05	.10	.06	04		
74LS32	.10	.06	04		
74LS138	.14	.08	06		
74LS175	.14	.08	06		
74HC423	.17	.10	07		
74HC541	.17	.10	07		
74HC564	.21	.12	-		
74HC4017	.17	.10	-		
COMPUTER CHIPS					
6116LP-4	1.00	.60	40		
Z80A CPU	.60	.35	25		
Many other devices in stock at the same low prices eg. IN4007 0.015 in 5k lots. 1% 1/4W Rs £6/k 5% 1/4W Rs £3.50/k AA NICADS £58/100 10% 25V radial £13/k					

GREENWELD

27C Park Road, Southampton, SO1 3TB
Tel No: (0703) 236363 Fax No: (0703) 236307
All prices exclude VAT. Add £2 carriage to all orders. Access, Visa and official orders welcome. Callers welcome from 9-5.30 Monday to Saturday.

HITACHI OSCILLOSCOPES

Proven reliability coupled with a 2 year warranty. We can supply the following models from stock, willingly demonstrated at our premises.

V212 £335 V522 £635
V223 £474 V209 £748

METEX METERS

A wide range of Metex meters cater for most needs at an economical price. Features on the different models include: AC/DC voltage & current, Resistance, Capacitance, Frequency, Transistor & Diode testing, Continuity, Temperature, Conductance, Tachometer, Dwell angle. Prices from £32.17-£90.34, with discounts for quantity purchases. Full details in catalogue.

TESTLAB EQUIPMENT

We stock a wide range of budget test equipment offering excellent value for money. Full details in Catalogue.

Examples:

Y134B	Function Generator. Sine, triangular & square wave.....	£93.91
Y142B	Audio Generator/ counter. 10Hz-1MHz.....	£160.87
Y134C	LCR Bridge. To 11M, 111H, 1110µF.....	£100.00
SE6100	Signal Injector/ Tracer 60dB gain, 4.5V O/P.....	£47.82
CM3300	Digital Capacitance Meter to 99.9mF.....	£56.52
YF1065	Digital Lux meter. To 20,000 Lux.....	£47.78
FC5250	Frequency counter. 7 digit 150MHz.....	£56.52

CIRCLE NO. 141 ON REPLY CARD

SWITCH MODE POWER SUPPLIES

ASTEC AA12531

I/P 115/230Vac 50/ 60Hz
O/P V1 +5V 5A
V2 +12V 0.15A
Size 160x104x45mm
Partially enclosed panel with fixing holes in steel case on 120x125mm centres.
Inputs and outputs are on colour coded leads; there is also an EEC socket on a flying lead.
Price £6.04

Z8887 Made by STC, this 160x100mm panel is attached to an aluminium chassis 165x102x65mm and has a single 5V 6A output. Supplied with connection details, we can offer these at a fraction of their normal cost!
Price £5.17 10+ 4.30 100+ 3.43

Z8888 A larger version of the above, PCB 220x100mm and chassis 225x102x65mm providing a single 5V 10A output. Supplied with connection details.
Price Only £7.78 10+ 6.50 100+ 5.20

Z8889 A 40W dual output supply made by Astec, model AC8151, 115 or 230V input. Maximum currents from each output: 12V @ 3A; 5V @ 6A; -12V @ 300mA. Size 160x100mm
Price £11.26 10+ 9.50 100+ 7.75

Z8890 DC-DC Converter Boards. These panels 220x195 require 50V DC input for a 5V 19.5A output. Inputs and outputs on DIN41612 connector. These brand new panels made by STC are now being offered at just:
Price £6.91 25+ 5.20 100+ 3.89

Z8881 Switch mode PSU, 252W enclosed unit 235x95x65mm made by Intelligence Power Technology. Type FET 204.02. Mains input, outputs: +5V @ 15A; +15V @ 3A; -15V @ 3A; +24V @ 3A. With instruction sheet.
Price £28.26

Z660 Astec switched mode PSU type AA7271. This small PCB, just 50x50mm will accept 8-24V input and give a stable 5V dc at up to 2A output. The 6 transistor circuit provides current overload protection, thermal cut-out and excellent filtering. Offered at a remarkably low price.
Price £4.34

TEK 475 SCOPES

200Mhz. Dual Beam Delay Timebase. . .
TESTED & CALIBRATION VERIFIED. . .
SPECIAL . . . £485.00

TELEPHONE:
(0602) 864041 or
864902 for
Immediate Attention

TEK 434 Storage Scopes
TEK 465, TEK 2215, TEK 2225
Stock just arrived - Phone

ACCESS

MARCONI TF2015

Signal Generators

AM-FM-CW 10MHz-520MHz
11 ranges ±1.5% accuracy
Batt./Mains. Small.
£125.00

FAX line:
(0602) 864667

AVO Model 8

(Mil' Test Set 1 version)
MULTIMETER with AVO Ever-Ready
case, Leads, Probes. . .VGC. . .
TESTED . . . **£50.00**

VISA

IF YOU ARE NOT 100% SATISFIED. . . YOU GET A 100% REFUND ON THE PURCHASE PRICE!!
ALSO IN STOCK NOW: TF2002A, 2002B, 2006, 2008 Signal Generators. . . PHONE For Latest

ALL PRICES EXCLUDE VAT & CARRIAGE

ALL GOODS FULLY TESTED & GUARANTEED

LOGIC ANALYSERS

Gould K100-D 16-bit 100MHz including Probes £600

HP1607A - £250.00

TEK 7603 + 7D01 + DF1 16-Bit 50MHz incl probes £550

(0602) 864041 or 864902 FAX: (0602) 864667

CIRCLE NO. 142 ON REPLY CARD

Low-noise microwave oscillators

As noted in "Synthesiser noise" by Ian Poole (*EW+WW*, September 1990, pages 820-825), the phase noise characteristic of frequency sources, particularly PLL frequency synthesisers, greatly affects the performance limits of communications and radar receivers from MF upwards. Yet it is only relatively recently that due attention has been given to investigating the noise performance of basic oscillators.

It is now almost 50 years since W. A. Edson published the first detailed study of oscillator noise and its effect on the choice of the intermediate frequency of microwave receivers. In his book

Vacuum Tube Oscillators (1953) he wrote: "It is well known that the small voltages within solid conductors and the corresponding random emission of electrons within vacuum tubes set a lower limit on the magnitude of electrical signals which may be amplified and detected... It is not so commonly realised that noise voltages also affect the operation of oscillators. It is true that in most oscillator applications the effects of noise are quite small; but in some cases, for example in microwave oscillators used in superheterodyne receivers, the noise sidebands seriously restrict the choice of IF".

In the intervening years, as the noise contribution of solid-state amplifiers has been dramatically reduced, the practical significance of oscillator noise has increased with the recognition of reciprocal mixing as an important limitation on the rejection of strong adjacent-channel signals, which represents a practical limitation to the effective close-in dynamic range of receivers.

An oscillator can be considered as a selective amplifier with positive feedback. Noise voltages at the centre frequency build up into a continuous sine wave until limiting action causes the oscillation to reach a steady level. At the same time, noise voltages close to the centre frequency will also build up to form a roughly triangular spectrum of noise, rising above the basic flat noise output of the amplifier. The width of the spectrum depends on the loaded Q of the tuned circuit, and the level of the noise on the operating conditions of the circuit.

As pointed out by Ian Poole, the noise performance of an oscillator can vary widely between different designs and different types of active device. Recently, M. Ali Khatibzadeh and B. Bayraktaroglu of Texas Instruments, Dallas (*Electronics Letters*, August 2, 1990, pages 1246-7) have shown that the use of a heterojunction bipolar transistor (HBT) in a stabilized (DRO) microwave oscillator can result in an SSB FM noise level of -102dBc/Hz at 10kHz and -76dBc/Hz at 1kHz offset from the 11.06GHz carrier frequency.

This is one of the lowest phase-noise levels reported for an X-band solid-state transistor oscillator and underlines the potential of HBTs for low-noise local-oscillator applications at microwave and millimetre-wave frequencies.

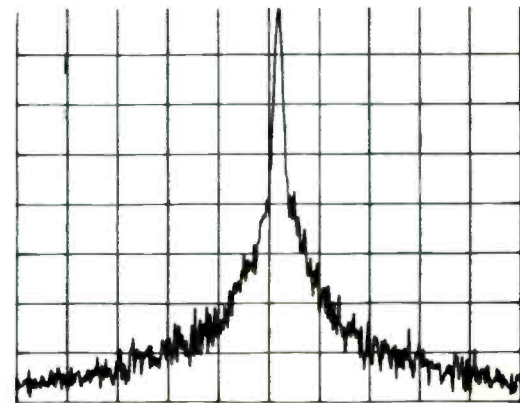

Output spectrum of oscillator in a 50kHz span around 11.06GHz.

The AlGaAs/GaAs HBTs were fabricated on MOCVD material, using a self-aligned process to minimise the parasitic base and collector resistances. Current-gain cut-off frequency, f_t , of these devices is 40GHz and f_{max} 60GHz . A common-emitter, parallel-feedback oscillator circuit was used, with the dielectric resonator coupled to the base and collector terminals to provide the required inductive feedback, the circuit being fabricated on 0.25mm alumina substrate with lumped bypass and DC decoupling capacitors for the bias network and a 50Ω thin-film resistor to terminate the base microstrip line. The unloaded Q of the dielectric resonator (high dielectric constant material) was about 8200 and was coupled to the microstrip lines without any spacer layer.

Noise performance compares very favourably with those from fet oscillators (without external noise-reduction circuit) and silicon bipolar oscillators in the same frequency band. Oscillator output power was about $+14\text{dBm}$, with harmonics lower than -30dBc and with no observed spurious modes.

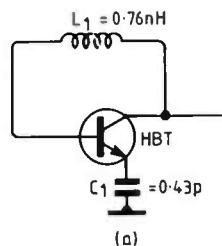

(a)

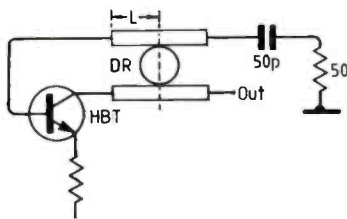

(b)

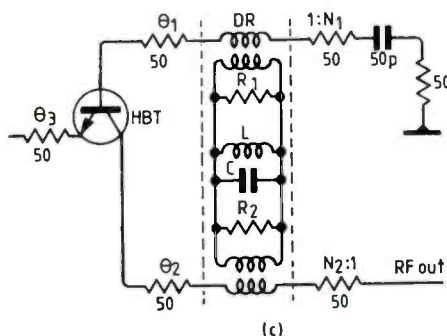

(c)

HBT oscillator. Lumped-element prototype (a) and microstrip version (b), with equivalent circuit of DRO at (c).

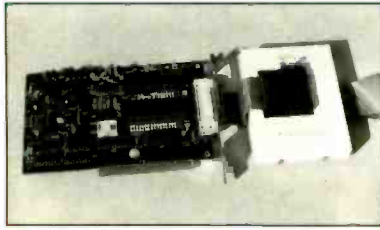

The MPE POWERLOGIC DEVELOPMENT SYSTEM.

- * PC PLUG IN
- * Programs Lattice Gals 16V8 and 20V8
- * Programs Altera EPLDs-EP310, 320 and 600
- * Integrated logic equation assembler
- * Easy to Install
- * Menu driven
- * Now with alternative CYPRESS 22V10 option.
- * Only £495

EPROM PROGRAMMERS

- * PC Plug-in
- * Programs EPROMS from 2716 to 27101
- * 1 or 4 gang available.
- * adaptors available extra for single chip micros
- * 1 gang £185.00
- 4 gang £225.00
- 8 gang and production programmers also available
- 8751 adaptor £75.00

**MicroProcessor
Engineering Ltd**

133 Hill Lane
Southampton SO1 5AF

TEL: 0703 631441

LeBURG EPROM Emulator

- * Cuts development time.
- * PC Plug in.
- * Emulates 2 EPROMs at once
- * Emulates all 28 pin types
- * Supports 8 and 16 bit bus widths
- * Expandable to 32 bit bus width.
- * £495

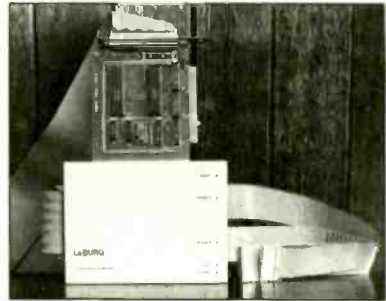

CATALOGUE of more hardware and cross-support software available on request.

CIRCLE NO. 143 ON REPLY CARD

The Archer Z80 SBC

The SDS ARCHER – The Z80 based single board computer chosen by professionals and OEM users.

- ★ Top quality board with 4 parallel and 2 serial ports, counter-timers, power-fail interrupt, watchdog timer, EPROM & battery backed RAM.
- ★ **OPTIONS:** on board power supply, smart case, ROMable BASIC, Debug Monitor, wide range of I/O & memory extension cards.

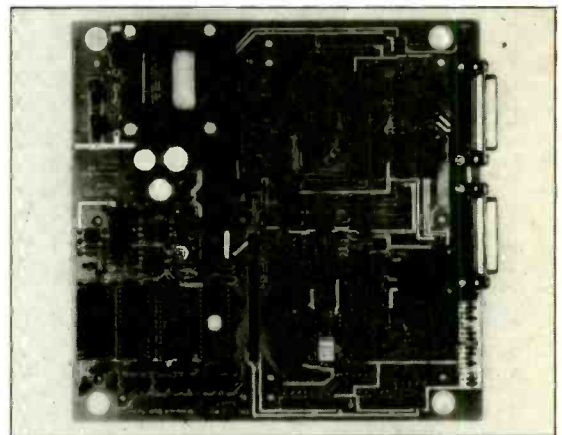

The Bowman 68000 SBC

The SDS BOWMAN – The 68000 based single board computer for advanced high speed applications.

- ★ Extended double Eurocard with 2 parallel & 2 serial ports, battery backed CMOS RAM, EPROM, 2 counter-timers, watchdog timer, powerfail interrupt, & an optional zero wait state half megabyte D-RAM.
- ★ Extended width versions with on board power supply and case.



Sherwood Data Systems Ltd

Unit 6, York Way, Cressex Industrial Estate, High Wycombe, Bucks HP12 3PY. Tel: (0494) 464264

CIRCLE NO. 144 ON REPLY CARD

J.A.V. ELECTRONICS LIMITED

THE COMPLETE PCB/SCH CAD SOLUTION

Announcing Protel Easytrax 2 (MS/DOS)

Save £100.00 now at £148.75 + VAT Limited Period Only



Protel Easytrax 2 is a very affordable, easy to use precision design tool that generates professionally accurate PCB artwork. With support for a wide range of displays, plus Photoplotters, Pen Plotters,

MACINTOSH USERS
PROTEL EASYTRAX & AUTOTRAX NOW
AVAILABLE CONTACT FOR DETAILS

Laser and Dot Matrix Printers all as standard. With pull down menus for ease of use and a comprehensive library of Through-Hole Devices the designer can easily create new or modify existing Devices.

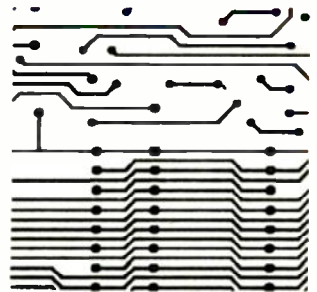

NEW FEATURES

Autorouting Capability

Curved Tracking

PostScript Printing

24 Pin Printer Support

Imperial & Metric Grids

Easytrax has user definable function key macros to provide a command driven fast track alternative for repetitive operations. Easytrax makes PCB layout easy. Concentrate on your design - not on complicated program commands.

Also available Protel Autotrax 1.5 professional PCB CAD with full autorouting and Design Rule Checking. Evaluation Packs available.

Protel Software available from The Sole UK Distributor

J.A.V. Electronics Limited, Unit 12a Heaton Street, Denton, Manchester, M34 3RG. Tel: 061-320 7210 Fax: 061-335 0119

CIRCLE NO. 103 ON REPLY CARD

COMPUTER ADD ONS

- ★ MAINBOARDS ★ XT ★
- ★ 286 (to 24Mhz) ★ 386 (to 33Mhz) ★
- ★ DISK CONTROLLERS ★ I/O ★
- ★ GRAPHICS CARDS ★ KEYBOARDS ★
- ★ CASES ★ POWER SUPPLIES ★

Call for price list

Examples

- 20Mhz 286 Neat mainboard£265.00
- 20/25Mhz 386 mainboard£580.00
- 25Mhz 386 mainboard with 32Kb cache ... £790.00
- 33Mhz 386, 64Kb cache, 4Mb RAM ... £1400.00

Complete Systems and machine upgrade service

Datamation Services Limited
 852 Plymouth Road,
 Slough SL1 4LP

Tel: 0753 696499 Fax: 0753 696211

CIRCLE NO. 104 ON REPLY CARD

SMC

South Midlands Communications

HF SYSTEMS

CHANNELISED SYSTEMS



TM180 Pioneer 100W HF SSB transceiver, 6 channel, USB, base or mobile applications and a full range of accessories.

BASE ANTENNAS

SMC TDA Series trapped dipoles factory pre-tuned, easily installed, up to 6 channels Rx to 1KW.

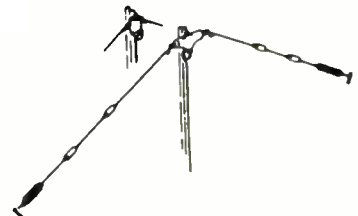

HF MOBILE ANTENNAS

HW4 1.5-30MHz single frequency tuned mobile whip complete with installation accessories, base mount and spring, spare channel coils available for multi frequency operation.

PRO SERIES Multi channel tapped whip antennas up to 4 frequencies 1.5-30MHz complete with base mount and spring.



FOR FURTHER INFORMATION, OR JUST ADVICE, CALL:

S.M. HOUSE, SCHOOL CLOSE, CHANDLERS FORD INDUSTRIAL ESTATE, EASTLEIGH, HAMPSHIRE SO5 3BY. TELEPHONE: (+44) (0)703 255111
 FAX: (+44) (0)703 263507 SMC FX TELEX: 477351 SMCOMM G

CIRCLE NO. 105 ON REPLY CARD

**SMALL SELECTION ONLY LISTED - EXPORT TRADE AND QUANTITY DISCOUNTS
RING US FOR YOUR REQUIREMENTS WHICH MAY BE IN STOCK**

Test Equipment. We hold a large stock of modern and old equipment - RF and AF signal generators - Spectrum analysers - counters - power supplies - chart recorders, all speeds single to multi - XY plotters A4-A3 - oscilloscopes - normal & storage.

Tektronix 475 - 200MC/S oscilloscopes - tested from £400 less attachments to £700 C/W manual probes etc. **Tektronix 475A** - 250MC/S - complete kit with probes - £750.

Telegquipment D755 - 50MC/S oscilloscopes - tested C/W 2 probes + manual - £250.

Marconi TF2002AS - AM-FM signal generator - 10KC/S to 72MC/S - £85 tested + probe kit & manual.

Marconi TF2002B - AM-FM signal generator - 10KC/S-88MC/S - £100 tested to £150 as new + probes.

Marconi TF2008 - AM-FM signal generator - Also sweeper - 10KC/S - 510MC/S - from £350 tested to £500 as new with manual - probe kit in wooden carrying box - £50.

HP Signature analyser type 5006A - £300.

HP DC Current source type 6177C - £300.

HP Frequency counter type 5384A - 225MC/S - £350.

HP DC Transfer standard type 735A - £200.

HP Frequency comb generator type 8406A - £400.

HP Amplifier type 8447A - 1 to 400 MHz - £300.

HP Sampling voltmeter (Broadband) type 3406A - £200.

HP Vector voltmeter type 8405A - £400 to £600.

HP Oscilloscope mainframe type 182C - £300.

HP Oscilloscope mainframe type 181TR - £400.

HP Signal generator type 8614A - 8616A - £400 to £800.

HP Sweep oscillator mainframe type 8690B - P.I's 1GHZ to 40GHZ P.O.R.

HP Power meters + head - £150.

HP Frequency counter type 5340A - 18GHZS - £1000.

HP Frequency counter type 5352B - 40GHZS - £85500.

HP Synthesiser/signal generator type 8672A - 2 to 18GHZS - £7500.

HP Vector impedance meter and probe type 4193A - £1500.

HP Network analyser type 8754A + HP8502A test set - £5000.

HP Frequency counter type 5383A - 520MC/S - £150.

HP Function generator type 3312A - P.O.R.

HP Spectrum analyser plug-in - .01 to 350MC/S - option .001 - £1000.

HP Mainframe type 8620A or C - £600 - £1200.

Racal/Dana digital multimeter type 5001 - £250.

Racal/Dana interface type 9932 - £150.

Racal/Dana GPIB Interface type 9934A - £100.

Racal/Dana RMS meter type 9301A - £300.

Racal/Dana RMS voltmeter type 9303 - £600.

Racal/Dana timer/counter type 9500 (9515 OPT 42) - 1250MC/S - £750.

Racal Thermionic store 4 recorder - £300.

Racal frequency standard generators type MA259 - 600KC/S - 1MC & 5MC/S - £200.

Marconi AF power meter type 893B - £300.

Marconi bridge type 2700 - £250.

Marconi attenuator type TF2163S - 1GHZ - £250.

Marconi O Meters type TF1245A + TF1246 - £150.

Marconi/Saunders signal sources types - 6058B - 6070A - 6055B - 6059A - 400 to 18GHZS.

Marconi/Saunders microwave sweep oscillator type 6600A + 18 to 40GHZ plug-ins - £1750.

Thurlby converter 19-GP-IEEE-488 - £150.

Fliuke transfer standard type 731A (DC) - £200.

Phillips logic multimeter type PM2544 - £200.

Gould J3B audio signal generator - £250.

Microwave systems MOS/3600 microwave frequency stabilizer - 1 to 18GHZS & 18 to 40GHZ - £1500.

Microwave systems MOS5 microwave frequency stabilizer - 1 to 18GHZS & 18 to 40GHZS - £300.

EIP Microwave counter type 371 - source locking - 18GHZS - £1400.

R & S Vector analyser ZPV with 100MC/S or 2000MC/S plug-in - £1200. XTRA PI - £500.

Scientific Atlanta LF realtime analyser type SD330A - £750.

Bradley oscilloscope calibrator - £600.

Bradley oscilloscope calibrator type 156 - £150.

Bradley oscilloscope calibrator type 192 - £600.

Tektronix curve tracer type 576 - £1400.

Tektronix curve tracer type 577 - £1000.

Tektronix mainframes - 7403N - 7603 - 7623 - 7633 - 7704A - 7834 - 7844 - 7904 - TM501 - TM503 - TM506. P.O.R.

Tektronix plug-ins - 7A13 - 7A14 - 7A18 - 7A24 - 7A26 - 7A11 - 7M11 - 7S11 - 7D10 - 7S12 - S1 - S2 - S6 - S52 - PG506 - SC504 - SG502 - SG503 - SG504 - DC503 - DC508 - DD501 - WR501 - DM501A - FG501A - TG501 - TR502. P.O.R.

Tektronix spectrum analyser type 491 - 1.5 to 40GHZS (as new) £1200.

Racal HF drive unit 1.6 to 25MC/S type 1724 - brand new - £350.

Racal HF drive unit type 1720 - 1MC to 29MC/S - £350.

Ailtech Stoddart receiver type 1727A - 01 - 32MC/S - £5000.

Ailtech Stoddart receiver type 37/57-30 to 1000 MC/S - £5000.

Ailtech Stoddart receiver type NM65T - 1 to 10IG/S - £3000.

HP Oscillographic recorder type 7404A - 4 track - £350.

HP Plotter type 9672B - 4 pen - £300.

HP Plotter type 7470A - £200.

Marconi TF2015. SIG/GEN - 10MHZ - 520MC/S - AM-FM - £250.

HP power meter type 431C to 18GHZ with C type head & waveguide head - £150 to £200.

HP sweep oscillators type 8690 A&B - plug-ins from 10MC/S to 18GHZ also 18-40GHZ. P.O.R.

HP 3325A synthesiser - function generator - £1500 + manual.

Marconi TF1245A circuit magnification meter + 1246 & 1247 oscillators - £100 to £300.

HP signal generators. Type 612 - 614 - 618 - 620 - 626 - 628 - frequency from 450MC/S to 21GHZS. P.O.R.

HP 8614A - HP8616A signal generators - 800-2400MC/S - 1800-4500MC/S - £800 - £600.

Gould J3B test oscillator - £250 + manual.

Ferrograph recorder test sets - RST2 - £200.

Racal/Dana 9301A - 9303 RF millivoltmeters. 1.5-2GHZ - £350 - £750.

Racal/Dana counters 9915M - 9916 - 9917 - 9921 - £150 to £450. Fitted ex-standard.

HP 8704A + 8412A + 8601A network analyser - 100KC/S - 110MC/S - £1000.

HP 8410A + B network analysers - 110MC/S to 12.4GHZ or 18GHZ plus most other units and displays used in this set up 8413A - 8414A - 8418A - 8740A - 8743A - 8750A. P.O.R.

HP 141T mainframe plus - 8556A - 8553B - 8554B - 8554L - 8555A - 8552A - 8552B plug-in units. P.O.R.

HP 181TR mainframe - £400 - **HP 182T mainframe** - £500. **HP 141T mainframe** - £500 - £1000.

HP 432A - 435B + 436A power meters + Powerheads - 10MC/S - 40GHZ.

HP 478A - p486A - K486 - 8481A - 8481B. P.O.R.

HP oscilloscope type 1740A - 100MC/S - £300 C/W manual.

Image Intensifiers - ex MoD - tripod fitting for long range night viewing - as new - £3000EA.

Intensifier tubes - £50 to £250 - tested - depending on grade - first gen XX1060.

Thermal Imaging Equipment - high definition - from £2500 - complete in transit case.

Clark air operated heavy duty masts - with legs and kit with pump. P.O.R.

Don 10 telephone cable - 1/2 mile canvas containers or wooden drum - new - Mk2-3 or 4 P.O.R.

Infra-red binoculars in fibre-glass carrying case - tested - £100EA also **Infra-red AFV sights** - £100EA. S.A.E. for details - **Infra-red spotlights and Infra-red filters** P.O.R.

Items bought from HM Government being surplus. Price is ex-works. S.A.E. For enquiries phone for appointment or for demonstration of any items, availability or price change. VAT and Carr. extra.

Johns Radio, Whitehall Works, 84 Whitehall Road East, Birkenshaw, Bradford BD11 2ER. Tel. No. (0274) 684007. Fax: 651160

Wanted: Redundant test equipment - valves - plugs - sockets - synchro's etc., Receiving & transmitting equipment - general electronic equipment

CIRCLE NO. 145 ON REPLY CARD

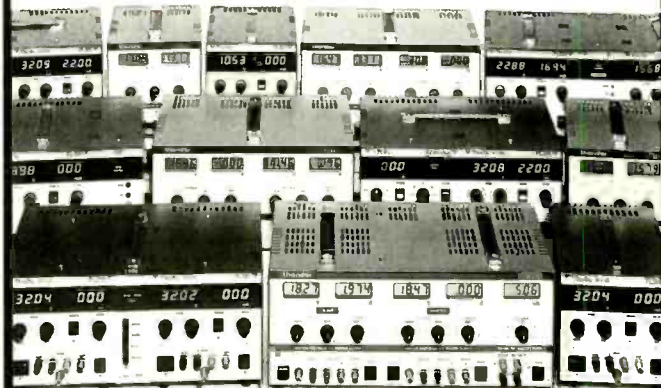

For Bench PSUs

Whatever your need in bench power supplies. Thurlby-Thandar can supply it.

Ten years ago we re-defined the standard for bench PSUs. Today we have the largest range available offering an unbeatable combination of features such as dual digital meters for each output, current limit preview, remote sense and current meter damping.

The range is vast and includes singles, twins, triples, quad-mode duals (with true-parallel and series tracking modes) and IEEE-488 programmable models.

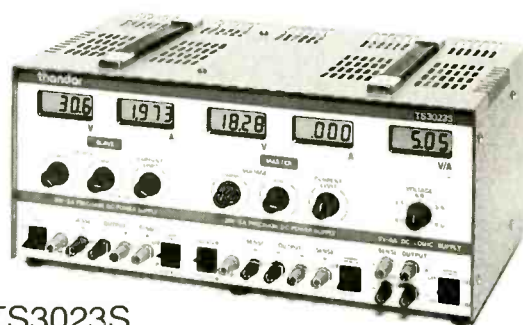

TS3023S

This model features dual 30V - 2A outputs (isolated or tracking) plus a further 5V - 4A output (with ±1V adjustment) and costs £385 + VAT.

Contact us now for full details of all our PSUs.

Thurlby-Thandar Ltd.
Glebe Rd., Huntingdon, Cambs. PE18 7DX.
Tel: (0480) 412451 Fax: (0480) 450409

CIRCLE NO. 146 ON REPLY CARD

RF filter for electro-explosive devices

It has long been recognized that the operation of radio or radar transmitters at medium or high powers near electrically-detonated explosives and flammable substances needs special care to ensure electromagnetic compatibility (EMC). Metalwork or wires can act as resonant antennas and pick up sufficient RF energy from local transmitters to generate sparks that may trigger off an explosion or ignite flammable substances. Considerable work on this aspect of EMC was carried out a few years ago at the Postgraduate School of Electrical & Electronic Engineering at the University of Bradford: see, for example, "The ignition hazard due to radiation from radio transmitters" by G.H. Butcher, P.S. Excell and D.P. Howson (IEE Conference Publication No 134, Electrical Safety in Hazardous Environments, pages 143-7).

Most of the published work in this area of EMC in the UK has been in civil applications, for example the potential risk of operating mobile transmitters near quarrying operations, or when refilling vehicles at petrol pumps, although there are few recorded instances of any serious accidental explosions being brought about in this way.

However, this is not the case with electro-explosive devices (EEDs) such as those in air-to-ground missiles, where the risk can be much greater and where at least one incident resulted in the loss of over a hundred lives. This was during the US operations in Vietnam and occurred on the American aircraft carrier Forrester. As described at Wescon 1988 by Daniel J. Kennally, a number of A-4 Skyhawks on the deck of the carrier were each loaded with two 1000 lb bombs, air-to-ground and air-to-air missiles, and were ready for take-off. But one of the aircraft had an improperly mounted shielded connector. As the rotating radar antenna swept round, RF voltages generated on the cable with the ineffective shield ignited the EED missile. The missile streaked across the deck of the carrier, hit an aircraft and blew its fuel tanks apart. Its two 1000lb bombs fell on the deck and exploded. Other aircraft, parked wingtip to wingtip, caught fire and exploded. The fire spread below deck and, by the time it was extinguished, \$72 million damage had been sustained and 134 men were dead or missing.

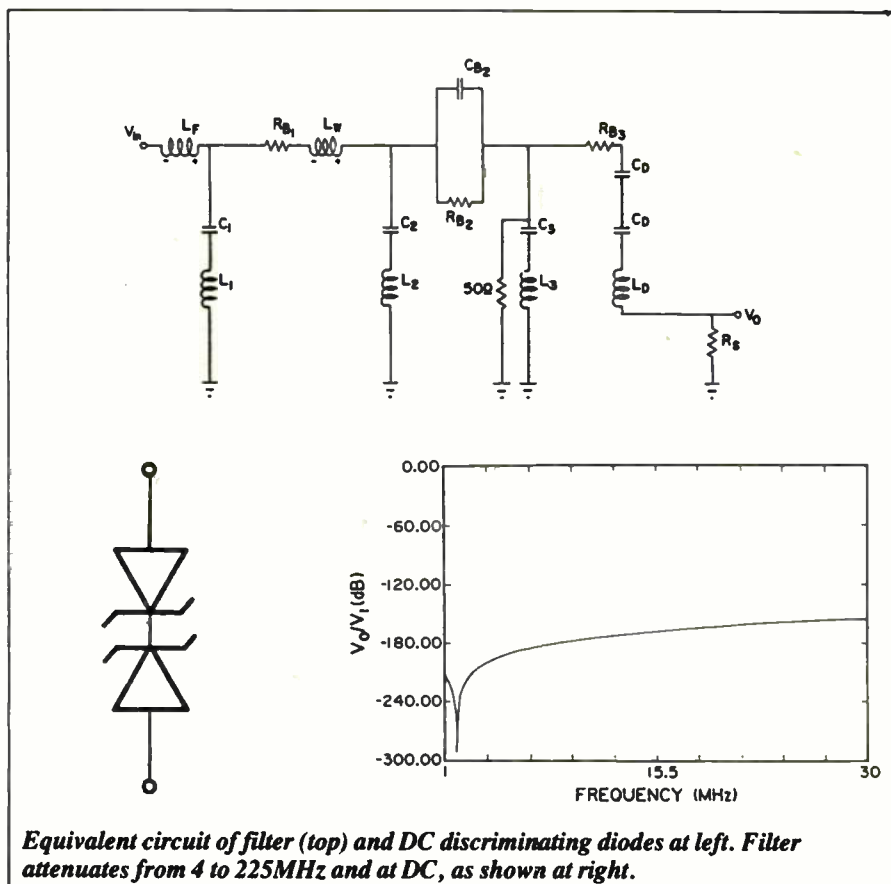

Equivalent circuit of filter (top) and DC discriminating diodes at left. Filter attenuates from 4 to 225MHz and at DC, as shown at right.

While American missiles have to be designed to comply with an EMC specification, they remain sensitive (at least under fault conditions) to RF radiation, including RF-induced arcing (discharge) under conditions that can arise in a naval environment where there may be large numbers of HF/VHF/UHF transmitters.

According to Thomas and Michael Baginski of Auburn University, Alabama (*IEEE Trans on Electromagnetic Compatibility*, May 1990, pages 163-7), the Mark 1 EED (1Ω, 1W, 1A all-fire rating), as used, for example, in a 2.75in-diameter, folding-fin aircraft rocket, has demonstrated a high susceptibility to EMI. The ignition system consists of an exposed metal firing band that surrounds the motor assembly at the rear of the rocket, a wire that connects the exposed band to the lead of the EED, and another wire which connects the second lead to the rocket case. The EED is fired by passing a direct current from the firing band to the rocket case. During handling, the exposed firing band may contact an aircraft, excited by RF, with the rocket

case earthed to deck via a person or a missile cart. This can result in RF current flowing directly through the EED which may cause ignition. Alternatively, the rocket case may act as an antenna coupling RF power to the EED and similarly may result in ignition.

There is now a high-attenuation RF filter (which could have other applications). It has been tested at frequencies of 9, 18, 24, 225 and 450MHz, providing an RF attenuation of about 160dB or better between 1 and 30MHz.

The passive RF filter severely attenuates RF from 4 to 225MHz and, in addition, removes any spurious DC which may result from rectification of a coupled RF signal. It comprises a 0.8μF (stable K) ceramic capacitor (C_1) followed by 30 ferrite beads, a second capacitor (C_2), followed by a ferrite toroidal core wound with 60 turns of 26-gauge magnet wire, a further capacitor (C_3) with 50Ω resistor as discharge path, then two further ferrite beads and a DC discriminating circuit comprising two zener diodes, reverse connected.



PHONE
0474 560521
FAX
0474 333762

P. M. COMPONENTS LTD
SELECTRON HOUSE, SPRINGHEAD ENTERPRISE PARK
SPRINGHEAD RD, GRAVESEND, KENT DA11 8HD

TELEX
966371
TOS - PM

A selection from our stock of branded valves

A1714 24.50	E286CC 17.50	EF8055 25.00	M5199 295.00	MULLARD 39.50	XFW50 1.50	4CX250R 125.00	6CG7 G.E. 7.50	7K7 7.50	30L1 0.45	5559 55.00
A1834 7.50	E810F 25.00	EF8065 25.00	M8079 6.00	QD07-50 55.00	XG1-2500 75.00	AMPEREX 100.00	6CH6 6.95	7L 1.50	30L15 0.60	5636 5.50
A2087 11.50	E1148 1.00	EF812 0.65	M8082 7.50	QD203-20 42.50	XL62BF 7.50	4CX350A 100.00	6CL6 3.25	707 4.50	30L17 0.60	5642 9.50
A2134 14.95	EAS0 1.00	EFL200 1.50	M8083 3.25	QD206-40 45.00	XNP12 2.50	4CX1000A 425.00	6CL8A 2.95	7Y4 2.50	30P4MR 1.00	5643 9.50
A2272 15.00	EAS2 75.00	EPF60 3.50	M8091 7.50	QD575/50 1.50	XR11600A 25.00	4CX1500B 475.00	6CW7 2.95	888 2.50	30P12 1.00	5651 2.50
A2293 6.50	EAT6 1.95	EPF90 0.72	M8096 3.00	QD595/10 4.85	XR13200A 79.50	4CX5000A 1000.00	6CS6 0.75	8810 2.50	30P18 0.60	5654 1.95
A2426 29.50	EAT9 1.95	EPK90 1.50	M8098 5.50	QD108/45 4.00	XR1-6400A 149.50	4D21/4-125A 85.00	6CS7 0.95	8805 1.95	30P19 1.00	5670 3.25
A2599 37.50	EAB9 1.95	EL32 0.95	M8100 5.00	QD150/30 6.95	X65 6.95	4D32 125.00	6CW4 8.00	8805 1.95	30P1 2.50	5672 4.50
A2792 27.50	EAC80 1.95	EL34 2.50	M8136 7.95	QD150/40 7.00	YD1100 75.00	4E27A 125.00	6C8B 3.95	8805 1.95	30P13 0.60	5675 28.00
A2900 11.50	EAC91 2.50	EL34 2.50	M8137 7.95	QD150/40 7.00	YD1100 75.00	4G57 2.25	6C8B 3.95	8805 1.95	30P14 1.75	5678 7.50
A3283 24.00	EAF42 1.70	EL34 2.50	M8161 6.50	QD150/40 7.00	YD1100 75.00	4G57 2.25	6C8B 3.95	8805 1.95	30P15 1.75	5678 7.50
A3343 35.95	EAF42 1.70	EL34 2.50	M8162 6.50	QD150/40 7.00	YD1100 75.00	4G57 2.25	6C8B 3.95	8805 1.95	30P16 1.75	5678 7.50
AC/SP3A 4.95	EAB1 3.95	EL36 2.50	M8163 6.50	QD150/40 7.00	YD1100 75.00	4G57 2.25	6C8B 3.95	8805 1.95	30P17 1.75	5678 7.50
AC/SP2EM 8.50	EAB1 3.95	EL36 2.50	M8163 6.50	QD150/40 7.00	YD1100 75.00	4G57 2.25	6C8B 3.95	8805 1.95	30P18 1.75	5678 7.50
AC722 59.75	EAC33 2.50	EL41 3.50	M8163 6.50	QD150/40 7.00	YD1100 75.00	4G57 2.25	6C8B 3.95	8805 1.95	30P19 1.75	5678 7.50
AH221 39.00	EAC33 2.50	EL41 3.50	M8163 6.50	QD150/40 7.00	YD1100 75.00	4G57 2.25	6C8B 3.95	8805 1.95	30P20 1.75	5678 7.50
AH238 39.00	EAC33 2.50	EL41 3.50	M8163 6.50	QD150/40 7.00	YD1100 75.00	4G57 2.25	6C8B 3.95	8805 1.95	30P21 1.75	5678 7.50
AL60 6.00	EAC33 2.50	EL41 3.50	M8163 6.50	QD150/40 7.00	YD1100 75.00	4G57 2.25	6C8B 3.95	8805 1.95	30P22 1.75	5678 7.50
AN1 14.00	EAC33 2.50	EL41 3.50	M8163 6.50	QD150/40 7.00	YD1100 75.00	4G57 2.25	6C8B 3.95	8805 1.95	30P23 1.75	5678 7.50
APR12 2.50	EAC33 2.50	EL41 3.50	M8163 6.50	QD150/40 7.00	YD1100 75.00	4G57 2.25	6C8B 3.95	8805 1.95	30P24 1.75	5678 7.50
APR34 1.25	EAC33 2.50	EL41 3.50	M8163 6.50	QD150/40 7.00	YD1100 75.00	4G57 2.25	6C8B 3.95	8805 1.95	30P25 1.75	5678 7.50
APR35 2.00	EAC33 2.50	EL41 3.50	M8163 6.50	QD150/40 7.00	YD1100 75.00	4G57 2.25	6C8B 3.95	8805 1.95	30P26 1.75	5678 7.50
AZ11 4.50	EAC33 2.50	EL41 3.50	M8163 6.50	QD150/40 7.00	YD1100 75.00	4G57 2.25	6C8B 3.95	8805 1.95	30P27 1.75	5678 7.50
B716 35.00	EAC33 2.50	EL41 3.50	M8163 6.50	QD150/40 7.00	YD1100 75.00	4G57 2.25	6C8B 3.95	8805 1.95	30P28 1.75	5678 7.50
B758 55.00	EAC33 2.50	EL41 3.50	M8163 6.50	QD150/40 7.00	YD1100 75.00	4G57 2.25	6C8B 3.95	8805 1.95	30P29 1.75	5678 7.50
B717 25.00	EAC33 2.50	EL41 3.50	M8163 6.50	QD150/40 7.00	YD1100 75.00	4G57 2.25	6C8B 3.95	8805 1.95	30P30 1.75	5678 7.50
BT113 35.00	EAC33 2.50	EL41 3.50	M8163 6.50	QD150/40 7.00	YD1100 75.00	4G57 2.25	6C8B 3.95	8805 1.95	30P31 1.75	5678 7.50
CK 27.50	EAC33 2.50	EL41 3.50	M8163 6.50	QD150/40 7.00	YD1100 75.00	4G57 2.25	6C8B 3.95	8805 1.95	30P32 1.75	5678 7.50
CM 17.95	EAC33 2.50	EL41 3.50	M8163 6.50	QD150/40 7.00	YD1100 75.00	4G57 2.25	6C8B 3.95	8805 1.95	30P33 1.75	5678 7.50
CL1149/1 120.00	EAC33 2.50	EL41 3.50	M8163 6.50	QD150/40 7.00	YD1100 75.00	4G57 2.25	6C8B 3.95	8805 1.95	30P34 1.75	5678 7.50
CL1150/1 135.00	EAC33 2.50	EL41 3.50	M8163 6.50	QD150/40 7.00	YD1100 75.00	4G57 2.25	6C8B 3.95	8805 1.95	30P35 1.75	5678 7.50
CL1166 125.00	EAC33 2.50	EL41 3.50	M8163 6.50	QD150/40 7.00	YD1100 75.00	4G57 2.25	6C8B 3.95	8805 1.95	30P36 1.75	5678 7.50
CL1534 32.00	EAC33 2.50	EL41 3.50	M8163 6.50	QD150/40 7.00	YD1100 75.00	4G57 2.25	6C8B 3.95	8805 1.95	30P37 1.75	5678 7.50
CA 32.00	EAC33 2.50	EL41 3.50	M8163 6.50	QD150/40 7.00	YD1100 75.00	4G57 2.25	6C8B 3.95	8805 1.95	30P38 1.75	5678 7.50
CD24 6.50	EAC33 2.50	EL41 3.50	M8163 6.50	QD150/40 7.00	YD1100 75.00	4G57 2.25	6C8B 3.95	8805 1.95	30P39 1.75	5678 7.50
CK1006 3.50	EAC33 2.50	EL41 3.50	M8163 6.50	QD150/40 7.00	YD1100 75.00	4G57 2.25	6C8B 3.95	8805 1.95	30P40 1.75	5678 7.50
CK5676 6.50	EAC33 2.50	EL41 3.50	M8163 6.50	QD150/40 7.00	YD1100 75.00	4G57 2.25	6C8B 3.95	8805 1.95	30P41 1.75	5678 7.50
CV NOS PRICES	EAC33 2.50	EL41 3.50	M8163 6.50	QD150/40 7.00	YD1100 75.00	4G57 2.25	6C8B 3.95	8805 1.95	30P42 1.75	5678 7.50
ON REQUEST	EAC33 2.50	EL41 3.50	M8163 6.50	QD150/40 7.00	YD1100 75.00	4G57 2.25	6C8B 3.95	8805 1.95	30P43 1.75	5678 7.50
CC1140 495.00	EAC33 2.50	EL41 3.50	M8163 6.50	QD150/40 7.00	YD1100 75.00	4G57 2.25	6C8B 3.95	8805 1.95	30P44 1.75	5678 7.50
CC1157 495.00	EAC33 2.50	EL41 3.50	M8163 6.50	QD150/40 7.00	YD1100 75.00	4G57 2.25	6C8B 3.95	8805 1.95	30P45 1.75	5678 7.50
CC1159 399.00	EAC33 2.50	EL41 3.50	M8163 6.50	QD150/40 7.00	YD1100 75.00	4G57 2.25	6C8B 3.95	8805 1.95	30P46 1.75	5678 7.50
D3A 27.50	EAC33 2.50	EL41 3.50	M8163 6.50	QD150/40 7.00	YD1100 75.00	4G57 2.25	6C8B 3.95	8805 1.95	30P47 1.75	5678 7.50
D63 1.20	EAC33 2.50	EL41 3.50	M8163 6.50	QD150/40 7.00	YD1100 75.00	4G57 2.25	6C8B 3.95	8805 1.95	30P48 1.75	5678 7.50
DA41 22.50	EAC33 2.50	EL41 3.50	M8163 6.50	QD150/40 7.00	YD1100 75.00	4G57 2.25	6C8B 3.95	8805 1.95	30P49 1.75	5678 7.50
DA42 17.50	EAC33 2.50	EL41 3.50	M8163 6.50	QD150/40 7.00	YD1100 75.00	4G57 2.25	6C8B 3.95	8805 1.95	30P50 1.75	5678 7.50
DA90 4.50	EAC33 2.50	EL41 3.50	M8163 6.50	QD150/40 7.00	YD1100 75.00	4G57 2.25	6C8B 3.95	8805 1.95	30P51 1.75	5678 7.50
DAF91 0.95	EAC33 2.50	EL41 3.50	M8163 6.50	QD150/40 7.00	YD1100 75.00	4G57 2.25	6C8B 3.95	8805 1.95	30P52 1.75	5678 7.50
DAF96 0.95	EAC33 2.50	EL41 3.50	M8163 6.50	QD150/40 7.00	YD1100 75.00	4G57 2.25	6C8B 3.95	8805 1.95	30P53 1.75	5678 7.50
DC70 1.75	EAC33 2.50	EL41 3.50	M8163 6.50	QD150/40 7.00	YD1100 75.00	4G57 2.25	6C8B 3.95	8805 1.95	30P54 1.75	5678 7.50
DC90 3.50	EAC33 2.50	EL41 3.50	M8163 6.50	QD150/40 7.00	YD1100 75.00	4G57 2.25	6C8B 3.95	8805 1.95	30P55 1.75	5678 7.50
DCX-4-5000 25.00	EAC33 2.50	EL41 3.50	M8163 6.50	QD150/40 7.00	YD1100 75.00	4G57 2.25	6C8B 3.95	8805 1.95	30P56 1.75	5678 7.50
DET16 28.50	EAC33 2.50	EL41 3.50	M8163 6.50	QD150/40 7.00	YD1100 75.00	4G57 2.25	6C8B 3.95	8805 1.95	30P57 1.75	5678 7.50
DET18 28.50	EAC33 2.50	EL41 3.50	M8163 6.50	QD150/40 7.00	YD1100 75.00	4G57 2.25	6C8B 3.95	8805 1.95	30P58 1.75	5678 7.50
DET20 2.50	EAC33 2.50	EL41 3.50	M8163 6.50	QD150/40 7.00	YD1100 75.00	4G57 2.25	6C8B 3.95	8805 1.95	30P59 1.75	5678 7.50
DET22 29.50	EAC33 2.50	EL41 3.50	M8163 6.50	QD150/40 7.00	YD1100 75.00	4G57 2.25	6C8B 3.95	8805 1.95	30P60 1.75	5678 7.50
DET23 35.00	EAC33 2.50	EL41 3.50	M8163 6.50	QD150/40 7.00	YD1100 75.00	4G57 2.25	6C8B 3.95	8805 1.95	30P61 1.75	5678 7.50
DET24 27.50	EAC33 2.50	EL41 3.50	M8163 6.50	QD150/40 7.00	YD1100 75.00	4G57 2.25	6C8B 3.95	8805 1.95	30P62 1.75	5678 7.50
DET25 22.00	EAC33 2.50	EL41 3.50	M8163 6.50	QD150/40 7.00	YD1100 75.00	4G57 2.25	6C8B 3.95	8805 1.95	30P63 1.75	5678 7.50
DET29 32.00	EAC33 2.50	EL41 3.50	M8163 6.50	QD150/40 7.00	YD1100 75.00	4G57 2.25	6C8B 3.95	8805 1.95	30P64 1.75	5678 7.50
DF61 3.50	EAC33 2.50	EL41 3.50	M8163 6.50	QD150/40 7.00	YD1100 75.00	4G57 2.25	6C8B 3.95	8805 1.95	30P65 1.75	5678 7.50
DF91 1.50	EAC33 2.50	EL41 3.50	M8163 6.50	QD150/40 7.00	YD1100 75.00	4G57 2.25	6C8B 3.95	8805 1.95	30P66 1.75	5678 7.50
DF92 1.50	EAC33 2.50	EL41 3.50	M8163 6.50	QD150/40 7.00	YD1100 75.00	4G57 2.25	6C8B 3.95	8805 1.95	30P67 1.75	5678 7.50
DF96 1.25	EAC33 2.50	EL41 3.50	M8163 6.50	QD150/40 7.00	YD1100 75.00	4G57 2.25	6C8B 3.95	8805 1.95	30P68 1.75	5678 7.50
DF97 1.25	EAC33 2.50	EL41 3.50	M8163 6.50	QD150/40 7.00	YD1100 75.00	4G57 2.25	6C8B 3.95	8805 1.95	30P69 1.75	5678 7.50
DG10A 8.50	EAC33 2.50	EL41 3.50	M8163 6.50	QD150/40 7.00	YD1100 75.00	4G57 2.25	6C8B 3.95	8805 1.95	30P70 1.75	5678 7.50
DH63 3.50	EAC33 2.50	EL41 3.50	M8163 6.50	QD150/40 7.00	YD1100 75.00	4G57 2.25	6C8B 3.95	8805 1.95	30P71 1.75	5678 7.50
DH77 1.50	EAC33 2.50	EL41 3.50	M8163 6.50	QD150/40 7.00	YD1100 75.00	4G57				

CLASSIFIED

081-661 8640

CLASSIFIED DISPLAY: £29 per single column centimetre (min 3cm).
LINE ADVERTISEMENTS (run on): £6.00 per line, minimum £48 (pre payable).
(Please add on 15% V.A.T. for prepaid advertisements).

BOX NUMBERS: £15.00 extra. (Replies should be addressed to the box number in the advertisement, c/o Quadrant House, The Quadrant, Sutton, Surrey SM2 5AS).

Cheques and Postal Orders payable to REED BUSINESS PUBLISHING GROUP LTD and crossed.

ARTICLES FOR SALE

Disposal of Electronic Components
Over 8,000 lines (100,000 pieces)
To be sold by competitive tender
For Details Apply:-

Independent Broadcasting Authority
4-5, Sandridge Close
Harrow, Middlesex HA1 1XD
Tel: 081-863 0011

(Closing Date 16th November 1990)

**TO MANUFACTURERS, WHOLESALERS,
BULK BUYERS, ETC.**

**LARGE QUANTITIES OF RADIO, TV AND
ELECTRONIC COMPONENTS FOR DISPOSAL**

SEMICONDUCTORS, all types, INTEGRATED CIRCUITS, TRANSISTORS, DIODES,
RECTIFIERS, THYRISTORS, etc. RESISTORS, C/F, M/F, W/W, etc. CAPACITORS,
SILVER-MICA, POLYSTYRENE, C280, C296, DISC CERAMICS, PLATE CERAMICS, etc.
ELECTROLYTIC CONDENSERS, SPEAKERS, CONNECTING WIRE, CABLES SCREENED
WIRE, SCREWS, NUTS, CHOKES, TRANSFORMERS, etc ALL AT KNOCKOUT PRICES

- Come and pay us a visit ALADDIN'S CAVE

TELEPHONE 081 445 0749/445 2713

R. HENSON LTD.

21 Lodge Lane, North Finchley, London N12 83G.
(5 minutes from Tally Ho Corner)

**VALVES FOR AUDIO, INDUSTRY,
RECEIVING & TRANSMITTING**

ALSO C.R.T.s., I.C.s., KLYSTRONS, MAGNETRONS, TRANSISTORS, USA VALVES.
ONE MILLION VALVES IN STOCK - OBSOLETE TYPES A SPECIALITY!
SPECIAL PRICES FOR WHOLESALE QUANTITIES. EXPORT ENQUIRIES WELCOME
FAX OR PHONE FOR IMMEDIATE QUOTE.



BILLINGTON VALVES

Oakendene Industrial Estate, Cowfold, Nr. Horsham, Sussex RH13 8AZ.

Callers by appointment only.

Fax: 0403 865106 Telex: 87271 PRODSS G

Telephone: 0403 865105

Min U.K. order £20 + VAT. Min Export order £50 + carriage.

COMPUTER WEEKLY BOOKS

★ ★ ★ ★ ★ ★ ★ ★

Hitchhikers' Guide to Electronics in the '90s

How the electronics industry works, its key products and the implications for everyone of this life-changing industry in the 1990s.

Price £12.95 (plus £1 p&p)

★ ★ ★ ★ ★ ★ ★ ★

Aliens' Guide to the Computer Industry

Lively, authoritative and jargon-free overview of how the industry works. Essential handbook for those inside and outside the industry. Ideal for new recruits.

Price £9.95 (plus £1 p&p)

★ ★ ★ ★ ★ ★ ★ ★

Ring Credit Card Hotline:

081-685 9435

Or send a cheque to: Computer Weekly,

120-126 Lavender Avenue, Mitcham, Surrey CR4 3HP

Technical & Scientific Supplies

Trace Recorder, EMU SE 0000, 800/1600 1p channel £700

Mass Disturbance analyser Stratos series £25 £2300

SIF Sig Gen HP4380 3.6 to 7.6 GHz £700

AC Calibrator HP 745A £2800

MM Min. Mill power supplies from 145 to £35

Quadrantary PRECISE 2000Hz, dual 10 to 500 Hz £200

Accumulator Switchport 4-Box £75 £700-400, Box £250

Pressure Trans. 1/2 inch vented gauge 0-10 4-200 Bar £25

AAA microphones 1/2 inch 4030, with 000000 00000 £500

Microscope/cathode-ray, Pye 6000, 1 inch objective £200

Stereograph, electronic with 400 display, 12", 100 £200

Fire Services Also: Valves, Components, etc

All prices are ex carriage and VAT.

Lists now available, please write/ran/phone:-

Technical & Scientific Supplies, #0 Box 10,

Hylton, Southamption, Hampshire, SO4 62Q.

Tel:- (0703) 848 086 Fax:- (0703) 897 070

GOLLEDGE

ELECTRONICS

**QUARTZ CRYSTALS OSCILLATORS
AND FILTERS** of all types. Large stocks
of standard items. Specials supplied to
order. Personal and export orders welco-
med - SAE for lists please. OEM support
thru: design advice prototype quantities,
production schedules. Golledge Electron-
ics, Merriott, Somerset TA16 5NS. Tel:
(0460) 73718. (0472)

TOROIDAL TRANSFORMERS

- ★ NOW BS5750 PART II APPROVAL FOR ALL OUR POWER PRODUCTS
- ★ High quality triple insulated Toroidal Transformers from 10VA to 1000VA.
- ★ SMPSU Transformers and chokes
- ★ Large and small production runs at very competitive prices
- ★ Short delivery

DAREN

TRANSFORMERS
23-29 Owen's Road
Diss, Norfolk.
Tel: 0379 644233
Fax: 0379 650118

BEDFORDSHIRE FIRE AND RESCUE SERVICE

**MAINTENANCE OF
MOBILISING AND
COMMUNICATIONS
EQUIPMENT**

Applications are invited from suitable firms wishing to tender for the main-
tenance, from 1st January 1991, of
Mobilising and Communications Equip-
ment. Tender forms may be obtained
from The Chief Supplies Officer, Bed-
fordshire County Council, County Hall,
Cauldwell Street, Bedford, MK42 9AP.
Telephone Bedford (0234) 228894.

Closing date for receipt of tenders is 9
November 1990.

**LATE TENDERS WILL NOT
BE ACCEPTED**

ARTICLES WANTED

WANTED

Receivers, Transmitters, Test
Equipment, Components, Cable
and Electronic, Scrap, Boxes,
PCB's, Plugs and Sockets,
Computers, Edge Connectors.
**TOP PRICES PAID FOR ALL TYPES OF
ELECTRONICS EQUIPMENT**

A.R. Sinclair, Electronics, Stockholders,
2 Normans Lane, Rabley Heath, Welwyn,
Herts AL6 9TQ. Telephone: 0438 812 193.
Mobile: 0860 214302. Fax: 0438 812 387

WANTED

Test equipment, receivers,
valves, transmitters,
components, cable and
electronic scrap and quantity.
Prompt service and cash.

M & B RADIO
86 Bishopgate Street,
Leeds LS1 4BB.
Tel: 0532 435649
Fax: 0532 426881

STEWART OF READING

110 WYKHAM ROAD,
READING, RG6 1PL.
TEL: 0734 68041
FAX: 0734 351696

**TOP PRICES PAID FOR ALL
TYPES OF SURPLUS TEST
EQUIPMENT, COMPUTER
EQUIPMENT, COMPONENTS
etc. ANY QUANTITY.**

103

**WANTED: VALVES TRANSISTORS
I.C.s** (especially types KT66, KT88
PX4, PX25). Also plugs, sockets and
complete factory clearance. If possi-
ble, send written list for offer by
return. Billington Valves, phone 0403
865105. Fax: 0403 865106. See adjoining
advert.

APPOINTMENTS

081-661 8640

DISPLAY APPOINTMENTS

£29 per single col. centimetre (min. 3cm).

Full page £2311

½ page £1271

Full colour £400

¼ page £693

2nd colour £275

Cheques and Postal Orders payable to REED BUSINESS PUBLISHING GROUP LTD and crossed.

Garibaldi - RF & Microwave

We are the specialist agency for 'Radio Frequency' design or test Engineers working from 1MHz to 11GHz! We have hundreds of top positions throughout the UK, working on RF mobile comms (GSM, PCN, CT2), opto, satellite, mm-wave & microwave projects. Please contact our consultant **Simon Luttrell MSc** on **0494 792592**
160 Bellingdon Road, Chesham, Bucks. HP5 2HF.

Wanted urgently. Practical people for the Third World.

Sharing your skill with people in the Third World is an experience which brings challenge and true job satisfaction.

VSO has urgent requests for the following:

- Studio Electronics Engineer
- Hospital Electronics Engineer
- Lecturers in Power and Communication
- Refrigeration/ Radio/TV Engineers
- Electrical Engineers for instruction/installation
- Electronics Instructors
- Maintenance and Repair Technician

For more details, please complete and return the coupon to: **Enquiries Unit, VSO, 317 Putney Bridge Road, London SW15 2PN. Telephone 081-780 1331.**

- Conditions of work:
- Pay based on local rates
 - Equipment and re-equipment grants provided
 - Rent-free accommodation usually provided
 - National Insurance and medical insurance paid
 - Language training provided where necessary
 - Return flight paid
 - Posts (always approved by our field staff) are for a minimum of two years.

VSO

It's a working experience.

I'm interested. I have the following training/experience:

Name _____

Telephone _____

Address _____

Postcode _____

EWV/8/90

Charity No. 313757.

20p stamp appreciated.



ALL THINGS TO ALL MEN?

Perhaps not. But we do recruit a wide range of professionals for companies throughout the UK and Europe.

So, if you have experience in the following areas:

- TEST ENGINEERS
- CALIBRATION ENGINEERS
- SERVICE ENGINEERS
- AUDIO ENGINEERS
- RF ENGINEERS
- DESIGN ENGINEERS
- DESIGN DRAUGHTPERSONS

and would like more information or an informal chat, call:

Martin Ennis or Paul Atherton
Telub Inforum Services Limited
11 Bancroft, Hitchin, Hertfordshire SG5 1JQ, UK
Telephone: +44 (0) 462 420024
Fax: +44 (0) 462 420394
D of E Licence No. Se(A) 2824

TelubInforum

ABERDEEN PORTSMOUTH HITCHIN
KAMPEN (NL) STUTTGART (D)

**To Advertise
in this section
please
contact
Jan Thorpe
on
081 661 3130
or
Fax copy to
her on
081 661 8939**

ELECTRONIC ENGINEERS

Make your next career
move a milestone not
a millstone.

Irrespective of your career
objectives — financial or
geographical — let Cadmus put
direction into your search.

If you are a Qualified Service,
Sales, Design, Production, Test
or Quality Engineer, send your
C.V. to the address below or
telephone Norwich 761 220 for
an informal chat.



PERSONNEL LIMITED

Freepost, Sackville Place
44-48 Magdalen Street
Norwich NR3 1BR



APPOINTMENTS

RF Engineers **Circuit Design Systems Design** to £27,000

PCN Systems Design

A rare opportunity for graduate engineers to play a leading role in forming the communications network of the decade. 1-3 years experience of cellular or mobile radio systems design. Antenna or network design skills an advantage. Full company benefits and a negotiable salary are on offer!

UHF Circuit Design

Several positions available for RF Engineers with 1-6 years circuit design experience, particularly at 900MHz and 1.6GHz. Projects range from CT2 and Cellular to GPS. Locations in Hants and Herts, Northants and Notts! Our client companies are seeking your skills urgently, so contact me today.

Project Manager

We have an urgent requirement for a senior level RF Project Manager to lead a small design team working on UHF communications techniques. A background in cellular or mobile communications, with perhaps GSM or leaky feeder knowledge is required, plus several years at group leader or similar level.

PMR/Trunked Systems

With a background of PMR or Utilities systems design, you will go far with this multinational company. At least 1 years relevant experience, plus HNC or equivalent. Trunked radio systems knowledge is a definite advantage. Very competitive salary plus outstanding career opportunities.

VHF Circuit Design

Two clients are keen to recruit engineers to join projects concerned with low power receiver and transceiver design. HNC or equivalent, plus 2 years relevant experience will get you an interview! These are CT1 and pager related projects - locations are Devon, Wales and Hants.

Want to know more?

Contact
Simon Luttrell MSc on
0494 792592

or write:

160 Bellingdon Rd.
Chesham
Bucks.
HP5 2HF.

Garibaldi

Please check our latest vacancies on ORACLE (London & TVS) page 284.

(7039)

BROADCAST ENGINEERS

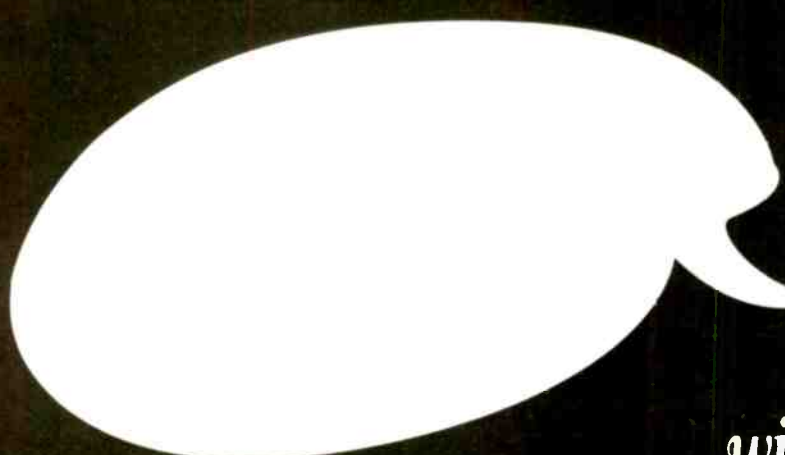

We'd be
lost for words
without the finest
Network Radio
Engineers



R A D I O

We are an equal opportunities employer

Keeping five Radio Networks on-air and trouble free is no mean feat. Much of the credit for this depends on the skill and commitment of our engineers.

We are looking for degree and HND qualified engineers with experience in a broadcast related or communications environment. If you want a technical leadership role that's hands-on and where you'll be expected to be effective from day one, then get in touch.

Your first year's earnings could be £19,250 (including shift allowances) depending on experience and you'll be based in London. We also welcome applications from recent graduates - salaries from £14,250. Training will be tailored to meet your individual needs.

Whether you're new to the BBC, or returning after a break, ring Jenny Mitchell on 071-927 4641 for more information, or write to: BBC Engineering and Technical Operations Recruitment, PO Box 2BL, London W1A 2BL, quoting reference 4427/EW/W.

NEW MATMOS 286 and 386 COMPATIBLE COMPUTERS

MATMOS 286 AND 386 HIGH PERFORMANCE COMPATIBLE COMPUTERS

16MHz 286 system: £399 plus VAT

A quality system using the industry standard 80286-12 processor, running at a Landmark speed of 16MHz; clock speed 12MHz. Complete with 1 Mbyte RAM expandable to 4 Mbytes. Serial and parallel (Centronics) ports, 101 keyboard, mono graphics card, 1.2 Mbyte 5.25 inch floppy drive, floppy controller for up to 4 drives, hard drive including eight expansion slots (386 bit, 5x16 bit), AMI bios with full setup routine and diagnostics including HDD formatting, well made stylish case with space for up to three 5.25 drives and two 3.5 inch drives, lock, front panel switches and LEDs, full manual included.

33MHz 386MHz system: £979 plus VAT

Same system as above but with state-of-the-art 386 motherboard. Uses full spec. Intel 80386-25 mother board running at a Landmark speed of 33MHz; clock speed 25MHz. This is not a 386sx but has a full 32 bit CPU. Comes with 1 Mbyte of RAM upgradable to 8 Mbyte. Also available in quality full height tower case at £1079 plus VAT. Carriage on systems £14 plus VAT. See below for add-ons.

FLOPPY DRIVES

Internal

720K 3.5 INCH DISK DRIVE! AMAZING NEW LOW PRICE TO CLEAR WAREHOUSE!

Excellent Japanese low component, half-height chassis drives. Ex almost new systems, 80 track double sided £29.95 (carr £3). Easy fit kit for Amstrad 1512/1640, IBM XT and AT, etc., including adaptor board and cradle for 5.25 inch slot, £8.49. Box of ten 3.5" disks £9.95 (carr £1). NB Drives work with virtually all computers including Amstrads, IBM XT and AT compatibles BBC's etc. not Ataris and Amiges.

360K 5.25 inch standard quality IBM half-height chassis drive £29.95 (carr £3.50).

720K 3.5 inch NEC FD1036 30mm drive £32.50 (carr £3). Fitting kit for 5.25 inch space £8.49.

1.44 Mbyte 3.5 inch Citizen OSDA 45A 3.5 inch slim (25mm) drive £49.50 (carr £3). Fitting kit for 5.25 inch space £8.49.

720K version of above £39.50. (carr. £3)

IBM standard floppy disk drive cable £4.

External

1.44 Mbyte cased Amstrad FO-9 drive for Amstrad 2286 only £59.50 (carr £3.50).

720K cased Standard 720K 3.5" in smart case with cable to suit Amstrad 2286 series of machines but could be adapted for standard XT/AT applications. £39.50 (carr £3.50).

HARD DISK DRIVES, etc

20 Mbyte Seagate ST 125-1.3.5" 28 m.sec. MFM hard drive: latest, fast, silent technology. £139 (carr £4). 20 Mbyte Miniscribe 8225 state of the art hard drive with embedded controller and all cabling to connect straight to 16 bit AT slot, 5.25 inch, half-height £159 (carr £5). £129 when ordered with 286 and 386 systems.

40 Mbyte Western Digital 584R RLL half-height 3.5 inch drive in 5.25 inch chassis £199 (carr £4).

50 Mbyte Seagate 3.5 inch 28 m.sec RLL £209 (carr £4) or available as hard card for Amstrad, XT or AT £229 (carr £5).

HD cable set £5.00.

DISK DRIVE CONTROLLER CARDS

XT MFM £37.50, XT RLL £37.50.

AT RLL £37.50, AT MFM £49.95 (Carr £2.50).

10MHz XT motherboard, 8088 processor, 8 expansion slots, legal bios, 8087 socket £49.50 (carr. £4). 640K RAM for above £44.50. Mono graphics cards, £22.50. Multi I/O board for XT systems including parallel port, serial port, real time clock, floppy disc controller and game port. £29.95 (carr £2.50) 102 key compatible AT and XT keyboard £34.50. Used but clean 101 key compatible keyboard £19.50 (carr £3.50).

MONITORS - MONO

12 inch Xerox System 60 Hercules paperwhite; very smart case with tilt-and-swivel base, particularly good, user-friendly high res. display £59.95 (carr £6.50).

12 inch Hercules amber; 12 volt supply voltage (psu needed) £34.50 (carr £5).

14 inch VGA paperwhite; smart case, tilt-and-swivel base £89.50 (carr £6.50).

MONITORS - COLOUR

Famous name 12 inch high resolution analogue RGB monitor; high definition (80 column, 0.28 dot pitch), modern, very stylish case with tilt-and-swivel base. Available modified (to 50Hz vertical) for use with a BBC, Amiga etc. at £149 or un-modified (60 Hz vertical) at £129 (carr £10). The modified version can be used on Ataris if sync signals are combined.

14 inch VGA Ex demonstration totally compatible 14 inch EGA ex-demonstration monitors. £139 (carr. £10) colour monitors. Good quality display £179 (carr £10).

14 inch 1024x768 VGA Latest multi sync VGA .28 dot pitch. Displays up to 1024x768 at a very high quality £299 (carr £10).

Hitachi CAD monitors CM1686A; 16 Inch 64KHz ultra high resolution (not VGA) £395; (carr £20).

PRINTERS

Olivetti DY200. Modern, office quality, bidirectional daisywheel printer. Complete with manual, daisywheel, ribbon and standard Centronics interface. Prints at 25 cps, variable pitch; 132 characters in 12 pitch, proportional spacing. Full IBM and Diablo emulations. £89.50 (carr £6.50). Cut sheet feeder £45.50, tractor feeder £43 (carr £4).

VGA CARDS

16 bit VGA card, 256K, all emulations, up to 800 x 600, with software to run all major packages, switchable for use in XT's £74.95.

16 bit designer VGA card, all emulations up to 800 x 600, 256K RAM, upgradable to 512K. Paradise chip-set with software to run with all major packages, XT switchable. £99.50. 1024x768 super VGA card. Very high resolution with 512K and software £119 (carriage on cards £2.00).

WESTINGHOUSE WPC500 MODERN CARD

Standard size card to fit inside IBM-style or similar PC and communicate at 1200 Baud, 1200/75 Baud or 300 Baud. Sold 'as is', with limited details and no support £9.50 (carr £2.50). Full user's manual available at £4.

POWER SUPPLIES

Astec BM140 IBM XT/AT compatible 150W: +5V at 15A, +12V at 5A, -5V at 0.3A, -12V at 0.5A; fan cooled, rear panel switch, good value at £19.50 (carr £4).

IBM COMPATIBLE XT and AT MOTHERBOARDS, CASES, MEMORY, CARDS AND KEYBOARDS

12MHz. AT motherboard, 80286 cpu, 8 expansion slots, full AMI bios with diagnostics etc., 80287 socket, manual, Landmark speed of 16MHz, accepts up to 4 Meg of RAM on board. £99.00 (carr £3.50). 1 Meg of RAM for above £49.50.

16 MHz. 08387 maths co-processor £199.

AT I/O card £27.50, AT floppy disk controller £20 (carr £2).

NB
* VAT and carriage must be added to all items (quotes for carriage overseas)
* Everything new and guaranteed 6 months unless stated
* Access and Visa telephone service
MATMOS LTD, UNIT 11 THE ENTERPRISE PARK, LEWES ROAD, LINDFIELD, WEST SUSSEX RH16 2LX.
0444 482091 and 0444 483830 (Fax 0444 484258)
Matmos Ltd. have been successfully trading since 1976.

CIRCLE NO. 148 ON REPLY CARD

INDEX TO ADVERTISERS

	PAGE		PAGE		PAGE
Anchor Surplus	1014	Gespac S.A.	943	PM Components	1020
Antex Electronics	930	Greenweld	1014	Professional Solutions	
Antrim Transformers	977	Halcyon Electronics	977		944 & 945
A P Products	972	Happy Memories	1013	Raedek Electronics	956
Artistic Licence	941	Hawke	1013	R Henson	987
ATS	1001	Ian P Kinlock	956	Scientific Computing	930
Audio Electronics	971	I Com (UK)	956	Sherwood Data Systems	
Blackstar	1012	IR Group	935		1016
Citadel	OBC	JAV	961	Smart	959 & 987
City Satellite Systems	1004	J B Designs	997	Solex	IFC
Crash Barrier	1013	Johns Radio	1018	South Midlands	
Datamation	961	Kestrel Electronics	971	Communications	961
Digitask	951	Labvolt	IBC	Sowter Transformers	971
Display Electronics	982	Langrex Supplies	959	Stewart of Reading	991
Ellmax	959	Laplace Instruments	954	Strumech Engineering	991
Emulux	972	Matmos	1024	Those Engineers	991
Farnell International	946	M&B Electrical	989	Thurlby Thandar	
Feedback (UK)	987	MPE	1016		989, 1018
Field Electric	1001	MQP Electronics	977	TRL	1001
Flash Designs	972	Number One Systems	932	Tsien	955

OVERSEAS ADVERTISEMENT AGENTS

France and Belgium: Pierre Mussard, 18-20 Place de la Madeleine, Paris 75008.

United States of America: Jay Fenman, Reed Business Ltd., 205 East 42nd Street, New York, NY 10017 - Telephone (212) 867 2080 - Telex 23827.

Printed in Great Britain by Carlisle Web Offset, Caxton Road, Newtown Trading Estate, Carlisle, Cumbria CA2 7NR, and typeset by Marlin Graphics, Sidcup, Kent DA14 5DT, for the proprietors, Reed Business Publishing Ltd, Quadrant House, The Quadrant, Sutton, Surrey SM2 5AS. © Reed Publishing Ltd 1990. *Electronics and Wireless World* can be obtained from the following: AUSTRALIA and NEW ZEALAND: Gordon & Gotch Ltd, INDIA: A.H. Wheeler & Co, CANADA: The Wm Dawson Subscription Service Ltd.; Gordon & Gotch Ltd., SOUTH AFRICA: Central News Agency Ltd.; William Dawson & Sons (S.A.) Ltd., UNITED STATES: Worldwide Media Services Inc., 115 East 23rd Street, NEW YORK, N.Y. 10010. USA. *Electronics & Wireless World* \$5.95 (74513).

FACET Fits Your Electronics Curriculum Today and Tomorrow

Lab-Volt's F.A.C.E.T. Training System is a flexible fault assisted circuits for electronics training system designed to conform to a wide variety of curriculum requirements.



F.A.C.E.T. is modular. It is comprised of a manual or computer-assisted base unit, and analog and digital circuit modules with companion lab manuals and software. Both system versions are compatible—making a hybrid laboratory arrangement possible.

F.A.C.E.T. aids in your students' comprehension and retention of basic-to-advanced technical topics . . . and does it while teaching proper troubleshooting techniques.

So, whether you choose a manual or computer-assisted configuration, F.A.C.E.T. is the system for managing your classroom.

For more information regarding this versatile electronics training system please contact:

Lab-Volt Systems
P.O. Box 686
Farmingdale, New Jersey 07727
Telephone: (in NJ) 201-938-2000
Telex: 13-2416 Fax: 201-774-8573

Lab-Volt (U.K.) LTD.
2 Stephenson Road, Industrial Estate
St. Ives, Cambridgeshire, PE17 4WJ
England
Tel: (0480) 300695 Fax: (0480) 61654



FACET, THE NEXT GENERATION OF INSTRUCTIONAL TECHNOLOGY

CIRCLE ENQUIRY NO. 102 ON BACK PAGE

PROGRAMMING SOLUTIONS — from £139

For the IBM PC, install the interface card and programming socket, load the menu driven software and you have a complete design system at your fingertips.

EASY TO INSTALL

The programmer comes with an interface card that plugs into any free slot of your PC. There is no DMA channel to worry about and it occupies limited I/O space. The programmer socket box is connected via a ribbon cable to the back of the interface card so that the socket box is external. After the interface card is installed the PC never need be opened again.

SOFTWARE DRIVEN

All software for the programmer is supplied on 5 1/4" low density disk. The software can be copied onto hard disk using the DOS copy command. Programs are supplied for the various features and are menu driven. All programming is done from the menu, no hardware switches are needed. Just select the type and manufacturer and the programming is done automatically.

SUIT ALL PC'S

The programmers will run on any compatible IBM machines such as XT's, AT's, '386 and '486. Whether it be AMSTRAD or COMPAQ the programmers will work. The software is text only monographic so is compatible with any machine.

FEATURES

The menu driven software is a full editing, filing and compiling package as well as a programming package. Save to disk and load from disk allows full filing of patterns on disk, to be saved and recalled instantaneously. Device blank check, checksum, program, verify, read and modify are all standard features. Hex to bin file conversions included for popular file formats including Intel, Motorola etc.

MODELS

PC84 -1, -4, -8 Eprom programmers only. The variant is only gang size. The -4 and -8 gang will program multiple EPROMs simultaneously. Device sizes are from 2716 to 271000 both C and NMOS. ZIF (zero insertion force) sockets are used on all models.

PC83

PAL programmer only. Will program most 20 and 24 pin types from TI, NS & MMI from standard Jedec files.

PC82

Universal programmer. The complete designers kit. This will program EPROMS, EEROMS, BPROMS, PALS, GALS, EPLD's Z8 and 87XX microprocessors.

A unique feature is the testing of logic parts such as 74LS393 etc. The PC82 can check and identify parts. Already programmed are the TTL and CMOS logic test vectors. Software is supplied to write vectors for most unique chips.



DEVICE GUIDE

	PC82	PC83	PC84
EPROM 2716, 32, 64, 128, 256, 512, 1324 Vpp 12.5, 21, 25	✓	—	✓
EPROM 27C16, 32, 64, 128, 256, 512 1024 Vpp 12.5, 21	✓	—	✓
EEPROM 2816, 16A, 17, 17A, 64A, 256A, 9306, 46, 56, CS06, C46, C56	✓	—	—
3PROM 32X8 to 4096X8. Incl 63S080, 7C28X, 29X	✓	—	—
PAL 10, 12, 14, 16, 18, 20, L, R, X, P, 1, 2, 4, 8, 10 (20&24 pin)	✓	✓	—
GAL 16V8, 20V8	✓	—	—
EPLD 20G10, 22V10, EP610, 320, 600, 900, 5C031, 32, 60, 90	✓	—	—
CMOS EPAL C16L8, R8, R6, R4	✓	—	—
MPU Z8, 8748, 49, 50, 51, C51, C52, C252. Inc. encryp. lock bits	✓	—	—
Device testing TTL/CMOS logic, DRAM & SRAM	✓	—	—
Selection of speed algorithm fast, intelligent, Intel etc.	✓	—	✓
Byte splitting for 16 & 32 bit files	✓	—	✓
Industry standard Jedec files	✓	✓	—
Hardware config. available for software design	✓	—	✓
Self test	✓	✓	✓

PRICE LIST

PC84-1 1 Gang Eprom	£139
FC84-4 4 Gang Eprom	£199
FC84-8 8 Gang Eprom	£299

PC83 Pal Programmer	£275
PC82 Universal Programmer	£469

All pricing includes software, interface card, socket box and full instructions.

(Prices do not include VAT or carriage)

ORDER INFORMATION

Please include £7 carriage plus VAT on all orders. ACCESS, VISA or CWO. Official orders welcome from Gov. bodys & Public Limited Companies. All products carry a one year guarantee.



CITADEL PRODUCTS LTD.
Dept. WW. 50 High Street
Edgware, Middx HA8 7EP.
Tel: 081-951 1848

TTL, CMOS, DRAM & SRAM TESTING

PC82 can test and verify any TTL/CMOS logic chip, DRAM & SRAM. The software will also identify a TTL chip. Do you have a few TTL chips aside not knowing whether they are working?

ALSO AVAILABLE

A wide range of PC expansion cards, Industrial control cards (A/D, D/A and Digital I/O) and PC peripherals.