

ELECTRONICS WORLD

+ WIRELESS WORLD

OCTOBER 1989 £1.95

MANDELBROT

Fractals, chaos
and computers

BIG BROTHER WATCHES

ELECTRONIC
SURVEILLANCE

SCIENCE

Lightning and the
ionosphere

SOFTWARE

CAE reviews
for the PC

Den mark Dkr. 63.00
Germany DM 12.00
Greece Dra. 680
Holland Dfl. 12.50
Italy L 6500
IR €2.97
Spain Pts. 700.00
Singapore S\$ 11.25
USA \$5.95

10



9 770266 324004

Carston - the leaders in top quality second user equipment

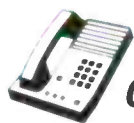

01-943 4477

**YOUR HOTLINE
FOR EQUIPMENT
ADVICE AND
STOCK GUIDE**

TEST & MEASUREMENT EQUIPMENT

COMPUTERS & PERIPHERALS

CALIBRATORS · COUNTERS · DATA LOGGERS
NETWORK ANALYSERS · POWER METERS
COMPUTERS · PRINTER/PLOTTERS · COMP
DATA COMMUNICATION TESTERS

LOGGERS · LOGIC ANALYSERS · OSCILLOSCOPES
POWER METERS · PROTECTIVE DEVICES
PLOTTERS · COMPUTER TERMINALS
COMMUNICATION TESTERS · MAINS TESTERS

**Every item we sell is fully refurbished back
to manufacturer's original specifications.**

ANALYSERS - SIGNAL

Hewlett Packard	
3561A Dynamic signal analyser, 0-100kHz	£6900
3581C Selective level meter	£2750
8566B Spectrum analyser, high performance	£35,000
8970B Noise Figure Meter	£5500

COMPUTER PRODUCTS

Hewlett Packard	
2225A Thinkjet Printer, HP/IB interface	£295
85A Computer/Controller	£650
85D Computer/Controller	£1,400
9122D Disc Drive, dual-sided, 1.42Mb	£650
IBM	
ATE PC with 286 processor, 1.2Mb floppy	£1,150
PC Twin Floppy PC	£195
XT 10Mb XT Computer with 10Mb hard disc	£395

COUNTERS AND TIMERS

Hewlett Packard	
5328A 100MHz Counter/Timer with opt. 020	£575
Racal	
9906 Counter/Timer, DC to 200MHz	£250

DATA LOGGERS

Solartron	
35301B Solid state selector card	£250
3530A 'Alpha' Data logger mainframe	£3000
3530D 'Delta' Data logger mainframe	£3950

DATA/COMMUNICATIONS TEST

Hewlett Packard	
4951A Protocol Analyser, with tape	£1500
4961B Protocol Analyser	£2500

GENERAL PURPOSE TEST & MEASUREMENT

Dranetz	
305C Phasemeter, with 305 PA-3001 plug-in	£4500
626 Mains disturbance analyser	£2600
808A Power demand analyser	£2750

LOGIC ANALYSIS

Hewlett Packard	
1630D Logic Analyser, 43 channels to 100MHz	£2500
1630G Logic Analyser, 65 channels to 100MHz	£4500
1650A Logic Analyser, 80 channels to 100MHz	£5700

OSCILLOSCOPES

Gould	
OS4020 DSO, 10MHz with 2MHz clock, XY out	£800

Our Stock Guide

**lists every-
thing we supply
— over 10,000 items. Ask
for your free copy today!**

Philips	
PM3311 125MHz sampling rate DSO	£1750
Tektronix	
2235 100MHz, dual channel oscilloscope	£900
2213 50MHz dual trace	£400
2213A 50MHz dual trace	£450

SIGNAL SOURCES

Hewlett Packard	
3312A Function Generator	£825
3325A Synthesised Function Generator	£2500
Marconi	
2022 Signal Generator, 1GHz	£2150

Carston ELECTRONICS

CARSTON ELECTRONICS LIMITED 2-6 Queens Road · Teddington · Middlesex TW11 0LR · Tel: 01-943 4477 · Fax: 01-977 9232 · Telex: 938120

CIRCLE NO. 1 ON REPLY CARD

OCTOBER 1989 VOLUME 95 NUMBER 1644

946 **Lightning strikes.** Thunderstorms are a voltage stabilizer between the ionosphere and Earth's surface, says Anthony Hopwood.

957 **Fractals, chaos and computing.** A fashionable branch of mathematics may yield answers to important questions, but is it art?

984 **Stepping on the GaAs.** Microwave integrated circuit technology is pushing the limits of high frequency performance. Fred Myers of Plessey's Caswell research facility defines the limits.

989 **Review – ECA-2 and PSpice.** Simulating a circuit on a PC can replace weeks of costly building and testing. We present a review of two leading software packages.

1006 **Sensors & Systems papers.** This year's conference on transducer and systems technology offers a particularly rich choice of subject matter. We present highlights from the presentations.

1010 **Magneto-resistive sensors.** There are more ways to measure magnetic flux than Hall effect and inductive loops. Magneto-resistivity provides a useful alternative.

1013 **Passive optical networks.** The use of copper in public switched network wiring may be a thing of the past. Optical telecomms may provide a high tech alternative.

SPECIAL FEATURE



970 **I spy.** Lee Tracey acts as a quartermaster and adviser to Western security services. He has also worked as a field officer in our own Government agencies. He gives a personal account of the technology used in professional electronic surveillance.



CERN's super collider – all 27km of it – is already producing a new view of fundamental matter. Even bigger machines are being planned, page 944.

next issue



In next month's issue. Audio amplifier design is one of the few areas of electronics where science appears to mix uneasily with art. The issue pits those who believe in the evils of feedback, the sound quality of oxygen-free copper wire and the necessity of using gold-plated connectors against those who advocate calculated electronics. Doyen of audio designers John Linsley Hood presents the first of a series of articles on the evolution of the audio power amplifier.

REGULARS

939 Comment. Green light for electronics, a sensible alternative to defence spending.

941 Research Notes. Micron-sized conductors, the fading star of superconductivity, water from oil, optical delay and smashing electrons.

949 Update. News from around the industry.

967 New Products Classified. The monthly round-up of new products at-a-glance.

995 Letters. Anti-gravity (yet again) gyros, cold fusion, pseudo-science, doubt and faith and more.

1001 Applications. Switch mode power supply without the switching, switched capacitor notch filter, Wheatstone light bridge and serial/parallel D to A.

1015 Pioneers. Léon Charles Thévenin gave the world a theorem. His paper "Extension of Ohm's Law to complex electrical circuits" was introduced as "a new theorem of dynamic electricity".

1019 Analogue Action. The design forum for analogue circuit engineers.

1021 Circuit ideas. Z80 compatible FSK transmitter, composite feedback amplifiers, random security light and transistor tester with integral h_{fe} measurement.

1023 RF Connections. Minimum power radio telemetry, low-noise oscillators and radio physics.

Readers in the USA facing difficulties in obtaining this magazine are invited to call Worldwide Media Services Inc. toll free on (800) 345-6478.

TAYLOR RF/VIDEO MEASUREMENT INSTRUMENTS

MEASUREMENTS MADE EASY



UNAOHM EP741FMS FIELD STRENGTH METER/SPECTRUM ANALYZER

Frequency Range:	38.9MHz to 860MHz, continuously adjustable via a geared-down vernier	
Frequency Reading:	TV Bands - 4 digit counter with 100kHz resolution FM Band - 5 digit counter with 10kHz resolution Reading Accuracy: reference Xtal +/- 1 digit	
Function:	NORMAL	picture only
TV Monitor	ZOOM	2 to 1 horizontal magnification of picture
		picture + line sync pulse (with chromaburst if TV signal is coded for colour)
Panorama:	Panoramic display of the frequency spectrum within the selected band and of tuning marker.	
Panorama Expansion	Adjustable expansion of a portion of the spectrum around the tuned frequency.	
Analogue Measurement:	20 to 40dB. Static measurement of received signal. Scale calibrated in dBuV (at top of picture tube) to rms value of signal level.	
DC/AC Voltmeter:	5 to 50V.	
Measurement Range:	20 to 130dBuV in ten 10dB attenuation steps for all bands. -60 to 130dBuV in nine 10dB steps for I.F.	
Measurement Indication:	ANALOGUE: brightness stripe against calibrated scale superimposed on picture tube. The stripe length is proportional to the sync peak of the video signal.	
Video Output:	BNC connector. 1Vpp maximum on 75Ω.	
DC Output:	+12V/50mA maximum. Power supply source for boosters and converters.	
TV Receiver:	Tunes in and displays CCIR system I TV signals. Other standards upon request.	
Additional Features:	(1) Video input 75Ω (2) 12V input for external car battery. (3) Output connector for stereo earphones	

PRICE: £1344.00 nett. excluding V.A.T. and Carriage



UNAOHM EP742 FIELD STRENGTH METER/SPECTRUM ANALYZER

Specification as EP741 + Synthesized Tuning 99 channels, Programme Storage (EP815 Satellite Converter can be added as illustrated)

PRICE: £1498.00 nett. excluding V.A.T. and Carriage

UNAOHM EP815 T.V. SATELLITE CONVERTER

Frequency Range of Input Signal:	650MHz to 1750MHz. Frequency is continuously adjustable through a geared-down control.
Frequency Reading:	Throughout the frequency meter of the associated field strength meter.
Input Signal Level:	From 20 to 100dBuV in two ranges -20 to 70 and 70 to 100.
Power Source:	Available at BNC input connectors as follows: 15V DC/0.5A internal or 25V DC maximum external.
Status Indication:	Continuity, overload and short circuit conditions of power circuit are all shown by LED lights
Demodulation:	FM for PAL and SECAM coding. Switching to MAC system is provided together with room for an optional MAC decoder
Audio Subcarrier:	5.5MHz to 7.5MHz continuously adjustable. Provision for an automatic frequency control

PRICE: £536.20 nett. excluding V.A.T. and Carriage



UNAOHM EP760 COLOUR TV FIELD STRENGTH METER

INPUT	
Sensitivity:	20 to 130dBuV in ten 10-dB steps for TV and FM bands. 60 to 130dBuV in eight 10-dB steps for I.F.
Readout:	Digital - input signal level provided directly in dB.
FREQUENCY	
Range:	38.9MHz to 860MHz
Selection:	-99 channel frequency synthesis within bands I-III-IV/V. -30 program storage capabilities. -manual tuning with sharp-tune control.
Readout:	Two LCD displays; the first for channel or program; the latter for frequency in MHz with 100kHz resolution for TV bands and 10kHz for FM
SPECTRUM ANALYSIS	
Frequency Range:	The entire TV and FM range. It is possible to display a portion of the selected band.
Marker:	Two markers are available in different colours and with digital frequency reading. In addition to locating frequencies, they are used to define frequency intervals.
Video Filter:	A switchable video filter is provided to improve measurement accuracy in connection with Unaohm noise generator NG750.
SYNC PULSE DISPLAY	
Display:	The entire horizontal blanking time, sync pulse and burst included, is displayed on the left side of the picture tube.
AUDIO	
Mono:	TV and FM audio can be heard through a loudspeaker. 0.5W maximum power.
Stereo:	TV and FM audio can be heard through a pair of earpieces (Z equal to or higher than 8Ω).
VIDEO	
External video input/output:	Approx 1Vpp on 75Ω, positive polarity. Pin pair 19-20 of SCART.
RGB output:	Approx 1Vpp on 75Ω. Pins 7-11-15 of SCART.
Teletext decoder:	All teletext pages broadcast can be recalled by means of the front keyboard of the unit.

PRICE: £2465.40 nett. excluding V.A.T. and Carriage.

TAYLOR BROS (OLDHAM) LTD.
BISLEY STREET WORKS, LEE STREET,
OLDHAM, ENGLAND. OL8 1EE
TEL: 061-652-3221 TELEX: 669911 FAX: 061 626 1736

CONSULTING EDITOR

Philip Darrington

EDITOR

Frank Ogden

EDITOR - INDUSTRY INSIGHT

Geoffrey Shorter, B.Sc.

01-661 8639

DEPUTY EDITOR

Martin Eccles

01-661 8638

COMMUNICATIONS EDITOR

Richard Lambley

01-661 3039

ILLUSTRATION

Roger Goodman

01-661 8690

DESIGN & PRODUCTION

Alan Kerr

01-661 8676

ADVERTISEMENT MANAGER

Paul Kitchen

01-661 3130

CLASSIFIED SALES EXECUTIVE

Christopher Tero

01-661 8640

ADVERTISING PRODUCTION

Una Russ

01-661 8649

PUBLISHER

Susan Downey

01-661 8452

FACSIMILE

01-661 8939



Electronics World + Wireless World is published monthly USPS#7540. By post, current issue £2.25, back issues (if available) £2.50. Order and payments to 301 *Electronics World*, Quadrant House, The Quadrant, Sutton, Surrey SM2 5AS. Cheques should be payable to Reed Business Publishing Ltd. Editorial & Advertising offices: FWW, Quadrant House, The Quadrant, Sutton, Surrey SM2 5AS. Telephones: Editorial 01-661 3614, Advertising 01-661 3130, 01-661 8469. Telex: 892084 REED BP G (FEP). Facsimile: 01-661 8939 (Groups II & III). **Beeline:** 01-661 8978 or 01-661 8986. 300 baud, 7 data bits, even parity, one stop-bit. Send ctrl-Q, then FWW to start, NNNN to sign off. **Newstrade:** Quadrant Publishing Services, No 01-661 3240. **Subscription rates:** 1 year (normal rate) £30, UK and £35 outside UK. **Subscriptions:** Quadrant Subscription Services, Oakfield House, Perry Mount Road, Haywards Heath, Sussex RH16 3D11. Telephone 0444 441212. Please notify a change of address. USA: \$116.00 airmail. Reed Business Publishing (USA) Subscriptions Office, 205 E. 42nd Street, NY 10117. **Overseas advertising agents:** France and Belgium: Pierre Musard, 18-20 Place de la Madeleine, Paris 75008. United States of America: Jay Feinman, Reed Business Publishing Ltd, 205 East 42nd Street, New York, NY 10017. Telephone (212) 867-2080. Telex 23827. USA mailing agents: Mercury Airfreight International Ltd, Inc. 100(b) Englehard Ave, Avenel NJ 07001. 2nd class postage paid at Rahway, NJ. Postmaster: send address to the above.

©Reed Business Publishing Ltd 1989. ISSN 0266-3244

Green light for electronics

While the spirit of *glasnost* has profoundly affected the lives of ordinary people in the Soviet Union and some of its satellites, it has yet to be reflected in any real way by the West's military establishment. The removal of cruise missiles from European bases has only been undertaken in the light of other military developments such as stealth bombers and air-launched cruise missiles which can effectively replace them – not much of a trade in the minds of those who feel strongly about disarmament.

Advocates of new weapons technology would say that while Mikhail Gorbachev may be a "man that we can do business with" we shouldn't trust the political hard-liners in the Kremlin even though we could possibly trust him. But they would say that, wouldn't they? The Warsaw Pact threat, real or imaginary, has provided the will for 'defence' development over the last 40 years and they don't want to see it end. We say that the time is now right to reassess the position.

A tangible enemy provides the spur to technology, but you don't have to look necessarily to the plains of Russia. There are many enemies which threaten us and some of them are becoming fashionable.

One has to admit that there isn't much money or kudos to be had in feeding hungry people. And in any case, the World's poor don't yet threaten our lifestyle directly and can thus be discounted. Atmospheric pollution? This looks more promising. Air pollution derives from fossil fuel burning. Technological warfare in the cause of energy conservation is acceptable, achievable, moves with the green political groundswell and will make money for successful combatants.

A fraction of the UK's current defence budget could provide heat pumps – a sort of refrigerator working in reverse – for every house in the land. These provide three units of heat as output for every unit of heat put into the system. Any Western industry or Government which caused massive energy savings through new technology could gain for itself the respect – if that is the right word – normally associated with membership of a nuclear weapons club.

Development of clean energy sources would open a second front against the rape of our environment, but this must be tinged with realism. Most people would not willingly endorse a decline in their standard of living; the development of a power-generation strategy based on pig manure simply isn't on. We need a switch of development resources from nuclear weapons into nuclear technology. We should start by reinstating the fast-breeder programme with a level of funding on par with the Trident programme. We must endorse high-energy physics research. We should examine district heating programmes beyond simple economics. We need to look at realistic wind and wave power schemes. A substantial wind power research programme initiated in Scotland would make scientific and political sense.

The place of electronics and computing in all this is fundamental. To embark on these projects with determination would produce the technology spin-offs normally associated with defence. And the end result would be far more useful to everyone.

Electronics World + Wireless World

This month sees a slight change in our title to reflect the wider changes in electronics. *Electronics World* reflects our coverage aimed at electronics professionals, for instance in the field of computing tools. *Wireless World* underlines our commitment to retain coverage of those things for which we are famous: prophetic science, audio technology, radiocomms. Cynical? Next month's issue will carry the first part of a definitive series on amplifier design by John Linsley Hood. I enjoyed reading it. I hope you will.

Frank Ogden

NEW PRODUCT

FX009 Digitally Controlled Amplifier Array

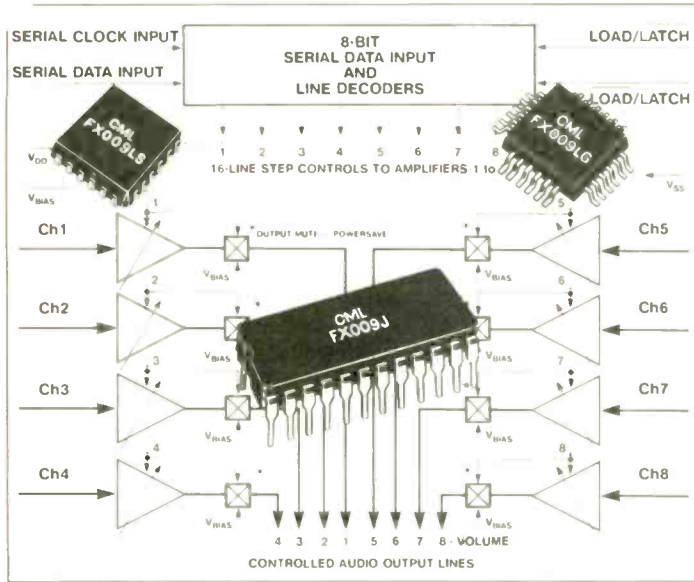

Features/Applications

- 8 Digitally Controlled Amplifiers
- 8-Bit Serial Data Control
- Multi-Channel Remote Control
- Audio/Data/D.C. Level Adjustment
- 7 Individually Controlled 'Fine Adjustment' Stages Providing a $\pm 3.0\text{dB}$ Range in $15 \times 0.43\text{dB}$ Steps
- 1 'Volume' Adjustment Providing a 28.0dB Range in $15 \times 2.0\text{dB}$ Steps
- Radio, Telephony and Control Applications

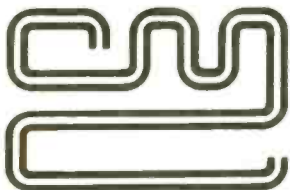

Consumer Microcircuits Limited

1 Wheaton Road, Witham, Essex, CM8 3TD ENGLAND.

Telephone: (0376) 513833. Telex: 99382 CMICRO G. Telefax: (0376) 518247.

CIRCLE NO. 38 ON REPLY CARD

USE PC COMPILERS FOR AN SBC

For really fast development of stand alone systems, use a Lancer or Hunter target board with Hexatron's PromDOS. This emulates DOS and BIOS calls, gives you silicon discs and even allows you to run non-ROMable compiled code in a ROM environment. Too good to be true? Call us now for a free demonstration. STOP PRESS: We now have a four port multi-standard serial expansion card for the Lancer and Hunter – ring us for details.

THE SDS LANCER

An 8088/V20 target board on a double Eurocard with two serial ports, four parallel ports, six counter-timers, four 32 pin memory sockets, battery backup, RTC, watchdog timer, optional 8087, optional mains psu and case.

THE SDS HUNTER

An 80188 target board with 256k bytes EPROM, 256k bytes battery backed RAM, 256k bytes D-RAM, two serial ports, three counter-timers, RTC, watchdog timer, optional mains power supply and case.

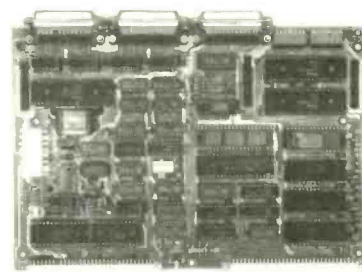

Sherwood Data Systems Ltd

Unit 6, York Way, Cressex Estate, High Wycombe. Tel: 0494 464264

CIRCLE NO. 33 ON REPLY CARD

Progress towards molecular wire

Micron-sized conductors may one day be considered large if research at the University of New Mexico in Albuquerque comes to fruition. Thomas Bein and Patricia Enzel, who presented their findings at a recent meeting of the American Chemical Society in Dallas, have been growing chains of conducting molecules no wider than about a nanometre in diameter.

The basis of their research has been synthetic versions of natural minerals called zeolites. These are rocks containing microscopic channels into which other molecules can migrate. Crystals of zeolite – Greek for “boiling stone” – are so called because they are formed in volcanoes under high pressure and often exude bubbles of water from their internal network of molecular channels.

What Bein and Enzel have done is to take crystals of artificial zeolite and heat them to 400°C in a vacuum to expel any water vapour from the internal spaces. Aniline and an oxidant were then introduced into the spaces, reacting to form long molecular chains of electrically-conducting polyaniline. Other conducting polymers such as polypyrrole and polythiophene have also been introduced into the molecular channels of zeolites, though no experiments have yet been done to pass electricity along them.

Obviously the extent to which this principle can be used to make practical electrical interconnects depends on the internal structure of the particular zeolite. Some zeolites naturally have parallel channels, while others have a variety of different networks. Bein and Enzel have noted about 200 different structures into which they believe it should be possible to introduce not just “wires” but also active components for switching purposes. All this, they think, should be possible using the appropriate chemistry.

Clearly the prospects for ultra-dense circuit fabrication are exciting, especially in view of the possibilities of three-dimensional arrays. What remains to be done now is to develop the fabrication techniques and to ascertain the electrical properties of conductors and active devices at sub-nanometre dimensions. Current-carrying limitations and quantum effects are likely to be among the more obvious limitations. Nevertheless this recent success is exciting because of the potential it holds for stimulating a whole new approach to circuit technology. Ångströtechnology?

Superconductivity: a fading star

One essential difference between high-temperature superconductivity and cold fusion is that the former definitely exists! Beyond that, one might well be forgiven for thinking that they have one very obvious feature in common: ingenuity that never quite became practical. Certainly hopes have faded rapidly for the prospects of instant easy commercialization of superconductivity, though giants like AT&T and IBM are still working hard on it.

As I pointed out in Research Notes (May, page 440) a serious obstacle in the way of many practical applications is the loss of superconductivity in the presence of high currents or high magnetic fields. So while zero resistance at liquid nitrogen temperatures may be achievable, it isn't always possible then to transmit commercially useful currents of 10^7 A/cm² or more.

Technically, the insurmountable obstacle is the breakdown of the magnetic flux lattice. This is an entity created by the quantization of any external magnetic field that penetrates the superconductor. When current is passed through a superconductor, the resulting force pushes against the magnetic lattice, making it “creep” or “melt”. The energy expended then appears to any external source of EMF as resistance. In other words, the superconductor has ceased to superconduct.

In the case of low-temperature (conventional) superconductors, the temperature at which this happens is

These electron micrographs show yttrium-based (left) and bismuth-based (right) superconductors in a 20 gauss magnetic field. Dots are magnetic particles attracted to the ends of flux lines – which, in the bismuth-based material, move about, revealing that the lattice has melted.

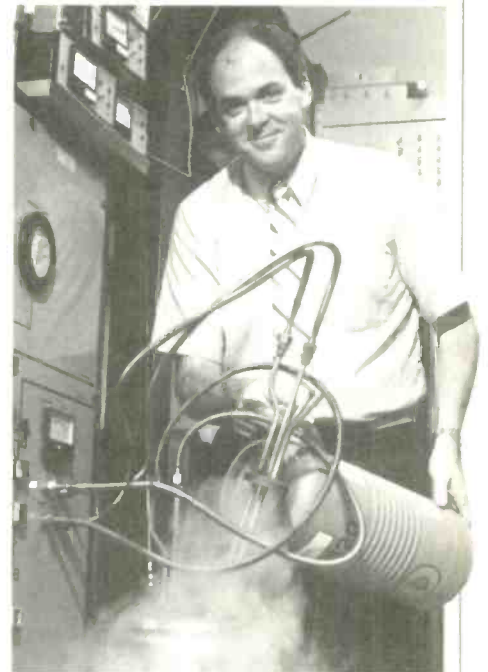

Dr David Bishop, whose images of flux lattice motion appear below (pictures by AT&T Bell Labs).

usually above the critical temperature at which the material superconducts. So while materials like niobium-tin need to be cooled in liquid helium, they can usually carry very large currents. With the so-called high-temperature superconductors, however, it's the other way round. Materials like the barium-yttrium-copper oxide superconductors may well become superconducting at temperatures as high as 93K, but their flux lattices melt at only 75K. This makes them unsuitable for commercial uses at liquid nitrogen temperatures.

What's particularly depressing for superconductivity researchers is the fact that although materials are being discovered with higher critical temperatures, the same higher temperatures are virtually always associated with weaker and more fluid lattices. So although materials are being persuaded to superconduct at ever-higher temperatures, there's an inverse factor that seems progressively to reduce the amount of current they can carry. For that reason some researchers now believe that the holy grail of room-temperature superconductivity may be unachievable – at least for any practical purpose.

ELECTRONIC TUBES/VALVES R.F. AND MICROWAVE COMPONENTS

PRODUCT RANGE

CRT's	R.F. CAPACITORS
CAMERA TUBES	R.F. TRANSISTORS
COAXIAL ISOLATORS & CIRCULATORS	RECEIVING TUBES
DIODES	RECTIFIERS
IGNITRONS	SILICON CONTROLLED RECTIFIERS
IMAGE INTENSIFIERS	SPARK GAP TUBES
INTEGRATED CCTS	TR/PRE TR TUBES
KLYSTRONS	TETRODES
MAGNETRONS	THYRATRONS
MICROWAVE TUBES	TRANSMITTING TUBES
NOISE GENERATORS	TRIODES
OSCILLATORS	TUBE ACCESSORIES
PHOTOMULTIPLIER TUBES	WAVE GUIDE
PLANAR TRIODES	CIRCULATORS

MAIN MANUFACTURERS

ACRIAN	MULLARD
AMPEREX	NATIONAL
EEV	PHILIPS
EIMAC	RCA
GENERAL ELECTRIC	SIEMENS
MACHLETT	SYLVANIA
MOTOROLA	THOMSON

For more information on any type of Electronic Tube/
R. F. Power Transistors please contact:



RAEDEK ELECTRONICS

BANNERLEY ROAD, GARRETT'S GREEN, BIRMINGHAM B33 0SL

Tel 021-784 8655, Telex: 333500 CROSAL G.

Fax: 021-789 7128

CIRCLE NO. 43 ON REPLY CARD

EPROM PROGRAMMER

100 (E)EPROM and MICRO-CONTROLLER types...

1 2508/10ms	24 27512	47 87256	70 GR27256	93 80C51*
2 2508/50ms	25 27512/OP	48 87C257	71 GR27512	94 8052*
3 2516/10ms	26 27513	49 8755	72 GR27513	95 8044*
4 2516/50ms	27 27513/OP	50 8755A	73 8748	96 NMC27C16B
5 2532/10ms	28 27011/OP	51 8355*	74 8749	97 NMC27C32B
6 2532/50ms	29 27010/OP	52 63701V	75 8750	98 NMC27C64
7 2564/10ms	30 HN27C101G	53 63701X	76 8748H	99 NMC27CP128
8 2564/50ms	31 NMC27C1023	54 63705V	77 8749H	100 NMC27CP256(B)
9 2758	32 27027C1001D	55 63705Z	78 8750H	101 NMC27C512
10 2716	33 TC571000D	56 63701Y	79 8741	
11 2732	34 TMS27C010	57 75P54	80 8742	
12 2732A/10ms	35 HN27C301P	58 75P64	81 8041*	
13 2732A/50ms	36 M5M27C100K	59 2816A	82 8042*	
14 2764/50ms	37 27027C1000D	60 2817A	83 8048*	
15 2764	38 TC571001D	61 2864A	84 8049*	
16 2764A	39 HN27C1024G	62 EMULATOR 2716	85 8050*	
17 2764A/OP	40 NMC27C1024	63 EMULATOR 2732	86 8751	
18 27128	41 27027C1024D	64 EMULATOR 2764	87 8752	
19 27128A	42 27210	65 EMULATOR 27128	88 87C51	
20 27128A/OP	43 TMS27210	66 EMULATOR 27256	89 87C51FA	
21 27256	44 M5M27C102K	67 EMULATOR 27512	90 8752	
22 27256/OP	45 TC571024D	68 GR2764	91 8744	
23 27256	46 87C64	69 GR27128	92 8051*	

*New
Devices
continually
being
introduced*

*read only
OP Quick Pulse

... what more could you ask!

THE MODEL 18 PROM PROGRAMMER

- All 1 Mbit EPROMS, Greenwich Instruments Emulators, 27C parts and EEPROMS now programmable!
- Upgradable for future types.
- Designed, manufactured and supported by MOP in England.
- Comprehensive User Manual.
- 32 and 40 pin devices require low cost socket adapter.
- Supports our new EPROM Emulator as 2716 to 27512 EPROM
- Mains powered unit external to your computer, without speed penalty.
- Fast interactive algorithms automatically selected as appropriate.
- Two independent communications protocols built in. Use with:
 - any host computer with RS232 port and terminal emulator
 - our PROMDRIVER Advanced Features User Interface Package available for all MS-DOS and PC-DOS computers. NEW FAST COMMS - 1 Mbit PROMS programmed in about 2 1/2 mins.
- Quick Pulse programming now available for suitable EPROMS - e.g. 2764s in 10 secs!
- Limited version also available for CP/M computers.

Hundreds of satisfied customers. As supplied to: BT Mercury, UKAEA, British Aerospace, Thorn EMI, Mitel, Cosworth Engineering, British Gas, Kodak, Lucas, Ferrari, Smiths Industries, Telecom Technology and major Universities and Colleges of Further Education.

Please enquire about our other products:
EPROM EMULATOR CROSS ASSEMBLERS
EPROM ERASER BIPOLAR PROM PROGRAMMER
PAL PROGRAMMER GANG EPROM PROGRAMMER
EPLD PROGRAMMER EPROM & PAL DESIGN & PROGRAMMING SERVICE

Telephone ACCESS orders welcome.

Phone for free information pack and price list - 0666 825146
**ELECTRONICS, UNIT 2, PARK ROAD CENTRE, MALMESBURY,
WILTSHIRE, ENGLAND SN16 0BX.**

CIRCLE NO. 20 ON REPLY CARD

Low Cost RS-232 Analysis

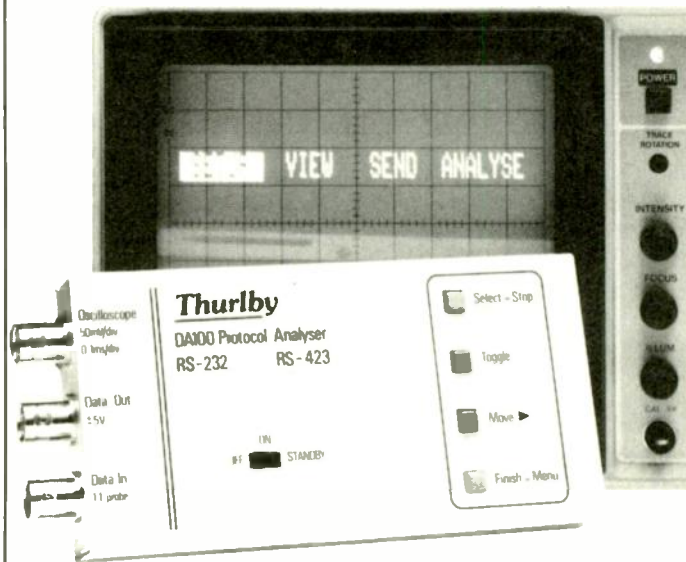

Serial Data Protocol Analyser

£79 plus vat

The Thurlby DA100 is a very low cost protocol analyser for problem solving on asynchronous serial data systems, particularly RS-232.

It provides baud rate analysis, data word format analysis, data monitoring (ASCII or Hex), triggered data capturing, and test data generation.

The DA100 uses an oscilloscope as its display device. It connects to any standard 'scope via a single cable and displays 32 characters of text. Alternatively an optional LCD display unit can be fitted. An optional RS-232 breakout-box is also available.

Contact us now for full technical details.

Thurlby

Burrell Road, St. Ives, Huntingdon, Cambs PE17 4LE
Fax: 0480 64832 Tel: 0480 63570

CIRCLE NO. 18 ON REPLY CARD

Oil from troubled waters

A growing problem facing the oil industry is the need for what's called liquid phase separation; or, more simply, getting rid of the salt water that inevitably accompanies crude oil pumped up from the sea bed.

In theory, all that's necessary is to put the fluid mixture into a separating tank and wait for the water to sink. In practice – as with good salad dressing – it can take a very long time, especially if the oil is viscous.

One method of speeding up the process, developed many years ago, is to apply a high-voltage AC field between pairs of electrodes in the mixture. The effect is to help water droplets coalesce and hence grow to a point where gravity does the rest. The physics of the process is only vaguely understood and may include a variety of effects such as electrophoresis, dipole coalescence and the formation of intermolecular bonds.

Whatever the theory, practical systems have been developed using conventional electrodes and AC at a variety of frequencies. They all work to a useful extent but suffer from the need for bulky equipment and from reduced efficiency due to short-circuiting within the fluid mixture.

Dr Philip Bailes and his colleagues in the department of chemical engineering at Bradford University have now discovered that the separation process becomes much more efficient if square pulses of direct current are used instead of AC. By optimizing the shape and frequency of these pulses, the separation of oil and water can be improved very considerably.

Depending to some extent on the design of the electrodes, the optimum

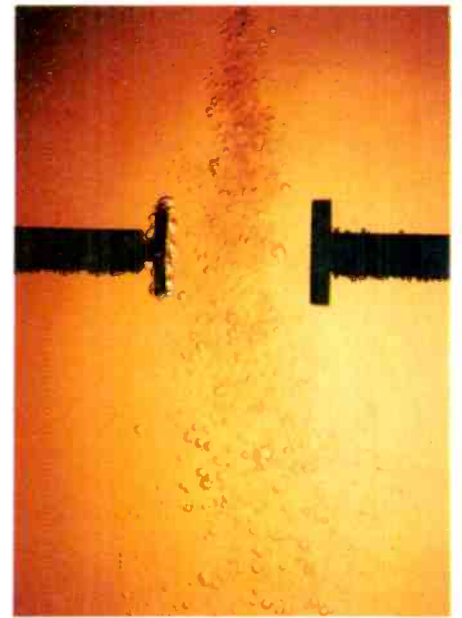
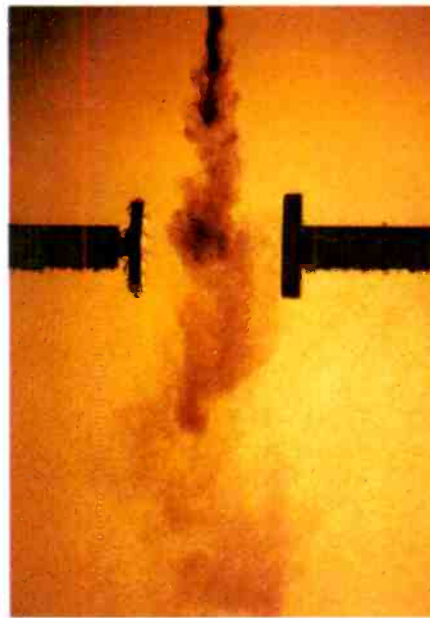

Removing water from oil mixtures. With no electric field applied (left), droplets in the jet are slow to coalesce; but with a pulsed high-voltage field (right), the process is much faster. Gravity can now complete the separation. Pictures by Dr Philip Bailes.

mark:space ratio is around 1:1 at frequencies between 8 and 10Hz. Also, because of the pulsed nature of the voltage, Bailes has been able to insulate his electrodes with plastic, thus avoiding short circuits through the fluid. Under pulsed conditions, charge distribution in the fluid is still high, even with insulated electrodes, because the determining factor is no longer DC conductivity but the relative permittivity of the insulation and the oil/water mixture. This remains relatively constant, even when the water content rises.

Of particular interest to engineers is the fact that the pulsed DC generator is

considerably lighter than its AC predecessors, a significant benefit aboard oil platforms where real estate tends to be expensive. Laboratory prototypes (*J. Electrostatics* Vol 17, 321-328) have used a conventional 15kV EHT generator, the output of which is shorted by a PD500 triode wired in shunt fashion. Waveforms applied to the grid of the PD500 chop up the EHT as required.

Dr Bailes and his colleagues are now extending their work to investigate the uses of electrostatic fluid coalescence in a variety of other industrial situations where liquid phase separation is involved and where mechanical methods would be cumbersome.

Optical delay for high-speed photography

How do you photograph events before they happen? Or, to be more precise, how do you trigger a camera to catch the very beginnings of a sequence that may last only a few nanoseconds? That was the problem faced by Edward F. Kelley, formerly of the US National Institute of Standards and Technology (the National Bureau of Standards, as was). He wanted to film the essentially random-timed electrical breakdown between a pair of electrodes immersed in fluid such as hexane or transformer oil. The trouble is that even if it were possible to trigger a camera in zero time (which it

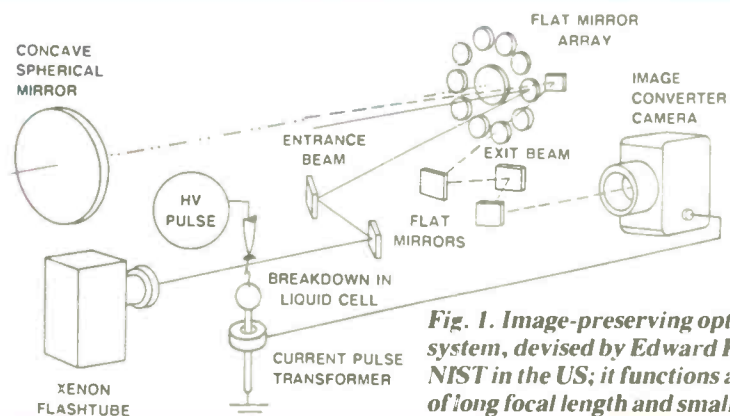

Fig. 1. Image-preserving optical delay system, devised by Edward Kelley at NIST in the US; it functions as a mirror of long focal length and small aperture.

Continued overleaf

obviously isn't), there are initial phenomena that precede any detectable insulation breakdown. What's needed is some means of delaying the image from reaching the camera for at least a few hundred nanoseconds. This, under ideal circumstances, can allow the camera to record the phenomena that precede the triggering event.

What Kelley has successfully developed is a device called an IPOD (image-preserving optical delay) which he's currently attempting to patent. It consists of an arrangement of mirrors that ingeniously lengthens the optical path by over 100 metres (Fig. 1). Since the system exploits the entire surface of the concave mirror in a symmetrical fashion, all astigmatism is effectively cancelled out, leaving a high quality image, dependent mainly on the quality of the mirror.

Using the set-up as shown, Kelley has recorded the evolution of an electrical discharge in oil from its very first moments. (The xenon tube provides illumination to permit shadowgraph photography.) What happens is that at some random time after application of the

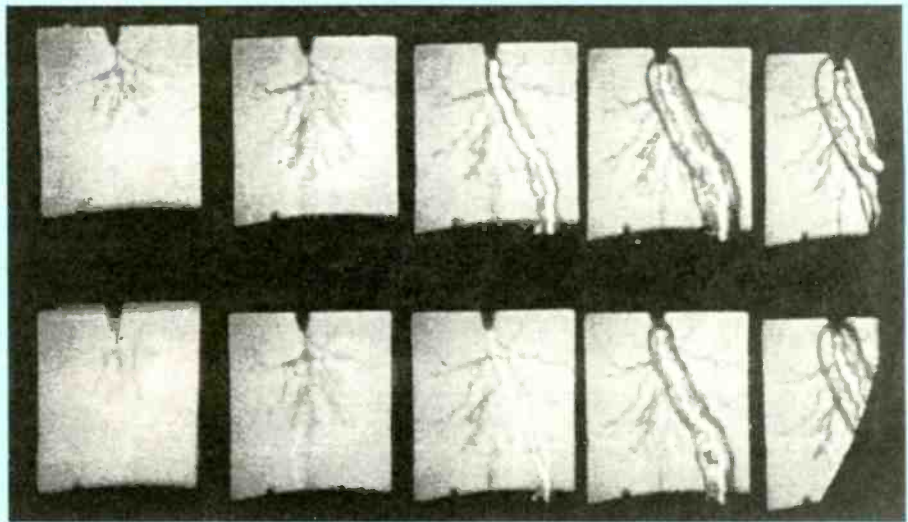

high-voltage pulse, a "streamer" appears from the tip of the needle electrode and grows across to the spherical electrode. When it makes contact, breakdown occurs, resulting in a hot plasma channel across which the voltage drops to zero within a few nanoseconds. The sequence (Fig. 2) shows just how complex the whole process is.

Fig. 2. Result of the image-preserving delay. The camera was triggered a few nanoseconds after breakdown occurred, at which point the phenomena in the gap were as in frame 5. The camera began taking pictures about 150ns later (corresponding to frame 8). Interval between frames is 50ns. Most of the frames were stored in the air.

Smashing electrons reveal all

CERN's massive new atom-smasher, the Large Electron Positron collider (LEP) started work in mid-June under the Jura mountains on the French-Swiss border. Five years in the building, it comprises a 27km-long circular tunnel (pictured here) large enough to drive a train through. British Rail would be envious of its performance, because inside the tunnel is a circular evacuated tube in which electrons and positrons travel at almost the speed of light. They're injected by means of special accelerators and controlled in their flight by powerful magnets located all the way around the 27km tunnel.

The object of the LEP is to accelerate electrons and positrons (their positively-charged equivalents) in opposite directions around the ring. The particles then collide in the most violent way possible, releasing what physicists hope will be a shower of fascinating subatomic debris.

Up till now, atom smashers have mostly used larger micro-missiles such as protons and ions because in some ways they're easier to generate and manipulate. The trouble is that, being more complex, such particles are correspondingly harder to analyse when

they break up. It's like trying to study the innards of a chip using a hammer.

What CERN scientists hope will emerge from their electron-positron collisions are some interesting entities called W and Z particles. These are believed to be the means by which the so-called Weak Force is mediated. Or, thought of in another way, the W and Z particles are to radioactive decay what photons are to electromagnetic radiation.



LEP's first experiment involves an initial look at the electrically-neutral Z particle, first discovered at CERN in 1983. Even at reduced beam power, LEP's four experiments, code-named Aleph, Delphi, Opal and L3, are expected to intercept a few thousand Z particles per day. This, it's hoped, will give physicists the chance to specify the parameters of the Z and so help towards a Grand Unified Theory that ties

together electromagnetism, the nuclear forces and gravity. (Britain, incidentally, is heavily involved in Aleph, Delphi and Opal; together with other aspects of CERN's work, they receive £45 million per annum from the Government.)

As well as W and Z particles, CERN researchers will also be looking for Higgs particles, hypothetical mass carriers which appear only at very high energies – and of course the element quarks, particles from which all other subatomic particles are thought to be composed.

Meanwhile over in the USA, physicists at the Stanford Linear Accelerator Center have already created particles using a much smaller 3km-long machine. In the first four events recorded, the Stanford machine revealed a pair of narrow back-to-back jets of hadron, thought to be the characteristic fingerprint of a pair of quarks.

The battle is now clearly on to make fundamental discoveries that may lead for the first time to a true and details understanding of the very finest structure of matter.

Research Notes are by John Wilson of the BBC World Service's science unit.

Put our test set to the test. Can you find anything it can't test?



Cordless telephone



Pager



DTMF System



Cellular mobile



Cone



PMR



Base station



Stabilock 4031: Portable Communication Test Set

In the time it takes to read this, the Stabilock 4031 could test any of the devices pictured above – with one minor exception. Quite a performance given the dramatic evolution in radiocommunications techniques and standards.

To meet the challenge, we packed more than 25 years of experience into a single, highly versatile unit. You won't need an operating manual to use it: time-saving features include automatic measurement functions and brilliant graphics, with both numeric display and simulated analogue meters.

The Stabilock 4031 comes with all test devices integrated, while its modular design and flexible software system can adapt to all testing demands, both present and future. The exceptions are hardly worth mentioning.

Born to set tomorrow's standards in measurement reliability.

Schlumberger Instruments

Schlumberger

Technologies

Instruments Division
Schlumberger Instruments
20 North Avenue
Burlington, MA 01803, U.S.A.
Tel (617) 229-2548
Fax (617) 229-4885

Schlumberger Instruments
Victoria Road
Farnborough, Hampshire
GU14 7PW, England
Tel (0252) 544433
Fax (0252) 543854

Schlumberger Technologies GmbH
Instruments Division
Ingolstadter Straße 67a
D 8000 Munich 46 Germany
Tel (089) 3 18 89 0
Fax (089) 3 18 89 160

Schlumberger Instruments
50 avenue Jean Jaurès
BP 620-06
92542 Montrouge France
Tel (1) 47 46 67 00
Fax (1) 47 46 67 27

CIRCLE NO. 37 ON REPLY CARD



LIGHTNING STRIKES

Storm cells act as a giant voltage stabilizer between the ionosphere and Earth says electrometry researcher Tony Hopwood

At any one time, there are several thousand thunderstorms roaming the planet to sustain the continuous electrical discharge between the earth and the upper atmosphere.

The driving force behind this activity is the sun, raining charged particles on the ionosphere and charging it to hundreds of thousands of volts with respect to earth across a leaky atmospheric dielectric. On a normal summer day, the atmospheric voltage gradient averages 100V/m positive above earth, rising to kilovolts per millimetre when the atmospheric dielectric breaks down in a

thunderstorm.

That breakdown is lightning and, although the thunderstorm generator is powered by charge separation in the turbulent maelstrom of ice crystals, rain and cloud at the core of every cumulonimbus, each lightning stroke to ground also drains charge from the ionosphere. It is very difficult to tell how much charge is drawn from the ionosphere outside the storm cell by lightning strokes, because it is impossible to draw an accurate energy balance for the complex reactions taking place in several cubic kilometres, let alone accurately measure the energy content of every discharge. This paper suggests ways of

pinpointing the ionospheric contribution.

A single thunderstorm cell is quite compact, only influencing a few hundred square kilometres during its short life; the only effects that extend more than 20km from it are electrical, of two main types. Most easily observed is the radio-wave signature broadcast by each lightning stroke; this is detectable thousands of miles away and individual storm fronts can be tracked for days on end using radiogoniometers.

Field variations

The other electrical signature is the local distortion of the ambient electric field by a storm. A single cell can affect the field up to 50km away and a band of storms over 100km. Occasionally, giant electrical storms alter the ambient field up to 300km away. Electric field variation is logged by a DC electrometer connected to a well insulated antenna, and recorded.

Electric field variations provide some clues to what happens as rising warm air condenses into cumulus shower clouds or develops into a full-blown cumulonimbus with its characteristic anvil shape, spiced with lightning and hail. Although normal atmospheric behaviour dictates increasing positive

polarity with altitude, growing cumulus shower clouds become negatively electrified underneath as invisible water vapour puffs into visible cloud. As the cloud grows, cloud-building condensation releases heat at higher levels, sustaining the updraught until the raw cold of the upper atmosphere freezes the top of the cloud into a crew cut in a zone

At any one time, there are several thousand thunderstorms roaming the planet

where the natural atmospheric potential may be over a million volts positive to earth. It is this extra ingredient of positively charged ice crystals and hail that turns the shower cumulus cell into a sparkling anvil cloud.

As they start to fall from a height of several miles, the positively charged ice crystals and hailstones meet the warm updraught head on. Over a period of minutes, the increasing burden of melting hail and coalescing drops (hyd-

rometeors) gradually prevails, and a cold core of positively charged precipitation forces its way towards the ground, presenting a highly positively charged wedge surrounded by or alongside a negatively charged zone of rising warm air.

Detection

A ground-based electrometer will see such a passing cloud cell as a negative charge, followed by a region of positive charge, then negative charge (Fig. 1); the ratio and duration of the charges will depend on the track and maturity of the cell. Individual young cells with little or no precipitation usually present mainly negative charge and an electrometer reading the edge of a passing mature cell will also record predominantly negative charge. From the electric field profile, it is possible to judge the maturity of any passing cell by noting the relative duration of the positive and negative phases.

The most striking feature of shower clouds (apart from lightning) is the abrupt transition from negative to positive charge, or vice versa, associated with the onset of precipitation (Fig. 2). The induced ground charge reading can swing from negative to positive kilovolts in seconds, demonstrating the abrupt

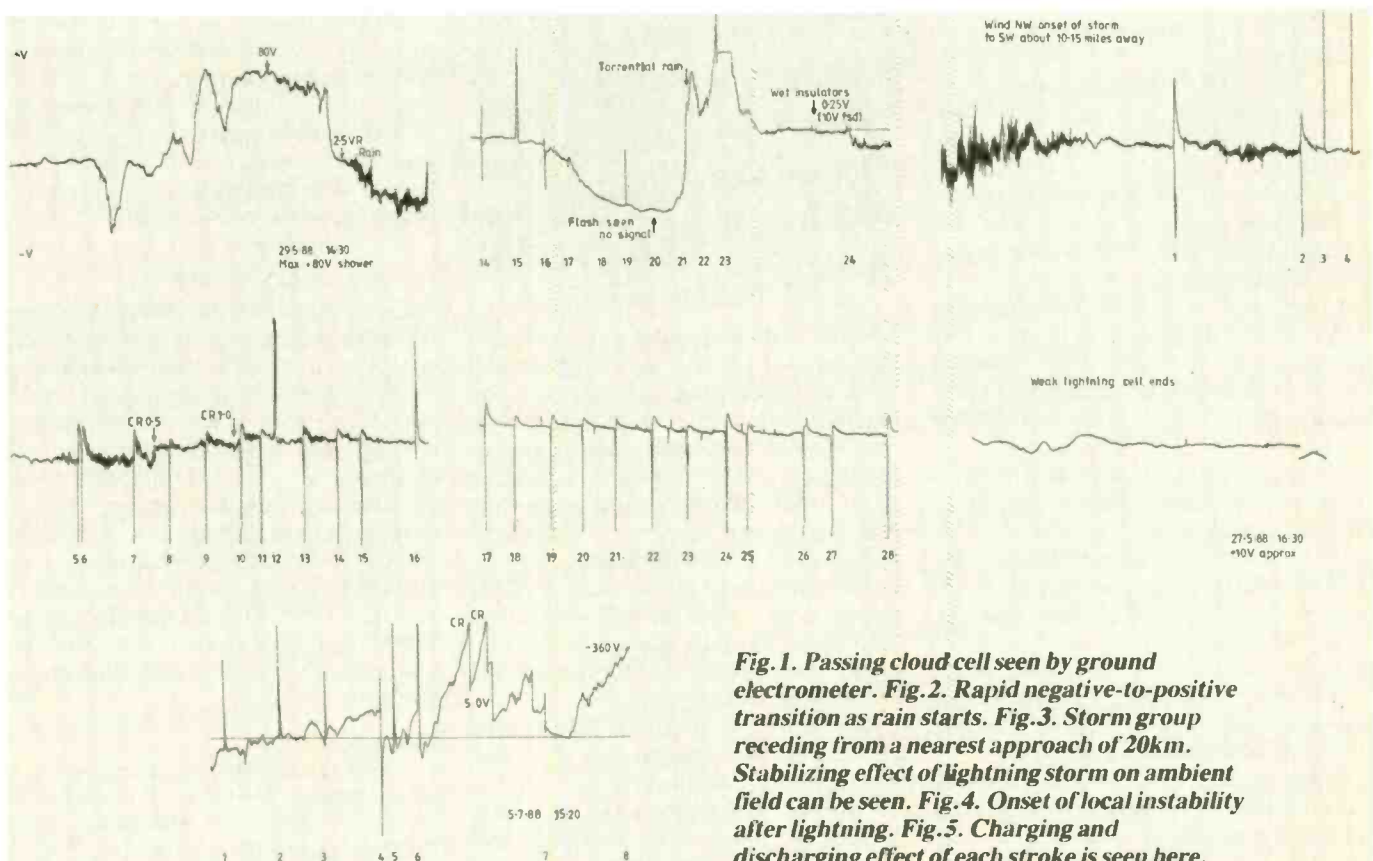

Fig. 1. Passing cloud cell seen by ground electrometer. Fig. 2. Rapid negative-to-positive transition as rain starts. Fig. 3. Storm group receding from a nearest approach of 20km. Stabilizing effect of lightning storm on ambient field can be seen. Fig. 4. Onset of local instability after lightning. Fig. 5. Charging and discharging effect of each stroke is seen here.

demarcation between charge zones as they pass overhead and showing clearly the enormous potential differences available to trigger lightning strokes between different parts of the cloud, or positive and negative strokes to earth.

An insulated antenna under a thunder cloud may reach very high voltages as charge centres pass overhead; and close to a storm accurate readings become very difficult, so lightning transient observations are more instructive and certainly safer when taken from outside the storm, where the fine detail of the electric field is not obscured by the electrical turmoil. Even at 15km, lightning strokes produce transients of over 100V on an antenna, but changes in the profile of the recorded transient, as well as its amplitude, provide an approximate measure of distance.

Observations

The electrometer trace of a storm group starting at 1530 on June 4, 1988 receding from a nearest approach of 20km, shows many typical features (Fig. 3). The first feature of note is the stabilizing effect of the onset of lightning on the ambient electric field. Judging from this and other recordings, it seems that a lightning storm can influence the stability of the ambient electric field over a large area. Figure 4 shows the onset of local instability when lightning ceases in an isolated storm cell some 50km away.

In May 1958, it was suggested by Vonnegut and Moore¹ in their paper 'Giant Electrical Storms' that the surprising stability of the intense electric field associated with tornadoes observed by Gunn² was due to the continuous discharge surrounding the vortex acting like a giant voltage stabilizer tube. It may well be that ordinary thunderstorm cells have a similar stabilizing effect by drawing excess charge from a much larger area as part of the global charge equalization between the ionosphere and earth.

The trace shows that there are probably three storm cells, comprising strokes 3,4,12,16 and 1,2,5-11, 13-15. The remainder, 17-28, are from a new cell, all three cells showing a typical active life of 15 – 20 minutes (Fig. 3). The trace was recorded on the $\pm 100V$ range to A, then on the $\pm 50V$ range, and nearly all the strokes were full-scale from an average atmospheric baseline falling from about +50V to +4V.

Fortunately, amplitude is not the only way of judging distance. The nearest cell was that producing negative-going strokes 3,4,12,16. Nearby strokes recorded from outside the storm field rise

cleanly from the background level. As they get further away, they begin to influence the background level with a delayed recovery (12) of increasing bipolarity (16). Stroke 1 shows a marked distance effect, which progressively reduces up to the last stroke from that cell (15). The nearest stroke from cell 3 occurs around 20, and strokes from a much more distant storm can be seen superimposed on some of the field recovery curves (Fig. 3b).

It is not possible to determine absolute distance scales from lightning transient traces, because the energy levels and local attenuation cause huge variations in the received signals. The nearest strokes were about 20km away, timed from the thunder. Stroke 1 would have been nearly 40km, and the others in the range 25-35km. The tiny strokes between 18 and 26 are over 50km distant. These distances alter with atmospheric impedance, which largely depends on humidity. The antenna background level of 4V suggests a relative humidity of 65-70%.

The reason for the delayed recovery of the ambient field is worthy of spe-

Each stroke is detectable thousands of miles away and storm fronts can be tracked for days on end using goniometers

culcation. The overshoot may represent that part of the stroke energy drawn from the ionosphere beyond the immediate storm zone. Although the recovery time approaches half a minute for strokes 1,2,5-8, the stroke pair 5,6 has a similar recovery time, suggesting that the energy reservoir available to restore the level is substantial, and may be the ionosphere above and round the storm. Close study of the effect may help show the part played by charges drawn from outside the storm cell in the thunderstorm energy equation.

Two storms recorded on July 5, 1988 provide further insight into the complexity of storm fields (Figs 2,5).

The first storm group passed within 1km to the south of the recording station, and gave a sequence of some 90 strokes in the period 1520-1700. There

was little rain, so the signature at closest approach was negative from strokes 2 onwards. The charging and discharging effects of each stroke were well shown, superimposed on an ambient field which rose to 800V across a 1000megohm electrostatic voltmeter switched into circuit as the electrometer limited at -350V. The discharging effect of positive strokes 14 and 15 is well shown, and linked strokes 16-17 show how strokes can recharge adjacent cells and trigger additional strokes by enhancing local potential differences.

A fresh storm group then approached (Fig.2), the outer positive charge field arriving at stroke 14 (1720). As the charge built to +300V, a stroke to ground was observed some 4km away to the north-west which did not appear on the trace. This confirms the highly screening effect of a strong local field shown by the highly attenuated strokes 16-19. The positive field collapsed and swung to -200V in less than 5s as a cloudburst started at 1726. During the first three minutes of the downpour, the aerial insulators became wet and the voltage readings decayed as the input impedance fell, so recordings continued on the higher-gain 10V FSD range. At this stage the storm centre was directly overhead, and corona can be seen on the trace as the charge swung positive.

Despite the loss of signal during the rain, the preponderance of positive charge suggests a mature cell, with the cold rain cutting off the warm updraught and bringing the thermodynamic thunder engine in that cell to a halt as new cells take over and leapfrog the storm across the countryside.

Equipment

The equipment used to record the electric field has been specially adapted and comprises a purpose-built valve electrometer capable of processing DC input signals to +350V at an input impedance of 2gigohms. It is self calibrating, and contains variable attenuation, compression and damping circuits. The signal is fed to a modified 6in-scale, single-channel DC servo pen recorder, type EPR10A, with full-scale recordings of electric field signals in the range $\pm 25mV$ to 350V from a well insulated wire antenna 20m long some 10m above ground. ■

References

1. Vonnegut and Moore. Recent advances in atmospheric electricity. Proceedings of Second Conference on Atmospheric Electricity, Ed. L.G. Smith, Pergamon, 1958.
2. Gunn, R., Giant electrical storms, *Journal of Meteorology*, 13.

BBC Telesoftware goes off the air

BBC television has announced the closure of its Ceefax telesoftware service, with effect from the end of August. This service, which provided a weekly ration of computer programs and data files for users of the BBC Micro and IBM PC-compatibles, was started in 1983 as part of the BBC's computer education initiative.

Its withdrawal, at little more than a month's warning, must be the most abrupt abandonment ever of a UK broadcast service. No hint of the closure is given in the BBC's annual report*, which appeared in the week of the announcement; and indeed a telesoftware transmission schedule extending into September had already appeared in the monthly computer press.

Telesoftware receivers, which cost

£100-£200, can still be used to access teletext pages in the ordinary way. But the closure comes at a time when other countries appear to be extending their teletext systems – Italy, for example, began a telesoftware service on August 1.

"It's quite a blow to us", said Ram Banerjee, managing director of GIS, the company which makes the teletext adapters approved and supported by the BBC. "Telesoftware is one of the main reasons why people acquire the card. We only heard about the chopping of the service one day before it was announced." GIS is already receiving angry letters from disappointed customers.

One feature of the BBC Ceefax service to disappear will be the daily satel-

lite weather image relayed as a data file from the Meteorological Office. This enabled computer users to receive and display high-resolution images of the UK's weather patterns and even to assemble them into animated sequences. Another major use of telesoftware was to distribute notes on educational radio and television programmes to receivers in schools.

By ending the service, the BBC expects to save about £60 000 each year, and to gain transmission capacity which it will use to provide, among other things, additional financial and sports news and regional teletext services.

*BBC Annual Report & Accounts 1988-89, BBC, 116 pages A4 format, £5.50.

Technology – which direction?

In West Germany and Japan, the thrust of technology is towards the development of products themselves; in the UK, we are still working on how to make them. This view is the outcome of a study conducted by the PA Consulting Group in Europe and Japan.

According to John Puttick of PA, "The UK is struggling to catch up in a global marketplace where product availability and quality are 'givens' and the better product will gain market share". UK products, says the report, are not highly rated, either by ourselves or our competitors; manufacturing technology in Germany and Japan consistently delivers high quality, short lead times and low costs, process technology no longer being an R&D priority.

The report isolates a number of issues of "concern and optimism" for the UK and Europe as a whole. Among those offering cause for concern, an unwillingness to invest and a reluctance to adapt to new technologies emerged as the main reasons for the UK's poor performance in the development of products. It also seems that the Japanese are readier to engage in collaboration before the competitive stage than European companies, although there is worldwide agreement on the benefits of such co-operation.

On the other hand, the UK and West Germany believe that leadership in R&D is the appropriate strategy, while France and Japan choose to follow close behind the development and thereby attain a competitive position.



As part of British Telecom's remit to diversify, the research people at Martlesham have come up with a possible solution to the capital's parking problems. And if that doesn't work, they'll use the system to test cellphone aeri-als.

Limited life for telepoint?

Replying to a suggestion in *The Independent* that the proposed Personal Communication Networks pose a threat to telepoint, in that they will be able to do anything that telepoint and cellular radio can do, a spokesman from Ferranti Creditphone said "The company is delighted with the announcement (of PCNs) and intends to respond to the call for licence applications. The company does not see PCN in any way as a threat to telepoint".

According to Richard Gosling, General Manager of Mercury mobile services, cellular radio equipment prices will decrease over the next few years and reduce the price differential

between that and telepoint from around 5:1 to perhaps 2:1. Since Mercury is involved with both, Gosling sees no problem there, either. As he points out, Lord Young's announcement of the proposed PCNs made it clear that PCNs are intended to compete with cellular radio, as evidenced by the prohibition of cellular licensees from holding PCN licences.

Mercury Callpoint also sees the estimated seven-year period to the introduction of PCNs as a time in which to establish telepoint as a facility which users will continue with in the presence of new, but far more expensive, methods of personal communications.

Making a career in electronics

Young people contemplating a career in electronics should find plenty to interest them in this year's *National Electronics Review*. This 88-page illustrated publication from the National Electronics Council contains a wide-ranging collection of articles on many aspects of electronics. Its theme this year, electronics in the home, is tackled by authors from manufacturing, research, education, trade unions and management. They deal with topics such as the automated home, information technology, personal computing, flat-screen displays, satellite TV, and electronic guidance for cars. Of particular interest to school-leavers will be the article by Tony Watts, of the National Institute for Careers Education and Counselling, on the use of computers in careers

guidance. Also included is an informative survey of optoelectronics, a version of the IEE's 1988 Mountbatten Lecture given by Sir William Barlow; and reviews of developments in electronics in 1988 and of the NEC's activities.

Among the objectives of the *Review* are to encourage young people to take up careers in electronics or information technology, and to emphasize the importance of these subjects to opinion-formers. Copies have accordingly gone out not only to schools but to MPs and the Good and the Great. However, single copies are still available, and without charge: to receive one, contact the editor, Jim Slater, at the Independent Broadcasting Authority, Crawley Court, Winchester, Hampshire SO21 2QA.

Late extra

All those in industry who were unable to study for a degree on leaving school need not despair: there exists The Engineering Council's examination, which is of degree standard.

To remind employers and employees of the opportunity for further study, The Engineering Council is running a campaign, with the aim of encouraging degree-less, but nonetheless able people to qualify as chartered engineers while in employment.

As Professor Levy, the Council's Director - Engineering Profession, points out, "Because of our education system, (these people) often think of themselves as failures. Most of them are far from failures and have a lot to give their companies and the country. We want to help them study to try to

achieve our qualification". In the six years of the Council's existence, it has been conscious of the need to make its examination better known, but was also aware of more pressing matters, since it was starting more or less from scratch.

An average person with a Higher National Diploma or Certificate will, it is estimated by Ron Kirby, Director of Public Affairs, take around three years to attain degree level, assuming a clear run at it.

The examination is held in May each year at 40 centres in the UK and throughout the world. For information, write to The Examination Officer, The Engineering Council, Savoy Hill House, Savoy Hill, London WC2R 0BU; telephone 01-379 7459.

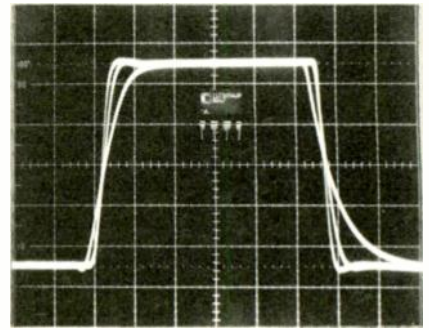

VHF op-amp

Not one of the usual sort which boast gain/bandwidth products in the high MHz range but a device which actually operates at 150MHz with just a 3dB droop.

Sold through Anglia Microwaves, the CLC505 is said to have a slew rate of 1700V/ μ s with a settling time of just 12ns. It provides this performance at a supply current of 90mA and a price of £5.75.

Fast bipolar

A self-aligned bipolar process claims gate delays of less than 80ps with power consumption of 2mW/gate. Developed by AT&T, the process uses polysilicon emitters with three levels of metal interconnect. Other trades between speed and power can be made by varying the process geometry. Power levels are programmable from cell to cell.

The company plans to offer a 200-cell library with a migration from gate array to semi-custom design. It has successfully produced a 5Gbit/s multiplexer and a 4.6GHz frequency divider using the process.

Up and away

Suffering only a minor hiccup in the launch sequence, the Olympus 1 satellite has been successfully placed in orbit by an Ariane 3 rocket out of Kourou, French Guyana.

The platform, the first in a series of several high powered communications satellites due for launch of the next few years, carries for separate payloads: DBS transponders for both RAI and the BBC, specialised business telecoms operated by several European PTTs and an experimental high frequency microwave link which aims to open up new bands for use towards the end of the century.

Maximum IEEE-488 Performance for Your High-Speed AT Computer

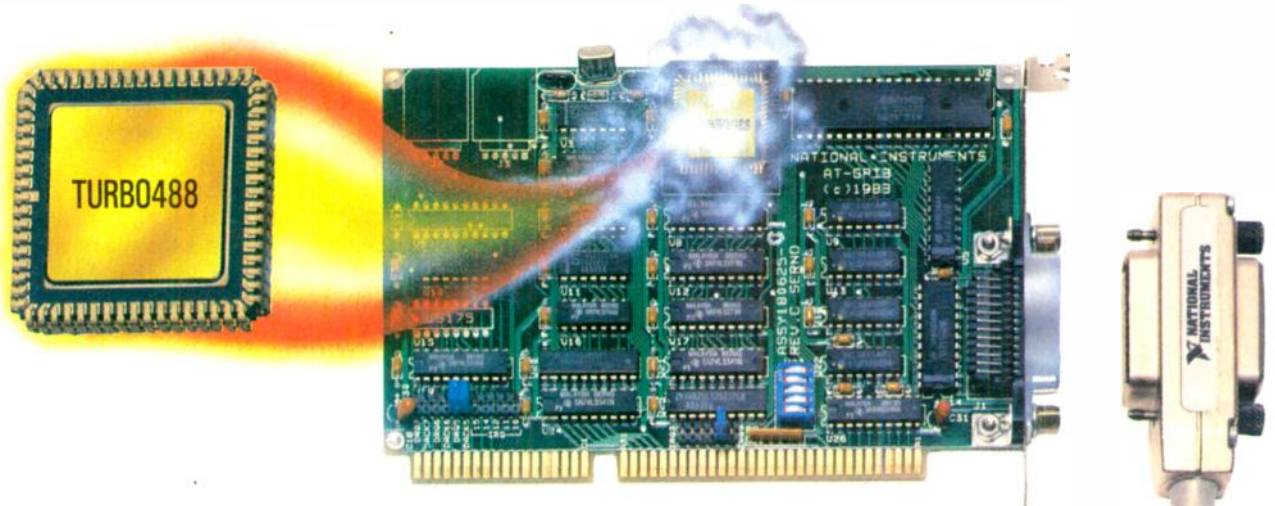

The National Instruments AT-GPIB . . . the new standard for IEEE-488 interfaces

At last, a low-cost IEEE-488 PC/AT controller board can transfer data continuously at the maximum specified rate of 1 Mbytes/sec. The key to this high performance is the state-of-the-art FIFO buffering and special last-byte handling circuitry of our custom gate array, Turbo488™. The Turbo488 also conserves valuable computer bus bandwidth by packing 8-bit IEEE-488 data bytes into 16-bit words.

By moving time consuming software functions into hardware, the Turbo488 significantly reduces the overhead of a software driver too. The combination of the AT-GPIB and our streamlined software driver gives you the power needed for today's high speed digitisers.

The AT-GPIB is controlled by the *de facto* industry standard NI-488 software. NI-488 has high-level routines that transparently handle IEEE-488 protocol and buffered DMA transfers. These routines can be used with any popular language and are the perfect match for the structured, hierarchical programming style preferred by users of high-speed, compiled languages such as C and Pascal.

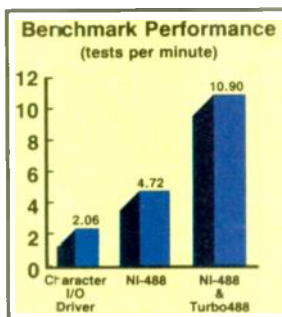

If you are familiar with dedicated controllers, NI-488 gives you the option of using our Universal Language Interface driver with any DOS language to programme with Hewlett-Packard style commands. The speed of this driver is best suited for interpretive languages like BASIC.

Your investment in National Instruments is a sound one. You can still run your existing NI-488 programs yet automatically take full advantage of the Turbo488. If you're just getting started, our interactive instrument control and menu-driven configuration utilities will get you up and running in no time.

Your relationship with National Instruments does not end when you purchase our products. A staff of applications engineers is always a free phone call away.

Ask for a **FREE** Catalog

Turbo488 technology is standard on our boards for Micro Channel and Macintosh computers

 **NATIONAL INSTRUMENTS**
The Software is the Instrument™
National Instruments UK Corp.
21 Kingfisher Court
Hambridge Road, Newbury
Berks RG14 5SJ
Tel: 0635 523545
Fax: 0635 523154

**Call FREEPHONE 0800 289 877
for a catalogue and details of our
FREE 'Hands On' Roadshows.**

CIRCLE NO. 13 ON REPLY CARD



Adele Dixon opens the world's first public television service from Studio A at the Alexandra Palace on November 2, 1936. AP's heritage is now under threat. (Photo: BBC)

Ally Pally threat

The cradle of television broadcasting, the Alexandra Palace in north London, may not after all have its old BBC studio space converted to a television museum because of the high cost of the plan. 'Ally Pally' as it is affectionately known, was badly damaged by fire in 1980 but its owner, Haringey Council, decided in

the public interest to restore the building at a cost of £45M, work which is nearly completed.

The south east wing, home of the world's first regular television service, was not damaged by the fire, and its use as an exhibition of television history and development was proposed by the

Royal Television Society in 1985, as the BBC was about to celebrate the 50th anniversary of its television service. However, the proposals were costly and the television industry did not commit sufficient funds. The position has remained uncertain ever since. It now seems that Haringey Council may offer the studio area to Mountview Theatre School for scenery storage.

Another plan, for a Birth of Broadcasting Centre, run by a full-time staff and costing around £3M to set up, has been put forward by the Alexandra Palace Television Trust. The Trust comprises members from the broadcasting and equipment industries, and those who were there at the birth of television in 1936.

Their work should not be lost. But the future for the museum seems uncertain unless a scheme can be found which could complement the present day uses of Alexandra Palace, and meet the need for economic viability. This might mean a more modest start to the project, with an expenditure counted in thousands instead of millions, staffed on an occasional basis, say when other events are staged at the new Alexandra Palace.

The Ally Pally Trust can be contacted at 1 Coleridge Gardens, London NW6 3QH.

— Roger Driscoll

Slipped disks and laptop scrap

Hard disk drives are the type of essential sub-system in a PC that most users take for granted. It is there, and it works, doesn't it? After all, it's bound to be faster than a floppy disk at reading and writing in data.

Sometimes these things can go wrong, however; and if it happens in a big way, the manufacturer can have a problem. This time the man with the problem is Alan Sugar, boss of Amstrad. The company has been obliged to recall more than 7000 of its 2286 and 2386 PCs because of disk controller problems — essentially the current controllers are not very good at the job.

Amstrad is operating the highest profile solution — swapping existing machines for new ones with better controllers in them. That will please the current users. It may also please some future ones, for there are suggestions — totally unfair and specious of course — that the recalled machines will themselves be refurbished and put back on the market at what is called an "aggressive" price.

The wrangle about PC bus standards — whether MCA or EISA is best for the future — took some interesting turns during the month. Intel announced it had an EISA chip-set available. This will make it possible for PC manufacturers to produce systems capable of taking 32-bit expansion boards designed for the "standard".

At the same time, Compaq and IBM, respectively chief protagonists for EISA and MCA, have signed a patent exchange agreement. Though Compaq vehemently denies it will be making one, this gives it the right to make an MCA machine. It also raises the intriguing prospect of IBM doing an EISA machine — licensing an adaptation of its own PC/AT "industry standard" bus.

Portables are all the rage at the moment, with Sharp deciding it is going to take over the UK market through its new distributor, Kode. Currently, of course, the market is dominated by Toshiba, and that company has just announced a product

that is bound to be the subject of a legal scrap.

This is the Dynabook, the company's smallest lap-top so far. Only available in Japan for the moment, it weighs just six pounds and is priced at the equivalent of £900. The name, Dynabook, is the legal problem, however. It has been adopted by a US company, which has also introduced a product of the same name. What is more, Dynabook's Dynabook (if you see what I mean) looks to have a much better specification, featuring a 286 processor against an 8086 in the Tosh system. It also features an LCD measuring 11 inches across the diagonal.

Not to be left out, Herman Hauser, designer of the dear old Acorn Beeb machine, has been back at the drawing board, threatening a book-alike lap-top that will have no keyboard. Instead, users will have an electronic stylus to scratch away at the display. Watch out for The Active Book Company — you have been warned.

— Martin Banks

Double standards

According to the Department of Trade and Industry (DTI), buying computer hardware that conforms to Open Systems Interconnection (OSI) standards takes the risk out of major investments in technology. Launching an initiative to encourage adoption of OSI by all sectors of the UK economy, Lord Young, Secretary of State at the DTI, stressed that the standards offer cost advantages (as hardware can be bought from many competing suppliers within the European Community), and are also more dependable (as hardware is interchangeable). Not being tied to one supplier also reduces the possibility of being lumbered with obsolete equipment.

Given the apparent advantages, it is surprising that the Government could not accept the recommendation, found in a recent report from MPs into the state of policy towards information technology, that "we recommend that OSI should be made mandatory for

public procurement forthwith"¹.

Explaining why, the director of the CCTA (the department most involved with directing the use of computer technology within government), told the MPs who produced the report that adoption of OSI would be "counter productive" and "it might detract from the perception of value for money". This 'message' was reinforced by Lord Young who told the same MPs that OSI was not mandatory because "you cannot have mandatory standards for every single contingency".

This reluctance on behalf of Government to abide by OSI standards creates a problem for the DTI's initiative. How can the Department make a case for the private sector to adopt OSI, if Government does not adhere to the advice itself? Perhaps a case of double standards?

—Chris Pounder

1. House of Commons Trade and Industry Committee, First Report, 'Information Technology', £5.90, ISBN 0 102714894.

HF radio goes SHF

International broadcasting reduces its dependence on the fickle ionosphere a little this month with the introduction of a new satellite radio service in the US. C-Span, the Cable and Satellite Public Affairs Network, which provides nationwide television coverage of legislative sessions and hearings in Washington DC, offers two new audio subcarriers on its satellite feed. On one is a selection of programmes from several European international broadcasters, while the other carries the BBC World Service 24 hours a day.

Through the new outlets, European programmes will be available to a potential audience of 44 million on US cable systems. Would-be listeners who lack a cable connection can receive the satellite direct on domestic equipment — the signal is not scrambled. For improved audio quality, the BBC hopes to switch to a digital audio feed direct to Washington.

In Europe, satellite reception of BBC World Service is already available via a subcarrier on Eutelsat.

Bugs in the woodwork?

Early in June, shortly after the Russian bugging accusations appeared in the Sunday newspapers, we offered the Soviet Embassy an opportunity to clear up speculation that the bugs said to have been found there were placed not by British agents, but by Russian agents in order to create propaganda.

We told its spokesman Mr Daneliski that we were prepared to hire an independent expert to examine the bugs, making it clear that we were quite happy to let a Soviet representative witness the examination. He said that he would speak to the relevant bodies about it and get in touch with us.

Since early June, we have not been able to contact Mr Daneliski and he has not contacted us, despite our many requests. In early July, we were told that Mr Daneliski was out of the country so we went straight to the Ministry of Foreign Affairs in Moscow; again no joy.

We were told, rather discouragingly, that we could try writing to the Embassy in London. But perhaps the Soviet authorities' apparent unwillingness to clear up the matter speaks for itself.

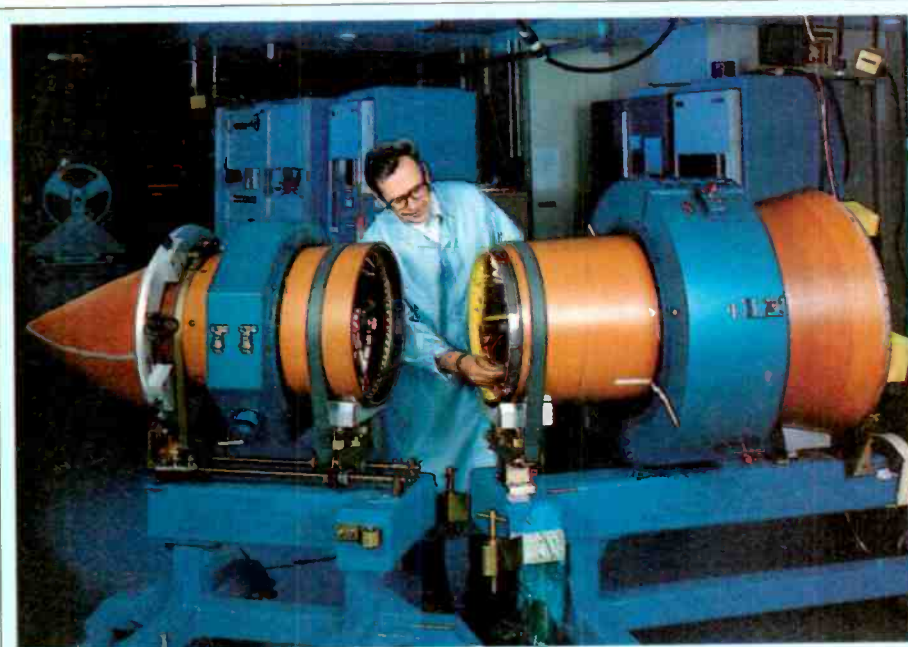

A test engineer from Hughes Aircraft inspects wiring inside the aft section of a kill vehicle, part of the Star Wars programme.

Space invader

Looking considerably out of place in the new politics of *glasnost*, the ground-launched KITE kill vehicle has been designed to intercept incoming missiles as they enter the earth's atmosphere.

Hughes Missile Systems, under contract to McDonnell Douglas, is providing target avionics for two of the three test interceptors. The first should have flown in an August launch.



OSCILLOSCOPES

Tequipment D755 Dual Beam 50MHz

£275.00

+ VAT

Carriage £8.75

5mv/div/sensitivity. Sweep 2s to 100ns/div
Delayed timebase 8 × 10 div crt



TEKTRONIX 475 200 MHz Dual Beam

£599.00

+ VAT

Carriage £8.75

2miv/div 1 n/sec Sweep rate, delayed sweep.
Trigger view 8 × 10cm display.

All items checked/tested with 30 days warranty. All in good clean condition.

M and B RADIO

86 BISHOPSGATE STREET, LEED LS1 4BB
Telephone: 0532 435649 · Fax: 0532 426881

28270

CIRCLE NO. 34 ON REPLY CARD

NORAL

Microprocessor In-circuit Emulation

SDT816 RANGE

8 BIT

8085, Z80, NSC800, 6502,
6800, 6802, 6808, 6809,
HD64180, Z180.

16 BIT

68008, 68000, 68010,
8086, 8088, V20, V30,
65SC816.

MICROCONTROLLER

RANGE

8051, 8031, 8032, 8052,
8059, 80515,
80535, 80512, 80C552, 8048,
ZS8, 68HC11,
DSP's
320C10, 320C15,
32C017, 320C25.

TRACE 32 RANGE

16 BIT

68000, 68008, 68010,
68070.

32 BIT

68020 (25MHz),
32008, 32016, 32032, 32132.

Ring now on (0254) 682092 for a FREE literature pack.

CIRCLE NO. 50 ON REPLY CARD

When Piper Alpha lost touch

The ill-fated Piper Alpha oil production platform was the hub of a system of radio links which failed with the initial explosion. In the subsequent confusion, gas was pumped to the centre of the disaster for a further hour. Jeff Crook has been following the Government's attempts to discover what lessons can be learned.

A ship called the MV Lowland Cavalier gave the first warning of an incident. She put out a "Mayday" call from her position in the North Sea close to Piper Alpha at just after 2158, on July 6, 1988.

Many ships, rescue boats and helicopters were involved in the rescue which followed; radio traffic became very heavy, making communication difficult.

A year later, Lord Cullen's inquiry continues to probe the terrible disaster. Witnesses have given evidence about communication problems experienced on the night. Improvements are being made to another Occidental Petroleum platform as a result of their experiences and these have been outlined to the inquiry.

The inquiry heard that after the coast-guard picked up the Mayday they were frustrated by the lack of information. Doctors who were sent to deal with the incident had no idea of the number of casualties. Furthermore, operators on platforms connected with Piper Alpha were unaware of the scale of the disaster. This delayed the shutting down of production and efforts to vent pipelines.

A network of pipelines joined Piper Alpha with three other offshore platforms, called Tartan, Claymore and MCP01; Piper was also linked with the Flotta oil terminal in the Orkney Islands.

One important conclusion of the De-

partment of Energy's investigation, contained in its interim report, was that rupture of the gas pipeline from Tartan released a huge quantity of fuel to the fire on Piper Alpha.

A field communication system linked the platforms and the coast with a number of separate telephone channels. It also transmitted process data for a computerized system which provided each platform with an overall view of pipeline operations.

Piper Alpha was the focal point of the communication system, with line-of-sight microwave links radiating to Tartan, Claymore and MCP01.

Signals from Tartan and Claymore passed to Piper Alpha where they were retransmitted to the shore either by a tropo-scatter radio on Piper Alpha or by retransmission to MCP01, where there was another tropo-scatter link to the shore. The inquiry heard that after the initial explosion on Piper Alpha, Claymore and Tartan could not be contacted.

Senior operators on Occidental's Claymore platform told the inquiry that after hearing the Mayday and losing their main communication link they made desperate attempts to contact Occidental's headquarters in Aberdeen by a back-up satellite system; yet meanwhile they continued production.

Witnesses differ as to the exact time that contact was made, but it was somewhere between 30 minutes and an hour

after the Mayday. The inquiry learned that it was only then that operators at Claymore learned of the scale of the disaster. Production was immediately shut down and arrangements were made to start de-pressurizing the pipelines.

Texaco's Tartan platform shut down gas export about 10 minutes after the initial explosion because its operators detected an increase in pipeline pressure caused by a valve closing on Piper Alpha.

According to the interim report, process shut-down on Tartan started at 22.45 and preparations to reduce pressure in the pipelines started at 23.20. When the work began, they found no pressure – gas had already escaped to feed the fire on Piper Alpha.

A witness said that they had a back-up VHF on Tartan but "a lot of people were using it so there was very heavy traffic". Texaco was in the process of installing satellite communications on the platform at the time.

Alistair McDonald, Occidental's head of communications, said that in his opinion it should be a statutory requirement to have back-up satellite communications.

He outlined four major improvements for Claymore, including battery back-up for radios, the provision of radios at muster points, longer-range lifeboat radios and a secondary control centre.

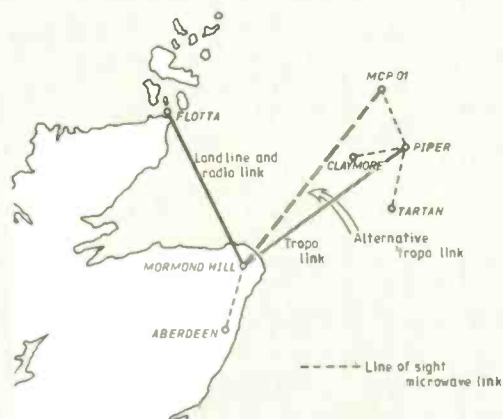

Communications links at the time of the Piper Alpha disaster.

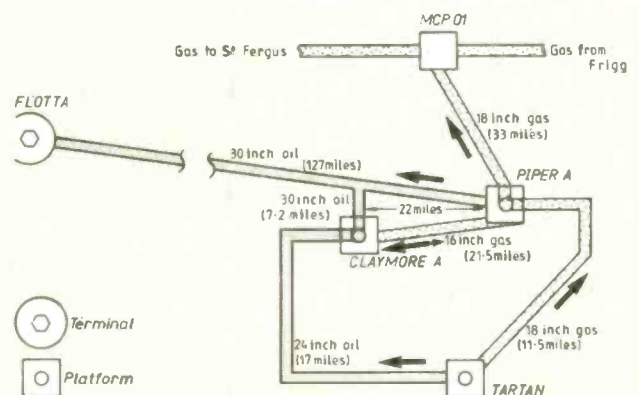

The pipeline system between the rigs.

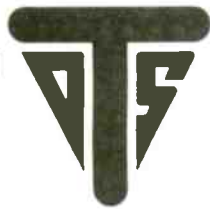

PROBLEM SOLVER...

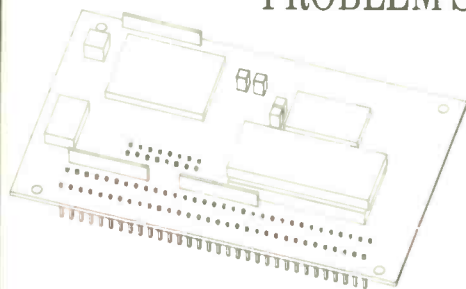

TDS
9090

This computer card is for building into your products. Put software for the application into PROM and it starts to run as soon as power is applied. Some existing uses:

- * Water control
- * Conveyor weighers
- * PABX telephone exchange
- * Diesel engine testing
- * Agricultural machinery
- * Machine-tool control
- * Remote robot handling
- * Heart rate data collection

1 off £194.95 including manual and non-volatile RAM.

Triangle Digital Services Ltd
100a Wood Street, London E17 3HX

Telephone 01-520 0442 Telex 262284 (quote M0775) Fax 01-509 3263

CIRCLE NO. 8 ON REPLY CARD

COMMERCIAL QUALITY SCANNING RECEIVER



The IC-R7000, advanced technology, continuous coverage communications receiver has 99 programmable memories covering aircraft, marine, FM broadcast, Amateur radio, television and weather satellite bands. For simplified operation and quick tuning the IC-R7000 features direct keyboard entry. Precise frequencies can be selected by pushing the digit keys in sequence of the frequency or by turning the main tuning knob. FM wide/FM narrow/AM upper and lower SSB modes with 6 tuning speeds: 0.1, 1.0, 5, 10, 12.5 and 25kHz. A sophisticated scanning system provides instant access to the most used frequencies. By depressing the Auto-M switch the IC-R7000 automatically memorises frequencies that are in use whilst it is in the scan mode, this allows you to recall frequencies that were in use. Readout is clearly shown on a dual-colour fluorescent display. Options include the RC-12 infra-red remote controller, voice synthesizer and HP-1 headphones.

ICOM Icom (UK) Ltd. Tel: 0227 363859. Telex: 965179 ICOM G
N.B. Authorised Welsh distribution by:
M.R.S. Communications Ltd. Cardiff. Tel: 0222 224167.

Please send information on Icom products & my nearest Icom dealer.

Name/address/postcode:

.....

.....

Status: Tel:

Post to: Icom (UK) Ltd. Dept. WW, FREEPOST, Herne Bay, Kent: CT6 8BR

CIRCLE NO. 9 ON REPLY CARD

METEX & TEST LAB INSTRUMENTS YOU PAY TRADE PRICES!

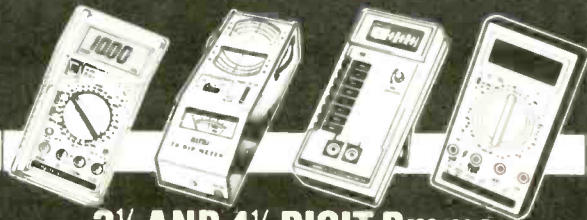

3½ AND 4½ DIGIT Dmms

ALL WITH CONTINUITY TEST (★ With Capacitance + With Hfe ○ With Freq.)

PRO SERIES METEX

3½ & 4½ DIGIT

All With Case. 20A AC/DC
17mm Display (3800 12mm)

3800 32 Range 0.5% (+)	£30.69
3610 30 Range 0.3% (-)	£38.86
3630 30 Range 0.3% (++)	£46.90
3650 30 Range 0.3% (***)	£50.90
3650B as 3650 with Bargraph	£57.60
4630B 4½ Digit 30 Range Data	£69.68
Hold 0.05% (**)	
4650 as 4630 Plus 2 Freq. Ranges	£72.36

STANDARD SERIES

3½ DIGIT 12 mm DISPLAYS

2315B 17 Range 10 ADC	£19.45
2318B 23 Range 10ADC (+)	£22.78
2335 31 Range 10A AC/DC (+)	£25.25
2325 32 Range 10A AC/DC (**)	£29.40
2355 32 Range 10A AC/DC (***)	£33.25
2365 38 Range 10A AC/DC (***)	£36.00
Plus Logic Probe	

Also Metex M80 21mm Display
3½ Digit Autorange. Datahold (°) £59.92

TEST INSTRUMENTS

3000 LCR AC Bridge	£103.20	TE220 1 MHz Audio Generator	£87.00
M3002A AC Millivolt Meter 1MHz	£85.80	3300 Autorange Digital Cap. Meter	£64.00
2020 500 KHZ Function Generator	£96.50	6100 Signal Tracer/Injector	£52.30
4162AD 150 MHz Fr Gen Plus 6 Digit Counter	£172.86	5250 150 MHz 7 Digit Frequency Counter	£64.50
2603AD 1 MHz Af Gen. plus 6 Digit Counter	£166.16	05T5M 5 MHz Bench Scope	£166.00
TE200 150 MHz Rt Gen. (350 MHz Harmonic)	£80.00	243 0/24V 0/3A Variable PSU	£52.13
		245 0/24V 0/5A Variable PSU	£65.50
		1544/15V 0/4A Variable PSU	£37.39

"POCKET" TEST INSTRUMENTS

F20 Dual Scale Sound Level Meter 120dB	£33.87	302K LCD Temperature Two 1/P	£34.74
225V VHS Video Head Tester	£30.39	3900TO LCD Dmm With Dwell And Tach Ranges	£49.58
1065 Digital Lux Meter - 3 Ranges	£148.00	KT50 LCD 8 Range Capacitance Meter	£34.84
07 Logic Probe	£6.10	6060 LCD Digital True Power Meter 6KW 19	£64.00
M625 Logic Probe/Pulsar	£14.74	2070 19 Range Multimeter 10ADC + Buzz	£11.35
300/310 AC Clamp Meter 600A/300V/Resis	£33.50	2030ET 27 Range 10A AC/DC. Cap. for Dmm's	£35.30
M265 Add on AC Clamp Probe	£16.48	Hfe Temp. Buzz	£25.33
501 Electronic Insulation Tester 500V	£53.00	5050E 41 Range FET mm	£18.69
504 Electronic Insulation Tester 1000V	£65.00	0M5 Wallet Autorange Dmm	£32.70
K0M6 TR Dip Meter 1.5 to 250 MHz	£45.02	YF120 Pen Type Autorange Dmm	£21.20
1062 LCD Temperature & data hold	£35.50	850 Mains Phase Tester	

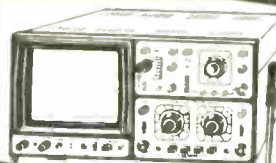

AUDIO-ELECTRONICS ARE
INSTRUMENT DISTRIBUTORS FOR
HAMEG • FLIGHT • BLACKSTAR
• ALTAI • THURLBY • THANDAR
• CROTECH • LEADER AND HITACHI
PHONE FOR BEST PRICES.

TELEPHONE YOUR ORDER WITH VISA/ACCESS
OPEN 6 DAYS A WEEK FOR CALLERS

ADD 15% VAT
(UK ONLY)

AUDIO ELECTRONICS

301 Edgware Road, London W2 1BN
Tel: 01-724 3564 Fax: 01-724 0322
Sales office 01-258 1831

TRADE/EDUCATION ORDERS ACCEPTED.
EDUCATION AND QUANTITY PRICES AVAILABLE

INSTRUMENT
CATALOGUE
WITH
DISCOUNT
VOUCHERS
REF TG
Send A4 SAE
(£1.00) or
£2.00 UK
for full
CATALOGUE

CIRCLE NO. 45 ON REPLY CARD

Chaos, fractals and computers

Keith Wood explores a spectacular branch of mathematics which is exciting widespread interest.

For well over two millenia, traditional mathematics has served us remarkably well for describing and predicting natural phenomena. We have a long tradition of straight lines and smooth curves in our geometry, architecture, astronomical observations and much more. It is not surprising, then, that our calculating skills are directed this way. On the one hand, skills are developed in response to a perceived need; while on the other, any attempt to quantify a phenomenon is couched in terms of established mathematics, even to the extent of simplifying the problem. New theories draw extensively on what has gone before.

Typically we would expect to be able to substitute, say, 12.00 noon on March 10, 1999, into an expression to calculate the height of the tide, and to obtain a result directly. Any errors would be a direct result of the accuracy limits of the constants in the equation and the height of today's tide. Subjects which were not amenable to this approach were in need of further research or bigger computers.

What we are seeing today is the development of a whole new branch of mathematics which is quite different from this. It is so new that today's state of the art is comparable to that of geometry when Euclid started work. This new branch is concerned with processes which move in steps, in which the next step is derived from the one before in a defined way.

Such processes as finite element analysis and numerical integration move in steps, but then our aim is to decrease the step size to approach the continuous function. To increase the step size is detrimental. There is a range of problems which are better described and investigated with large steps. Daily, monthly and annual phenomena are far easier to describe in those terms than as continuous functions. We have used empirical methods for a long time. The

snag is that we do not have a corresponding armoury of mathematical tools for this data.

Electrical devices may pose similar problems, as when a sample-and-hold amplifier is an element in a feedback loop. How many people would seek out a faster switching amplifier so that the nuisance frequency was outside the limits of operation of the loop? Often this is the only practicable solution.

Isolated examples of work, now re-

“The concept of repulsion is a natural if one accepts the contrary notion of attraction”

cognized as the precursors of the field, have appeared over the last 150 years. The coming of the computer has caused an explosion in this subject, as will be seen below.

The Verhulst Expression

Population growth cannot continue forever. A limitation in habitat, food supply, or other essentials will ultimately halt the expansion. This situation was given mathematical form in 1845 by P. F. Verhulst. He took an annual interval and defined the growth rate as R as the population ratio over that interval.

$$R = \left(\frac{z_{n+1} - z_n}{z_n} \right)$$

To account for the limitation, he further suggested that

$$R = r(1 - z_n) \quad (1)$$

where r is constant. This form normalizes the population to zero growth rate

at a population of 1. Eliminating R gives

$$z_{n+1} = (r+1)z_n - rz_n^2$$

A small deviation s_n in z_n gives rise to a small deviation in z_{n+1} of

$$s_{n+1} = (1-r)s_n$$

whence it follows that deviations will subside provided that $0 < r < 2$. In this range we have a stable feedback system.

Recent investigations have thrown up surprising discoveries about the range of r values above 2. As r increases past 2 the system starts to oscillate. This is the point at which the electrical engineer usually swears and starts again.

On closer examination, it turns out that there are two values either side of a population of 1 which alternate, a period of two years. As r is increased further the values change, but the period is constant up to an r value of 2.449. An analysis similar to equation 1 above for a two-year period shows a limit value for $r = \sqrt{6}$. At this point the period doubles to four years. Again, the period is stable over a range and there is a cycle of four different values for population for any given r . As r increases further the period doubles to eight years and eight values for population, and so on, each range of r rapidly becoming smaller as r increases, until at $r = 2.570$ chaos set in. That means there is no detectable period: the value for population varies apparently randomly from year to year.

This random behaviour is analogous to the pseudo-random number generators used in computer programs. They are completely determined. The same sequence of values derives from the same seed again and again, regardless of the particular machine. The random variations in annual population figures can be repeated at will, but only by starting at the beginning and working through every intermediate step. We cannot try 1999 and get a population figure; we have to work out 1990, 1991, . . .

ELECTRONICS FOR EVERY PURPOSE HENRY'S AUDIO ELECTRONICS

ELECTRONICS
DISTRIBUTORS
EDUCATION
INDUSTRY • MAILORDER
TRADE • RETAIL

PLUS - IN-DEPTH STOCKS
VOLUME DISCOUNTS

FAST SERVICE

COMPETITIVE PRICES

ASK FOR A QUOTATION
FOR YOUR REQUIREMENTS

Automatic account facilities for education, Company accounts on request.

- **TEST INSTRUMENTS** Scopes: Counters: Dmms: Probes: Signal sources: Power supplies: Main frames: Digital storage
- **SECURITY** Control panels: Pirs: Sirens: Contacts: Strobes: Bells: Doorphones: CCTV
- **PUBLIC ADDRESS** Mobile and Fixed station amplifiers: Horns: Speakers: Loudhailers
- **TV-VIDEO** Distribution and Booster Amplifiers VHF/UHF: Splitters: Cables
- **CB/SCANNERS** Mobile, Base Station and portables: Aerials: Matchers: Power supplies
- **AUDIO** Microphones: Stands: Mixers: Amplifiers
- **INTERCOMS** Single and Multiple Station: Wired and Wireless: Language Teaching System
- **COMPONENTS** Semiconductors: Tools: Production aids: Relays: Fans: Stripboard: Components

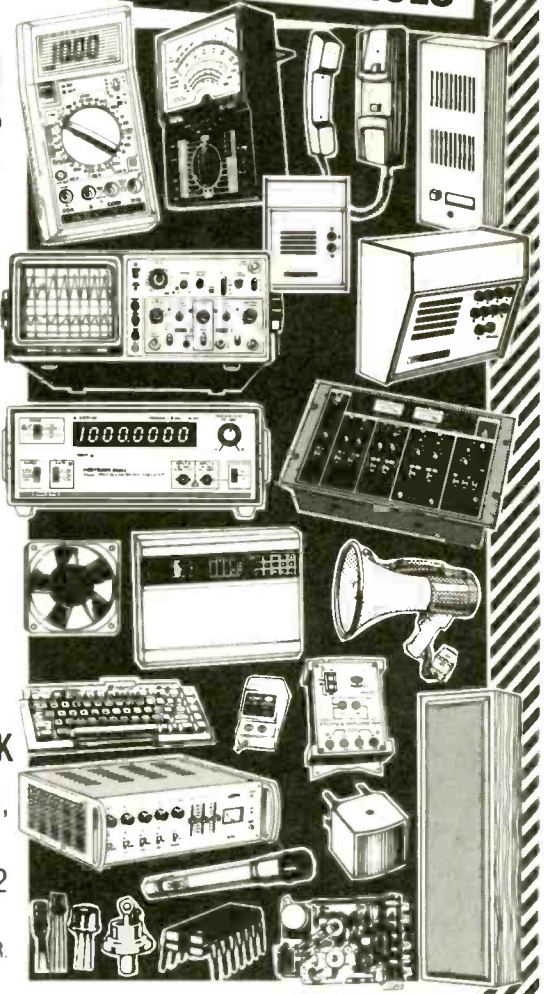

CALLERS WELCOME OPEN 6 DAYS A WEEK

AUDIO ELECTRONICS 301 Edgware Rd,
London, W2 Tel: 724 3564

HENRY'S 404 Edgware Rd, London, W2
Tel: 01-724 0323/01-723 1008

All correspondence to: Cubegate Ltd, FREEPOST, London, W2 1BR.
Sales Office: 01-258 1831 Fax: 01-724 0322 Telex 298102 (TRANS G)

**PLUS
MUCH
MUCH
MORE**

**FREE
£90**
TOTAL VALUE
PURCHASE VOUCHERS
WHEN YOU COMPLETE AND
RETURN THE COUPON

Post coupon to Cubegate Ltd, FREEPOST, London, W2 1BR (No stamp required)

DATE _____
 NAME _____
 TITLE _____
 ORGANISATION _____
 ADDRESS _____

 POSTCODE _____
 DAY TEL _____
 JOB FUNCTION (Please Tick)
 EDUCATION TRADE INDUSTRY HOBBY
 OTHER _____

- For further information and leaflets please tick relevant boxes
- TEST INSTRUMENTS
 - SECURITY EQUIPMENT
 - PUBLIC ADDRESS
 - TV-VIDEO
 - CB RADIO/SCANNERS
 - AUDIO
 - INTERCOM SYSTEMS
 - COMPONENTS/TOOLS

CIRCLE NO. 46 ON REPLY CARD

How the images were made

The equations and descriptions are to be found in the text. Here are the ranges of real and imaginary parameters. The total range will have to be divided by the screen resolution in each direction to create the grid of points for iteration.

Fig. 3: Re -2 to +2; Im -1.5 to +1.5.

Fig. 4: Re -1.33 to +1.33; Im -1.0 to +1.0.

Fig. 6: Re -0.75250 to -0.71550; Im 0.19849 to 0.22624.

Fig. 7: Re -1.773519041725 to -1.773519039401; Im 0.006836859946 to 0.006836861689.

Fig. 8: Re -0.6754 to -0.3986; Im -0.1038 to 0.1038.

The program used to create the figures is available from the author at 33 Glan Aber Park, Liverpool L12 4YP, England. Price is £15 inclusive, UK and Europe, £16 elsewhere, on 5¼ inch disk for PC. £1.50 extra for 3½ inch disk. The program includes an editor with syntax checker for writing programs, a calculating section which uses a coprocessor if present, and a display editor. The data file and picture file are both compressed to save disk space, and the program will run on most PCs with DOS 2.0 or higher and with 256K memory. It supports EGA and VGA displays. The data file can be expressed many ways without further calculation. Figures in this article were photographed from a VGA 640 x 480 x 16 colour display.

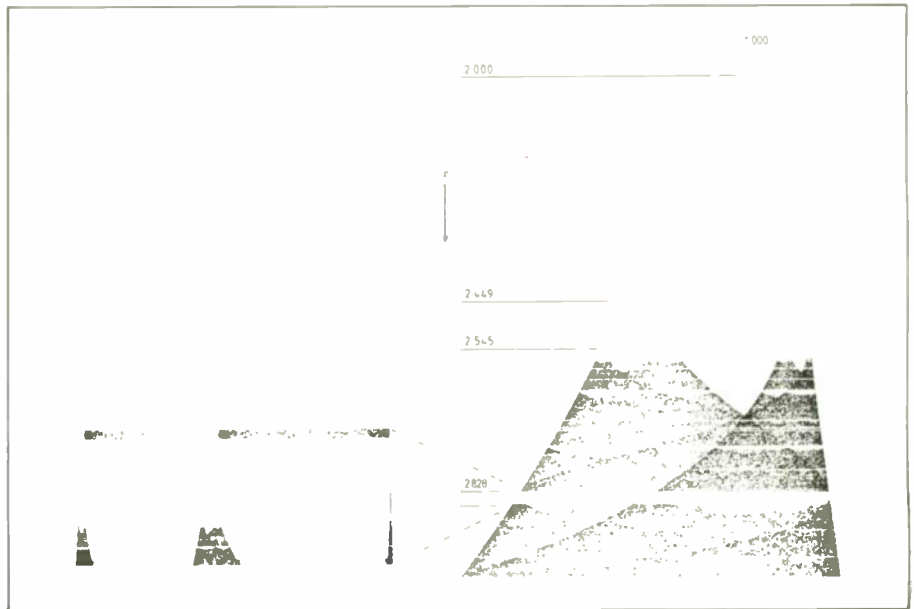

Fig.1. The dynamics of the Verhulst Equation.

Fig.2 appears on page 963.

Fig.3 (left). A Julia Set showing level sets.

Fig.4. The Julia Set of the cube root of 1.

Verhulst Equation. The ordinate is the normalized population and the abscissa the value of r . These plots were produced by taking a value of r and iterating for 5000 years to allow the system to rid itself of starting transients. The next 300 years' population figures are plotted. Below $r=2$ the population is 1 for a stable system. For $2 < r < 2.449$ there are two values for population. Then as r increases there are 4, then 8. Higher powers of 2 are not visible on this plot. Beyond $r=2.570$ chaos has a definite structure. This is the next big surprise.

From Fig.1 you will see that chaos has limits, preferred values lying in easily-recognized bands which are continuations of the regular periodic

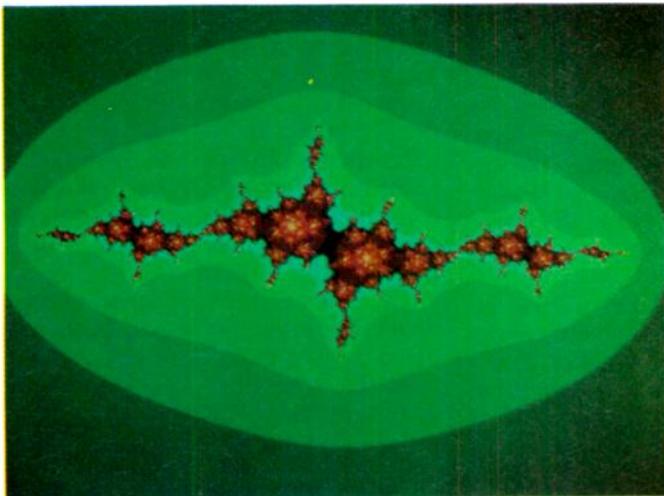

Another surprise concerns the ranges of r for which a certain mode of behaviour holds. If the range of r values over which doubling occurs is divided by the range of values over which quadrupling occurs, the result is found to be 4.669201660910 . . .

Also, the range of period 4 divided by the range of period 8 has the same ratio. Furthermore, the same ratio is found in the Mandelbrot set and in many other systems. This number is known as the Feigenbaum number, after the man who established its wide occurrence.

The precision of the process is a property of a mathematical expression; there would be a much more complex situation in a real world. Nevertheless similar behaviour is found in a variety of systems, including electrical circuits. If the above equation is implemented in hardware (using a sample-and-hold amplifier and analogue multiplier), the circuit behaves as described.

Fig.1 illustrates the dynamics of the

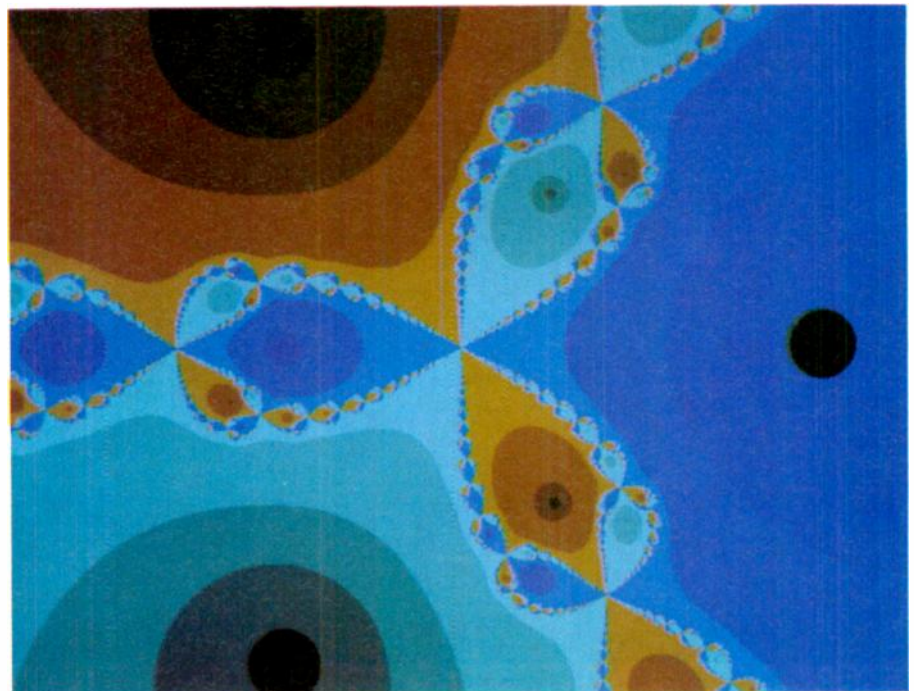

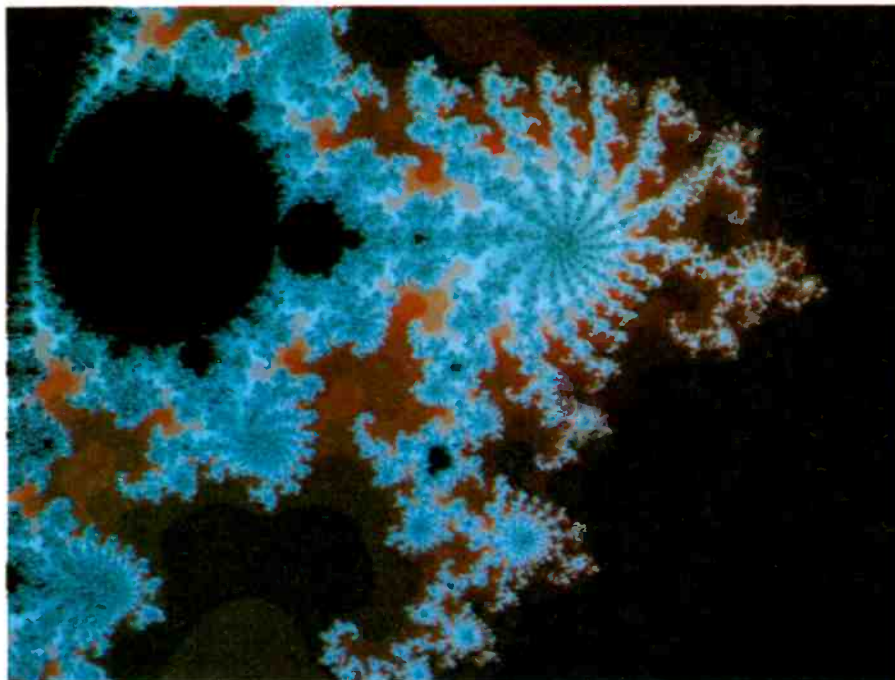

Fig.6. A bud from the Mandelbrot Set, a subset of period 15. (Fig.5 is on p.965).

values. It also has windows. A window at 2.828 has only three values, and as r increases further each of these three traces doubles to a total of six, then 12, 24 . . .

There are numerous other windows, some so narrow that they look like printer misalignment. Close inspection reveals a small number of values within the window. The two bands of chaos which appear as r is increased meet at a population value of 1, the stable value. This is pure observation; I doubt if it can

be derived and therefore it can't carry any mathematical significance. The envelope of a band of chaos at smaller values of r continues within the larger area of chaos which develops at larger r values.

The three traces in the window at $r=2.828$ each have the same form as the whole of Fig. 1. The window is expanded horizontally by a factor of 8.5 in the lower section of the figure. You will see that not only is the regular period data mimicked, but the small chaotic

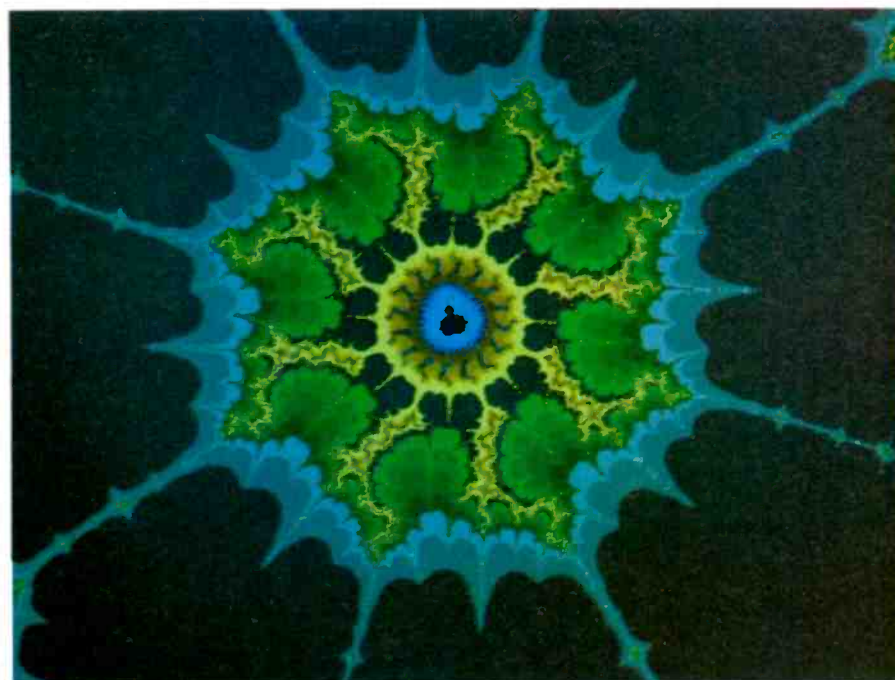

Fig.7. A 500 000 000 times enlargement from the Mandelbrot Set. Location suggested by Dr Dietmar Saupe.

regions which develop as r is increased have windows which correspond as well.

This repetition of a recognizable feature is a characteristic which will appear again and again. It is especially significant that the word "recognizable" applies here. Random data can be arranged to create a lasting impression on the mind, which is a pre-requisite for any analysis or hypothesis. Would the appearance of a contour within the chaotic region, on one side of which the probability of a result was higher than on the other, ever have been discovered from reams of printed data?

Notice also that the structure of chaos becomes apparent only when very large quantities of data are presented. A few points calculated by hand look far more random. Computers are essential because of the vast amount of arithmetic involved, and it follows that the method of display naturally centres on the monitor. Both these, coming together, are responsible for opening up a whole new field of endeavour.

It will be obvious that to produce chaotic behaviour a non-linear function is essential. A linear one would move smoothly and continuously in one direction towards zero or infinity.

The Verhulst example is a one-dimensional case, the second dimension being used to plot the results deriving from the value of r . Two-dimensional systems provide further revelations.

Julia and Fatou

A feature of stepwise processes which are determined by iteration is that one initial value can generate a result after a given number of iterations, while another arbitrarily close initial value can generate an entirely different result.

These two results may each be stable conditions, which is not chaotic; however, chaos will generally be found in some area covered by the process. A stable condition is one which is arrived at by iteration and from which the process does not depart by further iteration. It may be a single value or a cycle of values which repeat. These conditions are known as attractors. Another form of attractor is a closed contour which is finite, but within which a point does not repeat as iteration proceeds.

Where two or more attractors exist for a process it follows that there must be a dividing line between the regions of influence of each of the attractors. Once again the idea was first examined long before computers were available. It was clear that in using Newton's method to

MAKING ELECTRONICS C.A.D. AFFORDABLE

TINY-PC

PCB CAD, FOR THE PC/XT/AT

EASY-PC

- Are you still using tapes and a light box?
- Have you been putting off buying PCB CAD software?
- Have you access to an IBM PC/XT/AT or clone?
- Would you like to be able to produce PCB layouts up to 17" square?
- With up to 8 track layers and 2 silk screen layers?
- Plus drill template and solder resist?
- With up to eight different track widths anywhere in the range .002 to .531"?
- With up to 16 different pad sizes from the same range?
- With pad shapes including round, oval, square, with or without hole and edge connector fingers?
- With up to 1500 IC's per board, from up to 100 different outlines?
- With auto repeat on tracks or other features - ideal for memory planes?
- That can be used for surface mount components?
- With the ability to locate components and pads on grid or to .002" resolution?
- With an optional auto via facility for multilayer boards?
- With the ability to create and save your own symbols?
- That can be used with either cursor keys or mouse?
- That is as good at circuit diagrams as it is at PCB's?
- Which outputs to dot matrix printer, pen-plotter or photo-plotter (via bureaux)?
- Where you can learn how to use it in around an hour?

- That only costs from **£49.00?**

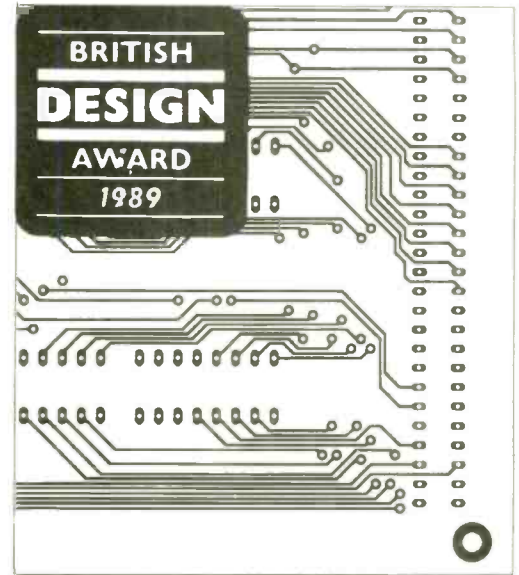

SMITH CHART PROGRAM — Z MATCH

CIRCUIT ANALYSIS BY COMPUTER ANALYSER II

For IBM, PC/XT/AT and clones inc. Amstrad 1512 and 1640 and BBC B, B+ and Master.

For IBM PC/XT/AT and clones inc. Amstrad 1512, 1640, R.M. NIMBUS, and BBC B, B+, and Master.

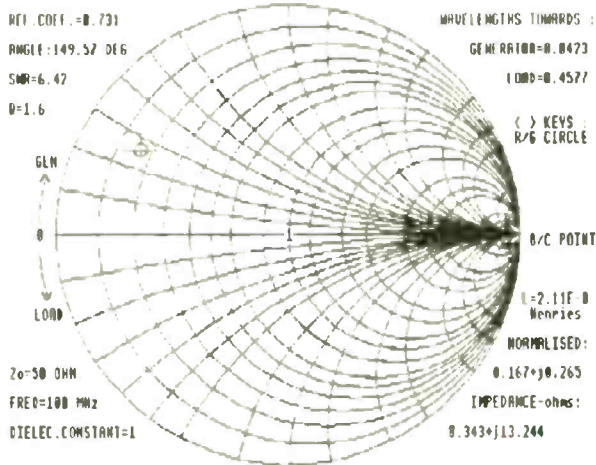

Z-MATCH - Takes the drudgery out of R.F. matching problems. Includes many more features than the standard Smith Chart.

Provides solutions to problems such as TRANSMISSION LINE MATCHING for AERIALS and RF AMPLIFIERS with TRANSMISSION LINE, TRANSFORMER and STUB MATCHING methods using COAXIAL LINES MICROSTRIP, STRIPLINE and WAVEGUIDES. The program takes account of TRANSMISSION LINE LOSS, DIELECTRIC CONSTANT, VELOCITY FACTOR and FREQUENCY.

Z-MATCH is supplied with a COMPREHENSIVE USER MANUAL which contains a range of WORKED EXAMPLES

£130 for PC/XT/AT etc.
£65.00 for BBC B, B+ and Master

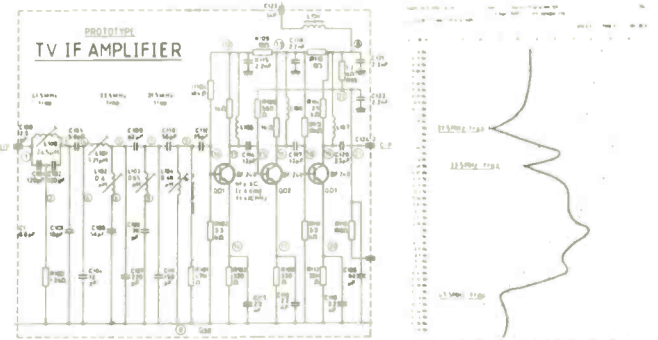

"ANALYSER II" - Analyses complex circuits for GAIN, PHASE, INPUT IMPEDANCE, OUTPUT IMPEDANCE and GROUP DELAY over a very wide frequency range.

Ideal for the analysis of ACTIVE and PASSIVE FILTER CIRCUITS, AUDIO AMPLIFIERS, LOUDSPEAKER CROSS-OVER NETWORKS, WIDE BAND AMPLIFIERS, TUNED R.F. AMPLIFIERS, AERIAL MATCHING NETWORKS, TV I.F. and CHROMA FILTER CIRCUITS, LINEAR INTEGRATED CIRCUITS etc.

STABILITY CRITERIA AND OSCILLATOR CIRCUITS can be evaluated by "breaking the loop". Can save days breadboarding and thousands of pounds worth of equipment.

£195 for PC/XT/AT etc.
£130 for BBC B, B+ and Master

All prices Ex-VAT
WRITE OR PHONE FOR FULL DETAILS:- REF WW

Number One Systems Ltd



Harding Way, St Ives, Huntingdon Cambs, PE17 4WR
Tel: St Ives (0480) 61778 (4 lines)
We provide full after-sales support with free telephone 'hotline help' service.
Software updates are free within 6 months of purchase date.

CIRCLE NO. 47 ON REPLY CARD

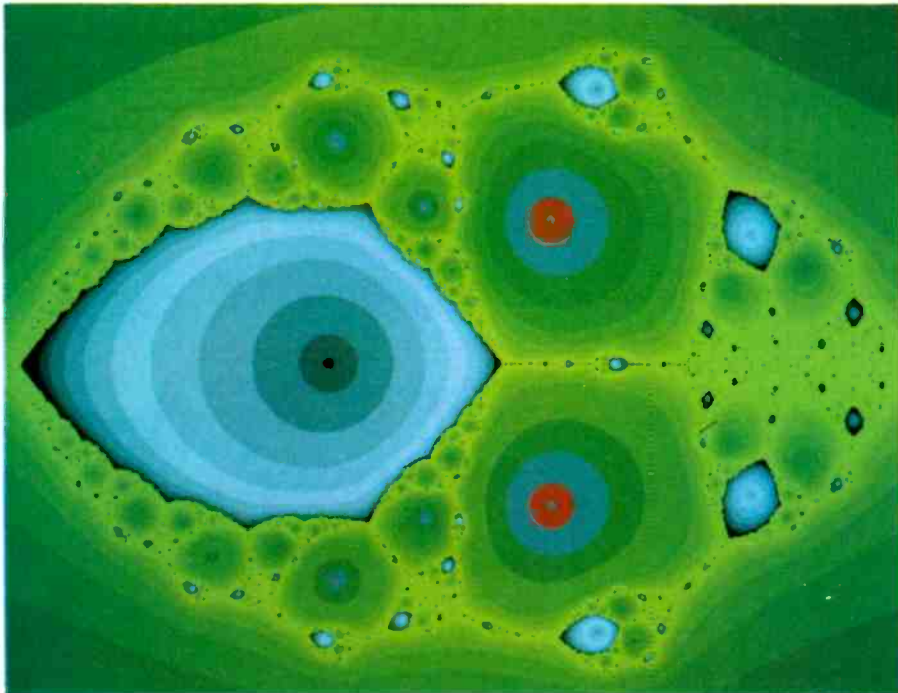

Fig.8. A typical cubic analysed by Newton's method. Location suggested by Peitgen and Richter.

Fig.9. Newton's method applied to a real function.

find the roots of an equation, the starting value influenced which root was ultimately found. The problem was to determine the spread of values leading to a particular root.

Newton's method states that a better approximation to a root of the equation $f(z) = 0$ can be calculated from an inferior value with the expression

$$z_{n+1} = z_n - \frac{f(z_n)}{f'(z_n)}$$

$$n = 0, 1, 2, 3, \dots$$

The method is repeated until the result has as much accuracy as is required. Clearly, starting with a close guess reduces the amount of computation and the wider problem considered here was of an academic nature.

Lord Cayley (1879) addressed the problem and found that the two roots of $z^2 - a = 0$ had an easily defined dividing line which is the perpendicular bisector case when complex roots are involved. The standard (or Gaussian) plot is to put the real component on the x-axis and the imaginary component on the y-axis, though for artistic purposes any other manipulation is equally acceptable.

Lord Cayley failed completely to find a solution with cubic or higher order functions. They appeared to be impossibly complex. This makes the work of Julia and Fatou (1918-20) seem particu-

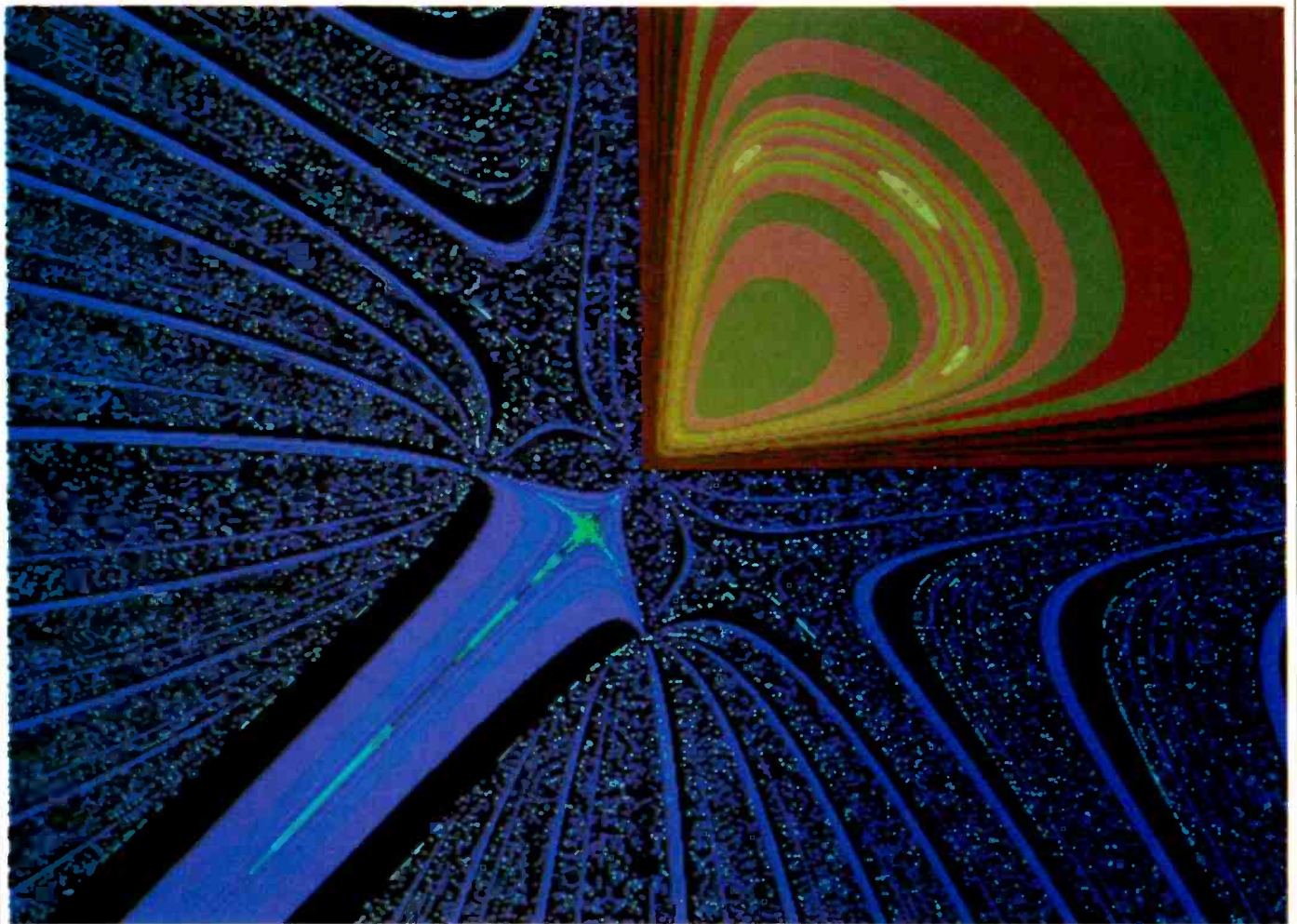

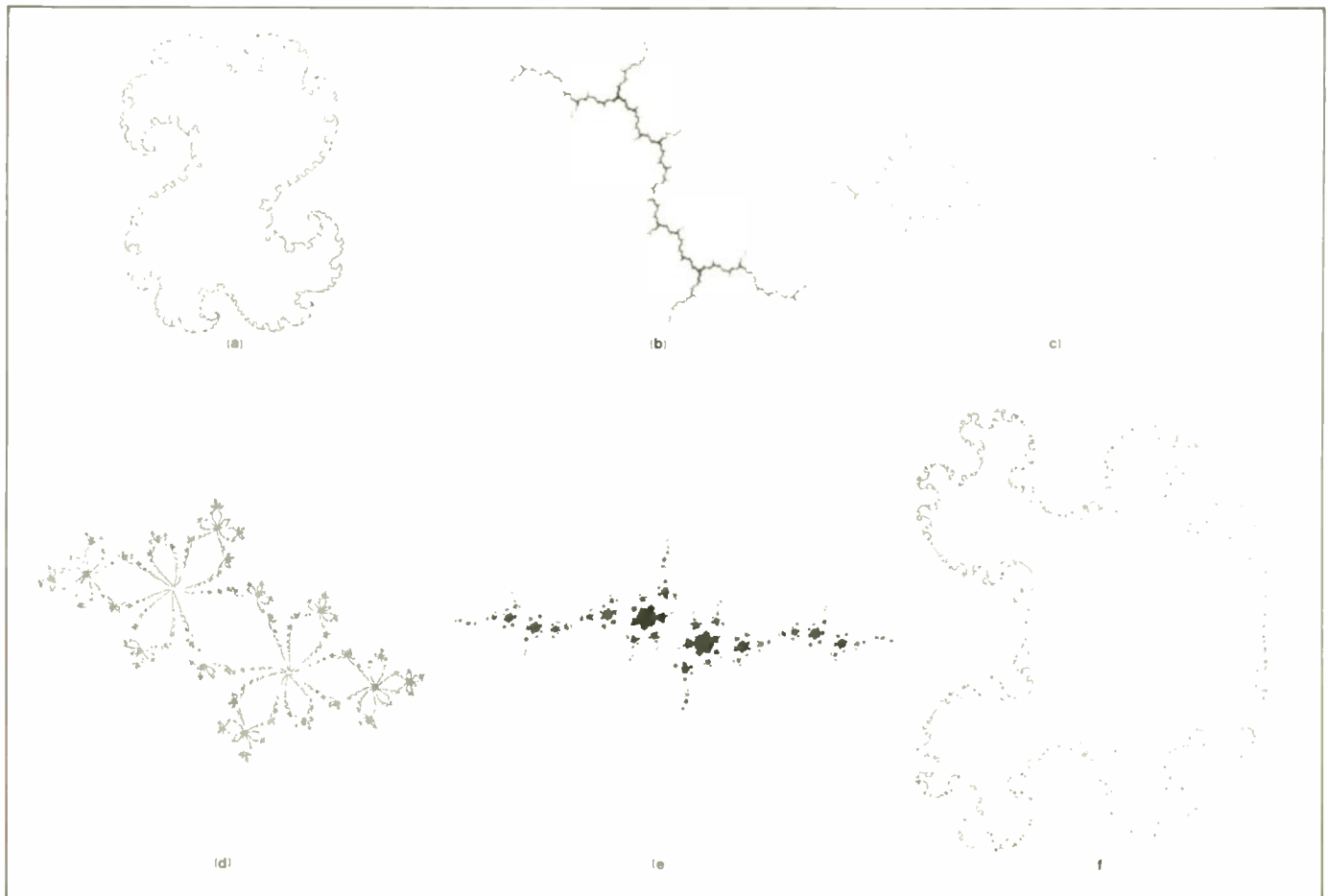

Fig.2. A selection of Julia Sets.

larly inspired, since they had no computer facilities to display and check their results.

Julia and Fatou looked at the general case of the regions of attraction in the complex plane and determined the properties of the division between them in terms of the set of points forming the dividing line. This set is known as the Julia set.

One surprising result was that the set of points forming the boundary of a region of attraction was the same set regardless of which attractor was in consideration. While this is self evident in the case of two attractors, it applies to any other number of attractors. This might seem impossible, but the case of three or more regions of attraction sharing a common boundary will be illustrated later.

The simplest non-linear function, and therefore the most amenable to calculation and analysis, is the quadratic function. Although general theories were being developed, they were tried out with the equation

$$z_{n+1} = z_n^2 + c \quad (2)$$

$n = 0, 1, 2, 3, \dots$

where both z and c are complex. This expression is quite general as all quadratic functions can be reduced to this form by substitution. One can generate a wide variety of displays with it, the simplest being the special case of $c=0$. The Julia set is then a unit circle.

To create a display, a grid of points is allocated in turn to z and the equation is iterated. The outcome is displayed with the points as pixel coordinates or printer dots. Since a point belongs to the Julia set or it doesn't, monochrome displays are quite suitable.

Fig.2a shows the way the unit circle distorts when the value of c moves away from zero. It is still a closed curve with a single attractor in the centre at $z=0$. For this set c has the value of $0.31+0.04i$. Fig.2b is the Julia set obtained when $c=i$. This is a set having only one attractor, at infinity. The line represents values that are not attracted to infinity, but it has no thickness and points on both sides of the line are repelled. The thickness in the figure is an artefact of the method of computation.

The concept of repulsion is a natural one if one accepts the contrary notion of attraction. A starting point arbitrarily close to a point in the Julia set, but not

being itself a member of the set, will be attracted to one or other of the available attractors. Points in the Julia set are therefore all repellent. A cycle of values can only belong to the Julia set if any other point not being part of it is never attracted to it. Such cycles have a period of 1. The value $z=1$ on the unit circle is an example, and is known as a fixed point.

Iterating a point within the Julia set will lead to other members of the set; since all are repellent this movement must be random and therefore in general chaotic.

Figs.2c and 2d are of Julia sets of equation 2, in which $c=-1$ and $c=-5052+0.5576i$ respectively. The former has two loops which connect at each junction point, while the latter has five. The loops do meet in this case; the error arises from the interaction between the method of calculation and printer resolution. These sets have attractive cycles with a period of two and five respectively; one cycle point lies in each loop round a common junction point, the one in the centre loop being the value $z=0$ which is always enclosed in these Julia sets. The attractive cycle is not symmetrical.

A great attractor – but is it art?

Mathematical practice has been largely spawned by Euclidean premises. Lines and curves are smooth, not a bit like nature. Nevertheless a lot of important and relevant work has resulted from this ethos.

While they seem to move in such a way, the planets themselves are impossible to describe in Euclidean terms. Why, for example does erosion not make everything smooth? We say because of local crustal variations and tectonic movements. Why do these occur? We say because of thermal instabilities. Why are there instabilities? We say because of crustal variations. Or, perhaps there hasn't been enough time for initial disturbances to lie down. Will they ever? Do we have a chaotic situation which is constantly on the move yet which manages to stay within limits over the long term? Mathematically we now find that such a scenario is possible, even though the simple demonstrations are far from application to the real world. Perhaps one day we will be able to apply new and distinctly different theories to familiar situations.

The climate is a clear example of a chaotic situation, yet we know general patterns and limits which place a broad restriction on unseasonable weather. Now that it is clear that chaos is not necessarily total, new methods of prediction may

emerge.

The study of iteration theory and fractals has made inroads into situations which were thought impossible to characterise, and both theory and experiment are making progress with the help of the computer, which is the only way to process enough data to show results. Computer output in the shape of dot printers and monitors has been the other essential element in enabling human comprehension of enormously large quantities of data, by organising it in ways which turn out to look surprisingly appealing and memorable.

Beside population dynamics, the Verhulst equation has been found to apply to some aspects of turbulence and chemical dynamics. Much is known about complex functions and Julia sets, but as yet there is much less known about real functions, and rules may not be generally applicable. One thing does emerge in nearly all cases, that chaos occurs in the region where two conflicting processes meet.

The displays which have done more than any other single development to excite interest in the subject have crossed the borderline between science and art. Elitists maintain that anything produced from an equation by a computer cannot be called art. Art must be a manifestation of human

vision and endeavour. They have a formula themselves. The colouring of displays requires considerable time and application if the result is to be comprehensible, have impact, and transmit the essentials of the message. That the message may be scientific rather than cultural shouldn't matter.

There is certainly a great deal of aesthetic appeal; there are far more hobbyists developing displays than there are scientists and mathematicians doing research. All that weight of application is bound to throw up an occasional discovery. I have myself made a fascinating display with what turned out to be a programme bug. I know the cause and will be programming it properly to see what can be done with it. This was sheer luck, most bugs create much worse chaos than the subject!

Another use of fractals is commercial art. For mountain ranges, seas and skies the motion picture artist is turning to the use of transformations. There is considerable scope for human intervention with this method. One can liken it to conducting an orchestra, a few directives and a guiding hand as the work proceeds produce a result which owes a lot to the concept of the artist.

Over the last couple of centuries a wide gap has developed between science and the arts. Perhaps the fractal can reverse the trend.

As c is increased further in equation 2, the resulting Julia set is not connected. When $c = -1.25 + 0.136i$, (Fig. 2e), the Julia set is of the type which has been called Fatou dust. Those c values for which the Julia set is connected constitute the Mandelbrot set. The unconnected set has only one attractor; there is no interior to the set.

Figure 2e looks as though it ought to have an interior. This is because the dust points are of no size, and the chance that any of them fall on the grid of points used for calculation is remote. The easiest method of display is to select a level set closely surrounding the Julia set and to display that. One can create a map of several such level sets by colouring them. Figure 3 illustrates the same Julia set as Fig. 2e in that way. While a level set is strictly the set having a unique number of iterations, a map of many level sets can be confusing.

Finally, Fig. 2f depicts a Julia set of an entirely different equation. The mathematical models of magnetic domains developed by Yang and Lee can be examined this way. It is of interest to plot them in the complex plane to see whether the known properties of such sets cast any further light on them. It turns out that they exhibit the same convoluted structure. The Julia set of Fig. 2f is of

$$x_{n+1} = \frac{x_n^2 + 9 - 1}{2x_n + 9 - 2}$$

where x and q are complex, but a real

value for q (4 in this case) yields plenty of interesting results.

Level sets

The complementary set to the Julia set in the complex plane is called the Fatou set. It is normally very large compared to the Julia set and in order to examine it we must split it up into manageable portions. One way to do this is to take a small arbitrary radius centred on an

“There are numerous windows, some so small that they look like printer misalignment”

attractor and count the number of iterations required to move from the starting value to within the circle represented by this radius. All starting values requiring a given number of iterations constitute a level set of that order. When the attractor is infinity, it is convenient to count the iterations required to exceed the reciprocal of the radius.

To display the collection of level sets in a mapping of the function, the most instructive and appealing method is to colour them. One can colour each set with a contrasting colour to its neigh-

bour. The result is usually a striped display such as that in Fig. 3.

Attractive points or cycles have their regions of attraction, and it is instructive to colour these differently so as to illustrate the extent of each region. Fig. 4 shows the Julia set of Newton's method applied to

$$f(z) = z^3 - 1$$

$$\text{roots } -1, 0.5 \pm \frac{\sqrt{3}}{2}$$

and there will be three regions of attraction. As mentioned earlier, one of the properties of the Julia set is that it is the boundary of each of the three regions of attraction. How this appears in practice can be seen in Fig. 4, where each region has a different colour. Each point in the Julia set is a three-colour point, a chain of islands bounds each region, and each island is itself bounded by a chain of islands, and so on.

Complex functions seem to be remarkably well-behaved when it comes to creating a display. The stripes in Fig. 3 seem to suggest a smooth progression towards the attractor in a manner suggestive of walking down a flight of steps. Actually, the movement of a point with successive iterations jumps around the map, happening to land in just such a way that the regular steps are created. In spite of this, the progression is not chaotic because the attractor ultimately collects the ongoing iteration in a defined situation.

Other methods of calculating Julia

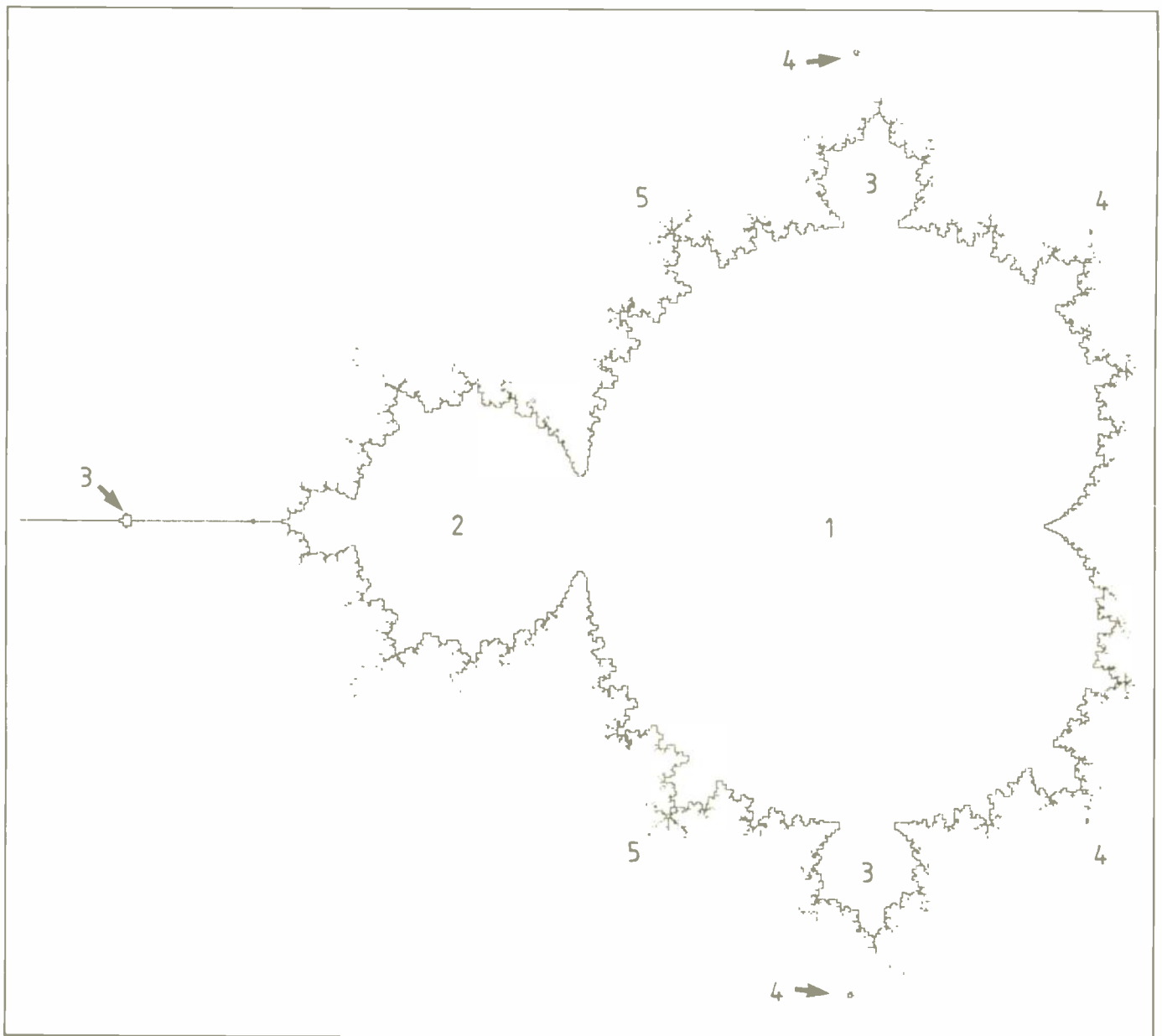

Fig.5. The Mandelbrot Set in outline.

sets, such as iterating backwards, yield multiple results at every step, all of which have to be followed up. Inverse iteration does not fill the whole set, some parts being preferred. Further complication arises in the attempt to overcome this. Julia sets are calculated this way, but larger, faster computers are required. Even so, the method depends on the convenient behaviour of the function being iterated. Some functions may not exhibit gradual progression away from the Julia set in terms of level sets and they may not be open to us yet, though the theoretical results which have been proved for complex sets will hold.

The Mandelbrot Set

The quadratic function has been extensively studied since it is the simplest and

can be reduced to a form with one constant. It was B.B. Mandelbrot who thought of extending the studies to the complex plane, and who had computer facilities available to him. The rest, as they say, is history.

The Mandelbrot set is derived from equation 2 with the difference that whereas the Julia sets for a quadratic polynomial were calculated for a fixed value of c , in this case the value of c is varied. Those Julia sets illustrated the outcome of iteration of a grid of starting values for z (z plane). We now look at the result of iterating the same value of z (zero) with a grid of c values (c plane). There are two attractors, one of which is infinity. The other attractor varies according to the value of c . The Mandelbrot set is defined as those values of c whose Julia sets are connected. This

definition includes sets like Fig. 2b which are a special case.

The Mandelbrot set is shown in Fig. 5. To the left of the main cardioid is the biggest bud and to the left of that is another bud, and so on beyond the resolution of this printout. The ratio of diameters of the biggest bud to the next is the Feigenbaum number again, and similarly for the successive buds. Not only that, but the tiny Mandelbrot shape on the antenna to the left corresponds in position to the main window in the Verhulst plot (Fig. 1). Perhaps this is not as surprising as might at first appear, since they are both quadratic functions.

The appearance of the set suggests immediately that it might be broken down into a number of subsets, such as the main cardioid and the attaching

buds. The corresponding Julia sets have attractive cycles with a periodicity of 1, 2, 3, . . . Where the cycle has a period of 1 it is a fixed point at $z=0$. It can be shown that the values of c yielding such a cycle are given by

$$c = \frac{u}{2} \left(1 - \frac{u}{2} \right)$$

$$u = \frac{d}{dz} (f(z))$$

and this defines the main cardioid bearing the number 1 in Fig. 5.

The test of the Julia set starts at $z=0$ in each case, so that the process is represented by

$$0 \rightarrow c \rightarrow c^3 + c \rightarrow c^4 + 2c^3 + c^2 + c \rightarrow \dots \quad (3)$$

Since $z=0$ is a part of the cycle, these quantities lie on the attractive cycle for the Julia set, and it follows that the cycle having a period of two requires that

$$0 = c^2 + c$$

which has two roots, 0 and 1. The zero root has already been dealt with, and the other root is the centre of the largest bud, which has a radius of 0.25, and encloses those c values giving rise to attractive cycles of period 2. Such a Julia set was shown in Fig. 2c.

Similarly, $0 = c^4 + 2c^3 + c^2 + c$ has four

"Put another way, if the whole set covered the British isles, this shape would still be much less than a single dot from a laser printer"

roots, $0, -1.755, -0.123 \pm 0.745i$. The centre of the tiny Mandelbrot shape on the main antenna is -1.755 , and the two largest side buds are centred on $-0.123 \pm 0.745i$ having a period of three. This process can be continued indefinitely.

The point at which the principal bud attaches to the main cardioid has the internal angle $\frac{1}{2}$; the points at which the largest side buds are attached have the angle $\pm \frac{1}{3}$; and period 4 buds attach at $\pm \frac{1}{4}$ (the remaining period 4 buds are not on the main cardioid). The denominator in the fraction is the same as the period of the attracting cycle.

Another concept is that of an iteration which starts at $z=0$ and proceeds to an attractive cycle which does not pro-

ceed to infinity, but which does not include $z=0$ as a fixed point. These sets are connected, but have no interior. They are a limiting case between the set with an interior and the unconnected set. Starting from $z=0$, iteration proceeds until the n th iteration equals the $(n-k)$ th. The first time this happens defines values for n and k which can be used to characterize the situation.

For example, with $c=2$, successive iterations produce the series $0, -2, 2, 2, \dots$ so that $n=3$ and $k=1$. This value of c lies at the tip of the main antenna of the set. Referring to equation 3, this case is represented by

$$c^4 + 2c^3 + c^2 + c = c^2 + c$$

whose roots are 0 and -2 .

Where $n=4$ and $k=1$ the roots are 0, one along the main antenna and $-0.228 \pm 1.115i$ which are the tips of the two traces which reach the farthest from the real axis. Values $n=4$ and $k=2$ produce c values for the tips of the next two most prominent side traces at $c=\pm i$. The process continues indefinitely and the points are known as Misiurewicz points.

The largest side buds have a branching antenna attached. Two arms reach out and a third connects the branch point to the bud making a three point star. This is the size of the attractive cycle of the associated Julia set. Proceeding round the main cardioid towards the cusp, the next largest is of order four, then six and so on. Going the other way, towards the principal period 2 bud, are the odd-numbered buds. Fig.6 is an enlargement of the period 15 bud.

Fractals

Fractals can be defined in two ways. One way is the visual aspect uncovered by B.B. Mandelbrot, which highlights the self-similar aspect of the displays. A nearby structure has a similar appearance, a magnified image likewise, so that it is not possible to tell by just looking what magnification a feature has. By way of example, Fig.7 is of a small part of the Mandelbrot set. The familiar shape at the centre is roughly 5×10^{11} times smaller than the main figure. Put another way, if the whole set covered the British Isles, this shape would still be much less than a single dot from a laser printer.

The formal definition is that a fractal is any figure whose Hausdorff dimension is not an integer. If a map is covered by small discs the number of discs required will vary with the size of the disc. The slope of the relation linking the number and size is, in the limit as disc size is reduced, the Hausdorff

dimension. If the mapping to be covered is in more than two dimensions, it can be thought of as being enclosed to any number of dimensions. More than three is not easy to visualize because we are used to linear methods of presentation; mathematically they are just variables. ■

OBITUARY

Professor William Shockley

Professor William Shockley, one of the team that invented the transistor, has died in San Francisco aged 79. He and his two colleagues, John Bardeen and Walter Brattain, demonstrated the first point-contact transistor at Bell in December, 1947.

Professor Shockley's intention was to develop an amplifying semiconductor device based on the field effect, but ran into difficulties. During the process of overcoming this problem, the bipolar type was invented and was closely followed by a working junction transistor, using layers of germanium instead of the metal contacts, early in 1948. It was only about five years later that the team discovered how to reach its original goal - the field-effect transistor.

In 1954, Shockley founded the Shockley Semiconductor Laboratories in California and effectively began the complex of industry now known as Silicon Valley.

Professionally, Shockley's reputation is secure, but his unorthodox views on race and genetics, and his disconcerting habit of recording almost every conversation he had with anyone and later producing the transcript either in evidence or to save himself the trouble of repeating it, did not endear him to those who tried to work with him.

The latter part of his life was spent at Stanford University, where he became Emeritus Professor. He leaves his second wife and two daughters.

● See also Pioneers: Shockley, Brattain and Bardeen, *Electronics & Wireless World* March 1988, p. 273.

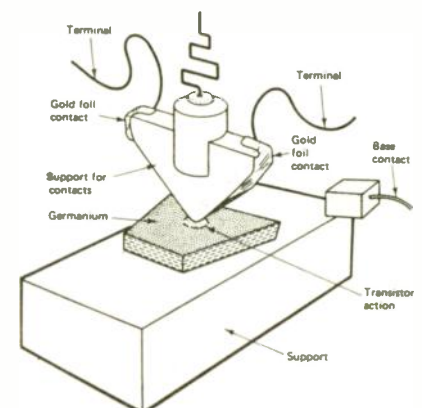

ASIC

Function-specific PLDs. Designed for high-speed (25MHz and faster) pipelined micro-computer systems, the 85C508 programmable address decoder with an on-board latch is said to be the industry's first c-mos 7.5ns PLD. Intel Corporation (UK), 793 696204

C-mos gate array family. A semicustom IC service for a family of low-cost metal-gate c-mos gate arrays in complexities ranging from 15 to 660 gates is available. Manufactured by EM-Microelectronics Marin, the CROSSMOS semicustom devices are suitable for low voltage (0.9 to 10V) and high voltage (3 to 18V) applications. MCP Electronics, 0734 772345

Programmable gate array. A bipolar programmable 1800-gate array, the PLHS502A, has 20 dedicated inputs, 16 dedicated outputs and eight bidirectionals, independent clocks, 64 full-back terms and 16 buried flip-flops. The output of each gate and flip-flop feeds back on itself and all other gates and flip-flops to achieve total interconnectivity of all logic functions. Philips Components, 01-580 6633

A-to-D and D-to-A converters

3½-digit converters. Two 3½ digit A-to-D converters offer on-board LCD (MAX 138) and led (MAX 139) display drivers, together with a built-in bandgap reference. In addition, the devices contain a charge-pump voltage inverter which allows measurement of both positive and negative input voltages while operating from a single power supply voltage (+2.5V to +9V). Dialogue Distribution, 0276 682001.

Low-power converter. The Teledyne Semiconductor TSC820 and TSC821 are low-power c-mos measurement system ICs which include analogue-to-digital converters and a frequency counter function. Two logic inputs drive LCD annunciators for high and low logic input levels. A peak hold input permits the highest readings to be held and displayed. Trident Microsystems, 0737 765900

Interfaces

STEBus interface. An Arcnet interface board for STEBus systems, SARCO1, provides a mechanism for STEBus-to-STEBus system communications and opens the path for STEBus industrial control systems to be interfaced to a wide variety of computer architectures. Arcnet Control Systems, 0223 411200

VMEbus DSP board. The DBV56, a single-Eurocard, digital signal-processing VMEbus board positions the i/o function on a separate daughter board, allowing the user to optimise the i/o for each application. The DBV56 directly couples to the i/o function board and avoids routing the input data around the VMEbus. By providing access directly on to its Motorola DSP56001 processor bus, the DBV56 allows fast data transfer and avoids system bus congestion. Data Beta, 0734 303631

Analogue control. A powerful modular computer-to-analogue control system, the DGH 3000/4000, generates accurate continuous outputs for motion control in robotic welding, proportional valve control, etc. The system is fully compatible with the DGH 1000/2000 modular data acquisition system and can be combined on the same serial (RS232 or RS485) link. The simple serial communications protocol allows the

modular controllers to be supervised and programmed by a standard PC, a dumb terminal or remotely from a modem. Rhopoint, 0883 722222

STD-CMOS system. The XTP-DOS is a wide-temperature, low-power STD-CMOS system which is capable of withstanding temperatures ranging from -40 to +85°C. It can be used in battery-based applications and consists of an STD-DOS equipped ZT88CT08 single-board controller with the optional ZT88CT25 expanded memory system and the ZT88CT41 quad serial interface. Wordsworth Technology, 0732 866988

Linear integrated circuits

Over/under voltage detector. The Maxim ICL 7665 dual over/under voltage detector is a c-mos single-chip device that operates from any voltage between 1 to 16V, draws a current of 3 microamps and offers a threshold accuracy of 2%. The 7665 has a propagation delay of 75 microseconds. The trip points and hysteresis of the two voltage detectors can be individually programmed with external resistors to any voltage greater than 1.3V up to several hundred volts. 2001 Electronic Components, 0483 742001

16-bit sampling A-to-D converter.

Incorporating a sample-and-hold amplifier and high-resolution converter in a single package, the AD 1380 analogue-to-digital converter guarantees a maximum 6-microsecond acquisition time and 14-microsecond conversion time, providing a throughput rate of 50 kHz. Maximum specifications include $\pm 0.1\%$ gain error, $\pm 0.05\%$ bipolar zero error, $\pm 0.003\%$ linearity error and $\pm 0.003\%$ differential linearity error. Analog Devices, 0932 253320

Monitor chip for vehicle lighting. When monitoring light bulbs, the technique is to measure the voltage drop across a resistor in series with the lamp circuit. The TLE 4951 is a monitor chip which requires a lower voltage drop across the series resistor, producing no perceptible decrease in light intensity of the bulbs. Siemens, 0932 75 2323

DC motor control. A series of monolithic integrated motor bridges controls DC motors. These short-circuit proof chips work at voltages up to 42V and currents up to 4A and are protected against over-temperature. The 4A device type TLE4203 employs an output stage without cross current, so that the speed of motors can be controlled by PWM techniques. Siemens, 0932 752323

10V references. A family of 10V references, the REF01 series, provides a precise 10V output while operating from a single 1.3V to 33V supply and is a drop-in replacement for the Precision Monolithics REF01. It uses the silicon bandgap principle to provide a stable output voltage with temperature variation. A voltage adjustment pin permits trimming the output voltage to exactly 10.00V. Teledyne Semiconductor, 01-571 9596

Memory chips

64K ECL ram. HM100494-10/12 and HM10494-10/12 ECL static rams that combine very high speed operation (10ns and 12ns maximum access time) with a power consumption of 650mW are organized as 16K x 4 and are available with ECL 100k or ECL 10k I/O levels. Hitachi Europe, 0923 246488

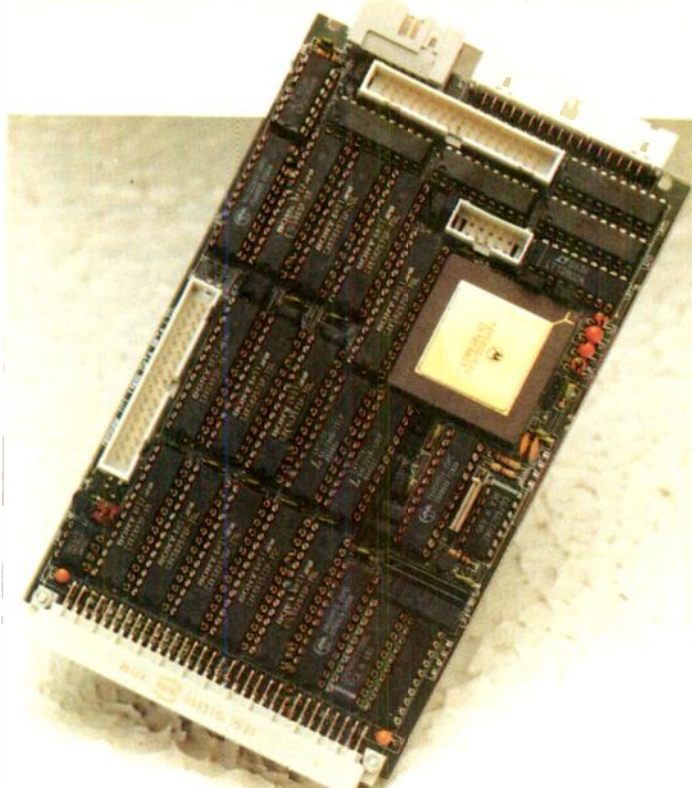

VMEbus digital signal-processor from Data Beta

Ram cache modules. A family of high-speed c-mos static ram cache modules supports IDT MIPS risc-architecture products. Directly compatible with the IDT 79R3000 CPU, each of these cache modules includes a complete data and instruction cache. They are available in 12, 16, 20 and 25MHz versions, with cache depths of 4K, 8K or 12K. Microlog, 048 62 29551

Optical devices

Fast optocoupler. A high-speed optocoupler family, the H11G1/2/3 features a collector-to-emitter breakdown voltage of up to 100V minimum at 1mA. Having a photodarlington output, the H11G series has a high current transfer ratio of up to 1000% and a low dark current of 100nA maximum at $V_{ce} = 80V$. Switching times are t_r and t_f of 5 and 100 microseconds respectively ($R_T = 100\Omega$). Isocom Components, 0429 863609

Optocoupler. The HP HCPL-2231 is optically coupled, dual-logic gate capable of providing logic compatible waveforms directly - eliminating the need for additional wave-shaping. With a typical data rate of 5Mbaud, it is intended for high-speed logic system isolation applications. Common mode transient immunity is 5000V/ μs at a common mode voltage of 300V and propagation delay is less than 300ns. Jernym Distribution, 0732 450144

Optical-fibre multiplexer. The FC2200 3X/AS400 optical-fibre multiplexer is designed for point-to-point, multiplexed, and star operations with IBM 3X/AS400 or plug-compatible equipment. It can support up to eight multiplexed and two individual point-to-point data links, which may be housed in the same unit. Solution Data, 0706 82736

Oscillators and crystals

Dil oscillator. A universal clock oscillator in a standard 14-pin dil package features a frequency range of 250kHz to 70MHz and is available with frequency tolerances of ± 100 , ± 50 or ± 25 ppm. The device features an extended operating temperature range of -40 to +85°C. Rise and fall times are 6ns maximum. Euroquartz, 0460 76477

Surface/mount crystals. The SX2050P crystals by M-tron combine AT cut technology with a high-temperature epoxy package designed for use with high-speed pick-and-place machines. The crystals are

available in frequencies ranging from 4 to 24MHz. MCP Electronics, 0734 772345.

Oscillators for TVROs. UHF carrier-wave synthesis is the function of the RF Monolithics range of saw hybrid oscillators. They are claimed to be particularly suitable for satellite television receive-only applications. A voltage-tuned version is capable of precise narrowband tuning over a ± 150 ppm range. The standard range operates at specified frequencies up to 1.5GHz with a tolerance of better than 100ppm. Quantelec, 0993 776488.

Power semiconductors

Current sampling powerMOS. SensorFETS BUK793-60A and BUK795-60A are PowerMOS devices which provide a cost-effective means of current sampling by dividing the load current into a power component and a much smaller proportional sense component which can be monitored across a signal-level resistor (the sense current is about 1/1500 of the power current). Philips Components, 01-580 6633.

Function-specific PLDs. Designed for high-speed (25MHz and faster) pipelined micro-computer systems, the 85C508 programmable address decoder with an on-board latch is said to be the industry's first c-mos 7.5ns PLD. Intel Corporation (UK), 0793 696204.

Task-oriented microprocessors

Advanced CRT controller. Manufactured by Hitachi, the HD63484-98 is for use at 9.8MHz. Although the ACRTC was designed as a member of the 68000 series of microprocessor peripheral devices, it can be used in many 8-bit or 16-bit computer designs. The ACRTC performs the key functions of logical drawing algorithms and physical drawing. Impulse Electronics, 0883 46433

Real-time Basic controller. RTC52 uses an 80C52 processor and is intended for on-board program development with a terminal and software compatibility with the BCC52 product series. RTC52 has provision for 64Kbyte of memory using ram/eprom, 12 bits of TTL parallel i/o and one serial port. The serial port supports both RS232 and RS485. J.B. Designs & Technology, 0285 68122

PASSIVE EQUIPMENT

Connectors and cabling

Optical-fibre connectors. A 'super' version of the Dri-Polish FL 3703 multi-mode optical-fibre connector offers greatly enhanced performance standards. It is compatible with the latest ST-II connectors and provides mean insertion losses of 0.1 dB, compared to the typical 1.0 dB loss of other multi-mode connectors. Leotec, 01-852 2203.

Displays

Dot-matrix LCD driver. This I2C-bus c-mos chip set is designed to drive medium-multiplex-rate dot-matrix LCDs and consumes only around typically 20µA per chip. The set, types PCF8578 and PCF8579, will drive full graphics or character displays using between 1:8 and 1:32 multiplex and can be configured to drive from 256 up to a maximum of 40960 dots. Philips Components, 01-580 6633.

Miniature leds. A range of miniature leds provides an effective surface-mount solution for indicating or illumination applications. The Telefunken SOT-23-packaged TLM 2200 components are available in red, green and yellow, with a mean luminescence of 0.63 mcd at 10mA. The TLMR has a dominant wavelength of 625nm, the TLMY 594nm and TLMG 2200, 575nm. Synchro Services, 0782 633633.

Filters

Programmable filter. Sierra Semiconductor has introduced the SC22324, which is claimed to be the industry's first c-mos universal programmable filter IC to include eeprom memory. It consists of four, second-order biquad, switched-capacitor filters, allowing any even-order filter up to the eighth to be designed. Devices can, however, be cascaded for higher orders. Sierra Semiconductors, 0793 618492

Tv IF saw filters. Tv IF saw filters are available for the tv standards M, N, B, G, I, D, L, E and H. The filters operate at picture carrier frequencies ranging from 32.7MHz for the SECAM 'L' system in France to 58.75MHz for the Japanese NTSC 'M' system. The devices use a lithium tantalate substrate for wide-band applications. Toshiba Electronics (UK), 0276 694600.

Hardware

Keypops. Keypops from Digran consists of a transparent cap which fits over the keypad itself. A label can be introduced between the two and easily interchanged as required. Digran, 0763 61600

Global 8500 50MHz pulse generator



PCB keyboards. Keyboards incorporating PCB-based membrane keyboards with rear mounted component assembly are custom-designed and built by IGT, which specialises in complete packages from around 25mm x 25mm to 8636mm x 5588mm. Designs can be delivered in around six to ten weeks. Industrial Graphic Technology, 0703 701881

Instrumentation

Programmable 50MHz pulse generator. The Global Model 8500 is a 50MHz instrument which is programmable either manually or via an IEEE-488 bus interface. The parameters that can be digitally set include period, amplitude, pulse width, delay, rise/fall times, duty cycle and burst. IR Group, 0753 580000.

Optical time-domain reflectometer. The Fiberlog OTDR is an aid for testing 850nm fibre links and systems used in short and medium distance links, such as local area networks. It can be used for fibre or link loss measurements, making accurate measurements of fibre length, real-time splice loss evaluation, and for connector or splice loss measurements. Lambda Photometrics, 05827 64334

1.3GHz counters. The PM6660 series of counters has a new input option which allows operation at up to 1.3GHz. There is also digit blanking on the PM6665; a feature that was formerly provided only on the PM6669. A wide choice of other options includes the GPIB (IEEE-488) interface module PM9604, the battery pack PM9605 and the high-stability MTCXO crystal oscillator timebase PM9607. Philips Test & Measurement, 0223 358866

Thermocouple/calibrator. The 1089 offers simulation and measurement of seven types of thermocouple, including type N, mV, mA and PRT to accuracies within 0.5°C. The microprocessor based instrument also features keyboard entry and alphanumeric LCD display, increment/decrement keys, non-volatile memory and timed memory-scanning. Time Electronics, 0732 355993

Literature

Fuses. A leaflet shows the range of Pudenz fuses and complementary fuseholders. Panel, printed circuit, and base-mounting flame-retardant fuseholders are described, together with the BS approved ranges of cartridge fuses from 32mA to 25A. Camden Electronics, 0727 64437

Backplanes. A technical application note discusses a number of common

performance and ease-of-use problems associated with backplanes. Dage (GB), 0296 393200

Controls and sensors. A new 124 page short-form catalogue covers eighteen ranges of components: control relays, power switches, motor starters and proximity sensors. MTE, 0702 421124.

Production equipment

Spot heaters. The Research Inc. Hotspot range of short-wave infrared spot heaters can heat a small object or spot up to 2000°F in seconds. Uses include small-scale soldering and unsoldering, for instance on a PCB. Thermal efficiency of the Hotspot depends on the use of a reflector, which may be shaped or cut to give the exact effect required. Astro Technology, 04895 77233

Wire stripper. The Model RT 2 wire stripper can be used for removing oxidation and other contaminants from component leads between 0.001in and 0.013in in diameter. Two conical fibreglass compounded wheels rotate at high speed to clean and polish leads with no risk of deforming or nicking the lead being cleaned. Eraser International, 0264 51347/8

SMD speed placer. Siemens has increased the scope of the HS-180 surface-mount device placement machine by developing the type SP-120 speed-placer module, which shares the layout, conveyors, feeders and system control of the HS-180 machine and has a twelve-nozzle rotary turret capable of handling 20-pin devices from sizes 0504 up to 501C. Siemens, 0932 752323

Power supplies

DC-DC converters. A new DC-DC converter with two dual independent 15V DC outputs, Model 12Q15 050, operates from a source of 12V DC and provides two isolated outputs at ±50mA each. The 2in x 2in module is only 0.375in high and is designed for low-noise instrument applications. Calex Electronics, 0525 373178

DC-DC converters. A range of single, dual and triple-output DC-DC converters with 2:1 input voltage range, the UM 1100 series is based upon a half-bridge, high-frequency switching converter using mosfets at 100kHz. Up to 30W of output power is derived from an encapsulated, shielded package measuring 4.56 x 2.56 x 0.83in. Load regulation is ±1% for single and duals and ±5% for triples. Gresham Powerdine, 0722 413080

Power supply. Regulating down to zero load from a single-input range of 85-264V AC at

power levels in excess of 110W, the NFS 110 power supply from Computer Products Power Conversion offers output combinations of 5, ±12 and -5 and 5, ±15 and -5V at 110V. XP, 0734 572611

Radio communications products

Shielded enclosures. Euroshield enclosures offer radio-frequency shielding which consists of 1110mm wide, hot-galvanized rigid-steel structural panels. No wooden parts are used, and retightening of the panel fasteners is not necessary. Modular panel enclosures can be tailor-made to fit any existing containments. Dielec, 0793 783137

Switches and relays

"Byte-wide" switch. HDMP-8 is an eight-pole, double-throw, compression-indexed, snap-action switch with gold-plated, stressed elliptical contacts. The contact mechanism has fewer parts than conventional double-throw switches, allowing the HDMP-8 to be built into high density package with 0.050in pin spacing. The 5 millionohm resistance is transparent to circuit operation. Annulus Technical (Canada), 010 1 416 648 8100.

Miniature mains rocker switches. A series of sub-miniature rocker switches, the 20 series, has a panel cut-out size of only 15.9 x 13.0mm. It incorporates a sliding action which wipes the moving contacts across the fixed contact until the circuit break occurs at the edge of both contacts, so that arcing affects only the non-critical surfaces. IMO Electronics, 01-452 6444

Miniature relay. A miniature double-pole monostable relay, the TRK22, is fully sealed to IP 67 and IEC 529 and tested to the specifications of IEC 68-2-17. Bifurcated changeover contacts switch power from 20W to 1.25A per contact at 150V DC. At an ambient temperature of 20°C, the relay requires a nominal coil power of 0.55W and is available in five coil voltages from 4.5V to 48V DC. Iskra, 01-668 7141

Transducers and sensors

Automotive sensing elements. A range of potentiometric sensing elements designed specifically for automotive applications, include throttle potentiometers, light dimmers, position sensing and other control functions. They are based on either polymer/cermet or conductive-polymer ink elements. Bourns Electronics, 0276 692392

COMPUTER

Data communications products

Ethernet adapter. The Longshine DG1000 PLUS adapter is an Ethernet-based IEEE/802.3 local-area networking interface card which supports IBM PC LAN, MS-Net and Novell NetWare network operating systems. It is plug-compatible with Novell's NE-1000 Ethernet card at the hardware level. Dataguid Distribution, 0256 817788.

Repeater ICs. Complete PCM repeater ICs PMI RPT-86/87, for long-distance telecommunications systems, automatically optimize the signal level, determine if valid data is present and retransmit the signal. All the circuits required to implement a complete repeater are contained within the single chip. Jermyn Distribution, 0732 450144

Mass storage devices

Helical-scan tape drive. The MegaTape GT-88 is a 2.3Gbyte helical-scan tape drive with BI bus subsystem. The GT-88 8mm cartridge backup system provides 256Kbyte of cache buffer. In addition, cartridges written on the GT-88 are compatible with the ANSI standard X3 27 for read/write tape format. Decade Computers, 0635 38008

Computer peripherals

VGA colour monitor. The XC-1449C 14in PS/2-compatible high-quality colour monitor from Mitsubishi has a 0.28mm dot pitch and displays up to 256 colours on screen from a possible palette of 262 144 colours. Other features include an XF-type gun for the focussing requirements of high-density displays and a diamond-coated (non-glare) screen. RR Electronics, 0234 270272

Modern Communications TRAINING SYSTEMS

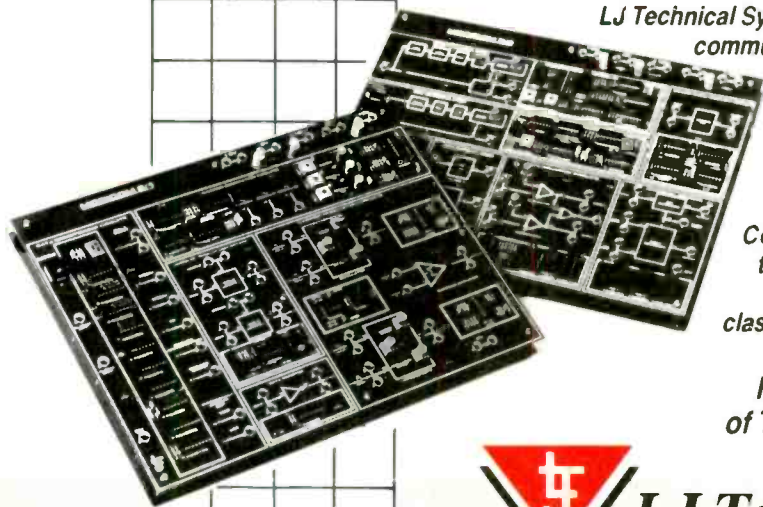

LJ Technical Systems offer a comprehensive range of modern communications equipment specifically designed for training and education.

Our modular systems cover the basic principles of AM, FM and digital communications and fibre optic technology.

Complete courseware packages are available for the systems we offer. These provide structured courses that can be used for both traditional classroom based study and open-access learning.

For further information on the LJ range of Telecommunications trainers contact:-



LJ Technical Systems Ltd.

Francis Way, Bowthorpe Industrial Estate
Norwich. NR5 9JA. England
Tel (0603) 748001. Fax (0603) 746340

CIRCLE NO. 40 ON REPLY CARD

FFT ANALYSIS SEMINARS

LEARN HOW TO EXPLOIT THE
FREQUENCY DOMAIN IN JUST
ONE DAY

- Insight into benefits
- Hands-on tutoring
- Applications based
- No confusing maths
- Local and convenient
- Small groups
Max number per seminar is 10
- 100% practical

COST ONLY
£150+ VAT
including lunch and
course materials

Ideal for applications engineers of all disciplines who are unsure of the very considerable benefits of using FFT Analysis Techniques in all manner of applications.



LAPLACE INSTRUMENTS LTD
PO BOX 14, BRAMHALL,
STOCKPORT SK7 2QS.
☎ 061-440 9579

CIRCLE NO. 28 ON REPLY CARD

LEVELL

LEVELL ELECTRONICS

The instrument specialists

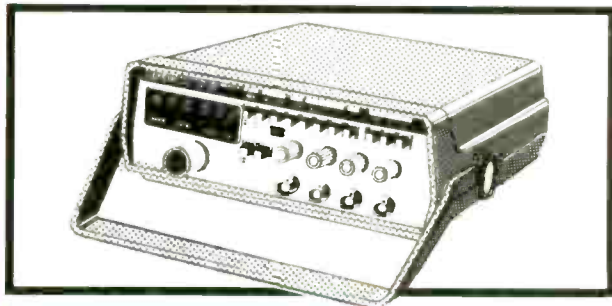

SPECIAL TG303
FUNCTION GENERATOR **£185.00**
+VAT

Leading instruments and meters, manufactured, serviced, and represented by Levell-Eurocoin

Black★Star // [Thurlby] **HAMEG**

QUANTITY DISCOUNTS
AVAILABLE

LEVELL



A DIVISION OF EUROCOIN LTD

LEVELL ELECTRONICS Fortune House Moxon St. Barnet Herts EN5 5SD
Fax: 01 449 7217 ☎ 01 449 0077 Telex: 266016

CIRCLE NO. 5 ON REPLY CARD

I SPY

Lee Tracey, quartermaster, engineer and associate of Peter Wright, unveils the quiet and secret world of electronic intelligence gathering. He tells of his experience as a real-life Q.



Night vision in action. See p 978

Recently, a glossy brochure dropped on to my desk which extolled the virtues of a new secret "bugging" device called an Infinity Transmitter, costing just under £1000; I was urged to snap up this bargain before the pressure of demand forced the price up. I have since received many telephone calls referring to another device mentioned in Peter Wright's book 'Spycatcher' — something to do with flooding. I could explain the device or even build one.

The "new" device, the infinity transmitter, was in fact invented over forty years ago by Manny Mittelman, chief bug artist to the Mafia (the world of covert surveillance, as you see, has its own bizarre argot) and the item mentioned in *Spycatcher* was Wright's favourite bugging tool. Both these devices worked on the telephone system, but did not bug calls. Bugging telephones is childishly simple, but eavesdropping on conversation in a room is most certainly not.

Figure 1 shows the circuit of the infinity transmitter, which consists of a microphone module, audio amplifier and tone-controlled on/off switch. Room audio energizes the microphone which drives the amplifier, the amplified signal passing along the telephone cable to the remote listening post.

So that this illegal use of the cable does not clash with legal conversations, a switching circuit is used. The older telephone systems work on two voltage levels: when the telephone is not in use, the level is nominally 50V; when in use, nominally 9V. The device works only when the voltage is low at the control end and high at the target end — if the target-end handset is lifted, the bug automatically switches off.

To use the bug, the eavesdropper must gain access to the room in question to install the device in parallel with the telephone pair. Then, from a control point anywhere in the world, he dials the target's number. The target answers; the eavesdropper asks for a non-existent person; the target denies all knowledge; apologies are offered and the target is allowed to replace his handset. Since the eavesdropper has control of the line and since he does not replace his handset, the F relay in the exchange is still 'in' and an audio path still exists, unknown to the target.

At this point, the eavesdropper sends a tone along the line which is amplified by the tuned amplifier on the right of Fig. 1 and used to switch on the microphone amplifier, the output of which is fed back down the line to the eaves-

dropper. When Mittelman invented the device, he used a mouth organ to activate the amplifier; its Mafia name was therefore inevitable — the Harmonica Bug. Later, I shall describe a modern version of this device which, in its original form, is now considered infantile.

That was the start of electronic surveillance; I intend now to look at the evolution and modern embodiment of the art of earwiggling by electronics.

Until a few years ago, elementary equipment was in use both privately and professionally; today, that is no longer the case. In this field of electronic surveillance, the British are years ahead of the rest of the world. This has nothing to do with technical skill in the technical support units or the research laboratories. It has to do with money.

Companies of the size, and possessing the resources of Racal, Plessey and

Bugging a room is not simply a matter of fixing a microphone under the coffee table and hoping for the best

Marconi do not find it attractive to enter an expensive design, development and manufacturing process for the relatively small intelligence market without considerable financial inducement, and this finance is, or was, not available to the security services. Neither are these organizations able to carry out the development work themselves. There is also, of course, a reluctance to buy secret equipment on the open market (there is a story that a Home Office department ordered bugs from a company in London and was discovered to have done so when the company was financed and probably owned by the Mafia). In this atmosphere of impasse, the technology did not advance quickly and the world of surveillance consequently became crowded with crooks, charlatans, idiots and dangerous opportunists.

But all that changed, and the reason was Northern Ireland. The fight against the IRA and terrorist organizations supporting them opened the treasury and technical budgets are now massive. The services are able to talk from financial strength to the large companies,

who are suddenly willing to commit their financial and research resources to development. The result is that British surveillance gear is now supreme.

The initiative for the development of a new piece of equipment is often accidental. For example, in 1968 I developed the bug detector Scanlock, which is now on the market. It started life as an automatic modulation meter designed by Racal engineers; when they showed me the prototype, I instantly saw it in its alternative application. Racal was not interested in carrying out the modifications needed to turn it into a detector, but offered me all the help I needed to do the work myself, with the further assistance of other engineers.

Another 'accidental' development came about as a result of a visit to Decca. Brigadier Bartley-Dennis showed me a system he was developing to measure vibration at a distance, using a laser. Part of the set-up was a radio chassis with the speaker cone exposed, the volume turned down so low that nothing could be heard. The laser was aimed at the cone with the intention of measuring its extremely small movements, but the problem was that the vestigial cone movement was a hindrance; connecting an amplifier and speaker to the laser's signal-processing circuitry reproduced the original audio. So was born the first laser system to detect audio. I wrote the project up and handed the paper to the infant technical support unit at Tintagel House. It was instantly classified, but has been re-invented many times since then.

Neither of these two devices would have been made as a result of direct investment; the money was never available. In these instances, the real investment was made by Racal and Decca and it still needed someone to spot the possibilities and force development.

Lethargy

Public, and sometimes even professional apathy and lethargy are perhaps the greatest advantages possessed by the spying community. Even though the opposition are well aware of the existence of the devices available, they still go on with their normal and nefarious activities without allowing for the possibility that they might be bugged in their turn. Countermeasures take time, trouble and money and sometimes they are too much effort.

Some time ago, when terrorist attacks on aircraft began, a businessman offered security equipment to airlines — such devices as metal-detector doorways. After some effort, he gained

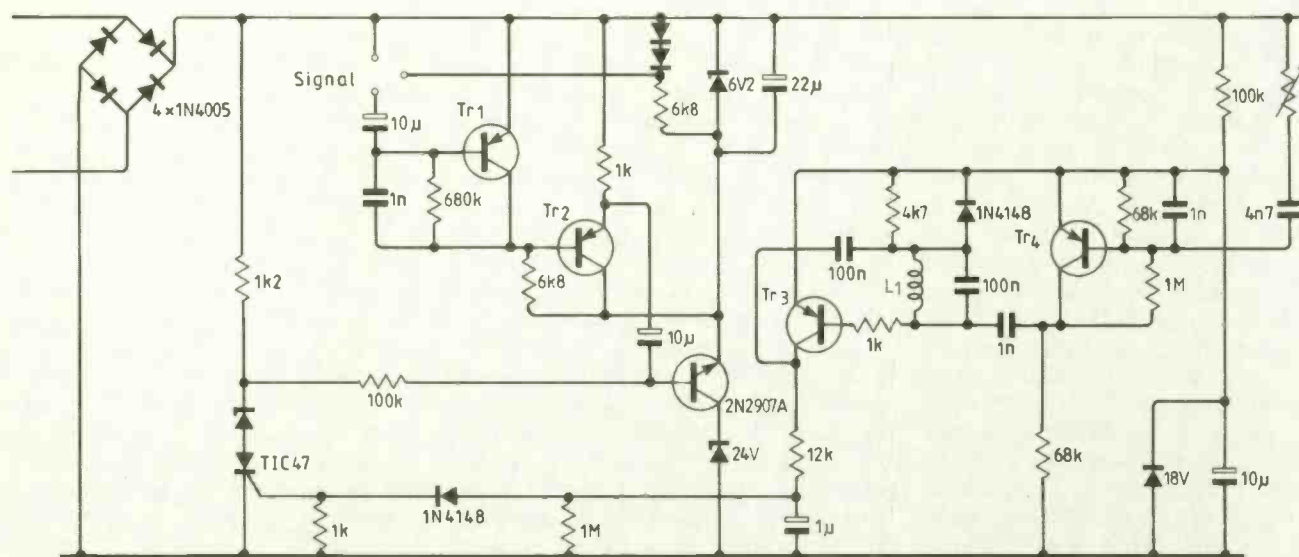

Fig. 1. Circuit diagram of the infinity transmitter, developed for the American Mafia forty years ago and regularly re-invented.

access to the head of a major airline, explained what he had to offer and was promptly given the heave-ho. He was told not to waste any more time; it was acknowledged that the equipment was worthwhile, and that airline security people believed such devices to be necessary, but no orders were forthcoming.

The reasoning went something like this. Take the losses incurred by the airline over the last five years due to criminal or terrorist attack and deduct

from this the amount recovered from the insurance companies. Divide the result by the number of take-offs from any airport. The answer was \$3 per flight.

If, I was told, you can supply a totally secure and miraculous system for less than \$3 per flight, you have a deal. In reply to my comment that the airline already spent a great deal more than that on the somewhat rudimentary system it was using, the airline head said "We have to go through the motions to

allay public anxiety".

The other problem with, in particular, airline security is shown by the experience of a commercial concern which set out to market an anti-terrorist system based on hidden cameras. To obtain sales, they set up a publicity campaign, which brought enquirers who needed detailed demonstrations. One of the enquirers was a member of a terrorist organization who went away and trained his colleagues to deal with the system.

In this article, I shall describe equipment from the earliest to that available in 1989, although readers should be aware that one or two deliberate errors and omissions will make it difficult to copy the devices.

The telephone line

For those not familiar with the telephone network, the old system is a mechanical arrangement of moving arms, contacts and relays and, as already explained, based on voltage levels. Two wires carry the audio and AC ringing current. It follows that if you connect a simple amplifier to any section of the wires and block the AC ringing current, you will pick up any audio present. It can even be made automatic by using the voltage swing to start and stop a tape recorder. Simple!

The real challenge is to use the telephone pair, to listen not to telephone conversations, but to conversation in the room. Peter Wright's flooding or swamping technique avoided the need to break in to the premises, since it used the microphone thoughtfully provided

Continued on page 975

BUGS AND THE MAFIA

In a far off land known as the United States of America, and in a small community in a town called Braintree, Mass., lived a Mafia family. This "family" was under surveillance by a law enforcement agency who one day hopped out of their prams in anguish at the discovery that the Mafia family were also "bugging". Too many bugs both law-enforcement legal and private illegal in the same area was not to be tolerated. Worse, USA law forbade the design, manufacture, ownership, use etc., of any and all bugging devices except by law enforcement agencies. Retribution was due upon the heads of those who had provided these bugs to the Mafia family.

To cut a long story short, detective work finally identified the bugs as British made. They had come from a "bug" supply house with offices in London not far from Piccadilly Circus. A police raid on the offices of this company (now defunct) showed that it was, in fact, financed by the Mafia and probably owned by the Mafia. Looking

through the files one of the searchers discovered an order from a British Home Office department for a number of miniature RF transmitters (bugs). This "searcher" had friends in the MI6 service and so not surprisingly a copy of the order fell into the hands of certain MI6 operatives. In the cause of good relations and gentle leg-pulling between MI5 and MI6, the MI6 operatives offered the document to Fleet Street with the suggested newspaper headline: MI5 BUYS BUGS FROM THE MAFIA.

Unfortunately for those of us with a warped sense of humour the project was quickly killed and the headline never appeared. So from the HARMONICA BUG for the Mafia by Manny Mittelman, the first to use the telephone line to the FLOODING bug of Peter Wright, also for the telephone line, to the Braintree Mafia bugs and the proposed newspaper headline, the bugging business almost always creates strange bed-fellows.

PINEAPPLE SOFTWARE

New New New SERIAL DATA PROBLEMS? New New New

A brand new program for IBM's and compatibles allows complete monitoring of two way data flow down any RS232 serial data line. DATACAP will capture and store data from 110 to 9600 BAUD and display it on screen or print it in such a way that it's direction as well as it's position in the data stream, is indicated.

Applications include diagnosis of both hardware and software faults, and investigation of any problems encountered with handshaking protocols. It is also ideal as a teaching aid to demonstrate the ways in which computers communicate.

DATACAP £25.00 p & p free

BBC PCB Software

PCB is a powerful Rom based printed circuit board design program suitable for all BBC computers. A second eeprom is optionally available to add a powerful auto track routing facility to the program. This utilises a 'rats-nest' input routine and allows any component to be 'picked up' and moved around the board without having to re-specify component interconnections. The full autoroute facilities are available even on a standard unexpanded model 'B'.

'PCB auto-route is remarkable. No similar software comes near the price.' ACORN USER Aug 88.
PCB manual track routing £85.00 PCB auto-routing £185.00
PCB plotter driver £35.00 P & P free

IBM PCB Software

EASY-PC EASY-PC is a powerful PCB design program combined with a schematic drawing package. Up to 8 board layers plus upper and lower silk screens. Board size up to 17" x 17". Powerful zoom and pan features. Suitable for IBM PC/XT/AT & compatibles with 512k Ram. - £98.00 P & P free

MARCONI TRACKERBALLS

We now have an adapter available to link the trackerball to the Archimedes, to enable it to directly replace the Archimedes mouse.

Bare Trackerball (No software) £45.00

BBC Model with software £59.00

Adapters to drive BBC Mouse software £8.00

Archimedes Adapter £19.95

IBM model (serial interface) £99.60

P & P on
Trackerballs
£1.75

Trackerballs also available for other computers, please phone for details.

MITEYSPICE, SPICE.AGE and ECA-2

Three very powerful circuit analysis packages. Miteyspice is available for the BBC range of computers, and Spice Age and ECA-2 for the IBM and compatibles.

Spice Age is a new product for the IBM range which provides facilities for transient and Fourier analysis as well as D.C. and freq. response performance.

Miteyspice (For BBC and Archimedes) £119.00

Spice Age (IBM PC/XT/AT 512k Ram) from £70.00

ECA-2 (IBM PC/XT/AT 256k Ram) £675.00

LCA-1 (Logic Analyser for IBM's) £450.00

P & P free



Pineapple Software, Dept. WW, 39,
Brownlea Gardens, Seven Kings, Ilford,
Essex, IG3 9NL. Telephone 01-599 1476.

Add 15% VAT
to all prices.



CIRCLE NO. 23 ON REPLY CARD

IN VIEW OF THE EXTREMELY
RAPID CHANGE TAKING PLACE
IN THE ELECTRONICS
INDUSTRY, LARGE QUANTITIES
OF COMPONENTS BECOME
REDUNDANT. WE ARE CASH
PURCHASERS OF SUCH
MATERIALS AND WOULD
APPRECIATE A TELEPHONE
CALL OR A LIST IF AVAILABLE.
WE PAY TOP PRICES AND
COLLECT.

R. Henson Ltd.

21 Lodge Lane, N. Finchley,
London, N12 8JG.

5 mins. from Tally Ho Corner

Telephone:

01-445 2713/0749

CIRCLE NO. 7 ON REPLY CARD

CONQUERING NEW HEIGHTS

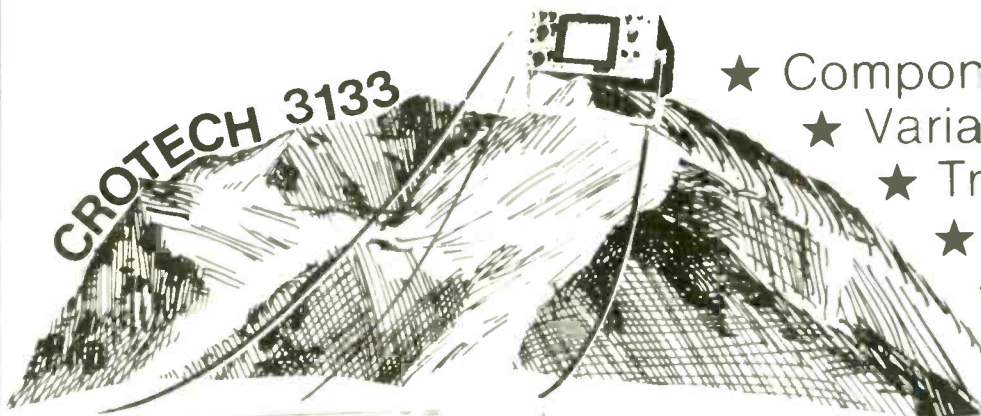

- ★ Component Comparator
- ★ Variable Hold Off
- ★ Triple DC Source
- ★ DC - 25 MHz
- ★ 40ns/div
- ★ 2mV/div
- ★ Low Cost

£319*

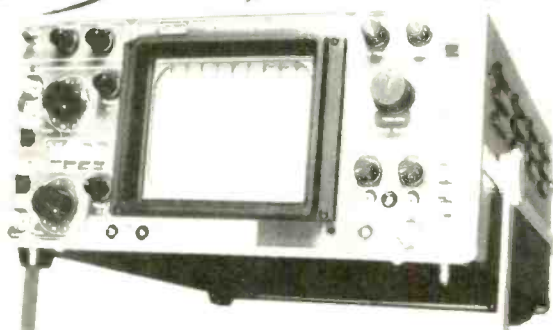

Yes its 25MHz for £319

To scale the heights, just call
us for your FREE copy of our
catalogue

*(Ex VAT & Delivery)

CIRCLE NO. 10 ON REPLY CARD

Crotech Instruments Limited

2 Stephenson Road, St. Ives, Huntingdon, Cambs. PE17 4WJ
Telephone: (0480) 301818

RF EQUIPMENT

LOW NOISE GASFET PREAMPLIFIERS

Aligned to your specified frequency in the range 30-1000MHz. Masthead or local use.

- TYPE 9006. NF 0.6dB. Gain 10-40dB variable. In the range 30-250MHz £78
 TYPE 9006FM. As above. Band II 88-108MHz £78
 TYPE 9002. Two stage Gasfet preamplifier. NF 0.7dB. Gain 25dB adjustable. High Q filter. Tuned to your specified channels in bands IV or V £102
 TYPE 9004. UHF two stage Gasfet preamplifier. NF 0.7dB. Gain 25dB adjustable. High Q filter. Aligned to your specified frequency in the range 250-1000MHz £102
 TYPE 9035. Mains power supply for above amplifiers £39
 TYPE 9010. Masthead weatherproof unit for above amplifiers £12



TYPE 9006

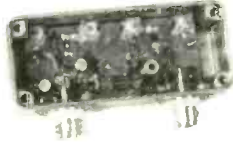

TYPE 9002

WIDEBAND AMPLIFIERS

Monolithic microwave integrated circuits in a fully packaged microstrip module format. Full-wave shottky diode protected inputs. Temperature compensated bias circuitry. Voltage regulated local or remote operation.

- TYPE 9007. 1-900MHz. NF 2.3dB at 500MHz. Gain 20dB £150
 TYPE 9008 Gasfet. 100MHz-2GHz. NF 2.5dB at 1GHz. Gain 10dB. Power output +18dBm, 65mW £150
 TYPE 9009 Gasfet. 10MHz-2GHz. NF 3.8dB at 1GHz. Gain 20dB. Power output +20dBm, 100mW £150
 TYPE 9253. 40-860MHz. NF 6dB. Gain 30dB. Voltage output 100mV, 100dBuV, -10dBm £94

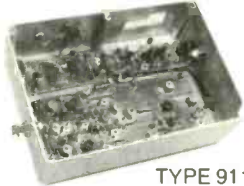

TYPE 9113



TYPE 9252

PHASE LOCKED LOOP FREQUENCY CONVERTERS

TYPE 9113 Transmitting. Converts your specified input channels in the range 20-1000MHz to your specified output channels in the range 20-1000MHz. 1mV input, 10mW output (+10dBm). AGC controlled. Gain 60dB adjustable -30dB. Will drive transmitting amplifiers directly £356
 TYPE 9114 Receiving. Low noise Gasfet front-end. NF 0.7dB. Gain 25 dB variable £356

TMOS WIDEBAND LINEAR POWER AMPLIFIERS

TYPE 9246. 1 watt output 100KHz-175MHz 13dB gain £108



TYPE 9176

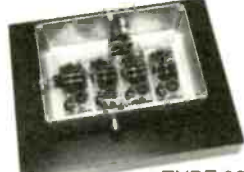

TYPE 9271

- TYPE 9247. 4 watts output 1-50MHz 13dB gain £108
 TYPE 9051. 4 watts output 20-200MHz 13dB gain £108
 TYPE 9176. 4 watts output 1-50MHz 26dB gain £254
 TYPE 9177. 4 watts output 20-200MHz 26dB gain £254
 TYPE 9173. 20 watts output 1-50MHz 10dB gain £308
 TYPE 9174. 20 watts output 20-200MHz 10dB gain £308
 TYPE 9271. 40 watts output 1-50MHz 10dB gain £616
 TYPE 9172. 40 watts output 20-200MHz 10dB gain £616
 TYPE 9235. Mains power supply unit for above amplifiers £164

PHASE LOCKED SIGNAL SOURCES

Very high stability phase-locked oscillators operating directly on the signal frequency using a low frequency reference crystal. Phase noise is typically equal to or better than synthesized signal generators. Output will drive the Types 9247 and 9051 wideband linear power amplifiers and the Types 9252 and 9105 tuned power amplifiers.

- TYPE 8034. Frequency as specified in the range 20-250MHz. Output 10mW £120
 TYPE 8036. Frequency as specified in the range 250-1000MHz. Output 10mW £170
 TYPE 9182. FM or FSK modulation. 20-1000MHz. Output 10mW £248

UHF LINEAR POWER AMPLIFIERS

Tuned to your specified frequency in the range of 250-470MHz. 24V. + DC supply.

- TYPE 9123 250mW input, 5 watts output £289
 TYPE 9124 2-3 watts input, 25 watts output £335

FM TRANSMITTERS 88-108MHz. 50 watts RF output

- TYPE 9086. 24V + DC supply £945
 TYPE 9087. Includes integral mains power supply £1,110
 TYPE 9182FM exciter ±75KHz deviation. Output 10mW £248

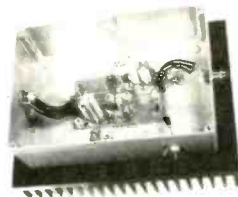

TYPE 9263

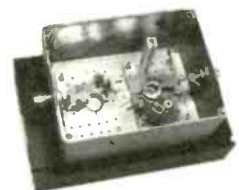

TYPE 9259

TELEVISION LINEAR POWER AMPLIFIERS

Tuned to your specified channels in bands IV or V. 24V + DC supply.

- TYPE 9261. 100mV input, 10mW output £218
 TYPE 9252. 10mW input, 500mW output £254
 TYPE 9259. 500mW input, 3 watts output £290
 TYPE 9262 500mW input, 10 watts output £530
 TYPE 9263. 2-3 watts input, 15 watts output £400
 TYPE 9266 10 watts input, 50 watts output £1,585

See below for Television Amplifiers in bands I & III.



TYPE 9105



TYPE 9158/9235

TMOS RF LINEAR POWER AMPLIFIERS

Tuned to your specified frequency in the range 20-250MHz, or your specified channels in bands I or III. 24V + DC supply.

- TYPE 9105. 10mW input, 1 watt output £230
 TYPE 9106 500mW input, 10 watts output £284
 TYPE 9155. 1 watt input, 30 watts output £327
 TYPE 9158. 5 watts input, 70 watts output £448

COMPLETE TELEVISION RETRANSMISSION SYSTEMS AVAILABLE

All prices exclude p&p and VAT.

RESEARCH COMMUNICATIONS LTD

Unit 1, Aerodrome Industrial Complex, Aerodrome Road, Hawkinge, Folkestone, Kent CT18 7AG.
 Tel: 0303 893631. Fax: 0303 893838

CIRCLE NO. 19 ON REPLY CARD

by the telephone manufacturer. But the problem is that when the target's handset is replaced, a switch (the hook-switch) most inconsiderately disconnects the microphone from the line. So a technique was needed to by-pass the hookswitch, but without seizing the telephone line, which would be equivalent to lifting the handset and alerting the exchange.

Wright's swamping system used RF to jump the hookswitch and make the carbon granules in the microphone go into a state of high excitement, which could be done from a remote point and without needing access to the premises. The circuit shown in Fig. 2 is not the whole story, since the exchange interface circuitry is omitted.

The purpose was to use an RF carrier to extract audio from the carbon microphone. Various types of modulation were considered, but amplitude modulation of the applied carrier at the RF generator terminals, by the change in resistance of the microphone in response to room audio, was greatest and was chosen. A level of 150mV of RF was needed and the output impedance of the generator was greater than that of the microphone; a modulation depth of 25% could be obtained by impedance ratios of between 5:1 and 10:1 over a frequency range of 30kHz to 20MHz. The conflicting constraints of small hookswitch capacitance and distance between energizing source and target enforced a frequency of around 1MHz.

In the method of excitation used, the drive circuit and line capacitance were made a series-resonant tuned circuit, so that the RF at the load was increased by between five and ten times. Additional-

THE INFAMOUS EAGLE

The most famous of all the known passive bugging operations is the case of the American Eagle in the US Embassy in Moscow. This Eagle emblem contained a Russian cavity resonator device which was like a passive microphone, vibrated by room sounds as are many normal room objects. Speech causes air pressure to change and air pressure will move objects. That is how a simple magnetic microphone works. The Eagle device was a deliberate action of introducing into the embassy a specially designed diaphragm cavity, knowing that any speech in the room would

modulate it. But how to energize it and get the speech out of the embassy?

The Russian answer was our old friend RF flooding. Send a concentrated beam of RF energy at the resonant frequency directly at the Eagle and then monitor the RF disturbance - phase modulation - caused by speech modulating the resonator. Basically quite simple. So why is it not used more frequently?

The problem is the immense power needed to get just a little energy into the bugging device. Modern equipment would detect this power source very quickly.

ly, the RF waveform was clean, simplifying demodulation and reducing beats with legitimate RF transmissions in the area.

The outcome of all this was that the device would pick up normal room conversation within a radius of about 3m.

Countermeasures

It is possible to detect the RF carrier by means of an RF sweeping technique, but it is likely that the signal would not be recognized, since no modulation would appear in even the most sensitive surveillance receiver. But there is an answer which will stop the earwiggers in their tracks: a 0.01µF capacitor across the line terminals or across the microphone. It will cost about 50p. I confidently expect someone to invent one of these components and sell it for £1000 as an anti-bugging unit!

Scanlock. This is an automatic bug detector which provides AM, FM and FM sub-carrier demodulation, in contrast with many such devices which merely indicate the presence of a carrier although some do possess rudimentary demodulators, the performance of which varies between poor and abysmal. In essence, they are simply field-strength meters, which respond to Radio 1 as well as to the carrier from a bug. Many are the stories of expensive panelling or air-conditioning ducts being demolished in an attempt to locate a bug, which turned out to be a standing wave on some innocent piece of trunking, the origin being the dear old BBC.

Scanlock prevents this kind of grief. It is a receiver scanning from 10MHz to 20MHz and their harmonics at high speed, the strongest signal found being

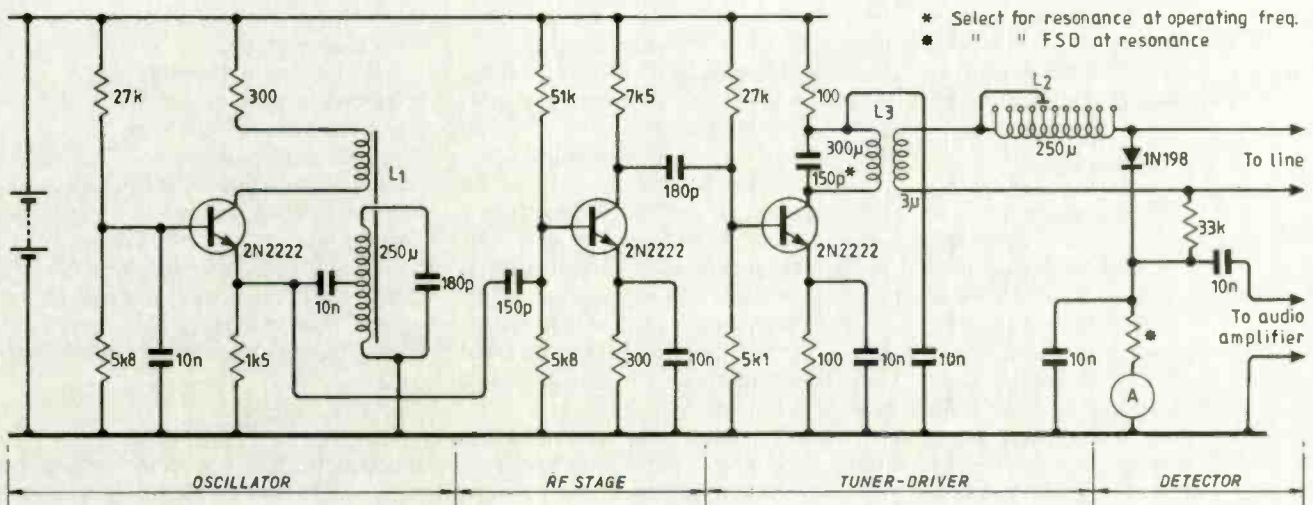

Fig. 2. Spycatcher Peter Wright's RF swamping system, which used the telephone microphone to listen in to room audio.

BUGGING PARLIAMENT FOR 30 YEARS

Without doubt there is a growing threat to individual privacy through the ready availability of electronic surveillance devices. They are freely advertised in the press, sometimes euphemistically as 'security products' or explicitly as 'little buggers', and their price (some devices cost less than £50) has begun to make some MPs sense that immediate action is vital to contain a growing menace.

In practice, the use of surveillance devices has never been off the parliamentary agenda since 1961, when Lord Mancroft introduced the first of a succession of 'Right of Privacy' bills. By the end of the decade the defeat of another privacy bill, sponsored by Labour MP Brian Walden, worried the Government enough to establish an official enquiry. It was known as the Younger Committee on Privacy and its comprehensive report into the threats to individual privacy has stood the test of time.

With respect to electronic surveillance, and this included all aural and visual devices and subsequent disclosures of gathered information, Younger's recommendations¹ were all-embracing. They called for a 'criminal offence of unlawful surveillance by surreptitious means' and commented that 'as incitement to commit the offence would be an offence', the sale of unlawful surveillance devices through the advertising of 'their aptness for surreptitious surveillance' could also be penalized through the criminal courts.

The Committee argued strongly that new criminal penalties were necessary, to ensure that once surreptitious surveillance was suspected, the aggrieved individual could call upon 'the resources of the police' to investigate and prosecute offenders. They reinforced their criminal law proposals by suggesting that the courts be allowed to award compensation to individuals who suffer damage through the use of information gained through such surveillance.

Although Younger's recommendations were never enacted, the civil law recommendations were taken one step further in a second official report, this time from the Law Commission². In their draft legislation, the Commission suggested

that a person who 'improperly obtained' information using a device adapted for surreptitious surveillance would have a legal duty to keep that information confidential. Any unauthorized use of information that caused damage would constitute a breach of confidence, and be actionable through the civil courts for compensation.

The first piece of legislation in the UK that defined when and how individual privacy can be lawfully infringed using some electronic surveillance techniques, occurred in 1985 with the passage of the Interception of Communications Act. This act was introduced by the Government, following a ruling from the European Court which stated that unfettered telephone tapping infringed individual privacy, and was specifically limited to address the Court's concerns. As a result, the act was (and still is) criticized as being too narrow in application (i.e. restricted to the official interception of telecommunications and letters), and too lax with the official supervision of interceptions³.

However, the pressure for legislation has still continued and, in the last parliamentary session, November 1988 to July 1989, James Cran, Conservative MP for Beverley, has hounded the Government. In the presentation of his Control of Electronic Surveillance Devices Bill⁴, he has called for a strict regulatory regime that would require a licence from the Home Office to sell, manufacture and buy surveillance devices; unlicensed behaviour would automatically be a crime. Although the Younger Committee rejected a system of licensing as 'unworkable', Cran believes that this is the only effective way to send a clear signal to the whole community that the invasion of privacy by these devices will not be tolerated.

The Government rejects this view and believes that regulation cannot control the use of electronic surveillance devices⁵. According to Tim Renton, the Home Office Minister who has been responding to Cran's frequent initiatives, either the draft law is worded too narrowly, in which case the next piece of technology is outside the law, or the law would be drafted too broadly, in which case the application of the law could become unreasonable in operation. In addition, the Government consistent-

ly resists (and suspects) any system of seemingly bureaucratic control that involves licensing (for example, the recent rejection of a dog licence to control vicious dogs).

Many MPs, especially those on the political left, see a more sinister motive for this rejection, and claim that the Government prefers to keep the hands of the security services free from official control. For example, if Younger's or Cran's recommendations into electronic surveillance were ever enacted, the legislation must bring into focus the thorny problem of when and how the state can legitimately 'bug' its citizens. Having been badly mauled and branded as illiberal and authoritarian by MPs of all parties during the passage of the Official Secrets Act 1989 and Security Service Act 1989, the Government is not eager to debate another can of national-security worms, which such legislation would necessarily entail.

To mollify some of the growing pressure, the Government did announce, during a debate on press freedom, the formation of a new privacy committee with terms of reference that may go beyond the simple examination of the salacious activities of the tabloid press. How far this committee can examine new issues, or whether it will merely repeat the ground covered by Younger, is as yet unclear. However, given a thirty-year record and two official reports buried under ten or more years of dust, there are many who believe that the classic definition of a committee as being 'the place where controversial subjects go and get buried' is being employed.

Chris Pounder

References

1. Report of the Committee on Privacy, paragraphs 562-570, Cmd 5012, 1972.
2. The Law Commission ('Breath of Confidence'), paragraphs 6.35-6.46, Cmd 8388, 1981.
3. See the 2nd-reading debate on the Interception of Communications Bill, Hansard, col. 151-261, 12 March, 1985.
4. Hansard, column 872, 10 May, 1989.
5. Hansard, column 187, 13 March, 1989.
6. Hansard, column 593, 21 April, 1989.

fed to a demodulator. Signals of 1800MHz have been located in this way. The theory is that the bug provides the strongest signal in the room if one is close enough to it and Scanlock locks to that signal, which can be identified. Public broadcasts are thereby eliminated.

Tempest

This is security service jargon for electronic eavesdropping of data and speech, which has been known to occur in the world of commerce but which mainly, because of the massive expense, is carried out by government agencies. It must be said that, if one of these agencies decides to intercept your radio or telephone communications, there is absolutely nothing you can do about it unless you wish to bankrupt yourself. Life can be made difficult for the 'spooks', but there is no hope of beating them.

One area in which it is possible to make interception especially difficult is the radiation from computer monitors, which is easy to detect and reassemble anywhere in the immediate vicinity of a building. Most circuitry within a computer is of a synchronous nature and most of the communication between PC and screen and PC and printer is a serial data stream. If it is possible to receive the data stream, it can be decoded to a character stream in much the same way as standard PC serial communication. It is also possible to capture the data stream from a keyboard, which means that it is then possible to capture the keystrokes required to gain access to confidential systems.

The way to beat this — or, rather, to make it relatively hard — is to ensure that any computer which is processing 'sensitive' data is surrounded by masses of other computers or in the middle of an industrial zone which radiates noise.

But do not forget that industry has a tendency to go home at 5.30 p.m. and also that any captain of industry staying late at the office might be using the only working computer.

The use of a Faraday cage, while effective, would be unwieldy. But an alternative to the CRT — the gas plasma display — is effective in reducing screen emanations. While a CRT is continually being refreshed, the gas plasma display only updates pixels when necessary, the resulting radiation being largely unintelligible. These displays, together with optical-fibre cables for data, make the theft of data considerably more difficult.

Television

During the last few years, vision has been added to sound in the well-dressed spook's working outfit. In such systems, the difficulty lies in concealment rather

Continued on page 979



A selection of devices available to the well equipped spy. (1) old-style video recorder and camera in a briefcase; (2) Scanlock bug detector; (3) video and sound microwave receiver in briefcase with 1.4GHz masthead preamp, radio control built-in; (4) scanner receiver; (5) 1.3GHz "how-tie" antenna; (6) new video and sound receiver using Sony Watchman and a variable-bandwidth 950-1750MHz PLL tuner; (7) Pressure Zone microphone; (8) and (10) single-channel VHF receiver; (9) simple SSB tracking receiver; (11) heavy-duty pulse target tracker; (12) PZ microphone; (13) body-worn microphone; (14) FM radio microphone; (15) personnel target tracker; (16) low-cost microwave TV transmitter; (17), (18), (22), (23) commercial lapel microphones; (19) parallel telephone transmitter; (20) series telephone transmitter without battery; (21) Canon camera with M911A night-vision lens; (24) Mullen 100mW body-worn VHF transmitter; (25) sucker microphone; (26) phantom-powered line pre-amp; (27) line amplifier; (28) target tracker transmitter in a pen; (29), (30) Gem VHF and 1.1GHz 100mW and 20mW body, room and telephone transmitters; (31) infrared target tracker; (32) "visiting card" audio VHF transmitter; (33) Wild (1970) VHF pen transmitter; (34) "visiting card" tracker transmitter which responds to light; (35) TV camera with motorized auto iris; (36) scrambler module; (37) video AGC unit for long cable runs; (38) Antenna Eye main unit.

ELECTRONIC SURVEILLANCE

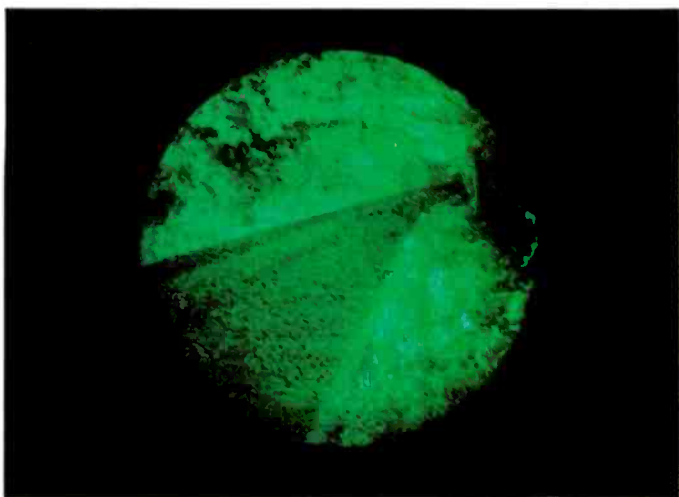

Tree covered country lane, nothing visible to the naked eye. The "grain" in the picture is due to individual photon strikes.



Moonless night, but under open sky. The naked eye could resolve the outline of a vehicle but no details. The light in the sky is reflected from a town some ten miles distant.

Seeing in the dark

The M911A image intensifier, shown here coupled to a Canon AE1 SLR camera, is standard issue to both UK and US security services. It weighs around 500g and runs for up to 12 hours from a pair of self contained AA batteries. It also incorporates an IR illuminator for operation in total darkness.

It is sensitive enough to detect individual photons: its operator can see quite clearly even on the darkest of nights deep in the country solely from ambient light. This is at least 100 times better than the human eye.

Unlike earlier night vision devices,



the M911A uses a channel plate photo-multiplier. Since the secondary emission is confined to localised channels, the device can't be blinded by a single bright light in its field of view. This enables the operator to look past bright lights into the shadows behind them. The technology originated as an aid to military pilots to enable sight of the ground around searchlights without being blinded.

The green colour is that of the output phosphor of the intensifier. All the night vision pictures were taken using 1600 ASA film, 1/30th second exposure.



Modern night vision devices can see past bright lights and into the shadows.



This picture was shot in total darkness using the "panic light" built into the intensifier.

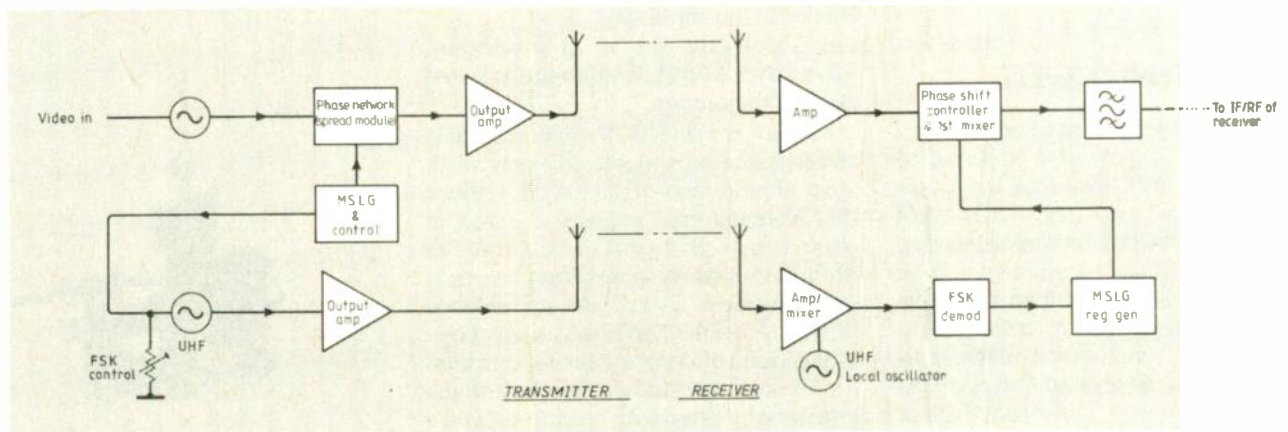

Fig. 3. Block diagram of a spread-spectrum transmitter and receiver. The maximal-length sequence synchronizing code is separately transmitted on UHF.

than in equipment supply, since small cameras and lenses are now on the market.

In days of old, visual surveillance was often carried out from a van parked close to the target, "systems" varying from holes bored in the side of a van to a revolving roof ventilator modified to contain a periscope. Long periods of duty gave rise to predictable bodily discomfort, which could sometimes be alleviated by making a hole in the van floor and parking over a drain! The vans were never totally secret: after a day of misery, it was common to hear a banging on the outside of the van and the voice of the target gleefully shouting that one could now go home!

But now, the briefcase camera has taken over, at least in following suspects or even in private offices. A built-in microwave transmitter provides a signal to a crew a short distance away. If the inevitable dropouts of the transmitted signal are important, for example when court evidence is being gathered, then it is necessary to record the output of the camera, a process which initially was performed by a stripped-down miniature camcorder in the briefcase, but which is now done very well by those nice people at Sony. I have already used their Watchman video recorder/monitor, which will give three hours of recording with batteries in the briefcase.

When a transmission is needed, to provide real-time information to a backing team who might need to take instant action, I have found that the best frequencies for omnidirectional covert work lie between 1.2GHz and 1.5GHz. The DTI allocation for this work is 22GHz, but this frequency is virtually useless for covert operation and has little to offer for overt point-to-point working.

The problem is the lack of low-power transistors in the range of frequencies up to about 1.5GHz. Devices for the 900MHz cellular telephone business exist, but they seem to have difficulty in reaching 1.4GHz. Very insanitary transmitters have appeared as a result, some of them being derived from the amateur television fraternity. The only way round the constraint is to move up

Bugging tele- phones is childishly simple

to military specified devices, which not only cost hundreds of pounds but can often work up to about 6GHz; some clients mistakenly insist that, since the devices work in this region, that is where they want to be and, since they are paying the bill, that is where they go.

The ideal transmitter is a synthesized, frequency-modulated, 2W unit covering 1GHz to 2GHz with digital frequency selection, and a sister unit covering 2GHz to 4GHz. AM transmissions have been picked up on ordinary domestic television sets, as the very large 'mother' and 'baby' in its pram found when an elderly man discovered a picture of his own street while idly tuning round the band. He mobilized the neighbours and wrathfully descended on 'mum', who wisely fled — all sixteen stones of him.

As regards detectability, I support the spread-spectrum method, covering the band 1GHz to 2GHz with a separate UHF frequency-hopping channel carrying the maximum sequence length generator. Such a system would possess selective address capability; code division multiplexing; a low-density power

spectrum; message screening; high-resolution ranging; and interference rejection.

Spread spectrum transmission is related to the frequency-hopping type of operation used by the military to gain protection against both detection and decipherment. A frequency hopper constantly changes its frequency, the receiver being synchronized to change frequency in step with the transmitter, so that there is apparently an unbroken transmission. A listener without the required receiver would simply hear a burst of noise as the transmission passed the frequency to which he was tuned. Instead of changing frequency, a spread-spectrum transmitter changes phase in response to a code generated by a maximum sequence length generator, with which the receiver is also provided. In the receiver, a voltage-controlled phase-shift network directed by the code provides a reconstruction of the original signal.

A synchronizing signal to ensure that the receiver is at the correct point in the sequence is transmitted separately using wide-band FSK and frequency hopping. Figure 3 shows a block diagram of a spread-spectrum system.

The Antenna Eye

Keeping video and sound observation from a parked vehicle has been the subject of many schemes, some hilarious and some plain stupid. Ideally, the vehicle should be a common saloon car and, furthermore, unoccupied; a car full of impassive passengers parked by the kerb for anything up to 14 hours a day is not likely to pass unnoticed.

One of the methods tried was an adaptation of the endoscope used in medicine: an optical fibre with a lens on the end is capable of having its tip moved about in response to a control at

BUGGING HOTSPOT

In the early days of covert Body Mic use, some bad techniques were employed by non-technical staff. They took the simple line that to get more range they could increase the power; so milliwatt transmitters gave way to watt transmitters, even as high as five watts. Apart from the inconvenient need to carry a tank battery, there was a painful consequence which many operatives soon discovered. One old friend of mine, now retired, has a party trick of dropping his trousers to reveal a very unusual burn mark in a very private place. Like many of his colleagues of the day he was badly burned by the heat of a five watt RF device strapped to his skin. When under the influence of the happy juice he lets rip about his intended lawsuit against the department for depriving him of offspring, a failure he insists is due solely to the BWM burning away his manhood potential.

the other end, so that it can be inserted in one's inside and look about to see what is wrong. The doctor looks through an eyepiece down the fibre. In my application, I coupled the eyepiece to a low-light camera, which fed a transmitter. The system worked, but there were problems with installation in a variety of vehicles.

In the 1986/87 solution to this problem, shown in Fig. 4, a common telescopic car aerial is used, the risk of some bored hooligan casually snapping it off being accepted. A very small right-angle lens with an automatic iris looks sideways out of a 3mm hole in the remotely controlled rotatable aerial and sends its image down a length of optical fibre to a camera concealed in the car.

If it is required to transmit the picture rather than rely on recording, frequency and aerial type are important factors for consideration. A preferred method is to use a 1.4GHz transmitter at around 6W in the car, transmitting to a nearby roof-mounted receiving aerial, very like all the other tv aerials. The signal is converted to a lower frequency and re-transmitted to a remote base. In this way, the car-mounted aerial need only be small and inconspicuous and yet the whole system will have as much range as might be needed.

The average subject for surveillance would not suspect that a television camera could be concealed in a car aerial and, of course, he would be right, since it is only the fibre and lens that are

hidden in the aerial tube.

An automatic iris is incorporated, driven by the level of video at a selected point in the camera.

Colour is a problem, since the best colour camera available will only work at an illumination of 3lux at f/1.4. Since the Antenna Eye camera is rated at about f/8, its performance begins to fall off quite seriously in anything less than bright sunlight. To provide surveillance in any possible condition, an image-intensified solid-state camera specified for 24-hour operation is needed, which also must be fitted with an auto iris and a neutral density spot to avoid damage to the image intensifier. The use of an intensifier means, of course, that the picture will be in black and white, since no colour intensifier exists.

In addition to a monochrome image, the use of an intensifier also reduces resolution to around 250 television lines, which is insufficient for the identification of subjects at a distance from the camera. It must be said, however, that Eyes are in use and have led to arrests.

Some over-enthusiastic correspondent to the BBC television programme *Tomorrow's World* thought it would be fun to feed all this information to the programme, which broadcast it to the world; incorrectly, as it turned out, because the car aerial is not used as the transmitter aerial, as stated. Nevertheless, the system was compromised and its effectiveness reduced, although it is still in use.

Microphones and rooms

Bugging a room for audio is not simply a matter of fixing a microphone under the coffee table with chewing gum and hoping for the best. There are probably more failures in this kind of operation than in any other sector of this cowboy-ridden business.

Most commonly, a single high-gain microphone is used, well away from the speech, so that direct and reflected

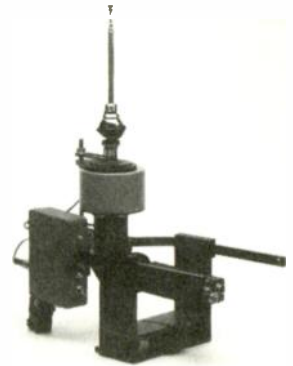

Fig. 4. Complete Antenna Eye assembly, with rotation motors and drives.

waves all contribute to 'boominess'; in this business, perfect acoustics are not the norm. Two microphones produce such a remarkable improvement that it is difficult to understand the commercial spy's insistence on using only one. Often, these people pay no attention to bandwidth, noise, speed stability of the recording or microphone placement. On average, I am asked several times a week to process some atrocious recording, the result of bad microphone technique.

Concealment dictates the use of small microphones and the fet-amplified type used in hearing aids are often employed. Since they need a direct-voltage supply and usually have three terminals, they are not ideal for the purpose, but the recorder or amplifier can easily be modified.

Room acoustics present problems too with phase cancellation of direct and reflected waves. The Pressure Zone microphone goes some way towards overcoming this effect, as shown in Fig. 5, which shows the difference between the response from a badly placed, phase-cancelling microphone and that from a PZ type.

Body-worn microphones

Microphones and their associated trans-

THE DISCOMFORT OF WATCHING

There was no favourite van, any van of the right size and shape would do. Certain individuals in certain police forces and certain security services tried to lay down guide-line laws dictating the choice and use of a particular van. But as the waves defied King Canute so the pressures of supply, availability and urgency defied the rigid rule book.

Due to the limited technology available the vans had to be occupied and sometimes for long stretches, maybe more than 14 hours. This presented some major headaches: first the van had to be large enough and with enough headroom for the long suffering occupants to stand up and even more vital it had to be provided with toilet facilities.

In the early days this consisted of little more than a funnel and a rubber hose but the rubber hose had to go somewhere. To the occupants of the van this became a scene of high drama but to any informed onlooker it became a scene of high comedy.

The rubber hose had to go down a drain so the van had to park not only over a drain but in the right position over the drain that the rubber hose could reach it. Life, however, just does not seem to favour the righteous, the antics involved in trying to look invisible while trying to move other vehicles so that the van could get in the correct position over its chosen drain would form the basis for a Mack Sennett comedy.

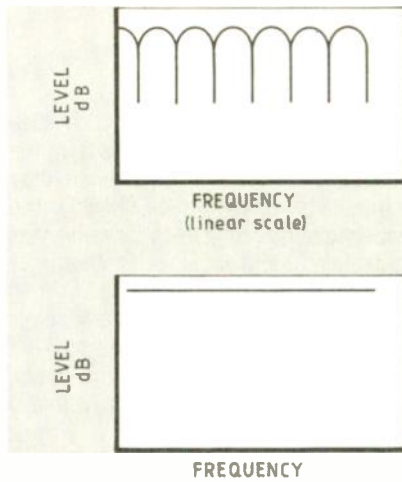

Fig. 5. On the left, the result of interference between direct and reflected waves showing phase cancellation. On the right, the output of a Pressure Zone microphone.

mitters worn about the body are, in essence, identical to the radio microphone used by entertainers. In practice, the two systems are quite different.

The problem common to both is the proximity of a concentration of fat and water (the body) to the aerial. In its entertainment function, the transmitter need only possess enough range to get the signal out of shot or off stage, whereas in its spying role it might need to transmit to the nearest back-up crew. There is also the question of concealment; a stage microphone only needs to be neat and comfortable to wear, the aerial hanging free and being insulated from skin contact by clothing, but a device used spying must be completely concealed, including its aerial, if the operator entertains any ambition to stay alive. It may even need to survive a body search.

A covert device presents, therefore, conflicting requirements — long range and concealment, and in the early days, increasing power up to as much as 5W was the only response to the problem. This, of course, presented the further problems of battery life and heat dissipation, the 'heat sink' being, of necessity, the spy's body.

Much work has recently been carried out on the design of body-worn microphone systems, but the type of equipment still being offered by commercial security companies is very basic, little thought having been applied to body absorption, path loss, noise suppression of selectivity. **Figure 6** shows data compiled by the Tesla-Popov Research Institute in Prague.

CLARITY — BUGGING IN STEREO

The simple introduction of twin microphones and twin audio circuits with moderate gain creates the first quantum leap. The separation between the two mics does not have to be excessive. One technique which works very well is to place one mic close to the operative's collar on the right hand side and the other on the wrist of his left arm; in practice the arm is kept away and, as far as is possible, extended over a table or chair or counter. This achieves remarkable improvements over the single channel, single mic systems.

This is the most commonly performed area of bugging yet it is the least understood by the commercial sector. More foul-ups and lousy recordings are produced than in any other section of spying technology.

Wiring rooms poses different problems when a microphone designed for high gain is placed in a position well away from the source of the speech room-boom is the major product. Targets are not well known for providing perfect acoustic surroundings.

As a start, no room should ever be tackled with a single microphone, two microphones in a stereo set-up is the absolute minimum.

In the world of professional entertainment recording engineers pay attention to bandwidth, signal-to-noise, temporal stability and, most important, the spatial characteristics of the sound signal. To record spatial characteristics, you must start from a basis of using two or more channels. So why does the commercial spy world stick to one channel and consistently produce unusable results?

For purposes of concealment the electronic spy world turns, once again, to the hearing aid

world for its supply of microphones. These tiny fet-assisted capsules require a DC voltage and are often provided with three terminals, not always convenient if all one has available is two old bell wires. However it is not difficult to modify them to work on two wires, or rather modify the amplifier or recorder.

If time is short and you have to get in and out quickly, place one close to the noisy side of the room and the other in the quieter part of the room. With a little more time and some preparation, take with you a miniature tape recorder/player on to which you have previously recorded about 10 minutes of normal speech. Set the tape player going at low volume in a position to simulate where speakers would be expected to sit or recline. Then move about the room and listen through a single portable mic. With a little experience and commonsense you will soon begin to "read" the response of each room and know where to put the mics.

The "how" of placing mics is critical. A knowledge of acoustics would come in handy. You need to create a pressure zone and place the mic capsule in the pressure zone just above the boundary where direct and reflected sounds combine effectively in-phase over the audible range. In a perfect room every wall and every surface would be covered with thick sound absorbing material, killing interfering reflected sound waves. The problem arises because reflected sound arrives at the microphone slightly delayed behind the direct sound. When these two sounds combine at the microphone out of phase the result is phase cancellation of various frequencies, sometimes called the 'comb-filter effect'. This is the condition which produces unnatural sound and distortion.

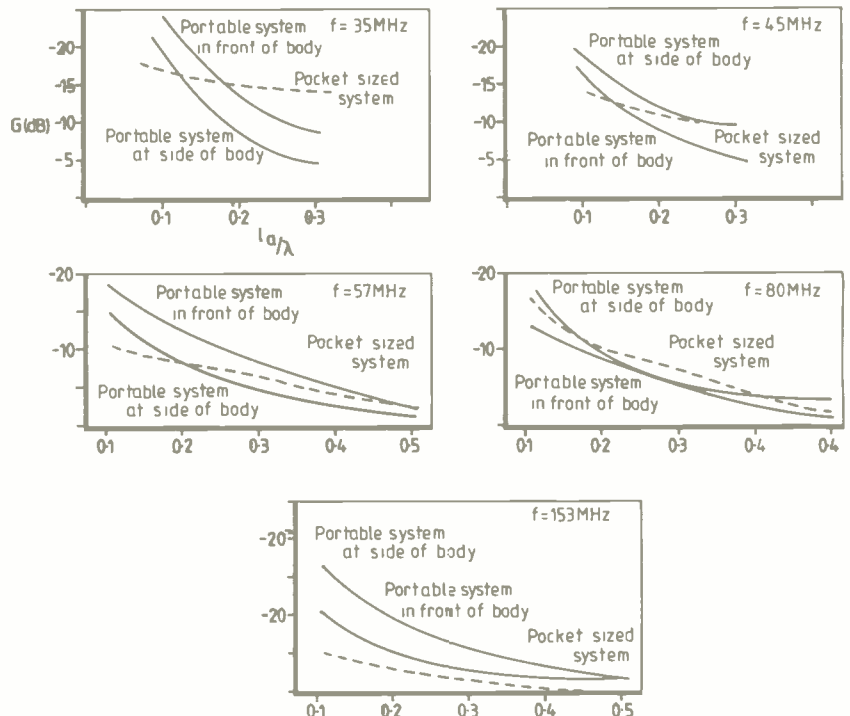

Fig. 6. Diagrams from a report by the Tesla-Popov Institute showing the variation in aerial gain for different frequencies at different positions on the body.

It is common practice to use FM, or sometimes even FM-on-FM for the transmitter, possibly with inverse scrambling. In my view, it would be far better to use the double-sideband, suppressed-carrier technique; Figs 7 and 8 show large improvements in path loss and power consumption over FM. Additionally, of course, the need to provide a stable carrier for insertion into the received signal would make it a bit more difficult to reconstruct the speech in an intercepted transmission.

Bug detectors would find that the part of the carrier that might show up would look very much like noise. I have tested all the commercial detectors I could find with a DSBSC transmitter and none of them could detect the device from a range of 30cm. Nevertheless, equipment available to the security services would fare better.

To make it almost impossible to detect transmissions, there is a process, already under investigation, which derives from work on interference suppression in radar. In this field, the result of the process would be the concealment of one FM transmission inside the carrier of a stronger one. All attempts to find the weaker transmission will only find the major one. The difficult bit is, obviously, extracting the information.

The use of two microphones in stereo would not only enhance intelligibility, but also allow the use of advanced techniques for the extraction of signal from noise – adaptive filtering. This is not the place for a full description, but an illustration will show the benefits to be had.

Certain cars of a certain department in a certain country are kept for the use of visiting dignitaries and are bugged. They have screens between the driver and passengers and the VIP compartment has a radio/cassette player, which is provided in the hope that the visitors will turn on the radio and imagine that the sounds will mask their own voices. Wrong!

Three microphones are used – two in the VIP section and one external. The adaptive-filter computer is controlled by the external microphone and radio output to subtract them from the two stereo tracks from the VIP compartment microphones. This system never fails and the resulting speech is crystal-clear.

The ultimate in concealment must be that due to Bill Edwards of the CIA who, twenty years ago, showed me a system capable of being implanted in a tooth. Developments on the theme have obviously continued, but must be

kept under wraps in the immediate future.

Telephone tapping

On the official level, tapping telephones is easy. An engineer known in the trade as a 'squirrel', working in the frame room of the target's local exchange, simply links the target pair to another pair connected to the 'Tinkerbelle' tapping centre, wherever that is. Every time the target telephone is in use, the tapping centre receives the same information. There is no possibility of putting a stop to this.

A method of detecting a tap might be a time-domain reflectometer which could be used to determine line length to the exchange; a tap would increase the line length by the distance to the tapping centre. Contrary to the impression given by film and television, the tapper does not reveal his work by mysterious clicks on the line. Indeed, the technology to detect telephone taps must be very advanced; and the process is time-consuming and expensive.

You carry out this process every day of your life. One day your TDR reads vastly more than the eight or ten miles. Now, it is highly unlikely that they have

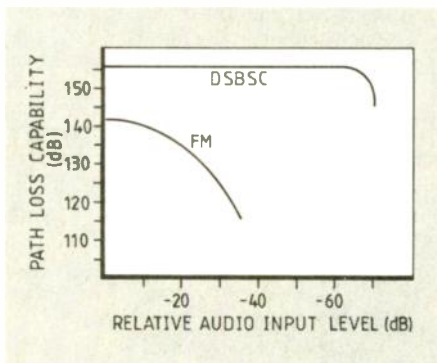

Fig. 7. Comparison between path losses in double-sideband, suppressed-carrier working and FM.

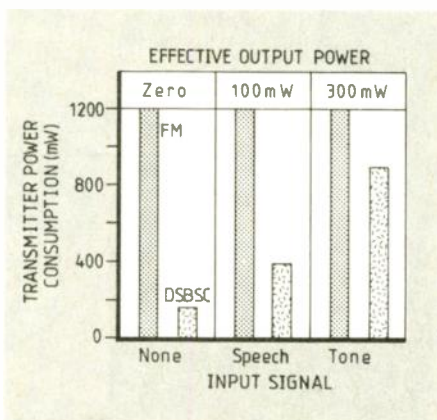

Fig. 8. Output power against power consumption in DSBSC and FM transmitters.

BLUFF

The best of the illegal squirrels carry false BT passes which identify them as from the Investigation Branch. If confronted they are trained to verbally attack. Should some innocent unsuspecting telephone engineer accidentally bump into one of them the tactic will be for the Squirrel to instantly hint at some serious criminal matter he is investigating and demand to know how the luckless BT engineer fits into the crime; usually enough to get the BT man making a hurried exit.

just upped the brickwork and moved the exchange and, in any case, you can soon check that. If it turns out that the exchange is still there and still in operation as your local exchange then the chances are that Tinker-Bell has a little love affair going with you.

Tapping by unofficial agencies is quite a different matter, if only insofar as the tapper has no access to the exchange. Many techniques exist, perhaps the most common being to open a street box, identify the target pair and another pair going to a non-working telephone in an empty room nearby. The two are then linked so that the outgoing and incoming calls can be heard in the empty room, with the numbers of the outgoing calls. It is also possible to connect a tape recorder, taped to the roof of the street box, to the target part, but constant visits to change batteries and tape would need to be explained away.

* To find the number of an incoming call is not easy. With the older exchanges, the concerted efforts of a number of engineers in different exchanges were needed to trace the call to its origin. The process was seldom successful and an 'unofficial' squirrel stands no chance at all. In a modern electronic exchange, on the other hand, the number can be found in a matter of milliseconds.

There is an expert alternative. This is a parallel-connection crystal NBFM transmitter with its own onboard NiCd battery pack and charging circuit; it is commonly called a "Pole Job". As the name implies, it is normally installed at the top of a suitable telephone pole and is connected to the target telephone line pair and also to another innocent pair. Whenever the target telephone is used

Continued on page 998

Small in Size,

Big on Features,

Competitively Priced...

... the new Analog Bargraph DMM's from SOAR.



SOAR 3200



SOAR 3230 E79



SOAR 3220 E65



SOAR 3210 E49

SOAR's newest range of feature packed analog Bargraph DMM's offer exceptional performance which is backed up with enhanced accuracy and custom LSI circuit technology.

The 3200 series comes with a standard 3 year guarantee and all models have an adaptor mode which enables Plug-in use of Soar's optional series 9300 adaptors for extended measurement capabilities of AC/DC current,

capacitance, temperature and transistor checks.

SOAR Digital Multimeters provide a wide range of capabilities, covering general purpose applications in research and development, production line service and maintenance use. The 3200 series up to the high accuracy 4½ digit DMM's is complemented with some economic models which include hand held as well as bench-type multimeters.

Look at these features:

- 32 segment Analog Bargraph display.
- 3¾ digit readout.
- Custom LSI circuit design.
- Accuracy up to 0.35%.
- High speed sampling.
- Auto or manual range selection.
- Data hold.
- Over 2500 hours battery life.
- Diode test.
- Adaptor mode.
- Continuity beeper AND MUCH MORE.

For further details or full colour test and measurement equipment catalogue contact the sole U.K. distributors:

SOLEX
INTERNATIONAL

TELEPHONE: (0455) 283486. FAX: (0455) 283912. TELEX: 342523 SOLEX.

Solex International,
95 Main Street, Broughton Astley, Leics. LE9 6RE.

SOAR

**3 YEAR
GUARANTEE**

CIRCLE NO. 26 ON REPLY CARD

GaAs microwave integrated circuits

Fred Myers describes Plessey's advanced GaAs MMIC process and two of its many applications: a radar component and a satellite-borne downconverter.

Fet-based GaAs monolithic microwave integrated circuits (MMIC) were first demonstrated in the mid-1970s by Plessey and others. Since then the technology has matured into a proven process commercially available from many manufacturers.

The MMIC, like many other new devices, had an initially slow take-up but it is now revolutionizing microwave applications, certainly to 20GHz and in the next few years, with enhanced technologies, probably to 100GHz. The revolution is comparable to that wrought by the silicon IC in the last 20 years or so. MMICs will replace large, bulky and expensive hybrid circuits, the microwave equivalent of the PC board, with small reliable and low-cost chips (at least in volume).

Most GaAs MMICs are based upon the field effect transistor (fet), the ubiquitous workhorse of solid-state microwaves. This device is fabricated upon semi-insulating substrates, which have very acceptable microwave properties, and the material doping and depth are chosen to optimize the device's properties. In a discrete fet, performance can be optimized by adjusting the circuit matching to a particular device; material variations, although important, can be tolerated to some extent. For an MMIC this is not so; every device and every circuit must be identical time after time with no adjustment – one of the process's many advantages.

Volume and performance requirements call for such repeatability that ion implantation is now established as the industry standard. Throughput of a typical production machine (>300 wafers/hour) and doping uniformity ($\approx 2\%$) make it close to ideal.

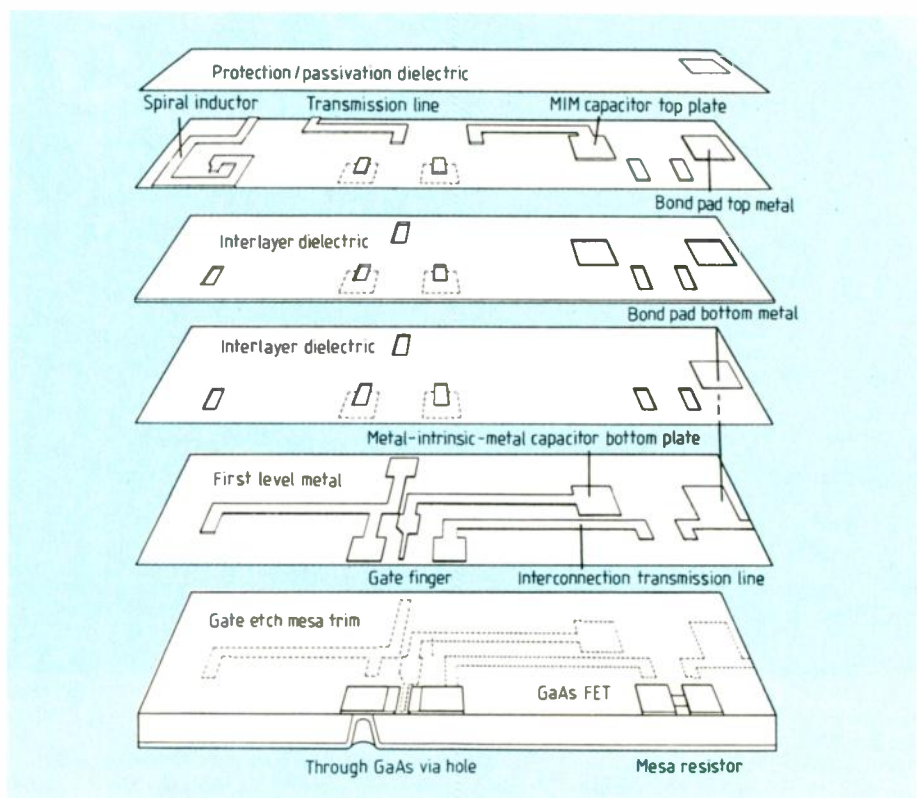

Fig. 1. Plessey's MMIC process.

Fabrication technology

Many manufacturers now offer either standard MMIC parts or a foundry service, or both. However, a proportion of the processes used must be considered little more than derivatives of a fet process; although acceptable for first-generation circuits they have little 'stretch' capability for the future. The process described here is a multi-metal/multi-dielectric process that allows cir-

cuit designers to exploit fully the capabilities of the medium. The gate length of the fet here is $0.5\mu\text{m}$ which allows the process to be used to at least 20GHz.

The first level metal (Fig. 1) is created at the same mask level as the gate metal, resulting in all the critical dimension components being manufactured with the same sub-micron accuracy techniques inherent in the gate process. This first level metal is used for capacitor bottom plates, gates, all underpass interconnects as well as some transmission lines and other passive components. Inter-layer dielectrics are then

placed on the wafer to separate the metal layers, planarize the wafer surface, provide the overlay capacitor dielectric and (if required) to passivate the active devices.

Holes ('vias') are etched through the dielectric layers and filled with metal at points where connections must be made between the various metal layers. At this stage a thick top-level metal is added which contains the low-loss transmission lines, inductors, capacitor top plates, bond pads and other interconnect features. The front-face wafer processing is then completed by adding a covering dielectric to act as a surface protection/passivation layer.

The most widely used MMIC dielectrics are Si_3N_4 , SiO_2 and polyimide, although Ta_2O_5 has also been reported. The choice of dielectric depends on many factors. For capacitor dielectrics, capacitance per unit area, thickness control and freedom from pinhole defects are the main considerations. For interlayer dielectrics which separate the first and second level metals, the step coverage capability of the dielectric film is important in order to avoid short circuits at crossovers. Here polyamide is especially useful since it has a low dielectric constant (≈ 3.5) and can be spun on the wafer at typically $1\mu\text{m}$ thicknesses (cf. Si_3N_4 at $0.2\mu\text{m}$).

After front-face processing has been completed, the IC wafer is thinned and, if required, holes are etched before final back-face metallization and chip separation. Thinning the wafer and backing with metal provides both a ground plane for the microstrip transmission lines and a controlled parasitic image plane for the lumped elements. Accurate control of the final wafer thickness is essential to maintain accurate transmission line characteristic impedances. Although GaAs can be thinned to $100 \pm 5\mu\text{m}$, the mechanical fragility of such a thin wafer precludes its use in genuine production processes: $200\mu\text{m}$ is the usual thickness standard.

Through-GaAs vias are required to provide a low-inductance path to ground and as such they are essential for high-frequency ($>12\text{GHz}$) and/or compact area circuits. The simple concept of "drilling" holes through the semiconductor is however far from straightforward in practice and a great deal of process r&d has been invested in the development of a high-yield technique for the vias. Wet etchant chemistry can create vias in thin GaAs wafers but its poor directional control causes difficulties in $200\mu\text{m}$ -thick wafers. Reactive ion etching (RIE) is a much more control-

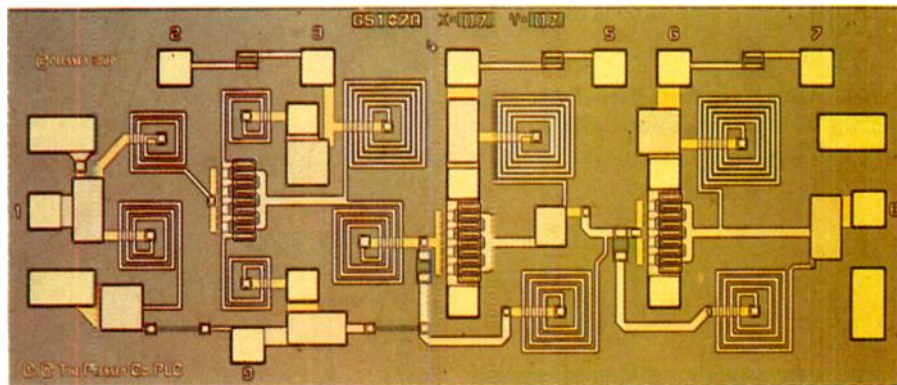

Fig.2. Typical broadband low noise amplifier.

led technique and is consequently becoming the common approach to vias.

MMIC circuit design

At frequencies between 1 and 20GHz, a totally different design philosophy from that commonly encountered by electronic engineers has to be used. At lower frequencies, elements are largely considered as lumped (i.e. pure) L, C and R; but at microwave frequencies, distributed effects and stray coupling are very important, making layout a vital part of the design. In other words, component geometry strongly influences the performance. Going from an equivalent circuit to a finished layout is a complex iterative procedure requiring a considerable database for design. Because of the distributed nature of the chips, only relatively simple concepts can be investigated by breadboarding the circuit using discrete devices; and, as in the silicon IC industry, this approach to MMIC design is now virtually dead.

Prior to mask layout and mask-making, extensive computer-aided designs of the chips are carried out by means of such software as Supercompact and Touchstone together with a number of in-house programs. Much attention at Plessey, and doubtless elsewhere, is now being given to the development of a sophisticated GaAs IC

software package which will enable the engineer to produce complex ICs more efficiently. The program Linmic+ is proving particularly amenable to this application.

Modern cad is so accurate that most linear circuits (e.g. low-noise amplifiers) can be expected to work satisfactorily on a single-pass design basis: only one mask design and process batch needs to be produced to obtain chips working to specification. Complex, novel circuits may require two or more design iterations, and cad engineers, circuit engineers and technologists are constantly striving to improve this position.

Examples of GaAs MMICs

Many circuit functions over the frequency range 3–30GHz have been successfully realized as MMICs. Space does not permit more than just a mention of these. Among circuits demonstrated are

- amplifiers – small signal, broadband and power.

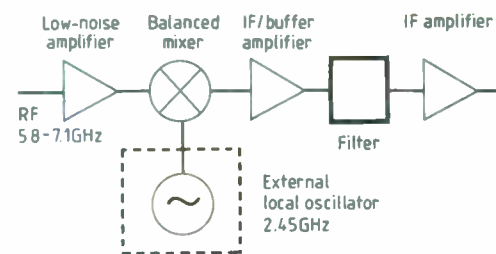
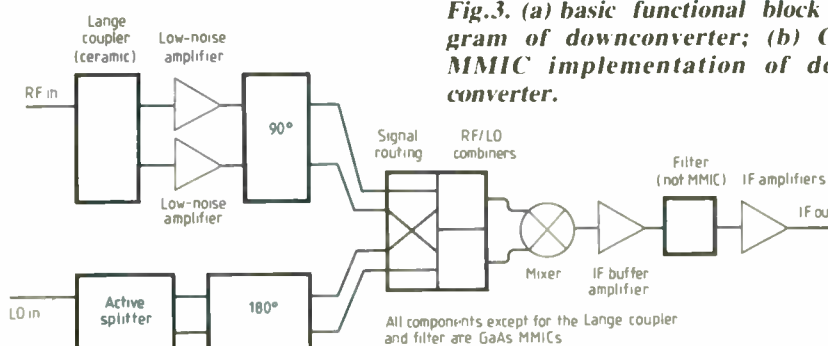

Fig.3. (a) basic functional block diagram of downconverter; (b) GaAs MMIC implementation of downconverter.



MICROWAVE

Fig.5. Voltage controlled oscillator (frequency 6–11GHz; power, 20mW; chip area ~1.5cm²).

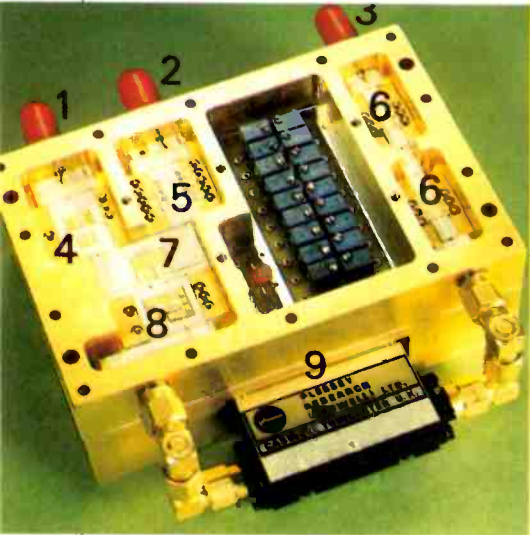
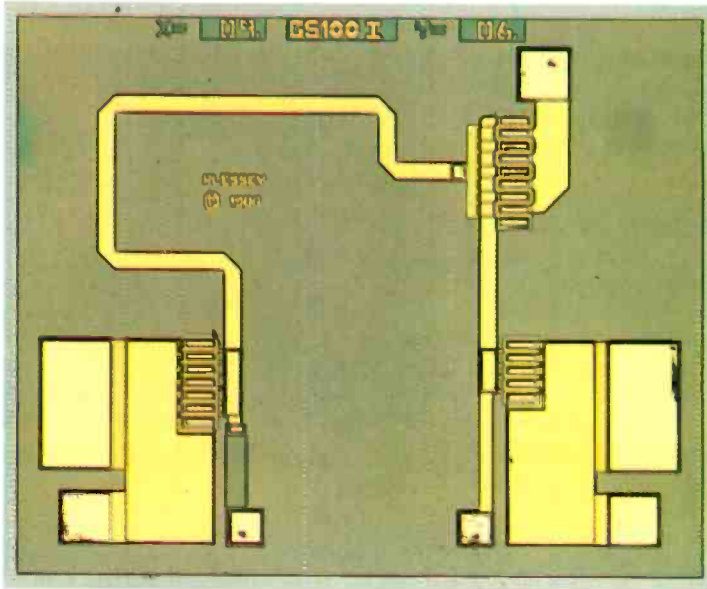

Fig.4. Complete MMIC-based down-converter.

Fig.7. Packaged single-function MMIC T/R module.

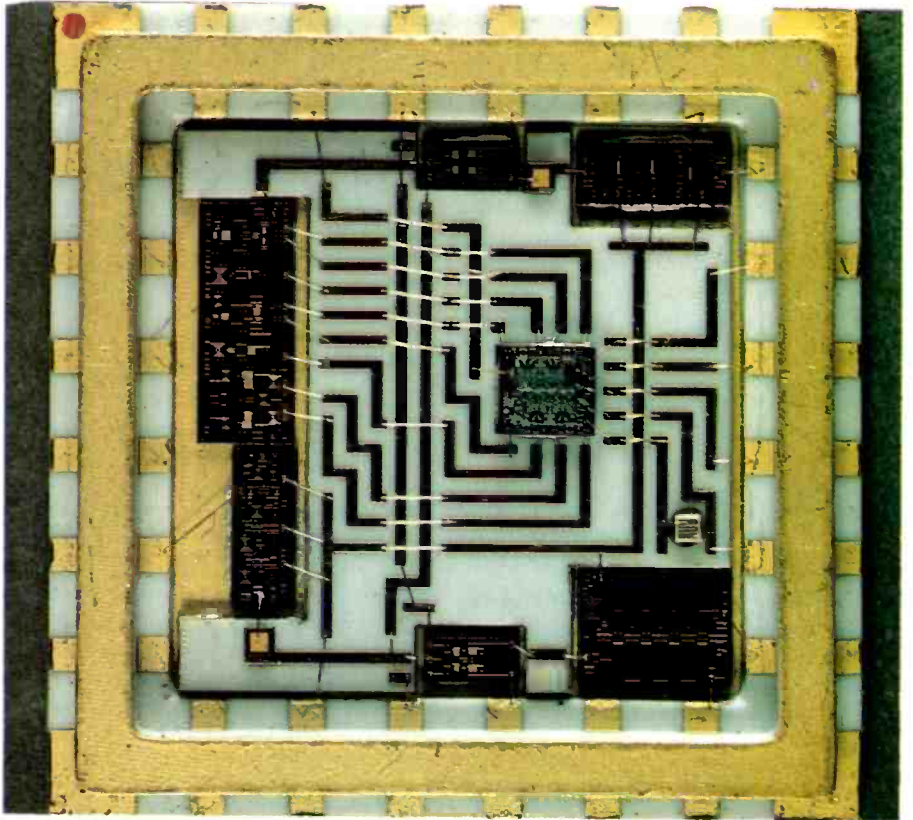
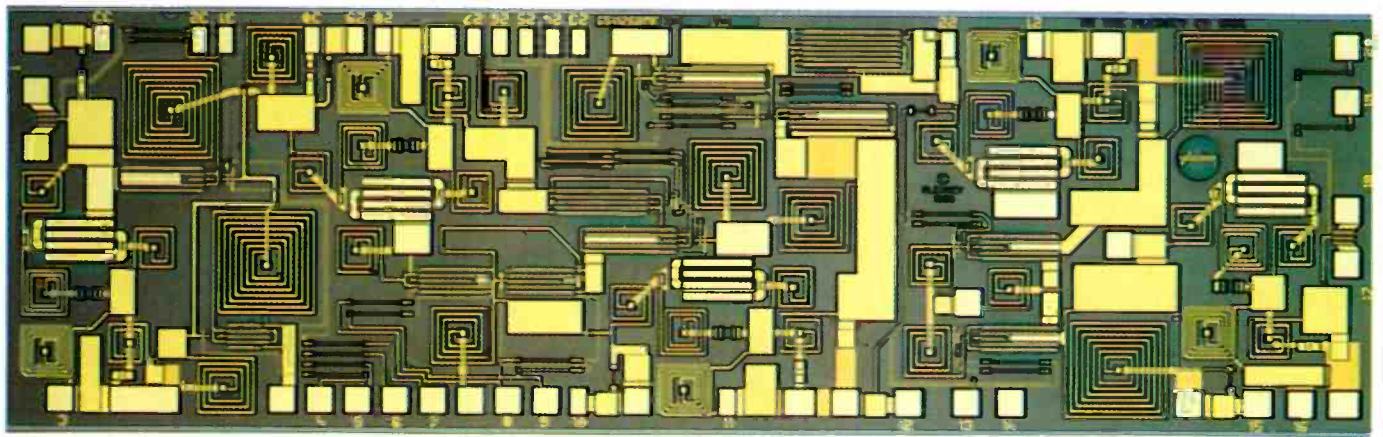

Fig.8. Advanced multifunction chip replacing the module of Fig. 7.



- oscillators – fixed frequency and broadband tunable.
- mixers – single-ended, balanced, image-rejecting etc.
- phase-shifters – time delay and constant phase.
- switches – SPDT, DPDT etc.
- multipliers – $\times 2$, $\times 4$ etc.
- power combining and splitting circuits.
- logic circuits.

Figure 2 shows an example of a typical MMIC produced using this process, a broadband amplifier working over the frequency range 2–6GHz with a gain of 21dB in a chip area of 5mm². The yield to specification of circuits such as this is typically around 50%, illustrating the mature nature of the process.

The building blocks listed above find application in many microwave systems. Below are examples of two such applications chosen to illustrate the use of MMICs.

Satellite downconverters

GaAs MMIC technology makes possible the development of receivers of small size and weight, low power consumption and with radiation-hard characteristics. The MMIC implementation of a 6–4GHz transponder incorporates a low-noise amplifier, mixer, miniature filter, high gain IF amplifier and integral power supply. This is a receive-only unit (Fig. 3), but it also downconverts the nominal 6GHz signal to 4GHz, and so requires a balanced mixer. This particular mixer has a conversion loss of 3dB and a noise figure of 14dB and was realized using the non-linearity of fets rather than diodes. The noise figure is not critical because the device is preceded by several stages of low-noise amplification, a balanced configuration of MMICs.

To apply the externally-derived local oscillator input, an active splitter chip has been used. With a single input the device provides 10dB gain per channel balanced to 0.2dB. Additional phase-shifting for optimum signal combining of the mixer is provided by passive MMIC chips using high-pass/low-pass networks and providing the necessary routing and combining functions.

The MMICs are mounted on four tungsten copper gold-plate carriers with signal routing on alumina microstripline. DC bias is supplied via vertically

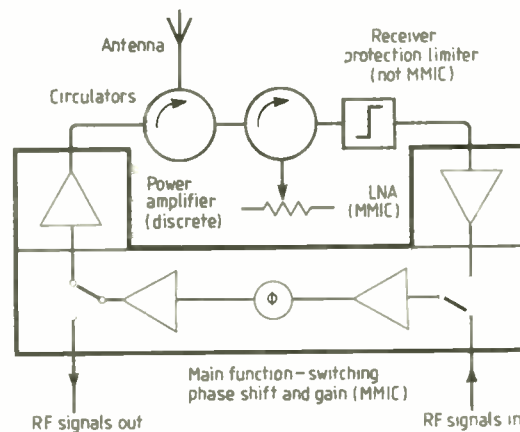

Fig.6. Functional block diagram of radar transmit/receive module (shaded region refers to the single chip in Fig. 8).

mounted feedthroughs from the distribution PCB.

The prototype unit shows a very significant weight reduction over typical hybrid designs and a reduction of volume of approximately 4:1.

The complete downconverter is shown in Fig. 4. With 18 chips it represents a very high density of GaAs MMICs. Such a downconverter is representative of a whole class of applications, and future developments will see the MMICs making inroads into such areas as direct broadcast satellite television (DBS). In this case an oscillator is required as an integral part of the subsystem. The MMIC is ready for the challenge and an example of a high-frequency voltage-controlled oscillator (VCO) is shown in Fig. 5. The Q factor of such an oscillator is usually too low for it to be used directly but synthesizer techniques or dielectric resonator stabilization can be applied.

Radar transmit/receive modules

A most attractive solution for high-performance radars is the phased array in which the beam is synthesized and controlled by integrating the output from many (several thousands) of individual radiating elements. The key to the commercial success of such a radar is the individual transmit/receive unit behind each radiator. Unless this can be produced at low cost the radar will be uneconomic despite its performance advantages.

Development at Plessey makes such a radar feasible. Spin-offs will allow the GaAs MMIC to find applications in other areas and the advanced multifunction chip concepts will lead to 'systems on a chip'. Indeed, the 18 chips in the

downconverter of Fig. 4 could now (two years after the prototype was demonstrated) be replaced by four complex chips and ultimately by a single chip.

A typical individual transmit/receive unit, or module, is as shown in Fig. 6. Figure 7 shows the realization of the small signal circuitry with modern single-function MMICs (each chip performing just one function, such as amplification) operating over 3–6GHz, mounted in a 16mm \times 16mm ceramic microwave package. The high power stages (\sim 10W) cannot as yet be achieved with GaAs MMICs

but are produced at present with discrete GaAs high power transistors. Similarly, the non-reciprocal circulator is realized using ferrite devices and the receiver protection limiter with p-i-n diodes. The square chip in the centre of the package is not a GaAs device. It is a silicon serial-to-parallel converter used to drive the phase-shifter.

But Plessey's process offers far more sophistication than has been used to date; and it allows the circuit complexity per unit area to be dramatically increased. As with silicon ICs, circuit elements can be created that have no hybrid equivalent, allowing circuit functions to be implemented efficiently. Through these techniques, which would require a separate article to describe them, all the GaAs chips of Fig. 7 can be realized in the one advanced chip shown in Fig. 8. The observant reader will spot that Fig. 8 does not contain the LNA, although this was for convenience only.

The significance of this development can be seen when it is recognized that the module of Fig. 7 requires 28mm² of GaAs to achieve its function whereas the multifunction chip only occupies 10mm². All the intermediate stages of testing and chip/wire bonding are saved also, resulting in a potentially much lower cost.

The GaAs MMIC has now come of age and should be considered as the first-choice medium for many applications. There remains considerable 'stretch' in the MMIC and the integration of more advanced devices into the process, beyond the scope of this article, will result in even higher performance and extended frequency operation. ■

Fred Myers is at Plessey Research Caswell Ltd.

Toroidal & E.I. Transformers

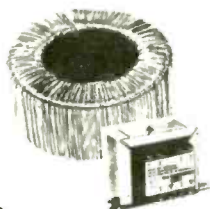

As manufacturers we are able to offer a range of quality toroidal and laminated transformers at highly competitive prices.

Toroidal Mail Order Price List

prices inclusive of VAT & Postage

15va 9.12, 30va 9.48, 50va 10.16, 80va 11.02, 120va 12.23, 160va 14.44, 225va 16.37, 300va 18.05, 500va 26.46, 625va 30.66, 750va 34.14, 1000va 49.40.

Also available 1k2, 1k5, 2k, 2k5, 3k. Prices on request.

Available from stock in the following voltages: 6-0-6, 9-0-9, 12-0-12, 15-0-15, 18-0-18, 22-0-22, 25-0-25, 30-0-30, 35-0-35, 40-0-40, 45-0-45, 50-0-50, 110, 220, 240. Primary 240 volt.

Quantity prices and delivery on request



Air Link Transformers

Unit 6, The Maltings, Station Road,
Sawbridgeworth, Herts. Tel: 0279 724425

CIRCLE NO. 29 ON REPLY CARD

Versatower:

A range of telescopic towers in static and mobile models from 7.5 to 36 metres with tilt-over facility enabling all maintenance to be at ground level.

Designed in accordance with CP3 Chapter V, part 2: 1972 for a minimum wind speed of 140 kph in conditions of maximum exposure and specified by professionals world-wide where hostile environments demand the ultimate in design, quality and reliability.

Suitable for mounting equipment in the fields of:

- Communications
 - Security surveillance - CCTV
 - Meteorology
 - Environmental monitoring
 - Geographical survey
 - Defence range-finding
 - Marine and aero navigation
 - Floodlighting
 - Airport approach lighting
- Further details available on request.



STRUMECH ENGINEERING LIMITED

Portland House, Coppice Side, Brownhills
Walsall, West Midlands WS8 7EX, England
Telephone: Brownhills (0543) 452321
Telex: 335243 SEL.G
Fax: 0543 361050



CIRCLE NO. 27 ON REPLY CARD

Those Engineers Ltd

The UK's leading suppliers of circuit simulation software

Product	Functionality	M/c	O/S	Recommendation	Price
ECA-2	Analogue circuit simulator. Allows effects of different components to be investigated - more effectively than by bench testing. Very high specification program includes Monte Carlo & Worst Case tolerancing, Fourier analysis of transients. Non-linear components characterised by breakpoints or polynomial functions	PC XT AT 386 256k RAM Mac	DOS 2.0 or later	Believed to be the most powerful PC-based analogue circuit simulator available. Regularly upgraded. Interfaces to many schematic drawing packages.	£675 (special terms for education - ask for ECA-2S)
Plot-D	HP & Houston plotter driver for ECA-2 high quality output.	As ECA	As ECA	Lets ECA-2 produce your brochure curves before you have even built the circuit.	£50
EC-ACE	Sub-set of ECA-2; retains DC, AC and transient analysis with non-linearities modelled by diodes.	As ECA	As ECA	Low-cost intro to ECA-2. Upgrade path to ECA-2 available.	£199
LCA-1	Logic Circuit Analyser; a new sister program to ECA-2. Produces logic analyser-style output traces (up to 68 signal traces) and incorporates delay and nestable macros.	As ECA	As ECA	This new program from Those Engineers will encourage thorough investigation of problem areas in circuits. True cost saver.	£350
MITEY SPICE	Analogue circuit simulator incorporates non-linear quiescent handling and small-circuit AC analysis. Full Ebers-Moll bi-polar transistor representation, new transformer model and graphics display - up to 26 parameters.	BBC-B Arch- me- des (ext. spec.)	DFS ADFS Na- tive OS	Established teaching standard. Mitey Spice on Archimedes is startling 200+ node capacity; almost instant calculation; immediate development of complex circuits.	£119 (special terms for education: - please ask us)
SPICE-AGE	Analogue circuit simulator in GEM environment. Available in modular form covering: 1 - Frequency response 2 - DC quiescent analysis 3 - Transient analysis 4 - Fourier analysis	PC XT AT 386 512k RAM mouse des/ble	DOS 2.0 or later	Licensed GEM supplied at no extra cost. Module 1 Additional modules Full program Multi-user Pro version	£70 £70 £245 Please ask us
MIMA.NET	Small-signal analogue circuit analysis with schematic entry of circuits & extensive output options including synthesis of transfer function; polynomial, Smith chart, Bode, etc. Butterworth and Chebyshev filter design incorporated.	HP 200 300 400 series w/s	Basic 2, 3 or 4	Outstanding program for RF designers or control engineers who need to trim transfer functions. Program is quite exceptional for its ease-of-use.	£850
Program A	Systems design aid analysis program with numeric entry of transfer functions or direct link to MIMA.NET. Multiple inputs, noise rejection modelling, and graphical outputs are provided.	As MIMA NET	As MIMA NET	Use Program A with MIMA.NET to develop your PLL filters, and so on.	£850
CODAS	Single-input control system simulator represents non-linearities and transport delays. Transient response, root locus, Nyquist, Nichols and Bode plots all available.	BBC Arch- PC XT AT	DFS emul DOS 2.0 or later	Ideal for control engineers. Very illuminating program for teaching control theory.	£220 to £350 (ask for details)
PCBAR	Auto-routing printed circuit board drawing program output to a plotter (driver extra) or to Epson FX compatible printer. Very easy to use.	BBC Arch- PC XT AT	DFS ADFS emul	Ideal for prototyping, hobbyists, and teaching. Excellent quality prints (double size) from dot-matrix printer.	£85 (manual) £185 (auto route)
VUTRAX S & A	A multi-sheet schematic drawing system with special features for drawing validation. May be used for entry of circuits into ECA-2.	PC XT AT 640k 8087 80287	DOS 2.0 or later	A very powerful schematic circuit drawing program with extensive features much favoured by professional users.	New low price £500 (if face to ECA-2 extra)

Those Engineers have been providing circuit designers with micro-based simulation and pcb layout software since 1983. We now have a broad range of packages covering many applications and running on machines from the BBC Micro to 386-based PCs. The chances are, if you want computer-based analysis software or a layout system, we have a cost-effective CAD package to suit your needs. When you telephone Those Engineers, you will be speaking to an engineer who will see it as his duty to advise you - our reputation is built on service and not opportunistic sales. Access payment accepted - please add VAT to above prices.

Those Engineers Ltd

106a Fortune Green Road • West Hamstead • London NW6 1DS
Tel: 01-435 2771 Fax: 01-435 3757



CIRCLE NO. 36 ON REPLY CARD

PC breadboard

Simulating a circuit on a PC can save weeks of costly prototyping. More than that, it can provide important information about the likely manufacturing yield by answering the question: "What happens if . . .?" John P. Martin reviews two popular simulators.

There was a time when fabricating a prototype integrated circuit cost an arm and a leg, and no engineer would dare to commit his design to silicon without being highly confident that the circuit would work, and would continue to work in varying conditions of temperature and where the parameters of the devices might vary greatly within their tolerance ranges. To create this pre-production confidence, computers (which then cost a mere leg) were programmed to simulate the design mathematically and provide data on the performance of the design over a wide range of possible conditions. Most prominent of those simulation programs was Spice (Simulation Program with Integrated Circuit Emphasis) developed at the University of California in Berkeley in the mid-1970s.

Spice spawned many offspring of varying legitimacy but the modern versions are now more accurate, more friendly, relatively cheap, run on the ubiquitous IBM-compatible PC and provide those all-important colour graphics without which no modern computer program is complete. For the engineer who is not engaged in integrated circuit design, libraries of standard components are available, enabling the simulation of discrete electrical and electronic circuits, which may themselves include standard or custom integrated circuits.

Why bother?

The design method which uses the back of a cigarette packet followed by the building and bench-testing of half-a-dozen prototypes seems to have a lot to commend it. For simple, non-critical circuits, this approach may well suffice.

But if the circuit's performance is more critical, many weeks (or months) of testing with expensive equipment may be necessary. For this reason alone a computer simulation may prove cheaper and immune from the errors that test equipment itself can introduce. More importantly, perhaps, is a simulator's ability to answer the designer's eternal question: "What if . . . ?". For example, a transistor with a nominal h_{FE} of 100 could actually have an h_{FE} of anywhere between 50 and 200. If the half-dozen circuit prototypes were all made using the same batch of transistors, then the likelihood is that the transistors would all have a fairly closely matched h_{FE} . So all the prototypes might well work within specification. But then, in the middle of a production run of 100 000 units, transistors are taken from a new batch, and suddenly all units fail to meet a part of the specification. At best, this problem can be solved by the alteration of some resistor values; at worst the circuit may need to be re-designed to accommodate a possible spread of h_{FE} . Naturally, this situation can be predicted by calculation, but for large circuits, the amount of number-crunching involved would be impossible without a computer.

Simulators are becoming an integral part of many computer aided design (cad) systems and the benefits are a more controllable, flexible and reliable approach to product manufacture. I can do no better than to refer the reader to Mike Walsh's excellent article "Designing with cad" (July, page 694) for a fuller development of these arguments.

There is an understandable feeling that anything simulated on a computer is going to be rather "ideal" compared to a "real" circuit. This feeling is based

on the suspicion that a computer doesn't know quite as much about a BC109 transistor as does an engineer who has been using them for some years. Similarly, what can a computer know about

The benefits are a more controllable, flexible and reliable approach to product manufacture.

the inductive effects of PCB tracks or the proximity of an amplifier's input stage to a mains transformer? Clearly, any simulator is only as good as the information it is given, and this information divides into two categories:

- Full details of the circuit must be given to the computer. This may seem obvious, but the effects of stray capacitance and inductance will be taken into account by the simulator only if they are included as part of the circuit description!

- Devices used in the circuit must be accurately modelled. It is this aspect which is most often neglected. Computers deal with numbers and those numbers are derived from mathematical models which are, in turn, derived from pseudo-physical models based on the observed operation of real devices. Resistors and capacitors are quite straightforward and idealized models are usually sufficient, although non-linear effects can be included if necessary. But semiconductor models are more complex.

Simple linear analysis packages such as Analyser II use ideal, linear models for transistors, fets and op-amps, with

the provision for including input resistance and capacitance. ECA-2 uses the well-known Ebers-Moll model for the bipolar junction transistor, while PSpice uses an enhancement of this, the Gummel-Poon model.

It is the passing of parameters into these models which creates specific devices like the BC109. Similar models are provided for fets, op-amps, etc., which have been the subject of many papers themselves; but for now it is sufficient to accept that the models used by these simulators are more realistic than those used by many engineers who design by hand. This is not to belittle the know-how of designers, but merely to point out that the polynomial functions used to describe the non-linear characteristics of semiconductor devices are extraordinarily tedious to work with using anything other than a computer. PSpice has an extensive library of common devices with good models, and an interactive parts modelling program to assist in the translation of manufacturers' data sheets into PSpice parameters.

Electrical, electronic?

PSpice and ECA-2 are "electrical" circuit simulators, which means they deal with volts, amperes, seconds, ohms etc. A group of transistors acting as a logic gate is treated no differently from a group of transistors acting as an audio amplifier.

The difference is in the application of the circuit, not its operation. Since logic signals are merely a special form of analogue signal, and since megavolts have no greater significance to a computer than microvolts, these analysis packages are useful for all types of circuit. For logic designers who are more interested in 0s and 1s than in volts, there are, of course, specialized logic analysis packages. However, PSpice has a "digital files" option and an extensive library of common TTL and c-mos parts, which could prove useful to those wishing to mix analogue and digital circuitry, either with discrete components or on a custom or semi-custom integrated circuit.

Which simulator?

Analyser II is a good introductory package for those new to computer simulation and for schools, colleges and similarly under-funded institutions. It runs on a BBC Microcomputer or on an IBM-compatible personal computer and provides a basic linear analysis of frequency versus gain, phase, input and output impedance and group delay for transistor, fet and op-amp circuits. It is

Table 1: main features of PSpice and ECA-2.

	PSpice	ECA-2
Price	£1195	£675
DC analysis	■	■
DC sensitivity	■	■
Frequency response (small-signal AC)	■	■
AC sensitivity	■	■
Transient analysis (time-domain)	■	■
Fourier analysis	■	■ (no graphics)
Distortion analysis	■	
Noise analysis	■	
Temperature runs	■	■
Monte Carlo and worst-case	£190 extra	■
Component sweeping	■	■
Parts libraries	■	
Digital/logic simulation	£190 extra	
Parts modelling program	■	
Supplied models	complex	simple
Hard-copy output	■	■ but needs £50 extra driver for EGA
Documentation	very good	good
Minimum hardware	512Kbyte ram, hard disk maths coprocessor	256 Kbyte ram, single floppy
Circuit size*	100 transistor equivalents (1 transistor equals 10 resistors)	> 100 nodes with 256K ram 500 nodes with 512Kram

* Direct comparison is difficult. Memory is used for circuit data and for the results of analyses, so there may be a trade-off. The figures are quoted by the suppliers.

very good value but is not quite in the same class as PSpice and ECA-2, which provide DC and time-domain analyses using non-linear modelling. Table 1 compares the main facilities available from PSpice and ECA-2, both of which run on IBM-compatibles. PSpice is 75% more expensive than ECA-2 but has the advantage of being an industry standard. It also comes with a library containing several thousand common devices, whereas ECA-2 does not yet have a library.

ECA-2 is a relative newcomer (1985) and therefore, in a sense, has to prove itself; but it has made a good start by running faster and being more interactive. Apart from PSpice's extensive component library, there is not a great deal of difference between the two packages, and your choice will depend on cost and personal preference. That preference is likely to depend on previous computer awareness more than on previous electronics experience. PSpice is more expensive and gobbles up a lot more memory than ECA-2, but the result is a more user-friendly package on all levels.

Fortunately, both suppliers can provide evaluation/demonstration versions of these packages at very modest cost,

The various types of analysis can be used in an almost infinite number of combinations.

and my advice is to obtain both and make your own mind up before committing yourself. You will also find the telephone support from the UK suppliers to be excellent.

Hardware requirements

ECA-2's hardware requirement is quite modest: the suppliers recommend a minimum of a single-drive PC with 256 kilobytes of ram. All types of display are supported but a graphics display is recommended. Similarly, most modest Epson-type dot-matrix printers will provide adequate graphical hard-copy.

If you have an enhanced colour display such as the IBM-EGA, or use a laser printer, then you will need an extra program called Print-ID which is utterly hideous to set up. Speed of operation is increased by two to four times if a maths co-processor chip of the 8087/80287/80387 type is fitted, but since the prices for those devices range from £84 to £641 many users may be content with the slower speed.

PSpice arrived on three quad-density disks, which meant I had to use an AT machine to make working copies on to eight DD disks before installing the program on my Amstrad PC 1640's hard disk. Minimum hardware requirements for PSpice are 512Kbyte of ram, a hard disk and a maths coprocessor chip. Again, most display and printer types are supported and the user can configure the software to recognize these by editing two refreshingly English-looking files. PSpice is supplied with a dongle - a special plug which fits into the serial port of the computer - and without it the program will not run. This

is to prevent the use of pirate copies of the software.

The documentation supplied with both packages, in the standard IBM-type jacketed ring binders, was good. Having been around longer, the PSpice manual has a more user-friendly feel and a rather more helpful and logical layout.

Simulation process

The basic sequence of steps for simulating a circuit is shown in Fig. 1. The first stage is to provide the simulator with a description of the circuit to be analysed. With both ECA-2 and PSpice this can be done from within the program by typing in the netlist²; or by importing the netlist from a schematic capture package like Votrax for ECA-2 and OrCAD/SDT for PSpice; or by writing the description file using any simple text editor. Which entry level you choose will depend on your previous experience of package-driving, but I find that creating an input file on a simple text editor to be the most satisfying. Also included in the input file must be the parameters for the required analyses, and some information specifying the required output format. Figure 2 shows a simple audio amplifier circuit with its complete input file in PSpice format. Lines starting with an asterisk are optional comments.

One of the fundamental differences between PSpice and ECA-2 emerges at this point. PSpice runs in a kind of

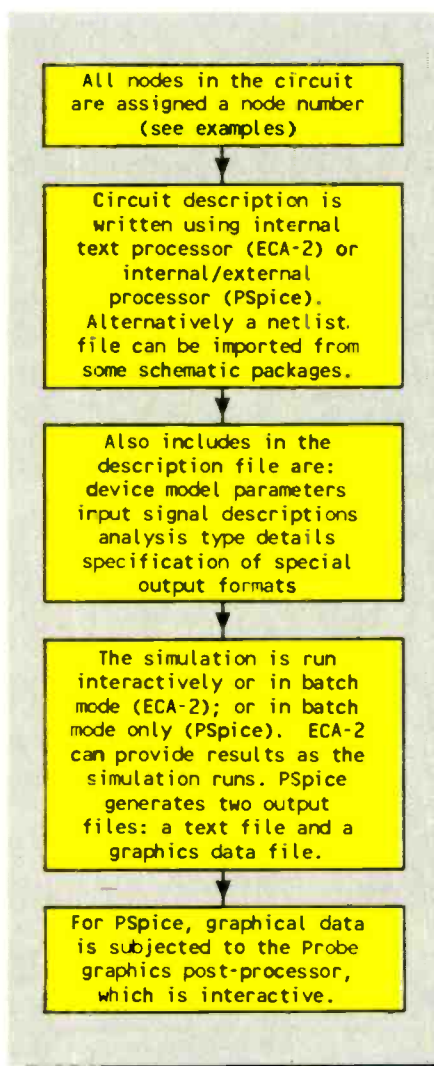

Fig. 1. General sequence of steps for circuit simulation.

Fig. 2. Simple amplifier circuit showing node numbers and (below) its associated PSpice description file containing analysis parameters for a frequency response measurement. The resulting frequency response curve is Fig. 3.

“batch mode” whereby the input file is analysed completely. If the circuit description or analysis parameters need to be adjusted, the input file must be re-edited and the simulation run all over again. With ECA-2, the operation can be in batch mode or more interactively: that is the simulation can be interrupted, a parameter “tweaked” and the simulation continued. This saves time in the early stages of product development. However, most engineers would want to run the entire simulation again after any tweaking.

A successful simulation run produces two types of output: textual and graphical. The text files can be simply read from the screen or sent to a printer in the usual way. The graphical outputs from the two programs are handled rather differently. With PSpice a data file called PROBE.DAT is created by the simulation and this is then subjected to the Probe graphics post-processor program supplied. High-resolution colour graphics then appear in a fully interactive menu-driven environment and data can then be mathematically manipulated into the required form. For example, simple ratios of voltages can be displayed on the graphs, or can be converted into logarithmic (dB) scales. Figure 3 shows a screen-dump of the resulting frequency response requested in Fig. 2, having logarithmic scales for frequency and for voltage gain.

ECA-2 gives a similar graphical output, with slightly less on-screen information, but has the advantage of presenting the graphs as the simulation progresses, rather than waiting for the complete range of analyses to be completed. Thus the simulation itself can become interactive. This is particularly useful during the early stages of product development when the basic circuit is being “computer-breadboarded”.

²A netlist is a textual list of components and their interconnections. Netlists can be generated manually or extracted from many cad packages which use schematic capture (screen-drawing). Netlist formats vary between manufacturers and the examples shown in the text can be compared with those in “Designing with cad” in the July issue of this magazine.

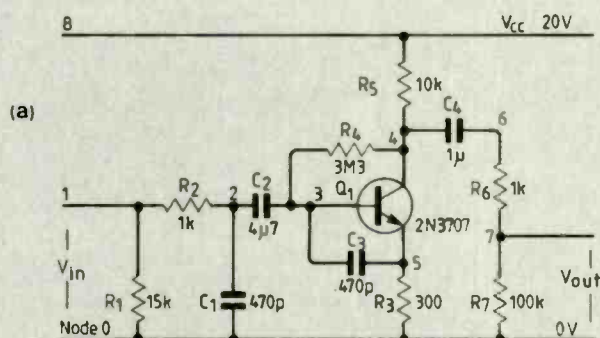

```

Simple amplifier frequency response
*
*Circuit description:
R1      1      0      15k
R2      1      2      1k
R3      5      0      300
R4      3      4      3.3Meg
R5      8      4      10k
R6      6      7      1k
R7      7      0      100k
C1      2      0      470pF
C2      2      3      4.7uF
C3      3      5      470pF
C4      4      6      1uF
Q1      4      3      5      Q2N3707
.LIB    Bipolar.lib
*
*Input descriptions:
Vcc     8      0      20V
Vin     1      0      AC      1 V
.AC     Dec    10      1Hz    1MegHz
*
*Generate data for PROBE graphics:
.PROBE
.END
  
```

Types of analysis

Table 1 lists the principal types of analysis available from these packages. However, remember that these analyses can be run together in an almost infinite number of permutations and combinations. For the newcomer, the following outline of these analyses might be useful:

DC analysis calculates the static voltages and currents at all points in the circuit. Capacitors are treated as open-circuits and inductors as short circuits (unless any resistive parameters have been specified in their models). The result of a DC analysis is a textual list of all nodes with their corresponding direct voltages. Currents through all components are available too.

DC sensitivity analysis calculates the effect on the DC analysis of variations in the parameters of any specified component or components.

AC analysis is the name given to frequency-domain measurements, resulting in Bode diagrams. It is a small-signal analysis, which means that the actual input voltage specified is immaterial and may conveniently be set to unity so that the output voltage is numerically the same as the gain of the circuit.

AC sensitivity reveals the percentage change in a specified AC parameter in response to a percentage change in a component value.

Transient analysis might better be called time-domain analysis since the outputs generated are more like an oscilloscope display. The actual values of input voltage are used in the calculations so that the effects of clipping and other non-linearities can be evaluated.

Fourier analysis can be requested at any point in the circuit, and the computer output lists the harmonic content of the output waveform. PSpice can display this graphically as a spectrum and it also calculates the percentage total harmonic distortion due to harmonics up to the tenth – this is the harmonic analysis referred to in Table 1.

Noise analysis is provided by PSpice, though not by ECA-2. This is a summation of all the noise generated by the components of the circuit.

Temperature sweeps can be performed on the circuit in much the same way an oven might be used on actual prototypes. Each component should therefore be assigned a temperature coefficient during the circuit description phase. Some manufacturers are able to supply ready-made PSpice models for their components.

If the circuit components are assigned a tolerance range, this information can

be used for evaluating "worst-case" conditions, i.e. when all the component tolerances conspire in a direction which causes out-of-spec operation. Coupled to this is the **Monte Carlo analysis** which randomly assigns actual values to com-

ponents within their specified tolerance ranges, and can thus produce the family of responses shown in Fig. 4.

It is worth repeating that these are only some of the more commonly used features of these programs, and that the

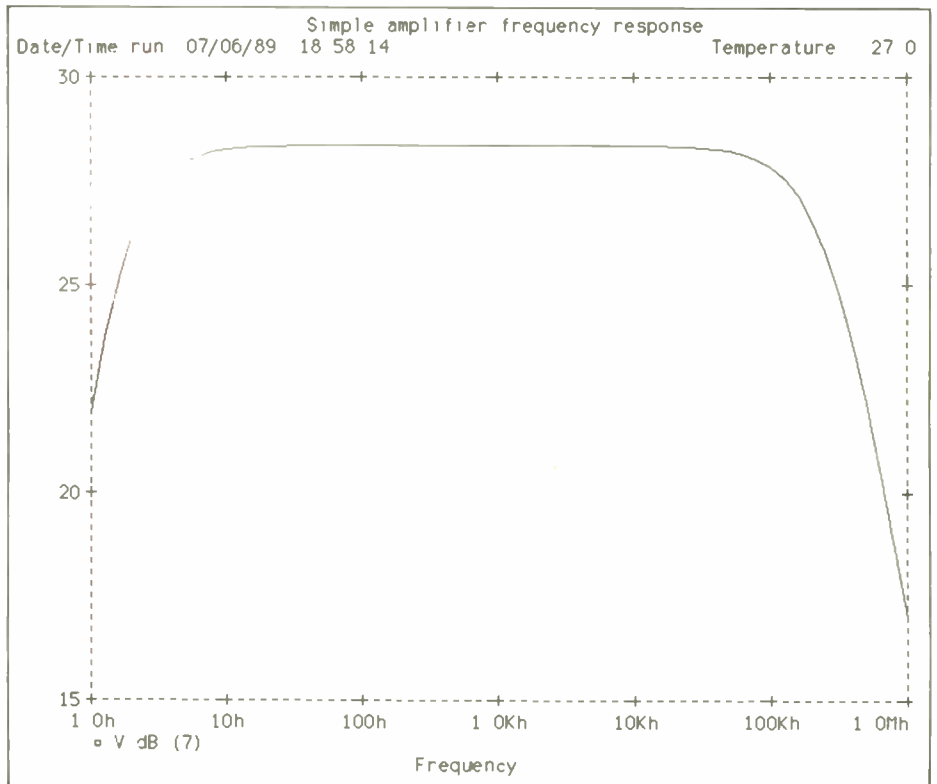

Fig. 3. Frequency response curve for the circuit of Fig. 2 (PSpice).

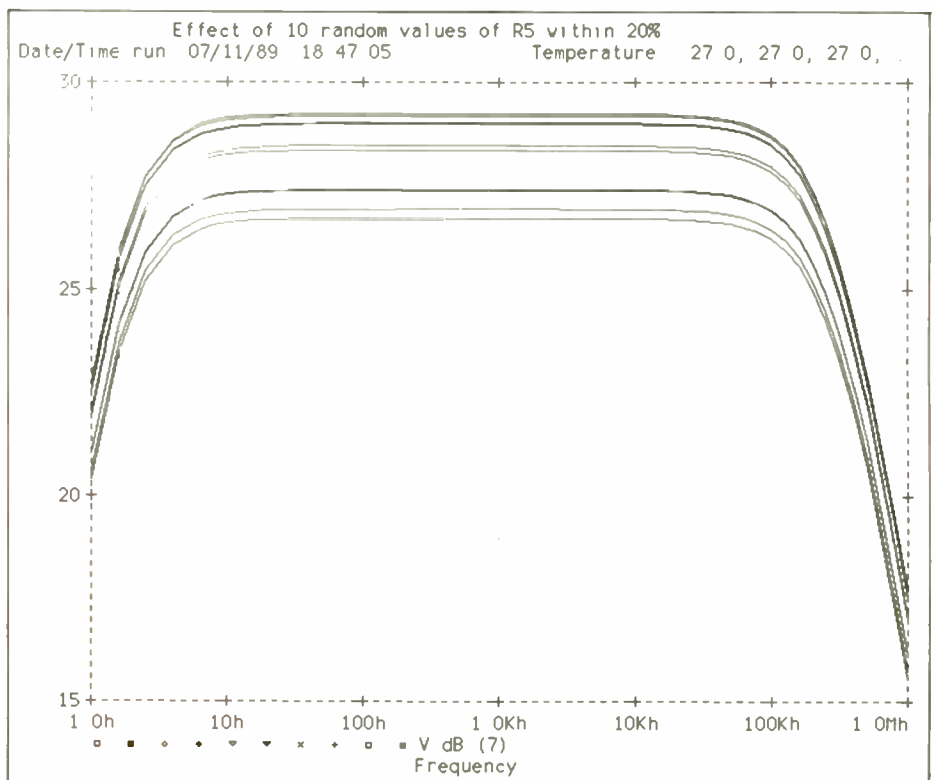

Fig. 4. Effect of 10 random values of R_5 within a 20% tolerance, obtained from Monte Carlo analysis (PSpice).

various analyses can be used in an almost infinite number of combinations. The simple examples shown here cannot begin to reflect the true potential of either PSpice or ECA-2 when used with larger circuits, and potential converts to computerized circuit simulation should obtain the demonstration/evaluation programs, which contain worked examples. ■

Sources

PSpice is available from ARS Microsystems Ltd, Doman Road, Camberley, Surrey GU15 3DF; tel. (0276) 685005. The price is about £1,195 with various optional extras. An educational users' discount may be available. A cheaper evaluation version is available, with an excellent introductory textbook.

ECA-2 is available from Those Engineers Ltd, 106a Fortune Green Road, London NW6 1DS; tel. 01-435 3757. The price is about £675 with various optional extras. An educational-users' discount may be available. A demonstration version is also available as are other Spice-type packages with GEM graphics front-ends.

● Since John Martin completed his review of ECA-2, version 2.40 has been introduced by Those Engineers Ltd, who tell us that it adds the following enhancements: (1) up to four variables can be plotted with independently – scaled parameters; (2) graphs may be titled independently of circuit title; (3) batch files may now be chained and/or nested; (4) a thyristor model is added.

Analysr II is available from Number One Systems Ltd, Harding Way, St Ives, Huntingdon, Cambridgeshire, PE17 4WR; tel. (0480) 61778. The price is about £195 for the PC version and £130 for the BBC Micro version.

John Martin B.Sc., C. Eng., M.I.E.E. is a senior lecturer at the Anglia Higher Education College, Cambridge.

Fig. 6. PSpice screen showing essentially the same response as Fig. 3. The red trace is the response at node 4 while the green trace is the response at node 7, after the DC-blocking capacitor.

Fig. 7. Split-screen facility offered by PSpice. The lower trace shows the input-output characteristic of a simple TTL inverter circuit. The upper plot has the same X-axis (viz. input voltage) but shows the power consumption of the gate. The peak is caused by the gate attempting to operate in its linear region.

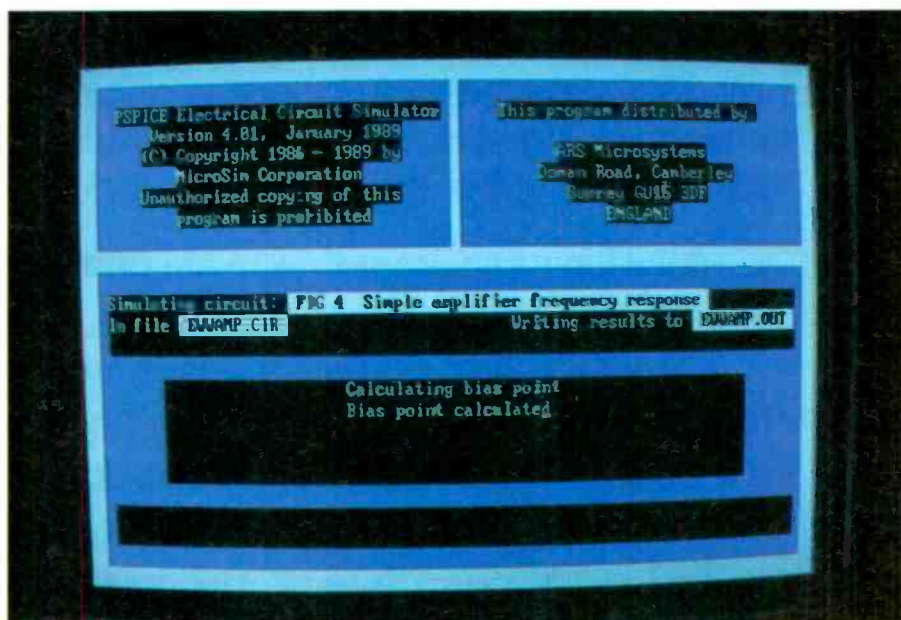
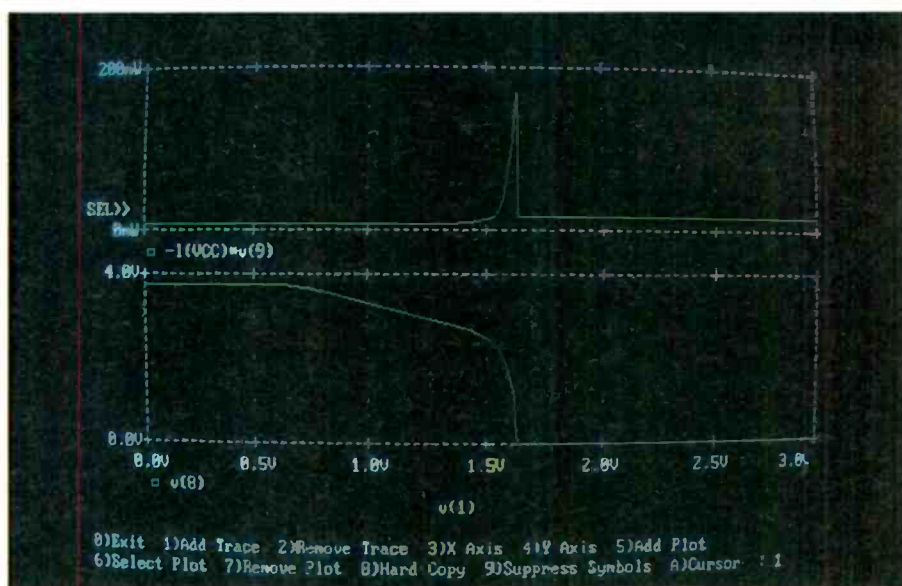
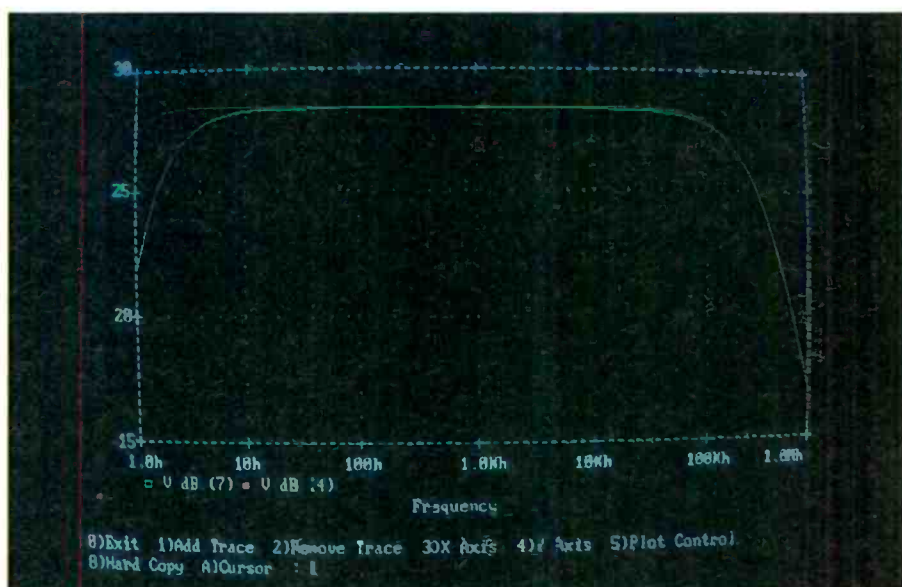

Fig. 5. PSpice's information screen provides status reports throughout the simulation.



COST-EFFECTIVE MEASUREMENTS OF EMC COMPATIBILITY AND BROADCAST EMISSIONS

The Farnell 352C Spectrum Analyser is a low cost, portable and easy to use instrument designed for monitoring spurious EMI radiations in the range 300kHz to 1000MHz. Its features include:

- Built-in radio receiver with AM and FM demodulation
- Picture store. Hard copy evidence of offending emissions with optional printer
 - Field strength measurement option
- Portable. Line or vehicle DC operation. Rechargeable battery option
 - Cursor measurements on screen of level and frequency
 - Control settings memory
 - Wide range of optional accessories

PRE-CHECK YOUR EQUIPMENT BEFORE YOU SUBMIT IT FOR APPROVAL REGARDING EMISSION LEVELS

Six page colour brochure available on request to:

 **Farnell International**

FARNELL INTERNATIONAL
JUBILEE HOUSE, SANDBECK WAY, WETHERBY,
WEST YORKSHIRE, ENGLAND LS22 4DH
TEL. +44937 61961 FAX. +44 937 66487
TELEX 55478 FARINT G

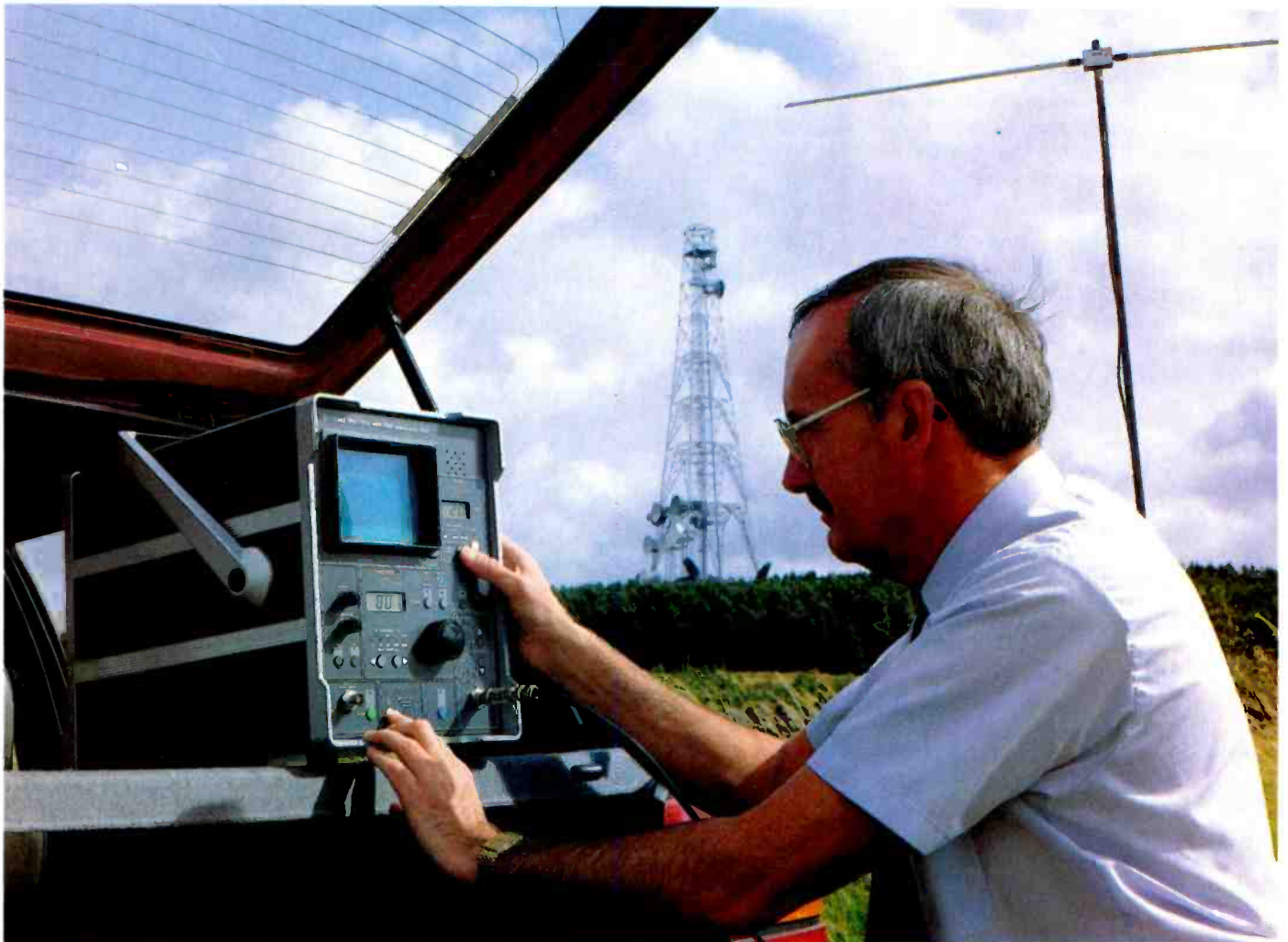

Whither the OTA?

I found the article on current-feedback op-amps (*E&WW*, August 1989) interesting for more than one reason. Apart from the improved performance these devices offer, I was reminded of the operational-transconductance amplifier (OTA), which was developed in the late 1970s. It was hailed as a breakthrough in analogue engineering but, curiously, nothing further was heard of it after a time.

I would be interested to know of its fate. Perhaps one of your readers could enlighten me.
B.D. Runagle
Burton on Trent
Staffordshire

Gyroscopes

As a relatively new regular reader of your magazine I have been impressed by the breadth and depth of coverage of topics. Therefore it is to be expected that aspects of mechanics will enter into articles and correspondence.

I was, however, surprised to read that some readers still believe that gyroscopic phenomena fall outside the jurisdiction of Newtonian mechanics. Whilst appreciating that any physical law is only an approximation and is only valid until proven incorrect, all observed gyroscopic phenomena are quite adequately explained by Newtonian mechanics.

The basic equation of motion for rigid body motion in three dimensions were established by L. Euler (1758) and gyroscopic motion in particular was discussed in some detail by E.J. Routh (1905). An excellent contemporary text is *Gyrostatics* by Arnold and Maunder (1961). In the seventies I published an article to help dispel some of the misconceptions that were being perpetrated at that time. Also at the same time other dynamicists and myself took part in a meeting with the same objective. I thought the matter now was just history, but apparently this is not so.

As a direct result of these 'close encounters' we constructed some simple experiments to show how rotating objects and oscillating bodies apparently 'levitate' when

using simple beam balances and spring balances. The gyroscopic 'levitation' demonstration is easily repeated but with a simple Newtonian explanation. I use these demonstrations to indicate that care is needed in making dynamic measurements and further that the senses can easily be confused when applied to three dimensional phenomena.

If anyone still believes that gyroscopes are non-Newtonian then I shall be pleased to arrange a short demonstration at The City University, London.

As an example of apparent anti-gravity effects in electronics consider the case of a charged particle moving in a plane normal to a uniform magnetic field. It is well known that the particle will move in a circular path. If now we take into account a gravitational field acting in the plane of motion, i.e. at right angles to the magnetic field, the path does not sink downwards but drifts sideways; apparently defying the law of gravity. The problem described is also readily solved by classical mechanics.

In all the above examples it is assumed that speeds do not approach that of light so that the theory of relativity does not need to be considered.

H.R. Harrison
Dept. of Mechanical
Engineering & Aeronautics
The City University
London EC1

Anti-gravity

Philip Lonsdale's letter in the July *E & W* describing the "Dean Drive" was most interesting. Presumably it consisted of two dumb-bell weights shuttled across a rotating shaft at twice the rotational frequency; or two contra-rotating devices, more likely. A less developed type of Dean Drive seems to be known to many 1½ to 3 year old toddlers as they persuade tricycles and trolleys to move, albeit slowly, in one direction on level surfaces by undulating their bodies and not using their feet at all. Anyone who has laid a concrete floor with a vibrating screed will also know that there is a definite preferred direction of travel for these devices.

I have always assumed that the horizontal force resulted from asymmetrical frictional forces

but perhaps someone more expert in the conversion of angular momentum into linear momentum could give me the real reason. Did I hear someone shout "conservation laws!"?

M. Hamer
Ullingswick
Hereford

Anti-gravity and cold fusion

H. Aspden's July letter is too contentious to be allowed to pass unchallenged. In support of his claim that several of the accepted conservation laws of physics might be invalid, he cited passages from the 1966 edition of a book by H.S.W. Massey. They have all the earmarks of having been written a decade or two earlier, since by that date quantitative experimental evidence was available confirming Pauli's hypothesis that the apparent breakdown of energy, momentum, and angular momentum conservation in beta decay arises through ignorance of the fact that, in such decays, a third particle is emitted. This unobserved third particle was subsequently called a neutrino.

Articles reviewing a wide range of such experiments, along with a presentation of modern beta decay theory which provides a detailed systematic coherent account of them, can be found in the Siegbahn's 'Alpha-, Beta-, and Gamma-Ray Spectroscopy'. Other articles deal with parity violation in beta decay (discovered in the late 1950s), and review the appropriate experiments. The most dramatic consequence of parity violation is that electrons emitted in beta-decay show strong longitudinal polarization, even when the emitting nuclei are oriented at random. I was myself involved in one of the earliest experiments to demonstrate this polarization, specifically in electrons emitted by Au^{198} . Previously no-one suspected its existence, so that it played havoc with the first attempts (in the 1930s) to check Mott's Dirac theory calculations of fast electron double-scattering experimentally. Successful neutrino detectors have now been in operation for many years, but because neutrinos can pass right through the earth with only a mild loss of intensity the

detectors are both bulky and wildly inefficient.

Dr Aspden admits that a gyro supported at one end of its shaft and precessing *freely* exerts a downwards thrust on the support just equal to its weight, any other forces being very small. This proposition Professor Laithwaite would at one time have strongly contested. Now if, as Aspden claims, the downward thrust can be made much smaller by encouraging the gyro to precess at slightly *more* than the free rate (- a heavy flywheel... lifted by Professor Eric Laithwaite's 'little finger'), then the thrust should be made much greater if the gyro is inadvertently encouraged to precess at slightly *less* than the free rate, i.e. handling it would be quite tricky. My recollection of seeing Professor Laithwaite and two volunteers (a man and a woman) handling a heavy gyro in turn is that each used the palm of one hand to support the end of the shaft, and that the volunteers were told not to try to influence the motion of the gyroscope, but simply to swing round so as to follow the free precession, i.e. that no such critical control was required.

I am now of the opinion that the progressive upward tilting of the gyro shaft sometimes observed in such experiments is associated with the frictional torque exerted by the spinning gyro on its shaft. Anyone holding the shaft and turning with the precession of the gyro has to oppose this torque to prevent the shaft from twisting in his or her hand, and in so doing sets up a torque about the vertical axis through the centre of the gyro. This causes the gyro to precess in a vertical plane, leading to the upward tilting mentioned above.

I found Dr Aspden's January description of 'The force-precessed gyroscope' unconvincing. In a diagram (a) (page 30) the mechanical system exerting a torque T on the bearing assembly S exerts no thrust on the vertical shaft the two gyros should tilt, but in such a way that the centre of gravity of the bearing, sleeve, and gyro pair does not move. In fact, he implies that it moves upwards, which suggest to me that the torque generating system *did* exert a thrust on the vertical shaft. If I'm wrong, that in itself proves his case, if not his

interpretation of the behaviour of the full system is invalidated.

C.F. Coleman
Grove
Oxfordshire

References.

1. Alpha-, Beta-, and Gamma-Ray Spectroscopy, ed. K Siegbahn, North Holland, Amsterdam, 1965.
2. Cavanagh, P.E. Turner J.F. Coleman, C.F. Gard, G.A. and Ridley, B.W. *Phil. Mag* 21 (1957) 1105.

Pseudo science

The article Science v. subjectivism in audio engineering (July 1988) by D.R.G. Self was excellent. It could also be applied to FM tuners, at least in the USA and I suspect Great Britain as well. Mr Self did an outstanding job in disputing the claims of "electrolytic capacitor sound" or the effect of 100 dollar per foot cables, and the argument is equally applicable to FM tuners which have only a 17kHz audio response at best because of the requirement to filter out the 19 kHz FM stereo pilot. The claim that an NE5534 operational amplifier modifies the sound of the low-pass filter is ridiculous. In one tuner, the manufacturer provides a low-level audio output before the NE5534 for those who want purer sound; the real result is that the capacitance of the cable connecting the tuner to the audio amplifier messes up the resistive termination of the low-pass filter and causes a peak at 16 kHz. This, of course, sounds a little brighter.

The other situation which continually causes problems is the desire for more selectivity. No non-technical person and very few engineers understand that filter selectivity and distortion produced on FM signals are related. Furthermore, the IEEE/IHF specifications on FM tuner measurements allow for "slight retuning" of a tuner when measuring THD. Digital synthesized tuners cannot usually be slightly tuned, but the generator can, so this is usually done. Unfortunately, the user is not able to ask the station to slightly alter its frequency. There are some very expensive tuners on the market today with a narrow bandwidth selection for those difficult reception

conditions, and the filter is often not exactly centred on the correct frequency. The result is that they often have 2% or more distortion on the narrow position, but the magazine reviewer will never say that he had to offset his generator to get the less than 1% claimed.

I will continue to apply the best engineering practice to my designs, and if the manufacturer want to add five dollars worth of polypropylene coupling capacitors to the audio output of his tuner, and the purchaser wishes to pay 50 dollars more for the satisfaction of knowing that no electrolytic capacitor is corrupting his sound, that is his business. An electrolytic capacitor still couples the FM detector output to the stereo decoder, however.

Jon GrosJean
Connecticut
USA

Alpha-torque forces

After reading the recent article (*E&W* June 1989 p.556) my first comment is that I do not understand the statement that "Electron beams in a vacuum do not obey Ampère's force law" since the designers of electron microscopes appear to have been successful in using magnetic focussing of electron beams. Perhaps the word 'solely' is omitted.

Then Fig. 1 of the article illustrates the danger of trying to reduce a three-dimensional problem to two dimensions: inspection of the diagram reveals immediately that as drawn $2\alpha + \epsilon = 180^\circ$ so that the last term in equations (1) and (2) is simply the number $+1.5$ ($\cos 180^\circ = -1$) and $\sin(2\alpha + \epsilon)$ in equation (3) is zero. This is true whatever the relative positions and directions of the current elements in the plant.

Ampère said that a three-dimensional magnetic force problem could be reduced to two dimensions, but how do we know that the hypothetical alpha-torque force obeys the same laws as the magnetic force due to currents? In any case, three dimensions can be handled as easily as two with vector algebra (which was not known to Ampère). If the alpha-torque force is "ponderomotive", does this imply that it is akin to gravity

and not electromagnetic? How else could it distinguish between the negatively charged conduction electrons and the equal positive charge on the atoms in an uncharged conductor? Remember William of Occam's razor* and try harder to explain odd phenomena in terms of the laws which have served us so well since the days of Ampère and Coulomb. (I have retired, so I am not going to do all the work, but hints for the mercury fountain are hydrostatic pressure due to the 'pinch effect' and the question of convection current as well as conduction.)

*Occam's razor was a rule that hypotheses are not to be multiplied unnecessarily.

D.A. Bell
Beverley
North Humberside

Doubt and faith

It is an old problem with the scientific method that the validity of all scientific laws is dependent on them being open to theoretical and empirical refutation. This status should not change with the passing of time. After all, Newton's laws had been established for 200 years before Einstein came along! At the same time, it is helpful for the pragmatic scientist to be able to have faith in certain "fundamental" laws of science. It is inevitable that the scientific community is sceptical whenever someone claims to have found violations to them.

Both doubt and faith in well established principles are healthy attitudes for science to adopt. But they are in conflict with each other and a proper balance must be struck. It is my belief that in recent years the emphasis has been too much in the direction of faith.

The trouble is this: it is almost impossible for a single mind to simultaneously have doubt and faith in anything. Consequently when a discussion about the absolute truth of a law arises, it tends to be between two factions of scientists (usually in the pages of a journal with the subscribers as onlookers). Scientists being only human, this debate can degenerate into personal attacks. Even if it doesn't, there are those who believe that this sort of discussion can only be

damaging for the image of science (which the general public has come to regard as the fount of all indisputable knowledge). They would rather there was never any public dissent. I maintain that these people are wrong. As in politics, dissent is a sign of a healthy system. It is only damaging to a false image of science. Although many scientific doubts can be resolved in private by appropriate research, there will always be some which can only be resolved by discussion amongst a wider audience.

But who are these dissenters? Why do they always sound so paranoid? Why have so many original ideas originated from outside the universities? My own experience when I started to doubt the universal validity of the second law of thermodynamics have given me an insight into these questions.

I thought (and still do think) I could see a flaw in the reasoning behind this law. Furthermore I thought I could see a way that the law might be circumvented to build what is known as a *perpetuum mobile* of the second kind. At first, I thought that it was likely I might be wrong and that some friendly colleague or consultant might point out the error. This did not happen. The next step was research in public and university libraries. This showed me some mistakes I had made that the people I consulted could have shown me but nothing that destroyed the idea. In fact this research enabled me to refine my theories and encouraged me to think that I might be on to something.

Writing to academics who had been recommended to be as knowledgeable in the field was unsuccessful. Usually I received no reply at all (although one lecturer wrote back and told me he was not interested in discussing ideas which defined "Common Sense"). Trying to get my ideas published also failed (even in *Wireless World*). Could it have been the style rather than the content? I never knew because I always received my manuscript back without comment. The only practical experiments I have been able to afford have proved to be encouraging but equivocal. Even the avenue of patenting my

device is denied to me because I am advised that the law forbids it. There seems no avenue left open to me to find the truth of the matter. I am sure that these experiences are not unique to me.

The next time you read an article in these pages by someone challenging a scientific orthodoxy, remember these things. He has probably had to refute many spurious objections from people who ought to know better. He has probably been ignored by many academics to whom the fear of ridicule damaging their career prospects is far greater than their lust for knowledge. He may even have been laughed at by people who have not the wit to understand one tenth of what he is trying to say.

If anyone is interested in discussing my revised theory of the second law and its applications, I would be happy to hear from them.

R. Lerwill
Castle Mills
Chirk, Clwyd

No integers for $a^n + b^n = c^n$

My previous notes, neatly and faithfully reproduced in the January issue, assume that it would be absurd to expect a solution simply by replacing the common exponent 2 in Pythagorean equations with a greater integer. This after all is merely an opinion and no matter how many might share it, hardly a proof.

Regarding any applicable set of integers, or P triple as some would call it, c is one of the odd numbers and a is usually the even one. Let this be the case at present.

If $c^2 - b^2 = a^2$ then a^2 would, like $c^2 - b^2$, be divisible by $c - b$. So also would a^n because this is a multiple of a^2 . Then $a^n/(c - b) = a^{n-2}(c + b)$ which is the product of two even numbers.

However, when n is odd, the other side, now $(c^n - b^n)/(c - b)$, equals the sum of an odd number of odd numbers.

In a different way it can also be shown that when n is even, the supposition is again unquestionably absurd. Fellow-readers might like to amuse themselves with this one while I

tidy up the explanation. Of course, if this were anything more than a diversion, scientists would have long since sorted it out.

Incidentally, a more revealing way of expressing the division of $x^n - y^n$ by $x - y$ is by saying that it equals the sum of n terms, the first and greatest of which is x^{n-1} with each succeeding term y/x times its antecedent. This changes the order used in the January examples which seemed easier to memorise.

Name and address supplied

Feedback and fets

Having just read Ivor Brown's letter in the July 1989 issue, I feel that the matter of slew-limiting needs a little more ventilation. I quite agree that in the amplifier system he describes, the slew-rate of the early stages has a marked effect on the distortion produced. However, to bring this about, he has had to assume a dead-band effect in the output stage; in other words, for small signals there is no output at all, as in a Class-B stage with zero quiescent current. Since much of the design work done on amplifiers in the last thirty years has been aimed at eliminating such gross crossover discontinuities, I must admit that I am inclined to view the demonstration as tending towards the not very useful.

The sharp spikes seen on the distortion residual of every under-biased Class-B amplifier are a demonstration of this effect. Improving the slew-rate of the early stages will make these spikes more narrow, but will not reduce their amplitude, and this would be considered a faulty or maladjusted amplifier rather than one under-designed for slewing. Increasing the quiescent current reduces the height of the spikes until they merge into the main body of the distortion products, and in fact this is the only reliable way of setting quiescent current. With it correctly set, a well-designed output stage will have only very small slope changes around the crossover point, and the early stages are not called upon to make particularly rapid adjustments to servo-out these errors. Clearly, with poor design slew-rate could be a problem, but then so could almost

everything.

To turn to the bipolar hybrid output stage, the driver transistors do indeed operate in Class AB, but I doubt if these relatively fast T05 devices have a bad effect on the crossover behaviour: all that can be said is that the stage as a whole is remarkably linear without any overall feedback. My own view is that the poor matching of the not-so-very-complementary MOSFETs around the crossover region is probably the cause of what crossover perturbations can be seen. I have tried Class-A drivers with AB bipolar output devices, and there seemed to be no benefit to be had.

Finally, it might be valuable if all of us provided more measurements in articles and letters, as otherwise comparison and reasoned discussion are very difficult. In particular, designs are often labelled "low feedback" or "lashings of feedback" without specifying how much. While measuring open-loop gain is not always easy, the results should be highly informative, and perhaps Mr Brown will reveal the results for his design in his forthcoming article.

Douglas Self
Forest Gate
London, E15

Motion through the ether

The May issue of *E&W* carried an article over my name.

With reluctance I must report three errors which are of importance if the content of the paper is to be correct. I have no idea how these came about and I apologize, but thought your journal should at least be made aware.

The equations for wavelengths published as

$$\lambda_1 = \lambda \left(1 + \frac{v}{c} \right),$$

$$\lambda_2 = \lambda \left(1 - \frac{v}{c} \right)$$

should be

$$\lambda_1 = \lambda / \left(1 + \frac{v}{c} \right),$$

$$\lambda_2 = \lambda / \left(1 - \frac{v}{c} \right).$$

And the equation for the Michelson-Morley experiment should have a + rather than a - on the left side.

E. W. Silvertooth
Olga
Washington
USA

Help!

I am currently working as part of the British Volunteer Programme in the electronics department of the National University of Engineering, Nicaragua. We are perhaps amongst your more far flung subscribers: we receive *EWW* via our sister university in Holland, the Technical University of Delft, which has an extensive programme of co-operation and aid with us.

EWW is in fact the only journal we receive because none of the free circulation journals seems willing to mail to a third-world country. Likewise, it is difficult to obtain data books: I have only two dog-eared Intel books from 1980 and 1981.

I wonder if any of your readers would be interested in helping out by sending us surplus copies of journals or data books that they are replacing. We would be interested in the whole range of specialist subjects, e.g. telephony, radio, microwave, electrical, power, Airmail is not that expensive and takes about three weeks.

We would also be very interested in designs for electrical or electronic products which could form student projects, and ideally which could be adapted for small scale manufacture here.

The address to send to is:
El Director
Escuela Eléctrica/Electrónica
Universidad Nacional de
Ingeniería
MANAGUA Apartado 5595
NICARAGUA
Donald Power
Escuela de Ingeniería Eléctrica/
Electrónica
Managua
Nicaragua

Continued from page 982

to receive or make a call the Pole Job transmits the speech and dialled number information. When the target telephone is not in use and, allowing that the innocent pair are also not in use, the Pole Job will recharge its NiCd battery from the current on the innocent pair.

Since it is not possible for this or any other device to take more than 2 to 3mA from a telephone line without pulling the line down to fault, it is sometimes necessary to take the charge current from a number of different lines.

The Pole Job transmitter, seldom of more than 10mW, will transmit to a receiver fitted with a carrier switch and a stop/start recorder; again the installation is left unattended. However, as the receiver can be a few hundred yards away from the telephone pole fitted with the transmitter, the chances of discovery are greatly reduced.

Another serious professional ploy is to use a parasitic parallel transmitter, operating from the telephone line current but only putting out about 1mW, or less. The range is very short, but this does not matter. A repeater is employed to receive the signal and then transmit it at high power, on a different frequency, for long range reception.

In the USA current favourite device is known as the "Brady Bug". This is not strictly a telephone tapping unit but a room-audio gatherer which uses the telephone line to get its collected information out to the "listeners". With a "Brady" fitted and one of the other taps in place then the listeners get both room speech and telephone speech. The "Brady" is a small microphone and audio circuit which fits into a wall telephone socket. It puts room sounds (therefore room speech) on to the telephone line in a way which is inaudible to the human ear. It never switches off, but it is never heard by normal users of the telephone line; only the "listeners" know how to recover the 60kHz signals.

A device of considerable enterprise is Promon, which is a complete telephone exchange in the target premises, using the telephone line to transmit room audio. It covers up to six rooms, with two microphones, hard-wired to Promon, in each. It usually fits under the floor or in the roof space where mains power and the telephone line are accessible; electrically, it is interposed between the telephone and the line, and contains a remotely controlled tape recorder.

The master controller at headquarters causes the target's number to be dialled, whereupon the ringing tone is

detected by Promon, but not by the handset unless the number of rings exceeds three – more than three causes the target telephone to ring. Promon seizes the line and listens for a handshake signal from headquarters, which activates Promon to carry out instructions such as recording from specified microphones, recording telephone calls from specified numbers, synthesizing out-of-order or engaged signals or running the recording. If the handset is lifted during these operations, Promon sends a dialling tone to the handset and shuts down the master controller.

The world of surveillance became crowded with crooks, charlatans, idiots and dangerous opportunists

Remote control

So much equipment exists for the remote control of electronic devices that often only a simple modification is needed. For example, the infra-red controls for television receivers or video recorders are perfectly usable, as are model radio control systems.

The simplest requirement is an on/off control, which a single tone will activate, to switch off a bugging transmitter when the operator is aware that a detection team has arrived or when it is clear that nothing is going to happen for some time.

It should be mentioned here that switching a device off is no guarantee that it will not be found. A device called a non-linear junction detector emits a 600MHz signal at high power and looks for harmonics of the signal to return. If the 600MHz encounters a semiconductor junction, the presence of harmonics indicates the fact. It is true that junctions other than the semiconductor variety have roughly the same effect, but there is an observable difference. The

device finds application in more straightforward guise in large stores; the stolen goods detector at the door recognizes the presence of a diode in the tag fixed to the goods.

I do not propose to go into other applications of remote control techniques because they include those used to detonate bombs.

Tracking

In this particular area, Hollywood has it right. The device hurriedly placed under a car and giving away the car's position to a mob of heavies in a following car is fact, not fiction. The device is larger than the ones usually seen on film because of the need for batteries, but essentially it is portrayed correctly.

Transmitters of this type put out a train of pulses which are picked up by the following tracking receiver, which has four aerials on its roof. A computer uses the four inputs to determine direction and displays the result graphically; the Plessey PRS3640 is such a device. I have repeatedly tracked and located vehicles at ranges up to five miles with the PRS3640.

More secure and less obtrusive systems now exist, but the Plessey device is still one of the best, providing distance information as well as direction; without this, it is easy for a quarry to give a pursuer the slip.

Battery life is not quite the problem it is with other miniature transmitters, since the pulsed nature of the transmission conserves power.

Them and us

The gulf between field operatives and people in technical support leads quite predictably to some fairly serious clashes of interest. The operative, who has just seen the latest Bond film, wants a device fitted inside his dress ring which will transmit colour television and sound from Istanbul to London, last for six years in continuous operation and simultaneously receive totally secret coded messages from his controller on holiday in Cuba.

On discovering he is to be issued with a device the size of a large book which will transmit for a maximum of 36 hours with a range of 600 yards, the operative immediately goes into spasm and calls on his stock of expletives. I once heard myself described, over a period of several minutes, in very imaginative language indeed; the tirade ended with "... and those are his good points"! ■

UNBEATABLE PRICES



GREAT OFFERS ON TRIED AND TESTED USED EQUIPMENT

DATA COMMUNICATIONS

Atlantic Research 4600 Protocol Analyser, 19.2kbps, X.25	£ 2,500
Hewlett Packard 4951A Protocol Analyser	£ 1,750
Hewlett Packard 4953A Protocol Analyser	£ 6,000
Hewlett Packard 4955A Protocol Analyser	£ 8,000
Marconi 2871 Data Communications Analyser	£ 3,950

TELECOMMUNICATIONS

Hewlett Packard 8970A Noise Figure Meter, 26.5GHz	£ 3,950
Marconi 2955 Radio Communications Test Set	£ 4,500
Marconi 2958 Cellular Radio Test Set, TACS	£ 6,000
Wandel & Goltermann PF-1 PCM Bit Error Rate Tester	£ 2,000

SPECTRUM ANALYSERS

Advantest TR4131, 10kHz-3.5GHz, 70dB dynamic range	£ 5,650
Hewlett Packard 3582A, 0.02Hz-25.5kHz, dual channel	£ 4,750
Hewlett Packard 8568A, 100Hz-1.5GHz, HPIB	£13,000
Marconi 2370, 30Hz-110MHz	£ 3,750
Marconi 2383, 100Hz-4.2GHz	£25,000

NETWORK/SCALAR ANALYSERS

Marconi 6500-001 Amplitude Analyser	£ 1,950
-------------------------------------	---------

GENERATORS

Adret 742A Signal Generator, 100kHz-2.4GHz	£ 7,500
Hewlett Packard 3325A Synthesiser, 21MHz, sweep, HPIB	£ 1,950
Hewlett Packard 8340A Sweeper, 10MHz-26.5GHz	£23,000
Marconi 2017 Signal Generator, 10kHz-1024MHz	£ 4,000
Marconi 2022 Signal Generator, 1GHz	£ 2,250
Wavetek 166 Pulse/Function Generator, 50MHz	£ 1,500
Wiltron 6663A Microwave Sweeper, 2-40GHz	£ 9,500

OSCILLOSCOPES

Philips PM3055 50MHz 'Smart Scope'	£ 650
Philips PM3320 DSO, 200MHz, 250MS/s per channel	£ 5,500
Tektronix 2245 100MHz dual channel scope	£ 995
Tektronix 2430 DSO, 150MHz, dual channel	£ 3,750
Tektronix 2445 150MHz, 4-trace scope	£ 1,650

METERS

Fluke 8050A 4 1/2 Digit Bench DMM	£ 175
Hewlett Packard 3406A RF Voltmeter, 10kHz-1.2GHz	£ 300
Marconi 2610 True RMS Voltmeter, 5Hz-25kHz	£ 650
Marconi 893B AF Power Meter, 20Hz-35kHz	£ 450
Solartron 7150 6 1/2 Digit Systems DMM	£ 525

COUNTERS

Marconi 2438 Counter, DC-520MHz	£ 400
Philips PM6654 Systems Counter, 1.5GHz	£ 1,850
Racal 9921 Counter, 10Hz-3GHz	£ 350

RECORDERS

Solartron 3530A Orion Alpha Data Logger	£ 2,000
Watanabe MC6623-6Z 6-channel Chart Recorder	£ 1,450
Yokogawa 3033-13 A3 Single-channel Recorder	£ 950

LOGIC ANALYSERS

Hewlett Packard 1630D 43-channel, 100KHz	£ 2,750
Hewlett Packard 1630G 65-channel, 100MHz	£ 3,700
Hewlett Packard 1650A 80-channel, 100MHz	£ 3,950
Tektronic 1240 72-channel, 100MHz Mainframe	£ 1,700

PROGRAMMERS

Stag PP39 Portable MOS Programmer	£ 300
Stag PPZ Universal Programming Mainframe	£ 1,850
Stag Zm2000 Universal PROM Module for PPZ	£ 995
Stag ZL30 Logic Programmer	£ 800

All prices advertised are exclusive of carriage and VAT.

All equipment sold subject to availability.

Warranty period 12 months on all equipment (except computers MDS - 3 months).

FOR FURTHER
INFORMATION
TELEPHONE



LONDON 0753 580000
MANCHESTER 061-973 6251
ABERDEEN 0224 899522

TELECOMMUNICATION TRAINING EQUIPMENT

Full range of Training Equipment including:

- ANALOGUE & DIGITAL COMMUNICATION CIRCUIT & SYSTEMS
- FIBRE OPTICS
- MICROWAVE
- TELEPHONY
- RADAR **NEW**

For more information contact:

LAB-VOLT (UK) LTD.

4A Harding Way,
St. Ives Industrial Estate
Huntingdon,
Cambridgeshire
PE17 4WR
Tel: (0480) 300695. Fax: 0480 61654

Lab-Volt®

CIRCLE NO. 12 ON REPLY CARD

20 MHz Function Generator

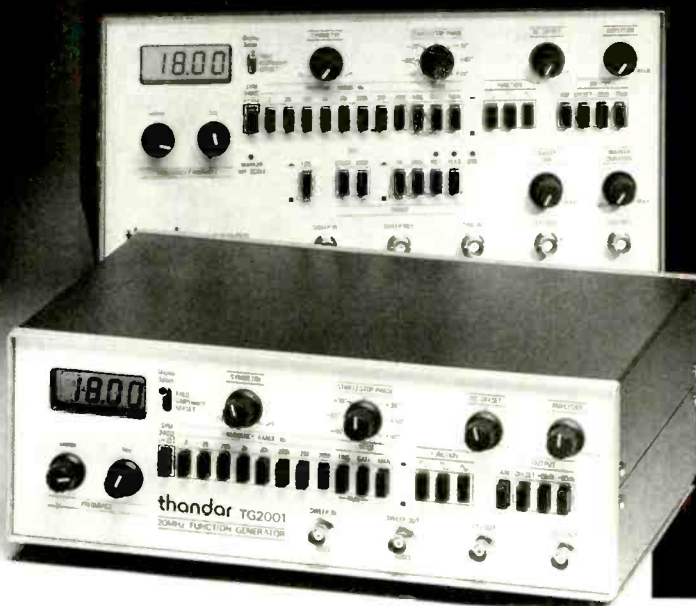

TG2001

- ★ Full-featured 20MHz function generator
- ★ Liquid crystal display of frequency, amplitude and offset
- ★ Variable start-stop phase and symmetry
- ★ AM input

PRICE: £595.00

TG2002

Sweep/function generator with all TG2001 features plus:

- ★ Precise setting of sweep limits
- ★ Variable sweep rate
- ★ Single sweep; sweep reset and hold

PRICE: £845.00

For further details of these and other products in the Thandar range please send for a catalogue.

 **thandar**
ELECTRONICS LIMITED

Thandar Electronics Limited, 2 Glebe Road, Huntingdon, Cambridgeshire, PE18 7DX. Telephone (0480) 412451 Fax (0480) 411463 Telex 32250 Test G

CIRCLE NO. 11 ON REPLY CARD

Switch-mode advantages without the switching

Nearly all power supply ICs are either switch mode or linear so you have the choice between efficient but noisy and quiet but inefficient. Cherry now manufactures a resonant-mode power supply IC – the CS3805 – that represents a compromise.

Rather than switch, a resonant-mode power supply oscillates: it regulates by shifting the oscillation frequency towards or away from the resonant point. Resonant-mode converters can be physically very small since they can operate at up to 1MHz, as opposed to the 50-100kHz limit for a normal PWM design.

This circuit is from the 3805 data sheet. There is little explanation of the circuit in the data sheet but there is a manual for the 3805 demonstration kit that describes components used.

Cherry Semiconductor, Clere Electronics, Kingsclere, Newbury, Berkshire RG15 8NL. Tel: 0635 298574.

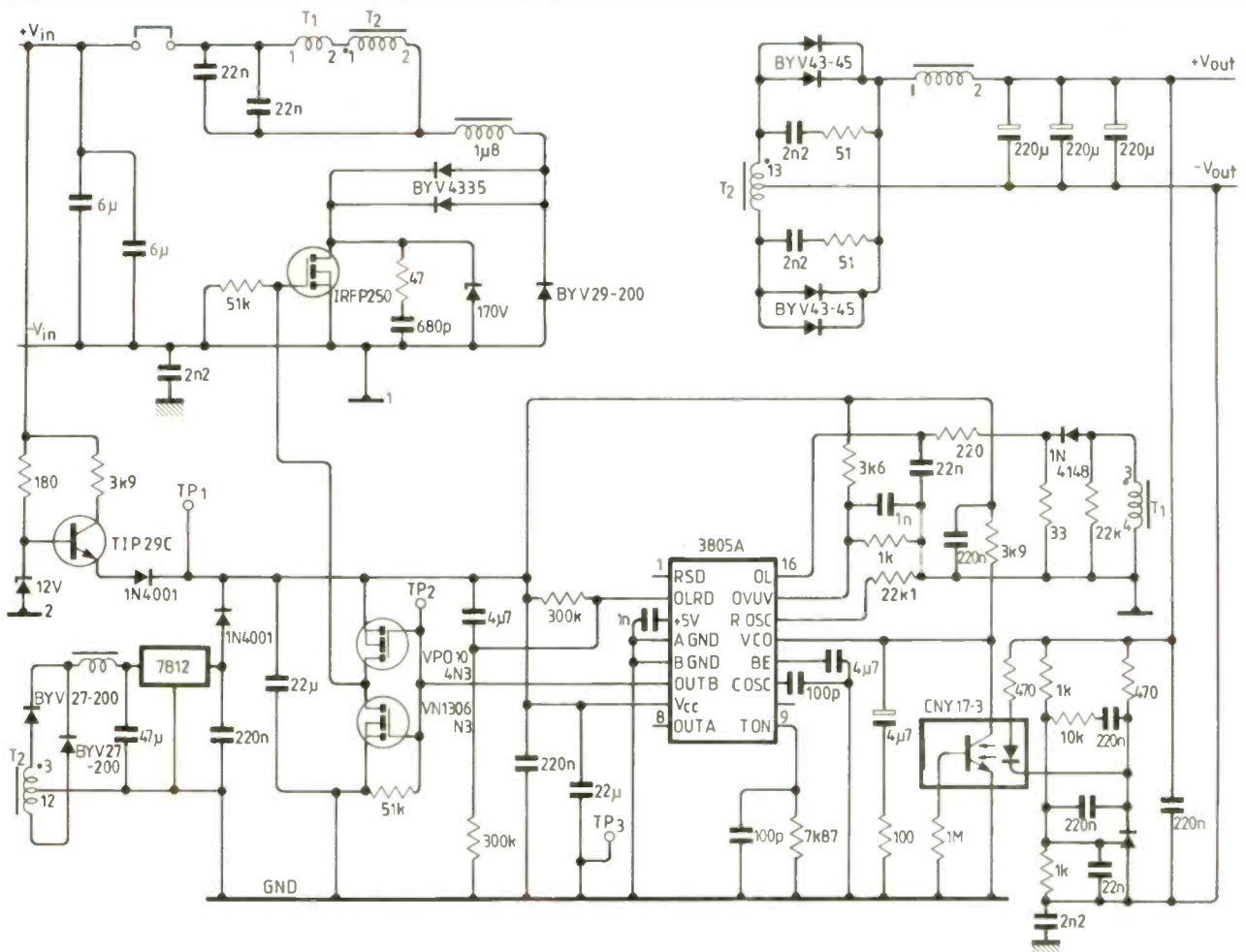
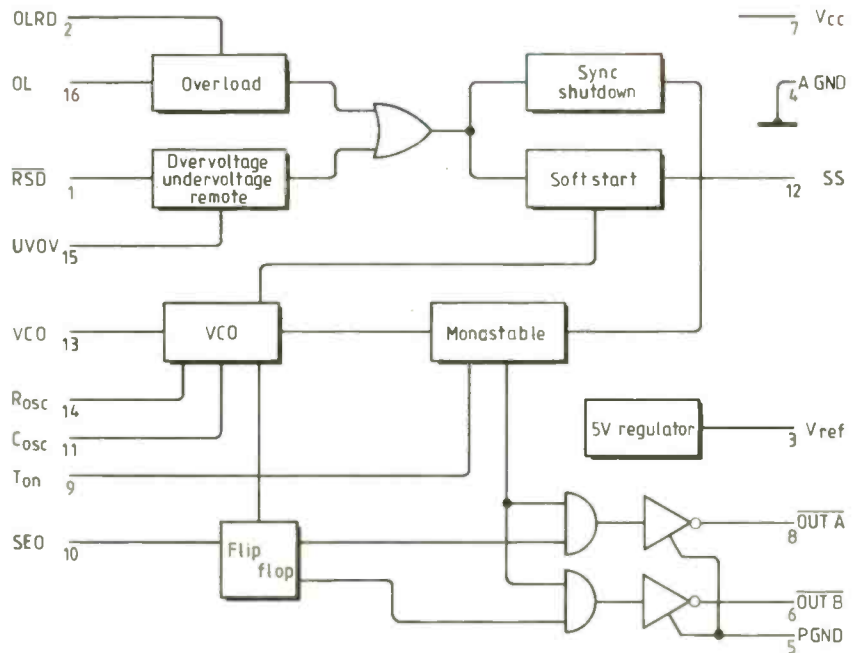

We've bridged the gap . . .



Designed for professional communicators, such as police and customs, the AEL 2230 also meets the needs of other organisations who require unlimited channel capacity with full 2 to 30 MHz frequency coverage at sensible cost.

The AEL 2231 is a 15 channel factory programmed version for less demanding operational requirements.

- Ultra Compact 100 watts PEP and CW
- Mobile and Fixed station
- Full 2 to 30 MHz keypad tuning in 100 Hz steps
- Detachable keypad/factory programme option
- Modular Construction in weatherproof case

AEL
COMMUNICATIONS LTD

GATWICK HOUSE - HORLEY - SURREY - RH6 9SU - ENGLAND - TEL: (0293) 785353 - TELEX: 87180 & 87116 (AERO G) - FAX: (0293) 820722 - CABLES: AEROCON TELEX HORLEY

CIRCLE NO. 59 ON REPLY CARD

THE COMPLETE DESIGN SERVICE

- **CAD** Analogue and digital design, simulations and PCB artwork produced for new or old circuits.
- **CUSTOM SILICON** capability. PALS, Gate Arrays, ASCII's designed and supplied.
- **ON BOARD MICROPROCESSOR** hardware and software to provide local "intelligence" can also be provided.

We specialise in small low cost projects.

To find out how we can help you phone Chris Barnett on **(0604) 713681**

NATEL
ELECTRONICS

Natel Electronics, 1 Beechcroft Gardens,
Northampton NN3 2JP

CIRCLE NO. 55 ON REPLY CARD

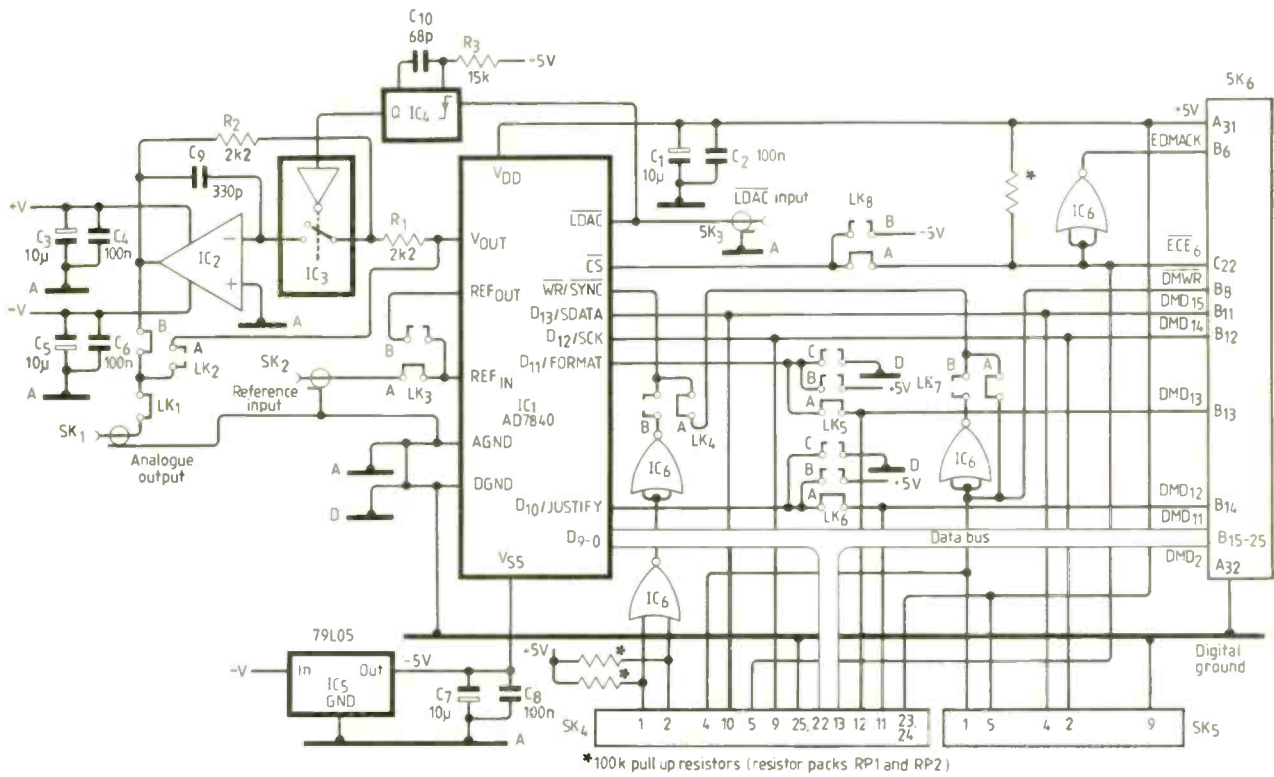

Serial/parallel D-to-A converter board

Monolithic data converters, other than those specifically for audio, are now reaching a quality level that allows their distortion and noise specifications to be quoted without causing analogue engineers to wince. An example is the AD7840 14bit d-to-a converter with

from 78 to 84dB distortion and from 76 to 80dB signal-to-noise ratio, depending on the version.

Designed for both general-purpose and digital signal processor interfacing, the 7840 has serial and parallel data loading channels; its serial channel can be clocked at up to 6MHz.

Within the 7840 data sheet are interfacing details for a number of DSP devices and 68000/8086 general-purpose processors. There is also a description of the evaluation board

shown here including PCB foil patterns.

Signal names on the interface connector relate to the ADSP2100 DSP chip but the design is general purpose; timing details for the converter are given in the data sheet but there is no information about the interface timing requirements.

Analog devices, Station Avenue, Watton-on-Thames, Surrey KT12 1PF. Tel. 0932 232222.

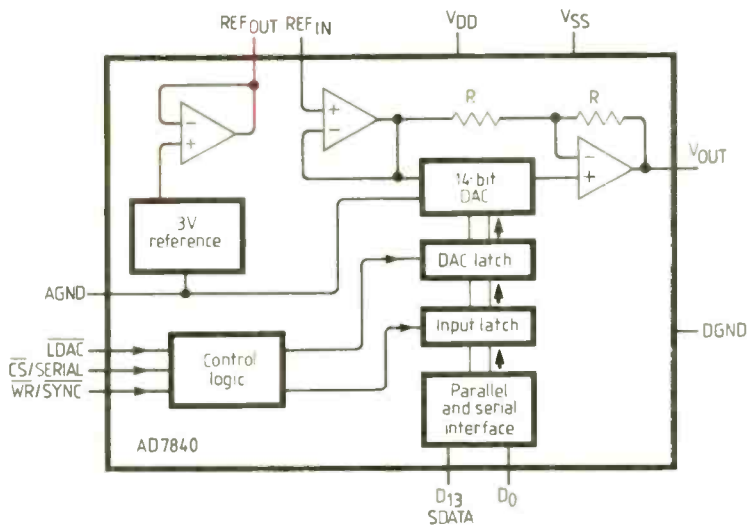

APPLICATIONS SUMMARY

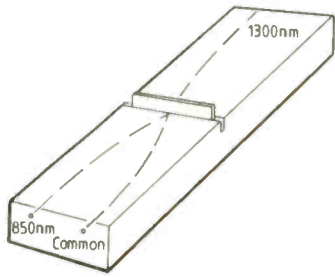

Light Wheatstone

Optical-fibre sensors for general instrumentation applications, like pressure and temperature measurement, are now established, and biomedical/biochemical applications, in which the fibre cladding is replaced with a reagent — so-called biosensors — are emerging fast.

A fibre's optical characteristics drift with temperature and the light changes in an optical-fibre sensor are minute. To the electronics engineer, the most obvious measurement configuration would be an electrical Wheatstone bridge, but the optical Wheatstone solution shown here avoids the additional errors that occur when converting the light signals to electrical ones.

For many applications the optical bridge would have been prohibitively expensive were it not for developments in optical waveguides in glass.

A brochure from Corning outlines optical waveguides, their applications in telecommunications and instrumentation, and the company's waveguide products which include both custom and standard parts. The brochure's full title is "Photocor integrated optic custom components."

Apora, 21 Victoria Avenue, Harrogate, Yorkshire HG1 5RD. Tel: 0423 569 307.

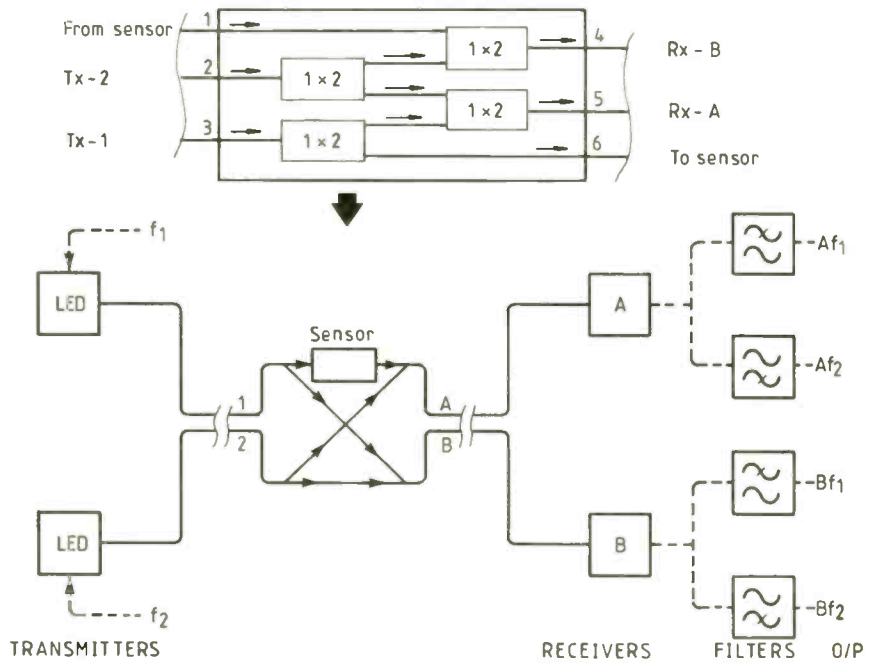

Switched-capacitor notch filter

This notch filter needs no external components for defining its response and it needs only variation in clock frequency to move the notch centre. Clock-to-centre-frequency ratio, attenuation and notch width are all programmable.

In the data sheet for the LMF90 fourth-order elliptic filter IC are ten applications circuits showing how to operate the device from single or dual supplies and how to use the crystal or external clock options.

National Semiconductor, The Maples, Kembrey Park, Swindon, Wiltshire SN2 6UT. Tel: 0793 614141.

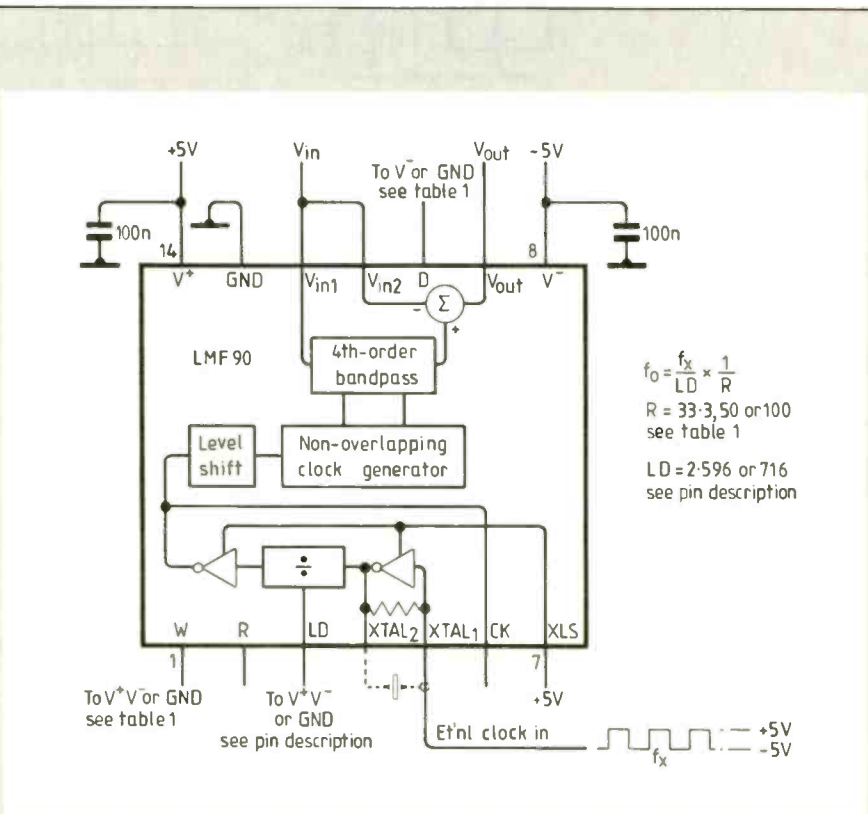

$$f_0 = \frac{f_x}{LD} \times \frac{1}{R}$$

$R = 33, 3, 50$ or 100
see table 1

$LD = 2, 596$ or 716
see pin description

Operation of LMF90 programming pins. Values given are for nominal levels of attenuation.

R	D	W	V (f _{CLK} /f ₀ = 100)			GND (f _{CLK} /f ₀ = 50)			V' (f _{CLK} /f ₀ = 33.33)		
			A _{min} (dB)	BW/f ₀	SBW/f ₀	A _{min} (dB)	BW/f ₀	SBW/f ₀	A _{min} (dB)	BW/f ₀	SBW/f ₀
V	V	V	30	0.12	0.019	-30	0.12	0.019	-30	0.12	0.019
V	GND	V	30	0.26	0.040	-30	0.26	0.040	-30	0.26	0.040
V	V'	V	30	0.55	0.082	-30	0.55	0.082	-30	0.55	0.082
V	V	GND	35	0.12	0.010	35	0.12	0.010	35	0.12	0.010
GND	GND	V	40	0.26	0.024	40	0.26	0.024	40	0.26	0.024
GND	V'	V	40	0.55	0.050	40	0.55	0.050	40	0.55	0.050

SPICE•AGE

Non-Linear Analogue Circuit Simulator £245 complete

Those Engineers have a reputation for supplying the best value-for-money in microcomputer-based circuit simulation software. Just look at what the new fully-integrated SPICE Advanced Graphics Environment (AGE) package offers in ease-of-use, performance, and facilities:

SPICE•AGE performs four types of analysis simply, speedily, and accurately:

- Module 1 – Frequency response ● Module 3 – Transient analysis
- Module 2 – DC quiescent analysis ● Module 4 – Fourier analysis

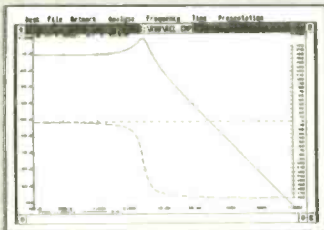

Frequency response of a low pass filter circuit

2 DC Quiescent analysis

SPICE•AGE analyses DC voltages in any network and is useful, for example, for setting transistor bias. Non-linear components such as transistors and diodes are catered for. (The disk library of network models contains many commonly-used components – see below). This type of analysis is ideal for confirming bias conditions and establishing clipping margin prior to performing a transient analysis. Tabular results are given for each node; the reference node is user-selectable.

1 Frequency response

SPICE•AGE provides a clever hidden benefit. It first solves for circuit quiescence and only when the operating point is established does it release the correct small-signal results. This essential concept is featured in all *Those Engineers'* software. Numerical and graphical (log & lin) impedance, gain and phase results can be generated. A 'probe node' feature allows the output nodes to be changed. Output may be either dB or volts; the zero dB reference can be defined in six different ways.

Node	Volts DC	dBm	Volts DC	dBm	Volts DC
1	0.000000	0.000000	0.000000	0.000000	0.000000
2	0.000000	0.000000	0.000000	0.000000	0.000000
3	0.000000	0.000000	0.000000	0.000000	0.000000
4	0.000000	0.000000	0.000000	0.000000	0.000000
5	0.000000	0.000000	0.000000	0.000000	0.000000
6	0.000000	0.000000	0.000000	0.000000	0.000000
7	0.000000	0.000000	0.000000	0.000000	0.000000
8	0.000000	0.000000	0.000000	0.000000	0.000000
9	0.000000	0.000000	0.000000	0.000000	0.000000
10	0.000000	0.000000	0.000000	0.000000	0.000000
11	0.000000	0.000000	0.000000	0.000000	0.000000
12	0.000000	0.000000	0.000000	0.000000	0.000000
13	0.000000	0.000000	0.000000	0.000000	0.000000
14	0.000000	0.000000	0.000000	0.000000	0.000000
15	0.000000	0.000000	0.000000	0.000000	0.000000
16	0.000000	0.000000	0.000000	0.000000	0.000000
17	0.000000	0.000000	0.000000	0.000000	0.000000
18	0.000000	0.000000	0.000000	0.000000	0.000000
19	0.000000	0.000000	0.000000	0.000000	0.000000
20	0.000000	0.000000	0.000000	0.000000	0.000000

DC conditions within model of 741 circuit

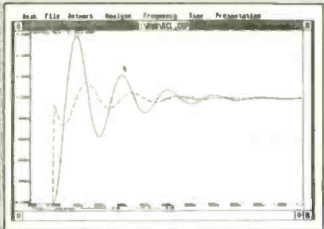

Impulse response of low pass filter (transient analysis)

3 Transient analysis

The transient response arising from a wide range of inputs can be examined. 7 types of excitation are offered (impulse, sine wave, step, triangle, ramp, square, and pulse train); the parameters of each are user-definable. Reactive components may be pre-charged to steady-state condition. Up to 13 voltage generators and current generators may be connected. Sweep time is adjustable. Up to 4 probe nodes are allowed, and simultaneous plots permit easy comparison of results.

4 Fourier analyses

SPICE•AGE performs Fourier transforms on transient analysis data. This allows users to examine transient analysis waveforms for the most prevalent frequency components (amplitude is plotted against frequency). Functions as a simple spectrum analyser for snapshot of transients. Automatically interpolates from transient analysis data and handles up to 512 data values. Allows examination of waveform through different windows. Powerful analytical function is extremely easy to use.

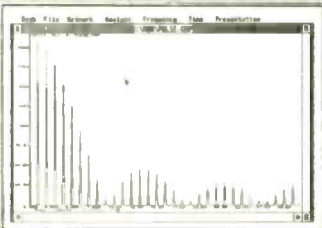

Spectrum of rectangular pulse train (Fourier analysis)

If your work involves designing, developing or verifying analogue or digital circuits, you will wonder how you ever managed without *Those Engineers* circuit Simulation Software.

A good range of properly supported and proven programs is available and our expert staff are at your service.

Those Engineers Ltd

106a Fortune Green Road • West Hampstead • London NW6 1DS
Telephone: 01-435 2771 • Fax: 01-435 3757

CIRCLE NO. 44 ON REPLY CARD

WANTED

J & M Computers specialize in all redundant Electronic Equipment, working or not, i.e.

- Computer equipment and peripherals
- Components (resistors to I.C.'s)
- Test equipment
- Modems
- Printer circuit cards
- Redundant stocks
- End of job lots
- Cable
- Factory clearances

If you have redundant equipment now or in the future, would you contact us. We would be pleased to price and collect it at our own expense.

J. & M. Computers

Eight Acres, Maldon Road, Wickham
Bishops, Witham, Essex.

Telephone: Maldon (0621) 892701
Fax: (0621) 891414

CIRCLE NO. 49 ON REPLY CARD

**W
A
V
E
B
A
N
D**

R.F. ACCESSORIES

FILTERS, ATTENUATORS, COUPLERS ETC.

CONNECTORS AND CABLES

CABLE ASSEMBLIES AND TEST LEADS MADE TO ORDER

Coaxial or Multiway. RF, video, audio and data

Double braid and tough PTFE coaxial cables.

Customers already include several universities and polytechnics, government departments, broadcasters and BT – Cellnet.

WAVEBAND ELECTRONICS

3 Lon Howell, Denbigh, Clwyd LL16 4AN.
Tel: 074 571 2777.

CIRCLE NO. 48 ON REPLY CARD

Sensors & Systems, the international transducer exhibition and conference, promises an unrivalled opportunity for catching up with the latest products and techniques. This year's event takes place at the Wembley Conference Centre, October 24, 25 and 26. On these pages we present some highlights of the technical sessions.

SENSORS
THE INTERNATIONAL TRANSDUCER EXHIBITION & CONFERENCE
SYSTEMS
WEMBLEY CONFERENCE CENTRE ■ OCTOBER 24 ■ 25 ■ 26 1989

Sensors and systems

Robot wrist sensor: a team from Delft University describes a capacitive wrist sensor for multi-axis force and torque sensing in robots. This replaces conventional strain-gauge sensors. Robots equipped with the sensor can be used in applications where a tool must be moved over a curved surface while being pressed against it with a constant force. R.F. Wolffenbuttel *et al.*, Laboratory for Electronic Instrumentation, Mekelweg 4, 2628 CD Delft, The Netherlands.

Brushless 360° angle sensor (pictured right): a stand-alone analogue shaft angle transducer, based on a rotary variable auto-transformer, is now available in commercial form. Radiodetection Ltd, Western Drive, Bristol; tel. 0272-839581.

Liquid/solid mixtures: Dr John Coulthard and Dr Benjamin Byrne of Teesside Polytechnic survey techniques for measuring the flow of granular or powdered fuels using electrostatic, gamma ray and X-ray sensors. They also describe mass-sensing methods based on ultrasound. School of Information Engineering, Teesside Polytechnic, Middlesbrough, Cleveland TS1 3BA.

Environmental sensors

Sensing the oceans: Dr Mark Varney of Southampton University describes the Autosub, an underwater vehicle which will be able to dive independently to the depths of the oceans and travel across

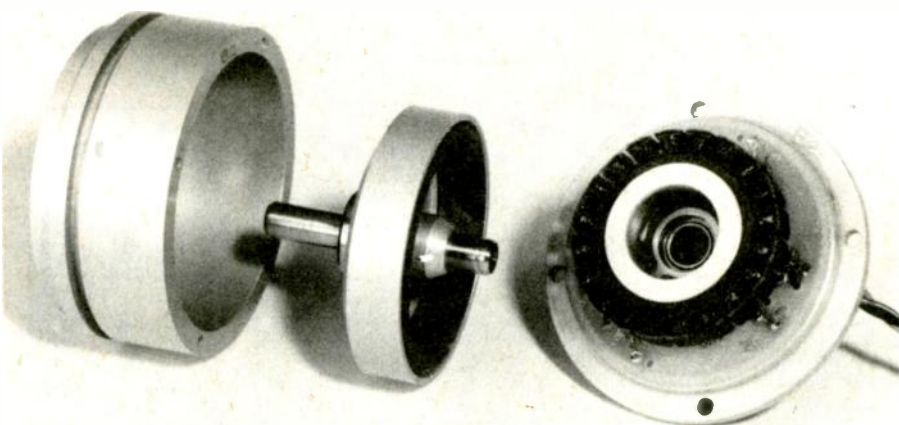

A cost-effective solution to shaft angle sensing: the Rovat brushless sensor developed by Radiodetection. It can also be used as an inclinometer.

ocean basins, carrying chemical, geological and physical sensors. Previous investigations of this sort have meant lowering an instrument platform from a ship, which then had to maintain its station for up to eight hours. Dr Varney also mentions some unique sensors for detecting trace substances in ocean waters. Department of Oceanography, Southampton University, Southampton SO9 5NH.

Toxic gases in the workplace: new regulations coming into force this month make it necessary to monitor the air in workplaces to assess the risk of exposure. A consultant, Brian Miller, surveys some of the instrumentation available for personal, portable and fixed use; among the sensors are infra-red,

ultra-violet, electrochemical, ionization and electron-capture types. Brian Miller, 22 Ashbourne Road, Runcorn, Cheshire WA7 4YD; tel. 09285-65884.

Open path gas detection: this new approach to detecting the build-up of hydrocarbon gases in hazardous concentrations is said to avoid the problems which arise with single-point sensors – siting these can be crucial to their effectiveness. By means of a novel dual-wavelength technique using infra-red beams, it is possible to monitor a substantial area with a single instrument. Sieger Ltd, 31 Nuffield Estate, Poole, Dorset BH11 7RZ; tel. 0202-676161.

Biosensors for pollution monitoring: the marriage between microbiology and

electrochemistry offers enormous potential in areas such as environmental monitoring. Prof. David Rawson of Luton College of Higher Education describes progress with transducers based on living cells such as those of bacteria and algae and considers some of their possible applications.

Optical-fibre sensors

Commercially available devices: a recent survey by ERA Technology Ltd identified over 200 potential manufacturers of optical-fibre sensors worldwide. Dr S.D. Crossley of Bradford University reviews current commercial devices and others which are in the final stages of development.

Distributed temperature sensor: Geoff Gamble describes a way of using standard multi-mode optical fibre as a temperature sensor. Using optical time-domain reflectometry, his system (pictured below) monitors back-scatter to give a temperature profile over the entire length of an optical fibre up to 2km long. York Ventures and Special Optical Products Ltd, York House, School Lane, Chandlers Ford, Hampshire SO5 3DG; tel. 0703-260411.



Optical-fibre hybrid sensors: Walter Gross of Siemens AG presents a hybrid sensor for measuring temperature with 0.2% accuracy. This unit obtains its power from the cable optically, using a specially developed optical-to-electrical converter which can deliver up to 150mW to the sensor head. Advantages are DC isolation and a reduced risk of explosion in hazardous environments. Siemens AG, Paul Gossen Strasse 100, D-8520 Erlangen, West Germany.

Measuring low-frequency vibration: a passive optical accelerometer (right) has been developed for measuring low-frequency (0.1-10Hz), large amplitude (10-15mm) movement of offshore structures. Dr Robert Jones, Cambridge Consultants Ltd, 0223-420024.

ACTIVITIES AT SENSORS & SYSTEMS

In parallel with the main exhibition and conference, a variety of other activities has been arranged

Theatre Workshop. Hands-on demonstrations by conference speakers and exhibitors will take place on all three days of the show, at the Theatre Workshop in the main exhibition area. Morning and afternoon sessions have been designed to complement each day's conference programme. For example, a visitor could spend the morning listening to conference presentations on, say, optical fibre sensors, and the afternoon seeing them demonstrated in the Workshop.

R&D Village. New devices and applications from universities and leading research centres in the UK will be on show in the R&D Village. This feature, sponsored by the Department of Trade and Industry, aims to highlight the importance of collaboration between research and industry.

One-day course. To accompany the show a one-day course on silicon sensors and microstructures is being organized, with the aim of increasing awareness among technologists and business managers. Silicon micromachining, according to some, is creating the same kind of revolution that led to the emergence of Silicon Valley 30 years ago. Micromachining, the three-dimensional sculpting of silicon using semiconductor batch processing technology, is the foundation of a new generation of diverse sensor-based products which could change our lives in the coming years.

Topics covered will include the birth and evolution of silicon sensor technology, silicon processing and micromachining, advanced silicon sensor designs and the emerging technology of silicon microstructures. The all day course, to be held on Wednesday, October 25, will be presented by Dr Janusz Bryzek and Dr Phillip Barth of NovaSensor (USA - tel 0101 415 490 9100, fax 0101 415 770 0645). Fee is £125, including lunch, refreshments and course notes.

Meet *Electronics World + Wireless World* at the exhibition, Stand L1a in the upper display area.

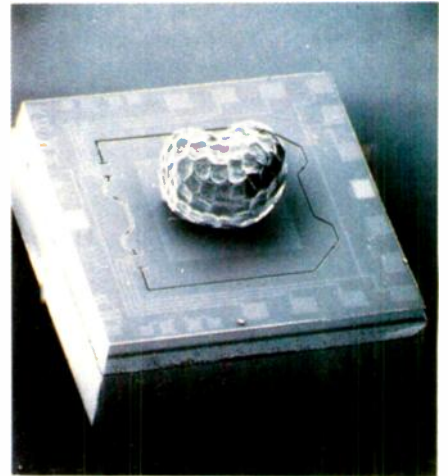

Acceleration sensor, with a poppy seed loading the paddle (scanning electron micrograph by NovaSensor).

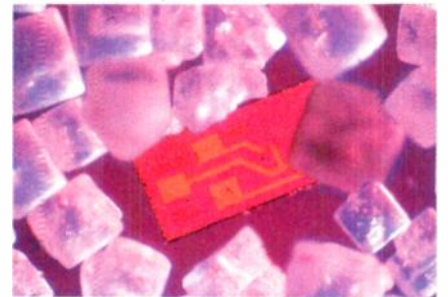

Calorimeter sensor chips surrounded by salt crystals (NovaSensor).

● **Sensors & Systems**, the international transducer exhibition and Conference, will take place at the Wembley Conference Centre, October 24-26, 1989. Organizers are Trident International Exhibitions Ltd, 21 Plymouth Road, Tawstock, Devon PL19 8AU, tel. 0822-614671.



Infrared and optical sensors

Optical rotation sensors: ring laser gyroscopes and optical-fibre gyroscopes show considerable promise for applications in inertial navigation systems, being potentially cheaper and more reliable than conventional gyros. An assessment of both types is provided by Dr John Nuttall, of the Ferranti team behind the Ariane rocket's navigational successes. Ferranti International, Silverknowes, Edinburgh EH4 4 AD; tel. 031-332 2411.

Probing plastics: as packaging materials grow ever more complex, modern tech-

niques such as multi-layer co-extrusion of plastics films (for example, nylon with polyethylene) present new challenges to the engineer. In producing the films, essential barrier layers must be of the right thickness and optical flatness is important. Thickness can be monitored on the production line by a method based on near-infrared absorption, which in many cases can provide separate measurements of individual layers. Dr I.B. Benson, Infrared Engineering Ltd, The Causeway, Maldon, Essex; tel. 0621-852244.

Laser-based pyrometer: temperature readings in industrial furnaces, such as those used for steel-making or petrochemicals, tend to be erroneously high because of energy emitted by the hot furnace walls. A system now in commercial production eliminates this error by making it possible to measure directly the emissivity of opaque, diffuse targets. Graham Kilford and Dr E.K. Matthews, Emmaflex Ltd, 192 Main Road, Stafford ST17 0UN; tel. 0785-665566.

Surface resistivity and reflectivity: D.M. Calcutt and Dr R.J. Batt of Portsmouth Polytechnic describe a pyroelectric method of measuring thin conducting films.

Smart sensors, solid-state sensors

Silicon microstructures: advanced micromachining and other processes are bringing new silicon devices such as a silicon accelerometer, which offers improved performance at a fraction of the cost of conventional devices, and a variety of special-purpose sensors, actuators and miniature mechanical elements. Dr James Knutti of IC Sensors Inc. describes these devices and the production techniques which make them possible. Eurosensor Computer Controls Ltd, 20-24 Kirby Street, London EC1N 8TS; tel. 01-405 6060.

Thick-film gas sensors: organic semiconductors such as the metal-based phthalocyanines make highly sensitive gas sensors, but they lack discrimination. Dr J.K. Atkinson, of the Department of Electronics and Computer Science at Southampton University, has been trying to produce sensor systems which can distinguish between different gases – with the help of collaborators at

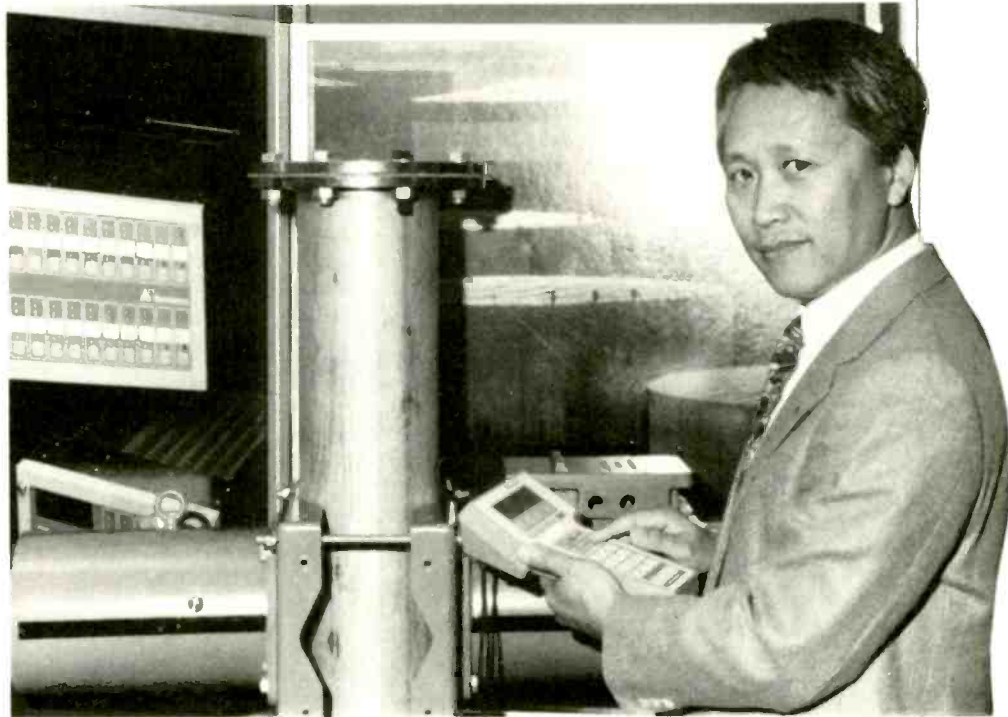

Bolted to this pipe-stack is a gamma-ray density sensor, designed in Britain for manufacture by Kay Ray Products of Chicago (Rosemount Ltd).

the University and at the Admiralty Research Establishment, Holton Heath.

Calorimetric flow-sensing: Günther Weber reviews flow sensors and their design, both intrusive and non-intrusive types. A promising area of application for calorimetric flow-sensors is likely to be the automobile industry. Weber Sensortechnik GmbH, Kollmar, D-2201 Germany; tel. (01049) 4128 591.

Measuring fluid density: Mark Beales and Tim Williams present a microprocessor-based instrument which uses a gamma-ray absorption method to determine the density of a fluid in a process pipe. The whole instrument is bolted to the pipeline and can be read and configured at a remote terminal via a digital communications link. Rosemount Ltd, Heath Place, Bognor Regis, Sussex; tel. 0243-863121.

Digital systems

Virtual instrumentation: Dr James Truchard and Richard House of National Instruments Corporation (USA) show how measuring instruments can be constructed on the computer screen. With plug-in data acquisition boards replacing dedicated instruments, the user can exploit to the full the graphics capability, processing power and con-

venience of the latest generation of personal computers. National Instruments, tel. 0101-512 250 9119; fax 0101-512 335 2569.

Digital measurement devices: by the use of digital transmission in place of the conventional current loop, intelligent measurement devices can be integrated into distributed control systems. In this way, the system can be said to be distributed right down to the process itself. Harvey Dearden, Foxboro GB Ltd, Devon PL19 8AU; tel. 0822 614671.

Field instrumentation: Lynne Rolfe introduces two technologies for digital communications between transmitters, control systems and hand-held communicators: Rosemount Ltd's Hart Protocol; and Fieldbus, an all-digital Eureka proposal. Rosemount Ltd, Heath Place, Bognor Regis, Sussex, tel. 0243-863121.

Gas detection: Mike Scott of Sieger Ltd describes his company's digital systems for gas detection in the offshore oil industry. These are based on a network of intelligent transducers addressed through a master-slave protocol developed in co-operation with Southampton University. Sieger Ltd, 31 Nuffield Estate, Poole, Dorset BH17 7RZ; tel. 0202-676161. ■

KERBOOM!

BLAST THESE OLD SENSORS
... I CAN'T ...
NOW WHAT'S GOING ON?

RING THE
EXHIBITION AND
CONFERENCE
HOTLINE
0822 614671

**SENSORS & SYSTEMS LETS
YOU KNOW EXACTLY WHAT'S
HAPPENING IN THE REAL WORLD**

A uniquely dedicated event, it assembles the complete spectrum of new and established sensors & transducers plus instrumentation for recording, controlling and reacting to analogue and digital input.

**FEATURING THE
NEWER THAN NEW**

Don't miss the R & D Village (sponsored by the DTI) for your pre-production preview of devices and applications from the leading research establishments in the UK.

**CONFERENCE &
THEATRE
WORKSHOP**

For dedicated delegates there's a full international conference plus a programme of hands-on demos open to all.

■ COMPETITIONS
■ INNOVATIONS
■ DETAILED
PRODUCT GUIDE

Sensors & Systems offers excitement and answers. It's your one-stop opportunity to problem-solve, to keep up to date with the latest in products and innovative systems.



Trident International Exhibitions Ltd.
21 Plymouth Road
Tavistock
Devon PL19 8AU
England
Tel: 0822 614671 Fax: 0822 614818

SENSORS
THE INTERNATIONAL TRANSDUCER EXHIBITION & CONFERENCE
SYSTEMS
WEMBLEY CONFERENCE CENTRE ■ LONDON
OCTOBER 24 ■ 25 ■ 26 1989

... WHERE YOU ARE RIGHT IN TOUCH!

Better magnetic sensors

Alan Collins of MR Sensors shows how these thin-film devices can, with advantage, replace inductive sensors in the measurement of movement and velocity

Ferromagnetic thin-film magneto-resistive sensors are solid-state magnetic-field sensors for sensing and measuring. Although the magnetoresistive effect in ferromagnetic materials has been known for more than 100 years, it is only recently that we have exploited the effect in thin film sensors.

The simplest form of a ferromagnetic magneto-resistive field sensor is shown in Fig. 1. The sensor's operation relies on the fact that, when a magneto-resistive thin-film stripe is placed in a magnetic field which is in the plane of the stripe and perpendicular to the stripe's length, a change in resistivity of the stripe occurs.

The magnitude of the change in re-

passing a constant current I through the magneto-resistive stripe: the magnetic field is then detected as a change in voltage v across the device.

The relationship between the field and field-dependent output voltage (v) is non-linear. However, the sensor may be linearized by biasing the sensor in the linear region by means of biasing field H which rotates the magnetization within the stripe to an angle of 45° to the stripe length. H may be provided for example, by a permanent magnet. The signal output from the detector is then directly proportional to the signal field which is superimposed on the bias field.

Other methods exist of biasing the sensor, some of which extend the linear region of the device, such as the "barber

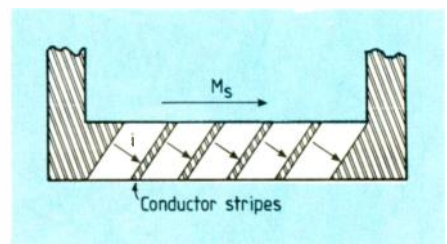

Fig. 3. Linearization using "barber-pole" structure to rotate current direction inside stripe.

pole" device. In these devices the current direction within the stripe is rotated (rather than the magnetization) by depositing narrow gold stripes over the magneto-resistive stripe at 45° to the length, as shown in Fig. 3. The transfer characteristic of a "barber pole" magnetoresistor is shown in Fig. 4.

Single, multiple and bridge detectors with a wide range of dimensions, saturating fields ($<100\text{Oe}$ to $\approx 300\text{Oe}$) and sensitivities can be manufactured economically. The basic sensor can be operated at frequencies of more than 5 MHz and at temperatures of up to 200°C . Temperature compensation can be applied to a sensor system where constant output with temperature is a

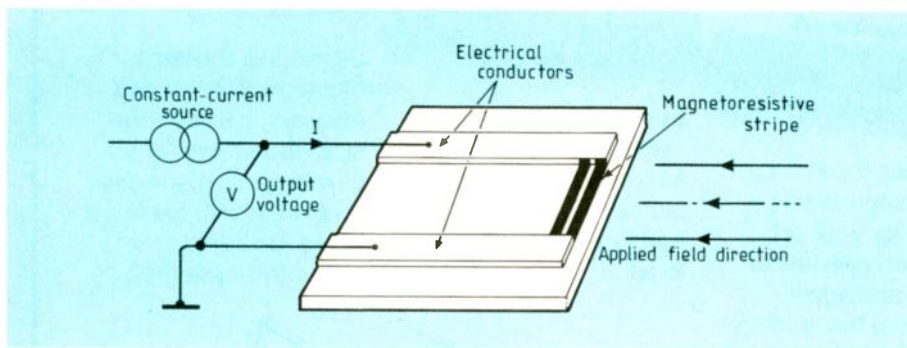

Fig. 1. Basic magneto-resistive sensor. Changing magnetic field varies resistivity of magnetic stripe.

sistance ΔR of the basic sensor stripe is a function of the applied field amplitude H as shown in Fig. 2. The field H_{sat} necessary to saturate the change in resistance, the maximum change in resistance ΔR_{max} , the zero field resistance, and the sensitivity dR/dH at any point on the characteristic may be tailored by a suitable choice of the magneto-resistive stripe's material and dimensions.

The sensor is normally operated by

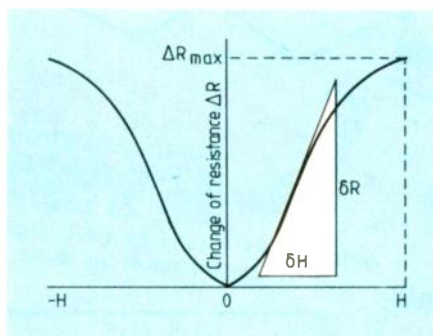

Fig. 2. Characteristic of sensor. Resistance is non-linear.

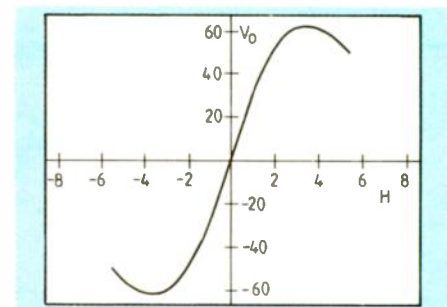

Fig. 4. Linearized transfer characteristic of barber-pole current rotation.

COMPUTER APPRECIATION

The Penny Theatre, 30/31 Northgate, Canterbury, Kent CT1 1BL
Telephone: (0227) 470512

HEWLETT PACKARD MODEL 5501A LASTER TRANSDUCER. With piezoelectric tuning for precise control of wavelength in measuring applications. With various mirrors and accessories..... £250.00
VICKERS INSTRUMENTS MODEL M17 METALLURGICAL MICROSCOPE with binoculars/micrographic head and all eyepieces. With 4 "Microplan" objectives & Nomarski interference contrast, variable illuminator etc. An immaculate instrument from the clean-room of a major semiconductor manufacturer. New cost over £6500.00. £1250.00

KRATOS MS30 DOUBLE BEAM MASS SPECTROMETER. Approximately 8 years old with negative ion capability & fast atom bombardment (FAB). With gas & direct introduction sample probes & with gas chromatograph inlet system. Output spectra are available directly via a HEWLETT PACKARD storage display & a UV recorder. An on-line DATA GENERAL DS60 computer system, which includes a graphics printer & two TEKTRONIX 4014 terminals, analyses output. The various sections of the instrument may be available separately. A new high flux magnet was fitted shortly before the instrument was decommissioned..... P.O.A.

SPECTRA PHYSICS MODEL 164 4 WATT ARGON ION LASER with MODEL 265 POWER SUPPLY and transformer for 3 phase supply. Suitable for research applications or a light show..... £1500.00

SPECTRA PHYSICS MODEL 164A 30mW HELIUM NEON LASER with power supply. A powerful Helium Neon laser ideally suited for holography..... £350.00

LUMONICS SYSTEM 2000 RUBY LASER with Q-switch, temperature controlled KDP frequency doubler, output monitor, 0.3 Joule per pulse, Q-switched output, 6 ppm. Suitable for holography involving moving objects. A low power He/Ne laser for mirror alignment and all manuals are included. Current new price of equivalent model exceeds £15000.00. £3500.00

HEWLETT PACKARD Model 5045A digital IC tester with CONTREL Model H310 automatic handler. With IEEE interface & print out of test results either pass-fail or full diagnostic including pin voltages at point of failure. With full complement of pin driver cards & complete with substantial library of mag. card test programs for 74 series TTL & other ICs. CONTREL handler allows fully automatic testing of ICs which are sorted into 2 bins. Price includes a second HP5045A (believed fully operational) for maintenance back-up. Very useful for recycling chips - originally cost over £6000.00..... £150.00

ITT PERFECTOR TELEX MACHINE. With 32k memory, screen with slow scrolling, keyboard etc., together with operators and service manuals..... £99.50

BIOMATION Model 810D LOGIC ANALYSER. Combines with any oscilloscope to provide 8 channel logic analyser. Size and colour to match Tektronix 400 series portables..... £75.00

DIGITAL Q-BUS, box, power supply, and 8 x dual slot backplane, all brand new. Needs easy modification (14 wirewrap connections) to update..... £75.00

TEKTRONIX Model 4051 intelligent graphics display with BASIC in ROM and RCA tape cartridge drive. Good tube and useful for maintenance purposes..... £99.50

TRIUMPH ADLER/ROYAL Office Master 2000 DAISY WHEEL PRINTERS. 20 cps. Full IBM & DIABLO 630 COMPATIBILITY. CENTRONICS INTERFACE. Features include underscore, bold, subscripts, superscripts, underline etc. 132 column; micro proportioned spacing. Complete with typewheel & ribbon, manufactured to highest standards in West Germany by Europe's largest typewriter manufacturer & offered elsewhere at over £350.00. Ex demonstration condition. Guaranteed 90 days..... £69.00 (£6.50 carr)

PLESSEY Model T24 V22/V22 bis 2400 Baud MODEM. Including free software disc for IBM or MATMOS PC. Compact, automatic modern featuring the latest technology & the highest possible data rate over the ordinary phone system. Offers both V22 & V22 bis compatibility. 1200/2400 Baud operation with auto bit rate recognition operation on both ordinary phone (PSTN) & private circuit (PC) auto call and auto answer. Duplex operation allowing simultaneous transmission & reception of data at 2400 Baud in both directions over a single phone line. Compact size (9" x 9" x 2 1/2"). BT approved & suitable for new PRESTEL V22bis service.... £59.50 (carr. £5.00)

Please note: *VAT & carriage (also + VAT) must be added to all prices.
*Guarantees vary from item to item, please enquire before purchase. *A full stock list with many other items and special offers is available on request.

CIRCLE NO. 32 ON REPLY CARD

M & B RADIO (LEEDS)

THE NORTH'S LEADING USED TEST-EQUIPMENT DEALER

Oscilloscopes			
Tektronix 475 200MHz Dual Trace Delayed TB	£599	Dymar 1585 AF Power Meter	£445
Tektronix 2445 150MHz Four Trace Delayed TB	£1450	Racal 409 Meter 1200 MHz	£1150
Tektronix 7503 Main Frame 7B537A 18 7A 18	£900	Radford L002 0M52 Audio Test Set	£200
Tektronix 475A 250MHz Dual Trace Delayed TB	£750	HP 202C Audio Oscillator	£50
Tektronix 1935A 35MHz Dual Trace Portable	£350	Farnell LF M2 Audio Generator	£75
Tektronix 1912 Portable Storage	£400	Farnell TM4 Microvolt Meter	£75
Tektronix 1915 15MHz Dual Trace	£225	Levell TM3 Microvolt Meter	£35
HP 1703A Dual Trace Storage Oscilloscope	£450	Levell TG150 Audio Oscillator	£20
HP 1715A 200MHz Dual Trace with DVM Opt	£895	HP 400AC RMS Voltmeter	£150
HP 1740A 100MHz Dual Trace Dual Trace	£600	HP 3400A RMS Voltmeter	£150
Kikusui 5060 50MHz Oscilloscope Boxed as New	£495	Sennheiser UPM550 10 MHz-1MHz AF Meter	from £300
Trio CS2100 100MHz Dual Trace	£475	Radford LD04E Oscillator	£195
Philips 3232 10MHz True Dual Trace	£195	DAWE 419C White Noise Generator	£450
Philips 3234 10MHz Storage Oscilloscope	£300	Gen Rad 1 383 Random Noise Generator	£45
Teledquipment D755 50MHz Dual Trace Delayed TB	£275	Gen Rad 1 390B Random Noise Generator	£150
Teledquipment D83 50MHz Dual Trace Delayed TB	£290	Radiorom5er SMC1 Stereo Generator	£100
Teledquipment D81 15MHz Dual Trace	£145	HP 5388A 80MHz Freq Counter	£100
Teledquipment D1016 10MHz Dual Trace	£135	Faxal 9839 570 MHz Freq Counter	£135
Cossor CDU150 35MHz Dual Trace Delayed TB	£155	HP 9915M 560MHz Freq Counter	£425
		Iwatsu SC7103 10MHz-1 GHz New Freq Counter	£195
		Marconi 2432A Freq Counter	£400
SIGNAL GENERATOR		HP3465A Digital Multimeter	£150
Marconi TF2008 10MHz-510MHz AM FM	£400	Solation-Schlumberger 7065 IEEE Voltmeter	£350
Marconi TF2002 10MHz-22MHz AM FM	£100	Racal VHF RT Calibrator	£25
Marconi TF2015 10MHz-520MHz AM FM	£375	Racal VHF-UHF Calibrator 9054	£75
Marconi TF2015 with TF121 Synthesizer	£500	AIM 401 LCR Comparator Databridge	£275
Marconi TF2012 UHF 400MHz-520MHz FM	£150	Wayne Kerr Comp Meter Set	£300
Marconi TF1086 10-470MHz AM FM	£175	Philips Pulse Generator IH2 100MHz	£65
Marconi TF995 1-220MHz AM FM	£35	HP VHF Oscillator 3200B 10-500MHz	£200
Philips PM5324 110MHz AM FM with Sweeper	£175	HP 6518 Test Oscillator	£150
Racal 901/9062 10MHz-160MHz Synthesized	£500	Gen Rad 1310B 2MHz Oscillator	£95
		Gen Rad 1362 UHF Oscillator 220-820MHz	£75
TEST EQUIPMENT		HP 5011T Logic Trouble Shooting Kit	£100
Marconi TF2950 Mobile Radio Test Set	£500	Bradley 156 Oscilloscope Calibrator	£200
Marconi TF2331 Distortion Meter	£250	Marconi TF1245-1247-1248 Q Meter	£300
Marconi TF2000 AF Oscillator + Att	£250	Thorn WC83-R TV Sync Pulse Generator	£195
Marconi TF2005R Dual AF AF Oscillator + Att	£325	Radiorom 470 0-2 5kV Power Supply	£75
Marconi TF2160 AF Monitored Attenuator	£100	Cohrent Radiation 212 Power Meter	£150
Marconi TF1313 0-1% LCR Bridge	£150	Fluke 6160A Freq Synthesizer 0-30MHz	£150
Marconi TF2120 Waveform Generator	£225	AVO B MKIII Multimeter	£60
Marconi TF2300 Modulation Meter	£175	HP R532A Freq Meter 26-40GHz	£100
Marconi TF2303 Modulation Meter as new	£300	HP R382A Variable Att 26-40GHz	£100
Marconi TF2600 AF Millivolt Meter	£30	HP 432A Crystal Detector 10MHz to 12.4GHz	£50
Marconi TF2604 RF Millivolt Meter (1500MHz)	£75	HP1B27 8558B Spectrum Analyser 1-1.5GHz	£3000
Marconi TF2650 FET Multimeters	£100	HP141T 8553B 8552A 110MHz Spectrum Analyser	£2000
Marconi TF1065 Radiotelephone RF/AF Power - Mono	£50		£650
Marconi TF460 RF Power Meter 10MHz-40GHz	£250		£500
Adret Codasyn 10MHz Synth-Generator	£195	HP8443A Tracking Generator	
Dymar 1785 Mod Meter 3-480 MHz Mains-Batt	£65	HPB750A Normalizer	

ALL PRICES PLUS VAT AND CARRIAGE

86 Bishopgate Street, Leeds LS1 4BB.

Tel: 0532 435649. Fax: (0532) 426881

CIRCLE NO. 17 ON REPLY CARD

SMC

South Midlands Communications

RADIO

TRANSCIEVERS/RECEIVERS

SMC the leading European specialist in general radio communications have developed modular systems for rapid delivery, particularly useful for emergencies, disasters, political unrest and aid concerns. This can consist of rugged, simple to use, HF transceivers i.e. the FT80C with a frequency range of 1.5-30MHz used with either one of the SMC basic wide band antennas, or more efficient, the multi spot frequency antennas complete with transportable masts.

More powerful and complex transceivers are also available.

Where monitoring or reception is required then either the FRG8800 HF receiver with VHF option or the FRG9600 VHF, UHF all mode scanning receiver are available with proven quality, sensitivity and reliability, at realistic prices.

ANTENNAS

The TWB2530 and TEB3 are just two samples of the large range HF, VHF and UHF antennas available from SMC. Both have been specifically designed for users with very different requirements showing the breadth of our capability. The rugged transportable TWB2530 is a full self-contained extremely lightweight, yet tough enough to withstand rough handling and quick assembly in adverse terrain.

The TEB series of spot frequency HF beam antennas give excellent forward gain, rugged construction for long life, at a cost effective price.

If you require further information on the 300 various support mounts, HF, VHF or UHF antennas, simply call for our new shortform catalogue.

Both can be supplied with the most efficient antennas and desirable accessories.



FT80C



FRG8800



TWB2530



TEB3

SMC LTD, SM HOUSE, SCHOOL CLOSE, CHANDLERS FORD
INDUSTRIAL ESTATE, EASTLEIGH, HANTS SO5 3BY.
Tel: (0703) 255111. Telex: 477351 SMCOMM G. Fax: 0703 263507

ENTER 26 ON REPLY CARD

With 48 years' experience in the design and manufacture of several hundred thousand transformers we can supply:

AUDIO FREQUENCY TRANSFORMERS OF EVERY TYPE

YOU NAME IT! WE MAKE IT!

OUR RANGE INCLUDES:

Microphone transformers (all types). Microphone Splitter/Combiner transformers. Input and Output transformers. Direct Injection transformers for Guitars. Multi-Secondary output transformers. Bridging transformers. Line transformers. Line transformers to B.T. Isolating Test Specification. Tapped impedance matching transformers. Gramophone Pickup transformers. Audio Mixing Desk transformers (all types). Miniature transformers. Microminiature transformers for PCB mounting. Experimental transformers. Ultra low frequency transformers. Ultra linear and other transformers for Valve Amplifiers up to 500 watts. Inductive Loop transformers. Smoothing Chokes. Filter, Inductors, Amplifiers to 100 volt line transformers (from a few watts up to 1,000 watts), 100 volt line transformers to speakers. Speaker matching transformers (all powers), Column Loud-speaker transformers up to 300 watts or more.

We can design for RECORDING QUALITY, STUDIO QUALITY, HI-FI QUALITY OR P.A. QUALITY. OUR PRICES ARE HIGHLY COMPETITIVE AND WE SUPPLY LARGE OR SMALL QUANTITIES AND EVEN SINGLE TRANSFORMERS. Many standard types are in stock and normal dispatch times are short and sensible.

OUR CLIENTS COVER A LARGE NUMBER OF BROADCASTING AUTHORITIES, MIXING DESK MANUFACTURERS, RECORDING STUDIOS, HI-FI ENTHUSIASTS, BAND GROUPS AND PUBLIC ADDRESS FIRMS. Export is a speciality and we have overseas clients in the COMMONWEALTH, EEC, USA, MIDDLE EAST, etc.

Send for our questionnaire which when completed, enables us to post quotations by return.



PO Box 36, Ipswich IP1 2EL, England.
Phone: 0473 252794 & 0473 219390 -
Telex: 987703G Fax: 0473 236188

CIRCLE NO. 41 ON REPLY CARD

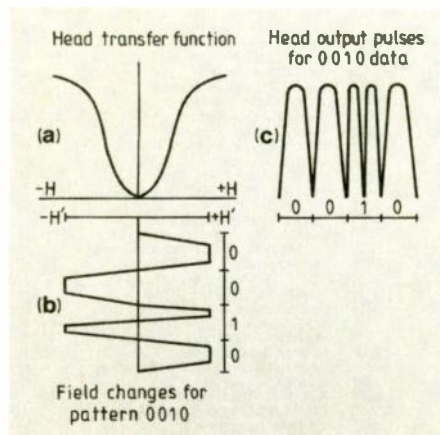

Fig. 5. Transfer characteristic of magnetoresistive head. Head does not differentiate between positive and negative excursions, so output is a train of single-polarity pulses.

requirement and electronic signal processing extends the operation and application of the devices.

Applications

The high sensitivity, spatial resolution and frequency range of thin-film ferromagnetic magnetoresistive sensors make them well suited for a wide range of magnetic-field detection applications. Because the characteristics and form of the sensor can easily be modified using standard thin-film processing techniques, it is relatively simple and cost-effective to customize sensors for specific applications.

Any physical quantity which can be transformed into a magnetic field is measurable using magnetoresistive sensors.

Traditionally, magnetoresistive sensors have been mainly employed as read-only heads for sensing magnetically encoded information on tape, discs and stripes. In particular, magnetoresistive read-only heads have been used to read the information on magnetic stripes on bank, transaction, credit and

security cards, and tickets. Because the sensor detects magnetic field amplitude H (whereas inductive read heads detect the rate of change of field dH/dt), the output is independent of the speed of the recorded medium past the sensor. Magnetoresistive sensors are, therefore, suitable for use as read heads in hand-held magnetic swipe card and ticket readers.

The basic characteristics of the unbiased magnetoresistive sensor head enable improved decoding techniques to be employed which, to date, have not been fully exploited. For each transition in NRZ recording, the field detected by the head changes from $-H'$ to H' (Fig. 5, which shows for illustrative purposes a convenient representation of the field changes arising from an encoded data pattern). As the magnetoresistive head cannot differentiate between the positive and negative going fields, the out-

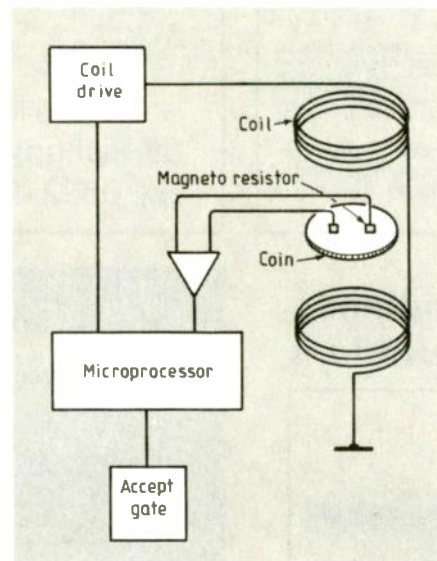

Fig. 7. Magnetoresistive sensor in a coin valuation system. Sensor scans coin as it passes through to provide discrimination between coins of similar size.

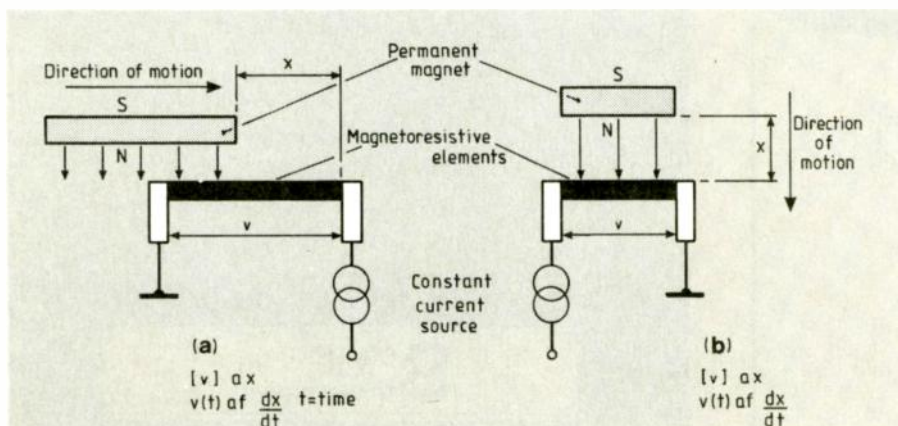

Fig. 6. Methods of detecting position (a) and velocity (b) of a magnet in linear movement.

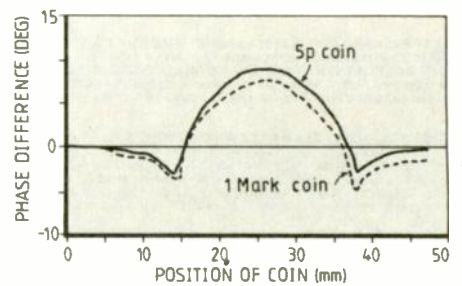

Fig. 8. Example of coin scan, showing difference between a standard British coin and the closest foreign one.

put from the head is a series of single-polarity pulses, as shown in Fig. 5(c), rather than the pulses of alternating polarity obtained from an inductive head.

The sensors can be used in a wide range of applications. For example, they are used to advantage in the measurement of position and velocity of both linear (Fig. 6) and rotating movements and the fact that the signal is proportional to field amplitude can again be useful in low-speed applications.

Coin evaluation

Detection of a varying magnetic field due to eddy currents has been used in a novel coin valuation system. The eddy currents are induced in a conducting material passing through the field by a high-sensitivity magnetoresistive sensor.

Figure 7 involves either a single magnetoresistive sensor or an array of sensors, depending upon the degree of discrimination required. In the time the coin takes to pass the sensor(s) the system performs a multitude of measurements (a scan) across the coin which effectively allows an electromagnetic fingerprint of the coin to be generated. This scan is a point-by-point comparison of the phase difference between the applied magnetic field and that due to the coin. This phase-shift scan is used to discriminate between differing coins.

The scan generated is independent of the velocity and acceleration of the coin passing the sensor within the normally expected range of operations, which simplifies the design of the mechanical flight deck of the coin mechanism; signal processing is carried out using a microprocessor. Setting up can be carried out on-site, if necessary, and recalibration is also possible during routine maintenance.

Discrimination achieved with this system is excellent. Examples of the signal scans for a standard British coin themselves and the closest false coin are seen in Fig. 8. ■

Towards the passive all-optical network

Costs of installation and interfacing have limited the use of optical fibre to long-distance networks. But progress has lowered costs and fibre now looks very attractive

Applications for local optical fibre cabling include telephone service and cable television, in both narrowband and broadband configurations. Experiments already conducted show that this technology is entirely feasible and only the lack of standards, uncertain market demand and an unclear regulatory situation are holding back its introduction.

An obvious route to take is to substitute optical fibre for the metallic cables currently used and combine this with digital loop carrier (DLC).

For larger users (25 lines or more) another mature technology is available: Flexible Access System or FAS, which is already being installed widely by British Telecom in London and elsewhere. FAS has the ability to deliver both normal telephone service and leased lines in 2Mbit/s channels. It is cabled as a separate overlay network, using a 96 fibre cable on the main line. Subsidiary cables with 48 or 24 fibres are split at joint points and led to customers' sites.

Both the former schemes, though admirable, are not really tailored to the economics of serving small users, nor are they ideal for distributing wideband services such as cable television. For these applications a radically new solution has been devised by British Telecom Research Laboratories, arguably a world-leader in this field.

The name of this is TPON or Telephony over a Passive Optical Network,



The end of the road for copper wiring? British Telecom considers that TPON – telephony over passive optical networks will be cost-effective for small business customers by the 1990s.

and its unique feature is that it is indeed passive: no active devices are used between the central exchange and the subscriber's termination. Intermediate distribution points contain no electronics. The system also uses a single rather than multi-fibre cable between the exchange and distribution points. Under the current scheme a single optical fibre leaves the exchange and is taken to a cabinet at an intermediate point; here a passive optical splitter feeds up to eight fibres. Each fibre then goes to a distribution point where another splitter serves cables to up to 16 customers.

Thus each system can support up to 128 customers.

Light transmission is duplex at 1300nm. Data transmission on TPON uses a total bit rate of 20Mbit/s and in the exchange-to-customer direction employs time-division multiplexing (TDM) in blocks of 8kbit/s to allow services of, say, 56, 64, 144 or 384 kbit/s. Return transmission uses time-division multiple access (TDMA); the head-end control system delays transmit pulses from customers so that they arrive at the exchange perfectly interleaved with other transmissions.

At the customer's end a network terminator converts the digital bit streams into the appropriate format using one or more interface adapters. For example, a telephony interface adapter translates the bit-stream back to analogue speech, detects signalling and provides ringing current.

The transfer to TPON and EPON will inevitably be gradual, regardless of the obvious advantages they offer over the existing copper cable-based local networks. British Telecom considers that TPON will be cost-effective for small business customers with, say, five lines by the early 1990s, while research continues to develop further improvements. ■

THE ORIGINAL SURPLUS WONDERLAND!

THIS MONTH'S SPECIAL!

Very high resolution, fully cased 14" green or amber screen monitor with non-glare screen and swivel/tilt base. The very latest technology at the very lowest price! Fully compatible and plug compatible with all IBM PCs and clones fitted with a high res Hercules or equivalent card! Enables superb graphics and resolution, all at a give away price. Has many extra features including aux +5 & 12v DC outputs to power at least 2 disk drives, if your PC power supply is getting hot! Supplied BRAND NEW and boxed. State whether amber or green screen required.

Amber£79 Green£69 (E)

COMPUTER SYSTEMS

TATUNG PC2000. Big brother of the famous Einstein. The TPC2000 Professional 3 piece system comprises: Quality high resolution Green 12" monitor. Sculptured 92 key keyboard and plinth unit containing Z80A CPU and all control circuits. PLUS 2 integral TEAC 5.25 80 track double sided disk drives. Generous other features include dual 8" IBM format disk drive support. Serial and parallel outputs, full expansion port, 64K ram and ready to run software. Supplied complete with CPM, Wordstar and Basic. Brand new and covered by our famous 90 day guarantee and backup. Normal price of this unit is over £1400!

Our price only£299 (E)

PC-AT 286 CLONE Lowest ever priced 8 mhz PC-AT clone complete with a 20mhz hard drive, a 5.25" 360k floppy, 640k of RAM plus Hercules card compatibility. The keyboard is NCR with 85 keys in an attractive beige, grey and cream finish to match the computer. The monitor is very high resolution 14" non glare, with your choice of amber or green screen. A very nice package at a super price!

Our price only£799 (E)

SPECIAL PURCHASE V22 1200 baud modems

We got a tremendous buy on further stocks of this popular **Master Systems 2/12** microprocessor controlled V22 full duplex 1200 baud modem - we can now bring them to you at **half least advertised price!** Fully BT approved unit, provides standard V22 high speed data comm, which at 120 cps, can save your phone bill and connect time by a staggering 75%! Ultra slim 45 mm high. Full featured with LED status indicators and remote error diagnostics. Sync or Async use; speech or data switching; built in 240v mains supply and 2 wire connection to BT. Units are in used but good condition. Fully tested prior despatch, with data and a full 90 day guarantee. What more can you ask for - and at this price!!

ONLY £69 (D)

Write to us today and get your name on our mailing list for our FREE eight weekly bargain flyer *The Display News* with thousands of unadvertised special offers.

MONITORS

COLOUR MONITORS

Decca 16" 80 series budget range colour monitors. Features include PIL tube, an attractive teak style case and guaranteed 80 column resolution, features which are only normally seen on colour monitors costing 3 times our price! It is absolutely ready to connect to a host of computer or video outputs. Manufacturers fully tested surplus, sold in little or hardly used condition with 90 day full RTB guarantee. Decca 80 RGB TTL and sync input for BBC and similar type interface etc. Decca 80 COMPO 75 ohm composite video input with integral audio amp & speaker. Ideal for use with video recorder or any Telexbox ST, or any other audio visual use.

Any type only £99.00 (E)

HI-DEFINITION COLOUR MONITORS

Brand new Centronic 14" monitor for IBM PC and compatibles at a lower than ever price! Completely CGA equivalent. Hi-res Mitsubishi 0.42 dot pitch giving 669 x 507 pixels. Big 28 Mhz bandwidth. A super monitor in attractive style moulded case. Full 90 day guarantee.

Only £149 (E)

20", 22" and 26" AV SPECIALS

Superbly made UK manufacture. PIL all solid state colour monitors, complete with composite video & sound inputs. Attractive teak style case. Perfect for Schools, Shops, Disco, Clubs. In EXCELLENT little used condition with full 90 day guarantee.

20"....£155 22"....£170 26"....£185 (F)

MONOCHROME MONITORS

Wang green screen 12" chassis monitor with composite video input. Adjustable for tilt. Requires 12 vdc. Brand new and boxed in perfect condition. Only £39 each or 2 for £75 (F)

Motorola M1000-100 5" black & white compact chassis measuring only 11.6H x 12W x 22D. Ideal for CCTV or computer applications. Accepts standard composite or individual H & V syncs. Needs 12vdc at only 0.8a. Some units may have minor screen blemishes. Fully tested with 30 day guarantee and full data. £29.00(C)

Fully cased as above in attractive moulded desk standing swivel. Dim 12 x 14.5 x 26cm. £39.00(C)

JVC 751 ultra compact chassis monitor for 12vdc 0.7a. Dim 11 x 14 x 18cm. Simple DIY data included to convert to composite video input. Full data. BRAND NEW £65.00(B)

20" Black & white monitors by Aztek, Cotron & National. All solid state, fully cased monitors ideal for all types of AV or CCTV applications. Standard composite video inputs with integral audio amp and speaker. Sold in good used condition - fully tested with 90 day guarantee. £85.00(F)

LARGE QUANTITIES OF OSCILLOSCOPES AND TEST GEAR ALWAYS AVAILABLE - CALL NOW!

DISPLAY

-Electronics-

MAIL ORDER & OFFICES
Open Mon-Fri 9.00-5.30
Dept W, 32 Biggin Way,
Upper Norwood,
London SE19 3XF.

LONDON SHOP
100's of bargains!
Open Mon-Sat 9-5.30
215 Whitehorse Lane,
South Norwood,
London, SE25 6RB.

DISTEL © The Original
Free dial-up database!
1000's of Items-Info On Line
300 bd 01-679-1888,
1200/75 bd 01-679-6183,
1200/1200 bd 01-679-8769

ALL ENQUIRIES
01-679-4414
Fax- 01-679-1927
Telex- 894502



All prices for UK Mainland. UK customers Add 15% VAT to total order amount. Minimum order £10. PO orders from Government, Universities, Schools & Local Authorities welcome-minimum account order £25. Carriage charges (A)=£1.50, (B)=£3.50, (C)=£6.50, (D)=£8.50, (E)=£12.50, (F)=£15, (G)=Call. All goods supplied subject to our standard Conditions of Sale and unless otherwise stated guaranteed for 90 days. All guarantees given on a return to base basis. We reserve the right to change prices & specifications without prior notice. Orders accepted subject to stock. Quotations willingly given for higher quantities than those stated.

FLOPPY DISK DRIVES BARGAINS GALORE!

NEW 5 1/4 inch from £29.95!

Massive purchases of standard 5 1/4" drives enables us to present prime product at industry beating low prices! All units (unless stated) are removed from other brand new equipment and are fully tested, aligned and shipped to you with a 90 day guarantee and operate from +5 & +12vdc, are of standard size and accept the standard 34 way connector.

SHUGART SA405. BRAND NEW £29.95(B)
TANDON TM100-2A IBM compatible DS £39.95(B)
TANDON TM101-4 80 Track DS £49.95(B)
CANON, TEC etc. DS half height. State 40 or 80T £75.00(B)
TEAC FD-55-F. 40-80 DS half height. BRAND NEW £90.00(B)

3 1/2" INCH BRAND NEW AT £19.95!!

Never before seen price for a 3 1/2" drive. Standard size believed to be by Canon. Brand new and packaged - mint condition! 40 track SS, run from +5 & +12vdc with standard power connector.Only..... £19.95 or 2 for £34.50(B)

CHOOSE YOUR 8 INCH!

Shugart 800/801 SS refurbished & tested £125.00(E)
Shugart 851 double sided refurbished & tested £195.00(E)
Mitsubishi M2894-63 double sided switchable hard or soft sectors- BRAND NEW £250.00(E)

SPECIAL OFFERS!!

Dual 8" drives with 2 megabyte capacity housed in a PC case with built in power supply! Only £499.00 (F)
Ideal as exterior drives!

End of line purchase scoop! Brand new NEC D2246 8" 85 megabyte of hard disk storage! Full CPU control and industry standard SMD interface. Ultra hi speed transfer and access time leaves the good old ST506 interface standing. In mint condition and comes complete with manual. Only.....£399(E)

MAINS SUPPRESSORS & FILTERS

The "Flitan" from Croton is a British made high current mains spike suppressor and RF filter in one, capable of handling up to 10 amps! The attractive case has an integral 13 amp socket for your equipment plug and a flying lead terminates in a quality plug (to BS 1363A standard) to go to the mains socket. There is an internal fuse plus one in the plug. Two LED indicators, one for power on and the other lights if the internal fuse fails. Dims: 6" x 3" x 2". Brand new. Normal distributor's price is £65.00! Our price only.....£15.95 each or 2 for £29.95 (B)
Bolling-Lee type L2127 mains RFI filters rated at 250 volts 3 amps maximum. Comes complete with a built in mains cable (English coding), and a three pin miniature non-reversible socket and a mating plug, to go to the equipment. Ideal for those who are bugged by RF interference. Very compact. Dims 3-1/8" x 2.5" x 1.5".....£3.95 each or 3 for £10 (A)

COOLING FANS

Please specify 110 or 240 volts for AC fans.

3 inch	AC 1 1/2" thick	£ 8.50(B)
3 1/2 inch	AC ETRI slimline. Only 1" thick.	£ 9.95(B)
4 inch	AC 110/240v 1 1/2" thick.	£10.95(B)
4 inch	AC 1 1/2" thick	£ 9.95(B)
10 inch	Round 3 1/2" thick. Rotron 110v	£10.95(B)
62 mm	DC 1" thick. No.812 for 6/12v. 814 24v.	£15.95(A)
92 mm	DC 12v. 19 mm thick.	£10.95(A)
4 inch	DC 12v. 12w 1 1/2" thick	£12.50(B)
4 inch	DC 24v 8w. 1" thick.	£14.50(B)

RECHARGEABLE BATTERIES

LEAD ACID

Maintenance free sealed long life. Type A300.
12 volts 12 volts 3 amp hours £13.95(A)
6 volts 6 volts 3 amp hours £ 9.95(A)
6-0-6 volts Centre tapped 1.8 amp hours £ 5.95(A)
12 volts 12 volts 24 amp hours. A200. RFE. £29.00(B)

SPECIAL OFFER!

100 amp/hours at 6 volt! Brand new Chloride Powersafe 3VB11. Leakproof with additional snap-on security lid. Perfect for uninterruptible power supplies, portable power source, caravans etc. Normally costs £80! £39 (E)

NICKEL CADMIUM

Quality 12v 4ah cell pack. Originally made for the Technicolor video company. Contains 10 GE top quality D nicad cells in a smart robust case with a DC output connector. Ideal for portable equipment. Brandnew. £19.95(B)
Ex-equipment NICAD cells by GE. Removed from equipment and in good, used condition: D size 4ah 4 for £5(B)
F size 7ah 6 for £9(B)

SPECIAL INTEREST

Recal-Redac real time colour drafting PCB layout system. Includes furniture and huge monitor. Complete ready to go! £3950
DEC VAX11/750 Inc. 2 Meg Ram DZ and full documentation, in brand new condition! £3900

Large Calcomp plotter £ 650
Tektronix RM529 Waveform Monitor £ 300
1.5kw/115v 60hz power source. £ 950
Wayne Kerr RA200 audio real time freq.res. analyser. £3000
VG Electronics 1033 Teletext Bridge £3750
Tektronics R140 NTSC TV test signal standard. £ 875
Verastek V80 Printer plotter £1500
DEC LS11/02 CPU board £ 150

SPECIAL EXPERIMENTERS PSU'S

These 2 PSU's are built to BT's rigorous specs and give fully protected DC outputs ideal for the electronic hobbyist & experimenter. Type EPSU1 input is 240v AC; outputs are 5v @ 2a, 12v @ 1a, 24v @ 1a, 5v fully floating 50ma. EPSU2 input is 30-70vdc outputs are 5v @ 6a, 12v @ 1a, 12v @ 0.5a & 5 others. Circuit diagram on request for EPSU1. No data with EPSU2 - hence the price! Both at parts alone price!

EPSU1.....£16.95 (C) EPSU2.....£9.95 (C)

BARGAIN PARTS & BOARDS PACKS

Its stock taking time once more so we have made up a lot of our famous bargain parcels again! These parcels represent the best value for money available and the greatest bargains of the century - a real thrill to open them up when you find that you have bought equipment and components (mostly brand new) for well under a third of our normal low price!!

Mix of general electronic parts & equipment:
5kilo weight for£8.95(B) 20 kilo weight for£22.50(D)
Boards Parcels for parts recovery:
Parcels contain almost any type of boards including ICs, memory, logic, passives and vast assortments of parts!
10 board parcel...£7.50(B) 20 board parcel....£13.95(C)

POWER SUPPLIES

All PSU's 220-240vdc input and are BRAND NEW unless stated. Many types ranging from 3v to 10kv always in stock.

Byte BD301 5vdc @ 1.6a. 12vdc @ 1.5a. Perfect for disk drives; with Molex sockets. Very attractively cased. Illum. sw. £19.50(B)
Greendale 19AB0E 60 watts switch mode. +5v @ 6a, 12v @ 1a, 15v @ 1a. RFE and fully tested. 11 x 20 x 5.5cms. £24.95(C)
Conver AC130. 130 watt hi-grade VDE spec. Switch mode. +5v @ 15a, -5v @ 1a, 12v @ 6a, 27 x 12.5 x 6.5cms £49.95(C)

Boshert 13090. Switch mode. Ideal for drives & system. +5v @ 6a, +12v @ 2.5a, -12v @ 0.5a, -5v @ 0.5a. £29.95(B)

IBM KEYBOARD DEAL

A replacement or backup keyboard, switchable for IBM PC, PC-XT or PC-AT. LED's for Caps, Scroll & Num Locks. Standard 85 keyboard layout. Made by NCR for the English & US markets. Absolutely standard. Brand new & boxed with manual and key template for user slogans on the function keys. Attractive beige, grey and cream finish, with the usual retractable legs underneath. A generous length of curly cord, terminating in the standard 5 pin DIN plug. A beautiful clean piece of manufacturer's surplus. What a deal!

BRAND NEW AND BOXED ONLY..... £49 (B)

THE AMAZING TELEBOX!

Converts your colour monitor into a QUALITY COLOUR TV!!



TV SOUND & VIDEO TUNER!

Brand new high quality, fully cased, 7 channel UHF PAL TV tuner system. Unit simply connects to your TV aerial socket and colour video monitor turning same into a fabulous colour TV. Don't worry if your monitor does not have sound, the TELEBOX even has an integral audio amp for driving a speaker plus an auxiliary output for headphones or Hi Fi system etc. Many other features: LED Status Indicator, Smart moulded case, Mains powered, Built to BS safety specs. Many other uses for TV sound or video etc. Supplied BRAND NEW with full 1 year guarantee.

Telexbox ST for composite video input monitors.....£29.95(B)
Telexbox ST as ST but with integral speaker.....£34.95(B)
Telexbox RGB for analogue RGB monitors.....£59.95(B)

NOT suitable for IBM or Clone type colour monitors.

BRAND NEW PRINTERS

Epson MX-80 FT One of the most popular printers around! Bi-directional printing with full logic seeking. 9 x 9 dot matrix for enlarged, bold, condensed etc. Standard parallel interface. Brand label removed from front. Handles tractor, fanfold and individual paper. OK with IBM PC and most others. A tremendous buy! £129.00 (E)

Hazeltine Esprint small desktop, 100 cps with RS232 and standard parallel. Full pin addressable and 6 user selectable fonts. Up to 9.5" paper. Sheet & tractor feed. £149.00(E)
Centronics 150 series. Always known for their reliability in continuous use - real workhorses in any environment. Fast 150 cps with 4 fonts and choice of interfaces.

150-SN up to 9.5" paper.....£155.00(E)
150-SW up to 14.5" paper.....£199.00(E)

Specify whether serial or parallel required.

CALL FOR THE MANY OTHERS IN STOCK INCLUDING DAISY WHEELS.

Visit our Shop - Technical help always on hand plus many un-advertised specials. You can buy a colour television for as little as £29! Come and join the gang at 215 Whitehorse Lane!

Thévenin's theorem is known and used throughout the world. But as is usual with such things, little thought is now given to the man whose name it bears. He has been described as a humble man and a model engineer and employee. He was hard working, held strict principles, was scrupulously moral and kind at heart. That alone would make a wonderful epitaph.

He is remembered today almost entirely for one small piece of work. His theorem, published in 1883, was based on his study of Kirchoff's Laws and is found in every basic textbook on electrical circuits. It has made his name familiar to every student of electrical circuits and to every electrical and electronics engineer.

Léon Charles Thévenin was born at Meaux just outside Paris on March 30, 1857. He graduated from the École Polytechnique in 1876 and two years later joined the Corps of Telegraph Engineers, later the French PTT, as one of the second intake to the newly reopened École Supérieure de Télégraphie. The public telegraph service was to be his working life until his retirement in 1914 on the eve of the first World War. During those 36 years he showed himself to be a great engineer, an excellent administrator and, perhaps first and foremost, a teacher. He continued some of his teaching duties to the end of his life.

At the start of his career, Thévenin joined the department responsible for long-distance underground telegraph lines which was then vastly expanding its service and requiring most of the newly trained young engineers leaving the École Supérieure². But he did not stay there long. His unusual talents were recognized and he moved to the Department of Materials and Construction which had started to tackle the problems involved in the construction of power lines. His standardization of the rules for the erection of overhead power lines stayed in force for many years.

Teaching

In 1882 Thévenin was asked to take on the job of teaching the young inspectors of the

engineering department at the École Supérieure. This was the start of his teaching career and his introduction to the work that led to his famous theorem.

He developed an interest in electrical measurement and, with his former teacher Jules Raynaud, he translated a British work on units and physical constants into French. Translation of such foreign publications was part of the routine work of the School. In conjunction with this work, Thévenin

made a very careful study of Kirchoff's Laws and discovered the rule which he then expressed in his theorem, having proved it by a clever application of the already established Superposition Principle.

Thévenin's Theorem was published in three separate scientific journals in 1883 in a paper entitled "Extension of Ohm's Law to complex electrical circuits"³. It was introduced as a "new theorem of dynamic electricity" and gave a simple method of calculating the current that would flow in a new conductor when it was added to an existing network. Nowadays it is expressed rather differently (in terms of an equivalent circuit consisting of a voltage source and a series resistor) but it is the same theorem. It was Thévenin's first article and appeared in the same year as the publication of the joint translation with Raynaud.

Three further articles followed in that year. The first gave a method of using a galvanometer to measure potential, and made use of the new theorem to achieve its ends. The second described a method for measuring resistance; and the third was on the use of the Wheatstone Bridge.⁴

A good launch

Publication of the theorem in three journals gave it a good launch, but Thévenin also taught it himself in his courses to telegraph engineers in France. By 1889, a century ago, others were already writing of it as the "théorème de Thévenin". It is an early example of practical engineering theory, in this case telegraph theory, being originated by an engineer and taught by an engineering school quite outside the scientific tradition of mathematical physics.

All was not, however, without problems. Thévenin reported his discovery to the French Academy of Sciences but first he disclosed it to another French telegraph engineer whom he deeply admired, A. Vaschy. Vaschy found the concept attractive but thought the theorem was wrong. Others were consulted and controversy grew as to whether it was right or wrong.

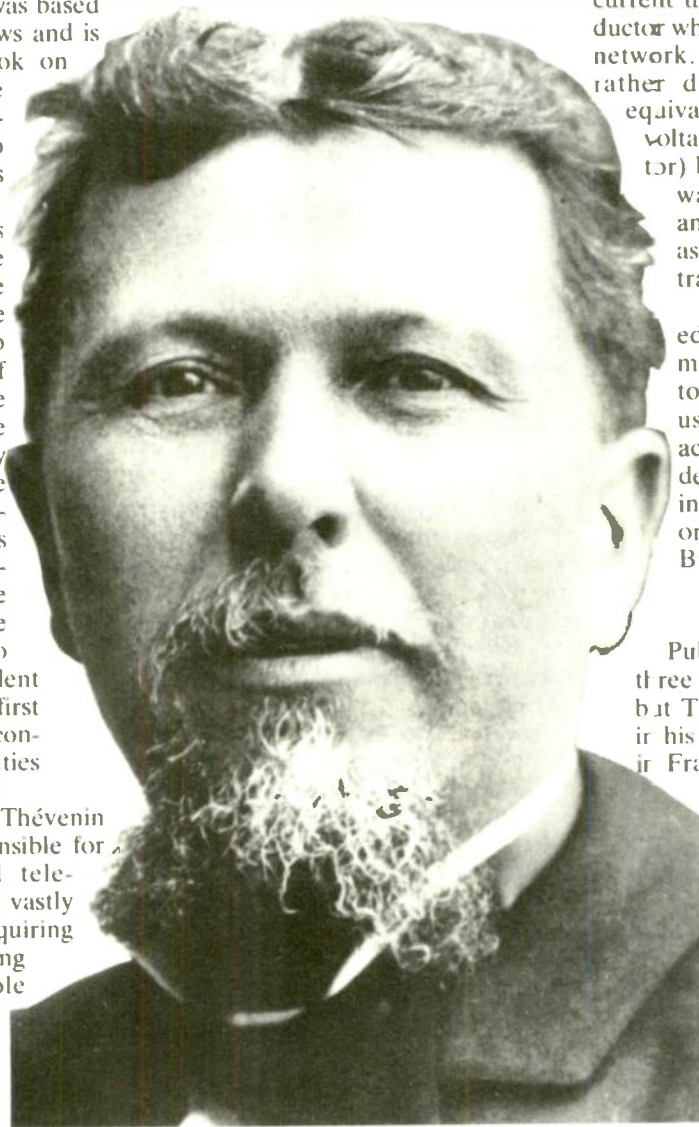

PIONEERS

Léon Charles Thévenin (1857-1926):
engineer, teacher and administrator

W. A. Atherton

Though Thévenin produced a rush of publications in 1883, he seems to have published nothing thereafter. Yet his career continued to advance and his teaching skills were sought outside the PTT. In 1885 he was asked to teach a course in industrial tools, and later one on industrial electrical engineering, at a school of commerce. The Institut National Agronomique employed him from 1891 to teach mechanics, and later to lead seminars in applied mathematics. He continued all of these teaching appointments until his death in 1926.

He had already proved himself as head of the Bureau des Lignes (where he improved and unified the construction of lines and personally supervised the implementation of his policies) when in 1896 he was appointed director of the telegraph engineering school. It was a job which brought him immense satisfaction.

Having no ambition to rise further he had almost to be prised out of that position in 1901 to take over as engineer-in-chief of the workshops, a position he held with distinction until his retirement in January 1914.

A crucial theorem

His theorem is now a fundamental part of the theory of electrical engineering and was crucial in developing transmission network theory. It was to prove of immense practical value to engineers. It is now usually taught alongside its complementary theorem, Norton's Theorem (see panel), which dates from

THEVENIN'S THEOREM

Below is a translation¹ of Thévenin's theorem, as originally stated in *Annales télégraphiques*:

Assuming any system of linear conductors connected in such a manner that to the extremities of each one of them there is connected at least one other, a system having some electromotive forces, E_1, E_2, \dots, E_n , no matter how distributed, we consider two points A and A' belonging to the system and having actually the potentials V and V'. If the points A and A' are connected by a wire ABA', which has a resistance r, with no electromotive forces, the potentials of points A and A' assume different values of V and V', but the current i flowing through this wire is given by the equation

$$i = \frac{V - V'}{r + R}$$

in which R represents the resistance of the original system, this resistance being measured between the points A and A', which are considered to be electrodes.

EDWARD LAWRY NORTON

Norton's theorem complements Thévenin's by presenting an equivalent circuit consisting of a current source and parallel resistance instead of Thévenin's voltage source and series resistance. It was published in 1926.

Edward L. Norton was born on July 29, 1898, at Rockland, Maine, and it was there that he went to high school. He served in the US Navy during World War I. After starting at the University of Maine he gained a B.S. degree from MIT in 1922 and then joined Western Electric. When the company's research laboratories merged in 1925 with those of AT&T to become the Bell Telephone Laboratories, Norton joined the new labs. In

the same year, Columbia University awarded him a Master's degree. Norton then spent the rest of his working life with Bell Labs. Even after his retirement in 1963 he continued to work as a part-time consultant.

His areas of work ranged wide, starting with network theory and moving into mechanical and acoustic networks, relay theory, anti-aircraft directors and bomb sights (during World War 2), guided missiles (he was a patent holder for the Nike missile guidance system), automation, data processing and high-speed data transmission. In all he held about 20 patents. He died, aged 84, at Chatham, New Jersey, on January 28, 1983, leaving a widow, Blanche, and a son, John.

1926 – the year Thévenin died. However, both theorems, it is said, had been anticipated by the German physicist Helmholtz in 1853.

Thévenin remained a bachelor for life, but provided a home for his mother's widowed cousin and her two children. Later he adopted the children.

His favourite recreation was angling and he owned a boat which he used on the River Marne for fishing. His students at the Institut Agronomique nicknamed him The Admiral. He was also a talented violinist but played only in private.

Late in 1926, Thévenin was taken to Paris for medical treatment and it was there that he died on September 21. A kindly man of simple tastes, Thévenin had requested that only his family should attend the cemetery and that a single rose from his garden should adorn his coffin. So it was when he was buried in his home town of Meaux.

References

1. C. Suchet, *Electrical Engineering*, vol.68, 843-844, 1949.
2. H. Thomas, *Annales des Postes, Télégraphes et Téléphones*, 1090-1098, 1925.
3. *Comptes rendus*, vol.97, 159-161; *Journal de Physique*, Vol.2, 418-419; and *Annales télégraphiques*, vol.3, 10; all 1883.
4. A.J. Butrica, Ph.D. thesis, Iowa State University, 1986.

The author is indebted to A.J. Butrica of the University of Pennsylvania and P. Carré of France Telecom for the information on which this article is based.

Corrections: Konrad Zuse

Dr Konrad Zuse has provided some corrections to the July article about his invention of the first successful computer. He was born not on July 10, 1910 but on July 22; the Z1 computer's memory was to hold 64 binary numbers of 24 bits, not 16 bits; and, very important, the Z3 was completed in 1941 and the Z4 begun in 1942.

Dr Atherton's previous subjects this year have included the following:

Hidetsugu Yagi and the Yagi-Uda antenna (January, 90).

Harold S. Black, inventor of the negative-feedback amplifier (February, 194).

Harry Nyquist and Hendrik Bode and their epic work on the stability of feedback amplifiers (March, 220).

Russell and Sigurd Varian, creators of the klystron (April, 417).

C.F. Gauss and W.E. Weber, and their exceptional scientific partnership (May, 521).

Alan Turing, the solitary genius who wanted to build a brain (June 582).

Konrad Zuse (July, 732; see note above).

Sir Charles Bright, who spanned the Atlantic with a telegraph cable (August, 810).

Joseph Henry, actor turned engineer and scientist (September, 906).

Next in this series of pioneers of electricity and electronics will be Lee de Forest, inventor of the triode valve.

AN UNBEATABLE COMBINATION



I.R. GROUP AND TEKTRONIX

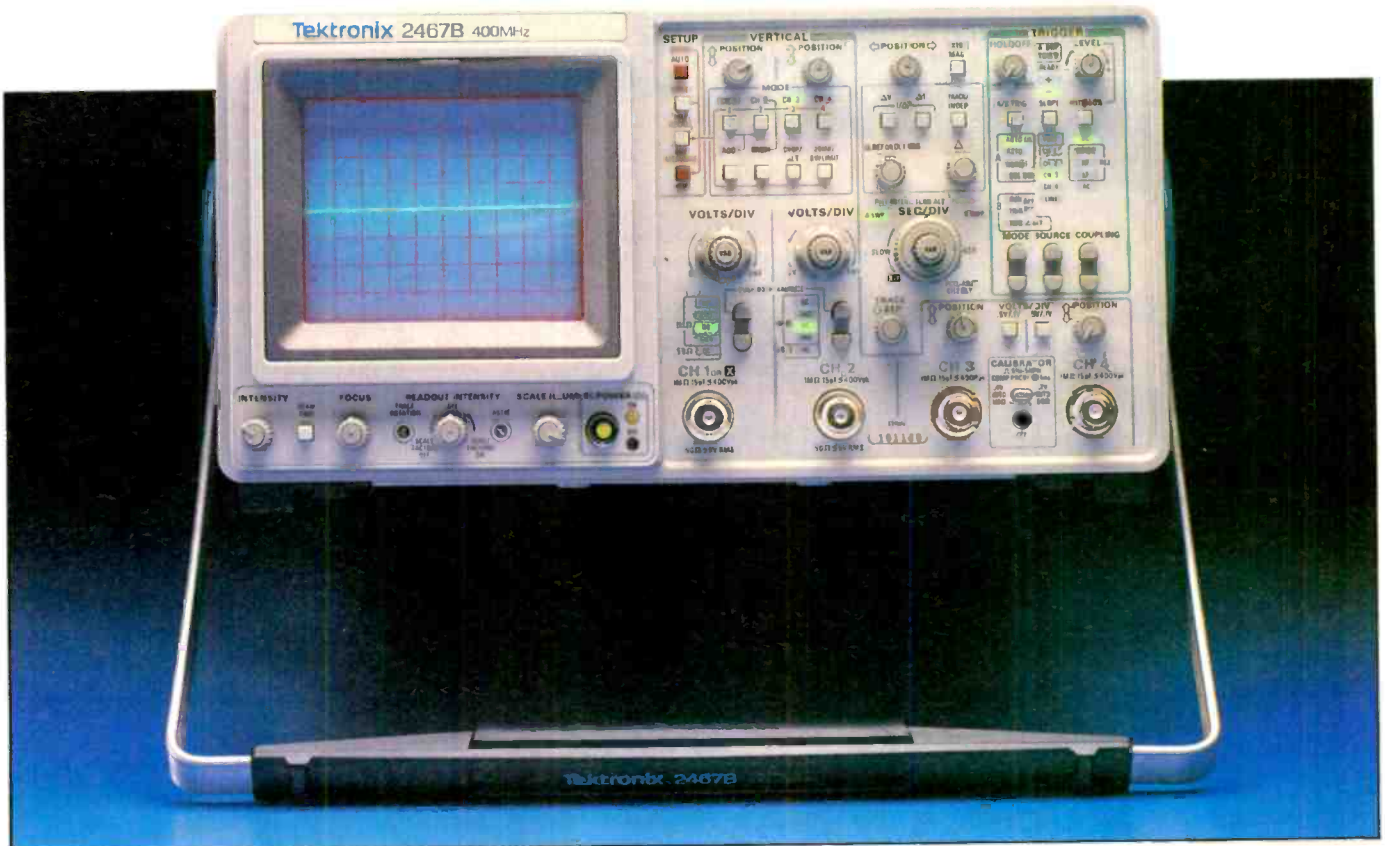

I.R. Group and Tektronix have teamed up to offer you the best possible combination – the quality of Tektronix oscilloscopes, plus the unique one-stop shop benefits and quality service of the I.R. Group.

I.R. Group offers:

- New equipment sales of a wide range of Tektronix portable oscilloscopes. No other distributor has such a quality range, all available from stock for next day delivery if needed.
- Rental of all these Tektronix oscilloscopes for your short-term needs or for one-off projects.
- Leasing, through our unique Lease Purchase Plan.
- Outstanding customer service. One telephone call puts you in touch with one person who can offer you all these services.



IR Group offers these Tektronix products:

- **2400B Series.** The cream of oscilloscopes with real time scopes from the 150MHz 2445B up to the 400MHz 2465B and 2467B. Digital storage models up to the 300MHz, 500MS/s 2440.
- **2300 Series.** A range of high quality 100MHz field service oscilloscopes.
- **2200 Series.** The best quality general purpose oscilloscopes available with real time and digital storage models ranging from 20MHz up to 100MHz.

Tektronix from I.R. Group – it's an unbeatable combination designed to offer you, our customers, an unbeatable service.

CIRCLE NO. 52 ON REPLY CARD

LONDON: 0753 580000 MANCHESTER: 061 973 6251 ABERDEEN: 0224 899522

TEKTRONIX

496P spectrum analyser 1kHz–1800MHz. Complete with tracking generator etc £9500.
 2236 100MHz oscilloscope/counter/timer/multimeter £1000
 2465 300MHz oscilloscope £1750
 2213A 60MHz oscilloscope £375



RALFE - ELECTRONICS

36 EASTCOTE LANE, S HARROW, MIDDLESEX HA2 8DB
 TEL: 01-422 3593 FAX: 01-423 4009

EST.
35
YEARS

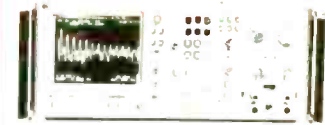

THIS IS JUST A SELECTION FROM OUR STOCK OF SECOND-USER TEST AND MEASUREMENT EQUIPMENT. PLEASE ASK FOR OUR CURRENT FULL RANGE LIST. TOP QUALITY EQUIPMENT WANTED NOW FOR STOCK. WE BUY, SELL AND SPECIALISE SOLELY IN TEST EQUIPMENT.

MARCONI

2019 synthesized signal generator AM/FM 80kHz–1040MHz £2500
 2022 synthesized signal generator AM/FM 80kHz–1040MHz £1850
 2370 spectrum analyser, in-built tracking generator. 110MHz £3500

VARIOUS

FLUKE 5100B calibrator £5950
 IWATZU SM2100 dual-channel audio spectrum analyser. In-built disc drive, GPIB £2950
 ANRITSU MS62D 1700MHz spectrum analyser £3250
 RACAL 9081 AM/FM signal generator 5–520MHz £950
 PHILIPS PM5534 NTSC standard test pattern generator £2500

HEWLETT-PACKARD

3582A dual-channel audio spectrum analyser £3500
 8558B/182T 1500MHz spectrum analyser & main frame £3250
 8559A/181R 21GHz spectrum analyser & main frame £4950
 8565A 40GHz spectrum analyser £8500
 5423A structural dynamics analyser £3000
 5505A laser interferometer £5000
 8165A programmable signal source 1mH–50MHz £1850
 8640B/001 phase-locked signal generator AM/FM 0.5–512MHz £2250

CIRCLE NO. 25 ON REPLY CARD

FROM £247.50
+ VAT*
COMPLETE

PROTEL PCB & SCHEMATIC DESIGN

LOW COST HIGH QUALITY

FROM £247.50
+ VAT*
COMPLETE

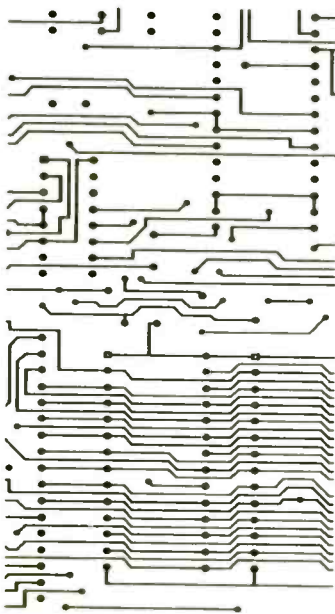

AUTOTRAX & EASYTRAX are the NEW generation of the PROTEL range of Software. Enabling you to produce High Quality Printed Circuit Boards of even Greater Complexity FAST.

AUTOTRAX (Half List Price* £697.50 + VAT). For Auto Component Placement. Auto Track Routing with User Definable Routing Strategies, Routing Grid, Track Width & Pad Size, plus Full Design Rule Checking to User Definable Minimum Clearance. Supports PTH & Surface Mount Printed Circuit Boards up to a 32" x 32" Board Size at 1 thou Res. with 6 Signal Layers, 2 Power Planes also 2 Identification Overlays. 2 Paste Masks. 2 Solder Masks & Drill Sheets. Outputs to a wide range of Plotters, plus Gerber Photoplotter & Excellon N/C Drill Machines are included. With Pull Down Menus for ease of use. FREE Evaluation Disk & Manual available on request.

EASYTRAX (Half List Price* £247.50 + VAT). For manual Routing of Single Sided & PTH Multi-Layer Boards with a wide range of tracks and pads. Outputs to a wide range of Plotters. With Pull Down Menus for ease of use.

SCHEMATIC (Half List Price* £497.50 + VAT). For Schematic layout of circuits, creates connection list used in conjunction with the above PCB Layout packages plus Bill of Materials & Design Error File. Sheet Sizes from A4 to A0 plus A to E. With Pull Down Menus for ease of use. FREE Evaluation Disk & Manual available on request.

Runs on MS DOS Machines (PC.XT.AT.PS2) & Supports Hercules. CGA. EGA. VGA Monitors.

Just one of the many products available from:

J.A.V. ELECTRONICS LTD

Unit 12a, Heaton Street, Denton. Manchester, M34 3RG

Tel No: 061-320-7210

Fax No: 061-335-0119

UK Distributor for the PROTEL Range

Dealers for Ferranti, Amstrad, Roland & OKI Microline.

(*Limited Period Only)

CIRCLE NO. 51 ON REPLY CARD

OP-AMP RUN-DOWN

What's so good about c-mos op-amps?

Most integrated circuits today are c-mos. You wouldn't believe this to be so if you looked only in the analogue manufacturers' data and application books: BJTs seem to be far more popular than c-mos devices for a variety of different but very valid reasons.

But, if low input bias current and a high, almost infinite, input impedance are important in your application, then take a look at the c-mos op-amps such as the OP-80 from PMI. Data sheets of these c-mos op-amps show extremely low input bias currents at 25°C, typically in the 10fA range, which for almost any application would seem to be virtually zero. But, what you might look at closely is how this figure increases with rising temperature; for example, the OP-80 has a quoted maximum input bias current at 25°C of 60fA and this rises to a maximum of 20pA at 125°C, almost three orders of magnitude in a 100°C temperature rise. Quite an increase, but still a very respectable input bias current for 125°C. One version of Murphy's Law states that high speed performance is incompatible with high impedance and the OP-80 does not disprove this, with a gain-bandwidth product of around 300kHz and slew-rate of some 0.4V/μs. Mos op-amps have a reputation of poor input offset voltage, and whilst they cannot get close to the best bipolar op-amps, the figures are quite reasonable at around ±0.5mV.

Chopper-stabilized amplifiers

To achieve the best performance in DC offset and drift, you cannot beat the chopper-stabilized amplifier design, sometimes referred to as an auto zeroing amplifier. Figure 1 shows a simplified diagram of a typical chopper stabilized amplifier. The LTC1052 from Linear Technology Corporation of Milpitas, California. Excellent overall DC features are achievable without the need for high-quality DC performance in any of the gain stages of the amplifier.

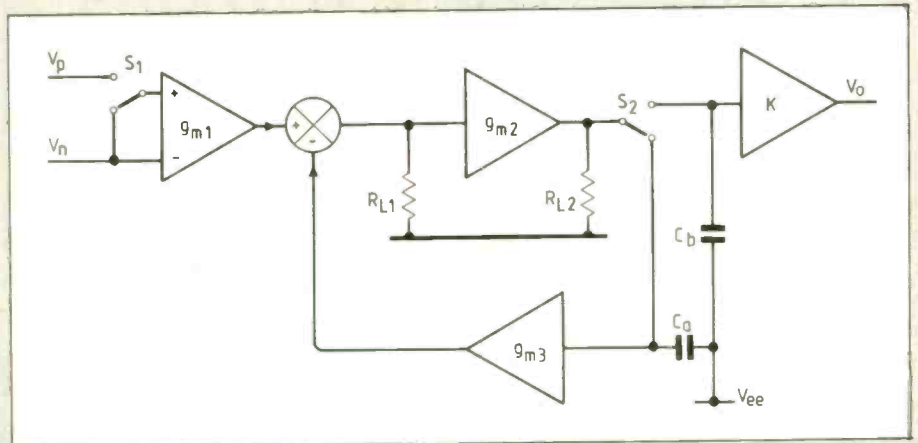

Fig. 1. Simplified block diagram of Linear Technology's LTC1052 chopper-stabilized op-amp.

Switches S1 and S2 are toggled in phase at 330Hz by an internal oscillator (not shown) and the circuit alternates between auto-zeroing and sampling states. Capacitors C_a and C_b together with S_2 form a sample-and-hold function. With both switches down, the input is shorted to ground and C_a charges to the output offset at R_{L2} . Output of the amplifier is directly proportional to the voltage across C_b , this being the voltage acquired by C_b at the end of the previous sampling switch state. When both switches are up, the input is connected to the first transconductance gain stage. The DC offset voltage stored across C_a during the auto-zeroing state is fed back to cancel the output offset voltage, reducing it almost to zero. Not shown in the figure is the additional circuitry needed to provide a feed-forward path at high frequencies and to correct for anti-aliasing errors introduced during the sampling process. Generally the two capacitors are external to the chip, but Linear Technology has recently introduced a new device, the LTC1050, in which the two sample-and-hold capacitors are integrated on to the chip, giving the device excellent performance whilst reducing the external component count. The device features typical offset voltage of $\pm 0.5\mu\text{V}$, drift of $0.01\mu\text{V}/^\circ\text{C}$, DC to 10Hz input noise voltage of $1.6\mu\text{V}$ peak-peak, slew-rate of $4\text{V}/\mu\text{s}$ and gain-bandwidth product of 2.5MHz. Priced at around £2.11 per piece (25-up), the device is certainly very good value if your application requires excellent DC characteristics.

Battery-power instrumentation amplifier

Another new offering from Linear Technology is a so-called micropower instrumentation amplifier, the LT1101, which draws $75\mu\text{A}$ supply current. It is based on the structure shown in Fig. 2, in which all the resistors are on-chip and the gain is set at either 10 or 100 simply by pin selection. The features one would expect from a high quality instrumentation amplifier are all there. However, as you would anticipate from a micropower device, the frequency performance is not high: gain-bandwidth product is around 250kHz. But the particularly interesting feature of this device is that it can be run on a very low DC voltage supply, as low as 1.8V, without loss of gain accuracy. This feature is of real value to the designer of battery powered portable instrumentation, which is one of the key areas for micropower devices.

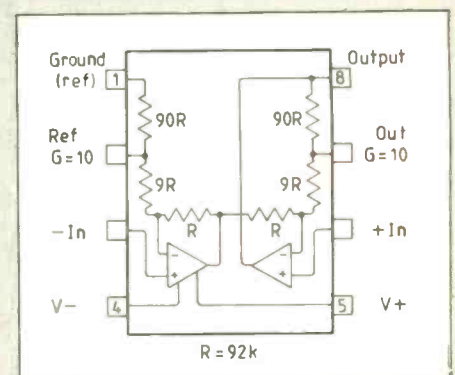

Fig. 2. This micropower instrumentation amplifier runs on supplies as low as 1.8V (Linear Technology).

New topology op-amp

Bob Widlar, father of the ubiquitous current mirror, has recently published his latest work¹, co-written with Mineo Yamatake, on the development of a new fast settling op-amp with low supply current. The design is quite novel and will give its manufacturer, National Semiconductor, a firm lead in what could well be a new generation of op-amps.

The new configuration is based on a fully complementary BJT structure. It promises the precision of the best bipolar op-amps without the usual slew-rate restrictions. In some ways the design is like the transimpedance amplifiers (see *Analogue Action, Electronics & Wireless World* August 1989, 826-7) in that it is capable of delivering high speed with low quiescent current; but no degradation of DC performance occurs in achieving this goal.

The input stage of a conventional op-amp is a simple long-tail pair and it will saturate for relatively small error voltages between the two inputs ($\approx 60\text{mV}$), severely limiting the current available to slew the internal compensation capacitor. Various techniques have been employed to improve slew-rate, such as the use of emitter degeneration, but these techniques reduce the potential open loop gain and as a result DC gain accuracy is sacrificed.

A diagram of the input stage of the new op-amp is shown in Fig. 3. The main difference between the new design and the conventional long-tail pair input stage is that the constant current source has been replaced by a new circuit which functions as a constant current source for low differential input signal levels. Buffers Tr_7 and Tr_8 increase the output current drive capability for higher level

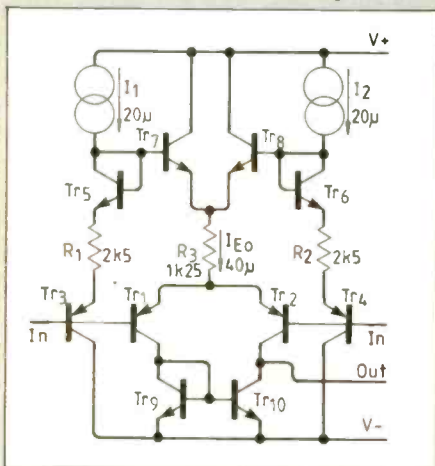

Fig. 3. Slew-boost input stage for National Semiconductor's new LM6218 op-amp.

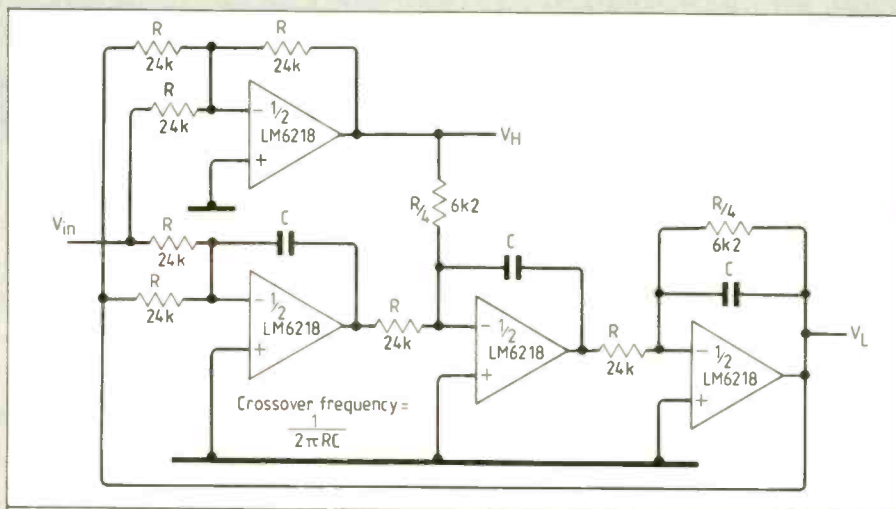

Fig. 4. Outputs of this active loudspeaker crossover circuit, when summed, produce an exact replica of the input signal (National Semiconductor).

differential inputs, which means that the available output current from the input stage to drive the second gain stage and the internal compensation capacitor is not limited to the value of long-tail source.

In the design of bipolar ICs it is common practice to make liberal use of emitter-followers to raise the effective current gain. When a follower drives the base of another transistor, strange things happen at frequencies approaching the f_T of the transistors¹. Even a simple two-stage follower can exhibit high-frequency oscillation, especially with capacitive loads. Computer models are inaccurate close to f_T and cannot be used to predict performance and to date no consistent experimental results have been obtained in attempt to explain these high frequency oscillation phenomena.

To steer round the problem, the manufactured device, the LM6218 (the LM6118 military specification device is due to be released in November) has been designed with fewer emitter-followers than other precision designs.

Large signal test results for the LM6218 show the effectiveness of the new slew-boost technique, with a very clean response and no evidence of any oscillatory tendencies especially for the inverter configuration. Closed-loop voltage-follower slew-rate is $70\text{V}/\mu\text{s}$, whereas the unity voltage gain inverter is $140\text{V}/\mu\text{s}$. The settling-time (0.01%) is 400ns for an output voltage change of 10V. The price for 100-up quantities of the LM6218 is in the region of £3.50 to £4.00.

References

1. R. J. Widlar and M. Yamatake, 'A fast settling op-amp with low supply current', *IEEE Journal of Solid State Circuits*, Vol 24, No. 3, June 1989, pp796-802.

Constant-voltage loudspeaker crossover

Loudspeaker crossover networks, both active and passive, are still keenly debated in the audio world. This active crossover (Fig.4) is one of few that will allow output of a dual-loudspeaker system to truly represent the input signal – in theory at least.

When added, high and low outputs of a constant-voltage crossover produce an exact replica of the input signal, unlike most conventional crossovers. In practice of course, driver voice-coil alignments and driver delays come into play, but that applies to any crossover network. The main drawback of this undoubtedly neat little circuit is that it has a roll-off of only 12dB/octave.

Apart from the op-amp type, this crossover circuit from the LM6118/6218 data sheet is identical to one in National Semiconductor's 1986 applications handbook. In the data sheet, there is no reference back to the original application note and no information on the revised circuit's operation or advantages.

In the original circuit, the LM833 low-noise dual op-amp was used. It has a 15MHz gain-bandwidth product, 0.002% distortion and $7\text{V}/\mu\text{s}$ slew rate. The 6118 has a 17MHz gain bandwidth product, $140\text{V}/\mu\text{s}$ slew rate and a similarly low distortion figure. Its input noise figure seems higher (its noise is not specified in the same way), but on the other hand it can output higher currents.

Analogue Action is written by John Lidgey of Oxford Polytechnic.

Random-time security light

Unlike commercially available units, this night-time security light has a pseudo-random lighting up time.

During daylight, IC₃ is clocked by oscillator IC_{1c}. When darkness falls, output of IC_{1a} goes low, stopping the oscillator. Device IC₃ stops with a random count.

At the same time, the relay is activated, turning the lamp on, and the reset signal to IC₂ clears, allowing it to start counting. Four bits of this count are compared with four bits of the random count, by IC₄. When equal, and when output O₁₂ of IC₂ is high, the equality output goes high. This output is used to stop the oscillator, so that IC₂ stops counting, and is also used to turn the relay off.

Nothing more happens until daylight, when the circuit resets. The count on IC₂ will be,

$$I \text{ xxxx } 0000 \text{ } 0000$$

where xxxx is the random four-bit count on IC₃, hence the lamp will be on for 1000_{16} to $1F00_{16}$ counts.

The time for one count is approximately $R_1 \cdot C_1$ so, with $C_1 = 10\mu\text{F}$ and

$R_1 = 180\text{k}\Omega$, the lamp will be on for between 120 and 230 minutes.

Ensure that the light sensitive detector is positioned so that light from the

lamp does not fall on it. Adjust the potentiometer so that the lamp switches on at the desired darkness level.

D. Stewart, Aberdeen

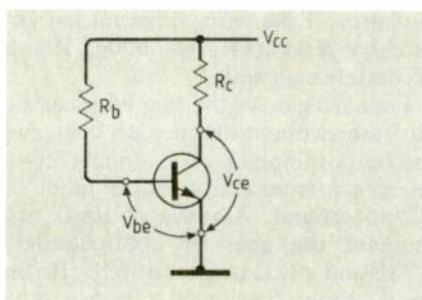
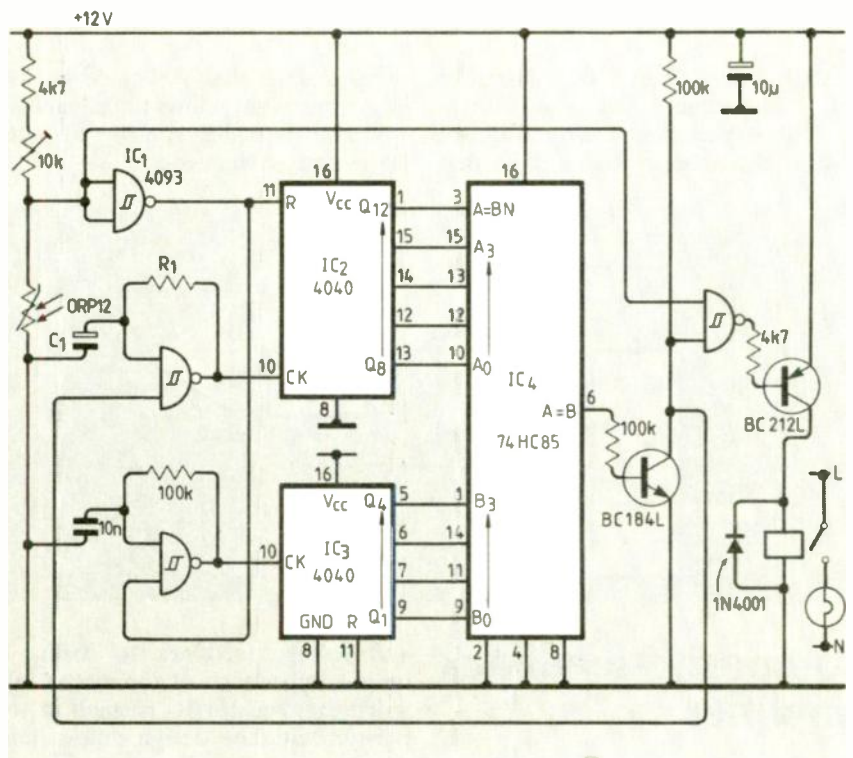

Transistor tester cum h_{FE} meter

We developed this inexpensive circuit for checking transistors and measuring h_{FE}.

In all transistors,

$$|V_{ce(sat)}| < |V_{be(sat)}|$$

and when $V_{ce} = V_{be}$, the h_{FE} of a transistor can be calculated from values of resistances R_b and R_c. Assuming a transistor in its active region,

$$\begin{aligned} V_{ce} &= V_{cc} - I_c R_c \\ &= V_{cc} - I_b h_{FE} R_c \end{aligned}$$

also,

$$V_{be} = V_{cc} - I_b R_b$$

$$\begin{aligned} \text{and when } V_{ce} &= V_{be}, \\ h_{FE} &= R_b / R_c. \end{aligned}$$

Resistances R_b and R_c are varied until the condition $V_{ce} = V_{be}$ is indicated by a change of state in the top led. At this point, R_b is divided by R_c to calculate h_{FE}.

To test a transistor, set the switch to position six from position one and look for a change in the state of the top led; if the led does not change state, the transistor is faulty.

Just because the led changes state, it does not necessarily mean that the transistor is fully functional. With the switch

in position six, close the switch; if the bottom led lights (or extinguishes in the case of a p-n-p device), the transistor is functional. In this second test, reference voltage V_R is slightly less than the V_{cc} of a normal transistor with zero base current.

The circuit is suitable for both silicon and germanium transistors, and does not suffer from errors associated with circuits that use diodes for V_{be} compensation.

A. Karnal and K.C. Tripathi
Bhabha Atomic Research Centre
Kashmir
India

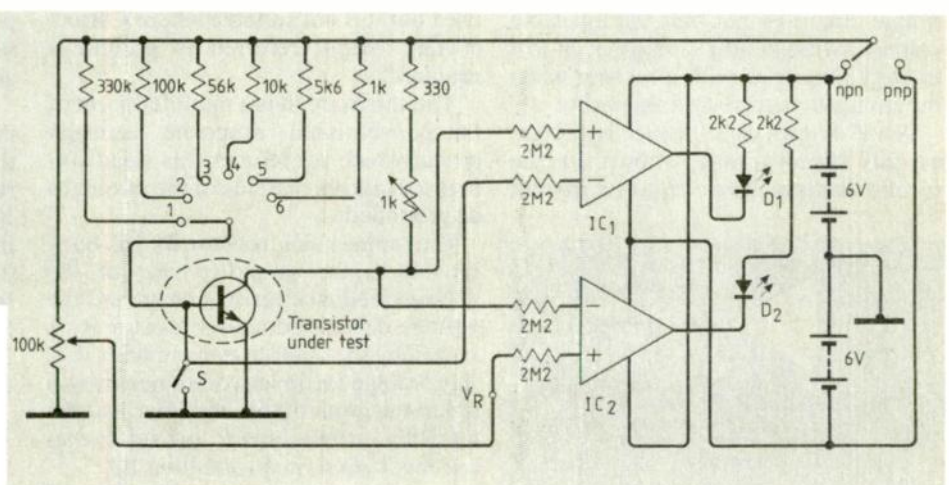

Z80-compatible FSK transmitter

Recently I needed an FSK transmitter that could be controlled by a Z80 system. The requirement was total control of channel frequency and shift so that

non-standard channels could be used. This transmitter allows full channel and shift control while requiring no setting up in terms of frequency.

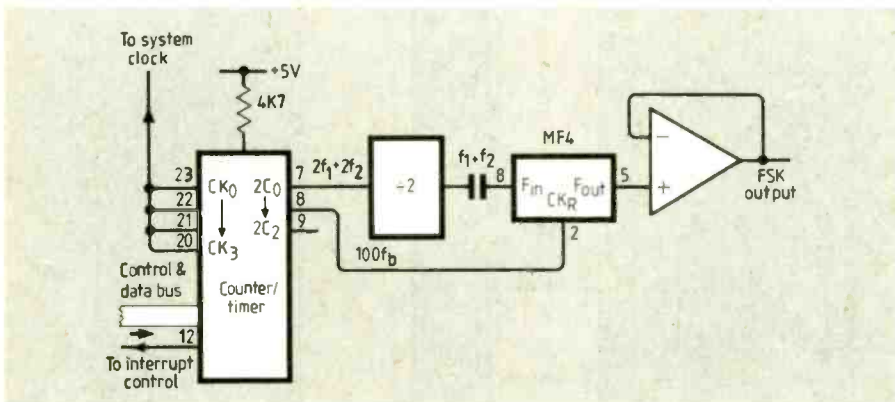

The circuit uses three channels (Z_0 , Z_1 , Z_3) of a Z80 counter/timer. All three channels are used in the counter mode; Z_0 is the FSK output. To create the two frequencies required ($f_1 + f_2$), channel Z_0 is loaded under interrupt control with the two constants required to create the shift. Channel Z_3 produces an interrupt signal at the required bit rate. When an interrupt occurs the output channel is loaded with a constant relating to twice the output frequency required. This pulsed output is divided by two to obtain the correct square wave output.

Channel Z_1 controls the break frequency (f_b) of the MF4 low-pass filter, used to remove the unwanted harmonics from the divider.

D.J. Viriden
Leeds

Composite-feedback amplifier

There are several methods of defining the output impedance of an amplifier. In the simplest method, shown in the first diagram, output source impedance is mainly defined by the series resistor. The main objection to this simple circuit is that half the available voltage swing of the amplifier is lost through the series output resistor when the circuit is correctly terminated.

A well known circuit which overcomes this disadvantage, shown in the second diagram, uses composite current

and voltage feedback to define the output impedance of the circuit. Provided that resistor R_3 is small in comparison with the design output impedance, virtually all the voltage developed across the amplifier is available at the output. However with this configuration neither side of the output is at ground potential. This presents no problems if an output transformer is used but it is not suitable where a direct current output referred to ground is required.

The third circuit is a modified form of the conventional composite feedback circuit which overcomes this disadvantage and allows one side of the output to be grounded.

Current sensing resistor R_3 has been moved to the amplifier side of the voltage-feedback resistor chain and the voltage developed across resistor R_3 is sensed by the operational amplifier IC_2 . The voltage feedback component is also fed to the input of this amplifier and the resulting output used to provide negative feedback to main amplifier IC_1 .

With the component values shown the amplifier has a gain of 13.6dB when terminated with a 600Ω load and an output impedance of 600Ω to within 3% up to 100kHz.

In practice, performance of the amplifier corresponds well with the predicted performance and our model showed no sign of instability when terminated with various complex load impedances. Take care, however, to ensure that resistors R_5 , R_7 and R_4 , R_6 are accurately matched.

Forward gain of the amplifier can be increased without significantly changing the output impedance by connecting a resistance from the negative input of IC_1 to ground. A value of 10kΩ will increase the gain by approximately 0.7dB and a 1kΩ resistor by 6dB. Resistor R_8 allows frequency response to be limited by connecting a capacitor from the output of IC_1 to its negative input terminal.

A.J. Chamberlain
(no address!)

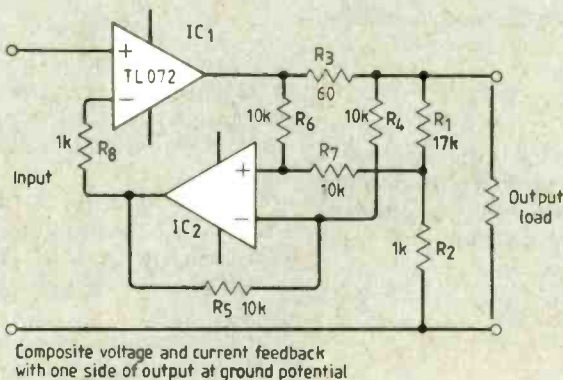
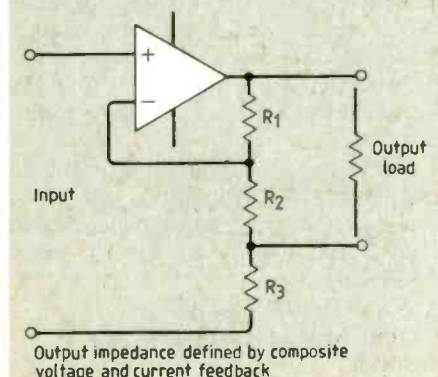
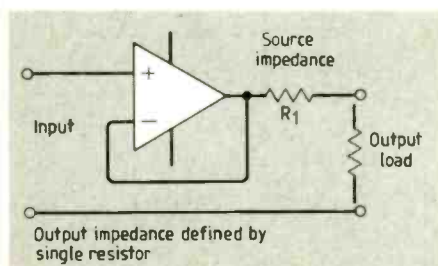

Minimum power radio telemetry

In March 1966, *RCA Review* described an experimental project to develop a pocket HF transmitter suitable for such emergency applications as enabling an aircrew, after an emergency landing or crash, to report their position by radio. The transmitter had an output of only 100mW and sent data at the very low speed of three bits per minute. To achieve a high degree of frequency stability the crystal was specially cut for a zero-temperature-coefficient turnover at 99°F (body temperature) mounted in a small enclosure held under the user's armpit to avoid the power loss of a crystal oven. In addition, because the bandwidth of the receiver at base was only 0.75Hz, the transmitter frequency was arranged to sweep over a band of 20Hz. During trials, using frequencies between 13 and 16MHz, messages were received reliably over distances up to 2000 miles. I do not think this equipment ever went into production for either military or civilian applications, although it may possibly have done so for use in Vietnam.

The lower noise floor that can be used for VHF receivers favours the use of even lower powers than 100mW. In 1980, A.L. Mynett, ZS6BMS/G3HBW pointed out to me that he had found that 10mW output on 144MHz can, without any very special techniques, be quite easily received over clear, but not necessarily optical, paths of up to 45km using only dipole antennas at each end. Signal strengths suggested that a range of at least 70km could be covered in this

way – results, he felt, substantially in agreement with standard propagation theory.

I was therefore interested to learn from Ray Scrivens (Minisig Systems Ltd, Unit 6E, Aberystwyth Science Park, Cefn Llan, Aberystwyth, Dyfed SY23 3AH, 0970-625650) that his company has been working for some time on the development of very narrow bandwidth radio data transmission with extremely low-power transmitters. Its first system, for commercial telemetry applications, operates in the de-regulated band 173.2 to 173.5MHz. Since the transmitter has an output power of only 1mW, and is approved to DTI specification MPT1328, it can be used over distances of 20-40km in normal terrain, not necessarily line-of-sight, without the user's having to apply for a licence.

Ray Scrivens writes: "The receiver incorporates a digital signal processor which operates on the audio output of a fairly conventional RF section. The DSP identifies the wanted signal, which is processed through a filter with an effective bandwidth of about 1Hz. Because of this, when compared with a conventional receiver with a 6kHz bandwidth, our system can operate with input signals some 38dB weaker, so that

the 1mW transmitter output becomes equivalent to a conventional 6W transmitter. This has been borne out in practice; we have a trial system operating in Northumberland with several links operating over obstructed paths of 15 to 25 miles with simple dipole antennas at the transmitters and a 3dB-gain vertical co-linear antenna at the receiver.

"Of course, the data rate has to be very low (one bit every seven seconds) but there are many applications where the parameters being measured can inherently change only slowly (e.g. meteorological conditions, rivers/reservoir levels etc.) or where some fairly long-term monitoring is required. With the availability of low-power microprocessors, data can be pre-processed at the remote site so that the amount of data which needs to be transmitted is decreasing, contrary to the present trend in data communications where everyone seems to think that it is necessary to transmit at ever increasing rates!

"The technical difficulty with very narrow bandwidths is finding a technique by which the receiver can identify and lock on to the signal in a reasonably short time. In a normal receiver bandwidth the incoming signal is well below the noise level and, due to oscillator inaccuracies at both transmitter and receiver, its precise frequency is indeterminate. Digital signal processing has provided us with an answer at quite low cost.

"Channel spacing with such a system

Some applications for telemetry at low data rates using VHF transmitters of only 1mW output. Ranges of 20-40km can be achieved in normal terrain: a line of sight is not necessarily required.

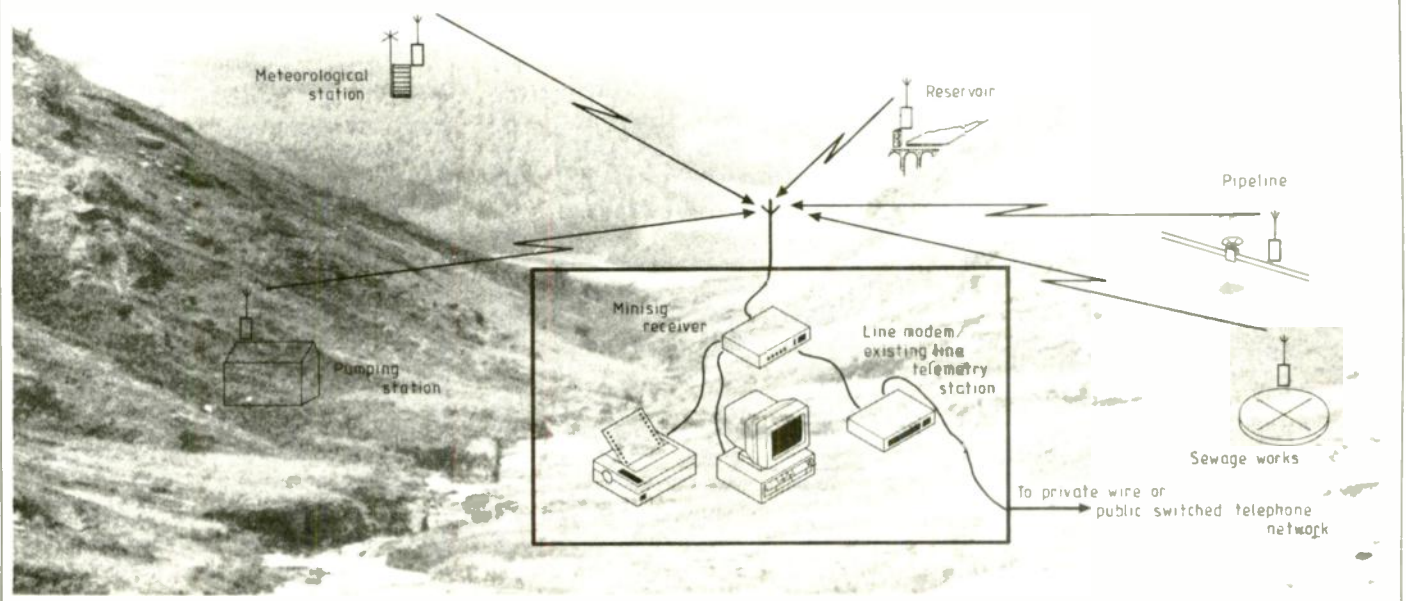

is determined almost solely by the frequency stability of the transmitter oscillator. At present we are able to operate on five sub-channels, spaced at 2.5kHz intervals, within each standard 12.5kHz channel.

"The idea of the system originated in amateur radio with the desire to exploit tropospheric scatter propagation using low-power transmitters. We were able to communicate between mid-Wales and Sussex on the 144MHz band in 'flat' conditions using a 5W transmitter and a simple antenna. Admittedly it took about three minutes to send a three-digit number! With signals exhibiting the considerable fading of tropo-scat for most of the time they were completely inaudible even through a narrow-band CW filter. Error correction coding was used to ensure that the odd missed bits would not corrupt the whole message. Preliminary calculations indicate that it should be possible to operate moon-bounce (Earth-Moon-Earth) using the system with reasonable transmitter powers and antennas. All we need now is the time to do it!

According to the Minisig brochure, transmitter power consumption of their first system is very low (an important consideration for remote sites). In a typical reservoir-monitoring application, transmitting the water level every hour, the mean current drain is about 6mA from 12V battery. With the addition of a small solar panel and charging regulator, the transmitter could easily be made self-sustaining. The receiver can separately identify and recover data from up to 33 transmitters operating in time-multiplex on the radio channel.

Oscillators – limitations and dynamic feedback

Professor Michael Underhill (Philips-MEL) has recently pointed out (IEE Conference Publication No 303) that there is a continuing need for better purity and stability of oscillators, particularly as the frequencies of operation of communications and radar systems extend ever higher. While he notes that in principle oscillators can be made more stable by better control of the physical elements that determine the frequency, the presence of phase noise is fundamentally inescapable. Phase noise can be reduced relatively to the desired output by operation of oscilla-

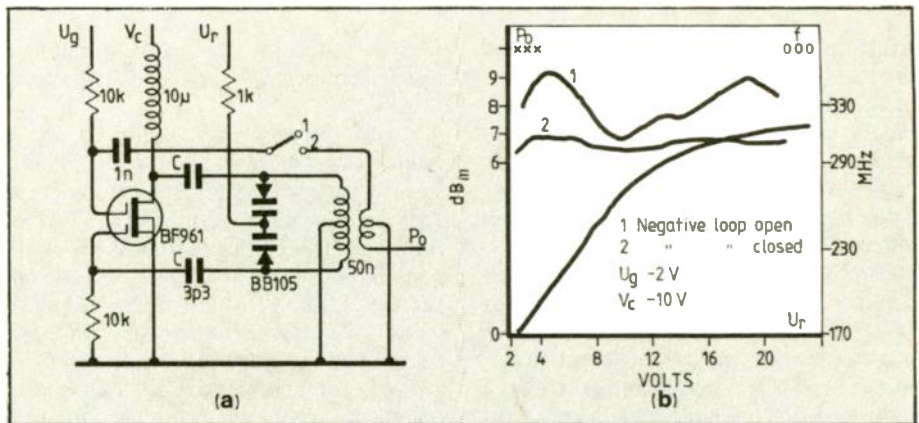

Experimental VHF voltage-controlled oscillator from Poland and (below) its performance. The design has switchable negative feedback.

tors at higher power or at least higher stored energy (PQ^2) but such an approach is eventually limited by physical breakdown of the components.

He suggests that probably the only parameter of oscillators which remains to be fully explored lies in low-temperature operation. Cryogenic temperatures would not only reduce the amount of noise produced in a given resistor but would also generally reduce the value of the resistor. However, although he believes that low-temperature operation remains an interesting area to be explored, he concludes, "It is highly probable that further physical barriers and limitations will prevent the perfect oscillator from ever being achieved".

Also at the IEE frequency control and synthesis conference, E. Efstathiou and Z. Odrzygodz (Warsaw University of Technology, Polish Academy of Science) described a more workaday approach to a voltage-controlled VHF oscillator with negative dynamic feedback. They recall that the idea of negative dynamic feedback in oscillators was studied by J. Groszkowski (1952) who showed that this could reduce the higher harmonic content, permitting a better frequency stability to be achieved.

In their paper, negative dynamic feedback is applied to a simple voltage-controlled oscillator based on a dual-gate mosfet type BF961. In such oscillators the frequency range is strongly dependent on the gain parameters of the active element as well as on the Q of the resonant circuit. They consider that it is sufficient to prove that the amplitude of an oscillator with negative dynamic feedback is rendered insensitive to these influences. Moreover, they point out, such an oscillator can be dynamically controlled and holds the Class A

mode, thus reducing the level of the higher harmonic components.

Their experimental VHF octave-range VCO is shown in the diagram. Output variations in an octave frequency range did not exceed ± 0.3 dB, with the second harmonic -55 dB. With the negative feedback loop open the output power level varied by ± 2.5 dB over the tuning range while the second harmonic was about -35 dB.

Radio physics and Auroral Oval

The sixth National Radio Science Colloquium (NRSC6), organized by the soon-to-be-disbanded British National Committee for Radio Science (URSI) and held this year at Southampton University, reflected the tightened purse strings of British radio-physics research. This year, the 30 papers in a single stream of six sessions were largely drawn from a limited number of universities plus a few from NPL, DTI and RAL. Only a single ERA paper on EMC standards came from a quasi-commercial organisation. Most of the projects appeared to involve at least an element of Defence funding.

The National Committee, as a committee of the Royal Society, is one of a number facing dissolution as an economy measure; however, it will continue as a panel, rather than the single URSI representative originally proposed by the Royal Society. It is hoped to continue the annual NRSC, which is less costly for participants than the more formal IEE conferences.

Professor Tudor Jones outlined the major new SERC initiative in proposing a scientific radar within the northern polar cap, possibly to be located at

Longyearbyen, Spitzbergen, at an appreciably higher geographic and geomagnetic latitude than the existing EISCAP radar installation in northern Norway.

Spitzbergen would provide access to active areas of the Auroral Oval region of intense ionospheric disturbances under all conditions and could provide an important new research tool. SERC believes that the most cost-effective installation, costing about £12 million, would comprise three fixed monostatic 32-metre dishes (one megawatt at about 1GHz) looking in different directions. SERC would provide about £2M and is seeking to co-operate with international partners, including Japan and USA possibly replacing France of the EISCAP partners (UK, West Germany, France, Scandinavian group).

Meanwhile, research into HF propagation within and across the Auroral Oval is continuing at Leicester University, based on beacon transmissions from Clyde River, Baffin Island, Canada (about 70° North). Automatic transmissions on 14 frequencies arranged as two sets of frequencies spread through the HF spectrum (3185/3230, 4900/5200, 6800/6905, 9941/10 195, 13 886/14 373, 18 204/17 515, and 20 900/20 300kHz) come from an Icom 735 amateur-grade transceiver with Icom 2KL linear amplifier providing an output of about 350W to a vertical trapped monopole antenna. The 735 is used with a very-high-stability reference oscillator to permit accurate measurement of Doppler spreads.

Transmission format includes two-minute transmissions on each frequency with callsign in Morse, 30 seconds continuous carrier and 30 periods of Barker-coded pulses (PSK) to provide time dispersion. These signals are received across the Auroral Oval at Leicester on a modified Racal RA6790 receiver (300Hz bandwidth) using a long-wire sloping-vee antenna, and also at Thule, Greenland, where the entire path is within the polar cap.

Preliminary results have been described at NRSC and at ICAP89 (E.M. Warrington, T.B. Jones, S.M. Orrell). Fig. 3 shows how reception across the Auroral Oval is highly vulnerable to ionospheric disturbances. When a geomagnetic disturbance occurs, reception is affected strongly on the day following the onset of the disturbance; the deterioration in HF propagation appears to be more closely correlated with direct observations of auroral

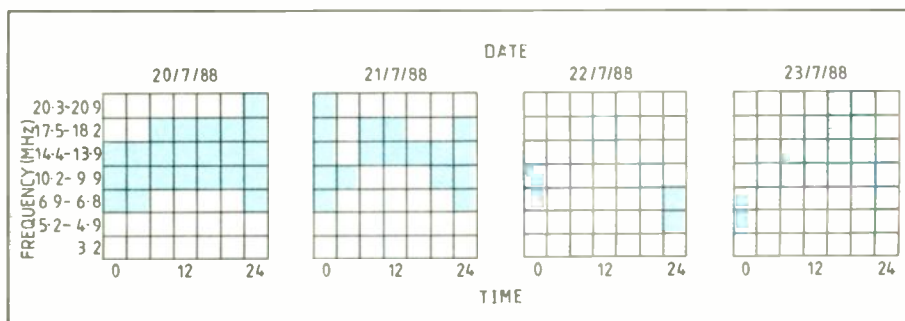

Reception times and frequencies of the Clyde River (Baffin Island) beacon transmissions, monitored at Leicester over a four-day period. A severe disturbance began on the second day. (University of Leicester).

activity than with the magnetic index.

The frequency of the received signals is often observed to spread over some ± 10 Hz, presumably because of Doppler shift from reflection by travelling ionospheric disturbances (TIDs), although it has not been possible to relate the frequency dispersion to any well-defined feature of the auroral ionosphere or to any changes in geomagnetic or auroral activity. Prof. Jones emphasized that HF signals along such paths are subject to a whole zoo of scattering elements: "Distorted wavefronts present serious problems with adaptive (communications) systems".

The Leicester team, working with computer modelling and the experimental use of the large Canadian Wullenweber D/F (direction-finding) antenna at Ottawa, has developed a new algorithm that improves HF D/F results. Improvements have been secured by including in the modelling the generation of a quality factor to indicate the reliability of individual measurements. Reception at Ottawa of CFH Halifax on 8197kHz suggests that a useful improvement can be achieved as a result of the ability to discard part of the spread of measurements.

At Hull University, advanced synchronization techniques for MFSK modems are proving successful. These require no specific synchronization "overhead" in the transmitted signal, but function entirely using the unmodified, information-bearing signal formats: if the transmission is interrupted or if the propagation delay changes suddenly, recovery is automatic. Three techniques have been investigated: modulation-derived synchronization (MDS); code-derived synchronization (CDS); and code-assisted bit synchronization (CABS). A modem for systems operating at 250bit/s has been implemented on a single TMS320C25

digital signal processor board.

Dr L. Kersley (University College of Wales) spoke on recent observations of Sporadic E propagation based on the reception of East European FM broadcast stations (about 70MHz) as received at a network of stations in the East Midlands spaced from 8 to 80km. Little correlation is observed with these spacings and further studies are being made with the spacing between receivers reduced to less than 10km. The team supports the wind-shear theory of the formation of SpE clouds of ionized particles. Vertical movements of ionizations occur when a horizontal wind blows across the magnetic field.

SpE layers form at height where the plasma flows towards the layer from both above and below, i.e. at nodes in the vertical ion velocity profile. Within the conventional structure of thermosphere winds, the nodes or nulls move progressively downwards, taking the layer with them. However, short term changes in the velocity pattern, perhaps due to interfering gravity waves, may interrupt the slow descent, with short term upward and downward movements, fading and reforming. Maxima occur in the morning and afternoon, with a preference for summer months.

The team has found no evidence of "two-hop" SpE modes such as those to which amateur summer-time transatlantic contacts on 50MHz have been ascribed: these have been thought not necessarily to involve intermediate ground (sea) reflection, but rather to take the form of a "chordal hop", with signals launched into and out of such entrapment by tilted SpE clouds. Many questions concerning long-distance VHF propagation in SpE conditions remain unresolved. ■

RF Connections is compiled by Pat Hawker

8051 Project....?

From simple minimum chip solutions through to complex turnkey multiprocessor systems, Cavendish Automation has the hardware and tools to allow you or us to design rapid and professional implementations.

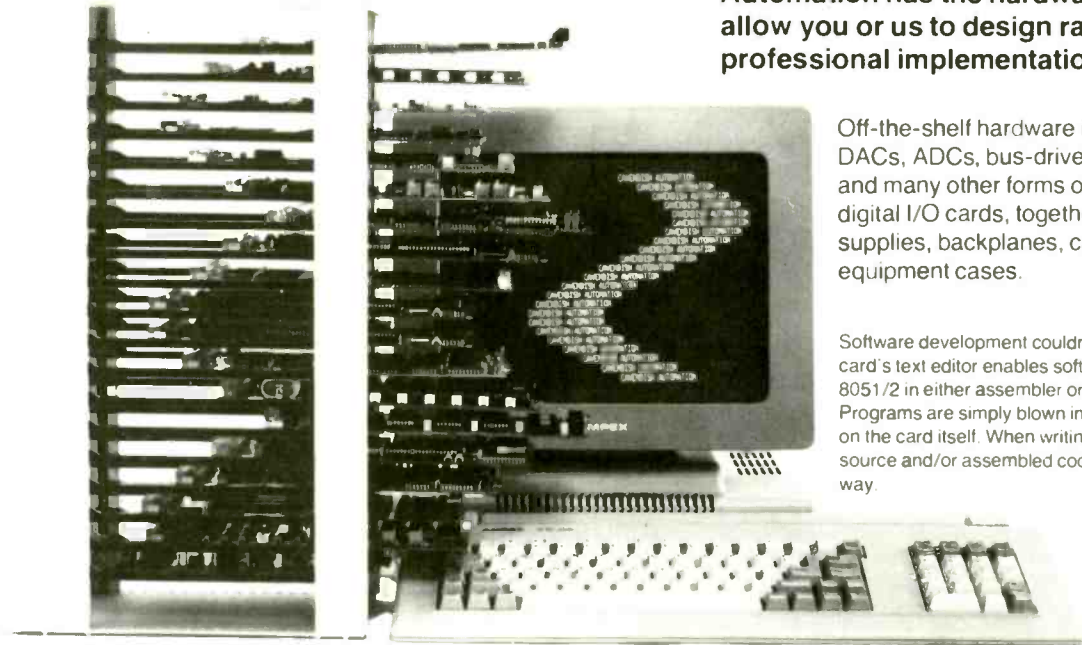

Off-the-shelf hardware includes numerous DACs, ADCs, bus-drivers and decoders, and many other forms of analogue and digital I/O cards, together with power supplies, backplanes, card cages and equipment cases.

Software development couldn't be easier. Our 7034 card's text editor enables software development for the 8051/2 in either assembler or MCS-52 BASIC. Programs are simply blown into EPROM or EEPROM on the card itself. When writing in assembler, both source and/or assembled code may be saved in this way.

For further information contact:

Cavendish Automation

Cavendish Automation Limited
Oak Park, Barford Road,
St. Neots, Huntingdon, Cambs PE19 2SJ.
Telephone: 0480-219457
FAX: 0480-215300 TELEX: 32681 CAVCOMG

CIRCLE NO. 53 ON REPLY CARD

512K EPROM

27C512 - 25DC

- 64K x 8 BITS
- CERAMIC PACKAGE
- ERASABLE

£7.59

EACH • INC. VAT

X-STOCK

FOR IMMEDIATE DESPATCH

Please add £1.00 p&p per order

Cheques and Postal Orders made out to:

Ambar
cascom Ltd

Rabans Lane, Aylesbury,
Bucks HP19 3RS

CIRCLE NO. 58 ON REPLY CARD

BOARDMAKER - the price performance leader

If you are looking for the solution to your PCB layout and schematic drawing problems - BOARDMAKER has all the answers. One integrated package provides a powerful, full-featured, layout and schematic editor that lets you design and document your PCB layouts, all at a down-to-earth price.

Some of BOARDMAKER's power features -

- Easy to learn and use
- Full WYSIWYG display
- Ultra-fast zoom, pan and re-draw
- Interactive placement and routing
- Auto via hole placement
- Auto line optimisation
- Handles multi layer boards - 10 available layers including silk screen idents
- Comprehensive surface mount support
- Screen drivers for CGA, EGA and VGA displays
- Extensive user definable symbol and layout macro facilities
- Sensible user interface - use a mouse or keys to access the menus
- Manual includes a user guide and full command reference

Standard outputs included in the package

- Dot matrix printer - 9 and 24 pin Epson or compatible
- Laser printer - HP Laserjet II emulation
- Penplot - HPGL or DMPL plotter support
- Photoplot - Gerber format
- NC drill - Excellon format

Tsien provide a full after sales support and software update service.

Requires an IBM PC/XT/AT or 100% compatible inc. Amstrad 1512 & 1640

BOARDMAKER costs only £195 + VAT

Write or phone today for your **FREE** demonstration disc
Corporate, education and dealers - ring for details

Tsien (UK) Ltd, Cambridge Research Laboratories, 181A Huntingdon Road, Cambridge
CB3 0DJ Tel. 0223 277777 (4 lines) Fax. 0223 276444

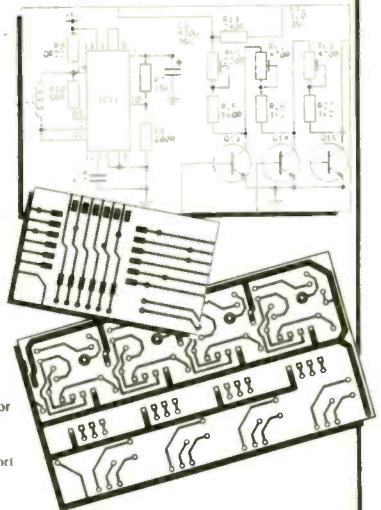

CIRCLE NO. 57 ON REPLY CARD



Field Electric Ltd. Tel: 01-953 6009.
3 Shenley Road, Borehamwood, Herts WD6 1AA.
Fax: 01-207 6375, 0836 640328

SPECIAL OFFERS

NEC 9" Green Screen Monitors 75 Comp Video Input Plastic case with handle. 240 VAC input 20 MHz bandwidth. £24.95 c/p 500
 Motorola TTL Monitor Chassis 7" Green Screen 22 MHz bandwidth 12 VDC input new & boxed with circuit dia compatible with IBM/BBG computers £25.00 c/p 400
 Mitsubishi M485 4 new 1/2" height disk drives 80 track d/sided d/density 360 rpm no motor. £40.00 c/p 300
 Laser 3" disk drive some into new & boxed £110.50 c/p 200
 MP full height floppy disk drives 40 track single sided 10.95 c/p 150
 Cherry TTL alpha numeric ASCII coded keyboard including 8 colour coded graphic keys 108 keys form a y Matrix full colour control & encode keys 5V rail new 5.75 c/p 325
 Black & White monitors with new tubes fitted 12" comp video input. £57.00 c/p 675
 Astrakru Pro headphones 6mm mono jack fitted new & boxed 200 ohm imp. £15.00 c/p 225
 Astrakru pro headphones 8mm mono jack fitted with built in boom mic ideal for communications £30.00 c/p 225
 Tandberg series 5000 reel to reel tape recorder chassis 15.95 c/p 450

HEWLETT PACKARD/TEKTRONIX EQUIPMENT

HP693D Sweep Oscillator 4/8 GHz. £475.00
 HP88 Sig Gen 50 Hz to 100 MHz
 HP486A Thermistor Mount £115.00
 HP1900A Pulse Generator System £375.00
 HP6518B Test Oscillator 10 MHz £200.00
 HP3450B Multifunction meter £200.00
 HP62605MD DC PSU 5VDC 100A £60.00
 HP Voltage Divider Probe 1000A0 New. £85.00
 HP343C 431C power meter 10 MHz/40GHz £40.00
 HP3330B Auto/Synthesizer 0.1 Hz £250.00
 HP86A Personal Computer New/Boxed £195.00
 HP82901S 2 x 5.25" d/drives new cased £200.00

GENERAL TEST AND MEASUREMENT EQUIPMENT

Marconi Inst 13 Universal Bridge 1:1:3A £200.00
 Fluke AC/DC Differential V. Meter £100.00
 Datron 1030 RMS digital voltmeter. £125.00
 Solartron frequency response analyzer 1310 £250.00
 Feedback variable phase OSC. 100KHz £100.00
 HML 411 capacitor charger 20kV new. £1000.00
 Devices instantaneous ratemeter 2751 £40.00
 Bet & Howell datalist call unit for FM £220.00
 Dase type 12090 transistor strobe £60.00
 Singer Genetsch phase angle w/meter £200.00
 Advance INST PDS2A pulse gen. £100.00
 Ungor 3P Multimeter £50.00
 Philips PM5168 function gen. £50.00
 SE Labs D Scope EM102 15MHz D/Trace £160.00
 Watanabe MD611 S2L multicoiler £50.00
 Radwinck 3.25" pen chart recorder £50.00
 Advance SG62B signal generator £50.00

COMPUTER EQUIPMENT

Altos Computer Systems DMAB002E £120.00
 DEC Rainbow 100A £120.00
 DEC PC350 Model WF32528 £200.00
 Ferranti F100V. Digital Micro £150.00

We would like the opportunity to tender for surplus equipment
 Official Orders/Overseas Enquiries Welcome/Order by phone or post. Open 6 days. Postal rates apply U.K mainland only. All test equipment carries warranty. All prices include 15% VAT unless stated. Phone your order for quick delivery. Access. Amex. Dinners. Visa accepted. We can supply telephone and some audio equipment, electrical and aerial equipment, much more than is shown in our ad. Please ring.

CIRCLE NO. 16 ON REPLY CARD

HEWLETT PACKARD OSCILLOSCOPE TYPE 1740A

Dual trace 120MHz Delay Sweep Trigger View £375

OSCILLOSCOPES

TEKTRONIX 2445A Four Trace 150MHz Dual 1B As new £2,000
 Manufacturer's guarantee (8 Feb 91)
 £375
 TEKTRONIX 2225 Dual Trace 50MHz Delay Sweep £475
 TEKTRONIX 2215 Dual Trace 60MHz Delay Sweep Dual TB £400
 TEKTRONIX 2213 Dual Trace 60MHz Delay Sweep £400
 TEKTRONIX 475 Dual Trace 200MHz Delay Sweep £650
 TEKTRONIX 465 Dual Trace 100MHz Delay Sweep £500
 TEKTRONIX 401 Four Trace 50MHz Delay Sweep £400
 TEKTRONIX 454 Four Trace 150MHz Delay Sweep £600
 HITACHI 350R Dual Trace 100MHz Delay Sweep £550
 PHILIPS PM3262 Dual Trace 100MHz Delay Sweep £475
 PHILIPS PM3212 Dual Trace 75MHz £250
 TELEQUIPMENT DB3 Dual Trace 50MHz Delay Sweep £250
 TELEQUIPMENT DP25 Dual Trace 50MHz Delay Sweep £275
 K. KUSUMI 9530A Dual Trace 35MHz £250
 HAMEG Z0 4 Dual Trace 15MHz £240
 HP 1220A Dual Trace 15MHz £200
 GOULD ADVANCE DS1100 Dual Trace 30MHz £210
 GOULD ADVANCE DS255 Dual Trace 15MHz £210
 COSSOR C04150 Dual Trace 15MHz Delay Sweep Solo £180
 Portable 8" 10cm display £10
 Optional unit over containing 21 tubes 1
 SE LABS SM 111 Dual Trace 15MHz Solid State Portable All £150
 external DC operation 8" x 10cm display £1300
 TEKTRONIX 647A Dual Trace 100MHz Sweep Delay £300
 GOULD AD/AMC OS3000A Dual Trace 10MHz Delay Sweep £300
 TRIO CSI 565A Dual Trace 20MHz £550
 TEKTRONIX 466 Storage Dual Trace 100MHz £375
 GOULD OS-4000 Digital Storage Dual Trace 10MHz with Output In X-Y £350

MARCONI V106 Radio Test Set TF2950 £650
 DARTON 145 Auto Digital M. Meter £450
 RACA DAHA 6002 Microprocessing Digital Multimeter 6 1/2 digit £185
 BOONTON 230A Power Amplifier x 500MHz Output 45 W x 15 plus £200
 FEEDBACK 1W610 Digital Freq Meter 0.001MHz 10M Hz £500
 MARCONI SANDERS Sig Source 60585 150 2150MHz £500
 MARCONI SANDERS Sig Sou. ce 60588 S 12.5MHz £650
 MARCONI TF2006 AM FM 10MHz 1GHz Sig Gen £500
 MARCONI TF2008 AM FM 10MHz 510MHz Sig Gen £375
 MARCONI TF2015 AM FM 10 500MHz Sig Gen w/1 Synchro scope TF217 £550
 MARCONI TF2016 without Synchro scope £425
 MARCONI TF2018 AM FM 10MHz 120MHz w/1 Synchro scope TF217 £750
 MARCONI TF2016 without Synchro scope £300
 MARCONI MOD Meters TF2300 TF2302B TF230 1 m £150
 DYWIDAR 15.5 AM FM 0.1 184MHz Sig Gen £200
 RACAL 9081 AM FM 10MHz 10MHz S/Ger Synthesised £600
 HP 618C Signal Generator 18 76GHz £400
 HP 618B Signal Generator 18 4 2GHz £450
 HP 614A Signal Generator 800 2100MHz £450
 K.E. (Rad omie) 101 Sig Gen 0.15 30MHz 36 x 30M 1 Bu 1/2 £750
 and sweeps locally
 LEADER LS621K Sig Gen AM + M 0.1 30MHz 75 115MHz Bu 1/2 FM Stereo Modulation £750
 WAVELET 57 Programmable Waveform Synthesiser 100 MicroHz 1MHz Sine Sq 1 0.01 Hz £500
 FLIDBACK F601 Sig Gen 0.01Hz 1M Hz Sine Sq T £175
 MARCONI Automatic Distortion Meter TF2337A 400Hz or 150 Measures 0.01 to 100MHz £150
 PHILIPS CCLOUR BAR GEN PM5519 UHF VHF Vide Over 20 test Patterns £400
 PHILIPS PK 5 32 Function Gen 0.1Hz - 1MHz £450

This is a very small sample of stock. SAE or telephone for LIST of OVER 700 ITEMS. Please check availability before ordering. CARRIAGE all units £16 VAT to be added to total of goods and carriage.

STEWART CF READING Tel: 0734 68041 Fax: 0734 351696
110 WYKEHAM ROAD, READING, BERKS RG6 1PL
 Callers welcome 9am to 5.30pm. MON-FRI. (UNTIL 8pm. THURS)

CIRCLE NO. 31 ON REPLY CARD

R.S.T. LANGREX R.S.T.
SUPPLIES LTD
 One of the largest stockists and distributors of electronic valves, tubes and semiconductors in this country.
 Over 5 million items in stock covering more than 6,000 different types, including CRT's, camera tubes, diodes, ignitrons, image intensifiers, IC's, klystrons, magnetrons, microwave devices, opto electronics, photomultipliers, receiving tubes, rectifiers, tetrodes, thyratons, transistors, transmitting tubes, triodes, vidicons.
 All from major UK & USA manufacturers.
 Obsolete items a speciality. Quotations by return. Telephone/telex or fax despatch within 24 hours on stock items. Accounts to approved customers. Mail order service available.
LANGREX SUPPLIES LTD
 1 Mayo Road, Croydon, Surrey CR0 2QP.
 Tel: 01-684 1166
 Telex: 946708
 Fax: 01-684 3056

CIRCLE NO. 6 ON REPLY CARD

SMALL SELECTION ONLY LISTED - EXPORT TRADE AND QUANTITY DISCOUNTS
RING US FOR YOUR REQUIREMENTS WHICH MAY BE IN STOCK

Cossor Oscilloscopes CDU150(CT531/3) £150 only. Solid state general purpose bandwidth DC to 35MHz at 5MV/Cm - Dual Channel - delayed time base - illuminated graticule - Beam finder - Calibrator - power 200V - 250 volts AC - protection cover containing polarized viewer and camera adaptor plate - probe (1) - mains lead. Tested in fair condition with operating instructions. FEW AVAILABLE - NO PROTECTIVE COVER BUT MAINS LEAD + 1 PROBE - £125 - TESTED - Manual £15 extra.

Tektronix 475 - 200Mc/s Oscilloscopes - tested from £500 less attachments to £750 as new c/w manual, probes etc.

Telequipment D755 - 50Mc/s Oscilloscopes - Tested c/w 2 Probes - £250. Manual £5 extra.

Marconi TF2002AS - AM-FM Signal Generator - 10Kc/s to 72Mc/s - £85. Tested probe kit - £15 extra - Manual £10 extra.

Marconi TF2002B - AM-FM Signal Generator - 10Kc/s-88Mc/s. - £100 Tested to £150 as new - Probe kit £15 extra - Manual £10 extra.

Marconi TF2008 - AM-FM Signal Generator - Also Sweeper - 10Kc/s-510Mc/s - from £450 Tested to £550 as new with manual - Probe kit in wooden carrying box - £50 extra.

Don 10 Telephone Cable - 1/2 mile canvas containers or wooden drum new from £20.

Army Whip Aerials screw type F sections and bases large qty available P.O.R.

Test Equipment we hold a large stock of modern and old equipment - RF and AF Signal Generators - Spectrum Analysers - Counters - Power Supplies - Scopes - Chart Recorders all speeds single to multiplex - XY Plotters A4-A3.

Racal Modern Encryption Equipment - Racal Modern Morse Readers and Senders - Clark Air Operated Heavy Duty Masts - P.O.R.

All items are bought direct from H M Government being surplus equipment; price is ex-works. S.A.E. for enquiries. Phone for appointment for demonstration of any items, also availability or price change V.A.T. and carriage extra.

JOHNS RADIO, WHITEHALL WORKS,
84 WHITEHALL ROAD EAST, BIRKENSHAW,
BRADFORD BD11 2ER. TEL NO. (0274) 684007. FAX: 651160

WANTED: REDUNDANT TEST EQUIPMENT - VALVES - PLUGS - SOCKETS - SYNCHRODS ETC. RECEIVING AND TRANSMITTING EQUIPMENT - GENERAL ELECTRONIC EQUIPMENT

CIRCLE NO. 30 ON REPLY CARD

APPOINTMENTS

CHRISTOPHER TERO 01-661 8640

DISPLAY APPOINTMENTS
£27 per single col. centimetre (min. 3cm).
1/2 page £1188
Full colour £400
1/4 page £648
2nd colour £275
Cheques and Postal Orders payable to REED BUSINESS PUBLISHING GROUP LTD and crossed.

A WORLD OF OPPORTUNITY FOR RADIO OFFICERS

We offer a secure and rewarding shore-based career in the forefront of modern telecommunications technology. Thirty weeks special training (plus 6 weeks for non-typists) will prepare you to undertake a wide range of specialist duties as a RADIO OFFICER covering the complete communication spectrum from DC to light.

To qualify **you need** to hold or hope to attain:
an MRGC or BTEC HNC in a Telecommunications subject with the ability to read morse at 20 wpm. City and Guilds 7777 at advanced level, incorporating morse transcription skills, would be advantageous.
Anyone without the above qualifications who has 2 years radio operating experience will also be considered.

Age – preferably under 45 years.

We offer you:

Comprehensive Training; Good Career Prospects; Opportunities for transfers within UK and Overseas; Generous Leave Allowances and a Non-contributory Pension Scheme; Job Security; Attractive Salaries – and much more.

Salary (Reviewed Annually) – As a Radio Officer after training:

£11,568 rising to £17,057 pa in 5 annual increments. (includes shift and weekend working allowance)
CIVIL SERVICE IS AN EQUAL OPPORTUNITY EMPLOYER.

For more information and application form write or telephone:



THE RECRUITMENT OFFICE, GCHQ, ROOM A/1108
PRIORS ROAD, CHELTENHAM, GLOS GL52 5AJ
OR TELEPHONE (0242) 232912/3

WHAT IS AN INVENTION? BECOME A PATENT ATTORNEY

and find out!

High-calibre Electrical/Electronic Graduates sought for training as Patent Attorneys by well-established Anglo-German partnership.

Must have an interest in new technology, an analytical approach, a flair for written expression, and knowledge of German or willingness to learn. Competitive salary and excellent prospects for suitable applicants.

Initial training in Munich followed by transfer to London branch.

Please reply with detailed Curriculum Vitae to:

S. J. Avery, Hoffman Eitle & Partners,
Sardinia House, Lincoln's Inn Fields,
London WC2A 3LZ
Telephone: 01-404 0116

RF DEVELOPMENT ENGINEERS

CAMBRIDGE £12K to £18K Neg.

PROJECT LEADERS SENIOR DEVELOPMENT ENGINEERS DEVELOPMENT ENGINEERS

We have challenging work in our very well equipped and expanding laboratories in this attractive City. The work will involve the development of a wide range of new products for the Satellite TV, MATV and CATV markets covering the frequency range DC – 1750 MHz.

Experience of RF and analogue circuit design to component level is essential. A knowledge of TV signals would be an advantage.

The Company offers negotiated salary, career development, good working conditions. Contributory Pension Scheme, 25 days holiday, canteen, sports and social club and relocation assistance where appropriate.

To find out more about our opportunities, please write or telephone:-

David Parkin, Personnel Manager, Labgear Cablevision Limited, PO Box 182, Abbey Walk, Cambridge CB1 2QN.
Tel: Cambridge (0223) 66521.



Labgear
Cablevision

A Member of the Teleste Group of Finland

WORK FOR DEVELOPMENT IN PERU

RADIO ENGINEER

CNR, the nationally coordinated committee for Peru's established community radio stations, urgently needs your skills to develop their technical training programme. This responsible and satisfying job offers you the freedom to use your initiative to create a team of technical trainers to provide a support service to the country's radio network.

CIIR Overseas Programme acts to challenge poverty and promote development. CIIR overseas workers are experienced professionals motivated to share their skills with local communities in developing countries.

CIIR's comprehensive benefits package includes ★ a salary based on local rates ★ UK allowance ★ free accommodation ★ return flights ★ pre-departure grant ★ insurance cover ★ discretionary dependents' allowance ★ a minimum two year contract ★ language training ★ extensive briefings ★ in country support.

If you have experience and knowledge of analogue electronics and digital circuits, of installing and working with radio transmitters and studio equipment and are looking for a challenging job

TAKE THE INITIATIVE: Phone Sue James now on 01-354 0883 or write to



The Enquiries Desk, CIIR Overseas Programme, 22
Coleman Fields, London N1 7AF.
Please send a 28p SAE and quote REF: RPT/EWW/1
WORKING TOWARDS EQUAL OPPORTUNITIES

RF DES ENGS

Extremely Competitive Salaries

Circuit and System design using leading edge radio architectures.

If you would like to hear about outstanding UK and European opportunities to work in satcoms, C/I radar, mobile radio and personal comms, call Ingenieur on:

0926 817612

INGINEUR LTD (Agy),
Pendicke Street,
Southam,
Warks CV33 0PN.

INGINEUR
ENGINEER • IN • EUROPE

WELL ROUNDED ENGINEER

The person we are interested in will have good communication engineering background. Must be willing to do maintenance and servicing and installation of all communications products. Must have a strong desire for advancement.

Salary to \$45K Canadian per year. We look after immigration clearance. In the first instance please contact:

Northern Communication &
Navigation Systems Ltd.
PO Box 2317, Yellowknife NWT,
Canada X1A 2P7.
Tel: (403) 873 3953
Fax: (403) 920 4282

A CAREER IN TECHNICAL AUTHORSHIP

There is a constant demand for technical authors throughout industry. If you have a technical background, a qualification in technical authorship can open up a prospect of a new and rewarding career. For details of a comprehensive Open Learning Course, leading to recognised qualifications in this field, send for free information pack to:

TUTORTEX SERVICES WW4
Freepost
ULVERSTON
Cumbria LA12 7BR
Telephone: 0229 56333

782

ROYAL POSTGRADUATE MEDICAL SCHOOL.

(University of London)

MAINTENANCE ENGINEER - MEDICAL SCHOOL MICROCOMPUTER EQUIPMENT

An Engineer/Technician is required to establish an equipment management and repair service for microcomputers and associated devices used for routine and research work by the Royal Postgraduate Medical School.

Candidates should be capable of electronic servicing to component level and be sufficiently familiar with microcomputers to distinguish between hardware faults, user difficulties and software problems. The post requires initiative and the ability to work with the minimum of supervision. Applicants should, preferably, have experience of supervising others. Minimum qualifications are BTEC, HNC or equivalent high substantial work experience in electronics/computing.

Appointment will be on MLSO 2 (£11821 - £16890) or MLSO 3 (£15711 - £19543) scale depending on experience and qualifications. Both scales include London Weighting.

For a job description and application form please contact the Personnel Office, Royal Postgraduate Medical School, Du Cane Road, London W12 0NN (Tel: 01-740 3204) quoting ref: AP/RP.

For further details please contact Mr K Wilson, Head of Medical Electronics. Tel: 01-743 2030 Ext 2210.

Closing Date: 5 October 1989

VIDEO ENGINEER/TECHNICIAN (MOBILE)

Ref: 82/89

We have an immediate vacancy for a qualified Video Engineer/Technician to work in the Portsmouth and West Sussex areas. Experience must include maintenance and repair of high band U-matics, TBSs, Vision and Sound Mixers, three tube colour cameras and CCUs.

The salary package includes the provision of a company vehicle and an excellent pension and life assurance scheme.

For further information and an application form please contact:

Mrs A. R. Sive, Assistant Personnel Manager.
Telephone: 02407 4461 Ext 407

PRIVATE MOBILE RADIO/TRANSCIVER

Maintenance Engineer required
by major courier Co. in SE1
Salary according to experience up
to £15,000.

Phone Dennis on
403 3636

8640

FOR MORE INFORMATION

CALL:
**CHRISTERO
ON
661-3033**

SKY TELEVISION BROADCAST ENGINEERS

Sky Television is seeking maintenance engineers to be based at its Centre in Isleworth, West London.

Involvement will extend to the maintenance and installation of the full range of broadcast equipment and applicants will, ideally, have previous experience in a broadcast environment. There will be a requirement for shift work, including nights.

Our benefits package includes:

- Contributory pension scheme
- BUPA membership
- Five weeks holiday allowance

The salary will be competitive depending on experience to date

Please forward written applications, including detailed CV, current salary and daytime phone no. to: Louise Stott, Personnel Officer, Sky Television, 6 Centaurs Business Park, Grant Way, Isleworth, Middlesex TW7 5QD

ELECTRONICS WORKSHOP TECHNICIAN

(Grade 4/5)

required in Department of Psychology, University of Reading, to design and construct a wide range of specialized equipment. The Departmental research and teaching activities depend heavily on the use of computers. The ideal candidate will have had a recognised apprenticeship and at least two years' of varied experience in electronics. Knowledge of BBC and IBM micro-computers would be an advantage. Salary scale £8645 to £10632 pa. Application forms available from the Personnel Office, University of Reading, Whiteknights, PO Box 217, Reading RG6 1AH. Telephone: (0734) 318751. Please quote Ref T01A



ELECTRONIC ENGINEERS

Make your next career move a milestone not a millstone.

Irrespective of your career objectives — financial or geographical — let Cadmus put direction into your search.

If you are a Qualified Service, Sales, Design, Production, Test or Quality Engineer, send your C.V. to the address below or telephone Norwich 761220 for an informal chat.



CADMUS
PERSONNEL LIMITED

Freepost, Sackville Place
44-48 Magdalen Street
Norwich NR3 1BR



CLASSIFIED

CHRISTOPHER TERO 01-661 8640

CLASSIFIED DISPLAY: £27 per single column centimetre (min 3cm).
LINE ADVERTISEMENTS (run on): £6.00 per line, minimum £48 (pre payable).
(Please add on 15% V.A.T. for prepaid advertisements).

BOX NUMBERS: £15.00 extra. (Replies should be addressed to the box number in the advertisement, c/o Quadrant House, The Quadrant, Sutton, Surrey SM2 5AS).

Cheques and Postal Orders payable to REED BUSINESS PUBLISHING GROUP LTD and crossed.

HAVING DIFFICULTY OBTAINING AN OBSOLETE VALVE/MAGNETRON/KLYSTRON?

(or transistor, i.c., CRT, trav wave tube etc)

- * RARE & OBSOLETE TYPES A SPECIALITY!
- * ALL POPULAR TYPES STOCKED AT COMPETITIVE PRICES
- * SPECIAL PRICES FOR WHOLESALE QUANTITIES
- * OFFICIAL ORDERS FROM GVT DEPTS, MILITARY, PLCs, OVERSEAS ETC. WELCOME
- * PHONE/FAX/TELEX FOR UP TO DATE PRICES ON YOUR REQUIREMENTS

Visa - Barclaycard - Access accepted



BILLINGTON VALVES

Good quality - Low price - Rarities a speciality

39 Highlands Road, Horsham, Sussex, RH13 5LS, UK.

Phone: 0403 210729. Fax: 0403 40214. Telex: 87271

Office hours Mon-Fri 9am-5.30pm. Callers welcome by appointment only



COOKE INTERNATIONAL SERVICES

ELECTRONIC TEST & MEASUREMENT INSTRUMENTS

We are looking for quality used test instruments. Large display always available in our showroom.

Examples:

Tektronix 7834 DC-400 MHz storage scope M/F	£2500.00
H.P. 8405A Vector voltmeter DC-1.6Hz RF. Phase volts, etc	£750.00
Northern Scientific Econ II plus height analyser	£450.00
Tektronix P6201 DC-900MHz probe kit	£300.00

VAT and carriage extra.

Business Hours 9.30am - 5.00pm. Mon. - Fri

Mail Order available - Send for Stock Lists

Cooke International, Unit 4, Fordingsbridge Site, Main Road, Barnham, Bognor Regis, West Sussex PO22 0EB
Telephone: 0243 545111 - Fax 0243 542457

8048/41 Cross-Assembler for MSDOS Computers

- Suitable for all IBM PC/XT/ATs or Clones.
- Completely compatible with the Intel 8048 Assembler.
- Comes complete with a 40 page User Manual and Mnemonic Card.
- Supplied with either 5.25 or 3.5 inch disc - please state which.

XA-48 Assembler source code for all members of the 8048/41 family:

8048	8748	8035	8049	8749	8039
8050	8750	8040	8020	8021	8022
8041	8741	8041A	8741A	8042	8742

The XA-48 Cross-Assembler is available from:
MAPLE Technology Ltd.,
Park Road Centre,
Malmesbury, Wilts SN16 0BY
Telephone: (0666) 825141



Only £49.80 + VAT (including postage)

TO MANUFACTURERS, WHOLESALERS, BULK BUYERS, ETC.

LARGE QUANTITIES OF RADIO, TV AND ELECTRONIC COMPONENTS FOR DISPOSAL

SEMICONDUCTORS, all types, INTEGRATED CIRCUITS, TRANSISTORS, DIODES, RECTIFIERS, THYRISTORS, etc. RESISTORS, C/F, M/F, W/W, etc. CAPACITORS, SILVER MICA, POLYSTYRENE, C280, C296, DISC CERAMICS, PLATE CERAMICS, etc. ELECTROLYTIC CONDENSERS, SPEAKERS, CONNECTING WIRE, CABLES, SCREENED WIRE, SCREWS, NUTS, CHOKES, TRANSFORMERS, etc ALL AT KNOCKOUT PRICES

- Come and pay us a visit ALADDIN'S CAVE.

TELEPHONE: 445 0749/445 2713

R. HENSON LTD.

21 Lodge Lane, North Finchley, London N12.

(5 minutes from Tally Ho Corner)

1613

Please mention
WIRELESS WORLD
when replying to
adverts

WANTED: VALVES TRANSISTORS I.Cs (especially types KT66, KT88 PX4, PX25). Also plugs, sockets and complete factory clearance. If possible, send written list for offer by return. Billington Valves, phone: 0403 210729, Fax: 0403 40214. See adjoining advert.

SUMMER SALE

OSCILLOSCOPES & GENERAL TEST EQUIPMENT

All items supplied in tested and working condition.
Calibration verified at no extra cost.

TEK 475 200MHz - D. Beam - DT. Base	£485
TEK 475A 250MHz	Phone for details
TEK 7603 c/w 7A16, 7A18, 7A26, 7B53A p/ins	£999
HP 1222A 15MHz Dual Beam	£165
Gould OS1100-S1 30MHz Dual Beam	£155
Philips PM3218 35MHz	£325
Philips PM3217 50MHz	£325
Cossor CDU150 35MHz	£149
SE LABS SM111 18MHz	£145

SPECIAL MARCONI TF2015 SIGNAL GENERATORS 10MHz - 520MHz AM-FM

£300	
Also	
Tequipment CT17 curve tracer - mint	£350
Marconi TF2008 Sig Gen's 10MHz - 510MHz AM-FM	£400
Marconi TF2002AS Sig Gen's 10KHz - 72MHz AM-FM	£80
Marconi TF 2603 RF Millivolt 10 1.5Ghz	£99
Accessory kits available.	

Racal Dana 9915M TXO 8 digit DFM 510MHz LED	£225
Advance DMM3 Mains/Batt Digital Multimeters incl. case/probes	£45
Megger Insulation testers 250v, 500v, V8, 9A	£35 - £50

MANY, MANY more items in stock and arriving daily at our three acre depot in Nottingham. We are open to callers 9am - 6pm weekdays - 8am - 4pm Saturday
PLENTY OF FREE PARKING.

Anchor Surplus Ltd., The Cattle Market Dept.,
off London Road, Nottingham NG2 3GY
Telephone (0602) 864041 or Fax (0602) 864667
Rob Taylor (Technical Manager)
ALL PRICES EXCLUDE VAT & CARRIAGE

742

RECHARGEABLE BATTERIES

HP7 99p HP2 £2.25
HP1 £1.99 HP3 £4.95
Each of our batteries may be recharged up to 1000 times! UNIVERSAL NI-CAD BATTERY CHARGER (charges up to 4 x HP2 117 and 1 x PP3) WAS £9.75 NOW £5.45

MAINS ADAPTOR plugs directly into 13 amp socket switchable 3 4 1/2 6 7 1/2 9 and 12 volts DC at 300mA

TV AERIAL AMPLIFIER Enjoy a clearer crisper picture with this UHF TV Aerial Amplifier. Simply plug into aerial lead. Mains powered with FREE TV extension lead

SEND STAMP FOR FREE CATALOGUE **£8.95**

J.E.C. PO Box 67, EASTBOURNE BN12 3LN
Mail Order only. Please add £1 per order p.p.p costs.

WANTED

Test equipment, receivers, valves, transmitters, components, cable and electronic scrap and quantity. Prompt service and cash.

M & B RADIO
86 Bishopgate Street,
Leeds LS1 4BB.
Tel: 0532 435649
Fax: 0532 426881

9956

STEWART OF READING

110 WYKEHAM ROAD,
READING RG6 1PL.
TEL: 0734 68041.
FAX: 0734 351696

TOP PRICES PAID FOR ALL TYPES OF SURPLUS TEST EQUIPMENT, COMPUTER EQUIPMENT, COMPONENTS etc. ANY QUANTITY.

103

WANTED

Receivers, Transmitters, Test Equipment, Components, Cable and Electronic Scrap Boxes, PCB's, Plugs and Sockets, Computers, Edge Connectors.

TOP PRICES PAID FOR ALL TYPES OF ELECTRONICS EQUIPMENT.
A. R. Sinclair, Electronics
Stockholders, 2 Normans Lane,
Rabley Heath, Welwyn,
Herts AL6 9TO
Telephone: 0438 812 193
Mobile ☎ 0860 214302
Fax 0438 812 387

780

ARTICLES FOR SALE

HEWLETT PACKARD 200 Computer HP9816S with disc Basic; HP 9121 twin 3 1/2" drive, MBA software. HP1B, plus HP 7225B fixed bed A4 plotter, all manuals, cables, £2,450.00 Epson PC with new 30MB hard disc, 5 1/4", Hercules restful green monitor, £369.00. AIM Electronics 501 ultra low distortion, IEEE oscillator 8Hz to 300kHz, £640. Time Electronics 9812 programmable IEEE switchbox 24 way, £540. Nicolet 44, dc to 100kHz spectrum analyser 1/2, 1 octave option, £2,350. All first class, known history with manuals + VAT. 01-794 2839.

720K 3.5 INCH DRIVES £39.50 + VAT

Japanese made (Y-E Data) high reliability, modern, low component count, cast chassis drive. Surface mount design. These drives have been removed from almost new systems being upgraded. They are in perfect condition, are boxed and carry a full six month (money back if not satisfied) guarantee. 80 track double sided 1 M byte (unformatted). £39.50 each (carr. £3) £35 ten or more. Quantities of 25 or more POA. Cradle to fit drive in a 5.25" slot eg IBM pc £5.49 (carr. £1.00; or free with drive) Power and data connectors to suit £0.99p (carr. free) Box ten 3.5" discs £9.95 (carr. £1.50)

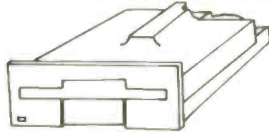

BONDWELL 286 AT COMPUTER £475

Fully IBM compatible AT machine with 80286 running at 10 MHz. Complete with ONE MEGABYTE of RAM, 101 Key keyboard, 1.2 M byte 5.25" floppy drive, Hercules video card, centronics and serial ports, real time clock, 5 expansion slots, MS DOS 3.2 and GW Basic. High quality construction by famous name. Small footprint size case with power supply all assembled and tested. Lowest ever price in the UK £475.00 (carr. £15)



EPSON 12" TTL MONO MONITORS (GREEN)

High resolution, IBM and Hercules compatible. TTL. Supplied complete with leads for direct connection to above or any other PC. £48.50 (carr. £5.50)

RACAL V22 MODEM MPS1222

Microprocessor based modem providing full duplex communication at 1200, 600 and 300 baud to the CCITT V22 standard. Features include: *Can be used on standard phone line (PSTN) and private circuit (PC) *Auto answer but needs telephone to dial *1200, 600 and 300 baud *Very high quality construction *BT approved *Self tests and loop tests (V54) *Comprehensive manual included. Uncased card with front panel £24.95 seven cards in rack £195 (carr. one £3.50; seven £15)



HARD DISC DRIVES

CDC Wren 80 M byte ST 506 32ms £349.00 (carr. £5)
Rodime 26 M byte ST 506 55ms £99.50 (carr. £4)
CDC Wren 35 M byte non standard NRZ interface £69.00 (carr. £3.50)

FLOPPY DISC DRIVES

Shugart SA455 5.25" (360K IBM) 40 track double-sided £34.95 (carr. £3.50)
Panasonic 5.25" (720K IBM) 80 track double-sided £34.95 (carr. £3.50)
Bondwell 5.25" 1.2 M byte IBM AT style drive £49.95 (carr. £3.50)

POWER SUPPLIES

Farnell N180 cased 180 Watt PSU +5V at 20A, +12V at 2A, -12V at 2A, +24V at 5A and -5v at 1A. £26.95 (carr. £3)

Visa & Access
accepted 24 hour
phone service

matmos

Matmos Ltd. Unit 11, The Enterprise Park, Lewes Road, Lindfield, West Sussex RH16 2LX
Telephone: (04447) 2091 or 3830 Fax: (04447) 4258

DAISYWHEEL PRINTERS

Olivetti: 25 CPS. daisy printers complete WITH DUAL BIN SHEETFEEDERS and RS232 interface. Emulates IBM, Qume and Olivetti. Ribbons available. £175.00 (carr. £10.00)
Triumph Adler Royal: 20CPS. 132 column, variable pitch, all the features that you would expect from a quality printer. Six month guarantee, ribbon and typewheel included. RS232 interface only. £99.50 (Carr £6.50) HURRY STOCKS COMING TO AN END!

FACIT ULTRA FAST DOT MATRIX PRINTERS

Prints at up to a maximum of 500 CPS. Made to a very high standard for continuous use. Compact slimline desktop model (only 26 inches wide). Ideal for Universities, large mailing lists, central printer in department or any other serious application £349.00 (carr. £25).

HITACHI COLOUR MONITORS

CM1457AE 14" PGA, 30.48KHz. Can be converted to VGA for £75.00 to provide high quality, maximum 640 by 480, £149.00 (carr. £6.50) Circuit for DIY conversion provided free.
CM2073A 20" ultra high resolution, 64KHz only £595.00 (carr. £30)
CM1255DE 12" 24KHz suit Olivetti or convert to EGA? £85.00 (carr. £5)
CM1588A 15" very high resolution but no details, hence £149.00 (carr. £6.50)

TRANSDATA Model 307 ACOUSTIC MODEM

V24 interface, 300 Baud, originate mode, etc. Fits modern or old style phones £9.95 (carr. £3.00)

STC SCRIBE KEYBOARDS

Keyboards as supplied with Scribe wordprocessors. These are serial units but no data is available. £5.95 (carr. £3)

SOUND EQUIPMENT all second-hand.

STUDIO LOUDSPEAKERS

EX-BBC 5-2 15" bass plus 2 HF units £99.50 pair (carr. £30)
EX-BBC LS3-1 as above but in smaller cabinets £89.50 pair (carr. £20)
EX-BBC LS3-4 compact corner cabinet with one 8" bass plus HF £79.50 (carr. £17.50)
EX-BBC RA8-1 mini monitor approx 14" high smart teak cabinets 8" bass plus HF £49.50 (carr. £10)

EDC RADIO MICS

Cygnus hand held system complete with mic., receiver, case and cables. £199 (carr. £4)

PA LOUDSPEAKERS

IK WATT SYSTEM £495.00

CINEMA PROJECTORS

Two x 35mm Gaumont-Kelle, Xenon lamp house, cinema projectors. Complete with screen, screen motor and sound equipment. Please ring for details and price.
VAT and carriage must be added to all items.
Everything new unless stated otherwise.

CIRCLE NO. 15 ON REPLY CARD

INDEX TO ADVERTISERS

Appointments Vacant Advertisements appear on pages 1028 - 1031

PAGE	PAGE	PAGE
AEL Communications 1002	JAV Electronics 1018	Ralfe Electronics 1018
Airlink Transformers 988	Johns Radio 1027	Research Communications 974
Amber Cascon 1026	L J Technical Systems 969	Schlumberger Instruments 945
Audio Electronics 956	Lab-Volt (UK) 1000/OBC	Sherwood Data Systems 940
Carston Electronics IFC	Langrex Supplies 1027	Solex International 983
Cavendish Automation 1026	Laplace Instruments 969	South Midlands
Computer Appreciation 1011	Levell Electronics 969	Communications 1011
Consumer Microcircuits 940	M & B Radio (Leeds) 1011/954	Sowter Transformers 1011
Crotech Instruments 973	M Q P Electronics 942	Stewart of Reading 1027
Display Electronics 1014	Matmos 1032	Strumech Engineering 988
Farnell International 994	Natel 1002	Taylor Bros. (Oldham) 938/IBC
Field Electric 1027	National Instruments 951	Thandar Electronics 1000
Henry's Audio Electronics 958	Noral Micrologics 954	Those Engineers 1005/988
I R Group 1017/999	Number One Systems 961	Thurlby Electronics 942
ICOM (UK) 956	Pineapple Software 973	Triangle Digital Services 956
ITT Instruments Insert	R. Henson 973	Trident International Exhibitions 1009
J & M Computers 1005	Raedek Electronics Co 942	Tsien 1026
		Waveband Electronics 1005

OVERSEAS ADVERTISEMENT AGENTS

France and Belgium: Pierre Mussard, 18-20 Place de la Madelaine, Paris 75008.

United States of America: Jay Feinman, Reed Business Ltd., 205 East 42nd Street, New York, NY 10017 - Telephone (212) 867 2080 - Telex 23827.

Printed in Great Britain by Carlisle Web Offset, Caxton Road, Newtown Trading Estate, Carlisle, Cumbria CA2 7NR, and typeset by Graphac Typesetting, 181/191 Garth Road, Morden, Surrey SM4 4LL, for the proprietors: Reed Business Publishing Ltd, Quadrant House, The Quadrant, Sutton, Surrey SM2 5AS. © Reed Business Publishing Ltd 1989. *Electronics and Wireless World* can be obtained from the following: AUSTRALIA and NEW ZEALAND: Gordon & Gotch Ltd, INDIA: A. H. Wheeler & Co. CANADA: The Wm Dawson Subscription Service Ltd., Gordon & Gotch Ltd. SOUTH AFRICA: Central News Agency Ltd; William Dawson & Sons (S.A.) Ltd. UNITED STATES: Worldwide Media Services Inc., 115 East 23rd Street, NEW YORK, N.Y. 10010. USA. *Electronic & Wireless World* \$5.95 (74513).

TAYLOR

R.F. EQUIPMENT MANUFACTURERS

PERFORMANCE & QUALITY

19" RACK MOUNT CRYSTAL CONTROLLED VESTIGIAL SIDEBAND TELEVISION MODULATOR

PRICES FROM £214.13 (excluding VAT & carriage)
Prices CCIR/3 £214.13
CCIR/3-1 £273.67



19" RACK MOUNT VHF/UHF TELEVISION DEMODULATOR

PRICE AT ONLY £198.45 (excluding VAT & carriage)

WALLMOUNT DOUBLE SIDEBAND TELEVISION MODULATOR

PRICES FROM ONLY £109.76 (excluding VAT & carriage)



Prices
CCIR/5-1 1 Modulator £109.76
CCIR/5-2 2 Modulators £167.99
CCIR/5-3 3 Modulators £237.59
CCIR/5-4 4 Modulators £307.19
CCIR/5-5 5 Modulators £376.79

CCIR/3 SPECIFICATION	
Power requirement	- 240V 8 Watt (available other voltages)
Video Input	- 1V Pk-Pk 75 Ohm
Audio Input	- 8V 600 Ohm
FM Sound Sub-Carrier Modulation	- 6MHz (available 5.5MHz)
IF Vision	- Negative
IF Sound	- 38.9MHz
Sound Pre-Emphasis	- 32.9MHz (available 33.4MHz)
Ripple on IF Saw Filter	- 50us
Output (any channel 47-860MHz)	- 6dB
Vision to Sound Power Ratio	- +6dBmV (2mV) 75 Ohm
Intermodulation	- 10 to 1
Spurious Harmonic Output	- Equal or less than 60dB
	- -40dB (80dB if fitted with TCFL1 filter or combined via TCFL4 Combiner/Leveller)
CCIR/3-1	
	- Specification as above but output level 60dBmV 1000mV Intermodulation 54dB
Other Options Available	
	- I.F. Loop/Stereo Sound/Higher Power Output
Alternative Applications	
	- CCTV Surveillance up to 100 TV channels down one coax, telemetry camera control signals, transmitted in the same coax in the reverse direction.
802 DEMODULATOR SPECIFICATION	
Frequency Range	- 45-290MHz, 470-860MHz
A.F.C. Control	- +/- 1.8 MHz
Video Output	- 1V 75 Ohm
Audio Output	- 75V 600 Ohm unbalanced
Audio Monitor Output	- 4 Ohms
	- Tunable by internal preset
	- Available for PAL System I or BC
Options	
	- Channel selection via remote switching
	- Crystal Controlled Tuner.
	- Stereo Sound.
CCIR/5 MODULATOR SPECIFICATION	
Power Requirement	- 240V
Video Input	- 1V Pk-Pk 75 Ohms
Audio Input	- 1V rms 30K Ohms Adjustable .4 to 1.2
Vision to Sound Power Ratio	- 10 to 1
Output	- 6dBmV (2mV) 470-860MHz
Modulation	- Negative
Audio Sub-Carrier	- 6MHz or 5.5MHz
Frequency Stability	- 2S Deg temperature change 150KHz
Intermodulation	- less than 60dB
Sound Pre-Emphasis	- 50us
Double Sideband Modulator	(unwanted sideband can be suppressed using TCFL4 Combiner/Leveller)
CHANNEL COMBINER/FILTER/LEVELLER	
	to combine outputs of modulators
TCFL2	2 Channel Filter/Combiner/Leveller. Insertion loss 3.5dB
TCFL4	4 Channel Filter/Combiner/Leveller. Insertion loss 3.5dB
TSKO	Enables up to 4x TCFL4 or TCFL2 to be combined

CIRCLE NO. 2 ON REPLY CARD

TAYLOR BROS (OLDHAM) LTD.
BISLEY STREET WORKS, LEE STREET,
OLDHAM, ENGLAND.

TEL: 061-652 3221 TELEX: 669911 FAX: 061-626 1736

Telecommunications Training

from fundamentals to state-of-the-art technology

Lab-Volt offers a comprehensive range of telecommunications training equipment that covers basic electronics, analogue and digital communications circuits and systems, fibre optics, and microwave and radar technologies.

Our equipment is:

- modular and easy to upgrade
- industry relevant
- engineered for educational purposes.

Lab-Volt closely relates its telecommunications training equipment to operational systems found in industry, with educational enhancements such as fault insertion switches in many of the modules, labelled and easily-accessible test points, short-circuit protection, silk-screened component identification, and full signal compatibility for system-level modules. We supply student and instructor manuals that are written specifically for the equipment; they provide practical hands-on technical training with step-by-step exercises, laboratory experiments, and troubleshooting activities.

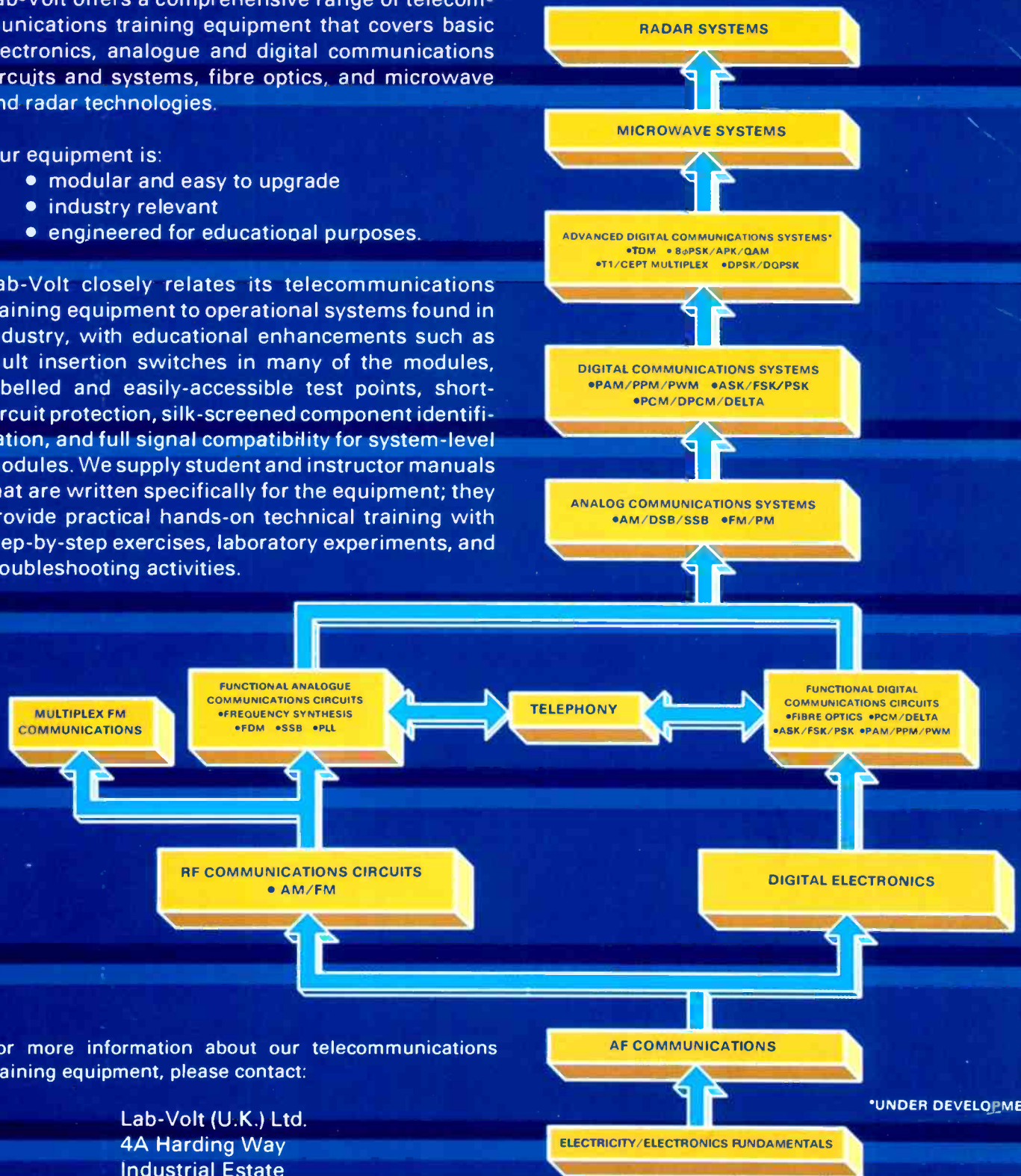

For more information about our telecommunications training equipment, please contact:

Lab-Volt (U.K.) Ltd.
 4A Harding Way
 Industrial Estate
 St. Ives
 Cambridgeshire
 PE17 4WR
 Or Call: 0480 300695

Lab-Volt®