

# ELECTRONIC Wireless World

Exclusive  
multifunction  
microcontroller offer

SEPTEMBER 1986 £1.25

**How Thames gets its  
logo into memory**

**Dynamic memory  
and the 68000**



**Subcodes explained**

**Developments in  
receivers**



**Single-chip computer  
with timers, adc, and  
serial interface**



**Linescan inspection  
camera**

**What makes a  
good oscillator?**



# ELECTRONIC BROKERS LAUNCH GRUNDIG

## THE HIGH TECHNOLOGY TEST INSTRUMENTS OF THE FUTURE

### GRUNDIG OSCILLOSCOPES

#### MO20: 20MHz DUAL-CHANNEL OSCILLOSCOPE

- ▶ 20MHz Dual channel oscilloscope
- ▶ 2 mV/cm with full bandwidth
- ▶ Automatic peak-value trigger
- ▶ TV line and field triggering
- ▶ Add and invert (Both channels invertable)
- ▶ Internal graticule and X-Y operation

This 20MHz dual-channel oscilloscope has advanced facilities, making it easy-to-use, with all the ruggedness and reliability to meet your go-anywhere testing needs. Included is a peak-value trigger to ensure stationary displays. Triggering facilities allow clear display of even complex signal shapes.

**£299**

#### MO22: 20MHz DUAL-CHANNEL OSCILLOSCOPE WITH AUTOMATIC TIME RANGE

- ▶ 20MHz Dual channel oscilloscope
- ▶ Automatic time base selection
- ▶ Soft tuning for fast manual adjustment
- ▶ Triggerable 2nd time-base, guarantees error free 'zooming-in'
- ▶ Hold-off control and Z modulation
- ▶ Plus all the advanced engineering of the MO20



Now, the world's first low cost 'scope with automatic time-base selection. Dual-range 20MHz capabilities also include 'soft tuning' in manual mode, so the 'scope leaves you free to carry out the measurement.

**£425**



#### MO53: 50MHz DUAL-CHANNEL OSCILLOSCOPE

- ▶ 50MHz Dual channel oscilloscope
- ▶ Automatic time-base selection
- ▶ Alternating 2nd time-base for expanded traces
- ▶ Digital display of time-bases, for unambiguous measurements
- ▶ Suits advanced applications in pulse, data and video technology

A 50MHz dual-channel oscilloscope. Time-base range is automatically selected and shown on a digital display. Like the MO22, it has a triggerable 2nd time-base, guaranteeing error-free 'zoom-in' on a selected area of the trace. Performance with TV signals is particularly impressive.

**£995**

### GRUNDIG TV/VIDEO TEST EQUIPMENT

#### VIDEO GENERATOR VG 1000

- ▶ Professional video generator
- ▶ Comprehensive range of test patterns
- ▶ Includes VTR head adjustment signal
- ▶ Excellent signal quality
- ▶ External sync. facility
- ▶ RGB output

A professional broadcast-quality pattern generator to meet the highest professional standards. Its special test card allows full visual assessment of the video system, including a special output for precision testing of VTRs.

**£1850**



#### COLOUR GENERATOR FG 7

- ▶ PAL pattern generator
- ▶ 15 test patterns
- ▶ Multiburst facility to measure frequency response
- ▶ 8 memories for rapid station store/recall
- ▶ Suitable for TV sets, monitors or VTRs
- ▶ Compact and versatile for field or laboratory use



Versatile enough to check-out TV receivers, monitors and VTRs, this compact generator is at home in the field as it is in the lab or workshop. In addition to 15 monochrome and colour image signals, further picture patterns can be achieved by superimposition. Eight station frequencies can be recalled from memory for rapid test capability — even for special bands and the IF output.

**£565**



#### FIELD STRENGTH METER ME90

- ▶ Fully automated field strength measurement
  - ▶ LF radio to UHF TV in a single unit
  - ▶ Versatile test result selection
  - ▶ Storage of received signal frequencies, for rapid testing
  - ▶ Alpha numeric display for station checks
  - ▶ Unattended monitoring with built-in results printer
  - ▶ Stereo decoding
  - ▶ Fully portable: integral battery and charger
- Microprocessor controlled for push-button operation in all transmitter checks. The ME90 allows fast and accurate measurements in radio and TV bands, long wave to UHF. Versatile print capabilities provide hard-copy confidence, whether routine or continuous monitoring.

**£2950**

For further information and a colour brochure contact our Sales Office.

All prices exclusive of carriage and VAT. Prices correct at time of going to press. A copy of our trading conditions is available on request.

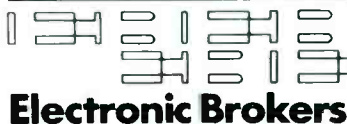

**Electronic Brokers**

**Electronic Brokers Ltd, 140-146 Camden Street,  
London NW1 9PB Telephone: 01-267 7070  
Telex 298694 Fax 01-267 7363**

CIRCLE 1 FOR  
FURTHER DETAILS.

# ELECTRONICS & Wireless world

over 70 years in independent electronics publishing

## CONTENTS

August 1986  
Volume 92  
Number 1606

**Editor**  
PHILIP DARRINGTON

**Deputy Editor**  
GEOFFREY SHORTER, B.Sc.  
01-661 8639

**Technical Editor**  
MARTIN ECCLES  
01-661 8638

**Projects Editor**  
RICHARD LAMBLEY  
01-661 3039 or 8637 (lab.)

**News Editor**  
DAVID SCOBIE  
01-661 8632

**Art Editor**  
ALAN KERR

**Drawing Office Manager**  
ROGER GOODMAN  
01-661 8690  
BETTY PALMER

**Advertisement Manager**  
ASHLEY WALLIS  
01-661 3130  
MICHAEL DOWNING  
01-661 8640

**Classified Executive**  
SUSAN PLATTS  
01-661 3033

**Ad. Production Controllers**  
BRIAN BANNISTER  
01-661 8648  
JACKIE PERRY  
01-661 8649

*Electronics & Wireless World*  
is published monthly USPS 687-540

Current issue price £1.25, back issues (if available) £1.06 at Retail and Trade Counter, Units 1&2, Bankside Industrial Centre, Hopton Street, London SE1 Telephone: 01-928 3567.

By post, current issue £1.30, back issues (if available) £1.40. Order and payments to 301 *Electronics and Wireless World*, Quadrant House, The Quadrant, Sutton, Surrey SM2 5AS. Cheques should be payable to Business Press International Ltd.

**Editorial & Advertising offices:**  
Quadrant House, The Quadrant, Sutton, Surrey SM2 5AS.

**Telephones:** Editorial 01-661 3614.  
**Advertising** 01-661 3130 01-661 8469  
**Telex:** 892084 BISPRS G (EFP)  
**Facsimile:** 01-661 2071 (Groups II & III)

**Beeline:** 01-661 8978 or 01-661 8986.  
300 baud. 7 data bits, even parity, one stop-bit. Send ctrl-Q, then EWW to start; NNNN to sign off.

**Subscription rates:** 1 year £18 UK and £23 outside UK.

**Student rates:** 1 year £11.40 UK and £14.10 outside UK.

**Distribution:** Quadrant House, The Quadrant, Sutton, Surrey SM2 5AS. Telephone 01-661 3248.

**Subscriptions:** Oakfield House, Perrymount Road, Haywards Heath, Sussex RH16 3DH. Telephone 04444 59188. Please notify a change of address.

**USA:** \$49.40 surface mail, £102.60 airmail. Business Press International (USA), Subscriptions Office, 205 E. 42nd Street, NY 10017.

**Overseas advertising agents:**  
**France and Belgium:** Pierre Mussard, 18-20 Place de la Madeleine, Paris 75008.

**United States of America:** Jay Feinman, Business Press International Ltd, 205 East 42nd Street, New York, NY 10017. Telephone (212) 867-2080 Telex 23827.

**USA mailing agents:** Expeditors of the Printed World Ltd, 515 Madison Avenue, Suite 917, New York, NY 10022. 2nd class postage paid at New York. Postmaster - send address to the above.

©Business Press International Ltd 1986. ISBN 0043 6062

### FEATURES

<b>Developments in radio receivers</b> 16 Whistlers, twitterings, noise and a diversity of radio systems, from the IERE's recent conference	<b>Designing with dynamic memory-2</b> 36 by Alan Clements Dynamic ram is not as complicated as timing diagrams suggest.
<b>Microcontroller includes peripherals</b> 24 by Mike Catherwood Built-in peripherals give versatility, illustrated by a limited-issue mask-programmed microcomputer.	<b>How to design good oscillators</b> 59 By K. Lewis Parameters to consider when designing these taken-for-granted circuits.
<b>Subcodes explained</b> 26 by J.R. Watkinson How control signals are combined with and separated from audio samples.	<b>Linescan camera</b> 49 by Les Hayward Considering their simplicity it is surprising these cameras are not more widely used.
<b>Solid state tv logo Player</b> 33 by I.G. Brown Thames TV is about to switch its familiar logo from film to silicon.	<b>8085 development for the BBC Micro</b> 54 by J. L. Gordon Simple system introduces 6502 users to another processor family.
	<b>The 1986 satellite and cable tv show</b> 30 Our roving reporter focuses on opportunities in d.b.s. - as seen at Cable '86

### REGULARS

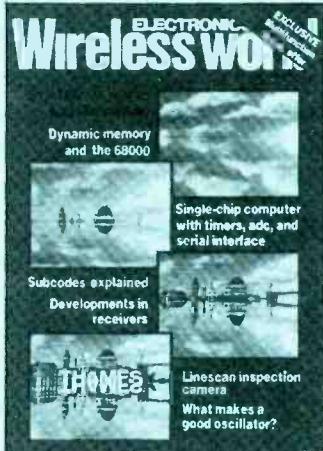
<b>News commentary</b> 4 Chips change jobs Ground probe radar News Satcom show	<b>Circuit ideas</b> 44 Data preamplifier Variable shift together Loop resistance corrector	
<b>Communications commentary</b> 9 VLF errors Hazards Cross-polar puzzle	<b>New products</b> 64, 66, 69, 71 Low-cost s.e.m. Rechargeable lithium cells Surface-mount kit	
<b>Feedback</b> 13 S5/8 objections Moisture measurement Seeing redder	<b>Appointments</b> 75	
<b>Report</b> 16,30 Radio receivers, Cable tv	<b>Advertisers index</b> 80	
	<b>Thames tv's well-known station identification, currently broadcast from telecine equipment, is to be re-housed in solid-state memory - page 33.</b>	

# RADIOCODE CLOCKS LTD

SPECIALISTS IN ATOMIC TIME, FREQUENCY AND SYNCHRONISATION EQUIPMENT

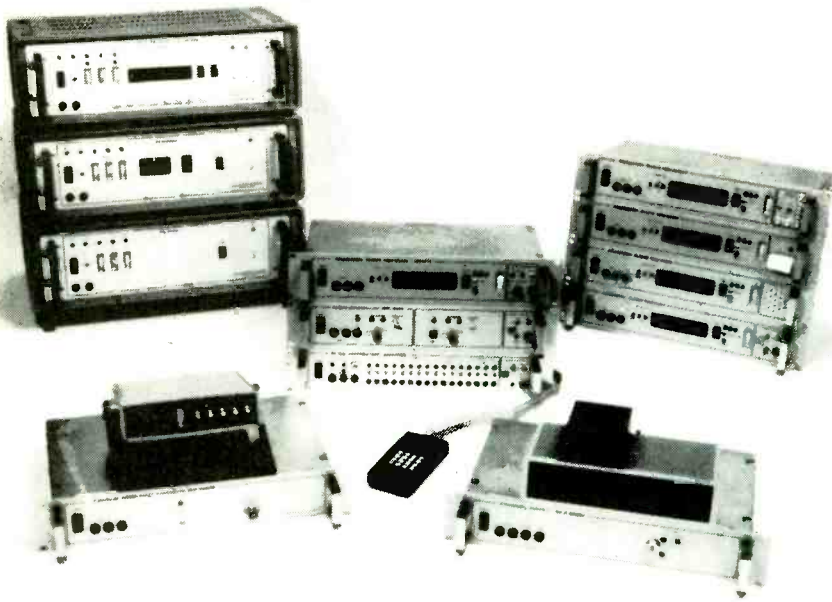

## NEW PRODUCTS

- **MINIATURE RUBIDIUM OSCILLATOR MODULE**  
Lower power, fast warm up, optional output frequencies, programmable frequency offsets.
- **RUBIDIUM FREQUENCY STANDARD**  
High performance, compact and rugged instrument. 2U rack or 1/4, ATR case options.
- **INTELLIGENT OFF-AIR FREQUENCY STANDARDS**  
Microcomputer controlled instruments, directly traceable to N.P.L., precision ovened local oscillator, comprehensive monitoring and status information, real time synchronisation.
- **LOW COST MSF FREQUENCY STANDARD**  
Instant operation, directly traceable to N.P.L., self-contained portable unit, no scheduled frequency changes, 24 hr transmission, real time synchronisation

- Off-air frequency standards
- Intelligent time systems
- Caesium/Rubidium based clocks & oscillators
- Master/slave systems

- Time code generators/readers
- Record/replay systems
- Intelligent display systems
- Precision ovened oscillators
- Time/frequency distribution systems

Radiocode  
Clocks Ltd\*

Unit 19, Parkengue,  
Kernick Road Industrial Estate, Penryn,  
Falmouth, Cornwall. Tel: Falmouth (0326) 76007

(\*A Circuit Services Associate Co.)

CIRCLE 28 FOR FURTHER DETAILS

## COMPLETE SINGLE BOARD COMPUTER & SUPPORT..

Now you can wield the power of the 8051 using BASIC.

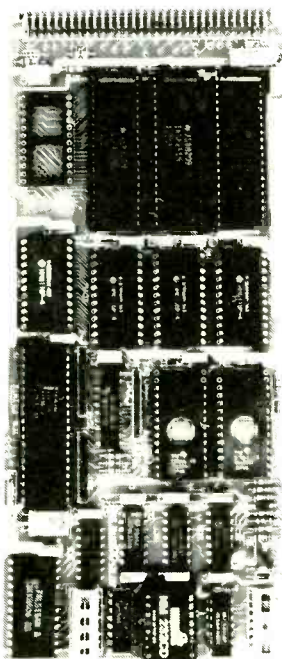

Based on the Intel 8052AH single component Microcontroller the CPU comes complete with a unique implementation of the BASIC language enabling direct access to the special function registers, timers and interrupts available on the 8051 device.

The new Cavendish Automation 7030 CPU is one of a complete range of Eurocards providing complete systems capability to OEMs. Support includes static MOS RAM boards (to 128K), Power-Down Control boards, Decoder boards, providing further address line decoding, watchdog, real time clock/calendar plus additional output flags and I/O. Mass storage devices. Backplanes. PSU and battery packs. Drive boards offering power output, signal conditioning and externally gated outputs. Multi channel DAC/ADC. Remote switch modules for power switching, sound or V.I.S. of vision.

Comprehensive documentation is supplied with each CPU and the 7030 CPU card requires only a +5v supply and dumb terminal for operation. Many unique features are incorporated and the system allows very fast interactive development of user software for super easy deployment in the target system.

### CPU Card Advantages:

- \* On card EPROM programming with single instruction & auto-start option
- \* 16K User EPROM/ROM plus 8K User RAM on card
- \* Twin Serial ports independently configurable (300 - 19,200 baud)
- \* 9 x 8 bit parallel I/O ports on card
- \* Full floating point arithmetic
- \* BASIC utilities may be called from Assembler
- \* Interrupts handled by BASIC or Assembler
- \* Very fast tokenised interpreter drastically reduces software development time
- \* 11 MHz operation as standard      \* low cost      \* customised options on low quantity

FOR ROBOTICS..ENVIRONMENTAL CONTROL.. PROCESS CONTROL..

For further information on the CA 7000 Series Controller contact:

**Cavendish Automation Limited.** 45 High Street, St Neots, Cambs, PE19 1BN. Tele(0480) 219457 Telex 32681 CAVCOM G.

CIRCLE 64 FOR FURTHER DETAILS



# You can't close your eyes to our Summer T&M SALE

HUNDREDS OF EXCITING SUMMER SALE OFFERS FROM ELECTRONIC BROKERS, THE LARGEST STOCKHOLDER OF SECOND USER TEST & MEASUREMENT EQUIPMENT IN EUROPE

## SOME EXAMPLES FROM OUR HUGE SALE LIST

**TEKTRONIX 308**  
**Data Analyser**  
 20 MHz, 8 Channels  
 MLP ~~£3500~~  
**SUMMER SALE** **£1500**

**FLUKE 7220A**  
**1.3 GHz**  
**Comms Counter**  
 9 Digit L.E.D. Display, 30 day warranty  
 MLP ~~£1380~~  
**SUMMER SALE** **£350**

**TEKTRONIX 475A**  
**250 MHz**  
**Oscilloscope**  
 Dual-trace, portable with Dual timebase  
**SUMMER SALE** **£1950**

**TEKTRONIX 4041**  
**SYSTEM**  
 Instrumentation Controller  
 MLP ~~£13500~~  
**SUMMER SALE** **£8800**

**MARCONI TF2702**  
**Inductor Analyser**  
 One of the most comprehensive inductance bridges available for use at low frequencies.  
**SUMMER SALE** **£750**

**FARNELL SSG/TTS**  
**520 Transmission Test Set**  
 10 to 520 MHz coverage, offers testing of transmitters with up to 100W capability.  
**SUMMER SALE** **£4000**

CIRCLE 3 FOR FURTHER DETAILS

  
**Electronic Brokers**  
**Electronic Brokers**

140/146 Camden Street, London NW1 9PB  
 Tel: 01-267 7070. Telex: 298694. Fax: 01-267 7363

To: Electronic Brokers Ltd., 140-146 Camden Street, London NW1 9PB

Please send me your Summer Test & Measurement Sale brochure by return.

NAME: \_\_\_\_\_

COMPANY: \_\_\_\_\_

ADDRESS: \_\_\_\_\_

POSTCODE: \_\_\_\_\_

TEL: \_\_\_\_\_

# Quartzlock OFF AIR FREQUENCY STANDARD



**You need a model 2A**

- Provides high accuracy 1MHz & 10MHz for frequency calibration
- If you use Counters  Timers  Frequency Meters
- Signal Sources & Generators or Radiotelephone Test Systems
- Medium term accuracy 1:10<sup>10</sup> Long term 2:10<sup>11</sup> without additional drift ageing or temperature coefficient  This new design on CAD PCB accommodates present & 1988 standard signals

## DARTINGTON FREQUENCY STANDARDS

MOOR ROAD, STAVERTON, DEVON TQ9 6PB ENGLAND  
Telex 42928 A/B WETRAV G (Quartzlock)

**FIRST CLASS/NEXT POST DATA SERVICE 080 426 524**

CIRCLE 67 FOR FURTHER DETAILS

# SmartWatch

**SPECIAL OFFER**  
from

**ELECTRONICS & Wireless world**

A battery-backed real-time clock/calendar with 64Kbit non-volatile ram for under £35.

This real-time clock/calendar from Dallas Semiconductor includes a battery-backed c-mos ram capable of holding data for 10 years.

SmartWatch keeps track of:

Hundredths of seconds — seconds — minutes — hours — day — date — month — year in any computer or controller application.

Looking like a 28-pin socket, SmartWatch fits into a computer's 8K-by-8bit memory socket\* — without any hardware modifications on most computers.

For memory read/write operations, no software modifications are required either.

Normally the computer sees SmartWatch as a standard memory i.c. but when a special code is sent to the socket, internal address decoding triggers the clock/calendar function, allowing time and date information to be read and written.

This means that both clock and memory occupy the same computer address range and no external decoding is required.

Only a small software routine is needed to trigger the clock function and read and write time/date information.

Built into the socket are the real-time clock, a lithium battery, address decoding and power-down switching.

Because of their extremely low power consumption, the 6264-type static memory i.c. and clock/calendar remain powered for 10 years using the same battery.

\*JEDEC pinout

Send to:— E&WW SmartWatch Offer.  
M.S. Components, Zephyr House, Waring St., West Norwood London, S.E.27 9LH.  
Offer applies to U.K. only. Please allow 28 days for delivery. Price includes data sheet.

To: E&WW SmartWatch Offer, M.S. Components, Zephyr House, Waring St., West Norwood, London, S.E. 27 9LH.

Please send me:—

.....SmartWatch(s) with memory @ £33.95 each, inclusive of V.A.T., post and packaging.

I enclose my cheque/p.o.'s value £..... made payable to E&WW SmartWatch Offer

Access/Barclaycard No.....

Signature.....

Name.....

Address.....

Regd. in England 15137 BUSINESS PRESS INTERNATIONAL LTD.,  
Regd. Office: Quadrant House, The Quadrant, Sutton, Surrey, SM2 5AS.

CIRCLE 69 FOR FURTHER DETAILS

ELECTRONICS & WIRELESS WORLD SEPTEMBER 1986



# IQD MOBILE RADIO COMMUNICATIONS

## WORLD LEADERS IN DTMF TECHNOLOGY

**IQD MICROPAD (600 Series)** The industry standard in DTMF microphones. Different models available include: ANI, amplified, high impedance and autodial.

**IQD SELCALL (600/7000 Series)** A unique DTMF selective calling system for mobile and hand-held radio with the operators number held within the microphone.

**IQD TONEPAD (200 Series)** These compact DTMF encoders are suitable for any hand-held radio and are available with either integral or remote electronics.

**IQD SMARTPATCH (5700 Series)\*** A microprocessor controlled autopatch that allows the user to make and receive telephone calls using any simplex mobile radio system.

**IQD SUPERPATCH (5200 Series)** A highly sophisticated duplex autopatch which gives true two way conversation between duplex mobile radio and the public telephone network.

Other products from IQD include cellular radio equipment, a unique remote control system; a telephone switchboard by-pass; and the complete range of quartz crystals, oscillators and filters of which we are the major manufacturer and supplier in this country.



# IQD

IQD Limited  
North Street, Crewkerne  
Somerset, TA18 7AR, England  
Telephone (0460) 74433  
Telex 46283

APPROVED for use  
with telecommunication systems  
run by British Telecommunications  
in accordance with the conditions  
in the instructions for use.

B.T. APPROVAL NO. NS/1523/3/F/45112

CIRCLE 6 FOR FURTHER DETAILS

# NEWS COMMENTARY

## Dull start for new broadcast exhibition

"Broadcast 86" was held at Frankfurt's Trade Fair centre June 24-27. Europe already has a major international broadcast show each year (IBC in Brighton and the Montreux TV symposium in Switzerland are held in alternate years). "Broadcast" is a newcomer to the European professional broadcast exhibition calendar and Frankfurt Trade Fair say they want it to become the number one show in Europe, on a par with NAB in the US.

However, the first "Broadcast" was more like a local German show than a major international event. Many major broadcast manufacturers were conspicuous by their absence. Ampex, Bosch, Philips, Rohde and Schwarz and Thomson were all absent as exhibitors.

The show's organisers put the poor turn-out down to the short notice at which the show was launched.

The low-level international

support for "Broadcast" can also be accounted for by the view held by many major broadcast equipment manufacturers that Europe already has enough broadcast exhibitions with IBC and Montreux.

There are also an increasing number of smaller national broadcast exhibitions. France now has 'Antenne' in October, Italy has a new broadcast and telecommunications show in Milan this September.

"Broadcast 86" on its first showing was a dull show for the international visitor, but the excellent exhibition facilities available at Frankfurt may attract larger international support if the planned "Broadcast 88" ever goes ahead.

## Satcom 87

A new Satellite Communications exhibition is to be included in the British Electronics Week 1987, the continuously expanding successor to the All-Electronics Show organised by Evan Steadman. The exhibition will be held alongside the other events at 'The Week' in London's Olympia from 28 to 30 April 1987, now comprising seven concurrent exhibitions: All-Electronics/ECIF Show, Circuit Technology, Fibre Optics, Electronic Product Design, Automatic Test Equipment, Power Sources and Supplies and now Satellite Communications.

At a presentation to potential exhibitors and the press at The Cafe Royal in July, Evan Steadman said that Satellite Communications was 'a natural' to add to the list. "We've done our homework and it's quite apparent that what the satellite industry needs is a professional show," said Steadman "right here in the middle of London." Situated on the top floor served directly by lift, the 75-stand show will cover professional satellite equipment, including receiving dishes and associated technology, up and down-link communication equipment and signal processors, as well as domestic receivers, programme services, marketing problems, and commercial exploitation of data communication and video conference services. A conference is planned for 1988 when Olympia will have its own conference facility. Next year's show is expected to attract European exhibitors as well as visitors, and the event will be supported by the journal that carried that pioneering article...

● Wearing two hats enabled one editor present to complain bitterly of the timing. Claiming to be chairman-designate of a newly formed 14-member European Satellite TV Association he revealed that 'Cable & Satellite 87' would be held a month earlier, also in London. As space runs out we have no room to tell you of the mud that was thrown...

## Design award

A tape-slide programme, with a booklet and teaching notes, to enable students to produce a simple microcomputer has been granted a design award from the Design Council. The award for £16,000 to Selwyn Houghton, Lecturer in Engineering at Wakefield District College is sufficient to complete the project.

## Radar probes ground

Hidden plastics objects can now be located underground through radar technology developed by ERA Technology. The new system uses a pulsed radar to 'illuminate' the ground through dispersionless antenna elements. A sampling receiver has been designed to detect the signals. Digitizing the return signals enables advanced signal processing algorithms to produce accurate pictures of the buried objects.

A detection map can be produced, showing the position in a searched area both in plan view and in cross section if depth information is needed. Developed for and funded by the MoD, the technology can be applied to a variety of civil and military tasks. Civil applications include structural inspection of reinforced concrete or other building applications and detection of pipes, including plastics pipes.

### Memory telephone dialler

Number storage and dialler i.c. UM91610 from UMC used in T. Segaran's March article, is available through Manhattan Skyline, Katakana Ltd, Manhattan House, Bridge Road, Maidenhead, Berkshire SL6 7DB at £1.85.

We are told that the 91610 is pin compatible with the obsolescent MM53143/44 and the AM125610. The AM1 chip has no confidence-tone output.

Three-dimensional computer-processed image of a buried plastics pipe produced by ERA's pulsed radar system operating over 400 MHz to 5GHz.

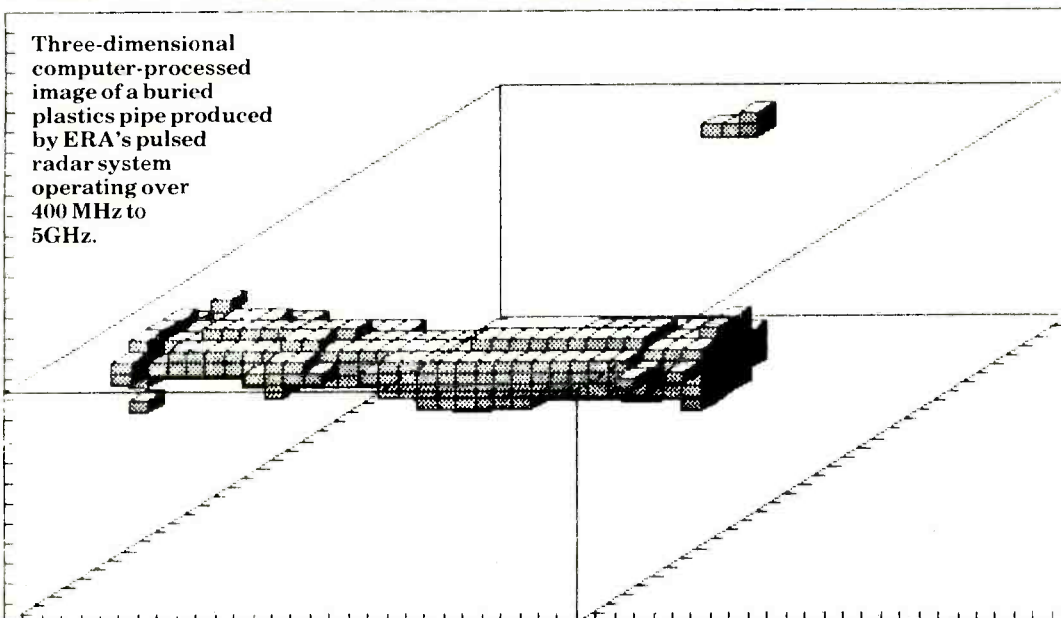



## Digital tv standard now...

A universal standard has been recommended by the CCIR (International Radio Consultative Committee) for digital video interfaces and for recording digital tv signals onto tape. The standard is based on that selected by the CCIR for video encoding which stipulates the use of digital component signals, sampled at

a rate of 13.5MHz for luminance and 6.75MHz for the two colour difference signals. Digital coding of the component signals, rather than conventional composite signals, offer great benefits to broadcasters and programme producers, says the report of the committee, since it allows almost unimpaired post-processing capability; special effects, electronic tricks and picture manipulation can be performed on recorded signals with the same level of quality that would be achieved if they were performed 'live' on the studio output signal.

## ...h.d. tv standard later

The CCIR also decided at their recent meeting in Dubrovnik to tackle the standardization of h.d. tv. But this is unlikely to follow such a smooth path as the digital standards; there are a number of national factions, each rooting for its own system. Main contenders are

the Japanese system which is concentrating on the studio production standard; the Europeans would like to see an integrated production, transmission and receiver standard based on the MAC family developed by the IBA. The CCIR does however recognise the need for a single international set of parameters and a working party is planning to offer recommendations to a meeting of a study group in 1988. Those recommendations should be adopted by the plenary assembly of CCIR in 1990.

**This flat antenna array comprising 64 interconnected elements on an etched circuit board is claimed to have extremely high gain. No performance figures were available for this 'optimum' d.b.s. antenna, shown at Cable '86 by DX Antennas of Japan. Report on page 30.**

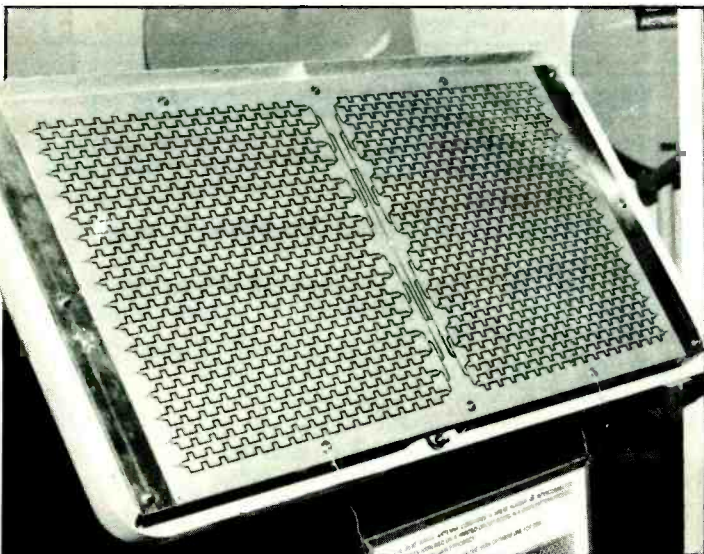

On Line Conferences

## New transmitters for IBA television

As part of a £40M scheme to replace its u.h.f. transmitters, the IBA has signed a contract with Marconi worth £7.5M for the first 14 of them. The transmitters have powers of 15, 25 and 40kW and use pulse operation for the external-cavity klystrons to give peak sync efficiencies of about 70%. This means that they use about half the electricity of the transmitters being replaced and can pay for themselves in terms of saved electricity bills.

Using the same transmitters at all the IBA sites will also save on maintenance costs as the number of different spare parts needed will be greatly reduced.

The transmitters have the capability of sending two sound channels. Although

there is no short-term plan for the IBA to introduced stereo tv services, the possibility is available and future competition from cable, satellite or other services might precipitate stereo sound.

Despite the future advent of d.b.s. services, John Whitney, IBA director-general, believes that there will be a continuing need for terrestrial tv, particularly in the regional services which could not be offered by satellite for a long time to come. Meanwhile the existing terrestrial u.h.f. transmitters, at 20 years old are reaching the end of their useful life and need to be replaced anyway. The new transmitters are expected to have a similar lifespan.

## Automation for social security computers

Five hundred local security offices are to be computerized and linked through a network to each other and to the central offices in Newcastle-upon-Tyne and North Fylde. This will eventually enable any claimant to discuss and obtain benefits and entitlements from any DHSS local office or unemployment benefit office in Britain.

The contract to provide the complete, integrated terminal system has gone to British Telecom, and will include the supply up to 1000 minicomputers and 28 000 terminals. It will also involve development, implementation and maintenance of software to last well into the next century. The first installation, at the Newcastle main office, will be used for accessing the retirement pension records. It is due to be brought into regular use by the end of the year.

Three main subcontractors are Information Technology

Ltd, who supply 32-bit minicomputers adapted to BT's design from its Momentum 9000 family, Newbury data, who supply displays to BT design and three designs of printer, and Real Time Developments whose flexible lan will be used to link terminal and computers within a site. BT themselves plan a full OSI network to link all the offices together and to various mainframe computer centres which process benefit claims and enquiries.

### In Brief

Amateur, CB radio, and tv licence fees are unaffected by the new scale of fees announced by the DTI. Most other fees have been increased by an average of about 18%, varying depending on the service. The full list is published by the DTI. Wireless Telegraphy (Licence Charges) Regulations 1986 (SI 1986/1039, HMSO £1.90).

# Get in control with the Zero-One-Q

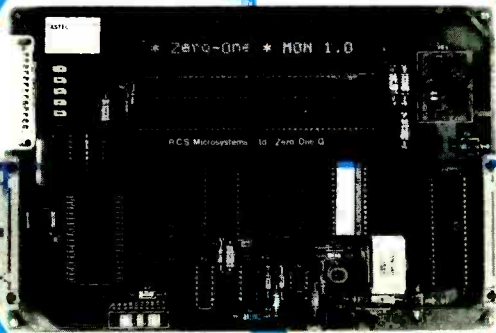

## The complete "Target System" with:-

Built in 20 character display, RS232 Port, Battery Backed RAM, three 16 bit counter-timers, 42 I/O lines and an expansion Port.

The Zero-One-Q features the R6501AQ Extended 6502 microcomputer operating at 2MHz and can be programmed in Assembly language or FORTH.

### R.C.S. MICROSYSTEMS LTD,

THE KINGS ARMS,  
141, UXBRIDGE ROAD,  
HAMPTON HILL,  
MIDDLESEX.  
TW12 1BL

Tel No. 01-979-2204  
Telex: 8951470 RCS MIC



RCS Microsystems is a  
Rockwell distributor

CIRCLE 37 FOR FURTHER DETAILS

# Happy Memories

Part type	1 off	25-99	100 up
4164 150ns Not Texas .....	.95	.85	.80
41256 150ns.....	2.40	2.15	2.05
2114 200ns Low Power .....	1.75	1.60	1.55
6116 150ns.....	1.40	1.25	1.20
6264 150ns Low Power .....	2.40	2.15	2.05
2716 450ns 5 volt.....	2.90	2.60	2.45
2732 450ns Intel type.....	2.70	2.40	2.25
2764 250ns Suit BBC.....	2.15	1.90	1.75
27128 250ns Suit BBC.....	2.45	2.20	2.10
27256 250ns.....	3.85	3.45	3.30

Low profile IC sockets: Pins	8	14	16	18	20	24	28	40
Pence	5	9	10	11	12	15	17	24

Please ask for quote on higher quantities or items not shown.

All memory products Japanese or American manufacture.

74LS series TTL, wide stocks at low prices with DIY discounts starting at a mix of just 25 pieces. Write or 'phone for list.

Please add 50p post & packing to orders under £15 and VAT to total. Access orders by 'phone or mail welcome.

Non-Military Government & Educational orders welcome for minimum invoice value of £15 net.

**HAPPY MEMORIES (WW),**  
Newchurch, Kington,  
Herefordshire HR5 3QR.  
Tel: (054 422) 618

CIRCLE 30 FOR FURTHER DETAILS

## 3" HITACHI DISK DRIVES

Suitable for use on the Amstrad 6128, 664, Tatung Einstein, BBC with DFS. 40 track, double density. 3 ms track access time. Unformatted capacity — single sided 250k; double sided 500k. Shuggart interface. Plug compatible with 5¼ inch drives.

PRICE:  
£29.95 + VAT  
Single sided  
£39.95 + VAT  
Double sided



Cables available for connection to  
Amstrad — £7.50 plus VAT.  
BBC — £10.00 plus VAT.  
Tatung — £10.00 plus VAT.

FOR FURTHER DETAILS SEND S.A.E. TO:

MATMOS Ltd., Unit 11, Lindfield Enterprise  
Park, Lewes Road, LINDFIELD,  
West Sussex RH16 2LX Tel. 0444-73830

Or Computer Appreciation,  
111 Northgate, CANTERBURY, Kent. CT1 1BH.

## R68K PERSONAL ROBOT

Mobile robot with optional arm controller includes 68000 processor, up to 128K rom, 16K ram, 16Ch. ADC, SPO256.

Uses: Security, Education, Industrial, Promotional, Home.

Built-in software makes it the first really useful personal robot, future extensions include improved speech recognition and vision.

Robot (inc. Controller) .....	£795
Arm .....	£595
Controller.....	£195

S.M.C. Electronics, Unit 29,  
Portsmouth Enterprise Centre,  
Quatermaine Road, Portsmouth PO3 5QT.  
Tel No: 0705 478881 Telex No: 869455 Fax No: 673647

CIRCLE 56 FOR FURTHER DETAILS

ELECTRONICS & WIRELESS WORLD SEPTEMBER 1986

# COMMUNICATIONS COMMENTARY

**T**wo conferences, held within days of each other in July, provided a good opportunity to catch up on current trends in radio communications research and development in commercial applications, military communications, university and Rutherford Appleton Laboratory projects, broadcasting and the world of amateur radio. The IERE Radio Receivers conference at Bangor, with 130-plus delegates, allotted some 25-35 minutes to each of over 30 papers. The URSI National Colloquium at Birmingham with about 65 delegates skipped through 26 papers at a rate of three or four an hour in a range that varied from far-out fundamental physics to the workaday world of measuring h.f. radio noise levels in ships (worryingly high!).

## VLF errors

An excellent example of how a project that starts out primarily to confirm other people's work can develop into a discovery of considerable practical significance was the account at the URSI colloquium by Dr R Barr (New Zealand DSIR, currently at Kings College, London) of his investigation of v.l.f. radio propagation over the Antarctica icescape. Initially his object was to confirm earlier work in Greenland and North America of the greatly increased attenuation of Omega navigational signals when they pass over thick layers of ice. However by making a synthetic aperture directional analysis of signals received during some routine flights to the New Zealand base in Antarctica he has shown that not only are the Omega signals greatly attenuated but they are in effect diffracted around the ice with the result that any signals with paths crossing or skirting large ice layers are "bent" out of their great circle paths, the arrival angle changed and resulting in false Omega readings. He points out that while Omega is seldom used as a radio-navigational aid above

the Antarctic icescape, the effects could apply over significantly large areas of the Pacific.

## Hazards

Dr P.S. Excel (Bradford University) who is examining probabilistic factors in the spark and ignition hazards arising from electromagnetic radiation is clearly convinced that the present British standards (BS6656 and BS6657) do not take enough account of the unlikelihood of a number of theoretically possible hazards arising at the same time. He questions, for example, "Why are not petrol stations blowing up willy-nilly around high-power m.f. transmitters?" and points out that most other industries accept some small level of "statistical" risk in their operations. I suppose he is right, although it does appear to some of us that his probabilistic theories fly in the face of Murphy's Law that if anything can possibly go wrong it will do so at the most inopportune moment. Perhaps of equal concern was his open admission of what has long been evident: that BSI committees are being leaned upon by Government, including the Health and Safety Executive as well as industry representatives, to accept compromises rather than to stick rigidly to "worst case" solutions.

## Cross-polar puzzle

At Birmingham, J.E. Doble of British Telecom Research showed how even the relatively stable microwave spectrum can still spring curious surprises that can cause unexpected outages of digital links.

An experimental 6GHz link over a 51km hop is designed to pass 140Mbit/s data in a cross-polarization mode. Initially problems were experienced during cross-polar interference due to the lack of off-axis cross-polar isolation of the dish antennas. These were redesigned to provide some 48dB isolation reducing to not less than about 38dB off-axis, and

it was expected that this would solve all the problems. A nasty shock came in April 1984 when cross-polar degradation occurred not only in the form of short frequency selective spikes but closely correlated to the slow fades that commonly denote tropospheric propagation, resulting in outages extending over five hours on circuits intended not to show outages not exceeding 28 seconds in any month.

Nor did this prove to be a one-off event. Similar effects were observed in February 1985 and enquiries showed that this unusual effect has been observed from time to time in West Germany, though this had not been reported internationally. It is now believed that such conditions can occur perhaps once or twice a year although difficult if not impossible to predict.

Present thinking suggests that in certain weather conditions a temperature inversion can occur about 200 metres above ground level and super-refraction conditions tends to be forced down even below the height of the microwave towers.

British Telecom are being forced to undertake an extensive monitoring programme to determine whether such conditions occur only in the coastal areas of East Anglia or, as seems likely, over the whole country. It is leading to the conclusion that if communicators are to use spectral-efficient systems operationally somebody will have to do a lot more work on cancellation techniques.

## Communicating

A major part of British communications R&D is directly linked to defence applications. There were times, particularly at Bangor, when one felt that engineers are endlessly involved in chasing their own tails. First you develop a system. Then you develop electronic countermeasures against your own system. Then you change your own system to provide electronic counter

countermeasures... and then knowing the weaknesses of your own system you once again set out to destroy its capability. Gradually the systems become more and more complex, more and more under software control (despite the difficulty of finding and correcting software errors under field conditions). Then you start a programme to reduce size and cost and based on the assumption that the Services are morons led by donkeys, and already leading to a confusion of the role of, for example, the Royal Signals with that of the Platoon signallers.

In the second of two 'key note' addresses at Bangor, Professor William Gosling of Plessey spoke eloquently of the danger of explosive growth of communications traffic but warned that we are taking too little account of the need for spectrum conservation. He bitterly attacked the use in the sections of Band III released to land mobile of "Armstrong's nightmare child" (i.e. frequency modulation) and the widespread use of excessive transmission powers. He regretted that the study of transmitters is not a fashionable subject, with only one university group engaged in such work. More should be done to develop digital vocoders which, combined with voice synthesizers, could result in voice channels narrower than that of 100-baud teleprinter circuits, he suggested.

Listening to the many new ideas for real-time channel evaluation, the wonders of spread spectrum and the like, it at times seemed that it might be more sensible to investigate not how much more information we can cram into the finite radio spectrum but whether users really need to be given an open-ended facility. Traffic expands to fill the channels available. But do we, civilian or military, really need to be able to speak to anyone at any time? Tell someone that they are limited to a few short telegraphic signals per day and it can concentrate the mind wonderfully.



# RAEDEK ELECTRONICS

Tel 021-474 6000

Telex No 312242

SERVING THE COMMUNICATIONS AND ELECTRONICS INDUSTRIES

MIDLTX G.

102 PRIORY ROAD, SCRIBERS LANE, HALL GREEN, BIRMINGHAM, B28 0TB. ENGLAND.

### TRANSISTORS:

### VALVES:

TYPE	LIST £	TYPE	LIST £	TYPE	LIST £	TYPE	LIST £	TYPE	LIST £	TYPE	LIST £	TYPE	LIST £
2N3375	10.90	2SC1978	6.40	AH211A	137.50	EF94	2.00	OA3	2.50	6AU6GT	3.70	813	30.00
2N3553	1.60	2SC2053	0.90	AH2511	90.00	EF95	1.60	OB2	2.50	6AZ8	3.80	934	18.00
2N3632	12.95	2SC2237	6.00	AH2532	31.50	EF183	1.90	OC3	2.50	6BA6	1.50	935	41.20
2N3733	12.95	2SC2287	9.60	BT5	52.50	EF184	1.80	OC3	2.50	6BF6	1.95	2050	4.80
2N3866	1.20	2SC2290	20.00	BT5B	52.50	EK90	1.40	2C39A	39.90	6BH6	2.15	2050A	4.80
2N4416	0.75	MRF240	20.70	BT17	142.00	EL34	3.90	2C39WA	42.00	6BJ6	2.00	5544	95.00
2N4427	1.40	MRF245	33.00	BT17A	130.00	EL36	2.30	2D21	2.00	6BK4	4.50	5545	61.00
2N5090	10.90	MRF247	33.30	BT95	125.00	EL84	1.60	2E26	7.50	6BN8	3.50	5557	24.50
2N5109	1.95	MRF433	9.00	C3J	30.00	EL86	2.10	2K25	114.00	6BZ6	2.50	5559	52.50
2N5160	3.00	MRF449A	10.15	C3JA	30.00	EL519	7.70	3 400Z	78.00	6C4	1.95	5577	2.95
2N5589	7.60	MRF450	11.50	E55L	56.00	EL8035	9.95	3 500Z	85.00	6C8A	1.60	5577A	140.00
2N5590	7.90	MRF450A	13.80	E80CC	14.00	EL821	13.75	3B28	15.00	6CJ3	2.30	5579	6.15
2N5591	9.50	MRF454	17.25	E88CC	21.00	EN32	16.25	3C45	24.50	6CV4	6.30	5591	2.20
2N5641	6.95	MRF454A	17.25	E90CC	3.90	EN91	2.00	3CX100A5	35.00	6D6	2.45	5597	32.00
2N5642	9.30	MRF455	16.50	E130L	21.25	EZ81	1.50	4 125A	52.50	6E5	4.20	6130	24.50
2N5643	11.85	MRF458	17.20	EB91	1.35	EZ90	1.50	4 250A	76.00	6E7	2.25	6146A	9.00
2N5913	2.50	MRF475	2.30	EBF91	1.10	FG17	24.50	4 400A	80.00	6HF5	4.25	6360A	4.95
2N5944	7.85	MRF476	2.15	EBF89	1.35	FG105	160.00	4 400B	80.00	6H5	3.95	6550A	7.25
2N5945	10.10	MRF644	22.50	EC90	1.25	GXU1	15.00	4 400C	80.00	6JB4	4.20	6883B	8.70
2N5946	10.80	MRF646	27.00	ECC32	3.25	GXU4	45.00	4B32	30.50	6J5	6.25	6973	3.95
2N6080	6.65	MRF648	32.70	ECC81	1.60	GZ34	2.10	4C35A	135.00	6J5C	4.70	7027A	6.50
2N6081	8.40	MRF901	2.75	ECC82	1.60	K166	9.00	4CX250B		6K7	2.50	7199	4.20
2N6082	10.50	SD1013	9.75	ECC83	1.60	KT77	8.75	EIM AMP	55.00	6K7	2.25	7247	3.20
2N6083	11.20	SD1019 STUD	23.10	ECC85	1.85	KT88	24.95	4CX250B	48.00	6L1	5.90	7262A	26.00
2N6084	12.00	SD1019-5	22.80	ECC88	2.00	ML8536	275.00	4CX350A	27.00	6L6	2.00	7360	12.20
2SC1729	12.50	SD1127	3.10	ECC91	2.00	ML8741	265.00	4CX50A	33.75	6L6	3.90	7586	11.50
2SC1945	3.45	SD1134 1	2.25	ECC189	2.00	NL SERIES		5AR4	2.10	6Q11	2.25	7591A	35.00
2SC1946A	16.00	SD1136	11.90	ECF80	1.50	QOV02 6	22.00	5AS4A	2.10	6S-7GT	2.25	7815AL GE	48.00
2SC1947	8.50	SD1143	9.40	ECF86	1.65	QOV03 10	5.30	5R4GYA B	3.95	6SN7GT	3.05	812R	53.00
2SC1969	1.80	SD1219	14.70	ECF81	2.30	QV3 12	7.00	5U4GE	2.10	6U6	2.00	8129	101.00
2SC1970	1.40	SD1272	10.95	ECL82	1.90	QY3 125	63.00	5Y4GA	2.50	12A7E	1.50	8906AL	55.00
2SC1971	3.50	SD1278	13.75	ECL86	1.60	RG1 250	69.80	6AH6	2.30	12AU6	1.70	906AL	6.50
2SC1972	9.50			EF85	3.00	RG4 3000	90.00	6AK5/7	2.50	12A76	2.00	572B	52.00

### INDUCTION AND DIELECTRIC HEATING SPARES

INCL	SOLID STATE RECTIFIERS
CERAMIC CAPACITORS	RECTIFIER VALVES
VACUUM CAPACITORS	OSCILLATOR VALVES
GRID LAMPS	COOLING FANS/FILTERS
CARBON FREE HOSE	etc. etc.
WATER FLOW SWITCHES	

1000's of VALVES/TRANSISTORS/IC'S IN STOCK. PLEASE ENQUIRE ON TYPES NOT LISTED

SERVICE AIDS	
CONTACT CLEANER - 1.00	HEATSINK COMP 100g 1.50
FREEZE IT AEROSOL - 1.25	SILICONE GREASE 1.50
	LARGE RANGE OF SOLDERING IRONS AND ACCESSORIES

PRICES - CORRECT AT TIME OF GOING TO PRESS  
TERMS - PLEASE ADD £1.00 P&P AND VAT @ 15% to orders.

WE ALSO SUPPLY EIMAC TUBES AND ACCESSORIES

CIRCLE 22 FOR FURTHER DETAILS

## LOW COST C.A.D. ATTENTION ALL ELECTRONICS CIRCUIT DESIGNERS!!

I.B.M. PC (and compatibles): BBC MODEL B, B+ and MASTER: AMSTRAD CPC and SPECTRUM 48K

ANALYSER I and II compute the A.C. FREQUENCY RESPONSE of linear (analogue) circuits. GAIN and PHASE, INPUT IMPEDANCE, OUTPUT IMPEDANCE and GROUP DELAY (except Spectrum version) are calculated over any frequency range required. The programs are in use regularly for frequencies between 0.1Hz to 1.2GHz. The effects on performance of MODIFICATIONS to both circuit and component values can be speedily evaluated.

Circuits containing any combination of RESISTORS, CAPACITORS, INDUCTORS, TRANSFORMERS, BIPOLAR and FIELD EFFECT TRANSISTORS and OPERATIONAL AMPLIFIERS can be simulated - up to 60 nodes and 180 components (IBM version).

Ideal for the analysis of ACTIVE and PASSIVE FILTER CIRCUITS, AUDIO AMPLIFIERS, LOUDSPEAKER CROSS-OVER NETWORKS, WIDE-BAND AMPLIFIERS, TUNED R.F. AMPLIFIERS, AERIAL MATCHING NETWORKS, TV I.F. and CHROMA FILTER CIRCUITS, LINEAR INTEGRATED CIRCUITS etc.

STABILITY CRITERIA AND OSCILLATOR CIRCUITS can be evaluated by "breaking the loop".

Tabular output on Analyser I. Full graphical output, increased circuit size and active component library facilities on Analyser II.

Check out your new designs in minutes rather than days.

ANALYSER can greatly reduce or even eliminate the need to breadboard new designs.

Full AFTER SALES SERVICE with TELEPHONE QUERY HOT LINE and FREE update service.

Used by INDUSTRIAL, GOVERNMENT and UNIVERSITY R&D DEPARTMENTS worldwide. IDEAL FOR TRAINING COURSES. VERY EASY TO USE. Prices from £20 - £195.

For further details and example computation or for details on our New DRAUGHTING program, please write or phone:

Number One Systems Ltd 1  
Dept WW, Crown Street,  
St Ives, Huntingdon, Cambs. PE17 4EB.  
Tel: (0480) 61778

CIRCLE 58 FOR FURTHER DETAILS



## TDS 900

FORTH COMPUTERS

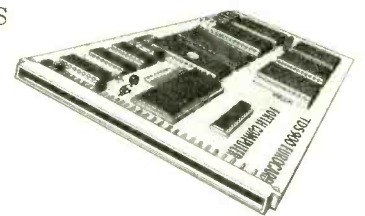

Build the TDS900 into products.

- \* Card computer. Up to 54K RAM, 8K ROM.
- \* C-MOS for low power.
- \* High level language. Compiled and fast. Use assembler and interrupts as needed.
- \* Easy connection with serial and parallel channels, A/D, D/A converters, triacs, printers, keyboards and displays.

Triangle Digital Services Ltd  
100a Wood Street, London E17 3HX

Telephone 01-520-0442 Telex 262284 (Ref M0775)  
CIRCLE 20 FOR FURTHER DETAILS

## Lifelong morse

The Department of Trade and Industry has agreed to a significant change in respect of Class A licences. For many years new licences have been issued only to applicants who have passed the official morse test within the past twelve months. This has meant that almost invariably candidates seek to obtain a pass in the Radio Amateurs' Examination (RAE) before attempting the morse test, otherwise there is always the possibility that the time may have expired before the RAE is passed with the result that the candidate has to retake the morse test.

It has also had the effect that those holding Class A licences are reluctant, even if inactive over a considerable period, to give up their licences since they have had to retake the morse test if they later re-apply. Another result tends to be prompt payment of licence fees to avoid the risk of having the licence cancelled and then having to retake the morse test to get it reactivated.

However the DTI has now ruled that the validity of the morse test, like that of the RAE certificate is unlimited in time. Once passed it need never be retaken.

The RSGB, following dissatisfaction expressed by would-be candidates for morse tests, has been able to announce the setting up of test centres in a number of counties, apart from the facilities being provided at mobile rallies.

It would appear that the establishment of the test centres, each able to call upon two approved volunteer examiners, received a set-back when British Telecom unexpectedly ordered its employees to take no part in the running of the RSGB tests, whether or not morse is involved in their work for BT. This followed the change when BT suddenly decided it would like to continue administering the tests after having formally given notice that it wished to hand this over to some other body.

The DTI is prepared to permit amateur operation from oil rigs and platforms, granting them the status of off-shore islands. However DTI stipulates that permission must al-

ways be obtained from the owners or lessees of the rig, the safety officer and the radio officer and that any restrictions imposed by them must be followed.

## Space

Although this year's series of launch vehicle disasters has thrown the West's space programme into near disarray, planning for various scientific and experimental projects is still continuing in the hope that, come the day, launchers and funding will be AOK.

Dr D.L. Croom (SERC/RAL) described the ambitious plans for a NASA international space station programme to establish a multi-element, multi-user manned or serviced space facility by the mid-1990s. The European Space Agency contribution ("Columbus") includes one of the manned modules of the main core station plus one of the 'Polar Platforms' for Earth observation and other payloads.

Dr J.R. Norbury (SECR/RAL) described the feasibility studies for a mobile radio payload for T-Sat which has picked up some of the ideas of the CERS project that was abandoned in 1984.

The plan is based on the idea that communications satellites are still based on the geostationary concepts of the mid-1960s. It is hoped that T-Sat will carry time-division-multiplex transponders into an elliptic Molinya-type 12-hour orbit in which the satellite would hover directly above the UK for eight hours, with an operational system comprising three orbiting satellites but each requiring only half the launch-energy of a comparable geostationary satellite. This would radiate L-band signals down to the UK for reception on flat 50cm square antennas mounted on the horizontal roof of vehicles.

It is argued that there would be much less signal variation than with the low elevation of geostationary satellites (only about 2dB fade margin) and little or no screening from building or vegetation. Mobile transmitters of 10 to 20 watts power with the simple flat antennas would suffice. But so far only the study work has been funded. Early in 1987 the

Government will have to decide whether to fund at least the next phase of the work or whether, like CERS, the projects will be abandoned.

## RAE courses

As usual a number of courses for the RAE are due to start in September or October at local adult education or further education centres.

There are also a gradually increasing number of courses in practical electronics construction; for example the one at Paddington Green aims to provide an elementary grounding in electronics, using the college facilities, as well as preparing candidates for RAE.

John Lawrence, GW3JGA, who provided the RAE course at the Prestatyn Evening Institute has for several years run instead a "Practical Amateur Radio Class".

The students — all from previous RAE classes — have had to choose from several constructional projects of varying complexity such as morse oscillator, v.h.f. reflectometer h.f. directional power meter, 100-watt dummy load, f.e.t. dip oscillator etc. Some projects were designed by GW3JGA from scratch, others based on existing designs, but in each case all the information together with a built and working sample was available on the first evening so that the level of constructional work and performance of the unit could be judged by students.

Then the first 20 minutes each week were spent on some aspect of construction or practical setting up of amateur radio station equipment, including soldering, fitting coaxial plugs, simple metal work, antenna construction, tuning up of transmitters, testing for television interference, safety aspects etc. The rest of the evening was spent with John Lawrence assisting students with constructional projects.

At first there was a great lack of confidence — some in the class, although holding amateur licences, had never used a soldering iron. Many had difficulty in equating the circuit diagram with physical components and wiring. The physical wiring of switches was regarded as difficult.

The subsequent de-bugging of projects that did not work first time needed to be covered in easy stages: visual examination, point-to-point checking; voltage measurements. In future John Lawrence intends to cover simple fault-finding at an earlier stage so that the students can make checks as the work proceeds.

In practice, all students completed their projects successfully. Several entered equipment in the constructional competition at the local club.

The general use nowadays by newcomers to amateur radio of entirely factory-built equipment has clearly left a gap that needs to be filled.

## In brief

Oxfam are seeking volunteers with a good knowledge of the safety aspects etc of electrical appliances to help sort out and check electrical goods donated for sale at their 750 shops throughout the UK (offers to Faye Wark, Oxfam, Freepost, London N12 9BR)... Shozo Hara, JA1AN, president of the Japanese Amateur Radio League has been awarded a "Ranjuhoshu" blue ribbon medal by the Japanese Ministry of Posts and Telecommunications, regarded as a high honour in Japan ... JAS-1 the first Japanese amateur radio satellite is due to have been launched on a Japanese H-1 vehicle by the time these notes appear... A new amateur radio emergency service has been established in Denmark... BARTG has its own rally at Sandown Park Racecourse, Esher, Surrey on Sunday, August 24... The rtty group is concerned that about 1000 of its members have failed to renew their subscriptions this year... Problems which arose on Oscar 10 during May which locked the satellite into Mode B still persisted in early July but there are hopes that they can be overcome. Uosat has also experienced some operational problems. The Uosat radiation detector (Channel 3) had been proving unreliable and had been switched off during the week following the Chernobyl disaster but during the following week recorded high radiation readings in the course of orbits that passed close to the Chernobyl area. —

PAT HAWKER G3VA

**RESEARCH COMMUNICATIONS LTD.**  
UNIT 3, DANE JOHN WORKS, GORDON ROAD, CANTERBURY, KENT CT1 3PP  
TELEPHONE: CANTERBURY (0227) 456489

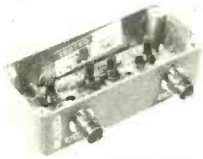

**TYPE 9006**



**TYPE 9002**



**TYPE 9252**



**TYPE 9259**

**TELEVISION LINEAR POWER AMPLIFIERS** Tuned to your specified channels in bands I, III, IV or V (or in the range 45-950 MHz). Power 24V + DC.  
 TYPE 9261 100mV input, 10mW output ..... £180 + £10 p&p  
 TYPE 9252 10mW input, 500mW output ..... £210 + £10 p&p  
 TYPE 9259 500mW input, 3 watts output ..... £240 + £10 p&p  
 TYPE 9263 2/3 watts input, 15 watts output ..... £330 + £15 p&p  
 TYPE 9235 Mains power supply unit for complete system ..... £120 + £12 p&p

**GASFET RF PREAMPLIFIERS.** Aligned to your specified frequency in the range 30-1000MHz. Masthead or local use.  
 TYPE 9006 N.F. 0.6dB. Gain 10-40dB variable. In the range of 30-250MHz ..... £65 + £3 p&p  
 TYPE 9006FM As above. Band II 88-108MHz ..... £65 + £3 p&p  
 TYPE 9002 Two stage Gasfet preamplifier. N.F. 0.7dB. Gain 25dB adjustable. High Q filter. Tuned to your specified channels in bands IV or V ..... £85 + £3 p&p  
 TYPE 9004 UHF two stage Gasfet preamplifier. N.F. 0.7dB. Gain 25dB adjustable. High Q filter. Aligned to your specified frequency in the range 250-950 MHz ..... £85 + £3 p&p  
 TYPE 9035 Mains power supply unit for above units ..... £24.50 + £4 p&p  
 TYPE 9010 Masthead weatherproof unit for above amplifiers ..... £9.50 + £3 p&p



**TYPE 9113**



**TYPE 8034**

**TYPE 9113 PHASE LOCKED LOOP FREQUENCY CONVERTER.** Provides the performance required for television retransmission systems. Converts your specified input channel in the range 30-1000MHz to your specified output channel in the range 30-1000MHz. 1mV input, 10mW output (+10dBm). Gain 60dB adjustable -30dB. Will drive transmitting amplifiers directly ..... £295 + £6 p&p  
**TYPE 9114 RECEIVING PHASE LOCKED LOOP FREQUENCY CONVERTER.** Similar to above but operating at lower input and output signal levels, suitable for receiving systems. Gain 25dB adjustable -30dB. Low noise gasfet front-end. Noise factor 1.0dB ..... £295 + £6 p&p  
**TYPE 9115 As type 9114 with integral mains power supply.** ..... £345 + £10 p&p  
**TYPE 8034 PHASE LOCKED SIGNAL SOURCE** using low frequency reference crystal. Specify output in the range 10-600MHz. Output 10mW (+10dBm) ..... £99.50 + £3 p&p  
**TYPE 8036 As above but operating directly in the range 600-1000MHz. Output 1mW.** ..... £149 + £4 p&p  
**TYPE 9182 FM EXCITER** 88-108MHz deviation ±75KHz. 10-600MHz deviation ±10KHz. Output 10mW ..... £205 + £5 p&p  
**TYPE 9086 FM TRANSMITTER** 88-108MHz. 50 watts RF output. 24V + supply. Complete modular system ..... £780 + £30 p&p  
**TYPE 9087 As above with integral mains power supply unit.** ..... £900 + £40 p&p  
 PLEASE ADD 15% V.A.T. ON TOTAL

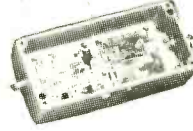

**TYPE 9155**

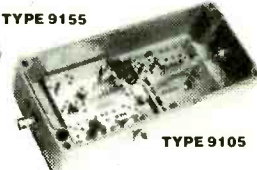

**TYPE 9105**



**TYPE 9158/9235**

**TMOS RF LINEAR POWER AMPLIFIERS.** Tuned to your specified frequency in the range 10-250MHz. Power 24V + DC.  
 TYPE 9105 10mW input, 1 watt output ..... £190 + £12 p&p  
 TYPE 9106 100mW input, 10 watts output ..... £235 + £15 p&p  
 TYPE 9155 1 watt input, 30 watts output ..... £270 + £15 p&p  
 TYPE 9158 5 watts input, 70 watts output ..... £370 + £20 p&p  
 TYPE 9235 Integral mains power supply unit for above amplifiers ..... £120 + £12 p&p



**TYPE 9051**



**TYPE 9046**

**TMOS LINEAR WIDEBAND POWER AMPLIFIERS** 4/20 watts RF output. Without tuning. Power gain 13dB (x20) 24V + DC supply.  
 TYPE 9046 100KHz-100MHz. 4 watts ..... £89.50 + £4 p&p  
 TYPE 9051 15-225MHz. 4 watts ..... £89.50 + £4 p&p  
 TYPE 9174 15-225MHz. 20 watts ..... £255 + £20 p&p  
**HIGH GAIN UNITS.** Power gain 26dB (x400). 24V + DC supply.  
 TYPE 9176 100KHz - 100MHz. Input 10mW, output 4 watts ..... £210 + £6 p&p  
 TYPE 9177 15-225 MHz. Input 10mW, output 4 watts ..... £210 + £6 p&p

**CIRCLE 41 FOR FURTHER DETAILS**

## TELESCOPIC MASTS

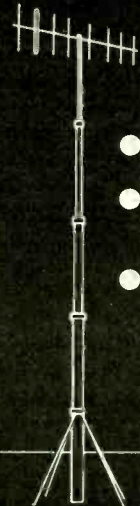

- Pneumatic
- Hydraulic Ram Operated
- Winch Operated



## Hilomast Ltd.

THE STREET - HEYBRIDGE - MALDON  
ESSEX - CM9 7NB - ENGLAND  
Tel: (0621) 56480 Telex: 995855

**CIRCLE 18 FOR FURTHER DETAILS**

## PRINTERS - MONITORS - TERMINALS - PERIPHERALS

**Burroughs MT710:** Intelligent Green 12" VDU with 3 micros and 64K store. RS232. Programmable. Only £149 new + £15 P&P.

**12" Open Chassis Video Monitor:** by Hitachi standard composite Video and 12v input. Green screen, wide bandwidth. £40.00 + £7.00P.

**Cased Video Monitors:** 12" or 15" Green Screens standard composite video & mains £60.00 + £7.00 P&P.

**Centronics 306 Line Printers:** Professional fast (120 cps), superb quality 80 column printer. Parallel i/f. ONLY £99 + £15.00 P&P.

**Texas Silent 700 Printers:** Whisper quiet 80 col matrix printer with RS232 interface. ONLY £50.00 + £7.00 P&P.

**Diablo 630 Daisywheel printer:** OEM i/f NEW £599 + £15 P&P.

**Calcomp 565 Drum Plotter:** OEF £450 + £10 P&P.

Many more bargains. Phone for your requirements. WE ALSO BUY.



### BECKENHAM PERIPHERALS LTD

Callers welcome by appointment

01-466 5582  
34 Rodway Road, Bromley  
Kent BR1 3JL

SAE for LIST and enquiries

**CIRCLE 32 FOR FURTHER DETAILS**

## Reduce Designer Fatigue

### Linc-Ace System

- 1 Linc-Ace (1of18)
- 2 Linc-Lug
- 3 Linc-Sink

Also: Feet  
Gaskets  
24 items

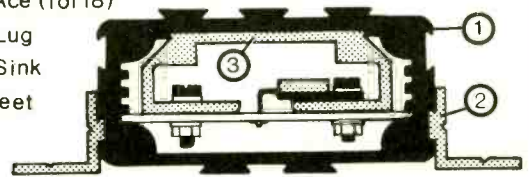

Catalogue



LINCOLN BINNS LTD  
ELECTRONIC ENCLOSURES

from:  
PO Box 110, Haywards Heath, West Sussex RH17 5YU.  
Tel: (0444) 451418

**CIRCLE 16 FOR FURTHER DETAILS**  
ELECTRONICS & WIRELESS WORLD SEPTEMBER 1986

# FEEDBACK

## RELATIVITY

Michael Dobson, in the August issue, claims that I neglect 'the force accelerating the clock balance wheel round'. I am careful that this is not so. For this reason I used a freely rotating disc as my clock. I specifically say in the section on Time and Relative Motion that 'to quantify the motion of a spring and balance wheel requires relativistic knowledge which we do not have at this stage of the argument'.

If one accepts that mechanical force as we experience or measure it is given by

$$\text{force} = \text{rate of change of linear momentum} = \frac{d}{dt}(mv),$$

then it is easy to show that

$$\text{torque} = \text{rate of change of angular momentum} = \frac{d}{dt}(I\omega)$$

follows irrespective of how  $I$  is changed. My freely rotating disc experiences zero torque; hence its angular momentum is constant and it slows down ( $\omega$  reduces) as its moment of inertia  $I$  increases and, conversely, speeds up as  $I$  reduces.

This phenomena is commonly observed, for example, in skating. When a skater is spinning we have all seen his (her) speed of rotation increase as he (or she) pulls in legs and arms. In this case the moment of inertia,  $I$ , is reduced and  $\omega$  increases to keep  $I\omega$  constant.

This answers the rest of the letter; for example, I do not need to argue about table recoil and no ambiguous equations are used to describe experimental affects.

A.H. Winterflood clearly understands why I reverse the usual argument but regards the hypothesis that 'energy has inertia mass' as equally crazy as the usual one about the speed of light.

It is generally accepted that

$$\text{force} = \text{rate of change of momentum} = \frac{d}{dt}(mv)$$

provides a recognition of mechanical force and a basis for measuring it. When force is zero we get Newton's first law and momentum,  $mv$ , is what Newton meant by 'quantity of motion' in his second law.

Accepting this definition of force and also that

$$\text{Mechanical work} = \text{force} \times \text{distance}$$

there is shoals of evidence that energy and mass go together in the way I express it. This evidence lies in particle accelerators, radiation

**May I thank all those readers who, as well as taking the trouble to fill in the recent questionnaire, wrote to offer criticism and to express their views on content and presentation. These opinions are helpful to the editorial team and are not treated lightly. In the very near future, readers will see many of their suggestions implemented.**

EDITOR

effects, interactions between particles, nuclear energy etc, etc.

If you insist that the concept 'energy has inertial mass' is crazy, then in order to explain what is consistently observed, you have to reconstruct the whole system of measurement and definition of energy. You will, for example, need to say that what is felt as a severe bang is not energy and/or propose complex laws such as in Michael Dobson's letter according to which the action of force in some unexplained way depends on velocity with a factor  $(1 - v^2/c^2)^{1/2}$ . You end up with far more 'mind boggling' rules than the one simple rule I propose, and also a requirement to explain them.

The task may be beyond human wit so far but it is not impossible. As commented in my article I am convinced that nature is essentially simple and that the basic laws are virtually self evident propositions. Newton's laws of motion and conservation of energy can be seen in this way. James MacHarg in his letter perhaps gives a basis for thinking that 'energy has inertial mass is also a self-evident proposition.

James MacHarg describes the concept of inertial mass very clearly as requiring acceleration and therefore preventing instantaneous change. He implies an objection to the proposition that energy has inertial mass but does not explain why. On the contrary his own idea makes it very reasonable. Since a packet of energy should not be instantaneously movable from A to B as we see it, then it must have inertial mass! The only other step that he needs to make to agree my line of argument is that the packet of energy sees itself as one event.

He makes another important point that we only see what we see and not what actually happens. This is why it is essential to base any positive theory on experimental procedures, i.e. measurements and definition of time, distance, energy, mass etc.

Albert was, of course, swallowed by the lion. When the savage understood he swallowed his ego and re-instated Albert. M.H. Butterfield Wimborne Dorset.

## MATHEMATICAL RAKE'S PROGRESS

*Wireless World* is to be congratulated for providing a forum for discussion of various 'non-establishment' views. I am thinking particularly of those of Ivor Catt, but there have been others in the past. Unfortunately, a subject (whether it be maths, physics or ice-skating) is easy when you cannot do it, but very difficult when you can do it—in other words a little knowledge is a dangerous thing. It is apparent that many of your correspondents fall into this trap, though I must qualify this with the thought that I may be falling into it too.

C.F. Coleman (Letters, July 1986) seems to doubt the 'well-known' phenomenon that the output of a low pass filter happens before the input pulse arrives. Well it *does*. If a perfectly square pulse or edge is fed to a perfect low-pass filter (by which we mean one that passes all frequencies below the cut-off with zero attenuation, and that stops all frequencies above the cutoff with infinite attenuation), the calculated output starts to happen before the input. This is, of course, impossible, so we deduce that either the maths is wrong, or that it will be impossible to make such a filter in the real world. The maths is quite a simple application of a Fourier transform and I can supply Mr Coleman with a derivation if he requires one. I am surprised that Mr Coleman has apparently not heard of this phenomenon, since he seems to be a firm believer in Fourier transforms. There are times however, (for example when a voltage step travels down a transmission line), when to dress the problem up in Fourier transform theory would make it needlessly and horribly complicated.

The situation as it relates to the 'low-pass filter' problem is that Fourier transforms are an abstract tool (one of a family of integral transforms) which bear no relation to the physical world. When we try and use them, we can only do so if they are a good model for observed phenomena. The ideal low-pass

filter is outside our experience, and it is a difficult thing to say whether the maths is right or wrong. If it is wrong then the theory needs modifying just as Newtonian dynamics needs modifying to take into account certain conditions.

Mathematics can be studied in its own right, but when it is used to help solve physical problems we must remember that it is a tool, and one does not use a sledgehammer to crack a nut. We must choose the right tool for the job, and this means a level of understanding to which people are not always trained.

David Gibson  
Broadstone  
Dorset.

## S5/8

While I would endorse one of Mr Hardie's objections to RS232, i.e. the lack of connector standardization, I must take issue with almost every aspect of the proposed S5/8.

What is the use of introducing this standard in Britain without first reaching agreement with other countries; in particular America and Japan? The use of S5/8 in this country alone will result in even more of the "break out boxes" and adaptors rightly despised by Mr Hardie.

Having slated the industry standard D type connectors, Mr Hardie proposes to use one of the worst connectors on the market! The DIN connector is only just suitable for the domestic audio equipment, for which it was introduced. It is certainly not robust enough for office use, and beyond consideration in an industrial environment.

The high-voltage bipolar signalling of RS232 is criticized, and a low-voltage ground-reference system proposed. This is surely retrograde. Where mains powered equipment is used, ground potentials can easily exceed the logic margins. This is the very reason for which RS232 was designed!

With good design it is quite possible to incorporate RS232 into battery equipment. Epson, for example, produce a small portable computer with RS232 and disc drive—all battery powered.

If a new standard is to be introduced, I would prefer to see a differential, line-matched system, based upon RS422. Suitable interfaces for this such as the MC3486/7 have been with us for years, and are inexpensive. This would have the added advantage of much longer lead lengths than presently practicable.

Finally, I think it is foolish to specify signalling rate and data structure. There will always be differing requirements, and to tightly specify these will lead to problems.

Much as I would like to see Britain in the forefront of standardization, such standards *must* have international agreement to be successful, and I doubt very much that S5/8 would find such agreement.

L. Hayward  
Technical Director  
Eastpoint Ltd  
Wareham  
Dorset

## SIMPLE PULSE GENERATOR

Having had no end of trouble with 4528 monostables myself, I was not surprised to find in Brian Frost's article in August 1986 familiar phrases like "...between 15V and 9V a change in pulse width of around 15% can be expected" and "Due to the nature of the 4528... an accuracy of around 20% will be quite good." I suspect also that the two pulse width controls interact to some extent, because the 4528's pulse width varies with repetition frequency as well as just about everything else!

If Mr Frost were to throw away his 4528 and replace it with a 4538, he would find that these problems have gone away. Accuracy would still depend on the capacitor tolerance and potentiometer calibration, of course, but at least the results would be repeatable, making it worthwhile to trim the capacitors.

Peter A. Ferris  
Acton  
London W3

## SEEING REDDER

One may perhaps quote without permission from private communications when what is quoted is non-personal, confidentiality is not requested, and the sender, at odds with one, talks of his own genius. What follows may be found helpful by some readers of Alex Jones's letter in the April issue.

In one letter to me, he uses the expression 'sources of monochromatic light (clocks)', agrees that

$$\sqrt{1-v^2/c^2}$$

is involved in red-shifting, but then states: "... the rate of clocks themselves remains invariant." As in the published letter, he very much seems to think that the

$$\sqrt{1-v^2/c^2}$$

effect is somehow a part of the

Doppler shifting *per se*, for light, as distinct from any clock-slowing. Why though, then, should he bother to stress that sources of light are clocks? He also says that 'we are forbidden to know' which of two relatively-moving observers was subjected to acceleration, that 'perhaps both were but it does not matter', that 'the situation is one of pure symmetry'. This, from a professed anti-Einsteinian. Whilst overt Einsteinians negate absolute motion but imply it, he attacks relativity but implicitly upholds the relativity principle.

Subsequently, I pointed out that an observational pure-symmetry could, indeed must, result from counterbalancing asymmetries – but not merely equal-and-opposite ones. Any relativist will imply this when showing how application of

$$\sqrt{1-v^2/c^2}$$

to both moving-source and moving-observer situations results in equivalent formulae, i.e. eliminates the classical difference which could betray absolute motion. This application of a real factor, given that it is real, implies something real applied-to, and must itself be done somehow asymmetrically in order to obtain the symmetry. There is equality of extent of the

$$\sqrt{1-v^2/c^2}$$

effect in the two cases, but these equal extents must of course be in opposite (quantitative) directions: the moving observer's real clock-slowedness causing an illusory violet-shift effect for incoming light, so as to bring what he observes down to midway between the two classical extents of red-shift; his own light, of course, brought up to that median red-shiftedness, for resting observers receded from. (It can be readily shown that observational symmetry will be preserved also when both observers have significant absolute speeds.) Mr Jones's response, essentially, was to restate that the symmetry was a *fact* (italics his), in a manner suggesting that there was simply no question of any more complex reality inferably underlying a fact. An evasive, simplistic concentration on what may be sheerly observed is characteristic also of relativists.

In stressing 'pure symmetry', he says that it 'has nothing to do with whether there is an aether or absolute frame of reference': but of course if there is a light medium, then *ipso facto* there cannot be such a (real) symmetry except in the case of equal and opposite velocities. And consider: the shifting can occur only at emission and/or reception (for it to occur in transit would of course mean *c*-violation); but if it is meaningless to ask whether either observer is

really in motion or at rest, then the situation (a) surely requires that the shifting occurs either all at emission or all at reception, and (b) affords no imaginable determinant of which. Since there must be some such determinant, it must in some sense be meaningful to envisage the motional state of each observer independently, and so their situation cannot be really symmetrical except in the equal/opposite case (in which they would be equally physically deluded).

As to increase of mass with increased velocity. Mr Jones's denial of this is associable with his denying that there is any limit to velocity. It seems odd that one elsewhere so fundamentalist about facts should ignore the evident fact of such a limit; his reason for doing so would seem to be the unlimitedness of the scale of integers. Numbers determining Nature: something else appropriate to an unwitting crypto-relativism.

Finally, as to: 'It is central to the teaching of electromagnetism that for all observers the product of frequency and wavelength shall be the constant *c*.' This is a most oddly roundabout way of saying that all electromagnetic waves have the same speed *c*; the fact that a wave's speed is given by the product of frequency and wavelength is hardly a specifically electromagnetic one.

Stephen Grieve,  
Reigate,  
Surrey

### Sample calculation

Consider two observers A and B, receding from each other at *relative* speed of 1.4*c* (as inferred by an observer between them, who, observing no deviation from

$$\sqrt{1-v^2/c^2}$$

is able to regard himself as having negligible absolute motion) – A having an absolute speed of 0.6*c* and B one of 0.8*c*. Each beams to the other with an identically-manufactured light source, whose normal frequency is *n*. What frequency of light received will each measure?

(i) For light from B measured by A:

$$(a) \text{ real frequency for } 0.8c = n \times \sqrt{1-v^2/c^2} = 0.6n$$

(b) real Doppler shift:

$$\frac{0.6n}{1+v/c} = \frac{0.6n}{1.8}$$

(c) illusory Doppler shift due to A's own 'absolute recession' (illusory in the sense that the light *per se* retains its proper, absolute, frequency):

$$\frac{0.6n \times (1-v/c)}{1.8} = \frac{0.6n \times 0.4}{1.8}$$

(d) illusory violet-shift effect

according to  $\sqrt{1-v^2/c^2}$  for A ( $\sqrt{1-v^2/c^2}$  for 0.6*c* = 0.8):

$$\frac{0.6n \times 0.4}{1.8 \times 0.8} = \frac{0.24n}{1.44} = \frac{1}{6}n$$

(ii) For light from A measured by B:

(a) 0.8*n*

$$(b) \frac{0.8n}{1.6}$$

$$(c) \frac{0.8n \times 0.2}{1.6}$$

$$(d) \frac{0.8n \times 0.2}{1.6 \times 0.6} = \frac{0.16n}{0.96} = \frac{1}{6}n$$

(N.b. Symmetry is also preserved when both observers are moving in the same 'absolute direction'.)

## MOISTURE MEASUREMENT

In Mr Linsley Hood's article in your July 1986 issue, on a moisture meter, he shows as Fig. 3 a "modified Schering bridge". Surely this is modified beyond all reasonable claim to the name, for all four arms are capacitances, whereas in the Schering bridge one arm is a standard resistance in terms of which the unknown capacitance and its loss are compared. The bridge used seems to be most like the Fleming & Dyke's four-capacitance type. M.G. Scroggie  
Bexhill  
Sussex.

Having read 'An engineers log—moisture measurement', by J.L. Linsley Hood, July 86, I am left wondering, where are all these "electronics engineers with industrial or manufacturing experience" who are "no longer young"? Have they all faded away?

I have tried, and failed, on many occasions to find just such people, both for our electronics services and for various research groups. Other departments and colleges throughout London University are in the same position.

For many young engineers and technicians our salary scales are poor compared with outside industry and we are unable to keep the people we train. However, for those in, say, their early fifties to whom money is not everything, a great deal of interesting and varied work goes on in universities, much of it pioneering new techniques. This is now in danger of drying up for lack of experienced staff.

In a country committed to high-technology advancement, I believe this would be disastrous; so please, if there's anybody interested spare us a thought.

D.R. Stone  
Physics Department  
Superintendent  
Queen Mary College  
London E1



# Carston

## USED TEST & COMPUTER EQUIPMENT

PHONE 01-943 4477 FOR OUR LATEST STOCKLISTS

### COMPUTERS/ CONTROLLERS

- HEWLETT PACKARD 85A £975
- HEWLETT PACKARD 9836S £5250
- IBM PC 128K Dual F/Disc System (inc. display and keyboard) £1200
- SAMLECO Director DY40 40CPS Daisy Wheel Printer £295
- Cut Sheet Feeder £295

ALSO AVAILABLE SOON:  
HEWLETT PACKARD 86A, 85B, 150  
INTEL PDS 100, PDS 130, PDS 110, PDS 140, Data I/O 29A + Unipak, Gangpak

### OSCILLOSCOPES

- HEWLETT PACKARD 1740A (100MHz) £1250
- TEKTRONIX 2215 (60MHz) £700
- PHILIPS PM3206 (15MHz) £225

### A FEW EXAMPLES OF OUR CURRENT STOCK

#### ★ SPECIAL OFFER ★

TEKTRONIX AM503, TM501, P6302  
CURRENT MEASURING SYSTEM  
ALLOWS DISPLAY OF CURRENT ON ANY OSCILLOSCOPE  
With 10mV/div sensitivity 50Ω or 1MΩ I/P  
20A DC + peak AC DC to 50MHz  
**£995 + VAT**

- TEKTRONIX 2335 (100MHz) £1850
- PHILIPS PM 3215 (Battery Option) £675
- TEKTRONIX 466 (100MHz Storage) £3950

### SPECTRUM ANALYSERS

- HEWLETT PACKARD 3582A £7050
- HEWLETT PACKARD 3580A £2850

- TEKTRONIX 7603/7L12 0.1-1.8GHz System £7750
- MARCONI TF2370 110MHz System £7500
- MARCONI TF2371 200MHz System £9500

### SIGNAL SOURCES

- HEWLETT PACKARD 8620C Sweeper Mainframe £1950
- HEWLETT PACKARD 86290B 18GHz Sweeper Plug-In £6950

- HEWLETT PACKARD 86260A 12.4-18GHz Plug-In £3250
- HEWLETT PACKARD 86220A 0.01-1.3GHz Plug-In £1850
- HEWLETT PACKARD 86250D 8-12.4GHz Plug-In £2550
- TEKTRONIX TM503/FG504 40MHz Function Generator £1050
- HEWLETT PACKARD 204C Audio Oscillator £275

### MISCELLANEOUS

- DRANETZ 606-3 Mains Monitor £2250
- RHODE & SCHWARZ Polyskop IV £2500
- TOA EPR 200A 2 Pen Recorder £695
- SE LABS 6150 UV Recorder £1150
- SE LABS 6300 UV Recorder £850
- BRUEL & KJAER 2218 Sound Level Meter £995

Prices exclude delivery and VAT

**Carston Electronics Ltd**

**01-943 4477**

3 Park Road, Teddington, Middlesex TW11 0AF Telex: 938120

We specialise in the purchase and sale of top quality under utilised equipment. Every item sold by us has been thoroughly tested and calibrated to manufacturer's original specification — and carries a full guarantee. If your requirement is not listed above, please phone. We have considerably more items in stock, plus a facility for locating rare equipment at short notice.

buy Carston sell Carston buy Carston sell Carston buy Carston sell Carston buy

CIRCLE 59 FOR FURTHER DETAILS

# Developments in radio receivers

## Whistlers, twitterings, noise and a diversity of radio systems, from the IERE's recent conference

The IERE's fourth international conference on radio receivers and associated systems was held in July at the University College of North Wales, Bangor. A set of conference papers is available as publication no. 68 from the Institution of Electronic and Radio Engineers, 99 Gower Street, London WC1E 6AZ, for £32 including postage (£37 outside Europe).

Sessions began with a tutorial day featuring presentations on various fields of current interest, including frequency synthesis and phase-locked loops, digital signal processing, cryptography, spread-spectrum techniques and applications for gallium arsenide. Many of these topics were to be raised again in the conference itself, which opened the following day with a keynote address by Dr Geoffrey Phillips, former head of the radio frequency group at the BBC research department.

Digital processing was now replacing analogue techniques in many areas of receiver design, though Dr Phillips recognized that manufacturers would adopt a cautious approach because of the high cost of very large scale integration, essential for some of the developments he spoke of.

Technical advances in terrestrial tv broadcasting were on the way: in two years' time, the BBC planned to offer a full digital sound service on its existing tv services. The new transmissions, which had undergone extensive field trial, would be compatible with the present f.m. subcarrier but would offer a marked improvement in sound quality, with stereophony besides. The system was based on a p.s.k. sub-

carrier at 6.55MHz with a data rate of 730kbit/s.

### Digital processing

The theme of digital signal processing was taken up by John Masterton of STC Technology, who reviewed some of the options for integrating digital receivers. Digital techniques had been applied predominantly in control circuits and frequency synthesizers, but it was becoming increasingly practical to consider their use in the signal path. Attractive prospects were offered by the zero-i.f. or direct-conversion receiver, which enabled digital signal processing to be carried out at the lowest frequency possible.

In a zero-i.f. receiver the incoming signal is mixed with a local oscillator at the same nominal centre frequency and the input is so translated to a band centred on zero frequency. But 'negative' frequencies are folded over on to the positive frequencies, producing an ambiguity. Masterton explained the method of resolving it using a quadrature local oscillator with two i.f. channels.

STC had applied digital techniques to the demodulator stage. In an experimental zero-i.f. receiver for f.s.k. signals such as those used in radiopaging, the quadrature i.f. channels are filtered, limited and applied to a D-type flip-flop, Fig. 1. One limiting amplifier provides the clock for the flip-flop, the other the D input. This arrangement can demodulate the signal because the output changes state whenever the relative phase of the two inputs is reversed: that is, when the carrier deviation changes from positive to negative.

Improvements in performance could be obtained by using more complex decoding logic. By increasing the number of pulse edges to be examined, the edge jitter (or distortion) could be reduced, Fig. 2.

Both types of receiver had been realized in integrated form by STC using a bipolar process. A photograph of the i.c. showed the outward simplicity of the design: the antenna connected to one pin and received data emerging from another. Receiver sensitivity at 150MHz was said to be good and power consumption low.

Masterton also described a two-i.c. design for f.m. speech and an h.f./v.h.f. programmable receiver using digital signal processing. This unit covered a.m., f.m. and s.s.b. plus commercial n.b.f.m., with software control of mode. The digital filter card, implemented in 5-6 micron c-mos, featured a d.s.p. chip said to be one of the largest ever produced in the UK - 1cm square.

### Microwave integrated circuits

Monolithic integrated circuits for microwaves were the subject of an interesting survey by Andrew Hughes of GEC's Hirst Research Centre. These devices, he said, offered attractive alternatives to conventional microwave construction techniques in many areas of receiver design: examples of these were satellite tv receivers, collision avoidance systems and mobile radio.

Microwave i.c.s had been demonstrated at frequencies up to 100GHz and transistors existed with gain as high as 13dB at 35GHz or 6dB at 60GHz. Among devices which could be integrated easily were mesfets, p-n, Schottky and p-i-

Fig. 1. Digital detector for frequency-shift-keyed data transmissions such as radiopaging signals.

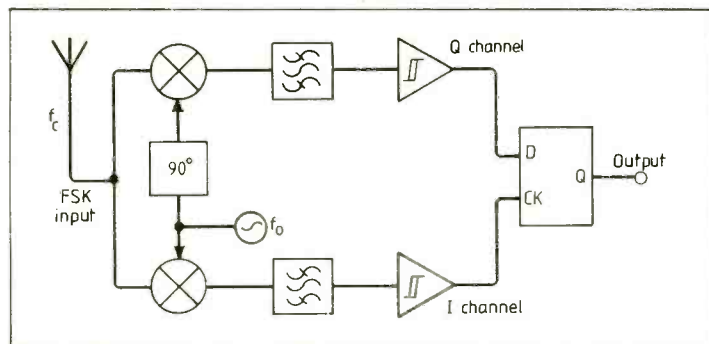

n diodes. Capacitors could be fabricated in values up to 10pF, transmission lines were possible with characteristic impedances in the range 25 to 95 ohms for stubs and interconnections, and spiral inductors could be contrived in the range 0.5 to 10nH. These last were awkward to produce and their Q was relatively low. The difficult part was making the so-called air-bridges for completing the spiral.

### Nav aids for the motorist

An interesting i.c. from another source formed part of a low-frequency receiver system for the Loran-C and Omega radionavigation systems. Presenting it, Dr Durk van Willigen of the Delft University of Technology explained that although military users of these systems were now switching to satellite navigation, there existed a vast potential market for privately-owned navigational receivers.

In Europe alone, there were some 300 000 small aircraft, and 40 million cars were being built every year. All were possible users of route-planning systems based on Loran-C.

Each vehicle would have on board a map stored in CD-rom. The driver would simply tell the system where he wanted to go and it would respond by giving directions from moment to moment as necessary. By sending traffic via the best route, such a system could yield real savings in time and fuel. It could be cheap to implement and would be usable worldwide.

Answering questions, Dr van Willegen said that the CD maps could be highly detailed: they would show one-way streets and the whereabouts of police stations. They would even mark varieties of restaurant: Indian ones, for example.

Loran-C was being phased-out for military purposes outside the US, though it would remain in operation beyond the year 2000. And European countries were being offered the opportunity to take over the system.

The accuracy of a Loran-C fix was about 200m and so the navigational system would have to rely on dead-reckoning for keeping track of a vehicle's exact position. But radio fixes would be needed to find its

starting point and subsequently to forestall any blunders due to ambiguities in the map.

Dr van Willegen said his i.c. could provide all the r.f. gain for the receiver and so would reduce the hardware complexity considerably. Limiter gain was better than 100dB at 100kHz and the receiver had perfect zero-crossing tracking ability at inputs as low as 0.75 microvolts r.m.s.

### Whistlers

Another low-frequency project was described by Hal Strangeways of Leeds University, who with Neil Thomson of the University of Otago in New Zealand has built a v.l.f. receiver for the British Antarctic Survey's Faraday Base on Galindez Island, and went there last January to install it. This location, by an accident of geography, is at the far end of lines of the Earth's magnetic force which emerge in Maine, USA, where the US Navy has a 1MW transmitter on 24kHz. As such it is an ideal site for studying field-aligned whistler mode propagation, by which transmissions are ducted through a kind of natural waveguide.

With such a receiver, it is possible to measure doppler shifts in the region of 10 millihertz which speak of events up to 100 000km away in the magnetosphere.

### Ignition noise

For many receiving systems it is not sensitivity but ambient noise that sets the limit to performance. Dr Adel Turkmani of the University of Liverpool described a receiving system for measuring the characteristics of impulsive noise. This system covered 20MHz-1GHz, a range of considerable commercial importance.

Dr Turkmani explained that ignition noise from motor vehicles was now the dominant noise source at h.f. and v.h.f. in cities; and because of its random nature it had to be quantified statistically rather than just measured.

To avoid disturbing the signals under observation, his receiver was designed for high linear dynamic range and for an impulse response with very low time side-lobes. Digital signal processing stages fol-

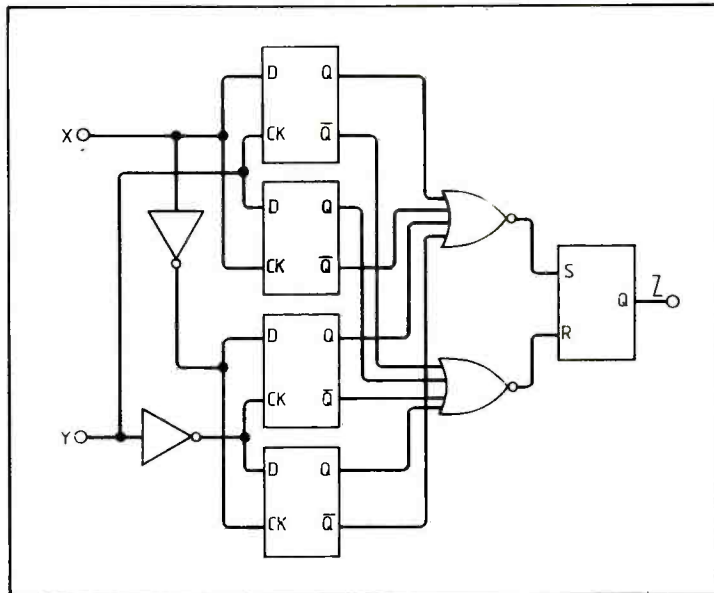

**Fig. 2. With a more complex detector than the D-type flip-flop of Fig. 1, the number of edges examined can be increased and performance improved.**

lowed the detector.

Already the unit had been tried in Liverpool for measuring noise at frequencies used for land mobile radio, both at base-stations and in vehicles. The system was easy to calibrate and use, according to Dr Turkmani, and it produced an accurate and useful characterization of the noise amplitude distribution.

### Radio nasties

Dynamic range is a quality where practical receivers often leave something to be desired, especially with domestic broadcast receivers where specmanship in the hi-fi market has resulted in sensitivity being valued much more than selectivity or freedom from intermodulation.

An alarming report from the BBC revealed that v.h.f. transmitter planning was almost being undermined by the apparent indifference of some set-makers to these important characteristics. The broadcasters are concerned at the large number of sets which do not meet internationally-agreed protection ratios for interfering signals. And the spread of pirate stations with over-deviating transmitters may mean that interference is even worse than the figures suggest.

Alan Hall, a service planning engineer, described tests the BBC carried out last year on 20 domestic stereo receivers. The tests were made objectively, following methods set out by the CCIR. Five sets were rejected right at the start as being unable to produce in

stereo a signal-to-noise ratio of 52dB from a 1mV input, even in the absence of other signals. The remainder varied widely in their immunity to unwanted signals, some doing especially badly with transmitters spaced 10.9MHz and 10.8MHz apart. A high price appeared to be no guarantee of excellence.

Fortunately, the especially troublesome 10.7MHz spacing has been avoided in the UK band-plan, apart from an instance in Kent where BBC Radio Kent at Dover is 10.7MHz above Radio 4 from Wrotham. However, no complaints have arisen because the Radio Kent listeners affected get their Radio 4 from Dover too.

One cause of poor performance, according to the BBC, is that manufacturers often leave a.m. intermediate-frequency transformers in circuit during f.m. reception, giving an unwanted peak in response at 500kHz.

Using recorded examples, Mr Hall demonstrated the severe twittering and noise produced by one set, a £120 tuner with digital display. "Next time signals are good and r.f. is rolling in from everywhere", he said, "don't blame the planners straight away!"

*Further reports from the conference are included in Pat Hawker's Communications Commentary on page 9.*

by Mike  
Catherwood

# Microcontroller chip includes peripherals

Using built-in peripherals gives versatility, as illustrated by a limited issue of specially-programmed microcomputers.

There is a great variety of single-chip microcomputers for control applications. Many recent devices contain not only ram and rom, but also peripheral functions such as a-to-d converters, serial interfaces, phase-locked subsystems and multiple timers.

Motorola's M6805 microcomputer family currently consists of 30 devices: some high-density mos and others c-mos, but all with instruction sets based on that of the 6800, which simplifies software writing.

Mike Catherwood is a systems engineer at Motorola's Semiconductor Products Division in East Kilbride.

Microcomputers for medium and large-volume production applications have mask-programmed rom; software designed by the user is programmed into this rom by the manufacturer. But for small-scale production and development, every mask-programmed rom part has an equivalent eeprom part that can be programmed directly by the user.

The most versatile h-mos family members are the MC6805S2 and the larger-memory version, MC6805S3. Designed in Geneva, these 28-pin microcomputers feature a four or five-channel a-to-d converter, three timers, two prescalers, a serial-peripheral interface, 1.5 or 3.7K-byte of rom

and 64 bytes of ram, 16 bytes of which may be used as standby battery-backed ram. An additional timer is included in the S3.

Fourteen of the devices' twenty-one i/o port lines are bidirectional; eight of these, port A of Fig. 1, may optionally be made c-mos compatible as outputs through the addition of a depletion-mode pull-up device on each line.

High-current sinking is possible on four lines of port B. A novel feature of these microcomputers is the software-programmable open-drain outputs associated with the serial interface, described later. To fit the device into a small 28-pin dil package, many pins have a dual function.

Both a crystal and RC network are suitable timing elements for the S2/S3 on-chip oscillator producing a clock frequency of typically 4MHz. Internal dividers quarter this frequency to provide the bus clock.

Figure two shows the S2's 4K memory map with the top half of page zero, addresses 0-7F<sub>16</sub>, expanded to show i/o, ram and data/control registers more clearly.

As with all 6805-family members, the S2 may be operated in self-check mode, enabling the device to perform a 90% functional test on itself through execution of a small amount of reserved rom code. Additionally, the S2 includes a small bootstrap routine, entered through the self-check mode, which transfers user-defined code such as an evaluation test routine from an external eeprom into ram and then executes it.

For development purposes and small production runs, there is an eeprom-based ver-

Fig. 1. Block diagram of the S2 single-chip microcomputer.

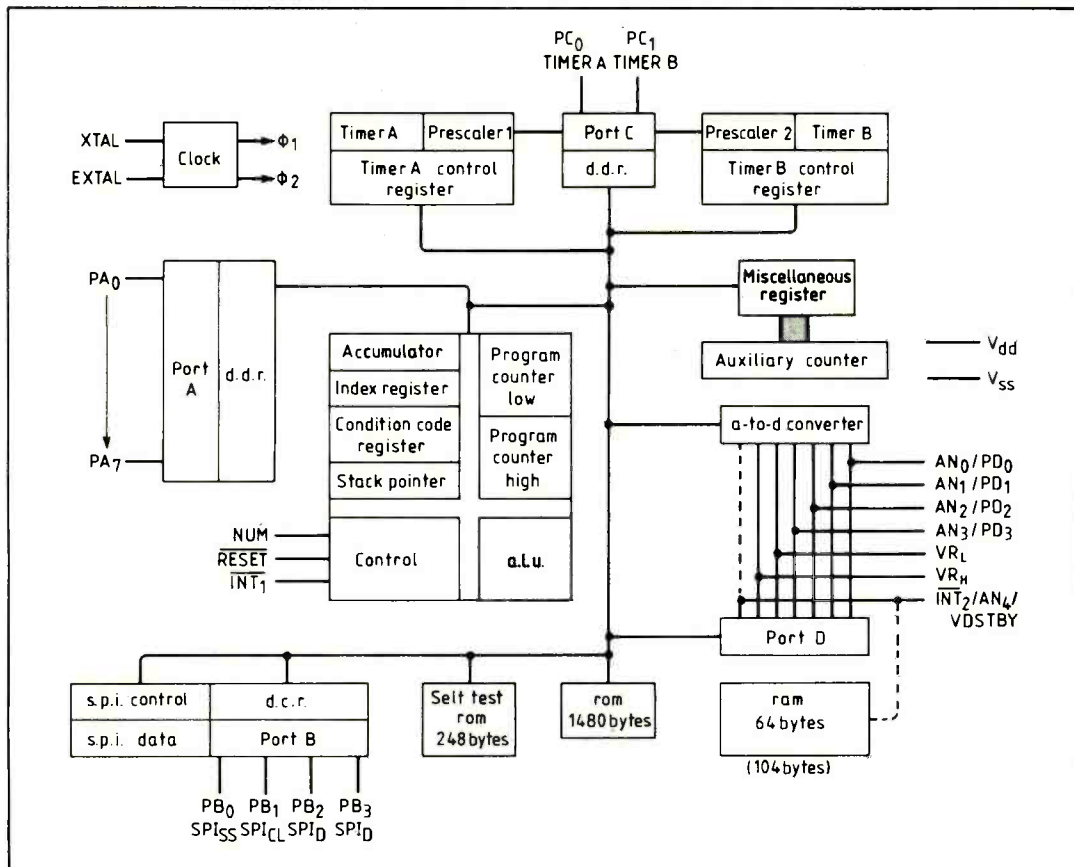

**Table 1. Analogue-input multiplexer selection**

Control register			Input	min.	Digital value typ.	max.
ACR <sub>2</sub>	ACR <sub>1</sub>	ACR <sub>0</sub>				
0	0	0	AN <sub>0</sub>			
0	0	1	AN <sub>1</sub>			
0	1	0	AN <sub>2</sub>			
0	1	1	AN <sub>3</sub>			
1	0	0	V <sub>RH</sub> *	FE	FF	FF
1	0	1	V <sub>RL</sub> †	00	00	01
1	1	0	V <sub>RH</sub> /4†	3F	40	41
1	1	1	V <sub>RH</sub> /2†	7F	80	81

\* AN<sub>4</sub> may replace the V<sub>RH</sub> calibration channel (mask option).

† Internal calibration levels.

sion of the S2 called the MC68705S3.

**Analogue-to-digital conversion**

Successive approximation is used for the S2's built-in eight-bit analogue-to-digital converter, Fig. 3. Up to four – or five by a mask option – external analogue inputs, via port D, connect to the converter through a multiplexer. Overall accuracy is typically ±1 l.s.b. Four internal channels are also available for calibration.

Multiplexer selection is controlled by the lowest three bits of converter-control register ACR at address 0E, Table 1. Whenever the a.c.t. is written to, the conversion in progress is aborted, conversion-complete flag ACR<sub>7</sub> is cleared and the selected input is sampled and held internally.

The converter operates continuously using 36 machine cycles to complete a conversion of the sampled input. When conversion is complete, the digitized sample or digital value is placed in the converter result register (ARR) at address 0F, the conversion complete flag is set, the selected input sampled again, and a new conversion started.

The converter is ratiometric. Two reference voltages, V<sub>RH</sub> and V<sub>RL</sub> are supplied to the converter via port-D pins. An input voltage equal to V<sub>RH</sub> converts to FF<sub>16</sub> (full scale) and an input voltage equal to V<sub>RL</sub> will convert to zero.

**Timers**

The S2 contains one eight-bit and one 16-bit timer, timers A and B respectively, whose clocks may be derived from 8 and 16-bit prescalers. Either prescaler may drive either timer under software control, as shown in Fig. 4.

An auxiliary counter is

available for use as a fixed rate polled timer or as a system watchdog. All the timer operating modes are software programmable.

Timer A incorporates a modulus latch which allows the timer to be reloaded with the latch contents when either the timer decrements to zero (auto-reload), or a rising edge is detected on the second interrupt line, port D<sub>6</sub>. This is called an asynchronous external event load.

The timer can of course be configured to allow loading at any time by a write to the timer data register at address location eight (direct load). Timer operation is controlled through control register TCRA at address location nine.

On timer overflow, i.e. at value zero, the interrupt-request flag, bit seven of timer-A control register (TCRA<sub>7</sub>), is set. Provided the timer and c.p.u. interrupt-mask bits TCRA<sub>6</sub> and I respectively are clear then an interrupt occurs on completion of the current instruction.

The timer overflow signal may also be used to toggle the

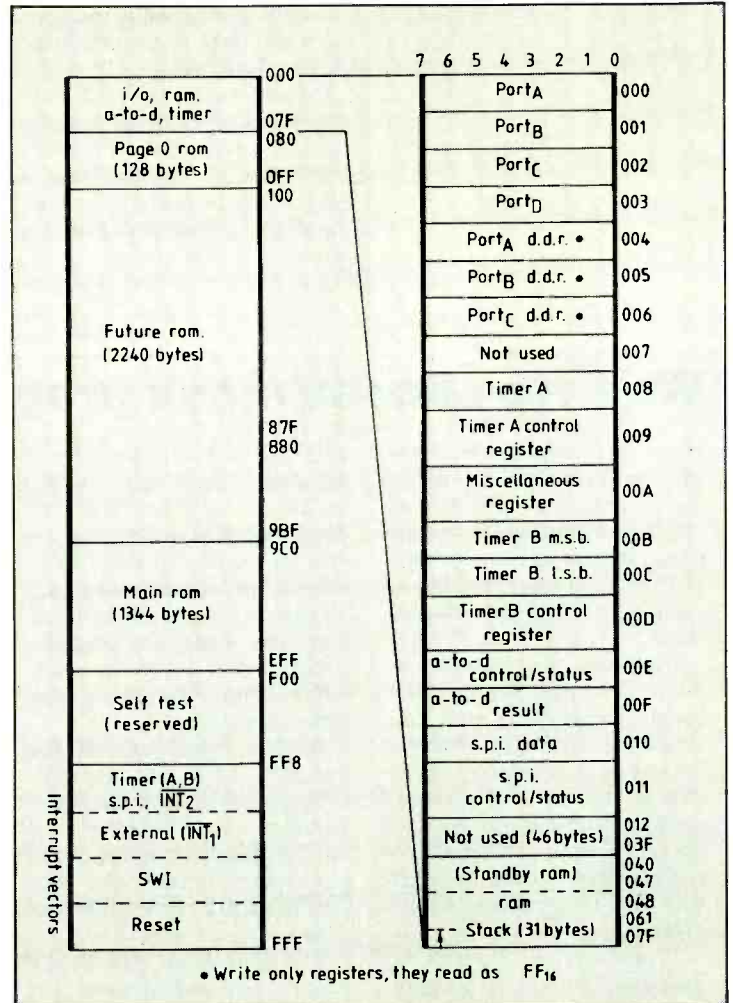

**Fig. 2. Memory map.** There is a version of this processor with eprom instead of rom.

**Fig. 3. Using a multiplexer, the single successive-approximation converter in the S2 reads four analogue channels.**

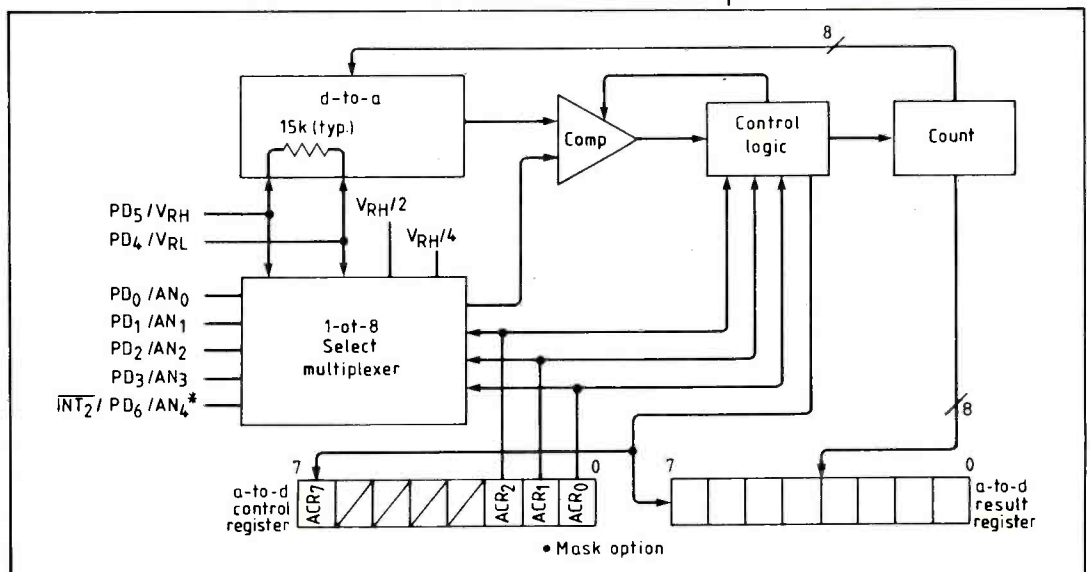

contents are transferred into the timer data register to time the next half cycle.

Prescale values are software selectable from divide-by-one (bypass) to divide by  $2^7$  (8-bit) or  $2^{15}$  (16-bit). Clock sources of the prescaler may be either the bus clock, gated bus clock, an external clock or no clock, Fig.4.

Sixteen-bit timer B offers

the same interrupt and port-toggle features and operates through a control register similar to that of timer A. However, to effectively remove the delay between a read or write of each half of the 16-bit timer data register, a pipeline latch is included. This latch captures the contents of the m.s.b. during a read of the l.s.b. and transfers the contents of

itself into the m.s.b. during a write to the l.s.b. Provided that the timer is accessed in the correct sequence, any timer counts occurring between m.s.b. and l.s.b. transfers will not cause any problems.

When using a processor in an electrically noisy environment, it is wise to include some sort of protection against the possibility of system failures. One common method that provides a good level of protection is to include a watchdog timer in the system. A watchdog timer is essentially a free-running counter which the processor clears on a regular basis. Should the system fail, then it is highly likely that the processor will not be able to clear the timer, letting it overflow and subsequently reset the system. Having regained control over itself, the processor can take recovery action.

The S2 auxiliary counter can be configured to operate in this manner. Alternatively, it may be used as a fixed-interval polled timer using 4095 bus cycles in applications which require lengthy delays.

## Serial data

Within the S2 is a clocked serial interface capable of operating either as a master (clock generator) or a slave. In master mode the serial-peripheral interface produces clock signals for synchronous operation and in slave mode it depends on clock signals from outside.

The s.p.i. is intended to be used for moving data between the S2 and serially-loaded peripherals, like certain display drivers, memory devices, etc., and/or other processors, releasing the S2 c.p.u. for other tasks during transfer.

Arbitration logic in the s.p.i. allows several S2 devices to interface to networks supporting multi-master-type protocols. A slave-select line is provided which can act as a slave-master in a single-master, multi-slave system.

The s.p.i. operates via port B and communicates with the processor through data and control registers at addresses  $10_{16}$  and  $11_{16}$  respectively. Essentially consisting of an 8-bit shift register, a divide-by-eight counter, some slave-select and arbitration logic and a control register, Fig.5, the s.p.i. may function in full or

## When to choose mask-programming

Used in numbers above the minimum-order quantity, microcomputer units with mask-programmed rom are cheaper than eprom versions but they are less flexible and cannot be bought off-the-shelf.

Consequently, eprom versions are used for development, prototyping and pre-production runs. In addition, eprom microcomputer units, m.c.us, are ideal for small to medium production runs of up to 10 000 units and for applications where the software will or might need altering.

Prices depend on quantity, features, fabrication technology and device maturity; eprom m.c.us from Motorola start at under \$5. For software security, devices with a feature which inhibits any access to the eprom after programming are available.

All mask-programmed rom m.c.us are subject to a

minimum-order quantity of between 1000 and 10 000 units, the actual value being determined primarily by die size. A mask charge of typically \$3500 is also levied, so it is almost always uneconomical to use a mask-programmed device in quantities below the minimum-order quantity.

At the upper end of the quantity scale, the general-purpose nature of the rom-based m.c.u. is reflected in a slightly higher cost compared with an efficient but less flexible fully-customized design.

For rom-based m.c.u. designs, availability of in-circuit real-time emulators and eprom-based equivalents shortens development time and allows users to be confident of their designs before committing them to a mask.

Assuming that an m.c.u. is suitable for the task in hand—environmental and appli-

cation-related problems may make an m.c.u. an impractical solution—the rom-m.c.u./full-custom break-even point is difficult to accurately predict as it depends on many less quantifiable factors than unit cost.

With a full-custom solution for example, consideration must be given to ease of testing, cost/time of test-philosophy, cost/time of program-development, long and short-term quality issues, acceptability of a single-source supply and the inevitable uncertainty associated with functioning of the first-pass silicon.

On the positive side, a fully-customized design gives users almost complete control over how the product functions and a greater influence over items such as electrical specifications and packaging.

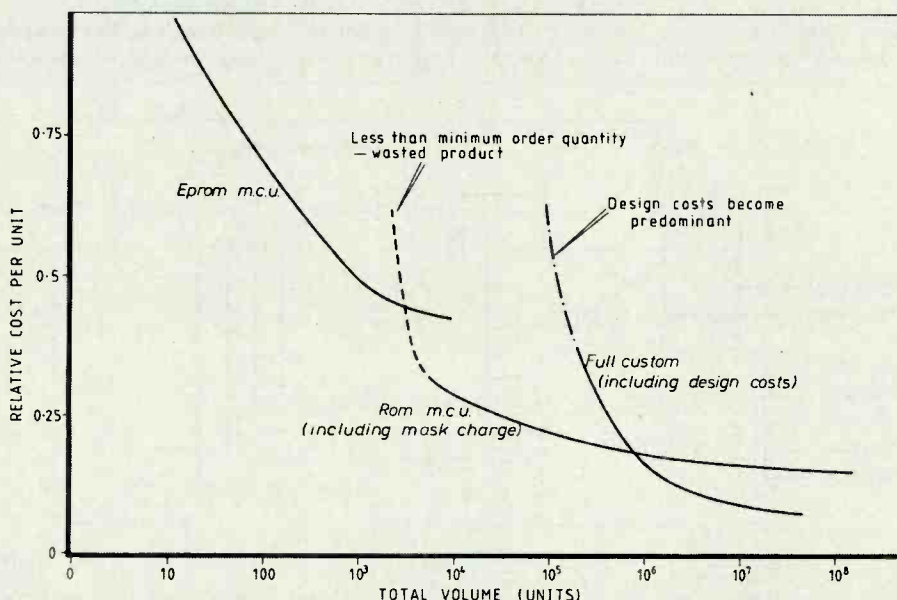

half-duplex transfer modes with or without clock arbitration and/or slave-select operation.

Transfer rates for the eight-bit data blocks may be up to 125Kbit/s, depending on the modulus-latch value, and therefore overflow rate, chosen for timer A. Single-wire auto-clocked transfer such as for n.r.z. data is possible using interrupt line INT to synchronize the start of the transfer.

In many systems, an individual chip enable for each slave device connected to the serial bus is not feasible. In this situation, each slave can be configured to respond to a unique address, which the master transmits prior to transmission of the data destined for that device.

As all transmissions are one byte long, distinguishing between address and data fields might be seen as a problem for the S2. In common with many standard systems however, the s.p.i. recognizes a unique change of state on the clock and data lines that it interprets as the start condition, setting a register bit, after which the software expects an address byte.

When enabled the s.p.i. will receive all data transmitted on the serial bus. However, once the processor has found an address field which does not contain its own address, the s.p.i. can be configured so as not to interrupt the processor again until another start bit is recognized, allowing the processor to continue with other tasks.

### Demonstration devices

For new rom-based m.c.u. products Motorola generally produces an evaluation device containing a demonstration

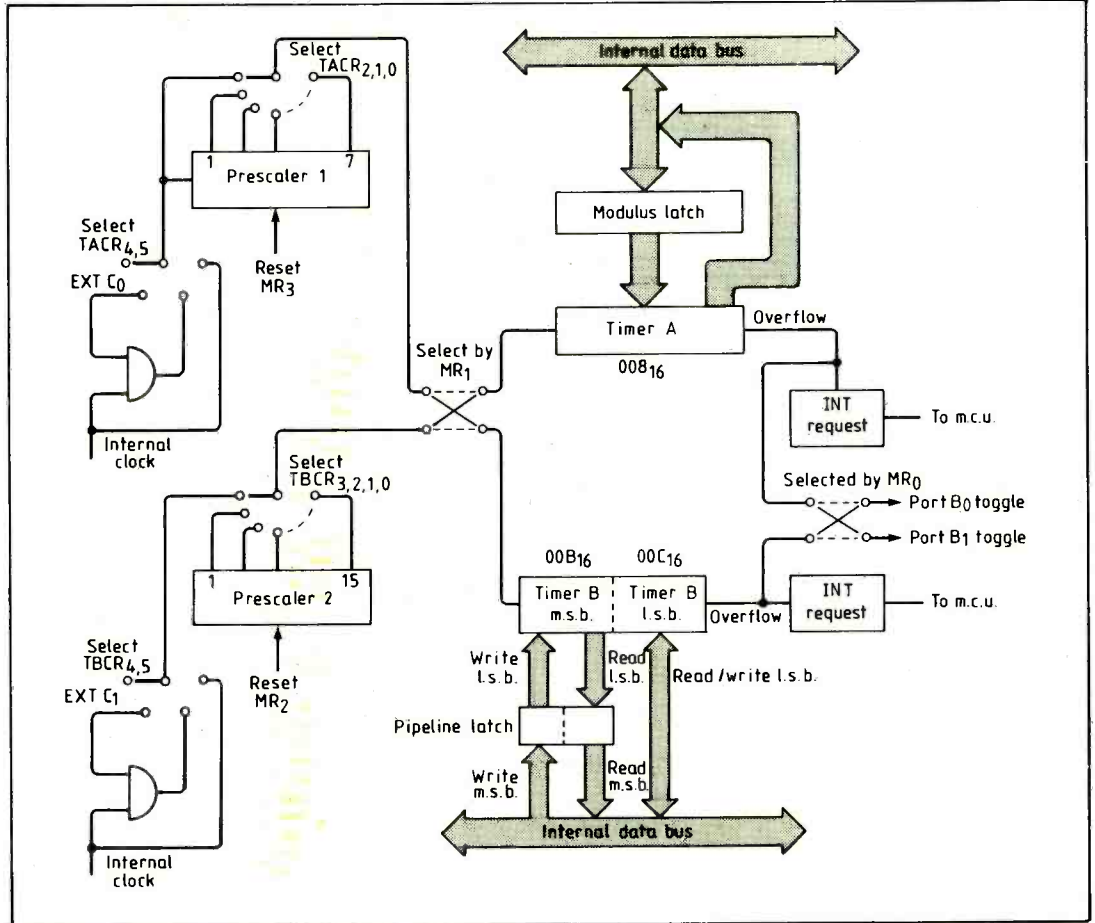

Table 2. A port code determines which routine runs.

Code	PA <sub>3</sub>	PA <sub>2</sub>	PA <sub>1</sub>	Routine
1	1	1	1	Monitor
1	1	1	0	A-to-d converter evaluation
1	0	1	1	Auxiliary counter demonstration
1	0	0	0	Pulse-burst generator
0	1	1	1	Audio-communications link, master
0	1	1	0	Audio-communications link, slave
0	0	1	1	Frequency meter

code; Table 2 lists the demonstration packages contained in the S2 demonstration device XC6805S2P1. After reset, a common initialization routine reads a code on port A<sub>1</sub> to A<sub>3</sub> to determine the selected demonstration package. It then jumps to the corresponding code.

Table 3. Monitor command set

Command	Action
R	Displays registers on stack+1 page-zero memory location as HINZC AA XX PPP VV = XY for condition codes, accumulator, index register, program counter, page-zero address and address contents respectively.
A	Examine/change accumulator
X	Examine/change index register
V	Examine/change page-zero address
M	Examine/change memory. Subcommand 'period' re-examines the same byte, 'circumflex' examines previous byte and carriage-return examines next byte.
C	Continue using present stack content, including PC.
Ennn	Executive from nnn <sub>16</sub> using current stack content except PC
Lmmm	List two 128-byte pages from address mmm <sub>16</sub> . A BREAK character terminates listing.

Fig. 4. Besides these 8 and 16-bit timers the S2 has an auxiliary timer that can be used as a system watchdog.

Fig. 5. The serial-peripheral interface communicates with the processor through registers at address locations 10<sub>16</sub> and 11<sub>16</sub>.

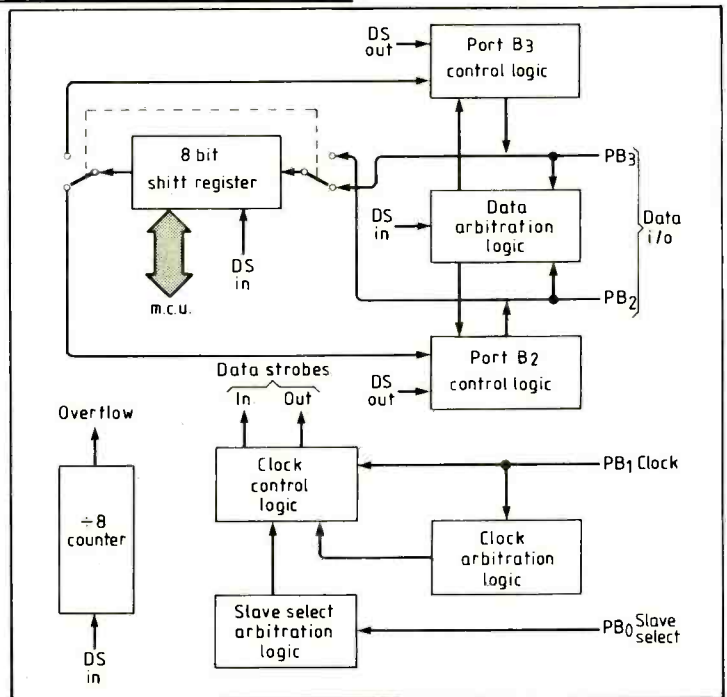

# SINGLE-CHIP MCU

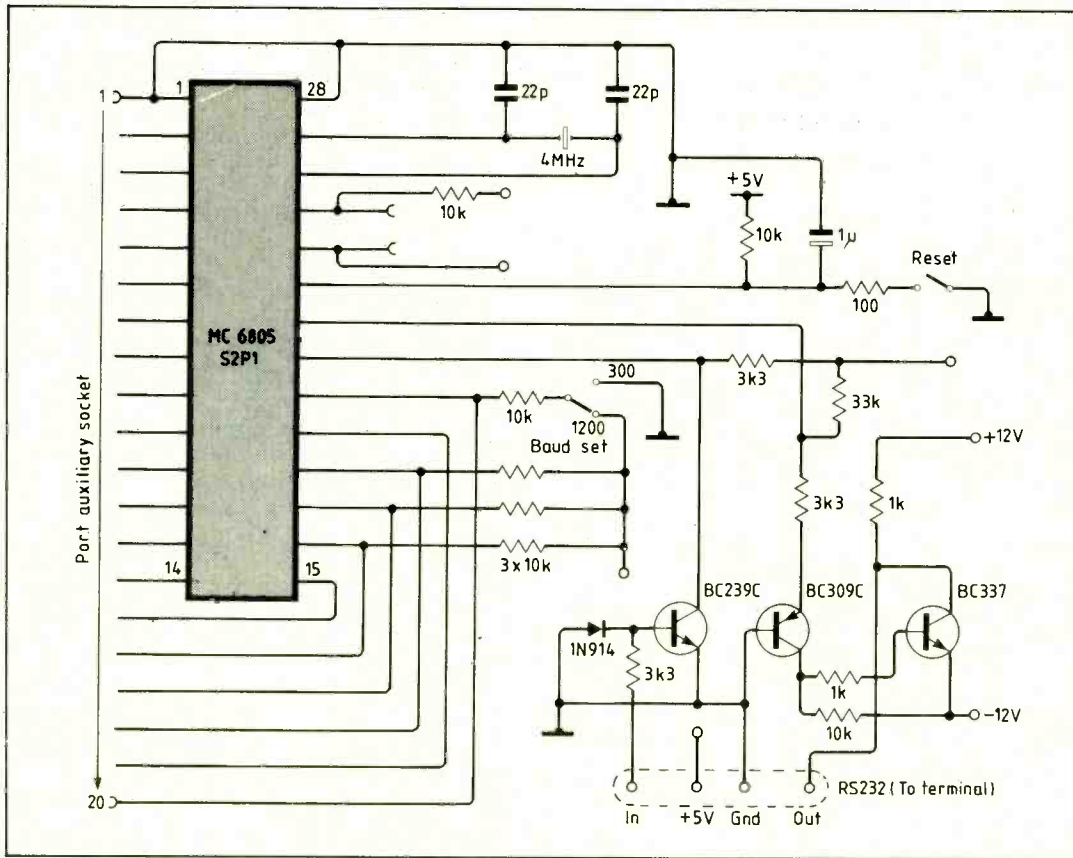

Fig. 6. An evaluation version of the S2 is available with a monitor program and other software programmed into it.

Fig. 7. One routine in the S2 evaluation version turns the device into a

pulse-burst generator producing up to 9999 cycles at 1Hz to 10kHz.

jumps to the corresponding code.

**Monitor.** The monitor will communicate with any terminal supporting an RS232 interface at either 300 or 1200 baud and is useful for evaluating the special features of the S2 or for testing short pieces of code.

Through a set of simple commands, the user can enter and debug code within the on-board ram area. Calls to any useful rom based subroutines are also permissible. The command set is shown in Table 3 and the circuit in Fig. 6.

**Pulseburst generator.** A pulse train containing a predetermined number of pulses can be useful when trying to debug synchronous logic circuitry. The pulse-burst generator can generate bursts of up to 9999 cycles at 1,10,100, 1k and 10kHz with a 50% duty cycle. Although programmed and operated through a small keyboard, the generator can produce a burst initiated by a digital input. Additionally it is possible to generate a positive-going trigger pulse on the rising edge of any of the 9999 pulses. Width of the trigger pulse is a half of the pulse-burst period.

Keyboard assignment is indicated in Table 4 and a diagram is shown in Fig. 7. The keyboard does not require isolation diodes. Figure seven also includes an optional circuit to provide some control over pulse duty cycle.

**Frequency Meter.** In this application advanced timer facilities have been used to produce a simple but useful four-and-a-half-digit frequency meter. It will accept an input frequency of between 0.1 and 530kHz using four switchable gate periods, Fig. 8. An input amplifier and a divide-by-100 prescaler would greatly extend its usefulness, creating a very cheap 50MHz frequency meter.

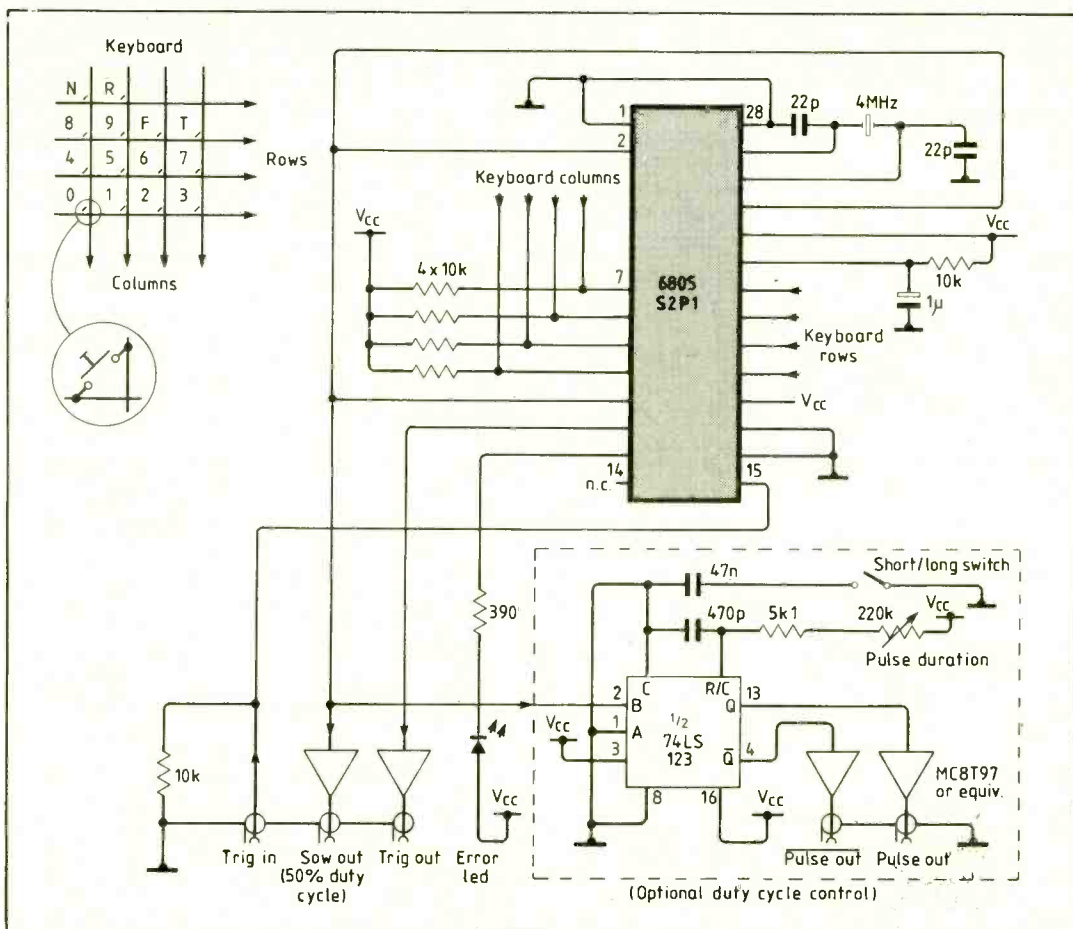

The demonstration device's audio communications and watchdog timer software are described in the next short article.



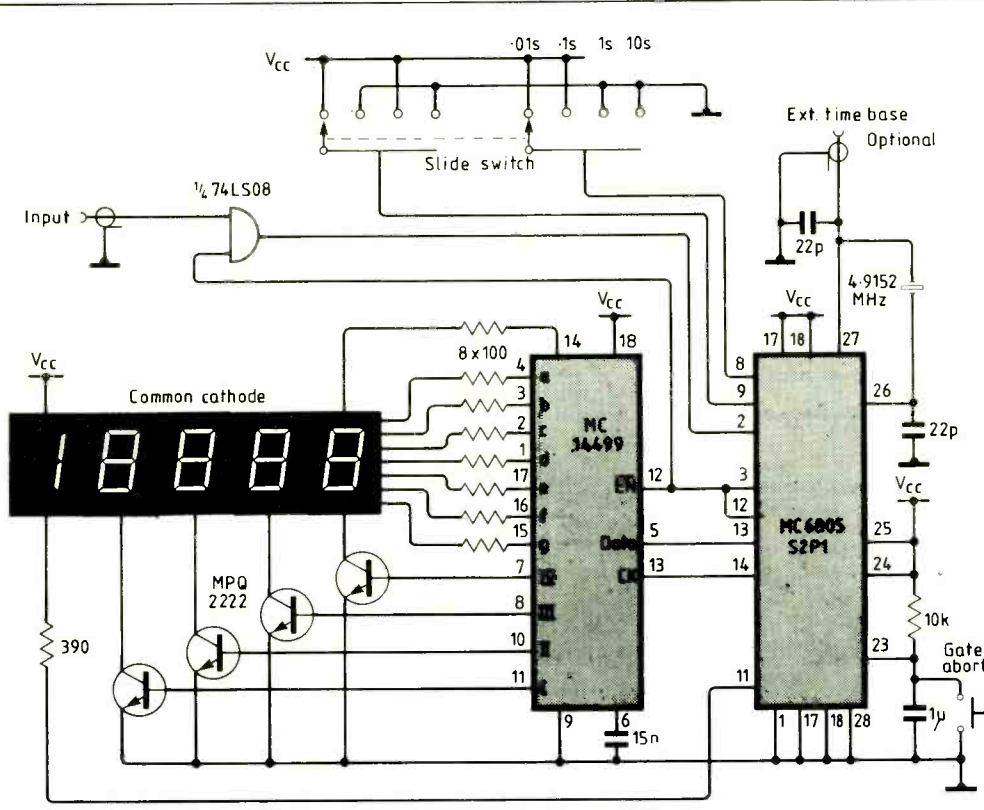

Fig. 8. Using a serial-input display driver, the S2 can be turned into a frequency meter for between 0.1 and 530kHz using four switchable gate periods.

## Stages in obtaining a rom-based m.c.u.

When the development team is satisfied that its code is fully debugged and unlikely to require change, the object code in eeprom or on disc is simply submitted to a distributor or sales engineer with an order form.

This code, referred to as a pattern, is assigned a unique part number. Next the code is loaded into a main-frame computer which generates a series of coordinates for shapes on the mask that define the rom content.

Mask options are also encoded on the program layer and a rom test-pattern database is produced. Remaining masks needed to make the device are generic and already exist.

A further program reconstructs the original binary file from the newly created mask data. This file, referred to as the verification file, is returned to the customer for checking against the original binary file to minimize the chance of errors on the program-layer mask.

Simultaneously with returning the verification file, the mask-coordinate file is sent to the local mask shop so that manufacture can start as soon as the customer confirms the

verification listing. Once the new mask arrives in the factory and passes the quality-assurance tests, a rom-verification wafer lot is produced. Following fabrication, the wafers are tested (probed) then cut (scribed) and a few good die are assembled locally.

Further testing is used to select ten devices which form what are called 'rom-verification units'. These ten are sent to the customer who evaluates them and if all is well, permission is given to make production quantities.

Remaining dice are simultaneously sent for assembly to become the pre-production batch, which will be sent out a few weeks later provided that the verification devices are satisfactory.

Both probe and final test programs use the rom test pattern database created during the computer processing of the customer's pattern.

In the UK, the cycle from the customer verifying the reconstructed pattern to production of the rom-verification units takes four weeks or less using Motorola's mos facility in East Kilbride.

Table 4. Pulse-burst generator keyboard operation

Key	Function
Fx	Set frequency, where x is an integer between zero and four representing the frequency exponent, i.e. 10 <sup>0</sup> to 10 <sup>4</sup> Hz.
Nxxxx	Set number of pulses, where xxxx is four digits representing the number of pulses between 0000 and 9999.
Txxxx	Set trigger point, where xxxx is four digits representing when the trigger pulse is to occur, between 0000 and 9999.
R	Run. If F or T parameters are not entered, R will cause a burst of 65536 pulses with no trigger pulse.

Unacceptable entries cause the command to be aborted and the error led to flash.

## Limited-issue m.c.u.

Around 300 S2 microcomputers with mask-programmed demonstration software have been made exclusively for *E&W* readers. Besides monitor, pulse-generator and frequency-counter software, these devices include two routines for full-duplex audio communication and one for demonstrating use of the auxiliary counter as a watchdog timer.

This limited number of single-chip microcomputers together with an MC14499 four-digit serial-input display driver and data are available for £11.45 including postage but excluding vat from Gothic Crellon Ltd, 3 The Business Centre, Molly Millar's Lane, Wokingham, Berkshire RG11 2EY. Mark your request, with cheque or order made out to Gothic Crellon Ltd, for the attention of Paul Gillman.

Assembly-language software listings are available from *E&W*'s editorial offices at Quadrant House, The Quadrant, Sutton, Surrey SM2 5AS in return for a large, addressed envelope (at least A4) and £2.50 to cover copying and postage costs. Please mark your envelope "S2".





# Subcodes explained

by J.R. Watkinson  
M.Sc.

## How control signals are combined with and separated from audio samples

This definitive compact disc series, introduced in January 1985, featured

- Principles of optical storage, March 1985, pp 70,71 April pp 43-46
- Channel code and disc format, May pp 27,28, June pp 80-82
- Compact disc mastering, February 1986, pp 47-50 & 62
- Compact disc mastering, February 1986, pp 47-50 & 62
- Digital audio editing, March pp 29-32, April pp 52-54.

It is very difficult in analogue audio recording to simultaneously convey control information without some degradation of the audio quality. Applications range from the simple pulsing of a slide projector to the recording of time code to synchronize to film video. In the digital domain no such problems arise because all information conveyed is numerical. A digital recording is not concerned with the meaning of the numbers it is entrusted with, it is only charged with recovering the same numbers later.

Provided that a standard format is used, it is possible to combine control signals in numerical form with audio samples, and achieve complete separation on replay. This is the function of the subcode system of CD. The purpose of the control signals is flexible, but definitions exist for the essential functions of locating the beginning of the different musical pieces on a disc, and providing a catalogue of their location on the disc and their durations. A further vital function is to convey the status of

pre-emphasis in the recording, so that de-emphasis can be automatically selected in the player.

The subcode information in CD is conveyed by including an extra byte, which corresponds to one EFM symbol, in the main frame structure. As the format of the disc is standardized, the player is designed to route the subcode byte in the frame to a different destination than the audio sample bytes. The separation is based on the physical position of the subcode byte in the frame. The player uses the sync. pattern at the beginning of the frame to reset a byte count so that it always knows how far through the frame it is. As a result, subcode bytes will be separated from the data system at frame frequency.

In the article on disc format (May 1985 issue, pages 27/8) I showed that the frames contain among other things six samples for each channel. As the sampling rate is 44.1kHz, the frame rate must be  $44.1/6 = 7.35\text{kHz}$ . The subcode bytes have their own block structure, and one block consists of

98 subcode bytes, each of which has come from a different frame. The choice of 98 bytes was carefully made, and results in a subcode block rate of exactly 75Hz. This frequency can be used to run the playing time display. Fig. 1 shows the relationship between all of the major data and signal rates in the CD system. This diagram first appeared in the June 1985 issue when it contained some errors; the version shown here has been corrected.

It is necessary for the player to know when a new subcode block is beginning. This is the function of the subcode sync. patterns which are placed in the subcode byte position of two successive frames. There are more than 256 legal 14-bit patterns, and two of these additional legal channel bit-patterns are used for subcode block synchronizing. The EFM decoder will be able to distinguish them from the patterns used to represent subcode data bytes. For this reason it is impossible to describe the subcode sync. patterns by a byte, and they have to be specific as 14 channel bits.

The subcode sync. patterns, and the contents of the subcode block, are shown in Fig. 2.

After the subcode sync. patterns there are 96 bytes in the block. The block is arranged as eight 96-bit words, labelled PQRSTUW and X; the choice of labelling is unfortunate because the letters P and Q have already been used to describe the redundancy in the error correction system. The subcode P and Q data have absolutely nothing to do with that. The eight words are quite independent and each subcode byte in a disc frame contains one bit from each word. This form of interleaving reduces the damage done to a particular word by an error.

The P data word is used to denote the start of specific pieces in the sound recorded. The entire word is recorded as data 'ones' during the start flag

Fig. 1 Relationship between major data and signal rates in a compact system. This diagram supercedes that shown in the June 1985 article.

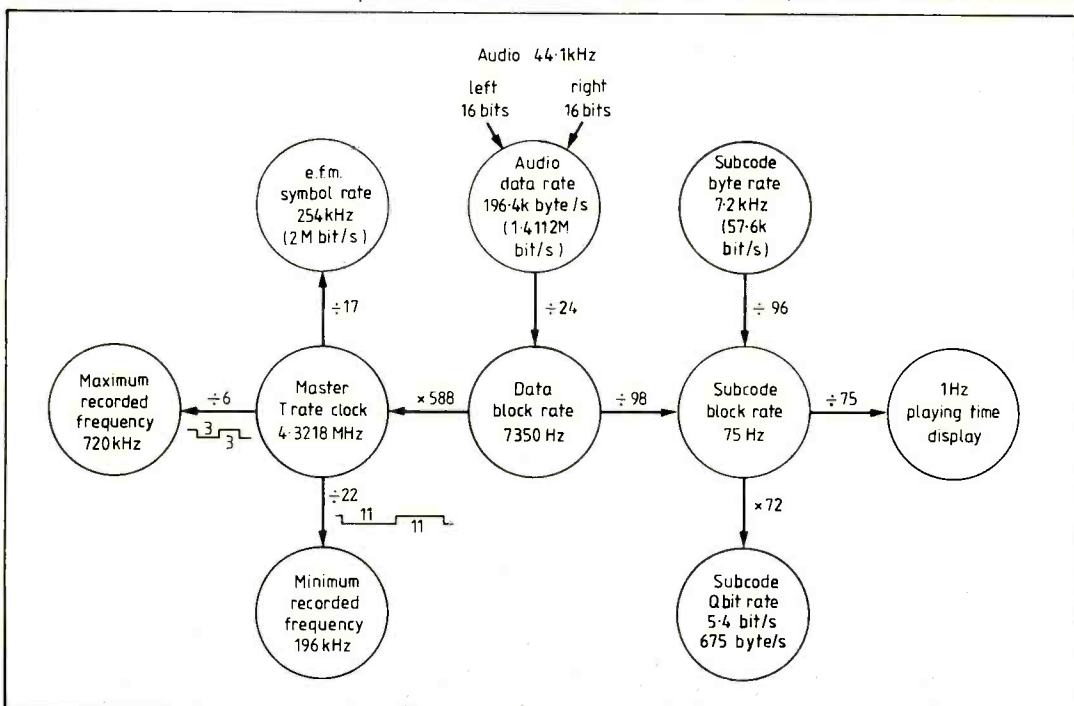

period. It can be used even where there is no audible pause in the music, since the start point is defined as where the p data becomes zero again. The CD standard calls for a minimum of two seconds of start flag to be recorded which seems wasteful but it allows a very simple player to recognise easily the beginning of a piece by skipping tracks. The fact that every bit is a 'one' means that it is not necessary to wait for subcode block sync. to be found before finding pause status on the disc track. The two-second flag period means that the status will be seen a few tracks in advance of the actual start point, helping to prevent the pickup overshooting. If a genuine pause exists in the music, the start flag may be extended to the length of the pause if it exceeds two seconds. Again for the benefit of simple players, the start flag alternates on and off at 2Hz in the leadout area at the end of the recording.

At the time of writing the only other defined subcode data word is the q word. This word has numerous modes and uses which can be taken advantage of by CD players with greater processing and display capability.

Fig. 3 shows the structure of the q subcode word. In the 96 bits following the sync. patterns, there are two four-bit words for control, a 72-bit data block, and a 16-bit c.r.c. character which makes all 96 bits a codeword.

The first four-bit control word contains flags specifying the number of audio channels encoded, to permit automatic decoding of future four channel discs, the copy prohibit status and the pre-emphasis status. Since de-emphasis is often con-



Subcode editor uses timecode readers and autolocator of audio editor, allows entry of subcode parameters and provides printout.

Sony Broadcast

trolled by a relay in the analogue stages of the player, the pre-emphasis status is allowed to change during a p-code start flag.

The second four-bit word determines the meaning of the subsequent 72-bit block. There can be three meanings: mode 1 which tells the player the number and start times of the recordings on the disc, mode 2 which carries the disc catalogue number, and mode 3 which carries the disc i.s.r.c. (the international standard recording code). Of all the subcode blocks on a disc, the mode 1 blocks are by far the most common.

Mode 1 has two major func-

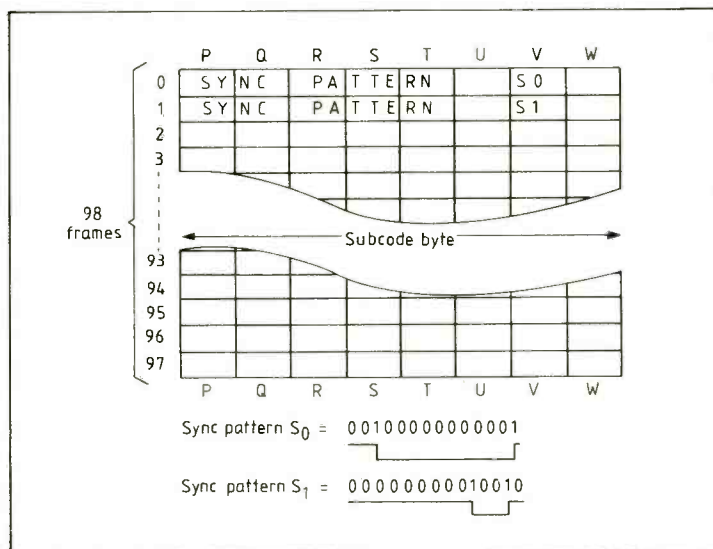

Fig. 2. Frame contains one subcode byte; after 98 frames, the structure repeats. Each subcode byte contains one bit from eight 96-bit words following the two synchronizing patterns.

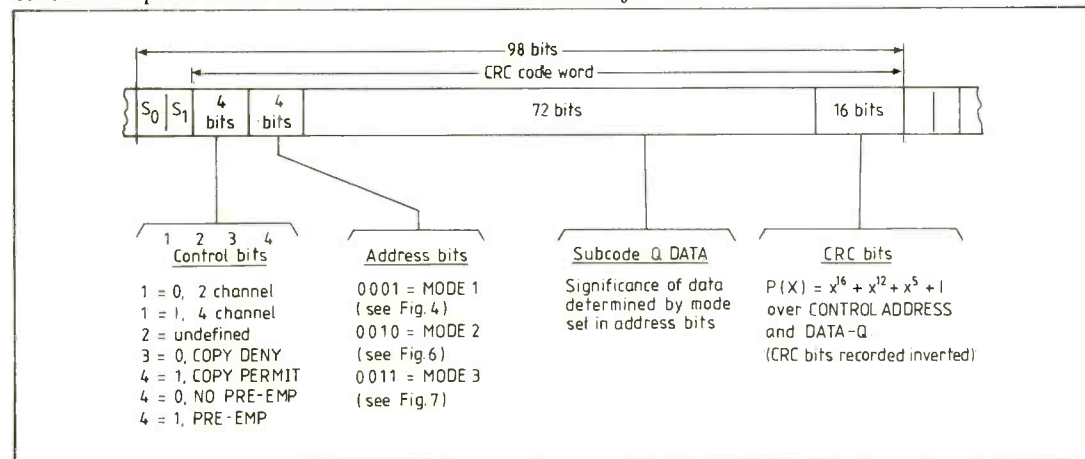
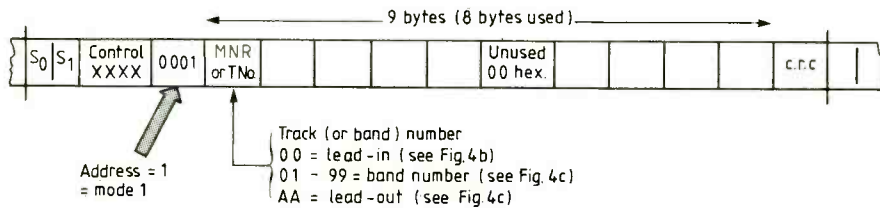

Fig. 3. Structure of the Q-data block: the 72-bit data can be interpreted in three ways, determined by the address bits.



**Fig. 4(a), above: General formal of Q subcode frame in Mode 1. There are eight unused bits, leaving eight active bytes. First byte is music or track number, which determines meaning of remaining bytes. (b), right: During lead-in T no. is zero, and Q subcode builds up a table of contents using numbered points with starting times. Point limit Codes A0 and A1 specify range of bands on multi-disc sets. Example shows two-disc set, with five bands on first disc and six bands on second. (c) bottom: During music bands T no. is 01-99 and subcode shows time through band and time through disc. The former counts down during pause, see Fig.5. Each band can be subdivided by index count.**

FRAME No.	POINT	POINT MIN.	SEC.	FRAME
n, n+1, n+2	0 1 ←	0 0	0 2	0 0
n+3, n+4, n+5	0 2	1 2	0 9	1 0
n+6, n+7, n+8	0 3	2 4	1 1	2 0
n+9, n+10, n+11	0 4	3 6	5 9	7 4
n+12, n+13, n+14	0 5 ←	4 8	5 0	2 2
n+15, n+16, n+17	A 0	--0 1	0 0	0 0
n+18, n+19, n+20	A 1	--0 5	0 0	0 0
n+21, n+21, n+22	A 2	5 9	2 7	3 1

First disc  
5 bands  
1-5

n, n+1, n+2	0 6 ←	0 0	0 2	1 0
n+3, n+4, n+5	0 7	1 0	0 3	2 0
n+6, n+7, n+8	0 8	2 0	0 5	1 1
n+9, n+10, n+11	0 9	3 0	0 4	0 3
n+12, n+13, n+14	1 0	4 0	0 2	1 9
n+15, n+16, n+17	1 1 ←	5 0	5 9	7 0
n+18, n+19, n+20	A 0	--0 6	0 0	0 0
n+21, n+22, n+23	A 1	--1 1	0 0	0 0
n+24, n+25, n+26	A 2	5 9	2 0	7 4

Second disc  
6 bands  
6-11

(b)

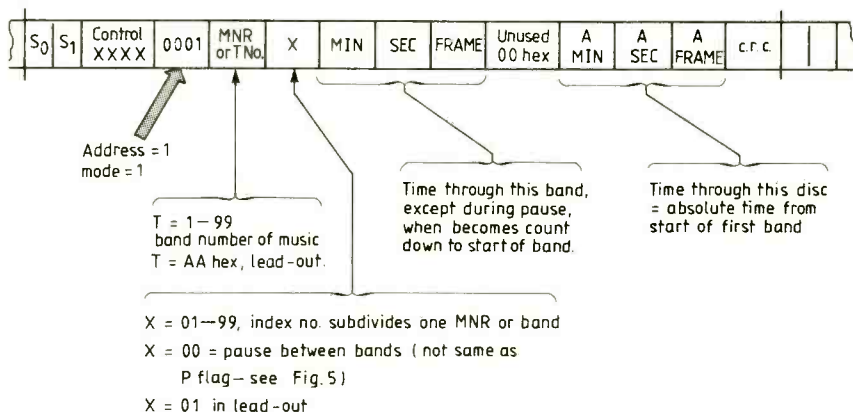
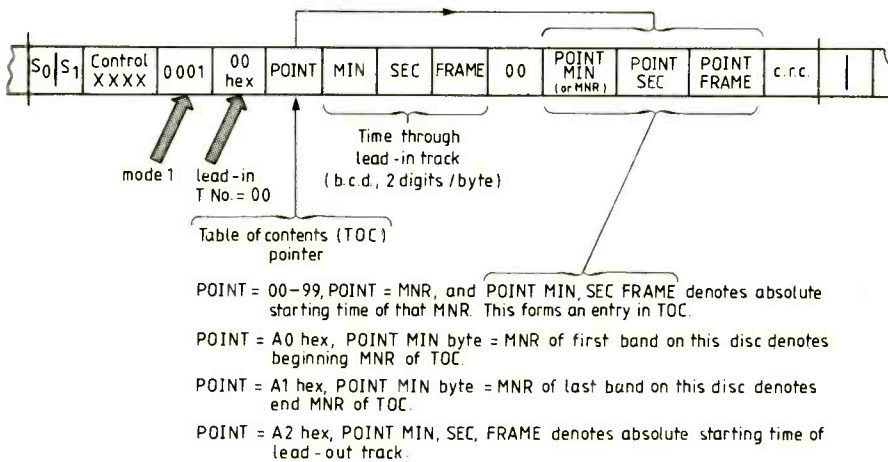

tions. During the lead in track it contains a table of contents (TOC), listing each piece of music and the absolute playing time when it starts. During the music content of the disc it contains running time.

The 72-bit block is subdivided into nine bytes, see Fig. 4 (a), one of which is unused and permanently zero. Each byte represents two hexadecimal digits where not all codes are valid. The first bytes in the block is the music number (MNR) which specifies the number of the track on the disc, where in this context track corresponds to the bands on a vinyl disc. The tracks are numbered from one upwards, and the track number of 00 indicates that the pickup is in the lead-in area and that the rest of the block contains an entry in the table of contents.

The table of contents is built up by listing points in time where each track starts. One point can be described in one subcode block. Fig. 4 (b) shows that the second byte of the block is the point number. The absolute time at which that point will be reached after the start of the first track is contained in the last three bytes as point minutes, point seconds and point frames. These bytes are two b.c.d. digits, where the maximum value of point frame is 74. As there is only error detection in the Q data, the point is repeated in three successive subcode blocks. The number of points allowed is 99, but the track numbering can continue through a set of discs. For example, in a two disc set, there could be five tracks, 1 to 5 on the first disc, and six tracks, 6 to 11 on the second disc. Clearly the first point on the second disc is going to be point 6, and to prevent the player fruitlessly looking for points that are absent, the point range is specified.

If the point byte has the value A0<sub>16</sub> the point minute byte contains the number of the first track on the disc, which in the example given would be 6. If the point byte has the value A1 the point minute byte contains the number of the last track on the disc, which would here be 11. A further point is specified, which is the absolute running time of the start of the leadout track, which uses the point code of A2. These three points

come after the actual music start points.

During the lead-in track, the running time is counted by the minute, second and frame bytes in the block. If the first byte of the block is between 00 and 99, the block is in a music track, and the meaning shown in Fig. 4 (c) applies.

The running time is given in three ways. Minute, second and frame are the running times from the start of that track, and A(absolute)Min, ASec and AFrame are the running times from the start of the first track on the disc. The third running time mode employs the index or x-byte. When this is zero, it denotes a pause, which corresponds to the P subcode being 1. During this pause, which precedes the start of a track, the running time counts down to zero, so that a player can display the time to go before a track starts to play. The absolute time is unaffected by this mode.

Non-zero values of x denote a subdivision of the track into shorter sections. This would be useful to locate individual phrases on a language course disc, or the individual effects on a sound effects disc.

Figure 5 shows an example of the use of P and Q subcode information in a hypothetical recording consisting of several pieces of music.

Mode 2 of the Q subcode allows the recording of the barcode number of the disc, and is denoted by the address code of 2 in the block as shown, in Fig. 6. The 52-bit barcode, along with 12 zeros and a continuation of the absolute frame count are protected by the c.r.c. character. If this mode is used, it should show up at least once in every 100 subcode blocks and the contents of each block should be identical. The use of the mode is not compulsory.

Mode 3 of Q subcode is similar to mode 2, except that a code number can be allocated to each track on the disc. Fig. 7 shows the i.s.r. code requires five alphanumeric characters of six bits each and seven b.c.d. characters of four bits each. Again the mode is optional, but if used, the mode 3 subcode block must occur at least once in every 100 blocks.

The R-to-W subcode is currently not standardized, but proposed uses for this data include a text display which

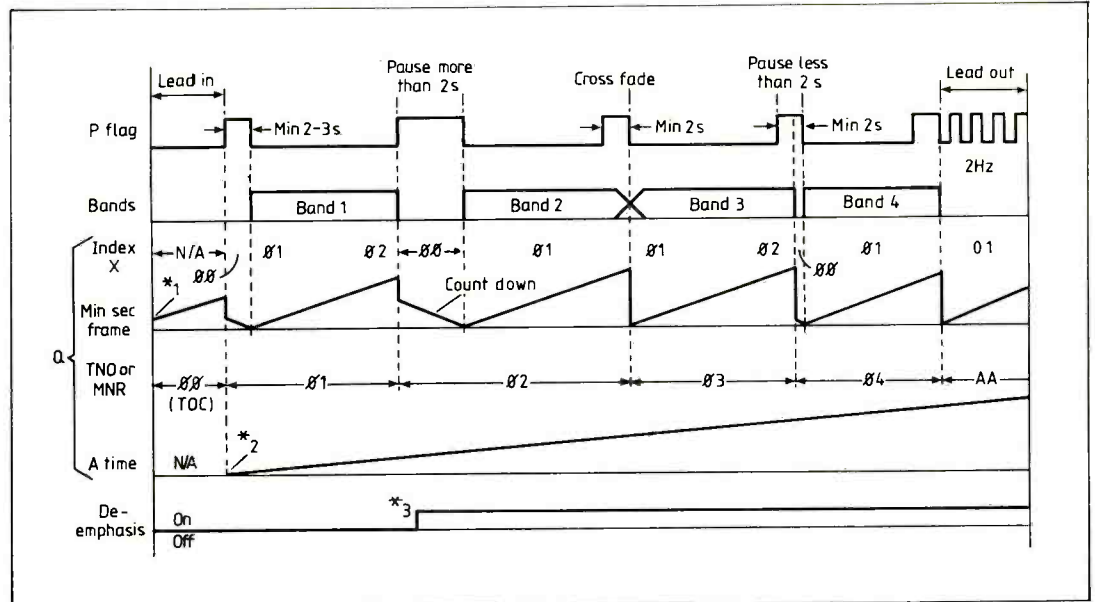

would enable the words of a song to appear on a monitor in synchronism with the sound played from the disc. A difficulty in this area is the requirement to support not only the kind of alphanumeric characters which would be needed for the Japanese market.

The second proposed mode is to support colour graphics display, and the third mode would be to store colour television stills. A frame store would be necessary in the player to refresh the c.r.t. The large number of pixels needed for a tv still would require some 2.5 seconds of playing time to read each one from the disc. A future article will describe the R-to-W subcode details as soon as the standardization process is completed.

The master tape from which a compact disc is cut contains the exact audio sample values which will be transferred to the disc. All timing for the insertion of subcode information during cutting must therefore be derived from the timecode on one of the linear tracks of the cassette. It should be clear from Fig. 1 that the timecode must be locked to the sampling rate for CD mastering. Most p.c.m. adaptors and editors offer this feature. Drop-frame timecode is obviously unsuitable for a synchronized application such as this.

A further constraint is that the timecode on a master tape should not roll across midnight i.e. it should not overflow from 24 hours. The actual timecode start on the mastertape is

irrelevant because the disc cutting computer subtracts the start timecode from all even timecodes, to obtain times with respect to the start of the disc. There is also need for some translation, since the master-tape timecode uses 525/60 video related frames, of which there are 30 in one second, whereas there are 75 CD subcode frames in the same period. The cutting computer also takes care of this.

The subcode data, containing table of contents and the timing of all pauses can be submitted on a standard form along with the cassette, or it can be recorded on the cassette itself. The timecode occupies analogue audio track 2 on the cassette, thus subcode is recorded on audio track 1. The standard for subcode recording specifies a block structure where TOC data and P-flag timings are conveyed along with an error correcting code. The channel coding is f.m. as in the timecode track.

The CD cutting computer needs to have read all of the TOC data from the subcode recording before commencing cutting the disc, since TOC is in the lead in area. It is also proposed that the subcode track will be available for recording R-to-W subcode in the future throughout the length

**Fig. 5. Relationship of P and Q subcode tuning to the music bands. P-flag is never less than 2s between bands, whereas INDEX reflects actual pause, and vanishes at a cross-fade. Time counts down during INDEX = 00. \*1: lead-in time does not have to start from zero. \*2: A-time must start from zero. \*3: De-emphasis can only change during pause of 2s or more.**

**Fig. 6. In mode 2, catalogue number can be recorded, but must be the same throughout the disc and appear in at least one out of 100 successive blocks.**

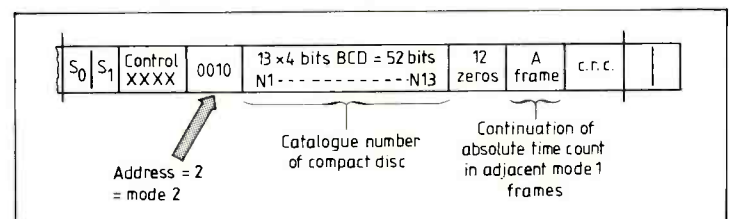

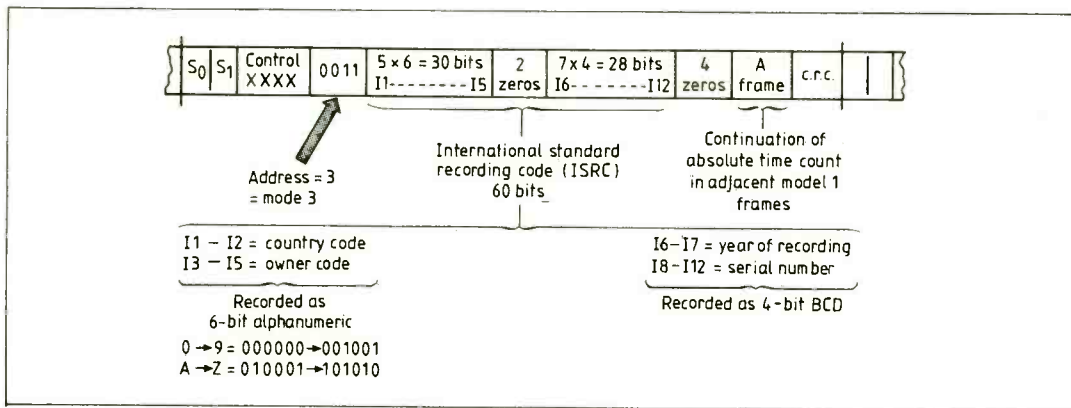

**Fig. 7. ISRC format in mode 3 allows each band to have a different code. All mode-3 frames must be the same within same T number, and must appear in at least one out of every 100 successive blocks. (Not present in lead-out tracks.)**

of the recording. For these reasons, the P and Q subcode information is placed on the cassette prior to the beginning of the first music track.

Specialised equipment is available for the generation of subcode recordings from time-code charts. Fig. 8 shows a subcode editor intended for use in conjunction with a digital audio editor, as it makes use of its time code reading and audio monitoring ability. The subcode editor is connected by in-

terposing it in the audio keyboard cable, where it can pick-off timecode from the v.c.r. going to the display on the keyboard, and where it can control the recorder by simulating transport commands from the editor keyboard. In this way the subcode editor can record the subcode data block in the correct place at the beginning of the cassette before the first music. The time codes entered into the subcode block can also be used to position the

mastertape using the autolocate function of the audio editor, so that the operator can verify that the P flags have been inserted at the correct time with respect to the music.

*This concludes the Compact Disc series, which has been most satisfying to research and write. I have been surprised and delighted by the response to the series, which has added to the satisfaction. I should like to thank the following people for their helpful discussions: Dr Kees Immink of Philips, Dr Toshi Doi of Sony, and Dr Roger Lagadec of Studer (now also with Sony). --JRW.*



# The 1986 satellite and cable tv show

Our roving reporter focuses on d.b.s. opportunities – as seen at Cable '86

The problem of cable in Britain is "to make those millions of Britons who do not have cable wish they had." So said Bryan Cowgill, head of Robert Maxwell's cable and tv interests, in his opening speech at Cable '86. "Cable and satellite" predicted Cowgill "will no longer be a small matter on the periphery of broadcasting." But in trying to answer the question of how successful cable has been so far in attracting new subscribers, Ian Young of Ewbank Preece told his audience that in the UK the answer is shrouded in "complications and secrecy".

Complications come from the confusion of existing low-capacity systems and upgraded cable systems, many of which offer only limited services. Surprisingly, official figures show that between February 85 and January 86, whilst there has been a 39% increase in the number of households 'passed' by new-build systems, the actual number of households in total subscribing to cable services fell over 18,000. This statistical freak was caused by mixing both old and new cable system into the same computation. Young wondered why, when clear information is required, the UK cable industry has allowed such confusion to occur in the basic data.

Ian Young explained that his

attempts to get accurate information on existing subscribers totals and growth projections on specific cable systems were usually met "with aimable but resolute evasion". Young's own estimates suggested that less than 20,000 subscribers are connected to 'new-build' cable tv networks in the UK. Penetration (numbers of households connected as a percentage of the numbers of houses passed) is around 21%.

From Finland, Helsinki Cable TV's (HTV) Esa Malm said that over 200,000 out of Finland's 1.8 million households are connected to cable networks. Helsinki alone has 110,000 households connected. Current estimates for Finland are that over 50% of all urban households will be connected by 1990. HTV aim to provide 38 channel capacity to all viewers by 1987.

## DBS: risks and opportunities

Jon Chaplin of ESA, the European Space Agency, in analysing the risk and opportunities of d.b.s. listed the four major risks as: loss of satellite (particularly at its launch), 'green field' operation (concerning the provision of suitable receivers and their installation in homes), regulation and government policy (where there are still some unknowns) and finally the uncertainty in the growth of revenue.

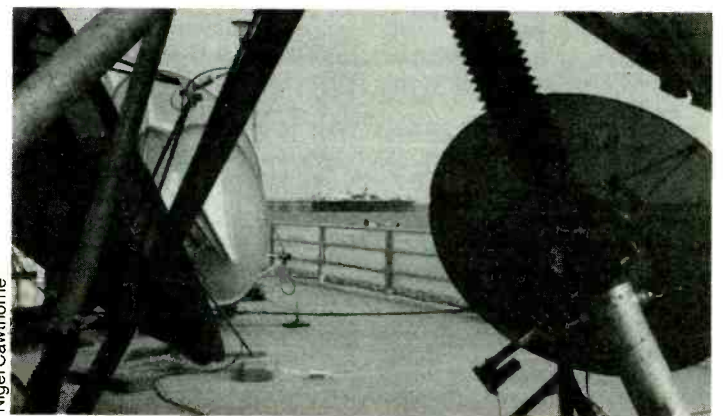

This display of satellite feeds included a stunning demonstration of low-power tv reception using only a 0.8m dish made by D H Satellites and supplied by Harrison Electronics.

Chaplin believes that the crucial factor in d.b.s. is to maximise the probability of realising predicted growth of revenue. The extraordinary high levels of front-end investment have to begin to be paid for as quickly as possible by providing a sufficient variety of services. DBS services should include not only radio and tv broadcast services but also closed user-group video services and specialist information services. Accurate local weather reports for farmers are an example of a service that could be marketed as part of the d.b.s. package. The sale of such d.b.s.-borne services could be used to off-set

some of the front-end investment and help to build up revenue quickly.

Chaplin complained that "more imagination" was needed by the UK government on the use of d.b.s.; it could also be used for innovative educational and training services. Chaplin forecast that it will be the "primary medium by the end of the century".

But in the meantime d.b.s. has to get over the launch problem. Launch failures only have disastrous consequences for systems relying on single new types of

Continued on page 51



# Z80 ■ CONTROL ■ Z80

## CARDMASTER CPU

- 4.6 MHz Z80 CPU
- CP/M compatible
- User transparent MULTI-TASKING
- Up to 32K EPROM & 16K RAM
- Watchdog crash protection
- RS232 & RS422 Comms
- 2 x Z80a PIO (one uncommitted)
- On board bus buffering
- Power-on jump hardware
- Euro-card construction

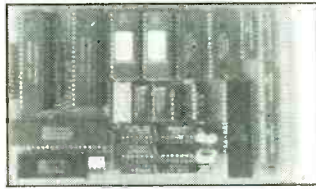

NOW FROM £99 + VAT

## CUB MICROCONTROLLER

- Z80 CPU
- 4 x Z80a PIO's (64 I/O lines)
- Z80a CTC
- 4K Battery backed RAM (2K sup.)
- 4K EPROM (2K MCV2.0 sup.)
- Powerful monitor (MCV2.0)
- Eurocard construction

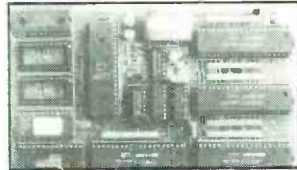

NOW FROM £86 + VAT

## STARBURST V1.31

A CROSS ASSEMBLER FOR CP/M80 covers four major families of single chip uP's and uC's

- \* 8048 inc. 8741/2 8748/9/50
- \* 8051 inc. 8031/2 8751 8744
- \* 6801 inc. 6800/1/2/3 68701
- \* 6805 inc. 68705 63705

Supplied with a complete set of demonstration files.

**STARBURST V1.31 £95.00**  
+ VAT  
Requires Z80 CPU

## CMR16 NOW FROM £165.00

Bare PCB's Available

	1+	10+
C/M CPU	28.50	25.65
C/M I/O	28.50	25.65
CUB	23.50	21.15
CMR16	40.00	36.00

Manuals on request

**GNC ELECTRONICS**  
Little Lodge, Hopton Road,  
Thelnetham, DISS IP22 1JN.  
Tel: 0379 898313

CIRCLE 17 FOR FURTHER DETAILS



**NEPTUNE I, II**  
2.5Kg at 1120mm  
Hydraulic using water



**MENTOR**  
1 Kg at 420mm  
DC servos

**ROBOTS from only £435!**



**WORKCELL COMPONENTS**  
indexing table  
expandable conveyor  
sensors gauges etc

**UK's WIDEST Range of low cost robotic & FMS equipment**



**Cybernetic Applications**  
West Portway Ind. Est.  
Andover, Hants SP10 3WW

Tel. 0264 50093  
Telex 477019



**SERPENT I, II**  
2Kg at 400 or 650mm  
DC servo/pneumatic SCARA



**NAIAD**  
water hydraulic/  
DC servo/  
pneumatic  
500gm at 500mm with see through perspex cylinders

CIRCLE 44 FOR FURTHER DETAILS



## UNIVERSAL COUNTER / TIMERS

The TF1000 and TF1100 are high performance Universal Counter/Timers with frequency, period, period average, time interval, time interval average, frequency ratio and totalise measurement modes.

The Counters also feature a bright 14mm LED display and many additional facilities which make them truly precision measurement instruments.

- Direct frequency measurement to 100MHz
- Frequency range extended to 1GHz on TF1100
- Period measurement from 50ns to 100s
- Time interval measurement from 1ns to 10<sup>6</sup>s
- Totalise and frequency ratio modes
- Matched high sensitivity 100MHz inputs
- AC/DC coupling, attenuator and HF filter
- Slope and trigger level controls, with monitor output
- Standard timebase or high stability option

**TF1000 £495 + VAT    TF1100 £595 + VAT**  
High stability timebase option £75 + VAT

For further information contact:

Thandar Electronics Ltd., London Road, St. Ives,  
Huntingdon, Cambridgeshire PE17 4HJ.  
Telephone: 0480-64646. Telex: 32250.



**thandar**  
ELECTRONICS LIMITED  
CIRCLE 35 FOR FURTHER DETAILS

# TAYLOR

VESTIGIAL SIDEBAND  
TELEVISION MODULATOR C.C.I.R/3



CRYSTAL CONTROLLED OSCILLATOR  
19" RACK MOUNTING, 1u HIGH, 205mm DEEP

**C.C.I.R/3 SPECIFICATION**

Power Requirement	- 240V 8 Watt (available in other voltages)
Video Input	- 1V Pk-Pk 75 Ohm
Audio Input	- 8V 600 Ohm
F.M. Sound Sub-Carrier	- 6MHz (available 5.5MHz)
Modulation	- Negative
I.F. Vision	- 38.9MHz
I.F. Sound	- 32.9MHz (available 33.4MHz)
Sound Pre-Emphasis	- 50us
Ripple on I.F. Saw Filter	- 6dB
Output (any channel 47-860MHz)	- +6dBmV (2mV) 75 Ohm
Vision to Sound Power Ratio	- 5 to 1
Intermodulation	- Equal or less than 60dB
Spurious Harmonic Output	- -40dB (80dB if fitted with TCFL1 Filter or combined via TCFL4 Combiner/Leveller

**CHANNEL COMBINER/FILTER/LEVELLER**  
to combine outputs of modulators

TCFL2	2 Channel Filter/Combiner/Leveller: Insertion Loss 3.5dB
TCFL4	4 Channel Filter/Combiner/Leveller: Insertion Loss 3.5dB
TSKO	Enables up to 4 x TCFL2 or TCFL4 to be combined.

C.C.I.R./3.1

- Specification as above but output level 60dBmV/1000uv

**TAYLOR BROS (OLDHAM) LTD**  
BISLEY STREET WORKS, LEE STREET,  
OLDHAM, ENGLAND.  
TELEPHONE: 061 652 3221 TELEX: 669911

CIRCLE 34 FOR FURTHER DETAILS.

# AEL

# AT

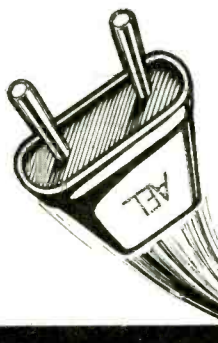

# SPEED

**TO BE CRYSTAL CLEAR**

# AEL CRYSTALS LTD

GATWICK HOUSE · HORLEY · SURREY · RH6 9SU  
TEL: 0293 785353 TELEX: 87116 AERO G

CAA approved

CIRCLE 61 FOR FURTHER DETAILS

## RUGBY TIME?

### MSF CLOCK IS EXACT

- 8 DIGIT** display of Date, Hours, Minutes and Seconds.
- SELF SETTING** at switch-on, never gains or loses, automatic GMT/BST and leap year, and leap seconds.
- EXPANDABLE** to Years, Months, Weekday and Milliseconds and use as a STOPCLOCK to show event time.
- COMPUTER** or **ALARM** output also, parallel BCD (including Weekday) and audio to record and show time on playback.
- DECODES** Rugby 60KHz atomic time signals, superhet receiver (available separately), built-in antenna, 1000Km range.
- LOW COST**, fun-to-build kit (ready-made to order) with receiver
- ONLY £89.80** includes ALL parts, 5x8x15 cm case, pcb by-return postage etc and list of other kits. Get the **TIME RIGHT**.

## CAMBRIDGE KITS

45(WJ) Old School Lane, Milton, Cambridge, Tel 860150

## KESTREL ELECTRONIC COMPONENTS LTD.

- \* All items guaranteed to manufacturers spec.
- \* Many other items available.
- 'Exclusive of V.A.T. and Post and Package'

1+	50+	1+	50+	1+	50+
74LS00	.13 .12	74LS273	.46 .42	2716	2.70 2.40
74LS04	.13 .12	74LS373	.43 .45	27C64	3.50 3.00
74LS08	.15 .13	74LS374	.48 .45	2764-250	1.90 1.80
74LS14	.19 .17	74LS393	.65 .45	27128-250	2.10 2.00
6502	3.30 2.80	74LS541	.45 .35	27256-250	3.40 3.20
6522	3.30 2.80	8155	1.50 1.30	6116LP-3	1.30 1.15
74LS138	.30 .25	8251	1.50 1.30	6264LP-15	2.30 2.10
74LS139	.30 .25	8253	1.50 1.30	4164-15	0.90 0.75
74LS157	.27 .24	8255	1.50 1.30	41256-15	2.20 2.00
TL071	.30 .26	6809	3.80 3.50	Z80ACPU	1.40 1.00
LM324	.23 .20	6821	1.40 1.25	Z80ACTC	1.50 1.10
74LS240	.50 .42	6850	1.50 1.25	65256AP	11.00 11.00
74LS244	.48 .45	4 meg Xtels	.70 .55	62256AP-15	23.00 23.00
74LS245	.50 .43	6 meg Xtels	.70 .55	27512-250	15.00 15.00

All memory prices are fluctuating daily, please phone to confirm prices.

178 Brighton Road,  
Purley, Surrey CR2 4HA  
Tel: 01-668 7522

CIRCLE 49 FOR FURTHER DETAILS

# Solid-state logo player

## Thames tv plans to switch its familiar logo from film to silicon

Thames Television's station identification appears at the start of every programme: in the Thames area alone, it is screened on average 50 times each week.

At present, the ident is televised from film, and usually the replay process also includes at least one videotape stage. To improve the consistency of replay quality and relieve pressure on expensive studio equipment, generating the logo from solid-state memory seemed an attractive alternative.

The memory capacity needed to store this type of material depends on two factors: the duration of the animated sequence and the amount of picture detail. Fully detailed pictures in full colour and with a full grey-scale range demand about eight million bits per picture. An animation sequence lasting only three seconds would therefore call for some 600M-bits of storage. Even with current chip capacities of 1M-bit per chip, a solid-state store of this size would still be somewhat unwieldy.

However, the idea of committing frequently-used station idents to solid-state memory is by no means new. At the BBC\*, the recording capacity limitation has been overcome in the case of material contain-

ing large areas of identical data effectively by storing only data changes which occur at transitions. In this way it has been possible to produce very efficient equipment.

Such memory conservation measures cannot be applied to Thames's main ident symbol, which is a highly detailed photo-montage of the London skyline. However, its saving grace lies in the nature of the animation sequence: in essence, the sequence is composed by read-and-reflect operations on a single master frame (Fig. 1).

A solid-state picture store can be considered as a two-dimensional array. The horizontal index represents the address of a pixel relative to the start of a television line and the vertical index corresponds to the line number. In the present case, the memory array is filled with data representing the picture in Fig. 1.

The moving sequence is synthesized by memory addressing which scans vertical segments of the stored picture. At any one time, only 50% of this picture is used in composing the output. The complete image is obtained by re-reading the first 50% in reverse to produce a reflected mirror image in the lower half of the output frame.

Figure 2 shows the scene which opens the ident. Picture data is derived from the upper half of Fig. 1, together with its

vertical mirror-image. To synthesize the scene, the array is first read from top to centre, producing the top half of the cloudscape. Then the vertical index counters are cued to count backwards so as to produce the reflected lower half.

As the animated sequence develops, new picture data emerges from the central line (Fig. 3). This effect is achieved by incrementing the vertical index start address by six lines at the start of each field.

The final image is shown in Fig. 4, which is made up entirely of data from the lower half of the array. In all, the animated sequence lasts about two seconds.

### Hardware

Two main sections make up the equipment required to generate the video sequence: an acquisition system, to convert the original artwork into digital form, and a read-out unit.

Design of the data acquisition hardware is in part determined by the read-out strategy. Our initial thoughts were to base the memory array on read-only memory chips

**Fig. 5. Block diagram. This simple system meets Thames's experimental requirement. But a dedicated computer-controlled version could be more versatile.**

by I.G. Brown

Ivan Brown T.Eng. (CEI) is a senior project engineer with the research and development group of Thames Television Ltd. His recent work includes investigations into new video systems, including variations on PAL, analogue t.d.m. and p.c.m. systems. In his spare time he is studying psychology with the Open University.

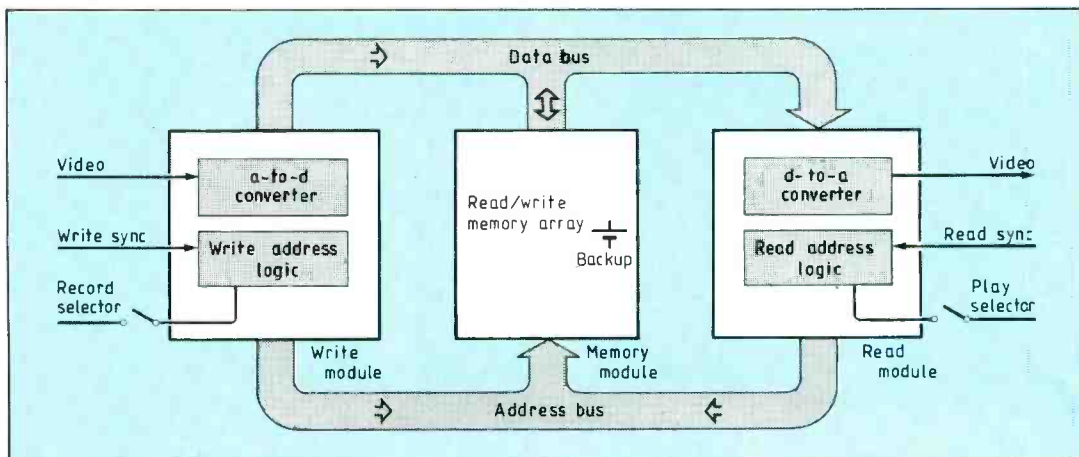
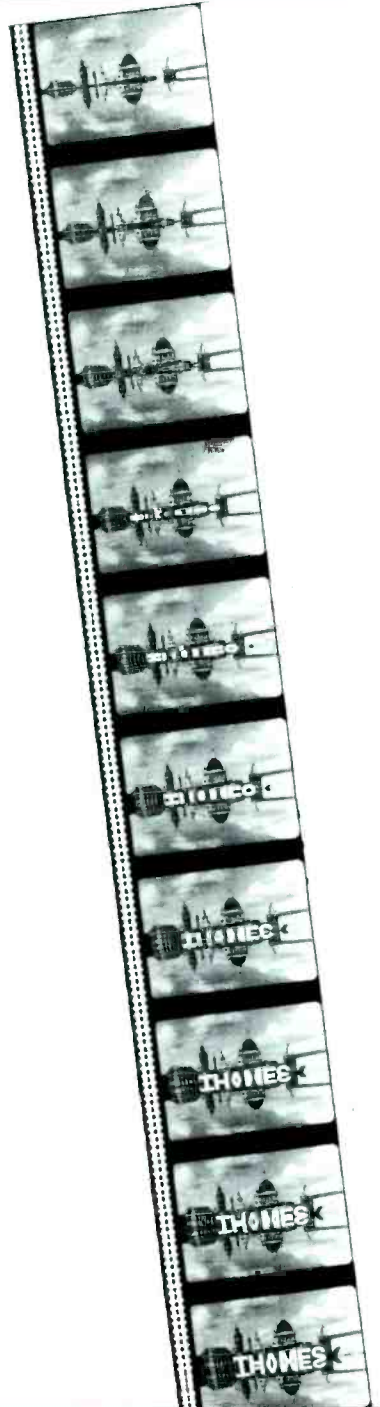



Fig. 1. Master frame. With appropriate addressing of the solid-state store, this digitized artwork yields all data needed for the animation sequence.

Fig. 2. The sequence begins with frames composed solely of picture material from the upper half of the store, reflected upon itself.

**The video content of Thames tv's station identification is fully detailed and contains a complete range of grey-scale tones. Recording an animated version of this in solid-state memory would normally require an unacceptably large and expensive store. But this design takes advantage of the special character of the Thames symbol to generate the complete animation sequence from a single stored master frame.**

and so we carried out a design study on a computer-controlled acquisition and manipulation system using proprietary modules. The advantage of this approach is the flexibility it provides. Once picture data has been acquired by the system it can be manipulated under software control to emulate a finished system before fixing it in eprom.

A possible alternative is to use static read/write memory. With this approach, the same memory can be used for both recording and playback. The recent introduction of 256K static ram chips makes this a viable proposition.

Both approaches have their

advantages and disadvantages. Undoubtedly the arrangement incorporating software control is more flexible: such equipment, once purchased, can be used as a general tool for video manipulation work, and an eprom-based system is less prone to accidental erasure. On the other hand, the static ram approach is less complex for a one-off requirement and it bypasses the need for disc and eprom transfer operations.

Accordingly, a decision was taken to develop an experimental read-write system. The system divides into three main modules (Fig. 5): a write module, a read module and a common read-write memory module.

The write module takes in the analogue representation of the scene along with its associated synchronizing signals. After a-to-d conversion, picture data is passed to the memory module.

In the read module, the read-address counters are locked to a sync input to ensure that the replayed logo is synchronized with other video sources at the station. A user-operated control starts the replay sequence.

Data fed into and out of the memory module represents full-bandwidth red, green and blue signals sampled at the 13.5MHz rate recommended by the CCIR. The unit's output simulates telecine replay equipment in providing analogue RGB outputs which can be further coded as required.

At the time of writing, 256K eprom devices were readily available and reasonably priced. But with the advent of read-write chips of the same size, it became possible to use these instead despite their rather higher price. A battery back-up system is therefore included to retain data in the event of mains power loss.

● *Thames Television's station symbol would not be complete without John Hawkesworth's accompanying fanfare. A further requirement of this project has therefore been to develop a solid-state reader for this five-second theme. Details are given by John Emmett of Thames Television in Thames Television Engineering Report No. 583.* ■

Fig. 3. As the sequence proceeds, our window on the master frame moves downward. Since the bottom half of the picture is simply an electronic reflection of the top half, the new material emerges at the centre line.

Fig. 4. Final scene is obtained from the bottom half of the memory array. Full-field picture output is created by redirecting the vertical addressing of the store to make the electronic reflection.



# MATURE, FRIENDLY EPROM PROGRAMMER

## GANG-OF-EIGHT BY DATAMAN

### Redesigned to Your Specification

GANG-OF-EIGHT is a successful product, because of its performance and unbeatable price. Since the launch we have taken careful note of comments made by engineers who have called us. This gave us a wish-list of extra features and revisions to work by. The result is an improved G8 which should suit you even better — it is just what you asked for.

**25 and 27 Series to 512K**  
G8 will handle 2516, 2532 and 2564 EPROMS, as well as all 27 series from 2716 to 27512.

### FAST and SLOW Programming Method

You can use a FAST, intelligent algorithm to program larger EPROMS, which speeds up the programming operation by a factor of five, at least. G8 will also program the old-fashioned way, with 50ms pulses.

### Voltage Selection

There are three different voltages selectable (by switches) and these are each resettable (by potentiometers) over a wide range. The factory-setting is 25 volts, 21 volts and 12.5 volts.

### Liquid Crystal Display

G8 shows the EPROM type, the Program-Method and the Program-Voltage and changes the display when you reset the switches. You always know what is happening with G8.

### Two Key operation

G8 has only two keys — START and RESET — simple to operate, yet it does all the useful things you need. Before every programming cycle it checks that you have not programmed any of the EPROMS already, reporting any which match the master. Then G8 tells you if any are not blank, so that you can erase them. Only if the EPROMS pass these tests does G8 start programming (but G8 will try to program unerased EPROMS, if you ignore the ERASE message and press START again — something else you asked for).

### Checksum Facility

G8 will calculate and display a 6-digit checksum of your master EPROM, when you press START and RESET at the same time. This helps you to identify EPROMS which are unlabelled, and provides a simple check on the integrity of your data.

### Tuneful, too

G8 provides audible feedback, to avoid the necessity for constant monitoring — that is, it makes noises so you don't need to watch it: rising and falling arpeggios as the program starts and finishes; occasional tones to remind you that your EPROMS are ready. Data is audible when uploading and downloading.

### Option — Steel Case

G8 normally comes in a plastic case, which is light and durable. However, some of you want your G8 in a steel case, and this option is available now.

### Option — Bidirectional RS232 Serial Interface

G8 was intended as a fast, low-cost production copier, but frequent enquiries made us think again and design a version which could be used for development purposes, capable of uploading and downloading in a variety of serial formats: INTELHEX, MOTOROLA S, TEKHEX, ASCII-HEX and BINARY. Links on your serial cable select the format.

### Quick delivery

We know you don't want to wait, so we keep lots of Gang-of-Eight programmers in stock. If you are in a real hurry telephone us — we will save your time and arrange the fastest delivery possible.

### No Risk Trial: Refund Guaranteed

Without any questions asked, you get your money back if you do not get along with your G8, provided you return the product within 14 days.

(we subtract only carriage expenses).

### Terms

Cheque with order or credit-card.

#### Dataman

Lombard House, Cornwall Road,  
Dorchester, Dorset DT1 1RX  
England

Telephone: (0305) 68066

Telex: 418442 DATAMN G

add for RS232 option £50.00

add for steel case option £35.00

to basic

**GANG-OF-EIGHT £395.00**

postage is free BUT please add VAT in U.K.

TOOLS  
FOR  
DATAMAN  
MICRO ENGINEERING

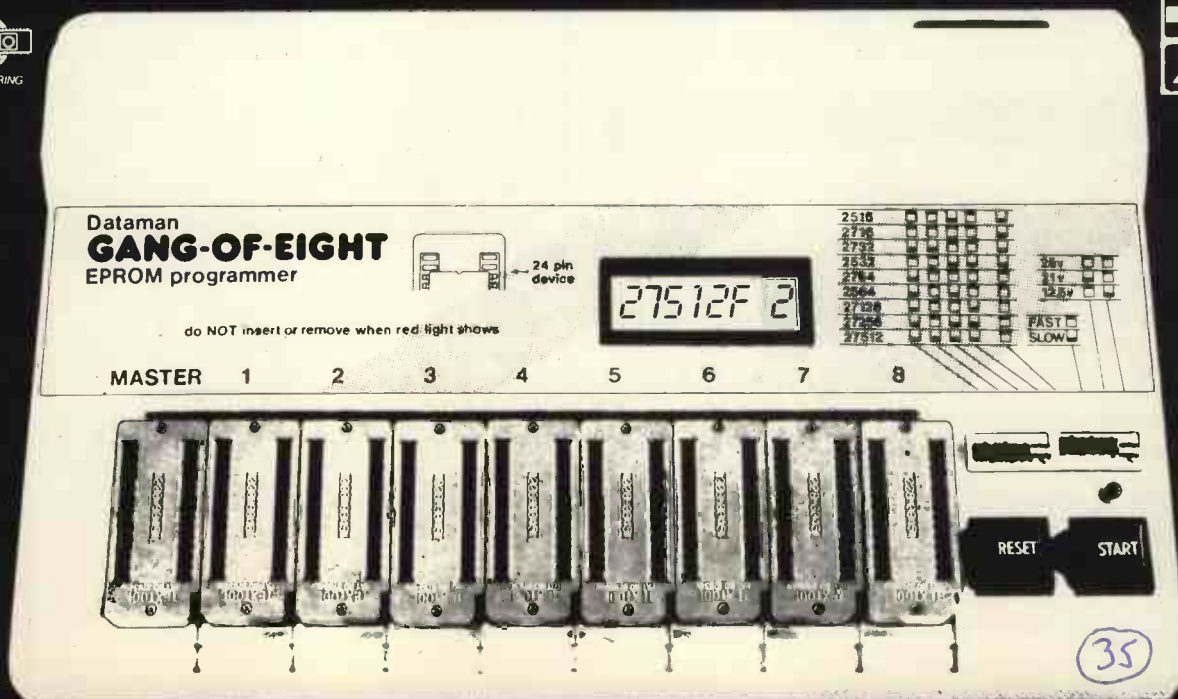

# THE PEAK...

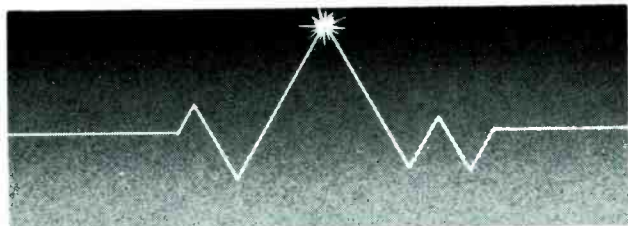

## OF PERFECTION

Designed and manufactured in West Germany by Hameg, one of the World's leading oscilloscope manufacturers—a complete range of high instrument-standard oscilloscopes, at prices that defy comparison.

Make the comparison and discover the 'Peak of Perfection'.

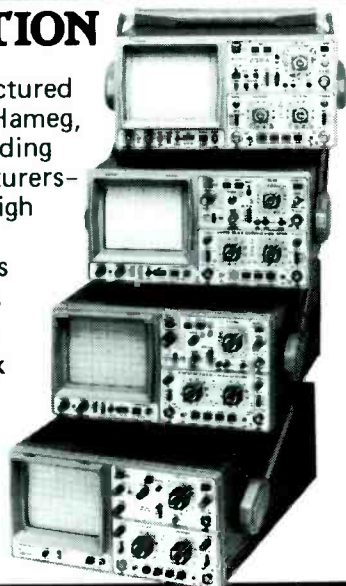

**HM208 £1300 (£1550 with IEEE)**

### 20 MHz Digital Storage

Outstanding 20 MHz max. sampling rate . 4 x 1k Memory . 8bit vert. resolution . Digital Timebase from 50 s/div. to 10µs/div. . Stores XY-Operation . Single/Refresh/Roll Mode . Analogue Output . IEEE-Bus optional . Sensitivity 1mV/div. — 20V/div.

**HM605 £ 515**

### 60 MHz Dual Trace

Sensitivity 5 mV/div. at 60 MHz, 1mV at 5 MHz . Automatic peak-value or normal triggering to 80 MHz . Delay Line Variable Sweep Delay . Timebase from 2.5s/div. to max. 5ns/div. . Unique fast-risetime 1 kHz/1 MHz calibrator . Y-Output . High-resolution 15 kV CRT

**HM204 £ 365**

### 20 MHz Dual Trace

Sensitivity 5mV — 20V/div. , 1 mV at 5 MHz . Timebase from 1.25s/div. to max. 10ns/div. DELAY LINE . Variable sweep delay . Single sweep . Automatic peak-value trigger to 50 MHz . Y-Output . Z-Modulation . Overscan indicator

**HM203 £270**

### 20 MHz Dual Trace

Western Europe's best selling 20 MHz - Scope! Sensitivity 2mV/div. . Trigger bandwidth 40 MHz . Timebase from 0.2s/div. to max. 20ns/div. . X—Y . Component Tester

2 Years Warranty

Prices U.K. list ex.VAT

# HAMEG

FOR THOSE WHO COMPARE

74 — 78 Collingdon St. Luton, Beds, LU1 1RX  
Tel: (0582) 413174 Telex: 825484

CIRCLE 11 FOR FURTHER DETAILS

## NEW

### MODULAR FORTH

- \* FORTH 83 in Modules
- \* MULTI-TASKING, Floating Point and many more features
- \* AN INNOVATIVE FORTH

## NEW

### FORTH 83 FOR ATARI ST

- \* WITH COMPLETE GRAPHICS

## AND

### Our dependable Work-Forth

- \* Takes the hard work out of Forth

#### EXTRAS: Floating Point

Source level De-bugger

Show prices: £48.00 + VAT  
and AMSTRAD £35.50 + VAT

### MicroProcessor Engineering Ltd

21 Hanley Road, Shirley  
Southampton SO1 5AP  
Tel: 0703 780084



are at the PCW Show  
Stand No.1918

CIRCLE 38 FOR FURTHER DETAILS

## Toroidal & E.I. Transformers

As manufacturers we are able to offer a range of quality toroidal and laminated transformers at highly competitive prices. Quantity Prices and delivery on request.

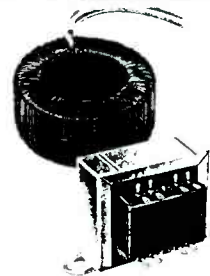

MAIL Order Price List  
(prices inclusive of VAT & Postage)

#### Toroidal transformers

15VA 7.95, 30VA 9.18,  
50VA 10.16, 80VA 11.36,  
120VA 12.07, 160VA 14.20,  
225VA 15.51m 300VA 17.04,  
500VA 22.10, 625VA 24.66,  
750VA 28.75, 1000VA 44.82.  
Available from stock in the following voltages 6-0-6, 9-0-9, 12-0-12, 15-0-15, 18-0-18, 22-0-22, 25-0-25, 30-0-30, 35-0-35, 40-0-40, 45-0-45, 50-0-50, 110, 220, 240 primary 240 volt. Also available 1k2, 1k5, 2k, 2k5, 3k. Prices on request.



#### E.I. transformers (clamp)

6VA 2.90, 8VA 3.40,  
12VA 4.20, 15VA 4.75,  
25VA 5.40, 50VA 6.50,  
100VA 13.02.  
Available in the following voltages: 6-0-6, 9-0-9, 12-0-12, 15-0-15, 20-0-20, 25-0-25. Primary 240 volt.



#### Printed circuit mounting transformers. (E.I.)

3VA 2.38, 6VA 2.99,  
8VA 3.75, 12VA 4.66.  
Available in the following voltage: 6-0-6, 9-0-9, 12-0-12, 15-0-15, 20-0-20. Primary 240 volt.



#### Portable isolating transformers

Input 240 output 110V. rating continuous/cool  
500/750VA 53.84,  
1000/1500VA 72.57,  
1000/1500VA 76.59,  
1500/2500VA 85.54.  
Input 240 output 240  
250/400VA 57.40,  
500/750VA 65.25.



#### Auto transformers

240 volt input 115 volt  
USA socket outlets  
(fully shrouded)  
150VA 11.00, 300VA 15.00,  
500VA 27.00, 1000VA 34.00,  
1500VA 48.00. 2000VA 53.00



### Air Link Transformers.

Unit 6, The Maltings, Station Road,  
Sawbridgeworth, Herts. Tel: 0279-724425

CIRCLE 40 FOR FURTHER DETAILS

# Designing with dynamic memory

## Dynamic rams are not as complex as their timing diagrams suggest

The write cycle timing diagram of a dynamic ram is not as simple as a read cycle diagram because of the more stringent requirements placed on the  $\bar{w}$  and data inputs. As the first part of this article (August issue) worked through the read cycle timing diagram, it is not necessary to plough through all the same material again. Fig. 10 gives the full timing diagram of a HM4864 64K  $\times$  1 dynamic ram during a write cycle; Fig. 11 is a copy but includes only parameters that differ between the read and writes cycles. You can see that all the timing requirements of the  $\bar{RAS}$ ,  $\bar{CAS}$  and address inputs are identical in both read and write cycles.

### Write timing

Consider first the requirements of the  $\bar{w}$  input, which signal has to satisfy six conditions. It is latched by the falling edge of the  $\bar{CAS}$  clock, and has a setup time of  $t_{WCS}$  seconds. The minimum value of  $t_{WCS}$  is  $-20\text{ns}$ , implying that  $\bar{w}$  can be asserted as late as  $20\text{ns}$  after the falling edge of  $\bar{CAS}$ . Once asserted, it has a minimum down-time of  $t_{WP}$  seconds (write pulse width  $45\text{ns}$ ), and must not be negated until at least  $t_{WCH}$  seconds (write pulse hold time  $45\text{ns}$ ) after the falling edge of  $\bar{CAS}$ .

In addition to these parameters,  $\bar{w}$  must be asserted at least  $t_{RWL}$  (write command to row strobe lead time) before the rising edge of  $\bar{RAS}$ , and at least  $t_{CWL}$  (write command to column strobe lead time) seconds before the rising edge of  $\bar{CAS}$ . These are both quoted as  $45\text{ns}$ . Finally,  $\bar{w}$  must not be negated at least  $t_{WCR}$  seconds (the write command pulse hold time referenced to  $\bar{RAS}$ ) after the falling edge of  $\bar{RAS}$ .

At this point, dear reader, you can be forgiven for thinking that the dynamic ram is a hideously complex device and that you would rather stick to static ram. There is an old saying "Look after the pennies and the pounds take care of themselves". So it is with dynamic ram. Look after the  $\bar{RAS}$  and  $\bar{CAS}$  clocks and the  $\bar{w}$  input will take care of itself.

To illustrate this point consider a simple example in which the write pulse is made equal to the  $\bar{CAS}$  clock, see Fig. 12. The  $\bar{RAS}$  pulse is given the minimum possible value of  $t_{RAS} = 150\text{ns}$ .  $\bar{CAS}$  is derived from  $\bar{RAS}$  by delaying its falling edge by  $50\text{ns}$  from  $\bar{RAS}$ , to yield a value for  $t_{RCD}$  of  $50\text{ns}$ , and for  $t_{CAS}$  of  $100\text{ns}$ , its minimum permissible down time. The  $\bar{w}$  signal is obtained by gating the  $R/\bar{w}$  output of the processor with  $\bar{CAS}$ .

Below the Fig. 12 timing diagram are the six parameters associated with  $\bar{w}$  during a write cycle and their minimum requirements, together with the values achieved by this circuit. In each case the righthand column gives the margin by which the requirement is satisfied. A negative value would indicate a failure to meet a requirement. As no entry in this column is negative, it can be concluded that this circuit satisfies all constraints on  $\bar{w}$ . Note that the margin on the write command setup time is only  $20\text{ns}$ , of the order of the propagation delay through two gates in series. A margin as low as this would require careful attention to fine detail in a real circuit.

### Data timing in a write cycle

Data is written into the memory on the falling edge of the

by Alan Clements  
Teesside Polytechnic

$\bar{CAS}$  clock. The requirements for data-input timing are entirely straightforward and involve only three parameters (see Fig. 11). The data to be written into the memory must be valid for  $t_{DS}$  seconds (data setup time) before the falling edge of  $\bar{CAS}$ , and must be maintained for  $t_{DH}$  seconds (data

Fig. 10. Full timing diagram of a dynamic ram in a write cycle (top).

Fig. 11. In this detail of the write cycle timing diagram (bottom) the 'critical event' is the falling edge of  $\bar{CAS}$  which latches the  $\bar{w}$  and the data input to the d-ram. Only parameters directly related to the write cycle have been included.

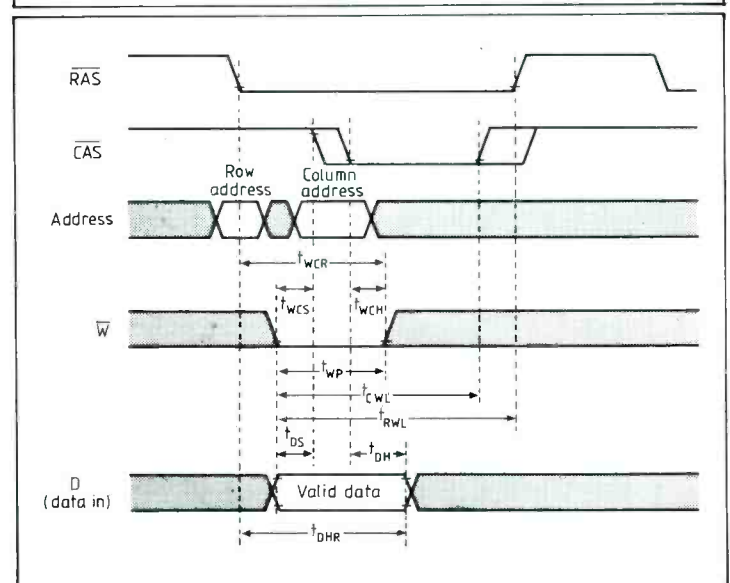
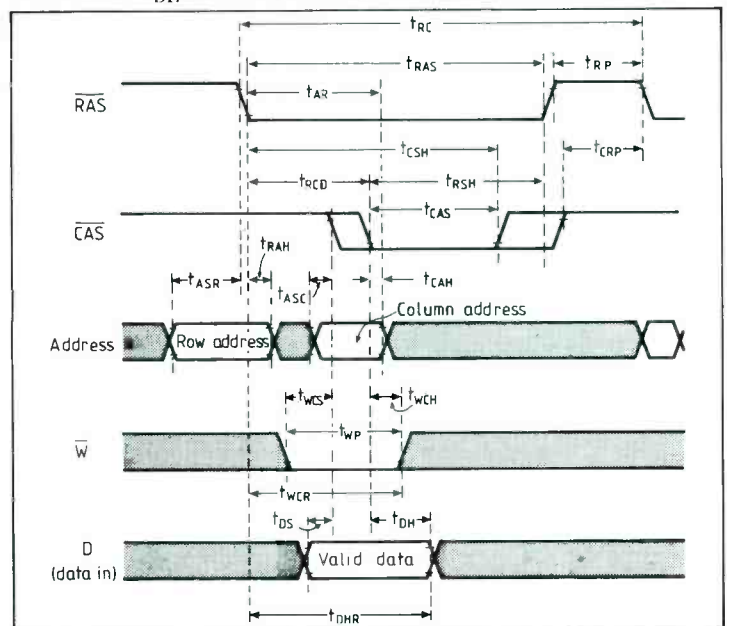

# DYNAMIC MEMORY

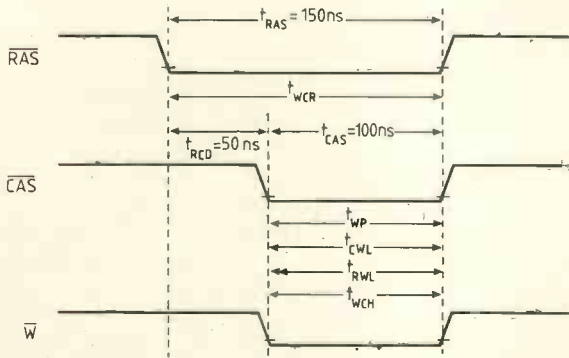
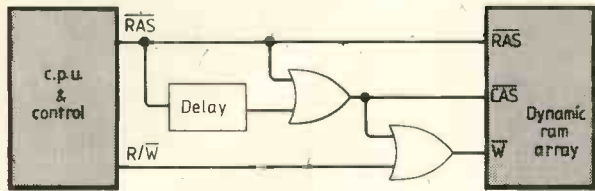

Parameter Name		Minimum value	Actual value	Margin
$t_{WCS}$	Write command setup time	-20ns	0ns	+20ns
$t_{CWL}$	Write command to column strobe lead time	45ns	100ns	+55ns
$t_{WP}$	Write command pulse width	45ns	100ns	+55ns
$t_{RWL}$	Write command to row strobe lead time	45ns	100ns	+55ns
$t_{WCR}$	Write command hold time referenced to $\overline{RAS}$	95ns	150ns	+55ns
$t_{WCH}$	Write command hold time	45ns	100ns	+55ns

Fig. 12. How to deal with  $\overline{W}$  timing in a dynamic RAM.

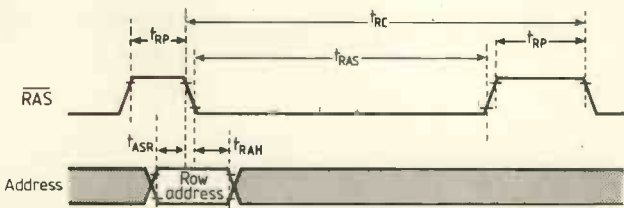
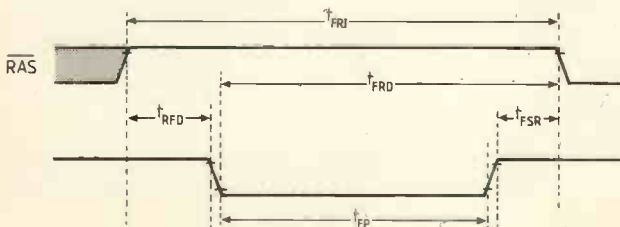

Fig. 13. In a  $\overline{RAS}$ -only refresh cycle, the refresh address is latched by the falling edge of  $\overline{RAS}$ .  $\overline{CAS}$  and  $\overline{W}$  are high throughout. Fig. 14. The REFRESH input, pin 1, is brought low to force an internal refresh cycle. That is, the d-ram generates its own row refresh address which is automatically incremented after each refresh cycle.

hold time) following the falling edge of  $\overline{CAS}$ . Setup time is 0ns (min.) and hold time 45ns (min.) Data must also meet a hold time criterion with respect to the falling edge of  $\overline{RAS}$ . Once  $\overline{RAS}$  has been asserted, the data must not change for at least  $t_{DHR}$  seconds (95ns minimum). In general, the data timing requirements are not critical during a write cycle. However, as the data from the



processor is latched into the memory by the falling edge of  $\overline{CAS}$  clock, which often occurs early in a write cycle, it is necessary for the processor to supply its data output very early in a write cycle. Otherwise  $\overline{CAS}$  must be delayed until data from the processor is available.

Besides the normal read and write cycles, dynamic memories can be operated in other modes: a page mode and a read-modify-write cycle. Page mode operations involve sequential reads or writes to different column addresses, while the row address remains fixed and  $\overline{RAS}$  low. This speeds up the cycle time of the device, and has applications in c.r.t display circuits in which memory is always accessed sequentially. The read-modify-write cycle is a memory access in which a write immediately follows a read the therefore avoids the need to latch the row and column addresses twice.

## Dynamic memory refresh timing

Because of the way in which a dynamic memory cell operates, with an automatic write-back of information following a destructive readout, all that is needed to refresh a memory cell is a periodic reading of its contents, at least once every 2ms. Even better news is that when a particular row is accessed, all columns in that row are refreshed. This means that only 128 refresh operations need be carried out every 2ms. Note that the number of rows in a 64K chip is 128 rather than 256, because of the way in which the memory is internally partitioned.

Refreshing can be carried out either by hardware or by software. If the software can be guaranteed to perform at least 128 read or write cycles to the row addresses specified by the chip's  $A_0$  to  $A_6$  address inputs, then no additional hardware is required. Of course, guaranteeing 128 refresh cycles every 2ms can be difficult. What happens if the reset button is pushed? Or if...

The vast majority of dynamic memories rely on hardware refreshing techniques. These are divided into two classes:  $\overline{RAS}$ -only refresh and "pin-1" refresh on certain types of dynamic memory. Figure 13 presents a timing diagram of

the  $\overline{RAS}$ -only refresh. For the duration of the refresh cycle,  $\overline{CAS}$  is inactive-high, and the data-in and  $\overline{W}$  inputs are 'don't care' conditions.  $\overline{RAS}$  behaves as it does in any normal memory access and the row address for the refresh is latched exactly in the same way as any other access. Thus, in order to execute a refresh, the row address is applied to  $A_0 - A_6$  and  $\overline{RAS}$  brought low for one cycle, while  $\overline{CAS}$  is held high. Couldn't be simpler, could it?

Every silver lining delineates a nasty black cloud. In this case, the simple refresh operation is, indeed, the silver lining, but fitting the refresh cycle into the processor's normal sequence of operations is the black cloud. Somehow a logic subsystem has to take a decision to perform one or more memory refresh cycles and then to interleave them with normal processor memory accesses. It is difficult to design a d-ram refresh system *without* reference to the host processor.

The alternative form of refreshing is called "pin-1" refreshing because it uses pin 1 on 64K dynamic rams, 64K rams without this mode of refreshing leave pin 1 unconnected. Fig. 14 illustrates the operation of the pin-1 refresh mode, available on the 6664A-15 dynamic ram. The  $\overline{RAS}$  signal is held high while the REFRESH input on pin 1 is forced active-low. Timing requirements are self-explanatory. Note that  $t_{FRI}$  (the  $\overline{RAS}$  inactive time during a refresh cycle) and  $t_{FRD}$  (REFRESH to  $\overline{RAS}$  delay time) are relatively long, 370 and 320ns respectively, and might cause timing problems if a pin-1 refreshed cycle is to be interleaved with normal processor cycles.

As  $t_{FRI}$  and  $t_{FRD}$  are long compared to the refresh pulse period,  $t_{FP}$ , with its 60ns minimum, it is advantageous to operate the 6664A in a pulse pin-1 refresh mode in which REFRESH is pulse while  $\overline{RAS}$  is high, see timing diagram in Fig. 15. A single row refresh cycle has a minimum duration of  $t_{FC} = 270ns$ , which equal to the chip's normal cycle time. In a pulsed refreshed mode, a batch of rows are refreshed in one burst, rather than by executing 128 separate pin-1 refresh cycles.



### Dynamic ram controller

The next step is to show how d-rams are actually used in microcomputers. The dynamic memory system of Fig. 16, is intended to be used in a 68000-based system without pin 1 refresh-mode d-rams. It is organized as 64K 16-bit words, with independent byte control. During normal (that is non-refresh) operation, the address decoder provides an active-low output,  $\overline{\text{MSEL}}$ , whenever a valid address within the array is generated by the computer. This triggers the timing generator, which synthesizes all the control signals required for the ram array and the address multiplexers.  $\text{MUX}_1$  selects the row or column address bus, while  $\text{MUX}_2$  selects the row-column address from  $\text{MUX}_1$  or from the row counter during a refresh.  $\text{MUX}_1$  and  $\text{MUX}_2$  together form a three-way multiplexer.

The complex part of the dynamic memory system is the timing and control circuit, which must perform both normal read/write memory cycles and memory refreshes. The way in which memory refreshes are slotted into the operation of the processor is a difficult design decision and many factors have to be taken into account. For example, should the refreshing be interleaved with normal memory accessing, or should it be done separately by stopping the processor and then carrying out a burst of refresh cycles?

Before considering the interface between a d-ram array and a 68000 microprocessor, first look at 68000 memory access. Figure 17 shows how

the 68000 uses  $\overline{\text{AS}}$ ,  $\overline{\text{LDS}}$ ,  $\overline{\text{UDS}}$ ,  $\overline{\text{R/W}}$  and  $\overline{\text{DTACK}}$  to carry out a read or a write cycle. A read or write cycle takes a minimum of eight clock states,  $S_0 - S_7$ , corresponding to 500ns at a typical clock frequency of 8MHz. The address strobe,  $\overline{\text{AS}}$ , is asserted after the address has stabilized and indicates that the current address on  $A_{01} - A_{23}$  is valid. Data strobes  $\overline{\text{LDS}}$  and/or  $\overline{\text{UDS}}$ , are asserted to access a byte on  $D_{00} - D_{07}$  and/or  $D_{08} - D_{15}$ .

Note that the data strobes are asserted concurrently with  $\overline{\text{AS}}$  in a read cycle and approximately one clock cycle later in a write cycle. The data strobes

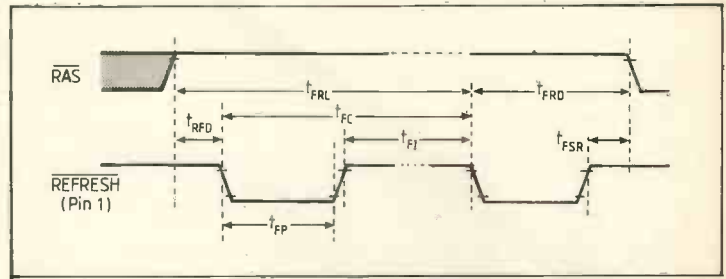

**Fig. 15** A burst of refresh cycles is carried out by pulsing REFRESH pin low.

are not asserted in a write cycle until after the data from the process on has stabilized. This allows the data strobe to be used to latch data into memory or a peripheral. A memory access is completed when the addressed device asserts the 68000  $\overline{\text{DTACK}}$  (data acknow-

**Fig. 16.** Structure of a dynamic memory module. 68000 bus arbitration control lines can be used to halt the processor while refresh takes place.

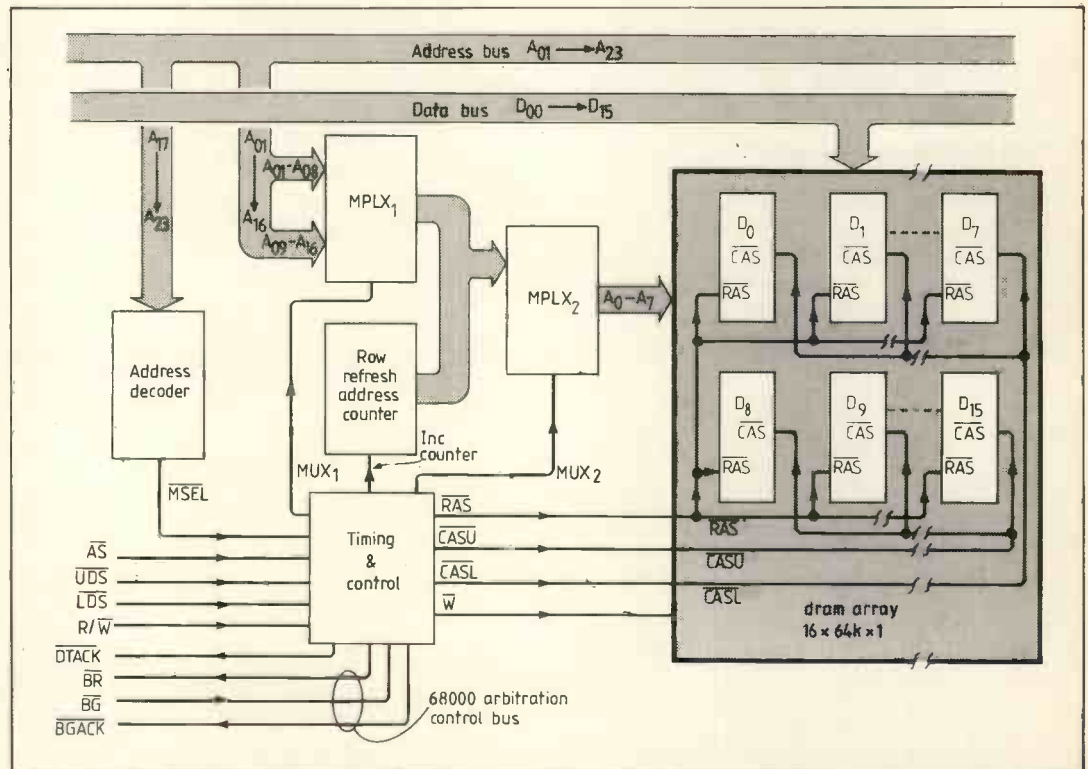

**Fig. 17.** Lines shown in these read and write cycle timing diagrams of the 68000 indicate indirect actions.

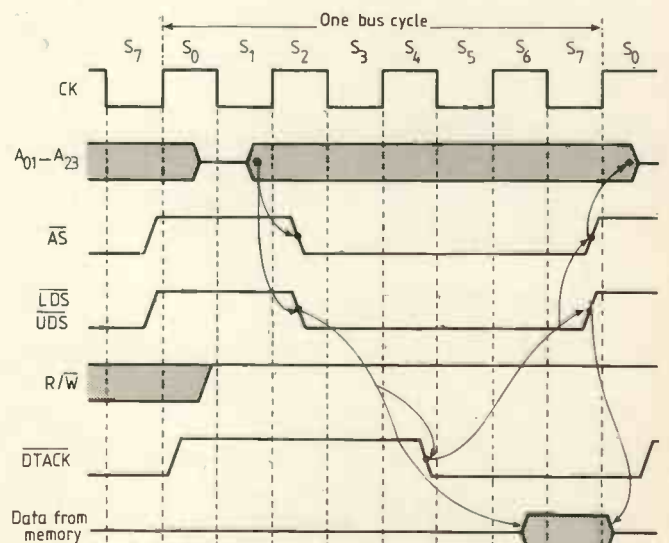
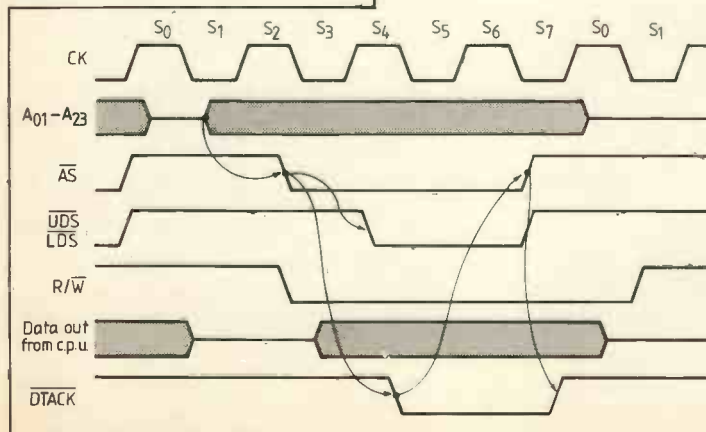

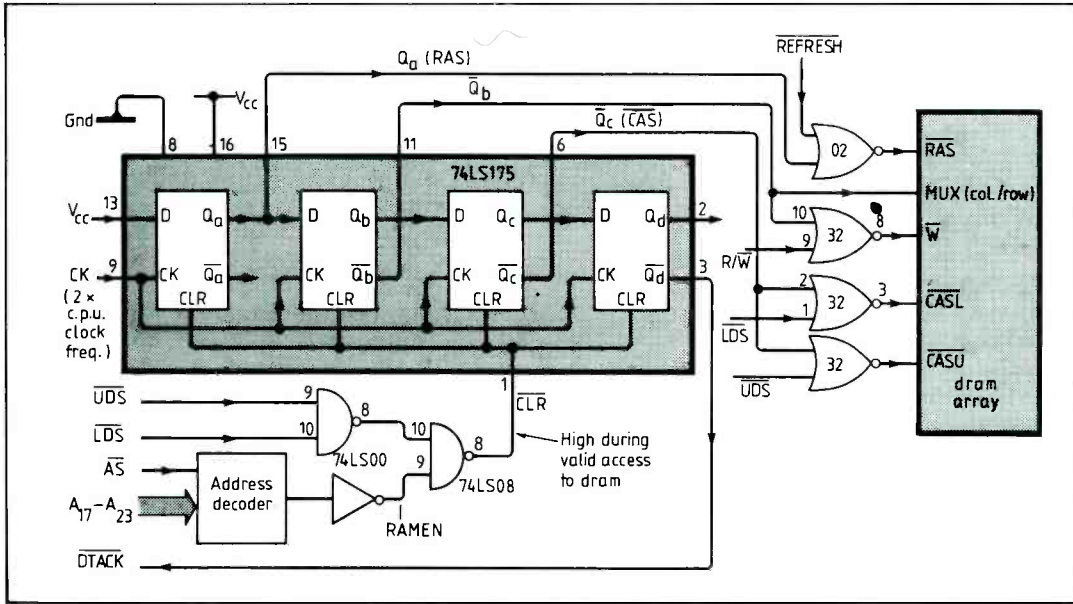

**Fig. 18.** In dynamic memory control on the 68000 board, valid access to d-ran array forces four-bit shift register out of reset (clear) state. Each clock pulse causes 1 to be shifted down the register to general RAS, MUX, CAS and DTACK signals in sequence.

**Fig. 19.** Read cycle timing diagram for Fig. 17.

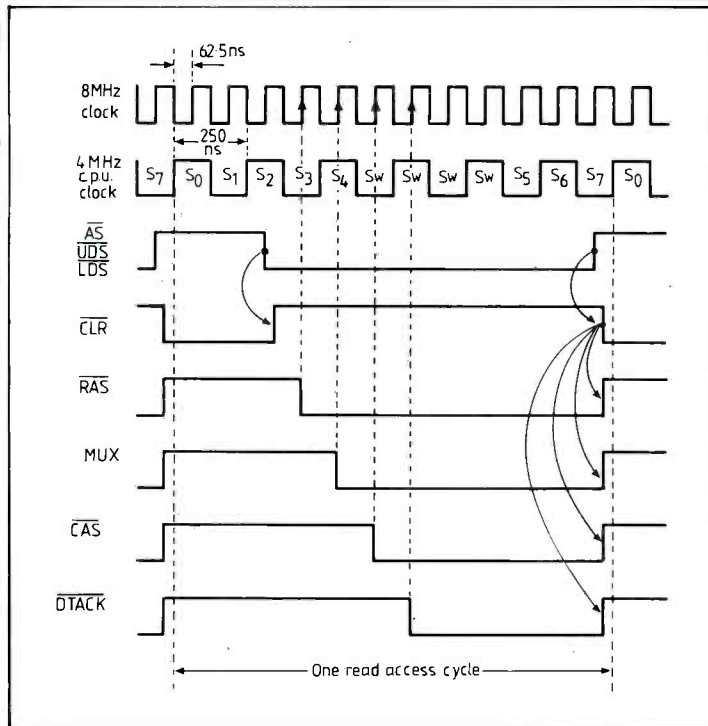

#### Typical time values (ns)

$t_{ASR}$	row address setup command	0
$t_{CWL}$	write-to-col strobe lead time	45
$t_{DH}$	data hold time	45
$t_{DH}$	data hold time ref. to RAS	95
$t_{DS}$	data setup time	0
$t_{FC}$	refresh cycle time	270
$t_{FI}$	REFRESH inactive time	60
$t_{FP}$	REFRESH pulse period	60-2 $\mu$
$t_{FRD}$	REFRESH-TO-RAS delay	320
$t_{FRI}$	RAS inactive time during refresh	370
$t_{FRL}$	RAS-TO-REFRESH lead time	370
$t_{FSR}$	REFRESH-TO-RAS setup time	-30
$t_{RAS}$	row address strobe pulse width	150-10 $\mu$
$t_{RAH}$	row address hold time	20
$t_{RC}$	random access read cycle time	270
$t_{RFD}$	RAS-TO-REFRESH delay	-10
$t_{RWL}$	write command-to-row strobe lead time	45
$t_{RP}$	row address strobe precharge time	100
$t_{WCH}$	write command hold time	45
$t_{WCR}$	write command time ref. to RAS	-20
$t_{WCS}$	write command setup time	-20

ledge) input. If  $\overline{DTACK}$  is not asserted in state  $S_4$  the 68000 inserts wait states and idles until  $\overline{DTACK}$  goes low. This feature permits the 68000 to be operated with a mixture of fast and slow peripherals.

A difficulty associated with 16-bit systems is the need to carry out byte operations on only half a word. While it would be possible to design two completely independent memory systems, one for the lower and one for the upper byte, such an approach would be hopelessly inefficient. To access data in a dynamic memory, both  $\overline{RAS}$  and  $\overline{CAS}$  are involved in a cycle. Therefore, by negating either  $\overline{RAS}$  or  $\overline{CAS}$  to

one half of a word, that byte is disabled and takes no part in the memory access. As refresh operations are applied to all bits of a word,  $\overline{RAS}$  should not be gated with  $\overline{UDS}$  or  $\overline{LDS}$ . In any case, it should not be gated with  $\overline{UDS}/\overline{LDS}$  because the data strobe is asserted late in a 68000 write cycle. In Fig. 16, the  $\overline{CAS}$  inputs to the 16 d-rams are divided into two groups of eight,  $\overline{CASL}$  and  $\overline{CASU}$ :  $\overline{CASL}$  is formed by gating  $\overline{CAS}$  with  $\overline{LDS}$ , and  $\overline{CASU}$  by gating  $\overline{CAS}$  with  $\overline{UDS}$ .

#### Control of 68000 board

An example of a 68000 dynamic memory system is provided by the Motorola 68000

single-board educational computer. This uses  $16K \times 1$  components, but the principles are valid for components of any size. Figure 18 gives the basic circuit of the timing generator for the read and write cycles. The arrangement of the dynamic memories and the row/column/refresh address multiplexers is not included here, as it is entirely straightforward. The read cycle timing diagram for this circuit is in Fig. 19.

The component at the heart of the controller is a 74LS175 four-bit shift register, clocked at twice the rate of the processor clock. As long as the dynamic memory block is not being accessed (that is both  $\overline{LDS}$  and  $\overline{UDS}$  high, or  $\overline{RAMEN}$  low), the output (CLR) of the two-input and-gate is low and the shift register is cleared with  $Q_a = Q_b = Q_c = Q_d = 0$ . Whenever the processor addresses the array,  $\overline{RAMEN}$  goes active-high, enabling one input to the and gate. As soon as  $\overline{LDS}$  or  $\overline{UDS}$  is asserted, the second input to the and-gate rises and its output,  $\overline{CLR}$  becomes high. The shift register is now enabled and a logical one is shifted along on each rising edge of the 8-MHz clock. Note that the educational board has a 4MHz version of the 68000.

On the first clock pulse, the  $Q_a$  output rises to a high level, because the serial input to the shifter is tied to  $V_{cc}$ . The  $Q_a$  output from the shift register is 'NOR'ed' with  $\overline{REFRAS}$  from the refresh circuitry (to generate  $\overline{RAS}$  pulses during refresh cycles), and inverted by a nor-gate to provide the system  $\overline{RAS}$ . On the next rising edge of the 8MHz clock,  $Q_b$  goes high and  $Q_b$  low;  $Q_b$  acts as the row/column multiplex control signal and also gates the  $\overline{R/W}$  signal from the 68000. The next rising edge of the 8MHz clock sets  $Q_c$  and resets  $Q_c$  to generate  $\overline{CAS}$ . This is followed one clock pulse later by  $\overline{DTACK}$ . The falling edge of  $\overline{DTACK}$  is recognized by the 68000 and the memory access continues with state  $S_5$ . During  $S_7$ ,  $\overline{AS}$  is negated (together with  $\overline{UDS}$  and  $\overline{LDS}$ ) and the shift register cleared, forcing  $\overline{RAS}$ ,  $\overline{CAS}$ ,  $\overline{MUX}$ ,  $\overline{W}$ , and  $\overline{DTACK}$  high.

(To be concluded).

## How to mix business with pleasure

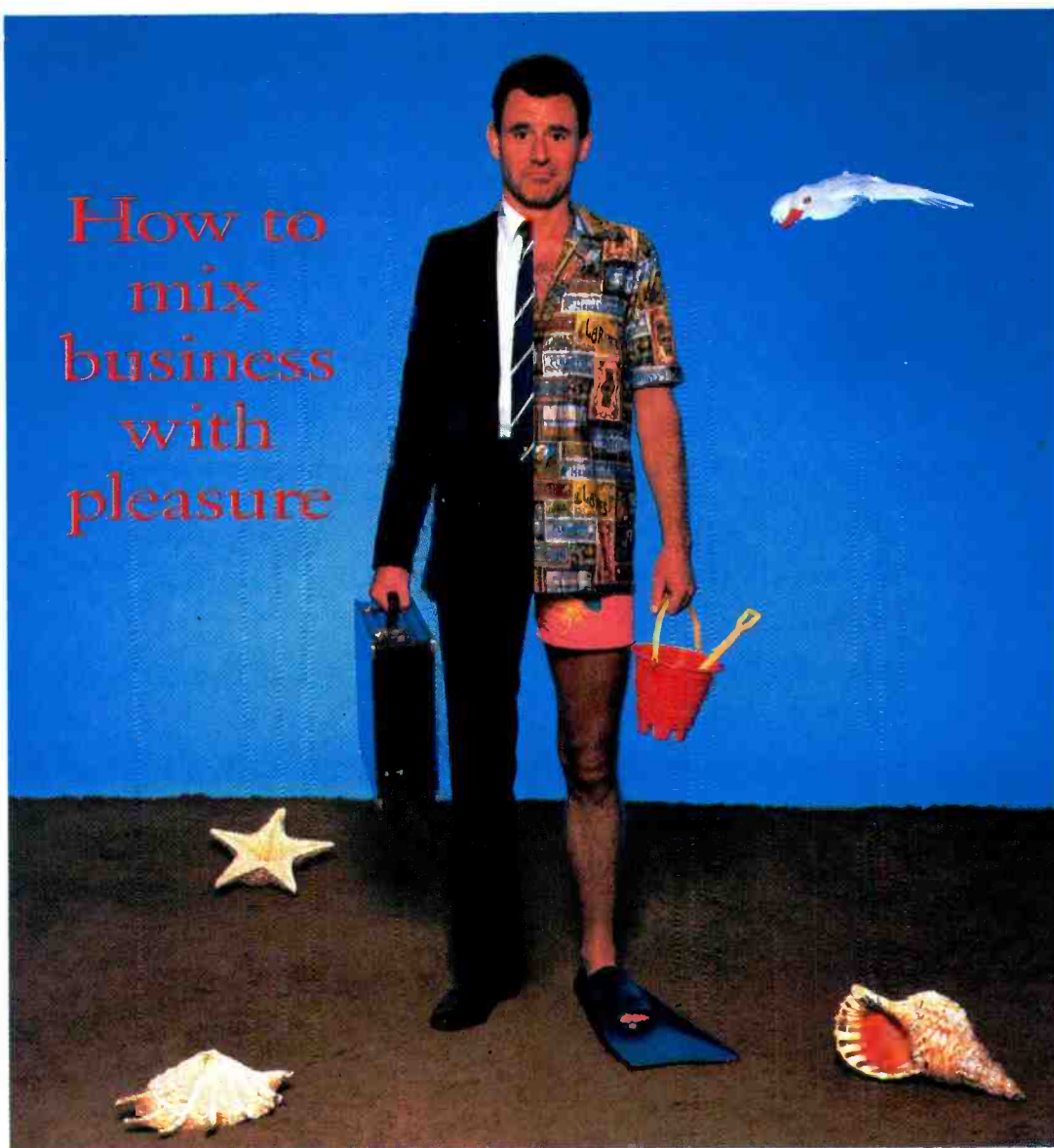

There can't be too many serious electronics events that enable you to save valuable time, do a very productive day's work and have the opportunity to enjoy yourself afterwards.

But that's the case with Internepcan – the electronic packaging show. This October, Internepcan in Brighton will play host to approaching 400 suppliers who'll be showing products for the construction of electronics apparatus. And of those, nearly 100 companies will be new to the event. Not only that, the Show will boast Britain's largest ever collection of connectors.

Come and talk to top names like: Amp, Molex, Imhof, Schroff, Siemens, A B Elect, ITT Cannon, BICC-Vero, Plessey, Varelco, who'll be showing the latest in components, connectors, wire & cable, racks, enclosures, PCBs and a lot more besides.

### More than just an exhibition

If you've been to any of the previous 18 Internepcans, (and most of your industry has) you'll be aware that it enjoys a rather special atmosphere. For a start there's a great deal of cross-fertilisation between exhibitors and visitors. And second, it's evolved into more of a club because it's an event that depends upon the participation of both you and your colleagues.

### High-powered, back-up Conference

As well as the 1000's of products on show there's also an authoritative Conference alongside to give you practical help. Relevant topics and special insights into the latest equipment and materials in the electronic packaging field will be covered in depth. Topics to be covered will include: Surface Mount Devices & Techniques, Connectors & Interconnection Techniques, CAD/CAM, RFI/Static Protection, Printed Circuits, Hybrid Techniques and Automated Assembly.

COMPONENTS, CONNECTORS, WIRE & CABLE,  
RACKS, ENCLOSURES, PCB'S ETC. . . . AND IT'S IN BRIGHTON.

### Brighton's such a nice place to do business in

Visiting Internepcan in Brighton does have its compensations. Because as well as being able to save yourself literally months of product evaluation time you've got a coastal location that's been delighting visitors for years. It's brimming full of good places to eat, breathtaking sights and exciting nightlife. So take this opportunity to spend a productive day (or why not stay over?) and then unwind in pleasant surroundings.

So make sure you don't miss out at Internepcan in Brighton this October. For you and your colleagues to gain FREE entry to the Show just complete the coupon below or better still ring **01 891 6471**.



Metropole Convention Centre  
CIRCLE 9 FOR FURTHER DETAILS

To: Internepcan – the Electronic Packaging Show, Cahners Exhibitions Ltd, 55 London Road, Twickenham TW1 3SZ.

Yes I'm planning a trip to the Show. Please send me \_\_\_\_\_ FREE tickets plus a Conference Programme.

I am interested in exhibiting.

NAME \_\_\_\_\_

POSITION \_\_\_\_\_

ORGANISATION \_\_\_\_\_

ADDRESS \_\_\_\_\_

POSTCODE \_\_\_\_\_

TELEPHONE \_\_\_\_\_

TELEX \_\_\_\_\_

No-one under 18 admitted EWW

# CIRCUIT IDEAS

## Loop-resistance corrector for telephone exchanges

This correction circuit was devised to rectify a fault which caused a lack of dialling tone in 2000Ω telephone lines connected to 700Ω telephone exchanges.

In a telephone exchange, maximum loop resistance is the highest value of resistance that a line can have without upsetting normal operation of the telephone set. When this resistance value is exceeded line current is insufficient to

drive the line relays at the exchange even though the handset can operate at as low as 5mA. In a 2000Ω exchange, minimum line current for relay switching is 15mA.

Connected at the exchange end, this circuit rectifies this fault provided that line current is above 8mA. Relay current is doubled while handset current is reduced by 20%.

Base and emitter currents of the two transistor pairs act as telephone line current and relay current respectively. Two transistor pairs must be used so that the circuit operates in either polarity.

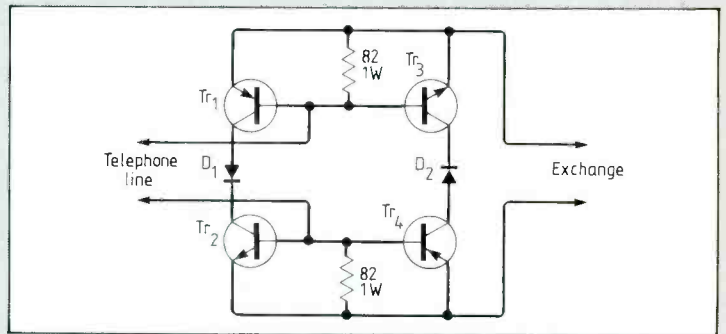

Resistors reduce the ratio of these currents to 1:3 while providing a bidirectional communication path. The two diodes stop the transistors from acting as zener diodes

while polarity is reversed. Ratings of all the transistors are 100V and 500mA. D.P. Ediriweera  
Tea Research Institute  
Talawakele Sri Lanka.

## Electromagnetic transducer using a flux guide

Magnetic pick-up coil transducers can be used in non-contact sensing applications but they have never been as popular as optoelectronic, inductive or capacitive proximity sensors because they tend to be large and clumsy.

Now though, miniature 3-by-2-by-1mm sintered samarium-cobalt magnets magnetized through their thickness are readily available from Mullard so a compact and inexpensive transducer can be made for inaccessible places.

A ferrite rod is used as a flux guide to couple flux from the magnet to the pick-up coil. The magnet is glued to the rotating target. Since mass of the magnet is only 50mg, the target's moment of inertia is not appreciably affected.

With a remnant dipole moment of the magnet as high as  $4.24 \times 10^{-3} \text{ A/m}^2$ , the magnetic flux can be coupled to the pick-up coil with the ferrite

rod 5mm away from the magnet.

The pick-up coil is a 21mm diameter Mullard FX2239 pot core wound with 250 turns of 0.224mm wire. The ferrite rod, fitting into the core, is about 50mm long and can be made up of segments to form a curved flux path for cases where the target is not accessible directly.

Magnitude of the induced e.m.f. is proportional to the rate of change of flux and even at 23Hz, as in the photograph, s/n ratio is high enough to allow processing with one op-amp and comparator i.c. like the LM392.

In the photograph, the top trace is output of IC<sub>1a</sub> with Y deflection at 0.5V/div. Section IC<sub>1b</sub> is used in Schmitt-trigger mode to produce output as shown in the lower trace with Y deflection at 5V/cm. For both traces, a 10ms/div horizontal deflection was used.

Power supply requirements are 4.5 and -4.5V at 2.5mA. A.de Sa  
School of Physics  
University of Newcastle-upon-Tyne

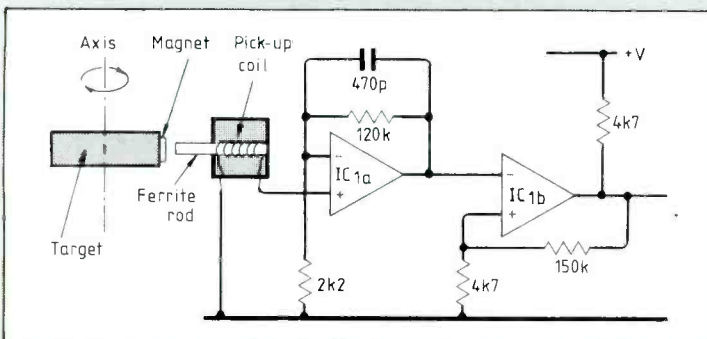

## Variable-length shift register

Length of this shift register can be varied from one to 64 bits. It overcomes the speed limitation and signal-level difficulties of the c-mos 4557.

Data at select inputs of the two 74151's determines the shift-register length. Setting inputs A to F to zero gives a one-bit delay between input

and output and setting all the inputs to one gives a 64-bit delay.

If need be, clock inputs of the 7491s can be gated with data selected lines D, E and F to avoid clocking unused registers on shorter shift sequences. This circuit could be extended using 16bit multiplexers and extra registers.

J. Jeffery  
University of London

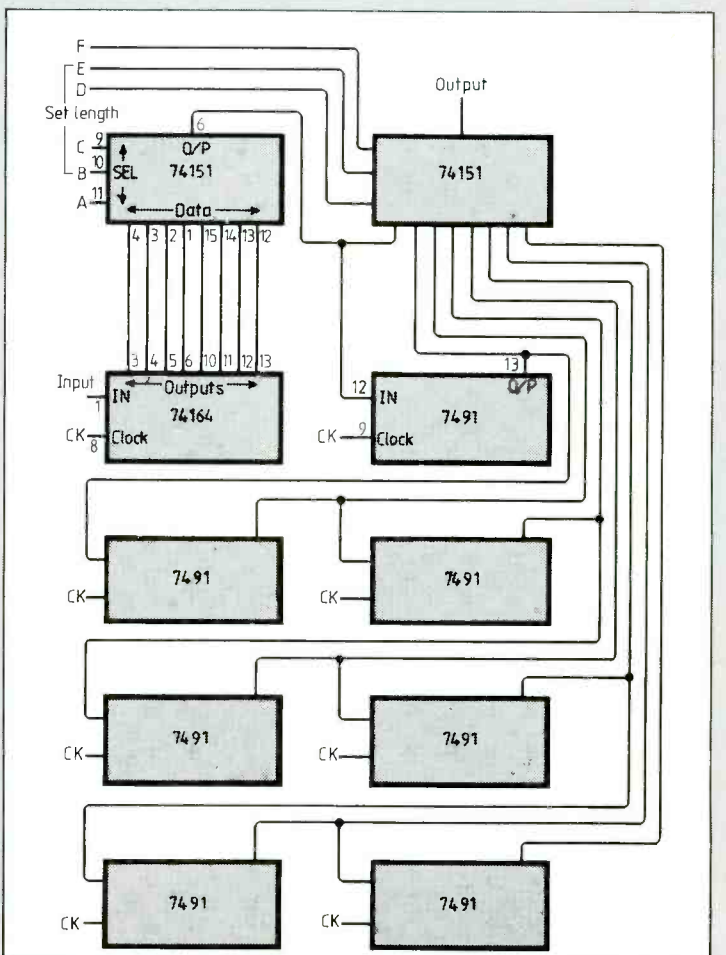

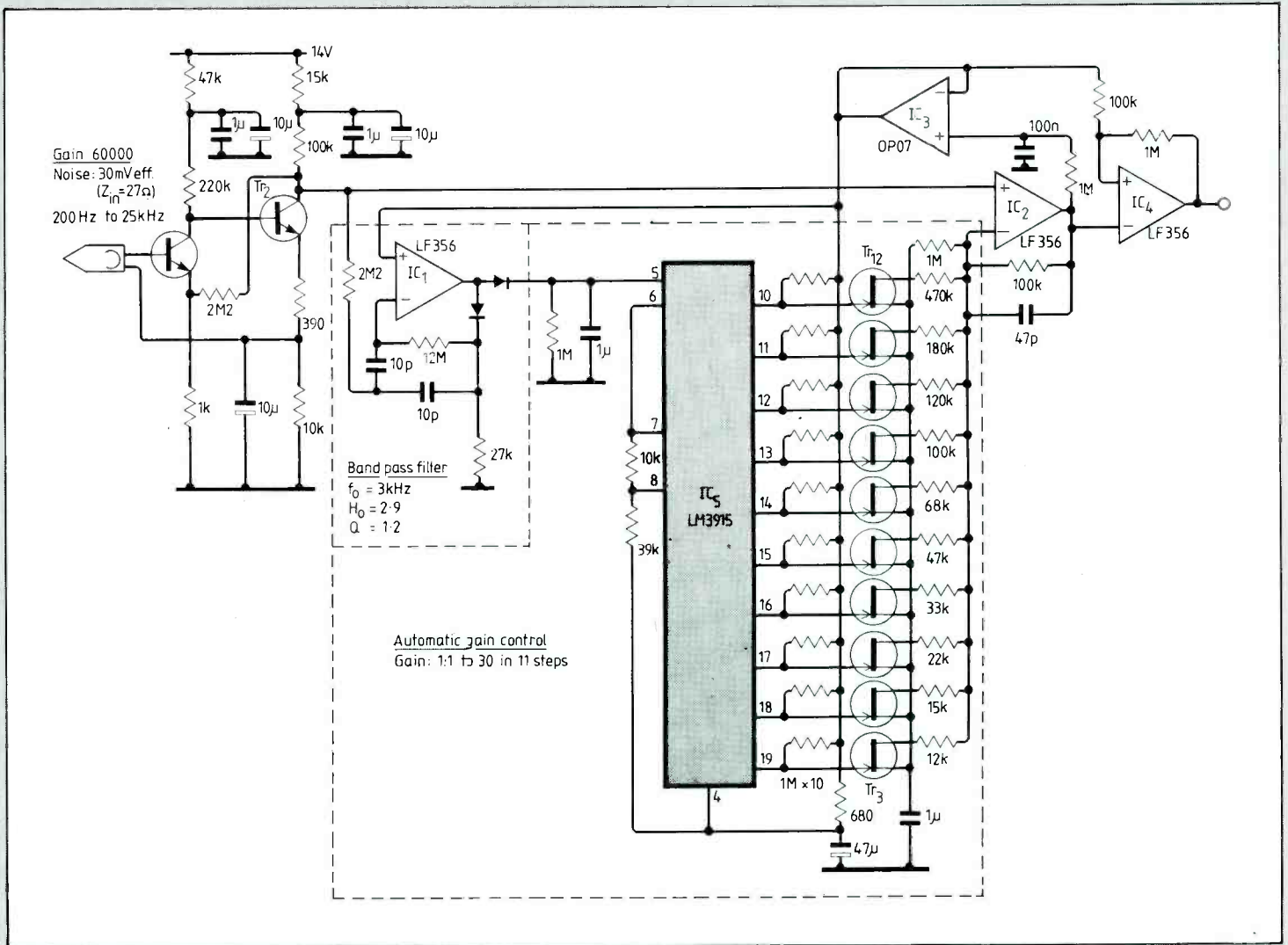

## Low-noise preamplifier for data

When a magnetic medium such as 1/4 in tape is used for data storage there are numerous potential error sources including inconsistent tape width, tape stress, wow, flutter and dust between head and tape. As a result, a widely fluctuating playback signal can be expected.

This circuit improves reliability by keeping digital output level constant over a wide range of input signals.

Output from the head is normally a few millivolts but flutter and dust can reduce the level significantly. With this circuit, a playback signal of 20µV still gives excellent results. To amplify a signal of 20µV, a very-low-noise amplifier is needed. Integration of the signal is impractical since the very high low-frequency gain required for the integration results in too much low-

frequency noise. Here a flat-response amplifier is used.

Noise in modern very-low-noise integrated amplifiers is higher than the noise of two low-cost BC107-type transistors which have been selected for noise and frequency performance in the actual circuit.

By choosing the transistors in this way, an effective output-noise value of 30mV was obtained over the whole bandwidth and an input impedance of 27Ω. Referred to the input, this noise figure with a gain of 60 000 is 0.5µV effective which is five times higher than the noise of figure of a 27Ω resistor.

Direct-current drift of the two transistors is compensated for. Here a d.c. reference level is created by integrating output from the two transistors. The integration constant of 10ms, determined by an RC

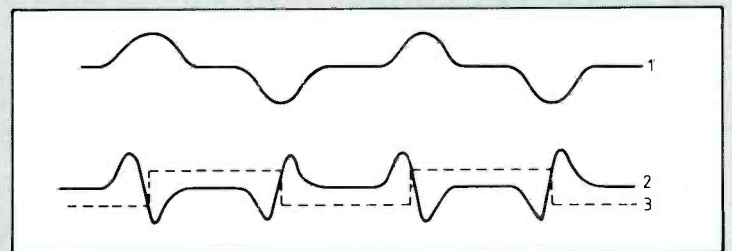

network, is long enough for the frequency of 3kHz used.

Gain correction is achieved with an LM3915 bar-display driver switching fet transistors which, with an op-amp, acts as a digitally-controlled-gain amplifier. In each step a parallel resistor is switched in or out to alter gain.

No feedback for the gain adjustment is used, therefore no pulses are lost due to overshoot, etc. Roll-off time for the gain adjustment is determined by an RC time constant; when the signal becomes smaller,

the gain is doubled every 70ms.

Circuit IC<sub>1</sub> is a bandpass filter added so that unwanted noise spikes do not alter the amplifier gain. Gain correction response is mainly determined by the time lag of this filter.

The circuit could be improved by inserting a delay line between Tr<sub>2</sub> and IC<sub>2</sub> to overcome the bandpass-filter time lag.

F. Ypenburg  
National Physical Research  
Laboratory  
Pretoria

## Capacitor-powered fibre-optic transmitter

This circuit takes electrocardiogram signals from a pair of electrodes and transmits down a fibre-optic link. It can be powered by a memory back-up type capacitor, 0.33F charged to 5V providing about five hours operation or it could equally well use a pair of watch type cells.

The circuit was designed for use in a nuclear magnetic resonance scanner, this being very sensitive to electrical noise as would be conducted down wires. Output is sufficient for transmission up to at least 10m using Honeywell "Sweet Spot" devices and 1mm polymer cable.

Input from the electrodes is bandpass filtered before being fed via a buffer to a long-tailed pair. The 33nF/3.3M $\Omega$  which filters a.c. from the drive to one

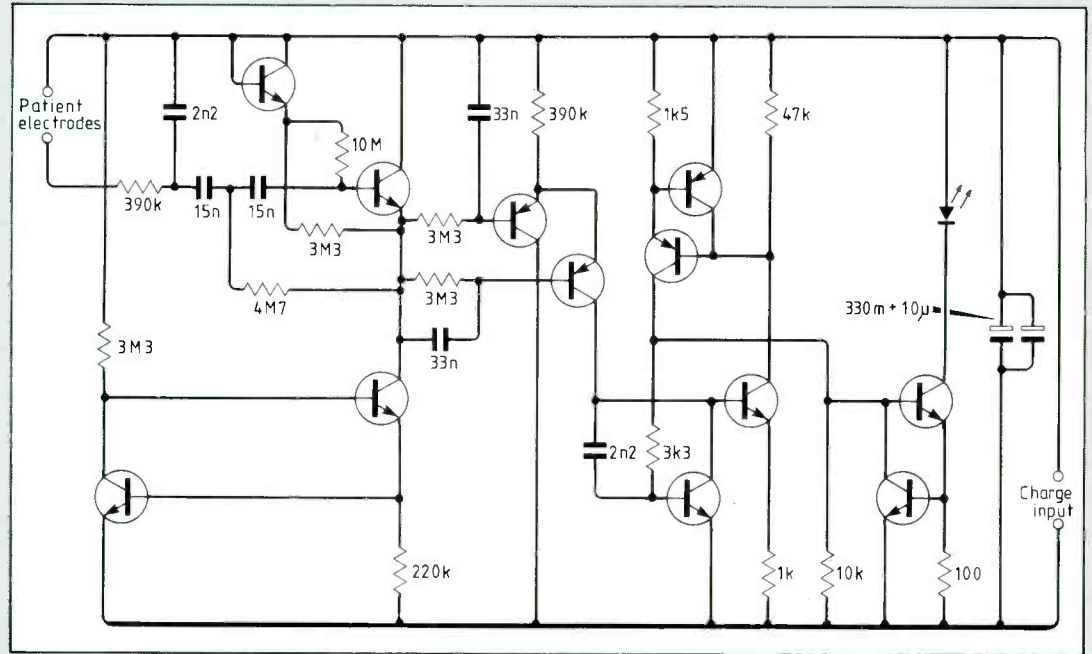

side of the pair also forms the third stage of the high-pass Bessel filter. This long-tailed pair limits the linear range to about 20mV, but this is adequate for the purpose intended.

Current from one collector, which is a linear function of

input voltage, is used to charge a capacitor in a current-to-frequency converter which in turn delivers approximately 3 $\mu$ s pulses to the led driver.

Extensive use of constant-current sources makes this circuit insensitive to supply vol-

tage changes, the lower limit of 2V being dictated by the led.

Receiver design is not critical. The requirement is for a frequency-to-voltage converter, linear up to about 1500Hz. G.G.R. Rutter  
London W2

## 8255 port-direction changing

In eprom programmers, the 8255 programmable peripheral interface is often used. But a problem arises when you try to use one of its ports in mode 0 or 1 as a data port for the programming socket and some pins of the other ports as control pins for activating relays or selecting programming voltages for example.

The problem is that during the program/verify sequence you must first output then input data from the same port. When this port is programmed in mode 0 or 1, is necessary to send another control word to the 8255 to change direction of the port. On sending this control word, all outputs are set to zero so an undesired situation may occur such as changing the  $V_{pp}$  level or relay states during programming.

This problem is easily overcome by programming port A for example in mode 2 and activating both  $PC_4(\overline{STB}_A)$

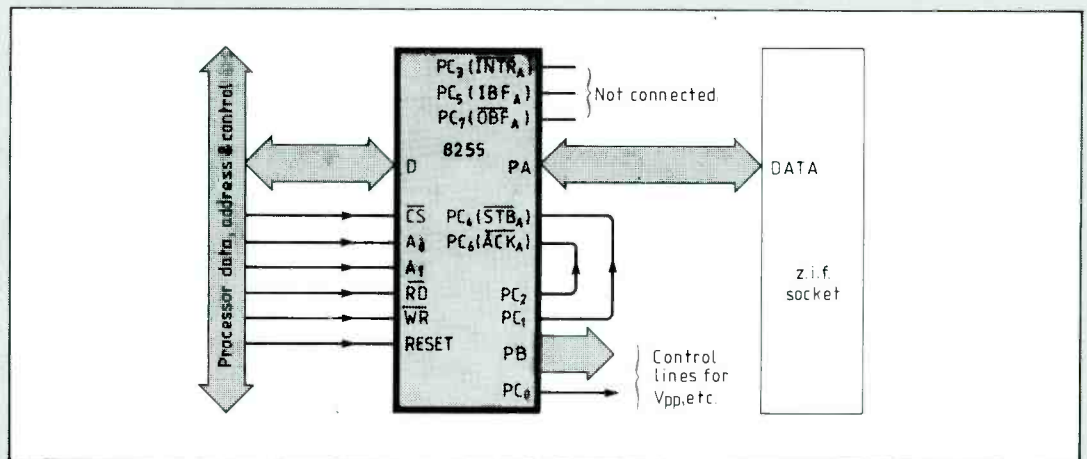

and  $\overline{PC}_6(ACK_A)$  signals by a single bit set/reset operation on the two remaining pins of port C ( $PC_{1,2}$ ).

Reading from port A is carried out by sending a zero then a one to  $PC_1$ . To output data to port A then set  $PC_2$  to zero. Data is held on port A as long as  $PC_2$  is kept low.

While  $PC_{1,2}$  are high, port A is in its high-impedance state. During i/o to and from port A, pins,  $PB_{0,7}$  and  $PC_0$  remain unchanged.

Tadeusz Jarosiński  
Warsaw

### DON'T WASTE GOOD IDEAS

We prefer circuit idea contributions with neat drawings and widely-spaced typescripts, but we would rather have scribbles on "the back of an envelope" than let good ideas be wasted.

Submissions are judged on originality and/or

usefulness so these points should be brought to the fore, preferably in the first sentence.

Minimum payment of £35 is made for published circuits, normally early in the month following publication.

# IT'S NEW IT'S EEV IT'S *photon* CCD

Years of research and development have enabled EEV to produce in the most modern, CCD plant in Europe, a completely new range of CCTV Cameras... "The Photon". They are tough, and very reliable featuring custom designed ceramic covered hybrid circuits which provide sensor drives and video processing in a miniature housing. Our new dedicated fabrication facility provides the low noise CCD sensor for these cameras which initially will offer a choice of variable integration time, switchable between 1 ms and TV, together with standard features such as gen-lock, auto iris drive, a.g.c. and video clamp. The cameras power requirement is less than 4 watts, at either 12V d.c. or via a line power supply. More new models will be released later this year as the Photon CCD family grows, but in the meantime, contact us for details of these exciting new cameras.



## EEV Solid State Devices

### UK:

EEV, Waterhouse Lane, Chelmsford, Essex CM1 2QU, England  
Telephone: (0245) 261777 Telex: 99103 Fax: (0245) 50424

### USA:

EEV Inc, 4 Westchester Plaza, Elmsford, NY 10523, USA  
Telephone: (914) 592 6350 Telex: 6818096 Fax: (914) 592 8342

### CANADA:

EEV Canada Ltd, 67 Westmore Drive, Rexdale, Ontario M9V 3Y6  
Telephone: (416) 745 9454 Telex: 06 989363 Fax: (416) 745 0618

### FRANCE:

EEV Département Tubes Electroniques de GEC Composants  
2 Rue Henri Bergson, 92000 Asnières, (France)  
Telephone: (331) 4790 5255 Telex: 610471 Fax: Paris (331) 4733 1131







# Gould OS300 versus Douglas DC3

OS300	DC3
Proven worldwide	Proven worldwide
Inexpensive	Inexpensive
Rugged construction	Rugged construction
Go anywhere	Go anywhere
Piece of cake to fly	Piece of cake to fly
NATO approved	NATO approved
Two-year guarantee	
U.K. design and manufacture	
Modern spec	
Available off-the-shelf	

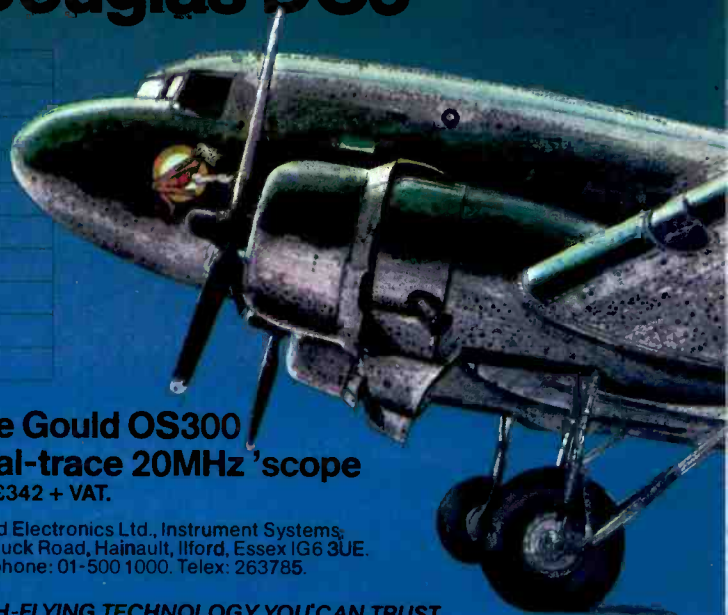

## The Gould OS300 dual-trace 20MHz 'scope

For £342 + VAT.

Gould Electronics Ltd., Instrument Systems,  
Roebuck Road, Hainault, Ilford, Essex IG6 3UE.  
Telephone: 01-500 1000. Telex: 263785.

### HIGH-FLYING TECHNOLOGY YOU CAN TRUST.

"Much as we admire the Dakota's traditional hard-working virtues, sadly its last spec. update was in 1945. The Gould OS300, on the other hand, offers 1980's features - dual-trace with true 20MHz operation, continuously variable amplifier sensitivity to eliminate loss of bandwidth over the 2mV to 5V/cm, X-Y operation, P43 phosphor and quick heat cathode for rapid set-up and brighter displays.



11257

CIRCLE 23 FOR FURTHER DETAILS



Ian R Sinclair

## Working with Microprocessors

Based on a broad range of equipment this book describes the hardware of modern microprocessor devices for those who know something of digital systems, but are unfamiliar with microprocessors and microprocessor circuits. Topics covered include how microprocessor systems are connected up, what signals exist, the timing relationships and the actions, and the servicing of microprocessor equipment.

156 pages £9.95

E A Parr

## Logic Designer's Handbook

An invaluable source of both theory and practical information including data on CMOS and TTL devices. Essential reading for all logic systems designers.

472 pages £20.00

**Order Form**

Please send me \_\_\_\_\_ copies of  
I enclose my remittance for £ \_\_\_\_\_  
(Postage and packing include £1.50 for first purchase,  
plus 50p for each additional item)

Name \_\_\_\_\_  
Address \_\_\_\_\_

## Collins Professional and Technical Books

8 Grafton Street, London W1X 3LA Tel: 01-493-7070 Ext. 4513

CIRCLE 36 FOR FURTHER DETAILS

## METER PROBLEMS?

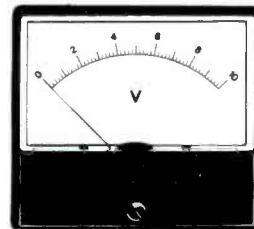

137 Standard Ranges in a variety of sizes and stylings available for 10-14 days delivery. Other Ranges and special scales can be made to order.

Full information from:

**HARRIS ELECTRONICS (London)**

138 GRAY'S INN ROAD, W.C.1

Phone: 01-837 7937

Telex: 892301

CIRCLE 5 FOR FURTHER DETAILS

## SATELLITE TELEVISION

Buy direct from the manufacturers, low cost full band satellite TV systems.

Full band system £650.00 + VAT & carriage.

Write of telephone for details, or call in at our factory showroom.

## NETWORK SATELLITE SYSTEMS LTD

Units 7-8

Newburn Bridge Industrial Estate  
Hartlepool, Cleveland TS25 1UB

Tel: (0429) 274239 or 869366

CIRCLE 13 FOR FURTHER DETAILS

# Line scan camera

by L. Hayward  
Technical director  
Eastpoint Ltd

Considering the basic simplicity of linescan cameras – photosensitive array, lens and straightforward electronics – it is surprising they are not more widely used.

**T**his article is based on results obtained using an EG&G Reticon LCO310 line scan camera together with some experimental electronics. The equipment was arranged to test the feasibility of a system for inspecting circular pressed metal lids passing along a conveyor. The report describes a practical system and suggests further work for improved operation.

The line scan camera operates like a normal optical television camera, with three important exceptions.

- Much higher stability, with no danger of burn due to continuous viewing of a stationary object.
- No field scan, so that instead of viewing an object using the raster principle, a single line only is viewed; consequently a movement of the item under inspection is required to view its complete area.
- The camera produces a 'clock' pulse for each picture element. This enables exact location of defects by counting clock pulses from start of scan.

The camera contains an array of photosensitive diodes (in our case 1024 but usually in multiples of 128 e.g. 256, 512 etc) mounted so that the image is focused onto it. Circuitry within the camera integrates the charge produced by the incident light, then clocks these representative charges out from the array by means of a shift register, thus providing a familiar video waveform. A sample and hold circuit provides a smooth transition from one element to the next. Electronics within the camera provide the clock timing pulses, and synchronized pulses for the analysing circuitry. The video waveform may be directly viewed on a oscilloscope to

enable positioning, lighting, and focus.

As integration time varies with clock frequency, camera sensitivity to light varies. The amount of light required is greater the faster the camera is run. Maximum clock rate is 500,000 pulses per second, giving a minimum line scan time of 2.064ms, and 484 lines per second. From this it is possible to determine the maximum inspection rate, given required definition and object size.

Typical uses of such cameras are for determining overall dimensions of goods, for example paper width or box height. But the excellent stability and definition of the line scan camera should enable its use in much more detailed work.

## Control electronics

The high definition electrical representation of the surface under inspection requires suitable electronics to analyse the results and take decisions. The product being inspected is a range of lids having various sizes and coatings. The difference in size is fairly well accommodated by altering the field of view of the camera. It is clearly desirable that the maximum dimension of the product should always fill the viewing width of the camera to maximize definition. Experiments showed two main problems.

The extreme edge of the lid has a number of serrations, is folded at differing radii, and may be painted any colour. This makes total inspection of this area very difficult due to the randomness of the reflected light, and positional difficulty. This problem is still under investigation.

Lids may be coated with a light-coloured plastics material, which is easy to inspect, or not, in which case striations in the grain of the metal cause direct reflection of light from

an unpredictable and wide range of angles. This should be overcome by using a very narrow angle of incident light with respect to the lid. At least two light sources will then be required to overcome shadow.

We constructed a form of optical bench that enabled lids of varying diameter to be placed at the camera's focal point. Using a local illumination of 50 watts at various angles and distances, the video waveform was observed. The definition was so good that the smallest visible blemish could be detected, and it is possible that 512 instead of 1024 pixels might be sufficient for the item in question, with a consequent saving of cost.

It was also clear from these tests that a fault might generate light levels either above or below that of the normal surface, particularly in the case of scratches, so that circuitry to detect this would be required. Circuitry to define a window of valid inspection would also be necessary to eliminate false rejection if the camera were scanning past the lid edge.

**Black spot or scratch in this example of a lid returns strong reject signal.**

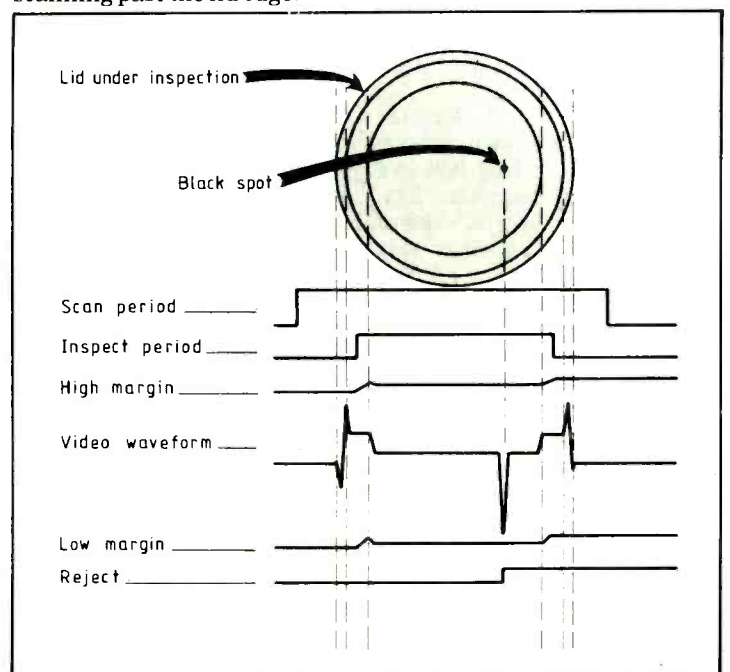

# CASE STUDY

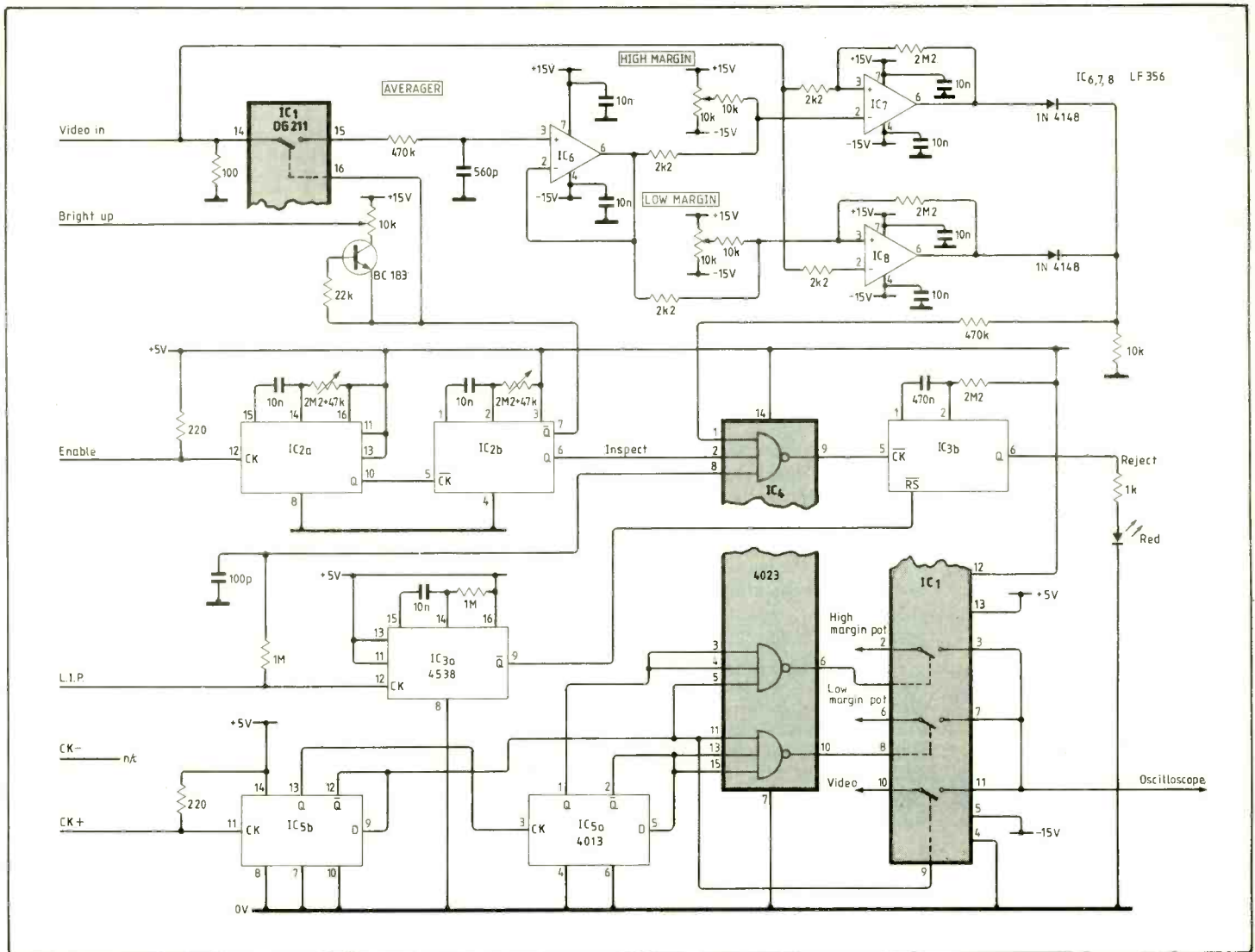

From these observations a basic detector unit was designed which works as follows. It is assumed that the lid can be fed intermittently, and rotated at least once in the camera field of view, and that a signal to indicate 'lid in position' can be derived.

The circuit of the detector electronics is shown above. Certain timing operations are generated by monostables. This was done for the sake of simplicity. A production unit would preferably have all timing derived from the camera clock for greater stability and ease of use. The camera is equipped to transmit differential data and clock signals, though this experimental circuit does not use differential receivers for the short range operation envisaged.

## Operation

The video waveform from the camera is fed to two voltage comparators, IC<sub>7</sub> giving a posi-

## Simple circuit detects flaws in material moving along a conveyor, provided that the inspected area is constant.

tive output when the video is higher than threshold, and IC<sub>8</sub>, when video is lower. The threshold voltage is an average of the video level, the waveform being integrated by the network at the input to IC<sub>6</sub>. A voltage may also be injected from a high and low margin potentiometer to allow an additional offset in each case. Since the reference is in part derived from the average light level, reasonable variations in the light source are tolerable. The video waveform is only connected to the averaging circuit during the 'inspect' period, so that reflections from the edge and background do not distort the average.

At the start of each scan, the camera produces a positive going 'enable' pulse. This is used to trigger, in sequence, IC<sub>2a</sub> and IC<sub>2b</sub>, the first of which determines the non-inspect

period from start to scan and the second determines the inspect period from then on. Two further monostables are used: IC<sub>3a</sub> provides a delay to ensure a short scan period to allow the averager to settle after the lid is ready for inspection, while IC<sub>3b</sub> is provided to light an indicator for about one second to indicate that a fault is present. The comparator outputs are OR-ed and gated with the 'lid in position' signal (LIP). The boolean expression for a reject then becomes

$$\text{REJECT} = (\text{COMP}_a + \text{COMP}_b) \cdot \text{LIP} \cdot \text{INSPECT (after delay)}$$

It became obvious during early tests that a visual method of setting time and voltage margins would be required, and the remaining circuitry of Fig. 1 is designed to present all the necessary data on a single channel oscilloscope, having

bright-up capability and sufficient speed (>10MHz bandwidth).

The camera clock drives a signal chopper, which splits the oscilloscope display up into a voltage displaying the high margin a voltage displaying the low margin and the video waveform. In addition the trace is brightened during the inspect period, so that its start and finish may be observed in relation to the video waveform. Page 49 shows a typical result.

A wideband buffer amplifier to drive the output to the oscilloscope is desirable for highest clock rate. Minimum times of the monostables will also need to be reduced. The trigger pulse for the oscilloscope time base is obtained directly from the camera, although the x-sweep could be generated directly from a digital-to-analogue converter driven by a counter of camera clock pulses.

The result of many tests using this method has shown

that a practical unit can be easily designed to fully inspect the interior face of lids of all practical diameters. The result of inspection using an intermittent and rotary scan would result in a slowing of the production line, but a linear scanning method would enable inspection at full conveyor line rate with minimal mechanical change. Problems arise regarding the initial sensing of the lid, tracking its edge, and then dynamically changing the non-inspect zones.

Sensing the lid edge as it appears in the camera field of view and adjusting the initial non-inspect area present little problem, but automatically defining the end of the inspect period is more complicated. The problem is not insuperable, and a block diagram of the proposed electronics is shown above. The theory assumes that the camera is adjusted in each case so that the field of view is that of the lid diameters, so that the lid diameter is 1024 elements. We can then state that the enable  $T_{on}$  measured in clock pulses from line start will be equal to the clock count at the detection of the lid edge plus the preset margin, and the enable  $T_{off}$  will be equal to  $1024 -$  the clock count at  $T_{on}$ . (The preset margin is assumed to be equal at start and finish of scan, and is thus included and defined at  $T_{on}$ .)

This hardware approach is preferred to a microprocessor

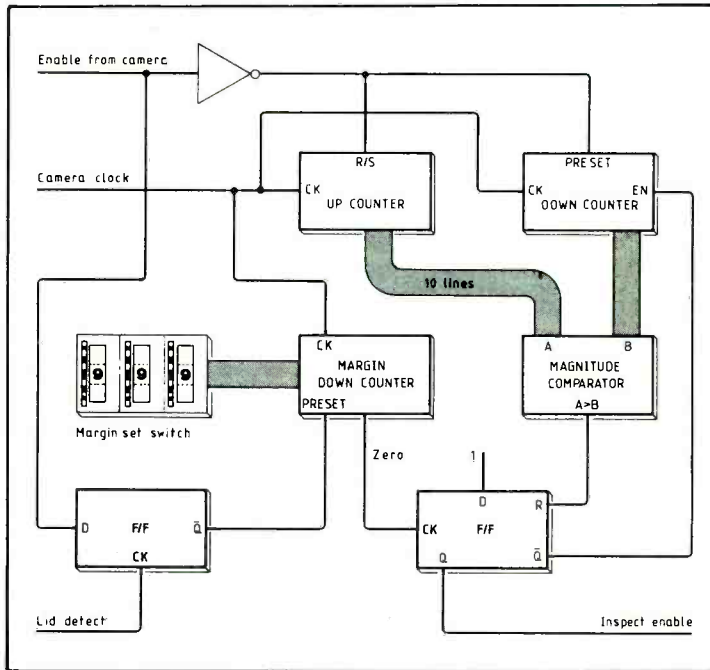

application, since the system speed will always be limited only by the camera and not the computer processing time. In fact the hardware required should be about the same or less, and servicing easier.

Clearly other techniques may be necessary to inspect other products. In cases where product speed is slow, inevitable with larger items, a microprocessor approach may be

**Only a simple circuit is required to produce video signal from the diode array. Power requirement is very low compared to vidicon cameras and overall stability much higher.**

**Inspecting circular objects where the inspect area varies according to diameter and position calls for a more complex digital solution.**

desirable to allow easier parameter change.

A variety of line scan cameras and arrays are advertised in this country and it may seem surprising that such a potentially useful device is not more widely used. One factor is the price. Diode arrays typically cost £500 for a 1024-element device, although some charge-coupled devices made by Fairchild would seem to give similar definition at a lower cost and faster data rate. ■

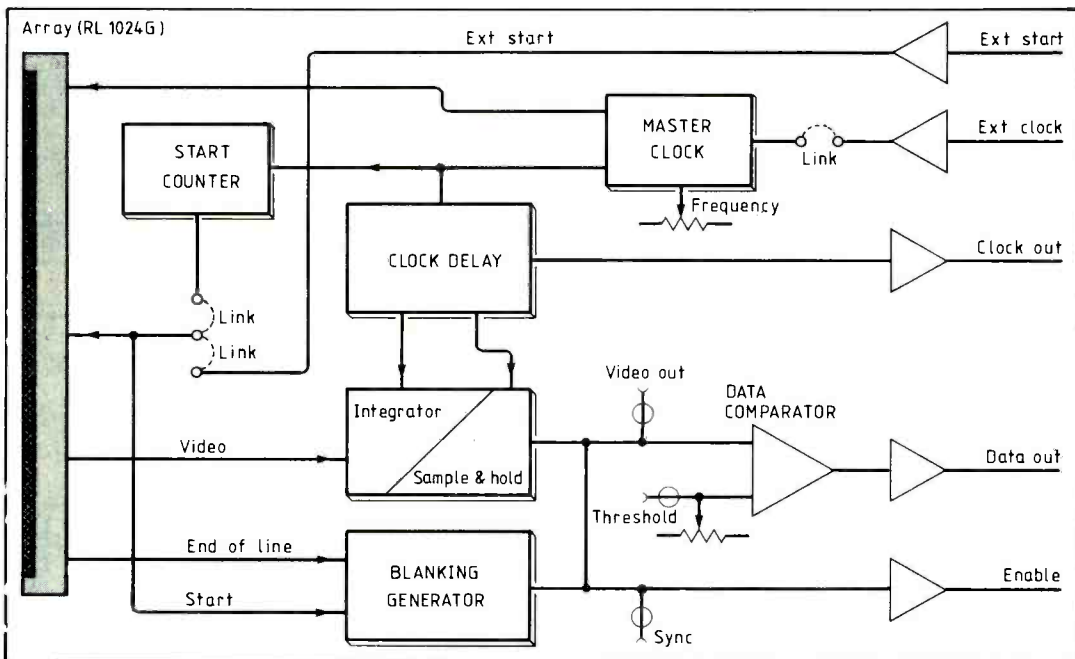

Continued from page 30

## Cable '86

satellite. This is just the situation with d.b.s.

But there was some disagreement on the actual size of the launch failure risk. Chaplin argued that despite recent failures (Shuttle and Ariane), the total launch success rate was 94%. Chaplin added however, that once a satellite was in orbit there was only a low probability of an in-orbit failure. The highest risks are in getting it there in the first place. Space consultant Rodney Buckland challenged Chaplin's launch failure figures saying that the true launch commissioning failure rates for commercial satellites are much higher, nearer 18%.

Bemoaning the fact that different countries in Europe are going their separate ways when it comes to d.b.s. transmission, Chaplin warned that in practice different modes of transmission may end up being used at different orbital locations. The UK and Irish direct broadcast satellites which will be at 31°W may be transmitting on isolation in C-MAC while other European satellites at 19°W and elsewhere will be using D2-MAC.

In a later technical session, Bernard Green, the IBA's satellite broadcasting head, entered the C-MAC v. D2-MAC argument saying that "C-MAC was the best of the MAC family for viewers in the UK, where cable is just not a major consideration."

DTI consultant Bernard Rogers said that B. C. D2-MAC were all good and that MAC provides the path for enhancement to future tv systems. MAC as a transmission system is more 'rugged' than PAL or SECAM, because there are no subcarriers.

Brighton was the cheerful seaside venue for this year's satellite and cable tv exhibition and conference, Cable '86, attracting 5,300 visitors and 72 exhibiting companies. The increases over the last year's figures (4,000 visitors and 50 exhibitors) reflects a growth of interest in an industry which impinges on many others: telecommunications, information technology and broadcasting.

The Cable '86 organisers, On-line, are bringing next year's exhibition and conference, CableSat, forward to 2-4 June 1987 to avoid clashing with the start of the European holiday season. With the recently announced launch delays and with rumours circulating that France is considering scrapping its high-powered TDF-1 d.b.s. project altogether in favour of a lower-powered satellite, it's anybody's guess whether there'll be any European d.b.s. in orbit by the time Cable '87 comes round! -NC■



# ERS — PRINTERS — PRINTERS — PRINTERS

## SUPER DEAL? NO — SUPER STEAL THE FABULOUS 25 CPS "TEC STARWRITER"

Made to the very highest spec the TEC STARWRITER FP1500-25 features a very heavy duty die cast chassis and DIABLO type print mechanism giving superb registration and print quality. Micro-processor electronics offer full DIABLO/QUEME command compatibility and full control via CPM WORDSTAR ETC. Many other features include bi-directional printing, switchable 10 or 12 pitch, full width 381mm paper handling with up to 163 characters per line, friction feed rollers for single sheet or continuous paper, internal buffer, standard RS232 serial interface with handshake. Supplied absolutely BRAND NEW with 90 day guarantee and FREE daisy wheel and dust cover. Order NOW or contact sales office for more information. Optional extras RS232 data cable £10.00. Tech manual £7.50. Tractor Feed £140.00. Spare daisy wheel £3.50. Carriage & Ins. (UK Mainland) £10.00.



NOW ONLY £499 + VAT

## DIY PRINTER MECH

Brand New surplus of this professional printer chassis gives an outstanding opportunity for the Student, Hobbyist or Robotics constructor to build a printer - plotter - digitiser etc, entirely to their own specification. The printer mechanism is supplied ready built, aligned and pre tested but WITHOUT electronics. Many features include all metal chassis, phosphor bronze bearings, 132 character optical shaft position encoder, NINE needle head, 2 x two phase 12V stepper motors for carriage and paper control, 9.5" Paper platten etc. etc. Even a manufacturer's print sample to show the unit's capabilities!! Overall dimensions 40 cm x 12 cm x 21 cm.

Sold BRAND NEW at a FRACTION of cost ONLY £49.50 + pp £4.50.

## TELETYPE ASR33 DATA I/O TERMINALS

Industry standard, combined ASCII 110 baud printer, keyboard and 8 hole paper tape punch and reader. Standard RS232 serial interface. Ideal as cheap hard copy unit or tape prep. for CNC and NC machines. TESTED and in good condition. Only £250.00 floor stand £10.00. Carr & Ins. £15.00.

## EX NEWS SERVICE PRINTERS

Compact ultra reliable quality built unit made by the USA EXTEL Corporation. Often seen in major Hotels printing up to the minute News and Financial information, the unit operates on 5 UNIT BAUDOT CODE from a Current loop, RS232 or TTL serial interface. May be connected to your micro as a low cost printer or via a simple interface and filter to any communications receiver to enable printing of worldwide NEWS, TELEX and RTTY services.

Supplied TESTED in second hand condition complete with DATA, 50 and 75 baud xtals and large paper roll.

**TYPE AE11**  
50 Column **ONLY £49.95**  
Spare paper roll for AE11 **£4.50**  
**TYPE AF11R 72 Col.**  
+ Ribbon **£65.00**  
**TYPE AH11R 80 Col.**  
ASCII/BAUDOT **£185.00**  
Carriage and Insurance £7.50

## GE TERMIPRINTER

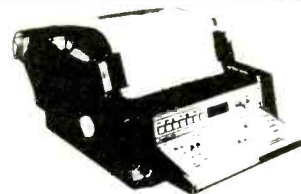

A massive purchase of these desk top printer terminals enables us to offer you these quality 30 or 120 cps printers at a SUPER LOW PRICE against their original cost of over £1000. Unit comprises of full QWERTY electronic keyboard and printer mech with print face similar to correspondence quality typewriter. Variable forms tractor unit enables full width - up to 13.5" 120 column paper, upper - lower case, standard RS232 serial interface, internal vertical and horizontal tab settings, standard ribbon, adjustable baud rates, quiet operation plus many other features. Supplied complete with manual. Guaranteed working. GE30 £130.00. GE1200 120 cps £175.00. Untested GE30 £65.00. Optional floor stand £12.50. Carr & Ins. £10.00.

## SEMICONDUCTOR 'GRAB BAGS'

Mixed Semis amazing value contents include transistors digital, linear, ICs, triacs, diodes, bridge recs, etc. etc. All devices guaranteed brand new full spec with manufacturer's markings, fully guaranteed.

**50+ £2.95 100+ £5.15**  
TTL 74 Series. A gigantic purchase of an "across the board" range of 74 TTL series IC's enables us to offer 100+ mixed "mostly TTL" grab bags at a price which two or three chips in the bag would normally cost to buy. Fully guaranteed all IC's full spec. 100+ £6.90, 200+ £12.30, 300+ £19.50

## MAINS FILTERS

CURE those unerving hang ups and data glitches caused by mains interference with professional quality filters SD5A match-box size up to 1000 watt 240 V Load ONLY £5.95. L12127 compact completely cased unit with 3 pin fitted socket up to 750 watts ONLY £9.99.

## EPROM COPIERS

The amazing SOFTY 2 The "Complete Toolkit" for copying, writing, modifying and listing EPROMS of the 2516, 2716, 2532, 2732 range. Many other functions include integral keyboard, cassette interface, serial and parallel i/o UHF modulator ZIF socket etc.

**ONLY £195.00 + pp £2.50**  
"GANG OF EIGHT" intelligent Z80 controlled 8 gang programmer for ALL single 5v rail EPROMS up to 27128. Will copy 8 27128 in ONLY 3 MINUTES. Internal LCD display and checking routines for IDIOT PROOF operation. Only £395.00 + pp £3.00.

"GANG OF EIGHT PLUS" Same spec. as above but with additional RS232 serial interface for down line loading data from computer etc. ONLY £445.00 + pp £3.00

Data sheets on request

## COOLING FANS

Keep your hot parts COOL and RELIABLE with our range of COOLING FANS ETRI 126LF21 240v 5 blade equipment fan 80 x 80 x 38mm £9.95 ETRI 99XUOI 240v Slimline fan 92 x 92 x 25mm equipment fan NEW £9.95 GULD JB3AR Dim. 3" x 3" x 2.5" compact very quiet running 240v operation, NEW £6.95, MUFFIN CENTAUR BOXER standard 120 x 120 x 38mm fans Order 110V OR 240V 3 or 5 blade, NEW at £10.50 or tested EX EQUIPMENT £5.50 Low Voltage DC Fans, BUHLER 691122 6-16v DC micro miniature reversible. Uses brushless servo motor, almost silent running, guaranteed 10,000 hr life. Measures only 62 x 62 x 22mm. Current cost £35.00 OUR PRICE ONLY £13.95 complete with data. 120 x 120 x 38mm (4 DC fans) PANSONIC FB-12C12H 12v DC 5 blade £18.00 PAPST 4124X 24 - 28v DC 5 blade £18.00

100's of other fans Ex Stock. Call for Details. Post & Packing on all fans £2.00

## 20,000 FEET OF ELECTRONIC AND COMPUTER GOODIES

ENGLAND'S LARGEST SURPLUS STORE - SEEING IS BELIEVING!!

## DEC CORNER

PDP 1140 System comprising of CPU, 124k memory & MMU 15 line RS232 interface. RP02 40 MB hard disk drive. TU10 9 track 800 BPI Mag tape drive, dual track system. VT52 VDU, etc. etc. Tested and running **£3,750.00**  
BA11-MB 3.5" Box, PSU, LTC **£395.00**  
DH11-AD 16" x RS232 DMA interface **£1,900.00**  
DLV11-J4 x EIA interface **£350.00**  
DLV11-E Serial, Modem support **£190.00**  
DUP11 Synch. Serial data i/o **£650.00**  
DQ200 Dialog - multi RK controller **£495.00**  
DZ11-B 8 line RS232 mux board **£650.00**  
KDF11-B M8189 PDP 1123 PLUS **£1,100.00**  
LA30 Printer and Keyboard **£80.00**  
LA36 Dectwriter EIA or 20 mA loop **£270.00**  
MS11-JP Unibus 32kb Ram **£80.00**  
MS11-LB Unibus 128kb Ram **£450.00**  
MS11-LD Unibus 256kb Ram **£850.00**  
PDP11/05 Cpu Ram, i/o etc **£450.00**  
PDP11/40 Cpu, 124k MMU **£1,850.00**  
RT11 ver 3B documentation kit **£70.00**  
RK05-J 2.5 Mb disk drives **£650.00**  
KLB JA PDP 8 async i/o **£175.00**  
M18E PDP 8 Bootstrap option **£75.00**  
VT50 VDU and Keyboard -20 mA **£175.00**  
VT52 VDU and RS232 interface **£250.00**

Give your VT100 a Birthday!!!  
Brand New VT100 Keyboards  
only £85.00

1000's OF EX STOCK spares for PDP8, PDP8A, PDP11, PD P1134 etc. SAE. for list, or CALL sales office for details.  
ALL TYPES OF COMPUTER EQUIPMENT AND SPARES WANTED FOR PROMPT CASH PAYMENT.

## MAG TAPE DRIVES

Many EX STOCK computer tape drives and spares by PERTEC, CIPHER, WANGO, DIGIDATA, KENNEDY etc. Special offer this month on DEI Cartridge tape drives ONLY £450.00 each.

CALL FOR DETAILS

## COMPUTER/SYSTEM CABINET & PSU

All in one quality computer cabinet with integral switched mode PSU, mains filtering, and twin fan cooling. Originally made for the famous DEC PDP8 computer system costing thousands of pounds. Made to run 24 hours per day the psu is fully screened and will deliver a massive +5v DC at 17 amps, +15v DC at 1 amp and -15v DC at 5 amps. The complete unit is fully enclosed with removable top lid, filtering, trip switch, power and run leds mounted on ali front panel, rear cable entries, etc. etc. Units are in good but used condition - supplied for 240v operation complete with full circuit and tech. man. Give your system that professional finish for only £49.95 + carr. 19" wide 16" deep 10.5" high. Useable area 16" w 10.5" h 11.5" d.

Also available less psu, with fans etc. Internal dim. 19" w, 16" d, 10.5" h. **£19.95. Carriage £8.75**

## 66% DISCOUNT ON ELECTRONIC COMPONENTS EQUIPMENT

Due to our massive bulk purchasing programme, which enables us to bring you the best possible bargains, we have thousands of ICs, Transistors, Relays, Caps, PCBs, Sub-assemblies, Switches etc. etc. surplus to OUR requirements. Because we don't have sufficient stocks of any one item to include in our ads we are packing all these items into the "GAIN OF A LIFETIME". Thousands of components at giveaway prices. Guaranteed to be worth at least 3 times what you pay. Unbeatable value and perhaps one of the most consistently useful items you will every buy!!! Sold by weight.

2.5kls £5.25 + pp £1.25  
10kls £11.25 + pp £2.25

5 kls £6.90 + £1.80  
20kls £19.50 + pp £4.75

1000's of other EX STOCK items including POWER SUPPLIES, RACKS, RELAYS, TRANSFORMERS, TEST EQUIPMENT, CABLE, CONNECTORS, HARDWARE, MODEMS, TELEPHONES, VARIACS, VDU'S, PRINTERS, POWER SUPPLIES, OPTICS, KEYBOARDS etc. etc. Give us a call for your spare part

Don't forget, ALL TYPES and QUANTITIES of electronic surplus purchased for CASH

CIRCLE 52 FOR FURTHER DETAILS

by J.L. Gordon

# 8085 development on the BBC Micro

## A simple system to introduce 6502 users to another popular processor family

John Gordon is senior lecturer in electronics and microelectronics at Blackburn College.

**Memory addresses for the 8085 board. Single bits may be read from memory by loading from either the set or clear addresses.**

2716 eeprom (firmware)	\$0000-\$1FFF
2114 ram	\$4000-\$43FF
8154 p.i.a.	\$8000-\$80FF
port A	\$8020
port B	\$8021
d.d.r. A	\$8022
d.d.r. B	\$8023
Set bit 0, port A	\$8010
Set bit 1, port A	\$8011
Clear bit 0, port A	\$8000
Clear bit 1, port A	\$8001
Set bit 0, port B	\$8018
Set bit 1, port B	\$8019
Clear bit 0, port B	\$8008
Clear bit 1, port B	\$8009

**Fig. 2 (opposite). The complete controller. The spare di1 device is included for convenience in making connections to the 8085's reset and interrupt inputs.**

**Fig. 1. Prototype of the 8085 controller board showing leads to the BBC Micro.**

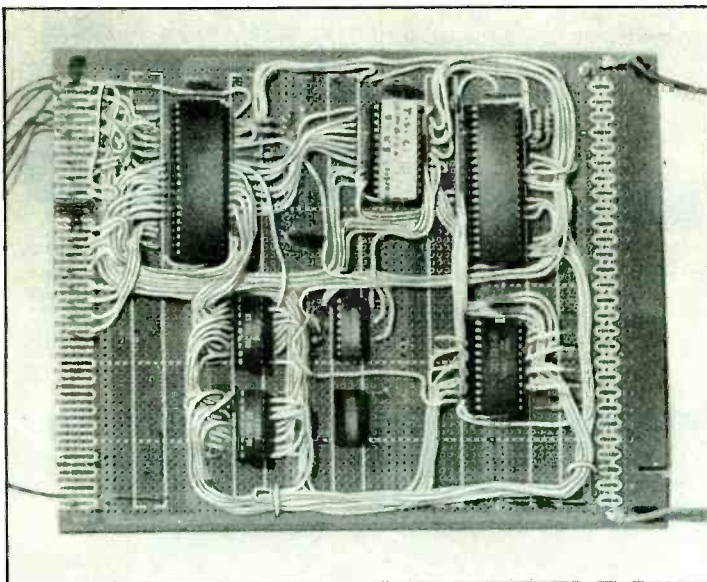

This article describes hardware, firmware and software which together allow the user of a BBC micro-computer to study and develop stand-alone applications for the 8080 series of microprocessors. For those who have had little microprocessor experience outside the confines of the 6502, the project offers an opportunity to experience a contrasting processor architecture. The 8080, 8085 and Z80 all have similar structures and the newer 16-bit 8086 and 8088 are upward-compatible with the 8080.

The system consists of a simple, almost minimal, 8085 controller board with firmware in a 2716 eeprom to handle communications with the BBC Micro. Software includes a simple but effective 8085 assembler written in Basic; a loader, also in Basic; and a communication program, in Basic and machine code, which allows memory transfer between the BBC and the controller. The software is designed for disc-based systems; but since only one data file is

open at a time, it will run from tape if cassettes are changed as required.

The 8085 microprocessor is described fully in many textbooks. The book listed as reference 1 is a general electronics text which contains an more than adequate description of 8085 hardware and software.

### Hardware

Construction of the hardware is quite straightforward, Fig. 1. A suitable basis for it is the dip board supplied by Maplin Electronics or RS Components. A spare 14-pin socket has been included with supply connections suitable for a 7400 or 7404. Such a device may be needed later if the reset output or interrupt inputs of the microprocessor are to be used.

The 8085 microprocessor and its associated address bus latch are situated at the right of the board. The latch is an 8212 eight-bit type which is activated by the address latch enable (ALE) line on the microprocessor. This active-high line is high during the first T-clock cycle to indicate that a valid address has been placed on the address/data multiplexed bus (the address is also valid during the trailing edge of ALE). This signal causes the strobe input to the 8212 to latch the lower address byte. The high address byte remains on the address bus for the complete instruction cycle.

On the circuit diagram, Fig. 2, ALE is connected to the 74138 enable line so that chip select does not occur during ALE. This is to prevent ram data from corrupting the valid address. The 2114 ram devices employ the not-write enable line as a read/write signal. This means that the ram is normally set to read (i.e. not-

write enable is set high) when software in ram is being accessed and it might otherwise corrupt the address/data bus during address latching. Reference 1 gives an alternative arrangement.

At the bottom left of the board, two 2114 static rams provide 1K-byte of memory organised as 1K by four bits. Each device handles one half of the data bus.

The system firmware is quite compact and so there is plenty of room in the 2716 eeprom to extend the board's capabilities further. The not-read strobe from the 8085 is used to enable the output of the 2716 and the chip select comes from the 74138 three-to-eight line decoder. The eeprom must be located at the lowest address, as shown in figure 2, since the reset start location for the 8085 is  $0000_{16}$ .

The i/o device is the 8154 p.i.a. This is useful for applications where the control of single bit i/o is predominant: it has separate address locations to set, clear and read any of the sixteen bits in the two eight-bit ports, as well as address locations for the ports as a whole. Especially useful in a small controller such as this is its 128-byte block of user ram.

The M/I/O line on the diagram is connected to  $A_7$  of the address bus and the chip is enabled at  $8000_{16}$  (or its shadows). For this configuration, the port bit address lines will lie between  $8000_{16}$  and  $807F_{16}$ ; and the addresses from  $8080_{16}$  to  $80FF_{16}$  will be user ram. In contrast to the ram i.cs, this device is of the 8000 series and therefore supports the correct not-read and not-write strobe lines.

With the 8085, the not-read and not-write lines require pull up resistors as shown in



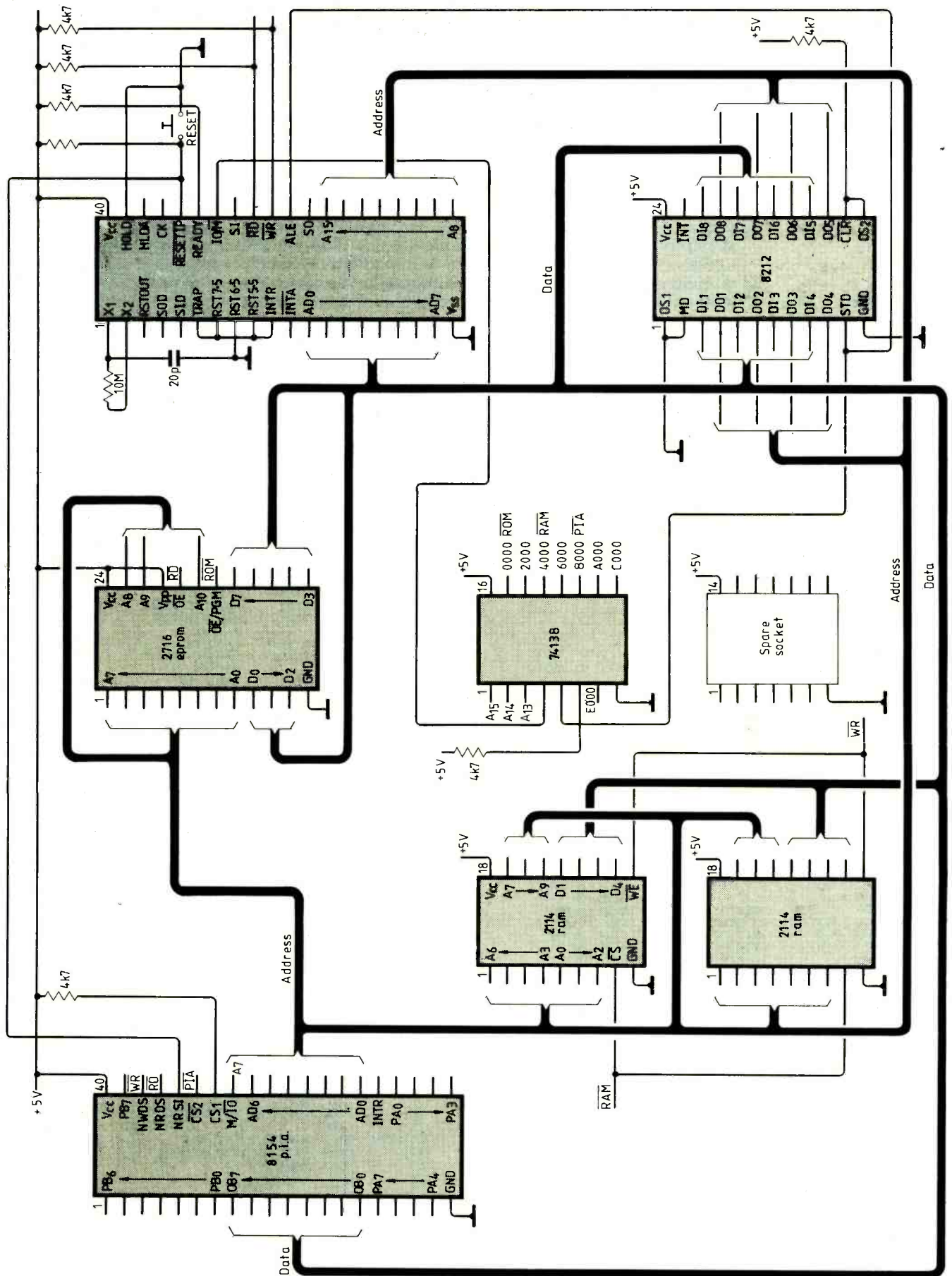

A kit of parts for this design is available from Microkit Ltd, Blakesley, Northamptonshire NN12 8RB at £39.99 including v.a.t. and postage. Send a stamped, self-addressed envelope for more details.

the circuit diagram. The clock can be generated on the 8085 simply by the addition of a resistor and capacitor at pins 1 and 2, or a 3MHz crystal may be used instead. The values shown given an input frequency of about 3MHz and an output clock frequency of half this value.

Reset is achieved by shorting together two pins at the top of the board, though a small push-to-make switch might be more serviceable. The reset-in line also resets the p.i.a.; but this may be altered so that the reset-out line resets the p.i.a., allowing controlled resetting of the i/o function.

Figure 1 shows eight short wires surrounding the 8212

latch. These wires, the low eight bits of the address bus, were left on the board to allow a logic analyser to be connected but are not needed on the complete board.

Connections to the computer user port are four control or data wires and a common ground. The board must of course be reset before communication takes place.

The interrupt facility of the 8085 has been rendered inactive, but any interrupt line may be used with only slight modification to the board. The interrupt lines have varying priorities and their inputs are active high.

Software for this design will be described in the next article.

## Simple pulse generator

Two separate kits are available for B.J. Frost's pulse generator described on page 43 of the August issue. Kit A comprising p.c.b., components and switches, costs £23.50 and Kit B, comprising low-profile case, screen-printed front panel, knobs and BNC connectors, costs £17.40; both prices exclude v.a.t.

The generator is also available built and tested for £78 excluding v.a.t. from the kit suppliers Ver Controls (St Albans) Ltd at Rookery House, Crowes Loke, Little Plumsted, Norwich NR13 5JB, tel. 0603 721215.

## References

1. The Art of Electronics by Horowitz and Hill. Cambridge University Press.
2. The Advanced User Guide for the BBC Microcomputer by A.C. Bray, A.C. Dickens and M.A. Holmes. Cambridge Microcomputer Centre, 1983.

001 COMMUNICATION FIRMWARE FOR THE	070 RECEV MVI A,0	CLEAR ACC	026A 3E 00
002 8085 CONTROLLER MODULE.	071 STA ERROR	CLEAR ERROR	026C 32 86 80
003 :	072 MVI L,8	INIT L REG	026F 2E 08
004 LABELS USED IN FIRMWARE	073 RECBYT CALL RECBIT	GET ONE BIT	0271 CD 44 02
005 :	074 PUSH PSW	SAVE CARRY	0274 F5
006 EPROK = \$8086	075 LDA ERROR	GET ERROR BIT	0275 3A 86 80
007 BYTE = \$8080	076 CPI 0	COMP ZERO	0278 FE 00
008 FB1 = \$8082	077 JNZ RECBEND	FAIL IF ERROR	027A C2 8A 02
009 FB2 = \$8083	078 POP PSW	GET CARRY	027D F1
010 FB3 = \$8084	079 LDA BYTE	GET BYTE	027E 3A 80 80
011 FB4 = \$8085	080 RAR	ROTATE BIT IN	0281 1F
012 ODRB = \$8023	081 STA BYTE	PUT BYTE BACK	0282 32 80 80
013 BIT0 = \$8008	082 DCR L	DEC L REG	0285 2D
014 BIT1S = \$8019	083 JNZ RECBYT	DO 8 BITS	0286 C2 71 02
015 BIT1C = \$8009	084 PUSH PSW	CORRECT PULL	0289 F5
016 BIT2 = \$800A	085 RECBEND POP PSW	RECOVER PSW	028A F1
017 BIT3S = \$801B	086 RET	RETURN	028B C9
018 BIT3C = \$800B	087 FAULT MVI A,\$FF	LOAD FF	028C 3E FF
019 ORG 0	088 STA ERROR	SIGNAL ERROR	028E 32 86 80
020 JMP START	089 RET	RETURN	0291 C9
021 :	090 SNDADR LHLD FB2	GET ADDR	0292 2A 83 80
022 :	091 XCHG	INTO DE	0295 EB
023 ORG \$0200	092 LDAX D	LOAD ACC	0296 1A
024 SNDBIT PUSH PSW	093 STA BYTE	STORE DATA	0297 32 80 80
025 SLIA LDA BIT2	094 CALL SNDBYT	SEND A BYTE	029A CD 25 02
026 CPI 0	095 RET	RETURN	029D C9
027 JP SLIA	096 RECADR LHLD FB2	GET ADDRESS	029E 2A 83 80
028 POP PSW	097 XCHG	INTO DE	02A1 EB
029 JNC SZERO	098 LDA FB4	GET DATA	02A2 3A 85 80
030 STA BIT1S	099 STAX D	STORE INDIRECT	02A5 12
031 JMP SEND1	100 RET	RETURN	02A6 C9
032 SZERO STA BIT1C	101 RECFOR LXI B,FB1	B&C POINTERS	02A7 01 82 80
033 SEND1 STA BIT3C	102 RELOOP CALL RECEV	GET 1 BYTE	02AA CD 6A 02
034 SLOOP LDA BIT2	103 LDA ERROR	TEST FOR ERROR	02AD 3A 86 80
035 CPI 0	104 CPI 0	COMP ZERO	02B0 FE 00
036 JM SLOOP	105 JNZ RLOOP	AGAIN IF ERROR	02B2 C2 AA 02
037 STA BIT3S	106 LDA BYTE	GET DATA	02B5 3A 80 80
038 RET	107 STAX B	STORE INDIRECT	02B8 02
039 SNDBYT MVI A,0	108 MVI A,\$86	END OF 4 BITS	02B9 3E 86
040 STA ERROR	109 INR C		02BB 0C
041 MVI H,B	110 CMP C	TEST END VALUE	02BC B9
042 SBLOOP LDA BYTE	111 JNZ RLOOP	DO 4 BYTES	02BD C2 AA 02
043 RAR	112 RET	RETURN	02C0 C9
044 STA BYTE	113 ACTION LDA FB1	GET COMMAND	02C1 3A 82 80
045 CALL SNDBIT	114 CPI 1	IS IT 1	02C4 FE 01
046 DCR H	115 JNZ ACT1	CARRY ON	02C6 C2 CD 02
047 JNZ SBLOOP	116 CALL RECADR	RECEIVE BYTE	02C9 CD 9E 02
048 RET	117 KET		02CC C9
049 SETUP MVI A,\$FA	118 ACT1 CPI 2	IS IT 2	02CD FE 02
050 STA ODRB	119 JNZ ACT2	CARRY ON	02CF C2 D6 02
051 STA BIT3S	120 CALL SNDADR	SEND BYTE	02D2 CD 92 02
052 RET	121 RET		02D5 C9
053 RECBIT MVI H,\$FF	122 ACT2 CPI 5	IS IT 5	02D6 FE 05
054 RECWAT LDA BIT2	123 JNZ ACT4	CARRY ON IF NO	02D8 C2 DF 02
055 CPI 0	124 CALL DOPROG	DO PROGRAM	02DB CD FA 02
056 JP OKGET	125 RET		02DE C9
057 DCR H	126 ACT4 MVI A,\$AA	GET AA	02DF 3E AA
058 JNZ RECWAT	127 STA BYTE	REPORT FAULT	02E1 32 80 80
059 JMP FAULT	128 CALL SNDBYT		02E4 CD 25 02
060 OKGET LDA BIT0	129 CALL SNDBYT		02E7 CD 25 02
061 RAL	130 RET		02EA C9
062 PUSH PSW	131 START LXI SP,\$80FF	STACK POINTER	02EB 01 FF 80
063 STA BIT3C	132 CALL SETUP	SET PORTS	02EE CD 3B 02
064 RECL1 LDA BIT2	133 MAIN CALL RECFOR	RECEIVE	02F1 CD A7 02
065 CPI 0	134 CALL ACTION	DO IT	02F4 CD C1 02
066 JP RECL1	135 JMP MAIN		02F7 C3 F1 02
067 STA BIT3S	136 DOPROG LHLD FB2	GET START ADDR	02FA 2A 83 80
068 POP PSW	137 PCHL	JUMP IND	02FD E9
069 RET	138 : END OF CODE		

# imhof EXPRESS

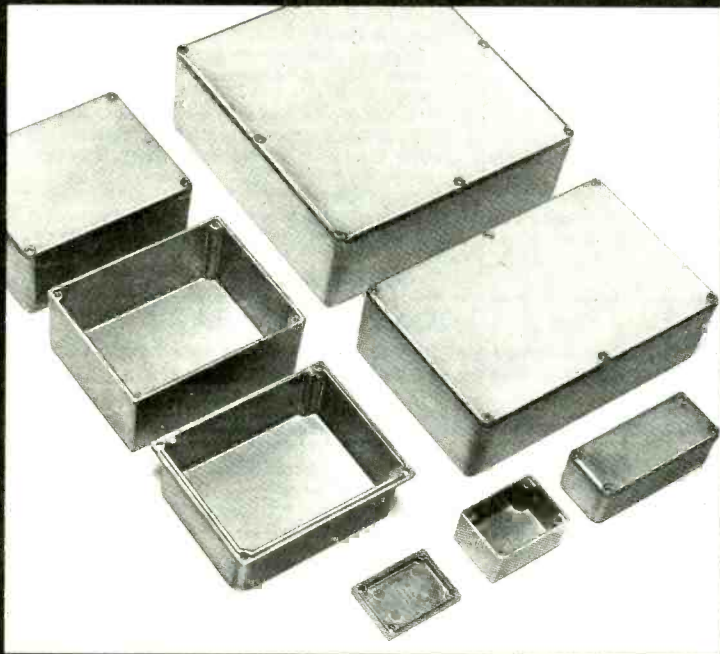

Imhof-Express gives you a 24-hour delivery of the most comprehensive range of small diecast boxes available anywhere.

They are ideal for the hobbyist who wants strong metal boxes with good screening properties.

To order you simply phone your Access or Visa card number and the goods will be despatched within 24 hours.

For details on these and all our many other products, ask for our latest catalogue.

**Imhof Express**

Riverside Way, Uxbridge  
Middlesex UB8 2YX

☎ (0895) 72247/8/9 and 72261/2/3/4



# 0895 72247

## SPECIAL OFFER - SAVE £££

**Tektronix 2215 Oscilloscope**

60MHz Dual Trace. Delay Sweep. With manual.

**ONLY £475 each**

## COMMUNICATION RECEIVERS

Racal RA 17L 500KHz-30MHz with manual ONLY £140 each  
EDDYSTONE 730-4 480KHz-30MHz with manual ONLY £110 each

## MULTIMETERS

PHILIPS DMM type PM2517X (LCO), 4 digit Audio ranging. Complete with Batteries & Leads (p&p £5) ONLY £75  
AVO 9 Mk4 (identical to AVO 9 Mk4 but scaled differently) Complete with Batteries & Leads. £35  
AVO 8 Mk2 Complete with batteries & leads. £45  
Above items in GOOD WORKING ORDER - appearance not! At hence the price.  
AVO Model 73, Pocket Multimeter (Analogue) 30 ranges. Complete with batteries & leads. £18

PROFESSIONAL 8" GREEN SCREEN MONITORS made by KGM for Reuters. Gives Quality 80 column - 24 line Display. Composite Video in Cased. Good Condition. NOW ONLY £32 each.

DISK DRIVE PSU. 240V in 5V 1.6A & 12V 1.5A Out. Size W125mm. £10 ea (p&p £2)

QWERTY KEYBOARD (as in LYNX MICRO). Push to make Cased. ONLY £5 ea (p&p £2)

AVO TRANSISTOR TESTER TT169. Handheld. GO/NOGO for in situ testing. Complete with batteries, leads and instructions. NOW ONLY £12 (p&p £3)

## NEW EQUIPMENT

HAMEG OSCILLOSCOPE 605. Dual Trace 60MHz Delay Sweep. Component Tester. £515  
HAMEG OSCILLOSCOPE 203.5 Dual Trace 20MHz Component Tester. £270  
All other models available

BLACK STAR COUNTER TIMERS (p&p £5)  
APOLLO 10-100MHz. Ratio/Period Time interval etc. £219  
APOLLO 100-100MHz (As above with more functions) £285  
BLACK STAR FREQUENCY COUNTERS (p&p £4)  
Meteor 100-100MHz £99  
Meteor 500-600MHz £126  
Meteor 1000-1GHz £175  
BLACK STAR JUPITER 500 FUNCTION GENERATOR  
Sine/Square/Triangle 0.1Hz-500KHz p&p £4 £110

HUNG CHANG DMM 6010. 3 1/2 digit. Hand held 28 ranges including 10 Amp AC/DC. Complete with batteries & leads p&p £4 £33.50

OSCILLOSCOPES PROBES. Switched X1, X10 £11 p&p £2

THIS IS A VERY SMALL SAMPLE OF STOCK. SAE or Telephone for LISTS. Please check availability before ordering. Carriage all units £12. VAT to be added to total on Goods and Carriage.

## OSCILLOSCOPES

TEKTRONIX 576 CURVE TRACER £4,500  
TEKTRONIX 485 Dual Trace 350MHz Delay Sweep £3,500  
TEKTRONIX 485B Dual Trace 100MHz Delay Sweep £1,200  
H.P. 1715A Dual Trace 200MHz Delay Sweep £1,500  
TEKTRONIX 485 Dual Trace 100MHz Delay Sweep £900  
TEKTRONIX 454 Dual Trace 150MHz Delay Sweep £550  
TELEQUIPMENT D75 Dual Trace 50MHz Delay Sweep £350  
GOULD OS300A Dual Trace 40MHz Delay Sweep £350  
TELEQUIPMENT D67 Dual Trace 25MHz Delay Sweep £250  
GOSSER CD1150 Dual Trace 35MHz Delay Sweep £200  
S.E. LABS SM111 Dual Trace 18MHz AC or External DC Operation £150  
TEKTRONIX 547 Dual Trace 50MHz Delay TB. Delay Sweep £145  
TELEQUIPMENT D43. Dual Trace 15MHz £100  
TEKTRONIX 434 STORAGE Dual Trace 25MHz £500  
GOULD OS4000 with Output Unit 4302 Dual Trace 10MHz £400

## GENERATORS

MARCONI TF2950/a Mobile RADIO Test Set £1,200  
MARCONI TF2006 FM 10-1000MHz £1,750  
MARCOBI TF2006 FM 10-500MHz £1,000  
H.P. SWEEP OSCILLATOR 691D 1-2GHz £400  
Other frequencies available.  
HEWLETT PACKARD 616B 1.8-4.2GHz £2,500  
MARCONI TF2006 AM/FM 10KHz-510MHz £1,250  
MARCONI TF1066B/1 AM/FM 10MHz-470MHz £350  
MARCONI TF995A/5 1.5-220MHz Narrow Deviation £250  
ADVANCE type SGG3E AM/FM 4-200MHz £100  
ADVANCE type SGG2B AM 150KHz-220MHz £45  
H.P. TEST OSCILLATOR 651A 10Hz-10MHz £100  
FARNELL Modul-Pulse Generator system 1Hz-10MHz £40

H.P. 4342 O Meter £1,250  
MARCONI Q Meter TF1245 with TF1248 or TF1247 £500  
H.P. POWER METER 431G with Thermistor Mount 10MHz or 12.4-18GHz £250  
MARCONI RF MILLIVOLTMETER TF2603 50KHz-1500MHz £150  
MARCONI VALVE VOLTMETER TF2600 10Hz-10MHz 1mV FSD £40  
MARCONI INSITU UNIVERSAL BRIDGE TF2701 £75  
MARCONI UNIVERSAL BRIDGE TF2700 Battery Operated £250  
MARCONI UNIVERSAL BRIDGE TF8888 £75  
H.P. BROADBAND SAMPLING VOLTMETER 3406A 10KHz-1.26GHz £500  
MARCONI AF SIGNAL SOURCE TF2000 20Hz-20KHz £200  
H.P. RF MILLIVOLTMETER 411A 500KHz-500MHz £60  
LEVELL TRANSISTOR AC MICROVOLTMETER TM3B £85  
KEITHLEY ELECTROMETER type 610B with Adaptor 6105 £500  
SOLARTRON TRUE RMS VOLTMETER VM1484 £150  
H.P. TRUE RMS VOLTMETER 3400A 10Hz-10MHz £400

RACAL 32MHz UNIVERSAL COUNTER/TIMER type 836 £50 each with manual

## ISOLATING TRANSFORMERS

240V input-240V output £15 each p&p £5  
500VA £8 each p&p £3  
200VA

Used Equipment - with 30 days guarantee. Manuals supplied if possible. This is a very small sample of stock. SAE or telephone for LISTS. Please check availability before ordering. Carriage all units £12. VAT to be added to total on Goods and Carriage.

**STEWART OF READING Telephone: 0734 68041**

**110 WYKEHAM ROAD, READING, BERKS RG6 1PL**

Callers welcome 9am to 5.30pm. MON-FRI. (UNTIL 8pm. THURS)

## BEST PRICE MEMORIES

ALL THE LATEST FASTEST DEVICES AS USED BY INDUSTRY. DO NOT CONFUSE WITH SLOWER OLD STOCK OFFERED ELSEWHERE.

WE ONLY STOCK MEMORIES PRODUCED BY ESTABLISHED MANUFACTURERS WHOSE COMPONENTS HAVE BEEN SUBJECTED TO LONG-TERM UK TESTING. BEWARE OF CHEAP FAR EASTERN MEMORIES THAT MAY BE UNRELIABLE.

### DRAM 5v NMOS 150nS

(not Samsung or Texas)

4164 64k x 1 £0.99  
41256 256k x 1 £2.20  
4416 16k x 4 £2.80  
41464 64k x 4 £5.90  
MSM3764 128k x 1 £5.90

### SRAM 5v NMOS 150nS

2114LP 1k x 4 £1.50  
2128LP 2k x 8 £2.50

### SRAM 5v CMOS 150nS

6116LP 2k x 8 £1.30  
6264 8k x 8 £3.40  
62256LP 32k x 8 £39.50

### EPROM 5v NMOS 250nS

2716 2k x 8 £2.85  
2732 4k x 8 £2.65  
2764 8k x 8 £2.50  
27128 16k x 8 £2.40  
27256 32k x 8 £3.90

### EPROM 5v CMOS 250 nS

27C64 8k x 8 £8.50  
27C256 32k x 8 £15.00

### EEPROM

2816A 2k x 8 250nS £13.50  
2864A 8k x 8 250nS £45.00

## 10% DISCOUNT

On orders over £25 regardless of mix. Add 15% VAT p&p free.

A complete kit of components for the 8085 microcontroller project featured in this article is available from Microkit at £39.99 inclusive of VAT. Send SAE for details.

**DESPATCH BY RETURN FROM LARGE STOCKS**

## OUR EXTREMELY POPULAR EX-EQUIPMENT MEMORIES

**GUARANTEED** UV ERASED, CLEANED & TESTED. 1,000's sold to delighted customers.

4116	16k x 1 DRAM 60p	10 for £5.50
2716	2k x 8 EPROM £1.50	10 for £14.00
2732	4k x 8 EPROM £1.50	10 for £14.00

Orders under £25 add 15% VAT plus 50p p&p UK. Overseas orders welcome add £2.00 p&p no VAT (payment in £ sterling please).

SEND S.A.E. FOR FULL LISTS, 74HC CMOS LOGIC, DISK CONTROLLERS, ETC.

TELEPHONE 0933 626420 (24 hour service)

New telephone number from 1st September 0327 860130

**MICROKIT LIMITED**  
BLAKESLEY, NORTHANTS NN12 8RB

CIRCLE 56 FOR FURTHER DETAILS

CIRCLE 68 FOR FURTHER DETAILS

# PINEAPPLE SOFTWARE

Programs for the BBC models 'B' with disc drive with FREE updating service on all software

## DIAGRAM

Still the only drawing program available for the BBC micro which gives you the ability to draw really large diagrams and scroll them smoothly around the screen stopping to edit them at any time if required.

Pineapple's unique method of storing the diagram information on disc means that the size of diagrams is limited only by the free space on disc, and not the amount of computer memory you have available. (A blank 80 track disc will allow up to 39 mode 0 screens of diagram).

The superb print routines supplied with the program enable large areas of the diagram to be printed in a single print run in a number of different sizes and rotated through 90 deg. if required. Full use can also be made of printers which have a wider than normal carriage available.

The program is fully compatible with the Marconi Tracker ball described below.

PLEASE STATE 40 or 80 TRACK DISC & WHETHER STANDARD BBC or MASTER VERSION IS REQUIRED

PRICE £25.00 + VAT

## DIAGRAM UTILITIES

A suite of six utility programs which add additional features to the 'Diagram' drawing program. The utilities include the saving and loading of areas of diagram to and from disc. The ability to display the whole of your large diagram on the screen at one time (in either 4\*4 or 8\*8 screen format). The addition of borders and screen indents to diagrams, and the ability to shift a whole diagram in any direction.

PRICE £10.00 + VAT

## MARCONI TRACKER BALL

This high quality device comes with its own Icon Artmaster drawing program and utilities to enable it to be used in place of keyboard keys, joysticks, or with your own programs.

PRICE £60.00 + VAT p&p £1.75

PRICE INCLUDING 'DIAGRAM' SOFTWARE £79.00 + VAT p&p £1.75

## TRACKER BALL for MASTER series

The Pointer ROM is supplied instead of the Icon Artmaster disc and enables the Tracker ball to work directly with the MASTER series computers. (e.g. to use with TIMPAINT etc.) Prices are the same as for the standard tracker ball.

## POINTER

The Pointer Rom is available separately for people already owning tracker balls, and comes with instructions for use with the MASTER computer.

PRICE £12.50 + VAT

## PCB

This new release from Pineapple is a printed circuit board draughting aid which is aimed at producing complex double sided PCB's very rapidly using a standard BBC micro and any FX compatible dot-matrix printer.

The program is supplied on EPROM and will run with any 32k BBC micro (including Master series). Also supplied is a disc containing a sample PCB layout to demonstrate the programs features.

By using an EPROM for the program code the maximum amount of RAM is available for storing component location and ASCII identification files etc. (Up to 500 components and 500 ASCII component descriptions may be stored for a given layout). There is no limit to the number of tracks for a given PCB, although the maximum size of board is restricted to 8" \* 5.6".

Using a mode 1 screen, tracks on the top side of the board are shown in red, while those on the underside are blue. Each side of the board may be shown individually or superimposed. A component placement screen allows component outlines to be drawn for silk screen purposes and component numbers entered on this screen may be displayed during track routing to aid identification of roundels.

The print routines allow separate printouts of each side of the PCB in a very accurate expanded definition 1:1 scale, enabling direct contact printing to be used on resist covered copper clad board.

This program has too many superb features to describe adequately here, so please write or phone for more information and sample printouts.

PRICE £85.00 + VAT

## CONVERTER LEADS

Converter leads to enable the Trackerball to run mouse software and the mouse to run trackerball software (inc. DIAGRAM). Please state which way round when ordering.

PRICE £8.00 + VAT

## BASIC COMPILER

Use our Basic Compiler to produce direct 6502 machine code programs and ROMs for your own Basic programs. Speed increases of up to 25 times are achieved.

PRICE £25.00 + VAT

## ALL ORDERS SENT BY RETURN OF POST

39 Brownlea Gardens, Seven Kings, Ilford, Essex IG3 9NL. ☎ Tel: 01-599 1476

CIRCLE 22 FOR FURTHER DETAILS

## EMS Power Systems



EMS manufactures DC Power Supplies and Battery Chargers both linear and switch mode in a range from 5 VA to 3.2 KVA.

Also a complete range of Standby, UPS and Mains Stabilizer Systems 35 VA to 1 KVA. EMS specialises in the manufacture of customised products and has a full design and development facility.

**EMS (Manufacturing) Limited,**  
Chairborough Road,  
High Wycombe,  
Bucks HP12 3HH.  
Tel: (0494) 448484

CIRCLE 24 FOR FURTHER DETAILS

## STEREO STABILIZER



- Rack mounting frequency shifter for howl reduction in public address and sound reinforcement.
- Mono version, box types and, 5Hz fixed shift, and circuit boards also available.

**SURREY ELECTRONICS LTD.,**  
The Forge, Lucks Green, Cranleigh,  
Surrey GU6 7BG  
Telephone: 0483 275997

## SMALL SELECTION ONLY LISTED - RING US FOR YOUR REQUIREMENTS WHICH MAY BE IN STOCK

**Racal Solid State Communication Receivers** - RA1217 - Mechanical digit readout 1 - 30MC/S - £300. **Racal RA17L Communication Receivers** 500KC/S to 30MC/S in 30 bands 1MC/S Wide - £175 - All receivers are air tested and calibrated in our workshop - supplied with dust cover - operation instructions - circuit - in fair used condition. **Racal Synthesizers** (Decade frequency generators) MA250 - 1.6MC/S to 31.6 MC/S - £100. MA1350 for use with RA17 receiver - £100. MA259G - precision frequency standard 5MC/S - 1MC/S - 100kHz - £100 to £150. RA137 and RA37 - LF converters 10 to 980KC/S - £40 to £75. RA98 SSE-USB converter - £50. RA121 SSB-USB converter - £75. **Plessey PR155G Solid State receivers** - 60KC/S - 30MC/S - £300. **Transtel Matrix Printers AF11P** - 5 level baudot code - up to 300 bauds - for print out on plain teleprinter paper - £50. **Army Field**

**Telephone sets** type F, L and J - large quantity in stock - £6 to £15 depending on type and quantity. P.O.R. **Don 10 Telephone Cable** - half mile canvas containers - £20. **Night Viewing infra-red periscopes** - twin eyepiece - 24 volt DC supply - £100. EA. Original cost to Government over £11,000. EA. **Static Invertors** - 12 or 24 volt input - 240 volt AC sinewave output - various wattages. P.O.R. **XY Plotters and pen recorders** - various - P.O.R. **Signal Generators** - various - P.O.R. **TF 893A** - Power meter - £50. **Racal frequency counter** type 836 - £50. **Tektronic plug-ins** - 1A1 £50, 1A2 £40, 1A4 £100, M £50. All items are bought direct from H.M. Government being surplus equipment. Price is ex works S.A.E. for enquiries. Phone for appointment for demonstration of any items; also availability or price change. V.A.T. and carriage extra.

**EXPORT TRADE AND QUANTITY DISCOUNTS**  
**JOHNS RADIO, WHITEHALL WORKS,**  
84 WHITEHALL ROAD EAST, BIRKENSHAW,  
BRADFORD BD11 2ER. TEL NO: (0274) 684007  
WANTED: REDUNDANT TEST EQUIPMENT - VALVES - PLUGS - SOCKETS,  
SYNCHROS ETC. RECEIVING AND TRANSMITTING EQUIPMENT

# What makes a good oscillator?

by K. Lewis  
M.I.E.R.E.

**Oscillators are sometimes taken for granted. This article discusses the parameters to consider when defining their performance.**

Function generators have become common place instruments in a typical laboratory and provide a versatile source of signals with square, triangle and sinusoidal waveforms. The source of these signals is usually an astable circuit formed by a closed loop, consisting of an integrator and a hysteresis gate. The hysteresis gate generates the square wave and the integrator generates the triangular wave from which the sine wave is formed by employing a diode shaping circuit. This method can provide reasonably low harmonic distortion.

Casual observation of a typical waveform generated by this method, displayed on an oscilloscope, can be deceptive, as it may not show the frequency or phase jitter generated. Although the performance of some function generators can be reasonable in this respect, closer examination of an inferior generator's waveform near the top end of its frequency range could well reveal observable phase jitter. This is seen at its maximum in the zero cross-over region of the waveform towards the end of the oscilloscope trace.

Phase jitter, together with any amplitude noise which may be present, can be observed and quantified with a spectrum analyser, providing it is within the resolution of the analyser. The displayed spectrum requires careful interpretation because (a) the spectrum analyser has its own limited resolving bandwidth and (b) the local oscillators within the spectrum analyser also exhibit phase jitter and there will be a reciprocal mixing between its internal oscillators and the signal being analysed. In the frequency do-

main, the ideal oscillator spectrum consists of a single discrete line at the frequency of oscillation. In practice, this ideal spectrum is contaminated by harmonics and noise which appears approximately symmetrical about the oscillator frequency. In r.f. oscillators harmonics may be reduced by filtering. The reduction of oscillator noise, however, is only realistically achieved by careful design.

Whilst astable oscillators perform an important role in the electronics laboratory, the oscillators considered here employ a frequency-selective network, around which is placed an active network that provides the necessary feedback to cause oscillation. This class of oscillator is capable of providing an excellent performance in terms of spectral purity, especially when compared to its astable counterpart.

It is possible to gain considerable insight into the performance of such an oscillator if one analyses the behaviour of a simple linear model. With this model the salient parameters are defined without restricting the oscillator to a particular circuit design. Although linearity is assumed, meaningful results may be obtained, particularly for higher grade oscillators.

The frequency selective network within the oscillator may normally be represented by a second-order bandpass function which, for example, takes the same form as the impedance function of a simple LCR parallel circuit. In general this may be represented by the equation:

$$B(f) = \frac{B_0}{1 + jQ(f/f_0 - f_0/f)} \quad (1)$$

In this equation,  $f_0$  is the re-

sonant frequency and  $B_0$  is the gain of the circuit at  $f = f_0$ .  $Q$  is the selectivity of the circuit and defines the 3dB bandwidth given by  $f_0/Q$ .

In the block diagram Fig. 1, an amplifier of gain  $A$  is shown driving a filter block  $B(f)$ . The output of this is fed back to the input of the amplifier via a summing point, where an external signal  $V_1$  has been added to investigate the response of the circuit to  $V_1$  as the amplifier gain is varied. Voltage  $V_2 = V_1 + V_4$  and therefore the overall feedback is positive, as  $V_4$  is in phase with  $V_1$  at resonance. The combined response of the block diagram illustrated can be simply derived and is the standard feedback equation.

$$V_4/V_1 = AB(f)/(1 - AB(f)) \quad (2)$$

Substituting equation (1) into (2) gives

$$\frac{V_4}{V_1} = \frac{AB_0}{(1 - AB_0)[1 + j(Q/(1 - AB_0))(f/f_0 - f_0/f)]} \quad (3)$$

Equation (3) is of fundamental importance in determining the behaviour of an oscillator. This can be appreciated when  $A$  is allowed to increase and the product  $AB_0$  approaches unity. At this point the gain goes to infinity. Therefore  $V_1$  can be zero and oscillation is maintained. However, in practice this description is a simplification, because the product  $AB_0$  sus-

Mr Lewis is group leader with responsibility for design and development of frequency synthesizers at Grinaker Electronics in South Africa. Before that he designed v.h.f. synthesizers at Plessey, Ilford.

Fig. 1. Linear model of an oscillator, which is a frequency-selective network, represented by  $B(f)$ , an active network to provide gain and feedback.

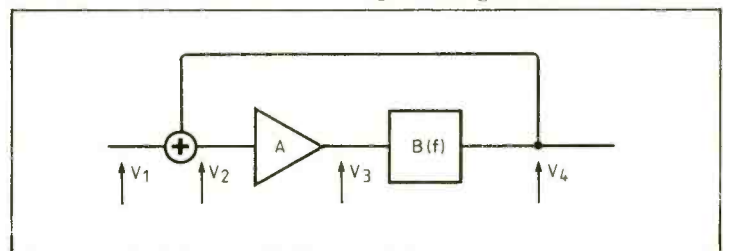

tains an average value less than unity. A practical oscillator therefore turns out to be a very high-gain amplifier having a narrow bandwidth, which employs automatic gain control or limiting to define a given output level. The input to this amplifier is noise!

Equation (3) above is of the same form as equation (1) and, by comparison, it can be seen that at frequency  $f_0$  the operational gain has been increased to

$$G_0 = V_4/V_1 = AB_0/(1-AB_0) \quad (4)$$

The operational  $Q$  has been increased to

$$Q_0 = Q/(1-AB_0) \quad (5)$$

The 3dB bandwidth has therefore been reduced to

$$f_{3dB} = f_0/Q_0 = f_0(1-AB_0)/Q \quad (6)$$

Now let the voltage source  $V_1$  be replaced by a noise source of voltage density  $V_n$ , r.m.s. volts per  $\sqrt{\text{Hz}}$ . This noise may be regarded as the equivalent voltage noise source of the amplifier. The oscillator output level, determined by the a.g.c. characteristic of the oscillator design, is not of course a function of  $V_n$ . Since the closed-loop voltage gain of the oscillator is capable of reaching infinity, the amplifier gain will adjust itself. At this point it is worth noting from equations (4) and (6), that each time the operational gain,  $G_0$ , is doubled, i.e. increased by 6dB, the 3dB bandwidth is halved. This reduction in bandwidth alone results in a 3dB reduction in output signal. The net increase in signal is therefore 3dB.

Any white-noise which is subject to narrow band filtering will, when examined on a suitable storage oscilloscope, take on the appearance of a sinusoid. The average r.m.s. value of that sinusoid is simply given by the product of the voltage noise density  $V_n$  and the square root of the filter noise bandwidth. The oscillator is an extreme example of the narrow-band filtering of noise.

From this discussion it should be apparent that the output  $V_4$ , taken as the r.m.s. value, is the product of  $V_n$  times the gain, given by equation (4), times the square root of the noise bandwidth. This may be shown to be the 3dB

bandwidth, given by equation (6), multiplied by  $\pi/2^1$ . The result of combining these equations is

$$\frac{V_4}{V_n} = \frac{AB_0}{1-AB_0} \sqrt{|f_0\pi(1-AB_0)/(2Q)|} \quad (7)$$

This equation is also fundamental, since it enables the product  $AB_0$  to be qualified and therefore the operating  $Q$ , gain and bandwidth to be determined. Equation (3) can now be used to determine the noise spectrum of the oscillator within the limitations of the theoretical model.

Equation (7) cannot be written explicitly in terms of the product  $AB_0$ , which in practice is very close to unity. Only the difference terms  $(1-AB_0)$  therefore need be considered. In making this approximation equation 7 simplifies to:

$$(1-AB_0) = (V_n/V_4)^2 \pi f_0 / 2Q \quad (8)$$

Substituting equation (8) into the above equations gives the following results

**Operational  $Q$**   

$$Q_0 = 2Q^2 (V_4/V_n)^2 / \pi f_0 \quad (9)$$

**Operational gain**  

$$G_0 = 2Q (V_4/V_n)^2 / \pi f_0 \quad (10)$$

**Oscillator gain response,**  

$$G(f) = \frac{G_0}{1 + jQ_0(f_0/f - f/f_0)} \quad (11)$$

In oscillators the spectral purity can be measured as the ratio of the carrier amplitude to the noise level measured at some frequency offset  $\Delta f$  from the carrier such as  $\Delta f = f - f_0$ . Assuming that  $|\Delta f| < f_0$ , equation (11) may be approximated by

$$G(f) = \frac{G_0}{1 + j2Q_0\Delta f/f_0} \quad (12)$$

If practical values are substituted, as is done shortly, it will be noticed that an oscillator's 3dB bandwidth is typically very small. Therefore at practical values of  $\Delta f$  the real term 1, in the denominator of equation (12), may be neglected. This gives a simple expression, after some cancellation, for the magnitude of gain.

$$|G(f)| = f_0 / (2Q\Delta f) \quad (13)$$

This remarkably simple result could have been derived

directly from equation (3) by equating the product  $AB_0$  to unity in order to obtain the theoretical gain of the oscillator when the input noise is zero. In practice this means that as  $\Delta f$  increases, positively or negatively, the gain of the oscillator rapidly converges on to the ideal gain response and is independent of the output voltage  $V_4$ ! From this result it is apparent that the carrier-to-noise ratio can be maximized by simply designing the oscillator to provide a large voltage output swing: the accompanying noise output being the product of the gain, given by equation (13) and the voltage noise density  $V_n$ .

Equation (13) also illustrates a fundamental property of oscillators. This is that the operating gain, and therefore its accompanying noise, is proportional to the oscillator frequency  $f_0$  for a given value of  $\Delta f$ ,  $Q$  and  $V_n$ . Because of this property, even the noise performance of audio oscillators which typically operate with low- $Q$ , frequency-selective networks, can be very good when compared to r.f. oscillators. The basic requirements for a low-noise oscillator are therefore a high value of  $Q$ , and low values of  $V_n$  and  $F_0$ , if this is possible. This may be intuitively obvious; however, equation (13) quantifies their simple relationship.

The frequency stability of an oscillator also relates to its effective operating bandwidth. The oscillator output, which is essentially amplified noise, will be coherent in phase for a time proportional to the reciprocal of the effective bandwidth. It can therefore be appreciated that even with perfectly stable components there will be a random drift in the oscillator's phase.

In general, the oscillator output  $V_4$  exhibits less noise, at larger values of  $\Delta f$ , than the output  $V_3$  because of the filtering action of  $B(f)$ . Output  $V_3$ , assuming that it is available in practical oscillator, is simply equal to  $V_4$ , divided by the filter response. At larger values of  $\Delta f$ , the enhancement of gain, due to positive feedback, becomes negligible and the output noise is equal to the product  $V_n A$ . Also, any harmonic distortion introduced by the amplifier is reduced at the

filter output. This is of particular relevance in the design of low harmonic-distortion audio oscillators.

Take the example of an oscillator operating at 100 MHz. Let the  $Q$  of the frequency-selective network be 40, the amplifier noise voltage be  $10nV/\sqrt{\text{Hz}}$ , and the output voltage be 3V r.m.s. From equation (8),  $(1-AB_0) = 4.4 \times 10^{-11}$ . The operating gain, defined by Equation (4), is the reciprocal of this, i.e.,  $G_0 = 2.3 \times 10^{10}$ . From equation (9)  $Q_0 = 9.2 \times 10^{11}$  and  $f_{3dB} = 1.1 \times 10^{-4}$  Hz. At 10 kHz from the carrier the gain given by equation (13) is 125 and the noise is  $1.25 \times 10^{-6}$  volts per  $\sqrt{\text{Hz}}$ . The carrier-to-noise ratio, 10kHz off, is therefore -128dB. Figure 2 is a graph of the oscillator gain in dB over the frequency span of 40 kHz as defined by equation (11). Figure 3 shows the output level, in dBV as would be displayed by an ideal spectrum analyser employing a true rectangular filter with a noise resolution bandwidth of 1 Hz. In Fig. 4 the frequency span has been reduced to 200 Hz and the flat top of the filter is just visible. The extreme values of gain and  $Q$  may appear incredibly high. However, it should be remembered that in the ideal oscillator model both these parameters are infinite.

Consider now the degradation in noise performance of an oscillator which has an amplifier that introduces an arbitrary phase shift  $\theta$  at the oscillator frequency. If it is assumed that this phase shift is constant over the frequency range of interest the gain of the amplifier may be represented in polar form by  $A > \theta$ . The oscillator is now forced to operate at a frequency removed from  $f_0$  so that the bandpass filter can offset this phase shift. If equation (3) is rewritten in terms of  $\Delta f$ , and  $A \Delta \theta$  is written in its trigonometric form, the equation becomes:

$$\frac{V_4}{V_1} = \frac{AB_0(\cos\theta + j\sin\theta)}{1 - AB_0\cos\theta + j(2Q\Delta f/f_0 - AB_0\sin\theta)} \quad (14)$$

This equation will have a maximum value at a frequency which makes the  $j$  terms in the denominator zero. This gives the result:

$$\Delta f = (f_0 AB_0 \sin\theta) / 2Q \quad (15)$$

At practical values of  $\Delta f$ , in

equation (14) the real part of the denominator may be equated to zero. This results in the equation:

$$\cos\theta = 1/(AB_0) \quad (16)$$

Substituting the  $AB_0$  in equation (15) gives the particular value of  $\Delta f$  which defines the modified operating frequency:

$$\Delta f = (f_0 \tan\theta)/2Q \quad (17)$$

This result may be illustrated by considering a phase shift  $\theta$  of 45 degrees in the amplifier. Then  $\tan 45 = 1$  so that  $\Delta f = f_0/2Q$ . This corresponds to the 3dB corner frequency of just the filter where it is generally known the filter phase shift is the corresponding 45 degrees.

To examine the effect of the phase shift on the oscillator noise, it is convenient to redefine the offset frequency as  $\Delta f_1$  which will now equal the offset from the actual oscillator frequency. If  $\Delta f_1$  is used in equation (14), the term  $AB_0 \sin \theta$  falls away and for practical values of  $\Delta f_1$ , the term  $(1 - AB_0 \cos \theta)$  is negligible. Equation (14) then simplifies to

$$\frac{V_4}{V_1} = \frac{AB_0(\cos\theta + j\sin\theta)}{j2Q\Delta f_1/f_0} \quad (18)$$

If from equation (16)  $AB_0$  is substituted by  $1/\cos \theta$ , the magnitude of the gain simply becomes

$$|G(f)| = f_0/(2Q\Delta f_1 \cos\theta) \quad (19)$$

This expression can be directly compared to equation (13) from which it can be seen that the gain has been raised by a factor of  $1/\cos \theta$ . (In practice a small correction is necessary to allow for the fact that  $f_0$  is defined by the filter and is no longer the oscillator frequency.) For the example of  $\theta = 45^\circ$  it is apparent that the gain and therefore the oscillator noise will be increased by 3dB.

It may seem surprising that the gain symmetry predicted by equation (19) has been preserved, since the centre frequency of the filter no longer coincides with the oscillator frequency. However, substituting practical values in the more exact equation confirms this symmetry for reasonable values of  $Q$ . In contrast the gain  $V_3/V_1$ , and therefore the noise, will no longer be symmetrical, as can be demonstrated by dividing equation

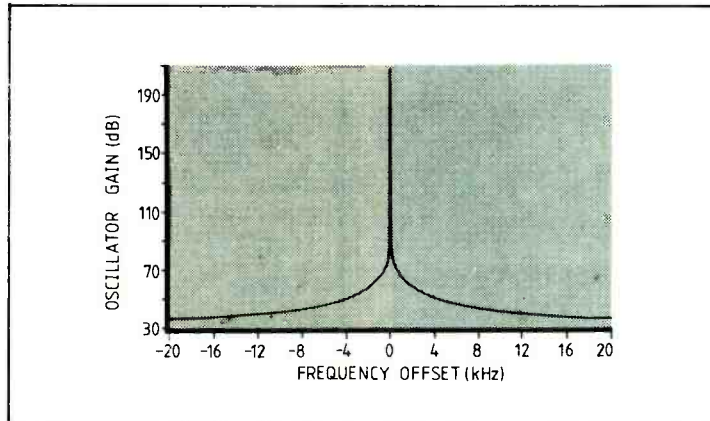

Fig. 2. Oscillator gain over a range of 20kHz either side of carrier: gain defined in equation (11).

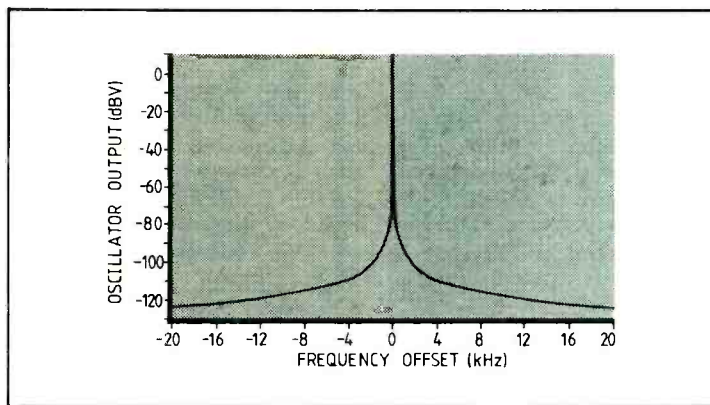

Fig. 3 Oscillator output (in dBV) shown by ideal spectrum analyser.

(19) by the filter response defined by equation (1).

In a practical oscillator it is a simplification to represent the total oscillator noise source by a single white noise generator particularly in r.f. oscillators. Also no allowance has been made for the noise generated by the tuned circuit. However, it should be apparent that this noise source may also be referred to  $V_n$  when considering just the output  $V_4$ . In practice, the close-in noise determined by equation (12) is ideal and is degraded by a flicker noise and non linearity in the amplifier or tuned circuit. This results in a complex frequency translation of low-frequency amplifier noise which is folded symmetrically about the oscillator frequency.

The principle of injecting a stimulus, such as a sinusoidal source, is an important one. This enables closed-loop responses of oscillators to be analysed. The model depicted in Fig. 1 may readily be extended to represent an actual oscillator circuit to enable a more complete analysis to be carried out employing the approach described.

In the oscillator model discussed, the sideband noise energy is equally divided be-

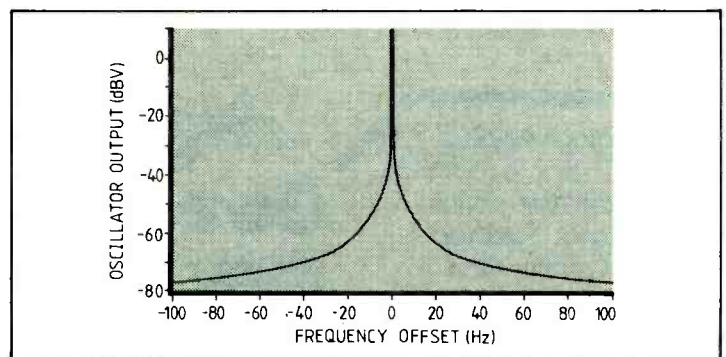

Fig. 4. Fig. 3 graph on 200Hz base, showing flat top of spectrum analyser filter curve.

tween phase noise and amplitude noise. However, in practice, the phase noise will normally predominate because of voltage-sensitive capacitances in the amplifier. These, for example, convert power supply noise to phase noise. This is particularly true for Varactor-diode frequency-controlled oscillators. Varactor diodes, in addition to increasing oscillator non-linearity, readily convert externally injected noise into phase noise to the extent that induced phase noise can become totally dominant.

#### Reference

1 Transmission Systems for Communications, 4th ed., Bell Telephone Labs, Western Electric Co. Winston-Salem, N.C. ■

# Versatower:

A range of telescopic towers in static and mobile models from 7.5 to 36 metres with tilt-over facility enabling all maintenance to be at ground level.

Designed in accordance with CP3 Chapter V; part 2; 1972 for a minimum wind speed of 140 kph in conditions of maximum exposure and specified by professionals world-wide where hostile environments demand the ultimate in design, quality and reliability.

Suitable for mounting equipment in the fields of:  
 Communications  
 Security surveillance - CCTV  
 Meteorology  
 Environmental monitoring  
 Geographical survey  
 Defence range-finding  
 Marine and aero navigation  
 Floodlighting  
 Airport approach lighting  
 Further details available on request.



**STRUMECH ENGINEERING LIMITED**  
 Portland House, Coppice Side, Brownhills  
 Walsall, West Midlands WS8 7EX, England  
 Telephone: Brownhills (0543) 374321  
 Telex: 335243 SEL.G.

CIRCLE 4 FOR FURTHER DETAILS

<p><b>MARCO TRADING</b> ELECTRONIC COMPONENT SUPPLIERS</p>		<p>1/4 W RESISTOR KITS 5 EACH VALUE (985) 10 EACH VALUE (6.0) 15 EACH VALUE (7.5)</p>	<p>1/2 W RESISTOR KITS 5 EACH VALUE (1.85) 10 EACH VALUE (3.6)</p>	<p>SEND £1 NOW (£2.50 OVERSEAS) FREE TO SCHOOLS &amp; COLLEGS FOR YOUR TOP ORDER INCLUDING PRE-PAID 99¢ VOUCHER ORDER FORM &amp; SPECIAL OFFER FOR EACH VOUCHER NEW SPECIAL OFFER FOR EACH VOUCHER THESE TESTS ARE ON A FRICTION OF OUR RANGE</p> <p><b>LATEST CATALOGUE</b></p>
<p>ZENER DIODE KIT 500 100 MW 55 ZENER DIODES 5 EACH VALUE £3.50</p>		<p><b>SEPTEMBER SPECIAL OFFER</b>                  ANTEX XS 25W SOLDERING IRON                  ONLY <b>£4.99</b>                  WITH ORDERS OF £10 OR OVER</p> <p>NORMALLY £6.20</p>		<p>CEFRANIC KIT 50 VOLT 15 CAPACITORS 5 EACH VALUE 14.5</p>
<p><b>PORTABLE GAS SOLDERING IRON</b>                  TOTALLY PORTABLE FILLS IN SECONDS WITH ORDINARY LIGHTER FUEL FOR UP TO 60 MINS CONTINUOUS USE. TIP TEMPERATURES TO MAX. 400°C.</p> <p>SMALL SIZE 175 x 19mm</p> <p>SPARE TIPS - £4.50 each                  SIZES - 2.4, 3.2 &amp; 4.8mm</p> <p><b>£13.90</b>                  MEETS ALL SAFETY STANDARDS</p>		<p><b>NI-CAD BATTERY CHARGER</b>                  THIS BATTERY CHARGER IS SUITABLE FOR AA, AAA, C, D &amp; PP3 TYPE NI-CAD CHARGING AND CAN COPE WITH UP TO 4 OF EACH AA, C &amp; D PLUS 1 x PP3 AT ANY ONE TIME.</p> <p><b>£4.50</b>                  + 15% V.A.T.</p> <p>NORMALLY £5.17</p>		
<p><b>12V RECHARGEABLE UNIT</b>                  A BANK OF 10 D TYPE NI-CADS ENCAPSULATED IN A BLACK PLASTIC BOX COMPLETE WITH INLET AND OUTLET SOCKETS (XLR TYPE) AND FUSE HOLDER THIS GIVING 12V FROM A VERY NEAT AND TIDY UNIT.</p> <p>Approx. 24mm x 75mm x 75mm</p> <p><b>£5.99</b> + £1.85 P&amp;P + 15% V.A.T.</p>		<p><b>RECHARGEABLE BATTERIES (NI-CADS)</b>                  A RANGE OF NICKEL CADMIUM BATTERIES WHICH WILL REPLACE DRY BATTERIES CAN BE QUICKLY AND EASILY RECHARGED USING THE ABOVE NI-CAD CHARGER.</p> <p>AA - 95p each 10+ 85p each                  C - £2.14 each 10+ £1.98 each                  D - £2.30 each 10+ £2.10 each                  PP3 - £3.75 each 10+ £3.65 each</p>		
<p><b>MARCO TRADING</b>                  DEPT EW9, THE MALTINGS,                  HIGH STREET, WEM,                  SHROPSHIRE SY4 5EN.                  TEL: (0939) 32763 TELEX: 35565</p>		<p>24 HOUR ANSWERPHONE SERVICE</p>	<p><b>SWITCH CLEANING LUBRICANT</b> £1.24                  226 gm AEROSOL TIN WITH APPLICATOR</p>	<p><b>B.T. SOCKETS</b>                  MASTER SOCKET 2/4A £2.85                  SECONDARY 2/6A £1.95</p>
<p>ALL ORDERS + 65p P&amp;P + 15% V.A.T.</p>				

CIRCLE 39 FOR FURTHER DETAILS

The Wings Appeal Fund helps to maintain the RAF Association Home for Disabled and Chronic Sick. Care is essential for those who have served their country and who are in need. So please help by giving all you can for an emblem in WINGS WEEK in September or send a donation to show that you care.



## Give as they Gave



To: Royal Air Forces Association, Appeals Dept., (DS) Portland Rd., Malvern, Worcs. WR14 2TA.

I enclose a donation of \_\_\_\_\_ for the Wings Appeal Fund.

Name \_\_\_\_\_

Address \_\_\_\_\_

Please tick if receipt required   
 or information on RAFA Membership

Space donated by  
**Electronics & Wireless World**

## LOW COST UNIVERSAL PROGRAMMER EPROMS EEPROMS MICROS

- Completely self contained unit.
- No personality modules required.
- Controlled via RS232 serial interface.
- Supports Intel, Motorola and Ascii hex data formats.
- Easily controlled by most computers.
- Fast and standard programming modes.
- Low and high byte programming for 16 bit data.
- Byte, block and chip erase for Eeproms.
- Eeproms:  
 2508/16/32/64  
 2758  
 2716/32/32A/64/64A/128/  
 128A/256/512/513  
 27C16/32/64/128/256/512  
 68732/64/66
- Eeproms:  
 2816A/64A 52B13/23/33 48Z02
- Micros:  
 8748/48H/49/49H

Price uncased £295 plus VAT.

**Micro Concepts**

Tel: 0242 510525

2 St. Stephens Road · Cheltenham · Glos · GL51 5AA

CIRCLE 53 FOR FURTHER DETAILS

## VIDEO TERMINAL BOARD

★ 80 characters X 24 lines ★

Requires ASCII encoded keyboard and monitor to make fully configurable intelligent terminal. Uses 6802 micro and 6845 controller. Program and character generator (7 x 9 matrix with descenders) in two 2716 EPROMs. Full scrolling at 9600 baud with 8 switch selectable rates. RS232 interface.

Bare board with 2 EPROMS and program listing — £48 plus VAT. Assembled and tested — £118 Send for details or CWO to:

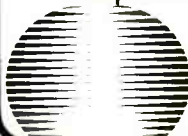

**CORTEX CONTROLLERS**

50 St. Stephens Place, Cambridge CB3 0JE  
 Telephone (0223) 68000

CIRCLE 25 FOR FURTHER DETAILS.



# APPLICATIONS SUMMARY

## Ten-channel graphic equalizer

One of numerous application examples in Samsung's audio i.c. data book is this graphic equalizer circuit in which two five-channel i.cs are combined.

The KA2223 consists of an op-amp and five active-filter circuits. Total harmonic distortion for 1V input at 1kHz is 0.02% and noise between 10Hz and 20kHz is  $7\mu V$ .

Other products in this, the first Samsung audio data book to be made available in the UK, include f.m./a.m. r.f. devices, stereo decoders, pre/power amplifiers and led level meters.

Enter 300 on reply card.

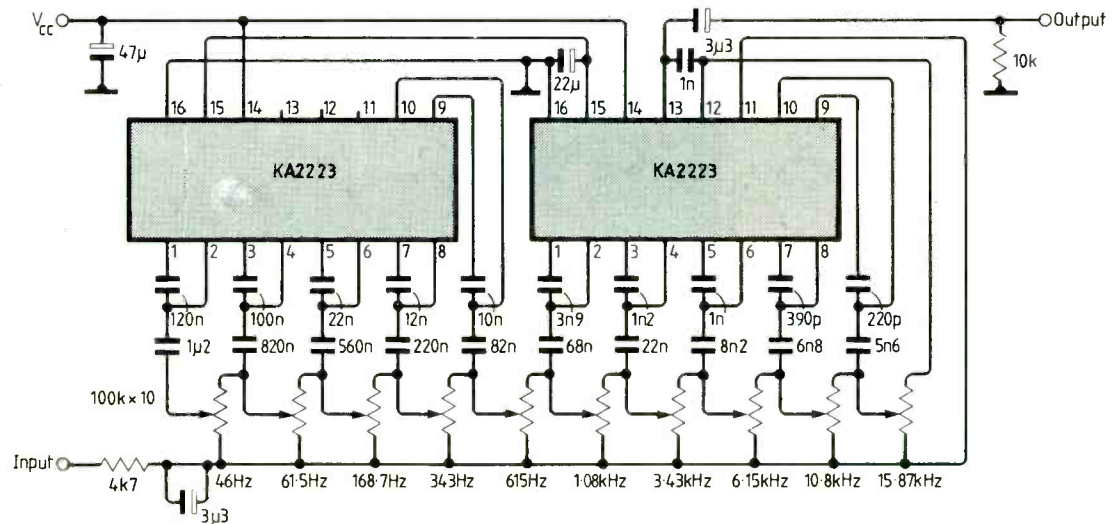

### ADDRESSES

Maxim  
Dialogue Distribution Ltd  
Wicat House  
403 London Road  
Camberley  
Surrey GU15 3HL

Samsung (UK) Ltd  
6th floor, Victoria House  
Southampton Row  
London WC1

Supertex, see Maxim

## 50-240Hz inverter with precision snubber

In switching power converters using more than one power transistor, a delay is usually needed between switching one transistor off and the next one on. Without this delay, transformer ringing would be dissipated in the switching transistors.

In this inverter circuit, one of 29 applications in "Dmos design entries and articles" from Supertex, the  $11.25^\circ$  delay is produced digitally. Output power is increased by connecting more switching transistors in parallel.

Enter 301 on reply card.

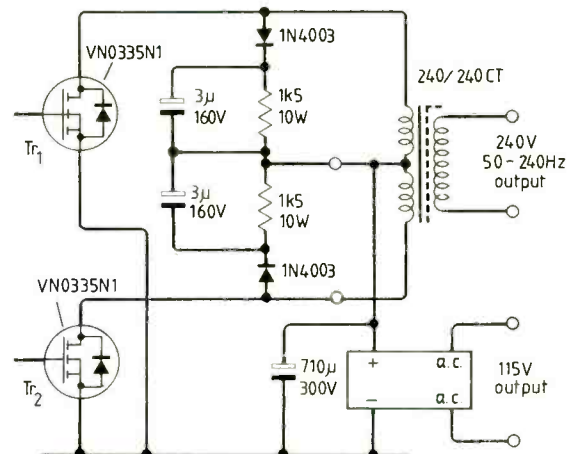
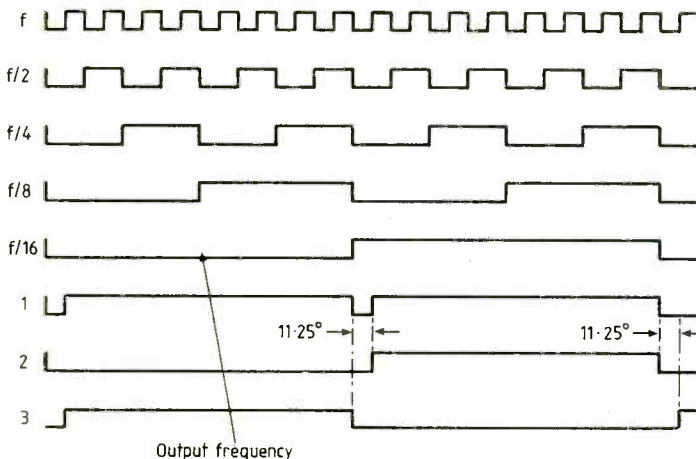
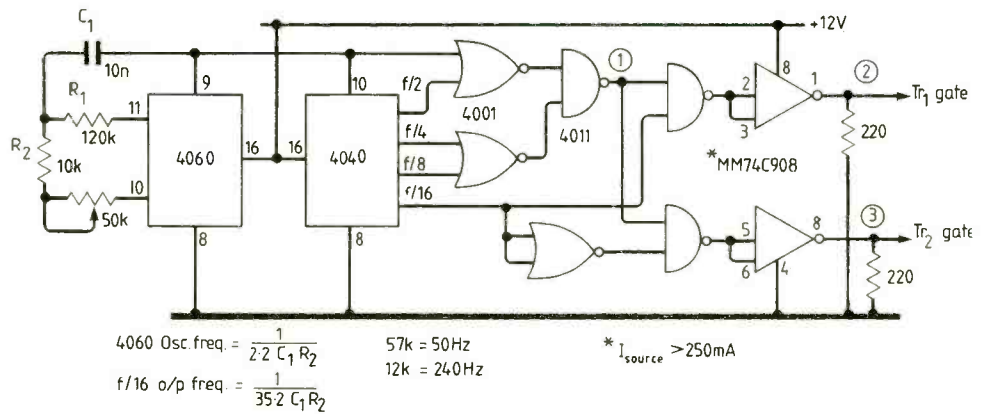

# NEW PRODUCTS

## Digital capacitance meter

Capacitance values between 0.1pF and 2mF can be measured on the Levell 7705 capacitance meter. Accuracy on this 3-digit instrument is 0.5%. The test voltage is 3.2V peak with two measurements a second. The unit has an input protection fuse. £49 (+ tax) from Levell Electronics Ltd, Moxon Street, Barnet, Herts EN5 5SD. EWW218 on reply card.

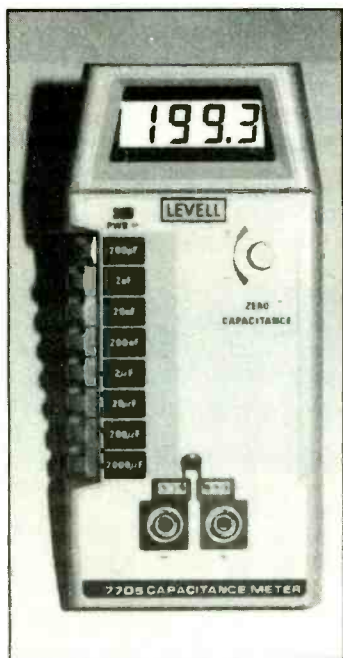

## Fast 256K d-ram

Claimed to be the fastest available, the 256K d-ram from Inmos has an access time down to 60ns, more than twice as fast as the usual standard of 150ns. The IMS2800 is suitable for all applications in replacing 64K d-rams in, for example, personal computers or upgrading first-generation 256K d-rams in mainframe applications. It also has an important application with the latest generation of 32-bit processors where, according to Inmos, it is the only dynamic ram that can enable them to work at peak performance. The c-mos devices can operate at up to 30Mbit/s. Inmos International plc, Whitefriars, Lewins Mead, Bristol BS1 2NP. EWW209 on reply card.

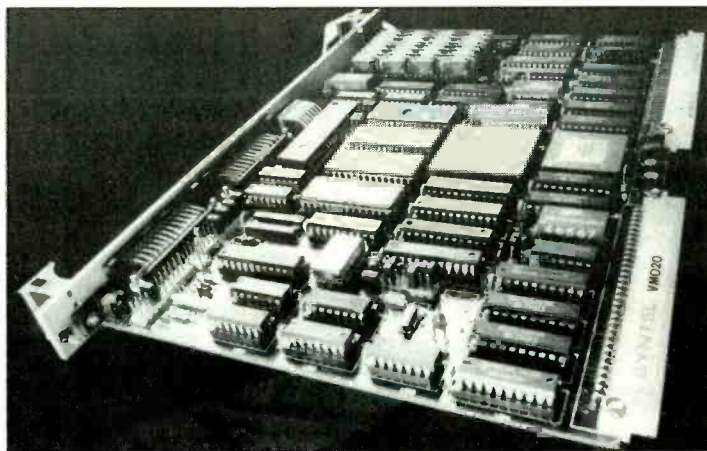

## 68020 on VME card

The VME processor module from Syntel is claimed to be the first to use the 68020 and the 68881 maths co-processor with a G-64 i/o interface. High-speed maths and graphics are possible. The addition of the G-64 interface allows the user to select from over 300 i/o modules from more than 15 suppliers. Processing power is further enhanced by the 1Mbyte, 32-bit wide on-board memory. Additional memory cards can be added in units of 64 and 256K d-ram.

The processor can operate at 12 or 16MHz and the VME interface offers 16Mbyte, 16-

bit wide addressing space with bus access logic and full line buffering in accordance with the VME specification. The G-64 interface allows off-board transfers at 1 or 2MHz within a 1Mbyte memory address space. A separate on-board i/o memory space allows slow devices to be used with the 2MHz clock.

The module includes a real-time calendar/clock and dual RS232/422 ports. It supports the OS9 68000 operating system, providing multi-user, multi-tasking capabilities for both rom and disc-based systems. Syntel Microsystems, Queens Mill Road, Huddersfield, HD1 3PG. EWW206 on reply card.

## Pulse generator

An instrument from Ver Controls is suitable for field or bench work and has sufficient output for direct drive of positive logic families, and is also capable of driving capacitive loads such as power mosfets and small relays. The frequency range extends from 1Hz to over 5MHz and the mark/space ratio can be adjusted as required. Based on the design described in last month's issue

(pages 43-47), two complimentary outputs are provided to allow push-pull driving; 30V peak-to-peak and pre-trigger functions. A single shot facility is also included. The generator is powered by a.c. mains and there is also provision for internal rechargeable batteries. Ver Controls (St Albans) Ltd, Rookery House, Crowe's Loke, Little Plumstead, Norwich NR13 5JB. EWW210 on reply card.



## Surface-mount starter kit

Designed to make surface mounting a viable proposition for the smaller company, the Cosy surface mounting starter kit is manufactured by Contact Systems in Switzerland. Hand assembled boards can be produced with the kit which is made up from a screen printer, assembly station, vacuum pick-up pen and a conveyor oven for reflow soldering.

The screen printer offers two sizes of work area; 100 by 120mm and 220 by 300mm. It uses etched or drilled stencils of varying thickness, according to the nature of the circuit. An accurate pin and vacuum positioning system holds the board while the adhesive or solder paste is applied through the screen.

The assembly station can accommodate all of the formats that components are supplied in; stick and tape feeders as well as loose components. An

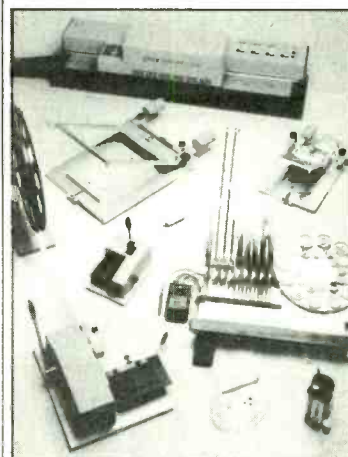

optional control unit can be programmed to light indicators on each component feeder in the correct sequence for rapid population of the board.

The bench-mounted infra-red conveyor oven features three heating zones and can accept boards up to 108mm wide an up to 34mm high. Typical reflow temperatures are between 180 and 280°C but temperatures above and below this range can be selected for specific applications. All three heating zones and the speed of the conveyor can be adjusted. Sohlberg-Surtech Ltd, Intec 2, Wade Road, Basingstoke, Hants RG24 0NL. EWW222 on reply card.

# LANGREX SUPPLIES LTD

Climax House, Fallsbrook Rd., Streatham, London SW16 6ED

RST Tel: 01-677 2424 Telex: 946708 RST

SEMICONDUCTORS		SEMICONDUCTORS		SEMICONDUCTORS		SEMICONDUCTORS		SEMICONDUCTORS		SEMICONDUCTORS		SEMICONDUCTORS		SEMICONDUCTORS	
AA119 0.10	AA216 2.00	AA217 1.00	AA218 1.00	AA219 1.00	AA220 1.00	AA221 1.00	AA222 1.00	AA223 1.00	AA224 1.00	AA225 1.00	AA226 1.00	AA227 1.00	AA228 1.00	AA229 1.00	AA230 1.00

VALVES		VALVES		VALVES		VALVES		VALVES		VALVES		VALVES		VALVES	
A1834 9.00	E1834 10.50	E1835 10.50	E1836 10.50	E1837 10.50	E1838 10.50	E1839 10.50	E1840 10.50	E1841 10.50	E1842 10.50	E1843 10.50	E1844 10.50	E1845 10.50	E1846 10.50	E1847 10.50	E1848 10.50

BASES		CRTs		CRT sockets		INTEGRATED CIRCUITS		INTEGRATED CIRCUITS		INTEGRATED CIRCUITS		INTEGRATED CIRCUITS		INTEGRATED CIRCUITS	
B7G Unskirted	2AP1 8.50	5P15A 15.00	5P17 25.00	DG7-5 63.32	DG7-6 65.00	DG7-7 65.00	DG7-8 65.00	DG7-9 65.00	DG7-10 65.00	DG7-11 65.00	DG7-12 65.00	DG7-13 65.00	DG7-14 65.00	DG7-15 65.00	DG7-16 65.00

Terms of business: CWO. Postage and packing valves and semiconductors 50p per order. CRTs £1.50. Prices excluding VAT, add 15%.  
 Price ruling at time of despatch.  
 In some cases prices of Mullard and USA valves will be higher than those advertised. Prices correct when going to press.  
 Account facilities available to approved companies with minimum order charge £10.00. Carriage and packing £1.50 on credit orders.  
 Over 10,000 types of valves, tubs and semiconductors in stock. Quotations for any types not listed: S.A.E.

Telephone 01-677 2424/7  
 Telex 946708  
 E. & O.E.  
 Open to callers Monday-Friday 9 a.m.-5 p.m. WW

CIRCLE 21 FOR FURTHER DETAILS



## Low-cost scanning microscope

Especially suitable for the inspection of electronic components and microcircuits. The T100 scanning electron microscope costs £1500 which is less than an advanced optical microscope. It offers magnification up to 100 000 times. It comes with a 24-function maintenance checker to help the user to check quickly the operating parameters.

A fast scan facility presents the operator with continuous images up to tv frame

frequency and images can be captured by the integral camera. Optimum settings are automatically maintained even when the field-of-view or magnification are altered. With a resolution down to 8nm, the scanning electron microscope offers several advantages over optical instruments in terms of sharper detail and in electronic circuit testing. Many other facilities, such as X-ray spectroscopy and backscatter electron detection are possible with the system. Jeol UK Ltd, Grove Park, Colindale, London NW9 0JN. EWW214 on reply card.

## Flat cable goes round

The routing flexibility of round cable is combined with the easy termination of flat ribbon types in the 3M 3659 cable. The flat cable is surrounded by a film foil shield which is in turn covered by a 90% tinned copper braid. This combination offers effective r.f.i. shielding. A flat cable termination area occurs every 20mm along the cable which minimizes cable waste during preparation. The outer p.v.c. insulating sleeve, rated at 80°C, is available in four colours. Connect and Control Systems Ltd, Unit D3, Taylor Industrial Estate, Culcheth, Warrington, Cheshire WA3 6BH. EWW221 on reply card.

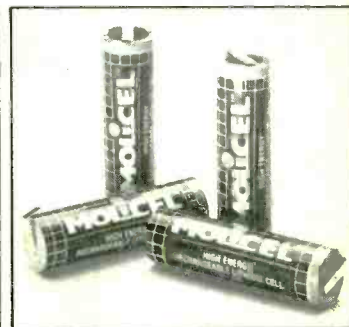
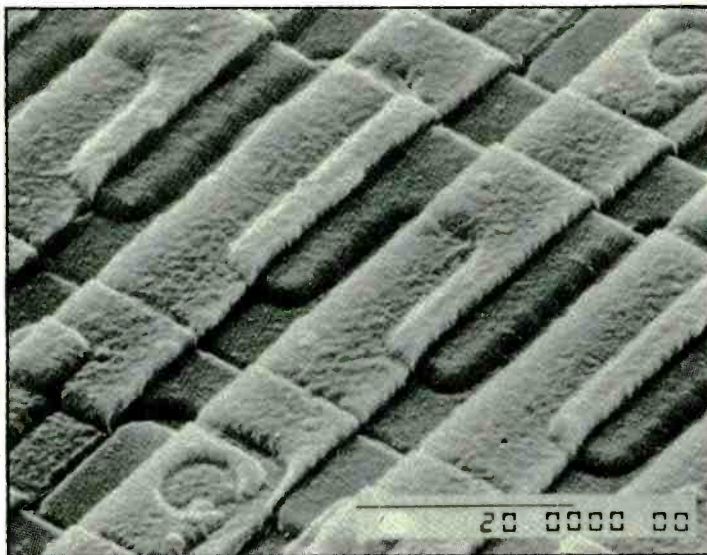

## Rechargeable lithium

The Molicell lithium battery has an energy density about twice that of NiCd cells. Self-discharge rates are very low and cycle life is similar to that of other rechargeable batteries. A useful feature of the lithium cells is that relationship between discharge and voltage is almost linear which allows the stored charge to be monitored accurately. Available through All Batteries at Watford and Suvicon Ltd, of Solihull. EWW216 on reply card.

## Thyristors for medium-power applications

Designed for use in general purpose phase-control applications such as converters, lighting circuits, battery chargers, regulated power supplies and temperature or motor speed control circuits, the RIA series of glass-passivated thyristors come from International Rectifier. Features of the devices include, depending on type, a maximum 'on' current of 25 or 35A; and a maximum peak non-repetitive current of 190, 285 or 335A. The maximum repetitive reverse voltage is 100 to 1200V and the typical turn-on time is 0.9µs. Available through Hi-Tek Electronics, Ditton Walk, Cambridge CB5 8QD. EWW215 on reply card.

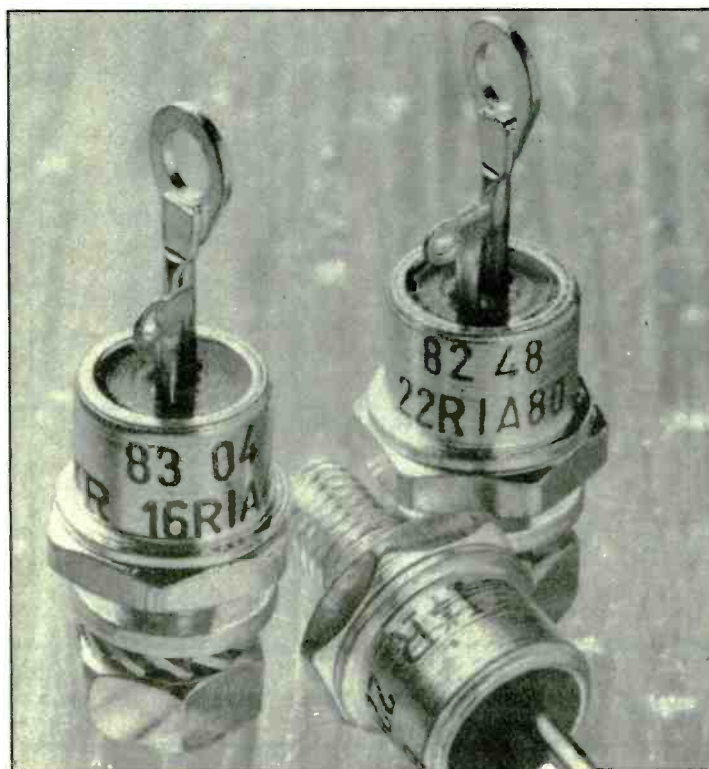

## Low-distortion audio oscillator

According to Sage Audio, traditional measuring instruments do not match the equipment that they are supposed to measure with the advent of digital audio, compact discs and mosfet amplifiers. The SA1 audio oscillator offers a total harmonic distortion of typically 0.0001% (or 1p.p.m.) at 1kHz. Its four fixed test frequencies of 100 and 400Hz, 1 and 10kHz have a continuously variable output level up to 1V r.m.s. Other frequencies are available to order. The instrument also incorporates a noise test button which removes the test frequency whilst leaving the generator's gain, source impedance and residual noise level as they were. An accurate noise reference can then be established which can be subtracted from the t.h.d. + noise reading to give a more accurate measurement for the system under test. Sage Audio, Construction House, Whitely Street, Bingley, W. Yorks BD16 4JH. EWW213 on reply card.

# The Archer Z80 SBC

The SDS ARCHER – The Z80 based single board computer chosen by professionals and OEM users.

- ★ Top quality board with 4 parallel and 2 serial ports, counter-timers, power-fail interrupt, watchdog timer, EPROM & battery backed RAM.
- ★ **OPTIONS:** on board power supply, smart case, ROMable BASIC, Debug Monitor, wide range of I/O & memory extension cards.

from £185 + VAT.

CIRCLE 42 FOR FURTHER DETAILS

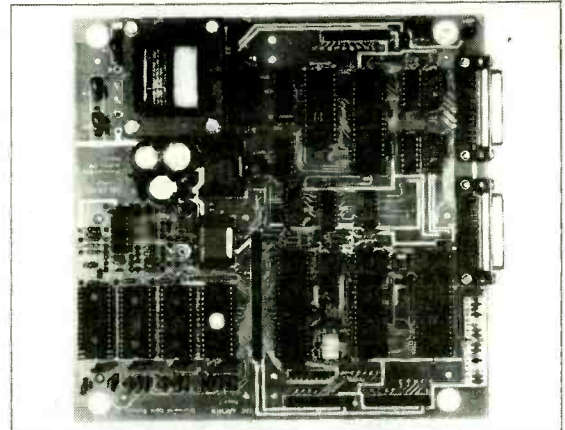

# The Bowman 68000 SBC

The SDS BOWMAN – The 68000 based single board computer for advanced high speed applications.

- ★ Extended double Eurocard with 2 parallel & 2 serial ports, battery backed CMOS RAM, EPROM, 2 counter-timers, watchdog timer, powerfail interrupt, & an optional zero wait state half megabyte D-RAM.
- ★ Extended width versions with on board power supply and case.

from £295 + VAT.

CIRCLE 43 FOR FURTHER DETAILS



# Sherwood Data Systems Ltd

Sherwood House, The Avenue, Farnham Common, Slough SL2 3JX. Tel. 02814-5067

## HIGH QUALITY – LOW PRICES

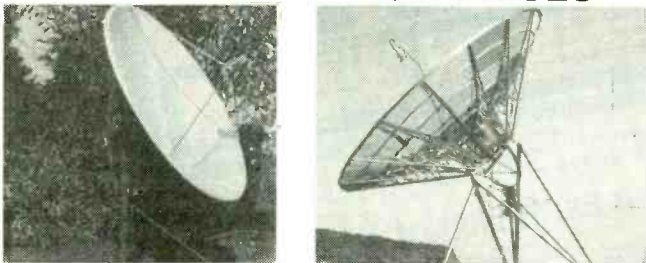

### 4+11GHz SATELLITE TV RECEIVING EQUIPMENT

RECEIVERS, LNB's, LNC's, FEED HORNS, ANTENNAS, ANTENNA POSITIONERS, POLAROTORS, LINE AMPLIFIERS, ETC.

For further details contact

**HARRISON ELECTRONICS**

Century Way, March, Cambs. PE15 8QW Tel: (0354) 51289

1/508

## HART – The Firm for QUALITY

### LINSLEY HOOD 300 SERIES AMPLIFIER KITS

Superb HART designed, integrated amplifier kits derived from Linsley-Hood's articles in 'HiFi News'

Ultra easy assembly and set-up with sound quality to please the most discerning listener. Ideal basis for any domestic sound systems if quality matters to you. Buy the complete kit and save pounds off the individual component price

K300-35, 35 Watt, Discount price for Complete Kit	£98.79
K300-45, 45 Watt, Discount price for Complete Kit	£102.36
RLH4&5. Reprints of Original Articles from 'HiFi News'	£1.05 no VAT



### LINSLEY-HOOD SYNCHRODYNE AM RECEIVER

Very high quality kit for this recent design featured in 'Wireless World'. Advanced construction system, approved by the Author, uses 3 double sided PCBs in a stacked layout for total stability, ease of construction and minimal wiring. This module will form the AM section of an ultra high quality AM/FM switched bandwidth tuner to match our 300 series amplifiers. Power supply and tuning gang will be included with the FM section.

K450 JLH Synchrodyne Kit ..... **Special Price £59.95**

### LINSLEY-HOOD CASSETTE RECORDER CIRCUITS

Complete stereo record, replay and bias system for reel-to-reel recorders. These circuits will give studio quality with a good tape deck. Separate sections for record and replay give optimum performance and allow a third head monitoring system to be used where the deck has this fitted. Standard 250mV input and output levels.

K900W Stereo Kit with Wound Coils and Twin Meter Drive	£65.67
RJS1 Reprints of Original Articles	£1.30 no VAT

### HIGH QUALITY REPLACEMENT CASSETTE HEAD

Do your tapes lack treble? A worn head could be the problem. Tape heads are constantly improving and fitting one of our latest replacement heads could restore performance to better than new! Standard mountings fit most decks and our TC1 Test Cassette will make it easy to set the azimuth spot on. As we are the actual importers you get prime parts at lowest prices. All our heads are suitable for Dolby machines.



HC20 Permalloy Stereo Head. Good quality standard head fitted as original equipment on many decks	£5.11
HS16 Sendust Alloy Super Head. Quite simply the best. Longer life than permalloy, higher output than ferrite, fantastic frequency response	£9.91
HQ551 4-Track head for auto-reverse or quadrophonic use. Full specification record and play head	£9.73
Special Offer Stereo R/P Heads	£2.49
4-Track Auto-Reverse Play Head	£3.50

### HART TRIPLE-PURPOSE TEST CASSETTE TC1

One inexpensive test cassette enables you to set up VU (Dolby) level, head azimuth and tape speed without test equipment. Vital when fitting new heads. Complete with instructions

Send for your **FREE** copy of our lists with full details of our complete range of Kits, Components, PCBs, Cassette Heads and Decks: - Overseas please send 5 IRCs for Airmail Post. Please add VAT to all prices. Postage on orders up to £10 - 50p. £10 to £49 - £1. Over £50 - £1.50.

## RF POWER

**U.S. supplier of RF POWER DEVICES.**  
Prices **LOWER** than current domestic prices.  
Query us for immediate needs.

A quality source for a complete range of RF POWER devices - From 2-30MHz, SSB 12.5V 7.28V transistors - 14-30 MHz CB/AMATEUR 27-50 MHz, low band FM - 66 - 88MHz, mid band FM - 66 - 88MHz, mid band FM - 156 - 162MHz VHF MARINE RADIO FM - 130 - 175MHz HI-BAND VHF FM - 108-152MHz VHF AIRCRAFT AM - 225 40MHz UHF 28V - 407 - 512 UHF CATV/MATV CLASS A linear transistors - A SMALL indication of types are listed below. SEND FOR OUR FREE BROCHURE AND/OR CONTACT FOR IMMEDIATE QUOTES.

MRF450	MRF453	MRF646	BLY88A	BLY90	BLY93A
.2N3553	.2N4933	.2N5109	.2N3375	.2N5016	.589
.2N4128	.2N5070	.2N5591	.2N6080	.2N4427	.2N5090
.2N5634	.2N6083	.2N4431	.2N5102	.2N5918	.2N6084

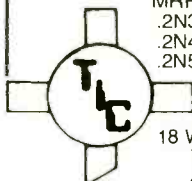

**TIC Semiconductor Inc.**

18 WEST 21st STREET NEW YORK, N.Y. 10010 U.S.A.  
TEL: (212) - 675 6722 TELEX: 284564 TICS UR

CIRCLE 15 FOR FURTHER DETAILS

**HART ELECTRONIC KITS LTD**  
1, Penylan Mill, Oswestry, Shropshire SY10 9AF  
24 hr SALES LINE (0691) 652894 Please add VAT

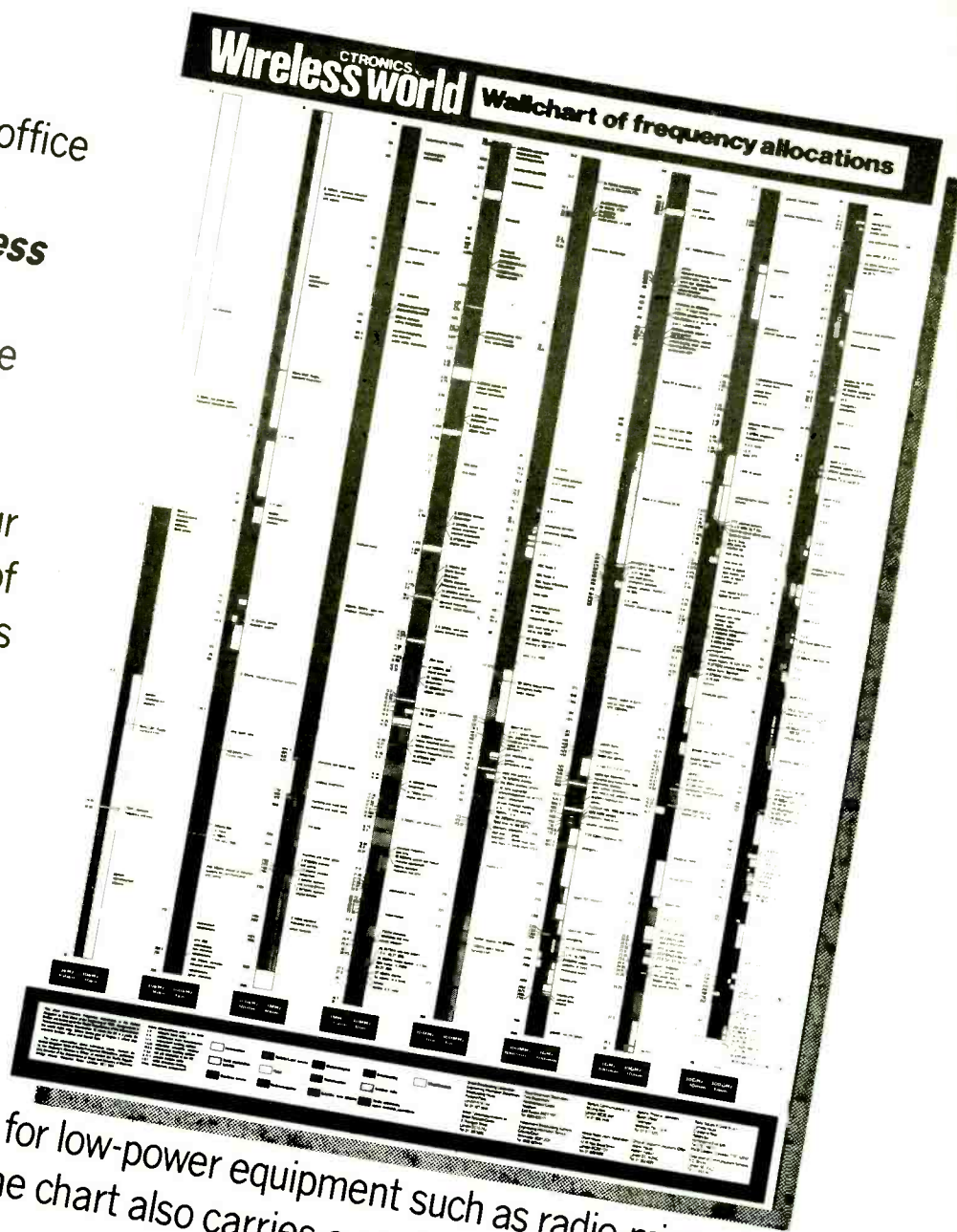

Brighten up your office or lab with a copy of **Electronics and Wireless World's** wallchart of frequency allocations. The chart covers frequencies from 3kHz to 300GHz in eight sections, with colour codes to show the uses of each band. Detailed notes mark areas of special interest to the scientist and engineer — such as standard frequency and time signals, radio-astronomy bands, mobile radio, public radiophones and pagers, and assignments for low-power equipment such as radio-microphones and anti-theft devices. The chart also carries a useful list of addresses.

This special unfolded edition of the chart is laminated for protection and it comes to you in a cardboard tube. The price is just **£5.75** inclusive.

# Electronics & Wireless World 1986 Frequency Wall Chart

Please send me ..... copies of the 1986 Frequency Wall Chart.  
 Each wall chart is priced at £5.75 (including VAT)  
 I enclose my cheque/postal order for £ ..... Please make cheques payable to Business Press International Ltd.  
 Please debit my credit card (circle) VISA/ACCESS/AMEX/DINERS CLUB  
 My card number is                       
 My card expires on.....  
 Name..... Signature.....  
 Address.....

Please return this form with payment to:  
 Electronics & Wireless World,  
 Computing Posting Ltd,  
 120-126 Lavender Avenue, Mitcham,  
 Surrey CR4 3HP

## Calibration system

A programmable calibrator can be combined with a personal computer to give an automated, documented calibration system for multiplexers, oscilloscopes, wattmeters and watt-hour meters. The system is aided by menu-driven programmes to enable less-skilled operators to conduct tests and calibrations. Compucal, as it is called, assures quality control by programming the test to be carried out on each instrument. Results before and after the adjustment can be recorded, and a test certificate automatically printed. Storage

of an instrument's test history on disc can help in the organizing of test instrument inventory. New test procedures can be entered simply by response to program-generated questions. All tests can be password protected. Control is carried out through an IEEE488 interface.

The tests are carried out to certification standard in accordance with BS5750 and can be used by those who previously had to send the equipment to other test laboratories to be certified. PPM Instrumentation Ltd, Hermitage Road, St. Johns, Woking, Surrey GU21 1TZ. EWW212 on reply card.

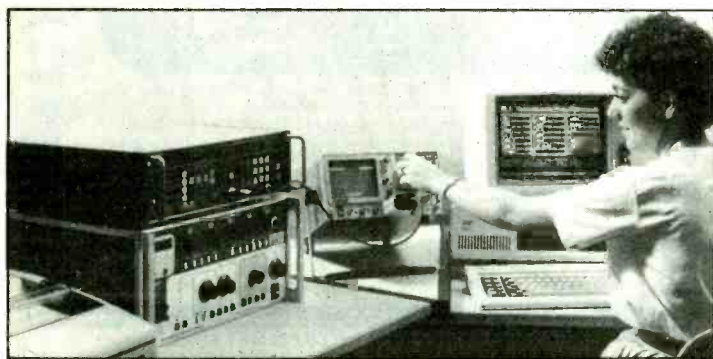

## Function generator

A frequency range from 1Hz to 100kHz with calibrated vernier adjustment is available on Global's 2001 function generator which can also provide frequency sweeps. High and low-level sine, triangle and rectangular outputs are augmented by a separate t.t.l.-level rectangular-wave output which can drive up to 30 standard loads with rise and fall times less than 25ns. Outputs levels are adjustable

over a range of more than 40dB. The voltage-controlled sweep oscillator can be set to any range of frequencies, and the sweep input can be within the range of  $\pm 10V$ . Of low weight and easily portable, the instrument is suitable for field servicing and measurement of audio and video equipment and for oscilloscope sweep drives, as well as for general use in the laboratory. Global Specialties Corporation, Shire Hill Industrial Estate, Saffron Walden, Essex CB11 3AQ. EWW205 on reply card.

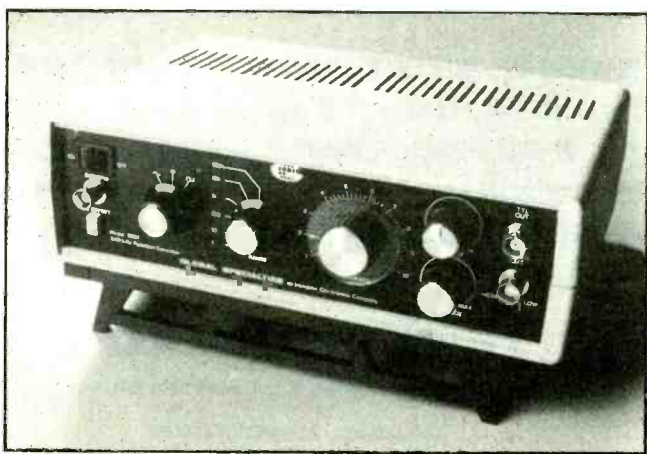

## Instant crystals

A service designed to supply quartz crystals in the frequency range 1 to 70MHz on an express made-to-order basis is available from Piezo Products. Their production unit in Hampshire is geared to producing crystals within three days, or even less in an emergency. The crystals are tested for compliance with the relevant standards. They can reproduce a crystal from its type number or specification, or from the equipment type and model number together with the frequency. Piezo Products Ltd, Millstream Trading Estate, Christchurch Road, Ringwood, Hants BH24 3SD.

EWW225 on reply card.

## Two-port ram speeds interprocessor access

A dual-port static ram simplifies multiprocessor system design by allowing independent read/write access to the devices' common data bank. The 1K by 8 device, AM2130, has separate i/o ports, addresses and controls, as well as busy and interrupt signal for interfacing with most popular processors. For increased flexibility the device also independent chip-enables for each port control.

Automatic power-down circuitry allows the respective sides of the device to remain in standby power mode while it is inactive. On board arbitration circuitry and an internal mailbox prevent clashes between simultaneous access to the same memory location and eases port-to-port communication.

The main function of the device is to offer a data communications memory between two asynchronous processors or controllers. This aids efficient instruction and data transfer between c.p.u. and i/o processor in mini and multiprocessor computers. Advanced Micro Devices (UK) Ltd, Goldsworth Road, Woking, Surrey GU21 1JT. EWW224 on reply card.

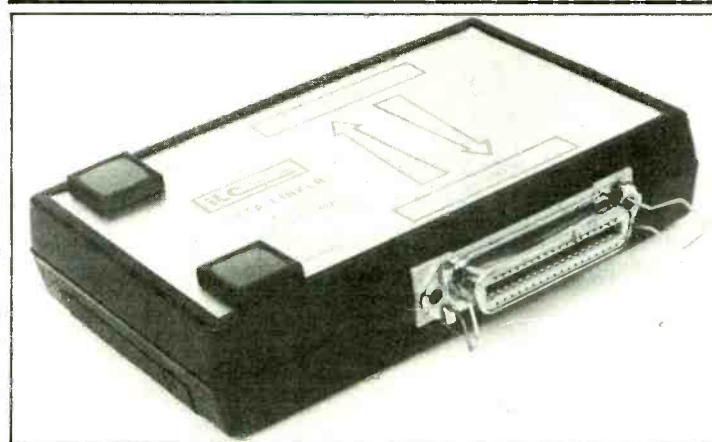

## Serial/parallel printer buffers/converters

Two versions of the Model B Datalinker serial-to-parallel and parallel-to-serial conversion and either 8 or 32K of printer buffer. The 8K version can be upgraded to 32K at a later stage. Other attributes include selectable

page repeat and automatic line-feed generation. Recommended prices for the converters are £120 for the 8K and £180 for the 32K models. Interlink Communications Ltd, 6 Buchanan Units, Gorse Lane Industrial Estate, Clacton-on-Sea, Essex CO15 4XA.

EWW208 on reply card.

**CROSSWARE**

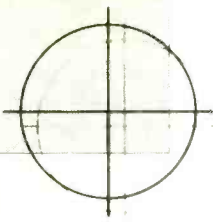

SOFTWARE  
DEVELOPMENT TOOLS FOR  
THE BBC MICROCOMPUTER

**CROSS · ASSEMBLERS**

FULLY SUPPORTED  
QUALITY SOFTWARE

**Assemblers and Disassemblers on ROM**

The BBC Microcomputer is an impressive machine, especially the new Master 128 running with the hierarchical Advanced Disc Filing System. Our software allows full use of its advanced facilities. For example, source code modules held in separate files of any name in any directory on any drive can be linked and assembled to create your machine code program in Motorola S, Intel hex or binary format.

It's also very fast. In fact, one of our customers has compared the speed of the BBC micro with Hewlett-Packard's powerful HP64000 development system. He assembled identical software on both machines and was surprised to find the BBC micro running with our 6801XR cross-assembler to be the fastest of the two.

Our software is available for assembling machine code programs for the BBC micro itself (for which our 65C02XR rom is ideally suited) or for any of the other target processors listed below. It is compatible with the models B, B+ and Master 128 and with all DFS, ADFS and Econet filing systems. (Owners of early model B's should ensure that their computer is equipped with Basic 2).

Order Code	Target Processors	Price
6801XR	6800,6801,6802,6301...6301X	£48.00
6805XR	6805,146805,6305	£48.00
6809XR	6809 family	£48.00
8085XR	8085,8080A	£48.00
Z80XR	Z80, HD64180	£48.00
68000XR	68000,68008	£56.00
65C02XR	65C02, 65S02, 6502	£38.00

Further information from: (prices exclude VAT)  
**CROSSWARE PRODUCTS**  
2 The Lawns, Melbourn, Royston, Herts SG8 6BA  
Telephone: 0763 61539



CIRCLE 25 FOR FURTHER DETAILS

**ELECTRONICS & Wireless world**

**Editorial Feature List**

**OCTOBER**

**Oscilloscopes**

From high performance to low-cost, the October issue takes a comprehensive look at the array of oscilloscopes available on the UK market.

**NOVEMBER**

**Mobile Radios**

With the launch of 900 MHz cellular radio last year and the release of Band III frequencies, mobile radio in the UK is enjoying a period of unprecedented expansion. November's special feature focuses on the systems and the equipment currently available.

For further advertising details please ring Ashley Wallis on: 661 3130

**LOOK AHEAD!**

**WITH MONOLITH MAGNETIC TAPE HEADS**

DOES YOUR VCR GIVE WASHED OUT NOISY PICTURES - ITS PROBABLY IN NEED OF A NEW HEAD - FAST FROM OUR EX-STOCK DELIVERIES. SAVE £££'s ON REPAIR CHARGES.

Our replacement video heads fit most models of VHS or Betamax VCR's. Following our replacement guide and with a practical ability, you can do the whole job in your own home with our head replacement kit.



**VIDEO HEAD REPLACEMENT KIT**



VMC-02 KIT ONLY £19.95 inc. VAT. + £2.50 p&p  
(Kit does not include video head)

TELEPHONE US NOW FOR INFORMATION OF THE REPLACEMENT HEAD FOR YOUR VIDEO RECORDER.

**CATALOGUE:** For our full Catalogue of Replacement Video and Audio Cassette/Reel to Reel Heads, Motors, Mechanisms, etc. Please forward 50p p&p.

**THE MONOLITH ELECTRONICS CO. LTD.**  
5-7 Church Street, Crewkerne, Somerset TA18 7HR, England.  
Telephone: Crewkerne (0460) 74321 Telex: 46306 MONLTH G

CIRCLE 19 FOR FURTHER DETAILS

**DATA GENERAL MINICOMPUTER PARTS AND SYSTEMS**

Does your application need those multi-user megabytes but your budget stretch only to a PC? Or is your old DG mini flat on its back? Need an upgrade? Second printer? Hardware support? As traders in commercial systems, we always have stock of older (and newer) equipment. We also deal in second-hand and surplus micro systems. Large SAE for current catalogue.

Sample stock: Ferranti PC860 IBM-compatible with twin floppy disks and 20MB hard disk, Perfect Filer, Writer & Calc, on-site warranty (used 4 months) - £1,200; Torch ZEP 100 Z80 add-on for BBC Micro with Perfect Software - £150; Data General 10+10MB disk drive subsystems with 3 spare disks, refurbished & tested - £800 + carr.

**SILICON GLEN LTD**

Moray Street, Blackford, Perthshire, Scotland  
Callers & Overseas Enquirers welcome  
or Telephone: 076482 315 or 464  
Telex: 295141 TXLINK G quoting MBX 076482315 on first line  
Bulletin Board Sales Catalogue (Prestel Standard) on 076482465

CIRCLE 27 FOR FURTHER DETAILS

IN VIEW OF THE EXTREMELY RAPID CHANGE TAKING PLACE IN THE ELECTRONICS INDUSTRY, LARGE QUANTITIES OF COMPONENTS BECOME REDUNDANT. WE ARE CASH PURCHASERS OF SUCH MATERIALS AND WOULD APPRECIATE A TELEPHONE CALL OR A LIST IF AVAILABLE. WE PAY TOP PRICES AND COLLECT.

**R. Henson Ltd.**

21 Lodge Lane, N. Finchley, London, N.12. 5 mins. from Tally Ho corner

Telephone 01 445 2713/0749

CIRCLE 52 FOR FURTHER DETAILS

ELECTRONICS & WIRELESS WORLD SEPTEMBER 1986



# NEW PRODUCTS



## Portable data acquisition and control

Up to 100 remote measurement channels can be monitored and controlled through the Solartron Impact system. This is designed to work with the same companies' IMP family of

isolated measurement pods; rugged remote scanners that can be sited close to the sensors in the plant or test rig. Impact interfaces through a two-wire network link with up to five of the IMP units, each of which has up to 20 measurement channels. The controller comes in a portable case and includes a keyboard, 8-line display,

## Video controller with touch screen

Maurice is a touch-screen software based controller that can interface with a wide variety of studio equipment to provide real-time, on-line control of digital effects on one, two or more channels, as well as signal processing and route switching. Digital effects, mostly from v.t.r.s, can be added during the post-production cycle and include smooth zooms, slides, flips, folds as well as compressions, montages, coloured borders and key signals.

Menu-driven software allows moves to be planned, with start and stop points,

rehearsed and then stored. Nine such moves can be stored at any one time. Many commands are easily accessed through the central flat screen touch sensitive c.r.t. In addition to the joystick, spin wheel, T-bars, and image control knobs, there is a built-in floppy disc drive to download software and store commonly used effects sequences. The controller is at the heart of a modular system of interfaces and frame stores and the system can be expanded for additional channels or extra effects units, picture combiners etc. very easily. CEL Electronics Ltd, Chroma House, Shire Hill, Saffron Walden, Essex. EWW219 on reply card.



graphic printer and a serial interface for RS232/422 or a 20mA loop. It can be fitted with a mini-disc drive or battery-backed c-mos ram for mass storage. GPIB interfacing is available as an option. The unit is mains or battery powered with an automatic switch-over for protection in case of failure of the supply.

Scanning is performed under the control of an internal clock, setting date, day, hours and seconds as well as the intervals between scans. External triggering is also possible. Results may be stored in several forms: a complete record, alarm conditions or none at all. All remote inputs can be converted into any required units. Alarm limits can be set, including a rate-of-change limit. Solartron Instruments, Victoria Road, Farnborough, Hants GU14 7PW. 217 on reply card.

## Bus controlled 0.002% multimeter

Keithley's latest 6½-digit six-function multimeter is capable of reading rates up to 1000 readings per second in its 3½-digit mode. For 4½ digits this reduces to 200, and for 5½ digits it makes 20 readings per second. Direct voltage, two and four-wire resistance, decibel measurements, thermocouple and resistance thermometry, and l.f. alternating voltage from 0.1 to 10Hz are the basic functions of model 193. True r.m.s. readings are available (crest factor 3, bandwidth 500kHz) with optional accessories, as are direct current, high voltage and high current ranges. Best 24h accuracy is  $\pm 0.007\% \pm 2$  counts over a 12 month period. The 6½-digit mode allows a resolution of 100nV on the 200mV range.

The unit contains Keithley's Translator Software which allows the definition of more meaningful terms, for example, 'DC Volts' (*sic*) may be used in place of the typical GPIB alpha numeric command. Long control strings are replaced with short mnemonics, increasing efficiency through bus traffic reduction. And the emulation facility means that a 193 can be substituted into an existing

ATE System, with minimal software exchanges.

Other features of the 193 include a 500 point non-volatile memory, data retention during a power loss, and digital calibration from either the front panel or over the bus. Keithley Instruments Ltd, 1 Boulton Road, Reading, Berkshire. EWW220 on reply card.

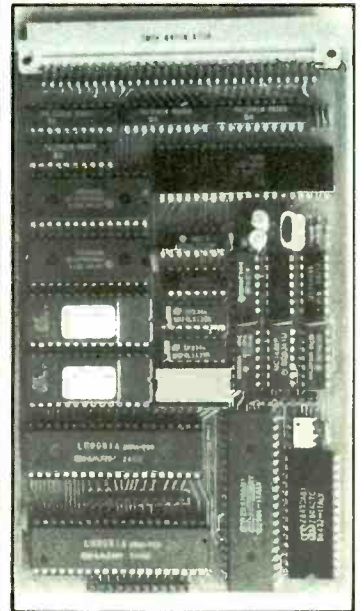

## CP/M control card

Centred around a Z80 processor is a single-board controller which can also function as the heart of a larger unit. The card contains two peripheral i/o chips; dart, c.t.c. and an array of memory up to 48K with 16K of c-mos ram made non-volatile by the addition of optional Smart sockets. Other features include a watchdog timer and multi-tasking facilities.

The software provided with the card is Mirror, a communications package that reflects the functions of CP/M. Once connected via RS232C to a host computer, the operator has the illusion of CP/M running on the Cardmaster board. Named programs load and run automatically, as they do on the host computer, correctly locating themselves in the new system. GNC Electronics, Little Lodge, Hopton Road, Theltham, Diss, Norfolk IP22 1JN. EWW211 on reply card.



# Hitachi Oscilloscopes

the highest quality from **£299**  
the most competitive prices + VAT

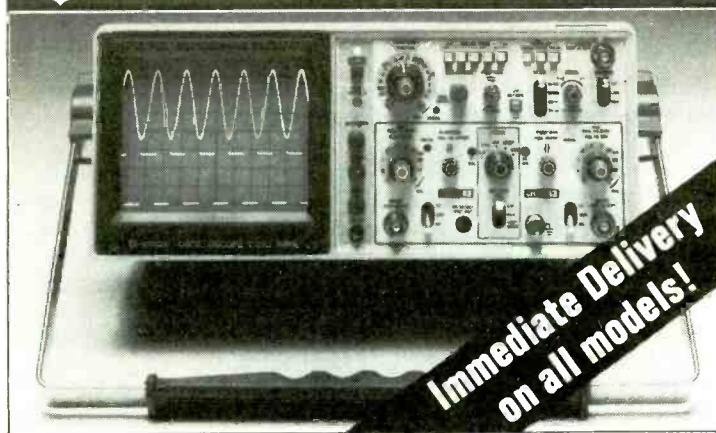

**Immediate Delivery  
on all models!**

Hitachi Oscilloscopes provide the quality and performance that you'd expect from such a famous name, with a newly-extended 14 model range that represents the best value for money available anywhere.

V-212/222	20MHz Dual Trace	V-650	60MHz Dual Timebase
V-223	20MHz Sweep Delay (illustrated)	V-1050	100MHz Quad Trace
V-209	20MHz Mini-Portable	V-1070	100MHz Four Channel
V-422	40MHz Dual Trace	V-1100	100MHz DMM/Counter
V-423	40MHz Sweep Delay	V-134	10MHz Tube Storage
V-509	50MHz Mini-Portable	VC-6015	10MHz Digital Storage
		VC-6041	40MHz Digital Storage

Prices start at £299 plus vat (20MHz dual trace) including a 2yr. warranty. **We hold the range in stock for immediate delivery.**

For colour brochure giving specifications and prices ring (0480) 63570  
**Thurlby Electronics Ltd, New Road, St. Ives, Cambs. PE17 4BG**

CIRCLE 45 FOR FURTHER DETAILS

## IEEE-488 controlled laboratory Power Supplies - at low cost the new Thurlby PL-GP series

- 30V/2A and 15V/4A single and twin units
- Constant voltage or constant current operation
- Programmable to 10mV and 10mA resolution
- Readback of current demand via the bus
- Twin units have fully independent outputs
- Remote sensing terminals provided
- Bench mounting or 19" rack mounting
- **Singles £395 + vat, Twin units £598 + vat**



Thurlby Electronics Ltd  
New Road, St. Ives, Cambs. PE17 4BG  
Tel: (0480) 63570

**Thurlby**   
designed and built in Britain

CIRCLE 46 FOR FURTHER DETAILS

## The world's most advanced low-cost bench multimeter!

**Thurlby 1905a £349 + VAT**



### A complete high performance bench DMM

- 5½ digits; 0.015% acc; 1 µV, 1mΩ, 1nA.
- Full ac and current functions as standard

### A sophisticated computing and logging DMM

- Linear scaling with offset; null/relative
- Percentage deviation; running average
- dBV, dBm general logarithmic calculations
- Limits comparison; min and max storage
- 100 reading timed data logging
- RS232 and IEEE-488 interface options

Thurlby Electronics Ltd  
New Road, St. Ives, Cambs. PE17 4BG  
Tel: (0480) 63570

**Thurlby**   
designed and built in Britain

CIRCLE 47 FOR FURTHER DETAILS

## Now Thurlby makes logic analysis affordable ! from

the new Thurlby LA-160 **£395 + vat**



**Now with microprocessor  
disassembly!**

- 16 channels, expands to 32
- Clock rates up to 20MHz
- State and timing displays
- Selectable display formats
- 2K word acquisition memory
- Non-volatile reference memory
- Search and compare facilities
- Hard-copy data print-out

An oscilloscope and logic probe are not enough to unravel the complexities of today's electronic equipment. A logic analyser is as essential for observing digital signals as an oscilloscope is for observing analogue signals, and now Thurlby puts one within every engineer's reach. Contact us now and get the full technical data.

**Thurlby**   
designed and built in Britain

Thurlby Electronics Ltd  
New Road, St. Ives, Huntingdon,  
Cambs. PE17 4BG, England. Tel: (0480) 63570

CIRCLE 48 FOR FURTHER DETAILS

# AFFORDABLE ACCURACY

Quality Multimeters from

## Cirkit

A comprehensive range of Analogue and (Pushbutton or Rotary Switched) Digital Models



**NEW  
SUMMER CAT  
OUT NOW**

### ANALOGUE

HM-102BZ - 10ADC Range, 20kV/DC, Buzzer, Battery Test Scale ..... £12.50  
19 measuring ranges  
HM-102R - Low end voltage & current ranges, Jack for Audio o/p voltages £11.00  
20 measuring ranges  
HM-1015 - Rugged, Pocket sized meter, for general purpose use ..... £7.50  
16 measuring ranges

Battery, Test Leads and Manual included with each model.

Please add 15% for VAT and 60p for p&p

### DIGITAL

HC-7030  
0.1% Accuracy, Standard Model ..... £39.50  
HC-6010  
0.25% Accuracy, Standard Model ..... £33.50  
HC-5010T  
0.25% Accuracy, TR Test Facility ..... £39.50  
DM-105  
0.5% Accuracy, Pocketable ..... £21.50

All models have full functions and ranges and feature 3 1/2 digit, 0.5" LCD display - low battery indication - auto zero & auto polarity - ABS plastic casing - DC AC 10amp range (not DM-105) - Overload protection on all ranges - battery, spare fuse, test leads and manual.

Full details and specification from:

**Cirkit Distribution Ltd**

Park Lane, Broxbourne, Herts EN10 7NQ  
Telephone (0992) 444111 Telex 22478

TRADE ENQUIRIES WELCOME



CIRCLE 63 FOR FURTHER DETAILS

# Liniplex

## HF Broadcast Relay Receivers

Now available in 2 - 4 channel, clock controlled, diversity configurations for unattended operation. HF feeds can now compete with satellites.

Phase Track Ltd.,  
55 Russell Street,  
Reading RG1 7XG

Tel: 0734 53933  
Telex: 848888



### 19" RACK MOUNTING CASES

A range of lightweight aluminium 19" rackmounting cases at competitive prices, available in the following sizes.

Height	Depth	Price
1RU	89mm	28.00
1RU	153mm	28.50
1RU	254mm	29.00
2RU	89mm	30.90
2RU	153mm	31.75
2RU	254mm	32.60
3RU	89mm	34.50
3RU	153mm	35.25
3RU	254mm	36.35



Front panel, 3mm extrusion finished in dawn grey, all other panels 16 SWG clear anodised aluminium. It should be noted that no constructional fixings are visible on the front panel.

For finishes or sizes different from above, or for details of our range of blank panels, vent panels, audio and video jackfields, panel punching and prototype manufacturing services, please call.

Please add 3.00 P&P +15% VAT

**Ian P. Kinloch & CO. Ltd**

75 Milford Road, Reading, Berkshire, RG1 8LG

Tel: (0734)598867 & 599773

CIRCLE 60 FOR FURTHER DETAILS



the chameleon  
that stands out  
from the crowd...

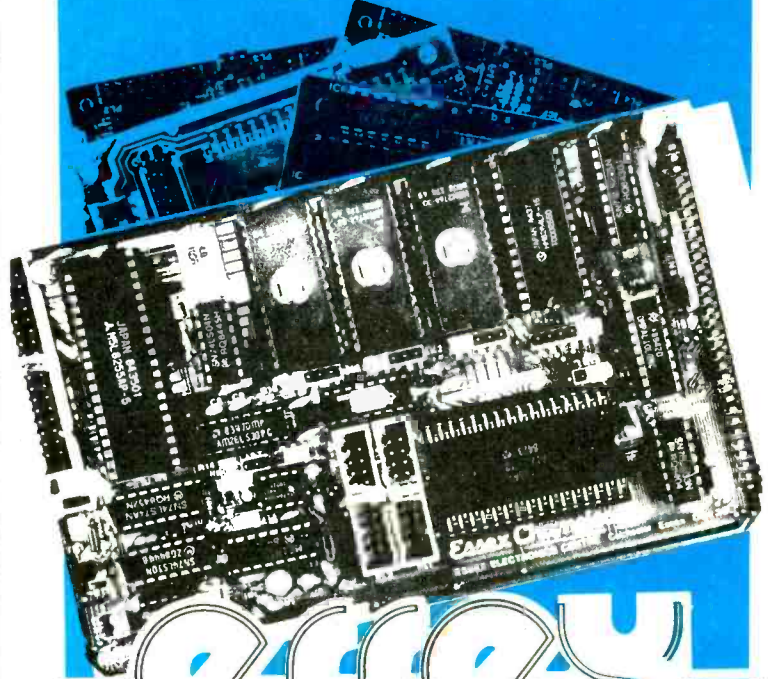

# Essex chameleon

## controller

all you need in a single card!

- Program in BASIC or FORTH/ASSEMBLER
- Fully 'Romtable' Code
- 54 Digital I/O Lines
- 64K Memory Space (8K RAM supplied as standard)
- Flexible Memory Mapping with PAL and PROM
- Full Duplex Serial Line RS422/423 + CTS, RTS
- Essex Bus with buffered data lines

The Chameleon Controller Card allows you to rapidly get to grips with your application and eliminates wasteful development time. A 5v supply and a terminal is all that is required to enable you to program in BASIC or FORTH/ASSEMBLER

Other system options include: Floppy Disk Interface, EPROM Programmer, Battery Backed Memory, Real Time Calendar Clock, Opto Isolated I/O, Mains Interfaces, 12 Bit A/D D/A Conversion. A packaged development system is also available.

Attractive discounts  
for volume users.

Send Today  
for Full Information



## Essex Electronic Centre

UNIVERSITY OF ESSEX COLCHESTER CO4 350  
Tel COL (0206) 865089

Also supplied by:

RCS MICROSYSTEMS, 01-979-2204

CIRCLE 51 FOR FURTHER DETAILS

# HAMEG

Instruments

## The New Modular System 8000

### the complete Test System

Consisting of Mainframe with power supply and constantly expanding Range of plug-in test and generator modules. It accommodates two modules at a time and can be placed above or below the Oscilloscope, or it may be stacked with other Mainframes.

The Modular System 8000 has been designed to match the new HAMEG Low Profile Oscilloscope series and thus enables the user to assemble a complete and variable test rack in a minimum of space. In addition, some of the modules can be accessed from the rear panels between Mainframe and Oscilloscope thus expanding their flexibility. The resulting system is unique and will be the standard of the future.

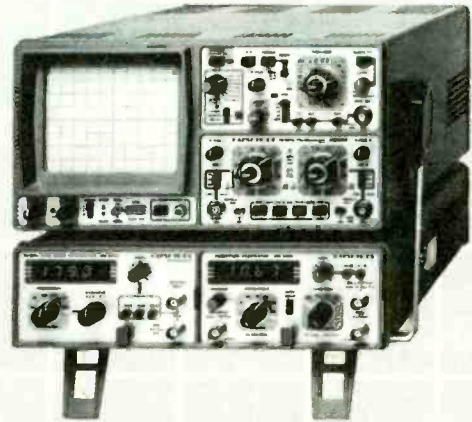

#### Modular System:

Mainframe with Power Supply	HM8001
£121.00	
Digital Multimeter 4½ digits	HM8011-2
£184.00	
Milliohm Meter incl. HZ84 Test Leads	HM8014
£165.00	
Counter/Timer 10Hz - 1 GHz	HM8021-2
£181.00	
Distortion Meter	HM8027
£134.00	
Function Generator 0.1Hz - 1MHz	HM8030-2
£150.00	
Sinewave Generator 20Hz - 20MHz	HM8032
£150.00	
Pulse Generator 2Hz - 20MHz	HM8035
£243.00	
Low Distortion Sinewave Generator	HM8037
5Hz - 50kHz	
£134.00	
Blank Module with Connector	HM8050
£16.00	
Module Adaptor - for external operation	HM8051
£34.00	

2 Years Warranty, parts and labour

For more information contact:

# HAMEG

Instruments

HAMEG Ltd. 74 - 78 Collingdon Street, Luton, Beds.  
LU1 1RX. Tel: (0582) 413174. Telex: 825484.

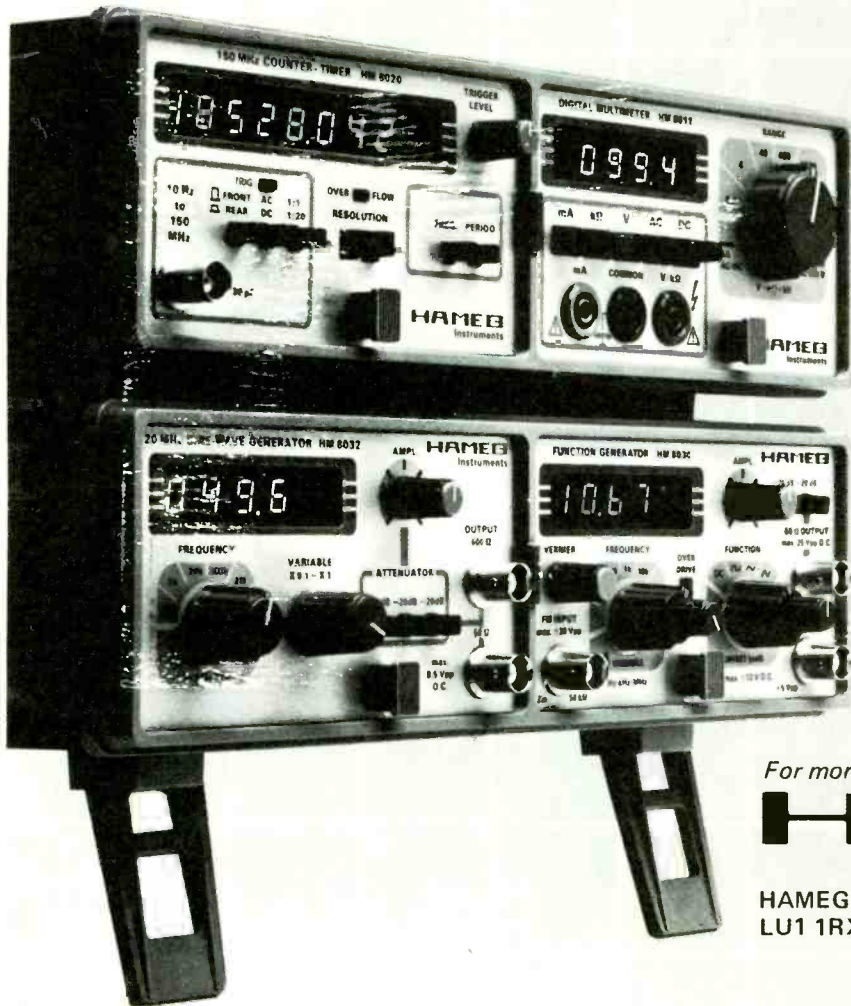

CIRCLE 66 FOR FURTHER DETAILS

# Appointments

Advertisements accepted up to 12 noon September 3 for October issue

DISPLAYED APPOINTMENTS VACANT: £23 per single col. centimetre (min. 3cm).  
 LINE advertisements (run on): £5 per line, minimum £40 (prepayable).  
 BOX NUMBERS: £11 extra. (Replies should be addressed to the Box Number in the advertisement, c/o Quadrant House, The Quadrant, Sutton, Surrey SM2 5AS).  
 PHONE: SUSAN PLATTS, 01-661 3033 (DIRECT LINE)

Cheques and Postal Orders payable to BUSINESS PRESS INTERNATIONAL LTD. and crossed.

## ELECTRONIC TECHNICIAN

INTERESTING WORK REPAIRING, MANUFACTURING AND DEVELOPING ELECTRONIC FLASH EQUIPMENT FOR A LEADING PHOTOGRAPHIC DISTRIBUTOR IN CENTRAL LONDON

Applicants should have a knowledge of basic electronics to City & Guilds standard but experience in this field is not essential. A driving licence would be an advantage.

Salary negotiable.

Apply in writing to:  
**Tony Beveridge**  
 The Flash Centre  
 54 The Brunswick Centre  
 Bernard Street, London W1

294

## EXPERIENCED MAINTENANCE ENGINEER

urgently required for large expanding recording complex in North London.

Box No: 307

## ELECTRONICS ENGINEER

### Lights... Camera... Action!

The National Museum of Photography, Film and Television in Bradford is planning to open new Television Galleries in November 1986.

You will assist with the design and installation of complex electronic displays and will be responsible for the technical operation and daily maintenance of this equipment once installed. Maintenance of all existing audio-visual displays, particularly the electrical and computer-based exhibits will play an important part in your work. You will also be responsible for the installation of future innovative, interactive exhibits.

You must have either an HNC/HBTEC in electronic engineering or a C and G Full Technological

Certificate in a relevant subject or be a registered Technician Engineer or have a degree in electronic engineering. In addition you must have between 2 and 8 years' post-qualification experience, depending on qualifications.

Salary £9010 - £11,395 depending on qualifications and experience. Significant improvements in pay scales will take place over the next 3 years - in addition to normal annual pay increases.

For further details and an application form (to be returned by 29 August 1986) write to Civil Service Commission, Alencon Link, Basingstoke, Hants RG21 1JB, or telephone Basingstoke (0256) 468551 (answering service operates outside office hours). Please quote ref: T/6930.

An equal opportunity employer

## NATIONAL MUSEUM OF PHOTOGRAPHY, FILM AND TELEVISION

# Professional Career Opportunities



The Easy Way to look for your new job from the comfort of your own armchair. Our well qualified consultants will carefully match your requirements against appropriate vacancies.

We have many clients seeking Engineers and Technicians at all levels and we are particularly interested in hearing from you if you have experience in the following:-

- Real Time Software
- Technical Sales
- ATE Programming
- Radar Systems
- RF Development
- Technical Authorship

Your next step is to complete and return the attached coupon or telephone **John Prodger** on 0442 47311 or one of our duty consultants on 0442 212650 during evenings or weekends.



Executive Recruitment Services

THE INTERNATIONAL SPECIALISTS IN RECRUITMENT FOR THE ELECTRONICS, COMPUTING AND DEFENCE INDUSTRIES

Freepost, Hemel Hempstead, Herts. HP1 4BR.



NAME ..... (Mr/Miss/Mrs)

ADDRESS .....

POST CODE .....

TEL NO: .....

QUALIFICATIONS ..... AGE .....

NONE  CG/HNC  DEGREE  OTHER

SALARY .....

JOB ..... WW

# Appointments



## THE START OF SOMETHING NEW

If you are leaving College and planning a career in modern communications or if your present job lacks interest and challenge . . . why not join us in GCHQ?

We are recruiting

### RADIO OFFICERS

who after initial training will become members of an organisation that is in the forefront of communications technology. Government Communications Headquarters can offer you a satisfying and rewarding career in the wide field of communications. Training involves a 32 week course (38 weeks if you come straight from Nautical College) which will fit you for appointment to RADIO OFFICER.

Not only will you find the work as an RO extremely interesting but there are also good prospects for promotion opportunities for overseas travel and a good salary. Add to this the security of working for an important Government Department and you could really have the start of something new.

The basic requirement for the job is 2 years radio operating experience or hold a PMG, MPT or MRGC or be about to obtain a MRGC. Registered disabled people are welcome to apply.

Salaries start at **£5,817** at age 19 to **£6,920** at age 25 and over during the training and then **£7,954** at 19 to **£10,162** at 25 and over as a Radio Officer. Increments then follow annually to **£13,777** inclusive of shift and week-end working allowances.

application form phone 0242 32912/3

or write to:



The Recruitment Office  
Priors Road  
CHELTENHAM  
Glos GL52 5AJ

A/1108

2806

OXLEY 

## ELECTRONIC DESIGN ENGINEER

## ELECTRONIC PRODUCTION ENGINEER

Oxley Developments Company has been established for over 40 years, and is a leading designer and manufacturer of high reliability electronic components.

Vacancies exist in both design and production areas, supporting the development and manufacture of components for operation at frequencies up to 10GHz.

These are exciting opportunities, and are ideally suited to newly qualified graduates in an engineering/science discipline.

The Company is situated on the edge of the Lake District, in an area offering a whole range of recreational facilities.

Please write for an application form to:

The Personnel Director,  
Oxley Developments Company Limited,  
Priory Park, Ulverston, Cumbria LA12 9QG.

291

## Radio Communications Technicians Zimbabwe

The Zimbabwe Republic Police are seeking three Communications Technicians to assist in the training of local staff in Harare and Bulawayo. The ZR police radio network operates on UHF and VHF and stations, posts and patrols are radio linked.

As "on the job instructors", you will give practical instruction to Technicians of all grades and also help with routine maintenance where necessary to avoid backlogs building up.

Equipment used includes base and mobile equipment of 40 MHz band and VHF packsets of dual frequency 40 MHz and 120 MHz bands - all amplitude modulated and fully solid state; 4 watt output VHF handheld walkie talkies; 100 watt synthesised SSB transceivers; and SSB packsets both crystal controlled and synthesised.

Applicants should be British Citizens, ideally with C&G Full Technological Certificate in Communication Engineering or similar qualification and 10 years experience including fault finding to component level with the equipment listed. The ability and willingness to train young inexperienced technicians is essential.

The appointments are on contract to ODA, on loan to the Government of Zimbabwe, for a period of 2 years. Salary (UK taxable) will be commensurate with qualifications and experience and will include an element in lieu of superannuation. A tax free Foreign Service Allowance, currently in the range £1,315 to £3,380 pa, is also payable.

The posts are wholly financed by the British Government under Britain's programme of Aid to the developing countries. Other benefits normally include paid leave, free family passages, children's education allowances, free accommodation and medical attention.

For further details and application form, please apply, quoting ref. AH364/ES/EWW, stating post concerned, and giving details of age, qualifications and experience to: Appointments Officer, Overseas Development Administration, Room 351, Abercrombie House, Eaglesham Road, EAST KILBRIDE, Glasgow G75 8EA.

Closing date for applications is one month from the date of publication.



OVERSEAS  
DEVELOPMENT

Britain helping nations to help themselves

# Appointments

## ENGINEERING OPPORTUNITIES NATIONWIDE

Edinburgh (031) 226 5381  
 Leeds (0532) 580510  
 Manchester (061) 832 5856  
 Birmingham (021) 643 1994  
 Leicester (0533) 544193  
 Milton Keynes (0908) 666872  
 Bishop's Stortford (0279) 506464  
 London (01) 637 0781  
 Bristol (0272) 211035  
 Bracknell (0344) 481808  
 Maidstone (0622) 687171  
 Crawley (0293) 514071

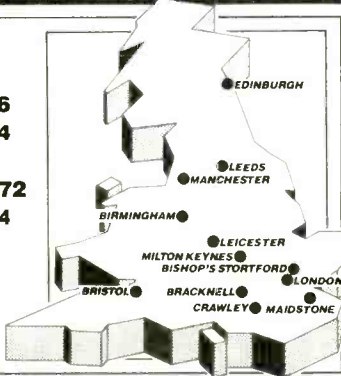

**Salaries £8,000 to £30,000 p.a.**

As the UK's leading specialist sales and technical recruitment consultancy, we provide a FREE service to engineers seeking a career move.

If you have experience in digital, analogue, microprocessor or communications technologies (either hardware or software), ideally with a recognised qualification, we have hundreds of vacancies throughout the UK in R & D, Design, Manufacturing, Test, Service and Sales.

Call your nearest branch for more information or send a comprehensive C.V. (no stamp required) to:-

**ata**

**Engineering Recruitment**

A Division of ATA Selection and Management Services Ltd  
 FREEPOST, Bishop's Stortford, Herts. CM23 2BR.

### VIDEO/ELECTRONICS TECHNICIAN

to service and repair wide range of video equipment including professional monitors, Umatic recorders, miniature cameras etc. Qualified to C&G finals or equivalent plus 5 years practical experience. Age 26 upward. Salary negotiable.

Please telephone  
 01-902 8835 ext. 251.

### FIELD SERVICE ENGINEER

required for the commissioning and maintenance of geophysical logging equipment in the UK and overseas. A sound practical ability to troubleshoot analogue and microprocessor-based digital circuitry is essential as is an enthusiasm for worldwide travel.

Box No: 305

### RIVERSIDE HEALTH AUTHORITY Westminster Hospital, SW1.

Department of Clinical Measurement

### ELECTRONICS TECHNICIAN

This post is in the electronics section of the Department of Clinical Measurement, Westminster Hospital and is associated with the arrangement of a wide range of analogue and digital equipment used for patient monitoring and therapy. Duties will involve safety testing and commissioning as well as routine maintenance and repair of such equipment.

There will also be opportunities for the design and construction of new devices for hospital use. You will work in both workshop and clinical areas and will need the ability to communicate with medical and nursing staff.

The electronics section is supported by small computer systems for equipment data bases and job recording and by well equipped mechanical workshops.

Hours: 37. Salary: £6,786 - £9,797 (inc) dependent upon experience and qualifications.

Job description and application form from Personnel Department, Westminster Hospital, Dean Ryle Street, Horseferry Road, London SW1. Tel: 01-828 9811 Ext 2323 (24 hour answering service). Closing date: 4th September, 1986.



## Telecommunications Technical Officer Grade III

The Operations (Technical) Support Group have a vacancy for a TTO III in the Metropolitan Police Forensic Science Laboratory, which is located in South East London, about 10 minutes walk from Lambeth North Tube Station.

The Laboratory enjoys a worldwide reputation for uncovering facts and providing the police and the courts with invaluable assistance.

The vacancy exists in the Laboratory's Electronic Support Unit where the successful candidate will be required to service, maintain and occasionally modify a wide range of equipment. There will also be an opportunity to be involved in the design, development and construction of new equipment. It will be necessary for the postholder to liaise with scientists of several disciplines on a regular basis.

The skills required range from basic workshop practice to modern micro-processor technology. A knowledge of, or a willingness to learn, computer programming would also be an advantage.

Applicants must possess as a minimum qualification an ONC in Engineering or an equivalent City and Guilds/TEC qualification in a relevant discipline and have at least four years' relevant experience.

Salary: £8,595 per annum to £11,392 per annum inclusive of London weighting allowance.

Annual Leave: 4 weeks 2 days rising to 6 weeks plus 10½ days public and privilege holidays.

For further details and an application form write to: The Establishment Officer, E8(1) Branch, Room 213 (TTO/FSL), 105 Regency Street, London SW1P 4AN, or ring 01-230 3122 (24 hour answering service).

The Metropolitan Police Office is an equal opportunities employer.

## METROPOLITAN POLICE

### Senior Design Engineer

For exciting development of computer graphics products for television use.

Experience in Digital and Analogous design, and an understanding of video technology would be essential. You could be required to manage a small development team, and be able to take products from conception through to production. If you have an active enthusiasm for Computer graphics together and a liking for a small but expanding company you would be ideally suited to this job.

Salary dependent on age and experience up to £15,000.

### Design Engineer

For assisting in the design of Computer Graphics products.

Experience in at least one of the following fields would be required. Digital Design, Analogue Design, Video Engineering. You would have the opportunity to participate in many aspects of design, from CAD or schematics and PCB layouts to prototyping. Salary depending on age and experience from £8,000 to £12,000.

Applications in writing please, together with full C.V. to The Technical Director, Spaceward Microsystems Ltd., The Old School, Stretham, Cambridge CB6 3LD.



# CAPITAL APPOINTMENTS LTD

## THE UK's No. 1 ELECTRONICS AGENCY

If you have HNC/TEC or higher qualifications and are looking for a job in design, test, customer service, technical sales or similar fields:

Telephone now for our free jobs list  
We have vacancies in all areas of the UK  
Salaries to £15,000 pa

**01 808 3050**  
(24 hours)

CAPITAL APPOINTMENTS LTD  
76 WILLOUGHBY LANE, LONDON N17 0SF

(291)

North Lincolnshire  
Health Authority

ST GEORGE'S  
HOSPITAL

Department of Medical  
Physics and Computing

MEDICAL  
EQUIPMENT UNIT

**Medical  
Physics  
Technician  
Grade II/III**

Required to join a team providing a comprehensive service to users of medical equipment throughout the District. The range of services provided includes evaluation and acceptance testing of commercial equipment, development of new equipment and the maintenance of equipment.

Experience in the field of diagnostic imaging or a general medical electronics background would be preferred.

Applicants should hold an HNC or equivalent and five years of relevant experience for Grade II. Applicants with less experience may be considered for a post at Grade II level.

A current driving licence is essential; Salary: Grade II £8,073 - £10,070 (Award pending), Grade III £6,703 - £8,664.

For further information please telephone Dr N Granvill or Mr D Watson, on (0522) 29921 ext 7246.

Application forms and job descriptions are available from and should be returned to: Mr N Barron, Unit Personnel Officer, St George's Hospital, Long Leys Road, Lincoln LN1 1EF.

Telephone: Lincoln 29921 ext 7184

304

**RADIO SERVICE ENGINEER** required by expanding company dealing with P.M.R. systems. Cellular and Community Repeater Equipment. R.C.S (London) Ltd., Unit 7, Millmead Centre, Millmead Road, London N17 9QU. 01-801 6457 Contact Frank Stafford. (302)

## CLIVEDEN

- SERVICE ENGINEER**  
Repair of printers and peripherals.  
c. £7,000, Berks.
- TEST ENGINEER**  
Repair and commissioning of radar systems.  
£10,500, Essex.
- SERVICE ENGINEER**  
To help run a workshop repairing telecoms and datacomms products.  
£9,000, Surrey.
- SUPPORT ENGINEER**  
Maintain a range of PDP 11/70 based laser printers and graphic controllers.  
£16,000 + Car, Berks.
- REPAIR ENGINEER**  
Knowledge of cellular radio and synthesiser systems.  
£12,000 +, Berks.
- FIELD SERVICE ENGINEER**  
Datacomms/networking control systems.  
£12,000 + Car, Bucks.

Hundreds of other Electronic and Computer vacancies to £15,000

Phone or write:

Roger Howard C.Eng. M.I.E.E. M.I.E.R.E.  
CLIVEDEN RECRUITMENT  
92 Broadway, Bracknell,  
Berkshire RG12 1AR  
Tel: 0344 489489

Telephone  
Susan Platts on  
**661 3033**

if you wish to advertise  
on these pages

## ELECTROLOOM (BEDS)

Competitive rates for a reliable service including  
**PCB & CABLE ASSEMBLIES  
FULL CHASSIS WIRING  
SUB & FINAL ASSY. WELCOMED**  
PLEASE CONTACT:  
**0525-378590**  
for immediate attention 290

## BILLINGTON VALVES

SEND TODAY FOR OUR FREE CATALOGUE OF THERMIONIC VALVES  
Audio, transmitting and industrial types stocked. SAE please. We aim to be the cheapest source anywhere! We have huge stocks and SPECIALISE IN RARE AND UNUSUAL TYPES OF VALVES AND TRANSISTORS.  
Wholesale inquiries welcome! Export inquiries welcome!  
WE WILL BUY VALVES AND TRANSISTORS!  
including complete shop clearance etc. We urgently require a quantity of valves types: D44 and PX25 (or equivalents) PP3/250, PP5/400, DA301. Equipment examples are acceptable. Please state price required, if possible.  
23 Irwin Drive, Horsham, W. Sussex RH12 1NL.  
Mail Orders Only. Callers strictly by appointment only.

## ARTICLES FOR SALE

TO MANUFACTURERS, WHOLESALERS  
BULK BUYERS, ETC.

## LARGE QUANTITIES OF RADIO, TV AND ELECTRONIC COMPONENTS FOR DISPOSAL

SEMICONDUCTORS, all types, INTEGRATED CIRCUITS, TRANSISTORS, DIODES, RECTIFIERS, THYRISTORS, etc. RESISTORS, C/F, M/F, W/W, etc. CAPACITORS, SILVER MICA, POLYSTYRENE, C280, C296, DISC CERAMICS, PLATE CERAMICS, etc. ELECTROLYTIC CONDENSERS, SPEAKERS, CONNECTING WIRE, CABLES, SCREENED WIRE, SCREWS, NUTS, CHOKES, TRANSFORMERS, etc. ALL AT KNOCKOUT PRICES — Come and pay us a visit ALADDIN'S CAVE

TELEPHONE: 445 0749/445 2713

R. HENSON LTD.

21 Lodge Lane, North Finchley, London, N.12  
(5 minutes from Tally Ho Corner)

(1613)

## QUALITY USED EQUIPMENT

**Hewlett Packard Synthesizer**  
8660C main frame with keyboard entry  
86602B RF section 1-1300MHz  
86631B Auxiliary section AM/Pulse mode  
Fully restored **£5,000.00**

**Hewlett Packard Vector Voltmeter**  
8405A measures voltage and phase  
1-1000MHz **£1,850.00**

**Hewlett Packard Spectrum Analysers**  
Price and details on application.

**Marconi PCM Tester/Analyser Kit**  
TF2807A PCM multiplex tester  
TF2828 PCM digital simulator  
TF2829 PCM digital analyser  
All as new complete **£2,950.00**

This and other equipment can be inspected at  
**COOKE INTERNATIONAL**  
Unit 4, Fordingbridge Site, Main Road, Barnham,  
Bognor Regis PO22 0EB  
Tel: 0243 68 5111/2

292

## G.W.M. RADIO LTD.

40/42 PORTLAND ROAD, WORTHING, SUSSEX.  
Tel: 0903 34897

Marconi TF 791D Deviation Meter 4 1024MHz **£85**  
Buyers collect Eddystone EB37 Solid State Receiver, similar to EC10 but no BFO 150KHz-350KHz +550KHz-22MHz 9V **£65 inc.** Pye Bantam H/B FM with battery box and microphone **£25 inc.** Pye W25FM mobile units solid state. High power Westminster 10 channel, ex car telephone high band, no control gear (units only) **£40 inc.** Signal generator advance type B4B directly calibrated from 30KHz to 30MHz **£35 inc.** Pye 460/461 UHF base **£40 inc.** Iantavox public address Amps. 20 watts 4-3 or 16 ohm 01 70 volt line output 230V AC or 12V DC **£29 inc. p&p.** Pye Bantam HP1 AM mid band, example frequency TX 107MHz Rx 139MHz. Will mod to air band sets only no mics, or battery but with dry battery tray **£25 inc p&p.**

293

## Singer Spectrum analyser 5SSB/50 10Hz-40MHz complete with 2 tone variable audio generator. Solid State. Excellent condition perfect for SSB transmitter checkout £1395. High stability communications receiver Eddystone EC958 10KHz-30MHz £595. Microwave power meter 10MHz-12GHz with head £395 TF2300 modulation meter 5MHz-1GHz £375 Hewlett Packard spectrum analyser type 8551B 10MHz-12GHz £1500. Many other high quality items. SAE for full list VHF FM Broadcast transmitters currently available 10w-1kw.

## CYBERSCAN INTERNATIONAL

3 Eastcoke View,  
Pinner, Middx HA5 1AT.  
Tel: 01-866 3300

**PCB'S MANUFACTURED,** prototypes, small/large production runs, single, double-sided, P.T.H. screen printing, panels, labels, solder masking & photography. Orbitechnic Circuits, The Rear of 127 Woodlands Road, Hford, Essex. Tel: 01-553 5211. (154)

**TEKTRONIX OSCILLOSCOPES**  
2215 60MHz £495, 568/230/241 1GH system £495, 454A 150 MHz £475, 661 3-9 GHz 1495, PCB Sub-assemblies, Transistors, Delay-lines, viewing hoods, valves. 1L5 £375, 7B50A £295, 3A74 £85. Tequipment D83 £325. HAMEG 70 MHz £415. H.P. Delay-lines 1100A £65, Transformers 9100-147z (new) £15. Brimar C.R.T.s. Manuals. Tel: (01) 868-4221.(293).

When replying to  
classified  
advertisements,  
readers are  
recommended to  
take steps to  
protect their  
interest before  
sending money

**GOLLEDGE**  
**ELECTRONICS**

**QUARTZ CRYSTALS OSCILLATORS AND FILTERS** of all types. Large stocks of standard items. Specials supplied to order. Personal and export orders welcomed - SAE for lists please. OEM support thru: design advice, prototype quantities, production schedules. **Golledge Electronics**, Merriott, Somerset YA16 5NS. Tel: 0460 73718. (2472)

**BRIDGES** waveform/transistor analysers. Calibrators, Standards, Millivoltmeters, Dynamometers, KW meters, Oscilloscopes, Recorders. Signal generators - sweep, low distortion, true RMS, audio, RM, deviation. Tel: 040 376236. (2616)

**NOW AVAILABLE - Bumper Catalogue - 170 pages - for collectors of vintage radio, audio & TV equipment. Price: £2.00 post paid UK, £3.00 post paid overseas. Vintage Wireless Co. Ltd., Cossham Street, Mangotsfield, Bristol BS17 3EN. Phone: 0272 565472. (208)**



**SERVICES**

**CIRCOLEC**  
**THE COMPLETE ELECTRONIC SERVICE**

Artwork, Circuit Design, PCB Assembly, Test & Repair Service, Q.A. Consultancy, Prototypes, Final Assembly. Full PCB Flow Soldering Service.

Quality workmanship by professionals at economic prices. Please telephone 01-646 5686 for advice or further details.

**TAMWORTH MANOR**  
**302-310 COMMONSIDE EAST, MITCHAM**

(1391)

**DISC COPYING/  
 FORMAT CONVERSION**

We can convert your files to and from most CP/M, MS-DOS (and look alike) disk formats and sizes.

£7.50 + Disks (if required) + VAT

For details contact Clive Waller at Chiatronix Ltd, 238 Old Bedford Road, Luton, Beds, LU2 7EQ Tel: (0582) 21010

(Callers by appointment please)

**PCB'S MANUFACTURED.** Prototype, small/large production runs. Single/double sided, multilayer, PTH all produced to consistently high standards. Screen printing and photography. Full CAD artwork design service from circuit diagram. Prices are competitive, delivery fast 2, 5, 14 days or by agreed schedule. Translab Electronic Services, 38 Matlock Close, Rugby CV21 1LB. Tel enquiries: (0788) 536626. (284)

**IMPORTS/EXPORTS** of all kinds of Electronics and Computers. Please send your enquiry or product details to **DEDICATED MICROPROCESSORS LTD**, 299A Edgware Road, London W2 1BB, England, or Telex 945922 GLADEX-G for the attention of Mr. C.Paps. (300)

**TURN YOUR SURPLUS** i.e.s transistors etc. into cash, immediate settlement. We also welcome the opportunity to quote for complete factory clearance. Contact **COLES-HARDING & CO**, 103 South Brink, Wisbech, Cambs. 0945584188. (52)

**CLASSIFIED RATES ARE:**

*Displayed:* £23 per single column centimetre  
*Linage:* £5 per line (minimum £40)

**WANTED**

**WANTED**

Test equipment, receivers, valves, transmitters, components, cable and electronic scrap and quantity. Prompt service and cash. Member of A.R.R.A.

**M & B RADIO**  
 86 Bishopsgate Street  
 Leeds LS1 4BB  
 0532 435649

(9956)

**STEWART OF READING**  
 110 WYKEHAM ROAD  
 READING RG6 1PL  
 TEL NO: 0734 68041

**TOP PRICES PAID FOR ALL TYPES OF SURPLUS TEST EQUIPMENT, COMPUTER EQUIPMENT, COMPONENTS etc. ANY QUANTITY**

103

**WANTED**

Test equipment, computers, components. Any quantity. Good prices paid. Immediate settlement.

Give us a ring.  
**Q-Teq Electronics**  
 Unit 6, 28 Botley Road,  
 Hedge End, Southampton.  
 Tel: Botley 81487

186

**E C COMPONENTS**

We buy large and small parcels of surplus I/C, transistors, capacitors and related electronic stock. Immediate settlement.

Tel: 01-208 0766  
 Telex: 8814998

(2491)

**USED TEST EQUIPMENT FOR SALE & WANTED**

Buyers & Disposal Officers Contact

**COOKE INTERNATIONAL**  
 Unit 4 Fordingbridge Site  
 Main Road Barnham  
 Bognor Regis  
 West Sussex PO22 0EB  
 Tel. 0243 68 5111/2

(179)

**NEW WINCHESTER 20 MEGABYTE HARD DISC**, controller board, IBM PC, host adaptor, £325, 10 megabyte disc controller board, £235, 20 megabyte tape streamer IBM PC, host adaptor, £295. Oscilloscope D83, 50MHz dual trace, £449. IN5406 12,000, £295. B.N.C. connectors 1500, £295. Transformers 30V/1A 300, £149. 36V/1½A 160, £90. 24V/4A 90, £199. Slough (0753) 824027. (278)

**CLASSIFIED ADVERTISEMENTS**

**Use this Form for your Sales and Wants**

PLEASE INSERT THE ADVERTISEMENT INDICATED ON FORM BELOW

To "Wireless World" Classified Advertisement Dept., Quadrant House, The Quadrant, Sutton, Surrey SM2 5AS

- Rate £4.50 PER LINE. Average six words per line. Minimum £36 (prepayable)
- Name and address to be included in charge if used in advertisement
- Box No. Allow two words plus £10
- Cheques, etc., payable to "Business Press International Ltd." and cross "& Co." 15% VAT to be added

NAME.....  
 ADDRESS.....  
 .....  
 .....

				REMITTANCE VALUE.....	ENCLOSED

PLEASE WRITE IN BLOCK LETTERS. CLASSIFICATION..... NUMBER OF INSERTIONS..... (1)

**CATALOGUE**  
Over 100 pages with £4 discount vouchers.  
Send large s.a.e (min 12x9) 46p (UK) (Export Send £1.00, no s.a.e.)  
**FREE** for schools, colleges, companies, etc.  
Please write in for your copy  
Available to callers - £1.00

**HENRY'S**  
AUDIO ELECTRONICS



**SCOPES**  
HITACHI • HAMEG • CROTECH

**GENERATORS**  
BLACK STAR • THANDAR  
LEADER • TRIO

**MULTIMETERS**  
THURBY • SOAR • PANTEC  
BECKMAN • THANDAR  
PLUS LOW COST RANGE

**COUNTERS**  
THANDAR • BLACK STAR

**POWER SUPPLIES**  
LARGE RANGE STOCKED

**RANGE OF EQUIPMENT INCLUDES**  
TV TESTING: DIGITAL AND ANALOGUE  
MULTIMETERS: SCOPES: CLAMPMETERS:  
INSULATION TESTERS: WOW/FLUTTER  
METERS: DISTORTION METERS: FUNCTION  
PULSE AND R-C GENERATORS: LCR BRIDGE  
DIGITAL CAPACITANCE: MULTIPLEXERS:  
LOGIC ANALYSER: LOGIC PROBES:  
COUNTERS: POWER SUPPLIES:  
TRANSISTOR CHECKERS, ETC.

**PLUS COMPONENTS: TOOLS:  
COMPUTER SOFTWARE AND  
ACCESSORIES: SEMICONDUCTORS:**

LET US QUOTE FOR YOUR REQUIREMENTS

OPEN 6 DAYS A WEEK

DISCOUNTS FOR EDUCATIONAL, TRAINING SCHEMES, ETC. OFFICIAL ORDERS WELCOMED

301 Edgware Road, London W2 01-724 3564  
404 Edgware Road, London W2 01-724 0323  
EDUCATIONAL, EXPORT, TRADE AND ACCOUNT ENQUIRIES 01-258 1831

CIRCLE 7 FOR FURTHER DETAILS

## Computer Appreciation

111 Northgate, Canterbury, Kent CT1 1BH  
Tel: Canterbury (0227) 470512. Telex: 966134 COMPAP

**SAMURAI Model S16 computer.** With twin 8" NEC floppy disc drives (total 2.5Mb), 8086 processor with 128K monochrome monitor & MSDOS. Originally cost over £2,000. BRAND NEW. (We have very low cost software packages available for this machine for WP, comms etc. Also, we have details of a do it yourself memory upgrade to 512K). BRAND NEW £399.00

**ITT SCRIBE III WORD PROCESSING SYSTEM.** Dual processor (Z80H & T1 990) machine with 128K memory. QUUME printer interface & RS232 comms interface. With dual 5 1/4" floppy disc drives (double density, double sided, 40 track), high resolution monochrome monitor & low profile keyboard. Excellent professional word processing software is included and the machine is capable of running CP/M although we do not yet have a configured version available. Manufactured 1983 and originally selling at over £5,000. BRAND NEW £295.00

**ITT SCRIBE III.** As above, but with 10MB WINCHESTER hard disc drive and single floppy £495.00

**NEC SPINWRITER Model 7700** daisy wheel printer. 55 c.p.s. printer suitable for use with SCRIBE III word processors. BRAND NEW £580.00

**NEC SPINWRITER.** 35 c.p.s. daisy wheel printer suitable for use with ITT SCRIBE III word processors £390.00

**ITT SCRIBE III memory expansion.** Extra 128K board (64K chips) £50.00

**ITT SCRIBE III PACKAGE, WORD PROCESSOR AS ABOVE WITH 10MB WINCHESTER HARD DISC DRIVE, FULL 256K MEMORY & NEC MODEL 7700 SPINWRITER 55 c.p.s. PRINTER, ALL BRAND NEW & GUARANTEED.** £395.00

**HEWLETT PACKARD** desktop computer. Model 9825A with 24K RAM, operating system ROM (69705) & General I/O - Extended I/O (98213A) & String - Adv. Programming (98210A) ROMs. With QWERTY keyboard, single line alphanumeric display, tape drive & printer £275.00

**HEWLETT PACKARD Model 7225B** A4 graph plotter. IEEE interface, with self test & electrostatic paper hold £350.00

**MATMOS PC.** Available without disc drives only. 64Kb Z80 based machine with RGB, composite video & UHF outputs; serial, parallel and cassette interfaces with motor control relay. MICROSOFT BASIC in ROM. BRAND NEW £49.00

**MATMOS TERMINAL.** MATMOS PC with EPROM for terminal emulation. Probably the lowest cost terminal available anywhere. BRAND NEW £59.00

**MATMOS TERMINAL.** As ABOVE but complete with ZENITH 1230 monochrome monitor and monitor cable. BRAND NEW £145.00

**PYRAMID Model 501 CPM MICROCOMPUTER SYSTEM.** With 4MHz Z80A processor, 64K memory and twin double sided, double density, 80 track half height 5 1/4" disc drives (total 1.5Mb). With serial RS232 and parallel CENTRONICS interfaces. These very compact (23 1/4" high) machines are S-100 based, and are software compatible with NORTH STAR HORIZON. Originally priced at £2,000. BRAND NEW (Requires terminal) £195.00

**TEKTRONIX Model 4051 DESKTOP GRAPHICS COMPUTER.** With integral tape cartridge drive and 4000 Series ultra high resolution storage display. BASIC is in ROM. £425.00

**DEC Model BA11MF.** 8-slot box, backplane and psu for Q-bus devices. NEW £295.00

**HITACHI Model 305S 3" disc drives.** With SHUGGART compatible interface as for 5 1/4" drives. Uncased. These drives have been tested by us on the BBC with DFS and on the AMSTRAD 6128. The same drive is used in the TATUNG Einstein. Single sided, 250kb unformatted. BRAND NEW. £29.95

**AS ABOVE.** But double sided £39.95

**HITACHI Model 1480P** colour monitors (cased). High resolution 14" monitor with separated RGB input at TTL levels (positive - video, intensity & sync) Resolution is 640 dots x 200 lines £175.00

**NEC & GUB** colour monitors. Low resolution ex-demo (unmarked) with TTL input, 12" and 14" available £75.00

**RICOH Model GP11** graph plotter. Continuous feed intelligent graph plotter with RS232 interface £75.00

**RICOH Model GP15** graph plotter. As above, but with 15" paper width, self test and three pens. BRAND NEW £195.00

**TEKTRONIX Model 7603 100MHz.** Oscilloscope with CRT readout, 2 x Model 7A18 dual trace amplifier & Model 7B53A dual time base £2100.00

**TEKTRONIX Model 7403M** oscilloscope with 7A18N & 7B53A £1500.00

**TEKTRONIX Model 5403** oscilloscope with 5A18N & 5B11N £750.00

**TEKTRONIX Model 5403** oscilloscope with 2 - 5A48 - 5B42 £950.00

**TEKTRONIX Model 466** portable storage 100MHz oscilloscope £2850.00

**TEKTRONIX Model 7012** A/D converter with M2 sample/hold module £1200.00

**HATFIELD Type 2105** 50 Ohm attenuator £50.00

Please Note: \* VAT & Carriage extra for all items  
\* Visitors by appointment, please

CIRCLE 54 FOR FURTHER DETAILS

# Wirelessworld

# INDEX TO ADVERTISERS

Appointments Vacant Advertisements appear on pages 75-79

PAGE	PAGE	PAGE	PAGE
AEL Crystals.....32	Electronic Brokers..... IFC, 3,0BC	Internepon Packaging.....41	Pineapple Software.....58
Airlink Transformers.....36	EMS Mfg. Ltd.....58	IQD Ltd.....5	PM Components.....46/47
Beckenham Peripherals.....12	English Electric Valves.....45	John Radio.....58	Radiocode Clocks.....2
Cambridge Kits.....32	Essex Electronics Centre.....73	Kestral Electronic Components	Raedek Electronics.....10
Carston Electronics Ltd.....15	E&WW 1986 Frequency Chart 68	.....71	RAFA Wings Appeal.....62
Cavendish Automation.....2	E&WW Edit Feature List 70	Langrex Supplies Ltd.....65	RCS Micro Systems Ltd.....8
Cirkit Holdings PLC.....73	E&WW Smart Watch offer 4	Lincoln Binns.....12	Research Communications.....12
Collins & Sons Co Ltd (Wm).....48	Gould Electronics.....48	Marco Trading.....62	Sherwood Data Systems Ltd.....67
Componedex.....IBC	GNC Design.....31	Matmos Ltd.....8	Silicon Glen Ltd.....70
Computer Appreciation.....80	Hameg.....36, 74	Micro Concepts.....62	SMC Electronics.....8
Cortex Controllers.....62	Happy Memories.....8	Micro Kit Ltd.....57	Stewart of Reading.....57
Crossware Products.....70	Harris Electronics (London).....48	Micro Processor	Strumeh Engineering Ltd.....62
Cybernetic Application.....31	Harrison Electronics.....67	Engineering Ltd.....36	Surrey Electronics Ltd.....58
Dartington Frequency	Hart Electronic Kits Ltd.....67	Monolith Electronics.....70	Taylor Bros.....32
Standards.....4	Henry's Audio Electronics.....80	Network Satellite Systems.....48	Technomatic Ltd.....24/25
Dataman Design.....35	Henson, Ltd (R).....70	Number One Systems.....10	Thandar Electronics Ltd.....31
Display Electronics.....52/53	Hilomast Ltd.....12	Phase Track Ltd.....73	Thurby Electronics.....72
	Ian P Kenloch Ltd.....73		TIC Semiconductors.....67
	Imhof Express.....57		Triangle Digital Services.....10

### OVERSEAS ADVERTISEMENT AGENTS

France and Belgium: Pierre Mussard, 18-20 Place de la Madeleine, Paris 75008.

United States of America: Jay Feinman, Business Press International Ltd, 205 East 42nd Street, New York, NY 10017 - Telephone (212) 867 2080 - Telex 23827.

Printed in Great Britain by Ben Johnson Printers Ltd, Oldhill, Dunstable, and typeset by Graphic Typesetting, Imperial House, 108 The Broadway, Wimbledon SW19, for the proprietors, Business Press International, Quadrant House, The Quadrant, Sutton, Surrey SM2 5AS. © Business Press International 1986. *Wireless World* can be obtained from the following: AUSTRALIA and NEW ZEALAND: Gordon & Gotch Ltd, INDIA: A. H. Wheeler & Co, CANADA: The Win. Dawson Subscription Service Ltd., Gordon & Gotch Ltd. SOUTH AFRICA: Central News Agency Ltd; William Dawson & Sons (S.A.) Ltd. UNITED STATES: Eastern News Distribution Inc., 14th Floor, 111 Eighth Avenue, New York, N.Y. 10011.

# TEST COMPONEDEX

## PUT OUR TESTERS TO THE TEST



### TEST COMPONEDEX

Practical, value for money British test equipment for everyday test and diagnosis on communications equipment. Designed by Compondex for simple operation, powerful features at realistic, affordable prices.

**FAKERSCOPE 2000 £795.00**  
**SDLC/HDLC FAKERSCOPE 2000 £864.50**

The Fakerscope 2000 is a new portable data analyser from Compondex. The Fakerscope 2000 provides a wide range of data test facilities including: data capture and analysis, pre-defined message generation and BERT testing. The Fakerscope 2000 supports a wide range of standard data codes and formats including Synchronous and (optional) SDLC/HDLC operation.

The Fakerscope 2000 is totally portable, powered by re-chargeable batteries and is supplied with all accessories and transit case.

**DATAFAKER £360.00**

The Datafaker is a portable RS232 message generator/error checker. The unit is simple to operate and features a "Centronics" data port. The Datafaker is an ideal unit for testing terminal devices, the Datafaker features an EPROM socket allowing custom messages to be transmitted. Supplied with transit case and accessories.

CIRCLE 29 FOR FURTHER DETAILS

**CABLEFAKER £69.50**

Test the Compondex CABLEFAKER! a pocket LCD RS232 breakout box and line monitor which requires no batteries. The Cablefaker is supplied with case and patch leads.

The prices quoted are UK prices and subject to VAT.



To: Sales Manager, Compondex Ltd., Unit 87 Alston Drive, Bradwell Abbey, Milton Keynes, MK13 9HF  
Tel: (0908) 322177 Tlx: 265871 MONREF code: WJJ093

Please send me information on the Compondex range of data testers.

Please arrange a demonstration.

Name: \_\_\_\_\_

Company: \_\_\_\_\_

Address: \_\_\_\_\_

Tel: \_\_\_\_\_

Compondex testers are distributed throughout Europe and Australia, contact us for your nearest dealer.

# THERE'S A PHILIPS INSTRUMENT THAT'S JUST RIGHT FOR YOU AT ELECTRONIC BROKERS

## OSCILLOSCOPES

### PM3055 DUAL TIME BASE 50MHz SCOPE

**NEW** Philips' all-new PM3055 is the smart scope – in more ways than you'd think! First, it's smart in performance. With an advanced-technology 16 kV CRT, versatile triggering functions up to 100 MHz, and fast computer hook-up via an IEEE option.

And it's smart in simplicity, with Autoset, right-every-time micro-computer control and full modular design for fast, easy service.

But most of all it's smart at Electronic Brokers' price of only £845.

## THE SMART SCOPE



- Auto-set for amplitude, timebase and triggering
- Multi-function menu driven soft keys
- LCD panel displays settings and status
- Fast action up/down controls
- Trigger bandwidth 100MHz
- CRT 16kV acceleration voltage

**£845**

(also available PM3050 single time base 50MHz scope

**£795)**



### PM3302 DIGITAL STORAGE WITH TWO MEMORIES

- Max sampling frequency 20MHz
- Maximum resolution 50nS
- 2K x 8 bit memory
- 2K back-up memory
- X-Y recorder output for hard copy
- 50s/div roll mode for low frequency signals.

**£1,450.00**

## DIGITAL MULTIMETERS



### PM2534 COMPLETE SYSTEM MULTIMETER

- IEEE interface fitted as standard
- 3½ to 6½ digit modes
- Up to 100 measurements/second
- Accuracy to 0.005%
- True RMS measurements
- Resolution to 100nV.

**£795.00**



### PM2518X/PM2618X/PM2718X PORTABLE METERS

- Direct dB and relative measurements
- 200kHz frequency counter
- 0.3% analogue bargraph display
- Up to 0.05% DC accuracy
- 10MHz logic view function
- Up to 100kHz true RMS readings.

PM2518X/01 **£149.00** PM2618X/01 **£195.00** PM2718X/01 **£225.00**

## FUNCTION GENERATOR



### PM5193 PROGRAMMABLE SYNTHESISED GENERATOR

- Wide 0.1mHz to 50MHz frequency range
- Extremely high frequency accuracy and stability
- Full 8 digit resolution with clear LED readout
- 8 standard programmable waveform outputs
- Modulation facilities include FM, AM, Gate, Sweep, Burst
- Remote control of all programmes via IEEE interface.

**£3,225.00**

## PATTERN GENERATOR



### PM5515I COLOUR TV GENERATOR WITH USER PROGRAMMES

- Synthesised control of RF frequency
- Keyboard call-up of up to 70 patterns/combinations
- Simple switch selection of PAL or NTSC
- Operation of up to 3 or 4 receivers on a 10mV output
- Storage and recall of up to 10 complete programmes
- Covers every RF band from IF bands IV/V including cable TV bands.

**£1,050.00**

## COUNTER/TIMER



### PM6670/01 HIGH RESOLUTION WITH EXTRA FUNCTIONS

- High accuracy frequency measurements
- High resolution counting
- Burst frequency average, phase and RPM
- Time interval, single and average
- High trigger accuracy
- Excellent 10mV sensitivity.

**£695.00**

## R.C.L. BRIDGE



### PM6303 AUTOMATIC METER FOR FAST MEASUREMENT

- Easy to read crystal display
- Extremely fast automatic operation
- Displays component value, measurement units and equivalent circuit
- All displays appear simultaneously
- Push button selection of nine different parameters
- Two or four wire optional test attachment.

**£825.00**

**Electronic Brokers**

Electronic Brokers Ltd., 140-146 Camden Street, London NW1 9PB.  
Tel: 01-267 7070 Telex 298694 Fax No: 01-267 7363

For further information contact our Sales Office. All prices exclusive of carriage and VAT.  
Prices correct at time of going to press. A copy of our trading conditions is available on request.  
CIRCLE 2 FOR FURTHER DETAILS