

# wireless world

AUGUST 1979 40p

Australia SA1.25  
Canada \$2.25  
Denmark Kr. 11.00  
Germany Dm. 4.00  
Greece Dr. 47.00  
Holland Dfl. 4.50  
Italy L. 1100  
New Zealand \$NZ 1.50  
Norway Kr. 11.00 incl. moms  
Singapore M \$3.25  
Spain Ptas. 80.00  
U.S.A. \$1.65



**TV colour synthesizer**  
**Audio pre-amplifier**  
**Speech processor**

# Telequipment gives you more'scope

From a simple single trace, battery/mains operated instrument small enough to be carried in a brief case to a sophisticated 50MHz dual trace dual sweep oscilloscope suitable for advanced computer applications Telequipment bring you oscilloscopes for a wide range of applications together with a selection of plug-in units, accessories and a semi-conductor curve tracer.

To find out more contact your Telequipment area sales engineer, phone or write, we'll be pleased to help.

**TELEQUIPMENT** <img alt="Globe icon" data-bbox="355 341 408 358"/>

Tektronix UK Limited, P.O. Box 69, Coldharbour Lane, Harpenden, Herts. Tel: 05827 63141 Telex: 25559





This month's front cover reveals the contents of Burr Brown's model 3554 f.e.t. op-amp. The hybrid device offers a slewing rate of 1000V/ $\mu$ s.

**Logarithmic sweep generator.** Log or linear frequency sweeper for audio testing, presenting a 10:1 range of frequencies, for example 20Hz-20kHz.

**Victorian microwaves.** 60GHz oscillators, horn aerials and solar radio astronomy were all working or attempted before 1900.

**Microcomputer interfaces.** Connecting microcomputer buses to peripheral equipment.

Current issue price 40p, back issue (if available) £1.00, at Retail and Trade Counter, Paris Garden, London SE1. Available on microfilm: please contact editor.

By post, current issue 55p, back issues (if available) £1.00, order and payments to Room CP34, Dorset House, London SE1 9LU.

**Editorial & Advertising offices:** Dorset House, Stamford Street, London SE1 9LU.

**Telephones:** Editorial 01-261 8620. Advertising 01-261 8339.

**Telegrams/Telex:** Wiworld Bispres 25137 BISPRS G. Cables Ethaworld, London SE1.

**Subscription rates:** 1 year £9.00 UK and \$31 outside UK.

**Student rate:** 1 year, £4.00 UK and \$15.50 outside UK.

**Distribution:** 40 Bowling Green Lane, London EC1R ONE. Telephone 01-837 3636.

**Subscriptions:** Oakfield House, Perrymount Road, Haywards Heath, Sussex RH16 3DH. Telephone 0444 59188. Please notify a change of address.

**USA mailing agents:** Expeditors of the Printed Word Ltd, 527 Madison Avenue, Suite 1217, New York, NY 10022. 2nd-class postage paid at New York.

© IPC Business Press Ltd, 1979  
ISSN 0043 6062

# wireless world

ELECTRONICS / TELEVISION / RADIO / AUDIO

AUGUST 1979 Vol 85 No 1524

## 33 Spread the word

## 34 Audio processor design

by P. Anderson

40 **News of the month**  
Women's rights      P.O. monopoly talks  
UHJ position strengthens

## 43 No radio without displacement current

by D. A. Bell

## 45 Converting between analogue and digital quantities — 4

by G. B. Clayton

## 48 Literature received

## 49 Automatic interference remover

by A. J. Ewins

54 **Letters to the editor**  
High-level computer languages      Displacement current  
S.s.b. for mobile radio

## 58 Audio preamplifier with no t.i.d.

by Y. Miloslavskij

## 61 Citizen's Band communication system

by H. T. Tillotson

## 63 Passive notch filter — 1

by G. Kalanit

## 69 Colour synthesizer design for the PAL system

by N. C. Roberts

## 74 Novatexts

by P. Williams

## 76 World of amateur radio

## 79 A scientific computer — 5

by J. H. Adams

## 83 USSR National Exhibition

84 **Circuit ideas**  
Phase meter      Four-trace switch      VU meter

## 87 New products

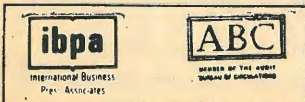

# Simply ahead!

## HIGH PERFORMANCE MODULAR UNITS BACKED BY NO-QUIBBLE 5 YEAR GUARANTEE

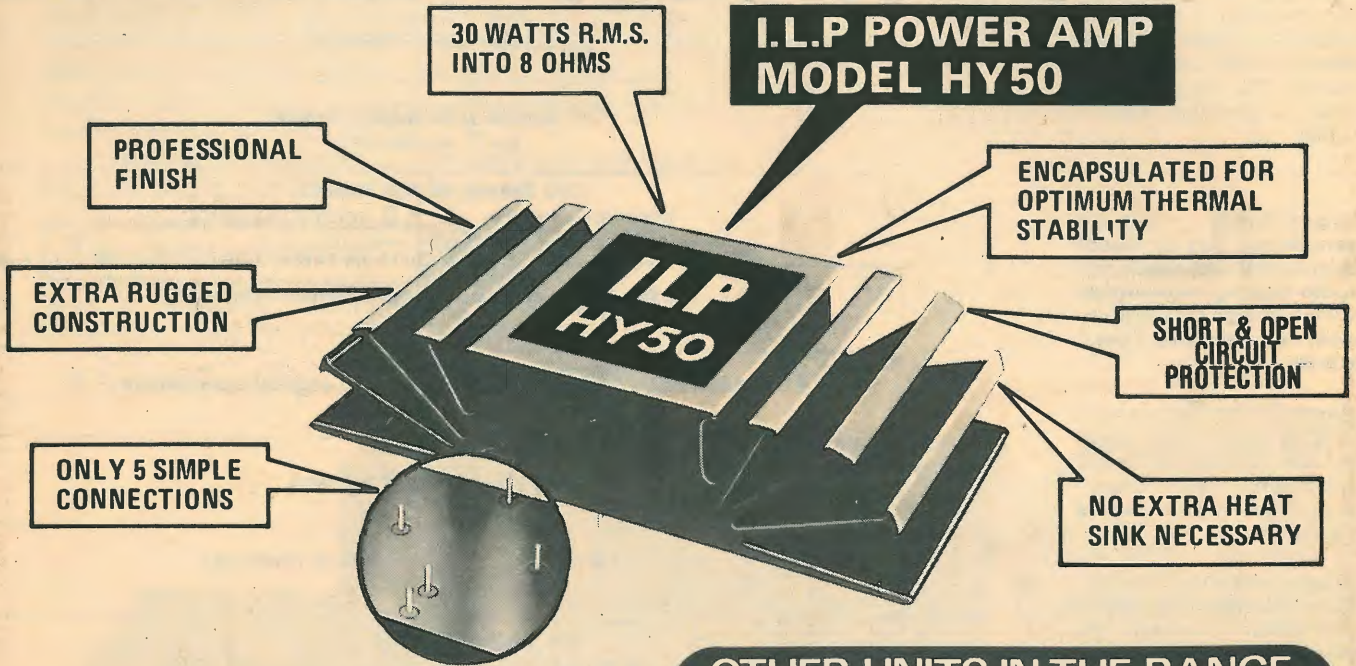

Of all the purpose-built power amplifier modules by I.L.P., the HY50 is understandably the most popular with those wanting to build or up-grade a hi-fi system, run a small high quality P.A. system, amplify a musical instrument (say for practise or small range use) or use it for lab work. Its useful 30 watts RMS output into 8 ohms, its rugged construction and freedom from heatsink worries make HY50 the ideal all-purpose quality power amp — and it is unconditionally guaranteed for five years! Tens of thousands are in regular use throughout the world.

### ... and a spec that just means what it says!

Encapsulated power amp with integral full-rated heatsink.  
 Input — 500mV.  
 Output 30 watts RMS / 8Ω.  
 Load Impedance — 4 to 16Ω.  
 Distortion — 0.04% from 100mW to 25 watts at 1KHz / 8Ω.  
 Supply Voltage ± 25V. Size 105 x 50 x 25mm.

Inc. VAT and postage in U.K.

**£8.33**

Nothing has been overlooked in the design and manufacture of I.L.P. Modular Units. Heavy duty heatsinks, encapsulated circuitry, no-compromise production standards and true professional finish ensure world leadership for I.L.P. Now we have **up-graded** output ratings and **down-graded** prices to bring I.L.P. within easier reach of all who want the best.

**New production techniques have enabled us to reduce prices by an average of 20%, making I.L.P. a better buy than ever.**

**\* Guaranteed 7 days despatch on all products**

#### USE OUR FREE POST SERVICE

for sending your orders, requests for information sheets, etc. Simply address envelope. No stamps required.



**FREEPOST 5, Graham Bell House, Roper Close, CANTERBURY, Kent CT2 7EP. Phone (0227) 54778.**

### OTHER UNITS IN THE RANGE

All prices inc. VAT at 15% and postage in the U.K.

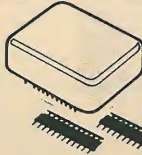

#### HYS PRE-AMPLIFIER

Compatible with all I.L.P. power amps and P.S.U.s. In a single pack, needs external pots and switches. Multi-function equalization, 5 inputs. High over-lad margin. Active tone controls, 500mV out. Distortion at 1 KHz-0.01%. Two connects easily for stereo.

**£5.34**

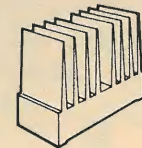

#### THE POWER AMPS

With heatsinks, full load line and thermal protection. Distortion typically 0.05% at 1 KHz.

**HY120** 60 Watts RMS / 8 Ω 114 x 50 x 85mm **£17.48**  
**HY200** 120 Watts RMS / 8 Ω 114 x 50 x 85mm **£21.21**  
**HY400** 240 Watts RMS / 4 Ω 114 x 100 x 85mm **£31.83**

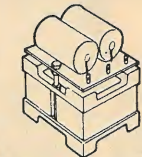

#### THE POWER SUPPLY UNITS

(Split line outputs to suit I.L.P. power units and HY5).

**PSU 50** for 1 or 2 x HY50 ..... **£9.32**  
**PSU 70** for 1 or 2 x HY120 ..... **£15.65**  
**PSU 90** for one HY200 ..... **£15.65**  
**PSU180** for one HY400 or 2 x HY200 ..... **£26.47**

Information sheets on application. Use our **FREEPOST** service.

### ★ OUR VALUES REMAIN SUPREME!

Please supply .....

Total Purchase Price .....

I enclose Cheque  Postal Orders  Money Order

Please debit my Access / Barclaycard Account number.

Name and address .....

Signature .....

FP58 .....

Ref. Bus. No. 1032630 Eng.



# DON'T GAMBLE WITH PERFORMANCE BUY LEVELL VOLTMETERS

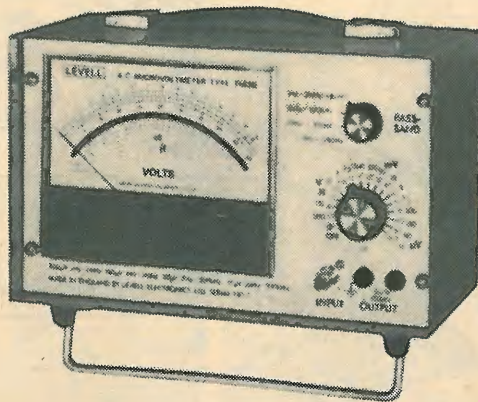

## A.C. MICROVOLTMETERS

VOLTAGE & dB RANGES

15 $\mu$ V, 50 $\mu$ V, 150 $\mu$ V . . . 500V fsd.  
Acc.  $\pm 1\% \pm 1\%$  fsd  $\pm 1\mu$ V at 1kHz.  
-100, -90 . . .  $\pm 50$ dB.  
Scale -20dB/+6dB ref. 1mW/600 $\Omega$ .

RESPONSE

$\pm 3$ dB from 1 Hz to 3MHz,  
 $\pm 0.3$ dB from 4 Hz to 1MHz above 500 $\mu$ V.  
TM3B filter switch: LF cut 10Hz,  
HF cut 100KHz, 10KHz or 350Hz.

INPUT IMPEDANCE

Above 50mV: 10M $\Omega$  < 20pF.  
On 50 $\mu$ V to 50mV: > 5M $\Omega$  < 50pF.

AMPLIFIER OUTPUT

150mV at fsd.

type **TM3A £110**

type **TM3B £120**

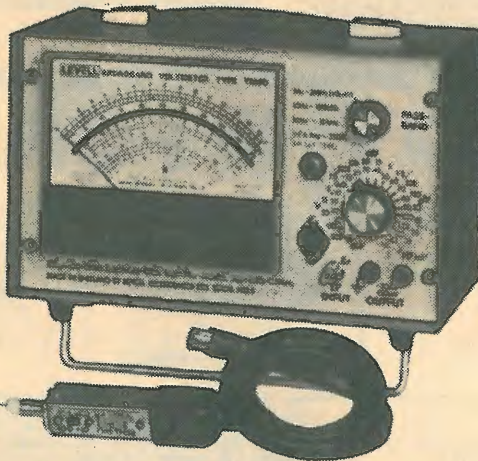

## BROADBAND VOLTMETERS

H.F. VOLTAGE & dB RANGES

1mV, 3mV, 10mV . . . 3V fsd.  
Acc.  $\pm 4\% \pm 1\%$  fsd at 30MHz.  
-50, -40 . . . +20dB.  
Scale -10dB/+3dB ref. 1mW/50 $\Omega$ .

H.F. RESPONSE

$\pm 3$ dB from 300kHz to 400MHz.  
 $\pm 0.7$ dB from 1MHz to 50MHz.

L.F. RANGES

As TM3.

AMPLIFIER OUTPUT

Square wave at 20Hz on H.F. with  
amplitude proportional to square of input.  
As TM3 on L.F.

type **TM6A £170**

type **TM6B £180**

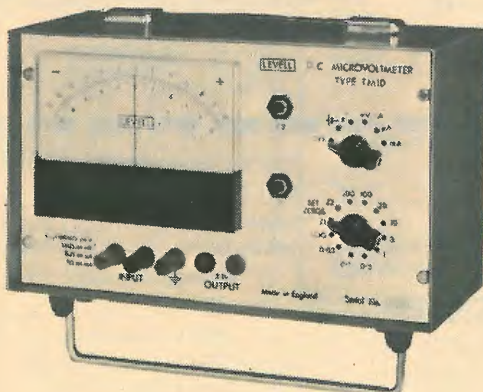

## D.C. MICROVOLTMETERS

VOLTAGE RANGES

30 $\mu$ V, 100 $\mu$ V, 300 $\mu$ V . . . 300V.  
Acc.  $\pm 1\% \pm 2\%$  fsd  $\pm 1\mu$ V. CZ scale.

CURRENT RANGES

30pA, 100pA, 300pA . . . 300mA.  
Acc.  $\pm 2\% \pm 2\%$  fsd  $\pm 2$ pA. CZ scale.

LOG. RANGE

$\pm 5\mu$ V at  $\pm 10\%$  fsd,  $\pm 5$ mV at  $\pm 50\%$  fsd,  
 $\pm 500$ mV at fsd.

RECORDER OUTPUT

$\pm 1$ V at fsd into >1k $\Omega$ .

type **TM10 £90**

Fully detailed specification sheets are available on request for our complete range of portable instruments. Prices are ex-works, carriage, packing and VAT extra. Optional extras are leather cases and power units.

**LEVELL** ELECTRONICS LTD.

MOXON STREET, BARNET, HERTS., EN5 5SD.  
TEL: 01-449 5028/440 8686

# TPA SERIES D — PROVEN POWER

Only the best designs stand the test of time. The reliable power of the TPA Series D has been a consistent choice of professional audio engineers.

- 19" x 3 1/2" rack mounting
- Load sensing output protection circuits
- Stable into loads of any impedance characteristic
- Available with a range of connectors and line transformers
- TPA 100 D incorporates plug-in PCB's and power transistors
- AM 8/12 fits loudspeakers enclosures for monitor purposes
- Conservative power rating 25,50 and 100W RMS. Full power at 15 ohms
- At 8 ohms power rating of 45,80 and 170W RMS
- Designed to operate in ambient temperatures in -25°C + 50°C range

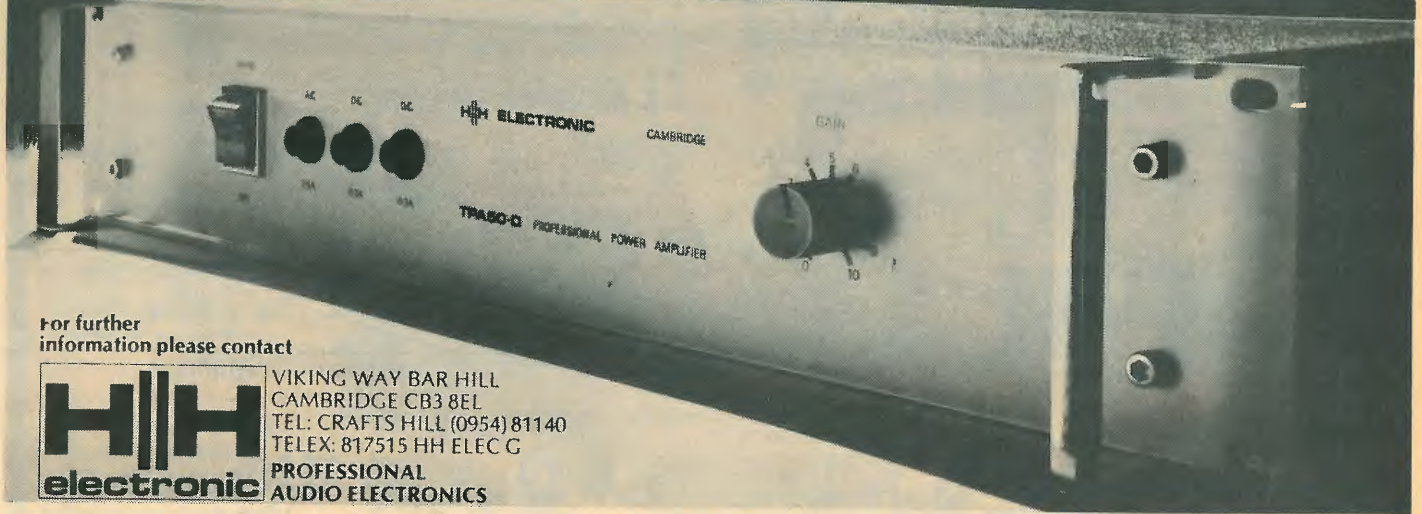

For further information please contact



VIKING WAY BAR HILL  
CAMBRIDGE CB3 8EL  
TEL: CRAFTS HILL (0954) 81140  
TELEX: 817515 HH ELEC G  
PROFESSIONAL  
AUDIO ELECTRONICS

WW — 049 FOR FURTHER DETAILS

# MULTIMETERS TO THE FORE

Gould Advance proudly present our new Alpha IV.

The fourth generation of an outstanding multimeter, its price of £105\* is so reasonable when compared to those of its competitors — in these inflationary times.

While the improved spec. and high reliability are a result of the experience we gained from the first three models.

The Alpha IV measures a.c. and d.c. voltage and current, plus resistance — with a choice of 25 accurate measurement ranges. A "2000 Count" large, clear l.c.d. display.

And true ease of use with its long life battery power facility.

Plus a two-year guarantee (in common with all our instruments). Buy one now. (Or four!)

\* Valid until 30th Sept. 1979  
V.A.T. extra @ 15% + £3.00 carriage per instrument and its accessories.



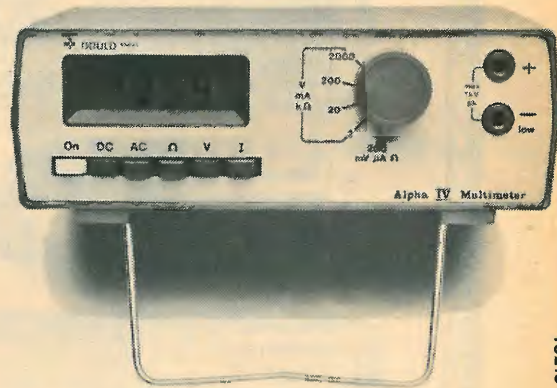

An Electrical/Electronics Company  
Gould Instruments Division,  
Roebuck Road, Hainault, Essex IG6 3UE.  
Telex: 263785.  
TELEPHONE: 01-500 1000



To: **Gould Advance Limited**,  
Roebuck Road, Hainault, Essex IG6 3UE.  
Telephone: 01-500 1000.

Payment Choice:- Cheque or money order  
(payable to Gould Advance Ltd.) Purchase Order  
— terms 30 days net. Credit card:

Access/Barclaycard number  

Signature.....

Name .....

Address.....

.....

.....

Tel: .....

Product required and Accessories

| Item               | Qty | Price* | Total |
|--------------------|-----|--------|-------|
| Alpha IV           |     | £105   |       |
| Option O1B         |     |        |       |
| Battery Eliminator |     | £8.50  |       |
| Option O4B         |     |        |       |
| High Voltage Probe |     | £47.00 |       |
| Option O5B         |     |        |       |
| Carry Case         |     | £20.00 |       |
| Option O6B         |     |        |       |
| R.F. Detector      |     | £27.00 |       |

V.A.T. @ 15%.....  
Carriage @ £3.00 per instrument.....  
**TOTAL**.....

\*Prices valid until Sept. 30th 1979 (V.A.T. extra @ 15%)

WW — 066 FOR FURTHER DETAILS

PRIME TTL & CMOS AT LOWEST PRICES

ALL NEW

REAL-STATE OF-THE-ART

NEW LOW PRICES

Table with 4 columns: Part Number, Price, Part Number, Price. Includes 54xxTTL and 74CxxTTL series.

Table with 4 columns: Part Number, Price, Part Number, Price. Includes 74CxxTTL and 74LSxxTTL series.

Table with 4 columns: Part Number, Price, Part Number, Price. Includes 4xxxCMOS and 74LSxxTTL series.

Table with 4 columns: Part Number, Price, Part Number, Price. Includes 74xxTTL series.

Table with 4 columns: Part Number, Price, Part Number, Price. Includes 74LxxTTL series.

Table with 4 columns: Part Number, Price, Part Number, Price. Includes 74SxxTTL series.

Two new 10Hz to 600MHz frequency counters from Optoelectronics USA each c/w built-in Nicads + charging circuits.



MODEL OPTO 8000.1A ONLY £260 (was £320)

- Precision TCXO time base 0.1 PPM stability
• Super sensitivity with preamps in both Hi-Z & 50 ohm inputs



MODEL OPTO 7000 ONLY £123 (was £155)

- TCXO time base 0.08 PPM/°C
• Aluminium case
• Hi-Z & 50 ohm inputs

- Frequency Counter Accessories
P-100 50 ohm 1X £12
P-101 Lo Pass £12
P102 Hi-Z 2X £13

ELENCO ELECTRONIC/DIGITAL DESIGN STATIONS

Elenco's electronic or digital design stations contain the essential equipment for quick and easy breadboarding of circuits. All power supplies are regulated and protected by a special current limiting circuit.

MODEL XK-1000 ELECTRONIC DESIGN STATION

- Dual DC Power Supply 0 to -15V, 0 to -15V @ 2 Amps
• Fully Regulated
• Short Circuit Protection



Ideal for DC, AC, Semiconductor, and Electronics Circuit Experiments.

MODEL XK-2000 DIGITAL DESIGN STATION

- Three Power Supplies -5V @ 1A, -12V @ 1A, 12V @ 1A
• Fully Regulated
• Short Circuit Protection



Comparable with most IC Logic Families including RTL, DTL, TTL, CMOS, PMOS, NMOS, Linear.

BRAND NEW FROM EICO MODEL 390 Function/Sweep Generator £135.00



- Offers linear, logarithmic sweeps
• Six position calibrated attenuator
• BNC front panel output jack

ELENCO PRECISION Digital multimeter 1200B

The most versatile DMM we have ever offered at lowest ever price!



ONLY £58

- 3 1/2 digits jumbo LED display 0.05% basic accuracy
• Measures AC/DC voltages from 100 microvolts to 1000 volts, AC/DC current from 1 microamp to 2 Amp, resistance from 0.01 ohm to 20 Megohm

ELENCO POWER SUPPLIES

Model XP 600 dual metered regulated variable 0-40V, 0-3 Amp £75
Model XP 90 regulated 13.8V @ 8 Amp-converts your CB/Ham & mobile units to base station £55

BRAND NEW!

JUST RELEASED 1979 IC MASTER 2500 pages



Complete integrated circuit data selector! Master guide to the latest IC's including microprocessors and consumer circuits

£39.95 inc. VAT not applicable

MICROPROCESSORS

Table with 4 columns: CPU's, Price, RAM's, Price. Lists various microprocessors like 6502, 8080A, Z80, EPROM, 1702A.

Texas Instruments Low Profile Sockets

Table with 4 columns: Contacts, Price, Contacts, Price. Lists socket options like 8 PIN, 14 PIN, 16 PIN, 18 PIN, 20 PIN.

FAIRCHILD RED LED LAMPS

#FLV5057 Medium Size Clear Case RED EMITTING. These are not restated off-spec units as sold by some of our competition. These are factory prime, first quality, new units.



9p each 1 off 6p each 10 off

THE COLOSSUS FAIRCHILD SUPER JUMBO LED READOUT A full .60 inch character. The biggest readout we have ever sold! Super efficient.

YOUR CHOICE FND 847 Common Anode £2 each FND 850 Common Cathode £1.50 each 100 off

Z-SEGMENT DISPLAY LEADS AT LOWEST PRICES

Large table with 4 columns: TYPE, POLARITY, HT, PRICE. Lists various Z-segment display LEDs with their specifications and prices.

Ordering Information - equipment prices are inc. of P&P for components add 25p P&P. Add 15% VAT on all orders.

MICRO CIRCUITS

Your single source for factory prime components & professional quality test gear at solid savings.

Unit 10 1st Floor, East Block 38 Mount Pleasant LONDON WC1X 0AP 01- 837 1165 Telex 8953084

## BIMENCLOSURES



**ALL METAL BIMCASES**  
Red, Grey or Orange 14swg Aluminium removable top and bottom covers. 18 swg black mild steel chassis with fixing support brackets.  
BIM 3000 (250x167.5x68.5mm) £14.58

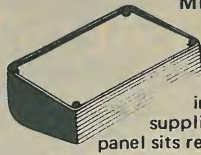

**MINI DESK BIMCONSOLES**  
Orange, Blue, Black or Grey ABS body incorporates 1.8mm pcb guides, stand-off bosses in base with 4 BIMFEET supplied. 1mm Grey Aluminium panel sits recessed with fixing screws into integral brass bushes.  
BIM 1005 (161 x 96 x 58mm) £2.18  
BIM 1006 (215 x 130 x 75mm) £3.05

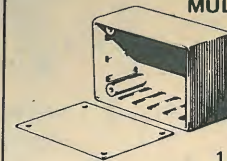

**MULTI PURPOSE BIMBOXES**  
Orange, Blue, Black or Grey ABS with 1mm Grey Aluminium recessed front cover held by screws into integral brass bushes. 1.8mm pcb guides incorporated and 4 BIMFEET supplied.  
BIM 4003 (85x56x28.5mm) £1.18  
BIM 4004 (111x71x41.5mm) £1.62  
BIM 4005 (161x96x52.5mm) £2.19

## ALL METAL BIMCONSOLES



All aluminium, 2 piece desk consoles with either 15° or 30° sloping fronts, sit on 4 self-adhesive non-slip rubber feet. Ventilation slots in base and rear panel for excellent cooling. See latest catalogue for new styles and sizes

| Colour Code | Top Panel   | Base  |
|-------------|-------------|-------|
| A           | Off White   | Blue  |
| B           | Sand        | Green |
| C           | Satin Black | Gold  |

| 15° Sloping Panel            | 30° Sloping Panel             |        |
|------------------------------|-------------------------------|--------|
| BIM7151 (102x140x51 [28] mm) | BIM7301 (102x140x76 [28] mm)  | £10.67 |
| BIM7152 (165x140x51 [28] mm) | BIM7302 (165x140x76 [28] mm)  | £11.44 |
| BIM7153 (165x216x51 [28] mm) | BIM7303 (165x183x102 [28] mm) | £12.61 |
| BIM7154 (165x211x76 [33] mm) | BIM7304 (254x140x76 [28] mm)  | £13.82 |
| BIM7155 (254x211x76 [33] mm) | BIM7305 (254x183x102 [28] mm) | £15.36 |
| BIM7156 (254x287x76 [33] mm) | BIM7306 (254x259x102 [28] mm) | £16.67 |
| BIM7157 (356x211x76 [33] mm) | BIM7307 (356x183x102 [28] mm) | £17.58 |
| BIM7158 (356x287x76 [33] mm) | BIM7308 (356x259x102 [28] mm) | £18.55 |

## LOW PROFILE BIMCONSOLES

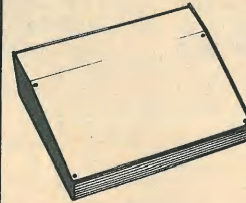

Orange, Blue, Black or Grey ABS body has ventilation slots as well as 1.8mm pcb guides and stand-off bosses in base. Double angle recessed front panel with 4 fixing screws into integral brass bushes. 4 BIMFEET supplied.

BIM 6005 (143 x 105 x 55.5 [31.5] mm) £2.37  
BIM 6006 (143 x 170 x 55.5 [31.5] mm) £3.08  
BIM 6007 (214 x 170 x 82.0 [31.5] mm) £4.12

## ABS & DIECAST BIMBOXES

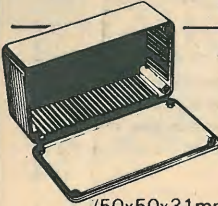

6 sizes in ABS or Diecast Aluminium. ABS moulded in Orange, Blue, Black or Grey. Diecast Aluminium in Grey Hammetone or Natural. All boxes incorporate 1.8mm pcb guides, stand-off supports in base and have close fitting flanged lids held by screws into integral brass bushes (ABS) or tapped holes (Diecast).

|                | ABS        | Diecast    | Hammetone | Natural |
|----------------|------------|------------|-----------|---------|
| (50x50x31mm)   | N/A        | BIM5001/11 | TBA       | £1.02   |
| (100x50x25mm)  | BIM2002/12 | BIM5002/12 | £1.46     | £1.19   |
| (112x62x31mm)  | BIM2003/13 | BIM5003/13 | £1.78     | £1.46   |
| (120x65x40mm)  | BIM2004/14 | BIM5004/14 | £2.24     | £1.82   |
| (150x80x50mm)  | BIM2005/15 | BIM5005/15 | £2.84     | £2.28   |
| (190x110x60mm) | BIM2006/16 | BIM5006/16 | £3.94     | £3.33   |

Also available in Grey Polystyrene with no slots and self-tapping screws  
BIM 2007/17 (112x61x31mm) £1.00

## EUROCARD BIMCONSOLES

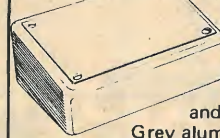

Orange, Blue, Black or Grey ABS body accepts full or 1/2 size Eurocards, with bosses in the base for direct fixing. 1.8mm wide pcb guides incorporated and 4 BIMFEET supplied. 1mm Grey aluminium lid sits flush with body top and held by 4 screws into integral brass bushes.

BIM 8005 (169x127x70 [45] mm) £4.12  
BIM 8007 (243x187x103 [66] mm) £6.10

## BIMTOOLS + BIMACCESSORIES



### MAINS BIMDRILLS

Small, powerful 240V hand drill complete with 2 metres of cable and 2 pin DIN plug. Accepts all tools with 1mm, 2mm or .125" dia. shanks. Drills brass, steel, aluminium and pcb's. Under 250g, off load speed 7500 rpm. Orange ABS, high impact, fully insulated body with integral on/off switch £10.53

Mains Accessory Kit 1 includes 1mm, 2mm, .125" twist drills, 5 burrs and 2.4mm collet £2.48

Mains Kit 2 includes Mains BIMDRILL as above, 20 assorted drills, mops, burrs, grinding wheels and mounted points, 1mm, 2mm, 2.4mm and .125" collets. Complete in transparent case measuring 230x130x58mm £22.14

### BIMDAPTORS

Allows pcb's to be flat mounted sandwich fashion in BIMBOXES, BIMCONSOLES, and all other enclosures having 1.5mm wide vertical guide slots. One plastic BIMDAPTOR on each corner of pcb(s) enables assembly to be simply slid into place. 54mm long, 10 slots on 5mm spacing and can be simply snapped off to length. £1.08 per pack of 25.

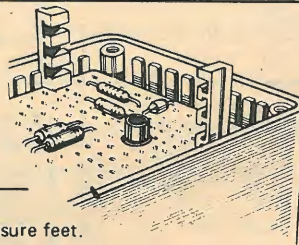

### BIMFEET

11mm dia. 3mm high, grey rubber self-adhesive enclosure feet. £0.77 per pack of 24

### 12 VOLT BIMDRILLS

2 small, powerful drills easily hand held or used with lathe/stand adaptor. Integral on/off switch and 1 metre cable.

Mini BIMDRILL with 3 collets up to 2.4mm dia. £ 8.10  
Major BIMDRILL with 4 collets up to 3mm dia. £13.60

Accessory Kits 1 have appropriate drills and collets as above plus 20 assorted tools. Mini Kit 1 - £15.12, Major Kit 1 - £19.44. Accessory Kits 2 have appropriate drills, collets plus 40 tools and mains-12V dc adaptor. Mini Kit 2 - £34.02, Major Kit 2 - £39.42. Accessory Kits 3 as appropriate Kits 2 plus stand/lathe unit. Mini Kit 3 - £45.36, Major Kit 3 - £50.76.

### BIMPUMPS

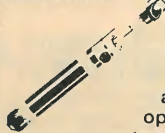

BIMPUMP Major (180mm long) £7.99  
BIMPUMP Minor (150mm long) £6.80

### BIMIRONS

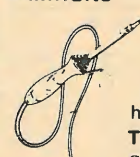

**Type 30** General Purpose 27 watt iron with long life, rapid change element, screw on tip, stainless steel shaft and clip on hook. Styled handle with neon. £4.05  
**Type M3** Precision 17 watt iron, quick change tip, long life element, styled handle with clip on hook. £4.43

## BIMBOARDS

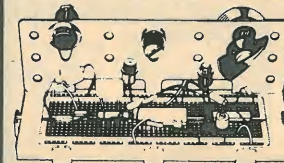

DIL COMPATIBLE BIMBOARDS

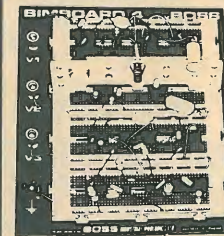

Accept all sizes (4-50 pin) of DIL IC packages as well as resistors, diodes, capacitors and LEDs. Integral Bus Strips up each side for power lines and Component Support Bracket for holding lamps, switches and fuses etc. Available as single or multiple

units, the latter mounted on 1.5mm thick black aluminium back plate which stand on non slip rubber feet and have 4 screw terminals for incoming power.

BIMBOARD 1 has 550 sockets, multiple units utilising 2, 3 and 4 BIMBOARDS incorporate 1100, 1650 and 2200 sockets, all on 2.5mm (0.1") matrix.

BIMBOARD 1 £ 8.83  
BIMBOARD 2 £21.01  
BIMBOARD 3 £29.84  
BIMBOARD 4 £38.79

### DESIGNER PROTOTYPING SYSTEM

1, 2, or 3 BIMBOARDS mounted on BIM 6007 BIMCONSOLE with Integral Power Supply (±5 to ±15Vdc @ 100mA and fixed +5Vdc @ 1A) All O/P's fully isolated. Short circuit and fast fold back protection. Power rails brought out to cable clamps that accept stripped wire or 4mm plug.

DESIGNER 1 £55.62  
DESIGNER 2 £61.02  
DESIGNER 3 £66.42



# Cambridge Learning Enterprises

## SELF-INSTRUCTION COURSES

### UNDERSTANDING DIGITAL ELECTRONICS

In the years ahead the products of digital electronics technology will play an important part in your life. Calculators and digital watches are already commonplace. Tomorrow a digital display could show your vehicle speed and fuel consumption; you could be phoning people by entering their name into a telephone which would automatically look up their number and dial it for you.

These courses were written by experts in electronics and learning systems so that you could teach yourself the theory and application of digital logic. Learning by self-instruction has the advantages of being faster and more thorough than classroom learning. You work at your own pace and must respond by answering questions on each new piece of information before proceeding.

After completing these courses you will have broadened your career prospects and increased your fundamental understanding of the rapidly changing technological world around you.



**Digital Computer Logic and Electronics** is designed for the beginner. No mathematical knowledge other than simple arithmetic is assumed, though the student should have an aptitude for logical thought. It consists of four volumes - each A4 size - and serves as an introduction to the subject of digital electronics. Everyone can learn from it - designer, executive, scientist, student, engineer.

Contents include: Binary, octal and decimal number systems; conversion between number systems, AND, OR, NOR and NAND gates and inverters; Boolean algebra and truth tables; De Morgans Laws; design of logic circuits using NOR gates; R-S and J-K flip flops; binary counters, shift registers and half adders.

**FLOW CHARTS & ALGORITHMS** help you present: safety procedures, government legislation, office procedures, teaching materials and computer programs by means of YES and NO answers to questions.

### The Algorithm Writer's Guide

explains how to: define the questions, put them in the best order and draw the flow chart, with numerous examples shown. All that students require is an aptitude for logical thought. Size: A5, 130 pages. This book is a MUST for those with things to say.

**NEW** from Cambridge Learning Enterprises

### O - LEVEL ENGLISH LANGUAGE

More and more jobs require a C-GRADE PASS, and over 250,000 people fail to get this every year. Will one of them be in your family? This new course, written by experts in a style that's serious yet fun to read, shows you how to mark your own work and compare it with the work of other people in their exam year. Set your own pace and assess your results immediately with no postal delays: watch your speed and standards improve. In Book 1 learn how you will be marked on COMPREHENSION, Book 2 covers SUMMARY, PUNCTUATION & SPELLING, and Book 3 coaches you in the principles of COMPOSITION. Size: 3 A4 volumes totalling 250 pages.

**CAMBRIDGE LEARNING ENTERPRISES, UNIT 31 RIVERMILL SITE, FREEPOST, ST. IVES, HUNTINGDON, CAMBS. PE17 4BR, ENGLAND**  
 TELEPHONE: ST. IVES (0480) 67446.

PROPRIETORS: DAYRIDGE LTD. REG. OFFICE: RIVERMILL LODGE, ST. IVES REGD. IN ENGLAND No. 1328762

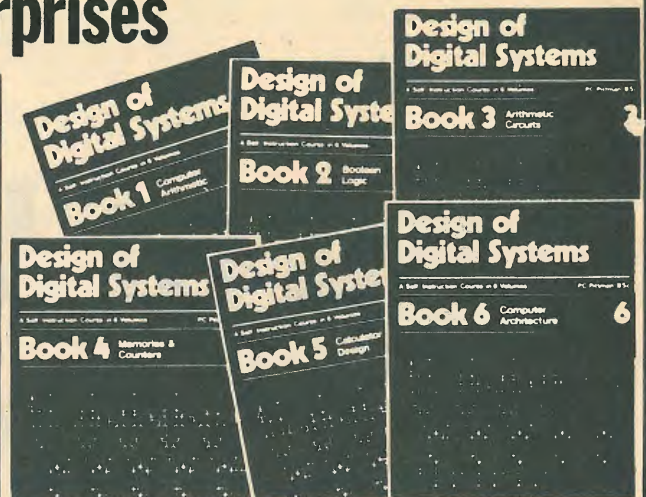

**Design of Digital Systems** is written for the engineer seeking to learn more about digital electronics. Its six volumes - each A4 size are packed with information, diagrams and questions designed to lead you step-by-step through number systems and Boolean algebra to memories, counters and simple arithmetic circuits, and finally to a complete understanding of the design and operation of calculators and computers. Contents include:

**Book 1** Octal, hexadecimal and binary number systems; conversion between number systems; representation of negative numbers; complementary systems; binary multiplication and division.

**Book 2** OR and AND functions; logic gates; NOT, exclusive-OR, NAND, NOR and exclusive-NOR functions; multiple input gates; truth tables; De Morgans Laws; canonical forms; logic conventions; Karnaugh mapping; three-state and wired logic.

**Book 3** Half adders and full adders; subtractors; serial and parallel adders; processors and arithmetic logic units (ALUs); multiplication and division systems.

**Book 4** Flip flops; shift registers; asynchronous and synchronous counters; ring, Johnson and exclusive-OR feedback counters; random access memories (RAMs) and read only memories (ROMs).

**Book 5** Structure of calculators; keyboard encoding; decoding display data; register systems; control unit; program ROM; address decoding; instruction sets; instruction decoding; control program structure.

**Book 6** Central processing unit (CPU); memory organization; character representation; program storage; address modes; input/output systems; program interrupts; interrupt priorities; programming; assemblers; computers; executive programs; operating systems and time sharing.

Four volumes Digital Computer Logic & Electronics at £6.50 inc

Six volumes Design of Digital Systems at £10.50 inc p & p

Three volumes O-Level English Language at £6.50 inc p & p

The Algorithm Writer's Guide at £3.40 inc p & p

If your order exceeds £14 deduct £2 from your payment

Price includes surface mail anywhere in the world, airmail extra

**GUARANTEE** If you are not entirely satisfied your money will be refunded

Please allow 21 days for delivery

Cambridge Learning Enterprises, Unit 31, Rivermill Site, FREEPOST, St. Ives, Huntingdon, Cambs. PE17 4BR, England.

Please send me the following books:

..... sets Digital Computer Logic & Electronics at £6.50, p & p

..... sets Design of Digital Systems at £10.50, p & p included

..... O-Level English Language at £6.50 p & p included

..... The Algorithm Writer's guide at £3.40, p & p included

Name .....

Address .....

.....

I enclose a \*cheque/PO payable to Cambridge Learning Enterprises for £.....

Please charge my \*Access/Barclaycard/Visa/Eurocard/Mastercharge/Interbank account number .....

Signature..... \*delete as appropriate.

Telephone orders from credit card holders accepted on

0480-67446 (Ansafone). Overseas customers should send a

bank draft in sterling drawn on a London Bank, or quote credit

card number.

# Out of bounds

A power amplifier has to produce an adequate output voltage. This voltage has to be able to change at a sufficiently high rate to trace accurately any possible programme waveform. It has to be able to do all this independently of the current drawn by the loudspeaker.

These are the three dimensional limits of a power amplifier, usually referred to as voltage clipping level, slew rate and output current limit.

If an amplifier is operated so that none of these limits is exceeded, and is otherwise competently designed, then the amplifier will not degrade the programme. (If the programme were auditioned at the input or the output of such an amplifier there would be no audible change).

QUAD amplifiers are such amplifiers.

For further details on the full range of QUAD products write to:

The Acoustical Manufacturing Co. Ltd.,  
Huntingdon, Cambs. PE18 7DB. Telephone (0480) 52561

## QUAD

**for the closest approach  
to the original sound**

QUAD is a registered trade mark.

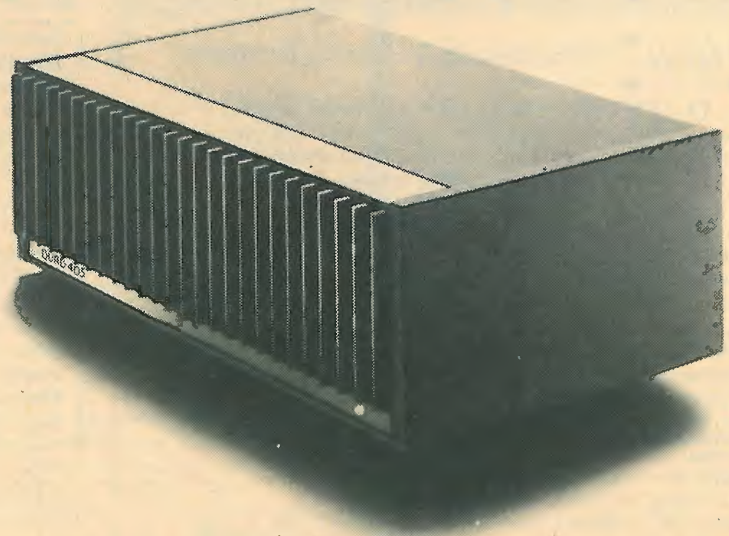



Our catalogue even includes some popular car accessories at marvellous prices.



A genuine 150W per channel stereo disco to build yourself. Full specification in our catalogue.



Speakers from 1 1/2 inch to 15 inch; megaphone, PA horns, crossovers etc. They're all in our catalogue. Send the coupon now!



Our catalogue describes a wide range of plugs and sockets, all at marvellous prices. See cat. pages 114 to 120 for details.



61-note touch-sensitive piano to build yourself. Full specification in our catalogue.



These are just some of the metal cases we stock. There are dozens of plastic ones to choose from as well. See pages 52 to 57 of our catalogue.



A digitally controlled stereo synthesiser the 5800S with more facilities than almost anything up to £3,000. Build it yourself for less than £700. Full specification in our catalogue.

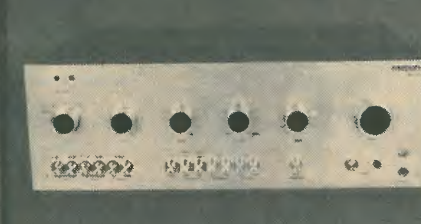

A very high quality 40W per channel stereo amplifier with a superb specification and lots of extras. Full construction details in our catalogue.



Multimeters, analogue and digital, frequency counter, oscilloscopes, and lots, lots more at excellent prices. See cat. pages 108 and 183 to 188 for details.

# MAPLIN

**ELECTRONIC SUPPLIES LTD**

All mail to:-

P.O. Box 3, Rayleigh, Essex SS6 8LR.  
Telephone: Southend (0702) 554155.

Shop: 284 London Road,  
Westcliff-on-Sea, Essex.  
(Closed on Monday).

Telephone: Southend (0702) 554000



A high stereo tuner with medium and long wave, FM stereo and UHF TV sound! Full construction details in our catalogue.



A 10-channel stereo graphic equaliser with a quality specification at an unbeatable price when you build it yourself. Full specification in our catalogue.



A massive new catalogue from Maplin that's even bigger and better than before. If you ever buy electronic components, this is the one catalogue you must not be without. Over 280 pages - some in full colour - it's a comprehensive guide to electronic components with hundreds of photographs and illustrations and page after page of invaluable data.

Our bi-monthly newsletter contains guaranteed prices, special offers and all the latest news from Maplin.

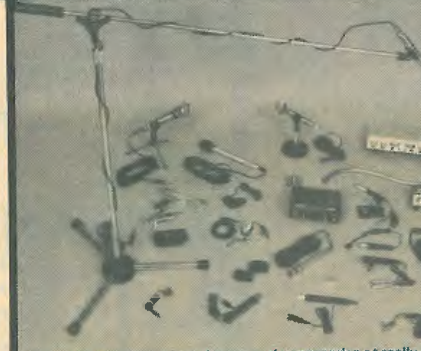

A superb range of microphones and accessories at really low prices. Take a look in our catalogue--send the coupon now!

**Post this coupon now for your copy of our 1979-80 catalogue price 75p.**

Please send me a copy of your 280 page catalogue. I enclose 75p but understand that if I am not completely satisfied I may return the catalogue to you within 14 days and have my 75p refunded immediately. If you live outside U.K. send £1 or ten International Reply Coupons.

NAME .....

ADDRESS .....

WW 879

# SPEAKER KITS FROM KEF

Now you can build a loudspeaker system which incorporates all the features developed for the world famous KEF Model 104aB, and hear its quality at your KEF dealer before you buy and build the kit.

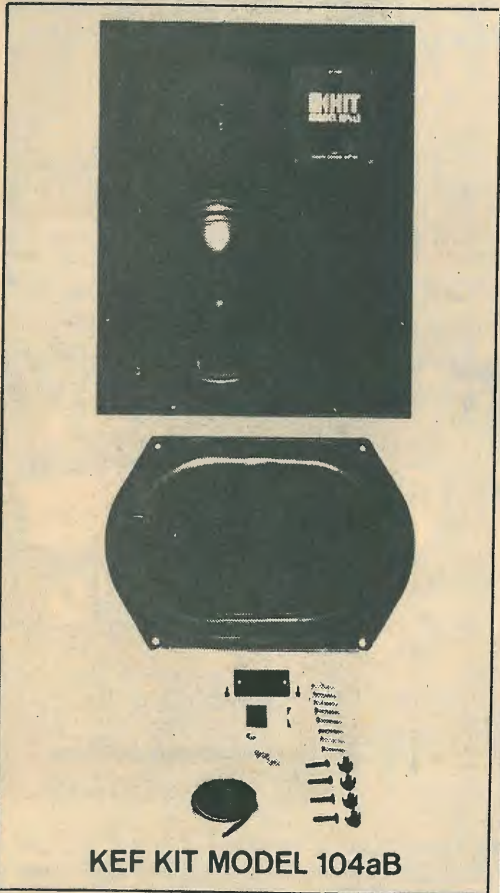

KEF KIT MODEL 104aB

The kit contains two baffles (only one illustrated) with the two drive units already preassembled, pretested and fully wired through an Acoustic Butterworth filter network. The mid frequency response can be adjusted by a 3-position contour control, and the tweeter is fuse protected.

The lowest frequencies come from an acoustically coupled bass radiator, without overall loss in efficiency from such a compact enclosure.

The instruction leaflet takes you through the enclosure construction sequence step-by-step with photographs to help.

Write now for more details, and the name of your nearest KEF dealer where you can hear how good the Model 104aB system is, before you buy the kit.

KEF Electronics Ltd.,  
Tovil, Maidstone, Kent ME15 6QP.  
Telephone: 0622-672261. Telex: 96140.



WW - 044 FOR FURTHER DETAILS

# THE JAMES SCOTT INDUSTRIAL MICROWAVE RANGE OF EQUIPMENT

The James Scott range of Microwave equipment offers industrial users a greater choice of alternative systems in robust, industrial, cast aluminium housings, for a wide variety of applications.

The range is made up of standard sub-assemblies which can be permuted to suit individual application requirements. Here are some suggested applications for these units.

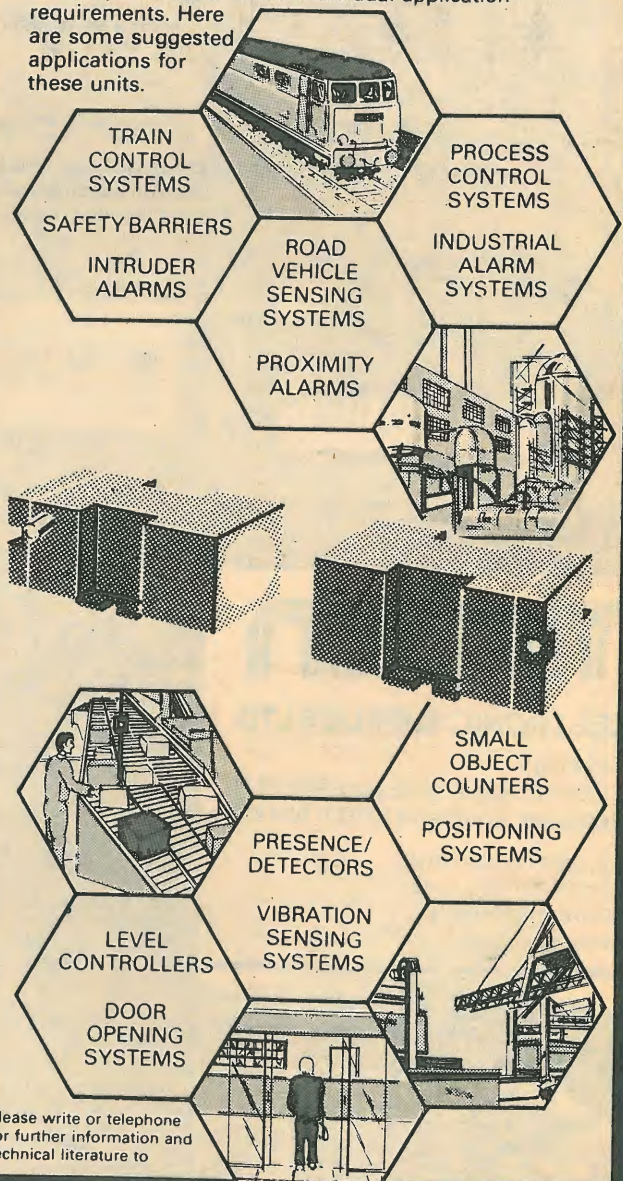

Please write or telephone for further information and technical literature to



JAMES SCOTT (Electronic Engineering) Ltd

CARNTYNE INDUSTRIAL ESTATE  
GLASGOW G32 6AB Tel 041-778 4206 Telex 778286

WW - 022 FOR FURTHER DETAILS

# THREE FOR FREE FROM CSC

**ELECTRONICS BY NUMBERS**  
**FREE PROJECTS**  
 No 1, No 2,  
 & No 3.

## ELECTRONICS BY NUMBERS LED BAR GRAPH UNIVERSAL INDICATOR

Now using **EXPERIMENTOR BREADBOARDS** and following the instructions in "Electronics by numbers" ANYBODY can build electronic projects. Look at the diagram and select R1, this is a resistor with a value between 120 to 270 ohm. Plug it into holes X20 and D20, now take LED 1 and plug it into holes E20 and F20. Do the same with the Diodes e.g. plug D7 into holes G7 and G10.

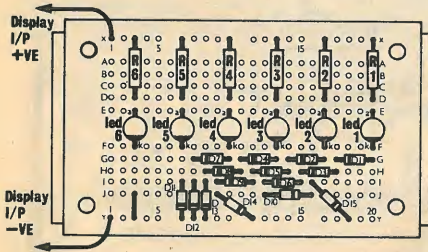

### YOU WILL NEED

- EXP- ANY EXPERIMENTOR BREADBOARD
- D1 to D15 - Silicon Diodes (such as 1N914)
- R1 to R6 - From 120-270 ohm resistors 1/4 watt.
- LED1 to LED6 - Light emitting diodes.

**LED BAR GRAPHS** are replacing analogue meters as voltage-level indicators in many instances.

This circuit uses the forward voltage drop of diodes to determine how many LEDs light up. Any type of diode can be used but you must use all the same type. For full working details of this circuit fill in the coupon. If you have already built the Two-transistor Radio and the Fish'n'cliks projects you will find that you can reuse the components from these projects to build other projects in the series.

**FILL IN THE COUPON AND WE WILL SEND YOU FREE OF CHARGE FULL COPIES OF "ELECTRONICS BY NUMBERS" PROJECTS No 1, No 2 and No 3.**

## PROTO-CLIP TEST CLIPS.

Brings IC leads up from crowded PC boards. Available plain or with cable with clips at one or both ends.



- PC - 16 pin. £2.75.
- PC - 16 pin with cable. £6.00.
- PC - 16 with cable and 16 pin clips at both ends. £10.25.



Europe, Africa, Mid-East: CSC UK LTD. DEPT. 7T2 Unit 1, Shire Hill Industrial Estate, Saffron Walden, Essex CB11 3AQ. Telephone: SAFFRON WALDEN 21682. Telex: 817477.

## EXPERIMENTOR BREADBOARDS.

No soldering modular breadboards, simply plug components in and out of letter number identified nickel-silver contact holes. Start small and simply snap-lock boards together to build breadboard of any size.

All EXP Breadboards have two bus-bars as an integral part of the board, if you need more than 2 buses simply snap on 4 more bus-bars with the aid of an EXP.4B.

**EXP.325.** The ideal breadboard for 1 chip circuits. Accepts 8,14,16 and up to 22 pin IC's. **ONLY £1.60.**



**EXP.350.** £3.15. 270 contact points with two 20-point bus-bars.

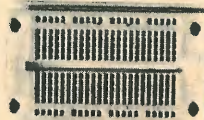

**EXP. 300.** 550 contacts with two 40-point bus-bars. **£5.75.**



**EXP. 650** for Micro-processors. **£3.60.**

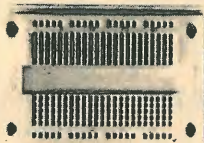

**EXP 4B.** More bus-bars. **£2.30.**



ALL EXP.300 Breadboards mix and match with 600 series.

## PROTO-BOARDS.

THE ULTIMATE IN BREADBOARDS FOR THE MINIMUM COST. TWO EASILY ASSEMBLED KITS.

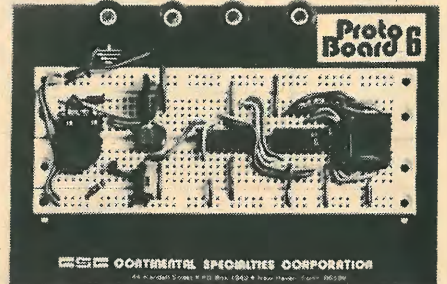

PB.6 Kit, 630 contacts, four 5-way binding posts accepts up to six 14-pin Dips. **PROTO-BOARD 6 KIT. £9.20.**

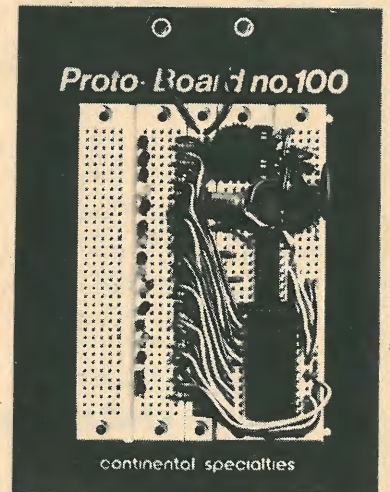

PB.100 Kit complete with 760 contacts accepts up to ten 14-pin Dips, with two binding posts and sturdy base. Large capacity with Kit economy. **PROTO-BOARD 100 KIT £11.80.**

### HOW TO ORDER AND RECEIVE FREE COPY OF TWO-TRANSISTOR RADIO PROJECT, FISH'N'CLIKS AND LED BAR GRAPH.

CSC UK LTD. DEPT. 7T2 Unit 1, Shire Hill Industrial Estate, Saffron Walden, Essex CB11 3AQ.

It's easy. Give us your name and full postal address, in block capitals. Enclose cheque, postal order or credit card number and expiry date. OR telephone 0799 21682 and give us your Access, American Express or Barclaycard number and your order will be in the post that night.

| EXPERIMENTOR BREADBOARDS. | CONTACT HOLES.         | IC CAPACITY 14 PIN.DIP.                | UNIT PRICE INCLUDING POSTAGE AND V.A.T (15%) |
|---------------------------|------------------------|--|--|
| EXP. 325                  | 130                    | 1                                      | £2.70  |
| EXP. 350                  | 270                    | 3                                      | £4.48  |
| EXP. 300                  | 550                    | 6                                      | £7.76  |
| EXP. 650                  | 270                    | use with 0,6 pitch Dip's Bus-Bar Strip | £4.99  |
| EXP. 4B.                  | Four 40 Point Bus-Bars |  | £3.51  |
| TEST CLIPS                |                        |  |  |
| PC. 16.                   |                        |  | £4.03  |
| PC. 16-18.                |                        |  | £8.05  |
| PC. 16-18 Dual Clip.      |                        |  | £12.94                                       |
| PROTO-BOARDS.             |                        |  |  |
| PB. 6.                    | 630                    | 6                                      | £11.73                                       |
| PB. 100.                  | 760                    | 10                                     | £14.72                                       |

NAME .....

ADDRESS .....

**FILL IN COUPON & RECEIVE FREE COPY OF ELECTRONICS BY NUMBERS PROJECTS Nos 1, 2 AND 3**

WW - 012 FOR FURTHER DETAILS

# PROOPS BROS. LTD.

Special purchase of Shinohara's SEW Panel meters at fantastic low prices.

## MR RANGE — DC MOVING COIL TYPE (Accuracy ± 2%)

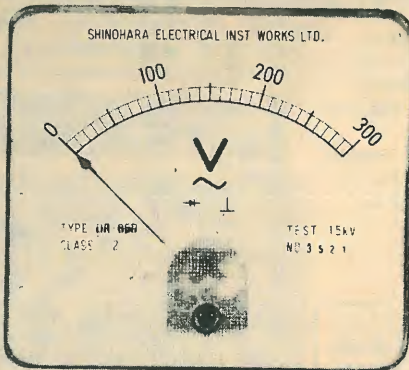

**DIMENSIONS:**

|                            |       |
|----------------------------|-------|
| 110 x 120 x 47 mm Ref. 85P | £3.00 |
| 78 x 86 x 41 mm Ref. 65P   | £2.50 |
| 60 x 60 x 40 mm Ref. 52P   | £2.50 |
| 50 x 50 x 34 mm Ref. 45P   | £1.50 |
| 42 x 42 x 32 mm Ref. 38P   | £1.50 |

Prices inclusive of VAT. Add 25p per item for carriage and packing.

**References:**

|           |            |           |
|-----------|------------|-----------|
| ± 50uA    | 100mA - DC | 10V - DC  |
| ± 100uA   | 200mA - AC | 15V - AC  |
| ± 500uA   | 500mA - AC | 15V - DC  |
| ± 1mA     | 500mA - DC | 50V - AC  |
| 50uA      | 1A - AC    | 50V - DC  |
| 200uA     | 1A - DC    | 150V - AC |
| 1mA'S     | 10A - DC   | 150V - DC |
| 5mA       | 30A - DC   | 300V - AC |
| 10mA      | 50A - AC   | 300V - DC |
| 50mA - AC | 50A - DC   | 500V - AC |
| 50mA - DC | 5V - DC    |           |

Most values available in most sizes.

Please state second preference when ordering.

### ED 107 EDUCATIONAL RANGE

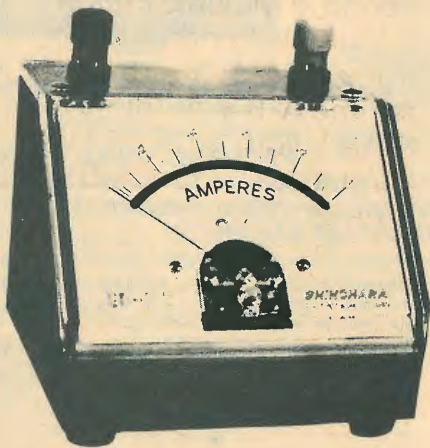

Dimensions: 78 (H) x 90 (D) x 100 (W) mm

£3.50 each including VAT. Add 50p per item carriage and packing

|       |          |
|-------|----------|
| 50uA  | 5/50V DC |
| 10V   | 20V DC   |
| ± 1mA | 50V DC   |
| 100uA | 300V DC  |

Barclaycard & Access Accepted — Order by telephone or post.

Mail Orders to Proops Bros. Limited, Dept. WW  
The Hyde Industrial Estate, Edgware Road, London NW9 6JS  
Tel. 01-205 8006  
Personal Shoppers: 52 Tottenham Court Road, London W1P 0BA  
9-6 Monday-Saturday

WW — 015 FOR FURTHER DETAILS



# Hilomast Ltd

## HILOMAST SYSTEMS

## PNEUMATIC TELESCOPIC MASTS

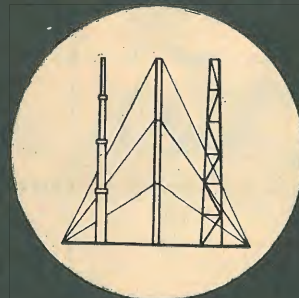
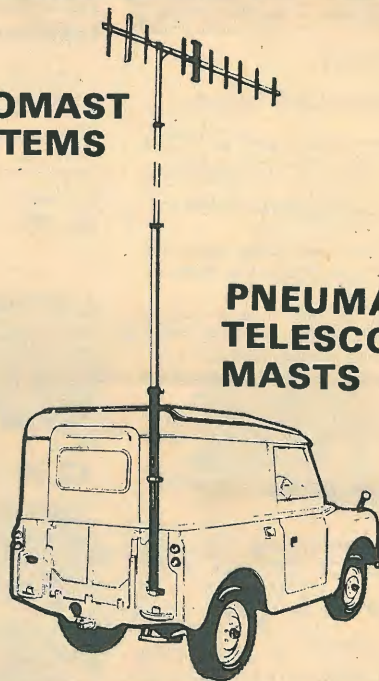

## HILOMAST LIMITED

THE STREET HEYBRIDGE — MALDON  
ESSEX CM9 7NB ENGLAND  
Tel. MALDON (0621) 56480  
TELEX NO. 995855

WW — 043 FOR FURTHER DETAILS

# IF IT'S TIME YOU HAD A NEW TIMER COUNTER, DC TO 35 MHz IS ENOUGH

Gould Advance have a *wide* range of timer counters.

And here are two which should meet most engineers' needs.

Both the TC320 and the TC321 have made extensive use of the latest low-power circuitry (CMOS, Schottky and thick film resistor networks, for example) and we have no hesitation in offering a (seldom-used) 2-year guarantee.

Check the functions—whilst remembering that both instruments are truly portable when internal rechargeable batteries are fitted as an option.

- \* Frequency (Manual and Autoranging)
- \* Single Period
- \* Multiple Period
- \* Multiple Period Average (Manual and Autoranging)
- \* Time A-B
- \* Automatic Pulse Width
- \* Count
- \* Totalise
- \* Count A/B-B
- \* Ratio.

Of the two instruments, the 321 has the more sophisticated 'spec'. But both are interesting.

Do ask for data. It'll be *enough* to impress you.



TC320



TC321



 **GOULD**

*An Electrical/Electronics Company*

Gould Instruments Division,  
Roebuck Road, Hainault, Essex IG6 3UE  
Telex: 263785

TELEPHONE: 01-500 1000

Testing...  
Testing...  
Testing...

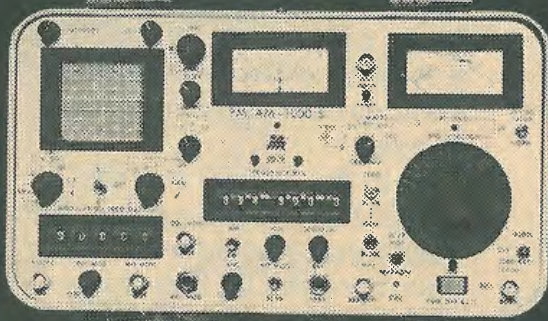

anywhere!

**The FM/AM 1000s with Spectrum Analyser**

A portable communications service monitor from IFR, light enough to carry anywhere and good enough for most two-way radio system tests. The FM/AM 1000s can do the work of a spectrum analyser, oscilloscope, tone generator, deviation meter, modulation meter, signal generator, wattmeter, voltmeter, frequency error meter - and up to five service engineers who could be doing something else!

For further information contact Mike Taylor



**FieldTech**

FieldTech Ltd  
Heathrow Airport -  
London Hounslow  
TW6 3AF  
Tel: 01-759 2811  
Telex: 23734  
FLDTEC G

**IFR precision simulators**

WW - 048 FOR FURTHER DETAILS

**NEC**  
NIPPON ELECTRIC

**RADIO AMATEUR COMMUNICATION EQUIPMENT**

**CQ-P-2200E**  
137-150 Mhz

2 meter FM 12 channel portable/mobile 1/3 watt transceiver



Features: battery cartridge system, all 12 channels X-tal fitted, 1750 Hz tone-call system, AXC or RIT switchable, highly efficient squelch, high (3 watts) low (1 watt) output power switchable, lambda 1/4 or 5/8 telescopic antenna selectable. Provisions for: external power 13.5 V DC, external antenna, earphone, external speaker. NEW: Professional plug-in moduls construction, with all units shielded, selected high quality parts secure long life. Range: up to 50 KM. direct, up to several hundreds of kilometers over repeaters. Universality: mobile or portable (with the snap of a finger). High sensitivity: 0.2 uV for 20 db S/N.

**CQ-R-700**

6 band general coverage receiver with ultra high sensitivity (0.1 uV for 170 KHz-30.0 Mhz 15 db S/N on 30 Mhz)



Features: VFO patent allows perfect frequency read-off and tune-in with ease. Selectivity selectable wide/narrow. Modes: SSB (USB/LSB), CW or AM. Noise-blanker incorporated, large, illuminated two colour S-meter, 500 KHz and 50 Hz calibration facility. Modern electrical layout. A true solution for all searching a reliable mean for short range or continuous long haul reception.

**CQ-LINE**

300 - 3000 watts HF-LINE. Modes: USB/LSB, CW, AM, RTTY (FSK), FAX in 1.6 - 30.0 Mhz full digital readout.



In many thousands of applications the CQ-LINE has proven their reliability and sturdiness. Its versality and high power make the CQ - LINE a true partner for long distance communication. Even with simple antenna from home or car, world-wide contacts are no problem.

UK: please contact our distributor Messrs. William Munro, Invergordon, High Street 100, telef.: 349-852351-4 - Telex: 75265.

**CEC**

SOLE DISTRIBUTOR EUROPE OF **NEC**  
RADIO AMATEUR AND CB EQUIPMENT  
VIA VALDANI, 1, CH 6830 CHIASSO/SWITZERLAND,  
TELEF. 091/446464, TELEX 64077 CEC CH  
WW - 031 FOR FURTHER DETAILS



# Hall Electric Limited International Semiconductor Distributor



Germanium Transistors



Silicon Transistors



Integrated Circuits



Zener Diodes



Rectifier Diodes

Hall Electric,  
International  
Semiconductor specialists  
and Worlds largest  
independent  
Tube distributor

Electron House, Cray Avenue, Orpington, Kent BR5 3QJ Telephone: Orpington 27099. Telex: 896141 Cralec G

# THINK OF A SHAPE



S 500D — dual channel  
up to 500W/RMS per  
channel DC-20 KHZ

## Whatever it is, the **H||H** 'S' range of power amplifiers will handle it

The **H||H** 'S' range is designed to handle heavy industrial usage in the fields of vibrator driving, variable frequency power supplies and servo motor systems.

### **S 500D**

#### Dual Channel

19" rack mount 3½" high  
500w r.m.s. into 2.5 ohms per channel  
900w r.m.s. in bridge mode  
DC-20 KHZ at full power  
0.005% harmonic distortion (typical) at  
300w r.m.s. into 4 ohms at 1 KHZ  
3KW dissipation from in-built force cooled  
dissipators

### **S 250D**

#### Single Channel

19" rack mount 3½" high  
500w r.m.s. into 2.5 ohms  
Retro-convertible to dual channel  
DC-20 KHZ at full power  
Full short and open circuit protection  
Drives totally reactive loads with no  
adverse effects

A complete range of matching transformers and peripheral equipment for closed loop, constant current and voltage use are available.

Alternative input and output termination to order. Rack case for bench use built to specifications. For complete data write or call.



## Kirkham Electronics

MILL HALL, MILL LANE, PULHAM MARKET, DISS, NORFOLK IP21 4XL  
DIVISION OF K.R.S. LIMITED  
TELEPHONE (037 976) 639/594

FRANCHISED COMMERCIAL AND INDUSTRIAL AGENTS FOR **H||H** ELEC-  
WW — 033 FOR FURTHER DETAILS



# TOTAL AMPLIFICATION FROM CRIMSON ELEKTRIK

WE NOW OFFER THE WIDEST RANGE OF SOUND PRODUCTS —

## STEREO PRE-AMPLIFIER



**CPR 1 — THE ADVANCED PRE-AMPLIFIER.** The best pre-amplifier in the U.K. The superiority of the CPR 1 is probably the disc stage. The overload margin is a superb 40dB, this together with the high slewing rate ensures clean top, even with high output cartridges tracking heavily modulated records. Common-mode distortion is eliminated by an unusual design. R.I.A.A. is accurate to 1dB; signal to noise ratio is 70dB relative to 3.5mV; distortion < .005% at 30dB overload 20kHz.

Following this stage is the flat gain/balance stage to bring tape, tuner, etc. up to power amp. signal levels. Signal to noise ratio 86dB; slew-rate 3V/μs; T.H.D. 20Hz—20kHz < 0.08% at any level.

F.E.T. muting. No controls are fitted. There is no provision for tone controls. CPR 1 size is 138x80x20mm. Supply to be ± 15 volts.

**MC 1 — PRE-AMPLIFIER.** Suitable for nearly all moving-coil cartridges. Sensitivity 70/170μV switchable on the p.c.b. This module brings signals from the now popular low output moving-coil cartridges up to 3.5mV (typical signal required by most pre-amp disc inputs). Can be powered from a 9V battery or from our REG 1 regulator board.

**XO2:XO3 — ACTIVE CROSSOVERS.** XO2 — two way, XO3 — three way. Slope 24dB/octave. Crossover points set to order within 10%.

**REG 1 — POWER SUPPLY.** The regulator module, REG 1 provides 15.0-15V to power the CPR 1 and MC 1. It can be used with any of our power amp supplies or our small transformer TR 6. The power amp kit will accommodate it.

**POWER AMPLIFIERS.** It would be pointless to list in so small a space the number of recording studios, educational and government establishments, etc. who have been using CRIMSON amps satisfactorily for quite some time. We have a reputation for the highest quality at the lowest prices. The power amp is available in five types, they all have the same specification. T.H.D. typically 0.1% any power 1kHz 8 ohms. T.I.D. insignificant, slew rate limit 25V/μs; signal to noise ratio 110dB; frequency response 10Hz-35kHz, — 3dB; stability unconditional, protection drives any load safely; sensitivity 775mV (250mV or 100mV on request), size 120x80-25mm.

**POWER SUPPLIES.** We produce suitable power supplies which use our superb TOROIDAL transformers only 50mm high with a 120-240 primary and single bolt fixing (includes capacitors/bridge rectifier).

## POWER AMPLIFIER MODULE

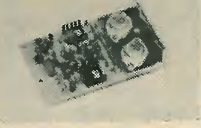

**POWER AMPLIFIER KIT.** The kit includes all metalwork, heatsinks and hardware to house any two of our power amp modules plus a power supply. It is contemporarily styled and its quality is consistent with that of our other products. Comprehensive instructions and full back-up services enable a novice to build it with confidence in a few hours.

## PRE-AMP KIT

This includes all metalwork, pots, knobs, etc., to make a complete pre-amp with the CPR 1(S) module and the MC 1(S) module if required.

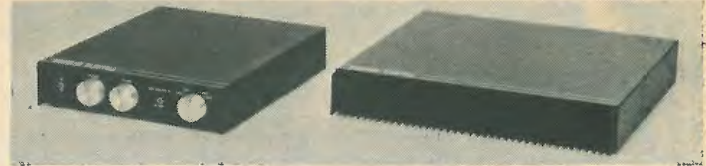

## POWER AMPLIFIER MODULES

|                              |        |
|------------------------------|--------|
| CE 608 60W/8 ohms 35-0-35v   | £19.52 |
| CE 1004 100W/4 ohms 35-0-35v | £23.02 |
| CE 1008 100W/8 ohms 45-0-45v | £25.96 |
| CE 1704 170W/4 ohms 45-0-45v | £31.00 |
| CE 1708 170W/8 ohms 60-0-60v | £33.97 |

## TOROIDAL POWER SUPPLIES

|                                  |        |
|----------------------------------|--------|
| CPS1 for 2xCE 608 or 1xCE 1004   | £16.56 |
| CPS2 for 2xCE 1004 or 2/4xCE 608 | £18.80 |
| CPS3 for 2xCE 1008 or 1xCE 1704  | £19.75 |
| CPS4 for 1xCE 1008               | £17.12 |
| CPS5 for 1xCE 1708               | £24.15 |
| CPS6 for 2xCE 1704 or 2xCE 1708  | £25.53 |

## HEATSINKS

|                               |        |
|-------------------------------|--------|
| Light duty, 50mm, 2 C/W       | £1.44  |
| Medium power, 100mm, 1-4 C/W  | £2.35  |
| Disco/group, 150mm, 1-1 C/W   | £3.04  |
| Fan, 80mm, static 120 or 240v | £19.70 |

Fan mounted on two drilled 100mm heatsinks  
2x4 C/W, 65 max. with two 170W modules

£31.05

£1.54

£1.54

## POWER AMP KIT ..... £35.03

## PRE-AMPS

These are available in two versions — one uses standard components, and the other (the S), uses MO resistors where necessary and tantalum capacitors.

|        |        |
|--------|--------|
| CPR 1  | £31.85 |
| MC 1   | £21.28 |
| CPR 1S | £40.87 |
| MC 1S  | £33.17 |

## ACTIVE CROSSOVERS

|     |        |
|-----|--------|
| XO2 | £15.16 |
| XO3 | £23.58 |

## POWER SUPPLY

|      |       |     |       |
|------|-------|-----|-------|
| REG1 | £8.90 | TR6 | £1.97 |
|------|-------|-----|-------|

## PRE-AMP KIT £38.07

## BRIDGE DRIVER, BD1

Obtain up to 340W using 2x170W amps and this module.

BD1

£5.75

## CRIMSON ELEKTRIK

1A STAMFORD STREET, LEICESTER LE1 6NL. Tel. (0533) 553508

U.K. — Please allow up to 21 days for delivery

All prices shown are UK only and include VAT and post, COD 90p extra, £100 limit. Export is no problem, please write for specific quote. Send large SAE for 3 International Reply Coupons for detailed information.  
Distributors: Minic Teleprodukt, Box 12035, S-750 12 Uppsala 12, Sweden. Badger Sound Services Ltd., 46 Wood Street, Lytham St. Annes, Lancashire FY8 1QG.

# ADAMIN IRONS SOLDER ON.. AND ON.. AND ON..

Maybe that's because we've been making ... and developing ... and refining miniature tools for over 25 years.

The result is probably the smallest iron in the world (the Adamin 6) and probably the smallest mains operated iron in the world (the Adamin 12). But it's not only reliability and smallness that make these irons so effective. It's the fine, delicate control afforded by an ergonomically designed hand-grip. And the way the non-seize bits squeeze the maximum heat out of the element by fully enclosing it.

In addition both the irons can be had with mains isolating, low-voltage, variable power units (for greater safety and longer element life) or a highly practical spring stand.

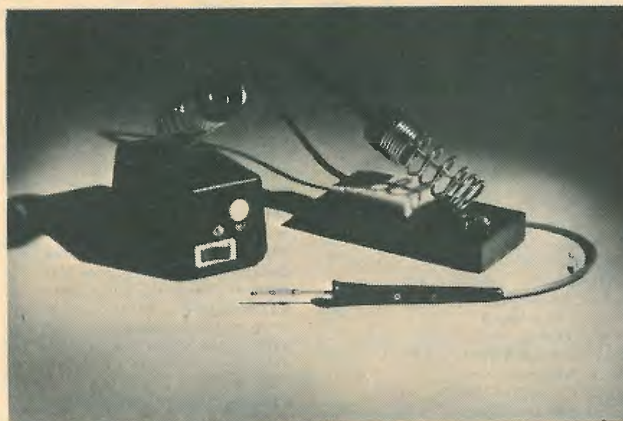

Gain a tactical advantage — put Adamin's controlled power and accuracy to use — constructively.

## PRICES

Adamin 6 (6W, 6V weighing just 7gm. With 3 spare bits) £6.60.  
As above with long-life bits £8.61.

Adamin 12 (12W, 12-240V weighing just 15gm. With 4 spare bits) £7.53.  
As above with long-life bits £10.22.

# LITESOLD

Light Soldering Developments Ltd.,  
97/99 Gloucester Road, Croydon,  
Surrey CR0 2DN, England.  
Telephone: 01 689 0574  
Telex: 8811945

Variable Power Units: Type PU610 (for model 6) & Type PU1218 (for model 12) £14.80 each.

Spring Stand for either model £3.92 each.

All prices include P.&P. and 15% VAT.

Send for full specification now.

# REDUCED BOOK PRICES AT

# MICRODIGITAL

Introduction to Microcomputers. Vol. 0.  
A. Osborne — £5.95  
Computer lib/dream machines  
T. Nelson — £5.95  
Your Home Computer  
J. White — £5.10  
How you can learn to live with Computers  
H. Hinberg — £7.16  
Microcomputer Primer  
M. Waite — £6.35  
Microprocessors: from chips to systems  
R. Zaks — £7.50  
An introduction to Personal and Business  
Computing — R. Zaks — £4.95  
The Home Computer Revolution  
T. H. Nelson — £2.75  
How to buy and use minicomputers and  
microcomputers — W. Borden — £7.95  
Home computers: a beginners glossary  
and guide — M. Miller — £4.95  
Small Computer Systems Handbook  
S. Libes — £6.30  
Getting acquainted with Microcomputer  
L. Frenzel — £7.95  
Getting involved with your own computer  
L. Solomon and S. Veit — £4.76  
Understanding Microcomputers and small  
computer systems  
N. Wadsworth — £7.95  
Computer and programming guide for  
engineers — D. Spencer — £9.45  
Scientific and Engineering problems  
problems solving with the computer  
Bennett — £15.96  
Basic BASIC: an introduction to computer  
programming in the BASIC language  
— £4.80. — and  
Advanced BASIC: applications and  
problems — both by J. S. Coan — £4  
A guided tour of computer programming  
in BASIC — T. A. Dwyer and  
M. S. Kaufman — £4.16  
Computer resource book — Algebra  
T. A. Dwyer and M. Critchfield — £4.16  
BASIC with business applications  
R. W. Lott — £8.40  
BASIC and the personal computer  
T. A. Dwyer and M. Critchfield — £10.36  
Basic: a hands on method  
H. Peckham — £6.36  
Instant Basic  
G. R. Brown — £7.20  
Introduction to BASIC  
J. Morton — £6.50  
BASIC — a unit for secondary schools  
D. Spencer — £4.45  
Teachers manual for BASIC  
— £6.45  
Accent on BASIC — £4.95  
Beginning BASIC  
P. Chirlian — £7.12  
A Quick look at BASIC — £4.45  
Sixty challenging problems with  
BASIC solutions — £5.95  
Fun with computers and BASIC  
D. Spencer — £5.45  
My computer likes me . . . when I speak  
in BASIC — O. H. Ahi — £1.65  
BASIC programming — £6.95  
Basic with style  
Nagin and Ledgard — £3.60  
Basic for home computers. A self  
teaching guide — B. Albrecht — £4.75  
Basic Programming  
J. Kemeny — £6.10  
The Basic Workbook  
K. Schoman — £3.70  
Introduction to microprocessors  
L. A. Leventhal — £16.75  
Microprocessors  
A. M. Veronis — £12.80  
The Architecture of microcomputers  
S. E. Greenfield — £18.20  
Microcomputers, Microprocessors,  
Hardware Software and Applications  
J. Hilburn — £16.95  
Programming a microcomputer: 6502  
C. C. Foster — £7.96  
Microcomputer Programming: 6502  
R. Zaks — £7.95  
6502 Applications book  
R. Zaks — £10.25  
6502 Hardware manual — £7.50  
6502 Software manual — £7.50  
The first book of KIM  
J. Butterfield et al. — £7.16  
APPLE II Operators manual — £5.50

APPLE II Integer BASIC manual  
J. Raskin — £4  
APPLE II APPLESOFT extended BASIC  
manual — J. Raskin — £4  
TIS Workbooks for the Commodore  
PET 2001 — TIS — £3 each  
Volume 1 Fundamental Algorithms  
D. E. Knuth — £9.50  
Volume 2 Seminumerical algorithms  
D. E. Knuth — £17.56  
Volume 3 Searching and sorting  
D. E. Knuth — £17.56  
Top-down structured programming  
techniques — C. L. McGowan and  
J. R. Kelly — £12.76  
Software Tools  
Kernighan and Plauger — £7.20  
Programming Proverbs  
H. Ledgard — £5.56  
Software design for microprocessors  
J. G. Wester and W. D. Simpson — £10.36  
A collection of programming problems and  
techniques — H. A. Maurer and  
M. R. Williams — £11.16  
Problems for computer solution  
S. Rogowski — £7.96  
The design of well-structured and correct  
programs — S. Alagic and  
M. A. Arbib — £10.24  
Assembly level programming for small  
computers — W. J. Weller — £12.76  
Microprocessor interfacing techniques  
R. Zaks — £7.50  
Practical solid circuit design  
Olesky — £5.20  
555 Timer applications source book — £  
Understanding solid state electronics  
Texas Instruments — £2.40  
Modern operational circuit design  
Smith — £18.60  
Microprocessor systems design  
Klingman — £14  
Microcomputer Design — Martin — £12  
Designing with TTL integrated circuits  
Texas Instruments — £24.80  
Fundamentals and applications of digital  
logic circuits — S. Libes — £6.36  
Analysis and design of digital circuits  
P. Chirlian — £16.40  
Linear IC principles, experiments, and  
projects — E. M. Noll — £7.16  
Semiconductor circuit elements  
T. Towers and S. Libes — £5.56  
TTL cookbook  
D. Lancaster — £6.95  
CMOS Cookbook — D. Lancaster — £7.65  
RTL Cookbook — D. Lancaster — £4.25  
Active Filter Cookbook  
D. Lancaster — £10.90  
T.V. Typewriter Cookbook  
D. Lancaster — £7.25  
Cheap Video Cookbook  
D. Lancaster — £4.30  
Microcomputer problem solving using  
PASCAL — D. K. L. Bowles — £7.84  
PASCAL User Manual and Report  
Jensen and Wirth — £5.52  
An introduction to programming and  
problem solving with PASCAL  
Schneider, Weingart & Perlman — £10.36  
Programming in PASCAL  
P. Grogono — £7.50  
PASCAL — An introduction to methodical  
programming — W. Findlay and  
D. A. Watt — £7.84  
Best of BYTE Vol. 1  
Helmert et al. — £8.95  
Best of Creative Computing Vol. 1  
AHL et al. — £6.95  
Best of Creative Computing Vol. 2  
AHL et al. — £6.95  
Dr. Dobbs Journal of Computer  
Calisthenics and Orthodonita Vol. 1  
J. C. Warren — £10  
Scelbi-Byte Primer  
Helmert et al. — £9.95  
The Best of Micro  
Tripp et al. — £5.50

The First West Coast Computer Faire  
proceedings — J. C. Warren — £9.56  
The Second West Coast Computer Faire  
proceedings — J. C. Warren — £9.56  
Program Design  
B. W. Liffic — £4.80  
Simulation — B. W. Liffic — £4.80  
Basex — P. Warne — £6.40  
The BYTE book of computer music  
C. P. Morgan — £8  
Superwumpus — J. Emmerichs — £4.80  
Ciarcia's Circuit Cellar  
S. Ciarcia — £6.40  
Bar Code Loader  
K. Budnick — £1.60  
Tiny Assembler 6800 v3.1  
J. Emmerichs — £7.20  
LINK 68: An M6800 Linking loader  
J. Hemenway et al. — £6.40  
Tracer: A 6800 debuggin program  
J. Hemenway — £4.80  
MONDEB: An advanced 6800  
Monitor-debugger — D. Peters — £4  
RA6800ML: An M6800 Relocatable  
Macro-assembler — J. Hemenway — £20  
The 8080A Bugbook-Microcomputer  
interfacing and programming  
P. R. Rony et al. — £7.65  
8080 machine language programming for  
beginners — R. Santore — £5.10  
Scelbi "8080" software gourmet guide and  
cookbook — Scelbi computer consulting  
— £7.80  
A step by step introduction to 8080  
microprocessor systems — D. L. Cohn and  
J. L. Melsa — £5.70  
8080/8085 Software Design  
C. A. Titus, P. R. Rony et al. — £6.95  
8080 Programming for logic design  
A. Osborne — £5.95  
Practical microcomputer programming:  
The Intel 8080 — W. J. Weller et al. — £17.56  
Scelbi's 8080 standard monitor — £9.95  
Scelbi's 8080 standard editor — £9.95  
Scelbi's 8080 standard assembler — £9.95  
Scelbi computer consultants  
8080 Assembly language programming  
L. Leventhal — £7.95  
An Editor/Assembler system for  
8080/8085 based computers  
W. J. Weller — £11.96  
Scelbi 8080 Galaxy game  
Scelbi Computer Consultants — £1.95  
8080 Hex code card  
Scelbi — £1.95  
8080 Octal code card  
Scelbi — £1.96  
Z-80 Instruction Handbook  
Scelbi — £3.50  
Practical microcomputer programming:  
the Z-80 — W. J. Weller — £20  
Sargon Z-80 Chess Program  
D. and K. Spracklen — £9.50  
The Z-80 microcomputer handbook  
W. Barden — £6.95  
Z-80 Programming for logic design  
A. Osborne — £5.95  
Z-80 Programming manual  
Mostek — £4.50  
Nascom-1 Hardware notes  
— £1.50  
Nascom-1 Seminar notes — £1.50  
Sorcerer Technical Manual — £8.95  
Practical microcomputer programming:  
the M6800 — W. J. Weller et al. — £17.56  
Scelbi 6800 Gourmet Guide  
Scelbi Computer Consultants — £7.80  
Programming the 6800 microprocessor  
Bob Southern — £8  
6800 Assembly language programming  
L. Leventhal — £7.95  
Using the 6800 microprocessor  
E. Poe — £5.05  
6800 Programming for logic design  
A. Osborne — £6.30  
77-68 Design manual  
T. Moore — £7.50

APL — an interactive approach  
Gilman and Rose — £9.50  
Structured Programming in APL  
Geller and Freedman — £7.96  
APL — A short course  
Pakin et al. — £7.65  
APL — The language and it's usage  
Polivka et al. — £15.05  
Microprogrammed APL implementation  
R. Zaks — £14.75  
Fortran fundamentals — A short course  
J. Steingraber — £2.95  
FORTRAN Programming — £6.75  
FORTRAN Workbook — £4.75  
Instructor's manual for FORTRAN  
programming — £4.95  
FORTRAN Programming — £6.95  
A guide to SC/MP programming  
Drury — £4  
A Guide to KITBUG  
Drury — £1  
Artist and Computer  
R. Leavit — £3.96  
Basic Computer Games  
D. H. Ahi — £5.50  
Game playing with BASIC  
D. Spencer — £5.50  
How to build a computer controlled robot  
T. Looftorrow — £6  
Starship simulation  
R. Garrett — £5.10  
Game playing with computers  
D. Spencer — £12  
57 Practical programs and games in BASIC  
K. Tracton — £8.40  
Chess and computers  
D. Levy — £7.16  
1975 U.S. Computer Chess Championship  
D. Levy — £4.75  
1976 U.S. Computer Chess Championship  
D. Levy — £4.75  
Chess skill in man and machine  
P. Frey ed. — £11.84  
Some common Basic programs  
A. Osborne — £6.30  
Introduction to artificial intelligence  
Jackson — £14.80  
How to profit from your personal computer  
T. G. Lewis — £6.40  
Build your own working robot  
D. L. Heiserman — £4.76  
Computer programs that work  
Beech et al. — £2.55  
The mind appliance: Home computer  
applications — T. G. Lewis — £4.75  
Robots on your doorstep  
N. Winkless and I. Browning — £5.56  
Artificial intelligence  
P. H. Winston — £12  
Computer power and human reason  
J. Weizenbaum — £4.76  
The thinking computer: mind inside matter  
B. Raphael — £5.56  
TTL Data book, 2nd edition — £5  
TTL Data book supplement — £1  
Semiconductor memory Data book — £2.40  
Power semiconductor handbook — £6  
Transistor and diode data book — £6.80  
Opto. electronics Data book, 5th ed.  
— £2.80  
Linear Control circuits Data book — £2.40  
Interface Data book — £2.80  
MOS memory Data book — £2.80  
Scientific Research-Basic library  
1—Book-keeping, Games, Pictures  
— £17.50  
2—Maths/Engineering, Plotting/  
Statistics, Basic Statements defined  
— £17.50  
3—Advanced business, Billing, Inventory,  
Investments, Payroll — £26.95  
4—General Purpose — £7.95  
5—Experimenters Programs — £7.95  
6—Mini-ledger — £32.50  
7—Professional programs — £29.95  
8—Homeowners programs — £7.84

Send cheque, P.O., Access/Barclaycard Number to:

**MICRODIGITAL LTD**  
25 BRUNSWICK STREET, LIVERPOOL L20 BJ  
Mail Order  
051-236 0707

Other Departments  
051-227 2535



# sales hire repair



**You'll do better at Martin Associates  
we guarantee it!**

**ANALYSERS**

|  |               |
|--|---------------|
| AIRMEC 248 5-300MHz                                    | £125.00       |
| AIRMEC 853 30KHz-30MHz                                 | £85.00        |
| MARCONI 2330 20Hz-78KHz                                | £500.00       |
| TEKTRONIX 1L20 10MHz-4.2GHz Spectrum Analyser          | £1500.00      |
| <b>ATTENUATORS</b>                                     |               |
| ADVANCE A.64 0-70dB in 1dB step 600 ohms               | £30.00        |
| MARCONI TF.1073A 0-100dB in 1dB steps 50 ohms.         | £75.00        |
| <b>BRIDGES</b>   |               |
| B.P.L. CZ.457 Mk. II Component Comparator              | £70.00        |
| GENERAL RADIO 1607 Transfer Function Immittance Bridge | From: £450.00 |
| WAYNE KERR B.221 0.1% Universal Bridge                 | £200.00       |
| WAYNE KERR 521 1.0% Universal Bridge                   | £85.00        |
| <b>COUNTERS</b>  |               |
| MARCONI TF.1417 + 500MHz Divider 7 digit               | £225.00       |
| RACAL 835 DC-15MHz 6 digit                             | £130.00       |
| SYSTRON DONNER 6035 20Hz-3GHz 7 digit                  | £550.00       |
| <b>DIGITAL VOLTMETERS</b>                              |               |
| DYNAMCO 2022S 0-2000V Scale 39999 10uV                 | £250.00       |
| ROBAND RDV.4. 0-1000V 4 digit                          | £95.00        |



**MARTIN ASSOCIATES**  
34 Crown Street  
Reading  
Berks. RG1 2SE  
Tel. Reading (0734) 51074

**METERS**

|  |          |
|--|----------|
| JAC.331 Freq. Meter & Generator DC-3GHz                    | £200.00  |
| AVO Precision Meter  | £160.00  |
| MARCONI TF.1245/46/47 Cct Magnification Meter + Oscillator | £1000.00 |
| MUIRHEAD D-729-BM Phase Meter                              | £225.00  |
| RADIOMETER BFK.6 Distortion Meter                          | £250.00  |
| <b>OSCILLOSCOPES</b>                                       |          |
| TEKTRONIX 535A DC-15MHz c/w H Plug In Unit                 | £250.00  |
| TEKTRONIX 567 Sampling 1GHz Digital Readout                | £750.00  |
| SCOPEX 4D-10B DC-10MHz 10mV Sens. NEW                      | £188.00  |
| SCOPEX 4D-25 DC-25MHz NEW                                  | £315.00  |
| SCOPEX 4S-6 DC-6MHz NEW                                    | £138.00  |
| HEWLETT-PACKARD 130C X-Y-T DC-500KHz 200uV Sens            | £275.00  |
| TELFORD 'A' OSCILLOSCOPE CAMERA                            | £250.00  |
| VARIOUS PLUG INS & PROBES Information on Application       |          |

**POWER SUPPLY UNITS**

|                                       |         |
|---------------------------------------|---------|
| ADVANCE CV.500/A 240V r.m.s. 500 Watt | £30.00  |
| ROBAND T.172 0-30V 10A                | £140.00 |
| ROBAND T.113 0-30V 20A                | £200.00 |

**SIGNAL SOURCES**

|  |         |
|--|---------|
| ADVANCE J1B 15Hz-50KHz 600ohms/5ohms               | £60.00  |
| GENERAL RADIO 1362 UHF Oscillator 220-920MHz       | £400.00 |
| GENERAL RADIO 1209C UHF Oscillator 250-960MHz      | £100.00 |
| GENERAL RADIO 1215C Oscillator Unit 50-250MHz      | £150.00 |
| HEWLETT-PACKARD 608D 10-420MHz                     | £350.00 |
| HEWLETT-PACKARD 608F 10-455MHz 50ohms              | £500.00 |
| MARCONI TF.995A/3/S 1.5MHz-220MHz FM/AM            | £500.00 |
| MARCONI TF.1066B/6 10MHz-470MHz                    | £600.00 |
| MARCONI TF.1099 Sweep variable to 20MHz almost new | £200.00 |
| MARCONI TF.144H/4 10KHz-72MHz 50 ohms A.M.         | £470.00 |
| MARCONI TF.1370 10Hz-10MHz                         | £150.00 |
| R & S SWF 5MHz-225MHz Sweep Generator              | £185.00 |
| R & S SWH 50Hz-12MHz Sweep Generator               | £195.00 |

**RECORDERS**

|   |          |
|---|----------|
| LIGHT LAB 361D 0-100°C & -70° -0°C 9 Probes | £65.00   |
| SMITHS Miniscript 0-100uA                   | £40.00   |
| <b>MISCELLANEOUS</b>                        |          |
| GALLENKAMP FR.554 Muffle Furnace 1100°C     | £200.00  |
| GRIFFIN Oven Amb. -100°C                    | £60.00   |
| ADMIRAL CORP 198A/B IFF/ATC Radar Test Set  | £800.00  |
| WESTON ROTEK 146AG5 A.C. Voltage Standard   | £350.00  |
| PERKIN ELMER F.11 Gas Chromatograph         | £1000.00 |



WW — 047 FOR FURTHER DETAILS

## METER PROBLEMS?

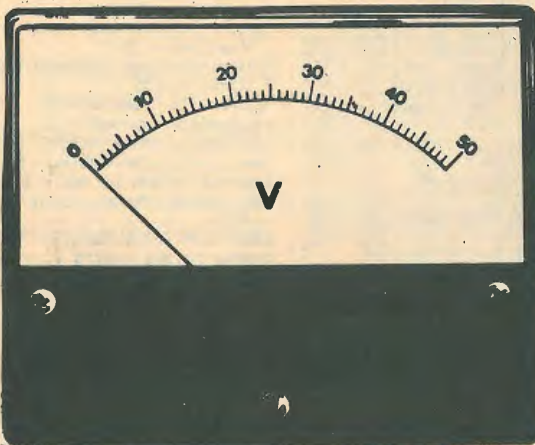

137 Standard Ranges in a variety of sizes and stylings available for 10-14 days delivery. Other Ranges and special scales can be made to order.

Full Information from:

**HARRIS ELECTRONICS (London)**

138 GRAYS INN ROAD, W.C.1 Phone: 01/837/7937

WW — 028 FOR FURTHER DETAILS

## Keep those Contacts CLEAN

BY USING A

## DIACROM SPATULA

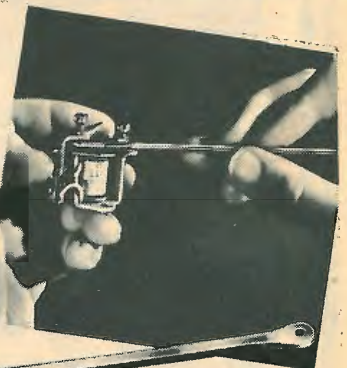

Manufactured in France  
British Patents applied for

No other cleaner has all these advantages:—

1. Only 100% pure, natural diamond grains are utilised.
  2. Blades are treated with hard chrome to reinforce the setting of the diamond grains, to obviate loosening or breakaway during use. This process also prevents clogging of the diamonded surface by residues resulting from use.
  3. All diamonded blades are rectified to ensure an absolutely smooth surface by eliminating diamond grains which may rise above the surface. This eliminates all excessive scratching during use.
  4. All diamond grains are rigidly calibrated to ensure a perfectly uniform grain size of either 200, 300 or 400.
  5. The chrome gives a very weak co-efficient of friction and the rigidity of the nylon handle is calculated to permit proper utilisation and yet pliant enough to avoid undue pressures on highly delicate relays.
- Grain size 200, thickness 55/100 mm., both faces diamonded. For quick cleaning of industrial relays and switching equipment, etc.
  - Grain size 300, thickness 55/100mm., both faces diamonded. For smaller equipments, like telephone relays, computer relays, etc.
  - Grain size 400, thickness 25/100 mm., one face diamonded. For sensitive relays and tiny contacts. Two close contacts facing each other can be individually cleaned, because only one face of the spatula is abrasive.

**Sole Distributors for the United Kingdom  
SPECIAL PRODUCTS (DISTRIBUTORS) LTD**  
81 Piccadilly, London W1V 0HL. Phone: 01-629 9556  
As supplied to the M.O.D., U.K.A.E.A., C.E.G.B. British Rail and other Public Authorities;  
also major industrial and electronic users throughout the United Kingdom.

WW — 014 FOR FURTHER DETAILS





## Clip and Save

Clip-on Thermalloy "Slip Clip" heat sinks and save assembly time, board space, and heat sinks costs. They require no mounting hardware, PC board drilling, or adhesives, and clamp firmly to the device for maximum heat transfer. "Slip Clips" are available for TO-202, TO-220, TO-126, Motorola case 90 and most other popular case styles.



**Thermalloy**  
Number one in Semiconductor Accessories



## Plastic Power Coolers

New low profile heat sinks save board space. The 6073B requires only 750" board space and is just 375" tall - the right heat sink for 500" centrelines PC board applications. Cools SCR's and transistors in TO-220, Motorola Case 70 and Case 90 packages. Dissipates 21°C/watt in natural convection. Available in Black Anodized and Pre-Black Anodized finish.



**Thermalloy**  
Number one in Semiconductor Accessories

Full data and Free sample on request.



**MCP Electronics Limited**  
Station Wharf Alperton Wembley Middx.  
Telephone: 01-902 5941

WW - 074 FOR FURTHER DETAILS

# The King of Valves



Genuine Gold Lion<sup>™</sup> valves - hand built, utilising advanced pumping techniques and individually tested to a tight specification - are your answer to the high quality sound demands made by musicians and listeners alike.

Gold Lion KT77's and KT88's covering 30-200 watts, are now available from M-OV along with data and distribution details. Find out all about the King of Quality - from M-OV.

<sup>™</sup>Trade Mark of M-OV Audio Valves.

**M-OV**  
A MEMBER OF THE GEC GROUP

S&C

S711

THE M-OV VALVE CO. LTD., HAMMERSMITH, LONDON, ENGLAND, W6 7PE.  
TELEPHONE 01-603 3431. TELEX 23435. GRAMS THERMIONIC LONDON.

WW - 005 FOR FURTHER DETAILS

## FOR POWER SEMICONDUCTORS



## INTERNATIONAL RECTIFIER

Diodes Thyristors  
Fuses for protecting Semiconductors  
Power Transistors Potted Bridges  
Solid State Relays  
Silicon Stacks Surge Suppressors

**IN A HURRY!**  
**070-681 4931**

HARMSWORTH, TOWNLEY & CO. LTD.  
HAREHILL TODMORDEN LANCS OL14 5JY

Phone: 070 681 4931  
Telex 635 091 Albion G Attn: HARMSWORTH



**CAN YOUR BUSINESS  
REALLY OPERATE SUCCESSFULLY  
without a MICROPROCESSOR**



**STRUTT**

Electrical and Mechanical  
Engineering Ltd.

3c BARLEY MARKET STREET, TAVISTOCK,  
DEVON. PL19 05F.

TELEPHONE: TAVISTOCK 5439

TELEX: 45263

**BUSINESS  
MICROPROCESSOR**

The SEMEL 1. Microprocessor can be used for VAT, Wages, Invoices, Stock-Control, School Computer Studies, Wordprocessing, Sales, Purchasing, Addressing Envelopes, Auditing, Estate Agents: (For listing all Properties in groups ie. Size, Cost, Area) For doing all Bookings: Coach Tour Operators, Travel Agents, Hotels, etc.

The SEMEL 1. Can also be used for operating Machines and Equipment.

The SEMEL 1. can be coupled, via suitable interface circuits, to a wide variety of external devices, such as Computers, other Microprocessors, Printers, Cash Registers, Tape Readers & Punches, Cassette Readers/Recorders, any input output Typewriter, and many more.

**SEMEL Business System** - this system consists of the Microprocessor unit with keyboard and VDU and one Floppy Disc Unit. This system contains a software package of Editor assembler and debug, and full file handling capabilities in Basic Language. Systems requiring high level language including an extended operating system and utilities and 64k of RAM can support Basic, Fortran and Cobol.

**SEMEL-1**

The MICROPROCESSOR is perhaps the most important development the electronics industry has seen for at least the last decade. It was introduced with the ever increasing demand for speed and efficiency required in industry and commerce, and because of its ability to perform a wide variety of different functions, whether in the office, stores, on the factory floor, in warehouses, schools, on ships, in vehicles and many more places of business.

WW — 006 FOR FURTHER DETAILS



**LOGICAL ANALYSIS TEST KITS,  
COMPLETE, PORTABLE DIGITAL  
TEST CAPABILITY IN A  
HANDY CARRYING CASE**

**ONLY  
£127.00**

- Everything needed for fast, easy stimulus/response testing.
- Economical alternative to bulky, costly scopes and meters.
- Analyses static/dynamic logic states with complete accuracy.
- Completely circuit-powered — no power supplies.
- Self contained in portable rugged carrying case.
- Find out more — send the coupon below.

*Not one, but two new logical analysis test kits. Perfect for most design, test, production line, educational and troubleshooting applications.*

**LTC-1 Standard Test Kit.**  
Logic Probe, Digital Pulser, Logic Monitor.  
Fully portable.

**£127.00** (+ Post and V.A.T.)

**LTC-2 High Speed Test Kit.**  
High speed and memory capabilities.

**£143.00** (+ Post and V.A.T.)

CONTINENTAL SPECIALTIES CORPORATION



To CSC (U.K.) LIMITED, SHIRE HILL INDUSTRIAL ESTATE,  
DEPT. 7N, UNIT 1, SAFFRON WALDEN, ESSEX.  
Please send me full details of the LTC1 and LTC2, and  
details of your breadboard and testing devices.

Name .....

Position .....

Company .....

Address .....

WW-011 FOR FURTHER DETAILS

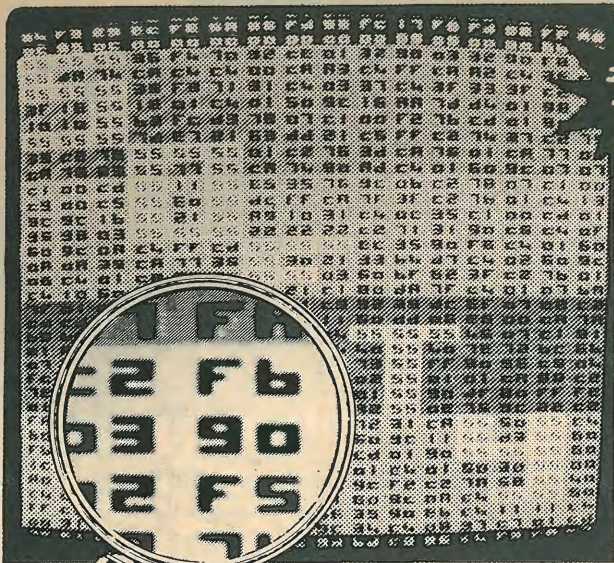

£79.50  
+ VAT

# A NEW TOOL FOR A NEW TECHNOLOGY

**SOFTY is not just another training aid for the engineer wishing to become acquainted with microprocessors - it is a BENCH-TOOL for the system designer.**

Until quite recently all the electronics design engineer really required was a scope and a meter. Now even the smallest of companies are investing thousands in microprocessor development laboratories — afraid of being left behind in the technology-race. But SOFTY is here to help, and a microsystem can be developed without expensive equipment right through the design and prototype stages and even into production.



"A revolution will probably take place soon, with the appearance of complete development systems costing less than £1,000..."

### WHAT SOFTY WILL DO

- IT COPIES MEMORY DEVICES (ROMs &c) presenting the data as an address-mapped hexadecimal display on the screen of a monitor or TV set.
- IT DEVELOPS PROGRAMS for virtually any microprocessor with facilities similar to an ASSEMBLER: you may enter, insert or delete instructions, shift blocks of data, match specific bytes, calculate displacements to labelled locations — and all with the overwhelming advantage of being able to test the program instantly and even develop it one instruction at a time!
- IT RECORDS PROGRAMS on ordinary cassette tape using an ordinary cassette recorder at ultra-high-speed — around 2000 baud equivalent!
- IT PROGRAMS EPROMS of the 2708 family at a speed which is close to the theoretical minimum (2 mins per 2708). It may therefore be used as an "instant-copier" for software.
- IT IS A HANDY COMPUTER which may be programmed to do useful jobs in the home or workshop, and may even be included as the "brains" of larger equipment, performing sequential or combinatorial control functions. SOFTY has a microcycle length of exactly one microsecond and there is a programmable timer. The manual lists a simple interpretive language which anyone may learn to use in ten minutes!
- IT IS A FABULOUS LEARNING AID because the trainee can actually see what is happening — SOFTY is completely transparent! The internal MPU will cease execution at a breakpoint, which may be substituted for any program step, and display contents of internal registers.
- IT FILLS THE GAP BETWEEN THEORY AND PRACTICE for the serious user who already has a computer and dedicated assembler to develop his software. The computer makes documentation — not prototypes. SOFTY places the program in addressing space to be actioned by the MPU of his choice in a real system — the proof of the pudding! Simple debugging and condensing of code may often be handled without recourse to the assembler.

SOFTY can be assembled in a couple of hours. No extras are required except for a power supply providing +5, +12 & -5 volt rails and +30 volts for the EPROM programmer. The kit includes sockets for all the 23 ICs, UHF modulator for TV use, 4MHz crystal, DIN socket and lead for cassette interface, 21 key keyboard, a quality double-sided PCB of fibreglass with solder mask and component overlay and a comprehensive manual covering assembly and use.

A DEVELOPMENT KIT is also available which includes all of the above and a lever-operated ZERO INSERTION FORCE SOCKET for the EPROM programmer, 43 way card edge connector, ribbon cable and 24 pin header (for connection to the system under development as firmware) and a spare 2708 EPROM.

It is not possible to present a full technical specification in the space available here. We will therefore send you a SOFTY on the understanding that you may examine it and read the literature and, if you wish to do so, return the goods for a complete refund within 14 days.

**VIDEOTIME PRODUCTS, 56, Queen Road, BASINGSTOKE, Hants, RG21 1RE**  
 TEL: (0256) 56417    TELEX: 858747  
 We welcome Barclay & Access orders by telephone.

Address Bus    Control Bus    Data Bus    Power Rails

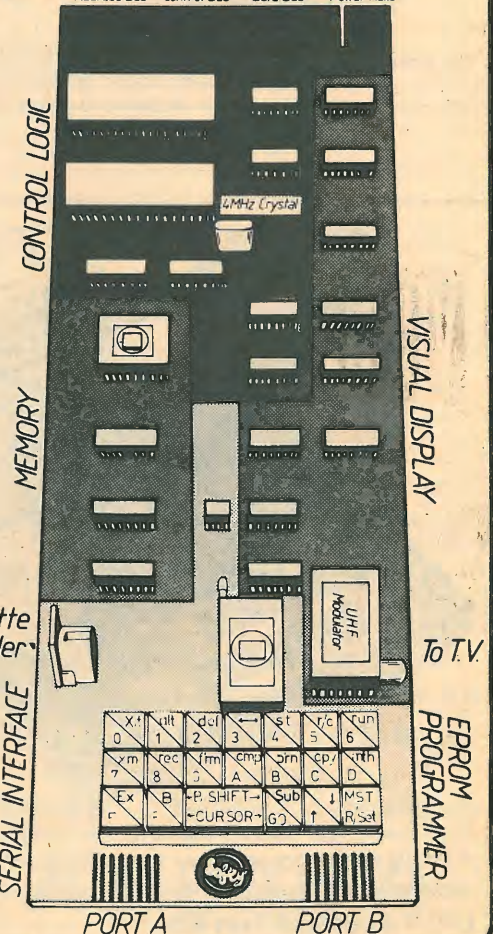

Please send me: (I enclose Cheque/Company Order)

- ..... SOFTY Kits @ £92.00 (Incl. VAT & 50p p & p)
- ..... DEVELOPMENT Kits @ £113.85 (Incl. VAT & 50p p & p)
- ..... BUILT DEVELOPMENT Kits @ £136.85 (Incl. VAT & 50p p & p)
- ..... POWER SUPPLY Kits @ £17.25 (Incl. VAT & £1 p & p)

Name .....

Address .....

WV08

VIDEOTIME PRODUCTS, 56, Queen Road, BASINGSTOKE, Hants, RG21 1RE



# With the new Oryx miniature low voltage soldering station

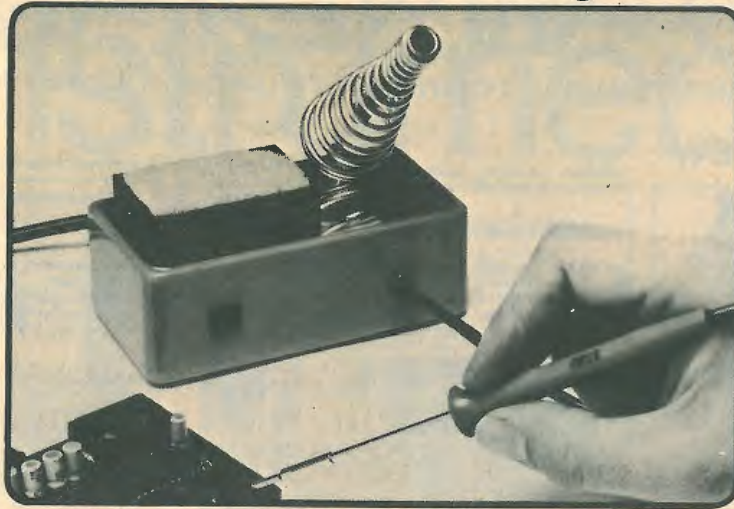

**FIRST  
EVER COMPLETE  
6 WATT SOLDERING  
STATION**

**you get precision, operator safety, a choice of soldering iron tips and superb value at £9.95 (+VAT)**

The new PSU 6 volt soldering station, operating at 360°C has its own compact power unit, a double insulated transformer and comes complete with an Oryx 6 watt miniature soldering iron, sponge, sponge well, spring holder mounted at an easy load angle, indicator lights and an internal safety fuse.

Obtainable also from our distributors: Electroplan Limited, Orchard Road, ITT Electronic Services, Edinburgh Way, Toolrange Limited, Upton Road, Royston, Herts. SG8 5HH. Harlow, Essex. CM20 2DE. Tilehurst, Reading. RG3 4JA.

## Greenwood Electronics

Portman Road, Reading, Berks. RG3 1NE Tel: (0734) 595844 Telex: 848659

WW — 017 FOR FURTHER DETAILS



**OUR RANGE OF PRODUCTS ARE NOW INDIVIDUALLY AND ATTRACTIVELY PACKAGED**

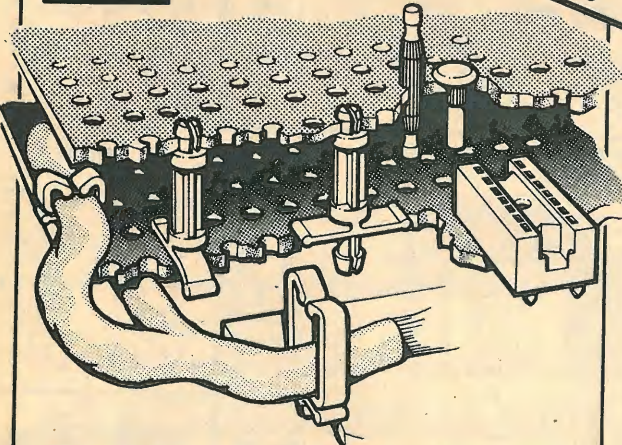

Our new catalogue lists circuit board accessories for all your projects — DIP sockets, pins, stand-offs, cable clips, hand tools. And we've got circuit boards, module systems, cases and boxes — everything you need to give your equipment the quality you demand. Send 25p to cover postage and packing, and the catalogue's yours.

**VERO ELECTRONICS LTD. RETAIL DEPT.**  
Industrial Estate, Chandlers Ford, Hants. SO5 3ZR  
Telephone Chandlers Ford (04215) 2956

WW — 016 FOR FURTHER DETAILS

**PRODUCTION TESTING**

**DEVELOPMENT**

**SERVICING**

**POWER UNITS**  
Now available with  
**3 OUTPUTS**



Type 250VRU/30/25

OUTPUT 1: 0-30v, 25A DC  
OUTPUT 2: 0-70v, 10A AC  
OUTPUT 3: 0-250v, 4A AC

ALL  
Continuously  
Variable



**VALRADIO LIMITED, BROWELLS LANE, FELTHAM  
MIDDLESEX TW13 7EN  
Telephone: 01-890 4242/4837**

WW — 038 FOR FURTHER DETAILS

# TRANSAM

TRANSAM COMPONENTS LTD., 12 CHAPEL STREET, LONDON, N.W.1. TEL: 402 8137

## The exciting new **TRITON** Personal Computer

**TRITON** — A British designed home computer kit that can be expanded up to 64k memory on the motherboard shown.

**AVAILABLE NOW!! NO WAITING!!**

- 3 options in basic, including 7k scientific.
- Up to 8K on main board, 56k off board.
- 64 graphic characters.
- Power supply and cabinet supplied with basic kit.
- Fully encoded ASC keyboard.

- Software printer interface with options 2 & 3.
- Easy conversion from option 1 to 2 and 3 using EPROMS and our programming facility.

**TRITON** — An easy-to-buy computer.

- All components available separately or in packs to suit your budget.
- 118 page manual with all you need to know.
- TV or monitor display.
- Modem tape I/O or communications interface.

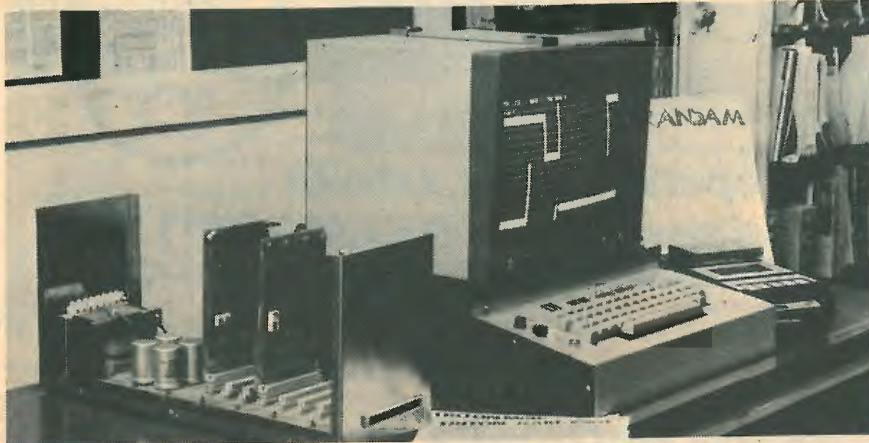

**FIRMWARE OPTIONS ON TRITON SYSTEM**  
 option 1: L4.1 with 2k tiny basic and 1k monitor on main board ..... £286.00  
 option 2: L5.1 with 2.5k tiny basic and 1.5k monitor on main board ..... £294.00  
 option 3: L6.1 with 7k scientific basic and 1.5k monitor. Resides off board and price includes motherboard system plus EPROM card all buffered and 56k to go ..... £399.00  
 Future options include floppy disc interface and controller.

**EXPANSION BOARDS** — available now!  
 Motherboard kit with 6 amp power supply, buffering and 2 sockets ..... £50.00  
 8k RAM card kit (using 2114's) ..... £97.00  
 EPROM card kit (with 2708's) ..... £97.00  
 EPROM card kit (without 2708's) ..... £31.00  
 Motherboard case ..... £13.00

All prices exclude VAT at 8% (currently).

118 page manual £5 + 70 P&P — full details in Summer 1979 catalogue available now at 40p.

**CMOS**

|      |     |
|------|-----|
| 4000 | .15 |
| 4001 | .15 |
| 4002 | .15 |
| 4007 | .15 |
| 4011 | .15 |
| 4012 | .15 |
| 4013 | .26 |
| 4015 | .76 |
| 4016 | .28 |
| 4017 | .57 |
| 4018 | .65 |
| 4020 | .67 |
| 4021 | .67 |
| 4022 | .65 |
| 4023 | .15 |
| 4024 | .48 |
| 4025 | .15 |
| 4027 | .31 |
| 4028 | .54 |
| 4029 | .70 |
| 4040 | .65 |
| 4042 | .53 |
| 4043 | .57 |
| 4044 | .57 |
| 4046 | .82 |
| 4047 | .95 |
| 4049 | .28 |
| 4050 | .31 |
| 4051 | .51 |
| 4052 | .51 |
| 4053 | .51 |
| 4060 | .94 |

### ★★★ WE HAVE MEMORIES ★★★

|                              |       |                    |       |
|------------------------------|-------|--------------------|-------|
| 2104-2 4096 bit DRAM (200ns) | 6.50  | 75110 Interface    | .54   |
| 4116-3 16kX1 DRAM (250ns)    | 9.00  | 5325 Memory Driver | .97   |
| 4118 1k X 8 SRAM             | 19.50 | Z-80 CPU 4MHz      | 11.50 |
| 74118AN 256 bit PROM         | 2.00  | Z-80 PIO           | 9.50  |
| 2708 1k X 8 EPROM (450ns)    | 9.50  |                    |       |

|      |     |
|------|-----|
| 4066 | .33 |
| 4068 | .15 |
| 4069 | .15 |
| 4070 | .15 |
| 4071 | .15 |
| 4072 | .15 |
| 4073 | .15 |
| 4075 | .15 |
| 4076 | .73 |
| 4077 | .15 |
| 4078 | .15 |
| 4081 | .15 |
| 4082 | .15 |
| 4093 | .39 |

### LET US GIVE YOU A TIP

|         |     |          |      |
|---------|-----|----------|------|
| TIP 29A | .31 | TIP 34C  | .76  |
| TIP 29C | .36 | TIP 35A  | 1.25 |
| TIP 30A | .32 | TIP 35C  | 1.50 |
| TIP 30C | .36 | TIP 36A  | 1.36 |
| TIP 31A | .33 | TIP 36C  | 1.63 |
| TIP 31C | .36 | TIP 41A  | .47  |
| TIP 32  | .33 | TIP 41C  | .53  |
| TIP 32C | .36 | TIP 42A  | .49  |
| TIP 33A | .57 | TIP 42C  | .53  |
| TIP 33C | .68 | TIP 2955 | .57  |
| TIP 34A |     | TIP 3055 | .57  |

**DIL SOCKETS**

|        |     |
|--------|-----|
| 8 pin  | .12 |
| 14 pin | .13 |
| 16 pin | .14 |
| 18 pin | .20 |
| 20 pin | .21 |
| 22 pin | .23 |
| 24 pin | .24 |
| 28 pin | .31 |
| 40 pin | .44 |

VAT Included  
P&P 30p

Resistors 1/4w 5% E12

Access Cards Welcome

Same Value .80 per 100



**STRUTT ELECTRICAL & MECHANICAL  
ENGINEERING LTD.**  
TELEX 45263

3C BARLEY MARKET ST.  
TAVISTOCK, DEVON PL19 05F  
TEL. TAVISTOCK 0822 5439

# Test instruments

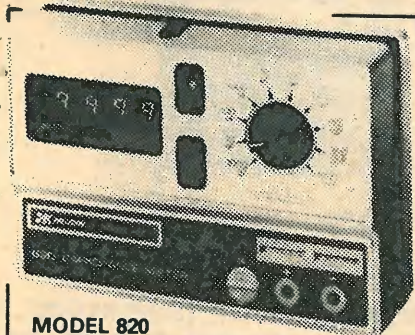

**MODEL 820  
NEW PORTABLE  
DIGITAL CAPACITANCE METER**  
Measures capacitance from 0.1pF to 1 Farad in 10 ranges · Resolves to 0.1pF on lowest range · 4 digit easy-to-read LED display · 0.5% accuracy · Uses either rechargeable or disposable batteries.

**MODEL 1640  
MOBILE EQUIPMENT POWER SUPPLY**  
Features: Regulated adjustable output from 11-15VDC, 0 to 3 Amp · Fully automatic overload protection, manual reset, 5A surge limit · Perfect for servicing car radios and all other 12 volt equipment · "OTHER Models up to 50v. at 5 Amps. Available".

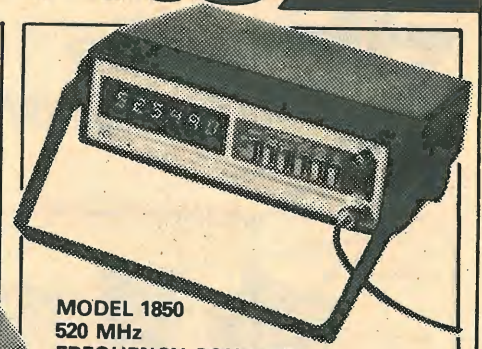

**MODEL 1850  
520 MHz  
FREQUENCY COUNTER**  
Features: 5Hz to 520 MHz reading guaranteed · Gate times from 10ms to 10 seconds · Period measurement capability · 50 mV input sensitivity at 520MHz · 240 VAC, or 12 VDC · Well protected input circuitry · Temperature compensated crystal oscillator · LED readout.

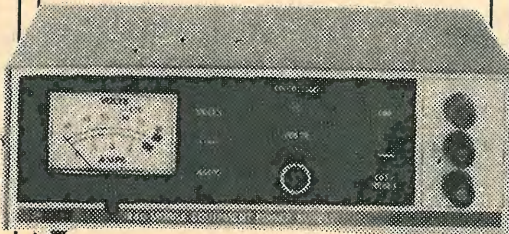

**MODEL 510  
PORTABLE TRANSISTOR TESTER**  
Features: Fast GO/NO-GO in-circuit testing · Fast and thorough GOOD/BAD out-of-circuit testing · Tests FET's and SCR's in-circuit or out-of-circuit · Gives positive emitter-base-collector identification in LO drive-positive base identification in H1 drive · Light-Emitting Diodes indicate NPN-OK or PNP-OK · Pocket-size-Over 100 hours of testing from single set of "AA" cells · Digital stability-no adjustments; nothing to go out of calibration.

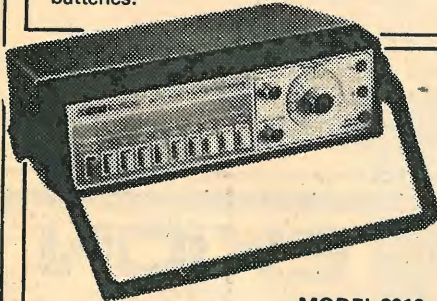

**MODEL 3010  
NEW LOW DISTORTION FUNCTION GENERATOR**  
Features: Generates sine, square and triangle waveforms · Variable amplitude and fixed TTL square-wave outputs · 0.1 Hz to 1 MHz in six ranges · Typical sine wave distortion under 0.5% from 0.1 Hz to 100 kHz. · Variable DC offset for engineering applications · VCO external input for sweep-frequency tests.

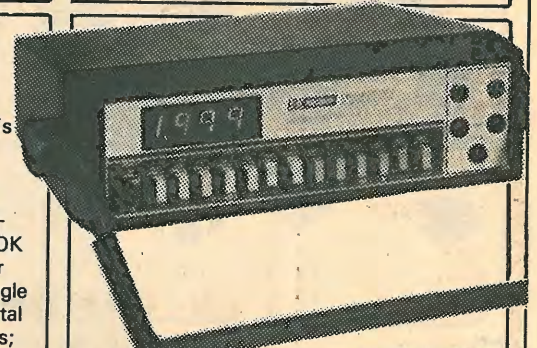

**MODEL 2830  
NEW 3 1/2 DIGIT LAB DMM**  
Led display · 0.5% accuracy · 1000 volts DC · 750 volts AC · Seven OHMS · Ranges provide measurement from 0.01 OHM to 20 Meg OHMS · 10 amp current range · AC Operation · Standard DC Power pack available.

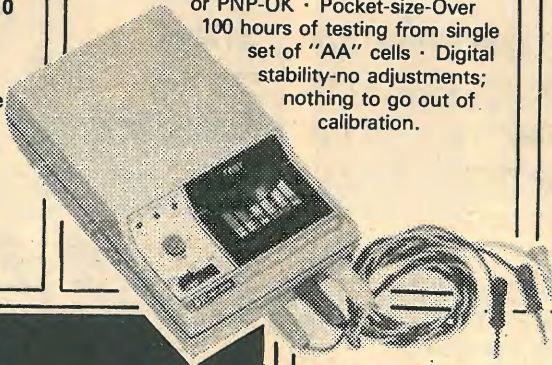

**MODEL 467  
CRT RESTORER/ANALYZER**  
B & K Precision Tridynamic multiplex technique to test all three guns of color CRT simultaneously. Measures beam current through G1 aperture to screen. Unique computer-derived digital circuitry for accurate results. Tests focus electrodes lead continuity to catch faults that other testers miss. Uses the most powerful restoration method known for best results with minimal danger to CRT. Removes shorts and leakage to save more CRT's.



## 7 OF THE BEST FROM....

**BK PRECISION DYNASCAN**

For details of the full range of Electronic Test Equipment:- including Capacitance Meters DMM'S Frequency Counters Scopes Power Supplies and Semi-Conductor Testers

Contact - Sole UK Distributors

**RADIO SUPPLIES(Components)LTD.  
P.O. BOX 27  
39 WHITBY STREET, HARTLEPOOL  
CLEVELAND. TELEPHONE: 0429-75750**

**there are  
transformers  
and...**

**Drake  
Transformers**

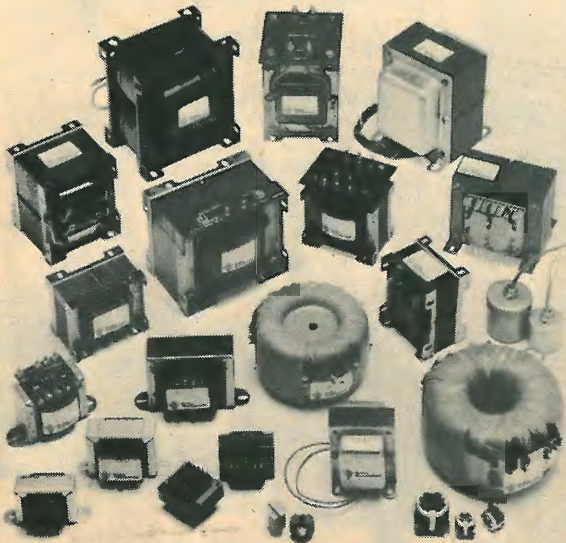

OEM — let Drake Transformers advise you on a component specification and design to solve that special problem. Pre-production prototypes and development undertaken as necessary.

Well known over a quarter century for personal service and high-quality products, Drake specialise in the design and manufacture of transformers and other wound components for large and small quantity production.

Expertise and service put **DRAKE TRANSFORMERS** in a class of their own.

### **DRAKE TRANSFORMERS LIMITED**

South Green Works Kennel Lane  
Billericay Essex CM11 2SP

Telephone: Billericay (02774) 51155  
Telex: 99426 (prefix Drake)

WW — 064 FOR FURTHER DETAILS

## **ELECTRONIC INDUSTRIAL THERMOMETER**

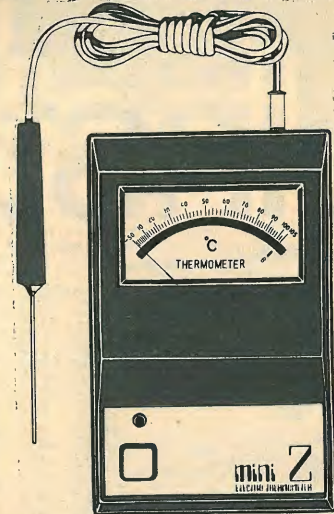

### **THE MODERN WAY TO MEASURE TEMPERATURE**

A Thermometer designed to operate, as an Electronic Test Meter. Will measure temperature of Air, Metals, Liquids, Machinery, etc., etc. Just plug-in the Probe, and read the temperature on the large open scale meter. Supplied with carrying case, Probe and internal 1 1/2 volt standard size battery.

Model "Mini-Z 1" measures from  $-40^{\circ}\text{C}$  to  $+70^{\circ}\text{C}$ . Price £30.00

Model "Mini-Z 2" measures from  $-5^{\circ}\text{C}$  to  $+105^{\circ}\text{C}$ . Price £30.00

Model "Mini-Z Hi" measures from  $+100^{\circ}\text{C}$  to  $500^{\circ}\text{C}$ . Price £33.00

(VAT 15% EXTRA)

Write for further details to

**HARRIS ELECTRONICS (LONDON)**  
138 GRAY'S INN ROAD, LONDON, WC1X 8AX  
(Phone 01-837 7937)

WW — 027 FOR FURTHER DETAILS

## **VORTEXION**

a happy  
event...

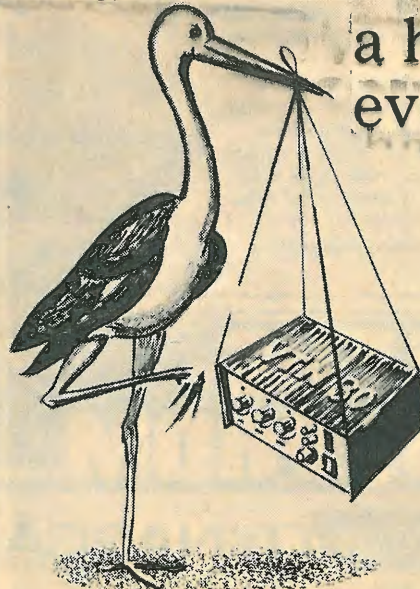

... a new addition to our family of amplifiers. The VTN 30. The new baby weighs in at 30 watts, and has a maximum of 3 inputs.

The other members of the Vortexion family are the system 2000, 50/70 watt and CP50 mains/battery amplifiers.

Contact Jennifer Hall — VORTEXION DIVISION.

Clarke & Smith Manufacturing Co. Ltd., Melbourne Works,  
Melbourne Road, Wallington, Surrey. Tel. 01-669 4411 Ext. 38.

Telex Casint G 22574; Telegrams: Electronic Wallington.

WW — 041 FOR FURTHER DETAILS

| U.K. Two-way Radio Checklist |        |          |     |     |
|------------------------------|--------|----------|-----|-----|
|                              | STORNO | MOTOROLA | GEC | PYE |
| Most EXPERIENCE              |        |          |     | ✓   |
| Most DEPOTS                  |        |          |     | ✓   |
| Most SITES                   |        |          |     | ✓   |
| Most ENGINEERS               |        |          |     | ✓   |
| Most SALES                   |        |          |     | ✓   |

# OK

## But what does it all add up to?

Big is not always beautiful.

So when we boast more resources than all our competitors put together you might be inclined to think: so what?

We agree.

When *you* are making substantial investments in two-way radio we expect more than facts and figures to be taken into account.

Like the people you are dealing with, starting with the salesman and right up to the top. How good is your relationship with the man up front. Is he thinking long term or looking for a quick sale today?

And who is backing up his promises - a well resourced U.K. based manufacturing and supplying

company wholly dedicated to the future growth and development of two-

way radio or a remote parent company looking for maximum advantage in whichever markets suit it best at the time? (If the latter, ensure he'll be around next time you have a replacement or extension problem).

We are not suggesting that you look to Pye Telecom for perfection. In this business staying the course for 35 years and making all the running for the future will always have its problems. But if ever those problems happen to be yours, you can count on our full commitment now and our resources whenever you need them.



Pye Telecommunications Ltd.,  
St. Andrews Road, Cambridge, CB4 1DW.  
Telephone: 0223 61222

WW - 068 FOR FURTHER DETAILS

# WHY BUY A MICRO-COMPUTER FROM **PETALECT** ELECTRONIC SERVICING LTD.

## BECAUSE

- 1) Established company trading since 1971
- 2) Electronic servicing is our speciality
- 3) We have in house programmers/systems analysts
- 4) We have our own service engineers
- 5) We will demonstrate the PET at your premises
- 6) We can customise the PET to your requirements
- 7) We can arrange finance
- 8) We offer, after the three-month warranty, a service contract from £69.50
- 9) You benefit from our experience of having sold over 250 micro-computers to industrial, educational and business, personal users.
- 10) We specialise in programs and interfaces for weighing applications for average weight control and counting, etc.

8K £550.00 + VAT  
16K £675.00 + VAT  
32K £795.00 + VAT

New Large  
Keyboard 'PETS'  
Now in Stock



All 'PETS' sold with a Basic Tutorial Tape.  
In our showroom we sell  
Books, Programs, etc.

### Also available:

24K Memory Expansion Boards (disk-compatible), only £320 + VAT  
PET-compatible dual floppy disk unit with advanced operating system, only £840 + VAT  
Large Extension Keyboard for the PET £89.50 + VAT  
Telephone for complete system prices: Wide Range of Printers Available

If you require any more information or demonstration regarding the PET 2001/8 or any associated equipment, programs, etc., please contact Mr. P. J. A. Watts or Mr. D. W. Randall at:

**PETALECT ELECTRONIC SERVICES LTD**  
33/35 Portugal Road, Woking, Surrey  
Tel. Woking 69032/68497

**Shop at:**  
**PETALECT**  
Chertsey Road, Woking, Surrey  
Tel. Woking 20727/23637

WW — 046 FOR FURTHER DETAILS

## Dual output power supplies

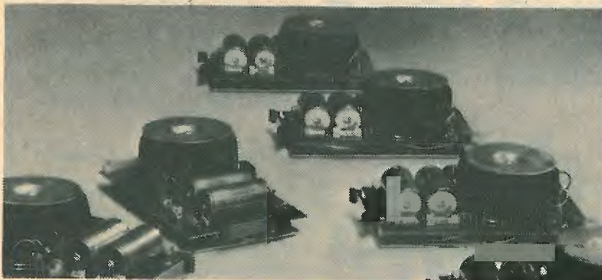

Now you can get on-card dual output power supplies from Vero Systems — in five versions:

- DUAL 5 Volts
- DUAL 12 Volts
- DUAL 15 Volts
- MIXED 5 and 12 Volts
- MIXED 5 and 15 Volts

The cards are designed to Eurocard standard size (100 x 160mm) to fit straight into your card or case frame.

Each supply is fully regulated with over voltage over current and thermal protection. Input voltage is 110/120/220/230/240 volts AC and both outputs are fully isolated from each other but may be connected to give different power rail configurations.

The cards are supplied fully tested each one complete with 64-way indirect connector plug, card handle and connection chart.

| ORDER CODE | FUNCTION   | PRICE |
|------------|------------|-------|
| 89-2665G   | DUAL 5V    | £27   |
| 89-2671K   | DUAL 12V   | £35   |
| 89-2703B   | DUAL 15V   | £35   |
| 89-9017B   | DUAL 5-12V | £35   |
| 89-9018H   | DUAL 5-15V | £35   |

# VERO SYSTEMS

VERO SYSTEMS (ELECTRONIC) LTD

362 Spring Rd. Southampton Hants. SO9 5QJ Tel: (0703) 440611 Telex: 477164

WW — 056 FOR FURTHER DETAILS

## TV TUBE REBUILDING

Faircrest Engineering Ltd., manufacture a comprehensive range of equipment for processing all types of picture tubes, colour and mono. Standard or custom built units for established or new businesses. We export world-wide and have an excellent spares service backed by a strong technical team.

Full training courses are individually tailored to customers' requirements.

For full details of our service contact Neil Jupp

### FAIRCREST ENGINEERING LTD.

Willis Road, Croydon, 01-684 1422, 01-689 8741  
CRO2XX. Tel: 01-689 8741

WW — 023 FOR FURTHER DETAILS

## STEREO DISC AMPLIFIER 3

A reference amplifier for disc monitoring and transfer when replay signals of the highest quality are required.

Based on the Surrey Electronics Disc Amplifier 2 and manufactured under licence, two unbalanced outputs are provided enabling Line and DIN level inputs to be driven simultaneously. To facilitate cartridge matching, a wide range of switchable load capacitance and resistance values are provided, together with left and right 20 turn gain presets.

Noise measurement are often quoted with the disc input short circuit thus ignoring the noise contribution of the cartridge and the noise figure of the amplifier itself when loaded with the complex source impedances characteristic of magnetic cartridges.

Disc Amplifier 3 noise is specified with a simulated high inductance cartridge source. The CCIR noise weighting curve is also used as it gives a better correlation with the subjective annoyance of noise than other weighting or broadband measurement techniques.

High (Line) output: 1kHz at -44dBV.7 (5mV) set for 0dBV.7 output

| CCIR468-2 weighting and peak meter | CCIR/ARM Ref. 2kHz | 20Hz-20kHz average reading meter |
|------------------------------------|--------------------|----------------------------------|
| -64dBV.7                           | -75dBV.7           | -71dBV.7                         |
| Cartridge source 1H + 1kΩ          | 67dBV.7            | -68dBV.7                         |

**Dominus** P.O. Box 1  
Cranleigh, Surrey Tel. 04866 6477

Price: Cash with order. UK postage and 15% VAT inclusive **£169**





# NewBear Books



Please contact NEWBEAR for a complete catalogue of books.

NEWBEAR, 40 Bartholomew Street, Newbury, Berkshire RG14 5LL

Telephone: Newbury (0635) 30505

|                                 |   |   |        |
|---------------------------------|---|---|--------|
| Introduction to Microcomputing  | Instant Freeze and Dried                | Practical Microcomputer                   |        |
| Volume 0. The Beginners Book    | £ 5.95 Programming in Basic             | £ 7.20 Programming (6800)                 | £17.56 |
| Volume I. Basic Concepts        | £ 5.95 Illustrated Basic                | £ 2.25 The 6800 Microprocessor            | £ 3.60 |
| Volume II. Some Real Products   | £18.95 Beginning Basic                  | £ 4.95 D.N. 4 Definite description of the |        |
| Volume III. Some Real Support   | Learning Basic Fast                     | £ 6.30 6800 Instruction Set               | £ 1.50 |
| Devices                         | £11.95 Advanced Basic                   | £ 6.00 Z80 Books                          |        |
| Understanding Microcomputer     | Microcomputer Basic                     | £ 6.60 Z80 Programming for Logic Design   | £ 5.95 |
| and Small Computer Systems      | £ 7.56 The Basic Workbook               | £ 4.50 Z80 Technical Manual               | £ 4.00 |
| Introduction to Computers       | £11.15 Discovering Basic (a problem     | £ 4.90 Z80 P10 Technical Manual           | £ 2.75 |
| Introduction to Computers in    | solving approach)                       | £ 4.50 Z80 Programming Manual             | £ 4.50 |
| Business                        | £10.45 The Users Guide to North Star    | £10.00 Z80 Microcomputer Handbook         | £ 7.25 |
| An Introduction to Personal     | Basic                                   | £ 5.56 Practical Microcomputer            |        |
| and Business Computing          | £ 5.75 Basic with Business Applications | £10.36 Programming (Z80)                  | £23.96 |
| Getting Acquainted with Micros  | £ 7.95 Basic and the Personal Computer  |   |        |
| Home Computers - A Beginner's   | A Guided Tour of Computer               |   |        |
| Glossary and Guide              | £ 4.95 Programming in Basic             | Pascal                                    |        |
| Getting Involved with your Own  | Basic Basic (An introduction to         | £ 4.16 Pascal: User Manual & Report       | £ 5.52 |
| Computer - A Guide for          | Computer Programming in                 | Problem Solving Using Pascal              | £ 7.84 |
| Beginners                       | £ 4.75 Basic Language)                  | Programming in Pascal                     | £ 7.50 |
| Introduction to Computer        | Advanced Basic Applications             | £ 5.40 A Practical Introduction to Pascal | £ 3.50 |
| Programming                     | and Problems                            |   |        |
| The First Book of               | £ 3.84                                  | £ 6.00 6502                               |        |
| Microcomputers                  | £ 3.60 6800 Books                       | The Best of Micro 6502 Journal            | £ 5.99 |
| A Consumers Guide to Personal   | 6800 Programming for Logic Design       | Sym Reference Manual                      | £ 7.50 |
| Computing and                   | £ 5.95 6800 Programming Manual          | £ 7.50 Sym Programming Manual             | £ 7.50 |
| Microcomputers                  | 6800 Assembly Language                  | £ 7.00 First Book of Kim                  | £ 7.00 |
|                                 | £ 5.65 Programming                      | £ 6.95 6500 Hardware Manual               | £ 7.50 |
| Basic Books                     | Using the 6800 Microprocessor           | £ 5.65 6500 Programming Manual            | £ 7.50 |
| Introduction to Basic           | £ 6.50 77-68 6800 Microprocessor        | £ 7.50 Programming the 6502 SYBEX         | £ 7.95 |
| Beginning Basic                 | £ 2.95 6800 Software Gourmet Guide      |   |        |
| Introduction to Basic           | £ 1.95 Cook Book                        | £ 7.95 Fortran                            |        |
| Some Common Basic Programmes    | £ 6.45                                  | Elementary Computer                       |        |
| Payroll with Cost Accounting in |   | Programming in Fortran IV                 | £ 6.30 |
| Basic                           | £ 9.95                                  | Fortran with SF/R and WATFEV-S            | £ 6.95 |

WW - 078 FOR FURTHER DETAILS

the indispensable  
**BIRD43**



**THRULINE® WATTMETER**  
0.45-2300 MHz / 0.1-10,000 watts

The Standard of the Industry  
What more need we say...

Exclusive UK representative

**aspen electronics limited**

2 KILDARE CLOSE, EASTCOTE, MIDDX. HA4 9UR  
TELEPHONE: 01-868 1188 - TELEX 8812727

**crae** UK  
L.T.D.

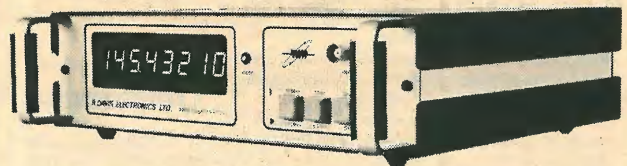

Model HFC600-D 1HZ=600MHZ Frequency Counter fitted with XTAL Oven 8 digit .5" LEDs driven to high brightness.

**Ranges**= 1HZ - 60MHZ=60 - 600MHZ.

**Gate** = XTAL 5.24288MHZ 1.0 or .1 sec. by pushbutton selection.

**Input Imp**=50Ω at 60 - 600MHZ 1MΩ par with 15PF at 60MHZ.

**Typical Sensitivity** = 10mV = 50MHZ. 20mV = 200MHZ. 150mV = 500MHZ.

**Resolution** = 1Hz=0.60MHZ. 10 HZ=60-600MHZ.

**Typical Stability** = 3 parts 10 per °C after 1 min. warm-up time.

**Power**=100-240V A.C. 40-60HZ=9-16V D.C.

**Size**=H.68mm W=263mm D=216mm. (Provision for int. batt pack). Anodized aluminium cabinet.

**Price £145.00 + VAT**

7 HUGHENDEN ROAD, HASTINGS, SUSSEX,  
TN34 3TG ENGLAND. Telephone: (0424) 428131

WW - 029 FOR FURTHER DETAILS

# fact: this condenser microphone sets a new standard of technical excellence.

The Shure SM81 cardioid condenser is a new breed of microphone. It is a truly high-performance studio instrument exceptionally well-suited to the critical requirements of professional recording, broadcast, motion picture recording, and highest quality sound reinforcement—and, in addition, is highly reliable for field use.

Shure engineers sought—and found—ingenious new solutions to common

problems which, up to now, have restricted the use of condenser microphones. Years of operational tests were conducted in an exceptionally broad range of studio applications and under a wide variety of field conditions.

As the following specifications indicate, the new SM81 offers unprecedented performance capability—making it a new standard in high quality professional condenser microphones.



## SM81 puts it all together!

- WIDE RANGE, 20 Hz to 20 kHz FLAT FREQUENCY RESPONSE.
- PRECISE CARDIOID polar pattern, uniform with frequency and symmetrical about axis, to provide maximum rejection and minimum colouration of off-axis sounds.
- EXCEPTIONALLY LOW (16 dBA) NOISE LEVEL.
- 120 dB DYNAMIC RANGE.
- ULTRA-LOW DISTORTION (right up to the clipping point!) over the entire audio spectrum for a wide range of load impedances. MAXIMUM SPL BEFORE CLIPPING: 135 dB; 145 dB with attenuator.
- WIDE RANGE SIMPLEX POWERING includes DIN 45 596 voltages of 12 and 48 Vdc.
- EXTREMELY LOW RF SUSCEPTIBILITY.
- SELECTABLE LOW FREQUENCY RESPONSE: Flat, 6 or 18 dB/octave rolloff.
- 10 dB CAPACITIVE ATTENUATOR accessible without disassembly and lockable.

## Outstanding Ruggedness

Conventional condenser microphones have gained the reputation of being high quality, but often at the expense of mechanical and environmental ruggedness. This no longer need be the case. The SM81 transducer and electronics housing is of heavy-wall steel construction, and all internal components are rigidly supported. (Production line SM81's must be capable of withstanding at least six random drops from six feet onto a hardwood floor without significant performance degradation or structural damage.) It is reliable over a temperature range of  $-20^{\circ}\text{F}$  to  $165^{\circ}\text{F}$  at relative humidities of 0 to 95%!

Send for a complete brochure on this remarkable new condenser microphone!

## SM81 Cardioid Condenser Microphone

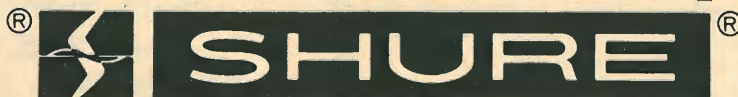

Shure Electronics Limited, Eccleston Road, Maidstone ME15 6AU—Telephone: Maidstone (0622) 59881

# wireless world

## Spread the word

**Editor:**

TOM IVALL, M.I.E.R.E.

**Deputy Editor:**

 PHILIP DARRINGTON  
 Phone 01-261 8435

**Technical Editor:**

 GEOFFREY SHORTER, B.Sc.  
 Phone 01-261 8443

**Projects Editor:**

 MIKE SAGIN  
 Phone: 01-261 8429

**News Editor:**

 RAY ASHMORE, B.Sc., G8KYY  
 Phone 01-261 8043

**Communications Editor:**

TED PARRATT, B.A.

**Drawing Office Manager:**

ROGER GOODMAN

**Production & Design:**

ALAN KERR

**Advertisement Controller:**

G. BENTON ROWELL

**Advertisement Manager:**

 BOB NIBBS  
 Phone 01-261 8622

 DAVID DISLEY  
 Phone 01-261 8037

 BARRY LEARY  
 Phone 01-261 8515

**Classified Manager:**

 BRIAN DURRANT  
 Phone 01-261 8508 or 01-261 8423

 NEIL McDONNELL  
 (Classified Advertisements)  
 Phone 01-261 8508

 JOHN GIBBON (Make-up and copy)  
 Phone 01-261 8353

**Publishing Director:**

GORDON HENDERSON

In the first nine months of 1978, the public bought two-thousand television receivers equipped with teletext decoders. The last quarter of the year saw a further 7,000 sets sold — a grand total for the fourth year of teletext transmission of 9,000 receivers. The total number of colour receivers delivered to the UK market during the year was about 1.75 million, of which nearly 80% came from UK manufacturer members of BREMA, from whose report these figures were taken. BREMA confesses to being disappointed at the statistics.

Teletext has been described as a breakthrough, a revolution in mass communication — even a threat to newspapers and periodicals. It may turn out to be any of these, but it seems not yet to have been accepted by the British public as a compelling reason for spending two or three hundred pounds more on a television receiver than is needed for a 'picture-only' set.

One reason advanced for this is, indeed, the question of cost. In absolute terms, this cannot be an insurmountable barrier in a period when £41 million was spent on video recorders in 1978 alone (96,000 units), or when the television set itself costs an average of £310 at discount prices. Attractive gadgets such as television games find a ready market and are not cheap. It seems likely, therefore, that teletext is not as attractive to the public as these more immediately spectacular devices.

This lack of sustained interest and the consequent non-appearance of the anticipated droves of gleeful teletext receiver owners could be put down to the verifiable fact that not very many of them have a clear idea of just what it is they are being asked to buy. The majority of objects and services on the market have been reasonably well advertised by their makers and

suppliers and, when a market did not already exist, one was created by advertising and other public relations operations. This procedure may be seen as an unacceptable face of capitalism, but acceptable or not, it works. Pocket calculators were not, prior to 1972, the average person's idea of what he most wanted in life, but they were soon thought to be as necessary as the morning bowl of cornflakes (another public-relations success). This being so, it is remarkable that still, as far as the general public is concerned, Ceefax and Oracle could be the names of a couple of rather undistinguished racehorses. Television makers have done some informative advertising, but both BBC and IBA seem to regret the whole business and rarely refer to it either in ordinary television advertising or in the links between programmes.

Although the editorial teams of the BBC and IBA teletext services are severely handicapped by the coarse format of only 960 characters per 'page,' performing extremely well in these circumstances, perhaps the content could be altered slightly to more certainly attract and retain the interest of potential buyers. A Letter to the Editor feature ought to be popular, with the possibility of broadcasting a hundred or so a day. Free small advertisements might be useful (*Swap Shop* is a precedent for the BBC) and potted histories of current affairs, such as the events leading up to the oil shortage, could be of great interest. A recent suggestion was that open letters to politicians, with their replies, might be presented for all to see.

To sum up, it appears that unless the public's interest can be attracted by publicity and held by a content of more vital relevance, the service is unlikely to grow. To quote BREMA, it could "wither and die."

# Audio processor design

Improving the intelligibility of s.s.b. communications

by P. Anderson, G80AV

After monitoring many amateur radio transmissions, the author came to the conclusion that most of the deficiencies in sound quality could probably be corrected, or at least much improved, by a number of fairly simple modifications. The unit described in this article was therefore built to investigate the possibilities of improving the quality of signals transmitted from a typical amateur radio station under both local and difficult DX conditions.

**COMMON DEFECTS** in sound production from an amateur transmitter include woolly, muffled or excessively top-py audio, insufficient or poor compression on frequency modulated transmissions, and excessive or distorted compression on single-sideband transmissions. Most of the defects are subjective in nature and this applies particularly to the 'punchiness' of the signal, which is a subtle blend of the correct frequency response, amount of compression and voice quality of the operator. The unit described was designed to correct these types of defect. However, this only goes part way towards a complete solution. A block diagram of the audio processor is shown in Fig. 1.

While involved in this project, the author decided to find a way of improving the intelligibility of the voice under very weak signal conditions and it was hoped that this could be done without degrading the audio quality excessively. Some transmissions, for example, in an attempt to improve intelligibility, produce signals which are so distorted that they have the reverse effect. One part of the unit consists of a speech processor based on the techni-

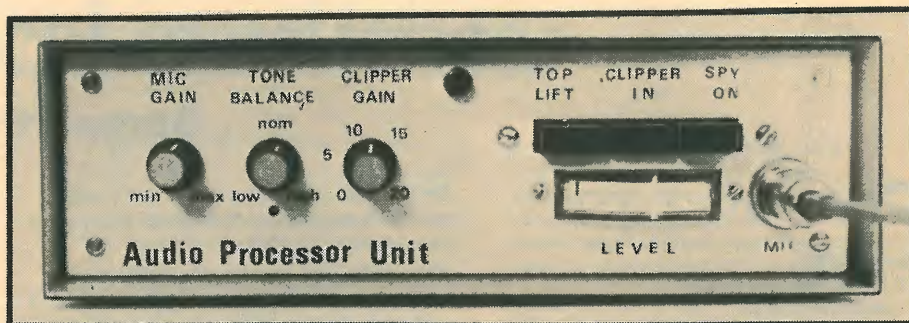

Front panel of audio processor unit

que of clipping a single-sideband radio frequency signal, but with this technique care must be taken to ensure that each circuit is dynamically able to cope with the maximum, expected signal level without adding any distortion to that caused by the actual clipping circuit. This unit has proved to be capable of providing signals with a very high level of clipping while adding only relatively small amounts of distortion to the signal.

## Development history

Listening tests with several types of microphone, including those designed specifically for communications or hi-fi applications, suggested that three main characteristics could need attention. These are: excessively wide frequency response, which causes 'woofy' bass and 'glassy' tops; sloping frequency responses, which cause woolly or muffled

sounds — or the opposite effect of thin bodyless quality; and lack of 'punch' DX quality (so important if really effective audio compression is required), which appears to be due to a fairly high resonant peak in response at the higher end of the frequency range. For simplicity the author decided to use one circuit for each function, to allow the design to be easily altered. The first circuit used was the microphone amplifier, which primarily amplified the low output of most microphones up to a level of about 1V, and provision was also made for fitting a resonant circuit to boost the higher audio signals. The second circuit enabled the response to be tilted about the centre of the frequency range and the third circuit consisted of steep high and low pass filters which removed unwanted extremes of audio signal. This arrangement, which forms the basis of the final unit, was able to provide clear sounds from all of the microphones available. The microphone which gave the best account of itself was an electret type incorporating its own preamplifier, which produced superb quality sounds, even though it was totally unsuitable before being 'processed.' In fact, this commonly-available microphone is probably the match for the unit, for those wishing to provide the best possible signal quality.

Attention was then turned towards finding a satisfactory method of improving the intelligibility of audio signals during long distance communications when the received signal is weak. The main requirement is to compress the dynamic range of the audio signal such that all of the vital intelligence to be conveyed is kept at the maximum permissible signal level and the most commonly used method of doing this is to clip the audio signal by

Fig. 1. Block diagram of the audio processor

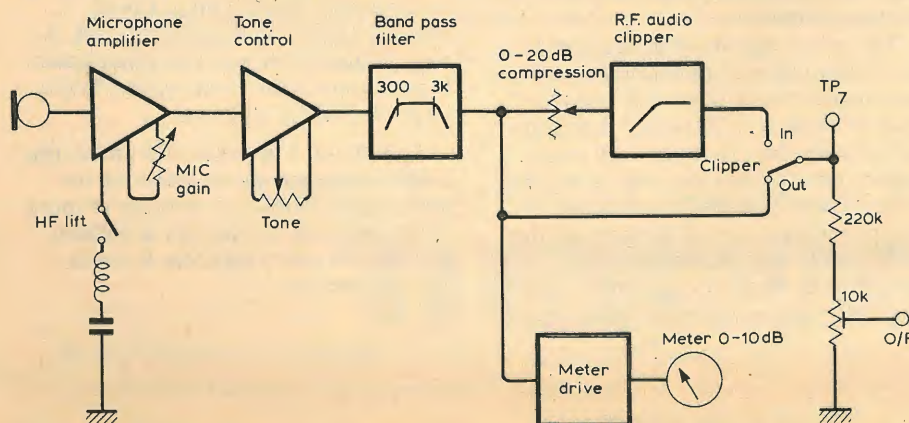

the use of back-to-back diodes either across the audio signal path or in the feedback circuit of an amplifier. Although the second method sounds better, because it does not produce such hard clipping and hence produces less unpleasant distortion, in practice neither method was able to provide more than about 4dB improvement in subjective audio level without introducing high levels of distortion. An automatic gain control approach was also ruled out, because it does not compress the audio dynamics but merely brings all the speech peaks to the same level, which was not desired. The desired property a processor must have is to compress the dynamics of the signal, without distortion, so that all information carried is at a maximum and will therefore have a better chance of being above the noise floor, and audible at the receiving end.

It was decided that the single-sideband clipping method was most likely to satisfy the requirement because it has two major advantages. Firstly, any harmonic components produced appear at twice the frequency of the clipped signal and in this case, because the frequency used was 10.7MHz, the harmonics were far removed from the audio frequencies. Secondly, as a direct result of this effect, there is very much less intermodulation between audio frequency components and the only intermodulation products produced are between the harmonics of the voice tones applied to the clipper. If the signal is well filtered before processing, the maximum number of harmonics is unlikely to exceed four (2nd, 3rd, 4th and 5th) at lower frequencies and there may not be any at higher frequencies. This is one reason why it is often beneficial to boost high frequencies prior to clipping so that harmonics produced by the clipper are not mixed down into the audible range where they cannot be filtered out. Products of mixing that does occur are of relatively lower amplitude (-10dB) and so do not become dominant.

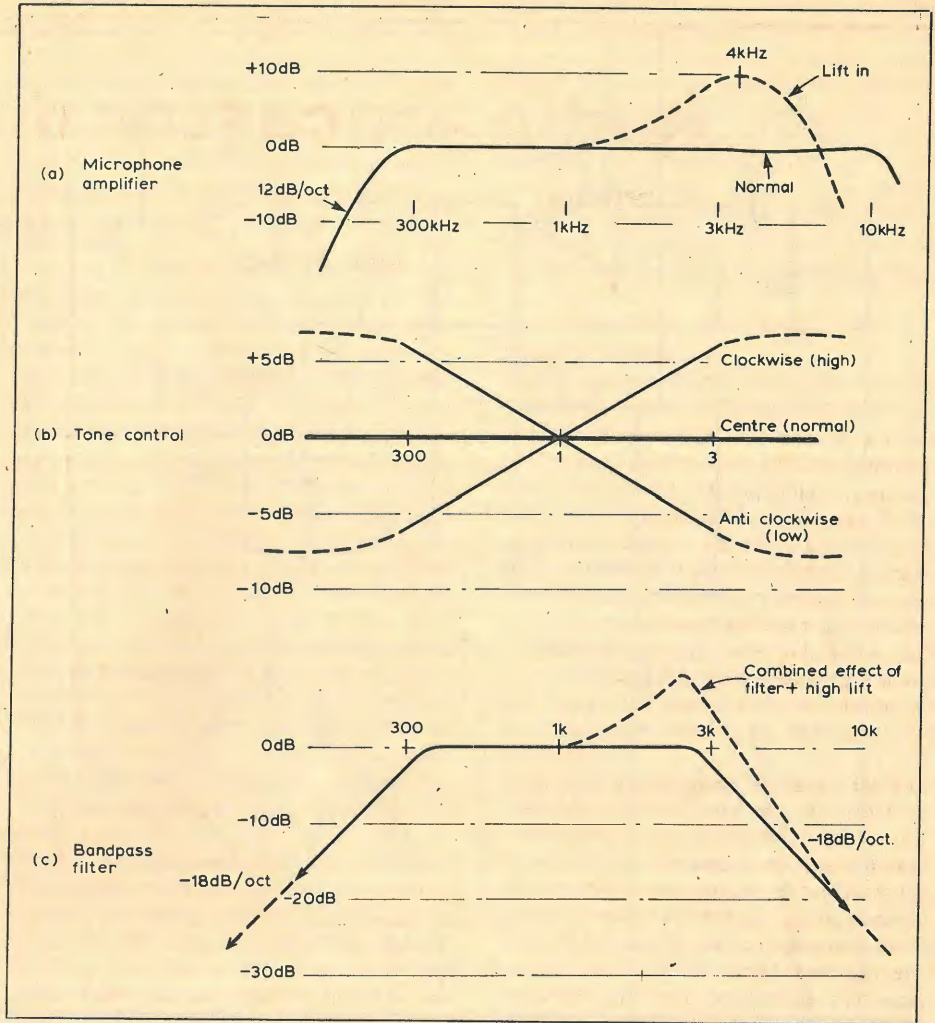

Fig. 2. Performance characteristics of the microphone amplifier, tone control and bandpass filter used in the audio processor

With the final design, which will compress audio signals by up to 30dB while generating a relatively small amount of audible distortion, sinewave inputs appear at the output virtually unchanged as the clipping level is increased to its maximum level and the limit is only reached when the modulator is overdriven and itself produces distortion. However, because compression above 20dB was found to provide little extra improvement in intelligibility, the circuits were set up to provide this level as a maximum (leaving 10dB headroom for speech peaks), so avoiding any additional distortion. With 20dB of clipping the audio signals sound as loud, and as intelligible, as an unclipped signal peaking 10dB higher than the clipped signal.

**Circuit description**

All components used in the unit are readily available and, with the exception of the i.f. block filter, are mainly low cost. A different type of filter may be used with suitable circuit changes, if desired, and there is no reason why a different i.f. frequency should not be used provided there is sufficient sideband selectivity. An s.s.b. filter designed

for the purpose should provide even better results, particularly at lower audio frequencies where the effects of poor selectivity are more apparent. CA3130 bi-m.o.s., operational amplifiers have been used in preference to the more commonly used types as they have several desirable characteristics not found together in other series' devices. These include lower noise, absence of crossover distortion, higher output current capability, and the ability to operate down to 0.5V below the negative supply rail. These parameters are all used to advantage in this unit.

**Microphone amplifier**

L<sub>1</sub>, C<sub>1</sub> and C<sub>2</sub> filter out any radio frequencies picked up on the microphone cable. It is preferable that these components are mounted behind the input socket and that they are grounded, along with the screened lead carrying the signals to the microphone preamplifier board, to the input socket. To simplify the bias and feedback arrangements, the inputs to the first integrated circuit IC<sub>1</sub> are biased to 0.5V above ground, which is quite adequate for the input levels expected. The gain is controlled by feedback, which avoids any problems of noise or overload, and high frequency lift is provided by switching in a series resonant circuit centred on 4kHz. In addition, the Q of the circuit is controlled to provide the optimum shape for the response. De-

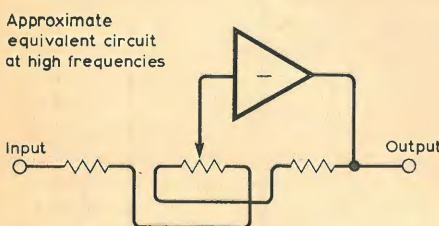
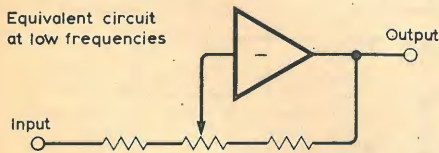

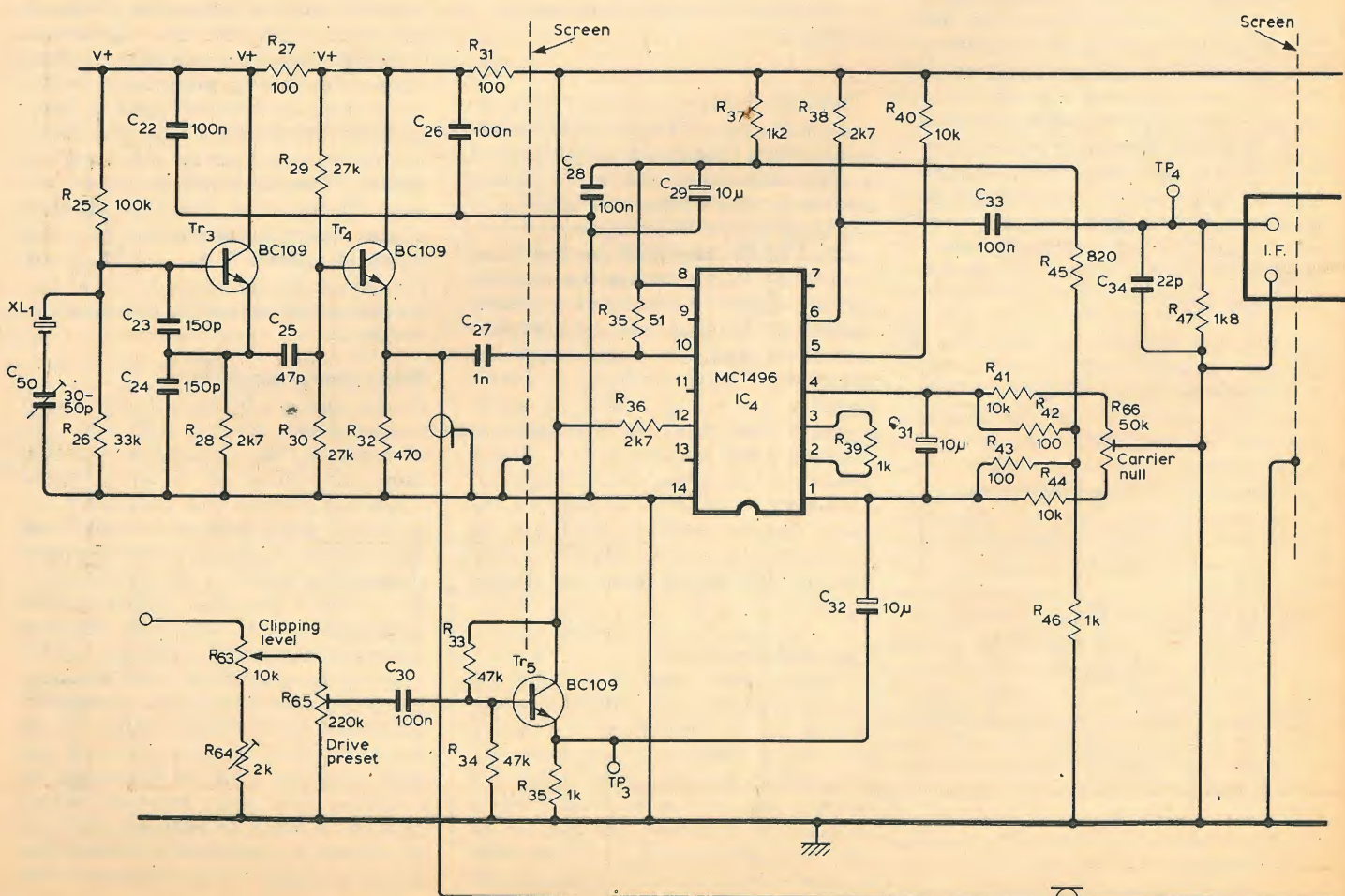
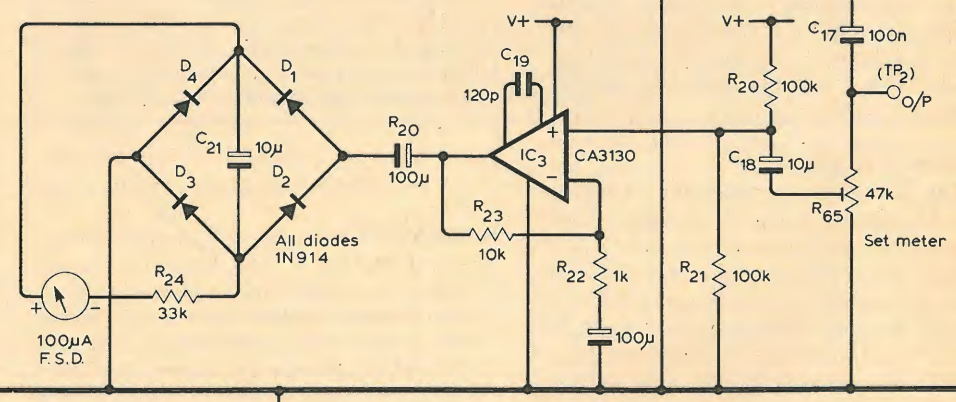
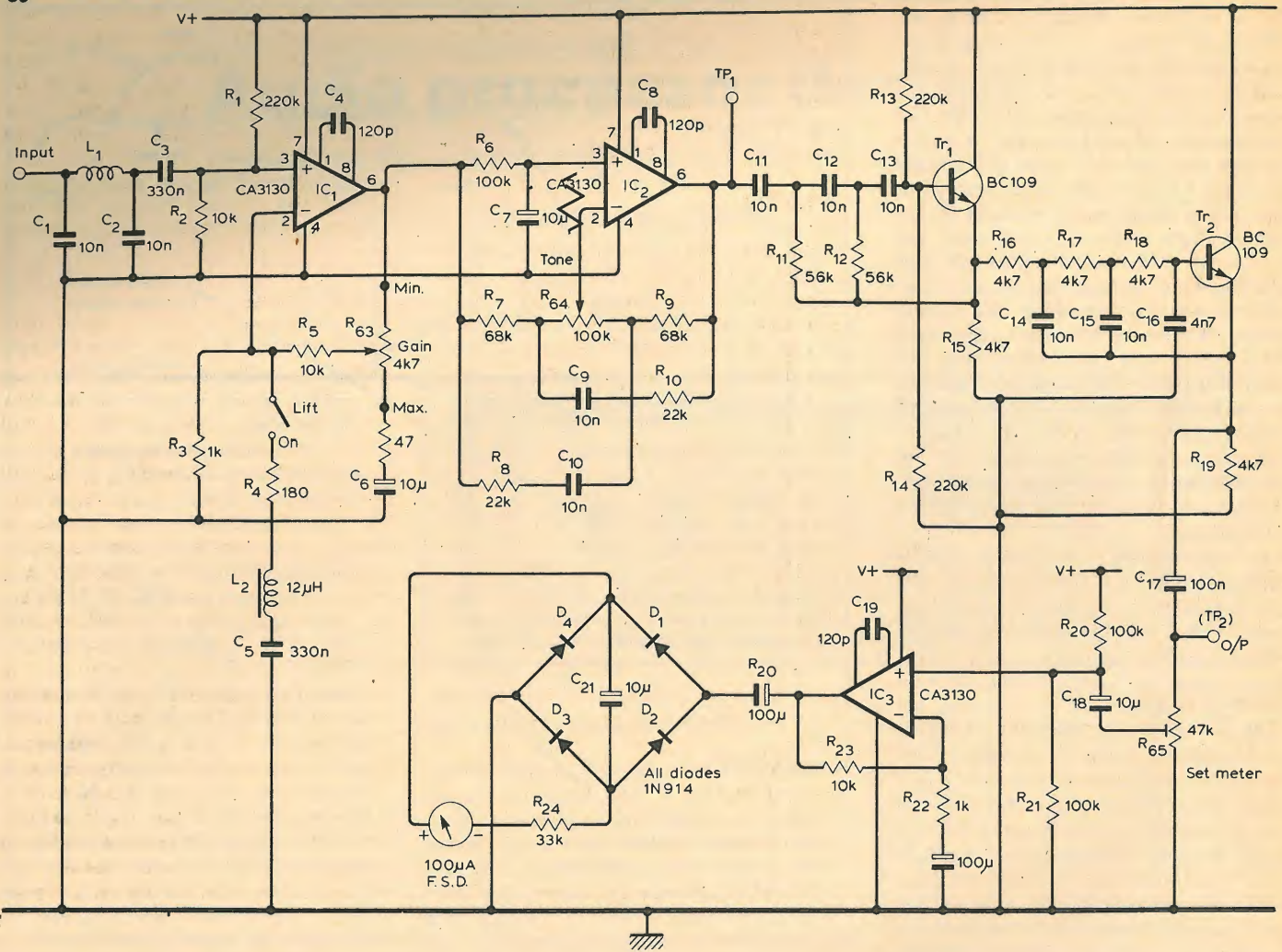

◀ **Fig. 4. Audio filter board and meter drive circuits**

creasing the value of  $R_4$ , for example, will increase the lift and broaden its effect. In conjunction with the band-pass filter this provides about 10dB lift at 3kHz. Frequency response characteristics for the microphone amplifier are shown in Fig. 2a.

**Tone control**

In addition to providing a flat response over the centre frequency range, the feedback network enables the frequency response to be tilted about 1kHz providing 6dB lift or cut at extremes of rotation (see Fig. 2b). This operation can be explained by reference to Figs 3a and 3b, which show the equivalent circuit at low and high frequencies respectively. Clearly the effect of rotating the slider is reversed so that the signal strength is increased as the wiper approaches the input end, and decreased as the wiper is rotated towards the output end.

**Band pass filter**

The filter has the frequency response characteristics shown in Fig. 2c and consists of two modified Sallen Key type circuits, one connected as a high

pass the other as a low pass. The - 3dB points, which are at 300Hz and 3kHz respectively, each have a roll-off of 18dB/octave thereafter and this was found quite adequate. (An earlier design had roll-offs of 54dB/octave, but this did not provide any additional advantage.) Each circuit has unity gain at 1kHz.

**Metering**

To incorporate some method of monitoring the signals applied to the clipper, the author initially tried a system of i.e.ds, but when no easily viewable arrangement was found he adopted an edge-reading meter. This meter had a pseudo peak readout with a range from 10dB to full scale, which was found to be the normal variation in speech level during communication. Careful voice modulation can keep this down to within a few dB, but certain sounds will produce much higher levels. The 'I' sound for example as in FIVE, will produce a level approaching 10dB above the normal speech level. In normal use the aim is to keep the needle averaging half scale as this will give about 15dB of clipping on normal speech and a little over 20dB on peaks. This appears to provide about optimum readability under all conditions. IC<sub>3</sub> in Fig. 4 operates as a normal voltage amplifier with a gain of  $\times 10$  and the meter relies on this i.c. being able to supply fairly high output currents to quickly charge up  $C_{21}$ . With the input preset correctly adjusted, a signal equivalent to 10dB

below peak will just overcome the forward voltage drop of the diodes, and with a signal equivalent to peak (0dB) the voltage stored on  $C_{21}$  will provide enough current through  $R_{24}$  and the meter to cause full scale deflection. The use of a 100 $\mu$ A movement allows  $C_{21}$  to discharge slowly, permitting meter readings close to the true peak value. In practice the reading is about 3dB low but this can be corrected during setting up.

**Speech clipper**

The r.f. clipper shown in Fig. 5 is divided into four main sections. The crystal-controlled oscillator operates at a little below 10.607250 but the exact frequency can be obtained during setting up and will be within the pulling range of the crystal (in fact a 10.7MHz crystal will pull far enough if one is to hand). It uses the common Colpitts circuit loosely coupled into an emitter follower buffer capable of driving both modular and demodulator with a signal of 1V pk-to-pk. The modulator itself is built around the MC1496 balanced-modulator/demodulator i.c. which receives the local oscillator signal at pin 10 and the audio at pin 1. The output available from pin 6 is a double-sideband, suppressed carrier signal so the signal is filtered to remove one of the sidebands, in this case the lower one.  $R_{38}$  in parallel with  $R_{47}$  and  $C_{34}$  define the optimum impedance the filter should see for correct performance and a similar arrange-

**Fig. 5. Circuit diagram of the r.f. clipper board**

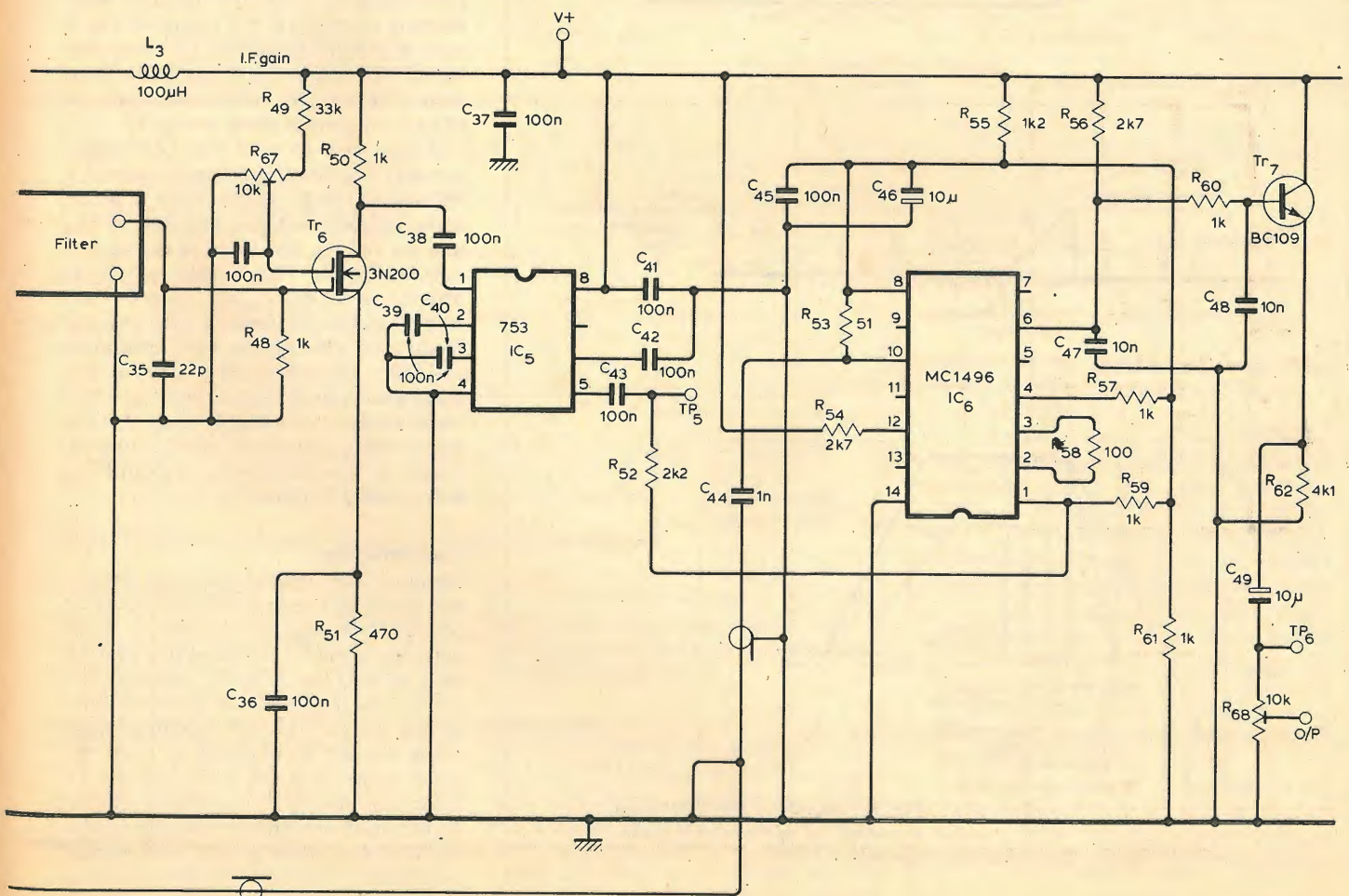

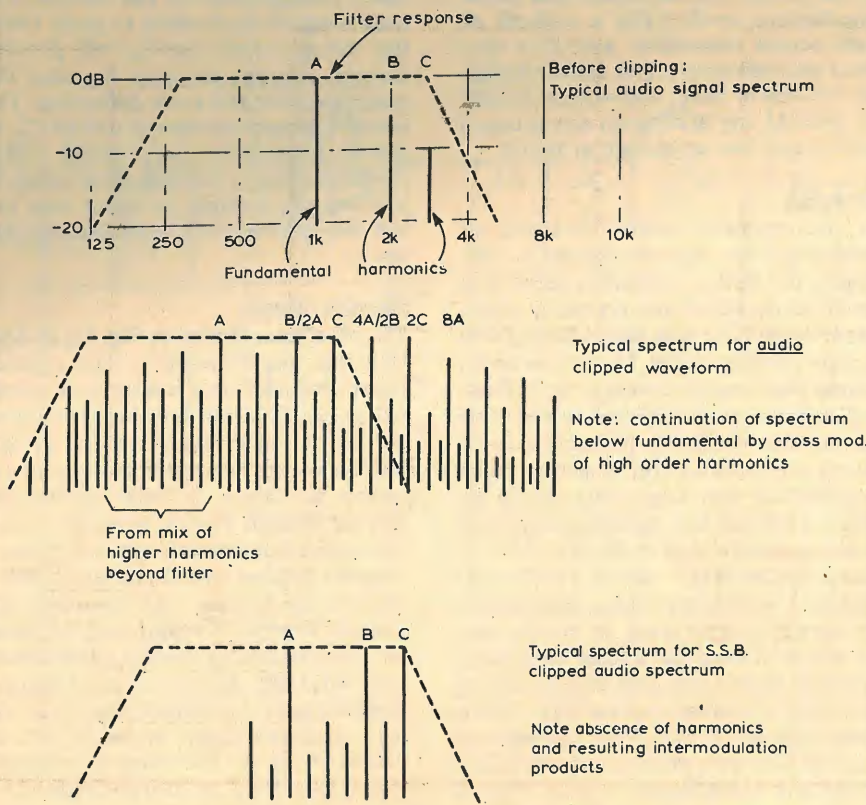

**Fig. 6. Typical frequency spectrum diagrams showing the differences between audio and s.s.b clipping**

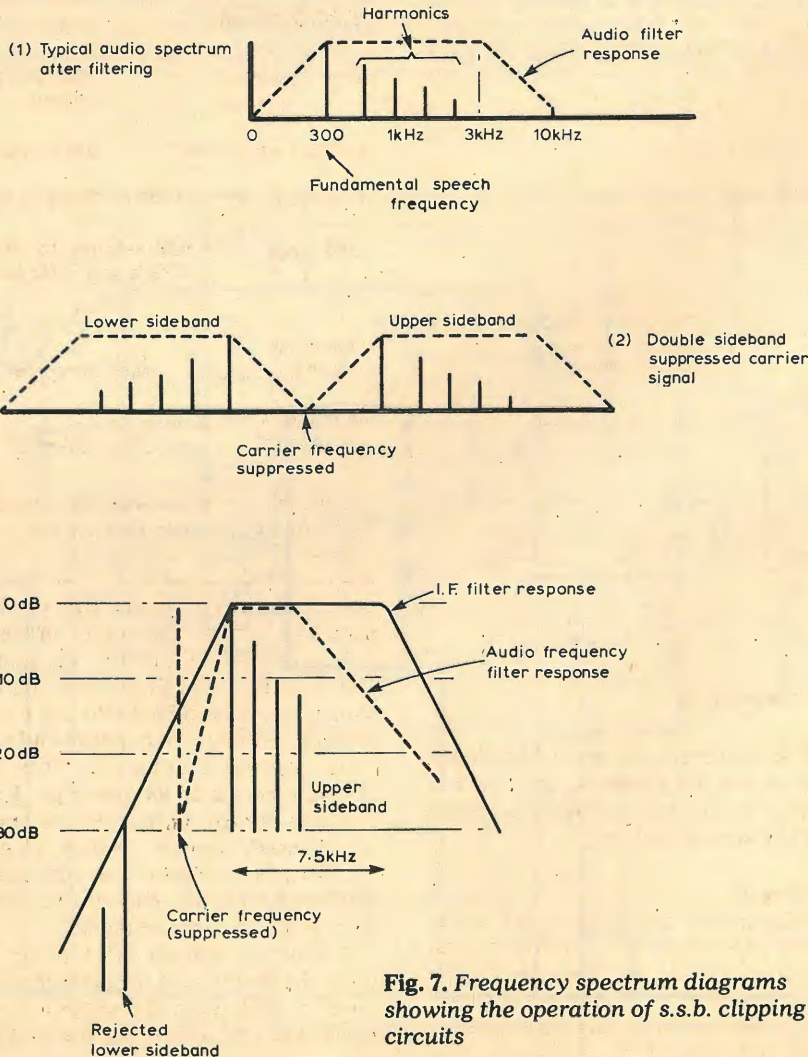

**Fig. 7. Frequency spectrum diagrams showing the operation of s.s.b. clipping circuits**

ment of  $C_{35}$  and  $R_{48}$  terminates the other end ( $910\Omega/22pF$ ). If a different filter is used these components will probably need changing to suit the differing filter requirements but do not alter the value of  $R_{38}$  as this will affect the balance of the modulator.

The filter used was the KVG type XFM 10.7-F61, which was designed primarily for f.m. It has a bandwidth of  $\pm 3.75kHz$  for  $-3dB$  relative to 10.7MHz centre frequency. A filter designed especially for s.s.b. would probably be better, but these tend to be more expensive and are not so readily available on the surplus market. During alignment the oscillator frequency is adjusted so that the upper sideband produced by a modulating signal of 300Hz is placed at the  $-3dB$  point of the filter. This ensures maximum suppression of the other sideband which is only 600Hz lower in frequency and with careful adjustment, 26dB sideband rejection is possible, which is quite adequate. Rejection of the carrier is not so important because the modulator provides about 60dB of suppression at these frequencies when the carrier balance is correctly adjusted. The filter output is then amplified by  $Tr_6$ , a low noise f.e.t., which has provision for gain adjustment and provides a nominal 10dB gain to drive the clipper. The clipping is performed by  $IC_5$ , a device primarily designed for f.m. limiting, i.f. amplifiers, which performs well in this application, suppressing harmonics so that no filtering is necessary. The f.e.t. preamplifier may be omitted if the full 30dB clipping potential is not required. Fig. 6 uses spectrum diagrams to show the basic difference between audio and s.s.b. clipping and further information of s.s.b. clipping is given in Fig. 7.

If you wish to omit the f.e.t. stage, connect  $C_{35}$  only and then connect a  $560\Omega$  resistor in series with a  $0.1\mu F$  capacitor between the live end of  $C_{35}$  and pin 1 of  $IC_5$  (the input of the i.c. is a defined  $300\Omega$ ). The output of  $IC_5$  is attenuated by  $R_{52}$ ,  $R_{59}$  etc., to provide a level suitable for feeding into the demodulator, which is also built around an MC1496. The modulator provides a good quality audio signal with very low noise levels, even with the high i.f. gain.  $R_{66}$  presets the level of the output, which is filtered by  $C_{47}$ ,  $C_{48}$  and  $R_{60}$  before being buffered by  $Tr_7$ .

**Construction**

Layout of the audio board is not critical, and it may be constructed on any circuit board. It is suggested that all leads carrying audio be screened to avoid r.f. pick-up, and that they be connected to the chassis together with the earth lines of the p.c.bs. The microphone input cable should be earthed at both the input socket and the p.c.b. and the r.f. filter, comprising  $C_1$ ,  $C_2$  and  $L_1$ , should be mounted behind the socket and also earthed. Any press-to-talk lines should be similarly earthed and decoupled at the socket;  $0.1\mu F$  capacitors work well.



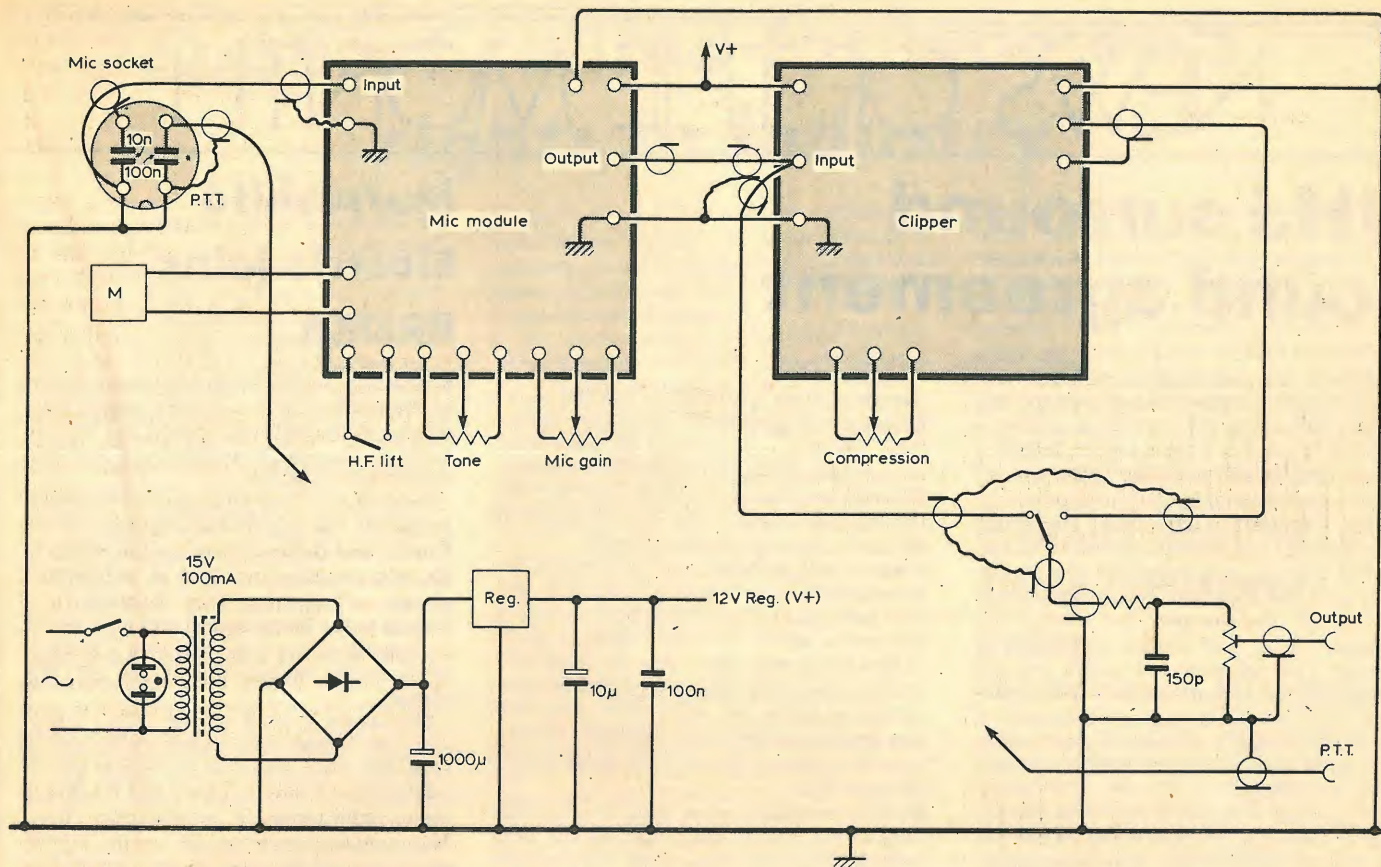

Fig. 8. External connections and power supply details

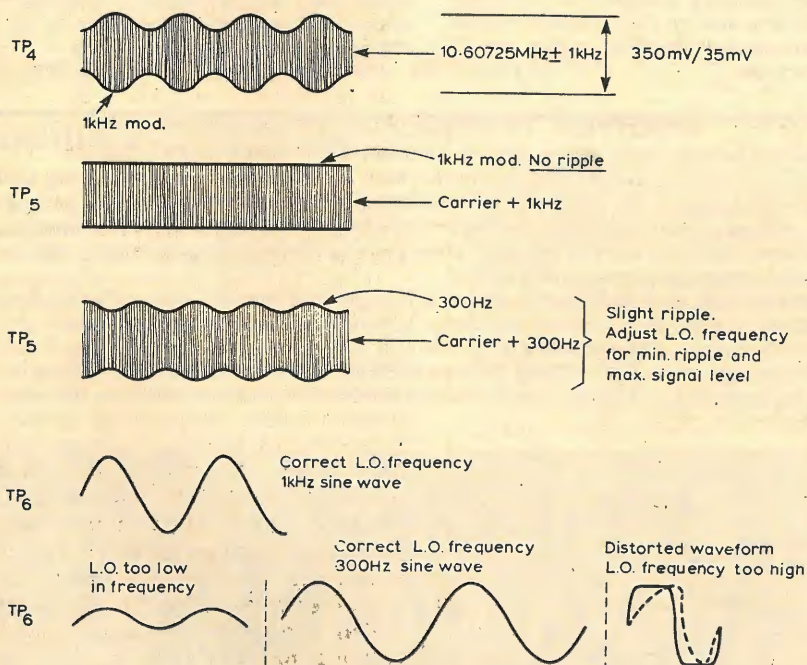

Fig. 9. Waveforms expected during the alignment procedure

If adequate carrier and sideband suppression is to be obtained, the speech clipper module must be laid out on a ground plane and it is also desirable to fit screens where shown. The filter screen should be mounted across the centre of the filter on the track side between the input and output pins, and be solidly bolted under the fixing bolts of the filter. Preferably, the whole unit should be built into a metal screened enclosure to avoid r.f. pick-up which can cause howl-round problems, when

all of the controls are set at high level. Fig. 8 shows the power supply used in the original unit, but any well-smoothed 12 to 15V supply will do.

**Alignment**

The alignment procedures are quite simple and require an audio signal generator and an oscilloscope with a 10MHz bandwidth. First inject a 10mV, 1kHz sinewave into the microphone socket and observe the output at TP2. Set the tone control to centre, switch off

**Specifications**

|                              |   |
|------------------------------|---|
| INPUT sensitivity            | 100µV to 10mV   |
| overload                     | 100mV   |
| OUTPUT adjustment            | 0 to 50mV   |
| High freq. lift              | 10dB at 3kHz (see Fig. 2a)                            |
| TONE range                   | ±6dB relative to 1kHz at 300Hz and 3kHz (see Fig. 2c) |
| MAXIMUM COMPRESSION          | 30dB, but set for 20dB                                |
| FREQUENCY RANGE              | Limited to 300Hz — 3kHz (—3dB) (see Fig. 2c)          |
| SIGNAL TO NOISE RATIO OUTPUT | 60dB with full compression, mic. gain mid-way         |

and adjust the mic. gain for 1V pk-to-pk. Secondly, adjust the meter preset for full scale reading. Set the sig. gen. for 10mV, 3KHz. Switch on, and the trace should increase to 3V pk-to-pk (+10dB). Restore switch to off position and rotate tone control clockwise. The trace should increase to 2V pk-to-pk. Rotate the tone control anticlockwise and the trace should reduce to 0.5V pk-to-pk (+6dB). Next reset the sig. gen. to 300Hz and repeat; the control should now produce opposite results.

Set the sig. gen. to 1kHz, meter f.s.d. (as in the first part of the procedure) and monitor TP4. Turn the clipper drive to maximum and adjust R<sub>65</sub> for 35mV pk-

*continued on page 62*

# NEWS OF THE MONTH

## UHJ surround sound agreement

Agreement has just been reached between Duane Cooper, of the University of Illinois, Nippon Columbia Co. of Tokyo, and the National Research Development Corporation for patent and licensing rights in surround sound technology. The assignment of Duane Cooper's portfolio of surround sound patents and patent applications to the NRDC, follows the informal statement reported in our June 1977 issue (page 46) that agreement "in principle" had been made between NRDC and Nippon Columbia, to provide a kernel surround sound system, combining the attributes of the NRDC ambisonic psychoacoustic research with that of UD-4 technology. A US patent interference was partly responsible for holding up this latest agreement.

The pooling of interests may ease acceptance of ambisonic technology by the recording industry, which still remembers public resistance to the quadrasonic approach. One UK record company, Nimbus Records of Monmouth, has already issued 16 two-channel UHJ recordings, and according to the co-director Gerald Reynolds a further 12 will be issued later this year made with the

Gerzon/Calrec sound-field microphone. Actually, the agreement covers only equipment licensing — recordings are a separate issue — but it's ironic that Nippon Columbia Co. were just beaten to the post by JVC for the Japanese rights to the Nimbus material (though only in two-channel form)!

But it will probably take acceptance internationally by such bodies as the FCC and EBU before major record companies commit themselves again. The tragic death recently of Ben Bauer may mean that the rival USQ multichannel proposals, scheduled for presentation at the last AES convention, will lose momentum and thus consolidate a swing in UHJs favour — in the most unfavourable way possible.

● System UHJ is more than the tactical compromise announced jointly by the BBC and NRDC (page 77, December 1977 issue) as HJ, which the BBC optimized with a bias toward mono compatibility. System UHJ is a universal encoding standard for all directions, for two, three or four channels, whose basic two channel signals fall within the HJ tolerance zones. □

## Matsushita Electric joins BREMA

Matsushita Electric (UK) Ltd, which is part of Matsushita Electric, Japan's largest electronics manufacturer, joined the British Radio Equipment Manufacturers' Association (BREMA) on July 1.

Brian Reilly, the chairman of National Panasonic UK and former chairman of the Finance and General Purposes committee of BREMA, described the move as "recognition of the contribution that Matsushita is making to the British electronics business by its manufacturing presence here". Brian is representing Matsushita on the BREMA council.

Matsushita started making colour television sets at Pentwyn, Cardiff at the end of 1976, and now produces Panasonic colour televisions, music centres and Technics stereo radio tuners in two factories there. The company employs 380 people and in addition to substituting imports, generating exports, and introducing new technology, has pursued a policy of sourcing as many components within Britain as possible. Its colour televisions, for example, have up to 72% of British components by value. □

## Phone cable between UK and USA gets go-ahead

A new telephone cable between Britain and the USA, that will increase transatlantic telephone cable links by more than 50%, has been given international go-ahead. Having a capacity of more than 4000 calls at any one time, the £100 million undersea link will carry phone calls, computer data and telex between Europe, America and Canada.

Throughout the 1970's, the demand for telephone services between Britain and America has been growing by 15 to 20% per year and this shows no signs of slowing up. At present, more than 20 million phone calls are made each year between the two countries and more than half of these go by cable. The new system, which is known as TAT 7, because it is the seventh in a series of telephone cables between Europe and America dating back to 1956, will be manufactured by the USA, Britain and France. It is due to come into service in 1983 and will run some 3,400 nautical miles from Sennen Cove, Land's End, to Tuckerton, New Jersey.

The international agreement was reached at a conference in Brighton of the British Post Office and 23 other organisations who are participating in the project. Although the cost is being shared equally between Europe and America, Britain is paying the largest (22%) share of the European half. There are 16 other participants partnering Britain in this half of the project. □

*On April 22 an amateur radio station aboard the Queen Mary, which is now a floating restaurant in America, was dedicated to provide public service communications to Long Beach and Southern California. The ship's original wireless room has been rebuilt and now includes amateur radio equipment in addition to the former radio gear. Volunteer operators, wearing uniforms similar to those worn by the ship's crew years ago are manning the station, call-sign W6RO, daily spreading international goodwill.*

*In case of disaster, such as an earthquake, it is thought that the ship would suffer no damage and could use its generators to power the station to handle welfare messages in traditional amateur radio fashion. The organisers have arranged with the Red Cross and the city of Long Beach for messages to be given to local libraries for transmission to the ship by amateurs using portable battery-operated transceivers. Scheduled contracts with British amateurs have been arranged.*



# Support rallied for women's rights in industry

In industry, normal business pressures tend to take priority over such things as equal opportunities promotion and as a result the segregation of jobs into men's and women's work is still widespread, according to a survey by the Equal Opportunities Commission (EOC). However, it seems that Britain is not alone in this. When the European Communities Commission (ECC) reported recently on how its nine (now ten) member countries were implementing the community equal policy for men and women (EEC background reports ISEC/B53/78 and ISEC/B8/79), it found that in all of the countries practice fell short of principle.

The aim of the EOC survey, carried out during 1977 and early 1978, was to enable the Opportunities Committee to identify problems and priorities and to encourage the development of good practices. Many companies regarded positive action towards equal opportunities as unnecessary and costly and only a few were given praise in the survey report. Only a quarter had actually written out equal opportunity policies and less than half had analysed their workforce by sex. Although flexible working hours were quite common amongst the white-collar workers, part-time work and child care facilities were not widespread.

The EOC consider that an analysis of possibilities for part-time work, including costings, should be carried out, and that it is vital that firms take positive action to move away from job segregation.

The commissioner responsible for the ECC's equal pay policy for men and women, Mr Vredling, decided in March to start infringement proceedings under the Rome Treaty against those member states whose national legislation fell short of the ECC directives on equal pay, equal access to employment, training and promotion. The Commission then sent letters to the governments asking them to submit their comments on the infringements within 60 days, and it is giving them a specified period of time to either confirm the ECC's opinions or face the Court Justice.

Letters have been sent to Germany, Belgium, Denmark, France, Luxembourg, the Netherlands and the United Kingdom. The ECC consider that the UK's legislation does not conform because "the concept of work of equivalent value seems to be given a restrictive interpretation of the Equal Pay Act". A worker may only request equal pay for equivalent work if a job evaluation scheme is not practised in the firm in which he or she is employed. An ECC report says that the

British government has maintained that the Equal Pay Act of 1970 and the Sex Discrimination Act of 1975 fully comply with ECC legislation against sex discrimination but there is a strong body of opinion that believes that, in present circumstances where only 25% of firms operate job evaluation schemes, British law has loopholes which militate against women workers when it comes to an evaluation of 'equivalent values'. This body believes that the broader ECC legislation ensures a fairer system. □

## Product liability cloud has silver lining

Dr. D. W. Budworth, deputy director of company affairs at the Confederation of British Industry (CBI), addressing the conference on "prospective laws on liability for defective products" at the Institution of Electrical Engineers in London on May 30, said that manufacturers should capitalize on product liability legislation (see p47, Jan. 1979 issue) by making safer products and thus winning a larger market share. He thought that if this approach was taken some good might come out of it for both industry and society.

Dr Budworth criticized the European Economic Community, from whom the main drive for product liability legislation was coming, and suggested that their current proposals were commercially unacceptable, grossly unfair, and incomplete. The EEC draft convention, according to an IEE account, says that the producer of a product is liable even if the product could not have been seen to be defective with the science and technology available at the time of manufacture. "The CBI feels this opens up the manufacturer to being held liable for unknowable defects", said Dr Budworth, "this is taking things too far. Nothing is completely safe, but the public fails to appreciate this fact." He then warned that liability was limited by the resources at the manufacturers' disposal. There was, for example, a limit to the insurance cover available, and at present this was £250,000, so industry had a limited capacity to pay. However, nothing was likely to happen for several years because it was impossible to get domestic legislation in less than two years, and it would probably take longer than that.

Giving the consumers' case, Maurice Healey of the National Consumer Council, and a former editor of *Which* said that it was the NCC's belief that liability should rest with the manufacturer of the goods because he was in the best position to ensure the quality and safety of the product. They thought it right that the added cost of insurance be borne by consumers, but that the costs would be small. For the average engineering company, costs would be doubled if the current proposals went ahead, he said, but since current insurance premiums costed only 0.1% of turnover this would rise to only 0.2%. □

## European consumer electronic manufacturers association formed

With the election of the European Parliament, representatives of the National Associations of European Consumer Electronic Manufacturers (of which BREMA is a member) have created, from amongst their own associations, a European Association of Consumer Electronic Manufacturers (EACEM).

Today, the domestic consumer electronics industries are mainly concerned with the assembly of equipments widely used for entertainment and cultural purposes. In the future, however, they will also be concerned with processes, materials, equipment and systems which use domestic tv receivers as home terminals for the display of data. To achieve this, according to the EACEM, the industries must have "strong links, both in research and development, with their allied electronics sectors in telecommunications, information services and, above all, in the components industry."

Within the EACEM there is a Council which has the duty to nominate a Chairman and Vice-Chairman, whose terms of office last no more than three years, and a Secretariat, staffed by the national professional organisation belonging to the country from which the EACEM Chairman comes. There is also a Technical Advisory Committee, which is qualified in standardization and safety and works with the appropriate national and international organisations. An Economics and Statistics Advisory Committee has the job of establishing, in consultation with the professional associations of the EACEM and their national and international administrations, an annual document recording the

final results of market data on the production of brown goods of the EEC members, and to record details of the imports and exports of these equipments to the EEC member's countries.

At its inaugural meeting in April, the EACEM elected for two years, the Chairman, Monsieur Jacques Fayard, Administration Director of Thomas Brandt, Director General of Groupe Grand Public de Cette Societe since 1973 and past president of SCART (one of the French National Association members) and the Vice Chairman, Doctor R. Koeberle, Director of the SABA Society and Vice President of the Fachverband Unterhaltungselektronik im ZVEI, the German National Association member. During these two years the Secretariat will be established in France. □

## Marconi to make tv monitors

Marconi Communications Systems Ltd has agreed with EMI to take over manufacture of the range of colour and black-and-white tv monitors previously made by EMI/Prowest. This means that the company, who will start making these products and a number of video switching accessories at their Chelmsford factory in the near future, will then be able to offer a complete package of studio equipment from its own manufacture.

The range of products, which is well known throughout the broadcasting world for its quality and reliability, includes 35cm and 50cm colour units and a series of black-and-white monitors. □

## Work on tv subtitling for the deaf continues

In the October 1978 issue of *Wireless World* we described the work being carried out by the IBA into tv subtitling for the deaf. Dr Alan Newell, of the Department of Electronics at Southampton University is conducting research into the possibility of using teletext for this purpose and is now working under a three-year contract between the IBA and the university. Robert Baker, who is a research fellow assisting Dr Newell, recently sent a report about their work to the Royal National Institute for the Deaf.

In his report, Mr Baker said that although the tv decoders needed to receive pages of teletext were still expensive, they had good reason to believe that prices would soon fall. They hoped that research would contribute to a greater availability of teletext decoders by increasing public awareness of the many possibilities of teletext in general and of the value of subtitles for the deaf in particular. Their research was being carried out along three main lines. Firstly, they were sending out questionnaires to determine what programmes deaf and hard of hearing people watch on television — that is, the most popular ones and why. They wanted this

information because they hoped to be able to show a few real-life tv broadcasts with subtitles in the near future, and they wanted to be sure that they appeared on programmes that deaf people watched already. In addition, they wished to know which programmes would benefit most by having subtitles.

The research team's second line of approach was to make careful and detailed studies of the best way to present subtitles on the tv screen. To determine, for example, on which part of the screen they should appear, what kind of background they should have, how many words that should be shown on the screen at any one time, and whether they should stick to short uncomplicated sentences, or show every word that was said. Mr Baker then pointed out that the viewer should be able to read the necessary information and still see the action on the screen.

The third line of research was to investigate the more subtle aspects of tv subtitling, such as how to indicate offstage voices and noises or how to keep the subtitle clear of a football during soccer presentations.

## MPs form committee for personal radio service

An all-party committee of MPs was set up during June to put pressure on the government to introduce a personal radio service. The chairman of the committee, Tory MP Patrick Wall, said that they would not use 27MHz but would choose an operating frequency which would not interfere with radio-controlled models, tv or radio amateurs. The committee now intends to hold another meeting this month in the House of Commons to take its proposals to the Home Secretary, William Whitelaw.

The last words from the Commons apparently came from Mr Timothy Raison, the Home Office minister in charge of radio regulation, who said that the arguments in favour of c.b. have some merit but its introduction would bring regulatory, social, economic and administrative problems in its train — very similar to the last government's standard reply to pro-CBers (see p71, Sept. 1978 issue).

Mr Wall's views seem to follow very closely those of the Citizen's Band Association president, James Bryant, who is undoubtedly the most prominent pro-CBer to date. Mr Bryant's views (see p65, April 1979 issue), be they right or wrong, have now become quite popular, due mainly to his own efforts. James Bryant, however, does not agree with Mr Wall's suggestion that it will take one or two years to legalise a personal radio service. In his opinion it is not necessary to change the law; all that is needed he says, is a few minor changes to the Wireless Telegraphy Act and an agreement with the Post Office to a general breach in its monopoly.

Although Mr Wall was not prepared to say

what frequency band the committee would be recommending, it is thought that they will be working roughly along the same lines as the NEC report published in the May/June 1978 issue of the *National Electronics Review* (see p38, August 1978 issue).

Labour MP and tv personality, Austin Mitchell is the vice chairman of the committee and the secretary is Tory MP John Butcher.

● The early morning raids which were carried out by police and government officials on the homes of people illegally operating personal radios in Birmingham, UK, seem to have given some people the idea that the city is a national centre for these law breakers. We do not think so. Birmingham is only one of many large cities which has, according to the Citizen's Band Association, thousands of illegal operators (see p65, April 1979 issue).

The last government, and it seems the new government too, have and do clamp down very hard on offenders — as if it was something far more serious — and if a nucleus of these offenders are discovered then raids of this kind are only to be expected. Since the law says that the illegal operator must be caught in the act, the raid must take place when the offence is being committed, whether it be early morning or not.

If the authorities were as keen to stop muggers and rapists (and we were not the first to make this comparison, see "C.B. communications likened to robbery, plunder and rape, p47, July 1978 issue) people would be a lot safer on the streets — especially first thing in the morning.

## Ariel VI (UK-6)

now in earth orbit

Britain's scientific satellite, Ariel VI, which went under the pre-orbit name UK-6, was successfully launched into earth orbit on June 3 (at 23.26 GMT) from the National Aeronautics and Space Administration (NASA) Flight Centre at Wallops Island, Virginia. The satellite was financed by the Science Research Council and was designed, built and tested by Marconi Space and Defence Systems Ltd. British Aerospace Dynamics Group at Bristol, under contract to Marconi Space and Defence systems Ltd, designed and built the satellite's structure, including the body, deployable booms and outer sphere of one of the experiments. The mechanical ground support equipment was also designed and built at Bristol.

The satellite's purpose is to carry out studies of the charge and energy spectra of cosmic radiation, which can give an insight into the conditions of the source and the processes of nucleosynthesis that have occurred in high energy objects. This sort of information is important to scientists because cosmic rays are the only sample that they can get of matter which lies outside the solar system. Information gained from the mission should provide a better understanding of astrophysical phenomena that involve large energy densities and their high-energy products, such as quasars, radio galaxies, supernovae and pulsars.

Ariel VI carries three primary science instruments: a cosmic ray detector, for Bristol University, and two X-ray astronomy experiments, one for Leicester University and the other for Birmingham University and the University College of London's Mullard Space Science Laboratory. Also on board are two technological experiments for the Royal Aircraft Establishment at Farnborough, which will investigate the performance of new types of solar cells and of metal oxide semiconductor devices in a space environment.

## Girl technician engineer of the year

The second competition by the Caroline Haslett Memorial Trust and the IEETE to find the Girl Technician Engineer of the year is to be held this year. A prize of £250 will go to the girl who will have successfully undertaken the necessary technical education and training, and have proved herself capable of holding a responsible job. The award sponsors hope that she will, by her example, encourage more girls to enter the electrical and electronic engineering profession. The IEETE gives the closing date for nominations as September 19, and they say that the winner will be announced in November.

### Spot frequency distortion meter — correction

In Fig. 4 of this article, which appeared in our July 1979 issue, the BC214C (first transistor of the input amplifier) should be shown as 'Tr<sub>1</sub>' and the gate and source connections of Tr<sub>2</sub> should be shown connected together. The figure for residual distortion (0.001%) shown at the foot of p64, col. 1, should read '0.0001%'.

# No radio without displacement current

An aid to understanding Maxwell's equations for wave propagation

by D. A. Bell, M.A., B.Sc., Ph.D., F.Inst.P., F.I.E.E.

"Faraday's conception of electric and magnetic force and their interrelations, expressed in terms of his lines of force, were fundamental. In terms of them James Clerk Maxwell developed the equations that underlie all modern theories of electromagnetic phenomena."  
*Encyclopedia Britannica.*

BECAUSE displacement current forms a vital link in Maxwell's equations for wave propagation in empty space, text books often give the impression that Maxwell invented displacement current as a kind of mathematical trick to make his equations work. This is not so. In his two-volume *Electricity and Magnetism*, displacement current appears first on p.65 in volume 1, in the part dealing with electrostatics, and the idea follows from Faraday's work on lines of force. It is easy enough to think of electric and magnetic fields as stresses in a tangible medium such as insulating material or iron, but what happens when the material medium is replaced by a vacuum, leaving the fields 'hanging in space'? We no longer believe in an all-pervading ether, yet experience has long shown that light from the stars travels freely through space which is practically empty and now radio waves travel back to the earth from a vehicle which is near Jupiter. So it seems that we must accept that electromagnetic fields can exist in empty space.

But has something been slipped through in the last sentence? How did electric and magnetic fields come to be replaced by electromagnetic fields? Of course it was Maxwell who transformed "electricity and magnetism" into "electromagnetism" by setting out four equations which link together to form a closed cycle of electric field - magnetic field - electric field . . . and so on, continuing for ever as radiation if no conductors get in the way. Looked at from the experimental viewpoint, the most basic factor is electric charge, which usually is associated with a number of electrons (negative charge) or of protons (positive charge). A charge in steady motion constitutes a current, which produces a steady magnetic field. With varying motion a varying current produces a varying magnetic field which acts on an electric charge like an electric field. This looks

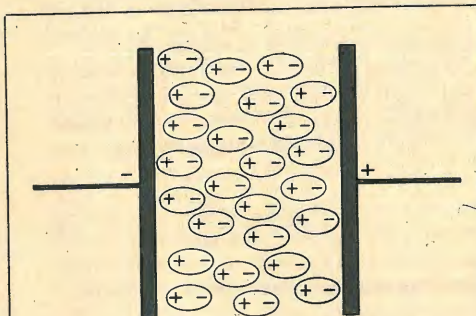

Fig. 1. Displacement of molecular charges in the dielectric of a capacitor.

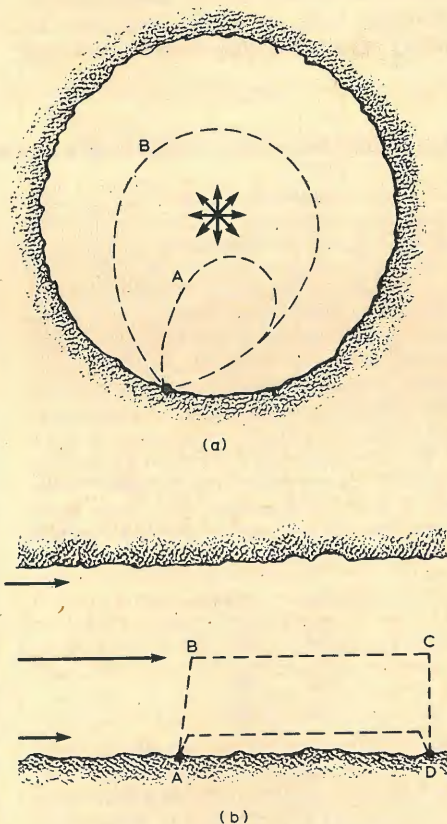

Fig. 2. (a) Water flowing outward from a spring, to illustrate a vector with divergence but no curl. No work is done in traversing a closed path. (b) River with faster flow in the middle to illustrate curl. Work is done in traversing a closed path which encloses an area.

like a closed cycle, but it involves electric charge so it will not do for the propagation of electromagnetic waves in empty space where there is no charge.

Maxwell was able to solve this problem because he was at home with the mathematics of vectors (which we will look at cautiously a little later) and he used the idea of 'displacement current' to show how electromagnetic waves could be propagated through empty space. Although Maxwell used the idea in his famous equations, he did not invent it for this purpose but rather to rationalise the circuit behaviour of a capacitor. If the capacitor has a material dielectric the picture is very simple, Fig. 1. When a positive potential is applied to the right-hand plate, all polarisable molecules have their negative parts pulled to the right and positive parts repelled to the left. Maxwell pointed out that this very definitely constitutes an electric current since it is a movement of charges, although it is not a steady flow of charges, as in a conductor or in an electron beam, but a displacement of charges from their normal positions, so it is called a displacement current. Note that as the charges are moved against an 'elastic' force the displacement of the charges is proportional to the electric field between the capacitor plates, and therefore to the applied potential; but the displacement current is proportional to the rate of change of electric field.

But now take away the dielectric, as for example in a vacuum capacitor. There are no polarisable molecules to produce a tangible displacement current, but as far as any circuit properties are concerned there is no different kind of capacitance (apart from dielectric loss and breakdown strength). So displacement current is still said to flow, in proportion to the rate of change of electric field. But with nothing to displace, is this displacement current real? The test is whether it produces a magnetic field, and the existence of electromagnetic waves in empty space is proof that it does.\*

\*The need for displacement current in the dielectric (possibly vacuum) of a capacitor in order to satisfy the laws of static magnetic fields is given in Ramo, Whinnery and Van Duzer, *Fields and Waves in Communication Electronics*, Wiley (1965), pp. 232-3.

Admittedly this implies faith in the results of Maxwell's equations, but surely no reader of *Wireless World* will doubt that electromagnetic waves (radio waves, light) can travel through a vacuum. Incidentally, we can now demonstrate directly that light waves are electromagnetic, by letting the focused beam of a high-power laser produce a spark in air. So if electromagnetic waves could not travel through empty space the world would be cold and dark because no radiation could reach us from the sun.

To understand why there are four of Maxwell's equations, we must look at the properties of vectors to see why we need two equations concerned with the electric field and two for the magnetic field. Most of the mathematics of vectors was worked out in the first place for hydrodynamics, with pressure and velocity of flow as the important vectors, so we need not hesitate to use hydraulic models to illustrate the properties of vectors, and in particular divergence and curl.

Divergence means simply "spreading out" and is an attribute of a vector field around a source—water flow around a spring or electric field around a charge. Imagine a pond having a spring at its centre so that water flows outwards in all directions, as indicated by the arrows in Fig. 2(a). Then a floating object may be moved along the closed path A, towards the spring and back, or along the path B which goes round the spring, or round by other closed path, without any net work being done.

Next consider a river which flows faster in the middle than near the banks, as suggested by the lengths of the arrows in Figure 2(b). In order to travel by water from point A to point D and back, the clever oarsman will row out to mid-stream so as to get the help of the current from B to C but will return from D to A close to the bank where the current is less. The work done by the vector field (the flow of water in this case) is proportional to the area enclosed so long as the flow pattern is uniform within the area, and the coefficient by which one can relate 'work done' to 'area enclosed' is the curl of the vector.<sup>†</sup>

Now in general a vector may have both divergence (abbreviated as div) and curl so that two equations are needed to specify a vector fully; and so with two vectors, electric and magnetic, Maxwell needed four equations. A complication is that it is common to split each of the two vectors into 'force' and 'flux' vectors, as with magnetomotive force  $H$  (oersted or ampere/metre) and magnetic flux  $B$  (gauss or tesla). But for a linear isotropic medium (which empty space certainly is) the

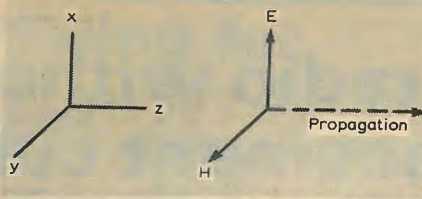

Fig. 3. System of axes for plane wave propagating in the z direction.

relationship within each pair is simply multiplication by a constant, so we will simplify the equations by using only  $E$ ,  $B$ , dielectric constant  $\epsilon$  and magnetic permeability  $\mu$ . Then the electric vector is defined by the two equations

$$\begin{aligned} \text{div } E &= \rho \\ \text{curl } E &= -\frac{dB}{dt} \end{aligned} \quad (1)$$

and the magnetic vector by

$$\begin{aligned} \text{div } B &= 0 \\ \text{curl } B &= \mu \left( J + \epsilon \frac{dE}{dt} \right) \end{aligned} \quad (2)$$

Here  $\rho$  is the charge density and  $J$  the density of current due to movement of charges, both of which are zero in empty space. So Maxwell's equations

for empty space reduce to

$$\begin{aligned} \text{div } E &= 0 \\ \text{curl } E &= -\frac{dB}{dt} \\ \text{div } B &= 0 \\ \text{curl } B &= \mu \epsilon \frac{dE}{dt} \end{aligned}$$

Since curl corresponds to a particular kind of space variation of the vector (compare Fig. 2(b)), the second and fourth of these equations say that the space variation of  $E$  depends on the time variation of  $B$  and the space variation of  $B$  depends on the time variation of  $E$ . Given expertise in the mathematical manipulation of vector differentiations, it is possible to treat these two as a pair of simultaneous equations which can be solved for  $E$  and  $B$ . (The simplest case, avoiding the use of vectors, is solved in the Appendix.) Since  $E$  and  $B$  vary both in space and time it should not be surprising that the solutions are propagating waves, with a velocity of propagation equal to  $1/\sqrt{\mu\epsilon}$ . But this result is only obtained through the existence of displacement current, without which the right-hand side of the fourth equation would be zero and neither  $E$  nor  $B$  could propagate: no radio waves without displacement current.

### Appendix: Solution of Maxwell's equations for plane waves

The vector equations (3) are true for any shape of wave (plane, cylindrical, spherical) depending on the boundary conditions, which in practice means the way in which the waves are launched. Solution of the vector equations shows that for any shape the vectors  $E$  and  $B$  are at right-angles to each other and to the direction of propagation. Having established this, one can take as a special case a plane wave propagating in the  $z$  direction with  $E$  in the  $x$  direction and  $B$  in the  $y$  direction; and if the wave is of infinite extent in the  $x$ - $y$  plane, the only space variation is in the  $z$  direction. The vector equations from (3) can then be reduced to simple differential equations:

$$\frac{dE}{dz} = -\frac{dB}{dt} \quad (i)$$

$$-\frac{dB}{dz} = \mu \epsilon \frac{dE}{dt} \quad (ii)$$

(The negative sign on the left of (ii) arises from the directional relationships implicit in the full vector equations.) Now differentiate (i) with respect to  $z$  and (ii) with respect to  $t$ :

$$\frac{d^2E}{dz^2} = -\frac{d^2B}{dzdt}$$

$$-\frac{d^2B}{dzdt} = \mu \epsilon \frac{d^2E}{dt^2}$$

$$\frac{d^2E}{dz^2} = \mu \epsilon \frac{d^2E}{dt^2}$$

This is the differential equation of a sinusoidal propagating wave of the general form

$$E = A \sin[\omega(t - cz) + \phi] \quad (iii)$$

where the velocity of propagation is  $c = 1/\sqrt{\mu\epsilon}$  and the arbitrary phase constant  $\phi$  depends on the placing of the origin of the time scale. A similar result is obtained for  $B$  by eliminating  $E$  between (i) and (ii). But we still have to satisfy the individual equations, which need a particular ratio between  $E$  and  $B$ . However, it is usual to express this in terms of  $H = B/\mu$  and it is then found to be

$$\frac{E}{H} = \sqrt{\frac{\mu}{\epsilon}}$$

This ratio, which has the value  $120\pi$  for empty space, is often called the intrinsic impedance of the medium, by analogy with the characteristic impedance  $\sqrt{L/C}$  of a transmission line. It is a characteristic of the medium in which the waves are propagated, and independent of the shape of the waves.

Professor David Bell, who joined the University of Hull in 1965 to set up its Department of Electronic Engineering, retired in September 1978. From 1949 to 1961 he was Reader in Electromagnetism in the electrical engineering department of Birmingham University, and thereafter till 1965 he was the director of AMF British Research Laboratory. He has contributed widely to the learned journals and has been writing for *Wireless World* throughout his career.

<sup>†</sup>More exactly, the line integral around the path of the force is equal to the surface integral over the area enclosed of the curl of the relevant vector.

# Converting between analogue and digital quantities

More analogue-to-digital conversion techniques

by G. B. Clayton, B.Sc., Liverpool Polytechnic

The a.-to-d. conversion techniques described in the previous sections give a digital output which depends upon the value of the analogue input signal existing at some precise instant in time, and their output is thus affected by the presence of noise on the analogue input signal. A variety of conversion techniques has been developed in which the digital output depends upon the integral or average value of the analogue input signal during some prescribed time interval.

**INTEGRATING TECHNIQUES** have the advantage of giving repeatable results even in the presence of high frequency noise on the analogue input signal. The effect is averaged out, provided that the noise frequencies present are such that  $1/f_n < T$ , where  $T$  is the integration period.

Monolithic i.c. devices suitable for the implementation of integrating a.-to-d. converters are available from several manufacturers; they are comparatively inexpensive yet, nevertheless, can provide very accurate conversion. Their main disadvantage when compared with the techniques discussed previously is their much longer conversion time.

Presently-available integrating converters fall into two categories; those which employ the so-called dual-slope technique and those which employ the quantized feedback method to perform a conversion. The dual-slope technique is the simpler in concept and implementation, and has been the preferred integrating conversion method for a number of years. Quantized-feedback converters are comparative newcomers, and in some applications provide several advantages over the older, dual-slope techniques.

### Dual-slope conversion

The operating principles involved in a basic dual-slope conversion may be understood by reference to the simplified circuit schematic in Fig. 22. It is a two-stage process; in the first stage, an analogue integrator, whose output has been previously reset to zero, has the analogue signal which is to be converted connected as its input signal. The input signal is integrated for a fixed time interval  $T_i$  and if it remains constant during this time the output of the integrator is a linear ramp.

The second stage of the process commences at the end of the time interval  $T_i$ , at which instant the control logic disconnects the analogue input signal and connects a reference voltage in its place as the integrator input. The reference voltage polarity is opposite to that of the analogue input signal, and makes the integrator output fall linearly, a comparator being used to sense when it reaches zero. The time taken ( $T_r$ ) for integration of the reference to bring the output back to zero is directly proportional to the average value of the analogue input signal during the interval  $T_i$ .

The time interval  $T_i$  is the time during which a fixed number of clock pulses

are counted  $T_i = N_i T_c$ , where  $T_c$  is the clock period and  $N_i$  is normally taken as the number of pulses which are required to fill and recycle the counter. The time interval  $T_r$  is measured in terms of the number of clock pulses counted in the time  $T_r = N_r T_c$ . During the 'integrate-signal' stage the output of the integrator changes by an amount:

$$V = \frac{1}{CR} \int_0^{T_i} V_{in} dt$$

where  $V_{in}$  is the analogue input signal. During the integrate-reference stage

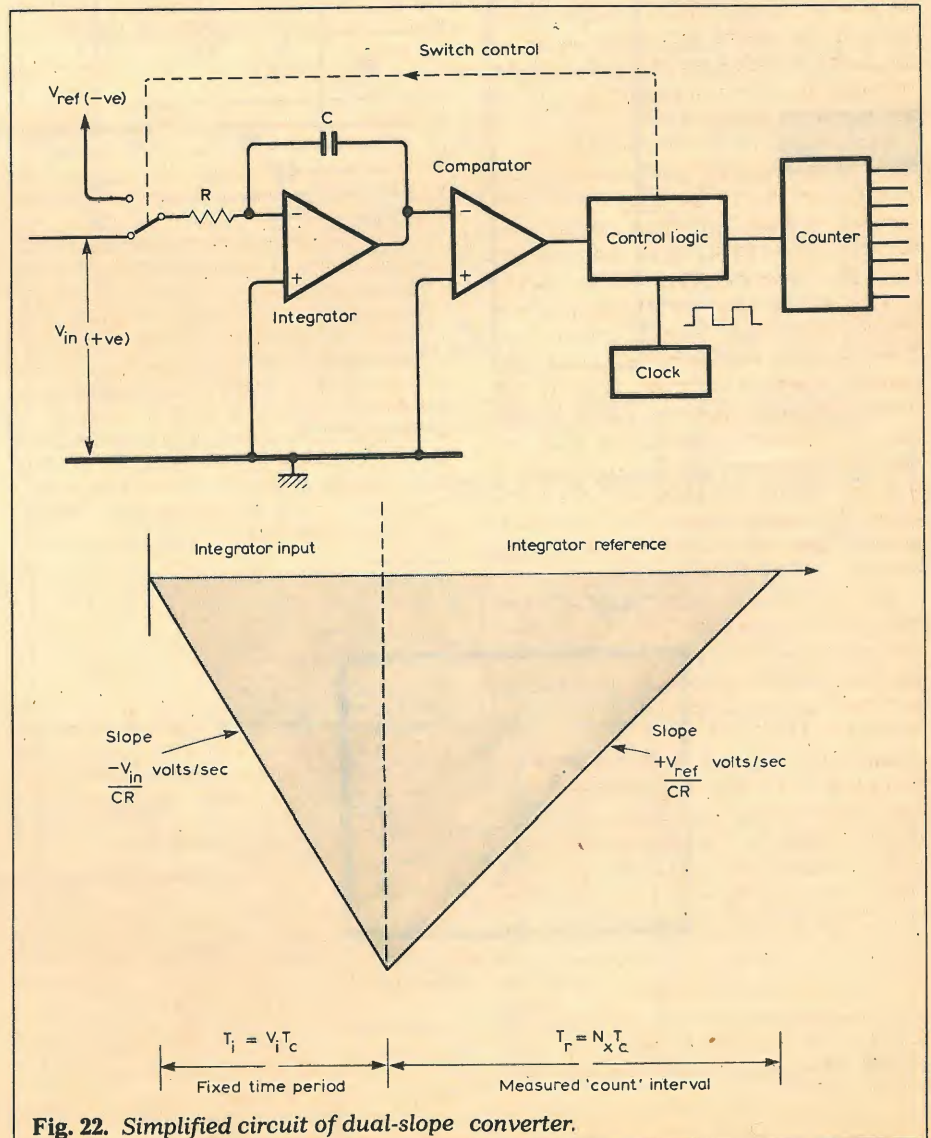

Fig. 22. Simplified circuit of dual-slope converter.

the output of the integrator is returned to zero.

Thus,

$$\frac{1}{CR} \int_0^{T_i} V_{in} dt - \frac{1}{CR} \int_0^{T_r} V_{ref} \cdot dt = 0.$$

Substituting  $T_i = N_i T_c$  and  $T_r = N_x T_c$  and re-arranging gives:

$$N_x = \frac{N_i}{V_{ref}} \times \frac{\int_0^{N_i T_c} V_{in} dt}{N_i T_c}$$

or

$$N_x = \frac{N_i}{V_{ref}} \cdot V_{in} \quad (14)$$

where  $V_{in}$  is the average value of the analogue input signal during the 'signal-integrate' stage of the conversion. The count  $N_x$  is recorded; it represents a digitally-encoded form of the analogue input signal.

The beauty of the dual slope-technique is that the theoretical accu-

racy depends only upon the absolute value of the reference voltage and the equality of the individual clock periods during a conversion cycle. Only short term stability of clock frequency is required and this is far easier to obtain than long term stability. Note that the component values (C and R) do not enter into the conversion relationship and it is therefore not necessary to use precise values. In the dual-slope conversion technique conversion time is not fixed but depends upon the value of the analogue input signal. This feature is a disadvantage in some applications.

The dual slope technique for a.-to-d. conversion has for a number of years been the preferred method for use in digital panel meters, the increasing size of the market for d.p.m.s having encouraged continual developments in i.c. devices for use in dual-slope systems. Various refinements to the basic techniques of Fig. 22 have been incorporated in the devices, including input buffering, automatic zeroing and

automatic polarity selection. Automatic zeroing involves an extra stage to the conversion cycle in which offsets in the analogue circuitry are automatically balanced out. The automatic polarity function allows both positive and negative analogue input signals to be converted, and involves the switching in of a reference voltage polarity opposite to that of the analogue input signal.

Integrated circuit devices which function as dual-ramp converter subsystems are available (e.g. Motorola MC1505/MC14435, Intersil 8052/T101.) Analogue circuitry is contained in one device, digital circuitry in another. More recently single-chip, dual-slope converters have appeared on the market. The ICL 7106 (or 7107) is a device which contains all the active circuitry required for a 3½ digit d.p.m. with automatic zero and polarity. The device requires the addition of a display, four resistors, four capacitors and an input filter (if required) to make a working instrument.<sup>7</sup> The basic circuit diagram of liquid-crystal display d.p.m. using the ICL 7106 is shown in Fig. 23. The Intersil d.p.m. evaluation kit (ICL7106 EV/KIT) contains the p.c. board, converter chip, display and passive components, and gives a practical and convenient way of looking into the dual-slope technique. At the same time it allows one to construct a working, high performance instrument. Test points are available at which signals can be monitored. Fig. 24 shows the waveform at the output of the analogue integrator (pin 27) for two values of analogue input signal. Note the fixed 'integrate-signal' time period and the constant-slope but varying time period of the 'integrate-reference' stage of the conversion. The measurement required the use of a high-impedance oscilloscope probe so that loading should not interfere with the correct circuit operation.

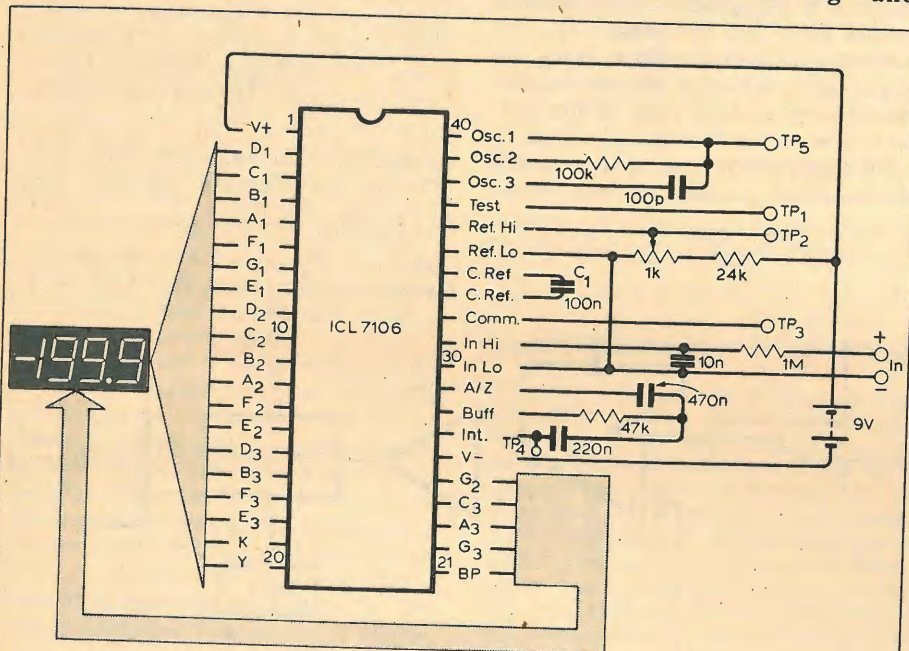

Fig. 23. Using ICL7106 to make simple d.p.m.

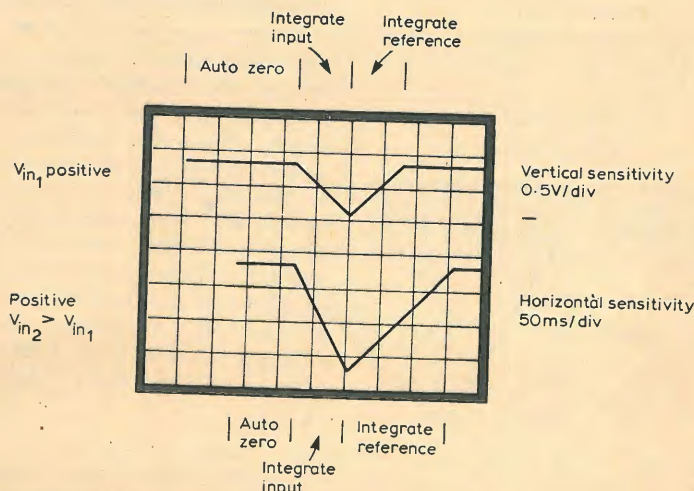

Fig. 24. Waveforms from circuit of Fig. 23.

### Quantized-feedback conversion

The quantized-feedback and dual-slope methods for a.-to-d. conversion are somewhat similar, in that both systems employ a charge-balancing technique. In the dual-slope system the charge supplied by the analogue input signal during the fixed 'integrate-signal' time period is balanced by an equal and opposite charge supplied by the reference during the variable 'count' interval. The different stages of conversion occur as separate phases of the conversion process. However, in the quantized feedback-method, they occur simultaneously during a single fixed conversion time period.

Fig. 25 is a simplified circuit diagram illustrating the functional operations underlying the quantized-feedback method. During conversion the sum of a continuous input current  $I_{in} = V_{in}/R_{in}$  and pulses of a reference current  $I_{ref} = V_{ref}/R_{ref}$  is integrated for a fixed number



of clock periods. The reference current is of opposite polarity to the input current and is larger than the input current  $I_{ref} = 2I_{in(f.s.)}$ . It is switched in for exactly one clock period at a time, just frequently enough to maintain the integrator output near zero.

The comparator in the system senses when the output of the integrator exceeds a reference level (near zero) and signals the control logic to perform the clock switching of the reference-current charge increments. The system maintains a continuous charge balancing between the charge supplied by  $I_{in}$  and that taken away by the  $I_{ref}$  pulses. The total number of  $I_{ref}$  pulses needed to maintain the balance during the fixed conversion time is counted, the count representing the digitally-coded value of the analogue input signal. Waveforms appearing at the integrator output in a practical quantized feedback converter are shown in Figs. 27 and 28.

An expression for the conversion relationship in a quantized-feedback converter is readily derived from the condition of zero net charge transfer.

Letting  $T_c$  represent the clock period, the magnitude of the  $I_{ref}$  charge increments are

$$q = \int_0^{T_c} I_{ref} \cdot dt = \frac{V_{ref}}{R_{ref}} \cdot T_c \quad (15)$$

The charge supplied by the continuous

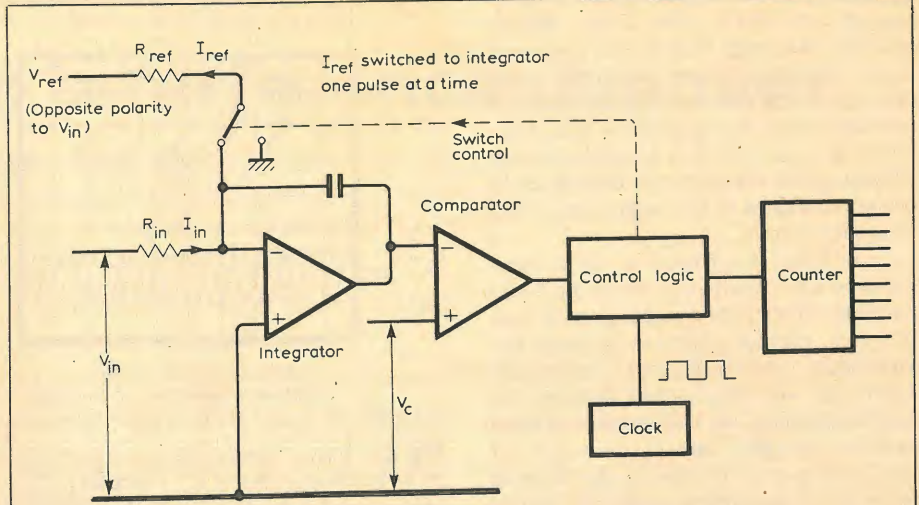

Fig. 25. Simplified quantized-feedback converter.

input current during the fixed conversion time period  $T_i$  is

$$Q = \int_0^{T_i} \frac{V_{in}}{R_{in}} \cdot dt \quad (16)$$

where  $T_i = N \cdot T_c$  ( $N$  is a fixed number).

Eq. (16) may be written as

$$Q = N \cdot T_c \int_0^{NT_c} \frac{V_{in}}{N \cdot T_c R_{in}} \cdot dt,$$

or

$$Q = \frac{N \cdot T_c}{R_{in}} \cdot V_{in} \quad (17)$$

where  $V_{in}$  is the average value of the input signal during the conversion period.  $Q$  is balanced by  $N_x$  charge increments of  $I_{ref}$ . Thus:  $N_x \cdot q = Q$ . Substitution of values from Eq. 15 and Eq. 17 gives

$$N_x = \frac{R_{ref}}{R_{in} \cdot V_{ref}} \cdot N \cdot V_{in} \quad (18)$$

The quantized-feedback technique is insensitive to both long and short term

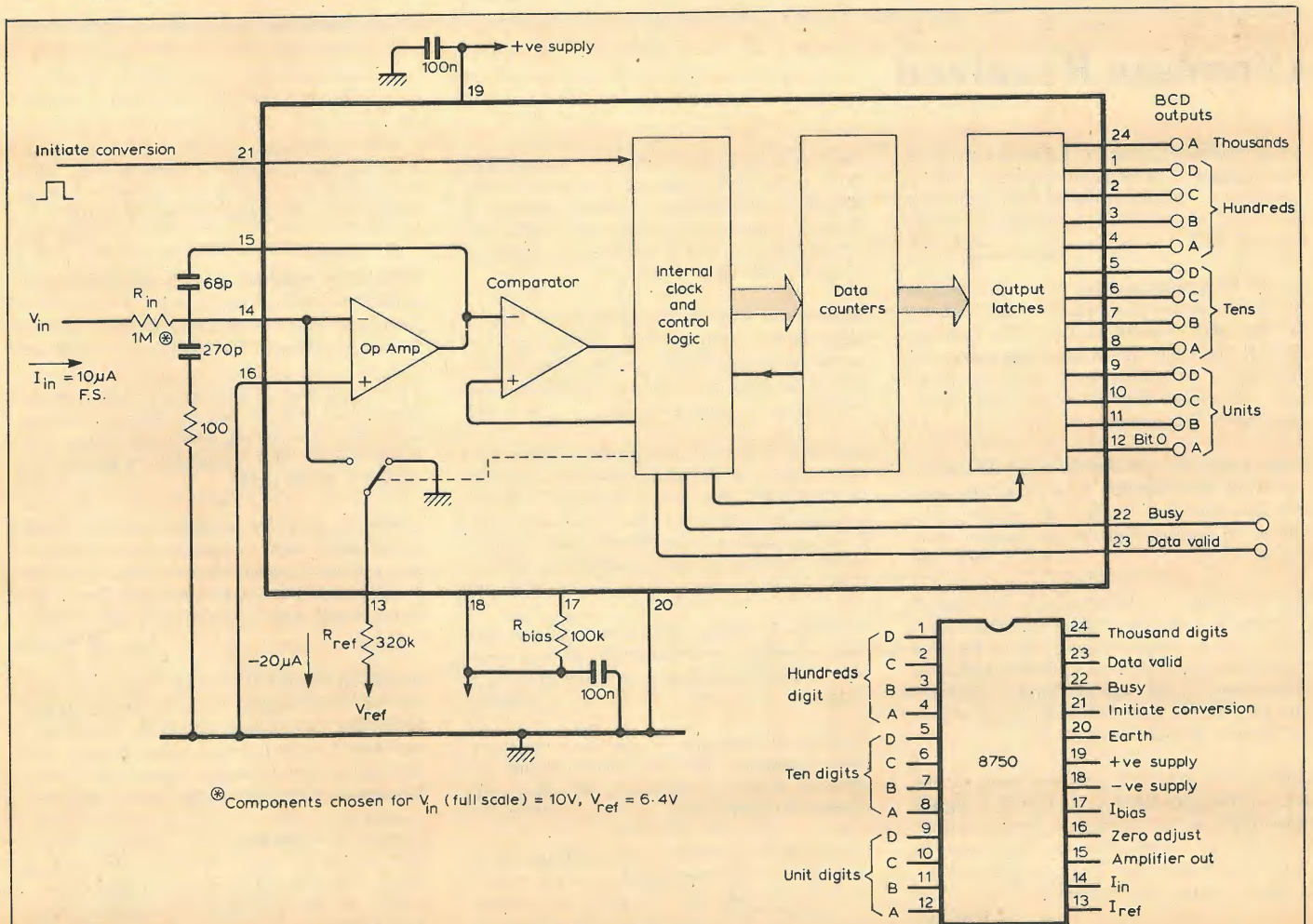

Fig. 26. Circuit using Teledyne 8750 quantized-feedback converter.

drift in clock frequency since any change in clock frequency effects equally the charge supplied by the input signal and the charge supplied by the reference. The fixed conversion time of the technique is valuable if the converter is to be used in a data acquisition system, since it allows the converter to be synchronized to the operation of the complete system.

Quantized-feedback a.-to-d. converters are available from several manufacturers. They come as two-chip sets (e.g. Intersil LD111/110) with the analogue and digital circuitry separated, and single-chip devices are now appearing on the market. However, a design constraint with all single-chip converters is the digital noise which inevitably crops up during a conversion and limits the maximum achievable sensitivity.

The Teledyne Semiconductor 8700 series of converters are c.m.o.s. devices which employ the quantized-feedback technique, requiring only the addition of a few external passive components, power supplies and reference. A test circuit is shown in Fig. 26. The 8700 series of converters can be interfaced with microprocessor systems<sup>8</sup>.

A simple test of the nature of the quantized-feedback mode of operation is to examine the waveform appearing at the output of the integrator (pin 15 of the device in Fig. 26). Typical integrator output waveforms for different values

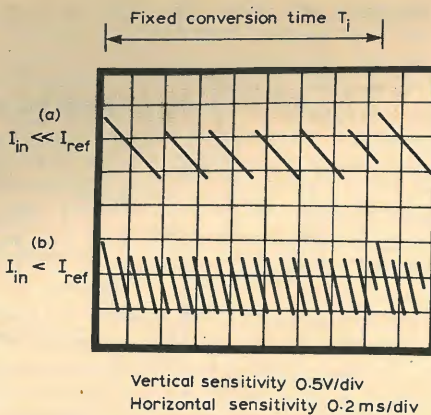

Fig. 27. Waveforms from circuit of Fig. 26 at various levels of  $I_{in}$ . Trace at (a) shows working when  $I_{in}$  much less than  $I_{ref}$ .

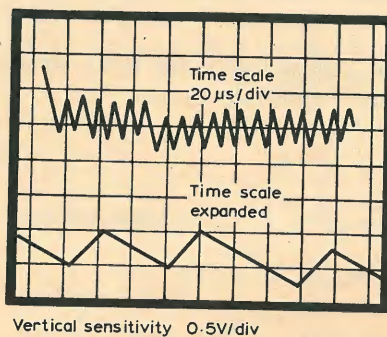

Fig. 28. Version of Fig. 27 with  $I_{in}$  almost at full scale.

of the analogue input signal are shown in Fig. 27 and 28. In Fig. 27(a)  $I_{in} \ll I_{ref}$  and only 5  $I_{ref}$  charge pulses are required during the conversion time in order to maintain charge balancing. Clock switching of the  $I_{ref}$  pulses is allowed when the integrator output exceeds approximately 1 volt. In the second trace (Fig. 27(b)),  $I_{in}$  is increased with a consequent increase in slope of the integrator ramp and a greater number of  $I_{ref}$  charge pulses required to maintain the charge balance. In Fig. 28,  $I_{in}$  has been increased to a value approaching full scale ( $I_{in} \geq I_{ref}/2$ ) and the time scale has been expanded so that the clock switching of the  $I_{ref}$  pulses can be clearly seen. Note that at times during the conversion the larger values of  $I_{in}$  cause the integrator output to appreciably exceed the comparator reference level before the next clocked pulse of  $I_{ref}$  can cause the return of the integrator output.

## References

- Fullagan D. and Dufort M. "Low-cost digital panel meter designs". Intersil Inc. Application note.
- "Digital panel meter experiments for the hobbyist". Intersil Inc. Application note.
- Guzeman D. "Interfacing the 8700 A/D Converter with the 8080  $\mu$ P System". Teledyne Semiconductor application Notes. August 1976.

## Literature Received

Wallchart from Cambion, showing a range of **printed-board accessories**—sockets, links, handles, etc. Copies available from Cambion Electronic Products Ltd, Castleton, Nr. Sheffield S30 2WR. WW 401

B and W Loudspeakers have printed in booklet form the paper read by G. J. Adams on their **801 monitor** at the CES, Chicago 1979. It describes the design objectives and methods of achieving them, with results of tests. Obtainable from Meadow Road, Worthing BN11 2RX at 50p.

Programmable electromagnetic/radio frequency **interference** data collection system described in a leaflet from Ailtech UK, Sherwood House, High Street, Crowthorne, Berks. WW 402

Sound Verdict 11, published by L. Borough of Camden, is index to reviews and articles on audio which appeared in 1978 in various magazines. Compiled by Libraries and Arts Department, L. Borough of Camden, Holborn Library, 32-38 Theobalds Road, London WC1X 8PA, and published at £2.

Leaflet from Pye TVT provides basic details and performance figures of LDM 3001 **digital noise reducer** for television broadcasting. Reduces noise from cameras, film, tape or transmission path. Pye TVT Ltd, P.O. Box 41, Coldhams Lane, Cambridge CB1 3JU. WW 403

Catalogue, giving full details of **loudspeaker** drive units, kits, cabinets and accessories, including components for many published designs, available from Wilmslow Audio Ltd, Swan Works, Bank Square, Wilmslow, Cheshire SK9 1AN at 15p.

Booklet on the choice and use of **silicon photodiodes**, with data on many types, is produced by Centronic Optical Systems Ltd, Centronic House, King Henry's Drive, New Addington, Croydon CR9 0BG. WW 404

Technical Note 7, from TCI, describes a new approach to the design of wide-band aerials, culminating in the design of the TC1 Model 540. Leaflet obtainable from Technology for Communications International, 1625 Stierlin Road, Mountain View, California 94043, USA. WW 405

Catalogue of **safety equipment** for industrial use is available from Safety Equipment Centres, 53 Elm Road, New Malden, Surrey KT3 3HB. WW 406

Illustrated catalogue of complete range of **radar equipment** and services produced by Marconi Radar Systems Ltd, Writtle Road, Chelmsford CMI 3BN. WW 407

Leaflet on multi-channel (up to 30) **transient recorder**, using the a-to-d converter and memory technique, to store analogue waveforms for subsequent oscilloscope

examination. Copies of leaflet DL 2000 obtainable from Data Laboratories Ltd 28 Wates Way, Mitcham, Surrey CR4 4HR. WW 408

**Metal-film resistors** now made by CGS described in leaflet FZ4, from CGS Resistance Company Ltd, Marsh Lane, Gosport Street, Lymington, Hants SO4 9YQ. WW 409

TIW Systems describe a 32m **beam waveguide dish aerial** for use in Intelsat terminals in a leaflet obtainable from TIW Systems Inc., 1900 Embarcadero Road, Palo Alto, CA 94303, USA. WW 410

Leaflet on a device to allow playback **speed variation of tape** cassettes, without distorting the pitch. Speed can be varied from 60% to 250% nominal. Copies from VSC Corp., 185 Berry Street, San Francisco, CA 94107, USA. WW 411

Technical bulletin from KEF (Vol. 3, No. 4) is on the relationship between **loudspeaker enclosure** size, power handling, efficiency and low-frequency response. Copies are obtainable from KEF Electronics Ltd, Tovil, Maidstone, Kent ME15 6QP. WW 412

**Coaxial r.f. connectors** of Transradio types BNC, Series N, TNC, VMP are collected in a short-form catalogue from Comstock Electronics, 42/44 Bowlers Croft, Basildon SS14 1BR, Essex. WW 413

# Automatic interference remover

Removing interference spikes from f.m. recorded data

by A. J. Ewins

WHEN THE DYNAMIC performance of such structures as railway carriages, buses or aircraft are studied, various electrical transducers are attached in critical positions and their output signals recorded for subsequent analysis.

One of the most popular instruments used for recording these transducer signals is the multi-track, f.m., magnetic tape-recorder, which is capable of recording signals with bandwidths from zero to several kilohertz.

So that detailed analyses of these recording signals may be obtained, increasing use is being made of computers with analogue/digital interfaces. A problem often encountered under such circumstances is the presence of unwanted electrical interference among the required signals.

IF THE FREQUENCY of the electrical interference is outside the bandwidth of the required signals it can generally be filtered out but, in the presence of certain types of interference, the use of filters can be a considerable embarrassment, giving rise to greater problems than it cures. Interference spikes which over-modulate the f.m. channels of the tape-recorder, producing momentary signal drop-out and tape drop-out itself, are two such types of interference. The signal drop-out so produced is of an amplitude much greater than the full modulation range (f.m.r.) and, depending upon the tape-recording speed and bandwidth of the data channels, can have a duration of several milliseconds. Such an interference signal passing through a filter produces considerable ringing, possibly lasting for several times longer than the duration of the interference itself. It is possible to edit the interference out of the required data once the data has been passed through the analogue-to-digital conversion stage and before any subsequent analysis. However, this can only be done by reconstructing the digital data into analogue form and visually examining the computer print-out. This may result in a considerable increase in the amount of computer time used. Also, if the interference signal has passed through a filter stage, the ringing so produced introduces an element of doubt as to when the effects of the interference may be considered as passed. It can therefore only be

removed with any certainty by editing out a much larger 'chunk' of the data than the duration of the actual interference.

From the preceding comments it will be readily appreciated that some means of automatically removing the unwanted interference prior to any filtering stages and before the computer analysis is highly desirable.

The equipment described in this article is able to do this over the bandwidth of the type of recorded data encountered by the author.

## System operation

The block diagram of the automatic interference remover (AIR) is shown in Fig. 1. Output signals from one channel of an f.m. tape-recorder enter the unit via a differential input stage. This is followed by an amplitude-limiting stage which limits the amplitude of the incoming signals to a level approximately 10% greater than the full modulation range of the tape-recorder,

in both the positive and negative directions, so as not to overload the analogue delay which follows. The analogue delay line introduces a delay of some 2 to 80ms, adjustable by varying the frequency of the clock-oscillator. From the delay line the signal passes to a track/hold circuit with a low-pass filter as an integral part of it. The output from the track/hold circuit is the output of the 'cleaned-up' signal.

In the absence of any interference signals, the track/hold circuit tracks the data signals. When an interference signal occurs it is detected at the moment of its entry into the delay line by either the overload detector or the window comparator. Once an interference signal has been detected one or both of the two detection circuits will

Fig. 1. Block diagram of the interference remover. At (a) is the method adopted to prevent the circuit holding on unfiltered noise signals.

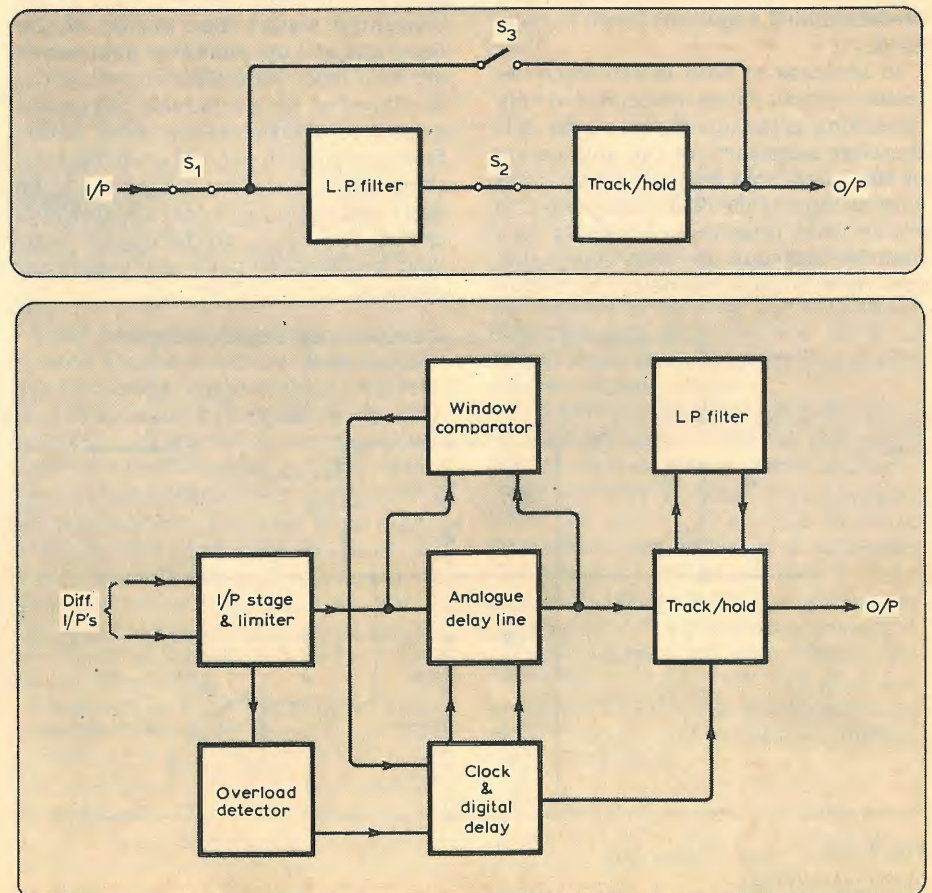

produce a pulse, which is fed to the clock-oscillator and digital delay circuit block. This immediately feeds a pulse to the track/hold circuit, switching it into its 'hold' mode. The track/hold circuit remains in its hold mode for a minimum time (determined by the digital delay) after the last detectable traces of the interference signal have passed through the delay line. At the end of this hold period the track/hold circuit reverts to its 'tracking' mode. The total duration of the hold period is equal to one analogue delay period plus the detectable period of an interference signal plus a minimum digital delay period.

The overload detector detects certain types of interference by virtue of the fact that their amplitude exceeds the f.m.r. of the data signals. The two types of interference signal referred to earlier (tape dropout and signal dropout) are detected and an output pulse is produced for as long as an overload exists. The detector is able to cope with overloading interference of any duration.

The window comparator is connected across the input and output to the delay line. Because of this it is able to detect amplitude changes in the data signal that exceed a pre-determined value over the delay-line period. By suitable adjustment of the predetermined value, only those rates of change in the amplitude of the data signal that can be regarded as outside the required bandwidth will be detected. In this way, interference signals that do not overload the f.m.r., but would otherwise be difficult to remove by filtering alone, are effectively removed. An output pulse is produced by the window comparator only for as long as the window level (the predetermined amplitude level) is exceeded.

In the case of both interference detectors, output pulses are produced only for as long as the interference lasts. It is therefore necessary for the hold period of the track/hold circuit to last for at least as long as the delay-line period, to ensure that interference signals of a duration less than the delay line period pass right through the delay line before

the track/hold circuit reverts to its tracking mode. It is for this reason that a minimum hold period is produced by the digital delay circuit.

An f.m. tape-recorder incorporates a low-pass filter as its final playback stage to remove the carrier frequency from the data signal. In the presence of interference signals, this filter inevitably produces some ringing. The window comparator will detect the presence of this ringing until its amplitude falls inside the window. Any remaining ringing is likely to be removed in the final minimum hold period which, for this reason, is made adjustable from  $1\frac{1}{4}$  to  $4\frac{1}{4}$  delay-line periods.

It is not pretended that the two types of interference detector will detect all types of interference or unwanted signals. For instance, consider a square-shaped pulse of amplitude less than the f.m.r. and of a duration greater than one delay-line period plus the minimum hold period. The leading edge of the pulse will be detected by the window comparator, by virtue of its rapid rate of change in amplitude, as it enters the delay line, and again as it leaves the delay line. A hold period of at least  $2\frac{1}{4}$  delay line periods ( $1 +$  the min. hold period of not less than  $1\frac{1}{4}$ ) is thus initiated. However, at the end of the hold period, the trailing edge of the pulse will still not have entered the delay line. Both inputs to the window comparator will be at the same amplitude (the height of the pulse) and thus no further indication of the unwanted signal's presence will be given until the trailing edge enters the delay line. The track/hold circuit therefore reverts to tracking in the middle of the unwanted signal. The period of the delay line and the minimum hold period are both made adjustable to reduce the likelihood of such relatively infrequent events to a satisfactory level. Interference signals in general are defined by their short duration relative to the delay-line period and only those which exceed the f.m.r., producing an overload, are likely to be of any significant duration.

A low-pass filter is used to remove low-amplitude, high-frequency signals that are outside the required bandwidth and not otherwise removed by the interference detectors. It has been found that the position of this filter in relation to the track/hold circuit has a significant effect upon the cleaned-up signal. When the filter was placed immediately after the delay line and before the track/hold circuit, it was found that the ringing produced by an interference signal passing through it lasted for much longer than the largest minimum hold period that could reasonably be set. Consequently, a large amount of ringing interference was not removed. Placing the low-pass filter after the track/hold circuit produced inexplicable little 'blips' in the cleaned-up signal that were not present in the untreated, but filtered, signal.

These blips were subsequently found to be due to the track/hold circuit sometimes holding on the peak of the high-frequency noise content of the, as yet, unfiltered signal. After some thought, a satisfactory solution was arrived at which is illustrated in Fig. 1 (a). Under normal tracking conditions, the switches  $S_1$  and  $S_2$  are closed and  $S_3$  is open. The low-pass filter thus precedes the track/hold circuit. When a hold signal is received, switches  $S_1$  and  $S_2$  open simultaneously and  $S_3$  closes. The track/hold circuit thus holds the output at a level from which the high-frequency noise has been removed. At the same time the low-pass filter is disconnected from the delay line's output, preventing interference signals from entering it, and connected to the output of the track/hold circuit. In spite of the fact that the low-pass filter must introduce a delay into the signal line, resulting in slightly different amplitude levels between its input and output, the resultant output signal is much cleaner using this method than in either of the other two methods. It is important, however, when using a low-pass filter in this manner, that it has zero d.c. offset between its input and output and a voltage gain of exactly unity in the pass band.

### Circuit design

Figure 2 shows the circuit diagram of the differential input stage, amplitude limiter and overload detector. Two operational amps, OPA<sub>1</sub> and OPA<sub>2</sub>, form the combined differential-input stage and amplitude limiter. Two 2.7V Zener diodes connected back to back, limit the output to a value of  $\pm 3.3V$  (Zener voltage plus diode voltage). A 10 kilohm potentiometer connected across the Zener diodes provides a means of adjusting the required amplitude limit. OPA<sub>2</sub> is simply a voltage follower, its output being fed back to the negative terminal of the input stage to give a closed-loop gain of unity for the combined input stage and amplitude limiter. The value of the amplitude limit can thus be adjusted to the required

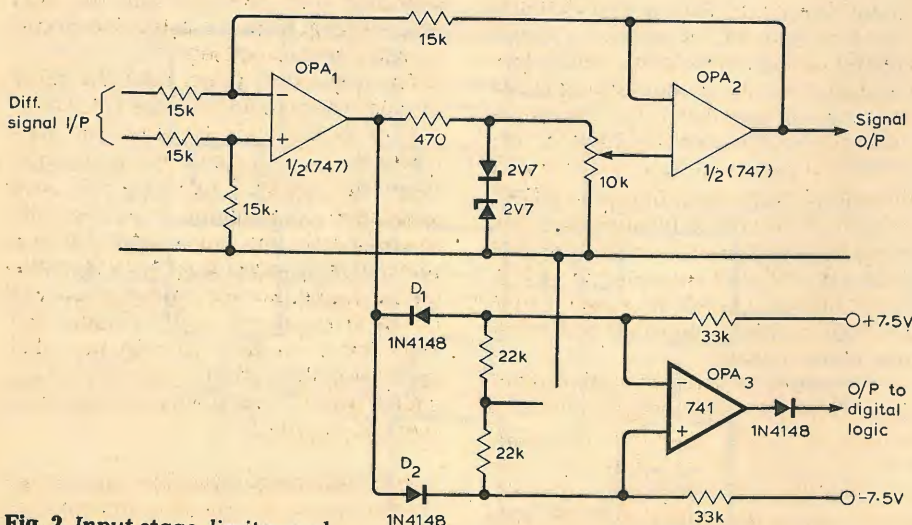
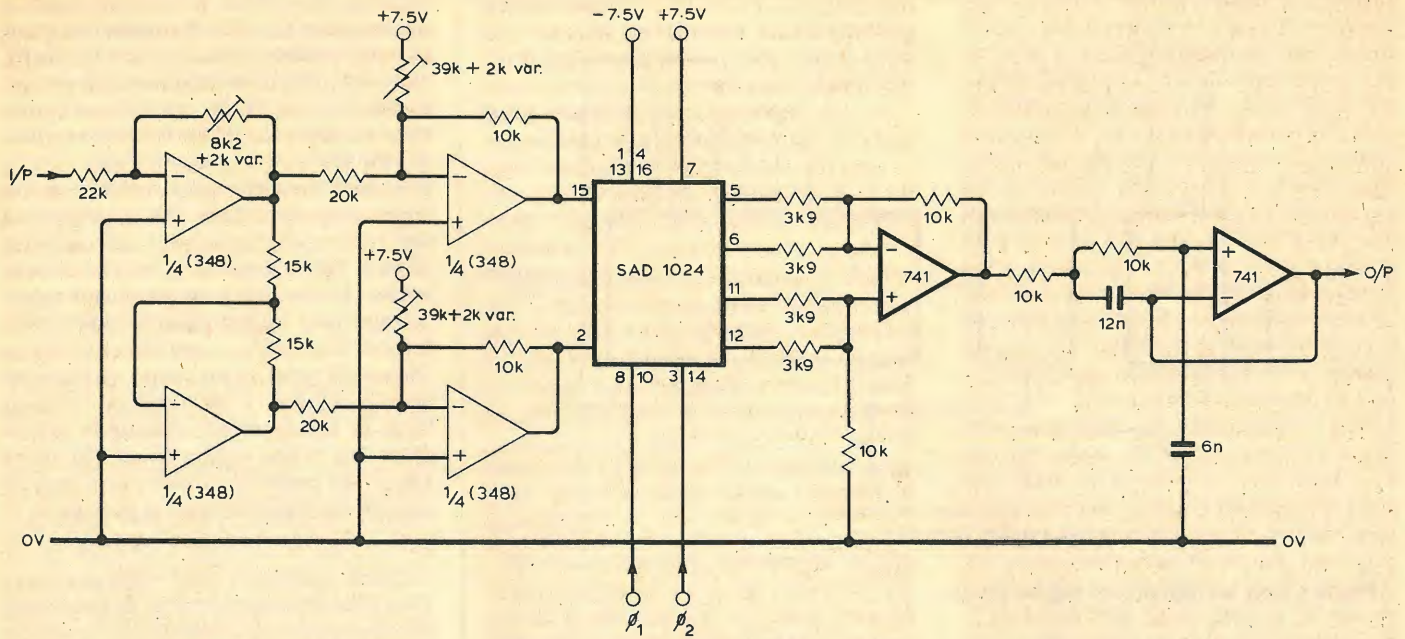

Fig. 2. Input stage, limiter and overload detector.



**Fig. 3. Analogue delay and 2kHz low-pass filter.**

level without altering the unity gain of the two stages. For a full-scale input voltage range of  $\pm 1V$ , the amplitude limit is set to a nominal value of  $\pm 1.1V$ .

The output from the overload detector is normally at a level of about  $-7.5V$  (logical '0') producing a positive-going pulse of about  $7.5V$  (logical '1') whenever its input voltage exceeds a value of  $\pm (7.5V \times 22k) / (22k + 33k) + V_d$ , where  $V_d$  is the voltage drop across diode  $D_1$  or  $D_2$ ; i.e.  $\pm 3.6V$ . When the output from OPA<sub>1</sub> exceeds the Zener-plus-diode voltage of  $\pm 3.3V$ , it rises rapidly in attempt to provide the necessary feedback voltage for unity gain, quickly exceeding the overload level of  $\pm 3.5V$ . An output pulse is thus produced from the overload detector. Because the pulse is used in an either/or configuration with that from the 'window' comparator,  $D_3$  is placed in its output line.

**Delay circuit.** The most important component of this circuit, shown in Fig. 3, is the Serial Analogue Delay integrated circuit, the Reticon SAD 1024 which consists of two independent, 512-stage, bucket-brigade delay sections. Sampled levels of the input voltage are passed along from stage to stage at a rate determined by the external clock oscillator, the samples arriving at the output after a time of 512 half-clock periods. The two delay sections of the device are used in a differential mode for reduced even-harmonic distortion, reduced clocking noise and cancellation of the standing direct output voltage. Each section has its output split into two channels so that an output is provided over each full clock period by adding the signals from the two channels together. The device is capable of operating from a total supply voltage of between 10 and 17 volts and to be compatible with the rest of the circuitry, it is operated from  $\pm 7.5V$  rails. The analogue inputs to the device

**Fig. 4. Window comparator.**

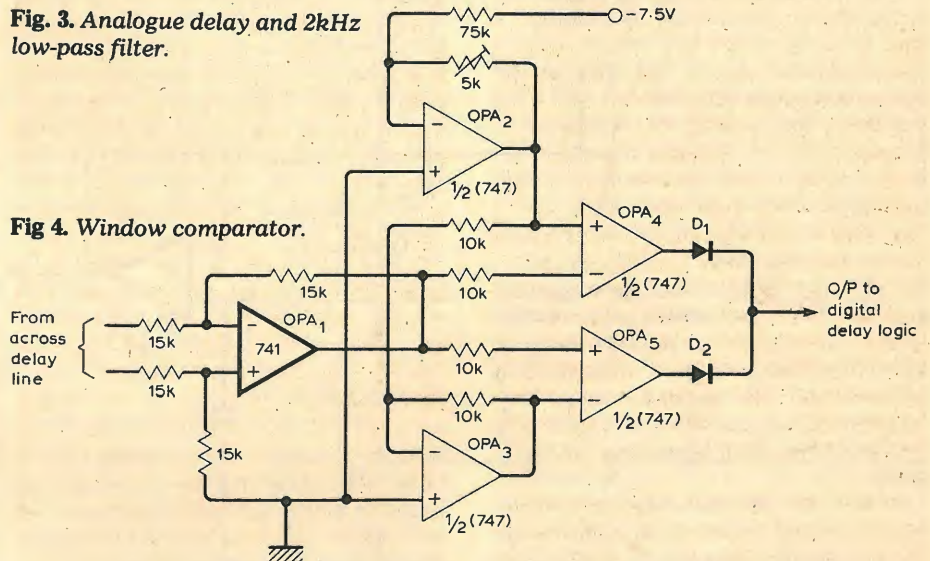

require a d.c. bias voltage of approximately  $+6$  volts with respect to the negative supply terminal. For the circuit of Fig. 3 this means a d.c. bias of  $-1.5$  volts with respect to the zero volt line.

Total harmonic distortion produced by each section of the i.c. rises rapidly with increasing input voltage, but is less than 1% for signals of approximately 500 mV r.m.s.: at this level, the signal-to-noise ratio is of the order of 70dB. As the two sections of the device are used in a differential mode, resulting in an effective gain of two, the input signals to the two sections are attenuated to a level of about 150 mV (for an input of  $\pm 1V$ ). This results in a much improved distortion figure of less than 0.1% for a s/n ratio of about 65dB.

To produce a differential output signal from the single-ended input, two sections of a quad amplifier i.c. Type 348, are used in a phase-splitter arrangement. The 2 kilohm variable resistor, in series with the 8.2 kilohm resistor in the feedback line of the first amplifier, allows the overall gain of the

delay line circuit to be adjusted to unity. The two remaining sections of the i.c. are used to mix the  $-1.5V$  bias levels with the differential signals. Both d.c. bias levels are made adjustable so that the optimum setting for minimum distortion may be found and the final output signal from the delay line circuit adjusted for zero offset.

The first 741 amplifier after the delay i.c. adds the signals from the two channels of each section together and subtracts the overall signal of one section from the other. The final 741 and associated components is a two-pole, Butterworth, low-pass filter for the removal of the clock frequency from the output signal. For the values given, the cut-off frequency is 2 kHz. Finally, the clock inputs to the SAD 1024, provided by the oscillator of Fig. 5, are two-phase square-waves, one being the complement of the other.

**Window comparator.** The input stage of the circuit in Fig. 4 is differential, accepting inputs from across the delay circuit of Fig. 3; i.e., from the input to

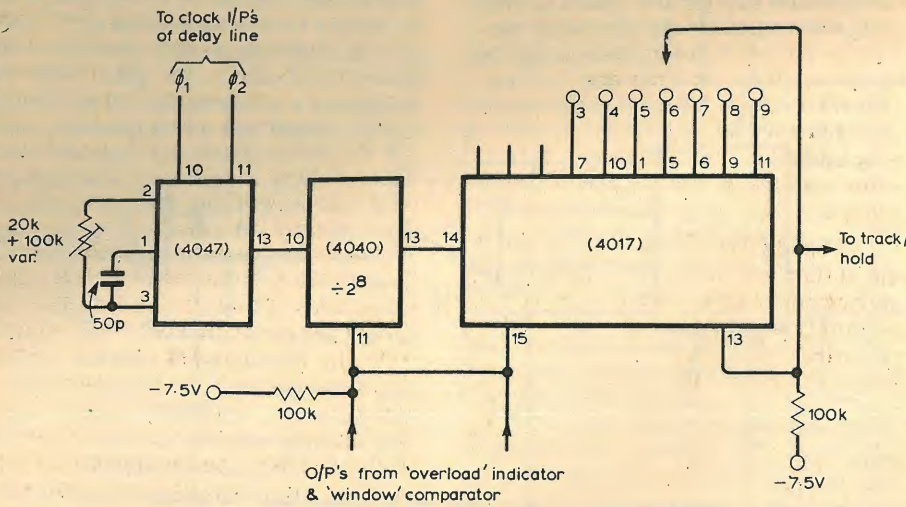

Fig. 5. Clock oscillator and digital delay.

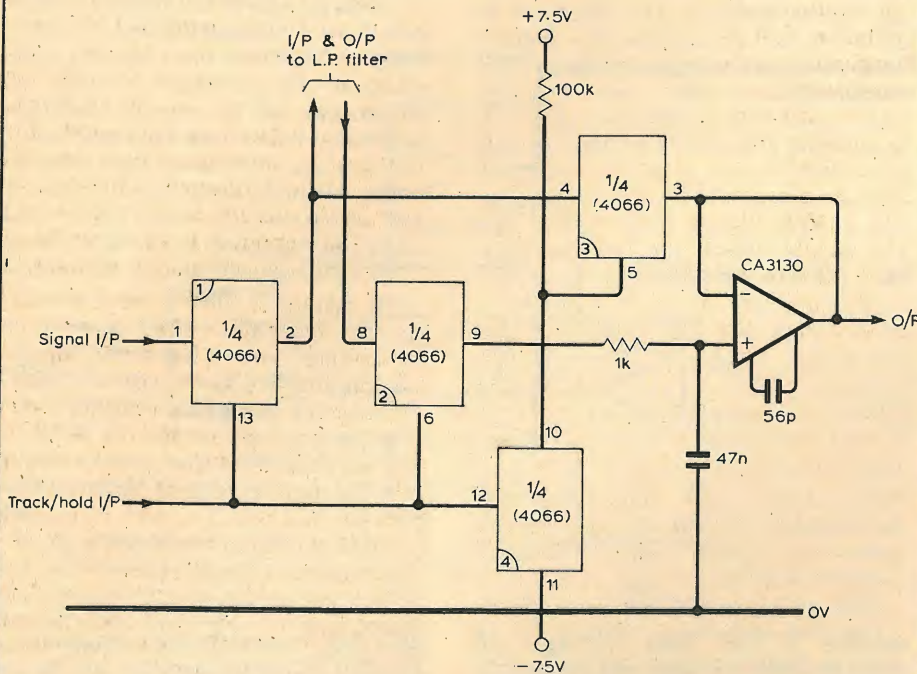

Fig. 6. Track/hold and filter-switch, which corresponds to blocks of Fig. 1(a).

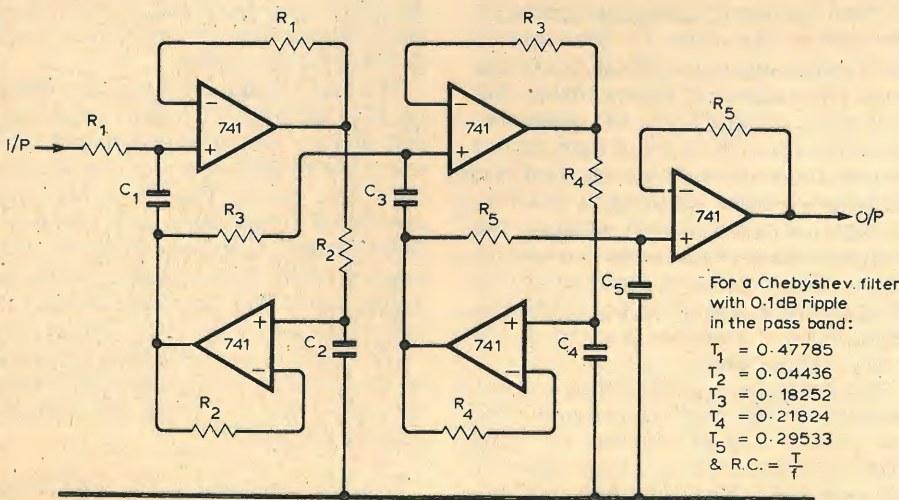

Fig. 7. Low-pass filter. Component values depend on application.

Fig. 3 and the output from Fig. 3. It has a voltage gain of unity. By means of the 5 kilohm variable resistor in the feedback line OPA<sub>2</sub>, the reference voltages on the positive input of OPA<sub>4</sub> and the negative input of OPA<sub>5</sub> can be varied from zero to +0.5V and -0.5V, respectively. Thus, providing the differential voltage to the input stage is within the 'window' of the reference voltages, the outputs of both OPA<sub>4</sub> and OPA<sub>5</sub> will be nearly -7.5V. However, whenever the input voltage falls outside the 'window', i.e. greater than  $\pm V_{ref}$ , then either OPA<sub>4</sub> or OPA<sub>5</sub> will produce an output voltage of nearly +7.5V. This positive voltage level is transmitted, via diode D<sub>1</sub> or diode D<sub>2</sub>, to the digital delay circuit of Fig. 5. The positive voltage pulse lasts as long as the window level is exceeded.

**Clock oscillator and digital delay.**

This circuit, shown in Fig. 5, generates the required two-phase square waves for the delay i.c., accepts inputs from the two interference detector circuits and controls the operating mode of the track/hold circuit.

The clock oscillator is constructed from a 4047 c.m.o.s. i.c. and is connected for astable operation. The time-period of the square-wave output from pin 13 is given by  $2.2RC$ , where  $R$  is the 20 kilohm resistor in series with the 100 kilohm variable and  $C$  is the 50 pF capacitor. Two square waves, in anti-phase to each other, are available from pins 10 and 11 with a period that is twice that from pin 13, i.e.  $4.4RC$ . These two square-waves are used to clock the analogue delay i.c. of Fig. 3. The output from pin 13 is fed to a multiple-stage ripple counter (c.m.o.s. type 4040), the output of which is fed to a decade counter (c.m.o.s. type 4017). These two counters together produce the adjustable 'minimum hold' period of from  $1\frac{1}{4}$  to  $4\frac{1}{4}$  times the analogue delay period. The multiple-stage ripple counter divides the clock frequency by 256 to produce a square-wave with a period of half the analogue delay time. Since the decade counter is advanced by positive-going pulses on its clock input, it advances its first count (from the reset condition of both counters) after a period of only a quarter of the analogue delay time. The third count is thus reached after  $1\frac{1}{4}$  analogue delay periods, the fourth after  $1\frac{3}{4}$  analogue delay periods, and so on up to a maximum delay of  $4\frac{1}{4}$  analogue delay periods after 9 counts. The output from the decade counter is used to control the mode of operation of the track/hold circuit. The required minimum hold period is selected by connecting the input of the track/hold circuit to the appropriate output from the decade counter, i.e. outputs 3 to 9. The 'enable' input to the decade counter is also connected to the selected output of the decade counter so that when the selected count is reached the counter is disabled until such time as it is reset. In the absence of any interference pulses

the decade counter will be in its disabled state, having reached its selected count. The output to the track/hold circuit is thus at the logical 1 level, maintaining it in its track mode. When an interference pulse is detected, the ripple counter and the decade counter are immediately reset. The output to the track/hold becomes logical 0, initiating the hold mode. The hold condition is thus maintained until the reset line to both counters is released and the selected delay period completed.

**Track hold and filter switch.** The principle of the circuit of Fig. 6 is as described earlier with reference to Fig. 1(a). The three switches of Fig. 1(a) are contained in a quad bilateral switch i.e. type 4066. (This was used in preference to the 4016 type because it has a lower on resistance.) Each switch of the quad package is shown separately as an individual circuit block with appropriate pin connections. The switches  $S_1$ ,  $S_2$  and  $S_3$  of Fig. 1(a) are shown in Fig. 6 as circuit blocks 1, 2 and 3 respectively. As switch  $S_3$  is normally open when  $S_1$  and  $S_2$  are closed, the remaining switch, circuit block 4, is used to control its operation. When tracking the input signal the input to the track/hold circuit is at the logic 1 level. Under this condition circuit blocks 1, 2 and 4 are in their on state. The on state of circuit block 4 produces a logic 0 level at the control input of circuit block 3, with the result that it is held in its off state. When the track/hold input becomes logic 0, circuit blocks 1, 2 and 4 go into their off states, but circuit block 3 goes into its on state. Thus the correct operation of the three circuit blocks 1, 2 and 3 is controlled by the logic level on the track/hold input.

The holding of the input signal is achieved by storing it across the 47 nF capacitor. Because of the low source impedance of the input to the capacitor, it is able to follow the input signal in the tracking mode. When the input to the capacitor is disconnected in the hold mode, it discharges only very slowly because of the high input impedance of the CA 3130 to which it is connected.

**Low-pass filter.** The circuit of a 5-element, Chebyshev, low-pass filter with 0.1 dB ripple in the pass band is shown in Fig. 7. Operational amplifiers, not emitter-followers, are used to buffer each element of the filter, because zero d.c. offset between input and output, with good temperature stability, is required. The overall voltage gain of the filter within the pass-band is unity. Values for the resistor/capacitor combinations are not given, but may be obtained for each element by referring to the appropriate time constant,  $T_n$ , and the formula,  $R_n C_n = T_n/f$ , where  $f$  is the required cut-off frequency at the 0.1 dB attenuation point. For good results, the  $R_n C_n$  combinations should be determined to within 1%.

### Adjustment

For the AIR to function satisfactorily, there are a number of parameters that must be adjusted to suit the bandwidth of the required data. They are:

- the filter cut-off frequency
- the analogue delay period
- the minimum hold period
- the window comparator reference voltage

The bandwidth of the data in which the author was interested was a fairly narrow one of zero to 25Hz. The data to be analysed had previously been recorded onto magnetic tape using frequency-modulation and frequency-multiplexing techniques. The cut-off frequency (3dB point) of the low-pass filter in the recorder replay electronics was 150Hz.

Since the required bandwidth of the data was zero to 25Hz, the choice of the cut-off frequency for the filter was an easy one, namely 25Hz. The selection of the analogue delay line period, the minimum hold period and the window comparator's reference voltage are all dependent upon one another. A good way to start considering their values is to consider the period of the ringing produced by the filter in the tape-recorder playback electronics. As this was a 150Hz filter the period was, not surprisingly, about 7ms. For the maximum value of the minimum hold period of  $4\frac{1}{4}$  analogue delay periods to be greater than 7ms, the analogue delay period must not be less than  $7/4\frac{1}{4}$ , i.e. 1.7ms. For convenience, this was rounded to 2ms. This, in turn, determined that the minimum hold period be adjusted to  $3\frac{3}{4}$  periods, i.e.  $7\frac{1}{2}$ ms.

The setting of the window comparator reference voltage was determined by considering the highest frequency signal of full modulation range that should remain undetected by the comparator. For the type of data being analysed it was known that there were no large-amplitude signals present with a frequency higher than 10Hz. This value was thus taken as the upper frequency limit that should remain undetected up to full modulation amplitude.

The maximum rate of change of voltage for a sine-wave occurs at the zero-crossing point and has a value of  $2\pi f V_{pk}$  volts/sec. For a full modulation range of  $\pm 1V$  and a frequency of 10Hz this value is approximately 63 volts/sec. For an analogue delay period of 2ms, the window comparator reference voltage should thus be set to  $63 \times 0.002 = 0.126V$ . If a larger period had been chosen for the analogue delay period, then a larger window reference voltage would also have had to be chosen.

### Application

In case any readers are dubious about the value of the instrument over the narrow bandwidth of zero to 25Hz, let me give a specific example of its useful-

ness. As was mentioned earlier, transducers are attached to such structures as railway carriages and road vehicles in order that the dynamic performance of these structures can be analysed. Among the more frequently used transducers are strain-gauges, used to study the dynamic strains (and, hopefully, stresses) that structures undergo in their normal working environments. A most important result that can be obtained from measuring these strains is an estimate of the structure's fatigue life. It is a fact that the higher values of strain have a considerably greater effect upon the accumulated damage to the structure than the lower ones. Consequently, it is absolutely essential, if anything like a correct estimate of fatigue life is to be obtained, that unwanted high amplitude signals be removed from the data. In a recent experiment to determine the fatigue life of part of a road vehicle's chassis, much of the recorded data suffered from a considerable amount of interference of the sort previously mentioned. Whether the magnetic tape used was of poor quality, or the tape-heads were dirty is not known, but the interference was such that the data was quite impossible to analyse. By passing the data through automatic interference removers, as described in this article, prior to feeding it into the computer, it was possible to salvage the results of the experiment.

The results of fairly simple simulations showed that the effect of using the interference remover when carrying out spectral analysis, is to raise the background noise level to a uniform value over the entire bandwidth. It was found that the noise level rose proportionally with the number of hold periods simulated per unit time, i.e., with increasing levels of simulated interference. It was also found that the noise level rose, the higher the frequency of the signal source and the larger the hold period, though not proportionally. To put some figures to these comments: it was found, that a signal-to-noise ratio of about 70dB resulted when a 5Hz signal was used as the data source, with a hold period of 5ms and an interference level of about 1% (i.e. an average of 2 hold periods/sec.). For a 20Hz signal as the data source, a hold period of 15ms and a 1% interference level (i.e. an average of about 0.67 hold periods/sec) the ratio worsened to about 50dB.

In the writer's experience, interference levels greater than 1% constitute a serious interruption to the recorded data and, fortunately, do not seem to occur, except perhaps in short bursts in a relatively long piece of recorded data. It is fairly confidently concluded, therefore, that the effect of using the equipment when carrying out spectral analysis may be considered as negligible in most cases. If interference levels greater than 1% are experienced, then due consideration must be given to the benefits, or otherwise, of using automatic interference removal. □

## CB, STARLINGS AND EXHAUST FUMES

No sooner do I return from my first visit to England, than my first copy of *Wireless World* appears. And, upon scanning through the issue, I find a letter from my esteemed colleague, Shruki Switzer, defending citizens' band radio (May letters).

Shruki, of all people, should know better than to defend the social and technical desirability of c.b. just because it has proliferated so widely in North America. A similar defence could be made for starlings, chlorinated hydro-carbons, and exhaust fumes.

I think that there are excellent arguments to the effect that c.b. radio is wasteful of resources, both spectrum and material, which in some other allocation system (an auction system, for example) might be otherwise used. C.b. may be an amusing technological hobby or pastime, but I have seldom seen it used as an effective communications tool.

Benjamin F. Dawson III  
Hatfield & Dawson  
Seattle  
Washington, USA

## HIGH LEVEL COMPUTER LANGUAGES

The development of Basic Using Reverse Polish (BURP) by John Adams is noteworthy for the efficient way he uses the 57109 number cruncher (current articles on "A scientific computer"). I wonder how well engineers appreciate the efficiency that is achieved in a programming language if it is designed using Reverse Polish notation throughout.

It is the proud boast of engineers that they can do for 50p what others do for £1. If engineers are to keep this reputation in software (and firmware) they will need tools which are more compact, faster and more flexible than the well known languages such as BASIC and FORTRAN.

Such a language was developed by C. H. Moore<sup>1</sup> who now runs a software consultancy to market this language, FORTH. There is a clear hallmark of authenticity that will attract many industrial users to FORTH Inc. But there is also a large, and growing number of hobbies versions, and versions that have been developed in research and educational establishments are now available at nominal cost. They have such names as STOIC, URTH, 6502FORTH, LABFORTH and IPS.

Users claim software development times are well under half those required for BASIC or FORTRAN, while execution speed is still as high as 40 to 80% of assembler. (An assembler is also provided so that full speed can be achieved by writing modules in assembler in the most speed sensitive parts of an application.) Memory requirements are also very low, with programs longer than 2Kbytes tending to be shorter in FORTH than in assembler. There is a 'kernel' of approx ½Kbyte of machine code which is usually all that needs rewriting to move to a different microprocessor. Best of all, however, is the 'extensibility' of the language. This allows new features and new data types to be added to the language as required. It is the use of Reverse Polish syntax which has



led so simply to this feature. Only a single pass compiler is necessary whereas many passes are necessary in other languages. Again, in other languages the addition of new items to the language can only be done properly by rewriting the compiler, but Reverse Polish seems to avoid the problem.

Readers may be interested to know that the OSCAR amateur satellite uses IPS<sup>2</sup> which was developed in Germany. There is now a FORTH Interest Group<sup>3</sup> in USA devoted to spreading an awareness of these languages in the public domain. I am a member, and would like to hear from any UK readers that can provide information about these languages, or would like to receive information from me.

W. H. Powell  
16 Vantorts Road  
Sawbridgeworth  
Herts CM21 9NB

### References

1. C. H. Moore, "FORTH: a new way to program a mini computer," *Astron. Suppl.* 15, 1974.
2. K. Meinzer, "IPS, An unorthodox high level language," *Byte Magazine*, Jan. 1979.
3. J. S. James, "FORTH for microcomputers," *Dr Dobbs Journal*, No. 25.

## MICROS FOR AUTOMATION

Before attending the Robots '79 Conference\* I was completely in accord with your editorial "Micro mania" in the April issue and perhaps even more doubtful of the practical importance of "chips with everything." The first paper tended to reinforce this attitude by regretting the decline in mechanical engineering research, and in discussion of this paper it was agreed that the cost of a microprocessor is a minute fraction of the cost of a complete industrial robot.

However, as the conference progressed, with descriptions of actual working robots and their applications in manufacturing industry, it became apparent that the information-processing capability of the microprocessor, giving "intelligence" to a robot without the need for a cable connection to a large computer such as has often been used in robot research, makes all the difference. In the simplest case the microprocessor is used to make available (on request by a suitable signal) a specific selection from a very large memory. For example, one of the longest-established uses of robots

is for paint spraying, the robot simply repeating the pattern of movement which it has been "taught" by a human operator. With a microprocessor control it is possible to have a number of movement patterns stored and to call up the right one, together with the appropriate colour of paint, by an external signal. Then it is possible to have robot paint spraying on a car assembly line when successive cars are to be of different colour and may be different models (e.g. two-door and four-door). This could be done with an array of either relays or solid-state switches, but it would be very complicated, less reliable, less versatile and more expensive. Another example is a robot spot-welder which can follow a car as it moves down the assembly line, regardless of the exact speed of the line.

In 1959 I wrote a small book (rashly entitled "Intelligent Machines") in which I distinguished between mechanisation and automation on the criterion of information-handling by the machines in question. At that time there was very little true automation but a great deal of elaborate mechanisation — sometimes known as "Detroit automation" because of its association with the automobile industry in the form of transfer machines for multiple machining operations etc. Most of the "robots" of a decade ago also worked to a constantly repeated cycle, whatever the possibilities of changing that cycle by human intervention. It is the microprocessor which is now making it attractive to provide robots with sensors so that they can react to changes in their surroundings, without human intervention, thus constituting true or "cybernetic" automation. Examples of sensors are force transducers to control grippers or to prevent damage in the event of obstruction of an assembly operation and optical inspection of components for correctness and orientation before assembly. In most cases the microprocessor adds versatility rather than reducing cost, though there are a few cases in which great complexity of control has always been necessary and this can now be attained more cheaply by a microprocessor. It is notable that there is no mention of this aspect of the impact of microprocessors on industry in the report by the Central Policy Review Staff (the "Think Tank")†: they mention only quality control and control of the amount of work in progress in industry.

The moral of this seems to me to be that it does not matter whether we manufacture chips in Britain as long as British industry uses them: the effect on our balance of trade of importing the chips would be negligible compared with the effect on productivity of using them. I think it is agreed that the main problems are in programming (software) so that expertise in manufacture is not vital. In relation to the incorporation of chips in consumer products like automatic washing machines, I regard the question whether to manufacture microprocessor chips in Britain as a continuation of the debate whether to have a home semiconductor industry.

Part of the "micro mania" is the wild talk about unemployment which ignores the real problems. First, hours of work have decreased during this century and there is nothing sacrosanct about 40 per week. It may be that we should now be moving towards 30 per week, but this will exacerbate the educational and cultural problem of the use

\*Organised by the British Robot Association, 35-39 High Street, Kempston, Bedford MK42 7BT.

†"Social and Employment Implications of Microelectronics," November 1978.



of leisure (not mentioned by CPRS). Second, there will be a continuing move in the direction of shortage of labour with special skills and lack of employment for the unskilled (this is mentioned in one paragraph of the CPRS report). The danger is that qualified engineers and managers may be working 60 hours per week while unqualified school leavers stay permanently unemployed. On the one hand education must try to make people capable of acquiring appropriate skills. On the other hand we may have to provide for those who cannot acquire the skills required in automated industry: in 1956 I suggested that a suitable organisation to employ these people might be called "Omneploy," by analogy with Remploi. These are the real problems which are being largely ignored, drowned in the flood of "micro mania."

D. A. Bell (Professor)  
Walkington  
Beverley  
York

## DISPLACEMENT CURRENT

Your contributors (I. Catt *et al.*, December and March issues) are not alone in their dissatisfaction with the usual textbook assertions about the magnetic fields "caused" by "displacement currents". A more satisfying viewpoint supporting theirs is presented in the book "Classical Electromagnetism via Relativity" by W. G. V. Rosser, Butterworths (1968), (see particularly Chapter 4, Appendix 2 (p.243) and Appendix 6). However, Maxwell's equations themselves remain unchallenged, only our interpretation of certain terms is in question. Both electric and magnetic fields are associated with the moving charges set in motion when a capacitor is discharged and the changing electric field in the airgap does not "cause" a contribution to the magnetic field by the Biot-Savart relation. There is then no paradox to be explained when a finite-sized capacitor is regarded as a short transmission line.

Incidentally the controversy about relativity and time signals (L. Essen, October and April issues) is touched upon by Professor Cullwick in another philosophical book on electromagnetism ("Electromagnetism & Relativity", E. G. Cullwick, Longmans (1959), see Chapter 5, p.72).

R. W. Watford  
St Albans  
Herts

### The authors reply:

With the best will in the world, R. W. Watford's letter is based on the premise that, in the main, the body of knowledge in e-m theory and relativity is sound and coherent. He feels that all that is needed is to brew up the right mix of existing knowledge and all will be well. His contribution is to bring relativity to the rescue; a nice touch in the centenary year.

Previously, with less good will, P. I. Day brought  $\omega$  to the rescue. We would prefer to leave both out. After all,  $\omega$  is incompatible with relativity. (A sine wave exists at more than one point in space, which makes it unacceptable as a primitive in a relativistic universe which excludes instantaneous action at a distance.) These men have brought

up two incompatible fire engines to put out the fire.

It is of the utmost practical importance that digital designers have a theoretical framework which makes them able to design and build working, reliable systems.  $\omega$  has nothing to do with their problems, theoretical and practical. Also, computers do not rush past other computers at the speed of light. We must not continue to abandon high speed digital systems very late in the development cycle, as we have continually done in the past. (cf. *Computing*, 16 March 1978, page 2 and 30 March, letter.)

Maxwell's theory is pre-relativity. If someone has cobbled up a viable post-relativity Maxwell, please tell us where the ex cathedra statement of this theory is. Einstein did not do this, because he was not expert in electromagnetic theory. (*Physics Bulletin*, July 1978, page 297.) Einstein never read Heaviside, and did not have a grasp of Heaviside's concept of a transverse electromagnetic wave which travelled forward unchanged at the speed of light. Also, he never mentioned the impedance of space — a major oversight of e-m is being considered. Einstein did not know Heaviside's concept of energy current. Neither do contemporary relativity theorists, including Cullwick. Cullwick does not know about Heaviside's contribution to electromagnetic theory. Einstein's famous gedanken experiment, performed when he was aged sixteen and restated by him fifty years later (see "Albert Einstein: Philosopher-Scientist," ed. P. Schilpp, 1949) as the cornerstone of relativity, is incompatible with the energy current concept.

We must not let the ignorance and oversights of the last half century prevent us from building a sound electromagnetic theory from the ground up, and building thereon a viable digital electronics industry.

I. Catt, M. F. Davidson, D. S. Walton

## HIJACKING CARFAX?

I remember reading an account in *The Daily Telegraph* a few years ago describing the hijacking of a BBC radio programme and the statement that all transmitters had been changed to prevent a repeat of this. Now your report in your June issue (p. 56) the subsequent hijacking of various broadcasting services and comment that transmitters have been modified to make another such attempt impossible! The very way your article is written seems designed to provoke this kind of joke, since those working in electronics know that there is a way round any problem, provided one has imagination and is prepared to take enough time and trouble.

The forthcoming Carfax traffic information system is surely an even more vulnerable service as someone could presumably imitate the signalling tones and make whatever announcements he wanted to a captive audience. One can imagine people with transmitters fitted in their cars using them to clear vehicles from the road ahead by announcing bogus details of accidents or whatever, and it would be naive to assume that pirates could be easily tracked and prosecuted. Just look at the level of unlicensed citizens' band activity one hears of in London and other big cities which remains largely unchecked by Post Office action. Are the designers of Carfax considering the problem now, while the system is still in the trial stage?

Another area of concern must be satellites, not only for direct broadcasting, but also their use for live international programme link-ups. One recalls the 'black propaganda' operations during the last war, Project Aspidistra and the like, and wonders whether we should ever allow ourselves to become dependent on satellites for domestic broadcasting, whatever the attractions, as a malevolent foreign power would presumably have the resources to hijack such services.

Unless these possibilities are taken more seriously than in the past could we see the Carfax opening ceremony reported by newspaper headlines "Minister Opens Hoax?"

Peter Manson  
Leeds  
West Yorkshire

## S.S.B. FOR MOBILE RADIO

Regular readers of the electronics press will by now be aware of the recent publicity given to a new v.h.f. s.s.b. mobile radio system (June issue, p.95) Although it would appear at first glance to offer an ideal solution to the rapidly ensuing overcrowding of the v.h.f. private mobile radio bands, a question arises concerning the practicability of such a system. Receiver a.g.c. and demodulation processes rely on a very narrow crystal filter which extracts a pilot carrier from the received signal. From a paper and various articles on the system it seems that this filter operates with a bandwidth of 300Hz on a signal at an i.f. in the region of 10.7MHz.

Most crystal manufacturers will agree that the production of a conventional crystal filter with a bandwidth of 300Hz at a centre frequency of 10.7MHz is a daunting proposition. Obviously such a device has been manufactured, but it is most unlikely that a crystal filter of this specification could be produced in volume at a price that would be acceptable to the cost conscious mobile radio market.

This system represents an undeniable step forward in the field of mobile communications, but its viability for use in the near future should not be overestimated.

S. Walding  
Chelmsford  
Essex

## MILITARY ELECTRONICS

Having resisted the urge to reply to your January editorial I feel that the continuation of this dangerous line of reasoning by the publication of Mr Laycock's letter (May) demands that the other side of the argument be presented.

If you have read *Jane's Weapon Systems* thoroughly you must have noticed that much of the equipment described therein has been developed, and is deployed, by nations which at best can be considered unfriendly to Britain and her allies. Admittedly two wrongs will never make a right but one wrong plus the ostrich posture which you are trying to encourage will lead us to a world where, for most of us, freedom will mean the freedom to do as we are told.

I must also agree with Mr Laycock that there is excitement in the work and, as in any other industry, the prospect of personal

progress. Those of us who take our business seriously, however, are also strongly motivated by the need to contain a threat to the Western world which is being systematically developed at an alarming rate. If we succeed we will preserve for our society the opportunity to work for the improved quality of life which we, like everybody else, would like to see. If we fail then the freedom to publish emotive arguments entirely at odds with the carefully considered policy of the elected government of the land will be but a minor casualty.

C. D. Johnson  
Stockport  
Cheshire

## UNIONS AND ELECTRONICS

I had long since given up hope for Britain and was therefore particularly amazed to read the article "The role of the specialist in microelectronics - a trade union view" by Ken Gill of the Amalgamated Union of Engineering Workers. The only thing wrong with the article is that it is printed in *Wireless World* and not in the *Daily Mirror*. What a shame it is that the daily newspapers never see fit to print such important thinking instead of the banal, uninteresting, boring, and usually completely untrue rubbish that is usual and which I believe misleads the greater part of the people.

Whilst Ken Gill's letter is directed at engineers, I believe that most engineers have thought this way for at least the last ten years, but the unions don't seem to be able to achieve much in this direction, mostly as they are against any kind of reform.

A much more important point to arise from the article is that a trade unionist should think in this direction *at all*, and it is this I believe that needs much wider publication and should be brought home to the workers.

G. F. Nudd  
Oberfahlheim  
West Germany

## C-D IGNITION FOR A MOTORCYCLE

I have recently been successful in modifying Mr Marston's capacitor discharge ignition system (*Wireless World*, January 1970, p.2) for use with a two-cylinder motorcycle engine. Whereas it is the norm for cars to use one coil with a distributor it is usual for motorcycles to have one contact breaker and coil per cylinder. In-line four-stroke four-cylinder engines can economise by using one coil to serve a pair of cylinders - a plug being connected to each end of the coil secondary and both firing once per revolution. I have simply doubled up the thyristor part of the circuit, with each capacitor being connected to the inverter via an extra diode (see accompanying circuit).

For most engines that is all that would appear to be necessary, but experience with my own 90°V twin (Moto Guzzi) caused me to add  $Tr_5$ . Twice during the first 350 miles of use (about 2,000,000 sparks) it happened that a spectacular backfire occurred through the right-hand carburettor. Consideration of the operating cycle of this engine showed that

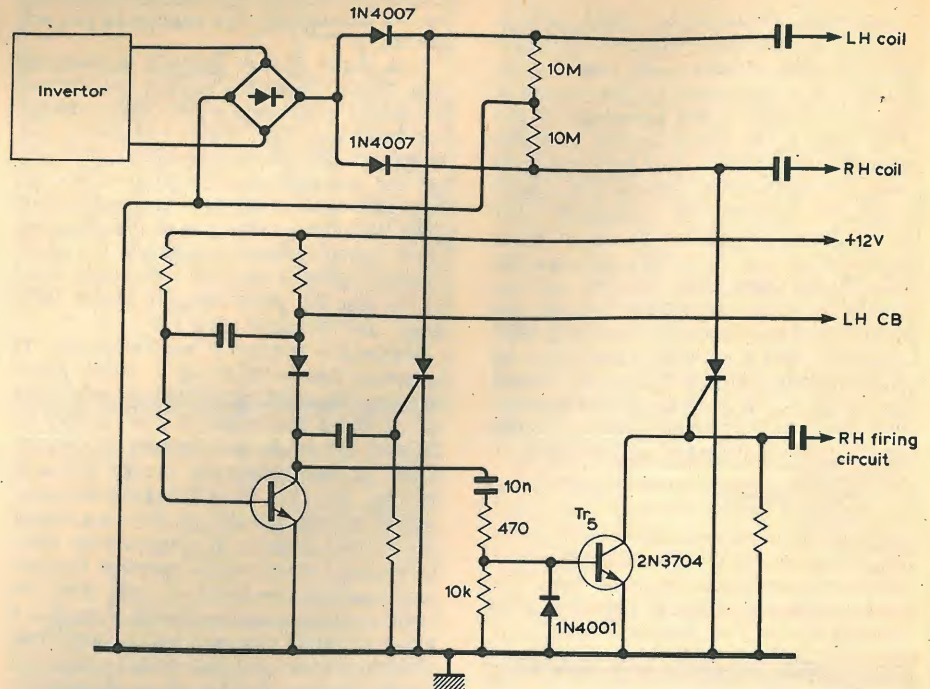

since the big ends share a common crank the l.h. cylinder fires during the intake cycle of the r.h. cylinder. (The r.h. cylinder fires during the exhaust cycle of the l.h. cylinder.) Presumably stray inductive or capacitive coupling caused false triggering of the r.h. thyristor. Even though this was a p.p.m. occurrence it seemed wise to try to avoid dumping the motive power in the carburettor again. Thus  $Tr_5$  has been added to clamp the gate of the r.h. thyristor when the l.h. one is fired.

Several million more sparks will be necessary before I can make any statistically significant statement as to the efficacy of this remedy. The same problem will be found in all three-cylinder engines and there it should suffice to add three clamp transistors in a cyclic fashion. However, a three-cylinder two-stroke engine will require a very high spark rate capability (450 sparks/second at 9,000 r.p.m.) which in my experience will be pushing the Marston inverter to its limit.

J. H. J. Dawson  
Kenilworth  
Warwickshire

same time, obviously you cannot move through air faster than sound. But we know from experience that this mathematically logical conclusion is nonsense. At 500 yards an Enfield will put the bullet past your nose before you hear the report. You hear the shock wave of the supersonic projectile, then the report. Shock wave phenomena were unanticipated by my mathematical model, and so the logically derived result bears no resemblance to reality.

All mathematical conclusions are conjecture until demonstrated.

It is extraordinary that after half a century Einstein's conclusions await demonstration.

Jack D. Dennon  
Micromethods  
Warrenton  
Oregon, USA

## CASSETTE COMPATIBILITY

I was interested in Adrian Hope's piece on cassette compatibility on page 71 of the June issue because I have been researching into the performance of metal particle tapes on ordinary decks designed specifically for metal oxide formulations. I cannot agree with Hope and I veer more strongly towards Philips' views that "good results" can be obtained with metal tapes.

Of course, the greater coercivity is going to have a marked effect on upper-frequency response, but one must not be blinded by the upper frequency lift when response measurements are made at a mere 20nWb/m (e.g., 20dB below Dolby level). The trouble with oxide tapes is that they "compress" at h.f. and at high levels far earlier than metal tapes. Thus by using metal tapes on ordinary machines a far greater h.f. headroom is secured. Each year we measure some 500 tapes on many different machines and have devised a method of ranking, taking account of seven parameters (including small-flux frequency response). The results overall are referred to a "star" notation, where \*\*\*\*(+) is highest and \*(-) lowest. On the machines

## RELATIVITY AND SOUND WAVE SPEED

Thank you. Few publications would yield space for Dr Essen - or anyone else - to suggest that the Theory of Relativity might be anything less than perfect (October 1978 issue).

There is an interesting similarity between the mathematical expressions found in Relativity and those found in compressible flow theory. For example, it may be proven mathematically that nothing can move through air faster than the signal speed through the medium, that is, the speed of sound. It is the sound waves moving out in front of you that tell the air to get out of your way. If you were to move too fast you would overrun your sound waves; the air out front would not know you are coming and so it would not get out of your way. Since no two masses can occupy the same space at the

so far measured with metal tapes overall results of \*\*\*\*(+) have been achieved relative to top-formulation oxide tapes of various kinds.

We have been getting erase ratios of 60dB, 400Hz, 66dB, 1kHz and 80dB, 10kHz. M.o.l. at 10-11kHz (-30dB 3rd-order i.m.) is up to -6dB with metal tapes compared with -12dB (typical) with oxide tapes — on ordinary machines! It seems that someone sometime published that metal tapes will be sinularly unsuitable for ordinary machines and that now commentators are incorrectly disseminating this original statement without the support of detailed measurements.

A mere 10% coercivity spread in my judgement is not going to yield the inter-metal tape compatibility problems as cited by Hope. It seems such a pity that the start of a new cassette tape era is so blatantly attacked seemingly without technical support in defence.

As a further thought metal tapes can give a renewed 'sparkle' to those machines in which the heads are worn and as a result the upper-frequency response impaired with oxide tapes.

Gordon J. King  
Brixham  
Devon

*The author replies:*

Although I am not qualified to agree or disagree with Mr King's lab. measurements, I have a gut feeling that it makes sense to at least start with an agreed coercivity e.g. 1,000 oersted, rather than a spread of 10%. The situation is analogous with surround sound. If material is encoded according to one specified format then ideally it should be decoded according to the same format. The fact that liberties may be taken with the encode-decode chain, just as liberties may be taken with the coercivity-bias/equalization relationship, is a bonus of serendipity.

I discovered at Eindhoven airport, on the way back to England from the original Philips metal cassette launch, that the tape would both record and erase on a portable machine without even a chrome setting switch. I was advised that the real test would be to use the same portable machine to try and erase a metal cassette recorded on a metal machine. At the JVC and Metafine joint launch in London I did just this. I loaded my portable machine with a demonstration Metafine cassette produced by JVC and my portable erased it. Even when reproduced over the hi-fi sound system used by JVC for the press launch there was no trace of residual signal after erasure on the portable. No one from JVC or 3M who was present could explain this phenomenon, which flies in the face of everything we had been told to expect about metal tape, and both JVC and 3M promised to come back to me with further information. I have not heard anything further from either JVC or 3M.

Adrian Hope

## 3D TELEVISION

The article by Professor D. A. Bell, "What future for television" (November, 1978, issue) calls for comment and correction.

He mentions the visual analogue of surround sound shown in Brussels in 1952. I did not see that show but did see a very similar demonstration in London, I believe in the early 1960s. As described in Bell's article the

audience stood and could walk about in a circular theatre to observe a "circle" of eight pictures of the usual Academy 4 x 3 format projected on screens above head level. The eight projectors were synchronised and appropriate sounds emanated from speakers behind the screens. The exhibition was called "Circlarama" and I believe was sponsored by a Russian organisation. There was no story line to the presentation but just a series of moving scenes filmed in the USSR. It was most effective and I particularly remember one of the last sequences where the cameras were mounted atop a vehicle travelling through a large city and it suddenly swung through 90 degrees to the right to pull into a coach park. The psychological impression was so forceful that, although perfectly sober and standing on a solid cement floor, I had the greatest difficulty in maintaining my balance and almost fell over! The theatre was situated just behind Piccadilly Circus the entrance being situated in Denman Street. If any reader could refresh my memory concerning the date or other details I would be most obliged.

The suggestion that one may present a stereo pair by halving the field of view and presenting two side-by-side pictures which can then be combined by polarisation techniques ignores two problems, although basically feasible. In practice the non-linearity of the line timebase in normal domestic receivers resulting in differing geometric distortions in the horizontal plane will prevent the left and right images being correctly superimposed. Also one cannot simply superimpose them by cross-polarisation. One has to displace them optically, which of necessity requires the use of a light tunnel with suitable mirrors and then this limits viewing to one person at a time. Not a viable commercial/domestic proposition although suitable for some scientific applications.

A three-dimensional colour system fully compatible with existing colour tv channels has been in existence for some time. It produces 3-D pictures in colour and the only modification necessary to existing equipment is the addition of a separate module inserted into the camera lens. The resultant pictures which may be on ordinary colour film or colour tv are seen as normal "flaties" when viewed normally, but if viewed through appropriate spectacles are seen in 3-D. A description of the system, based on the analglyph system is described in the *American Cinematographer* for April, 1974. This journal contains several "stills" taken by this method plus a set of spectacles which cause the pictures to appear in 3-D. Therefore a compatible system as called for by Professor Bell is now available. It was developed by Video West Inc.

Professor Bell states that "the cinema tried stereoscopic presentation, e.g. by the red/green method as a stunt but does not appear to have produced any normal film in 3-D, neither feature nor documentary". This is one hundred per cent incorrect. A list of one hundred and twenty-one 3-D films appears in the above mentioned journal including features, shorts, documentaries and cartoons. At least one hundred and eighty such productions have been made in the West, variously in Polaroid, Analglyphic and Lenticular.

In the USSR stereoscopic cinematography has absorbed a large amount of effort for many years and many special 3-D motion picture theatres have been constructed in their larger cities and have a regular and

large attendance. Full length feature films are regularly shown.

Finally, there is now some sign that condensed versions of American 3-D productions are becoming available to amateurs. One is "The Creature From The Black Lagoon", 1954 (Polaroid system) available from P.M. Films Ltd, Windsor End, Beaconsfield. This is a 2-reel sound analglyph version for the amateur market (so-called Duocolour). A second is "It Came From Outer Space", 1953 (Polaroid system) but Duocolour analglyph for amateurs. This is available on Super-8 sound from Capitol Films Ltd, 193 Wardour Street, London, and on 16mm sound from Golden Films, of Frances Road, Windsor.

Professor Bell really must do his homework before he writes another article on this subject! However, where I would support him is in prodding the broadcast authorities into televising some of the professional films made in analglyph. Although only people with colour receivers could view them and they would probably have to be broadcast outside normal peak hours, why not! The BBC in particular seems addicted to showing old films; why not a few 3-D as well! Most of us have never seen them and would welcome the chance.

A. E. Lott  
Reading, Berks

## SHOW LEGISLATION ON TELETEX

Another use for teletext has presented itself. In the January issue, on page 47, you reported that "nearly 70% of the top executives in Britain are ignorant of the product-liability laws soon to be drafted into the country." This is just another example of a problem which the Kilbrandon report described in 1973, when it remarked that the modern flood of legislation makes ignorance of the law not only excusable but inevitable.

Elsewhere (para 1243) Kilbrandon said that television should be used to show people how government is run. If teletext had existed at the time the Commission would doubtless have remarked on its various possibilities.

Teletext can go a long way towards solving the problem of ignorance of the law by systematically keeping us up to date with legislation. It can become a "legislative-information-system" by setting aside a group of pages which would list and summarise all new bills and statutory instruments for a period of 1 or 2 months.

In addition the most important bills should be treated more fully with the most important clauses being displayed verbatim twice; once in the form in which they were introduced into parliament and again in the form that was eventually passed. The purpose of the initial display would be to enable us to make representations to the government before it was too late.

If teletext begins this service it will soon become an indispensable aid to business.

Those responsible for teletext should take comfort from the fact that the system is currently in the same position that the laser was in 20 years ago. It is a solution looking for a problem. There are plenty of problems which teletext can solve and the people concerned should take heart from the laser example.

S. Frost  
Dunsyre, Lanarkshire

# Audio preamplifier with no t.i.d.

Passive equalization eliminates transient intermodulation

by Yuri Miloslavskij, Institute of Constructional Physics, Moscow

In valve circuits, device linearity received much more attention than it does with transistors. Now, everything relies on feedback. Or one decreases steepness of the output characteristic of bipolar transistors with the help of an additional transistor.

But you may use a single transistor with better linearity. The problem of optimizing the number of stages is associated with having sufficiently linear transistors of optimal frequency properties, gain, noise and other characteristics. Designers of semiconductor devices should pay serious attention to designing such components. Their use would give even better results than the circuit described provides.

THE GREAT MAJORITY of published designs for electromagnetic pickup preamplifiers realized with valves or semiconductor devices have a feedback correction circuit according to RIAA covering one amplification stage but more often the entire preamplifier. In other, rare, cases preamps have a common negative frequency-independent feedback in individual units with the correction in a passive circuit. By such a circuit design superior results have been often achieved as to the harmonic and intermodulation distortion, though such attainment will never help to improve the sound to its original state as may be aimed and because some factors do not lead to any improvement at all.

As to the playback frequency response it is clear that this, along with non-linearity increasing with increase in frequency, contributes to the emphasizing of difference tone distortion, and the greater the frequency shift between the basic components and their associated difference tones the stronger is such emphasis.

So-called transient intermodulation distortion has not been measured as a result of novelty and complexity of this measurement, the lack of a unified and standard measurement method<sup>1</sup> and the lack of quantitative information on perceptibility; in some cases it has been completely ignored.

Listening tests also reveal specific distortions in preamplifiers, particularly in i.c. types. This was the reason for getting back to valve circuits. Temporal

problems have been involved also by some other trends in the amplifier design (among other things as a result of the quest for the realisation of the entire preamp as a d.c. amplifier).

But the return to valve circuits is hardly justified, even though it leads to a decrease in transient intermodulation. As to semiconductor amplifiers the situation for most of their technical parameters is more favourable, i.e. frequency properties, noise characteristics, and power consumption. The common tendency is questing for non-linear distortion of the order of 0.001% or even less (this aim is difficult to attain by valve circuits and has not really been attempted). It is known that under contemporary conditions such a distortion level can be achieved only by the one method. But will it lead to the desired results?

To try and answer this question the following must be taken into account:

- Often a recording level relating to particular frequencies at velocity 14 cm/s is taken for the rated recording level—at l.f. the recording level is limited to a certain amplitude of groove displacement. (It would be useful to plot a frequency response of the maximum velocity for example on the basis of the data given in reference 2; this relationship is also necessary to provide a logical method for distortion measurement.) It's known that during recording some signals exceed this rated level. But the probability of appearance of a signal having, for example, a level  $9 \times 3.54$  cm/s is not likely to be high (though this statement is not strictly exact because some firms make records under a high level condition). In addition, only few pickups can reproduce such signals.<sup>3</sup>
- Distortions introduced by recording process and disc production technology (harmonic distortion, difference and additive tones, intermodulation distortion) at velocity 14 cm/s are less than about 1% (at velocity 25cm/s no more than 4% (!) harmonic distortion at 1kHz is guaranteed on B&K test-record QR2010).
- Distortion introduced by the reproduction process because of certain factors (tracking distortions, pinch-effect, angle distortion, refs 4 to 7) at

corresponding recording velocities exceeds distortion introduced by recording process, and at some frequencies may be as great as 10% and even more for harmonic distortion, 3 to 4% and more for intermodulation distortion<sup>3,8</sup>. Additive and difference tones distortion is of the same order as harmonic distortion.

- The hearing square and cubic non-linearity ( $P_2 = \alpha_1 P_1 + \alpha_2 P_1^2 + \alpha_3 P_1^3$ ) shows itself as the subjective presence mainly of difference tones, as a rule exceeding hearing thresholds under masking. Masking effect consists in masking of some tones including distortion products by louder tones under certain conditions. For example the white noise in the bandwidth 20Hz to 20kHz masks the tone if the sound pressure level exceeds the spectral density noise level by 17 to 30dB. (Refs 9.)
- Studies performed in the USSR during late 1950's and 1960's revealed that more than 50% of sound producers and conservatoire students could not notice 2% square or cubic distortion in organ and violin solo performances.<sup>10</sup> It was also revealed by these studies that cubic distortion is more noticeable than square distortion as one would expect.
- Distortion introduced by tape recorders during recording, by the final mixing of sound tracks, by loudspeakers and other permanent factors act as an essential addition to distortion introduced during reproduction.

Based upon the above-listed considerations one can obviously conclude that in numerous cases sound coloration by preamplifiers and power amplifiers is caused by some special, and if you like pathological, non-linear distortion not properly pertaining to the electro-acoustic transducers and to the ear.

Transient intermodulation distortion as well as distortion severely increasing at low levels and large non-linearity of high order may be attributed to the above-mentioned special non-linear distortion.

Large high-order non-linearity results in large amplitudes of high harmonics, and of difference and additive tones of high order (an increase of side components of intermodulation spec-

trum). This means lack of steepness in non-linearity attenuation, i.e. insufficiently fast approach of coefficients  $\alpha_4$  to  $\alpha_n$  to zero in

$$V_{out} = kV_{in} + \alpha_2 V_{in}^2 + \alpha_3 V_{in}^3 + \dots + \alpha_n V_{in}^n \dots \alpha_2 \text{ to } \alpha_n \rightarrow 0,$$

$$V_{in} = b_1 \sin \omega_1 t + b_2 \sin \omega t \dots$$

$$\alpha_k = \alpha_k(b, \omega).$$

Therefore the problem consists of finding a more optimal (logical) way of obtaining specified parameters (quantitative values)  $\alpha \dots \alpha_n$ , t.i.m. distortion, signal-to-noise ratio,  $f_{upper}$ , and by as simple a method as possible.

In designing the preamplifier it was proposed that distortion introduced by disc reproduction would not practically increase correspondingly with frequency and velocity and that distortion not properly pertaining to the electroacoustical transducers would not be introduced. It was expected that signal-to-noise ratio with pickup connected would be about 69dB(A) referred to an input level of 2mV (3.54cm/s) at 1kHz (ref. 11) and no less than 50 to 55dB in linear band of 20Hz to 20kHz (though it is not necessary to aim at such a high figure as 69dB at all because of worse signal-to-noise ratio of discs).

Based on the above-mentioned considerations I propose a circuit design for a preamplifier for electromagnetic pickups with bipolar transistors which produces practically no transient intermodulation distortion (below).

There is no common negative feedback; correction according to RIAA is accomplished in a passive circuit. The design is comparatively simple but it calls for high-quality components. The number of components and amplifier stages is practically minimal. The preamplifier provides a gain of 34dB at frequency 1kHz which more than twice exceeds the allowance required on the basis of data given in reference 2.

This circuit design is based on a close analysis, leading to the following main conclusions:

1. Bipolar low-noise transistors are now available which provide rather good amplification linearity at collector currents beginning from 100 to 150µA, at the same time as maintaining the required frequency properties at these currents.
2. From the distortion viewpoint the optimal place for a passive correction circuit is between the first and second amplification stages.

3. Signal attenuation by a passive correction circuit does not cause trouble, provided the operating conditions of the subsequent (and the first) stage are optimally selected and a low-noise transistor used.

4. Analysis of circuitry for a preamplifier having one voltage amplification stage with either passive or negative feedback RIAA correction) leads to unattainable technical requirements, especially for moving-coil cartridges.

**Circuit description**

The first amplification stage provides 75µs-time constant referred to 2mV per 3.54cm/s and its input resistance is decreased by resistor  $R_L$  to the required standard value (30,47 or 100kΩ). The required collector current in the first amplification stage is set by  $R_3$ . A bias circuit with fixed base current (rarely used) was selected mainly on the basis that the input resistance of the first amplification stage should be at least 100kΩ, and that contemporary low-noise low-power silicon transistors have collector reverse current of less than 1nA ( $V_c = 0$  to 5V,  $T = 20^\circ C$ ). At temperatures of  $25 \pm 20^\circ C$  instability of collector current is less than  $\pm 7\%$  (with

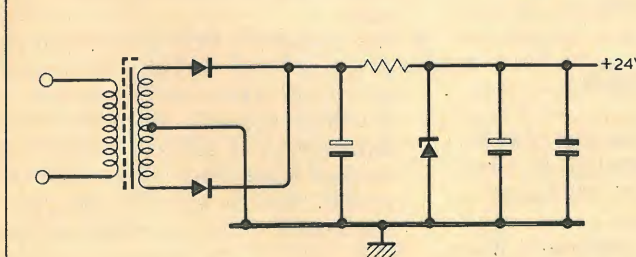
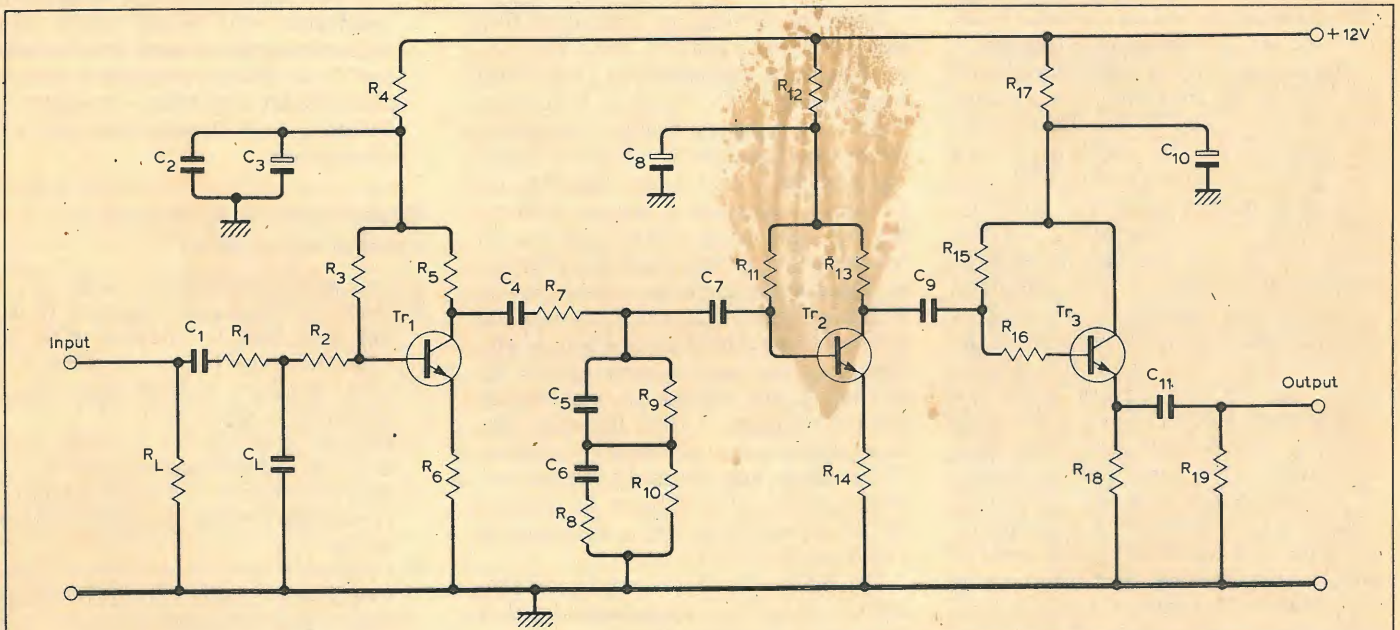

Michael Sagin plans to provide printed circuit boards for a stereo version for £3 inclusive of V.A.T. and postage. His address is 23 Keyes Road, London, N.W.2.

|                 |          |                |          |                 |     |
|-----------------|----------|----------------|----------|-----------------|-----|
| Tr <sub>1</sub> | BCY 55   | C <sub>5</sub> | 220n     | R <sub>7</sub>  | 25k |
| Tr <sub>2</sub> | BCY 55   | C <sub>6</sub> | 47n      | R <sub>9</sub>  | 33k |
| C <sub>2</sub>  | 100n     | C <sub>7</sub> | 1.0µ     | R <sub>8</sub>  | 160 |
| C <sub>3</sub>  | 300µ,25V | C <sub>8</sub> | 300µ,25V | R <sub>10</sub> | 1k4 |
| C <sub>4</sub>  | 1.0µ     |                |          |                 |     |

|                                | 2mV/3.54 cm/s            | 200µV/3.54cm/s           | 110µV/3.54cm/s           |
|--------------------------------|--------------------------|--------------------------|--------------------------|
| C <sub>L</sub>                 | 50-250p                  |                          | 220n-10n                 |
| R <sub>L</sub>                 | see text                 | see text                 | 100                      |
| C <sub>1</sub>                 | 2µ2                      | 22µ                      | 22µ                      |
| R <sub>1</sub> ,R <sub>2</sub> | 100                      |                          | 7R5                      |
| R <sub>6</sub>                 | 1k                       | 100                      | 27                       |
| R <sub>5</sub>                 | 75k                      | 33k                      | 33k                      |
| R <sub>4</sub>                 | 24k                      | 6k8                      | 6k8                      |
| R <sub>14</sub>                | 750                      | 330                      | 330                      |
| R <sub>13</sub>                | 43k                      | 33k                      | 33k                      |
| R <sub>12</sub>                | 33k                      | 6k8                      | 6k8                      |
| R <sub>3</sub>                 | -IC <sub>1</sub> = 200µA | -IC <sub>1</sub> = 500µA | -IC <sub>1</sub> = 500µA |
| R <sub>11</sub>                | -IC <sub>2</sub> = 200µA | -IC <sub>2</sub> = 500µA | -IC <sub>2</sub> = 500µA |

a sufficiently high value of  $R_3$ ) and may be easily tolerated. Analysis reveals that this instability depends mainly on temperature drift of transistor current gain, and also on voltage source stability, resistance value of isolation filter resistor (for voltage supply), and resistor stability.

The value of collector current in the first stage ( $200\mu\text{A}$ ) meets in a compromising way the following contradictory requirements: necessity for utmost minimized noise level on the one hand and obtaining the required distortion level, satisfactory frequency response and a level allowance with regard to peaks on the other.

The value of the local negative feedback resistor is selected on the basis of the same compromise. It should be noted that more stringent requirements are placed upon the linearity of the first stage of voltage amplification and upon its independence on frequency, and this approach helps to decrease the level of difference tones derived even from very high frequencies. Harmonic distortion (referred to the second harmonic) should not exceed 0.03 to 0.06% ( $V = 14\text{cm/s}$ ); the upper frequency limit should be as high as possible.

The subsequent amplification stage is realized in the same manner. The collector current value in this stage ( $260\mu\text{A}$ ) was selected on a similar basis. The next stage is the emitter follower.

The preamplifier is constructed with the help of the following components. Transistors  $\text{Tr}_1$  and  $\text{Tr}_2$  are the differential assembly BCY55, which provides a low level of infrasonic and low frequency noises, sufficient linearity, high gain in the operating current range, around 200, and has the required frequency properties. For isolation polycarbonate capacitors are selected (several isolating capacitors provide the required steep sharpness for attenuating signals containing infra-low frequencies). Resistors are of the high stability, 1% tolerance, low-noise class. Capacitors in the correction circuit are of polycarbonate type, 2% tolerance. Capacitor  $C_L$  is of mica or polycarbonate type; it is selected on the basis of pickup specification and input cable capacitance. Transistor  $\text{Tr}_3$  is a low-noise linear silicon transistor, current gain is about 1000.

The preamplifier is supplied by battery or by a stabilized voltage source in a separate casing. The principle circuit diagram of this supply unit is shown on Fig. 1. Stabilized output voltage is 24V, hum level no more than 3mV. The application of this power supply circuit provides a safety margin for the required isolation from conducted interference of various frequencies and hum. This power unit and its isolation filters, does not introduce additional noise and interference at the preamp. output. Electrolytic capacitors of power unit and isolating filters are of solid tantalum type. Other capacitors are of low-inductance film type.



Thirty-two years old Yuri Miloslavskij is presently doing post-graduate work in the laboratory of architectural acoustics within the Institute of Constructional Physics, Moscow. He first started working in the field of acoustics and electro-acoustics at the Institute of Television and Broadcasting, which he joined five years ago. Yuri Miloslavskij graduated in physics from Saratov University in 1971.

Recently moving-coil cartridges find expanding application even in non-professional reproduction, resulting from the obvious merits of that type. With such a circuit design the preamplifier may be directly connected to a moving-coil cartridge merely by changing component values, without giving rise to a deterioration in specification; in this case the preamp. provides a gain increase of 20dB (26dB). Collector current in the first and the second stages is increased to  $500\mu\text{A}$ . The former power unit is used merely by changing the values of resistors in isolation filters. It thus becomes unnecessary to use a special pre-amplifier. The preamp. may be used even for cartridges such as the Ortofon SL20Q and MC20, providing a very low output of  $110\mu\text{V}$  per 3.54cm/s.

Similar modifications enable this preamp. to be fed by tape-recorder head or dynamic microphone signals.

#### Measurement data at input levels of about 2mV

1. Gain at 1kHz frequency: 34dB (amplification instability in the above-mentioned temperature range is no more than 0.5dB).
2. Signal-to-noise ratio referred to input level 2mV at 1kHz with a magnetic pickup connected: 64dB(A); in linear band 22.4Hz to 22.4kHz: 58dB.
3. Harmonic distortion at input level 8mV (14cm/s) at 1kHz: 0.15%. (In constant output voltage mode harmonic distortion doesn't increase with increase in frequency. Analysis of the level of high harmonics  $n = 4$

to 20 with  $f_{n=1} = 1\text{kHz}$  has revealed that their amplitudes are well below the third and especially the second harmonic; this demonstrates more than necessary attenuation of non-linearity.)

4. Intermodulation distortion at input levels  $1\text{mV}/60\text{Hz}$  and  $8\text{mV}(16\text{mV})/7\text{kHz}$ : 0.25%.\*
5. Difference tone 1kHz with input level of basic frequencies 10kHz and 11kHz being 8mV and at an amplitude ratio 1/2: 0.3%. Additive tone distortion doesn't exceed harmonic distortion.
6. Distortion increases proportionately to input level with a proportionality factor of about one.
7. Frequency response accords to the RIAA standard in the range of 100Hz to 10kHz with  $\pm 0.5\text{dB}$  accuracy ( $30\text{Hz} + 1\text{dB}$ ,  $20\text{kHz} + 3\text{dB}$ ).
8. With the gain at 1kHz being equal to 40dB (the second stage gain increase is 6dB) s/n ratio referred to  $2\text{mV}/\text{kHz}$  is 67dB(A). In this case the harmonic and intermodulation distortion increase for times (compared with 3 & 4); the difference tone distortion remains of the same order as in 5.
9. The upper 3dB frequency limit of amplification exceeds 125kHz (internal resistance of the sinusoidal oscillator was made  $15\text{k}\Omega$ , the approximate equivalent of a pickup and  $C_L$  at h.f., the correction circuit under RIAA stipulation changed to 240-ohm resistor; and capacitor  $C_L$  eliminated).

#### Measurement data at input levels of about $200\mu\text{V}$

1. Gain at 1kHz frequency: 54dB.
2. Signal-to-noise ratio referred to input level  $200\mu\text{V}$  at 1kHz with an equivalent cartridge resistance 5 ohm: 61dB(A) and in linear band 22.4Hz to 22.4kHz: 54dB.
3. Harmonic distortion at input level  $800\mu\text{V}$  at 1kHz frequency: 0.15%.
4. Intermodulation distortion at input levels  $100\mu\text{V}/60\text{Hz}$  and  $800\mu\text{V}/7\text{kHz}$ : 0.25%.
5. Difference tone with level of basic frequencies 10kHz and 11kHz being  $800\mu\text{V}$  and at amplitude ratio 1/2: 0.2%.
6. Signal-to-noise ratio referred to input level  $110\mu\text{V}$  at 1kHz at preamp. gain 60dB (first stage gain nearly doubled): 59dB(A), and referred to input level  $9 \times 110\mu\text{V}$ : 78dB(A). Difference tone doubled (compared with 5), though harmonic and intermodulation distortion remain as in 3 & 4.
7. Other technical data are not worse than in preamp. version for input levels of 2mV per 3.54cm/s.

\*maximum recording velocity at 60Hz around 2cm/s.

# Citizens' band communication system

by Howard T. Tillotson, M.A., M.Inst.P.

Although many of the world's developed nations permit a citizens' band, where untrained amateurs may communicate using modest radio transceivers, this is not so far the case in the UK. One of the licensing authority's central objections to its introduction here is that other established services working on the frequencies which are conventional for c.b. in other countries would be adversely affected by its introduction. The author of this article maintains that there are alternative reasons for not introducing it in its existing form. Furthermore he claims that it will always be ineffective as a basic channel of "message carrying" for the same reason as the telephone's main limitation, i.e. that someone has to be there to answer it, and he outlines a possible microprocessor-aided method working on conventional c.b. frequencies.

The idea for this communication system had its origin in a long-standing wish to own and operate a pair of "personal" transceivers. At first sight it might seem that they would be very useful, but on reflection it becomes clear that they could never be employed in an effective manner. As an example, a "c.b." walkie-talkie could be taken along when a family makes a shopping trip to a busy city centre and subsequently becomes split up in the crowds. In principle it could be used to arrange a rendezvous, but in practice very few people would be prepared to hang around in a busy street wasting time in an effort to "raise" someone who may or may not be listening out for a contact.

In its conventional form c.b. communication is very much like the telephone in that it is a good idea but somewhat inadequate as a direct contact device. It is really only useful if the person you want to speak to happens to be near the particular instrument you are calling. Further deficiencies include the fact that a message cannot be left if the instrument is not answered (except where an answering machine is in use) and the impossibility of speaking to someone on a line which is already engaged. Companies are forced to install switchboards and exchanges to overcome this inadequacy. The private subscriber probably suffers this situation because of the more time-consuming act of writing a letter. Also, most sub-

scribers are not aware that technical processes exist which could provide a much more effective system. In a similar way, c.b. communication in its conventional form requires that the recipient be listening when the transmission is made, and voice transmission is a wasteful way of deploying channel capacity.

The outline which follows is concerned with principles rather than technical details and combines some of the advantages of the telex system with aspects of c.b. operation, based upon microprocessor techniques.

## General outline

The hardware consists of a hand-held portable unit with dot matrix display units capable of displaying alphanumeric characters. The unit is also fitted with a key-pad providing features similar to those of a typewriter. As messages are entered on the keyboard of the sending machine, so they are transmitted in an encoded form to the receiver, where they are displayed. Each new character enters at the right-hand side of the display, moving gradually to the left for reading.

As it stands, such a system demonstrates certain deficiencies. The recipient needs to be waiting for a message in order to read it as it appears, and in such a basic system the carrier would be operating all the time the message was being displayed, thereby wasting power. An improvement could be effected here by using electronic storage to assemble a whole message prior to transmission and then to transmit this into a similar storage system at the other end. Having received a message the unit would give either an audible or visual alarm to indicate that a message had been received. The operator could then press a button to activate the display. Such a storage method also implies that a unit could be left switched on in a pocket or handbag. On hearing the alarm the owner of the machine knows that a message has arrived but need not be read immediately — this could be left for a more convenient moment, say in quieter conditions.

One important point is that the equipment should provide confirmation to the sender that the message has been received and stored — this would be essential should a reply be required.

## User identification and the c.p.u.

As a large number of users would probably be in range of each message transmitter, and there may well be restricted bandwidth available, it would be necessary to introduce more selective operation of each process. This could be managed by introducing microprocessor control and an "address" code which refers only to the recipient of the message. This code is transmitted first and only the receiver with the correct code continues to read. Similarly, in order that the recipient knows who has sent a message, the address code of the sender could be included at the end of each transmission.

## In-car communication

A popular feature of conventional c.b. activity is the capability it gives to the occupants of cars to communicate with each other. However, the need to operate a key-pad would in general force a driver to stop the car before sending a message. This could help to overcome one of the objections of those opposed to the introduction of c.b. which maintains that it is dangerous for a driver to attempt both activities simultaneously, although it might be argued that the temptation to transmit while actually driving might still be acted upon, making the process even more dangerous. On the other hand, at least car registration numbers could be used as the address codes which would also make it a fairly simple matter for the licensing authorities to maintain a check upon such activities.

The requirements for users to know each address code in the network might be thought a dangerous feature at first sight as a perverse approach might lead to trouble — using someone else's code for example. This will probably not prove to be the case as any messages received which were intended for somebody else would automatically prevent any decoding of messages intended for the eavesdropper. A crude analogy might be that of someone holding the telephone handset off the hook in the hope of picking up an interesting message on a crossed line, thereby missing any messages actually intended for him.

So far, the system would function, but there are a number of problems related to traffic density in terms of messages.

For example, if a machine could not get time on a channel owing to the available spectrum space having been used up by other machines, the processing unit would have to calculate the wait required before transmission could take place and fit this into a priority sequence. How long a machine should wait before abandoning the message completely is another problem, as is the question of linking all units together (perhaps using a brief pulse "recognition" sequence) so that the intelligence to calculate traffic density, waiting time and urgency would exist in a form shared by all units.

Most of these processing activities should be fairly easy to arrange using current logic devices, but the question of restricted range introduces a fundamental problem of transmitter coverage. As each transmitting unit would have to be restricted in its output power, messages might not be read properly, so a network of relay stations would have to be set up. Undoubtedly this would cause a good deal of debate between the advocates of such a system and the relevant funding body, but it would clearly be essential if the system were to be truly effective. The relay system could be optimised by program-

ming in a "relay" facility, to be activated by the user when the destination is considered out of direct range.

### Summary

As described here, a basic message communication system could overcome the inherent interference problems of conventional c.b. operation, although it would of course eliminate the usual "chit-chat" nature of immediate voice contact. However, it could be useful and economical as a message medium and should be relatively easy to design around modern processing and display devices.

## Audio processor design

*continued from page 39*

to-pk. Turn the clipper drive to maximum and adjust  $R_{65}$  for 350mV pk-to-pk, then turn it to minimum and adjust  $R_{64}$  so that the level falls to 35mV pk-to-pk at TP4. Monitor TP5 and with  $R_{67}$  set to the earth end of track, adjust the oscillator frequency by  $C_{50}$  until a maximum i.f. signal is obtained. Temporarily remove the audio and carefully adjust  $R_{66}$  for a minimum i.f. signal — less than 200mV pk-to-pk. Reconnect the audio and monitor TP6 to observe a sine wave. If the output is not a sine wave, repeat procedure on TP5. Increase  $R_{67}$  until the signal limits, then reduce slightly and turn up the clipper drive, checking that the level remains constant.

Set the sig. gen. to 300Hz, readjust  $C_{50}$  until the waveform is undistorted and the level has fallen slightly below its maximum (about 15%). Repeat the carrier null adjustment (i.e. remove audio and adjust  $R_{66}$  for minimum i.f. signal). Next adjust the output preset  $R_{68}$  to obtain a 1V pk-to-pk fully-clipped signal at the output.

Monitor TP7, checking that the level is the same with the clipper circuit switched in and out, — i.e. 1V pk-to-pk. Finally, connect the microphone and monitor TP7, adjusting the meter for speech to just peak. Turn the clipper to minimum and compare the signal with the clipper in and out. If there is any sign of clipping, adjust  $R_{67}$  to reduce the i.f. gain until the effect disappears. Typical waveforms expected at the test points are shown in Fig. 9.

### Application

It is vitally important that a compressed signal is correctly applied to the transmitter with which it is to be used. The methods of setting up levels will, to a large extent, depend on the transceiver in use and what metering is available. Most s.s.b. transceivers have power-output metering, so setting levels should be straightforward. Switch in the clipper and turn up to full, adjust the mic. gain for correct meter reading, turn up mic. gain on transmitter to full and

set the output preset on the processor to minimum. Key the transmitter and talk loudly or whistle, to ensure fullest modulation, then turn up the output preset until the output power just reaches its maximum. An output-power/v.s.w.r. meter would also suffice for this stage of the proceedings. For f.m. applications, the process ideally requires a peak deviation meter for best results. In this case, proceed in a similar manner to the above but only increase the output to the point where the peak deviation reaches that required — typically 5kHz for amateur applications.

Experience shows that, in normal use, the tone control should be adjusted for clear, well-balanced audio from local stations, and the clipper should be used progressively as the stations become more difficult to work. When the clipper is about half advanced it is advantageous to switch in the high lift which will make the effect of the clipper more pronounced. Use of the high lift is optional and experimentation will provide the optimum for a station's needs. When used with f.m. transmissions, the

clipper should be turned half up at all times. When using the clipper at high level, it is very desirable to keep the mic. gain down and talk closely into the microphone to avoid picking up room noise. When using the audio processor s.s.b. talk power should be increased by about 10dB and f.m. talk power by about 5dB.

### Components

All resistors are  $\frac{1}{8}W$   
Electrolytic capacitors are 16V working unless stated otherwise.  
Capacitors in audio stages are polyester or similar types.  
Preset and control potentiometers are carbon track linear.  
 $L_1$  and  $L_3$  are Cambion type or similar.  
 $L_2$  is made as follows: 130 turns of 0.355 ECW enamel covered wire wound on Mullard LA1222 21mm Ferroxcube Pot Core.  
Filter: KVG XFM 10.7-F61.

### Acknowledgements

The author would like to express his thanks to the many amateurs (especially Gerry G3MMW and Richard G8LVB) who gave him signal reports and subjective comments.

*Internal layout of the audio processor unit*

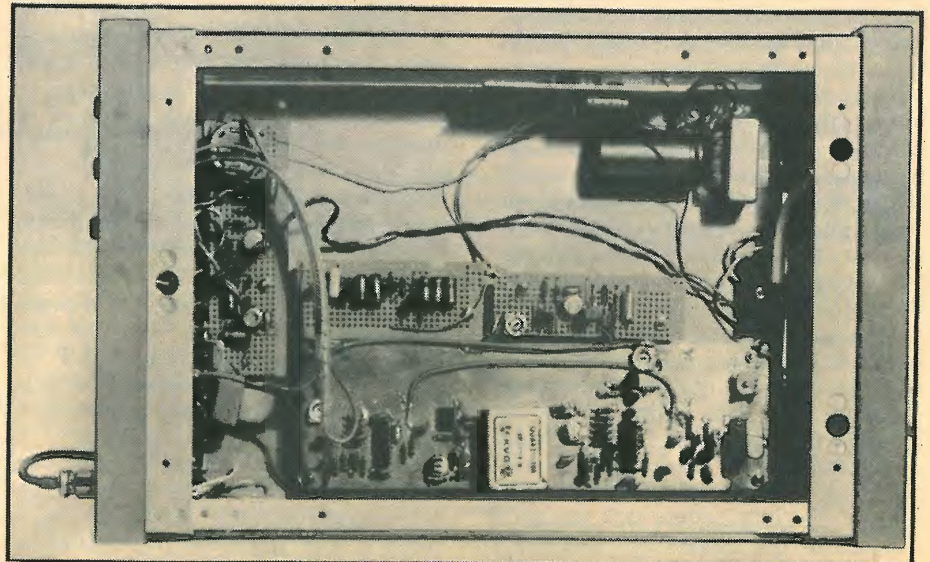



# Passive notch filters — 1

How to design narrow-band stop filters for the range 1 to 100MHz

by G. Kalanit, B.Sc., M.I.E.E., Rediffusion Engineering Ltd

Information for a variety of types of narrow band stop filters is available from many sources. Most specialize in a type and in a frequency range and the reference list at the end of the articles groups them under specialized headings. But selecting the right type of filter for the particular job at hand from the list of articles is laborious and time consuming. And little information is provided about design procedure and hardware.

This article provides design procedure and simple formulae by way of examples as well as hardware details. To simplify the description of the examples sufficient formulae and statements are given without theoretical proof; normally theoretical and mathematical development is left to the end of each section.

THIS ARTICLE concentrates mainly on null-type notch filters which are derived from a prototype lattice or Wheatstone

bridge. At the notch frequency the arms of the bridge are made to resonate into four equal resistances which perform a null of the bridge and no output of the frequency appears at the filter output. At all other frequencies the filter acts as an all-pass network.

The lattice which possesses four resonant arms is a balanced type of network. In most practical applications an unbalanced or grounded form that employs only two resonant arms is preferred, achieved with a hybrid transformer.

There are number of unbalanced configurations, all of which use the same hybrid transformer and the choice depends on the particular application at hand. The notations of the formulae refer always to the prototype lattice; thus the same set of formulae serve all the variations. A detailed description summarising all the configurations is given in the section about the hybrid transformer.

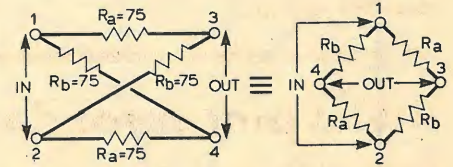

Fig. 1.2

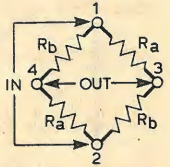

Fig. 1.3

inspection of Fig. 1.2 or Fig. 1.3 one can conclude that when  $R_a = R_b = 75\Omega$  —output port 3, 4 has no voltage component

—input 1, 2 and output 3, 4 impedances at resonance equal  $R = 75\Omega$

Away from resonance the circuit approximates to an all-pass network, shown in Fig. 1.4.

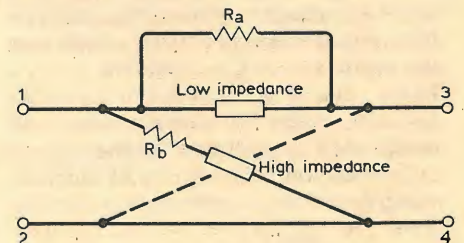

Fig. 1.4

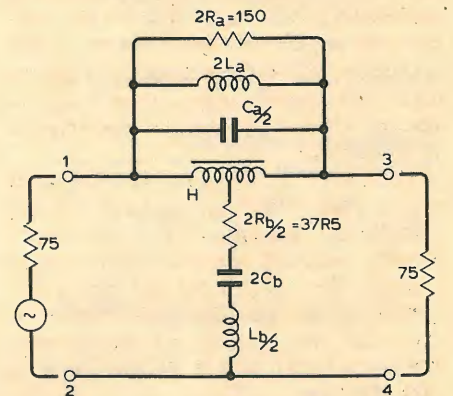

Fig. 1.5

The bridged-T equivalent circuit of Fig. 1.1 is shown in Fig. 1.5, where H is a hybrid transformer. Assuming H to be an ideal transformer with equal turns, Fig. 1.5 is completely equivalent to Fig. 1.1, i.e. input and output impedance is 75 ohms at all frequencies, including  $f_0$ ; there is no output at 32MHz across terminals 3, 4; all the energy at 32MHz is dissipated in the resistors.

To satisfy resonance

$$\omega_0^2 = 1/L_a C_a = 1/L_b C_b \quad 1.1$$

## Example 1: Constant resistance bridged-T null notch filter

One may consider the constant resistance notch filter as the general case from which other types are derived. Its importance is mainly in transmission lines where the total energy of the rejected signal is absorbed in the resistive arms of the filter, i.e. no energy is transmitted beyond the filter and no energy (in practice a little) is reflected back. Also the pass band has practically no insertion loss.

The following demonstrates a design of bridged-T constant-resistance null notch filter. The requirements are —notch frequency  $f_0$  32MHz —stop band-width at insertion loss of —40dB to be  $f_{40}$  0.080MHz —filter to be used on a 75ohm transmission line, i.e. constant resistance of filter to be 75 ohms.

The prototype lattice is shown in Fig. 1.1. To simplify the description, all losses are assumed to be in resistors  $R_a$  and  $R_b$ ; the coils and capacitors are assumed to have no losses.

At resonance (32MHz) the circuit has a null and looks like Fig. 1.2, or redrawn to Fig. 1.3 as a Wheatstone bridge. By

### Notation units and basic formulae

- Inductance  $L_{in}$   $\mu H$
- Capacitance  $C_{in}$   $\mu F$
- Frequency  $f_{in}$  MHz
- Radial frequency  $\omega$  Mrad/s
- $\omega = 2\pi f$
- Coil reactance  $\omega L$
- Capacitive reactance  $1/\omega C$
- Q-factor of coil  $\omega L/r$ , where  $r$  is series loss of the coil.
- Dynamic impedance of coil:  $Q\omega_0 L$  where Q is the Q factor of the coil and  $\omega_0$  is the resonance of the parallel tuned circuit.

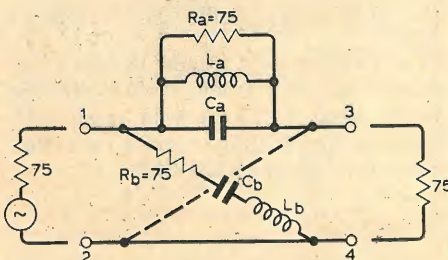

Fig. 1.1

To satisfy constant resistance at all frequencies (appendix B)

$$L_a/C_b = L_b/C_a = R_a R_b = R^2 \quad 1.2$$

From Fig 1.2, for a null  $R_a = R_b$  1.2(a) Thus, for a constant resistance null filter  $R_a = R_b = R$ .

Next, the filter 3dB insertion loss bandwidth  $f_3$  is to be determined from Fig. 1.6 (appendix A, Fig. A.1; see also ref. 10 page 226).

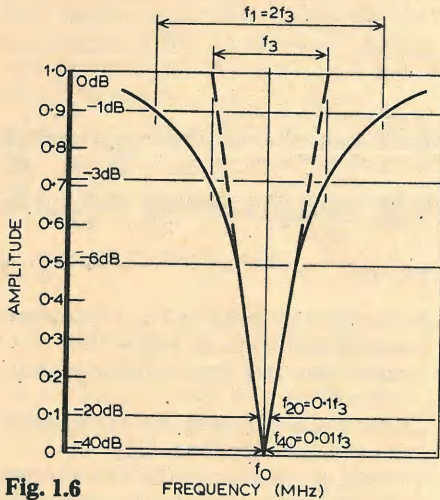

Fig. 1.6

The filter notch width is proportional to the amplitude response (Fig. 1.6). The filter requirement is that at -40dB loss the width is to be  $f_{40} = 0.08MHz$ .

From Fig. 1.6,  $f_{40} = 0.01 \times f_3$ , thus  $f_{40} \times 100 = 0.08 \times 100 = 8MHz$ . The 3-dB points are  $32 \pm 4, 28$  and  $36MHz$ .

The relation between the filter bandwidth  $f_3$  and the components (appendix B) is

$$\omega_3 \cdot L_b/2 = \frac{1}{\omega_3 \cdot C_a/2} = R \quad 1.3$$

where  $\omega_3 = 2\pi \cdot f_3 = 2\pi \cdot 8 \text{ Mrad/s}$

**Component evaluation**

From equation 1-3,

$$L_b/2 = \frac{R}{\omega_3} = \frac{75}{(2\pi \cdot 8)} = 1.49\mu H$$

$$C_a/2 = \frac{1}{\omega_3 \cdot R} = \frac{1}{(2\pi \cdot 8) \cdot 75} = 265 \text{ pF.}$$

From equation 1.1 (resonance at  $\omega_0 = 32MHz$ ),

$$C_b = \frac{1}{\omega_0 \cdot L_b} \text{ or}$$

$$2C_b = \frac{1}{\omega_0^2 \cdot L_b/2} = \frac{1}{(2\pi \cdot 32)^2 \cdot 1.49} = 16.6pF$$

Also

$$L_a = \frac{1}{\omega_0^2 \cdot C_a}$$

Or

$$2L_a = \frac{1}{\omega_0^2 \cdot C_a/2} = \frac{1}{(2\pi \cdot 32)^2 \cdot 0.000265} = 0.093\mu H.$$

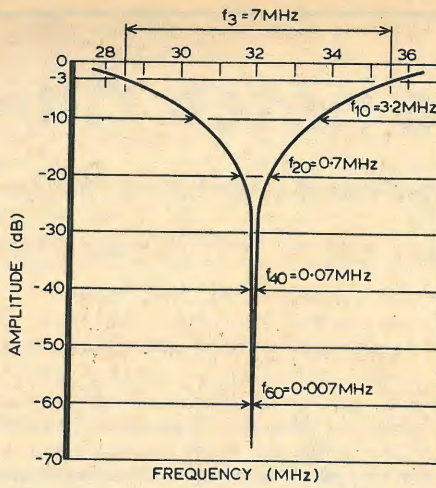

Fig. 1.7

The requirement of the hybrid transformer H is that the two windings are equal and the coupling is close to unity. This is achieved with bifilar winding on a ferromagnetic toroid core. The inductance of H appears in parallel with  $2L_a$ , hence it should be much greater than the inductance of  $2L_a$ . Two bifilar turns of 0.2 mm dia. enamelled copper wire are wound on a ferrite bead, and connected in series to form a centre-tapped four turn hybrid transformer. Total inductance is about  $2.5\mu H$ , which is about 25 times  $2L_a$  inductance.

The complete circuit is shown in Fig. 1.8, where the coils and resistors are adjustable. The amplitude response is shown in Fig. 1.7, where the practical result provides a narrower notch (less 12%).

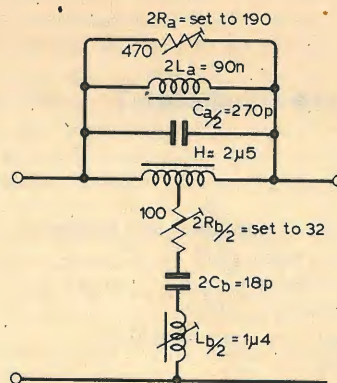

Fig. 1.8

**Components**

( $2L_a$ )—three turns of 0.4mm dia. enamelled copper wire on Neosid former 790/3/4W. Core  $4 \times 0.5 \times 10mm$ , grade F25.

( $L_b/2$ )—12 turns of 0.2mm dia. wire, as above.

( $C_a/2$ ) and ( $2C_b$ )—polystyrene capacitors.

H — two bifilar toroidal windings of 0.2mm dia. enamelled copper wire on ferrite bead  $4 \times 1.5 \times 5.5mm$  grade F14, Neosid. The bifilar wire is threaded twice through the bead hole.

**Notes**

1. Only equations 1.3 and 1.1 were used to derive the components values, be-

cause the conditions of equation 1.2 are contained in equation 1.3. Equation 1.2 may be used to check the results.

2. An important point from equation 1.3, is that the notch width  $\omega_3$  is independent of the resonance frequency  $\omega_0$ . By re-writing equation 1.3 in another form,  $\omega_3 = 2R/L_b = 2/R_a$  it is clear that to have a narrow notch (small  $\omega_3$ ), both coil  $L_b$  and capacitor  $C_a$  must be large. Also, it is possible to have a variable frequency notch of a fixed bandwidth, by keeping  $L_b$  and  $C_a$  fixed and only varying  $C_b$  and  $L_a$ .

3. The resistive component of arm 'a' is composed of the dynamic impedance of the tuned circuit  $L_a$  and  $C_a$  in parallel with resistor  $R_a$ . Thus in practice a variable resistor is employed which is adjusted during alignment to have a total parallel resistance equal to  $R_a = 75$  ohms, (or as in Fig. 1.5 equal to  $2R_a$  or 150 ohms). Similarly, the resistive component in arm 'b' is composed of the losses of  $L_b$  in series with  $R_b$  (losses of  $C_b$  are negligible). A variable resistor in series with  $L_b$  is adjusted to have total series resistance equal to  $R_b = 75$  (or as in Fig. 1.5 equal to  $R_b/2$ , or 37.5 ohms).

The Q factor of the coils need not be particularly high. Q factor of a coil is defined as  $Q = \omega_0 L/r$  where r is the series internal resistive loss of the coil L at  $\omega_0$ .

Dynamic impedance,  $D = Q\omega_0 L$ , is the amplified impedance of the coil L at  $\omega_0$  and Q is the Q factor of the coil L. The minimum Q required for the coils, is found in the case where the total resistive losses occur in the coils and no real resistor is employed. Therefore, if  $Q_{a(min)}$  and  $Q_{b(min)}$  are the minimal Q factors of coils  $L_a$  and  $L_b$  respectively, and Q is defined as the ratio of resonance frequency  $f_0$  to the 3-dB bandwidth  $f_3$ , thus

$$Q = \frac{f_0}{f_3} = \frac{\omega_0}{\omega_3}$$

then (appendix E3)

$$Q_{a(min)} \cdot Q_{b(min)} = 2Q \quad 1.4$$

That is, the minimum Q factor for the coils in Fig. 1.8 is

$$Q_{min} = 2Q = 2 \left[ \frac{32MHz}{8MHz} \right] = 8$$

$Q_{a(min)}$  and  $Q_{b(min)}$  could also be considered to be the real Q factors of the total of each arm 'a' and 'b' respectively.

Another useful relation between the circuit Q and the coil values (App.E1), is

$$2Q = 2 \frac{\omega_0}{\omega_3} = \sqrt{\frac{L_b}{L_a}} \quad 1.5$$

For the bridged-T notch in Fig. 1.8, this equation becomes

$$2Q = 2 \frac{\omega_0}{\omega_3} = 2 \sqrt{\frac{L_b/2}{2L_a}} \quad 1.6$$

thus  $2Q = 2 \sqrt{\frac{1.49\mu H}{0.093\mu H}} = 8$

**Elimination of the hybrid transformer**

To reduce number of components the hybrid transformer H may be eliminated in two ways. The first one is to combine the transformer with inductance  $2L_a$ . This is shown in Fig. 1.9 where  $2L_a$  is

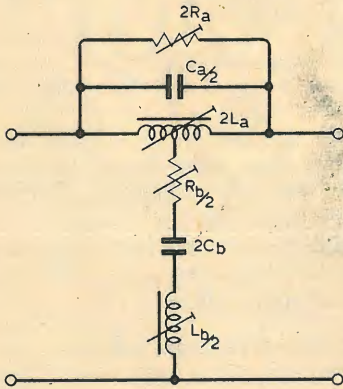

Fig. 1.9

provided with a centre tap. In the present example, where there are only three turn on ( $2L_a$ ), this modification does not work out well.

The second modification, which gives similar results to Fig. 1.7 is to centre tap the capacitor ( $C_a/2$ ), Fig. 1.10.

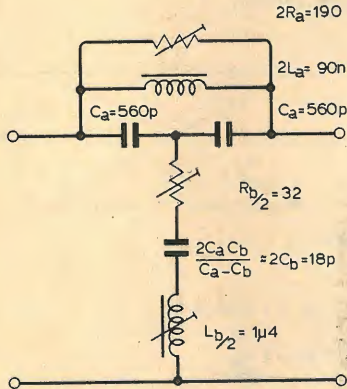

Fig. 1.10

Bartlett's bisection theorem (appendix F) shows that Fig. 1.10 is a derivation of the lattice in Fig. 1.1.

**Cascading stagger-tuned notch units**

Cascading units increases the rejection bandwidth without appreciably increasing the 3dB bandwidth. Cascading is possible due to the fact that each unit input and output impedance is a constant resistance at all frequencies.

The effect of two cascaded units is shown in Fig. 1.11. One unit is tuned 0.35MHz below 32MHz and one unit 0.35MHz above 32MHz. This stagger tuning produces a loss of 20dB, of each unit at 32MHz, giving a total of 40dB rejection. The bandwidth at -40dB is more than 0.7MHz while the 3dB bandwidth increased to about 10.7MHz.

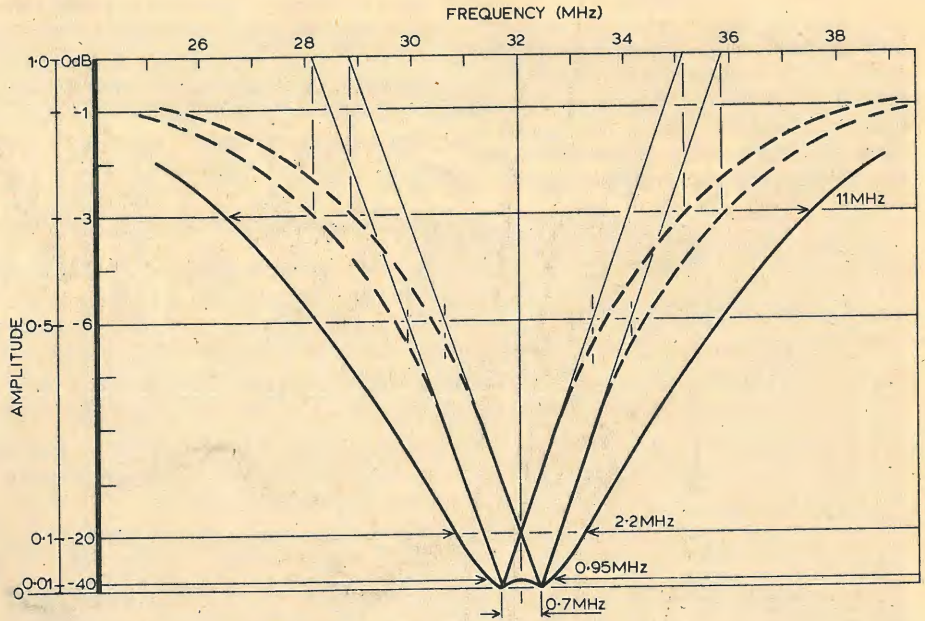

Fig. 1.11

Thus, while the -40dB rejection bandwidth has increased by more than ten times, the -3dB bandwidth has increased only by 1.53 times.

The practical results of two cascaded

notches, of Fig. 1.10 separated by 0.7MHz gave an increase of  $f_3$  by 1.57 times, from 7MHz to 11MHz, and an increase of  $f_{40}$  by 13.6 times, from 0.07MHz to 0.95MHz.

**Example 2: Constant resistance bridged-T notch filter (not null)**

Equations 1.1, 1.2, 1.3 and 1.6 hold good also for constant resistance bridged-T, non-null, notch filter shown in Fig. 2.1. At resonance frequency  $\omega_0$  the circuit behaves as a bridged-T attenuator shown in Fig. 2.2. The attenuation N gives the notch depth where  $N = V_1/V_2$  at  $\omega_0$ . It is clear that for high notch rejection, resistance ( $R_b/2$ ) must be very small and resistance ( $2R_a$ ) very large, compared to 75 ohm.

To achieve a minimal value for  $R_b/2$ , coil  $L_b/2$  must possess a high Q, where  $Q_b = \omega_0(L_b/2)/R_b/2$

$$R_b/2 = \frac{\omega_0(L_b/2)}{Q_b} \quad 2.1$$

Also, no other resistive component is to be added in series with coil  $L_b/2$ . To achieve a maximal value for  $2R_a$ , coil  $2L_a$  must possess a high  $Q_a$  to result in a high dynamic impedance D, where

$$D = Q_a \omega_0 2L_a = 2R_a \quad 2.2$$

Also, no other resistive component to be added in parallel to  $2L_a$ . Appendix E2 shows that the requirement of constant resistance of equation 1.2 leads to the requirement that the Q values of both

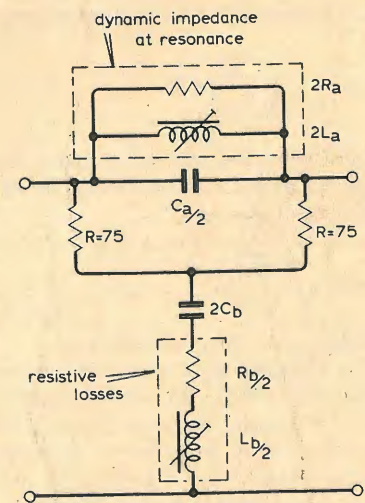

Fig. 2.1

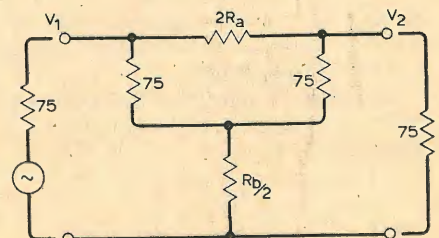

Fig. 2.2

coils must be equal.

$$Q_a = Q_b \tag{2.3}$$

In example 1 coil  $L_b/2$  has 12 turns and  $2L_a$  has three turns. To achieve a high Q with three turns is not easy. Hence, a tunable auto-transformer is employed for  $(2L_a)$  increasing the number of turns to nine, with a tap at three turns.

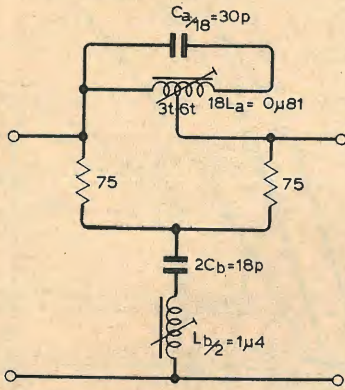

Fig. 2.3

The circuit is shown in Fig. 2.3. As the auto-transformer ratio is 3:1, the inductance is increased by three times squared.

$0.09 \mu H \times 3^2 = 0.81 \mu H = 2L_a$ ,  $9 = 18L_a$   
The tuning capacity is therefore reduced by the same multiple.

$$270 pF + 3^2 = 30 pF = (C_a/2) + 9 = C_a/18$$

The components used are the same as for Fig. 1.8 except that  $(18L_a)$  windings are made with 0.2mm dia. enamelled copper wire. The coils Q measured on a Q meter is about  $Q = 100$ . The notch maximum attenuation N is found from Fig. 2.2 bridged-T attenuator (see ref. 4).

$$\text{Thus, } N = \sqrt{\frac{2R_a}{R_b/2} + 1} \tag{2.4}$$

Substituting  $2R_a$  and  $R_b/2$ , from equations 2.2 and 2.1 respectively, in equation 2.4; N becomes

$$N = Q_a \sqrt{\frac{2L_a}{L_b/2} + 1} \tag{2.5}$$

where  $Q_a = Q_b$  from equation 2.3.

Exchanging the coils values ratio, under the square root, with the required radial frequencies ratio  $(\omega_3/\omega_0)$  from equation 1.6. N becomes an expression which enables estimating the notch depth from the notch requirements.

$$\text{Thus } N = Q_a \cdot \frac{\omega_3}{\omega_0} + 1 \tag{2.6}$$

As  $Q_a = Q_b = 100$  for coils of Fig. 2.3,  $N = 26$  or 28.3dB. The measured value of N is found to be 29dB.

Equation 2.6 may also be written in terms of notch Q, from equation 1.6, where  $Q = f_0/f_3$

$$N = \frac{Q_a}{Q} + 1 \tag{2.7}$$

It is clear from equations 2.3 and 2.7

that, while  $Q_a$  must equal  $Q_b$  to have constant resistance impedance,  $Q_a = Q_b$  must be much larger than Q to achieve large rejection at  $f_0$ .

**Appendix A. General expression for null notch filter**

The general expression for an RLC null notch filter (ref. 6) may be written

$$\frac{e_o}{e_i} \{p\} = \frac{\omega_0^2 + p^2}{\omega_0^2 + kp + p^2} \tag{A.1}$$

where  $e_i$  is input voltage,  $e_o$  is output voltage  $\omega_0$  is notch radial frequency and  $p = j\omega$ . Hence

$$\frac{e_o}{e_i} \{j\omega\} = \frac{\omega_0^2 - \omega^2}{\omega_0^2 - \omega^2 + j\omega k}$$

(Replace  $\omega$  by another variable d, which is half the notch width (Fig. A.1),  $\omega = \omega_0 - d$ , where  $d \ll \omega_0$ )

$$\begin{aligned} &= \frac{1}{1 + \frac{j\omega k}{\omega_0^2 - \omega^2}} = \frac{1}{1 + \frac{j(\omega_0 - d)k}{\omega_0^2 - (\omega_0 - d)^2}} \\ &= \frac{1}{1 + j \frac{(\omega_0 - d)k}{\omega_0^2 - (\omega_0^2 - 2\omega_0 d + d^2)}} \\ &= \frac{1}{1 + j \frac{(\omega_0 - d)k}{2d(\omega_0 - d/2)}} \approx \frac{1}{1 + j \cdot \frac{k}{2d}} \end{aligned} \tag{A.2}$$

For 3-dB points of insertion loss

$$\left| \frac{e_o}{e_i} \right| = \frac{1}{\sqrt{2}} \text{ or } \left| \frac{e_i}{e_o} \right| = \sqrt{2} = \left| 1 + j \frac{k}{2d} \right|$$

Thus,  $k/2d = 1$ .

$2d$  is the 3dB bandwidth  $\omega_3$ .

$$\omega_3 = 2d = k \tag{A.3}$$

Hence  $k$ , the coefficient of  $p$  in equation A.1, depicts the 3dB bandwidth.

Equation A.1 may be re-written as

$$\frac{e_o}{e_i} \{p\} = \frac{\omega_0^2 + p^2}{\omega_0^2 + \omega_3 p + p^2} \tag{A.4}$$

and equation A.2 as

$$\frac{e_o}{e_i} = \frac{1}{1 + j\omega_3/2d} \tag{A.5}$$

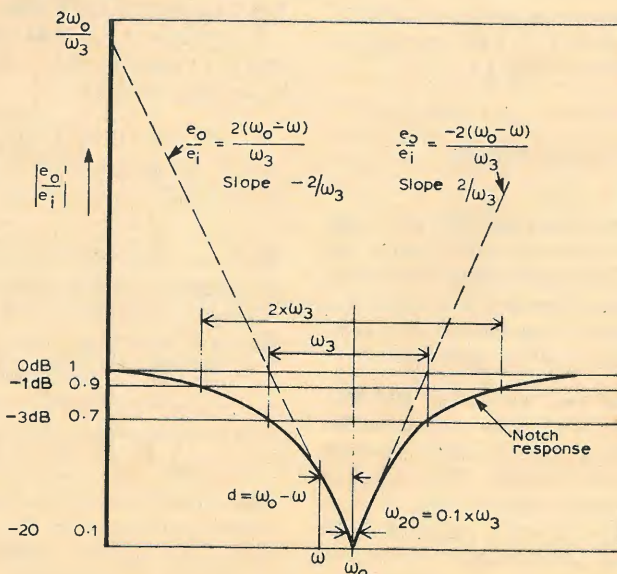

Fig. A.1

where  $2d$ , the notch width, is the variable.

$$\text{At } \omega_0, 2d = 0 \text{ and } \left| \frac{e_o}{e_i} \right| = 0$$

i.e. no output at  $\omega_0$ .

When  $d$  is very small,

$$\left| \frac{e_o}{e_i} \right| \approx \frac{1}{\omega_3/2d} = \frac{2d}{\omega_3} = \frac{2(\omega_0 - \omega)}{\omega_3} \tag{A.6}$$

as  $d = \omega_0 - \omega$ .

Equation A.6 is a straight line with a slope of  $-2/\omega_3$ .

For the response at frequencies greater than  $\omega_0$ ,  $d = \omega - \omega_0$  which gives equation A.6 a negative sign and a positive slope of  $2/\omega_3$ .

This is illustrated in Fig. A.1 and provides the explanation for Fig. 1.6 (see also reference 10, page 226).

**Appendix B Constant resistance lattice**

$$Z_{in} = \sqrt{Z_{oc} \cdot Z_{sc}} = R \tag{B.1}$$

where  $Z_{in}$  is input impedance to be equal to the terminating resistance R,  $Z_{oc}$  is input impedance when R is open-circuit,  $Z_{sc}$  is input impedance when R is short-circuited.

By inspection,

$$Z_{oc} = (a + b)/2$$

$$Z_{sc} = 2 \frac{ab}{a + b}$$

$$\therefore Z_{in} = \sqrt{Z_{oc} \cdot Z_{sc}} = \sqrt{a \cdot b} = R$$

$$\text{or } (Z_{in})^2 = R^2 = a \cdot b \tag{B.2}$$

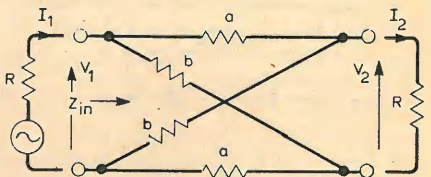

Fig. B.1

From Fig. 1.1 and B.1

$$b = R_b + pL_b + \frac{1}{pC_b}$$

$$\frac{1}{a} = \frac{1}{R_a} + \frac{1}{pL_a} + pC_a$$

# MICROPROCESSOR WORKSHOPS

The microprocessor revolution is well underway. And with that revolution comes a challenge to you, the designer. A challenge to rethink certain design concepts; to comprehend microprocessor software development; to understand microprocessor system integration.

The challenge, in short, is to learn. To learn in order to do your job more productively, and to take advantage of the design opportunities the microprocessor revolution has created.

To help you meet the challenge Tektronix are providing two types of Workshop:

## Workshop One Microprocessor Design Workshop

The emphasis is on software development and system integration. After five days of demanding, stimulating work, you'll be able to complete a software design from flowcharting through debugging; operate the Tektronix Microprocessor Development Lab; and understand and solve the problems involved in integrating software and hardware.

**Attendee Profile:**

Has limited experience with microprocessors; no previous design projects.

Has not used a disk-based microprocessor development system.

Has some programming experience, but probably not with microprocessor assembler language.

Wants an introduction to the use of a complete microprocessor development system and its role in the design process.

When you've completed the Workshop you'll be a more productive, complete designer, having acquired basic microprocessor software knowledge; basic microprocessor design organization; practice in implementing a microprocessor design; and hours of hands-on experience with the Tektronix Development Lab and the 8080.

Duration: 5 days. Cost: £250.

## Workshop Two Microprocessor Development Lab

This three day advanced Workshop emphasizes the use of the Tektronix 8002A in the design process.

Unlike the five day Workshop, there is little attention given to the basic principles of microprocessor software, programming, and design organization. Rather, Workshop time is devoted to hands-on experience with the Tektronix Development Lab, as attendees learn its operation and its role in hardware debugging, software development, and system integration.

**Attendee Profile:**

Has designed with one or more microprocessors.

Has used a disk-based microprocessor development system or mini-computer.

Has programmed a microprocessor in assembler language.

Primary interest is in acquiring specific, in-depth knowledge of Tektronix Microprocessor Development Lab and in applying that knowledge to his design tasks.

Duration: 3 days. Cost: £200.

Whether you choose the five or three day Workshop you'll find the emphasis is truly hands-on. We limit the number of delegates to 12 and there are 4 Tektronix 8002A systems available, which constitutes some £60,000 worth of equipment. The 8002A is capable of emulating- TMS 9900, SBP 9900, Motorola 6800, Intel 8080 and 8085, Zilog Z80A, Fairchild F8, Mostek 3870, RCA 1802 but because of time restraints the popular 8080 is used for all practical instruction and work.

The venue is Harpenden and dates so far are as follows:-

May 14-18, \*June 11-15, July 16-20, \*Sept. 4-6, Oct. 1-5, Nov. 12-16,

\*Dec. 11-13. \*Refers to Workshop two.

If you are interested, why not send for our comprehensive Workshop brochure, it's quite free.

**Tektronix**  
COMMITTED TO EXCELLENCE

Alan E. Hutley, Tektronix UK Ltd., P.O. Box 69, Coldharbour Lane, Harpenden, Herts. AL5 4UP. Telephone: Harpenden 63141.



Alan E. Hutley, Tektronix UK Ltd., P.O. Box 69, Coldharbour Lane, Harpenden, Herts. AL5 4UP. Telephone: Harpenden 63141.

Name .....  
 Position .....  
 Company .....  
 Address .....

**8K ON BOARD MEMORY!**

5K RAM, 3K ROM or 4K RAM, 4K ROM (link selectable). Kit supplied with 3K RAM, 3K ROM. System expandable for up to 32K memory.

**2 KEYBOARDS!**

56 Key alphanumeric keyboard for entering high level language plus 16 key Hex pad for easy entry of machine code.

**GRAPHICS!**

64 character graphics option — includes transistor symbols! Only £18.20 extra!

**MEMORY MAPPED**

High resolution VDU circuitry using discrete TTL for extra flexibility. Has its own 2K memory to give 32 lines for 64 characters.

**KANSAS CITY**

low error rate tape interface.

**COMPLETE  
KIT**

Cabinet Size 19.0" x 15.7" x 3.3"

Television by courtesy of Rumbelows Ltd., price £58.62

**2 MICROPROCESSORS**

Z80 the powerful CPU with 158 instruction, including all 78 of the 8080, controls the MM57109 number cruncher. Functions include +, -, /, squares, roots, logs exponentials, trig functions, inverses, etc. Range 10<sup>-99</sup> to 9 x 19<sup>-99</sup> to 8 figures plus 2 exponent digits.

**EFFICIENT OPERATION**

Why waste valuable memory on sub routines for numeric processing? The number cruncher handles everything internally!

**RESIDENT BASIC**

With extended mathematical capability. Only 2K memory used but more powerful than most 8K Basics!

**1K MONITOR**

Resident in EPROM

**SINGLE BOARD DESIGN**

Even keyboards and power supply circuitry on the superb quality double-sided plated through-hole PCB.

Only  
**£275.00**  
+ VAT

# POWERTRAN

**PS1 Comp 80.Z80 Based powerful scientific computer  
Design being published in Wireless World — NOW!**

The kit for this outstandingly practical design by John Adams being published in a series of articles in *Wireless World* really is complete!

Included in the PSI COMP 80 scientific computer kit is a professionally finished cabinet, fibre-glass double sided, plated-through-hole printed circuit board, 2 keyboards PCB mounted for ease of construction, IC sockets, high reliability metal oxide resistors, power supply using custom designed toroidal transformer, 2K Basic and 1K monitor in EPROMS and, of course, wire, nuts, bolts, etc.

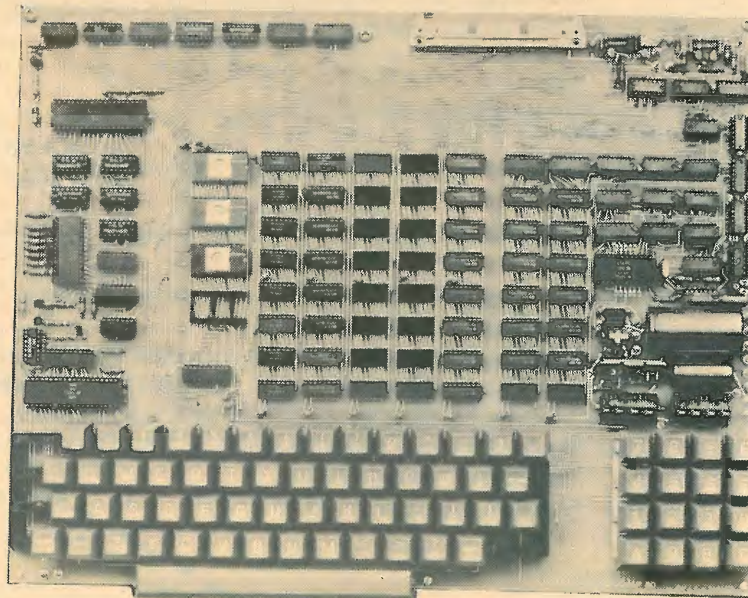
**SYSTEM  
EXPANSION  
COMING  
SHORTLY!**

Kit also available as separate packs; e.g. PCB, Keyboards, Cabinet, etc.

PCB size 16.0" x 12.5"

**Value Added Tax not included in prices**

**PRICE STABILITY:** Order with confidence! Irrespective of any price changes we will honour all prices in this advertisement until Aug. 31st, 1979, if this month's advertisement is mentioned with your order. Errors and VAT rate changes excluded.

**EXPORT ORDERS:** No VAT. Postage charged at actual cost plus 50p handling and documentation.

**U.K. ORDERS:** Subject to 8% surcharge for VAT\*. NO charge is made for carriage. \*Or current rate if changed.

**SECURICOR DELIVERY:** For this optional service (U.K. mainland only) add £2.50 (VAT inclusive) per kit.

**UK Carriage FREE**

## POWERTRAN COMPUTERS

(a division of POWERTRAN ELECTRONICS)

PORTWAY INDUSTRIAL ESTATE  
ANDOVER HANTS SP10 3NN

ANDOVER  
(0264) 64455

# Colour synthesizer design for the PAL system

Low-cost equipment for amateurs or schools

by N. C. Roberts, B.Sc.

The conventional approach to colour synthesis involves the use of standard colour matrix circuits. The individual components of the colour waveform are generated separately and fed to the matrix circuits. The result is an instrument which, while costing less than a colour television camera, is still outside the scope of any amateur system. The equipment described here generates a resultant colour waveform directly, without the use of matrix circuits, drastically reducing the cost and complexity of the finished instrument. The device is completely compatible with the PAL (Phase Alternating Line) colour system used in Britain.

The article is not intended as detailed constructional notes, but outlines the results of an investigation performed by the author into a new principle. The outcome was a working prototype design which the reader may wish to extend to suit his individual needs.

Before the new method is described, it is necessary to discuss the operation of the PAL system in detail.

## The PAL system

A colour television camera will be considered as a convenient source of colour video information.

The incoming light image from the lens is split into three primary colours, red, blue and green, using dichroic mirrors. These three colours are chosen because virtually any colour can be made up by combining these in suitable proportions. It should be noted that these colours are made by a process of addition on the display of a colour television receiver; for example, yellow is made up from a combination of red and green which, due to the spectral sensitivity overlap of the eye, is sensed as yellow.

Each of the three colours is focused onto a camera tube, usually a Plumbicon, which has a maximum spectral response at that colour. The outputs from the tubes are first added in the proportions

30% red + 59% green + 11% blue to give a component called Y, the luminance or monochrome signal, which is the only signal used by a monochrome receiver. These proportions are chosen to give a good white, called 'luminance C' white, from the camera tubes.

To economize in bandwidth in the final transmitted signal, colour difference signals are used to ensure that no brightness (luminance) information is transmitted in the chrominance channels. Difference signals (R-Y) and (B-Y) are formed by subtracting the brightness signal from the red and blue signals respectively. Only two signals are needed because the third, (G-Y), can be derived in the receiver from the other two.

A monochrome transmission consists of the luminance waveform separated by synchronizing pulses, used to lock the receiver's scan circuits to those of the camera. A colour signal, however, has to convey two additional signals to the receiver. As well as the luminance or Y signal and synchronizing pulses, the (R-Y) and (B-Y) signals must be transmitted, and yet must not interfere with the Y signal, so as to be compatible with monochrome receivers. To this end, a subcarrier is used, and this is added directly onto the luminance signal, as in Fig. 1. The subcarrier is phase modulated for colour hue, and amplitude modulated for saturation, or colour intensity.

The choice of subcarrier frequency is important. It must be within the video range of 0 to 5MHz, and it must not produce an objectionable dot pattern on a monochrome receiver. The chosen frequency is about 4.43MHz, the reasons for which will appear later in the discussion.

It is uneconomic in terms of transmitter power to transmit the subcarrier

and its associated sidebands, so the subcarrier is suppressed before transmission and only the sidebands are transmitted. In the receiver, therefore, the subcarrier has to be re-inserted before demodulation, the receiver's local subcarrier oscillator being locked to the transmitter's subcarrier. To this end, a small burst of subcarrier is inserted into the back porch of the video waveform, containing 10 cycles  $\pm$  1 cycle of the transmitter's subcarrier. This is known as the colour burst.

The suppressed-carrier modulation technique is used for two subcarriers of the same frequency, but differing in phase by 90°. The (B-Y) signal is modulated on one carrier, and the (R-Y) signal on the other, the basic (R-Y) subcarrier leading the (B-Y) subcarrier by 90°. The two signals are then combined to produce a resultant which varies in amplitude and phase, and this is then added to the video waveform, as seen in Fig. 1.

In some colour systems, for example, the American NTSC system, the phase of the colour burst and the basic phase of the colour subcarrier is the same on every line. This system, however, is prone to differential phase distortion, caused by slight subcarrier phase shifts brought on by different transmission path lengths, and giving rise to incorrect hues. The PAL system helps to overcome this by changing the phase of the colour burst on every other line by  $\pm$  45° about 180° to the (B-Y) carrier. The (B-Y) carrier relative phase remains unchanged, but the (R-Y) subcarrier is reversed in phase on every other line. As is seen in Fig. 2, the (B-Y) axis is called the U axis and the (R-Y) axis is called the V axis on a vector diagram. Fig. 3 shows the method of reducing differen-

Fig. 1. Colour television waveform, showing colour burst and subcarrier in area of colour.

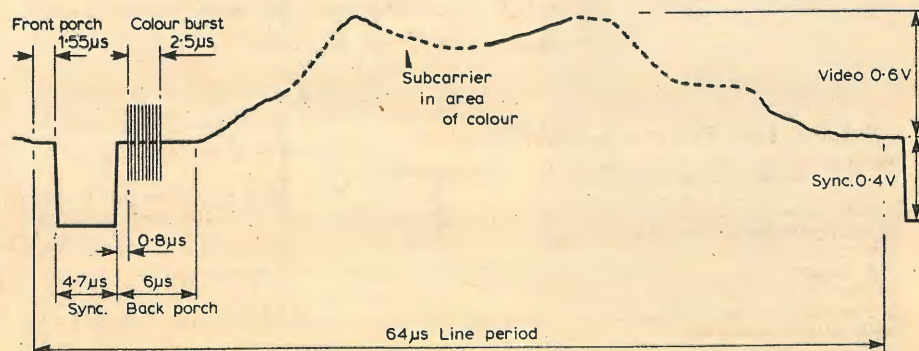

tial phase distortion —  $\phi^\circ$  in the diagram. In the receiver, the signal with  $-V$  phase is inverted to bring it into the same phase as lines with  $+V$  phase. The resultant vector over two adjacent lines is the original transmitted subcarrier phase. This does give rise to a slight decrease in saturation, but this effect can be minimised in the receiver.

The subcarrier frequency chosen is a multiple of line frequency, plus a quarter of line frequency, to offset the dot pattern produced on a monochrome receiver. In addition, by adding another half cycle per field (25Hz), dot pattern interlacing is achieved, making it even less visible. The final figure for the British system becomes:—

$$\left[ \frac{567}{2} + \frac{1}{4} \right] 15625 + 25(\text{Hz}) = 4.43361875\text{MHz.}$$

The figure of  $567/2$  times line frequency as the basic subcarrier frequency is chosen so that the chrominance sidebands intermesh with the luminance sidebands, and do not interact.

The dot pattern arises on a monochrome receiver because the subcarrier sine wave modulated on the video waveform is seen by the receiver as a high frequency video component. The effect is only noticed on areas of high saturation. The pattern does not appear on a colour picture because the colour subcarrier is filtered out before the luminance is displayed.

In the receiver, the three difference signals are obtained and added to the

brightness component of the waveform in the colour picture tube.

### Colour synthesis

The concept of colour synthesis is to use a monochrome video signal, such as one obtained from a monochrome television camera, to produce a colour picture.

The monochrome signal consists of

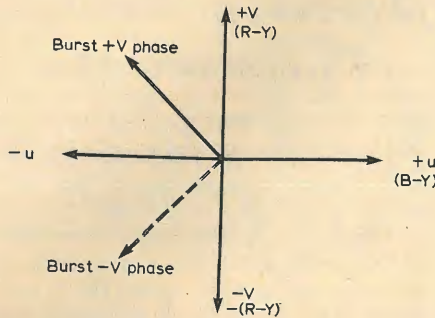

Fig. 2. Colour subcarrier vector diagram.

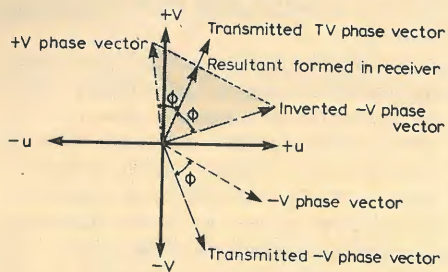

Fig. 3. Resultant formed in receiver from two phase-shifted vectors is in same phase as transmitted vector.

luminance information only, and therefore a colour synthesizer cannot reproduce the actual colours of the viewed scene, but will add colours as desired by the operator. This technique may be considered as painting the colours onto a black and white scene. A synthesizer is of particular use with captions, where a monochrome camera can be used to view the caption, and the caption's video converted to colour using a synthesizer. Furthermore, the colours can be changed at will.

Colour synthesizers normally have preset red, blue, and green signals, which may be used to colour areas of the picture. These signals, which normally consist of d.c. levels, are fed to a conventional PAL coder, and correspond to areas of constant colour. The expensive colour camera optics, video pre stages, and three camera tubes are therefore dispensed with. However, the PAL coder is still required to process the signals, and convert them into a form suitable for transmission; this constitutes a large proportion of the cost of a colour synthesizer. The author decided to try generating the subcarrier resultant directly, thus obviating the need for a PAL coder, but retaining complete compatibility with colour television equipment.

It was decided that the colour hue determining factor at any point of the picture would be the luminance amplitude at that point; a particular shade of grey would correspond to a particular hue of the electronically generated colour. The range of colours obtainable over a luminance range should be adjustable.

Since the colour saturation is determined by the amplitude of the colour subcarrier, the saturation is controlled via a subcarrier variable-gain amplifier. The generated subcarrier passes through fixed phase-shift networks and gating circuits to generate the colour burst. The colour hue is determined by the phase of the subcarrier; hence, a voltage-controlled phase-shift unit is employed as the colour hue determining network.

To be compatible with the PAL system, the phase of the subcarrier has to change on every other line. It has already been stated that with the PAL system, the phase of the (R-Y) subcarrier is inverted on every other line, while the (B-Y) subcarrier remains unchanged. This can be written mathematically as

$$A \sin \omega t + B \sin(\omega t + 90^\circ)$$

where  $A \sin \omega t$  represents the (B-Y) subcarrier and  $B \sin(\omega t + 90^\circ)$  represents the (R-Y) subcarrier on lines with  $+V$  phase.  $A$  and  $B$  are the relative amplitudes of each. Similarly, we can write

$$A \sin \omega t + B \sin(\omega t + 90^\circ) + 180^\circ \quad (2)$$

for lines with  $-V$  phase.

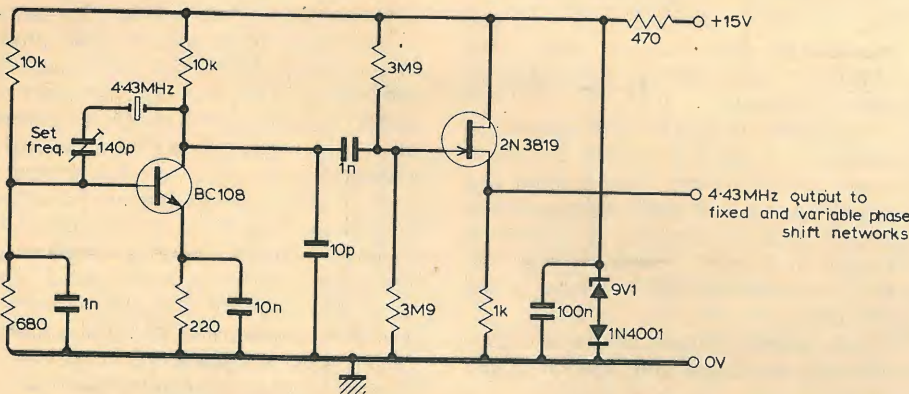

Fig. 4. Colour subcarrier generator circuit.

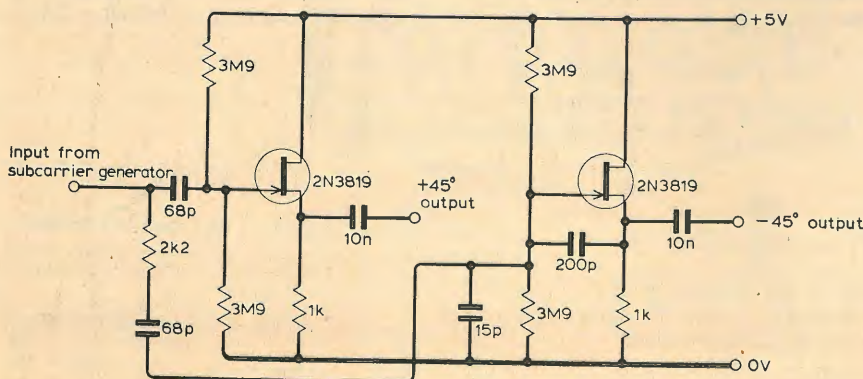

Fig. 5. Circuit to provide outputs leading and lagging by  $45^\circ$  on colour subcarrier to produce colour burst.



Now, since  
 $P\sin\Omega + Q\cos\Omega = R\sin(\Omega + \mu)$   
 where  
 $R = \sqrt{P^2 + Q^2}$ ;  $\mu = \tan^{-1}Q/P$ .

(1) becomes  
 $A\sin\omega t + B\sin(\omega t + 90^\circ)$   
 $= A\sin\omega t + B\cos\omega t$   
 $= C\sin(\omega t + \theta)$

where  
 $C = \sqrt{A^2 + B^2}$ ;  $\theta = \tan^{-1}B/A$ ,

and (2) becomes:-  
 $A\sin\omega t + B\sin(\omega t + 270^\circ)$   
 $= A\sin\omega t - B\cos\omega t$   
 $= D\sin(\omega t + \alpha)$ ,

where  
 $D = \sqrt{A^2 + (-B)^2} = C$ ;  
 $\alpha = \tan^{-1} -A/B$   
 $= -\tan^{-1}A/B = -\theta$ .

Hence (2) is  
 $A\sin\omega t - B\cos\omega t = C\sin(\omega t - \theta)$ .

Therefore, on lines with +V phase, the resultant subcarrier is  
 $C\sin(\omega t + \theta)$ ,

and on lines with -V phase, the resultant is  
 $C\sin(\omega t - \theta)$ ,

where C is a factor controlling colour saturation, and  $\theta$  controlling the colour hue.

These two expressions show that the resultant subcarrier can be simulated by phase advancing about a mean value on one line, and phase retarding on the next. This is the principle used in this design.

**Design**

The synthesizer can be considered in eight distinct stages.

**Oscillator.** The subcarrier master oscillator is crystal-controlled and is designed around a standard colour subcarrier crystal used in domestic colour television receivers. In Fig. 4, the oscillator is of the Pierce type, with a source follower f.e.t. stage to minimize loading effects. The stage is fed from a stabilized power supply to improve stability. The phase of the output subcarrier from this unit is assigned the phase of -(B-Y), the -U axis, and used as the reference phase about which all others are considered.

**Fixed phase-shift.** The phase of the colour burst alternates by  $\pm 45^\circ$  about the -U axis. Figure 5 shows two networks which use single RC and CR networks to provide the  $\pm 45^\circ$  phase shifts, the resultant being fed to source follower buffer stages. The outputs from the source followers are capacitively coupled to f.e.t. switches in the burst gating unit. The characteristics of the fixed phase shift unit are seen in Fig. 6.

**Variable phase shift.** At the heart of the system is the voltage-controlled phase-shift unit. In the circuit of Fig. 7, anti-

phase signals are fed into the input ports of the network. If resistor R is increased from zero to infinity, the phase of the output changes by  $180^\circ$ . If the impedance to both input ports is the same, and low compared with the reactance of capacitor C at the operating frequency, then the resulting output vector amplitude is essentially constant over the entire phase change. This is the basis of the voltage-controlled phase-shift unit. If R is replaced by an f.e.t., controlling the gate voltage controls the source-drain resistance and hence the output phase. Figure 8 shows the circuit of the voltage-controlled phase-shift network.

The input 4.43MHz. from the subcarrier generator is fed into a transformer, which splits the phase of the signal to feed the phase-shift elements. Two f.e.t.s in parallel provide a more linear phase-shift characteristic. The two phase-shift stages in cascade give nearly  $360^\circ$  phase shift over a control-voltage range of zero to  $-3.5V$  on the

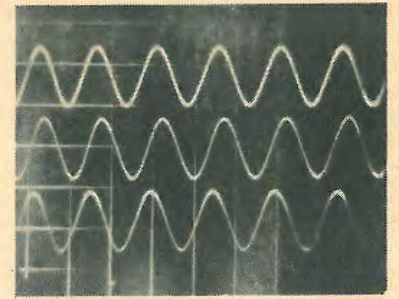

Fig. 6. Waveforms from circuit of Fig. 5. Top trace is input, middle trace leading and bottom output lagging.

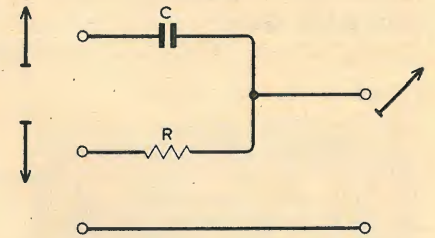
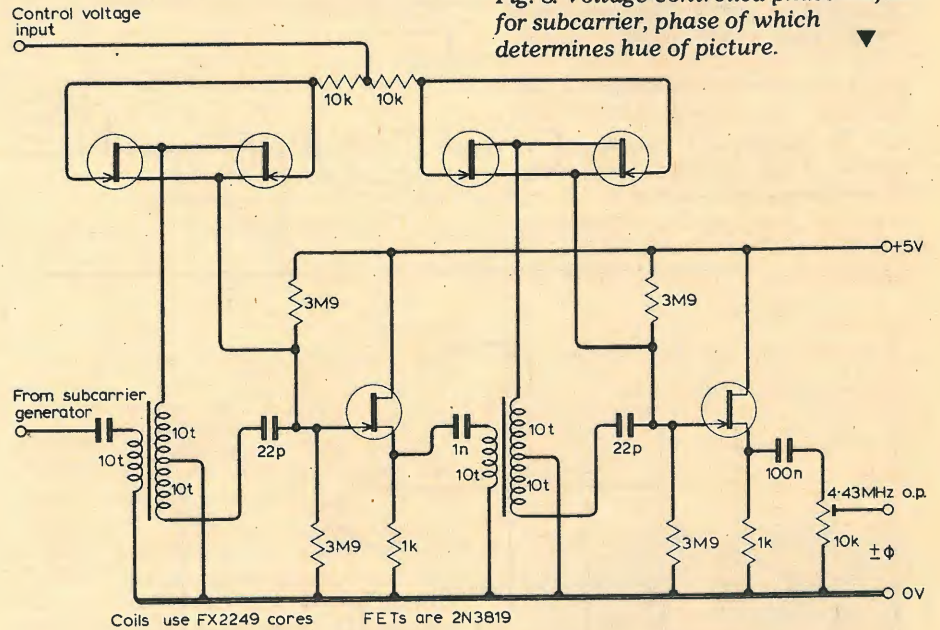

Fig. 7. Basic phase-shift element.

Fig. 8. Voltage-controlled phase-shifter for subcarrier, phase of which determines hue of picture.



f.e.t.s. Source follower stages are used between the phase shift stages to present the necessary high impedance to the output of the RC system, yet provide a low impedance transmitted through the transformer to the input of the RC system. The  $10k\Omega$  potentiometer on the output controls the amplitude of the subcarrier and hence the colour saturation. Figure 9 shows the characteristics of the unit. The operating range is chosen to be from  $-2V$  to  $-3.5V$  and this is achieved by adjusting the gain of the control circuits to be considered later.

Fig. 9. Characteristics of Fig. 8 circuit. Top trace is input; lower traces show phases when control voltage is set at  $-0V, -1.5V, -2V, -2.5V, -3V,$  and  $-3.5V$ .

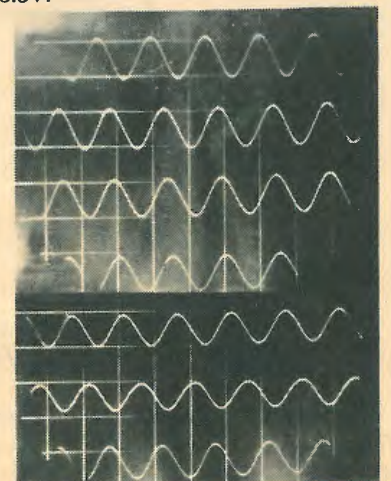

**Sync. separator.** In order that the burst may be gated in at the correct position, and to change the phase of the subcarrier at line frequency, it is required to extract the synchronizing pulses from the incoming video waveform. In Fig. 10, the p-n-p transistor is normally

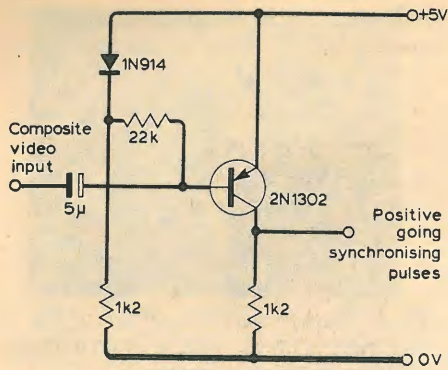

Fig. 10. Circuit to extract sync pulses from composite video.

biased into cut-off by setting the base at +4.5V with respect to the collector, using a silicon diode. Therefore, only when the level of the video is low enough does the transistor conduct. This low level is only reached during the negative-going synchronizing pulses. Hence, positive-going synchronizing pulses appear at +5V peak on the collector of the transistor, and are compatible with standard t.t.l. integrated circuits.

- 5 gates each 1/4 SN7400
- +5 and 0V to all ICs
- 5 transistors 2N3820

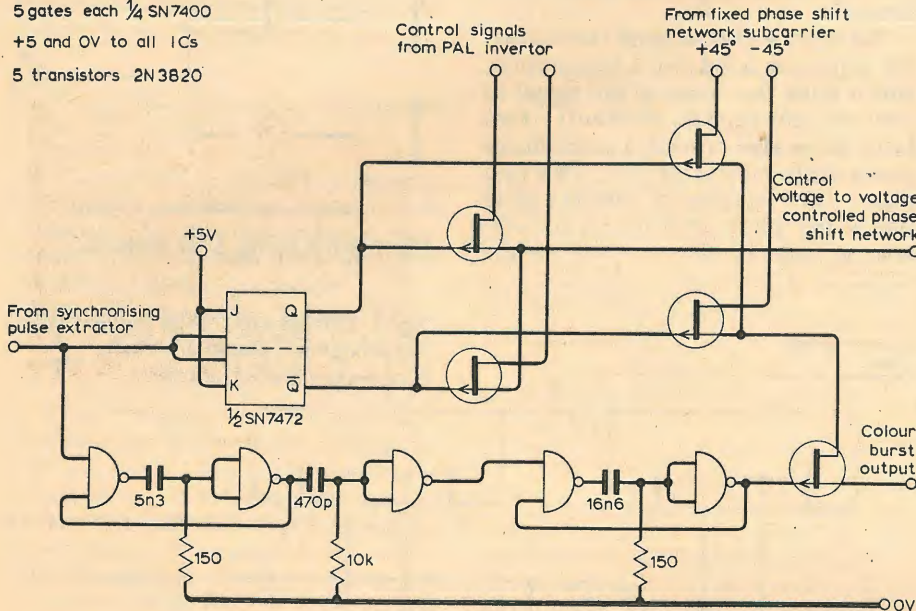

Fig. 11. Burst gating and line-frequency divider.

**Burst gate and line dividers.** Synchronizing pulses are fed to the half-line frequency divider and burst gating generator in Fig. 11. The half-line frequency switching-pulse generator is simply a t.t.l. bistable element, the burst gating generator consisting of two monostables. The colour burst is 2.5µs long, occurring 0.8µs after the line synchronizing pulse. The first monostable, triggered on the negative edge of the incoming pulses, provides the 0.8µs delay, its output pulse being inverted and used to trigger the 2.5µs monostable, which produces the burst gating pulse.

The half line frequency pulses select the appropriate burst phase, which is fed to the burst gating f.e.t. to provide the correctly timed and phased colour burst.

**Threshold gate.** To prevent colour information from entering the black level and synchronizing pulse region, and also the peak white region, a threshold detector is used, as shown in Fig. 12. Composite video is fed to the level detector and the two threshold levels are set on the potentiometers. The output controls an f.e.t. switch which gates-in the subcarrier in the video regions.

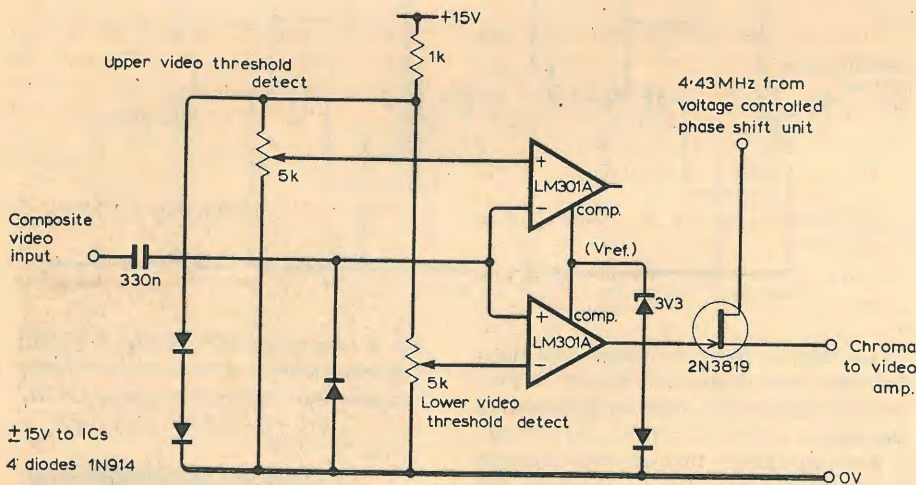

Fig. 12. Chroma threshold gate.

**Amplifier and inverter.** The control signal for the voltage-controlled phase-shift network is derived from the video signal in the circuit of Fig. 13. The video signal is amplified in a variable-gain operational amplifier configuration whose gain control determines the range of colours obtained on a picture. Another operational amplifier is used as an inverter and the two signals are fed to f.e.t. switches, which select the direct or inverted signal to control the phase-shift network. The chroma phase switch (Sw<sub>1</sub>) selects the phase of the control signal with respect to the colour burst: thus the basic colour of the picture (in the dark regions) can be changed.

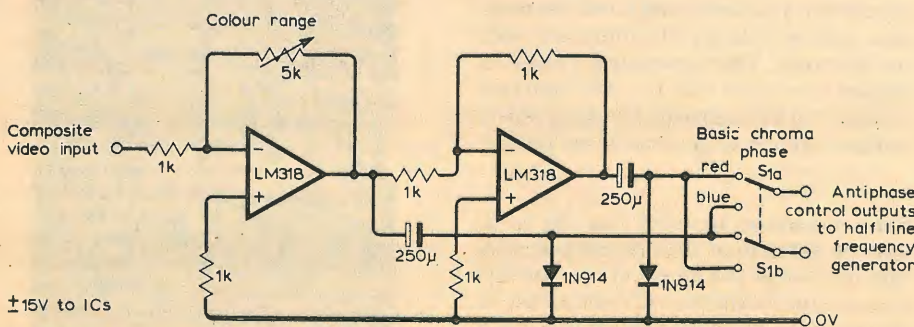
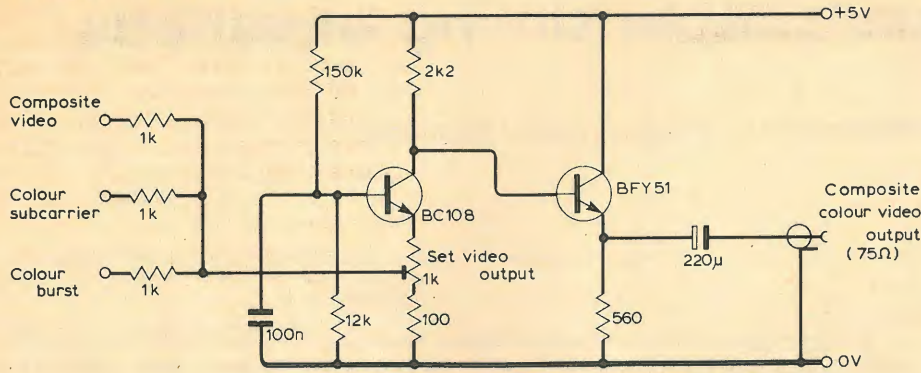

Fig. 13. Colour range amplifier and PAL inverter. Outputs are selected by f.e.t. switches in Fig. 11 to control voltage-controlled phase shifter of Fig. 8.

**Video output.** All the signals – the video, colour subcarrier, and colour burst – are combined in the video output amplifier of Fig. 14. The signals are fed to a common base amplifier which supplies drive to the emitter follower stage to present an output impedance of 75Ω.

A block diagram of the synthesizer is shown in Fig. 15.

It should be noted that with this



◀ Fig. 14. Video mixer and output amplifier.

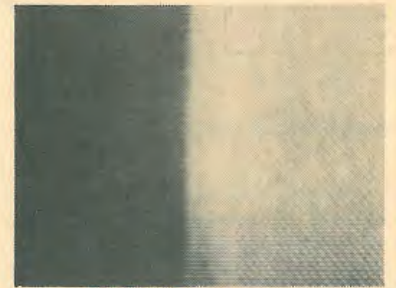

Fig. 16. Subcarrier dot pattern seen on a monochrome receiver.

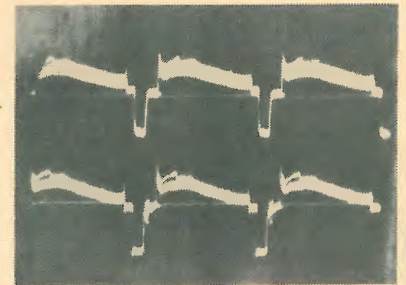
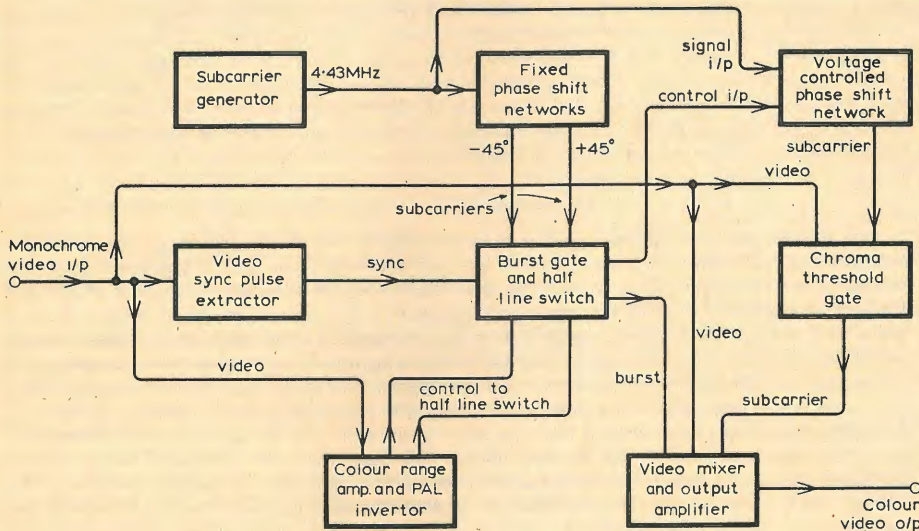

Fig. 17. Monochrome (top) and colour (bottom) video waveforms.

◀ Fig. 15. Complete block diagram of the equipment.

system, the subcarrier is not suppressed, but this means that additional information is conveyed to the receiver, where it is filtered out.

**Testing**

The complete unit may be connected to a monochrome television camera to enable the subcarrier pattern to be viewed.

After switching the unit on, with the camera viewing a scene, the saturation control may be advanced until the subcarrier dot pattern is visible, as in Fig. 16. Adjusting the colour range control changes the dot pattern slightly showing that the phase of the subcarrier has changed.

A comparison of the input and output waveforms of the device can be seen in Fig. 17, in which the colour burst appears after the line synchronizing pulse, and where the video region is slightly more indistinct, showing the presence of the subcarrier.

If the previous tests prove satisfactory, the unit may be connected to a colour television monitor, and the colour range and saturation control adjusted to give a good colour range when viewing the scene. The threshold controls are adjusted so that they just do not clip the chroma at either black or peak white: this is the correct setting of the controls for an all colour picture.

For pictures of high contrast, for example, a black caption with white lettering, two-colour pictures may be obtained. By changing over the chroma phase switch, the dark regions of the picture may be changed from red to blue.

There is a tendency on certain scenes for the colour to flicker at the top of the picture, due to the absence of Bruch blanking. This is the system whereby the burst is blanked off for the first few lines at the beginning of a field to allow the synchronizing circuits to settle down after the field synchronizing pulses.

The unit is capable of generating all the colours obtainable with the PAL system, with an even distribution of the colour, throughout the picture. the phase shift network is quick to respond to a sudden change of luminance with no spurious effects at the transition edge.

The results obtained with these simple circuits were very encouraging, and proved the principle of the design. The unit is intended as a low cost device for providing colour on an amateur system, or for schools. The presence of colour on a caption or diagram greatly increases the clarity and it is here where it would be most useful in an educational establishment.

The author wishes to acknowledge

the assistance of the staff of the University of Bath School of Physics, and, in particular, to thank Mr J. Hopkins for his help and encouragement throughout the project. □



**The author**

Mr Roberts took an honours degree in applied physics at the University of Bath in 1975, subsequently working for two and a half years at Marconi Space and Defence Systems on computers and automatic test equipment. At the present time he is a civil servant. In his spare time, his interests include the design of high-fidelity audio equipment and home computer systems, on which he occasionally lectures to groups of enthusiasts.

# RC networks: simple timing equations

by Peter Williams, Ph.D. Paisley College of Technology

TIME INTERVAL: CR STEP INPUT

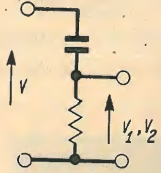

$$\begin{aligned} V_1 &= V e^{-t_1/\tau} \\ V_2 &= V e^{-t_2/\tau} \\ t_1 &= \tau \log_e (V/V_1) \\ t_2 &= \tau \log_e (V/V_2) \\ t_2 - t_1 &= \tau \log_e (V_1/V_2) \end{aligned}$$

GENERAL EXPONENTIAL CHARGING

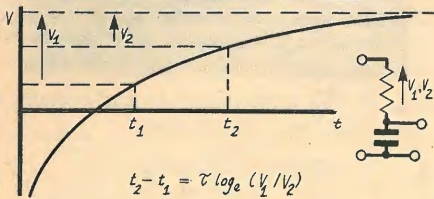

$$t_2 - t_1 = \tau \log_e (V_1/V_2)$$

TRANSISTOR MONOSTABLE / ASTABLE TIMING

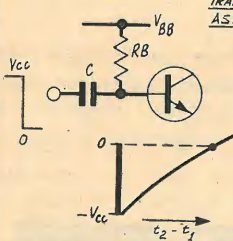

$$\begin{aligned} V_1 &= V_{BB} - (-V_{CC}) \\ &= V_{BB} + V_{CC} \\ V_2 &= V_{BB} - 0 \\ t_2 - t_1 &= \tau \log_e \frac{V_1}{V_2} \\ &= \tau \log_e \left( \frac{V_{BB} + V_{CC}}{V_{BB}} \right) \end{aligned}$$

EXAMPLES OF TIME INTERVALS

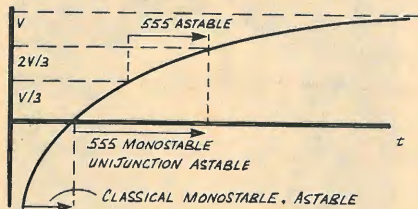

| TIME INTERVAL               | V <sub>1</sub> | V <sub>2</sub> | V <sub>1</sub> /V <sub>2</sub> | Log <sub>e</sub> (V <sub>1</sub> /V <sub>2</sub> ) |
|-----------------------------|----------------|----------------|--------------------------------|--|
| RISE TIME                   | 0.9V           | 0.1V           | 9                              | 2.2  |
| 555 MONOSTABLE              | V              | V/3            | 3                              | 1.1  |
| UNIUNCTION $\eta \sim 0.63$ | V              | 0.37V          | 1/0.37                         | 1  |
| 555 ASTABLE                 | 2V/3           | V/3            | 2                              | 0.69   |
| TWO TR. ASTABLE             | 2V             | V              |                                |  |
| C.MOS D-TYPE MOND.          | V              | V/2            |                                |  |

N.B. FOR ASTABLES TIME INTERVAL INDICATED IS FOR ONE OF THE QUASI-STAGE STATES ONLY.

In determining the time taken between successive switching points in an astable or monostable, it is often the voltage across the capacitor that is evaluated. Advantages accrue from considering that across the resistor and a very general result is obtained relating the time interval to the ratio of the voltages across the resistor at the beginning and end of the period. A step voltage is applied to a CR network in which the capacitor is initially discharged. The resistor voltage thus varies from V to zero as the capacitor charges from zero to V. Substituting into the exponential equation relating time and voltage it is then found that the time taken for the voltage across the resistor to change from V<sub>1</sub> to V<sub>2</sub> is given by  $t_2 - t_1 = \tau \ln (V_1 / V_2)$ . This result remains true even if the capacitor is charged to some initial value V<sub>c</sub> as in the equations V is simply replaced by V - V<sub>c</sub> but again cancels out in determining the time interval. This result is of such usefulness that it is worth stating explicitly: if a constant voltage is maintained across a series CR circuit the time taken for the resistor voltage to change from V<sub>1</sub> to V<sub>2</sub> depends only on the time constant and the ratio of V<sub>1</sub> / V<sub>2</sub>.

The advantage of this approach is that most monostable and astable circuits can be subdivided into just such a CR section or sections and active circuitry to sense and take action at particular voltage levels. They are then covered by this result and the corresponding pulse widths and frequencies can be determined by isolating the values V<sub>1</sub> and V<sub>2</sub> across the resistor at the beginning and end of the period. This bypasses the often lengthy algebra in which the exponential charging properties are re-established for each individual circuit, and unifies the treatment of almost all circuits of practical interest. As far as this calculation is considered, only the voltage across the CR network is of interest, but in many circuits the capacitor appears with one end grounded and the diagram shows how the information can be derived from the graph of the capacitor voltage; the resistor voltage has to be the difference between the applied voltage and that across the capacitor. That the resistor voltage is the key to this simple relationship is less surprising when it is realized that it is on this voltage that the charging current depends, i.e. the time interval depends on the ratio of the charging currents.

As an example of the application of this idea consider the standard transistor multivibrators. Their detailed treatment is left till later, but their common property is that a capacitor is connected to a collector that drops rapidly from a supply voltage V<sub>CC</sub> to zero. Prior to that drop the other end of the capacitor is clamped close to zero by the base-emitter of a second transistor. The step V<sub>CC</sub> thus swings that base from zero to -V<sub>CC</sub>. If the charging resistor R<sub>B</sub> is returned to a bias voltage V<sub>BB</sub> then the magnitude of V<sub>1</sub> is given by the sum of the collector and base supply voltages. Switching is assumed to take place when the base comes back into the conduction i.e. when the voltage across R<sub>B</sub> returns to V<sub>BB</sub>. Substitution into the time interval relationship gives the result usually obtained. By extension, allowance for base and collector saturation voltages can be seen to modify the values of V<sub>1</sub> and V<sub>2</sub> but still allow the use of the same time interval equation. Once that equation is established and accepted, the insertion of the values of V<sub>1</sub> and V<sub>2</sub> leads to a quick and convenient solution.

The advantage of this approach can be illustrated graphically: a general exponential waveform is drawn representing the voltage across the capacitor. In the case of the two-transistor astable and monostable the start of the cycle has a negative voltage ending close to zero. A 555 monostable and a unijunction astable circuit start with the capacitor discharged but charging to 2/3 of the applied voltage before switching (the unijunction is often designed to switch slightly earlier at 63% of the supply corresponding to  $\ln (V_1 / V_2) = 1$  i.e. resulting in a period  $T = \tau$ ). A 555 astable cycles between V/3 and 2V/3 with a 2:1 ratio of the resistor voltages. Using this graph any other circuit that depends on an RC charging cycle can be evaluated. The switching points are noted, the voltage across the resistor is calculated for each case and the ratio of the voltages leads to the time interval. The graph can be redrawn directly in terms of the resistor voltages, but it is most commonly met in this form since many circuits involve a grounded capacitor.

It is now possible to tabulate the time intervals for a number of well-known circuits some of which are discussed in more detail later. The first to be evaluated is the rise time of an RC section, the time taken for the output to rise from 10% to 90% of its final value. This is found to be  $2.2\tau$  where  $\tau = RC$  is the time constant. Both the 555 monostable and the unijunction oscillator have comparable timing cycles, with the discharge time for the unijunction being very short. (The 555 monostable can be adjusted for pulse width  $\tau$  by reducing the threshold voltage externally at pin 5.) The final group of circuits all have  $\sim 2:1$  ratio for the resistor voltages though starting and finishing at quite different values. Therefore each has a time interval of  $\sim 0.69\tau$ . For the astable case a complete period consists of two normally equal time intervals i.e.  $T = 2 \times 0.69\tau$  and  $1/T = 1/1.38\tau$ . For op.amp astables the thresholds depend on the external resistor values. Once these thresholds have been calculated the corresponding voltages across the resistors follow and the same time-interval equation can be used.

# RC networks: simple timing equations

## Theory

● For the capacitor  $Q=CV$

$$\frac{dQ}{dt} = C \frac{dV}{dt}$$

But  $\frac{dV}{dt} = -\frac{dV_R}{dt}$  for any constant applied voltage and  $\frac{dQ}{dt} = I = V_R/R$

$$\therefore C \frac{dV_R}{dt} = -\frac{V_R}{R}$$

$$\frac{dV_R}{dt} = -\frac{V_R}{CR} = -\frac{V_R}{\tau} \quad \frac{dV_R}{V_R} = -\frac{dt}{\tau}$$

where if the values of  $V_R$  at  $t_1$  and  $t_2$  are  $V_1, V_2$  respectively then

$$\int_{V_1}^{V_2} \frac{dV_R}{V_R} = \int_{t_1}^{t_2} -\frac{dt}{\tau}$$

● The result applies regardless of whether the R or the C is grounded i.e. of whether it appears to be a CR or an RC network provided only that the total voltage across the circuit remains constant for the period of interest. The time interval can be read from the capacitor voltage graph as indicated.

● For the particular case of traditional two-transistor monostables/astables, the voltages  $V_1$  and  $V_2$  correspond to the instant immediately following the transition of one collector  $V_{CC} \rightarrow 0$  and the instant at which the base potential recovers to zero, i.e. at  $t_1$  the resistor  $R_b$  has terminating potentials of  $V_{BB}$  and  $-V_{CC}$ ; at  $t_2$  of  $V_{BB}$  and 0.

$$t_2 - t_1 = \tau \log_e \frac{V_1}{V_2}$$

$$\therefore V_1 = V_{BB} - (-V_{CC}), \quad V_2 = V_{BB}$$

$$\text{Hence } t_2 - t_1 = \tau \log_e \frac{V_1}{V_2} = \tau \log_e \left( 1 + \frac{V_{CC}}{V_{BB}} \right)$$

Commonly  $V_{BB} = V_{CC}$  and  $t_2 - t_1 = \tau \log_e 2 = 0.69\tau$ .

When allowance is made for the different saturation and threshold voltages of the devices the form of the equation is unchanged but the values  $V_1$  and  $V_2$  are modified. Assume the collector voltage falls from  $V_{CC} \rightarrow V_{CE1}(\text{sat})$ . Hence the base is driven down to  $V_{BE2}(\text{sat}) - (V_{CC} - V_{CE1}(\text{sat}))$ .

$$\begin{aligned} V_1 &= V_{BB} - V_{BE}(\text{sat}) + V_{CC} - V_{CE}(\text{sat}) \\ &= V_{BB} + V_{CC} - (V_{BE2}(\text{sat}) + V_{CE1}(\text{sat})) \end{aligned}$$

Similarly the next transistor occurs not at 0 but at  $V_{BE2}(\text{th})$  the voltage at which the transistor just begins to conduct

$$V_2 = V_{BB} - V_{BE2}(\text{th})$$

● A number of practical circuits have very simple values of  $V_1, V_2$ . Monostables using the 555 i.c. timer have the capacitor voltage starting from zero and triggering at  $2V/3$ . Hence

$$\left. \begin{aligned} V_1 &= V \\ V_2 &= V/3 \end{aligned} \right\} \begin{aligned} t_2 - t_1 &= \tau \log_e 3 \\ &= 1.1\tau. \end{aligned}$$

Unijunction astables fire when the input voltage reaches 63% of the supply

$$\text{i.e. } \left. \begin{aligned} V_1 &= V \\ V &= 0.37V \end{aligned} \right\} \begin{aligned} t_2 - t_1 &= \tau \log_e (1/0.37) \\ &\approx \tau. \end{aligned}$$

An astable using the 555 has its voltage cycling between  $V/3$  and  $2V/3$  defining each portion of the cycle as of duration

$$t_2 - t_1 = \tau \log_e 2 = 0.69\tau.$$

A monostable based on a c.m.o.s. D-type flip-flop ends its timing cycle when the capacitor charges from zero to  $V/2$  and

$$t_2 - t_1 = \tau \log_e 2 = 0.69\tau.$$

## Examples

1. A CR network with a  $100\mu\text{s}$  time-constant is subjected to (i) a positive 5V step (ii) a further 5V step after an interval of 1s. Calculate (a) the fall times of the output pulses; (b) the time taken in each case for the output to fall by 50% of its initial value. What conclusions can be reached on the effect of the initial capacitor voltage on the timing equation?

The fall time is defined as the time taken to fall from 90% to 10% of its final value.

$$\text{i.e. } V_1 = 0.9 \times 5 \\ V_2 = 0.1 \times 5$$

$$\begin{aligned} t_2 - t_1 &= \tau \log_e 9 \\ &= 2.2\tau \\ &= 220\mu\text{s} \end{aligned}$$

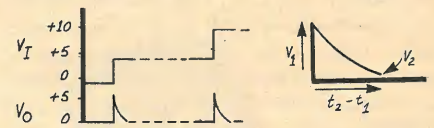

Because the interval between steps  $\gg$  time-constant, output has for all practical purposes returned to zero. Hence output pulse is identical for second step. This leads to the conclusion that the initial capacitor voltage is irrelevant since it is zero prior to the first step and +5V prior to the second. It is the voltages across the resistor that determine the time intervals since they determine the current.

The time taken to fall to 50% of initial value

$$t_2 - t_1 = \tau \log_e \left( \frac{V_1}{V_2} \right)$$

$$= \tau \log_e \left( \frac{5}{5/2} \right) = \tau \log 2$$

$$= 69\mu\text{s}$$

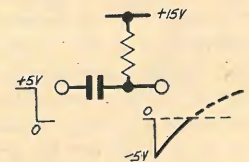

Because the waveforms are identical for the two cases so are time relationships.

2. A CR network forming part of a transistor monostable is shown together with the initial conditions and the step input. The monostable duration lasts from the negative transition until 'A' reaches zero again. Determine that period in terms of  $\tau = CR$ . If the input voltage falls only to 0.2V the initial value of A is 0.7V and the end of the period is when A reaches 0.5V, by what percentage does the period change?

$$\text{Initial voltage across resistor } V_1 = 15 - (-5) = 20V$$

$$\text{Final voltage across resistor } V_2 = 15 - 0 = 15V$$

$$\therefore t_2 - t_1 = \tau \log_e 20/15 = 0.288\tau$$

For modified figures voltage at A immediately after step is  $0.7 - (5 - 0.2)V$

$$\therefore V_1 = 15 - (0.7 - (5 - 0.2))$$

$$= 20 - 0.7 - 0.2 = 19.1V$$

$$V_2 = 15 - 0.5 = 14.5V$$

$$\therefore t_2' - t_1' = \tau \log_e \left( \frac{V_1'}{V_2'} \right) = \tau \log_e \left( \frac{19.1}{14.5} \right)$$

$$\approx 0.276\tau$$

$$\therefore \% \text{ change in period} = \left( \frac{0.276 - 0.288}{0.288} \right) \times 100 \approx 4.2\%$$

This is typical of the departure from the simple relationship when transistor saturation and conduction threshold voltages are allowed for.

## Cutting the ignition crackle

Mobile operators have always had to struggle with the problem of ignition and electrical appliance interference generated in their own and other people's vehicles. Seldom is there any one simple way of overcoming all such problems and it was discovered a few years ago that some engines are "super-noisy" generating interference peaks some 35-40dB more than "quiet" cars. Even on the same vehicle pulse amplitudes can vary by 30dB and there can be two separate r.f. pulses associated with each spark-plug firing.

Recently, however, two improved suppression techniques have become available in the U.K. The first makes use of inductively-wound distribution cable sets. These can provide appreciably greater impedance than resistive cables at frequencies between about 50 and 200MHz, although they tend to be less effective at m.f. and h.f. The second technique involves the use of spark plugs with in-built resistors. These are available (Champion, NGK etc) in all the popular heat ranges and although they cost rather more than conventional plugs for use with external resistors they do appear to result in improved suppression. In these plugs the suppression resistor is as close as possible to the spark and thus minimizes radiation from the central electrode above the screening of the metal shell.

While resistive suppressors of this type can be very effective for conventional ignition systems, some electronic and high-energy capacitor-discharge systems favour a low-resistance inductive approach. Champion have introduced a number of special plugs for marine applications where very powerful ignition systems may be used; these have a low-resistance inductive suppressor mounted inside the insulator.

## Yagi versus Quad

For some 30 years there has been a lively and often heated debate among amateur operators as to the relative merits of Yagi and quad beam aerials. It is now generally accepted that a two-element h.f. quad with one-wavelength loops is about the equivalent of a good three-element Yagi and that both are capable of providing a maximum forward gain of the order of 6dB reference dipole. But what about the large three- and four-element quads that appear to be increasingly popular in the United States and Japan although significantly more difficult to build and erect than their Yagi counterparts? And is there any foundation for the long-cherished belief that a quad is the much better performer at low heights?

Some years ago, detailed investigations in the United States using model aerials (440MHz) came out strongly in



favour of the quad, suggesting that for a given number of elements these arrays provided some 2dB more gain than a Yagi.

However, a recent article by Wayne Overbeck, N6NB in *Ham Radio* strongly questions the validity of the extra 2dB gain when applied to full-size h.f. and 144MHz beams. In fact his article throws considerable doubt on the value of using quads of more than two elements since multi-element Yagi arrays are not only easier to build but also to keep up; he finds no evidence to support the view that a quad is any more effective at low height than a Yagi. It is extremely difficult, however, to obtain meaningful measurements on the basis of ground-wave signals and one suspects that the verdict is still "not proven."

But there is increasing evidence that the conventional multi-band quad using three separate "nested" one-wave loops is not the optimum approach: the use of single 14MHz loops which become two-wave loops at 28MHz doubles the size of the array on the higher band provided that the problem of element-spacing can be overcome.

Also likely to have considerable influence on aerial (and equipment) design would be the new 10.1, 18.6 and 24MHz bands if these are granted to amateurs at WARC'79. Quad aerials with single untuned loops fed by open-wire transmission line could prove easier to adapt for multi-band use on the new frequencies than existing triband Yagi designs.

## Scanning the bands

Apropos the note in the March issue on the use by Lars-Erik Johansson, SM4AQL of a cow manure methane digester cum electric generator, Tim Hutchinson, 5Z4DV in Fort Ternan, Kenya tells me that he began using methane gas in 1955. His 2HP Lister engine, which charges a 32V bank of nife cells, has clocked up over 60,000 hours and an additional 8HP engine is now available, running either fully or

partly on "biogas" (methane/carbon dioxide mixture) obtained from cow and pig manure, coffee skins, grass etc. Like SM4AQL, this system also provides him with a rich organic fertiliser for his coffee crop. His "alternative technology" also includes water-heating by solar power.

The Oxford University EME Group continues to exploit successfully the earth-moon-earth path with no less than 29 different stations now worked on this mode since November 1978. Worked all continents on 432MHz was completed with a contact with VK5MC in South Australia. During a recent A.R.R.L. 'moonbounce' contest the group completed 17 non-scheduled two-way contacts with France, Germany, Holland, Italy, Luxembourg, Sweden, Yugoslavia, Rhodesia and the USA, using a 20ft parabolic dish aerial. The equipment is being prepared for e.m.e. operation also on 1.3GHz and 2.3GHz.

A new British 'YL' (Young Lady) Amateur Radio Association has been set up to encourage more YL activity. A quarterly newsheet is planned and 'on-air meetings' are to be held on Monday evenings at 1915 local time on 3605kHz. Secretary is Diana Hughes, G4EZI, 3 Primley Park Crescent, Leeds.

## In brief

Over 5,000 people attended the two-day RSGB national amateur radio exhibition at Alexandra Palace, north London. . . . The Society is to hold an "HF Convention" at the Warwickshire County Cricket Ground, Edgbaston, Birmingham on Saturday, September 15 with a film and lecture programme, dinner, etc. . . . A 2.3GHz beacon station (GB3NEW) is being built at Newbury and is expected to be operational by about mid-summer. . . . Canadian amateurs are being granted the right to operate in the band 902 to 928MHz to compensate for losing a segment (420 to 430MHz) of the 70cm band. . . . The RSGB National Mobile Rally is at Woburn Park on August 5 and other rallies include Scarborough and Colchester on July 29; Derby on August 12; and Preston (new venue Park Hall Leisure Centre, Charnock) on August 19. . . . American public concern with possible biological effects of non-ionizing radiation has led to a study of 27MHz radiation from c.b.-fitted vehicles but no firm conclusion has been reached and the Bureau of Radiological Health is continuing investigations. A Bill introduced in the Oregon State Senate would sharply restrict all forms of electromagnetic radiation in residential areas and would cover power transformers and high-voltage transmission lines. . . . UK proposals for WARC'79 include four new amateur microwave bands at 40.5, 49.5, 71 and 160GHz.

PAT HAWKER, G3VA

# Now, the complete MK 14 micro-computer system from Science of Cambridge

**VDU MODULE. £31.62**  
 (£25.14 without character generator) inc. p & p.

Display up to ½K memory (16 lines x 32 chars. with character generator; or 4096 spot positions in graphics mode) on UHF domestic TV. Eurocard-sized module includes UHF modulator, runs on single 5 V supply. Complete ascii upper-case character set can be mixed with graphics.

**POWER SUPPLY. £5.85 inc. p & p.**  
 Delivers 8 V at 600 mA from 220/240 V mains - sufficient to drive all modules shown here simultaneously. Sealed plastic case, BS-approved.

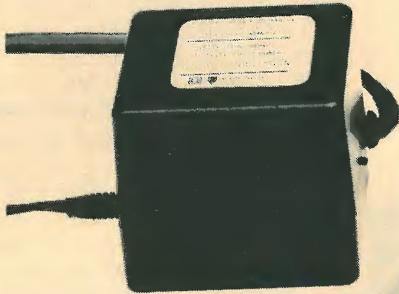

**PROM PROGRAMMER. £10.95 inc. p & p.**

Use to transfer your own program developed and debugged on the MK 14 RAM to PROM (74S571) to replace SC10S monitor for special applications, e.g. model railway control. Software allows editing and verifying.

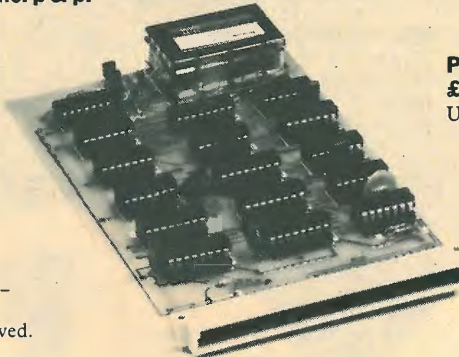

**MK 14 MICROCOMPUTER KIT. £43.55 inc. p & p.**  
 Widely-reviewed microcomputer kit with hexadecimal keyboard, display, 8 x 512 - byte PROM, and 256 - byte RAM, and optional 16-lines I/O plus further 128 bytes of RAM.

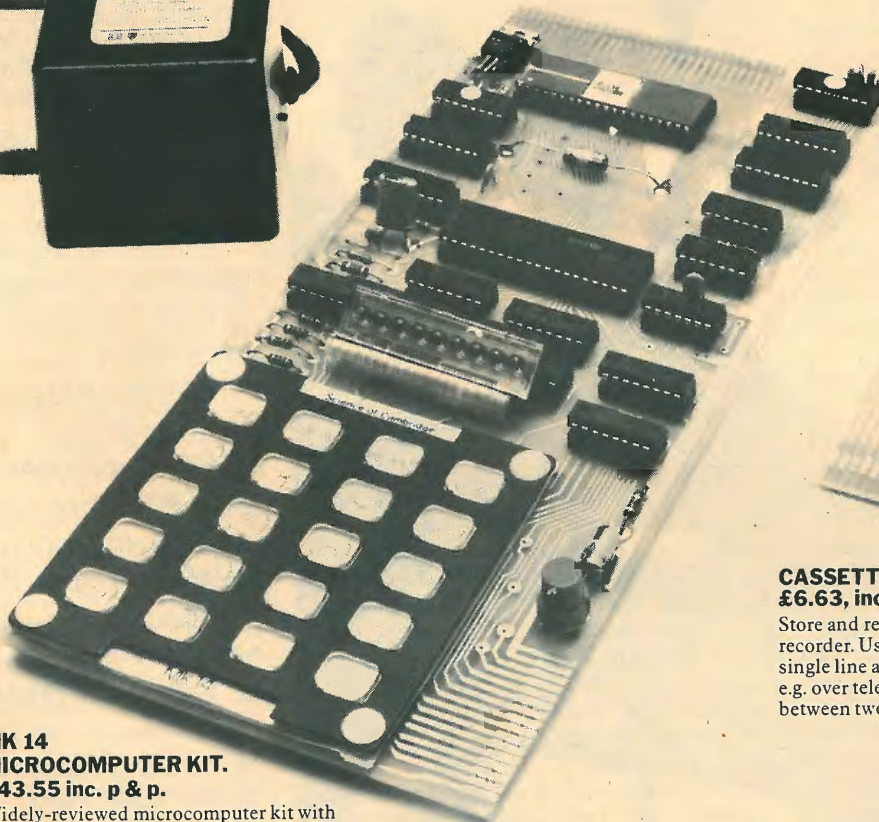

**CASSETTE INTERFACE MODULE. £6.63, inc. p & p.**  
 Store and retrieve programs on any cassette recorder. Use for serial transmission down single line at up to 300 baud (teletype speed), e.g. over telephone line, and to communicate between two or more MK 14s.

To order, complete coupon and post to Science of Cambridge for DELIVERY WITHIN 14 DAYS. Return as received within 14 days for full money refund if not completely satisfied.

## Science of Cambridge Ltd

6 Kings Parade, Cambridge, CAMBS., CB2 1SN.  
 Tel: 0223 311488.

To: Science of Cambridge Ltd, 6 Kings Parade, Cambridge, Cambs., CB2 1SN.

Please send me:

- MK 14 standard kit @ £43.55.
- Extra RAM @ £3.88 per pair.
- RAM I/O device @ £8.42.
- VDU module including character generator @ £31.62.
- VDU module without character generator @ £25.14.
- Cassette interface module @ £6.63.
- PROM programmer @ £10.95.
- Power supply @ £5.85.
- Full technical details of the MK 14 System, with order form.

All prices include p and p.

I enclose cheque/MO/PO for £ \_\_\_\_\_ (total).

Name \_\_\_\_\_

Address (please print) \_\_\_\_\_

Delivery within 14 days.

WW/8/79

WW — 082 FOR FURTHER DETAILS



“We’ve £150,000 worth of recording gear working 24 hours a day — all fed from the OTARI MX5050B. On a cost effectiveness basis alone the MX5050B is unbeatable, but when taking into account sheer professionalism and performance, it is unequalled by recorders three times the price.”

*Mike McLoughlin, Chief Engineer, Independent Tape Duplicators, Aylesbury.*

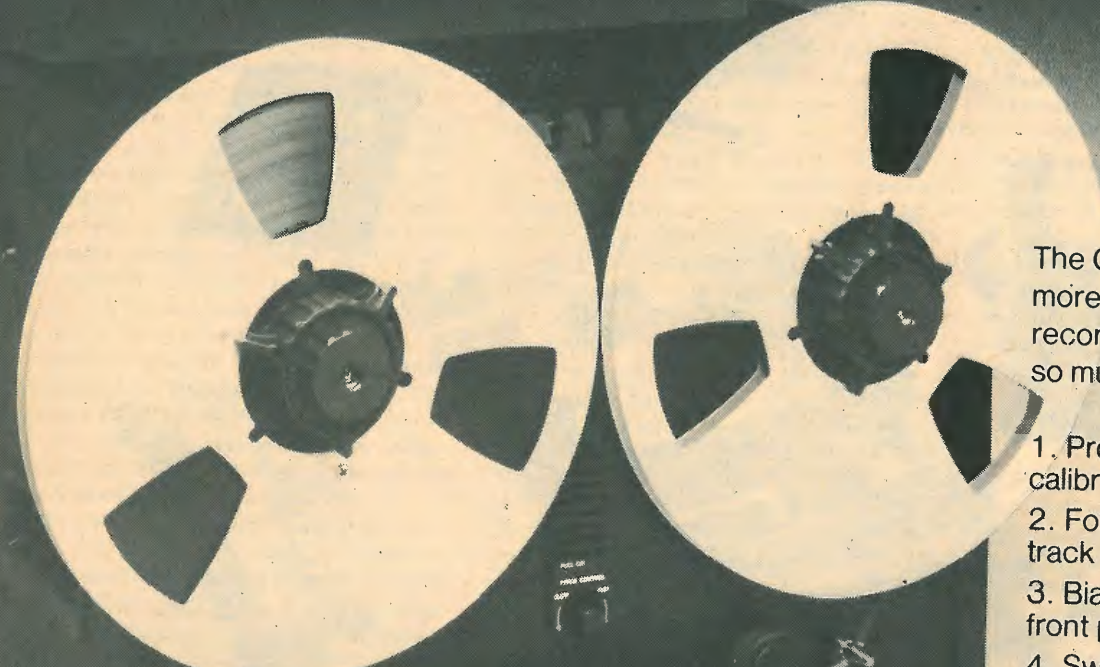

The Otari MX5050B costs little more than modified domestic recorders. That little extra buys so much more.

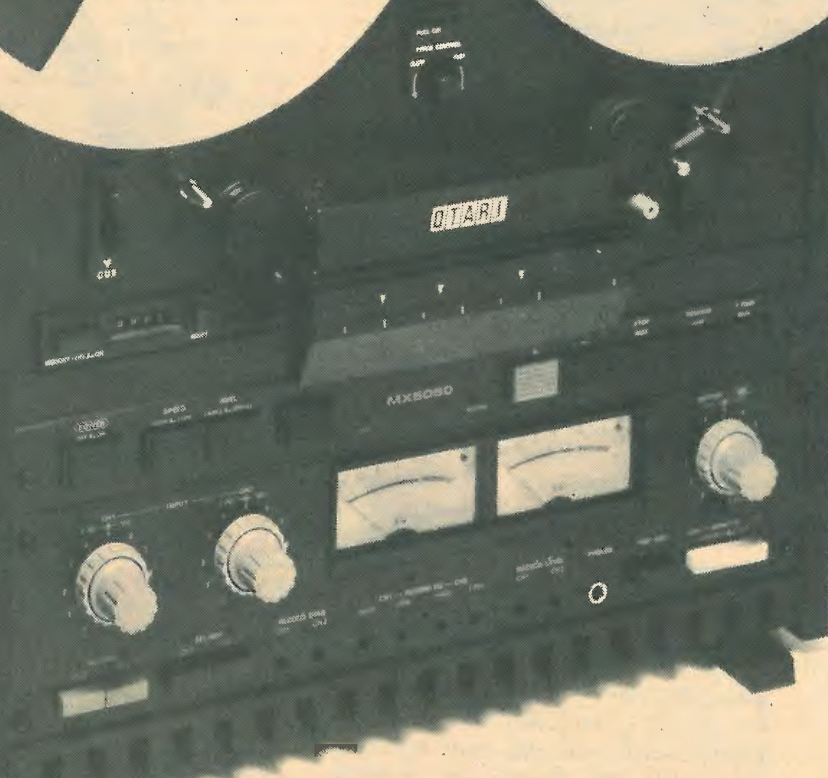
- 
1. Proper editing facilities with calibrated splicing block.
  2. Four heads provide 2 or 4 track replay.
  3. Bias and EQ adjustable from front panel.
  4. Switchable NAB and IEC EQ.
  5. XLR Connectors.
  6. +28 dBm 600 ohm balanced output.
  7. Direct drive capstan servo with varispeed.
  8. Variable or preset output level.
  9. 70 dB (weighted) signal/noise ratio.
  10. Sel sync on each channel.

# OTARI from ITA

1-7 Harewood Avenue, Marylebone Road, London NW1. Tel: 01-724 2497. Telex: 21879.

WW — 080 FOR FURTHER DETAILS



# A scientific computer — 5

## Graphics, graph plotting and e.p.r.o.m. programming

By J. H. Adams, M.Sc.

THE SET OF CHARACTERS chosen for the graphics option was selected to augment the standard ASCII set and also provide various shapes for constructing diagrams and pictorial displays, see Fig. 20. The characters are programmed into a 2708 e.p.r.o.m. so the set may be easily altered to suit individual constructor's requirements. To make the shapes continuous, a full 10 × 6 dot structure is used for each character cell. This is achieved by loading bit 6 of IC<sub>45</sub>, which was wired to 0 and thus inserted a one dot gap in between adjacent characters, and by disabling the line from IC<sub>34</sub> pin 11 to the video gate IC<sub>33b</sub>. The function of the gate was to blank the ninth and tenth line scan in each row of displayed characters to provide line spacing between those rows.

The 2708 is connected in parallel with the 2513 ASCII generator while bit 6 of the v.d.u. r/w.m. is fed directly to pin 11 of IC<sub>47</sub> and through an inverter to IC<sub>100</sub> pin 20. This bit selects which one of the character generators is enabled as shown in Fig. 21. The pulse at IC<sub>45</sub> pin 1, whose trailing edge loads the shift register IC<sub>45</sub> with the character dot pattern, is inverted so that its leading edge clocks the r/w.m. bit 6 into latch IC<sub>102</sub>. The latch output feeds the video gate and sets an input which, on lines 1 to 8 of the character scan, is held low by the signal from pin 11 of IC<sub>34</sub> applied to the S input. On the ninth and tenth scan when the S input is high, the video gate input will reflect the D input to the latch and thus the nature of the character being displayed, i.e. ASCII or graphic. Note that the latch must be loaded ahead of IC<sub>45</sub> otherwise time delays in the system will cause the bottom left-hand corner of any graphic following a non-graphic to be blanked. When IC<sub>100</sub> is disabled, the inverter on its D<sub>5</sub> output provides a low to IC<sub>45</sub> pin 6 which then retains the original character spacing on ASCII.

### Using graphics

As mentioned in part 3, ASCII may be directly loaded in low level language by opening a [ and then typing the characters required. To enter graphics from this mode, open another [ and then type in the graphic characters required. After typing the first character, which replaces the [ on the screen, a cursor

appears in the next screen position (a cursor is essential for picture construction) and the / key becomes a "rub-out and backstep" key for correcting errors. Typing a ] reverts the computer to the ASCII mode of loading. With the high level language the computer is already in the ASCII mode and so the first [ mentioned above need not be typed in. When loading ASCII or graphics in the low level, the computer includes ], 1D in hexadecimal, in the string of characters loaded into the program. This is recognised as the end-of-string marker by the low level subroutine at 03CE<sub>H</sub>, mentioned in part 4, and for this reason a ] can not be included in an ASCII string. In graphics, the [ key stands for a shape and so this restriction does not apply, also, RETURN does not function so for a new line type ], RETURN, [. All of the instructions for graphics are already in the monitor r.o.m.s so no re-programming is required for this optional facility. A selection of computer displays is shown in Fig. 22.

### Graph plotting

In part 4, a program was described which analyses the frequency response of an RIAA equalised pre-amplifier. Fig. 22(d) shows a version of this program which displays a graph of gain and frequency. Both quantities are logged before they are plotted to produce the standard dB versus log. of frequency format. The frequency is stepped logarithmically at line 52 at four increases per decade, and for each point plotted the frequency is displayed at the top of the screen. The original reason for developing this program was to examine the low-frequency gain of my hi-fi and so, after reaching 20kHz, the program branches to line 200 where it inputs a new value for F, the 25μF capacitor, and then replots a curve super-imposed upon the original.

When the graphics option is installed, the demonstration programs at the third end of the third e.p.r.o.m. in the computer can be replaced with firmware which enables it to accept two extra high level commands;

### AXIS a b

which declares the maximum values of the vertical and horizontal axes of a graph plot, and

### GRAPH a b

which plots the point (b,a) on a graph defined by the last AXIS statement. The terms a and b may be either variables or numbers. The plotted graph is of the first quadrant, i.e. both a and b positive, and is realised by dividing the screen into 8192 (128 by 64) cells which are selectively illuminated using graphic shapes at screen addresses obtained by scaling actual results to be plotted against the limits declared in the AXIS statement. The graph appears as discrete points, the spacing of which is usually determined by a FOR loop containing the GRAPH statement. The firmware controlling these processes ignores the sign of the variables (hence the first quadrant only) and will plot all results as positive. It also uses the variables P and Q for the scaling factors, thus only the remaining 24 are available in graph plotting programs.

### E.p.r.o.m. programmer

The 2708 seems to be the most popular e.p.r.o.m. at present and this is probably due to the ease with which it may be programmed. Unlike many of its competitors, address locations and the data to be programmed at those locations are entered at the same level and polarity, and at the same pins as those obtained during read operations. Apart from the application of data to the device, the only changes made during programming are that the chip enable input is taken to +12V and a +25V pulse is applied to the programming pin 18.

It takes 100 ms to program each byte but, unfortunately, the device cannot be programmed byte by byte because pulses this long may cause spurious programming of adjacent cells on the chip. The specified maximum pulse length is only 1ms and so a programmer must make at least 100 "laps" of the device, slowly bringing up the values in each cell to their final state. The programmer requires 8 data bits, 10 address bits and a signal bit to commence the programming pulse for each byte. In Fig. 23, the two upper bits of the addresses are supplied by a four-way switch and the remaining 16 bits are fed serially to a 16-bit shift register formed by two 4015s. Data is sent out via the buffered D<sub>7</sub> line using OUT commands, and pulses to clock the bits into the shift



@



A



B



C



D



E



F



G



H



I



J



K



L



M



N



O



P



Q



R



S



T



U



V



W



X



Y



Z



[

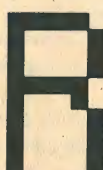

----- Not callable -----

Produces a space

Sp



!



"



#



\$



%



&

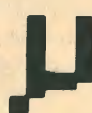

'



(



)



\*



+

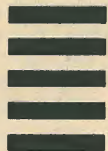

,



-



.



not callable



0



1



2

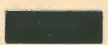

3



4

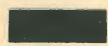

5

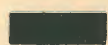

6

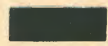

7



8



9



;



<



=



>



?

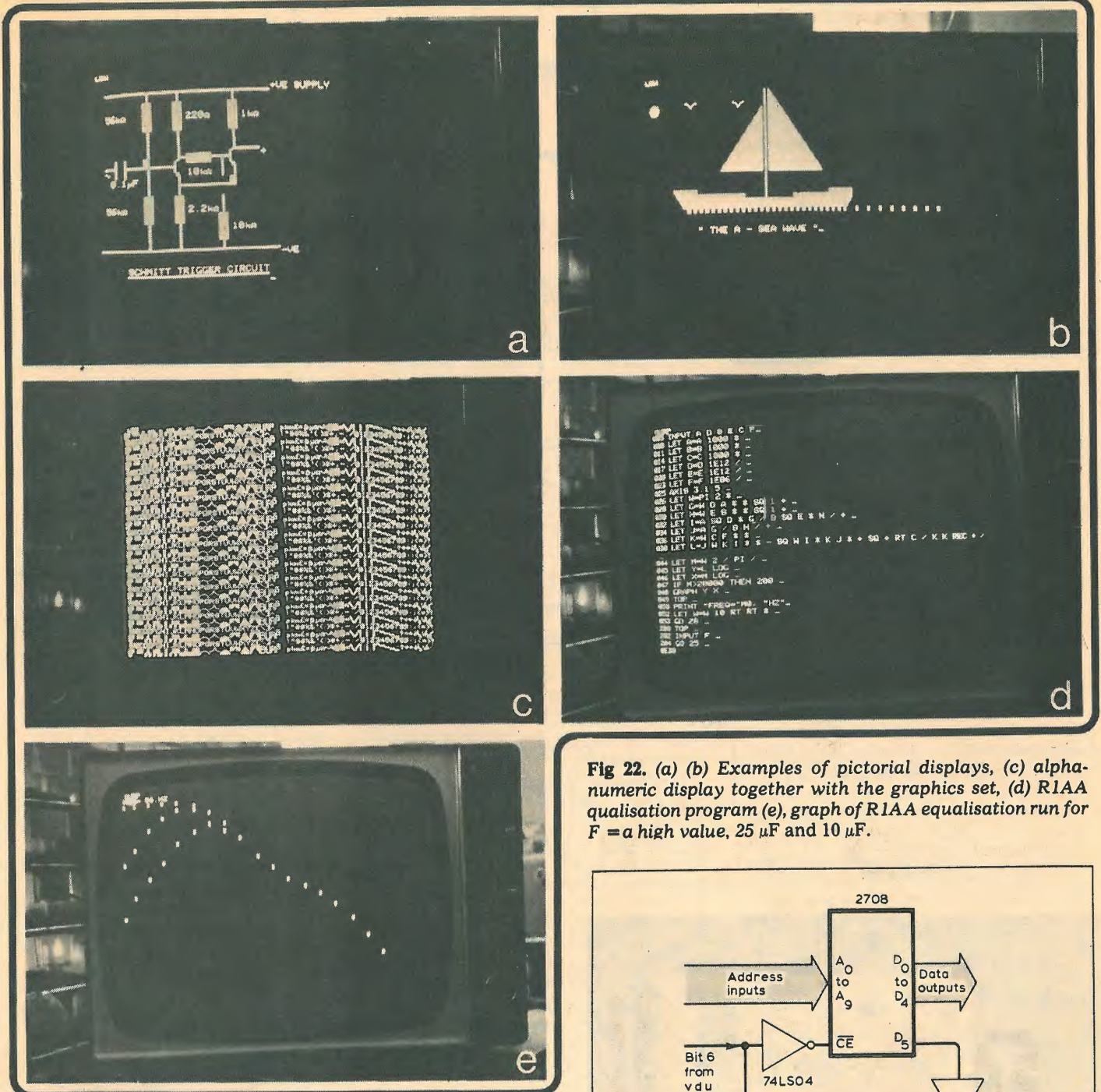

**Fig 22.** (a) (b) Examples of pictorial displays, (c) alphanumeric display together with the graphics set, (d) RIAA equalisation program (e), graph of RIAA equalisation run for  $F = a$  high value,  $25 \mu\text{F}$  and  $10 \mu\text{F}$ .

register are provided by the output write decoder IC<sub>2</sub>. A second line from IC<sub>2</sub> triggers the 1ms monostable when the 16 bits are in place and initiates the programming. A hardware time delay leaves the Z80 free to prepare the next string of data for transmission to the shift register. This small reduction in time is important because during the programming over 100,000 operations are carried out, each with its own period of data transmission and 1ms pulse. Although it would save time to transmit the data in parallel, the extra connection complexity was considered unnecessary. For reliable programming some extra lags should be included to allow for monostable time delay variation. Unless the full 100ms per location

**Fig. 21.** Optional graphics circuitry. All of the instructions for graphics are already in the monitor r.o.ms.

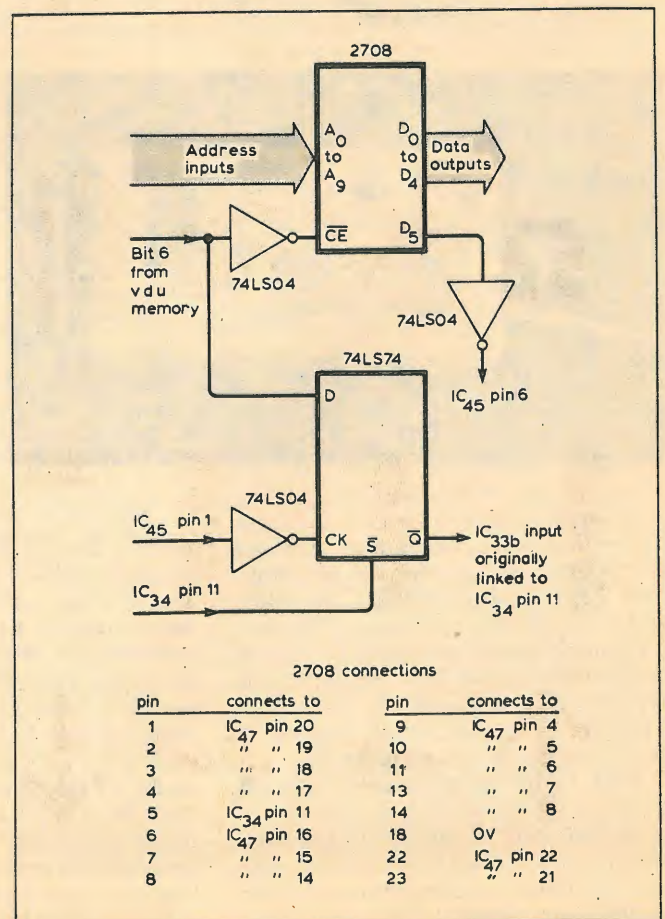

◀ **Fig. 20.** Graphics character set.

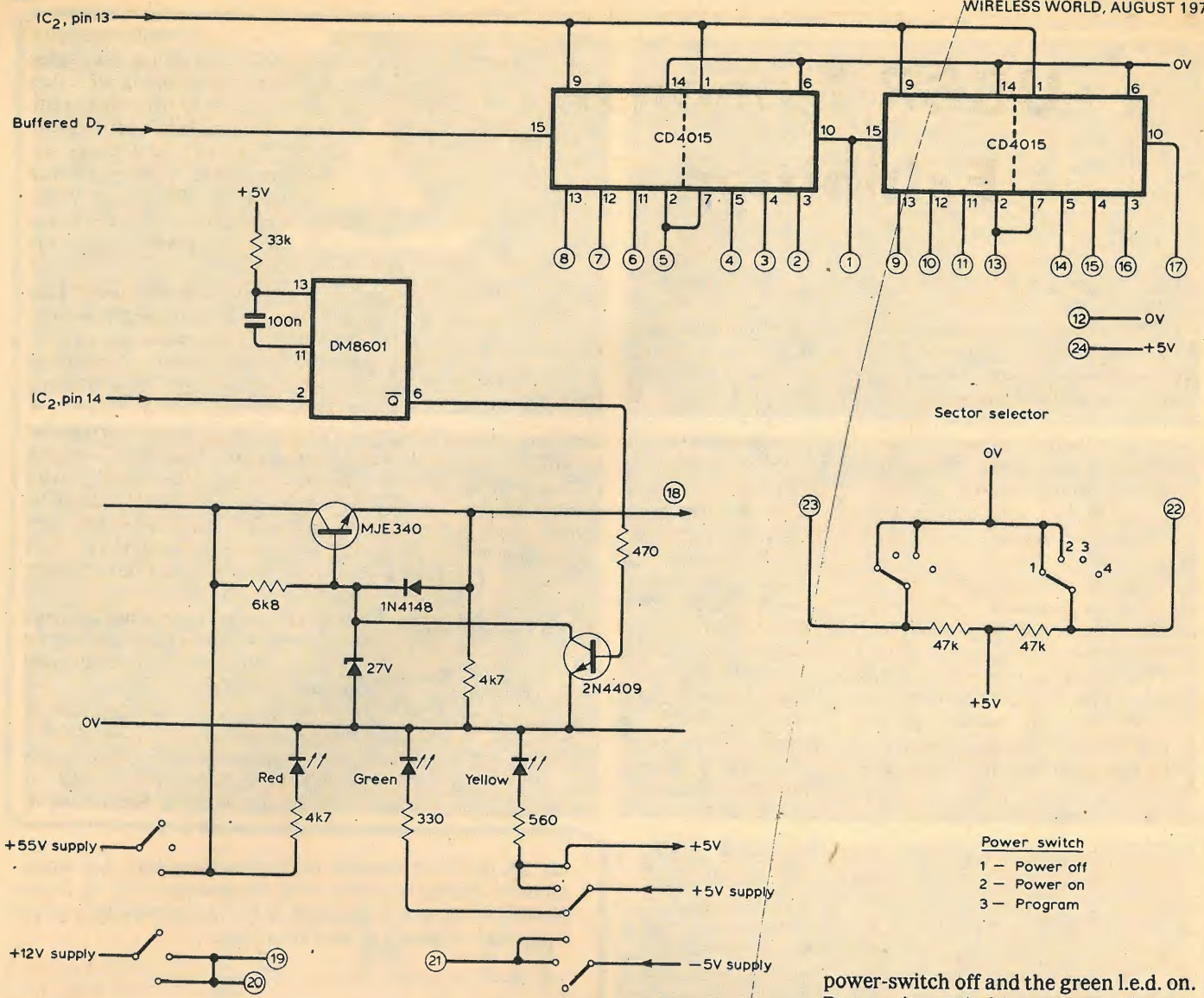
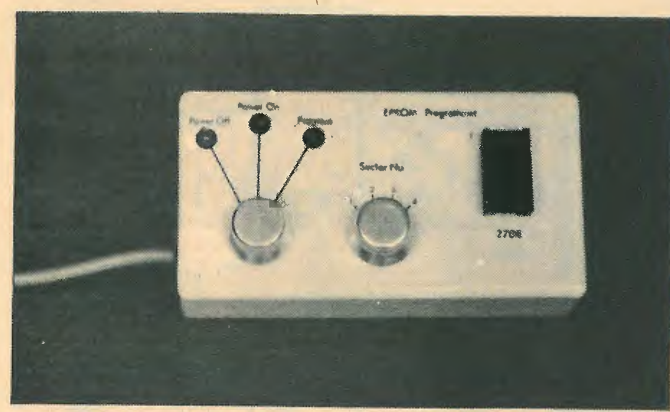

**Fig. 23. E.p.r.o.m. programmer and circuitry. Pin numbers for the i.c. socket are shown in circles.**

power-switch off and the green l.e.d. on. Progressive switching ensures that all of the required voltages are present before +25V is made available and prevents any chance of random programming. To program a sector, the command is PROM<sub>0</sub> but before this is used, check that the sector switch is in the required position. The programmer will also accept 2704 devices which are half the size of 2708s and only require sectors 1 and 2 although, in my experience, many 2704s are 2708s in another guise. All of the instructions for programming e.p.r.o.ms are in the original r.o.ms so no firmware changes are required for this option.

**Erasing e.p.r.o.ms**

For rapid erasing a high-power short wavelength ultra-violet lamp is required. Because commercial units are quite expensive I use a Philips 6 Watt u.v. lamp. The bulb should be coated in aluminium foil, except for a small window a third of the way from the glass end, to near the base. Because the base forms one of the connections, the foil must not touch it. This arrangement gives eye protection and concentrates the light at the window. The e.p.r.o.ms to be erased are placed as close as possible to the window and left for approximately three hours.  
To be continued



in applied some bytes may exhibit access times well outside the manufacturer's specification and this can cause erratic computer operation. The programming voltage is supplied through a conventional series-pass regulator and because at low levels pin 18 of the e.p.r.o.m. is a current source, the 1N4148 and 2N4409 form a positive clamp. Data to be programmed into an e.p.r.o.m. is assembled into the memory area 1C00 to 1CFF inclusive. Originally the memory was divided into four sectors and these were programmed separately which reduced the programmer

address bits to 8, to match the shift registers. However, it has also proved useful when adding to or modifying small areas of r.o.ms during firmware development. When the r.o.ms are new or erased, all of the locations hold a 1, i.e. the bytes are all FF. If a sector of a 2708 is not to be completely programmed, or if a partially filled sector is to be added to, the command FILL 1C00 will fill 1C00 to 1CFF with FFs and will thus mask any areas which are not to be programmed prior to entering the data. The e.p.r.o.ms must only be inserted or removed from the programmer with the

# USSR National Exhibition

Anyone who visited the Russian National Exhibition at Earl's Court could be forgiven for forming an unusual conclusion — that the Russian space effort might have owed its major successes to the exploitation of forces no more modern than steam power. There was plenty of colour and cultural entertainment available, but very little specific information on modern Russian technology.

The most delicate engineering had gone into the construction of impressive working models of industrial plant, chemical process works and a nuclear power station, although only general details were given concerning the latter. *"The Soviet Union pioneered the peaceful uses of atomic energy . . . without deterioration of the environment."*

Much of the entrance hall was liberally coated with further "informative" slogans such as *"The USSR is a voluntary union of 15 constituent republics enjoying equal rights,"* which may or may not have been true, but neatly demonstrated the naivety apparent in the Russian approach to the western visitor generally.

Even in the excellent models modern electronic techniques were notable for their complete absence, and although they were ingeniously contrived, they smacked more of the esoteric model-maker than the engineer or technologist. The concentration on heavy industry permits the conclusion to filter through that, either the "guns before butter" policy still operates or they don't want us to know too much about any microcircuit development, even in consumer applications. Whatever the true case it seems that mining, steel production and space research still receive most of the funds and the consumer industries a mere dribble of the residue.

Mashpriborintorg (a state import/export agency) seems to put most of its energy into down-rating its technical specifications. "Signal Generators" (an undated publication) gave details of a range of 14 instruments which looked more like western domestic radio receivers of the inter-war years than test equipment manufactured in 1978 or 1979. Some of them offered a spare "oscillator valve" as standard equipment and one even "featured" a nixie tube frequency display.

Such technical literature as there was proved difficult to come by although

one short book emerged entitled "USSR Science," carrying the interesting information on the fly leaf that the work had been "edited in 1976."

Nobody in fact would pretend that the available technical handbooks covered monitoring grade equipment or that they are likely to be the sort of machinery used at the Baikonur Cosmodrome (a model of which was provided) although if the organisers don't provide up to date information they can hardly blame visitors for taking 1954 designs as representing the pinnacle of current development.

In contrast to this depressed literature, Collet's bookshop (free enterprise, British-style) was doing a roaring trade in current Russian books, magazines, classical and folk music albums, as well as a variety of art prints.

A close search failed to uncover any electronic switching or opto-electronic devices in the numerous active displays and models. A steam hammer seemed to be crushing some walnuts — the Aeroflot route display (continuously alternating between European and Siberian services) revealed under its skirts some pretty heavy engineering, including noisy relays and metal-clad cables. A saving on power consumption and packing space could have been effected with a handful of l.e.d.s and display drivers, etc., but if the Russian technocrats were in the habit of using such devices, we were not permitted any details.

A model town (also a model in the display) somewhere on the 69th parallel looked very pretty at night. This community serves a mining complex and the quoted attractions include "sports facilities and fresh fruit and vegetables all year round." These are matters which do not raise a great deal of debate in western communities generally.

Displays of textiles (and all the displays were sensitively arranged) further suggested the minimal amount of state expenditure on consumer synthetics, except for the outer skin of one or two rather trashy cuddly toys — designs which have not changed at all in 10 years according to one visiting expert. *"The Soviet people's need for many durables that were only recently regarded as being in short supply is now being satisfied."* Only natural fibres were in fact evident, although the "people's clothing" exhibit contained some beautiful garments.

*"Soviet law prohibits hunting of 18*

*animal and 29 bird species."* Bukhara, another state agency, concerned with the export of animal skins and other luxury clothing, was dripping with furs only a few metres away from this proud boast. Some of the little information snippets on the walls were none too complimentary when viewed with a somewhat jaded eye: *"The Soviet Union leads the world in establishing top limits for noxious substances in the atmosphere."*

At a completely different level, visitors arriving via the underground entrance must have seen plenty of evidence of Russian "product reticence" — every single display frame up the escalator (which could have been usefully employed to show views of tractors, space probes or even the baby mammoth) was concerned with Stolichnaya Vodka. The alcoholic thrust continued inside near the bars where large posters said that "only vodka from Russia is genuine Russian Vodka."

One of the more interesting displays included several Soyuz capsules, but no information other than the basic role of each was provided.

At least Russian watches (on sale in the Russian shop) appear to be as good and as cheap as ever. So too is the "Saratov" refrigerator, which sells at about 1/3 the price of its English equivalent. The leaflet illustration was worth getting as well — it showed that the Russian view of the Englishman's 'fridge accessories includes several saucepans with handles sticking out of the door. The place where the reserved gentleman keeps his milk, bottom rack on the inside of the door, was taken up with a bottle of Gilbey's Gin and a bottle of White Horse whisky!

One thing was certain about this exhibition — information had been restricted to "non-classified" displays of artistic and cultural life.

It's a great shame that so much effort went into providing an admittedly interesting display of Russian artistic activities while so little was put into a really open view of Soviet technology. The overlay, of dogma, experienced at every turn and voiced in the familiar tones of that familiar lady and gentleman who have been telling us about the glorious five-year plans for several years on Radio Moscow, left this otherwise colourful and bright exhibition heavy with ideological fog.

On the credit side, the event showed that at last the snow on Russian boots is beginning to melt. As the divide between our different social and political systems begins to narrow, we may even see the birth of an Anglo-Russian tv receiver, more high quality consumer products from Soviet technology and less emphasis on the brain-destroying fluid which appears at the moment to be Russia's proudest export.

# CIRCUIT IDEAS

## Programmable attenuator

The network in Fig. 1 is a programmable attenuator where the attenuation in dB is set by a binary number on the switches. This principle may be extended to more bits, either in binary or b.c.d. The circuit is a development of a resistive transmission line where each section, when loaded at the right by a characteristic resistance of  $10k\Omega$ , presents an equal load of  $10k\Omega$  to its neighbour on the left and provides a selection of attenuations from 0 to 15dB. With the components shown the network has an error of less than 3% per stage for attenuation or impedance. Fig. 2 shows a c.m.o.s. changeover switch using two 4016 sections.

J. Allen  
Radcliffe  
Lancs

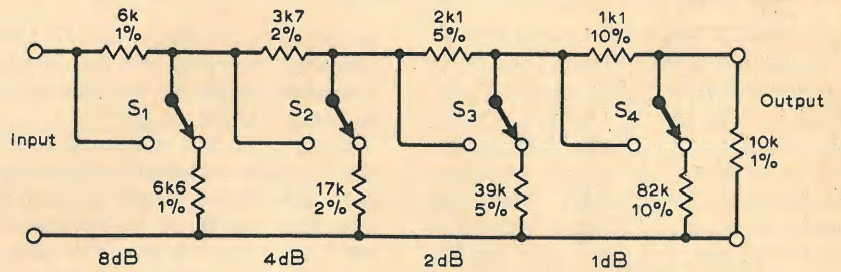

Fig. 1

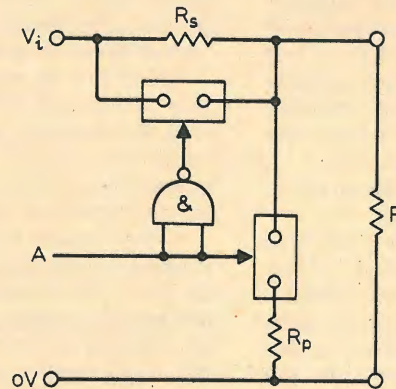

Fig. 2

## VU meter

This i.e.d. meter offers lower cost and greater flexibility than a conventional moving coil type. Diode  $D_1$  rectifies the audio input signal and the CR network provides a time constant for detecting peaks. Resistor  $R$  is selected so that the voltage swing at  $Y$  is about 150mV and the potentiometer is adjusted until  $D_6$  is just on. As the input voltage increases,

$Tr_1$  starts to conduct which causes a progressive voltage drop across the collector resistor chain of  $Tr_2$ . These voltages are used to drive five i.e.ds via transistors in the CA3046.

The display can exhibit an exponential law due to the emitter-current base-emitter voltage characteristic of  $Tr_1$ . Alternatively - a reasonably linear

law can be obtained by adjusting  $R$ . Other laws are also possible by changing the values of  $R_1$  to  $R_5$ .

If two meters are used and arranged as shown, point  $X$  should be made common and only one i.e.d. used for  $D_2$ .

Dr R. Green  
Chelmsford  
Essex

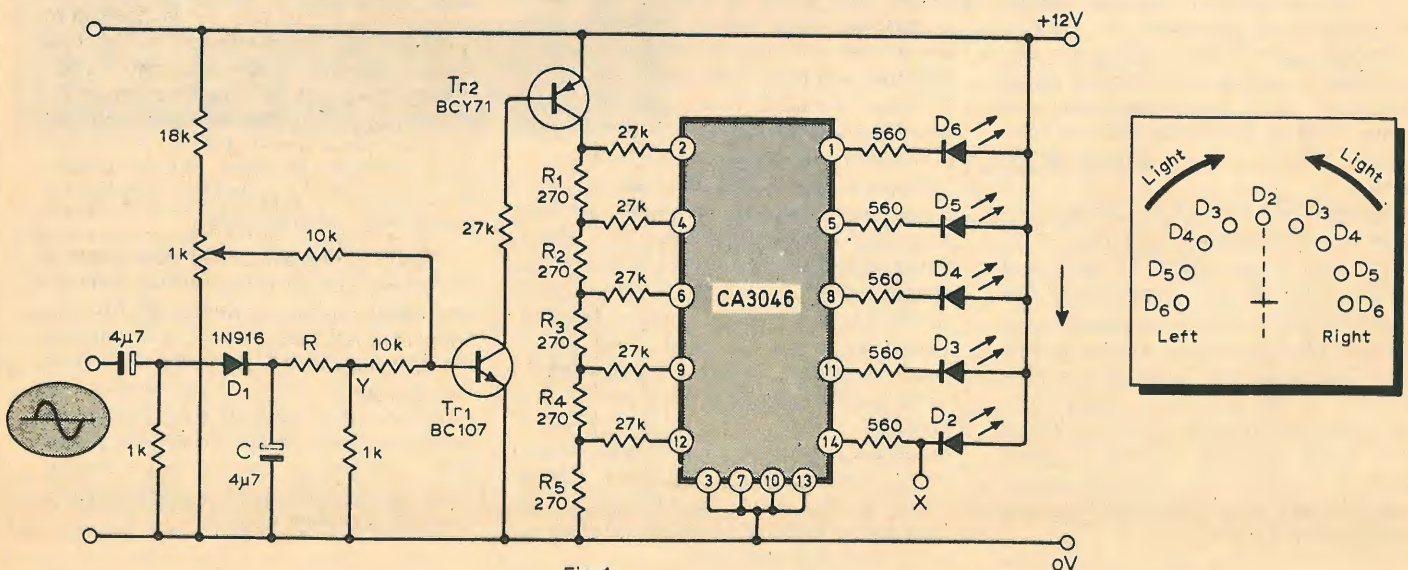
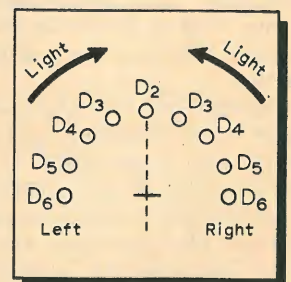

Fig. 1



### Phase meter

A standard multimeter can be used to make phase measurements at audio frequencies with the circuit shown. The meter is calibrated for a f.s.d. of 180° and an l.e.d. indicates when the phase difference is greater than 180°. The 4013 flip-flop is reset at the start of a positive excursion of the reference signal and a clock pulse is provided at the start of a negative excursion. If the data input of the flip-flop is high when the clock pulse occurs, the l.e.d. is switched on for half a cycle. The values shown are for a 12V supply.

N. G. Boreham  
Teignmouth  
S. Devon

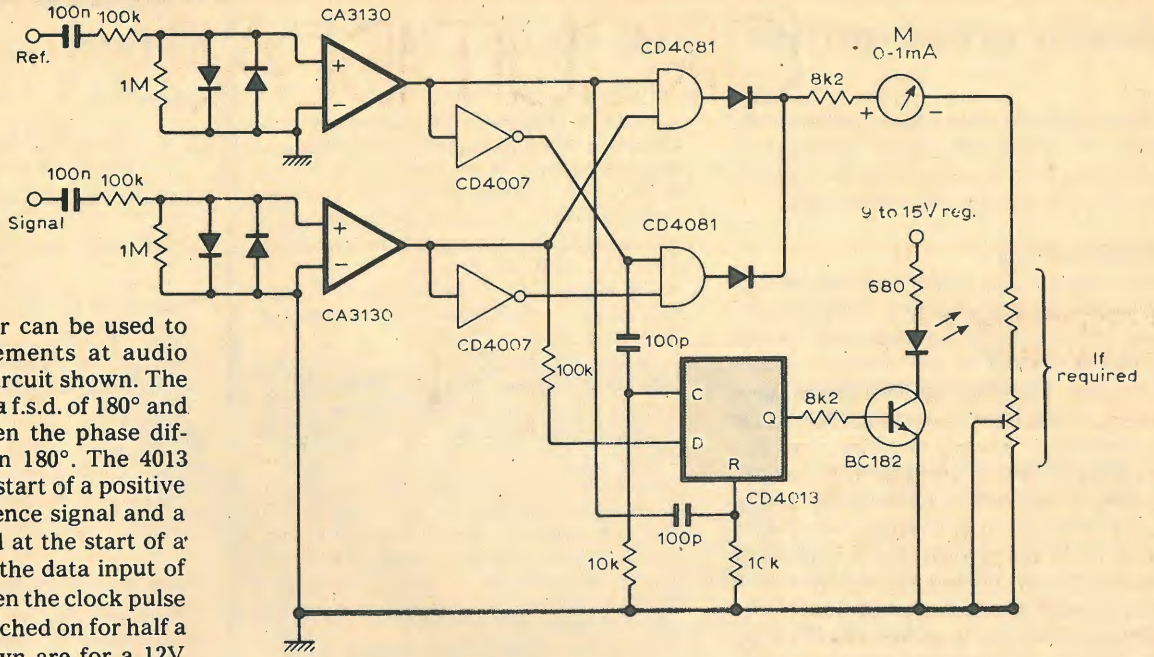

### Four-trace scope switch

This unit allows up to four signals to be displayed simultaneously on any oscilloscope which has an input summing facility and a timebase output. As each input is fed to the scope sequentially by a c.m.o.s. switch, a second switch in IC<sub>3</sub> selects a shift potential to alter the trace position. The input signal is then combined with its own shift voltage by the oscilloscope.

Inputs are selected by a +10 counter which has output 4 connected to the reset. Because the counter is clocked by pulses from the oscilloscope, the four traces operate in the alternate mode. The buffers in IC<sub>1</sub> are used to square the oscilloscope output so sawtooth and gate outputs can be used.

The prototype was powered from a ±5V supply so that d.c. coupled signals at or near earth could be accepted. For low sweep rates IC<sub>1</sub> can be connected as a chopping oscillator, and more switches can be connected if more inputs are required.

M. B. Tancock  
Worcester

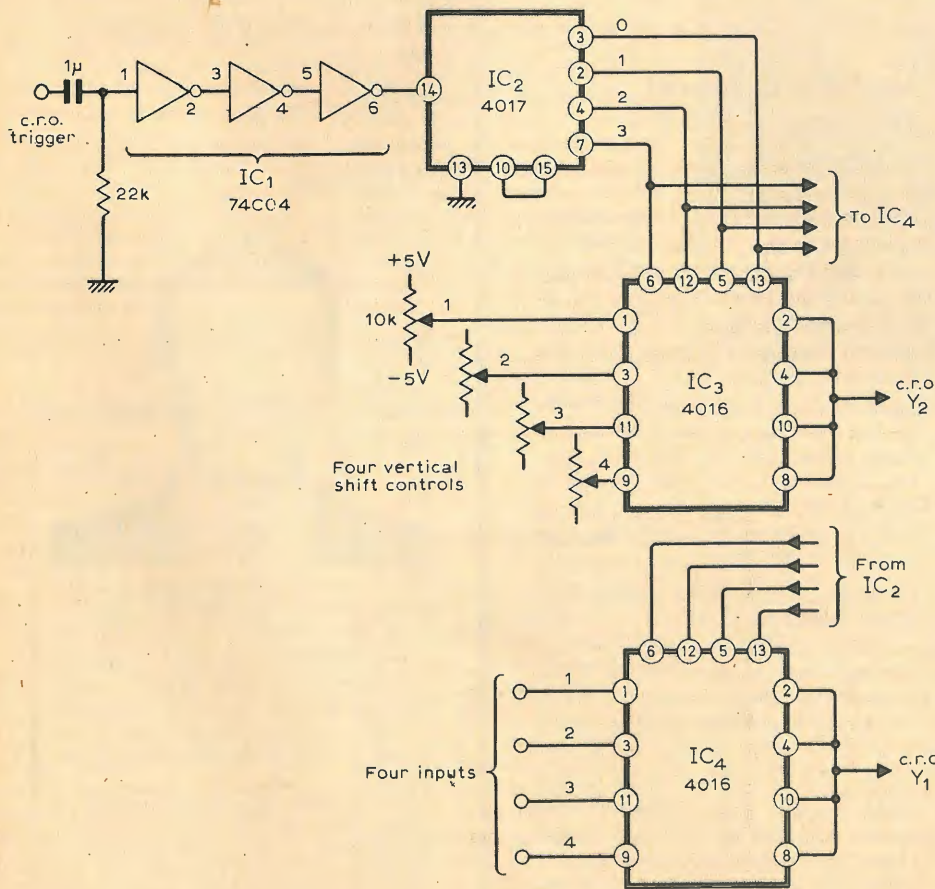

## Audio preamplifier

Measurements were conducted with the help of Brüel and Kjaer equipment. Listening tests confirm that the circuits do not introduce sound coloration.

### Modifications

Some increase in signal-to-noise ratio is available by the following alterations:

- gain increase in the first and second stages mainly at the expense of decrease of emitter resistor values
- use of transistors giving even lower noise
- collector current decrease in the first stage (this leads to some increase of s/n ratio over the band)

More close conformity of the frequency response to the RIAA recommendation (approximately 1dB increase), can be realized merely by changing the correction circuit time constant.

The quest for an increase in s/n ratio should agree with known turntable rumble, disc noise and sometimes with other factors, for example tape-recorder noise, acoustic noises of rooms, etc.

Of course in doing so one must comply with linearity requirements, especially in the first stage. In the case of a different gain distribution among stage it is possible to decrease difference tone distortion to some extent at the cost of an increase in harmonic and intermodulation distortion and vice-versa. Harmonic and intermodulation distortion level is decreased by increasing the collector current in the second stage.

Difference tone distortion level is drastically decreased by increasing collector current in the first stage, which may demand some increase in power-supply voltage, giving only an insignificant decrease in s/n ratio.

When connecting a pickup giving higher output than 200µV or 2mV at 3.54cm/s set the output voltage level according to the required output level 100mV by increasing the values of emitter resistors, chiefly in the first stage.

The application of transistors having better linearity will give even better results as to distortion, but . . . at the present time as a rule designers take little interest in problems of the linearity of amplification elements.

### References

1. Brüel & Kjaer, Electro-acoustic Measurements 9, Transient intermodulation distortion (TIM)
2. Holman, T. Dynamic range requirements of phonograph preamplifiers, *Audio*, 1977, no. 7.
3. Pisha, B.V. Nine CD-4 phono cartridges tested, *Audio*, 1974, no 3.

continued from page 60

4. Lewis, W.D. & Hunt, F.V. Theory of tracing distortion in sound reproduction from phonograph records, *JASA*, 1941, vol. 12, no 3.

5. Roys, H.E. Analysis by the two-frequency intermodulation method of tracing distortion encountered in phonograph reproduction, *RCA Rev.*, 1949, vol. 10 no. 2.

6. Corrington, M.S. & Murakami, T. Tracing distortion in stereophonic disc recording, *RCA Rev.*, 1958, vol. 19, no. 2.

7. Bauer, B.B. Tracing angle in phonograph pickups, *Electronics*, 1945, vol. 18, no. 3.

8. Hiraga, J. Mesurs sur les phonocapteurs, 2. La distorsion, *Revue du Son*, 1971, no. 220, 221.

9. Zwicker, E. & Feldtkeller, R. Das Ohr als Nachrichtenempfänger, S. Hirzel Verlag Stuttgart, 1967.

Ryffert, H. Die Grenzen der Hörbarkeit nicht-linearer Verzerrungen vierter und fünfter Ordnung für die einfache Quint; frequenz, 1961, vol 15, no. 8.

Lazenby, M. How little distortion can we hear?, *Wireless World*, 1957, vol. 63, no. 9.

10. Goron, E.I. Study on perceptibility of distortions in broadcasting channels, Svyaz publishing house, 1959.

11. Hallgren, B.I. Noise performance of a magnetic phonograph pickup, *JAES*, 1975, no. 7.

### Additional reading

Hamm Russell O. Tubes versus transistors - is there an - audible difference?, *JAES*, 1972, vol. 21, no. 4. □

## Wireless World binding - VAT change

As a result of the Government's recent increase of Value Added Tax we regret that the price of binding a volume of *Wireless World* has had to be increased. Instead of £6.65 the price is now £6.90 (which includes the index as before).

Apart from this the arrangements for the index and binding remain as noted in the May 1979 issue (p. 70). The index for Volume 84 (1978) is now available, price 50p including postage, from the General Sales Department, IPC Electrical-Electronic Press Ltd, Dorset House, Stamford Street, London SE1 9LU.

If you wish to use the binding service send your copies to Press Binders Ltd, 4-4a Iliffe Yard, Crampton Street, Walworth, London, SE17 with your name and address enclosed. Confirm your order to the General Sales Department (address above) and with this letter to Dorset House send a remittance of £6.90 for each volume. Please allow up to ten weeks for delivery.

In both cases cheques should be made payable to IPC Business Press Ltd.

## Passive notch filters

continued from page 66

Hence

$$a \cdot b = \frac{b}{1/a} = \frac{R_b + pL_b + 1/pC_b}{(1/R) + pC_a + 1/pL_a} \quad \text{B.3}$$

Assume the relation

$$R^2 = R_a \cdot R_b = \frac{pL_a}{pC_b} = \frac{pL_b}{pC_a} \quad \text{B.4}$$

then  $R_b = R^2/R_a$ ,  $pL_b = R^2 \cdot pC_a$ , and  $1/pC_b = R^2/pL_a$ .

Replace the numerator of equation B.3 with the above identities

$$a \cdot b = \frac{b}{1/a} = \frac{(R^2/R_a) + R^2 \cdot pC_a + R^2/pL_a}{(1/R_a) + pC_a + (1/pL_a)} = R^2$$

Thus, arm 'a' is the inverse of arm 'b' in the lattice of Fig. 1.1, i.e., the product  $a \cdot b$  equals  $R^2$ , the input impedance of the lattice, with components relation of equation B.4, equals  $R$  at all frequencies.

From Fig. B.1 and reference 5,

$$\begin{pmatrix} V_1 \\ I_1 \end{pmatrix} = \begin{pmatrix} \left(\frac{b+a}{b-a}\right) & \left(\frac{2ba}{b-a}\right) \\ \left(\frac{2}{b-a}\right) & \left(\frac{b+a}{b-a}\right) \end{pmatrix} \begin{pmatrix} V_2 \\ I_2 \end{pmatrix} \quad \text{B.5}$$

Thus

$$V_1 = \frac{1}{b-a} [(b+a)V_2 + 2ba \cdot I_2]$$

From Fig. B.1  $I_2 = V_2/R$

and from equation B.2  $a = R^2/b$

$V_1$  becomes

$$V_2 \frac{b+R}{b-R} \text{ or } \frac{V_2}{V_1} = \frac{b-R}{b+R}.$$

To be continued



With an honours degree in electrical engineering from the University College of North Wales, Bangor, Gideon Kalanit joined Rediffusion in 1956, and was involved with the development of cable television systems, including experimental pay-tv systems. This work led to the interest in notch filters, the subject of this article.

In 1965 he joined Marconi Instruments to design equipment for television signal measurement, and rejoined Rediffusion Engineering in 1969. Presently with the advanced systems department, he is concerned with instrument design and the development of Dial-a-Program cable tv systems.



# NEW PRODUCTS

## Electromagnetic shield laminate

A flat laminate, formed by a continuous adhesive-bond laminating process and designed as an electromagnetic shielding material, is now being manufactured by TME Corporation (US). The standard laminate uses loz copper as a conductor, bonded on both sides with "Nomex", a Dupont material which exhibits a dielectric constant of 2.5 at 1kHz and a dielectric strength in excess of 3,500V. The laminate is claimed to show excellent tear strength and dimensional stability, performing in temperatures up to 120°C. The makers claim that this material can provide a simple and relatively cheap means of establishing electromagnetic isolation between closely-stacked circuit boards, shielding electronic equipment against external electrostatic sources and providing a drain for internally-generated electromagnetic charges. The electromagnetic shield laminate is available either in flat sheets in sizes up to 24×36 in, continuous rolls up to 24 in by hundreds of feet in length or in tailored stampings, die-cut to specific sizes and shapes for applications such as keyboard shields. TME Corporation, 2 Cannon St., Newton, Mass 02161

WW301

## 1 Mbit bubble memory

The 7110 magnetic bubble memory provides bulk storage of 128K bytes as an alternative to magnetic discs or tape cassettes in computer or other digital systems. Internally it is organized as 4096 continuously circulating 256-bit shift registers which operate in parallel, but the input and output are serial. A block of 512 bits (contents of two registers) can be written or read by a single command. Storage is non-volatile (information is retained when the power is switched off) but the device has the read/write facility of semiconductor memories. Based on the standard shift rate of 50kHz, the average random access time is 40ms. Maximum data rate is 100kHz;

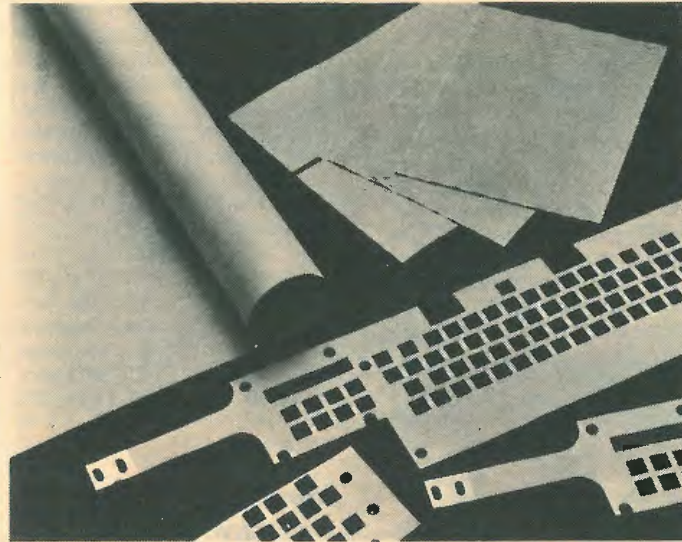

WW301

average is 78kHz. The makers, Intel, have also produced supporting chips to enable the memory to be used in full systems: a controller allows up to eight 7110s to work in parallel; a formatter/sense amplifier senses bubble signals, handles redundant loops and buffers data; a pulse generator supplies the high peak currents required by the device and a coil pre-driver interfaces the controller to driver transistors. A working memory system operates from +12V and +5V supplies and consumes 6W when active or 1.3W on standby. Intel Corporation (UK) Ltd, 4 Between Towns Road, Cowley, Oxford OX4 3NB

WW302

## Optical reflective sensor

Using a visible i.e.d. emitter and a matched i.c. photodetector, the HEDS-1000 is a high speed selective sensing head designed to scan colour-coded matrices or other colour-related patterns. The device, manufactured by Hewlett-Packard, contains a 0.178mm diameter emitter and is packaged in an eight-pin high profile T05 metal/glass encapsulation. A bifurcated aspheric lens is used to image the active areas of the emitter and detector into a single spot some 4mm in front of the glass faceplate. Each lens half



WW303

has a numerical aperture of 0.3 for maximum light gathering power and spherical aberrations are eliminated by the use of aspheric lens surfaces. Hewlett-Packard points out that the device is simple to instal as it requires no special alignment tools or optical test equipment and will operate from a d.c. supply of between 3.5 and 20V. Applications for the sensor include optical inspection, facsimile sensing, pattern recognition, edge sensing and tachometry. Hewlett-Packard Ltd, King St. Lane, Winnersh, Wokingham, Berkshire RG11 5AR.

WW303

## Thermal cut-off device

Roughly the size of a matchstick, the 002 series thermal cut-off device offers protection within the range 76°C to 242°C at 250V a.c. 50Hz and with current drain up to 25A. This device, recently introduced by 3M, is approved to BS 3955 and is already being incorporated in percolators, mains transformers, mini boilers, deep fat fryers, showers and steam irons. The device is available in a range of 20 cut-off temperatures and is claimed to be very fast-acting. Industrial Products Group, 3M United Kingdom Ltd., P.O. Box 1, Bracknell RG12 1JU

WW304

## B.c.d. encoder switch

The type 325 sub-miniature rotary encoder switch provides a four-line binary coded decimal output and ten switch positions. The makers, Impectron Ltd., suggest that it will prove useful where it is necessary to fit an encoder into a very tight corner, as the switch measures only 15×10×11.3mm overall (excluding mounting pins and spindle) and also where manual controls or mechanical assemblies have to be interfaced to logic circuits. Five pins are provided for p.c. board mounting — one pin is for supply input, the

others representing 1,2,4 and 8. On position "0" no contact is made, but as the spindle is "clicked" around its remaining 9 positions the remaining four pins represent the number of the position selected in b.c.d. form. The spindle may be continuously rotated and in this mode may be used as a shaft encoder with 36° resolution. Outputs are capable of direct interface to 50V with 25mA current drains. Impectron Ltd., Impectron House, 23-31 King St., London W3 9LH

WW305

### Silicone / epoxy moulding compound

A new silicone/epoxy moulding compound, the Dow Corning 631 "semiconductor grade" moulding compound, gives fast and reliable mouldability with virtually no rejects, according to the c.m.o.s. Products Division of Fairchild USA. Their complementary m.o.s. devices are used extensively in consumer clocks, clock radios and commercial/industrial timers and are encapsulated with this compound. The material is a granular compound based on a hybrid mixture of silicone and epoxy resins, combining the advantages of each individual material. It is claimed to possess the chip compatibility and moulding ease of silicones and the high strength, lead sealing and excellent salt atmosphere resistance of epoxies. This compound is intended for the moulding of dependable long-term packaging of integrated circuits and other semiconductor devices. Dow Corning Europe, Chaussee de la Hulpe, 154, 1170, Brussels

WW306

### High power servo amp. / motor driver

Programmable current limiting and excellent stability when driving into resistive or inductive loads are features which Fairchild (UK) points out as the prominent points of its SH3015



high power amplifier. This device can supply up to 6A continuously into a load at a variation of  $\pm 35V$ , provides an internal power dissipation (d.c.) of 70W with a case temperature of 25°C, input voltage differential of 30V and d.c. output current of 10A. The amplifier front-end incorporates Fairchild's  $\mu A741$  operational amplifier with additional voltage and current gain stages enabling it to meet the performance

required by servo systems. Output is protected from voltage transients caused by inductive surges and output current limiting is selected by fitting appropriate resistors between the supply pins and the respective current limit pins. The case is electrically isolated. Fairchild Camera and Instrument (UK) Ltd., 230 High St., Potters Bar, Herts EN6 5BU

WW307

### Locking test connectors

Where connecting cables or legs on a printed circuit layout have been cropped or pulled completely out, the firm application of test clips is difficult, giving rise to poor electrical contact. To overcome this problem an "EZ" test book, designed to lock through p.c. board test point holes has been introduced by a British company, British Central Electrical. The "XG" connector is

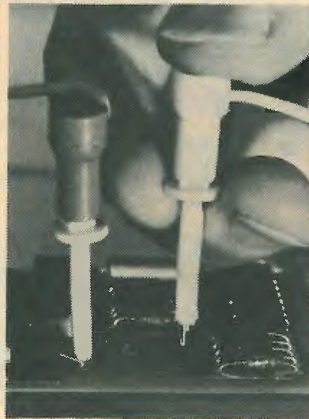

a further addition to this company's range of test connectors and depends upon a hypodermic" action which locks the probe firmly onto the board. This hook is designed to the same specification as the "EZ Micro-hook", being of particularly delicate construction so as to enable test clips to hook onto vertical p.c. boards without damaging connections by their own weight. The "XG" is available in three sizes to suit holes ranging from .025 in to .042 in. British Central Electrical Co. Ltd. (Special Products Div.), Unit 10, Cravers Trading Estate, Southampton Rd., Ringwood, Hants.

WW308

### Quick-connect 25A triac

Three versions of the CSB series of triacs, rated at 25A and specially designed to "plug in" to solderless connections can be obtained from Walmore Semiconductors. The CSB20, CSB40 and CSB60 feature repetitive peak off-state voltage ratings of 200V, 400V, and 600V respectively. Peak single cycle surge current is 250A, peak gate

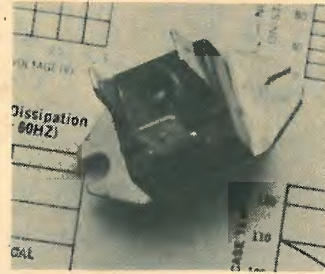

power is 16W and average gate power 0.5W. Operating temperature range is  $-40^{\circ}C$  to  $+110^{\circ}C$ . Walmore maintains that the reason for the wide capabilities of these triacs lies in the Unitorde ChipStrate assembly, which incorporates a copper heat spreader, a beryllium oxide substrate for low thermal resistance ( $1.2^{\circ}C/W$  max.) and a single-piece frame construction for mechanical strength and optimum power handling. The ChipStrate construction is also credited with providing the device/mounting flange isolation rating of 2.5kV r.m.s. Walmore Semiconductors, 11-15 Betterton St., Drury Lane, London WC2H 9BS

WW309

### Humidity measuring set

Comprising a measuring bridge (15HB-1), an oscillator (15ASO-1) and two complementary linearizers, the Ancom relative humidity sensing system provides a performance exhibiting an error margin of only 1%, according to the manufacturer. The oscillator output is a 60Hz sine wave of 10V, pk to pk, and the amplitude is claimed as stable within 150 parts per million per degree Celsius. Two models of the bridge are available, the 15HB-1A and 15HB-1B as are two models of the linearizer, being the RH1152A and RH152B. By using selected pairs of bridge and linearizer relative humidity within the range 30 to 100% or 10 to 40% can be measured. A power supply of 15.0-15V d.c. is required, and the output is then 100mV per % relative humidity, stable to within 250 parts per million. This humidity measuring system does not include a sensing device, so a suitable hygrometric element will be required to complete the measuring set. Ancom Ltd., Devonshire St., Cheltenham GL50 3LT

WW310



### 15W solar cell panel

"Alternative energy" in the form of a panel of solar cells producing just over 1A at 15V is now available from Siemens under the type number SFH 120-36. The makers claim that these panels will provide electrical power for a variety of external applications including communications systems in desert regions, on buoys or navigational beacons. The panel of battery cells measures  $560 \times 480 \times 13$ mm, the total weight being 4kg. In all, 36 cells, each producing about 1A at 400mV are connected in series via heat limiting resistors — the quoted panel output figure is related to a sunlight-level producing 100mW per sq cm. Individual cells are also available as 5mm and 10mm items in lengths up to 20mm. These are designated SFH-115 and consist of individual chips with solderable contacts and they can be arranged in series depending on the voltage required. Individual cells are suitable for supplying calculators, hearing aids and photographic flash equipment. The complete range of cells begins with 5mm square plates, increasing to 3in diameter round cells which are used in the complete panel. Siemens Ltd, Siemens House, Windmill Rd., Sunbury on Thames, Middlesex.

WW311

### Smoke detector chip

Although smoke detector i.c.s are by no means new, the MEM 4963 can function as the detecting and audio driving device in concert with an ionization chamber, a photoelectric detector or both. The manufacturer, General Instrument Microelectronics, points out that the recommended circuit offers interesting features to fire and smoke alarm system designers, due to the versatility of the circuit's interconnections. When used in a system format, if one detector "sees" smoke, all detectors will sound a warning. A further important feature is that the unit detecting smoke will generate an audibly different sound to the other units in the system, giving an indication of the location of the fire. Smoke detected locally causes the alarm signal to be continuous, while an alarm state relayed from an adjacent unit initiates a signal pulsing at 20ms every 100ms, a mark to space ratio of 20:80. The circuit takes current once every 10s, for  $150\mu s$  on stand-by and  $150\mu s$  every 0.5s when local smoke is detected. An intermittent alarm signal, 20ms long every 40s, is emitted when battery or other power sources are low. Stand-by power consumption is  $15\mu A$ . General Instrument Microelectronics Ltd., Regency House, 1-4 Warwick St., London W1R 5WB.

WW312



# Quantum Electronics

## THE LATEST AND BEST SOURCE OF SUPERFI AUDIO EQUIPMENT

Although we may be a new name to you, our products use refinements of circuitry which has been well proven over the past few years. By redesigning to what we consider the optimum cost / performance / appearance breakpoint we can now offer the best sound per pound that you will find anywhere. In addition to the items below we can supply ready built power amps, with active crossovers if required, in a variety of options including custom designed and finished metalwork in small (5+) or large quantities. If you do not see what you want please enquire.

### 'STATE OF THE ART' PRE-AMP



Undoubtedly the best pre-amp on the market, it is supplied ready built, **not a kit**, and caters for disc, aux and 2 or 3-head tape machine. The built-in supply regulators require only rough dc, available from all our power amps or the matching mains supply kit, CSI. The performance is almost perfect, with virtually zero thd ( $< .002\%$ , 1kHz), zero common mode distortion, fast slewing, high overload (40dB) and low noise (70dB mag). It is attractively finished in black and is also available in a special version to cater for moving-coil cartridges.

CI (mag): £67.85 CSI (mains supply kit): £10.13  
CI mc (m-coil): £73.10 Module (trade and export only): £47.25, £51.60 (m-coil)

### 'DOMESTIC' POWER AMP KITS



P1: Mono 45W/80 £67.81  
P2: Stereo 2 x 35W/80 £79.35  
P3: Mono 130W/80 £83.32  
P4: Stereo 2 x 110W/80 £99.48  
Also available ready built. £POA

Styled and finished to match the CI, they are supplied with ready built and tested pcbs and require only simple assembly and point-to-point wiring of power transistors, supply, etc. In this way the possibility of errors and subsequent damage is drastically reduced. The performance, again, is second to none in this magazine, with ultra low thd ( $< .004\%$ , 1k, 10W) and fast slewing contributing to their established exceptional subjective qualities.

### 'SLAVE TRAY' & RACK MOUNTING KITS



#### SLAVE TRAY KITS:

ST1: Mono 1 x 75W/40, 45W/80 £49.45  
ST2: Stereo 2 x 60W/40, 35W/80 £65.55  
ST3: Mono 1 x 130W/80 £63.94  
ST4: Stereo 2 x 110W/80 £93.61  
ST5: Mono 1 x 220W/40 130W/80 £74.74  
ST6: Mono 1 x 250W/80 £86.25  
Plain lid: £4.23  
Black lid: £7.68  
Rack mounting kit, Slave tray + £15.41

These kits are designed to cope with sustained high level use, for which the domestic kits are not suitable. The same high performance circuitry is used with the power transistors mounted on substantial external heatsinks. The "slave tray" is the bare bones of a power amp and comprises a simple plain finished chassis, tested amp pcbs and transistors, heatsinks and power supply. No specific connectors are supplied to allow flexibility of application. A plain finish lid and black lid are available. The rack mounting kits use a heavy gauge black finish front and lid and are supplied without connectors, a range of which are stocked for your convenience. We can also supply ready-built amps with your choice of connectors. There is spare room inside the case to accommodate pre-amp circuitry if required. Low field toroidal transformers are used in all kits.

### MODULES: UP TO 250W r.m.s.



These modules are available in a variety of powers and forms (including L bracket mounting) to trade and export customers only. They come ready built and tested and use the same proven circuitry as the other amps in our range and set an unsurpassed standard of performance and reliability. We also have power supplies for use with these. Please contact us for prices with competitive quantity discounts. The module illustrated is a medium duty 250W rms type using 4 of the latest Japanese "super" power transistors.

**EXPORT:** We can deal efficiently with orders to any country. Please write with your specific requirements for a quote by return. All power amps can be wired for 110v mains.

**INFORMATION:** Before ordering any of these or competitors' products, why not send for our detailed information? Large SAE or dollar bill please.

All prices shown are inclusive and all power ratings are real RMS watts, unlike the phoney ratings of many modules. Although we try to deal with orders promptly, please allow 28 days to avoid disappointment. Large orders please phone for delivery date.

**DISTRIBUTORS:** We are eager to establish distributors throughout the world and invite enquiries from interested parties.

**SERVICING:** We offer an after-sales service, with fixed maximum charges, for all our kits.

1A STAMFORD ST., LEICESTER LE1 6NL

Tel. 546198

WW — 060 FOR FURTHER DETAILS

# ANNOUNCING THE PROFESSIONAL Viewdata EXHIBITION

A  
DEMONSTRATION  
OF EQUIPMENT  
AND SERVICES FOR THOSE  
PROFESSIONALLY  
ENGAGED IN  
TELETEXT  
AND VIEWDATA

- The planned inauguration later this year by the Post Office of the world's first public viewdata system, in the form of the Prestel service, brings a pressing need for sophisticated hardware, software and other services for those intending to provide information to the system.
- But there is much confusion among both information providers and hardware suppliers as to the type of equipment available, what it can do and who supplies it.
- Since teletext and viewdata techniques offer ideal solutions for problems of information storage, retrieval and dissemination for both small and large organisations, these questions arise also among those responsible for such systems.
- To answer these questions and to bring together suppliers and users at one time in a convenient venue, "Viewdata and TV User" is setting-up a select professional exhibition of hardware and services for teletext and viewdata systems.
- This is not a show of domestic user equipment for the general public, but an exclusive event entirely devoted to the showing and demonstration of equipment and services for those professionally engaged in teletext and viewdata.

To be held at  
**The West Centre Hotel**  
Lillie Road, London  
on  
**November 7 and 8**

For further information, contact **The Exhibition Manager, Viewdata Exhibition, Room 821, Dorset House, Stamford Street, London SE 19LU. Telephone: 01-261 8865. Telex: 25137 BISPRS G.**

# ELECTRONIC COMPONENTS AND VARIOUS TESTERS



## MAIN PRODUCTS

- ELECTRICAL INDICATING METERS
- PANEL METERS
- EARPHONE & HEADPHONE JACKS
- POTENTIOMETERS
- VOM MULTI TESTERS
- BATTERY TESTERS
- CLAMP METERS
- PLANT PROBES

**HIGH PERFORMANCE! PROMPT DELIVERY! COMPETITIVE PRICES!  
WHAT MORE DO YOU WANT?**

Hung Chang, world's largest independent manufacturer & exporter of Meters and Testers, has production capacity of more than 1,000,000 Meters per month. You will be completely satisfied with our products that have been exported to more than 35 countries and made by our 1,200 workers with special care. Please contact us and you will know Hung Chang.

**HC HUNG CHANG PRODUCTS CO., LTD.**  
 HEAD OFFICE & FACTORY ADDRESS 310-222, Bulgwang-Dong, Seodaemun-ku, Seoul, Korea  
 MAILING ADD. C.P.O. Box 3125 Seoul, Korea  
 CABLE ADD. "HUNGPROCO" SEOUL  
 TELEPHONE 389-0111/2, 389-7001/3, 386-6001/5  
 TELEX ELECHCP K28447

SOLE UK AGENTS

**ARMON PRODUCTS LTD.  
COTTRELL HOUSE  
53-63 WEMBLEY HILL ROAD  
WEMBLEY  
MIDDX. HA9 8BH  
TEL: 01-902 4321**

# LCD Multimeter

£69.99 + VAT



We're about to lift the wraps off the most exciting new instrument of the year! Our new 3½ digit LCD multimeter is less than half the cost of competing products and brings ownership of these incredibly useful instruments within reach of everyone. The LMM 100 multimeter features 25 voltage current and resistance ranges and has a large 0.5in. LCD display. Up to 2,000 hours use from one transistor battery. The LMM 100 is the first portable LCD multimeter with a digital hold facility for data-logging etc. Send off immediately for full details of specification and price. First 100 brochures will be sent out with a '£5 off' voucher so take full advantage of this unique opportunity by contacting:

**LASCAR ELECTRONICS · BASILDON (0268) 727383**  
 Unit 1, Thomasin Road, Burnt Mills, Basildon, Essex SS13 1LH

WW — 061 FOR FURTHER DETAILS

7 HUGHENDEN ROAD, HASTINGS, SUSSEX TN34 3TG  
 Telephone: HASTINGS (0424) 436004

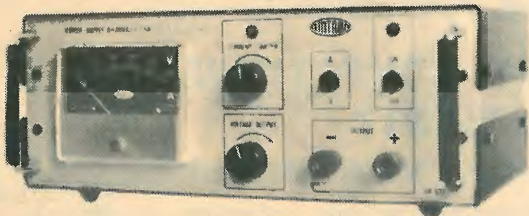

## UK677 KIT

- Stabilized Power Supply
- Variable Voltage 0-20v = 2.5 amp
- Variable Current Limiting
- LED Current Limit Indicator
- Calibrated Metering for Current and Voltage
- Load Regulation 0.15%
- Ripple < 1mV
- Input Voltage 115-220-250v A.C. 50-60 Hz
- All Aluminium Cabinet

£36.73 + VAT

Trade and Export Enquiries Welcomed

WW — 030 FOR FURTHER DETAILS

**QUARTZ  
 CRYSTALS  
 - FAST!**



**AEL**

**AEL CRYSTALS LIMITED**  
 Gatwick House, Horley, Surrey, England RH6 9SU  
 Telephone: Horley (02934) 5353 Telex: 87116 (Aerocon Horley)  
 Cables: Aerocon Telex Horley

WW — 025 FOR FURTHER DETAILS

# At last...

**A REALLY RELIABLE IN  
 CIRCUIT TRANSISTOR TESTER  
 THAT WORKS!**

Previous Testers have been too easily fooled by low shunt impedances resulting in false alarms on perfectly sound transistors. Designed for fast IN-CIRCUIT testing the new DATONG DATEST 2 tests transistors, FETs SCR's and Triacs even when shunted by resistors as low as 20 ohms!

Automatic NPN/PNP indication, foolproof three-LED display, and unique test probes allow a very high rate of testing even by unskilled users. Very competitive price includes probes and the DATEST 2 is available from stock. Full data sheet free on request.

ONLY £39.50 COMPLETE + 8% VAT

**DATONG ELECTRONICS LIMITED**  
 Spence Mills, Mill Lane, Bramley  
 Leeds LS13 3HE  
 Telephone: Pudsey (0532) 552461

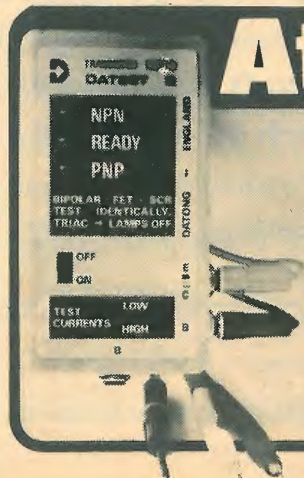

WW — 026 FOR FURTHER DETAILS



# West Hyde have more than 600 different instrument cases in stock + accessories

**WH** **KNOB**

Send for Mentor Catalogue

Hundreds of knobs to choose from



West Hyde stock thousands of knobs: collet, screw fixing, plastic, aluminium, fluted, textured, smooth, wing, pointer, insulated, slow-motion, digital, crank-handle, heavy-duty, contemporary, dual, diamond turned. With shafts 3 mm to 10 mm and diameters from 8 mm to 58 mm. See catalogue for prices.

**WH** **CONTIL WOODEND**

Leather textured PVC steel body with polished teak ends.

Two wooden ends and two tie bolts, result in a simple, light, inexpensive case. Ideal for Hi-Fi applications and domestic and office equipment.

|         | L   | B   | H  |        |
|---------|-----|-----|----|--------|
| WEC 801 | 202 | 240 | 80 | £14.50 |
| WEC 802 | 417 | 240 | 80 | £15.95 |
| WEC 803 | 550 | 240 | 80 | £17.25 |

**WH** **SWIFT**

It's a winner!

Swiftcase wins industrial design award at Hanover

A case for good looks, strength and efficiency. Particularly suitable for applications needing power dissipation.

|         | L   | B   | H     |        |
|---------|-----|-----|-------|--------|
| SWF 212 | 432 | 268 | 88.9  | £23.85 |
| SWF 222 | 219 | 268 | 88.9  | £18.35 |
| SWF 312 | 432 | 268 | 133.4 | £28.25 |
| SWF 322 | 219 | 268 | 133.4 | £22.50 |

**WH** **MOD-4**

A quick assembly case in eight parts

A mass produced economy case in intensely shiny black or royal blue leather textured PVC steel with bright white steel panel. Eight pieces inc. aluminium chassis assembled with only eight screws.

|     | L   | B   | H   |       | L   | B   | H   |     |       |
|-----|-----|-----|-----|-------|-----|-----|-----|-----|-------|
| 401 | 178 | 152 | 76  | £5.25 | 405 | 279 | 152 | 114 | £6.59 |
| 402 | 178 | 152 | 114 | £5.49 | 406 | 279 | 152 | 152 | £5.99 |
| 403 | 178 | 152 | 152 | £5.69 | 413 | 165 | 152 | 157 | £5.75 |
| 404 | 279 | 152 | 76  | £6.29 | 416 | 305 | 152 | 157 | £7.25 |

**WH** **HANDLES**

West Hyde have a wide range of high quality handles in nylon, chromium, anodised, flush, extruded, carrying and heavy duty.



Chromium from 81p Extruded from 2.19  
Nylon from 1.06 PVC from 76p  
Pivoting from 4.37  
Flush precision from 5.28  
V. heavy duty from 8.25

**WH** **STORAGE SYSTEM**

Stackable stove enamelled cabinets in three heights, all equal width and depths with movable shelves. Drawers in medium impact styrene with moulded handles and label slots in six sizes. Loose dividers fit length-wise and crosswise. Prices from £7.01 to £18.23 plus P&P

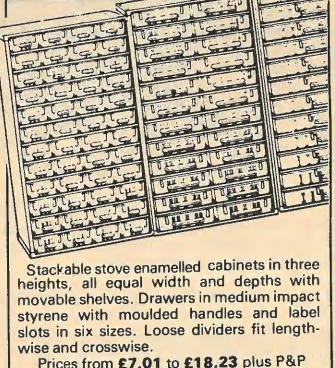

**WH** **CONTIL**

West Hyde's best selling case, strong, rigid and smart

|          | L   | B   | H   |       |
|----------|-----|-----|-----|-------|
| CON 755  | 178 | 177 | 127 |       |
| CON 475  | 279 | 178 | 127 | 13.58 |
| CON 867  | 263 | 152 | 178 | 12.25 |
| CON 127  | 305 | 178 | 178 | 14.73 |
| CON 161  | 406 | 305 | 178 | 19.14 |
| CON 191  | 489 | 267 | 267 | 27.65 |
| CON 191D | 489 | 381 | 267 | 44.50 |

Prices quoted, left, of our best-selling range of textured blue acrylic steel sybrow cases include front panel in painted white steel. Panels in PVC/steel a little extra. Also available unpainted up to size CON 127.

**WH** **ILEX & SORREL**

Push fit or screw fitting, nylon, insulating, mounting pillars. For fast assembly, fits different size boards one above the other.

|         | Push fit | per 10 |
|---------|----------|--------|
| ILX 025 | .25"     | 35     |
| ILX 050 | .5"      | 35     |
| ILX 075 | .75"     | 39     |
| ILX 100 | 1"       | 44     |
| ILX 150 | 1.5"     | 59     |

|         | Screw fix | per 10 |
|---------|-----------|--------|
| SOR 012 | .12"      | 37     |
| SOR 025 | .25"      | 47     |
| SOR 050 | .5"       | 47     |
| SOR 075 | .75"      | 53     |

**NOTE NEW ADDRESS**

All West Hyde cases are available with substantial discounts for quantities. Most cases have discounts at 5, 10 and 25 off with discounts up to 25% at 100 off. Prices include P&P but not VAT, and are less 10% if collected on first two price breaks on cases only. Send for catalogue. Prices correct at press date.

**WEST HYDE DEVELOPMENTS LIMITED, Unit 9, Park Street Industrial Estate, AYLESBURY, BUCKS. HP20 1ET. Phone: Aylesbury (0296) 20441. Telex: 83570 WW — 062 FOR FURTHER DETAILS**

**Audio Modules**

Build your system or make add-on's with SECOM audio modules.

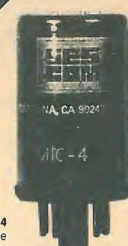

**MIC-4** Low Impedance Microphone Pre-amp



**LA-3** Line Amplifier Transformer  
Balanced 600 ohm output



**PS-1** Power Supply  
24 volts DC regulated 120/240 VAC input

**Pre-amps**  
Balanced low impedance for microphone, high impedance general purpose, RIAA Phono, NAB tape (1 1/2, 3 3/4, 7 1/2, 15 ips).

**Equalizers**  
Active (bass, mid-range, treble) high pass filter, low pass filter.

**Other Modules**  
Line amp, power amp, compressor, sine wave oscillator, plug-in power supply.

**Accessories**  
Sheet metal, sockets, slide pots.  
Low distortion < .1%, low noise, bi-fet op-amps, high slew rate, single supply (9-36 volts DC), plug-in.

**SECOM** Quality Engineered Sound Products

**SECOM, INC.**  
P.O. Box 590,  
12931 Budlong Ave.,  
Gardena, CA 90247 U.S.A.  
(213) 770-3510, (800) 421-1828,  
TWX (910) 346-7023

**SEND FOR YOUR FREE COPY OF OUR NEW CATALOG**  
We also manufacture audio transformers, snakes, direct boxes and mic-splitters.

**Immediate delivery of easy to fit Display Bezels**



**Supplied complete with lens and all fixings plus compatible display mounting boards.**

This unique design attractively frames a display and requires only a single rectangular cut-out for fixing. Vero bezels are manufactured in four sizes to accommodate 2, 4 or 6 digits. A choice of three types of lens are offered Neutral, Red and clear to suit LEDs AND LCDs. LED AND LCD mounting boards are available in seven versions compatible with VERO Bezels.

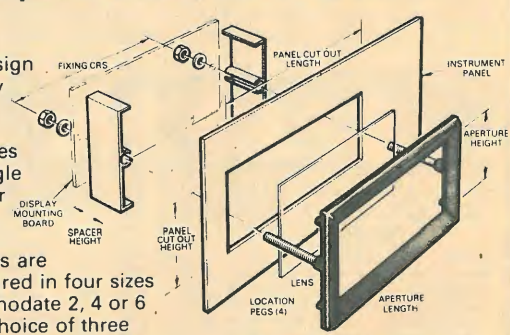

Further information on instant dispatch from:

**VEROSPEED**  
Barton Park Industrial Estate,  
Eastleigh, Hampshire SO5 5RR  
Tel: (0703) 618525





**OSCILLOSCOPES — FREQUENCY COUNTERS — OFF-AIR RECEIVERS**

**MODEL  
S1500  
15 MHz  
Dual Trace  
£280**



**MAINS/BATTERY  
PORTABLE OSCILLOSCOPE**

A professional standard model dual trace DC to 15MHz. Usable to 25MHz with alternate, chop and single-channel A or B amplifier selection. 5mv/cm, accuracy 3%. Excellent triggering wide range time base. Natural anodised aluminium case with blue vinyl steel covers, retractable angled feet, carrying handle.

**SUPPLIERS TO: Ministry of Defence, G.P.O., B.B.C., Government  
Depts., Crystal Manufacturers and Electronic Laboratories world-wide  
for 18 years**



**ELECTRONICS, 6 WOLSEY ROAD, ASHFORD, MIDDX. ASHFORD 53661**

WW — 009 FOR FURTHER DETAILS



**New Bear Systems**



**INTRODUCING.....**

**APPLE II. 16K — £950.00**

**COMMUNICATIONS INTERFACE CARD  
£110.00**

**HIGH SPEED SERIAL INTERFACE CARD  
£110.00**

**PROTOTYPING CARD  
£ 18.00**

**CARRYING CASE  
£ 25.00**

**PARALLEL PRINTER INTERFACE CARD  
£110.00**

**NORTH STAR  
HORIZON  
S100 bus Z80 based micro.**

**16K RAM WITH SINGLE DISC DRIVE  
(Double Density)  
£1265**

**32K RAM WITH DOUBLE DISC DRIVE  
(Double Density)  
WITH 2 SERIAL AND 2 PARALLEL PORTS  
£1983**

All prices subject to 15% VAT.

**Head Office:**  
40 Bartholomew Street, Newbury, Berkshire  
Telephone: 0635 30505 Telex: 848507 NCS  
**Northern Office:**  
2A Gatley Road, Cheadle, Cheshire  
Telephone: 061 491 2290

**Please telephone for a  
demonstration.**

WW — 077 FOR FURTHER DETAILS

**we wondered why....**

*The B.B.C., British Rail, B.A.C., Decca Acoustics, Institute of Sound and Vibration Research, I.C.L., Post Office Telecommunications, Philips Research, U.K. Atomic Energy Authority, and many Universities were among our customers.*

*Maybe they liked the competitive prices of our modules, or the fact that all modules have a frequency response from 20Hz to 22kHz, -0.2dB, a slewing rate of 8 volts per microsecond, input sensitivity of 0dB (0.775V), a damping factor greater than 400 to 1kHz and a total harmonic distortion less than 0.055% at 1kHz.*

*Or could it be that they went for the reliability and the comprehensive protection circuitry. Then there's the full 2 year guarantee which accompanies our range of modules.*

**OR PERHAPS ..... THEY JUST LIKED THE SOUND OF US!**

J.P.S. 60 : 60 Watt.  
J.P.S. 100 : 100 Watt.  
J.P.S. 150 : 150 Watt.



Power supplies available to suit all modules. Send for further information on our range of pre-amplifier modules. J.P.S. products are now stocked at the distributors shown below. Further information on all products available direct from J.P.S. Associates or via reader reply service.

All modules are made in the United Kingdom.



**J.P.S. ASSOCIATES  
(ASTONKILN LTD.)  
BELMONT HOUSE  
STEELE ROAD  
PARK ROYAL  
LONDON NW10 7AR  
Tel: 01-961 1274/5**



**BELGIUM**  
Studeek Elektronika  
Tienestraat 280  
3000 Leuven, Belgium  
Tel. (016) 234554  
Contact Mr. Leo Swinnen

**ENGLAND, Midlands**  
**CROXFORD CUSTOM EQUIP.**  
64 London Road  
Leicester  
Tel. 0533 638485  
Mr. Phil Croxford

**ENGLAND, West**  
**SEVERNSIDE AUDIO & LTD**  
28 The Promenade  
Gloucester Road  
Bristol BS7 6TZ  
Tel. 0272 41886  
Mr. Peter Hannay

**ENGLAND, South**  
**R.E.W. AUDIO VISUAL**  
129 Charing Cross Road  
London  
WC2  
Tel. 01-836 2372  
Mr. John Cowan

**SCOTLAND**  
**ATMOSPHERE LTD & SOUND**  
57 Nelson Street  
Aberdeen  
Scotland  
Tel. 0224 572805  
Mr. Keith Main

**FRANCE**  
**MUSIQUE & SON**  
1 Residence Bel-Event  
35200, Cavaillon, France  
Tel. (98) 89 67 77  
Mr. Yves Javelot

WW — 037 FOR FURTHER DETAILS

# Britain's BIGGEST Computer Exhibition COMPEC '79

COMPUTERS ...  
SMALL COMPUTERS ...  
SOFTWARE ... MINIS ... MICROS ...  
TERMINALS ... SOFTWARE  
PERIPHERALS ...  
SMALL BUSINESS SYSTEMS ...

OVER  
350 EXHIBITORS  
AT  
OLYMPIA,  
LONDON

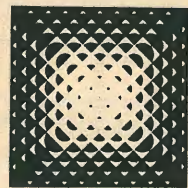

NOVEMBER  
6, 7 & 8  
from 10 am  
each day

Admission is £2 if you register on arrival,  
but FREE pre-registration tickets are  
yours if this coupon reaches us  
by October 15.

**COMPEC '79 tickets**  
Room 821, Dorset House,  
Stamford Street, London, SE1 9LU  
England.

Please send me . . . FREE  
pre-registration tickets  
for Compec '79

USE BLOCK LETTERS. WRITE WITHIN SPACE

|  |
|--|
|  |
|  |
|  |
|  |

Name  
Street & No.  
Town & Post  
or zip code  
Country

**Cables**  
**Cords**  
**Connectors**

we have a  
wide range  
at our fingertips

**FUTURE FILM DEVELOPMENTS**  
36/38 Lexington Street, London W1R 3HR  
Telephone 01-437 1892/3 • Telex 21624 ALOFFD G

WW — 024 FOR FURTHER DETAILS

### STEREO DISC AMPLIFIER 2

FOR BROADCASTING, DISC MONITORING AND TRANSFER WITH THE HIGHEST QUALITY. Stereo Disc Amplifier 2 is a self-contained mains powered unit which accepts cartridge inputs and produces balanced line level outputs. Permanent rumble filtering and switched scratch filtering are included.  
1KHz @ 6mV set for 0dBV, 7 output, loaded 600 Ohms.

**Total Harmonic Distortion**  
Output + 10dBV, 7 30Hz — 20kHz below noise.  
Output + 20dBV, 7 1KHz-88dB, 0.004%; 30Hz-20KHz—82db, 0.008%.

**Static Intermodulation Distortion** 50Hz + 7kHz, 4.1.  
Output + 10dBV, 7 —90dB; 0.003% limit of measurement;

**Dynamic Intermodulation Distortion** 3.18kHz square wave (single pole —3dB @ 100kHz) + 15kHz sine wave, 4.1. Relative to 15kHz component.  
Pre-emphasised inout 1V pk-pk —70dB, 0.03% limit of measurement

**Cartridge impedance interaction on frequency response.**  
High inductance cartridge, 1H + 1k Ohm. Less than 0.2dB.

**Clipping Point Complementary to RIAA Curve.** 1kHz clips at + 24dBV, 7 output.  
30Hz-20kHz Within 1dB  
Clipping determined by onset of peaky distortion products or THD exceeding —80dB.

**Differential Phase Shift between left and right channels.**  
50Hz-20kHz. Within 0.5°  
Worst error at LF and HF filter turnovers. Within 5°

**Crosstalk.** 1kHz — 76dB. 30Hz-20kHz — 60dB.

### SURREY ELECTRONICS

The Forge, Lucks Green, Cranleigh, Surrey GU6 7BG Tel: (04866) 5997

## BTS A Service for Churches and Charities



With extensive experience of the needs of broadcasters BTS can plan and commission an efficient and cost-effective studio. We recommend and supply a wide range of equipment to suit all budgets, and we can design and manufacture specialised items.



Contact BTS for advice, whether you need a simple voice booth, a studio complex or a complete media centre.

BTS supplies well-known makes of microphones, loudspeakers, tape machines, cassette and tape duplication equipment, tapes and cassettes, studio hardware.

Write to Alan Foster for an article on: Design, Planning and Equipment Supply for broadcasters; or Acoustic Design and Layout of Studio Buildings; or Sound Reinforcement.

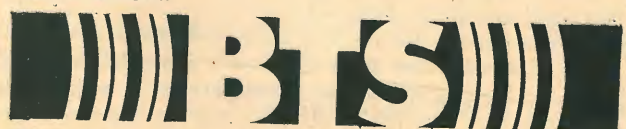

Broadcast Training and Services Ltd.  
2 Hills Road Cambridge CB2 1JP England  
Tel: Cambridge (STD 0223) 62392



# NRDC-AMBISONIC UHJ



## SURROUND SOUND DECODER

The **first ever** kit specially produced by Integrex for this British NRDC backed surround sound system which is the result of 7 years' research by the Ambisonic team. W.W. July, Aug., '77.

The unit is designed to decode not only UHJ but virtually all other 'quadrophonic' systems (Not CD4), including the new BBC HJ 10 input selections

The decoder is linear throughout and does not rely on listener fatiguing logic enhancement techniques. Both 2 or 3 input signals and 4 or 6 output signals are provided in this most versatile unit. Complete with mains power supply, wooden cabinet, panel, knobs, etc.

Complete kit, including licence fee **£49.50 + VAT**  
or ready built and tested **£67.50 + VAT**

## NEW S5050A STEREO AMP

50 watts rms-channel. 0.015% THD. S/N 90 dB, Mags/n 80 dB.

Tone cancel switch. 2 tape monitor switches.

Complete kit only **£63.90 + VAT.**



## Wireless World Dolby<sup>TM</sup> noise reducer

Trademark of Dolby Laboratories Inc.



Featuring:

- switching for both encoding (low-level h.f. compression) and decoding
- a switchable f.m. stereo multiplex and bias filter.
- provision for decoding Dolby f.m. radio transmissions (as in USA).
- no equipment needed for alignment.
- suitability for both open-reel and cassette tape machines.
- check tape switch for encoded monitoring in three-head machines.

### Typical performance

Noise reduction better than 9dB weighted.  
Clipping level 16.5dB above Dolby level (measured at 1% third harmonic content)

Harmonic distortion 0.1% at Dolby level typically 0.05% over most of band, rising to a maximum of 0.12%

Signal-to-noise ratio: 75dB (20Hz to 20kHz, signal at Dolby level) at Monitor output

Dynamic Range >90dB

30mV sensitivity.

Complete Kit **PRICE: £43.90 + VAT**

Also available ready built and tested ..... **Price £59.40 + VAT**

Calibration tapes are available for open-reel use and for cassette (specify which) ..... **Price £2.40 VAT**

Single channel plug-in Dolby<sup>TM</sup> PROCESSOR BOARDS (92 x 87mm) with gold plated contacts are available with all components ..... **Price £9.00 + VAT**

Single channel board with selected fet ..... **Price £2.75 + VAT\***

Gold Plated edge connector ..... **Price £1.75 + VAT**

Selected FETs **65p** each + VAT, **110p** + VAT for two, **£2.10** + VAT for four.

Please add VAT @ 15%

We guarantee full after-sales technical and servicing facilities on all our kits, have you checked that these services are available from other suppliers?

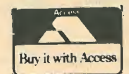

\*Please send SAE for complete lists and specifications

**Portwood Industrial Estate, Church Gresley,  
Burton-on-Trent, Staffs DE11 9PT  
Burton-on-Trent (0283) 215432 Telex 377106**

# INTEGREX LTD.

# INTEGREX

## S-2020TA STEREO TUNER / AMPLIFIER KIT

**SOLID MAHOGANY CABINET**

*A high-quality push-button FM Varicap Stereo Tuner combined with a 24W r.m.s. per channel Stereo Amplifier.*



**Brief Spec.** Amplifier Low field Toroidal transformer, Mag. input, Tape In/Out facility (for noise reduction unit, etc.), THD less than 0.1% at 20W into 8 ohms. Power on/off FET transient protection. All sockets, fuses, etc., are PC mounted for ease of assembly. Tuner section uses 3302 FET module requiring no RF alignment, ceramic IF, INTERSTATION MUTE, and phase-locked IC stereo decoder. LED tuning and stereo indicators. Tuning range 88—104MHz. 30dB mono S/N @ 1.2µV. THD 0.3%. Pre-decoder 'birdy' filter. **PRICE: £59.95 + VAT**

**NELSON-JONES MK.2 STEREO FM TUNER KIT** Price: **£69.95 + VAT.**  
Improved performance with linear phase IF and second generation IC decoder.

## NELSON-JONES MK. I STEREO FM TUNER KIT

*A very high performance tuner with dual gate MOSFET RF and Mixer front end, triple gang varicap tuning, and dual ceramic filter / dual IC IF amp.*

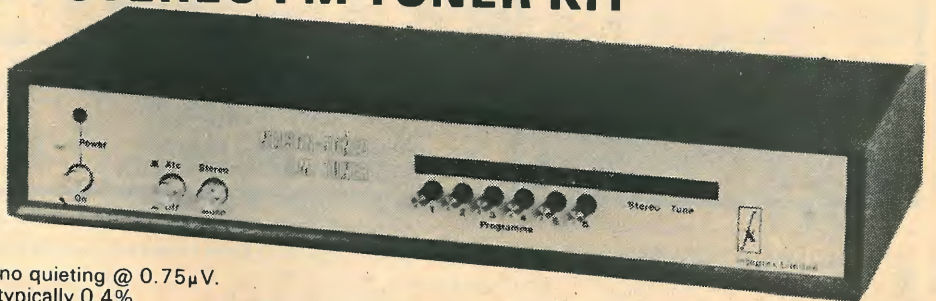

**Brief Spec.** Tuning range 88—104MHz. 20dB mono quieting @ 0.75µV. Image rejection — 70dB. IF rejection — 85dB. THD typically 0.4%. IC stabilized PSU and LED tuning indicators. Push-button tuning and AFC unit. Choice of either mono or stereo with a choice of stereo decoders.

*Compare this spec. with tuners costing twice the price.*

**Mono £36.40 + VAT**

**With ICPL Decoder £40.67 + VAT**

**With Portus-Haywood Decoder**

**£44.20 + VAT**

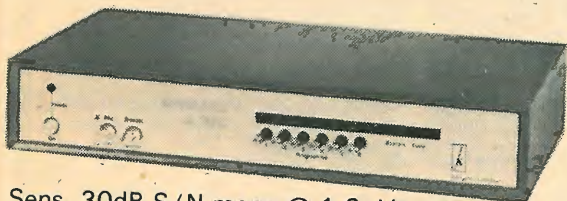

Sens. 30dB S/N mono @ 1.2µV  
THD typically 0.3%  
Tuning range 88—104MHz  
LED sig. strength and stereo indicator

## STEREO MODULE TUNER KIT

*A low-cost Stereo Tuner based on the 3302 FET RF module requiring no alignment. The IF comprises a ceramic filter and high-performance IC Variable INTERSTATION MUTE. PLL stereo decoder IC. Pre-decoder 'birdy' filter Push-button tuning*

**PRICE: Stereo £33.95 + VAT**

## S-2020A AMPLIFIER KIT

*Developed in our laboratories from the highly successful "TEXAN" design. PC mounting potentiometers, switches, sockets and fuses are used for ease of assembly and to minimize wiring Power 'on/off' FET transient protection.*

**Typ Spec.** 24+24W r.m.s. into 8-ohm load at less than 0.1% THD. Mag. PU input S/N 60dB. Radio input S/N 72dB. Headphone output. Tape In/Out facility (for noise reduction unit, etc.). Toroidal mains transformer.

**PRICE: £35.95 + VAT**

**BASIC NELSON-JONES TUNER KIT £15.70 + VAT**

**PHASE-LOCKED IC DECODER KIT . . . £4.47 + VAT**

**BASIC MODULE TUNER KIT (stereo) £18.50 + VAT**

**PUSH-BUTTON UNIT . . . £6.00 + VAT**

**PORTUS-HAYWOOD PHASE-LOCKED STEREO DECODER KIT . . .**

**£8.80 + VAT**



# YOU NEED NEVER BUY A COLOUR FILM AGAIN!

WIRELESS WORLD COLOUR PHOTO SERVICE



● **SUPER QUALITY HI-DEFINITION SHEEN COLOUR PRINTS**

● **FREE KODACOLOR FILM TO FIT YOUR CAMERA**

● **SEE YOUR PICTURES BEFORE YOU PAY!**



## ROLLEI POCKETLINE 200 COMPACT CAMERA AND ELECTRONIC FLASH-GUN

RSP £30.50 **Our Price £19.95**  
inc. VAT & P&P



From Rollei, one of the most respected names in photography. Precision made with a 3 element optical glass lens, colour corrected for quality colour photography. Supplied in gift box complete with wrist-strap. Fully guaranteed for 12 months. Finger-light push button shutter release • 2 brightness setting controls • Shutter speed 1/125 sec. reducing the possibility of camera shake • Clear view finder — easy to use even with spectacles • Drop-in 110 cartridge loading — simplicity itself • Detachable electronic flash — no complicated wires. 150 flashes from 2 pen-cell batteries (not supplied).

### CAMERA ORDER FORM

To: Camera Offer, Freepost, Teddington TW11 8BR.  
Please send me the Rollei Pocketline 200 Camera and Electronic Flash-gun.  
I enclose cheque p.o. for £19.95 (payable to Wireless World Camera offer) ✓

Name (please print) .....

Address .....

Registered in England No. 495406. Registered Office: 1 Throwley Way, Sutton, Surrey.

You get a special deal when you use our Colour Photo Service. Thousands of magazine readers are delighted with it. Because you save money on Kodak recommended prices — and you only pay for the prints you actually receive! So why not give it a try? You'll be delighted with our luxury borderless colour prints. Without borders you get as large a picture as possible — and our pictures have a hi-definition sheen for greater clarity.

### HERE'S WHAT YOU DO

Send us any make of colour print film inside the envelope enclosed in this issue. Or fill in the coupon below and send it with the film in a strong envelope to: Wireless World Colour Photo Service, FREEPOST, Teddington TW11 8BR. No stamp is required. Send no money at this stage.

### FREE KODACOLOR FILM

We'll send you a Kodacolor film, absolutely free, with your prints, together with an invoice for only the successful shots, eliminating the need for credit notes.

### UNBEATABLE VALUE

You're probably paying around 18p a print plus £1.10 for developing. Well, our price is an amazing 16p per print plus only 90p to cover developing, administration, postage and packing! Our minimum charge is 90p (assuming no prints come out) inc. V.A.T. Offer limited to U.K. and Eire, C.I. and B.F.P.O.

Remember, you only pay for successful prints — no credit vouchers. And you only pay on invoice: a straight forward business transaction with the extra advantages of quality, reliability and convenience. Value for money — and a free Kodacolor film worth about £1.00.

Films accepted on Standard Terms of Business (available on request).

From Wireless World  
**COLOUR PHOTO SERVICE,**  
Freepost, Teddington, TW11 8BR

NAME (please print) .....

ADDRESS .....

Postcode .....





MUSCAT & OMAN  
FRANCE  
DENMARK  
GAMBIA  
AUSTRALIA  
HONG KONG  
NAURU  
GERMANY  
TUNISIA  
LUXEMBOURG  
NIGERIA  
FINLAND  
SOUTH AFRICA  
CZECHOSLOVAKIA  
AUSTRIA

NEW GUINEA  
ISRAEL  
GUERNSEY  
CYPRUS  
BELGIUM  
UGANDA  
BRUNEI  
TRINIDAD  
SOUTH WEST AFRICA  
ITALY  
JAVA  
SIERRA LEONE  
WINDWARD ISLANDS  
CANADA  
MALTA

# 200+200 watt AMPLIFIER

As featured in Electronics Today International

**400W rms continuous — 800W peak!  
0.03% THD at FULL power!  
PLUS all the following features too!**

- \* Each channel totally independent with its own stabilised power supply driven by custom designed TOROIDAL transformers!
- \* Inherent reliability — monster heat sinks for cool running at the hottest venues — electronic open and short circuit protection!
- \* Ultra low feedback (an incredible low 14dB overall!), super high slewing rate (20V/μs), 200W rms continuous to 4 ohm from EACH channel, input sensitivity 0.775V (0dB).
- \* Professional quality components, sturdy 19" rack mounting chassis complete with sleeve and feet for free standing work too.
- \* Easy to build — plenty of working space with ready access to all components, minimal wiring, extensive instruction suitable for both experienced constructors and newcomers to electronics.
- \* Value for money — quality and performance comparable with ready-built amplifiers costing over £600!

## PSI 4002 STUDIO MODEL



Cabinet size 17.2" x 6.7"

**COMPLETE KIT ONLY £196.90 + VAT**

**READ THE REVIEW  
IN SOUND INTERNATIONAL DEC 78!**

# TRANSCENDENT 2000 SINGLE BOARD SYNTHESIZER

As featured in Electronics Today International



The kit includes fully finished metalwork, fully assembled solid teak cabinet, filter sweep pedal, professional quality components (all resistors either 2% metal oxide or 1/2% metal film) and it really is complete — right down to the last nut and bolt and last piece of wire! There is even a 13A plug in the kit — you need buy absolutely no more parts before plugging in and making great music! Virtually all the components are on the one professional quality fibre glass PCB printed with component locations. All the controls mount directly on the main board, all connections to the board are made with connector plugs and construction is so simple it can be built easily in a few evenings by almost anyone capable of neat soldering! When finished you will possess a synthesizer comparable in performance and quality with ready built units selling for between £500 and £700!

**COMPLETE KIT  
ONLY  
£172.00 + VAT!**

Comprehensive handbook supplied with all complete kits! This fully describes construction and tells you how to set up your synthesizer with nothing more than a multi-meter and a pair of ears!

# CHROMATHEQUE 5000 5-CHANNEL LIGHTING EFFECTS SYSTEM

This versatile system featured as a constructional article in ELECTRONICS TODAY INTERNATIONAL has 5 frequency channels with individual level controls on each channel. Control of the lights is comprehensive to say the least. You can run the unit as a straightforward sound-to-light or have it strobe all the lights at a speed dependent upon music level or front panel control setting or use the internal digital circuitry which produces some superb random and sequencing effects. Each channel handles up to 500W and as the kit is a single board design wiring is minimal and construction very straightforward.

Kit includes fully finished metalwork, fibreglass PCB, controls, wire, etc. — Complete right down to the last nut and bolt!

**COMPLETE KIT ONLY  
£49.50 + VAT**

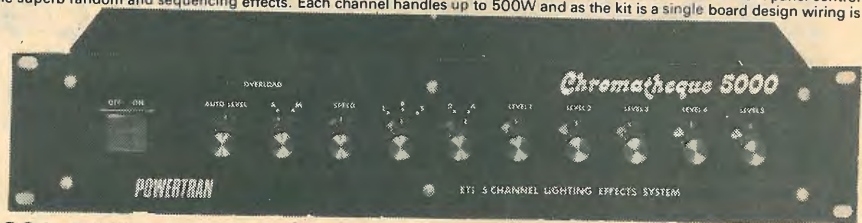

# MPA200 100W MIXER/AMPLIFIER

Featured as a constructional article in Electronics Today International the MPA 200 is an exceptionally low-priced but professionally finished general purpose, rugged, high-power amplifier which has an adaptable range of inputs such as disc, microphone, guitar, etc. There are 3 wide range tone controls and a master volume control. Mechanically the design is simplicity in the extreme with minimal wiring making construction very straightforward. Kit includes fully finished metalwork, fibreglass PCB's, controls, wire, etc. — Complete right down to the last nut and bolt!

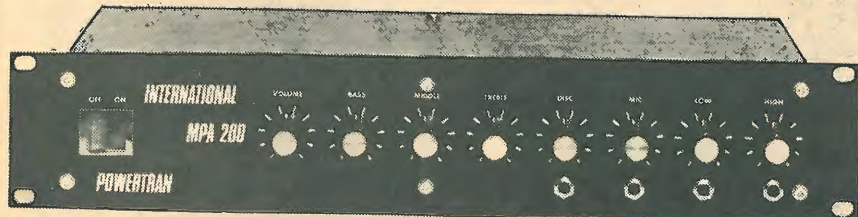

**COMPLETE KIT ONLY  
£49.90 + VAT**

All kits also available as separate packs (e.g. P.C.B. component sets, hardware sets, etc.). Prices in FREE CATALOGUE.

## EXPORT A SPECIALITY!

Our Export Department can readily despatch orders of any size to any country in the world. Some of the countries to which we sent kits last year are shown in this advertisement. To assist in estimating postal costs our catalogue gives the weights of all packs and kits. This will be sent free on request, by airmail, together with our "Export Postal Guide" which gives current postage prices. There is no minimum order charge. Prices the same as for U.K. customers but no Value Added Tax charged. Postage charged at actual cost plus 50p documentation and handling. Please send payment with order by Bank Draft, Postal Order, International Money Order or cheque drawn on an account in the U.K. Alternatively for orders over £500 we will accept Irrevocable Letter of Credit payable at sight in London.

**Value Added Tax not included in prices  
UK Carriage FREE**

**PRICE STABILITY.** Order with confidence! Irrespective of any price changes we will honour all prices in this advertisement until August 31st, 1979, if this month's advertisement is mentioned with your order. Errors and VAT rate changes excluded.

**U.K. ORDERS:** Subject to 12 1/2% surcharge for VAT (i.e. add 1/8 to the price). No charge is made for carriage. \*Or current rate if charged.  
**SECURICOR DELIVERY:** For this optional service (U.K. mainland only) add £2.50 (VAT inclusive) per kit.

**SALES COUNTER:** If you prefer to collect your kit from the factory, call at Sales Counter (at rear of factory). Open 9 a.m.-4.30 p.m. Monday-Thursday.

**QUALITY:** All components are brand new first grade full specification guaranteed devices. All resistors (except where stated as metal oxide) are low noise carbon film types. All printed circuit boards are fibreglass, drilled roller tinned and supplied with circuit diagrams and construction layouts.

**FOR FURTHER INFORMATION PLEASE WRITE OR  
TELEPHONE FOR OUR FREE CATALOGUE**

# POWERTRAN ELECTRONICS

PORTWAY INDUSTRIAL ESTATE ANDOVER  
ANDOVER HANTS SP10 3NN (0264) 64455



# Which Microcomputer System offers you a choice of CPU?

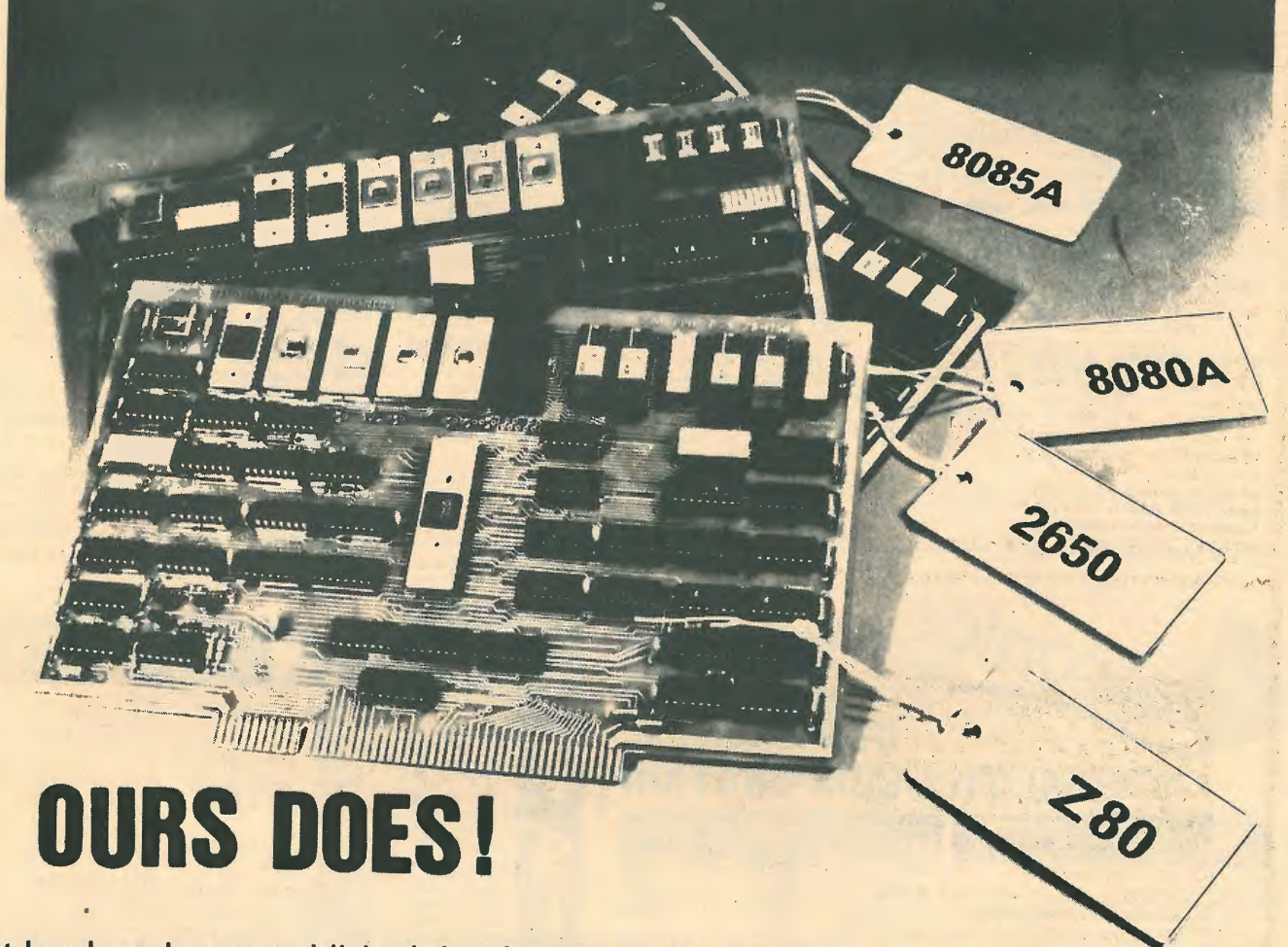

## OURS DOES!

It has long been established that for a particular application there is an optimum microprocessor, but the purchase of a new Microprocessor Development System for each application is prohibitively expensive. With the Quarndon Microcomputer System only the cpu board has to be changed. Each high-performance microcomputer board, using an 8080A, Z80, 2650, or 8085A as cpu can be used with an extensive common range of memory and interface boards, including our new high-performance fixed/floating point Arithmetic Processing Board.

**The Quarndon QMS System provides true economy, allowing a change of cpu with a minimum of expenditure on new hardware.**

## QUARNDON ELECTRONICS LTD

**SLACK LANE—DERBY DE3 3ED**

Telephone: DERBY 32651 Telex: 37163 (Quarndon Derby)

WW — 083 FOR FURTHER DETAILS





**Z & I AERO SERVICES LTD.**  
 Head Office: 44a WESTBOURNE GROVE, LONDON W2 5SF  
 Tel. 727 5641 Telex 261306

**RETAIL SHOP**  
 85 TOTTENHAM COURT ROAD, W. 1  
 Tel. 580-8403

**SPECIAL OFFER OF BRAND NEW USSR MADE MULTIMETERS**



|                  |               |               |
|------------------|---------------|---------------|
| <b>TYPE</b>      | <b>U4313</b>  | <b>U4315</b>  |
| Sensitivity D.C. | 20,000 o.p.v. | 20,000 o.p.v. |
| Sensitivity A.C. | 2,000 o.p.v.  | 2,000 o.p.v.  |
| D.C. Current     | 60µA-1.5A     | 50µA-2.5A     |
| A.C. Current     | 0.6mA-1.5A    | 0.5mA-2.5A    |
| D.C. Volts       | 75mV-600V     | 75mV-1000V    |
| A.C. Volts       | 15V-600V      | 1V-1000V      |
| Resistance       | 1K-1M         | 300Ω-500kΩ    |
| Capacity         | 0.5µF         | 0.5µF         |
| Accuracy         | 1.5% D.C.     | 2.5% D.C.     |
|                  | 2.5% A.C.     | 4% A.C.       |

Price complete with pressed steel carrying case and test leads  
 Packing and postage

£10.50      £10.50  
 £1.50        £1.50



**TYPE U4324**

D.C. Current: 0.06-0.6-60-600mA-3A  
 A.C. Current: 0.3-3-30-300mA-3A  
 D.C. Voltage: 0.6-1.2-3-12-30-60-120-600-1200V  
 A.C. Voltage: 3-6-15-60-150-300-600-900V  
 Resistance: 500Ω-5-50-500kΩ  
 Accuracy: D.C. 2.5% A.C. 4% (of F.S.D.)

PRICE complete with test leads and fibreboard storage case **£9.50**  
 Packing and postage **£1.20**

**TYPE U4323 COMBINED WITH SPOT FREQUENCY OSCILLATOR**



Sensitivity: 20,000Ω/V  
 Voltage ranges: 2.5-1000V A.C./D.C.  
 Current ranges: 0.05-500mA D.C. only  
 Resistance: 5Ω-1MΩ  
 Accuracy: 5% F.S.D.  
 Oscillator output: 1kHz 50/50 squarewave  
 465KHz sinewave modulated by 1KHz squarewave

PRICE, in carrying case, complete with leads and manual **£8.00**  
 Packing and postage **£1.00**



**TYPE U4341 COMBINED MULTIMETER AND TRANSISTOR TESTER**

Sensitivity: 16,700Ω/V D.C., 3,300Ω/V A.C.  
 Current: 0.06-0.6-6-60-600mA D.C., 0.3-3-0-30-300mA A.C.  
 Voltage: 0.3-1.5-6-30-60-150-300-900V D.C.  
 1.5-7.5-30-150-300-750V A.C.  
 Resistance: 2-20-200kΩ-2MΩ  
 Transistors: Collector cut-off current 60µA max  
 D.C. current gain 10.350 in two ranges

PRICE, complete with steel carrying case, test lead, battery and instruction manual **£9.50**  
 Packing and Postage **£1.50**

THIS OFFER IS VALID ONLY FOR ORDERS ACCOMPANIED BY REMITTANCE WHICH SHOULD INCLUDE DELIVERY CHARGES AS INDICATED AND 8% V.A.T. ON THE TOTAL.

OUR 1978 CATALOGUE/PRICE LIST OF VALVES, SEMICONDUCTORS, PASSIVE COMPONENTS AND TEST EQUIPMENT IS AVAILABLE. PLEASE SEND P.O. for £0.30 FOR YOUR COPY

WW — 053 FOR FURTHER DETAILS

**BI-PRE-PAK**

**NICKEL-CADMIUM BATTERIES AT LESS THAN HALF-PRICE**

BY A WORLD-FAMOUS MANUFACTURER IN 5 VALUABLE SIZES



BRAND NEW & GUARANTEED

| Type  | Capacity in mAh | Voltage | Charge Rate mA/12 hrs | Size in mm dia. x Thickness | Our price inc. 15% VAT |
|-------|-----------------|---------|-----------------------|-----------------------------|------------------------|
| NC20  | 200             | 1.24    | 20                    | 24.8 x 7.4                  | <b>45p</b>             |
| NC28  | 280             | 1.24    | 28                    | 34.4 x 5.3                  | <b>60p</b>             |
| NC50  | 500             | 1.24    | 50                    | 34.3 x 9.5                  | <b>80p</b>             |
| NC90  | 900             | 1.24    | 90                    | 50.5 x 8.3                  | <b>£1.20</b>           |
| NC175 | 1750            | 1.24    | 175                   | 50.7 x 14.9                 | <b>£1.75</b>           |

- High capacity for very small size.
- Wide temperature operating range.
- Low internal resistance.
- Very simple charging circuit required.
- INDEFINITE SHELF LIFE.

**TO ORDER**  
 Please send cash with order. Minimum order £3.00 plus 30p p/p in U.K. Orders over £10 carr. paid U.K. All prices inc. V.A.T.  
 Ideal for portable & emergency equipment, instruments, etc.

(WW) 222-224 West Road  
 Westcliff-on-Sea, Essex  
 SS0 9DF  
 Telephone 03708 5543

**BI-PRE-PAK LTD.**

**TESTING AMPLIFIER QUALITY YOU NEED A SIGNAL WITHOUT DISTORTION**

We do not claim our Model A0146 Signal Generator is distortionless. However it is so low (.0015%) that only the most sophisticated Analyser can detect it.



Spec. Sine wave distortion below .0015% output lv rms. Freq. coverage 10hz-100kHz Coarse and fine attenuation into 600 ohms. Square wave alternative.

**£36.00**  
 Tax extra 15%  
 P.P. £1.50.

**TELERADIO ELECTRONICS**  
 325 FORE STREET, EDMONTON, LONDON N9 0PE  
 01-807 3719 Closed Thursdays. S.A.E. for lists.

WW — 085 FOR FURTHER DETAILS

**FOTOLAK**

**POSITIVE LIGHT SENSITIVE AEROSOL LACQUER**

Enables YOU to produce perfect printed circuits in minutes! Method Spray cleaned board with lacquer. When dry, place positive master of required circuit on now sensitized surface. Expose to daylight, develop and etch. Any number of exact copies can of course be made from one master. Widely used in industry for prototype work.

|  |       |                                   |              |
|--|-------|-----------------------------------|--------------|
| FOTOLAK  | £1.50 | Pre-coated 1/16 Fibre-glass board | £1.50        |
| Developer  | 30p   | 204mm x 114mm                     | £3.00        |
| Ferric Chloride                                      | 40p   | 204mm x 228mm                     | £6.00        |
|  |       | 408mm x 228mm                     | £9.00        |
|  |       | 467mm x 305mm                     | £9.00        |
| Plain Copper-clad Fibre-glass.                       |       | Single-sided                      | Double-sided |
| Approx. 3.18mm thick sq. ft.                         | £1.25 | £2.00                             | £1.50        |
| Approx. 2.00mm thick sq. ft.                         | £2.00 | £1.50                             | £2.25        |
| Approx. 1.00mm thick sq. ft.                         | £1.50 | £1.50                             | £1.75        |
| Clear Acetate Sheet for making master, 260mm x 260mm |       |                                   | 12p          |

Postage and packing 65p per order. VAT 15% on total  
**G. F. MILWARD ELECTRONIC COMPONENTS LIMITED**  
 369 Alum Rock Road, Birmingham B8 3DR. Telephone: 021-327 2339

# ...and now No.3!

This third book in Wireless World's popular series will be welcomed by all concerned with designing, using and understanding electronic circuits. It comprises information previously included in the third ten sets of Wireless World's highly successful Circards — regularly published cards giving selected and tested circuits, descriptions of circuit operation, component values and ranges, circuit limitations, modifications, performance data and graphs. The book follows on from Circuit Designs Nos. 1 and 2. It is magazine size in hard cover and contains ten sets of Circards plus additional information and an explanatory introduction. Like its predecessors, it may soon be difficult to obtain, so you are advised to order your copy without delay.

- Voltage to frequency converters.**
- Amplitude modulators.**
- Reference Circuits.**
- Voltage regulators.**
- RC oscillators — part 1.**
- RC oscillators — part 2.**
- C.M.O.S. — part 1.**
- C.M.O.S. — part 2.**
- Analogue multipliers.**
- R.m.s./log./ power law circuits.**

## circuit designs

3

Collected Circards

PWilliams / JCarruthers / JHEvans / JKinsler

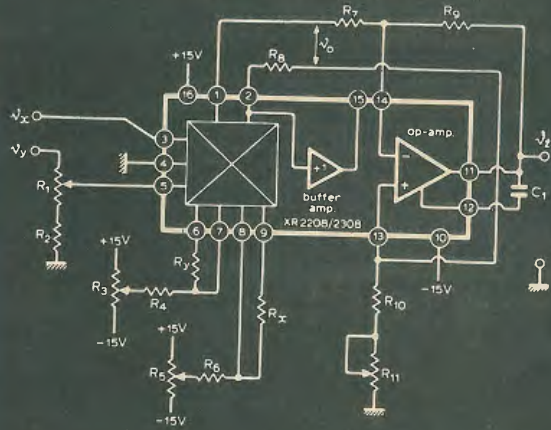

A WIRELESS WORLD PUBLICATION

A book from

# wireless world

General Sales Department, IPC Business Press Ltd.,  
Room, CP34, Dorset House, Stamford Street, London SE1 9LU.

### ORDER FORM

To: General Sales Department,  
IPC Business Press Limited, Room CP34, Dorset House,  
Stamford Street, London SE1 9LU.

Please send me.....copy s of  
Circuit Designs — Number 3 at £14.50 each  
inclusive. I enclose remittance value £.....  
(cheques payable to IPC Business Press Ltd.)

NAME.....  
(please print)  
ADDRESS.....  
.....  
.....

Company registered in England and a subsidiary of Reed International Ltd.  
Registered No. 677128. Regd. office: Dorset House, Stamford Street,  
London SE1 9LU.

WW 8







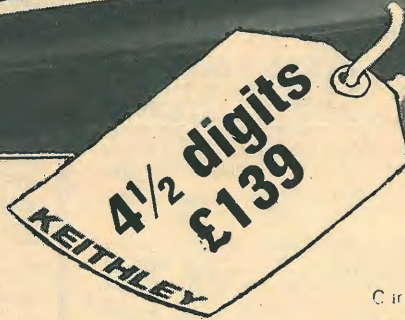
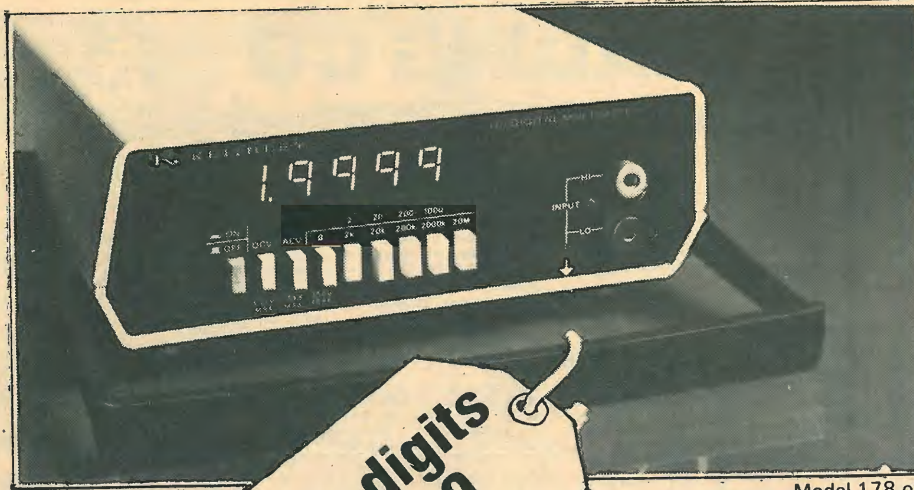

Model 178

**Now . . .  
the next  
generation of  
bench DMMs!**

Two New Keithley Models offer uncompromising performance and outstanding value!

- Accuracy 3 1/2's can't match 0.04% + 1 digit on dc volts and ohms
- Large, bright, 20,000-count LED display that's quick and easy to read.
- Convenient bench size that won't get "lost" yet doesn't crowd.
- Exceptional reliability.

Model 178 offers functions and ranges for most measurement needs 100µV to 1200V dc, 100µV to 1000V ac, 0.1Ω to 20MΩ.

Model 179 is a full-function, multi-feature model offering the same advantages as the 178. Plus,

**TRMS AC; 10µV Sensitivity; Hi and Lo Ohms; AC and DC**

Current Yet it's still half the price you'd expect. Only £199.

Both models feature designed-in reliability. Rugged circuits use a minimum of parts — high quality, off-the-shelf parts — carefully assembled and tested by Keithley. Outstanding overload protection and rugged mechanical design keep both units going even after severe abuse. One-year accuracy specifications minimise recalibration costs. A battery option, user installable, gets you off "line" for critical measurements or for field use.

For complete specifications on the 178 and 179, call Keithley Instruments, 1 Boulton Road, Reading. Phone 0734 861287

**KEITHLEY**

The measurement engineers.

WW — 051 FOR FURTHER DETAILS

ELF11 ELF11 ELF11 ELF11 ELF11 ELF11 ELF11 ELF11 ELF11 ELF11 ELF11 ELF11



**BUY A** only  
**minicomputer £79.95**  
for less than + VAT  
**some TV games**

**ELF 11 BOARD WITH VIDEO OUTPUT**

STOP reading about computer and get your "hands on" an, ELF 11 and Tom Pitman's short course. ELF 11 demonstrates all the 91 commands which an RCA 1802 can execute, and the short course speedily instructs you how to use them.

ELF 11's VIDEO OUTPUT makes it unique among computers selling at such a modest price. The expanded ELF 11 is perfect for engineers, business, industry, scientific and educational purposes.

- \* POWER SUPPLY (6.3v AC) for ELF 11 . . . . . 5.00
- \* ELF 11 DELUXE STEEL CABINET (IBM Blue) . . . . . 23.01
- \* GIANT BOARD KIT System/Monitor, Interface to/cassette, RS232, TTY etc. . . . . 35.00
- \* 4K STATIC RAM board kits (requires expansion power supply) . . . . . 69.44
- \* Expansion power supply (required when adding 4K Rams) . . . . . 19.00
- \* ASC 11 Keyboard Kits 96 printable characters, etc . . . . . 50.58
- \* ASC 11 D/lux steel cab. (IBM Blue) . . . . . 15.02
- \* KLUGE prototype board (build your own circuits) . . . . . 12.83
- \* 86pin Gold plated connectors (EA) . . . . . 4.00
- \* ELF Light pen writes/draws on TV screens . . . . . 6.50
- \* Video graphics board 32/64 characters by 16 lines on TV/monitor screens . . . . . 69.95
- \* ELF 11 Tiny basic on cassette . . . . . 13.50
- \* ELF 11 Bug/monitor powerful systems monitor/editor . . . . . 13.50
- \* T. PITMANS short course in programming manual (nil VAT) . . . . . 4.00
- \* T. PITMAN short course on tony basic manual (nil VAT) . . . . . 4.00
- \* RCA 1802 users manual (nil VAT) . . . . . 4.00
- \* On cassette test editor: assembler, disassembler (EA) . . . . . 16.95

**SAVE 10% AND BUY ALL THREE TOGETHER**  
All units can be supplied wired and tested  
Send s.a. for comprehensive brochure  
Add 15% VAT to all prices shown. Plus £2 P&P Over £20

**SPECIFICATION**  
\*RCA 1802 8-bit microprocessor with 256 byte RAM — expandable to 64K bytes  
\*RCA 1861 video IC to display program on TV screen via the RF Modulator  
Single Board with:  
Professional hex keyboard — fully decoded to eliminate the waste of memory for keyboard decoding circuits  
Load, run and memory protect switches  
16 Registers  
Interrupt, DMA and ALU  
Stable crystal clock  
Built-in power regulator  
5 slot plug in expansion bus (less connectors)

Name . . . . .  
Address . . . . .

Postmark . . . . .  
Barclaycard Access Diners Club

**To: NEWTRONICS**  
**The Personal Computer Div.**  
**of H. L. Audio Ltd.**  
**138 Kingsland Road E2 8BY**  
**Tel: 739 1582**

# More scope for your money.

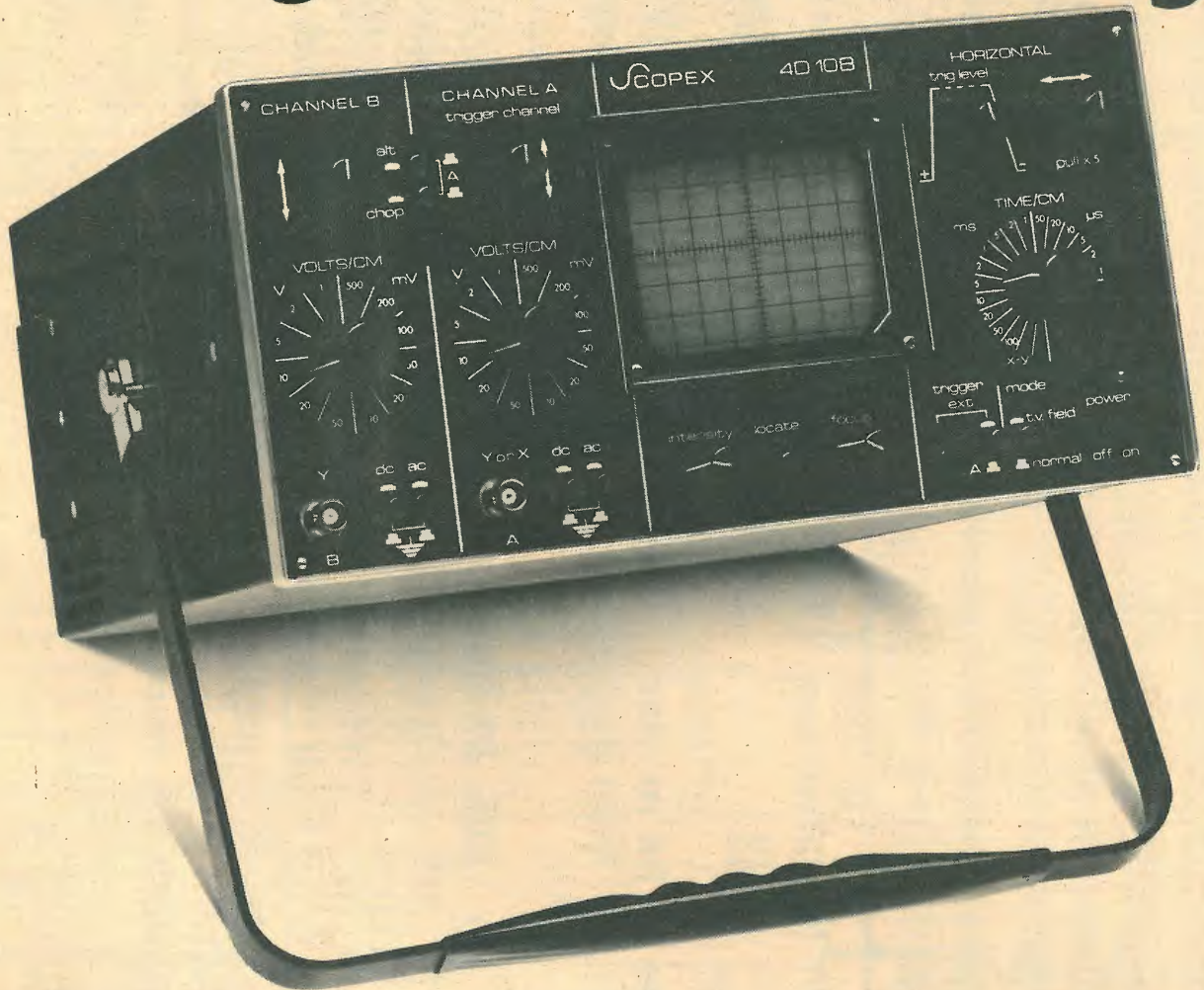

## The new Scopex 4D-10B.

The 4D-10B is a great newcomer to the Scopex range. Like all Scopex products it's extremely reliable, engineered to the highest standards and remarkably easy to use.

The fully stabilised power supply gives 3% accuracy, a significant 40% better than most and there are important new features including:—

- XY facility with fully matched sensitivities from 10mV to 50V/cm on both X and Y channels utilising CMOS integrated circuitry for extra reliability.
- Z modulation for brightening or dimming the trace.

Plus full 10MHz scan over the complete screen area. Trace locate and TV field trigger.

Finally there's free delivery in the UK mainland and the price—£210 excluding VAT.

That's a lot of scope for very little money. Also available, standard rack mount model.



Scopex Sales,  
Pixmore Avenue, Letchworth, Herts SG6 1JJ.  
Tel: (04626) 72771.

Please send me full details of the new Scopex 4D-10B.

Name \_\_\_\_\_

Company \_\_\_\_\_

Address \_\_\_\_\_

\_\_\_\_\_

\_\_\_\_\_

Tel: \_\_\_\_\_

WW 8/79









# Electronic Brokers

49/53 Pancras Road London NW1 2QB Tel: 01-837 7781. Telex 2986

## Our background

Electronic Brokers is Europe's largest specialist in quality, second user test equipment, mini-computers and associated peripherals. Established 11 years ago, we have pioneered the second user concept in Britain, and many overseas territories.

One reason for our success is the company's policy of continually

updating the type of equipment we sell. So from selling to private users, the business has rapidly developed, and today, our customer list includes leading international companies, research establishments, universities, colleges and government institutions throughout the world.

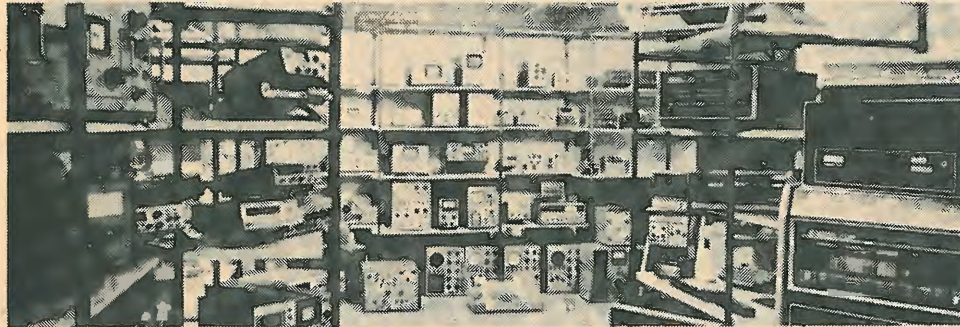

## Back up

To support our growth we have a skilled team. This includes trained sales staff, whose role is not only to sell, but provide a helpful information service to our many customers. Backing this team is our own service laboratory where technicians monitor each item of equipment we sell. Our maxim is

service, and those who have dealt with us will know that we endeavour to always live up to our reputation. Equipment can be configured to customer's exact requirement, and a number of options can be made available — almost like custom-tailoring.



## Refurbishing

Our own service laboratory checks each item that arrives at our Pancras Road headquarters. Electronic test equipment is then thoroughly cleaned and a schedule

prepared for any work which needs to be carried out to meet customer's requirements. Whether it is new test equipment or used, all items pass through the service

laboratory where they are given final tests to ensure they meet manufacturers' specifications, before delivery to the customer.

**Unless otherwise stated all equipment offered in the Electronic Brokers 4 page advertisement is refurbished and in the case of Test Equipment also calibrated. Test equipment is guaranteed for 12 months; computer peripherals for 3 months.**

**Hours of Business: 9 a.m. - 5 p.m., Mon.-Fri. Closed lunch 1-2 p.m.**

**A copy of our trading conditions is available on request.**

**Add 15% VAT to ALL PRICES**

**Carriage and Packing charge extra on all items unless otherwise stated.**

WW — 106 FOR FULL DETAILS

## SEND FOR AUTUMN '79 "TESTMEX ISSUE" CATALOGUE

Containing latest information on our stocks of Test Equipment, Minicomputers, Peripherals, Stroboscopes, Tachometers, etc. Airmail to overseas addresses £2.00.

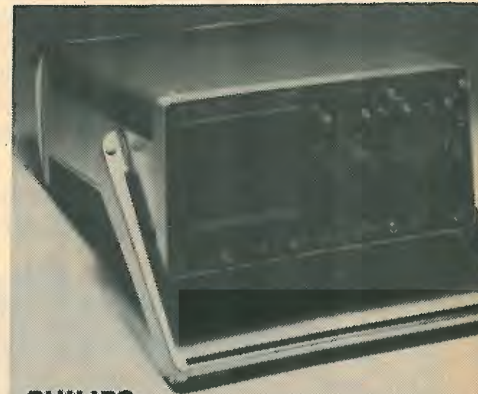

### PHILIPS

PM3261 Dual Trace Portable Oscilloscope  
DC — 120MHz 5mV — 2/div  
5nS — 15/div Full delayed sweep  
5 digit LED event display.  
Auto. TTL triggering

**£1250.00**  
current new price  
**£1990.00**

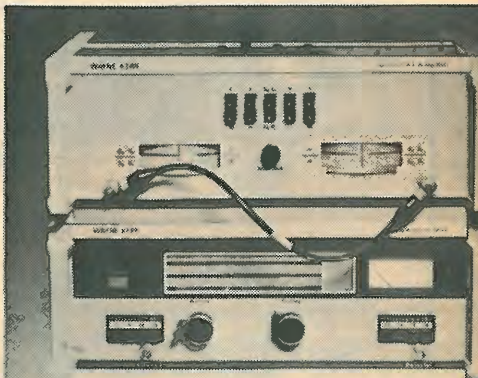

### WAYNE KERR

Wayne Kerr B602 VHF Admittance Bridge  
c/w SR265 source and Detector  
Frequency Range 100kHz — 100MHz.  
Ranges: 1fF — 1mF, 100μΩ — 100MΩ  
1pH — 10H, 10n mhos — 10k mhos  
Accuracy typically 1%

**£1900.00**



### PHILIPS

PM2524 4½ Digit D.M.M.  
AC/DC voltage and current and resistance.  
Full autoranging

**£299.00**  
Current new price **£435.00**



# No.1 in Second User Test Equipment

Add 15% VAT to all prices

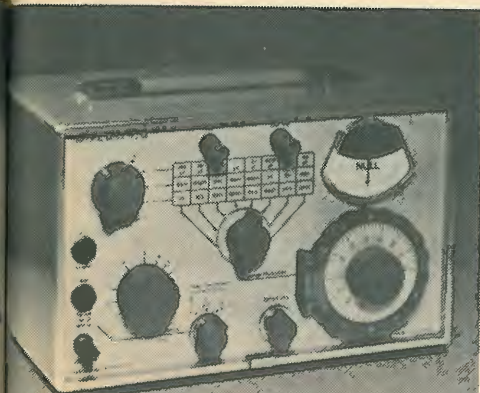

## MARCONI INSTRUMENTS

**TF2700 RCL Bridge**  
 Ranges: 0.2 $\mu$ H—110H,  
 0.5pF—1100 $\mu$ F,  
 0.01 $\Omega$ —11M $\Omega$ . Accuracy typically 1%  
 Battery operated

**£210.00**

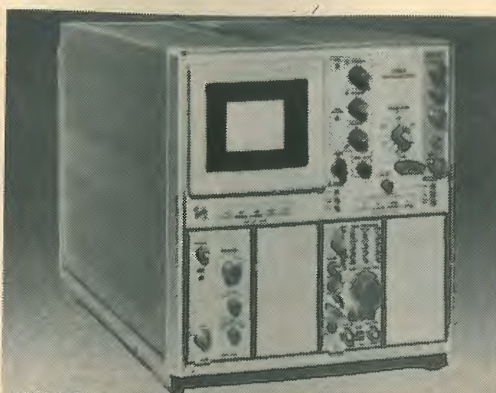

**7904 Oscilloscope Main Frame**  
 with 7A26—7A19—7A21—7B92  
 Bandwidth: 350MHz with 7A26  
 500MHz with 7A19  
 1GHz with 7A21  
 Sweep speeds 0.5nS—0.2S/div,  
 Full delayed sweep.  
**SUPERB/QUALITY AT VERY SENSIBLE PRICE**

## TEKTRONIX

**£6350**

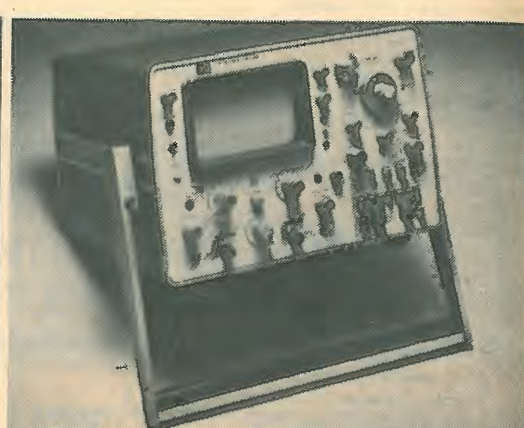

## HEWLETT PACKARD

**DUAL TRACE PORTABLE  
 OSCILLOSCOPE 1707B**  
 DC-75MHz. 10mV-10V sensitivity.  
 Delayed Sweep. Very  
 High Quality

**£925.00**

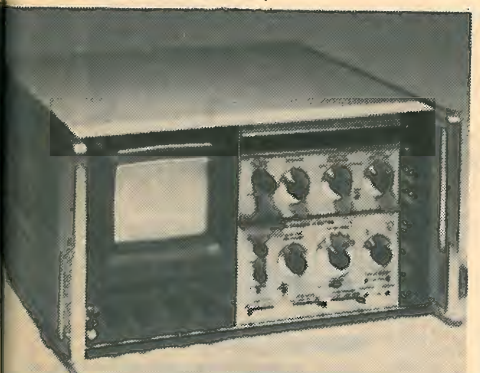

## HEWLETT PACKARD

**HP-8552A-8553B Spectrum  
 Analyser**  
 100kHz-110MHz Variable persistence  
 Display Sensitivity—140dBm  
**THE MOST POPULAR  
 ANALYSER OF ALL TIME.**

**£5100.00**

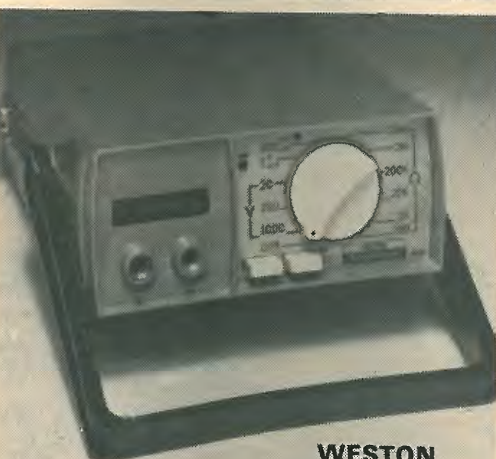

## WESTON

**4449 3 1/2 Digit D.M.M.**  
 AC-DC Voltage and current and resistance.  
**SUPERB VALUE AT ONLY  
 QUANTITIES AVAILABLE**

**£59.00**



## FLUKE

**931B True RMS Differential Voltmeter.**  
 10Hz-1 MHz. Very high accuracy  
**TOP QUALITY STANDARDS EQUIPMENT**

**£950.00**

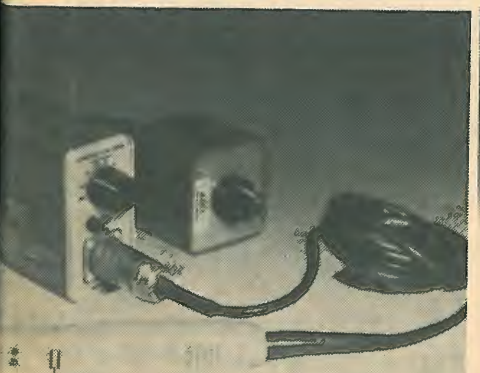

## TEKTRONIX

**1046 Differential Probe**  
 100MHz  
 1V-300mV/div.  
 Complete with power supply

**£350.00**



## HEWLETT PACKARD

**5 1/2 DIGIT D.M.M. 3490A**  
 AC-DC volts  
 and resistance  
 Self check facility

**only £550.00**

Current new price  
**£1,679.00**



## MARCONI

**TF1313A Universal Bridge**  
 L.C.R. 0.1% accuracy.

**£790**  
 Current new price **£995.00**



# No.1 in Second User Minis & Peripherals



**HAZELTINE H-2000A** NOW ONLY **£395**

Superb specification includes full edit capability, direct cursor addressing, standard V 24 (RS232) interface 90 days warranty

Also available: Off-the-shelf delivery of the latest Hazeltine Model 1510, Brand New and Boxed, at discounted price of **£825.00**.



**TEXAS SILENT 700**

Model 725KSR Terminal mounted in integral carrying case complete with built-in acoustic coupler. 64 ASCII character set with 5 x 7 dot matrix. 30 cps. Weight 35lbs, dimensions 21 1/2" x 19" x 6 1/2". **£695.00**.



**SHUGART FLOPPY DISC DRIVES**

A400 Minifloppy — 110KB capacity, 35 tracks, transfer rate 250Kbits/sec, AV access time 50msec. Power requirements +5VDC + 12VDC. PRICE: **£195.00**

S800 Floppy — 400KB capacity, 77 tracks, transfer rate 250Kbits/sec AV access time 260msec. Power requirements +24VDC, +5VDC — 5VDC. PRICE: **£395.00**



**DEC PDP11/04 — SPECIAL PURCHASE**

PDP11/04-MD 9-slot 5 1/4" Processor with 28K core and DL11W Interface. **BRAND NEW SURPLUS — ONLY £4,500.00.**

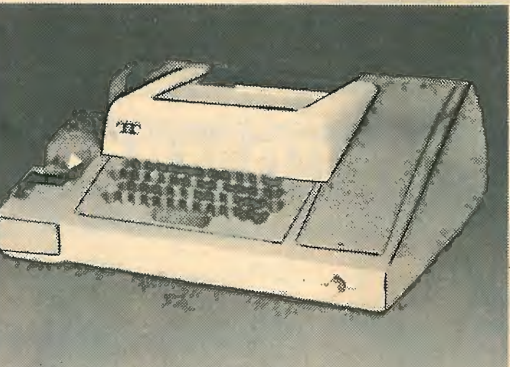

**ASR33 and KSR33 TELETYPE**

Input/Output terminals with 64 ASCII character set. 110 baud operation. Paper tape punch and reader (ASR33 only). Choice of interface (20mA or RS232) KSR33 — **£425.00**, ASR33 — **£650.00**. Pedestal **£30.00**.



**NEW ASCII KEYBOARDS**

KB756 ROM-encoded 56-station keyboards with full 128 ASCII character set. Standard TTL logic. Power requirements +5 — 12V. Supplied with full technical data and circuitry (see next column for prices).

**DEC EQUIPMENT**

|  |        |
|--|--------|
| PDP8A Add-on RAM Read/Write Memory   |        |
| MS8AA 1K   | £225   |
| MS8AB 2K   | £375   |
| MS8AD 4K   | £550   |
| PDP11-04/11-34 Add-on MOS Memory   |        |
| MS11FP 8K  | £550   |
| MS11JP 16K   | £1,200 |
| PDP11-05/11-40/11-45 Add-on Parity Core Memory   |        |
| MM11LP 8K  | £1,000 |
| MM11UP 16K   | £1,250 |
| MF11UP 16K complete with backplane   | £1,500 |
| PC81 High Speed Reader/Punch & Control for PDP81   | £895   |
| DD11A 4 SPC-slot backplane   | £195   |
| KW11P Programmable Clock   | £345   |
| PR11 High-speed paper tape reader and control  | £1,450 |
| RT01AB Single-line data entry terminal with hex keyboard and 20mA interface                        | £150   |
| TC11 TUS6 DEC tape drive and control   | £1,395 |
| H9602 Data system Cabinet complete with power distribution unit (no side panels). As new condition | £750   |
| TA11/TU60 Twin Cassette Drive and Control  | £1,500 |
| PR11 High-speed paper tape reader and control  | £1,450 |
| RK8E/RK05J Disk drive and control  | £3,950 |
| TWE16 ED 9-track 800/1600 bpi <b>BRAND NEW EX-CANCELLED ORDER</b>                                  | P.O.A. |
| DL11-B Serial Interface  | £275   |
| BA11-ES Expander Box   | £750   |
| KW11P Programmable Clock   | £345   |
| MM-11-LP 8K Add-on Core with backplane (11-05, 11-35)  | £750   |
| MS11-FP 8K Add-on MOS (11-04, 11-34)   | £375   |
| PDP8E — Series — Large stocks of add-on core and option modules.                                   |        |

**COMPUTER PERIPHERALS**

**CENTRONICS 101 Matrix printer**  
64 ASCII uppercase character set. 165 characters per second. 132 print columns. 5 x 7 dot matrix. Parallel input. PRICE: **£750**

**SCOPE DATA SERIES 200 PRINTER**  
240 cps 80 column receive-only matrix printer. Full upper and lower case ASCII character set. Standard RS232 interface Electro-sensitive printing ensuring quiet operation. **BRAND NEW SURPLUS**. New low price **£495**.

**DEC LA30 DECWRITER**  
80-column KSR terminal with selectable transmission speeds of 10, 15 and 30 cps. Upper case ASCII character set. Current loop interface. Integral pedestal **£575**.

**SEALECTRO PATCH BOARDS**  
Programme boards for switching and interconnecting input/output circuits. 11 x 20 XY matrix. Interconnection is by means of shorting. Skip and component holding pins (not included). Dimensions 7 1/2" x 5 3/4" x 1". PRICE **£12.50** (mail order total £14.58).

**CALCOMP 565 DIGITAL DRUM PLOTTER** Y-Axis 11", X-Axis 120". Maximum speed 300 increments 4 2" per second. Input Positive or negative polarity pulses, amplitude greater than 10V, rise time less than 10 microsec., minimum pulse with 4 microsec. Source impedance less than 500 ohms. PRICE **£1,250**.

**GE TERMINET 1200**  
Receive only impact printer with switch selectable print speeds of 10, 30 and 120 cps. 120 print positions with adjustable pinfeed paper tractor. 94 character upper and lower case ASCII. Current loop interface. PRICE **£695**.

**VIDEO TAPE — SPECIAL PURCHASE**

Ampex type 162-3000 DD-20. 1 1/2" x 3000' video tape on 9 1/2" reels. **BRAND NEW SURPLUS — ONLY £15.00** per reel (plus carriage and VAT).

**NEW KEYBOARDS** (mail order total)

|  |        |        |
|--|--------|--------|
| KB756 key-stations mounted on PCB                                      | £49.50 | £58.65 |
| KB756MF, as above, fitted with metal mounting frame for extra rigidity | £55.00 | £64.98 |
| Optional Extras  |        |        |
| KB15P Edge Connector   | £3.25  | £4.31  |
| KB701 Plastic Enclosure  | £12.50 | £15.24 |
| KB702 Steel Enclosure  | £25.00 | £30.48 |
| KB710 Numeric Pad  | £8.00  | £9.78  |
| KB2376 Spare ROM Encoder   | £12.50 | £14.95 |
| DC512 DC-DC Converter  | £7.50  | £9.20  |

**LATEST ADDITION TO THE RANGE**

KB771 71 Station keyboard incorporating separate numeric/cursor control pad and installed in custom-built steel enclosure with textured enamel finish. Case dimensions: 17 1/4" x 7 1/2" x 3 3/4". Total weight: 4Kg. PRICE **£95** (mail order total **£108**)

D25S Connector for KB771 ..... **£4.25** **£5.46**

Quantity Discounts available.

**NEW KEYTOP/KEYSWITCH KITS — ASCII CHARACTER SET. BRAND NEW SURPLUS**

Pack of 58 keytops and keyswitches comprising 49 "Qwerty" set, TTY format + 9 Edit/Function keys. PRICE **£15** (mail order total **£18.98**)

**SURPLUS KEYBOARDS**

KB3 ROM-encoded ASCII keyboard with 63 push-button key stations. TTL-compatible. Power requirements: +5V-12V. Constructed on rugged PCB with metal mounting plate. Supplied with full technical data. Manufacturers surplus. **ONLY £35** (mail order total **£41.98**).

# Electronic Brokers







# Appointments

Advertisements accepted up to 12 noon Friday, July 27 for September issue, subject to space being available.

**DISPLAYED APPOINTMENTS VACANT:** £10.00 per single col. centimetre (min. 3cm).  
**LINE advertisements (run on):** £1.50 per line, minimum three lines.

**BOX NUMBERS:** 70p extra. (Replies should be addressed to the Box Number in the advertisement, c/o Wireless World, Dorset House, Stamford Street, London SE1 9LU.)

**PHONE:** Neil McDonnell on 01-261 8508

*Classified Advertisement Rates are currently zero rated for the purpose of V.A.T.*

## RADIO TECHNICIANS

At the Government Communications Headquarters we carry out research and development in radio communications and their security, including related computer applications. Practically every type of system is under investigation, including long-range radio, satellite, microwave and telephony.

Your job as a Radio Technician will concern you in developing, constructing, installing, commissioning, testing, and maintaining our equipment. In performing these tasks you will become familiar with a wide range of processing equipment in the audio to microwave range, involving modern logic techniques, microprocessors, and computer systems. Such work will take you to the frontiers of technology on a broad front and widen your area of expertise — positive career assets whatever the future brings.

Training is comprehensive: special courses, both in-house and with manufacturers, will develop particular aspects of your knowledge and you will be encouraged to take advantage of appropriate day release facilities.

You could travel — we are based in Cheltenham but we have other centres in the UK, most of which, like Cheltenham are situated in environmentally attractive locations. All our centres require resident Radio Technicians and can call for others to make working visits. There will also be some opportunities for short trips abroad, or for longer periods of service overseas.



You should be at least 19 years of age, hold or expect to obtain shortly the City and Guilds Telecommunications Technician Certificate Part I (Intermediate), or its equivalent, and have a sound knowledge of the principles of telecommunications and radio, together with experience of maintenance and the use of test equipment. If you are or have been in HM Forces your Service trade may allow us to dispense with the need for formal qualifications.

## WORK IN COMMUNICATIONS R&D AND ADD TO YOUR SKILLS

You start at £3900 rising to £5530, and promotion will put you on the road to posts carrying substantially more. There are also opportunities for overtime and on call work paying good rate.

Get full details from our Recruitment Officer, Robby Robinson, on Cheltenham (0242) 21491, Ext. 2269, or write to him at GCHQ, Oakley, Priors Road, Cheltenham, Glos. GL52 5AJ. If you seem suitable we'll invite you to interview in Cheltenham — at our expense, of course.

(9106)

Inner London Education Authority

## TECHNICIAN

Grade 4

required at South Thames College, Wandsworth High Street, SW18 2PP. Tel. 870 2241. For Radio, Television and Electronics Servicing in the Engineering Processes Dept.

Applicants should have at least ONC, OND, 2 "A" levels and some "O" levels, ordinary City and Guilds or equivalent qualifications and a minimum of 7 years' experience (including training period).

Salary scale £3222-£3708 plus £525 London Weighting.

Application form and further details available from and returnable to the Vice-Principal at the above address within 14 days of the appearance of this advertisement.

(9403)

## Radio Communications Electronics Engineers and Software Designers

Mid-Sussex — S.W. London

Salaries up to £7,000

To join our expanding R&D Laboratories covering a wide range of R.F. spectrum, from L.F. to V.H.F. Equipments include transmitters and receivers for marine and land based use, radio nav aids and radio monitoring remote computer controlled systems.

Electronics Engineers should have experience in transmitter or receiver design, analogue or digital circuit design, microprocessor applications. Software Designers should be experienced Programmers with an interest in control, signal processing or navigational software.

Attractive salaries are complemented by excellent prospects and generous benefits.

Contact: **The Personnel Manager, Redifon Telecommunications Limited, Broomhill Road, Wandsworth, London S.W. 18. Phone: 01-874 7281** (reverse charges).

(9033)

## PRODUCT SUPPORT SUSSEX

M.E.L. is the professional equipment division of the International Philips Electronic Group and is an established world leader in the design and manufacturing of a wide range of Electronic Equipments for defence and civil markets. Due to major expansion of our product support activities, the following vacancies have arisen.

### PRODUCT SUPPORT ENGINEERS

To deal with 'post design' problems, resulting from the production and in service use of a wide variety of equipments and systems including military Radio and Radar. Engineers with a good knowledge of electronics up to H.N.C. standard will find these positions have the interest and challenge they require. Experience of similar work within H.M. forces and/or knowledge of M.o.D. procedures would be extremely useful.

### SERVICE ENGINEERS

These positions require applicants willing to use their own initiative and skills in carrying out diagnostic fault finding, repairs and retest of a variety of equipments including airborne radar units. The work will also involve some liaison with customers. A good general knowledge of electronics, including semi-conductors circuits, is essential and H.M. Services 2nd/3rd line maintenance experience will be especially useful.

These positions attract good starting salaries and excellent conditions of employment in a stimulating modern working environment and generous relocation expenses will be given where appropriate. For further details or an Application Form please contact: MR. A.G. BUDD, Personnel Officer, M.E.L., Manor Royal, Crawley, Sussex. Tel. Crawley 28787 Ext. 364.

9426

**M E L**

### LONDON BOROUGH OF HARINGEY — Education Service PART-TIME ASSISTANT HEARING AND VISUAL AIDS TECHNICIAN

required at Blanche Nevile Special School, Philip Lane, N.15, to work 15 hours per week x 52 weeks per annum to assist in the repair and maintenance of hearing and visual aid equipment.

Grade/Salary: Pro rata to N.J.C. Technical Grade 2 — £3,600 per annum rising to £3,972 per annum inclusive, which equals £1,542 per annum rising £1,704 per annum inclusive.

Applicants should preferably have experience in maintaining electronic equipment and should hold one of the following qualifications: Final City and Guilds Certificate for Electrical Technicians/Machine Shop Engineering/Mechanical Engineering, or other equivalent qualification. OR a minimum of 10 years' suitable experience in a school or industry. Hours of duty: 9.30 a.m. to 12.30 p.m. Candidates will be welcome to contact Mr. J. H. Stanway, Headmaster (01-808 5744). Application forms obtainable from: Chief Education Officer, Education Offices, Somerset Road, N.17. Forms returnable by: July 20, 1979.

(9431)

### APPOINTMENTS IN ELECTRONICS £5 — £10,000

Take your pick of the permanent posts in:

MISSILES — MEDICAL  
COMPUTERS  
RADAR — COMMS  
MICROPROCESSOR  
HARDWARE — SOFTWARE

For free, expert advice and immediate action on salary and career improvement, phone or write to, Mike Gernat BSc.

**Technomark**  
Engineering and Technical Recruitment

11 Westbourne Grove

London W2. 01-229 9239

(9257)

A leading manufacturer of artificial limbs and aids for the disabled based in South-West London require the following personnel to work in its research and development department.

### ELECTRONICS DESIGN ENGINEER

£5500 to £7500

Applicants should have experience in low-noise amplifier design such as in audio frequency systems and some experience of servo and electro-mechanical systems. Familiarity with digital techniques would also be an advantage. HNC, HND or degree preferred.

### ELECTRONICS TECHNICIAN

£4000 to £5500

Applicants should have experience with development of prototype electronic circuit breadboards. The range of work is varied, and the ability to work from initial design diagrams, in close liaison with the product development engineer and with the minimum of supervision, is essential.

The successful candidate will ultimately be expected to take over the task of laying out printed circuit boards for the development department and hence initial experience in this field would be an advantage.

ONC or C & G preferred, although consideration will be given to applicants working towards a qualification and wishing to continue their studies.

For either position apply in writing, stating age, qualifications, experience and present salary to **Box No. WW9459.**

(9459)

A leading company in the phototypesetting industry requires:

### SENIOR SYSTEMS TEST AND COMMISSIONING ENGINEERS

Capable of testing and installing a range of minicomputer based VDU terminal equipment, incorporating the latest in MSI and LSI techniques in real time applications. The right candidates will be qualified to at least HNC level and/or have considerable experience in digital electronics with the knowledge of 74 Series TTL. A background of word processing or the printing industry would be advantageous. The job involves some UK and European travel to handle back-up service for our agents.

Salary: £5,000+.

The Company provides four weeks holiday and pension scheme.

Phone for application form to:

Miss Bux

**DATEK SYSTEMS LTD.**  
849 Harrow Road, Wembley, Middlesex  
Tel. No. 01-904 0061

(9479)



# What's an electronics enthusiast like you doing in an advertisement like this?

We reckon that if you're a regular reader of this magazine, you might very well be the sort of man or woman who'd be interested in joining Marconi Avionics as an **Electrical Inspector**.

We say this with some confidence because if you're used to building up your own equipment, you're probably well used to finding your way round electronic circuits and wiring and that's just the sort of background we're looking for.

As an Electrical Inspector with us you'll be involved in the inspection of printed circuit boards and assemblies against drawings on a wide range of equipment. Mind you, this equipment will be considerably more complex than any you're likely to have worked on previously, for at Borehamwood we're engaged on a variety of

exciting and challenging projects relating to advanced electronic systems and hardware for such technically sophisticated aircraft as Nimrod and Tornado. But, provided you have a good basic background knowledge of electronic circuitry, we can soon train you to take your place in one of our inspection teams.

We offer a good salary, an attractive range of benefits and the opportunity to make your hobby pay off both financially and in terms of job satisfaction.

Write with details of your experience to Chris Hill at Marconi Avionics Limited, FREEPOST, Elstree Way, Borehamwood, Herts WD6 1BR. Telephone 01-953 2030 ext 3449 during office hours or 01-207 3455 anytime.

9418

**MARCONI  
AVIONICS**  
A GEC-Marconi Electronics Company

## Engineering Support Programmer

STC are heavily committed to the advanced uses of computer systems in telecommunications, both in their telephony products and in their manufacturing processes. Computer Aided Design is a well developed and expanding technique.

The range of projects is exceptional and firm development plans open up even more opportunities for male and female Programmers with an interest and aptitude for CAD.

Current and planned hardware includes a Honeywell 66/40 plus Honeywell Level 6, PDP, Data General and CMC minis.

You should be either an Electronic Engineer with experience of computer systems, or a Programmer with a background in scientific packages for engineering users. One or two years' experience is the expected minimum.

You will work in a small team of Engineers and Programmers providing support to users of large CAD packages and providing CAD engineering systems for use under time-sharing.

This is a senior position, with a negotiable salary based on expected contribution. There are a wide range of company benefits including relocation assistance. Location is on the edge of London/Herts with excellent road and rail communications.

Please telephone for an application form or write with full details to Mr. R. Edmonds-Brown, Recruitment Department, Standard Telephones and Cables Limited, Oakleigh Road South, New Southgate, London N11 1HB. Tel: 01 368 1234. Ext. 2579.

**STC** Changing the face of communications worldwide

9415

## ELECTRICAL AND ELECTRONICS ENGINEER

World leader in technical information is planning a new expansion of its patents services for the electrical and electronics industries.

Engineers are required for various editorial positions. Duties will comprise selecting, editing and coding information for subsequent publication and input into a database, and candidates will be expected to contribute constructive ideas.

A degree or equivalent qualification in electrical or electronics engineering is essential, together with industrial experience. A reading ability in German, French, Russian, Dutch or Swedish would be an advantage, and experience of patents is preferable. Preferred ages are 25-40.

Realistic salaries are offered and benefits are those associated with a market leader in publishing.

Please write in confidence with abridged curriculum vitae quoting ELEC/E to:

**General Manager**  
**DERWENT PUBLICATIONS LTD.**  
Rochdale House  
128 Theobalds Road  
London, WC1X 8RP



(9405)

### UNIVERSITY OF PAPUA NEW GUINEA

Applications are invited for the post of

### SENIOR TECHNICIAN (ELECTRONICS)

IN THE DEPARTMENT OF PHYSICS.

The appointee will be expected to perform the following duties: Take charge of a small, modern and well-equipped electronics workshop. — To provide on-the-job training to National Technicians. — Maintain and calibrate a wide variety of electronic instrumentation. Design and develop a digital and analogue instrumentation for teaching and research. Applicants should hold a Higher National Certificate or equivalent qualification in Electronic Engineering and have several years' appropriate experience.

Appointment will be at the level of Senior Technical Officer Grade 2. Salary: K10165 p.a. (£1 sterling=K1.49). Family passages; baggage allowance; gratuity; various generous allowances. Detailed applications (2 copies) with curriculum vitae and naming 3 referees to be sent direct to Secretary, Box 4820, University PO, Papua New Guinea as soon as possible. Applicants resident in the U.K. should also send one copy to Inter-University Council, 90/91 Tottenham Court Road, London W1P 0DT. Further details may be obtained from either address.

(9483)

### THE POLYTECHNIC OF CENTRAL LONDON Science Division ELECTRONICS TECHNICIANS

Required in the workshop and electronics/digital teaching laboratories of the Science Division. Duties in these areas include the design, development, repair and maintenance of a wide range of scientific instrumentation as well as the development of new experiments in analog and digital electronics and microprocessors for use by undergraduate, postgraduate and short course students. Grade 7 Technician Salary: £5163-£5736 inclusive of London Allowance to be responsible for the above areas. Grade 6 Technician Salary: £4509-£5283 inclusive of London Allowance to work in electronics, digital and microprocessor teaching laboratories Grade 3 Technician Salary: £3456-£3861 inclusive of London Allowance to work in the electronics workshop. Qualifications: Grades 6 and 7: HNC/HND or Final C&C plus several years of experience; Grade 3 — ONC/OND or Intermediate C&G plus experience. In the lower graded posts consideration would be given in respect of industrial experience in lieu of academic qualifications.

**Application form and further details from the Establishment Officer, PCL, 308 Regent Street, London W1R 8AL. (Tel: 01-580 2020 ext. 212).** (9446)

### TOP JOBS IN ELECTRONICS

Posts in Computers, Medical, Comms, etc. ONC to Ph.D. Free service.

Phone or write: **BUREAUTECH AGY, 46 SELVAGE LANE, LONDON, NW7. 01-959 3517.**

(8994)

# Avionics

## Development Engineers Test Engineers

**M.E.L. as part of the International Philips Electronic and Associated Industries group develop and manufacture a wide range of sophisticated military and professional electronic equipment.**

**To meet long term commitments, we are expanding our Development team of professional Development Engineers who are currently involved in a variety of Development activities. These include:-**

**Digital Signal Processing  
Display Systems  
Airborne Radar  
Microwave Navigation Systems**

**If you have a degree or HNC level qualification and preferably a knowledge of Government Ministry Standards, join our team and share the challenge of our Avionics expansion.**

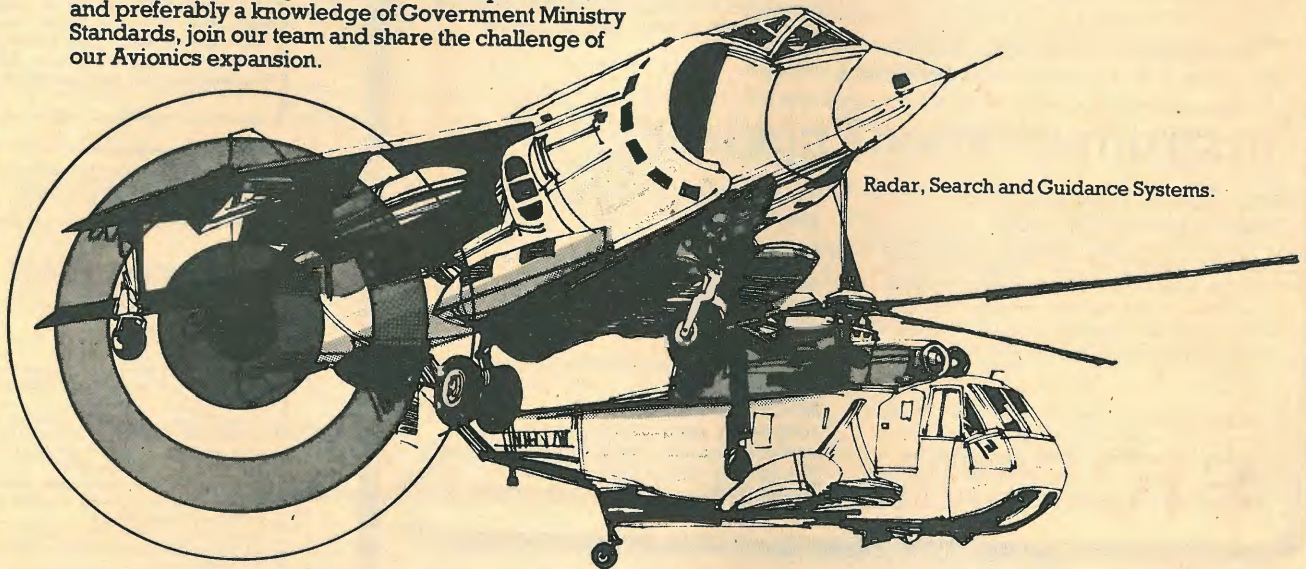

Radar, Search and Guidance Systems.

**We offer very attractive salaries, benefits and conditions for all positions including a mortgage subsidy where appropriate and excellent relocation expenses to the very pleasant and rural surroundings of Sussex. JOIN US: If you have the ability; We have the opportunity. Contact: ALISTAIR BUDD - PERSONNEL OFFICER - NOW FOR AN APPLICATION FORM. M.E.L., MANOR ROYAL, CRAWLEY, SUSSEX. TEL: CRAWLEY 28787 EXT. 364.**

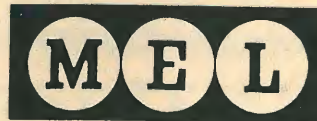

## ELECTRONIC SERVICE ENGINEERS

LONDON - BRISTOL - MANCHESTER - GLASGOW

Our Company specialises in both sales and servicing of Discotheque Sound and Lighting equipment. We currently have vacancies for engineers who have had previous experience of either HiFi, Studio, PA or similar equipment. Excellent salary plus quarterly bonus and P.P.P. Please telephone or write to Andree Mead for further details.

(9448)

**Roger Squire's**

Barnet Trading Estate,  
Park Road, Barnet,  
Herts. EN5 5SA  
Telephone: 01-441 1919

## Electronics & Computer Test To £7,500

Use your C&G/ONC/HNC/Forces Training and good DIGITAL/ANALOGUE/RF experience to advantage. Working with state-of-the-art MINI/MICRO PROCESSOR; LASER; ATE; COMMUNICATIONS; NUCLEONIC; CCTV and similar equipment. Most UK areas; from Technician to Manager.

For free confidential counselling and practical career advice contact GRANT WILSON ref: GW470.

TECHNOMARK, 11 Westbourne Grove, London W2 4UA.

Tel: 01-229 9239 (01-229 4218 - 24 hrs).  
Engineering Recruitment Consultants.

## Five Years in Electronics or Instrumentation?

### Get into Systems Engineering c. £5,250 Birmingham

Cadbury Schweppes, the world-wide food, drinks and confectionery manufacturer, can offer the Electronics or Instrumentation Engineer an excellent opportunity to put practical and theoretical skills to good use in modern industry. There are two vacancies on a small, flexible and integrated team in our

International Systems Engineering Department based at Selly Oak, Birmingham, for men or women who can work well with others and possess the initiative and adaptability for development work.

### Electronic Engineer

Your responsibilities will be to design and build special purpose electronic devices, including microprocessor based systems. You will also be required to calibrate and test

prototypes and undertake fault finding and maintenance on electronic workshop equipment.

### Instrumentation Engineer

You will have a broad-based role in designing and making parts of instrumentation systems and building special instrumentation test rigs. Other aspects of the job include various calibration and test routines and the maintenance of machine tool equipment. You will also be involved in devising diagnostic procedures for the Section.

practical skills and the willingness to absorb and use new technology.

Salary will depend on experience and qualifications and we can also offer the benefits expected of a major international organisation.

Please write or telephone for an application form to:

**Mrs. P. M. Carvosso**  
**CADBURY SCHWEPPES LTD.**  
**1-10 Connaught Place, London W2 2EX**  
**Tel. No. 01-262 1212, ext. 345.**  
Interviews will be held in Birmingham.

For both vacancies you should be aged 25+, have ONC level qualifications in relevant disciplines, and five years' experience in electronic/instrumentation construction and development. You should have sound

a member of **Cadbury Schweppes**

(9404)

## A SENIOR TECHNICIAN

with Degree Allowance

is required for a fixed-term contract of one year to assist in research work. The person appointed should be prepared to travel.

Salary: £4773-£5073 including supplement per annum.

The person appointed will have at least an ONC or OND, but an HNC in digital electronics or telecommunications will be preferred. Experience in prototype construction and interpretation of developmental circuit drawings, and in the field of radio communications, microprocessors, and radio circuitry, both transmitters and receivers, will be an advantage. Projects currently on hand include the possibility of installing a prototype radio trunking system in Alaska; the development of an AC signalling system to be used over Post Office private circuits; assistance with ongoing research into the fields of telecommunications systems, and measurement and control techniques which utilise advanced methods of digital processing.

Application forms and further details available from the **Institute Secretary, Chelmer Institute of Higher Education, Victoria Road South, Chelmsford CM1 1LL (Telephone: Chelmsford 354491, Ext. 221).** Closing date 3rd August, 1979.

(9466)

## THE POLYTECHNIC OF CENTRAL LONDON Educational Development Unit TECHNICAL GRADE 6

Salary: £4509-£5283 inclusive of London Allowance.

An experienced Technician is required to supervise and maintain the Language Laboratories of the Polytechnic of Central London. The post will be based in the School of Languages at Euston Centre, where currently five of the Laboratories are sited, but will also include responsibility for two other laboratories in the School of Social Science and Business Studies.

The post is on the technical establishment of the E.D.U. which provides an audio visual service to the two schools.

Qualifications: HNC or Advanced City and Guilds Certificate, and approximately 9-10 years' experience.

Application form and further details from the **Establishment Officer, PCL, 309 Regent Street, London W1R 8AL. (Tel. 01-580 2020, ext. 212).**

(9439)

## ENGINEER/TECHNICIAN

We require a Junior Engineer to test electronic sub-assemblies for video and audio routing switches. The post would suit a college leaver wishing to join a small dynamic company in the broadcast industry. On the job training in state-of-the-art video, audio and control techniques will be given but applicants will be expected to possess a basic understanding of analogue and digital circuit techniques together with an enthusiastic attitude to work and ambition for self improvement.

Please Phone Graham Row on Bracknell 56969 for further information.

**pro-bel**  
LIMITED

TERRACE ROAD, BINFIELD, BRACKNELL  
BERKSHIRE RG12 5DN ENGLAND  
Telephone BRACKNELL (0344) 56969/56960

(8930)

## LBC radio MAINTENANCE SUPERVISOR

Due to expansion of the Company's activities, LBC Radio has a vacancy for an experienced maintenance supervisor, to work in our broadcasting studios just off Fleet Street.

Suitable applicants must be familiar with the maintenance and operation of broadcast and ancillary equipment, and have had experience in a broadcasting environment. They must also be able to work within, as well as supervise, the small maintenance team.

Shift working will be required from time to time, although the hours will normally take the form of 9-5, Monday to Friday.

The position attracts an excellent salary with good conditions and five weeks' annual holiday.

Applications to:

**Roger Francis**  
**Head of Engineering**  
**LBC Radio**  
**Communications House**  
**Gough Square**  
**London, EC4**

(9482)

# Electronics-up to £6900

## Have you an Electronics Qualification?

### Could you apply it to Scientific Instruments?

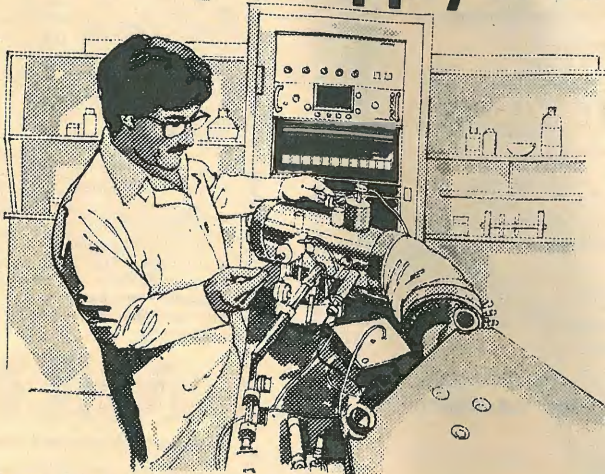

then this could be just the job you're looking for. It offers variety and real opportunity to apply both skill and design initiative to the solution of a whole range of technical problems of a one-off nature.

We are:

- \* a leading pharmaceutical company with world-wide interests.

You will:

- \* help to design, modify and where necessary repair advanced scientific instruments and computers in the Physical Chemistry Department.

Probably aged mid 20's, male or female, you should ideally have:

- \* formal training up to HNC or equivalent
- \* an interest in physics or chemistry
- \* sound practical experience of electronics.

We offer:

- \* a competitive salary dependent upon experience and ability
- \* day release opportunities for further study
- \* flextime working
- \* very modern facilities in a newly opened building.

Interested? Then please write, or telephone, for further details/application form to P. C. Anderson, Personnel Assistant, The Wellcome Research Laboratories, Langley Court, Beckenham, Kent BR3 3BS. Tel: 01-658 2211, ext. 218.



**Wellcome**



1979

**NT** NATIONAL THEATRE

## SOUND ENGINEER

Applications are invited for the above position in the National Theatre's Sound Department. The successful candidate will be responsible to the Sound Manager for equipment design, manufacture and maintenance. Applicants should have a full Electronic Engineer's qualification as well as some theatre background. Salary is negotiable.

Please apply in writing or telephone for an application form to David Roberts, Head of Establishments, National Theatre, Upper Ground, South Bank, London, SE1. Tel. 01-928 2033, Ext. 376.

(9411)

## RESEARCH ASSISTANT MICROPROCESSORS

FISONS have a vacancy in the Statistics Section at Levington Research Station near Ipswich for a Research Assistant to work on the application of mini computer (microprocessor) technology to scientific and industrial research projects. This work bridges the gap between electronics and computerised mathematical methods used in the control of chemical processes, automated laboratories and various agricultural systems.

Ideally, applicants should have at least "A" level Maths plus a keen practical interest in electronics and computing. Training in programming and other more advanced methods will be given. The section has PDPII, PET, ROCKWELL, INTEL AND ZILOG equipment. This is a rapidly developing field in which there are opportunities for advancement.

If this job appeals to you please write for an application form to: Mike Sharp, Divisional Personnel Officer, Fisons Limited, Fertilizer Division, Levington Research Station, Ipswich

**FISONS** FERTILIZER DIVISION



(9412)

The Development and Production Department of Cable & Wireless Ltd., situated in Southwark, has vacancies for

## Senior Development Engineers and Development Engineers

to take part in the continuing development of specialised telecommunications equipment for use in the Company system.

Successful candidates will be engaged in analogue or digital electronic design and microprocessor applications covering equipment for use on wideband telephone, data and telegraph transmission and switching systems plus some radio applications.

Applicants for the Senior Development Engineer positions should be Professional Engineers with an Engineering degree or equivalent qualification and have at least five years relevant development experience.

Applicants for the Development Engineer positions should be qualified at least to HNC or equivalent in the appropriate disciplines and have not less than three years relevant experience.

Salaries are on a rising scale, with yearly reviews, and the Company offer a wide range of benefits including a pension scheme, subsidised staff restaurant, and flexible working hours.

For an application form please contact:

Miss C. Morgan, Cable & Wireless Ltd.,  
Development & Production Department,  
114 Great Suffolk Street, London, SE1 0SG.

Telephone: 01-928 1901, ext. 236.



# Cable & Wireless

Helps the world communicate

(9473)



1979

Greengate House

## Studio Engineer

S01

Required to maintain and manage broadcast standard TV studio in the Faculty of Art and Design. The post involves working with academic staff and technicians, and also entails a large amount of contact with students. The applicant should possess a graduate or full professional qualification, and have at least five years' experience in broadcasts or closed circuit colour TV, studio engineering and management. Studio equipment includes IVS 2002, Hitachi FP1011B, Link SPG Link DA's, etc. Helical Scan VTR's. Salary scale ranging from £5553 to £5889 according to age, qualifications and experience.

For further details and application form please contact the Personnel Office, North East London Polytechnic, 109 The Grove, Stratford, E.15 or telephone 555 0811, ext. 32, quoting reference number A79/79. Closing date August 3, 1979.

# NELP

(9454)

## TECHNICAL STAFF REQUIRED

For a major recording studios in Central London. Experience desirable, coupled with a good knowledge of audio.

Please apply in writing to  
Box No. WW9485. (9485)

## DEVON AREA HEALTH AUTHORITY PLYMOUTH HEALTH DISTRICT Department of Medical Physics and Biomedical Engineering

# ELECTRONICS TECHNICIAN

required for interesting post in medical electronics. The person appointed will join a small team in a well-equipped laboratory. He or she will be responsible to a graduate electronics engineer for the maintenance of a wide range of patient-orientated electronic equipment. Development of special purpose systems is undertaken and safety and purchase decisions are made on new equipment.

The post offered on two grades, dependent on qualifications

(a) Medical Physics Technician IV for candidates with a City and Guilds Final Certificate in a relevant subject or its equivalent.

Salary scale M.P.T.IV £3,069 rising by 9 increments to £4,134 per annum. Increase pending.

(b) Medical Physics Technician III for candidates with a relevant ONC or HNC plus 3 years' relevant technical experience.

Salary scale M.P.T.III £3,744 rising by 7 increments to £4,788 per annum. Increase pending.

Hospital experience is not essential as further training will be given. The post involves some travel in South Devon and Cornwall and necessitates a current driving licence.

Application forms available from Mrs. W. E. Taylor, Senior Administrative Assistant, North Friary House, Greenbank Terrace, Plymouth, PL4 8QQ. Please enclose a stamped-addressed envelope. (9409)

# Radio Officers

If your trade or training involves radio operating and you are no more than 35 years of age, you qualify to be considered for a Radio Officer post with the Composite Signals Organisation.

A number of vacancies will be available in 1980 for suitably qualified candidates to be appointed as Trainee Radio Officers. Candidates must have had at least 2 years' radio operating experience or hold a PMG or MPT certificate.

On successful completion of 40 weeks' specialist training, appointees move to the Radio Officer Grade.

Trainee Radio Officers start on £2,605 at 19 up to £3,034 at 25 or over. After completion of specialist training Radio Officers start on £3,571 at 19 rising to £4,675 if you are 25 or over: then by 5 annual increments to £6,340 inclusive of shift and weekend allowances. Salaries at present under review.

## GCHQ

For further details apply to:

The Recruitment Officer  
Government Communications Headquarters  
Priors Road, Oakley  
Cheltenham, Glos. GL52 5AJ

Telephone: Cheltenham 21491 Ext. 2269 (9105)



# to all Computer Electronics Service Engineers...

# GET GOING!

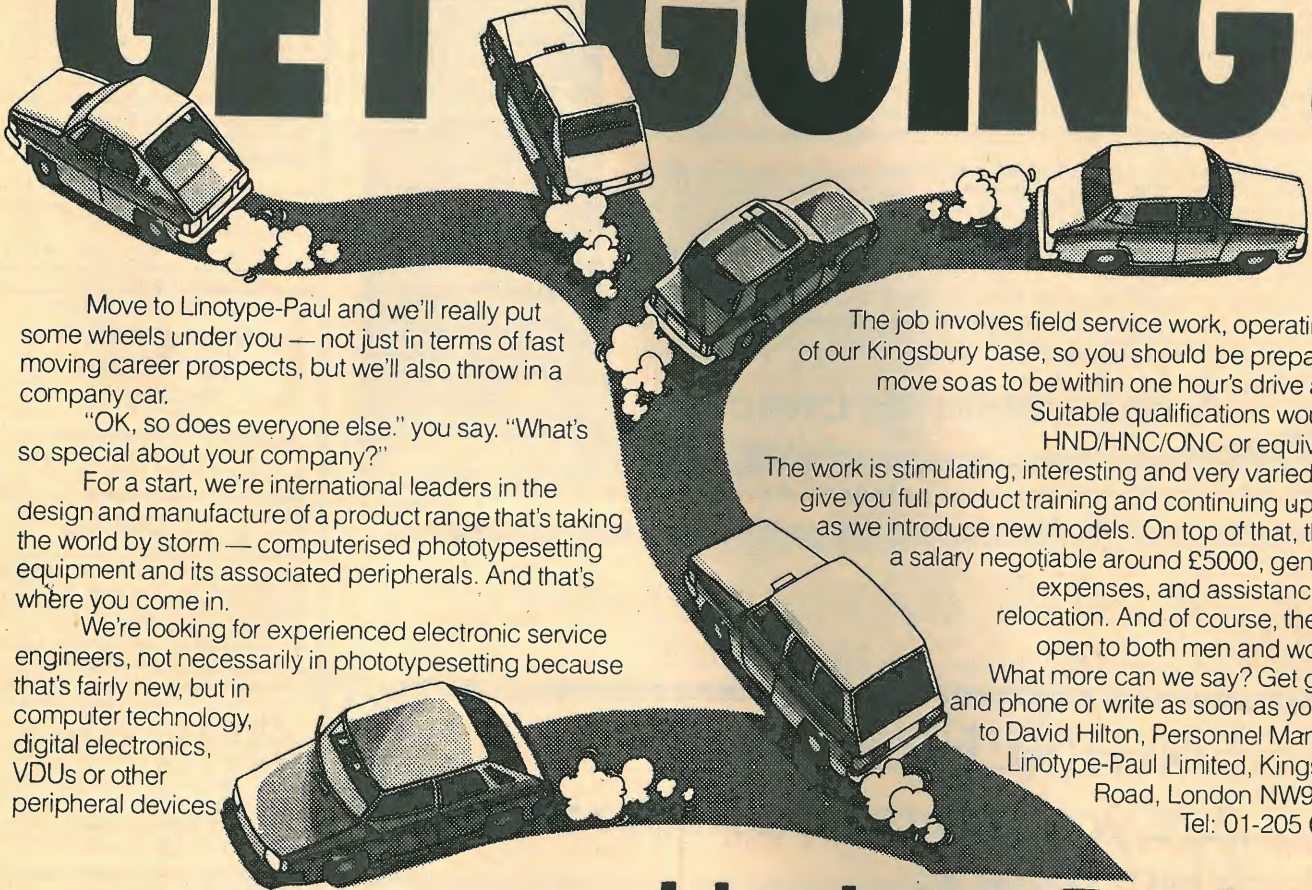

Move to Linotype-Paul and we'll really put some wheels under you — not just in terms of fast moving career prospects, but we'll also throw in a company car.

"OK, so does everyone else," you say. "What's so special about your company?"

For a start, we're international leaders in the design and manufacture of a product range that's taking the world by storm — computerised phototypesetting equipment and its associated peripherals. And that's where you come in.

We're looking for experienced electronic service engineers, not necessarily in phototypesetting because that's fairly new, but in computer technology, digital electronics, VDUs or other peripheral devices

The job involves field service work, operating out of our Kingsbury base, so you should be prepared to move so as to be within one hour's drive away.

Suitable qualifications would be HND/HNC/ONC or equivalent.

The work is stimulating, interesting and very varied. We'll give you full product training and continuing updates as we introduce new models. On top of that, there's a salary negotiable around £5000, generous expenses, and assistance with relocation. And of course, the job's open to both men and women.

What more can we say? Get going, and phone or write as soon as you can to David Hilton, Personnel Manager, Linotype-Paul Limited, Kingsbury Road, London NW9 8UT. Tel: 01-205 0123.

## Linotype-Paul

(9488)

### AUDIO + VIDEO LTD. VIDEO & TELECINE OPERATORS



required for Ampex and RCA Quad VTRs and Sintel and RCA. Telecine Channels for both our day and night shifts. Persons with requisite television engineering background may be considered for training positions.

Contact:

**Peter Horton**  
Audio + Video Limited  
48 Charlotte Street, London W1P 1LX  
Telephone: 01-580 7161

(9261)

### COME TO THE SUNNY SOUTH COAST

We require the following personnel in the areas: Hampshire, Dorset, Sussex, Somerset, Wiltshire and Berkshire.

ATE Engineers  
Control Engineers  
Electronic Design Engineers  
IC Development Engineers  
Production Engineers  
Microprocessor Engineers  
Sales Engineers  
Software Specialists  
System Design Engineers  
Test Engineers

Buyers  
Electro Mechanical/  
PCB Draughtsmen  
Instrumentation Engineers  
Physicists  
Microwave Engineers  
Service Engineers  
Software Programmers  
Technical Authors  
Q.A. Engineers

All these positions offer excellent salaries and in most cases relocation expenses.

Please write or ring: **CBS Appointments, 224 Old Christchurch Road, Bournemouth, Bournemouth 292155.** (24-hour Ansaphone Service—Agy.).

(9416)

### VERSATILE? GOOD

CSC (UK) Limited are seeking an electronics engineer who could enthusiastically approach all aspects of our business.

Duties would include:

- ★ Organisation and participation of electronic exhibitions
- ★ Technical back-up for our sales department
- ★ Demonstrations
- ★ Some service and repair work on our products
- ★ Involvement in advertising and marketing

We are a small but rapidly expanding subsidiary of a large American Corporation situated in new premises in the pleasant market town of Saffron Walden. In return for the required skills, we can guarantee endless variety within the job, an extremely convivial working atmosphere, and the benefits, including use of a car, normally attributed to a company of our reputation. Salary negotiable circa £5,000.

Please write or telephone for an application form to:

**Mrs. Sally Rossides**  
CSC (UK) Ltd.  
Shire Hill Industrial Estate  
Saffron Walden  
Essex

Tel. (0799) 21682

(9471)



## TV/AUDIO SERVICE ENGINEERS

**UP TO £5,500 BASIC + OVERTIME + ANNUAL BONUS**

An extensive expansion programme has created additional vacancies for fully experienced Service Engineers to work in our modern, well-equipped Service Department in Watford.

Qualifications to City & Guilds Level together with recent experience of servicing sophisticated Audio and TV is essential. Full training on our V.H.S. format Video Recorders and Projection CTVs will be given to the successful candidates.

In addition to a very high basic salary, the benefits package includes an annual bonus, around 10%, three weeks' holiday rising to four weeks, free Life Assurance and a contributory Pension Scheme, plus staff discounts.

Prospects for promotion in this young and rapidly expanding Company are excellent.

Please telephone Nick Dosanjh, Service Manager, on  
Watford 40566. Mitsubishi Electric (U.K.) Ltd.  
Otterspool Way, Watford, Herts.



## MITSUBISHI ELECTRIC



(9462)

## WANTED R.F. ENGINEER

A small group of companies in the Electronic/Electrical business based in South-East London require an Engineer with experience in R.F. power supplies and digital and analogue electronics. This is a growth position and while the successful applicant will initially travel throughout Europe servicing equipment he would be expected to grow into a managerial position. Some equipment modification and design work will also be involved. An initial training period will be spent in the U.S.A. This is an ideal position for someone who is disenchanted with large companies and wants to grow with and exert an influence on the group whose main involvement is supplying to the silicon chip production industry. Salary requirements are unlikely to be a problem.

Please send an outline of educational and work experience to Box No. WW9440. (9440)

## BRIGHTON POLYTECHNIC LEARNING RESOURCES

### ELECTRONIC ENGINEER

**£4245-£5073 per annum**

To work with a team of experienced engineers and technicians developing audio-visual facilities throughout the Polytechnic. The wide range of systems developments include sound and colour tv production, video recording and editing to near broadcast standards. The Electronic Engineer will apply digital and analogue techniques to develop and install new equipment, upgrade existing facilities, and assist with its maintenance. Formal training to degree, HNC or equivalent standard will be expected, and experience with electronic design and construction, preferably including television.

Further details and application form from Personnel Officer, Brighton Polytechnic, Moulsecoomb, Brighton, BN2 4GJ. Tel: Brighton 693655, Ext. 2536.

Closing date: July 31, 1979. (9413)

## THE UNIVERSITY OF ASTON IN BIRMINGHAM COMPUTER CENTRE ELECTRONICS TECHNICIAN

A technician over 21 years of age is required to assist in the computing laboratories and workshop. The work includes the design, development and maintenance of digital electronic equipment. There are excellent opportunities to learn about microprocessor technology, for which suitable training will be provided. Applicants should possess Higher National or similar qualifications. Salary will be in the range of £3222 to £3708 per annum.

Application forms are available from Mr C. J. Simpson, Staffing Department, The University of Aston in Birmingham, Gosta Graen, Birmingham B4 7ET, quoting reference number L/949/WW. (9449)

## ROYAL FREE HOSPITAL MEDICAL PHYSICS TECHNICIAN II OR III

for maintenance of EMI CT Brain Scanner, Thermography, Radiotherapy and other equipment. Qualifications: HNC or equivalent, with Electronics. Salary on scale: Medical Physics Technician II: £4824 p.a. to £5964 p.a. (increase pending). Medical Physics Technician III: £4098 p.a. to £5142 p.a. (increase pending).

All enquiries to Personnel Department, Royal Free Hospital, Pond Street, N.W.3. Tel. 01-794 0500, ext. 4288. Quote Ref. 0763. (9460)

## ENGINEERS

### Are you interested in the new Electronics?

At Rank Xerox we are doing much more than talking about microprocessors. Our current machines are microprocessor-based and our Parent Company, Xerox, has set up a modern LSI design and diffusion facility to keep us in the forefront of technology by developing the next generation of semiconductor components. We now need Engineers to join our Electronic Component Function at Welwyn to help guide us towards the next generation of electronic components. These cover the range from microprocessors, memories and optoelectronic devices through to resistors, capacitors and transformers. If you are interested in getting into the mainstream come and see us. Our prime require-

ment is that you have the interest to learn about this fast growing area of electronic component engineering. Even if you are currently working in electronic design this is an opportunity to obtain an in-depth knowledge of electronic components, and how to build-in reliability.

There are vacancies for both senior and junior positions, for candidates of either sex. Please phone Jim Collingham on 0908 312870 for an application form and company information, or write to him at Rank Xerox Engineering Group, Monks Way, Linford Wood, Milton Keynes MK14 6LA.

In the evening and at weekends an answering service is available.

9424

# RANK XEROX

ENGINEERING GROUP

**CAPITAL APPTS.**

**FREE LISTS**

101 Design/Development  
and Test Jobs  
Permanent and Contract  
**To £6,000**

(8782)

29 Windmill St.  
London, W.1.  
637 5551 day, 636 9659 eve.

**ELECTRONICS ENGINEERS** to £14,000, microwave design to £7 p.h., microwave test to £5 p.h., digital, analogue, communications and computer engineers, design/test/service for long (2 years) lucrative contracts at many sites throughout Southern England. Cliveden Consultants, 99 St Leonards Road, Windsor (07535) 57818 answer phone. (9470)

**THE NATIONAL AUDIO  
VISUAL AIDS CENTRE**  
254 Belsize Road, London, N.W.6  
requires an experienced  
**ELECTRONICS  
TECHNICIAN/ENGINEER**

Duties include: maintaining the Centre's video and sound studios, some production work during audio-visual courses and television servicing. Salary up to £5000. Friendly working atmosphere. For further details contact:  
**Jenny Suthrell, Training Dept.**  
624 8812 (9458)



## Do You See YOUR Future in Broadcasting ?

We can offer you a career with real job interest.

- If you'd like worldwide travel, customer contact and a high level of job responsibility.
- If you're self-motivated and able to work (after equipment training) on complex broadcast equipment with the minimum of supervision.
- If you're dissatisfied with the routine and predictability of your job, and looking for variety and a strong element of problem solving.

At Pye TVT we develop, manufacture and sell professional broadcast equipment, with the emphasis on export. We're looking for enthusiastic engineers at all levels and in all areas, from development of studio equipment or transmitters through systems testing to planning and after sales activities.

Telephone Alison Millar on Cambridge (0223) 45115 for an application form and further details.

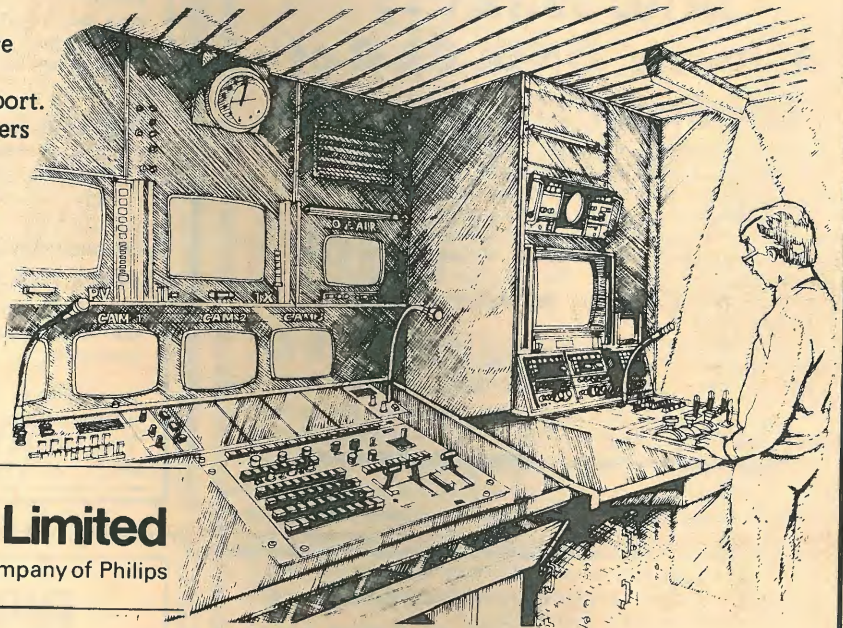

**Pye TVT Limited**  
The Broadcast Company of Philips

9429

### Medical Physics Technicians (Electronics)

**Your experience could lead to a happy experience in Hampstead . . .**

working at the Royal Free Hospital, Britain's newest and largest teaching Hospital.

We offer an experienced Technician (Grade IV — Electronics) the chance of working on the design and construction of specialised electronic equipment, which will be used in both research and clinical applications. This is an excellent opportunity for a man or woman who holds a City and Guilds Final Technological Certificate in appropriate subjects and ideally has experience in the use of both analogue and digital circuit techniques.

You will be working with four other Technicians and, apart from your design work, you will be expected to carry out maintenance on a wide range of commercial apparatus within our purpose-built and well-equipped workshop.

In addition to the salary of £4098-£5142 p.a. (including all allowances — starting point depending on qualifications and experience), we offer a first-class working environment and a superb choice of facilities which include a good staff restaurant, a social club and a brand new recreation and leisure centre with a large sports hall, swimming pool and bar.

**If you'd like to find out more, write to the Personnel Department, The Royal Free Hospital, Pond Street, NW3, or telephone 01-794-0500, ext. 4286. Please quote reference 0761.**

**Camden & Islington Area Health Authority (T)**

(9443)

### Salford Area Health Authority (Teaching)

(University of Manchester School of Medicine)

**HOPE HOSPITAL**

Eccles Old Road  
SALFORD  
M6 8HD

### MEDICAL PHYSICS TECHNICIAN

(Electronics) GRADE III

Applications are invited from suitably qualified and experienced electronics technicians for a post in the Medical Physics Department at Hope Hospital subject to rapid expansion.

Duties will include the repair, planned maintenance and safety checking of patient orientated and clinical laboratory equipment throughout the Salford Area. Modification and development of instrumentation for clinical and research use will also be involved.

Applicants should hold ONC or HNC and have a minimum of three years' electronics experience since qualifying.

Salary scales including supplements £3744-£4788 (increase pending). Application forms from the Sector Personnel Officer, Hope Hospital. Further information if necessary from Dr F. Cave, Senior Physicist, Hope Hospital.

(9450)



**Make  
your  
hobby  
more  
Constructive  
and  
Profitable!**

**NOW WHAT —  
'A' levels, OND, C&G of  
London Institute . . . ?**

Are you thinking about a career in Electronics? If you have Maths, Physics and English Language "O" levels then why not consider our Technician Engineer Certificate Course. This 2-year full-time course gives you a qualification recognised by industry — the Full Technological Certificate — and also provides an entrance qualification for a degree course. Specialisations include Computer Engineering (including Microprocessors), Sound Studio Engineering and Radar and Microwaves.

Write to the Secretary, Department of Electronic and Communications Engineering, Polytechnic of North London, Holloway Road, London N7 8DB, for details.

The Polytechnic of North London

(9406)

# ELECTROSONIC

## PRODUCTION TEST / FAULT-FINDING ENGINEERS



c. £4,500

Electrosonic Ltd. is a leading company in the expanding fields of lighting control equipment and audio visual systems.

The Company, based at Charlton within easy reach of rural Kent, offers an attractive working environment and excellent conditions of employment.

**PRODUCTION TEST/FAULT-FINDING ENGINEERS:** Engineers are required for a small batch production line and system testing/fault finding on a wide range of electronic equipment employing some of the latest digital, analogue and audio circuitry.

Applicants should have either experience in the testing/fault finding of electronic equipment or academic qualifications to HNC or degree level. Suitable applicants will find opportunities for advancement to higher paid technical support positions in the Company's software or hardware design teams and project engineering section after a period in the Test Department.

**SERVICE ENGINEERS/HIRE DEPT. ENGINEERS:** Engineers are also required for fault finding and presentation work on the above equipment both in — company and on customer's premises.

Applications in writing, giving a resume of career to date, addressed to: **P. W. Way, Production Director, ELECTROSONIC LTD., 815 Woolwich Road, LONDON, SE7 8LT. Tel: 01-855 1101.**

(9410)

Gallenkamp is a leading company in the laboratory equipment field, and a member of the Fisons Group.

We require two young

## Electrical Test Engineers

to fill posts in our expanding  
Product Assurance Section

One post will involve the examination in detail of the apparatus which we sell and the specification of any modifications necessary to ensure that it meets our quality assurance requirements and United Kingdom and foreign electrical safety specifications.

Experience of electrical testing is essential and experience of testing to BS3456 or to similar international specifications would be an advantage.

The other post will primarily involve the measurement of radio interference levels and the specification of suitable suppression systems. Experience of electrical testing is essential and experience with BS800 or similar international specifications would be an advantage.

The work is in a modern, well equipped laboratory at our Head Office building near Moorgate Tube and Liverpool Street stations.

A good starting salary is offered, plus four weeks' holiday, subsidised staff restaurant and other benefits associated with a large company.

Please phone 01-247 3211 ext. 285 or write to Sarah Bramble, Recruitment Officer, A. Gallenkamp & Co. Ltd., P.O. Box 290, Technico House, Christopher Street, London EC2P 2ER.

# Gallenkamp

(9478)

## DID MAGGIE LET YOU HAVE IT?

**OF COURSE SHE DIDN'T**

— IF YOU NEED IT —

**Money in your pocket look at these**

**Applications Engineer** for London based American Co. Manufacturing MSI — LSI integrated circuits. Good understanding of monolithic circuit functions, bit slice machines and 16 bit microprocessors. Salary could be up to £10,000 + car.

**Design Development Engineers** for a distributed intelligence system. The out stations of which are novel low powered, hand-held computers. These are interrogated by a central computer. Berks to £9,000.

**Senior Engineers** for Technical Management of £120,000 projects i.e. Hardware/Software aspects of a real time control system based on mini computers and state of the art Microprocessors. Berks to £8000.

**Logic Designers** for specification and design of Microprocessor systems and peripheral controllers using custom built LSI and MSI. Scotland. Excellent salary.

**Technological Think Tank Boffs**, i.e. pretty authoritative engineers to augment a team who have produced some of the most advanced satellite communications and radar systems of the century. To £10,000 for expertise in either computer controlled message switching, servo systems, Microwave systems or VHF/UHF equipment. Berks.

**Computer Engineers** for either technical support, permanent site, field service or systems test. Vacancies throughout UK. Salaries vary enormously but up to £17,000 for the 'Travel Anywhere' IBM 360/370 Variety.

**Electronic Blokes** — anyone with expertise and/or qualifications for literally thousands of unpublished vacancies.

For further details, please contact:

## Charles Airey Associates

"PROBABLY THE BEST KNOWN SUPPLIER OF ELECTRONICS ENGINEERS IN THE COUNTRY"  
FINANCIAL TIMES

155 KNIGHTSBRIDGE, LONDON, SW1. TEL: 01-581 0286

(9469)

## ELECTRONICS ENGINEERS

**c. £6,000 + BONUS + FREE MEALS**

Due to further expansion and internal promotions we urgently require Senior Test Engineers.

We rent a wide range of sophisticated electronic test equipment, including Microprocessor based instruments to companies of international repute.

Applicants must have a good all round knowledge of electronic test equipment. Engineers with experience of the following equipment types are particularly invited to apply.

R.F. Test Equipment including Spectrum Analysers.

Oscilloscope

Digital Voltmeters

Acoustic Equipment (B & K, C.E.L. etc).

Whilst academic qualifications to H.N.C. are desirable, emphasis will be placed upon ability. Generally suitable applicants will have had at least three years' directly related experience.

The vacancies are internal and based at our modern fully equipped premises in N.W. London.

The test equipment we stock is the finest available in the world and our engineers always have available the correct instruments to repair and calibrate these equipments.

Write or telephone to:

**Bernard Ellett**

**LIVINGSTON HIRE LTD.**

**Shirley House, 27 Camden Road, London NW1 9NR**

**Tel. 01-267 3262**

(9445)

## TELEVISION BROADCAST ENGINEER

We require an engineer to join the staff of a rapidly expanding video cassette duplicating facility. The candidate should have a minimum of three years' experience in broadcast television with specific knowledge of Quad and Helical Scan, VTRs, Flying Spot Telecines and related systems.

The candidate should be qualified to HNC, Full Technical Certificate, Degree or equivalent qualification. The job reports to the Technical Manager and the successful candidate will be responsible for maintenance of equipment, supervision of technical trainees and the installation of additional facilities.

High salary (level dependent upon experience and qualifications) plus normal benefits.

Please reply in confidence to:

**Mr. Tony Owers**

**PERSONNEL & ELECTRONICS LTD.**

Triumph House, 1096 Uxbridge Road, Hayes, Middlesex. UB4 8QH, England  
Telephone: 01-573 8333 Telex: 934271

## Professional Careers in Electronics

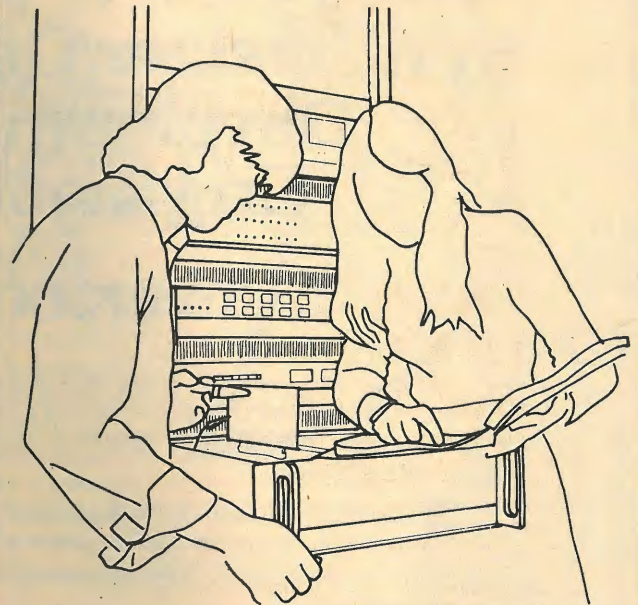

### All the others are measured by us...

At Marconi Instruments we ensure that the very best of innovative design is used on our range of communications test instruments and A.T.E. We have a number of interesting opportunities in our Design, Production and Service Departments and we can offer attractive salaries, productivity bonus, pension and sick pay schemes together with help over relocation. If you are interested to hear more, please fill in the following details:-

Name \_\_\_\_\_ Age \_\_\_\_\_

Address \_\_\_\_\_

Telephone Work/Home (if convenient) \_\_\_\_\_

Years of experience 0-1 1-3 3-6 Over 6

Present salary £2,500- £3,500- £4,500- over  
 3,500 4,500 5,500 £5,500

Qualifications None C & G HNC Degree

Present job \_\_\_\_\_

Return this coupon to John Prodger, Marconi Instruments Limited, FREEPOST, St. Albans, Herts, AL4 0BR. Tel: St Albans 59292

**Marconi  
Instruments**

A GEC MARCONI ELECTRONICS COMPANY

(9200)

**SITUATIONS VACANT**

# Radio Systems Synthesizer/Oscillator Development Engineers

## To £7000

A closely knit team of highly professional engineers are currently developing a new radio systems project for an International Electronics Group who have a reputation for being leaders in advanced technology.

Due to the expansion of this development programme, our client now wishes to appoint two engineers, for radio frequency design and to work on the fundamental applications of frequency synthesis circuits.

These career positions will attract creative, self-motivated individuals who offer appropriate qualifications, sound practical experience and a keen interest in this type of work.

The Company provides a first class remuneration package, excellent benefits and generous assistance with relocation, where necessary, to an attractive area 25 miles North of London.

For further details of these rewarding opportunities to enhance your present skills and progress in the world of advanced technology, please telephone or write to James T. Hayes quoting Ref. 2439.



**Lloyd Chapman  
Associates**

123, New Bond Street, London W1Y 0HR 01-499 7761

(9453)

**CHARING CROSS HOSPITAL  
MEDICAL SCHOOL**

(University of London)

**ELECTRONICS  
TECHNICIAN**

DEPARTMENT OF PHYSIOLOGY

Applications are invited for the post of Technician to work on Scientific Electronic Equipment used in teaching and research. The job combines the tasks of fault finding and repair (experience of which would be advantageous) with design, construction and development of new equipment.

The Department of Physiology is located in the laboratory block of the New Charing Cross Hospital. The successful applicant will be eligible for membership of the social club, which includes a swimming pool, squash courts and bar amongst its facilities.

Applicants must be qualified to HNC or Degree Standard or equivalent.

The salary will be on the incremental Whitley Scales which are under review (currently £3,261-£4,680 plus £354 London Weighting).

Applications on forms obtainable from the Secretary, Charing Cross Hospital Medical School, The Reynolds Building, St. Dunstan's Road, London W6 8RP. Tel: 01-748 2040, ext. 2067, quoting Ref. 023, by 6th August, 1979.

(9484)

**OPPORTUNITIES  
IN ELECTRONICS**

Broaden your experience by joining our team responsible for electronic support for a large chemistry research department. We tackle anything from D.C. — microwave and tiny microprocessors to massive electromagnets. Interest and initiative are more important than experience as training and the opportunities for further study are available. Salary (Technician Grade 3) in range £3455-£3860 inc. of London Weighting. Five weeks' annual paid holiday plus statutory and customary days giving one week at Christmas and Easter. Application form from Personnel Officer (Technical Staff CE24), University College London, Gower Street, London WC1E 6BT.

(9455)



**CAPITAL  
APPOINTMENTS LTD.**

**FREE JOBS LIST**

for  
**FIELD SERVICE ENGINEERS**  
BASIC SALARIES TO  
£7,000 + CAR

(8781)

30 Windmill Street, London, W1  
01-637 5551

**ARTICLES FOR SALE**

**NOSTALGIA COLLECTING**  
**THE VINTAGE  
WIRELESS COMPANY**  
1920 to 1950

Receivers, valves, components, service data, historical research, books, magazines, repairs and restorations. A complete service for the collector and enthusiast of vintage radio.

S.A.E. with enquiry and for monthly newsheet

**THE VINTAGE WIRELESS COMPANY**  
64 Broad Street, Staple Hill, Bristol BS16 5NL

Tel: Bristol 565472 (8966)



Private enquiries, send 13p in stamps for brochure

**THE QUARTZ CRYSTAL CO. LTD.**

Q.C.C. WORKS, WELLINGTON CRESCENT  
NEW MALDEN, SURREY 01-942 0334 & 2988

8493

**1,000,000 PLUS**

S.P.M. REED SWITCHES  
10,000 — £100 + Car. + VAT  
50,000 — £450 + Car. + VAT  
100,000 — £800 + Car. + VAT  
250,000 — Upwards — Offers  
Counted by weight  
S.A.E. for sample

**ELEY ELECTRONICS**  
100/104 Beatrice Road  
Leicester, England

(9417)

Complete repair information, any requested T.V. £5 (with diagrams £5.50). Any service sheet requested for £1 plus S.A.E. S.A.E. brings newsletter and special offers — service sheets from 50p, bargain vouchers.

**Unique Publications, Aus.(V), 76 Church Street, Larkhall, Lanarkshire.**

**TECHNALOGICS CPG6RF** colour bar and pattern generator. UHF Ae 1/P, new colour power battery design, 8 descending PAL colour bars crosshatch, dots, etc., full kit incl. case, etc., £36. Built £54. PG6RF kit £21.50, built £28. Add-on colour bar unit C8 in kit £15.50, built £22 plus £1 p&p, 8% V.A.T. Mail order from Technalogs, Dept WW, 8 Egerton St., Liverpool L8 7LY.

**WANTED:** Record disc cutting machine, working or not but complete. Tel: Melton Mowbray 4951 or 4475, Leicestershire. (9468)

**AERIAL BOOSTERS** improve weak VHF radio and television, price £5 s&e for leaflets. Electronic Mail-order Ltd, Ramsbottom, Bury.

**FOR SALE**

**24 (No.) Transmitters.** Teleprinter Model 75/K3 with 3 PRS.

**15 (No.) Receivers.** Teleprinter Model 75R.

**3 (No.) Trans/Perforators.** Teleprinter Model 75/RP/K3.

Offers invited. Tenders obtainable from British Rail, Director of Supply, Railway Technical Centre, London Road, Derby. Ref. 53/230/232T/085. (9487)

**T.V. TUBE REBUILDING.** Complete plant, equipment, supplies and training. If you can afford the best contact Western-Whybrow Engineering. Tel. 073 676 2265. (8048)

**TURN YOUR SURPLUS** Capacitors, transistors, etc., into cash. Contact **COLES-HARDING & Co.**, 103 South Brink, Wisbech, Cambs. 0945-4188. Immediate settlement. We also welcome the opportunity to quote for complete factory clearance. (7439)

**A & M**

BUY & SELL

**USED COMPUTERS AND PERIPHERALS**

Telephone:  
**048-67 80203**

(9480)

**SITUATIONS VACANT**

# OUR TEST ENGINEERS KEEP THE WORLD TALKING

Marconi Communications designs and manufactures advanced communication systems for an almost infinite variety of applications - from radio telephones to satellite systems, from outside broadcasting to the Tropospheric Scatter systems linking North Sea oil rigs with the mainland.

Customers know they can rely on their Marconi systems to keep them in touch. Our Test Engineers, male/female, obviously play an important role in the reliability of all our equipment, testing our complex digital and analogue systems throughout every stage of production.

In the process of fault location and rectification, they are often called upon to initiate design changes; and it is they who conduct the final commissioning tests of complete systems - however large - prior to installation. We provide them with the very latest test equipment, and offer them excellent scope for both career development and diversification. As an expanding international company, individual advancement is one of our prime considerations. We have a constant need for new management potential, and opportunities for advancement are excellent. In addition to highly competitive salaries we offer a full range of benefits,

which include first-class sports and social facilities; and relocation assistance will be offered wherever appropriate.

So, as long as you can bring us some recognised qualification - an HND, City & Guilds certificates, a student apprenticeship or training in the Forces - supported by some proven testing experience, come and help us keep the world talking.

**Please telephone Roy Humphries on Chelmsford (0245) 353221. Alternatively, write to him at Marconi Communication Systems Ltd., New Street, Chelmsford, Essex.**



*A GEC-Marconi Electronics Company* (9467)

**ARTICLES FOR SALE**

**THE SCIENTIFIC WIRE COMPANY**  
PO Box 30, London, E.4

**ENAMELLED COPPER WIRE**

| SWG      | 1lb.  | 5oz. | 4oz. | 2oz. |
|----------|-------|------|------|------|
| 10 to 19 | 2.65  | 1.45 | .75  | .60  |
| 20 to 29 | 2.85  | 1.65 | .90  | .70  |
| 30 to 34 | 3.05  | 1.75 | 1.00 | .75  |
| 30 to 40 | 3.40  | 1.95 | 1.15 | .84  |
| 41 to 43 | 4.55  | 2.55 | 1.95 | 1.30 |
| 44 to 46 | 5.05  | 3.05 | 2.15 | 1.70 |
| 47       | 8.00  | 5.00 | 3.00 | 1.80 |
| 48       | 15.00 | 9.00 | 6.00 | 3.30 |

**SILVER PLATED COPPER WIRE**

|         |      |      |      |      |
|---------|------|------|------|------|
| 14 & 16 | 4.50 | 2.25 | 1.44 | .90  |
| 20 & 22 | 5.00 | 2.85 | 1.74 | 1.06 |
| 24 & 26 | 5.70 | 3.31 | 2.00 | 1.22 |
| 28 & 30 | 6.67 | 3.86 | 2.35 | 1.44 |

Prices include P&P and VAT  
SAE brings list of copper & resistance Wires  
Dealer Enquiries Invited (9063)

**ONE INCH VIDEO TAPE** editing system, two Ampex 7800 Recorders and Zoom TV Automated Edit Control. Offers: Audio Visual Centre, University of Hull, Cottingham Road, Hull, N. Humberside. Tel. No. 0482 497239. (9451)

**CASTONS** 5in dia wheel, chrome plated forks, swivel, brand new, made by British castors, screw or expansive fitting, each £2.50 plus 8 per cent VAT and postage. SOLARTRON 7040 D.V.M., mint, £150 'Q' Services. Electronic (Camberley) Ltd., 29 Lawford Crescent, Yateley, Camberley, Surrey (0252) 871048. (9423)

**LAB CLEARANCE:** Signal Generators; Bridges; Waveform, transistor analysers; calibrators; standards; millivoltmeters; dynamometers; KW meters; oscilloscopes; recorders; Thermal, sweep, low distortion true RMS, audio FR, deviation. Tel. 040-376236. (8250)

**FOR SALE:** 24 band receiver RF8000 Super National Panasonic, unused, shop soiled only, value £2,000, will let go for £1,200. V.C.R. N.1700. Used, new cost £760, will let go for £450. Reusable 1 hour tapes available at £5 each. - Contact Morris 66455 (0223) office hours, 46274 after office hours. (9464)

**INVERTERS**  
High quality DC-AC. Also "no break" (2ms) static switch, 19" rack. Auto Charger.

**COMPUTER POWER SYSTEMS**  
Interport Mains-Store Ltd.  
POB 51, London W11 3BZ  
Tel: 01-727 7042 or 0225 310916 (9101)

2 x 24 volt base stations complete.  
1 channel 8, 726.8 MHz with 13 paging units.  
1 channel 13, 832.4 MHz with 15 paging units.

28 personal charging units.  
Various spares for base stations.  
Equipment by Multitone Ltd. was used for calling out Fire Brigade Personnel and could possibly be adapted for use as a paging system.

**Tender forms from County Supplies Officer, E.C.C. Supplies Department, 2 Beaufort Road, Dukes Park Industrial Estate, Chelmsford CM2 6PS.** (9428)

**SCREEN PRINT SYSTEM.** Prints labels, circuit boards, dials, front panels. Ready to operate, willing to train operator. About £200. J. Waller, Dunstable Street, Ampt-hill, Beds. 0525 402279.

**7400 SERIES TTL** ex eqpt g'teed. 7400/01/02/04/10/20/30 at 7p. 7451/102 at 8p. 11/13/74/93/107 at 20p. 150/154/163 at 50p. S. Dealer, 69 Bonnymuir Pl, Aberdeen. P&P 20p. (9481)

**1 INCH VIDICON**, separate mesh, professional grade, unused, with data, £15. - Telephone 01-854 0683. (9465)

**HP97 CALCULATOR** plus extra magnetic cards, Thermal paper and programmes, £285. - Ring 01-554 3360. (9421)

**XTAL FILTERS.** Cathodeon BP4742-00 25kHz channel spacing, 910 ohms/26pf, 10.7MHz ±7.5kHz pass band. Brand new. £18.00 each plus VAT and post. Domshelcon Ltd., South Drive, Littleton, Winchester. (0962-880878). (9436)

**9 UNIT 7 SEGMENT CALCULATOR DISPLAYS** 45p. Teleprinter 54s £35, and 75s £50. Spares etc. MKS, 27 Upper Stone Street, Maidstone, Kent. (9442)

SITUATIONS VACANT

Marconi Mobile Radio are putting out a call for Development/Systems Engineers and Test Engineers ...so put in a call to us

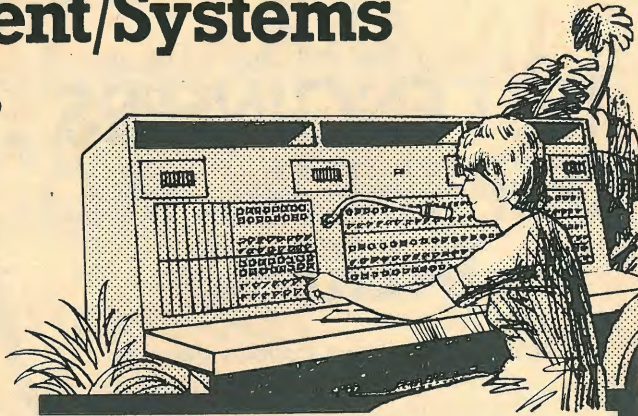

Marconi Mobile Radio are a leading manufacturer of radio telephone equipment which is used extensively throughout commerce, industry and the public services. With continuing expansion of our business, both in the UK and overseas, we are looking for additional experienced Engineers to join teams working on the development of advanced AM/FM, VHF/UHF mobile radio equipment and systems.

So why not put in a call to us and we'll make an appointment to discuss the excellent opportunities available to experienced men and women at our site in Baddow, near Chelmsford. Right now we need:

Development/Systems Engineers

Qualified to at least HNC or equivalent and possessing several years experience of radio communications and/or electronic development engineering.

Test Engineers

To work on the testing and fault location of a wide range of complex digital and analogue systems at all levels of production.

Applicants should be qualified, ideally, to HNC or equivalent, although those with relevant H.M.Forces experience would be particularly welcome.

So, if you would like to know more about these excellent opportunities, please write immediately to Terry Ford, Marconi Communication Systems Ltd. New Street, Chelmsford, Essex Telephone Chelmsford (0245) 353221



MARCONI COMMUNICATION SYSTEMS A GEC-Marconi Electronics Company

ARTICLES FOR SALE

EXCLUSIVE OFFER

Table with columns: Ref, H", Width", Depth", Price. Lists rack mounting cabinets with prices ranging from £10.00 to £70.00.

Over 60 types available from 12" to 90" high. Also twins, triples and consoles. Above are only a few types. Please send for full list.

AUDIO AND INSTRUMENTATION-TAPE RECORDER-REPRODUCERS

- List of audio equipment including Ferragraph, Ampex, Plessey, and Ampex models with their prices.

Prices of above £70 to £500 Also Transport Decks only available

We have a large quantity of "bits and pieces" we cannot list - please send us your requirements, we can probably help - all enquiries answered.

All our aerial equipment is professional MOD quality

- Extensive list of aerial equipment including Telesonic, Hell, Lankart, Bendix, Mullard, and various other models with prices.

ARTICLES FOR SALE

SURPLUS TO INDUSTRIAL REQUIREMENTS

- List of surplus industrial components like potentiometers, relays, solenoids, etc. with prices.

BLORE-BARTON LIMITED Reedham House, Burnham Bucks. (9420)

ANTIQUE MACHINES + CURIOSITIES

The world's first high quality glossy magazine devoted to mechanical and other collectables and curiosities of all types. Fifty-six page first issue out now price 95p including 16 pages in full colour and the unique collectors card index.

(9357)

CAPITAL APPTS. FREE LISTS Design/Development and Test Jobs All areas To £7,500 p.a. (9419) 637 5551 day, 636 9659 eve. 29, Windmill St. London, W.1.

ARTICLES FOR SALE TRANSFORMER PROBLEMS? 1VA-1KVA Prototypes in 7-10 days. Phone Vince Sellar on 06076-66716. TRENT TRANSFORMERS LTD. 26 Derby Road Long Eaton, Nottingham (8363)

MANUALS We have a quantity of Technical Manuals of Electronic Equipment, not photostats, 1940 to 1960, British and American. No lists. Enquiries invited. PLEASE ADD CARRIAGE AND V.A.T. P. HARRIS ORGANFORD, DORSET, BH16 6BR BOURNFORD MOUTH (0202) 765051 (82918)

## SITUATIONS VACANT

# ELECTRONIC TECHNICIANS

We have vacancies at the BBC Equipment Department for Senior Laboratory Technicians and Laboratory Technicians to make functional and test to specification, newly manufactured broadcast equipment to BBC design.

## SENIOR LABORATORY TECHNICIANS

Salary between £4630 and £5020, rising to £6295 per annum.

Successful candidates will have at least 3 years experience and be qualified to HNC or C&G F.T.C. (Telecoms or Electronics) level.

## LABORATORY TECHNICIANS

Salary between £4185 and £4535, rising to £5060 per annum.

Successful candidates, male or female, will have had 1-2 years' experience and at least O.N.C. or Final C&G (Telecoms or Electronics). Candidates less qualified or experienced may start at a junior grade.

The work is based at Chiswick with good accessibility by car or public transport, with staff restaurant and car parking facilities available.

For application forms, ring 01-994 8541 and ask for Mr. P. W. Green, or write to BBC Equipment Department, Power Road, Chiswick, London W4 5PG.

# BBC

9408

# COMPUTER MAINTENANCE ENGINEERS

## THE COMPANY:

Burroughs is an international computer company with world-wide activities. The high technology of its products designed and manufactured at Cumbernauld demands the extensive use of computers as shown below.

## THE JOB:

Installation and maintenance of a wide range of computer equipment which covers:

- 3 large scale (B 6800) computer systems and peripherals
- 4 medium scale (B 1800) computer systems and peripherals
- 24 small scale (B80) computer systems and peripherals
- over 100 terminals linked to the above.

## QUALIFICATIONS:

Ideally, a degree but emphasis will be on ability.

## SALARY:

Salary will not be a limiting factor in the selection of suitable candidates.

## FOR FURTHER INFORMATION:

Write or phone Paul Dunachie,  
Burroughs, Cumbernauld G68 0BN  
023-673 5457 day, 041-942 5599 eve.

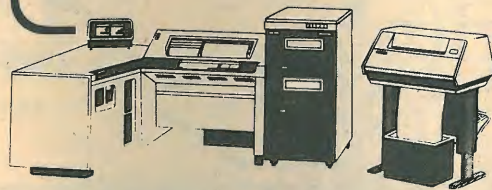

The Burroughs B80 Computer System designed and developed at Cumbernauld.

# Burroughs

(9447)

## ARTICLES FOR SALE

## TO MANUFACTURERS, WHOLESALERS & BULK BUYERS ONLY

Large quantities of Radio, T.V. and Electronic Components.  
**RESISTORS CARBON & C/F** 1/8, 1/4, 1/2, 1. 1 Watt from 1 ohm to 10 meg.  
**RESISTORS WIREWOUND.** 1 1/2, 2, 3, 5, 10, 14, 25 Watt.  
**CAPACITORS.** Silver mica, Polystyrene, Polyester, Disc Ceramics, Metalamite, C280, etc.  
Convergence Pots, Slider Pots, Electrolytic condensers, Can Types, Axial, Radial, etc.  
Transformers, chokes, hopts, tuners, speakers, cables, screened wires, connecting wires, screws, nuts, transistors, ICs, Diodes, etc., etc.  
All at Knockout prices. Come and pay us a visit. Telephone 445 2713, 445 0749.

### BROADFIELDS & MAYCO DISPOSALS

21 Lodge Lane, N. Finchley, London, N.12. 5 mins. from Tally Ho Corner (9461)

## SOWTER TRANSFORMERS

**WITH 37 YEARS' EXPERIENCE** we have the expertise to design and manufacture ANY TYPE OF AUDIO TRANSFORMER AT THE RIGHT PRICE.

Whilst we specialise in every kind of transformer for audio control desks and mixers demands are increasing for **LOUDSPEAKER TRANSFORMERS** and **100 VOLT LINE AUDIO OUTPUT TRANSFORMERS** FOR MOST KINDS OF AMPLIFIERS FROM 30 WATTS TO 500 WATTS OR MORE. We can also supply multi-output transformers for **COLUMN LOUDSPEAKERS**. A recent tendency is the demand for **OUTPUT TRANSFORMERS FOR ULTRA LINEAR AMPLIFIERS** using **KT 88** and **KT 66 BEAM TETRODES** and for these we have standard designs with exceptional performance.  
We call your attention to our very successful **MICROPHONE SPLITTER TRANSFORMER** type 4079 with a high impedance 200 ohm primary and two 200 ohm secondaries. It will handle up to 2.3 volts rms at 30 Hz and has a frequency response of plus/minus 1/2dB from 20 Hz to 20 kHz. It is contained in a Mumetal Can 33 mm diam x 37 mm high and **WORKING DETAILS OF THE CONSTRUCTION OF A SPLITTER ARE AVAILABLE ON REQUEST.**

We will supply single transformers, or any quantity, with short delivery times and, without obligation on your part, will quote price and exact dispatch on receipt of your requirements.

**E. A. SOWTER LTD., Manufacturers and Designers, P.O. Box 36 IPSWICH IP1 2EG, ENGLAND. Tel. IPSWICH (0473) 52794 and 219390.**

(8289)

## EQUIPMENT FOR SALE

**CG ADMITTANCE METER** 1302B with standard and lines in original wood case with handbook. £50. — Ring 0782-42155 after 6 pm. (9438)

## BUSINESS FOR SALE

**LONG ESTABLISHED** electronics company and 5,500 sq ft freehold factory due to retirement. Middlesex. Box No. 9437. (9437)

## EQUIPMENT WANTED

## A.R. Sinclair

Electronic Stockholders  
Stevenage 812193

We purchase all types of Mechanical and Electronic Equipment and Surplus stocks. (9206)

**VALVES RADIO** — T.V.-Industrial-Transmitting. We dispatch valves to all parts of the world by return of post, air or sea mail. 2,700 types in stock 1930 to 1976. Obsolete types a speciality. List 20p. Quotation S.A.E. Open to callers Monday to Saturday 9.30 to 5.00. Closed Wednesday 1.00. We wish to purchase all types of new and boxed valves. Cox Radio (Sussex Ltd., Dept WW, The Parade, East Wittering, Sussex PO20 SBN, West Wittering 2023 (STD Code 024366). (9082)

**ROBAND INVERTORS** 150 watts input, 12 volts DC output 110/240 volts AC 50 Hz compact encapsulated unit 3 1/2 in x 3 1/2 in. Ideal for operating equipment remote from mains supply. £65 each or £500 for 10. Tel 02518 2639 (Surrey). (9441)

**SOLAR CELLS;** bits, books and bargains. Send stamp for list or 95p for Solar Cell booklet and Data sheets. Edencombe Ltd. 34 Nathans Road, North Wembley, Middlesex HA0 3RX. (8061)





**SITUATIONS VACANT**

**W**

# Medical Equipment Repairman

**Saudi Arabia; c£7,500**

The Life Sciences Group of the Whittaker Corporation is responsible for the staffing and management of three general hospitals in Saudi Arabia, where the task is to provide a high standard of Health Care in this rapidly developing country.

We now wish to appoint a man with 2/3 years' experience of biomedical electronics who has successfully completed a formal course in biomedical electronic equipment repair.

The benefits package includes free accommodation, life and medical insurance and return air fare. In addition, there are bonuses of around £500 after 6 and 18 months' service and an extra month's salary on completion of the 2 year contract.

Please write with full career details, or telephone 01-584 7639.

Michael Kennedy,  
Whittaker Life Sciences Limited,  
199 Knightsbridge,  
London SW7.

**Whittaker**  
Life Sciences Ltd.

**CAPACITY AVAILABLE**

**PCBs Production runs or prototypes**  
*Assembly to sample or drawings*  
★ *Design Service if required*  
★ *Quick response to demand*  
★ *Expert hand soldering*  
★ *Nothing too large or too small*

Telephone or write:  
**SEAHORSE ELECTRONICS Ltd.**  
Unit 2, Picow Farm Road  
Service Industry Estate  
Runcorn, Cheshire  
Tel: Runcorn (09285) 75950 (9135)

**I.H.S. SYSTEMS**

Due to expansion of our manufacturing facilities we are able to undertake assembly and testing of circuit boards or complete units in addition to contract development.

We can produce, test and calibrate to a high standard digital analogue and RF equipment in batches of tens to thousands.

Telephone to arrange for one of our engineers to call and discuss your requirements, or send full details for a prompt quotation.

**TEL. 01-253 4562**  
or reply to Box No. WW 8237 (8237)

**COIL WINDING**

Large or small  
**PRODUCTION RUNS**

**AIRTRONICS LTD**

GARDNER INDUSTRIAL ESTATE  
KENT HOUSE LANE  
BECKENHAM KENT BR3 1UG  
01-659 1147 8936

**PCB ARTWORK DESIGN SERVICE**  
with component notation masters and assembly drawings. PADS Electrical Ltd, 01-850 6516, 45 Southwood Road, New Eltham SE9. (7905)

**DESIGN AND DEVELOPMENT** of electronic equipment.  
Scope Advance Systems Ltd., Dept A, 36 Singer Road, East Kilbride, Glasgow. 036-52-37112. (9474)

**ELECTRONIC CIRCUIT** Design and prototype construction production assembly. Test and PCB artwork design. Write: Powerline Electronics, High Street, Bognor Regis, Sussex PO21 1EZ or telephone STD 024-32 (Pagham) 66587 evenings. (8963)

**SMALL BATCH** productions wiring assembly to sample or drawings. Specialist in printed circuits assembly. Rock Electronics, 42 Bishopscroft, Harlow, Essex 0279 33018. (9094)

**PRINTED CIRCUITS** single or double sided. We offer a fast reliable service for small to medium runs and a quick turnaround on prototypes. Phone Aktronics, 06474 573. (9347)

**SERVICES**

**TEST EQUIPMENT CALIBRATION AND REPAIR**

Quick turn round, attractive rates, ring for details on Fair Oak 5252.

**DUTCHGATE LTD.**  
Pyle Hill, Winchester Road  
Fair Oak, Hampshire

**W.K.F. ELECTRONICS**  
(R.P.C.B.S. Ltd.)  
THE CIRCUIT BOARD SPECIALISTS - UNIVERSAL SUPPLIERS

Contractors for: P.C.B. Production, Contract Drilling, Electroplating, Laminate Cutting.  
Services for: Master Artwork Preparation, Process Photography, Circuit Diagrams, Layouts & Legends.  
Consultants for: Instrument Engineering, Automatic Control & Applications.

**DESIGN SERVICE.** Electronic Design Development and Production Service available in Digital and Analogue Instruments, RF Transmitters and Receivers for control of any function at any range. Telemetry, Video Transmitters and Monitors, Motorised Pan and Tilt Heads etc. Suppliers to the Industry for 16 years. Phone or write Mr. Falkner, R.C.S. Electronics, 6 Wolsey Road, Ashford, Middlesex. Phone Ashford 53661. (8341)

**PRECISION SHEET METAL** work, chassis, panels, etc., steel, stainless or aluminium, long/short runs, good deliveries. EES Ltd., Clifford Road, Monks Road, Exeter 36489. Tel: 42401. (8060)

**Do-It-Yourself Won't Do:** Today's assemblies demand close tolerances.  
**Goodbye to the Long Wait:** 3 to 7 Day Prototype P.C.B. Production Service.  
**Quotations:** By Return. **Guaranteed Quality** on every process.  
**Short or Long Term Production** now acceptable from 1 to 10,000 units.

**We Universally Distribute:** Laminate, Carbide Drill Bits & Routers, Process Chemicals (any), Pre-sensitised Laminate, Drilling Machines (Manual, Multi-spindle, N.C./C.N.C. Control), Graphic Art Drafting materials & aids.

**We Manufacture to Specification:** Quality Circuit Boards (Single or Double Sided with any finish). Due to expansion we now have space available for prototype or long term production.

**For Quotations:** Submit Copy Masters, Roughs, Circuit or Sample units for costing.  
To:  
**W.K.F. ELECTRONICS**  
FLEET HOUSE, WELBECK STREET  
WHITWELL, WORKSOP, NOTTS.  
TEL WORKSOP (0909) 720695  
TELEX: 847616  
Telephone Quotations: Ask for pricing.

**ELECTRONIC DESIGN SERVICES.** Wide engineering experience available for the design of basic circuits to complete systems. Analogue DC to 1GHz and Digital. Write or phone Mr Anderson, Andertronics Ltd, Ridgeway, Hog's Back, Scale (Nr. Farnham), Surrey. Runfold 2639. (9140)

**TECHNICAL WRITING SERVICES** available. Reports etc. prepared/edited to a high standard of readable, lucid English. For details of all services, please write: TECHNO-SCRIPT, 109 Southbridge Road, Croydon CRO 1AJ, England. (9435)

**ASSEMBLY P.C.B.** assembly, wire wrapping. Complete equipment construction, screen printing and engraving of panels.

**NOTICE TO OTHER MANUFACTURERS**

IS YOUR DRILLING / ROUTING DEPARTMENT A BOTTLENECK?  
IF SO TRY OUR SERVICE FOR DRILLING AND ROUTING

THE RATES ARE VERY REASONABLE AND THE FAST SERVICE WILL ENSURE THAT YOUR CUSTOMERS' DELIVERIES ARE MET.

**ARTICLES WANTED**

**MINICOMPUTERS PERIPHERALS INSTRUMENTATION**

For fastest, better CASH offer  
Phone  
**CHILTMead LTD.**  
Reading (0734) 669657 (9433)

**STORAGE SPACE** is expensive, why store redundant and obsolete equipment? For fast and efficient clearance of all test gear, power supplies, PC boards, components, etc., regardless of condition or quantities. Call 01-771 9413. (8209)

**COURSES**

**POSTGRADUATE COURSE IN SOLID-STATE ELECTRONICS**  
(M.Sc. and Ph.D.)

A 12-month course starts at UMIST in October each year. This course, suitable for graduates in Physics, Electrical Engineering or related subjects, is concerned with the design and behaviour of solid-state devices (such as transistors, integrated circuits, magnetic computer memories, etc.) and the solid-state physics on which they are based.

The M.Sc. course comprises two terms of lectures followed by a 5-month research project. Suitable candidates may be given the opportunity to proceed to Ph.D. work.

SRC studentships are available for suitably qualified candidates.

Further information from Dr. K. E. Singer, Department of Electrical Engineering and Electronics, UMIST, Manchester, M60 1QD. (9414)

**SPOT CASH**  
paid for all forms of electronics equipment and components.

F.R.G. General Supplies  
550 Kingston Road, London  
Tel: 01-404 5011  
Telex: 24224 Quote Ref 3165 (8742)

**WANTED** old Morse keys sing or in quantity. Give description or photo and price: Henry, 202 Lakeshore Rd, Pointe Claire, Quebec, Canada. (9477)

**OSCILLOSCOPE WANTED** by private buyer. Must be professional quality. Tel: 0602 259394. (9432)

**CAM TIMERS** (18+ cams/micro switches) and plastic cased relays, all 110V AC operation, wanted. Please quote for quantity and send sample. Millermatic, 32 High Street, Wymington, Rushden 59189. (9422)

**TO ALL MANUFACTURERS AND WHOLESALERS IN THE ELECTRONIC RADIO AND TV FIELD**

**BROADFIELDS & MAYCO DISPOSALS**  
will pay you top prices for any large stocks of surplus or redundant components which you may wish to clear. We will call anywhere in the United Kingdom.  
21 LODGE LANE  
NORTH FINCHLEY, LONDON N12 8JG  
Telephone Nos. 01-445 0749/445 2713  
After office hours 958 7624 (9123)

Here's why you should buy an I.C.E. instead of just any multimeter

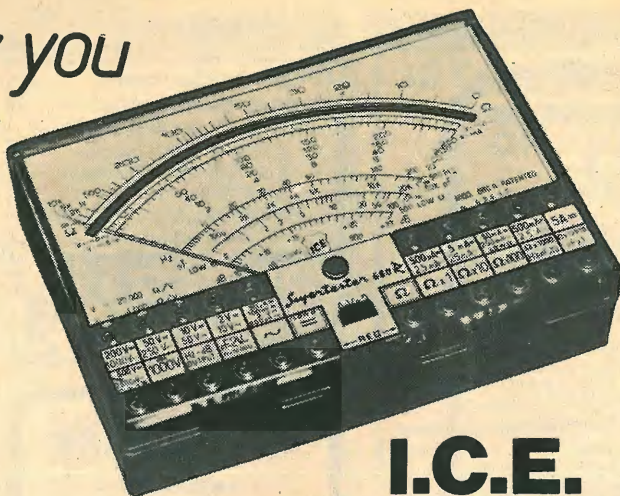

**I.C.E.**

WW - 088 FOR FURTHER DETAILS

- \* Best Value for money.
- \* Used by professional engineers, D.I.Y. enthusiasts, hobbyists, service engineers.
- \* World-wide proven reliability.
- \* Low servicing costs.
- \* 20K/volt sensitivity and high accuracy.
- \* Large mirror scale meter.
- \* Fully protected against overload.
- \* Large range of inexpensive accessories.
- \* 12 month warranty, backed by a full after sales service at E. B. Sole U.K. Distributors

Prices from £16.60 — £32.00 + VAT  
Send for full colour leaflet and prices on whole range including accessories.

**ELECTRONIC BROKERS LIMITED**  
49-53 Pancras Road, London NW1 2QB.  
Tel: 01-837 7781. Telex: 298694.

**INDEX TO ADVERTISERS**

Appointments Vacant Advertisements appear on pages 125-143

| PAGE   | PAGE   | PAGE  |
|--|--|---|
| Acoustical Mfg. Co. Ltd. .... 8                      | Hall Electric Ltd. .... 15                   | Quantum Electronics ..... 90                        |
| AEL Crystals ..... 92                                | Harmsworth Townley & Co. Ltd. .... 22        | Quarndon Electronics (Semiconductors) Ltd. .... 105 |
| Ambit International ..... 21                         | Harris Electronics (London) Ltd. .... 20, 28 |   |
| Amtron Ltd. .... 92                                  | Hart Electronics ..... 93                    |   |
| Armon Products Ltd. .... 91                          | H/H Electronics ..... 4                      | Radio Components Specialists ..... 107              |
| Aspen Electronics Ltd. .... 31                       | Hilomast Ltd. .... 12                        | Radio Supplies ..... 27                             |
| Astra Elec. Comps. .... 93                           | H.L. Audio ..... 112                         | Ralfe, P. F. .... 104                               |
|  |  | R.C.S. Electronics ..... 96                         |
| Barkway Electronics Ltd. .... 93                     | I.L.P. Electronics Ltd. .... 2               | R.S.T. Valves ..... 123                             |
| Barrie Electronics Ltd. .... 117                     | Industrial Tape Applications ..... 78        |   |
| Bi-Pre Pak Ltd. .... 108                             | Integrex Ltd. .... 98, 99                    | Samson (Electronics) Ltd. .... 124                  |
| Bi-Pak Semiconductors Ltd. .... 110                  |  | Science of Cambridge ..... 77                       |
| Boss Industrial Mouldings Ltd. .... 6                | JSP Associates ..... 96                      | Scopex Instruments Ltd. .... 113                    |
| Broadcast Training & Services Ltd. .... 97           |  | Scott, J. (Elec. Eng.) Ltd. .... 10                 |
|  | Kef Electric ..... 10                        | Semicon Indexes Ltd. .... 117                       |
| Cambridge Learning ..... 7                           | Keithley Instruments Ltd. .... 112           | Service Trading ..... 111                           |
| Carston Electronics Ltd. .... 17                     | Kelsey Acoustic ..... 117                    | Sescom ..... 94                                     |
| Catronics ..... 106                                  | Kirkham Electronics ..... 16                 | Shure Electronics Ltd. .... 32                      |
| CEC Corporation ..... 14                             |  | Sintel ..... 106                                    |
| Chiltmead Ltd. .... 116                              | Langrex ..... 123                            | Special Products Ltd. .... 20                       |
| Circards No. 3 ..... 109                             | Lascar Elec ..... 92                         | Strutt Elec. & Mech'l Engrs. Ltd. .... 23, 26       |
| Clarke-Smith ..... 28                                | Levell Electronics Ltd. .... 3               | Sugden, J. E. & Co. Ltd. .... 122                   |
| Colomor (Electronics) Ltd. .... 116                  | Light Soldering Developments Ltd. .... 18    | Surrey Electronics Ltd. .... 97                     |
| Coloured Photo Service ..... 101                     | Lindos Electronics ..... 95                  | Swanley Electronics Ltd. .... 95                    |
| Compec '79 ..... 97                                  |  |   |
| Computer Appreciation ..... 122                      | Maplin Electronic Supplies ..... 9           | Technomatic Ltd. .... 114                           |
| Continental Specialists Corp. .... 11, 23            | Martin Associates ..... 20                   | Tektronix (Telequipment) ..... cover ii, 67         |
| Crajel UK Ltd. .... 31                               | Marshall, A. & Sons (London) Ltd. .... 100   | Transam Components ..... 26                         |
| Crimson Elektric ..... 18                            | MCP Elec. .... 22                            | Teleradio Electronics ..... 108                     |
|  | Microcircuits ..... 5                        |   |
| Datong ..... 92                                      | Microdigital ..... 19                        | Valradio Ltd. .... 25                               |
| Display Electronics ..... 115                        | Mills, W. .... 100                           | Vero Electronics Ltd. .... 25                       |
| Dominus ..... 30                                     | Milward G.F. .... 108                        | Vero Systems (Electronic) Ltd. .... 30              |
| Drake Transformers ..... 28                          | Multicore Solders Ltd. .... Cover iv         | Vero Speed ..... 94                                 |
|  |  | Videotime Products ..... 24                         |
| Eagle/Carter Associates ..... 104                    | Newtronics ..... 124                         | Viewdata Exhibition ..... 90                        |
| Elektro Tek ..... 122                                | Newbear Computer Stores ..... 31, 96, 124    |   |
| Electronic Brokers Ltd. .... 118, 119, 120, 121, 144 |  | West Hyde Developments Ltd. .... 94                 |
| Electronic Equipment Ltd. .... 106                   | Petalect Electronic Servicing ..... 30       | Wilmslow Audio ..... 89                             |
|  | Powell, T. .... 95                           |   |
| Faircrest Eng. Ltd. .... 30                          | Powertran Electronics ..... 68, 102, 103     | Z. & I. Aero Services Ltd. .... 95, 108             |
| Farnell Instruments Ltd. .... Readers Card           | Proops Bros. .... 12                         |   |
| FieldTech ..... 14                                   | Pye Telecommunications Ltd. .... 29          |   |
| Future Film Developments ..... 97                    | Pye Unicam ..... cover iii                   |   |
|  |  |   |
| GEC M-O Valve ..... 22                               |  |   |
| Gould Advance ..... 4, 13                            |  |   |
| Greenwood Electronics ..... 25                       |  |   |

**OVERSEAS ADVERTISEMENT AGENTS:**

**France & Belgium:** Norbert Hellin, 50 Rue de Chemin Veat, F-92100, Boulogne, Paris.

**Hungary:** Mrs. Edit Bajusz, Hungexpo Advertising Agency, Budapest XIV, Varosliget Telephone: 225 008 — Telex: Budapest 22-4525 INTFOIRE

**Italy:** Sig. C. Epis, Etas-Kompass, S.p.a. — Servizio Estero, Via Mantegna 6, 20154 Milan Telephone: 347051 — Telex: 37342 Kompass.

**Japan:** Mr. Inatsuki, Trade Media — IBPA (Japan), B212, Azabu Heights, 1-5-10 Roppongi, Minato-ku, Tokyo 106. Telephone: (03) 585-0581.

**UNITED States of America:** Ray Barnes, IPC Business Press, 205 East 42nd Street, New York, NY 10017 — Telephone: (212) 689 5961 — Telex: 421710. Mr. Jack Farley Jr., The Farley Co., Suite 1584, 35 East Wacker Drive, Chicago, Illinois 60601 — Telephone: (312) 6 3074.

Mr. Victor A. Jauch, Elmatex International, P.O. Box 34607, Los Angeles, Calif. 90034, USA — Telephone (213) 821-8581 — Telex 18-1059.

Mr. Jack Mentel, The Farley Co., Suite 650, Ranna Building, Cleveland, Ohio 44115 — Telephone: (216) 621 1919. Mr. Ray Rickles, Ray Rickles & Co., P.O. Box 2008, Miami Beach, Florida 33140 — Telephone: (305) 532 7301. Mr. Tim Parks, Ray Rickles & Co., 3116 Maple Drive N.E., Atlanta, Georgia 30305. Telephone: (404) 237 7432. Mike Loughlin, IPC Business Press, 15055 Memorial, Ste 119, Houston, Texas 77079 — Telephone (713) 783 8673.

**Canada:** Mr. Colin H. MacCulloch, International Advertising Consultants Ltd., 915 Carlton Tower, 2 Carlton Street, Toronto 2 — Telephone: (416) 364 2269. \*Also subscription agents.

Philips bring you...

NEW

SuperScope



## Its only low-cost feature is its price

SuperScope is Philips new PM 3207 15MHz dual trace oscilloscope. As well as being the best looking instrument of its type available, it's also the best value by far.

Look at this unique feature package:

- Philips quality and advanced technology in design and construction. Inside it you'll see an electronic masterpiece, not a "birds' nest."
- Auto triggering from either channel with adjustable level between peaks. TV triggering, too.
- 5 mV sensitivity — the same X and Y — which is especially useful for weaker signals.

- B-invert button for displaying inverted polarity signals in phase with the reference.
- Big, rectangular screen giving a full 80 sq.cm. trace space.

• Choice of ground, due to double insulation. SuperScope is ideal for audio and video service, education, production — in fact any application which calls for a sophisticated yet tough all-purpose instrument.

For a leaflet about SuperScope, write to the Philips Electronic Instruments Department at Pye Unicam.

The instrument is also available from the following distributors:  
 British Tungstam, West Road, Tottenham, London N17 0RN. Tel: 01-808 4884  
 Philips Service Centres. (phone 01-686 0505 for the address of your nearest branch)  
 Wessex Electronics Ltd, 114-116 North Street, Downend, Bristol BS16 5SE. Tel: (0272) 571404



**Pye Unicam Ltd**

Philips Electronic Instruments Dept  
 York Street Cambridge, England CB1 2PX  
 Tel: Cambridge (0223) 58866 Telex 817331



**Test & Measuring  
 Instruments**

**PHILIPS**

# high quality

## Multicore solder helps Europe's OTS-2 satellite orbit at 23,000 miles

OTS-2, a forerunner of a European communications satellite, was launched from Cape Canaveral on May 11th 1978.

Now orbiting the equator at a height of 23,000 miles, OTS-2 was built for the European Space Agency by the MESH consortium, led by British Aerospace Dynamics Group, Stevenage.

In building OTS-2, complete precision was called for. Which is why Ersin Multicore solders were used for many of the soldering operations.

Quite simply, Multicore solders have *that* kind of reputation. For quality, toughness and reliability. That's why so many electronics manufacturers won't use anything else.

Next time you need solder of any kind, aim as high as OTS-2... and use Multicore.

Full details of Ersin Multicore solders, solder chemicals and high purity-bar solders for automatic soldering from



### Multicore Solders Ltd

Maylands Avenue  
Hemel Hempstead Herts HP2 7EP  
Tel: Hemel Hempstead 3636  
Telex: 82363

