

# wireless world

JUNE 1978 40p

## The Morsemaker

### Mobile radio bandwidths

### Radiating cables

Australia \$A1.25  
Canada \$1.75  
Denmark Kr. 11.00  
Germany Dm. 4.50  
Greece Dr. 47.00  
Holland Dfl. 4.50  
Italy L. 1100  
New Zealand \$NZ1.50  
Norway Kr. 11.00 incl. moms  
Singapore M \$3.25  
Spain Ptas. 80.00  
U.S.A. \$1.65

# The better value box for mobile radio servicing.

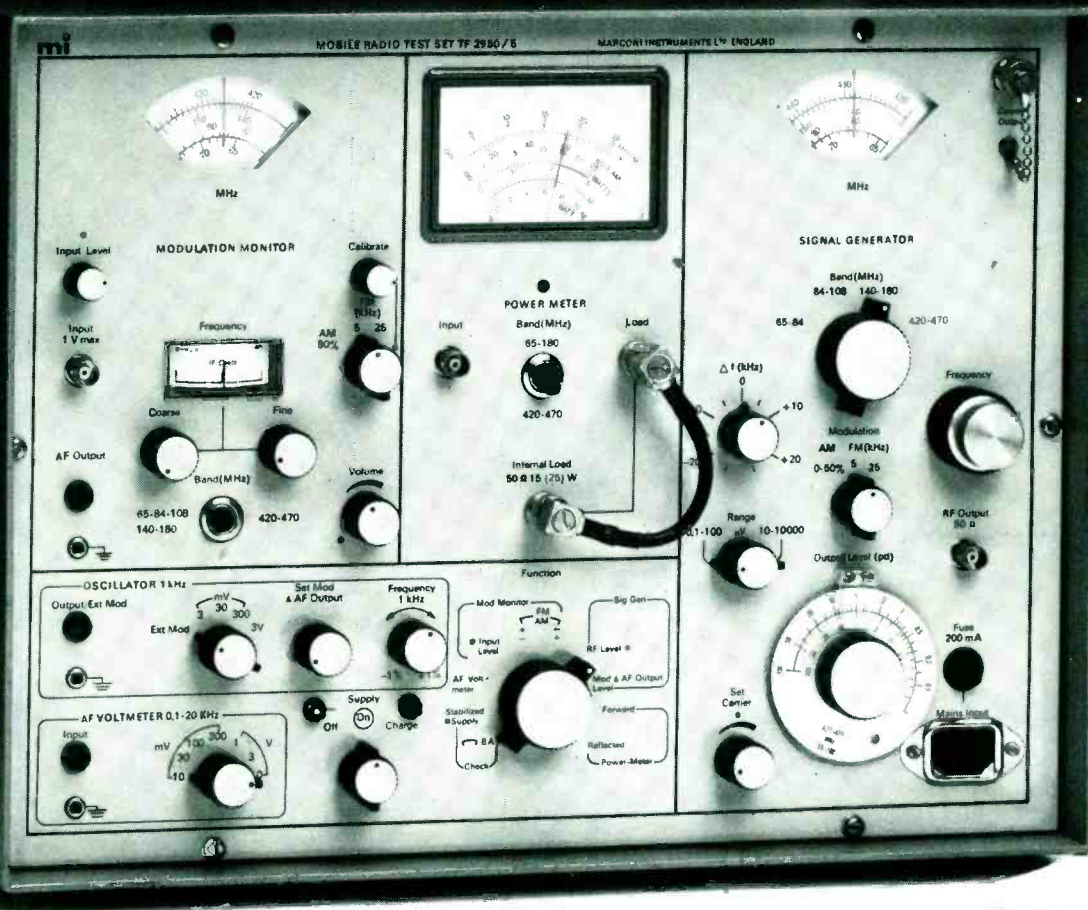

By combining all mobile radio servicing instruments in one portable unit, Marconi Instruments' Mobile Radio Test Set, TF 2950, streamlines your testing and servicing operation. And it is realistically priced.

Signal generator, a.f. voltmeter, modulation monitor, power meter (in-line and absorption) and a.f. oscillator are housed in a compact and robust cabinet – measuring only 315 mm high, 420 mm wide and 230 mm deep, and weighing only 16 kg.

TF 2950 is suitable for all a.m./f.m. mobile radio equipment and is available in a number

of versions to cover a wide frequency range.

For maximum convenience, the equipment operates from internal, rechargeable batteries or mains. A battery state meter is incorporated.

Marconi Instruments' TF 2950 gives you single-handed portability to meet all your mobile test needs.

Put it to the test.

Write or telephone for a full technical description and, if this whets your appetite further, we will be happy to arrange a demonstration.

## **mi** MARCONI INSTRUMENTS

Marconi Instruments Limited · Longacres · St. Albans · Hertfordshire · England AL4 0JN · Tel: (0727) 59292 · Telex: 23350  
Marconi Electronics Inc · 100 Stonehurst Court · Northvale · New Jersey 07647 USA · Tel: (201) 767-7250 · Twx: 710-991-9752  
Marconi Instruments · 32 avenue des Ecoles · 91600 Savigny-Sur-Orge · France · Tél: 996.03.86. · Telex: 600541.F  
Marconi Messtechnik GmbH · 8000 München 21 Jörgstrasse 74 · West Germany · Tel: (089) 58 20 41 · Telex: 5 212642

A GEC-Marconi Electronics Company

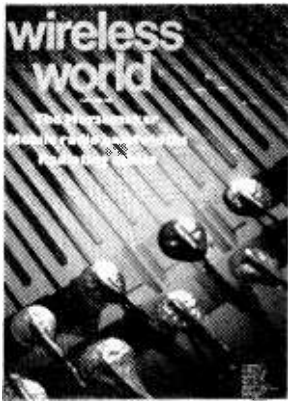

Front cover shows contacts and electrode arrangement of a birefringent electro-optic ceramic display made by SEL. Photo by Manfred P. Kage made available by SEL, Stuttgart.

**IN OUR NEXT ISSUE**

**Discriminative metal detector** using phase changes and digital electronics instead of beat frequency distinguishes positively between ferrous and non-ferrous objects by light spot direction of l.e.d. display. **The paperless revolution.** Latest developments in the use of electronics to store, process, transmit and display information, and the effect they could have on our lives.

**Valves vs. transistors.** Is valve amplifier sound better than transistor amplifier sound? Report on tests from an independent professional laboratory.

Current issue price 40p. back issue (if available) 50p. at Retail and Trade Counter, Paris Garden, London SE1. Available on microfilm please contact editor.

By post, current issue 55p. back issues (if available) 50p. order and payments to Room 11, Dorset House, London SE1 9LU

**Editorial & Advertising offices:** Dorset House, Stamford Street, London SE1 9LU.

**Telephones:** Editorial 01-261 8620. Advertising 01-261 8339.

**Telegrams/Telex:** Wiworld Bispres 25137 BISPRS G. Cables: Ethaworld, London SE1.

**Subscription rates:** 1 year: £7.00 UK and \$23.40 overseas (\$24 USA and Canada).

**Student rate:** 1 year. £3.50 UK and £4.50 overseas (\$11.70 USA and Canada).

**Distribution:** 40 Bowling Green Lane, London EC1R 0NE. Telephone 01-837 3636

**Subscriptions:** Oakfield House, Perrymount Road, Haywards Heath, Sussex. RH16 3DH. Telephone 0444 59188. Please notify a change of address.

**USA mailing agents:** Expeditors of the Printed Word Ltd, 527 Madison Avenue, Suite 1217, New York, NY 10022, 2nd-class postage paid at New York.

IPC Business Press Ltd. 1978  
ISSN 0043 6062



INTERNATIONAL BUSINESS  
PUBLISHERS



MEMBER OF THE 2000  
BUREAU OF CIRCULATION

# wireless world

ELECTRONICS/TELEVISION/RADIO/AUDIO

JUNE 1978 vol 84 No 1510

37 **The spectrum and society**

38 **Current dumping — does it really work?**  
by J. Vanderkooy and S. P. Lipshitz

41 **World of Amateur radio**

42 **Radiating cables**  
by R. Johannessen

45 **News of the month**  
Microwave landing — the decision  
Ideas for better spectrum use    Electret radioactivity dosimeter

49 **The Morsemaker**  
by Murray Ward

53 **Mobile radio bandwidths**  
by W. M. Pannell

57 **Letters to the editor**  
Circuit action and programme signals  
Long running C-D ignition    Spectra of tone bursts

61 **Interconnection of logic elements**  
by I. Catt, M. F. Davidson and D. S. Walton

64 **Circuit ideas**  
Modifying KB6 ASCII keyboard  
Fold-back limiter    Linear v.c.o.

67 **Loudspeaker system design — 2**  
by Siegfried Linkwitz

75 **Viewdata optimisation**  
by S. Fedida

78 **Logic design — 13**  
by B. Holdsworth and D. Zissos

85 **Generating ultra-short microwave pulses**  
by A. G. Hood

87 **How good are l.e.ds?**  
by J. Skinner

89 **New products**

92 **Sidebands**  
by Mixer

# GenRad's Top Trio...

## ... a low cost/high performance range of $\mu P$ -based bridges

GenRad's new range of  $\mu P$ -based bridges make full use of advanced technology to meet tomorrow's testing needs today. Check the list of features, and contact us for further information, price and delivery.

### 1658 RLC Digibridge

- \* Automatically measures R, L, C, D and Q
- \* 0.1% Basic accuracy
- \* 10 Bins for sorting
- \* Autoranging
- \* IEEE 488 bus/handler interface option
- \* Three test speeds
- \* Selectable continuous, average or single component measurements
- \* Three types of display programmed bin limits, measured values or bin number
- \* Five-digit display for R, L and C
- \* Four-digit display for D and Q
- \* Selectable test frequencies of 1 kHz and 120 Hz (100 Hz)
- \* Series or parallel measurement mode selection
- \* Built-in Kelvin test fixture tests radial and axial lead components

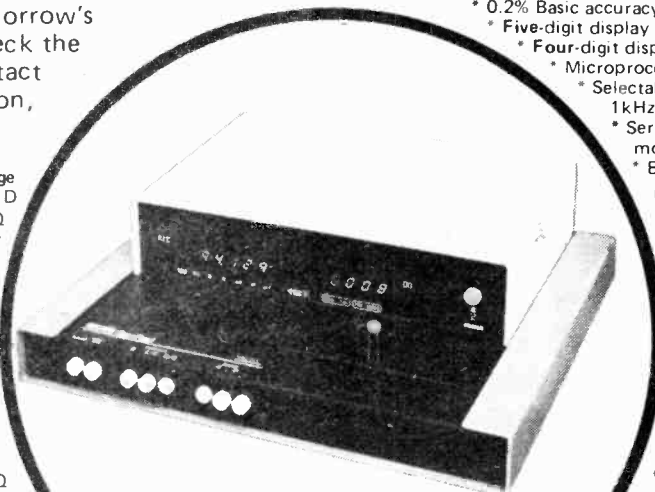

1657 Digibridge™

\* Under £1,000

### The 1657 Digibridge

- \* Automatically measures R, L, C, D and Q
- \* 0.2% Basic accuracy
- \* Five-digit display for R, L and C
- \* Four-digit display for D and Q
- \* Microprocessor-directed ranging
- \* Selectable test frequencies of 1 kHz and 120 Hz (100 Hz)
- \* Series or parallel measurement mode selection
- \* Built-in Kelvin test fixture tests radial and axial lead components

### 1687 Megahertz LC Digibridge

- \* Automatically measures Ls & Q, Cs & D, Cs & Rs, Cp & Gp
- \* 0.1% basic accuracy for C
- \* 0.2% basic accuracy for L
- \* Automatic limit-comparison (10 bins)
- \* Autoranging
- \* IEEE 488 bus/handler interface option
- \* Two test speeds
- \* Selectable continuous, average or single component measurements
- \* Four types of display - programmed bin limits, measured values, deviation measurement ( $\Delta L$  or  $\Delta C$ ), or bin number
- \* Five-digit display for L and C
- \* Four-digit display for Q, D, R and G
- \* Optional Kelvin test fixture tests radial and axial lead components

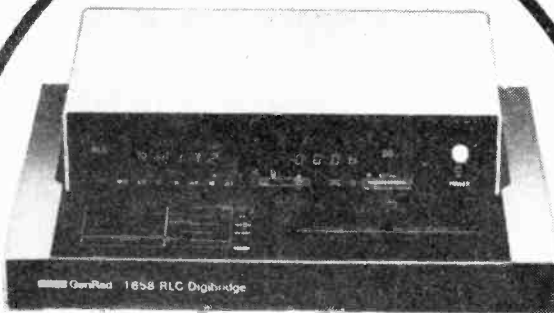

1658 RLC Digibridge™

\* Under £2,000

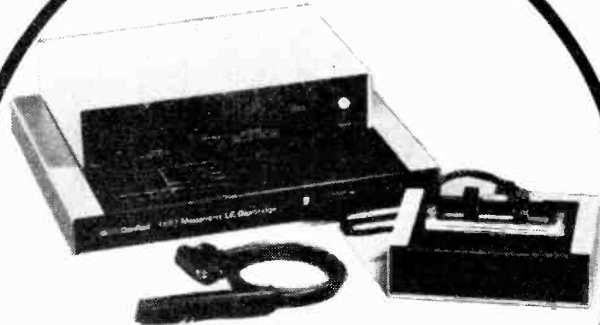

1687 Megahertz  
LC Digibridge™

\* Under £2,500

### GenRad Ltd.

Bourne End, Bucks. SL8 5AT  
Phone (06285) 2 66 11, Telex 848321



# GenRad

WW-077 FOR FURTHER DETAILS

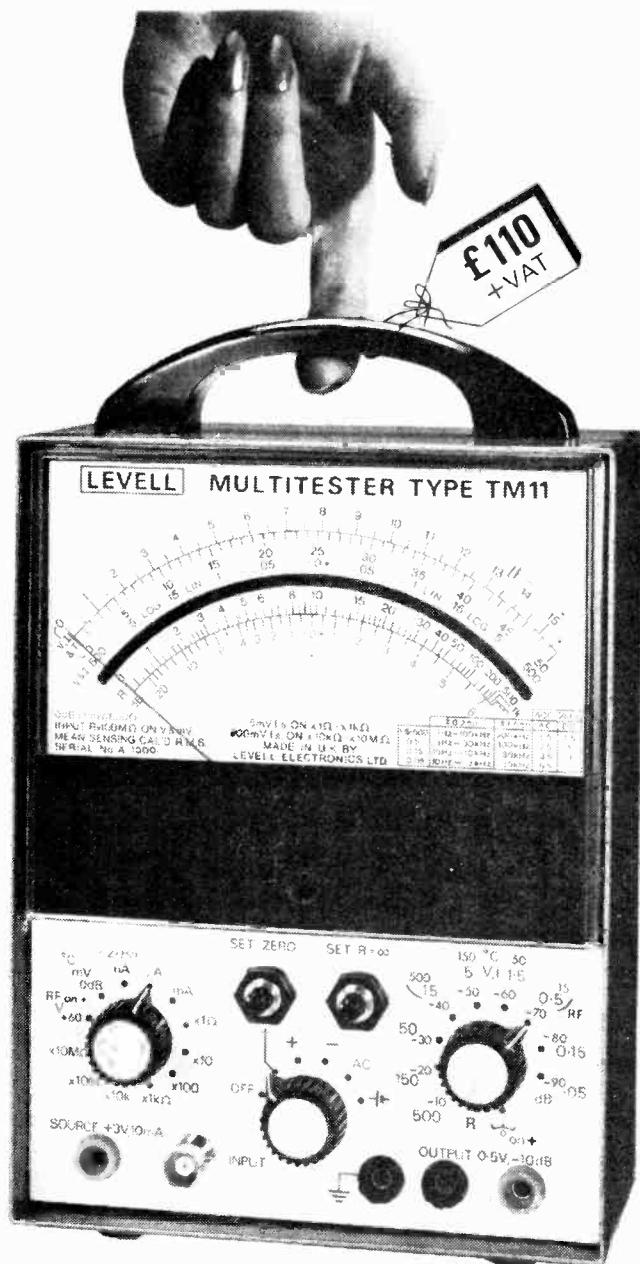

**VERSATILE**

**RELIABLE**

**PORTABLE**

**120 BASIC RANGES**

- AC V, I & dB : 50 $\mu$ V/500V fsd, 50pA/500mA fsd, -90dB/+50dB mid scale. Acc.  $\pm$ 1.5% fsd above 500 $\mu$ V & 500pA. Response 3Hz/200kHz above 500 $\mu$ V and 500nA. Input R = 100M $\Omega$  on volts.
- DC V, I & NULL : 150 $\mu$ V/500V fsd, 150pA/500mA fsd, polarity reversible. Acc.  $\pm$ 1.5% fsd above 500 $\mu$ V & 500pA. Input R = 100M $\Omega$  on volts. 5 Null ranges have centre zero lin/log scale covering  $\pm$ 4 decades.
- RESISTANCE : 0.2 $\Omega$ /10G $\Omega$  in 7 ranges, polarity reversible. Low test voltage for solid state circuits.
- LEAKAGE at 3V : Uses 3V source with current ranges to test capacitors, diodes and resistance up to 100G $\Omega$ .
- VOLT DROP at 10mA : Uses 10mA source with voltage ranges to test diodes, LED's and resistance down to 10m $\Omega$ .

**30 OPTIONAL RANGES**

- RF VOLTS : 0.5V/500V fsd, 10kHz/1GHz, using RF Probe. Price £22 + VAT.
- HIGH VOLTS : 1.5kV/50kV fsd, AC/DC, using HV Probe. Price £16 + VAT.
- HIGH CURRENT : 1.5A/50A fsd, AC/DC, using Current Shunt. Price £15 + VAT.
- TEMPERATURE : -150 $^{\circ}$ C/+500 $^{\circ}$ C fsd in 7 ranges using Temperature Probe. Price £38 + VAT.

The instrument operates from a 9 volt battery, life 1000 hrs., or, AC mains when optional Power Supply Unit is fitted. Size is 240mm x 150mm x 80mm. Weight is 1.75 kg. Meter scale length is 140mm. Leather case is available at £13 + VAT.

**LEVELLE ELECTRONICS LTD.**

MOXON STREET, BARNET, HERTS., ENGLAND, EN5 5SD.  
TEL: 01-449 5028/440 8686

WW-015 FOR FURTHER DETAILS

# years



INTERNATIONAL

DANAVOX (GT. BRITAIN) LTD.  
"BROADLANDS" BAGSHOT ROAD,  
SUNNINGHILL, ASCOT, BERKS.  
TEL. 0990 23732/6. TELEX: 84584

**of research...** "on components and accessories for dictating machines, tele-communications, hearing aids and electroacoustic equipment etc."



STETOCLIP JUNIOR 60 HEADSET

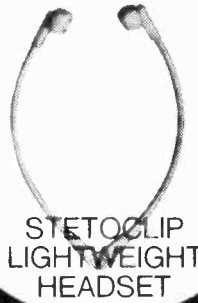

STETOCLIP LIGHTWEIGHT HEADSET



SENIOR STETOCLIP HEADSET

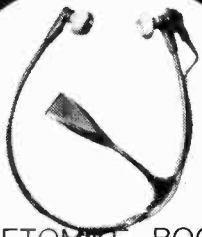

STETOMIKE BOOM MICROPHONE HEADSET

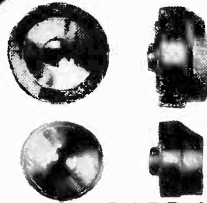

STANDARD & SUB-MINOR EARPHONES

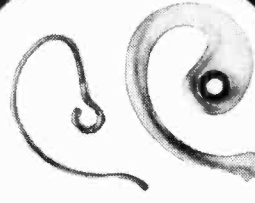

PLASTIC EARHANGERS



DANAMIC FIDELITY EARSET

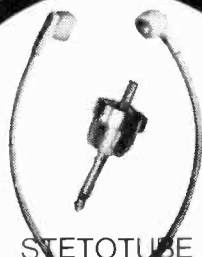

STETOTUBE HEADSET

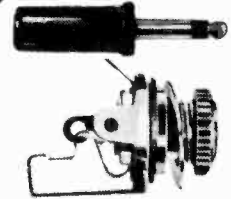

2,5 mm and 3,5 mm JACK PLUGS & SOCKETS



DANASOUND HEADSET



DANASONIC INDUCTION AUDIO LOOP RECEIVER

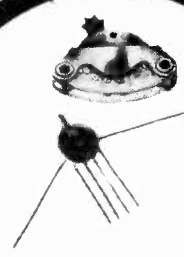

SUBMINIATURE SWITCHES

WW-054 FOR FURTHER DETAILS

# Get started with the best MPU KITS available ex-stock

## A.M.D. 2900 KIT

Advanced Micro Devices has designed an educational tool, the Am2900 Evaluation and Learning Kit, to be used by the design engineer learning microprogramming.

The kit consists of one Am2901 Bipolar Microprocessor, one Am2909 Bipolar Microprogram Sequencer, and several memories, registers, and multiplexers organized in a typical CPU (Central Processing Unit) structure.

This kit is NOT a four-bit computer. All components required in the assembly of the Am2900 Evaluation and Learning Kit are supplied in the kit package. The only item that need be supplied by the user of the kit is a +5V power supply capable of delivering approximately 2 amperes of current. The assembly diagram and assembly instructions in this book show the location of each of the components on the printed circuit board.

**Price: £202.30**

(add £16.18 V.A.T.)

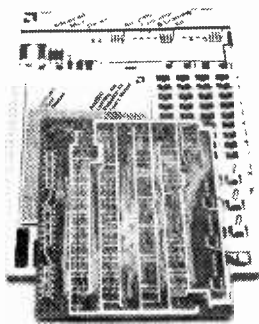

## MOTOROLA MEK6800D2 KIT

MEK6800D2 provides an expandable kit that is ideal for those who wish to develop systems using the M6800 microprocessor, but who do not want to invest in expensive terminals.

The kit includes a hexadecimal keyboard and display, 384 byte of RAM, 16 I/O lines, an ACIA, an audio cassette interface and 1K byte monitor with step-by-step and trace features, all built around the MC6800 MPU.

### Featuring

- \* 24 Key Keyboard
- \* 7 Segment Display
- \* Cassette Interface
- \* EROM Expandable
- \* RAM Expandable
- \* Wire Wrap Capability
- \* Parallel and Serial Interface Capability
- \* Single 5 Volt Supply Required
- \* Layout on Boards
- \* Documentation

**Price: £175.88**

(add £14.07 V.A.T.)



## T.I. MICRO 99-16

(ASSEMBLED BOARD ONLY)

Micro 99 is a microprocessor PCB system which is designed to fulfill the dual roles of OEM micro-computer board and a low cost, limited resource prototyping system for Texas Instruments microprocessors. The first board in the system is the Micro 99-16 CPU board which consists of a TMS9900, static RAM, PROM, 15 levels of interrupt, 16 I/Os, TTY and RS232 interface.

### Memory

RAM 256 x 16 bit words of STATIC RAM (TMS4042-2NL).

PROM sockets for 1536 x 16 bit words of FUSIBLE LINK PROM (SN74S472) or TIBUG monitor included.

### Power Supplies

- +12 volts ± 0.6v - 100mA
- +5 volts ± 0.25v - 2.0A
- 5 volts ± 0.25v - 5mA

### PCB

Double Euro-card-dimensions 233.3mm x 160mm

**Price: £340.00**

(add £27.20 V.A.T.)



## ZILOG Z80 KIT

The Z80-EBC kit (kontron) is a combined development system for evaluating the third generation Z80 microprocessor.

It comes as a complete kit with a 5 slot motherboard and requires only a 5V power supply. The Z80-EBC boasts a cassette interface, along with a hexadecimal keyboard and six, seven segment L.E.D.S. The ZPROG monitor gives the user control via the keyboard from where he may dump, load alter and run his programs.

Optional boards (PROM, RAM, and I/O) give the user expansion capability for a total system at a competitive price.

### Featuring

- \* 27 Key Keyboard
- \* 7 Segment Display
- \* Cassette Interface
- \* EROM Expandable
- \* RAM Expandable
- \* Parallel and Serial Interface Capability

**Price: £215.00**

(add £17.20 V.A.T.)



Get kitted out with Cramer the leading MPU distributor in the U.K.

# cramer

## MICROSYSTEMS

Cramer Components Limited, Hawke House,  
Green Street, Sunbury-on-Thames, Middlesex.  
Tel: (09327) 85577. Telex: 923592

### CASH WITH ORDER

Please send my MPU KIT by return (tick box)

AMD 2900  MOTOROLA MEK6800D2

TI 99-16  ZILOG Z80

enclose my cheque/PO for \_\_\_\_\_ (including V.A.T)

Signature \_\_\_\_\_

Name \_\_\_\_\_

Company \_\_\_\_\_

Address \_\_\_\_\_

WW 6/78

WW-078 FOR FURTHER DETAILS

**Stay ahead—follow this sign**

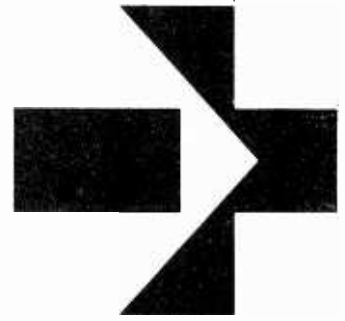

# GOULD ADVANCE INSTRUMENTS HAVE A WORLDWIDE REPUTATION. BUT THEY NEED NOT COST YOU THE EARTH.

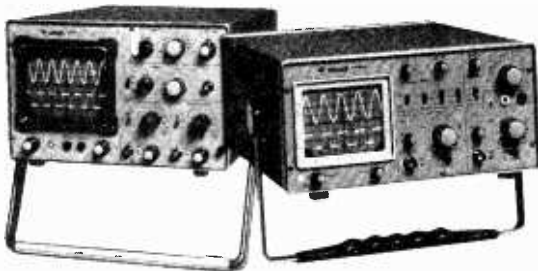

## OS245A AND OS250B OSCILLOSCOPES

Two dual trace oscilloscopes, with sensitivity of 5mV/div., and 2mV/cm respectively. The OS250B offers variable trigger level with or without bright line. The OS245A has a bandwidth of 10MHz, the OS250B offers 15MHz. Fully portable, these are the ideal instruments for servicing, educational and general purpose applications.

## ALPHA III DIGITAL MULTIMETER

A tough, attractive, 3½ digit multimeter with 25 ranges and a basic accuracy of  $\pm 0.2\%$ . A bright red LED display gives a clear reading even in high ambient light conditions, and yet power consumption is low enough for extensive field applications.

A purpose built CMOS chip incorporates all analogue and digital circuitry, giving a low component count and increased reliability.



## TC 320 TIMER COUNTER

This new, tough, 5-digit unit has an operating frequency of 35MHz. Plated through hole PCB construction keeps the component count down, for exceptional reliability. Frequency measurements up to at least 35MHz can be easily read from the clear 7-segment display. The TC320 offers outstanding performance—including "disciplined" triggering—at a remarkably modest price.

## BETA DIGITAL MULTIMETER

A general-purpose multimeter, offering 29 ranges, including temperature (optional), and a basic accuracy figure of  $\pm 0.2\%$ . A clear, 3½ digit Liquid Crystal Display, 0.5" high, gives a high-contrast read-out. Fully portable, with a minimum of 300 hours' battery life, the Beta has already established a reputation for accuracy and reliability.

For details of any of these instruments and the Gould Advance 2 year guarantee, write or phone today.

**Gould Instruments Division,**  
Roebuck Road, Hainault, Essex IG6 3UE.  
Telephone: 01-500 1000 Telex: 263785.



**GOULD**

WW—025 FOR FURTHER DETAILS





# How...Why...When?

Distress calls are made every day – hundreds each year, and in every case questions are asked. Questions which require accurate, up-to-the-minute answers. Answers that can only come from reliable and immediately accessible communications recordings.

When police, ambulance, fire, local ATC and other services are called upon, either by radio or telephone, they often receive hasty, garbled messages – sometimes several at a time. In such instances a positive need for communications

recording arises – a need for a system with instant message trace and replay – at the touch of a button – and at any speed to assist intelligibility.

All these facilities, and more, are available in the Racal-Thermionic 'Callstore' cassette recorder/reproducer. Actuated either by incoming audio signals or by local or remote control, Callstore uses four cassette transports, each giving up to four separate channels, including a search control track which is cued at the beginning of each message.

For details write to:

Racal-Thermionic Limited  
Hardley Industrial Estate  
Hythe, Southampton,  
SO4 6ZH England.

Telephone: 0703 843265.  
Telex: 47600.

## **RACAL**

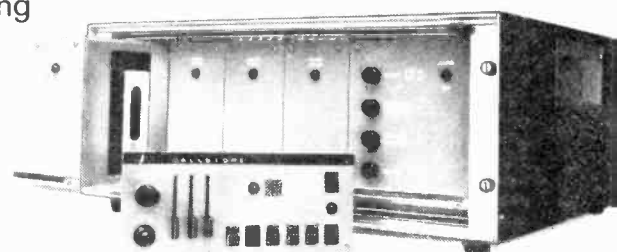

## **Callstore**, from Racal-Thermionic, answers all the questions.

WW-012 FOR FURTHER DETAILS

# BIMCONSOLES BIMBOXES BIMBOARDS BIMDRILLS BIMINDICATORS

## ABS & DIECAST BIMBOXES

5 sizes, in either ABS or Diecast Aluminium  
ABS moulded in Orange, Blue, Grey or Black  
Diecast Aluminium available in Grey Hammertone  
or Natural

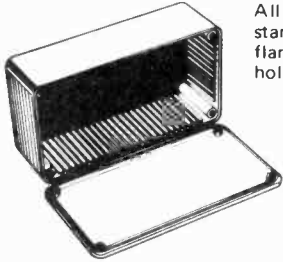

All boxes incorporate guides on all sides for holding 1.5mm thick pcb's and stand-off bosses in base for supporting small sub-assemblies etc. Close fitting flanged lids held by screws running into integral brass bushes (ABS) or tapped holes (Diecast).

	ABS	Diecast	Hammertone	Natural
(100x50x25mm)	BIM2002/12 £0.95*	BIM5002/12 £1.20*		£0.97*
(112x62x31mm)	BIM2003/13 £1.05*	BIM5003/13 £1.50*		£1.20*
(120x65x40mm)	BIM2004/14 £1.15*	BIM5004/14 £1.86*		£1.49*
(150x80x50mm)	BIM2005/15 £1.30*	BIM5005/15 £2.38*		£1.91*
(190x110x60mm)	BIM2006/16 £2.04*	BIM5006/16 £3.41*		£2.85*

Also available in Grey Polystyrene (112x61x31mm) with no slots and self tapping screws BIM2007/17 £0.88\*

## MINI DESK BIMCONSOLES

Moulded in Orange, Blue, Black or Grey ABS and incorporating guides on all sides for holding 1.5mm thick pcb's. 1mm Grey Aluminium panel sits recessed into front of console and held by screws running into integral brass bushes. Stand-off bosses in base for supporting small sub-assemblies etc. 4 self adhesive rubber feet also included.

BIM1005 (161x96x58mm) £2.12\*  
BIM1006 (215x130x75mm) £2.94\*

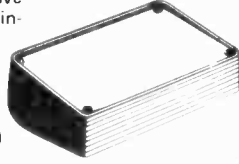

## LOW PROFILE BIMCONSOLES

1mm Grey Aluminium panel sits recessed into front of console base, which is moulded in Orange, Blue, Black or Grey ABS and sits on 4 self adhesive rubber feet. Incorporating guides for holding 1.5mm thick pcb, the base also has stand-off bosses for supporting small sub-assemblies etc. and ventilation slots. Front panel is held by 4 screws which run into integral brass bushes.

BIM6005 (143x105x55.5[31.5]mm) £2.32\*  
BIM6006 (143x170x55.5[31.5]mm) £3.08\*  
BIM6007 (214x170x82[31.5]mm) £4.12\*

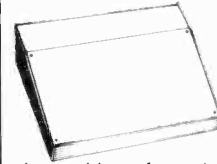

## MULTI-PURPOSE BIMBOXES

Moulded in Orange, Blue, Black or Grey ABS with 1mm thick Grey aluminium recessed front cover which is retained by 4 screws running into integral brass bushes. 1.5mm pcb guides are incorporated on all sides and as with all ABS boxes they are 85°C rated. 4 self adhesive rubber feet also included.

BIM 4003 (85x56x28.5mm) £1.24\*  
BIM 4004 (111x71x41.5mm) £1.56\*  
BIM 4005 (161x96x52.5mm) £2.08\*

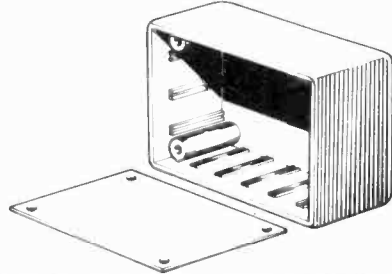

All aluminium, 2 piece desk consoles with either 15° or 30° sloping fronts, sit on 4 self-adhesive non slip rubber feet. Ventilation slots in base and rear panels permit efficient cooling.

Colour Code	Top Panel	Base	15° Sloping Panel	
A	Off White	Blue	BIM7151 (102x140x51[28]mm)	£ 9.43*
B	Sand	Green	BIM7152 (165x140x51[28]mm)	£10.43*
C	Satin Black	Gold	BIM7153 (165x216x51[28]mm)	£11.42*
			BIM7154 (165x211x76[33]mm)	£12.39*
			BIM7155 (254x211x76[33]mm)	£13.66*
			BIM7156 (254x287x76[33]mm)	£14.65*
			BIM7157 (356x211x76[33]mm)	£15.80*
			BIM7158 (356x287x76[33]mm)	£16.78*

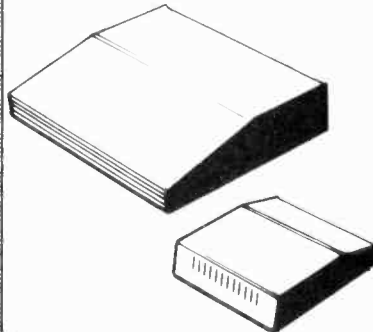

30° Sloping Panel	
BIM7301 (102x140x76[28]mm)	£ 9.43*
BIM7302 (165x140x76[28]mm)	£10.43*
BIM7303 (165x183x102[28]mm)	£11.42*
BIM7304 (254x140x76[28]mm)	£12.39*
BIM7305 (254x183x102[28]mm)	£13.66*
BIM7306 (254x259x102[28]mm)	£14.65*
BIM7307 (356x183x102[28]mm)	£15.80*
BIM7308 (356x259x102[28]mm)	£16.78*

## DIL COMPATIBLE BIMBOARDS

Bimboards accept all sizes of DIL packages as well as resistors, diodes, capacitors and LED's etc. They have integral Bus Strips running up each side for carrying Vcc and ground as well as Component Support Brackets for holding lamps, fuses and switches etc. Available as either single or multiple units, the latter mounted on 1.5mm thick, matt black aluminium back plates which stand on non slip rubber feet and have 4 screw terminals for incoming power.

Bimboard 1 contains 500 individual sockets whereas the multiple units containing 2, 3 or 4 Bimboards incorporate 1,100, 1,650 or 2,200 individual sockets, all arranged on a 2.5mm(0.1") matrix.

Bimboard 1 £ 9.72\* Bimboard 2 £22.68\*  
Bimboard 3 £32.40\* Bimboard 4 £42.12\*



## BIMINDICATORS

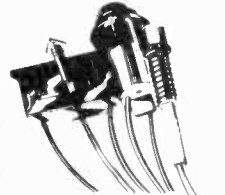

Remember we are also one of Europe's largest manufacturers of Filament, Neon and LED indicators. Send for our BIMINDICATOR DATA

## MAINS BIMDRILL

Operates directly from 220-240Vac and supplied with 2 metres long cable fitted with 2 pin DIN plug. Will drill brass, steel and aluminium as well as pcb's etc. Has integral biased-off switch and accepts tools with 1,2 and 3.2mm dia shanks £9.72\*

Accessory Kit including 1mm, 2mm, 125" twist drills, 5 burrs and 2.4mm collet £2.20\*

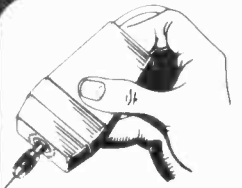

## 12 VOLT BIMDRILLS

2 small but powerful 12V dc drills, easily held in hand or used with lathe/stand adaptor. Both drills have integral on/off switches and 1 metre long cable.

Mini Bimdrill with 2 collets up to 2.4mm capacity £7.56\*

Major Bimdrill with 3 collets up to 3mm capacity £12.96\*

Mains to 12 Volts adaptor, lathe, stand and accessory kits also available, details on request.



# BOSS

## INDUSTRIAL MOULDINGS LIMITED

2 Herne Hill Road, London SE24 0AU

Telephone: 01-737 2383

Telex: 919693 Answer Back 'LITZEN G'

Cables & Telegrams: 'LITZEN LONDON SE24'

\*All quoted prices are 1 off and include Postage, Packing and VAT. Terms are strictly cash with order unless you have authorised BOSS account. For individual data sheets on all BOSS products send stamped, self addressed envelope

# MAPLIN

everything for the modern D.I.Y. electronics enthusiast and more.



**THE 'DRUMSETTE' RHYTHM GENERATOR**

Organists, pianists, guitarists... an automatic drum set to accompany you! Nine highly realistic instruments play fifteen different rhythms. Fifteen rhythm-select touch switches and a touch plate for stop/start without rhythm change gives absolute ease of operation. Build it yourself for under £65 including smart leak-effect cabinet. See it and hear it in our shop! Send for full construction details now: MES49, price 25p.

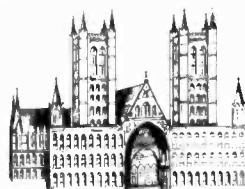

**REVERBERATION SYSTEMS**

High quality spring line driver module uses 4 integrated circuits and two transistors. Built and tested circuit board with wiring instructions for spring line. X8856, price £6.00. Power supply to suit drive module costs around £2.50 and construction details are in catalogue, or ask for leaflet MES24. Mechanical spring lines: Short line (X108J) £4.49; Long line (X884F) £10.39. (All prices include V.A.T. and p. & p.)

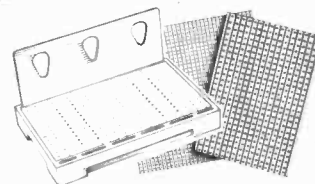

**BOARDS AND PCB's**

Pages 59 to 61 of our catalogue show you our range of Veroboards and S-Octs or if you prefer to make your own PCB's a range of etching systems including the novel etch-in-a-bag system, plus printed circuit transfers for the professional finish to your boards.



**9-CHANNEL RADIO CONTROL SYSTEM**

A comprehensive model control system, featuring nine independent fully proportional channels achieved by a design using very few components thus keeping the cost to a minimum. Full construction details in our booklet (XF03D) price £1.20.

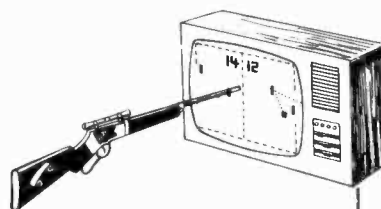

**T.V. GAME**

A fascinating TV game kit that plays football, tennis, squash and practice for only £21.59. Reprint of construction details 25p. Add on rifle kit only £10.60. (All prices include V.A.T. and p. & p.)

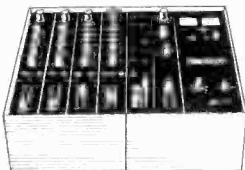

**AUDIO MIXER**

A superb stereo audio mixer. It can be equipped with up to 16 input modules of your choice and its performance matches that of the very best tape-recorders and hi-fi equipment. It meets the requirements of professional recording studios, FM radio stations, concert halls and theatres. Full construction details in our catalogue. A component schedule is available on request.

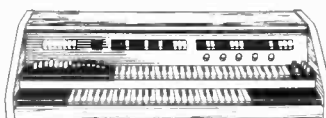

**ELECTRONIC ORGAN**

The only organ you can build in stages and tailor to your requirements as you go along — and at each stage you'll have a fully working instrument! We haven't got the gimmicks yet — (they're coming soon) but we have got the most beautiful sounds — you won't find them on any organ less than twice our price. So get our MES50 series leaflets now! 65p buys the three available so far.

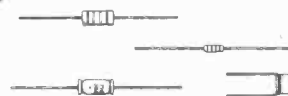

**MASSIVE RANGE OF COMPONENTS**

For instance the capacitor section in our catalogue includes non-polarised electrolytics and our resistor section includes even 1% tolerance types. Get our fascinating catalogue now — you won't regret it.

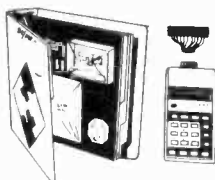

**MICROPROCESSOR**

Build a mini-computer with our microprocessor kit. Features: 46 different instruction types; 256 bytes of read/write memory (more are easily added); micro-processor can address up to 65,536 8 bit-bytes. Complete kit for use with teletype etc. (XB91Y), £74.10. 20-key keyboard for use with above (in place of teletype) (XB92A), £71.11. Both kits with detailed instruction books. See our newsletter for details of additional RAM's, tri-state interfacing chips, number-cruncher and standard cassette tape-recorder interface to store your programmes. (All prices include V.A.T. and p. & p.)



Our bi-monthly newsletter keeps you up to date with latest guaranteed prices — our latest special offers — details of new projects and new lines. Send 30p for the next six issues (5p discount voucher with each copy).



**IT'S A FANTASTIC BESTSELLER!**

216 big (11" x 8") pages! Over a thousand illustrations! Over 30 pages of complete projects to build! Thousands and thousands of useful components described and illustrated! No wonder it's a bestseller!

**DON'T MISS OUT! SEND 60p NOW!**

**MAPLIN ELECTRONIC SUPPLIES**

P.O. BOX 3 RAYLEIGH ESSEX SS6 8LR  
Telephone: Southend (0702) 715155  
Shop: 284, London Road, Westcliff-on-Sea, Essex  
(Closed on Monday) Telephone: Southend (0702) 715157

**POST THIS COUPON NOW FOR YOUR COPY OF OUR CATALOGUE PRICE 60p**

Please rush me a copy of your 216 page catalogue I enclose 60p, but understand that if I am not completely satisfied I may return the catalogue to you within 14 days and have my 60p refunded immediately.

NAME \_\_\_\_\_

ADDRESS \_\_\_\_\_

WW-013 FOR FURTHER DETAILS

# F.M. TUNERS, MODULES & UNITS by *Icon Design*

**T3** Six touch tuned pre-set stations plus manual tune, with digital frequency readout, combined with 1.8 micro-volt sensitivity and anti-birdy stereo make this one of the finest tuners available. Intelligent tuning indicator, a.f.c. and interstation mute included for easy operation by all the family. Two tone gold and brown front panel with teak veneer cabinet will blend with any surroundings. **£149.00**



**M1** This module is the heart of the above tuner, giving a mono output with a.f.c., mute, and tuning indicator functions. Drift free tuning by 10 turn pot over the range 88 to 108 MHz. This module will not let you hear out-of-tune stations, and the fine tuning lamp is extinguished unless a station is received. The ideal basis for any High quality F.M. system. **£29.95**



**M2** The ideal choice for adding stereo to the M1 module or any suitable mono receiver, this module has anti-birdy filters and pilot tone output filters, together with a phase-locked decoder for stable performance. **£8.36**

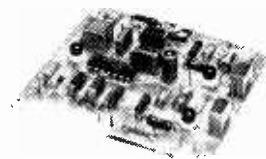

**M4** An integrated circuit regulator supplies all the power for the M1, M2 and M5, in addition to being short circuit proof and having automatic thermal shut-down, and ensuring hum free reception. **£6.93**

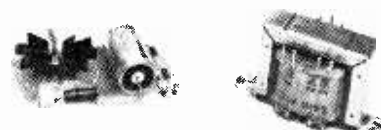

**M5** The M5(mk2) touch module adds 6 touch selected pre-set stations to the manual tuning already provided by the M1 module. Illuminated buttons indicate the channel selected, while remote control using a single contact push button steps the channels in an endless loop, including the manual control channel. Auto power-up channel selection may be set to any of the seven available channels. Remote inhibit and a lamp test facility are provided. **£17.54**



**M6** Using the optimum selection of discrete, E.C.L., T.T.L. and C-MOS technologies, this module will add the luxury of digital readout to the M1 module above, or any other LP1186 based receiver. The small (95 x 103mm) board contains all the logic, displays, and regulated power supply. Range is 60 to 99.9MHz, resolution 0.1KHz, and stability better than 40 p.p.m. per deg. C. It comes complete with mains transformer, polarised filter, and list of station frequencies. **£44.40**

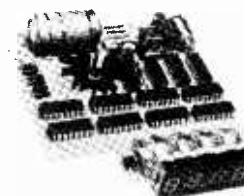

★★ PLUS TWO NEW ONES ★★

**M7** This new module is a 4 way touch select switch having illuminated touch buttons, and C-MOS logic level outputs. Features pre-set power-up selection, and remote step facility. Multiple units may be cascaded to give 8, 12 or more channels of switching, and two modules may be paralleled to give full remote control from two or more locations. The outputs may be used to control logic etc., or to drive the new M8 channel selector opposite. **£6.95**

**M8** Controlled from single pole switches, or the M7 module, this unit will switch 4 mono or two stereo audio channels. Two M8 modules will therefore switch 4 stereo signals driven by one M7 touch switch, or other combinations may be controlled by multiple touch switches, providing a flexible system of audio selection and control. The ideal module for pre-amplifier source selection, avoiding long signal wires to and from control panels, and their associated hum and cross-talk problems. **£4.95**

**ORDERING INFORMATION**

Small orders <£5.00 plus 50p handling charge.  
 U.K. Orders post free, plus 12.5% V.A.T.  
 Overseas, send for Pro-forma invoice first, or send £3.00 air mail for small items.  
 SEND FOR ILLUSTRATED DATA PACK  
 (Reply coupons please overseas)  
 ACCESS MASTERCHARGE BARCLAYCARD VISA  
 CREDIT CARDS TAKEN  
 (Just quote number when ordering)

**KITS AND COMPONENTS**

SL301	£1.67	BC184	£0.15	Cermet pre-sets	£1.20
SL3046	£0.94	BC214	£0.15	Transformers: 120/240v	
T8A750	£1.71	1N4001	£0.06	6VA 4.5v	£2.33
SL1310	£2.15	1N4148	£0.04	6VA 20v	£2.33
T8A625C	£1.65	P.C.B. M1	£2.64	Kil K14 (M1)	£27.95
UA78M20	£1.65	P.C.B. M2	£1.65	K57 (M2)	£6.84
UA78M05	£1.65	P.C.B. M3	£1.65	K112 (T3)	£137.80
SFJ10-7MA	£1.71	P.C.B. M4	£1.65	Descriptive booklet	50p
LP1186	£8.53	Coil ass.	£0.55	Overseas	£1.50
2N3904	£0.20	10t 50K pot	£3.89		

**TO ICON DESIGN.** 33 Restrop View  
 Purton, Wilts., SN5 9DG  
 Please supply data on (Circle as required)

M1 M2 M4 M5 Mk.2 M6 M7 M8 ALL

Address label Block letters

.....  
 .....  
 .....

# The amazing, automatic Logic Monitor LM-1.

Just clip it over your IC.  
It instantly and accurately shows both static and dynamic logic states, on a bright, 16-LED display.  
It finds its own power.

It cuts out guesswork, saves time, and eliminates the risk of short-circuits.

LM-1 is suitable for all dual-in-line logic ICs; DTL, TTL, HTL, CMOS; up to 16 pins.

LED on = logic state 1 (high), LED off = logic state 0 (low), and each LED is clearly numbered 1 to 16 in the conventional IC pattern.

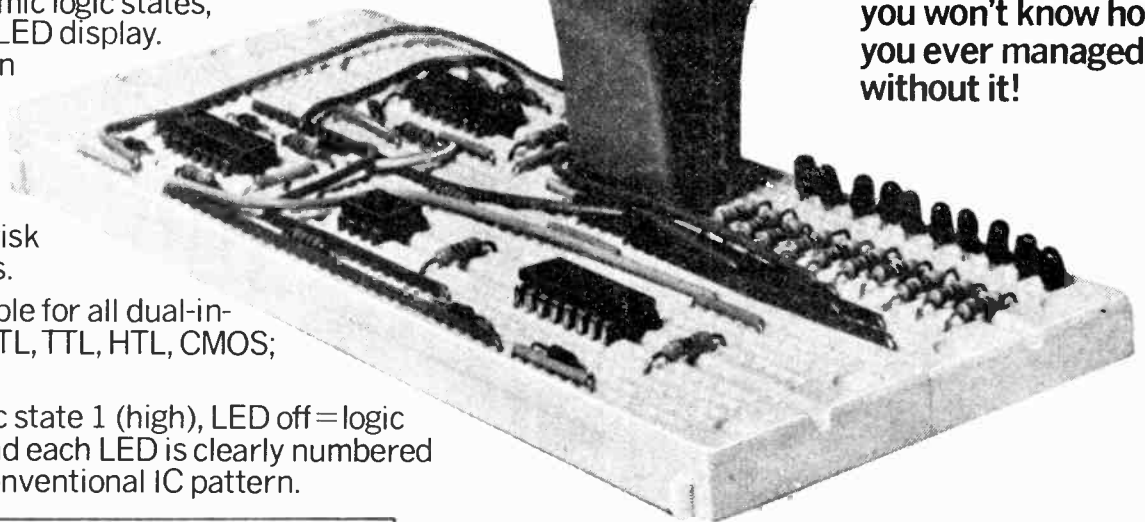

Try the LM-1 and you won't know how you ever managed without it!

#### Brief specification

Input Threshold	2V ± 0.2 volts.
Input Impedance	100,000 Ohms
Input Voltage Range	4 volts minimum 15 volts maximum across any two or more input leads
Maximum Current Drain	200 mA @ 10 volts
Maximum Input Frequency*	10,000 Hz 50% duty cycle
Operating Temperature Range	0°C to 50°C
Weight	3 ounces (85 grams)
Maximum Dimensions	4.0 x 2.0 x 1.8" 102 x 51 x 45 mm

\*LM-1 will respond to signals up to 0.1MHz when the input signal swing exceeds the threshold voltage by more than 0.5 volts.

#### Applications

Design, breadboarding, testing and checking new logic systems.  
Direct real-time monitoring of logic function in operating equipment.  
Long-term testing of individual ICs.  
Identification of unused elements, to find room for an extra gate, clock etc.  
Observing relationships between ICs on different boards of multiple board systems (you need more than one LM-1 to observe simultaneously, of course).  
Plus dozens of other uses. You'll find them.

#### It's Easy to Order

Ring us (01-890 0782) with your Access, Barclaycard or American Express number and your order will be in the post that night. Alternatively, send a cheque, or postal order (don't send credit cards!) and it still only takes a few days. Otherwise ask for our complete catalogue.

CONTINENTAL SPECIALTIES CORPORATION



# ONLY £28.70

Plus 8% VAT, plus post and packaging, total £32.35 including box and instruction manual.

CONTINENTAL SPECIALTIES CORPORATION (UK) LTD. SPUR ROAD, NORTH FELTHAM TRADING ESTATE, FELTHAM, MIDDLESEX TW1 40TJ. TELEPHONE: 01-890 0782.  
REG IN LONDON 1303780 VAT NO 224 8074 71 TRADE MARK APPLIED FOR CSC (UK) LTD 1977 DEALER ENQUIRIES WELCOME. TELEX: 8813669 CSCLTD.

WW-080 FOR FURTHER DETAILS

The new, comprehensive JVC 3/4" video cassette range

# See-and believe



**A pioneering electronics organisation with 51 years' experience of high-technology engineering, JVC has been developing and introducing new and better video products for 21 years.**

**Now, for the first time in Britain, you can choose from a new and comprehensive range of JVC 3/4" U-format colour-plus-monochrome video cassette units, up to 38% smaller than directly competitive equipment.**

**From the compact portable CR-4400E for location work to the versatile CR-8300E for production studios, these easy-to-use models meet every video cassette recorder demand. They give you exactly the same top-quality recording and playback throughout the range. Price differences simply reflect the number of facilities available, not the performance.**

**The range.** For those needing NTSC as well as PAL playback (perhaps for shipboard entertainment), JVC has the new CR-5060ED.

If you're looking for stop-action playback and PAL record/playback facilities, the new CR-6060E with its specially engineered still-frame system is the one for you. (Optional remote control available.)

PAL recording, plus PAL and NTSC playback, come together in the new CR-6060ED. Again, with optional remote control.

Full electronic editing facilities are built into the superb new CR-8300E, a PAL record/playback unit. For even more flexible editing, add the JVC RM83 editing suite.

Where you must have portable video equipment, able to record cassettes that can also be replayed by a mains cassette unit without an adaptor, it's got to be the new assembly-edit CR-4400E. This comes complete with built-in video/RF replay facilities. And, of course, there's a colour camera to match.

Use the inquiry service to get the literature from Bell & Howell and the name and address of an audio-visual centre where you can test for yourself the versatility of these new JVC units. Admire the outstanding picture quality each provides. Seeing is believing. You'll believe, as we do, that JVC U-format equipment is the best in the world.

WW 098 FOR FURTHER DETAILS

### Fuji Beridox tape

To get the optimum results from any U-format equipment use Fuji Beridox tape. *Provably* superior to conventional CrO<sub>2</sub> tape, it's now available from every Bell & Howell dealer.



Beridox 3/4" (19mm) video cassettes

**KCA-10** (10 min. playing time)

**KCA-15** (15 min. playing time)

**KCA-20** (20 min. playing time)

**KCA-30** (30 min. playing time)

**KCA-50** (50 min. playing time)

**KCA-60** (60 min. playing time)

1/2", 1" and 2" video tape also available.

Bell & Howell A-V Ltd.  
Alperton House,  
Bridgewater Road,  
Wembley, Middlesex, HA0 1EG.

 **BELL & HOWELL**

# MICRO-CPU'S MEMORY INPUT/OUTPUT INTELLIGENT PERIPHERALS

Intel – the world's leading manufacturer of advanced integrated circuits – scores again. Using MOS technology they've produced memory and microprocessor devices which together provide powerful computing functions in just a few packages ... at low cost! All are fully supported with development systems, software and debugging aids. Like the complete range of Intel products, they're supplied, stocked and supported by us in depth. A phone call will bring all you need.

Your  
**intelephone**  
number

**01-904 9303**

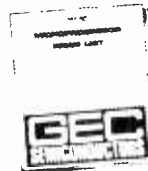

This easy-reference descriptive price list contains over 2000 Intel products. We'll be delighted to send it to you by return of post with our latest up-date material. Just use the reader reply service or send this coupon to GEC Semiconductors Ltd., East Lane, Wembley, Middx HA9 7PP, Telex: 923429.

Name \_\_\_\_\_

Company \_\_\_\_\_

Address \_\_\_\_\_

WW2

**GEC**  
**SEMICONDUCTORS**

WW-016 FOR FURTHER DETAILS

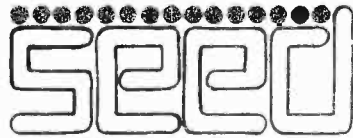

PORTLAND HOUSE, COPPICE SIDE, BROWNHILLS

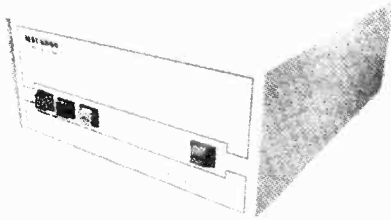

**MSI 6800**  
with 8K Ram.  
**KIT £375**



**NEW SWTPC 6800**  
Level 2  
**KIT £300**

**FD8 FLOPPY DISC £935. BFD68 MINI FLOPPY £522**  
**SOROC 1Q120 TERMINAL £699 ASS.**  
**CASSETTE INTERFACE KIT £18.95**

Send S.A.E. for full brochure

**STRUMECH ENG. ELECTRONICS DIV. BROWNHILLS 4321**  
**SOLE U.K. DISTRIBUTOR FOR MSI & SMOKE SIGNAL BROADCASTING**

WW-059 FOR FURTHER DETAILS

## METER PROBLEMS?

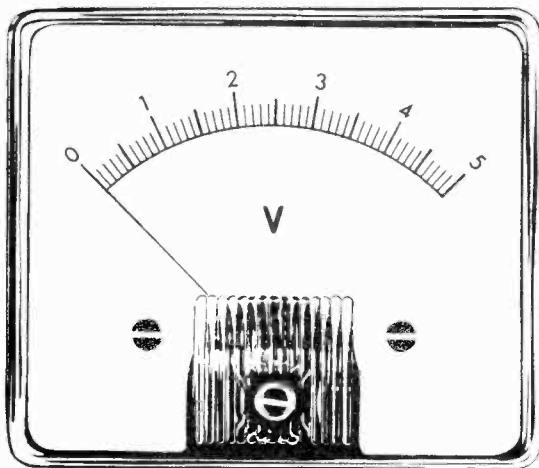

137 Standard Ranges in a variety of sizes and stylings available for 10-14 days delivery. Other Ranges and special scales can be made to order.

Full Information from:

**HARRIS ELECTRONICS (London)**

13B GRAYS INN ROAD, W.C.1 Phone: 01/837/7937

WW-051 FOR FURTHER DETAILS

## Autocrat

*The absolute leader in its class*

Farnell offer the only  
**DIGITAL MULTIMETER**  
with all these features

- ★ AUTORANGING (with hold) ★ AUTOPOLARITY
- ★ AUTOZERO ★ SIX RESISTANCE RANGES
- ★ LARGE DISPLAYS ★ A.C. & D.C. VOLTS & CURRENTS
- ★ TEMPERATURE MEASUREMENT

DM 131  
(mains powered)

**£159**

DM 131/B  
(mains battery)

**£195**



Details from: Farnell Instruments Limited - Wetherby - W. Yorks LS22 4DH  
Telephone: 0937-63541 or 01-864 7433

WW-089 FOR FURTHER DETAILS



# Five Great Kits from DORAM

Kit  
£79.95 + VAT  
Ready Built  
£99.95 + VAT

## DISTORTION METER

Range 20Hz to 40KHz.  
T.H.D. down to 0.003%.



Kit  
£69.95 + VAT  
Ready Built  
£89.95 + VAT

## AUDIO MILLIVOLTMETER

Measurement from 15Hz to 100KHz  $\pm 1/2$  db. Input impedance 1M $\Omega$  with 600 $\Omega$  load.

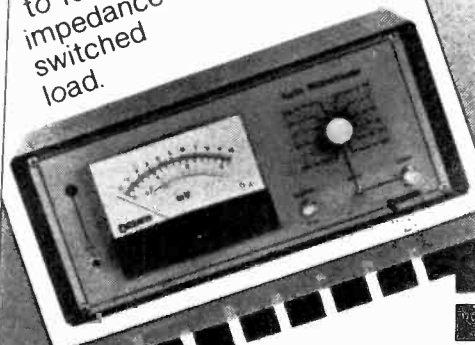

## FUNCTION GENERATOR

Sine, triangle and square waves from 0.1Hz to 100KHz  
Adjustable sweep (10:1) and burst facilities.

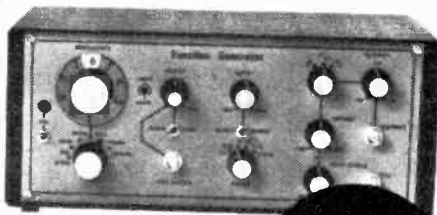

Kit  
£79.95 + VAT  
Ready Built  
£99.95 + VAT

Kit  
£59.95 + VAT  
Ready Built  
£79.95 + VAT

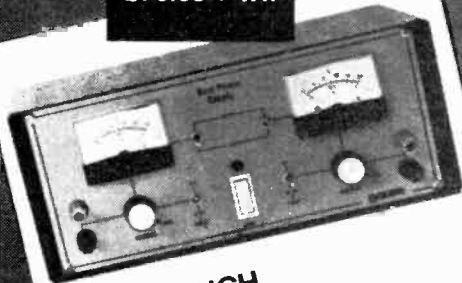

## DUAL BENCH POWER SUPPLY

Dual independent 3-20v dc.  
Current limits are switched at 100mA and 1A.

## LOW DISTORTION OSCILLATOR

Extremely low distortion (0.005% @ 1KHz). Range 10Hz to 100KHz in 4 decades.

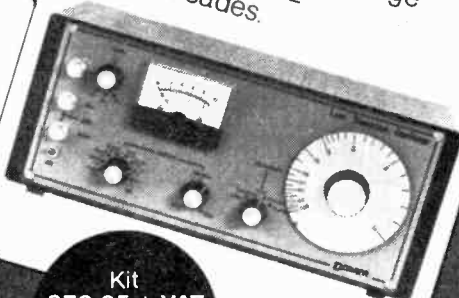

Kit  
£79.95 + VAT  
Ready Built  
£99.95 + VAT

Please send me the following, I enclose cheque/PO made payable to Doram Electronics value £.....

<b>Order Code</b>	<b>Distortion Meter</b>	
60-612-1	<input type="checkbox"/> Kit	£79.95 + VAT
74-720-0	<input type="checkbox"/> Ready Built	£99.95 + VAT
<b>Order Code</b>	<b>Function Generator</b>	
60-638-9	<input type="checkbox"/> Kit	£79.95 + VAT
74-740-6	<input type="checkbox"/> Ready Built	£99.95 + VAT
<b>Order Code</b>	<b>Audio Millivoltmeter</b>	
60-614-5	<input type="checkbox"/> Kit	£69.95 + VAT
74-730-3	<input type="checkbox"/> Ready Built	£89.95 + VAT
<b>Order Code</b>	<b>Dual Bench Power Supply</b>	
60-631-0	<input type="checkbox"/> Kit	£59.95 + VAT
74-750-9	<input type="checkbox"/> Ready Built	£79.95 + VAT
<b>Order Code</b>	<b>Low Distortion Oscillator</b>	
60-610-7	<input type="checkbox"/> Kit	£79.95 + VAT
74-710-7	<input type="checkbox"/> Ready Built	£99.95 + VAT

Name.....  
Address.....

**DORAM** Dept W. W.

PO Box TR8, Wellington Road Industrial Estate, Wellington Bridge, Leeds LS12 2UF.

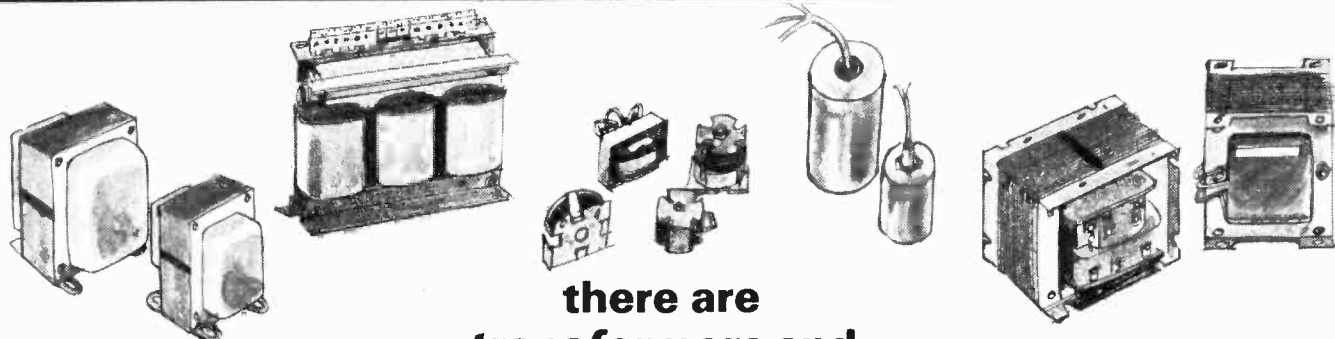

there are  
*transformers* and  
**Drake Transformers**

A wide range of transformers  
manufactured in production  
quantities to customers' own  
requirements; prompt design  
and prototype service.

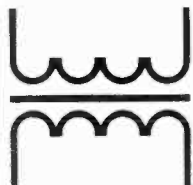
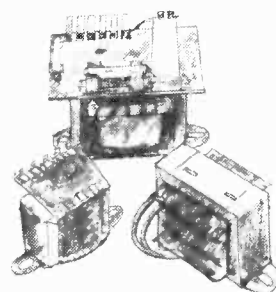
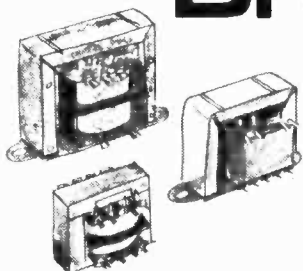

**Drake Transformers Limited**

South Green Works, Kennel Lane, Billericay, Essex CM11 2SP  
Telephone: Billericay 51155. Telex: 99426

WW/063 FOR FURTHER DETAILS

Total Capability  
in soldering

**LITESOLD**

ETC/2B SYSTEM Tamper-proof  
adjustable electronic  
temperature control

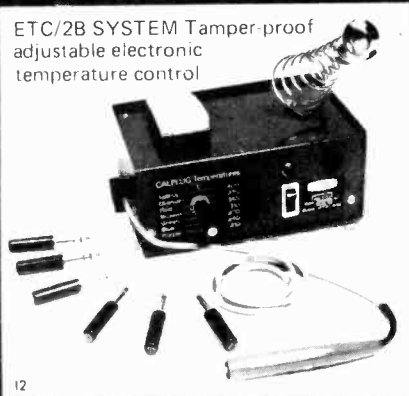

Send TODAY for FREE  
Catalogue with full details  
of this and other  
equipment



SOLDER Resin cored wire and chips  
for solder pots

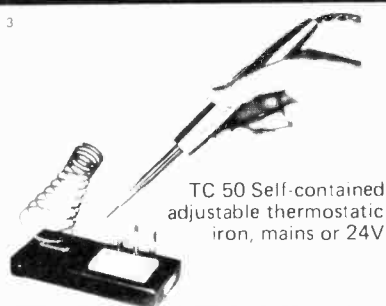

TC 50 Self-contained  
adjustable thermostatic  
iron, mains or 24V

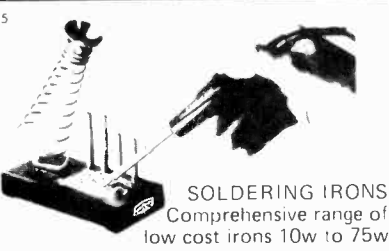

SOLDERING IRONS  
Comprehensive range of  
low cost irons 10w to 75w

THERMAL WIRE STRIPPERS  
Both blades heated for PVC etc.



**LIGHT SOLDERING DEVELOPMENTS LTD**

97-99 Gloucester Road, Croydon, Surrey CR0 2DN Telephone 01-689 0574, Telex 8811945

WW-093 FOR FURTHER DETAILS



# FAST RESPONSE STRIP CHART RECORDERS

Made in USSR

## Series H3020

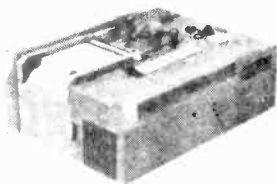

Basic error: 2.5%  
Sensitivity: 8mA F.S.D.  
Response: 0.2 sec.  
Width of each channel:  
Single and three-pen  
recorders: 80mm  
Five-pen recorders: 50mm

Chart speeds, selected by push buttons: 0.1-0.2-0.5-1-0.2-5-5-0-12-5-25 mm/sec.

Chart drive: 200-250V 50Hz

Recording: Syphon pen directly attached to moving coil frames

Curvilinear co-ordinates

Equipment: Marker pen, timer pen, paper footage indicator, 10 rolls of paper, connectors, etc.

**H3020-1 (Single pen):** 285mm wide x 384mm deep x 165mm high  
**PRICE £108.00**

**H3020-3 (Three pen):** 475mm wide x 384mm deep x 165mm high  
**PRICE £160.00**

**H3020-5 (Five pen):** 475mm wide x 384mm deep x 185mm high  
**PRICE £295.00**

## Series H327

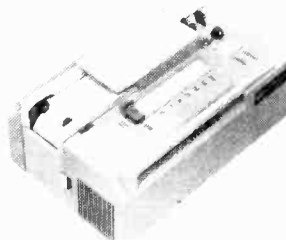

Polarized moving iron movements with syphon pens directly attached. Built-in solid state amplifier (one per channel) provides 8 calibrated sensitivity steps. Two marker pens are provided.  
Basic error: 4% Frequency response from DC to 100Hz 2dB

Sensitivity: 0.02 - 0.05 - 0.1 - 0.2 - 0.5 - 1 - 2 - 5 volts/cm

Width of each recording channel: 40mm

Chart drive: 220-250V 50Hz

Chart speeds: 1-2-5-10-50-125-250mm/sec

**Type H3271-1. Single pen:** Dimensions: 259 x 384 x 165mm  
Weight 15 kilos  
**PRICE £265.00**

**Type H327-3. Three pen:** Dimensions: 335 x 384 x 165mm  
Weight 20 kilos  
**PRICE £520.00**

**Type H327-5. Five pen:** Dimensions: 425 x 385 x 165mm  
Weight 25 kilos  
**PRICE £770.00**

Note: Prices are exclusive of VAT

Available for immediate delivery

# Z & I AERO SERVICES LTD.

44A WESTBOURNE GROVE, LONDON W2 5SF

Tel. 01-727 5641

Telex: 261306

WW-082 FOR FURTHER DETAILS

After the introduction of the CQ 110 E and CQ 301, NEC have completed their CQ-Line with the CQ 201 Digital VFO, the SP 110 Speaker and the M110 SSB Microphone. The NEC CQ-Line represents highest technical standard, with regard to design, quality, reliability and price which is available to the modern radio communicator today.

**NEC CQ 110 E**, 300 watts Digital transceiver Modes: FSK/USB/LSB/CW/AM, 100-240V AC/13.5VDC handmike. Control speaker, VOX Sidetone, 3 Xtal filters, Blower, RCA 7360 RX Mixer, 22 fix-channels, 60 Page Manual, 160-10 meter, 11 Ranges of 500 KHz.

**NEC CQ 301** 2-3 KW SSB/AM Linear Amplifier 160-10 meter, 2 EIMAC 3-500Z. Handbook, 100-240 V AC, High Speed Blower, incorp. Power Supply.

**NEC CQ 201** Digital Additional VFO for Split-Frequency Operation, containing 3 VFO systems, usable as frequency counter, 100-240 V AC/13.5VDC, Handbook.

**NEC SP 110** Communication Speaker with Electronical Digital

Clock, timer, etc. handbook 100-240 VAC

**NEC M 110** SSB Communications Microphone, designed for CQ-Line.

Colour of CQ line brown military sand-touch.

- ★ Dealer inquiries welcome
- ★ ASK ABOUT OUR UP TO 120 DAYS FINANCING FACILITIES
- ★ ASK FOR OUR COLOUR CATALOGUE against payment of SFR 16 — or any other equivalent currency.
- ★ Shipments to EVERYWHERE



Sole distributor in Europe:

**CEC** Corp., Via Valdani 1 — CH 6830 CHIASSO—SWITZERLAND  
Phone: (091) 44 26 51. Telex: 79959 CH

WW-042 FOR FURTHER DETAILS

# RA200/ADS1

## Frequency response analysis with a difference

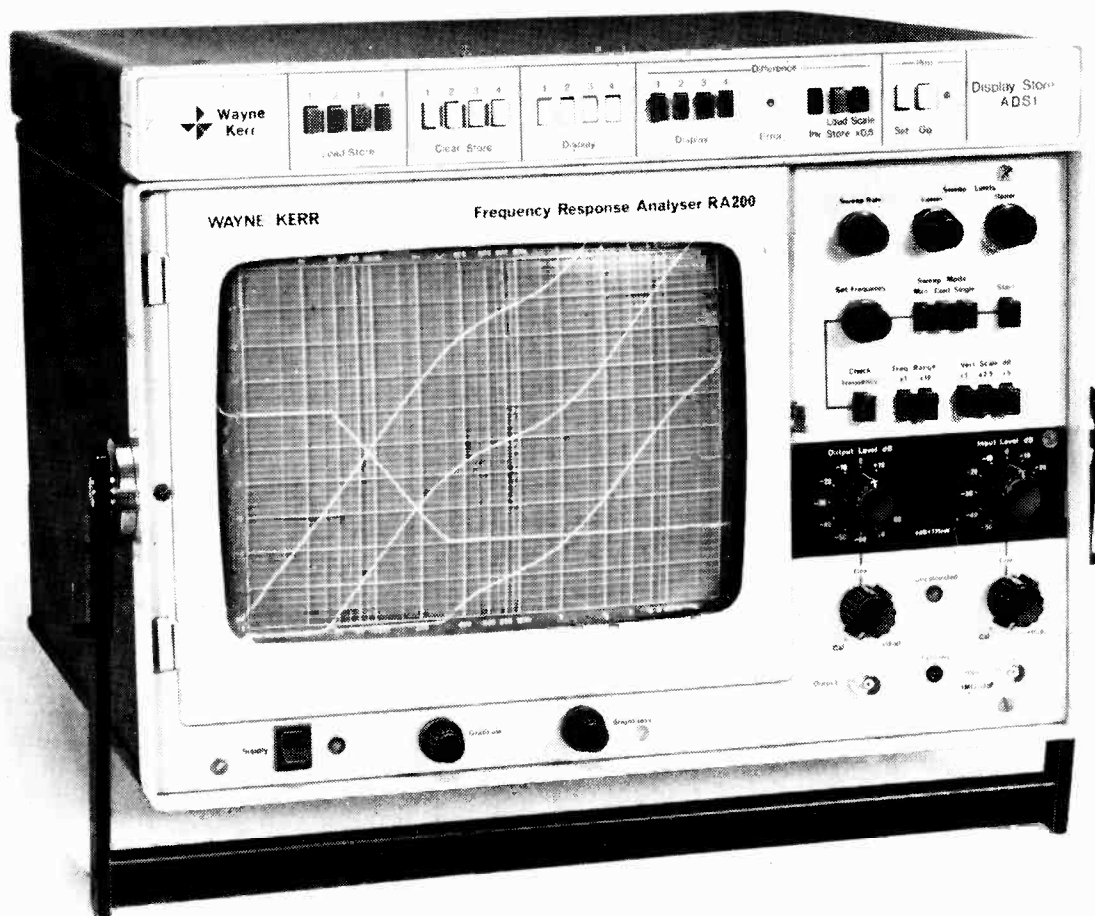

The Wayne Kerr RA200/ADS1 is undoubtedly unique. It gives fast, accurate frequency response measurements for any audio system - displaying up to five different curves as gain/frequency plots on a long-persistence CRT. The basic unit, the RA200, performs all the detector and sweep functions, requires no synchronisation, and will adjust automatically to the incoming frequency.

### Four Channel Digital Store

The matching display store, the ADS1, is a fully compatible digital storage unit powered by the RA200, and can give continual updating of each curve stored to ensure fast, precise readouts.

It incorporates rechargeable batteries to permit stored data to be retained for up to two weeks when the unit is switched off.

### The RA200/ADS1

This complete unit provides facilities for displaying the difference between any two stored curves, or comparison of any new input with a stored reference curve. Minor variations from a desired characteristic can be readily amplified, and departures from a linear response clearly shown as deviations from a straight line by use of the store 'invert'. Slow-acting pen recorders can also be driven by the unit.

For more details fill in the coupon or contact your nearest distributor:

Tekelec-Airtronic. Cite des Bruyeres. Rue Carle-Vernet. 92310 Sevres. Paris. France, Tel: 027 75 35.

Keithley Instruments GmbH. Heighhofstrasse 5. 8000 Munchen 70. West Germany. Tel: (089) 7144065.

G & P Electronics AG. Bernerstrasse-Nord 182. Ch-8064 Zurich. Switzerland. Tel: (01) 643231.

C N Rood BV. PO Box 42. 11-13 Cort van der Lidenstraat. Rijswijk ZH 2109. Holland. Tel: (70) 99 63 60.

Unitronics SA. Torre de Madrid. Princesa 1. Piso 12 Oficina 9. Madrid 8, Spain. Tel: 242 5204.

Scandia Metric AB. Fack 171 19. Solna 1. Banvaktsvagen 20. Sweden. Tel: (08) 820 410.

Please send me further information on the Wayne Kerr RA200/ADS1.

Name \_\_\_\_\_

Company \_\_\_\_\_

Address \_\_\_\_\_  
 \_\_\_\_\_  
 \_\_\_\_\_

Tel: \_\_\_\_\_



Wilmot Breeden Electronics Limited  
 442 Bath Road, Slough, Berkshire SL1 6BB England

WW/6/78

WW 096 FOR FURTHER DETAILS

# This FM Mobile Radiotelephone has a voice that you can live with

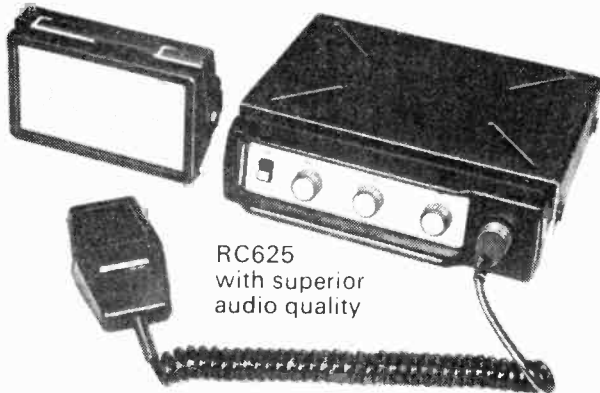

RC625  
with superior  
audio quality

Nothing wears a radiotelephone user more than listening to a 'squawk box.' Marconi Communication Systems Model RC625 gives you speech quality you can listen to all day.

Compact, lightweight, FM radio-telephone with 10-channel capability.

Outstanding reliability, with extended life and built-in ease of servicing.

Built to withstand agricultural and industrial use and hostile environments — vibration, heat, cold and dirt.

Quick and easy to install.

Full range of ancillary equipment and facilities available.

Ask for details of Model RC625 and of the full range of radiotelephones.

Please direct U.K. enquiries to Mr A. E. Robinson: overseas enquiries to Mr P. Metheringham.

## Marconi Communication Systems Limited Mobile Radio Division

Marrable House, Great Baddow,  
Chelmsford, Essex CM2 7QW, England  
Telephone: Chelmsford (0245) 73331 Telex: 99201  
A GEC-Marconi Electronics Company

WW-068 FOR FURTHER DETAILS

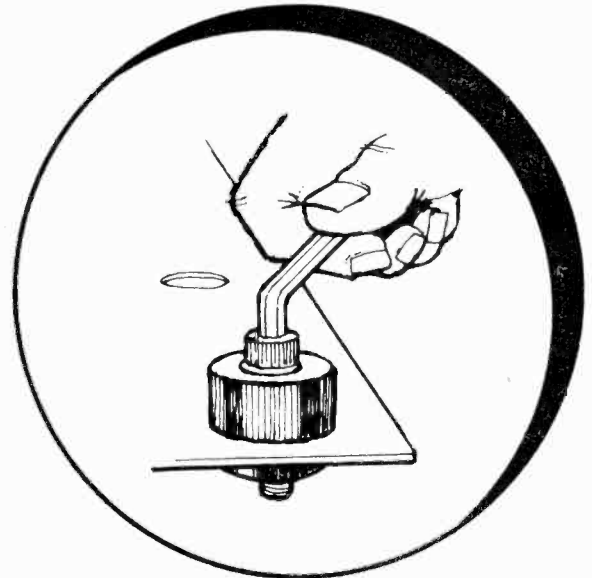

# FOR CLEAN HOLES FAST!

- Easiest and quickest way of punching holes in sheet metal (up to 1.625mm mild steel)
- Q-MAX stands for quality and reliability
- Holes are punched cleanly and no filing is necessary
- Continuous even load during punching  
No jagged edges. Burr freehole
- Specially heat treated to maintain keen cutting edge
- Used for years all over the world
- Simple operation, saving time and energy

57 METRIC & LINEAR SIZES



SHEET METAL PUNCHES

Q-Max (Electronics) Ltd <sup>(R)</sup>

40-41 Furnival Street  
London EC4A 1JQ  
Telephone: 01-242 7400

WW-067 FOR FURTHER DETAILS

# New from Thomson-CSF

the chip that converts  
any TV set into a  
low cost microprocessor  
interface display unit

625 line TV set or monitor

**features:**

- Low price – available as chip or display card
- Uses standard parts
- Full cursor control
- Multi-page capability
- Line erase
- Single 5V supply
- TTL/LSI compatible
- 16 lines, 64 characters
- Text scroll

Write or phone for full technical data

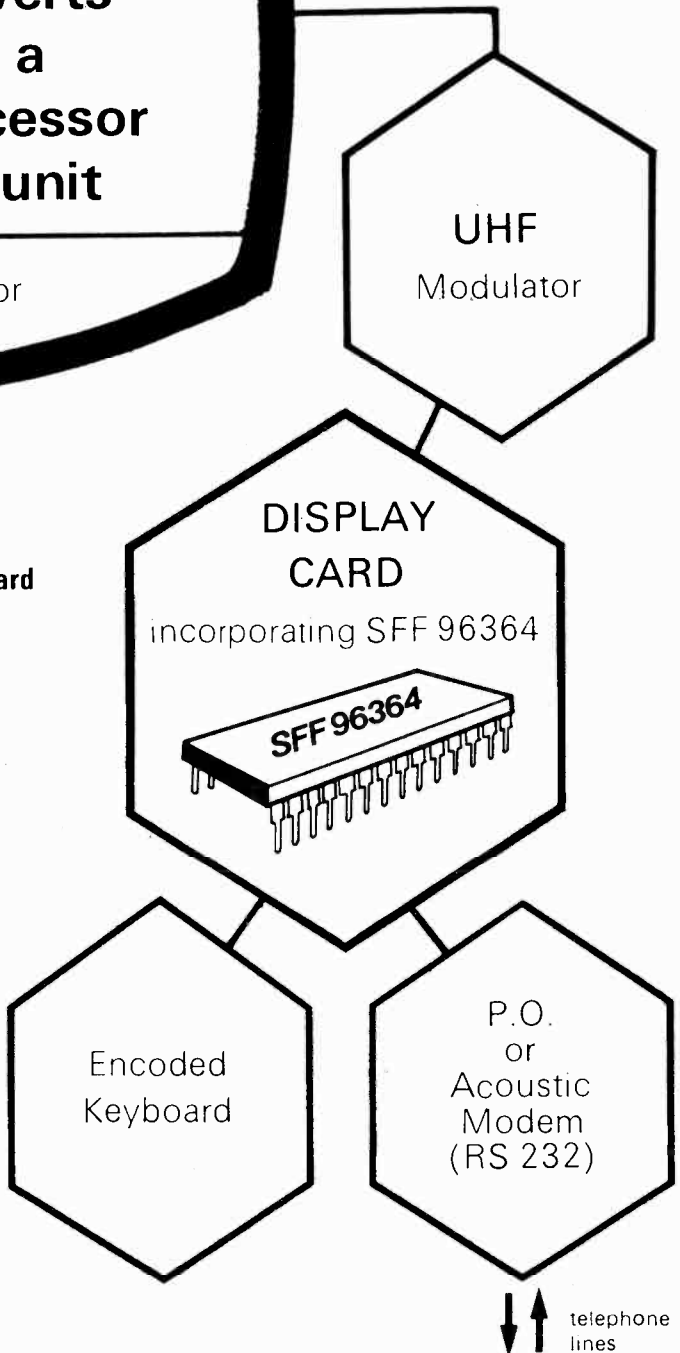

**THOMSON-CSF**

Thomson-CSF Components and Materials Ltd., Ringway House, Bell Road, Daneshill, Basingstoke RG24 0QG Telephone: 0256 29155  
 Available from these Thomson-CSF distributors: Barlec Ltd., 219 London Road, East Grinstead, Sussex. (0342 24383). Lock Distribution, Neville Street, Middleton Road, Oldham, Lancs OL9 6LP. (061 652 0431). A. Marshall (London) Ltd., 42 Cricklewood Broadway, London NW2. (01-452 0161). Omni Components Ltd., 59 Vastern Road, Reading, Berks (0734 594834). Phoenix Electronics (Portsmouth) Ltd., 139-141 Havant Road, Drayton, Portsmouth, Hants. (070 18 73441). Semiconductor Specialists (UK) Ltd., Premier House, Fairfield Road, Yiewsley, West Drayton, Middx (08954 46415). Spenco Electronics (Phoenix) Ltd., Kelvin Industrial Estate, East Kilbride, Scotland (035 52 36311). Woolley Components Ltd., Tudor Road, Broadheath, Altrincham, Cheshire (061 941 1911).

WW-100 FOR FURTHER DETAILS

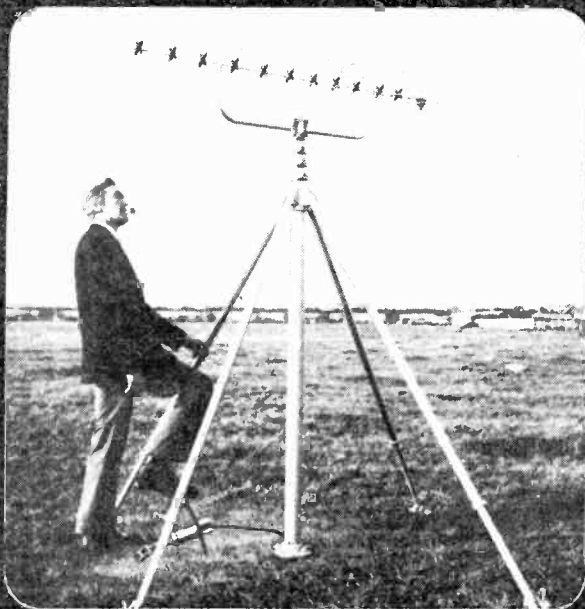

# Hilomast Ltd

## HILOMAST SYSTEMS

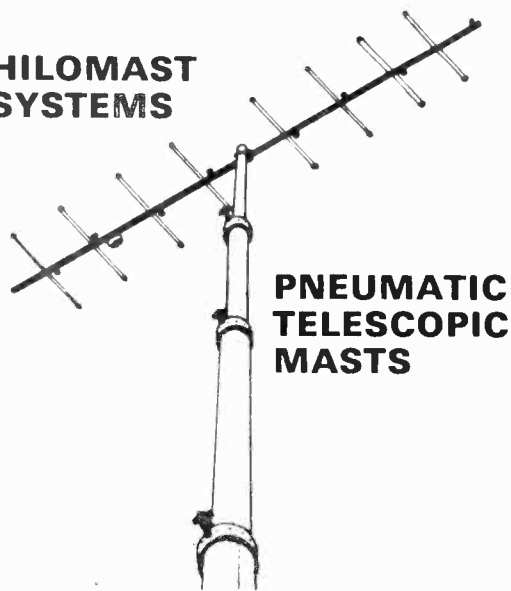

### PNEUMATIC TELESCOPIC MASTS

Pneumatic and winch operated telescopic masts and towers. Vehicle, field and wall mountings available. Many standard models ex-stock.

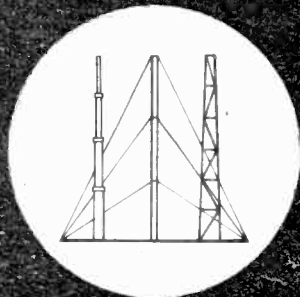

**HILOMAST LIMITED**  
 THE STREET HEYBRIDGE MALDON  
 ESSEX CM9 7NB ENGLAND  
 Tel. MALDON (0621) 56480

WW-050 FOR FURTHER DETAILS

# THE JAMES SCOTT INDUSTRIAL MICROWAVE RANGE OF EQUIPMENT

The James Scott range of Microwave equipment offers industrial users a greater choice of alternative systems in robust, industrial, cast aluminium housings, for a wide variety of applications.

The range is made up of standard sub-assemblies which can be permuted to suit individual application requirements. Here are some suggested applications for these units.

- TRAIN CONTROL SYSTEMS
- SAFETY BARRIERS
- INTRUDER ALARMS
- ROAD VEHICLE SENSING SYSTEMS
- PROXIMITY ALARMS
- PROCESS CONTROL SYSTEMS
- INDUSTRIAL ALARM SYSTEMS
- SMALL OBJECT COUNTERS
- POSITIONING SYSTEMS
- PRESENCE/ DETECTORS
- VIBRATION SENSING SYSTEMS
- LEVEL CONTROLLERS
- DOOR OPENING SYSTEMS

Please write or telephone for further information and technical literature to

**JAMES SCOTT**  
 (Electronic Engineering) Ltd  
 CARNTYNE INDUSTRIAL ESTATE  
 GLASGOW G32 6AB Tel. 041-778 4206 Telex 778286

WW-072 FOR FURTHER DETAILS



## POWER AMPLIFIER CP2-15/20



Each CP2-15/20 contains two identical amplifiers, each of which can give 20 Watts rms into 4 Ohms (15W into 8 Ohms). Alternatively the module may be connected to give 40 Watts into 8 Ohms. Protection is provided against short and open circuit loads, reverse supply connection (as all Magnum Modules) and thermal overload. Transient performance is virtually unaffected by loading and free from overshoot and TIM distortion. THD is typically 0.03% @ 1 kHz. All this adds up to a versatile and robust amplifier of extremely 'clean' and 'musical' performance

**CP2-15/20 £14.46 inc. (U.K.)**

**Also Available:** Pre-Amplifiers, Peak Programme Monitors, Filters, Stereo Image Width Control, Compressor/Expander, Active Crossovers, Power Supplies, Interconnection PCBs, plus all pots, switches, etc.

### MAGNUM AUDIO Ltd.

DEPT W2, 13 HAZELBURY CRESCENT  
LUTON, BEDS. LU1 1DF  
TEL: 0582 28887

SEND LARGE S.A.E. FOR DETAILS

WW-037 FOR FURTHER DETAILS

# seen from the professional angle

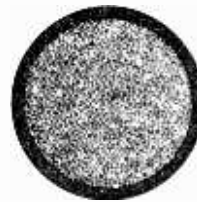

## the 201 is something quite personal...

The M 201 Hypercardioid moving coil microphone is designed for recording or broadcasting. The M 201 offers excellent separation characteristics in extreme acoustical conditions.

#### Specifications:

Frequency Response: 40-18000 Hz.  
Output Level at 1 kHz: 0,14 mV/ $\mu$  bar  
 $\pm$  -56 dbm (0 dbm  $\pm$  1 mW/10 dynes/cm<sup>2</sup>). EIA Sensitivity Rating: -149 dbm. Hum Pickup Level: 5  $\mu$  V/5  $\mu$  Tesla (50 Hz). Polar Pattern: Hypercardioid. Output Impedance: 200  $\Omega$ . Load Impedance: > 1000  $\Omega$ . Connections: M 201 N (C) = Cannon XLR-3-50 T or Switchcraft: 2+3 = 200  $\Omega$ , 1 = ground. M 201 N = 3-pin DIN plug T 3262: 1+3 = 200  $\Omega$ . 2 = ground. M 201 N (6) = 6 pin Tuchel.

Dimensions: length 6", shaft  $\varnothing$  0,95".  
Weight: 8,60 oz.



**BEYER DYNAMIC (GB) LIMITED**

1 Clair Road, Haywards Heath, Sussex.  
Tel: Haywards Heath 51003

WW-044 FOR FURTHER DETAILS

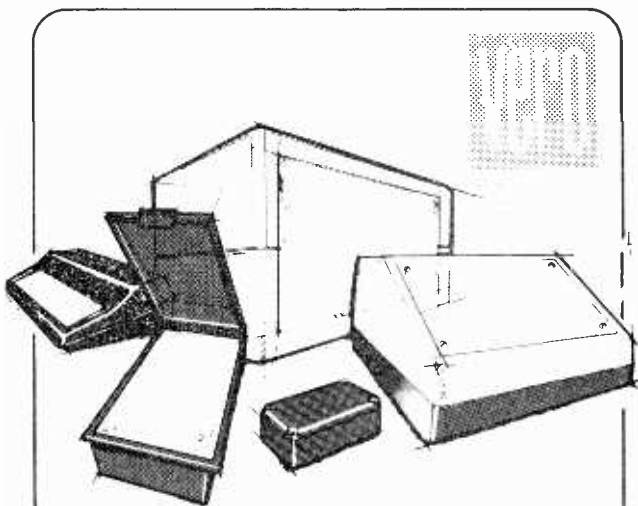

Our new 19/8 catalogue lists a whole range of plastic boxes to house all your projects. And we've got circuit boards, accessories, module systems, and metal cases - everything you need to give your equipment the quality you demand. Send 25p to cover post and packing, and the catalogue's yours.

**VERO ELECTRONICS LTD. RETAIL DEPT.**  
Industrial Estate, Chandlers Ford, Hants. SO5 3ZR  
Telephone Chandlers Ford (04215) 2956

WW-009 FOR FURTHER DETAILS

# Coaxial Relay

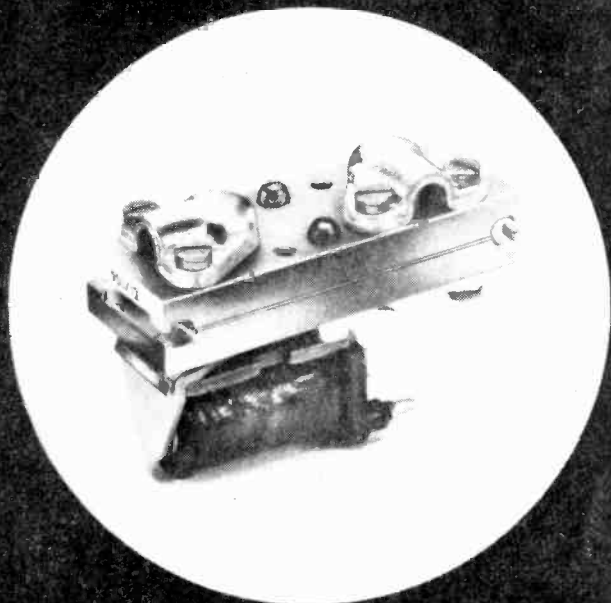

## for aerial switching

Pye Electro-Devices' Series 951 coaxial relay is designed for high speed switching of signals up to 450 MHz. It can be used to advantage in applications requiring exceptionally low inter-contact capacitance.

Multi-position clamps enable UR43 type coaxial cables to be connected directly to the relay body. Connection is simple and efficient. And there's no need for coaxial plugs and sockets. Consequently the relay is extremely compact, and weighs less than 100g.

The contacts are rated at 1A or 50W maximum, and coils are available for operation at up to 100V d.c.

Contact us today  
for further information.



**Pye Electro-Devices Ltd.**

Controls Division, Exning Road, Newmarket, Suffolk CB8 0AX  
Tel. Newmarket (0638) 5161 Telex 81245

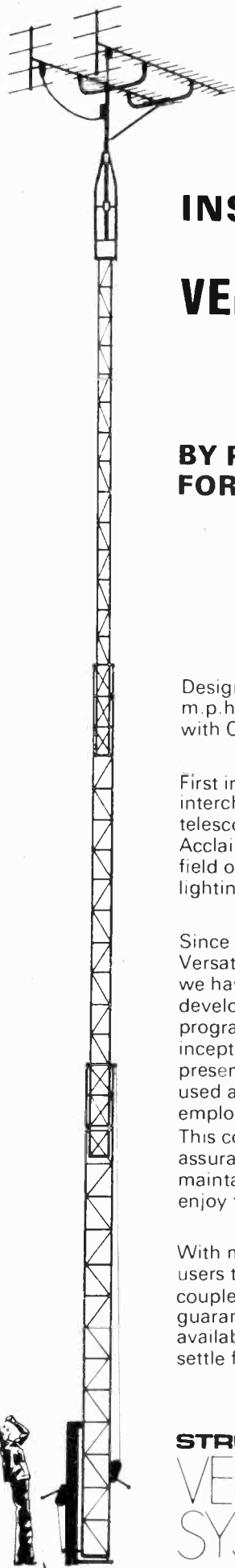

## INSIST ON VERSATOWER

### BY PROFESSIONALS— FOR PROFESSIONALS

Designed for Wind Speeds from 85 m.p.h. to 117 m.p.h., conforming with CP3 Chapter V, part II.

First in the field with a fully interchangeable (versatile) telescopic, tilt over, tower system. Acclaimed as the world leader in the field of communications and lighting, both static and mobile.

Since the launching of the Versatower system early in 1968 we have operated a continuous development and applications programme. Consequently from inception right through to the present day, detail design, materials used and production techniques employed are continually updated. This coupled with our quality assurance scheme ensures that we maintain the leader position we enjoy today.

With many thousands of satisfied users throughout the world, coupled with our no nonsense guarantee and immediate spares availability, it makes little sense to settle for an alternative product.

**STRUMECH**  
VERSATOWER  
SYSTEM



# A. D. BAYLISS & SON LTD.

## Behind this name there's a lot of real POWER!

Illustrated right is a **TITAN DRILL**

Mounted in a multi-purpose stand. This drill is a powerful tool running on 12v DC at approx 9000 rpm with a torque of 350 gm. cm. Chuck capacity 3.00 m/m. The multi-purpose stand is robustly constructed of steel and aluminium. The base and bracket are finished in hammer blue.

Also available for use in the stand is the **RELIANT DRILL** which is a smaller version of the Titan. Approx. speed 9000 rpm, 12v DC, torque 35 gm. cm. Capacity 2.4 m/m.

- |                                  |  |
|----------------------------------|--|
| <b>TITAN DRILL &amp; STAND</b>   | <b>£21.45</b>                                |
| TITAN DRILL ONLY                 | + 8% VAT = £23.17 + £1 P&P                   |
| <b>RELIANT DRILL &amp; STAND</b> | <b>£9.79 + 8% VAT = £10.57 + 35p P&amp;P</b> |
| RELIANT DRILL ONLY               | + 8% VAT = £19.92 + £1 P&P                   |
| <b>TITAN MINI DRILL KIT</b>      | <b>£18.44</b>                                |
| Drill Plus 20 Tools              | + 8% VAT = £19.92 + £1 P&P                   |
| <b>RELIANT MINI DRILL KIT</b>    | <b>£16.25</b>                                |
| Drill Plus 20 Tools              | + 8% VAT = £17.55 + 50p P&P                  |
| <b>TRANSFORMER UNIT</b>          | <b>£13.20</b>                                |
| Drill Plus 20 Tools              | + 8% VAT = £14.26 + 50p P&P                  |
| <b>TRANSFORMER UNIT</b>          | <b>£9.40</b>                                 |
|                                  | + 8% VAT = £10.15 + 75p P&P                  |

These are examples of the extensive range of power tools designed to meet the needs of development engineers, laboratory workers, model makers and others requiring small precision production aids. To back up the power tools, Expo offer a comprehensive selection of Drills, Grinding Points and other tools. SEND STAMP for full details to main distributors.

**A. D. BAYLISS & SON LTD.,** Pfera Works, Redmarley, Glos. GL19 3JU

Stockists: Richards Electric, Gloucester; Hoopers of Ledbury; Hobbs of Ledbury; D&D Models, Hereford; Bertella, Gloucester; J. Power Services & Co. Ltd., Worcester

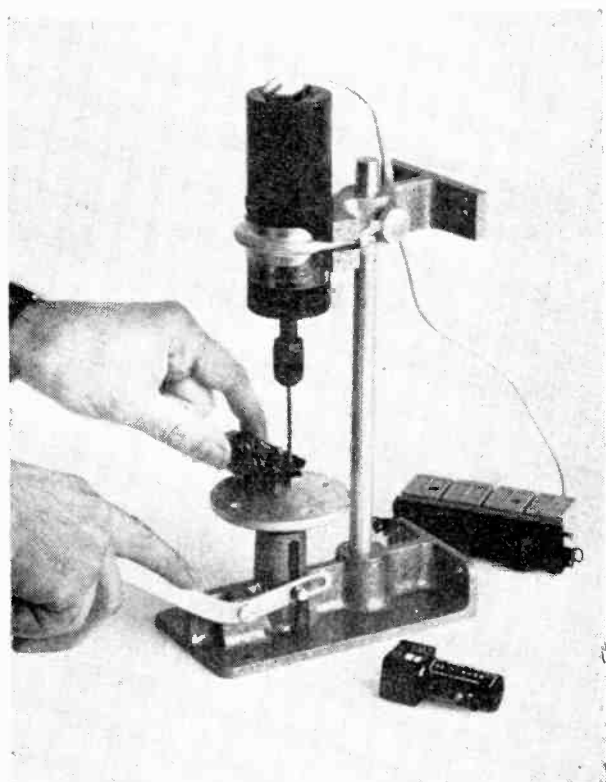

WW-014 FOR FURTHER DETAILS

**EXPORT ENQUIRIES INVITED!**

### VHF/UHF HEAD END AMPLIFIER (CM 7013)

- \* Very high output
- \* Cost effective design

Gain UHF 37dB VHF 33dB  
Output UHF 1000mV (60dBmV)  
VHF 708mV (57dBmV)  
(4 UHF TV + 2 VHF TV + FM)

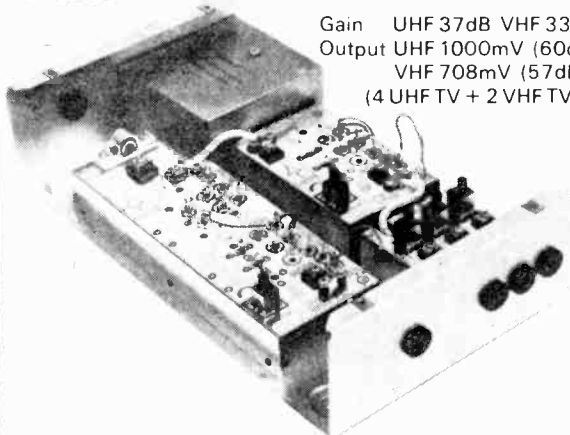

CM 7013 is a split-band high level amplifier with its own stabilised power supply. The high level launch capability is ideally suited to medium sized MATV networks but the CM 7013 is especially valuable as a distribution amplifier in larger systems.

**Labgear**

Labgear Limited Abbey Walk  
Cambridge CB1 2RQ England  
Telephone: 0223 66521 (7 lines) Telex: 81105 LAB  
Telegrams: Labgear, Cambridge

WW-008 FOR FURTHER DETAILS

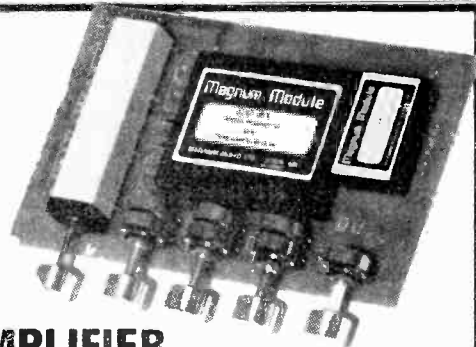

### PRE-AMPLIFIER CP-P1

Shown here mounted with its associated components (and the CP-TM1 Peak Programme Monitor) on the CP-MPC1 interconnection board, the CP-P1 is a complete stereo pre-amplifier and tone control module. Performance features > 70 db S/N ratio and > 30 db overload margin (both ref. 3 mV) and distortion of 0.02%. The internal R.I.A.A. feedback compensation around the low-level pre-amp may be replaced with external networks and the tone control circuits can be programmed to give different turnover frequencies if required (including separate bass and treble 'defeat' facilities).

**CP-P1 £14.96** incl. (U.K.)

**Also Available:** Power Amplifiers, Filters, Stereo Image Width Control, Compressor/Expander, Active Crossovers, Power Supplies plus all pots, switches, etc.

**MAGNUM AUDIO Ltd.**

DEPT W3, 13 HAZELBURY CRESCENT  
LUTON, BEDS. LU1 1DF  
TEL: 0582 28887

SEND LARGE S.A.E. FOR DETAILS

WW-038 FOR FURTHER DETAILS

# WHY SETTLE FOR LESS— THAN A 6800 SYSTEM

## MEMORY—

All static memory with selected 2102 IC's allows processor to run at its maximum speed at all times. No refresh system is needed and no time is lost in memory refresh cycles. Each board holds 4,096 words of this proven reliable and trouble free memory. Cost—only £80.00 for each full 4K memory.

## INTERFACE—

Serial control interface connects to any RS-232, or 20 Ma. TTY control terminal. Connectors provided for expansion of up to eight interfaces. Unique programmable interface circuits allow you to match the interface to almost any possible combination of polarity and control signal arrangements. Baud rate selection can be made on each individual interface. All this at a sensible cost of only £30.00 for either serial, or parallel type

## PROCESSOR—

"Motorola" M6800 processor with Mikbug<sup>®</sup> ROM operating system. Automatic reset and loading, plus full compatibility with Motorola evaluation set software. Crystal controlled oscillator provides the clock signal for the processor and is divided down by the MC14411 to provide the various Baud rate outputs for the interface circuits. Full buffering on all data and address busses insures "glitch" free operation with full expansion of memory and interfaces.

## POWER SUPPLY—

Heavy duty 10.0 Amp power supply capable of powering a fully expanded system of memory and interface boards. Note 25 Amp rectifier bridge and 91,000 mfd computer grade filter capacitor.

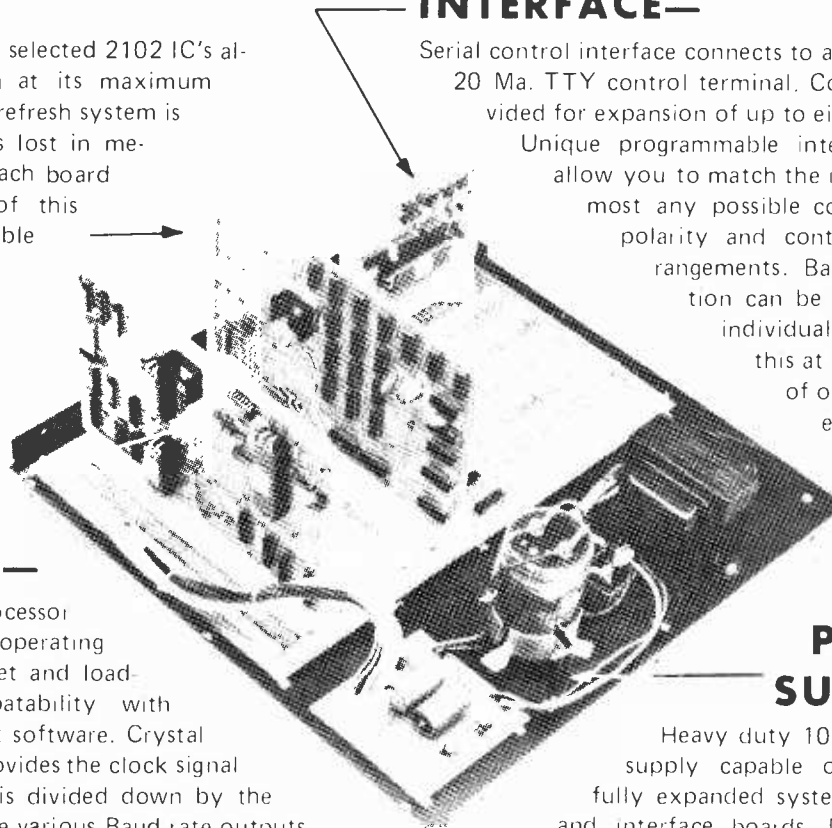

## DOCUMENTATION—

Probably the most extensive and complete set of data available for any microprocessor system is supplied with our 6800 computer. This includes the Motorola programming manual, our own very complete assembly instructions, plus a notebook full of information that we have compiled on the system hardware and programming. This includes diagnostic programs, sample programs and even a Tic Tac Toe listing.

*Mikbug<sup>®</sup> is a registered trademark of Motorola Inc.*

**SWTP 6800**  
Computer System

with serial interface and 4,096 words of memory. . . . . **£275.00**  
(Kit form only)

**PRICE EFFECTIVE 1st OCTOBER, 1977**



*Prices quoted do not include VAT*

Please send me details of your full range of computer equipment and software.

Name .....

Address .....

.....

.....

**Southwest Technical Products Co.  
Unit 12, Tresham Rd.,  
Orton Southgate, Peterborough**

WW-075 FOR FURTHER DETAILS



# Test Equipment

Here's a brand new multimeter from Eagle: 100,000 opv, 3-colour scale anti-parallax mirror, taut band movement, electronic protection, reversible polarity, 15 amps AC range. Complete with real leather carrying case, shoulder strap and probes.

**And all that for a retail list price of under £47.00!**

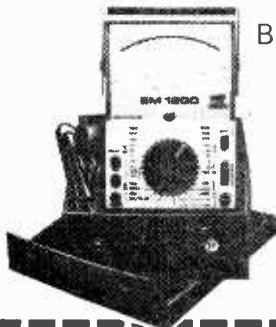

But that's not all - we've got a range of other meters to cover every possible need of the electrical or electronic engineer from about £6.50 upwards. Send the coupon now for the complete catalogue.

Please send me your catalogue with full details of all your test equipment.

Name  
Address



Eagle International, Precision Centre, Heather Park Drive, Wembley HA0 1SU Middlesex Tel: (01)-902 8832

# Eagle

W.W

WW-022 FOR FURTHER DETAILS

Cambridge Learning Enterprises

**SUMMER OFFER until 1st. August 1978**

Just send this token with your order for a 10% discount

which entitles you to books at the following prices

Digital Computer Logic & Electronics £4.95

Design of Digital Systems £8.10

Combined set £11.70

Algorithm Writer's Guide £3.06

# Join the Digital Revolution

**Understand the latest developments in calculators, computers, watches, telephones, television, automotive instrumentation . . .**

Each of the 6 volumes of this self-instruction course measures 11¼" x 8¼" and contains 60 pages packed with information, diagrams and questions designed to lead you step-by-step through number systems and Boolean algebra, to memories, counters and simple arithmetic circuits, and on to a complete understanding of the design and operation of calculators and computers.

Design of Digital Systems



## £8

plus £1 packing and surface post anywhere in the world.

Overseas customers should send a bank draft in sterling drawn on a London bank. Payment by credit cards accepted.

Also available - a more elementary course assuming no prior knowledge except simple arithmetic.  
Digital Computer Logic and Electronics

In 4 volumes

1. Basic Computer Logic
2. Logical Circuit Elements
3. Designing Circuits to Carry Out Logical Functions.
4. Flipflops and Registers

## £4.60

plus 90p P. & P.

Offer Order both courses for the bargain price £12 plus £1 P&P.

A saving of £1.50.

**Designer  
Manager  
Enthusiast  
Scientist  
Engineer  
Student**

These courses were written so that you could teach yourself the theory and application of digital logic. Learning by self instruction has the advantages of being quicker and more thorough than classroom learning. You work at your own speed and must respond by answering questions on each new piece of information before proceeding to the next.

**FLOW CHARTS & ALGORITHMS - The Algorithm Writer's Guide** - Construction, content, form, use, layout of algorithms and flow charts. Vital

for computing, training, wall charts, etc. **£2.95**  
Size A5, 130 pages. plus 45p P & P.

**Guarantee** - If you are not entirely satisfied your money will be refunded.

CAMBRIDGE LEARNING ENTERPRISES, Unit 3 Freepost RIVERMILL LODGE ST IVES HUNTINGDON CAMBS PE17 4BR ENGLAND TELEPHONE ST IVES (0480) 67446 PROPRIETORS DRAYRIDGE LTD REG OFFICE RIVERMILL LODGE, ST IVES Giro Ac No 278 9815 REGD IN ENGLAND NO 1328762

Cambridge Learning Enterprises, Unit 3 Freepost Rivermill Lodge, St Ives, Huntingdon, Cambs PE17 4BR England

Please send me the following books

sets Digital Computer Logic & Electronics @ £5 50 p&p included

sets Design of Digital Systems @ £9 00 p&p included

Combined sets @ £13 00 p&p included

The Algorithm Writer's Guide @ £3 40 p&p included

Name

Address

I enclose a cheque / PO payable to Cambridge Learning Enterprises for £

Please charge my Access / Barclaycard / Visa / Eurocard / Mastercharge / Interbank account number

Signature

'delete as appropriate

Telephone orders from credit holders accepted on 0480-67446 (Ansafone)

Overseas customers should send a bank draft in sterling drawn on a London Bank

WW6

# Select a standard POTENTIOMETER from **ITT** -of course

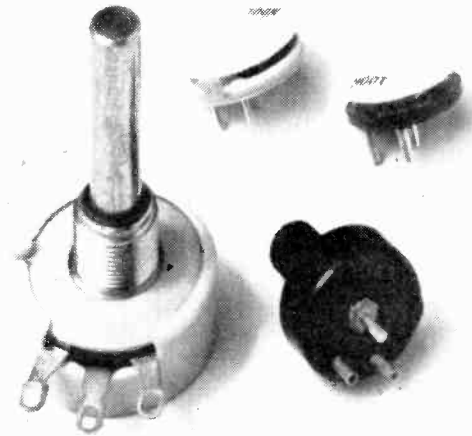

We make an extremely wide range of standard types, all available at low cost and on fast delivery. Based on years of experience in manufacturing potentiometers of all types, each of the units meets ITT's high standards of design and manufacture.

For performance and quality at low cost we have a wide selection of *hot-moulded-carbon* units available in three styles — panel mounted, preset and edge controlled.

For greater stability, lower TCR, better power handling and lower noise, choose our 1W *cermet* presets.

To meet your special requirements, we have a custom-design facility. Find out more about ITT potentiometers for yourself — just contact:

## ITT Components Group Europe

RESISTOR DIVISION,  
South Denes, Great Yarmouth, Norfolk NR30 3PX  
Tel: 0493 56122. Telex: 97421.



WW—020 FOR FURTHER DETAILS

## HAND TOOLS for lead forming

PR/1 FORMS LEADS BY SQUEEZING THE HANDLES. ADJUSTABLE AND ACCURATE.

TP/2A CROPS COMPONENT LEGS AND BENDS THEM OVER AT 90° — IN ONE OPERATION.

WH/3 CUTS AND FORMS LEADS; COMPLETELY ADJUSTABLE DIES.

**GRASER INTERNATIONAL LIMITED** WYBAR DIVISION  
3 HAMPTON COURT PARADE EAST MOLESLEY SURREY ENGLAND Telephone 01-979 8141 Telex No 928638  
HEADQUARTERS — SYRACUSE, NEW YORK

WW—079 FOR FURTHER DETAILS

# HARMSWORTH 070-681 2601

POWER DIODES & THYRISTORS  
RECTIFIER STACK ASSEMBLIES  
SEMICONDUCTOR FUSES



Westcode Semiconductors



International Rectifier



**BBC** British Brown Boveri **BBC**

**GEC** Fusegear **GEC**

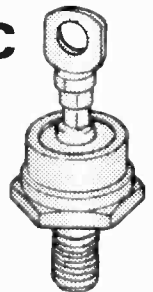
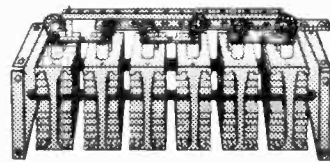
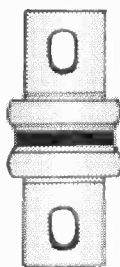

Express delivery by our own transport or Securicor

HARMSWORTH, TOWNLEY & CO. LIMITED  
HAREHILL TODMORDEN LANCS OL145JY  
PHONE: TODMORDEN 2601 & 5246  
TELEX: 635091 Attn. HARMSWORTH

# Instant LCR Answers.



The B424 is an easy-to-operate component meter, providing accurate measurements over an extremely wide range for under £600.

For every type of component: capacitor, resistor or inductor, the liquid crystal display shows the value in full. The decimal point is shown in position and the numerical readout is followed directly by the appropriate symbol for each range. No multiplying or scaling factors are ever needed, eliminating a prime source of operator error.

The meter automatically selects the test signal level and frequency, so that the operator doesn't have to calculate and reset for each type of measurement. The range finder will indicate on the display when a higher

or lower range could give a more precise readout.

In addition to the basic meter, a component jig, the CA4, is now available for rapid connection of components with axial, radial or pre-formed leads. The CA4 has built-in limits circuits for an automatic indication of 'Low', 'Pass' or 'High' as each component is connected. Setting of the limits takes only a few seconds, no external equipment or standards being necessary.

These features, combined with the 0.25% accuracy over the wide measurement range, make the equipment equally valuable in Goods Inwards sections or design laboratories.

For more details fill in the coupon or contact your nearest distributor:

## ...with the right contacts



## B424/CA4 New Simplicity in LCR Measurements

Tekelec-Airtronic, Cite des Bruyeres,  
Rue Carle-Vernet, 92310 Sevres,  
Paris, France, Tel. 027 75 35  
Keithley Instruments GmbH, Heiglhofstrasse 5,  
8000 Munchen 70, West Germany.  
Tel (089) 7144065  
G & P Electronics AG, Bernerstrasse-Nord 182,  
Ch-8064 Zurich, Switzerland, Tel (01) 643231  
C N Rood BV, PO Box 42,  
11-13 Cort van der Lindenstraat,  
Rijswijk ZH 2109, Holland, Tel: (70) 99 63 60  
Unitronics SA, Torre de Madrid Princesa 1,  
Piso 12 Oficina 9, Madrid 8, Spain, Tel. 242 5204  
Scandia Metric AB, Fack 171 19, Solna 1,  
Banvaktsvagen 20, Sweden, Tel: (08) 820 410

Please send me details of the Wayne Kerr B424/CA4

Name \_\_\_\_\_

Company \_\_\_\_\_

Address \_\_\_\_\_

Tel: \_\_\_\_\_



**Wayne Kerr**

Wilmot Breedon Electronics Limited  
442 Bath Road, Slough, Berkshire SL1 6BB  
England

ww/6/78

WW-097 FOR FURTHER DETAILS

### FREQUENCY COUNTERS

1 / 10 Hz to 1.2GHz  
Sensitivity 10mV  
Stability 5 parts 10<sup>6</sup>



FREQUENCY COUNTER  
TYPE 801B

### FREQUENCY STANDARDS

CRYSTAL 1 MHz 100KHz, 10KHz  
Stability 5 parts 10<sup>6</sup>  
OFF/AIR 10 MHz, 1 MHz, 1 part 10<sup>6</sup>

301M  
501  
801B/M  
Memory versions available if not suffixed M

32MHz 5 Digit £98  
32MHz 8 Digit £192  
250MHz 8 Digit £280  
£30 extra

401A  
701A  
901M  
1001M

32MHz 6 Digit £138  
80MHz 8 Digit £210  
520MHz 8 Digit £395  
1.2GHz 8 Digit £670

Start/Stop versions plus £18

Type 101 1MHz, 100KHz, 10KHz Crystal Standard £98

Type 103 Off/Air Standard £98

Type 203 Low Frequency Generator £78

### FREQUENCY GENERATORS

DISTORTION 0.3%  
Amplitude Stability  
0.1%  
10Hz to 100kHz

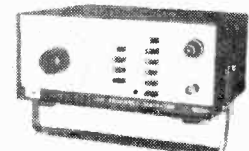

LOW FREQUENCY  
GENERATOR TYPE 203



**R.C.S. ELECTRONICS, 6 WOLSLEY ROAD, ASHFORD, MIDDX. ASHFORD 53661**

SUPPLIERS TO: Ministry of Defence, G.P.O., B.B.C., Government Depts., Crystal Manufacturers and Electronic Laboratories world-wide

WW—029 FOR FURTHER DETAILS

# CHROMASONIC

# electronics

56A Fortis Green Road  
Muswell Hill London N10 3HN  
Telephone 01-883 3705

## C MOS

4000	1.8*	4049	5.8*	7442	5.2*
4001	1.8*	4050	5.8*	7445	7.0*
4002	1.8*	4051	8.6*	7447	5.9*
4006	1.09*	4052	8.6*	7448	6.5*
4007	1.9*	4060	1.16*	7451	1.6*
4009	6.2*	4068	2.2*	7470	2.7*
4010	6.2*	4070	2.2*	7472	2.2*
4011	1.8*	4071	2.2*	7473	2.7*
4012	2.1*	4081	2.2*	7474	2.7*
4013	5.3*	4082	2.2*	7475	4.0*
4014	1.00*	4510	1.24*	7476	3.0*
4015	9.7*	4511	1.54*	7485	7.6*
4016	5.9*			7486	2.7*
4017	9.7*			7489	2.32*
4018	9.7*			7490	3.8*
4019	5.8*			7492	4.1*
4020	1.08*	7400	1.6*	7493	4.1*
4021	9.7*	7401	1.6*	74107	2.7*
4022	8.0*	7402	1.6*	74121	2.7*
4023	1.9*	7403	1.6*	74123	4.5*
4024	7.8*	7404	1.7*	74141	6.5*
4025	1.9*	7408	1.9*	74145	6.5*
4026	1.76*	7410	1.6*	74151	4.9*
4027	5.9*	7413	2.7*	74154	8.5*
4028	8.7*	7420	1.6*	74174	7.2*
4029	1.18*	7427	2.8*	74192	8.6*
4040	1.08*	7430	1.6*	74193	8.6*
4042	8.3*	7441	5.6*	74196	9.7*



You can combine C-MOS & TTL for quantity discounts.

25 plus less 5%. 100 plus less 10%.

## SEVEN SEGMENT DISPLAYS

### LIGHT EMITTING DIODES

9 125" (inc. clip)	1+	10+	100+
TIL209 Red	15p*	13p*	11p*
TIL212 Yellow (H.B.)	27p*	22p*	17p*
TIL216 Red (H.B.)	27p*	22p*	17p*
TIL232 Green (H.B.)	27p*	22p*	17p*
0.2" (inc. clip)			
TIL220 Red	15p*	13p*	11p*
TIL224 Yellow (H.B.)	30p*	26p*	20p*
TIL228 Red (H.B.)	30p*	26p*	20p*
TIL234 Green (H.B.)	30p*	26p*	20p*
0.2" (inc. clip)			
LITRONIX All Red			
DL701 Com A 0.30" L/H dec. pt	1.72*		
DL704 Com C 0.30" R/H dec. pt	1.72*		
DL721 Com A 0.51" R/H Dou. dt	3.04*		
DL746 Com A 6.30" L/H dec. pt	2.43*		
DL747 Com A 6.30" L/H dec. pt	2.43*		
MONSANTO Green			
MAN51 Com A 0.30" R/H dec. pt	2.34*		
MAN52 Com A 0.30" L/H dec. pt	2.34*		
MAN53 Com A 0.30" L/H dec. pt	2.34*		
MAN54 Com C 0.30" R/H dec. pt	2.34*		
Red			
MAN71 Com A 0.30" R/H dec. pt	1.52*		
MAN72 Com A 0.30" L/H dec. pt	1.52*		
MAN73 Com A 0.30" L/H dec. pt	1.52*		
MAN74 Com C 0.30" R/H dec. pt	1.52*		
XCITON			
XAN362 C.A. R 0.30" L/H dec. pt	1.81*		
XAN352 C.A. G 0.30" L/H dec. pt	2.21*		
XAN82 C.A. Y 0.30" L/H dec. pt	2.43*		
DL707 Com A 0.30" L/H dec. pt	1.72*		
DL707R Com A 0.30" R/H dec. pt	1.72*		
DL727 Com A 0.51" R/H Dou. dt	3.04*		
DL750 Com C 6.30" L/H dec. pt	2.43*		
Yellow			
MAN81 Com A 0.30" R/H dec. pt	2.34*		
MAN82 Com A 0.30" L/H dec. pt	2.34*		
MAN83 Com A 0.30" L/H dec. pt	2.34*		
MAN84 Com C 0.30" R/H dec. pt	2.34*		
Orange			
MAN3610 Com A 0.30" R/H dec. pt	2.17*		
MAN3620 Com A 0.30" L/H dec. pt	2.17*		
MAN3630 Com A 0.30" L/H dec. pt	2.17*		
MAN3640 Com C 0.30" R/H dec. pt	2.17*		
XAN662 C.A. R 0.60" L/H dec. pt	2.03*		
XAN652 C.A. G 0.60" L/H dec. pt	2.43*		
XAN682 C.A. Y 0.60" L/H dec. pt	2.03*		

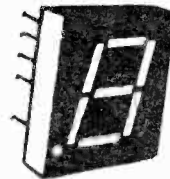

## SUPERSAVER

★ 555 Timer ★  
**4 for £1.00**  
★ 28p\* each ★

OUR NEW A4 E.C. BOOKLET  
Supplied FREE with orders of any I.C.s worth £4.00 or more. Contains Circuits, pin connections & Data (35p inc. P&P if sold alone)

## LINEAR I.C.s AUDIO I.C.s

MC1352P	1.20	SN7653N2	1.55
TD1352	1.20	SN76552N	.65
MC1327P	1.50	SN76660N	.65
TD1327	1.50	SN7666N	1.00
MC1330P	1.15	TAA263	2.50
MC1350P	1.00	TAA320A	.75
MC1351P	1.00	TAA350A	2.70
MC1357P	1.70	TAA570	2.50
LM2111N	1.50	TBA120S	1.00
MC1375P	1.50	TBA231	1.00
MC1456CG	2.50	TBA520Q	2.00
MC1495L	4.90	TBA530Q	2.00
MC3302P	1.65	TBA540Q	2.00
MFC6030A	1.00	TBA550Q	2.00
NE530L	2.25	TBA551	2.25
NE546	2.15	TBA150Q	2.00
NE555	.28*	TBA800	1.00
NE555	.90*	TBA810S	1.10
NE560	4.40*	TBA820	1.10
NE561	4.40*	TBA90Q	2.00
NE562	4.40*	TC1730	4.69
NE565	1.40*	TC1740	4.69
NE566	1.65*	TC1940	1.75
NE567	1.85*	TDA2020	3.50
SL414A	1.90	UAA170	2.75*
SL415A	2.47	UAA180	2.75*
SL440A	2.38*	ZNA14	1.68
SN5491N	.95*	ZNA17E	1.10
SN75492N	1.15*	ZNA23T	1.08*
SN76001N	1.40	ZNA24E	1.35
SN76003N	2.45	ZNA25E	3.78
SN76013N	1.60	ZN1034E	2.03
SN76023N	1.60	ZN1036E	8.43
SN76033N	2.45	ZNA116E	6.75*
SN76544N	1.55		

## I.C. SOCKETS

8 pin	10p*	16 pin	14p*	28 pin	30p*
14 pin	12p*	24 pin	26p*	40 pin	40p*
I.C. pins 100	54p*	1,000	£3.78*		

## LINEAR I.C.s

μA703 (TO99)	1.00	μA711 (14 pin DIL)	90
μA709 (8 pin DIL)	.41	μA711 (TO99)	98
μA709 (14 pin DIL)	.41	μA741 (8 pin DIL)	.25
μA709 (TO99)	.50	μA741 (14 pin DIL)	.42
μA709 (8 pin DIL)	.50	μA741 (TO99)	.45
μA710 (14 pin DIL)	.55	μA847 (14 pin DIL)	30
μA710 (TO99)	.60	μA748 (8 pin DIL)	.42

## LINEAR I.C.s

μA748 (14 pin DIL)	.60
μA748 (TO99)	.65
μA753 (8 pin DIL)	1.95
AY-1-0212	6.50
AY-1-5051	1.65
AY-5-1224A	3.39*
AY-5-3507	5.99*
AY-5-4007	7.99*
CA3045	1.50
CA3046	.89
CA3053	.85
CA3075	2.00
CA5080	.80
CA3081	1.50
CA3082	1.50

## AUDIO I.C.s

CA3089/TDA1200	2.30
CA3090	4.25
CA3123E/LM1820	1.50
CA3097E	1.75
CA3130S	.99
CA3140S	.99
CA3160S	1.60
CA3600E	1.75
LM301AN (8 pin)	.40
LM301AT (TO99)	.50
LM308N (8 pin)	.90
LM308T (8 pin)	1.40
LM339N	1.00
LM370N	2.75
LM371	1.75

## LINEAR LC.s

LM372N	1.75
LM373N	2.99
LM377N	1.95
LM380N B	1.00
LM380N	.99
LM381N	1.75
LM382N	1.35
LM3900N	.65
LM3905N	1.50*
LM3909N	.70*
MC1303 LM1303N	1.10
MC1310P	1.80
MC1312P	2.15
MC1314P	3.50
MC1315P	6.10

## AUDIO I.C.s

LM372N	1.75
LM373N	2.99
LM377N	1.95
LM380N B	1.00
LM380N	.99
LM381N	1.75
LM382N	1.35
LM3900N	.65
LM3905N	1.50*
LM3909N	.70*
MC1303 LM1303N	1.10
MC1310P	1.80
MC1312P	2.15
MC1314P	3.50
MC1315P	6.10

## VAT INCLUSIVE PRICES

Items followed by a \* include V.A.T. @ 8% all others include 12.5%. ALWAYS PLEASED TO SEE PERSONAL CALLERS  
TRADE AND EXPORT CUSTOMERS MOST WELCOME Overseas Customers deduct 2/27 from items marked with a \* 1/9 from others

WW—041 FOR FURTHER DETAILS



**Free! ADCOLA**  
**SOLDERING EQUIPMENT**  
1978 32 PAGE  
**COLOUR CATALOGUE**  
**RING NOW 01-622-0291/3**  
OR SEND TO  
**ADCOLA PRODUCTS LTD.**  
GAUDEN ROAD LONDON SW4 6LH  
**FOR YOUR COPY!**

WW—049 FOR FURTHER DETAILS



# HIGH POWER DC-COUPLED AMPLIFIER

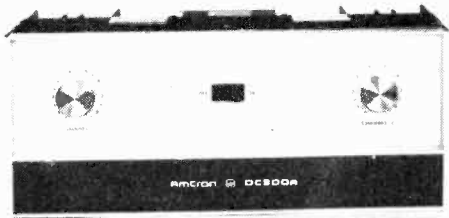

- ★ UP TO 500 WATTS RMS FROM ONE CHANNEL
- ★ DC-COUPLED THROUGHOUT
- ★ OPERATES INTO LOADS AS LOW AS 1 OHM
- ★ FULLY PROTECTED AGAINST SHORT CCT, MISMATCH, ETC.
- ★ 3 YEAR WARRANTY ON PARTS AND LABOUR

The DC300A Power Amplifier is the successor to the world famous DC300 which is so widely used in Industrial, and Research applications in this country. It is DC-coupled throughout so providing a power bandwidth from DC to over 20,000Hz. The ability of the DC300A to operate without fuss into totally reactive loads while delivering its full power, and maintaining its faithful reproduction of Pulse or complex waveforms has established the DC300A as the world's leading power amplifier. Each of the two channels will operate into loads as low as 1 ohm, and the amplifier can be rapidly connected as a single ended amplifier providing over 650 watts RMS into a 4 ohms load, and still providing a bandwidth down to DC. Below is a brief specification of the DC300A, but if you require a data sheet, or a demonstration of this fine equipment please let us know.

Power Bandwidth	DC 20kHz @ 150 watts + 1db. 0db.	Slewing Rate	8 volts per microsecond
Power at clip point (1 chan)	500 watts rms into 2.5 ohms	Load impedance	1 ohm to infinity
Phase Response	+0. -15 DC to 20kHz. 1 watt 8Ω	Input sensitivity	1.75 V for 150 watts into 8Ω
Harmonic Distortion	Below 0.05% DC to 20kHz	Input Impedance	10K ohms to 100K ohms
Intermod. Distortion	Below 0.05% 0.01 watt to 150 watts	Protection	Short mismatch & open cct protection
Damping Factor	Greater than 200 DC to 1kHz at 8Ω	Power supply	120-256V. 50-400Hz
Hum & Noise (20-20kHz)	At least 110db below 150 watts	Dimensions	19" Rackmount. 7" High. 9 1/2" Deep
Other models in the range: D60 — 60 watts per channel		D150A — 150 watts per channel	

Other models available from 100 watts to 3000 watts



## MACINNES LABORATORIES LTD.

Macinnes House, Carlton Park Industrial Estate  
Saxmundham, Suffolk IP17 2NL. Tel: (0728) 2262 2615

## MACINNES FRANCE

18 Rue Botzaris  
Paris 75019, France  
Tel: 206-60-80 or 206-83-61

WW—036 FOR FURTHER DETAILS

# SOME PEOPLE DO IT THE EASY WAY!



Well, young man, how do we know these diodes are the most suitable?  
That's easy, sir, I selected them from 11,000 others.

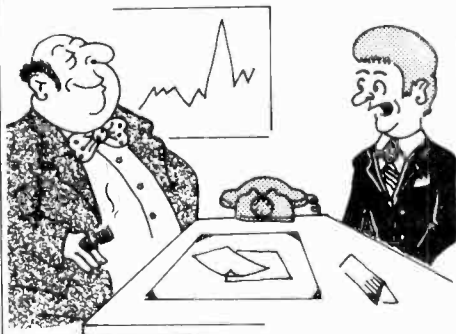

Impossible! How?  
Simple, sir, I spent 6 mins. using the Electronics Components Databank at a cost of 58.



So what else have you done today?  
(For information on the easy way, contact us at the address below)

European Space Agency Agence Spatiale Européenne ESRIN Via Galileo Galilei 00044 FRASCATI Italy

Tel 9422401-Telex 61637 ESRINROM

# The Electronic Components **DATABANK**



WW—086 FOR FURTHER DETAILS

# sales hire repair

**You'll do better at Martin Associates  
we guarantee it!**

**ANALYSERS**  
AIRMEC 248 Wave Analyser 5-300MHz  
DAWE 1471 Variable Filter  
MARCONI O A 1094A / S Spectrum Analyser. Freq. 100MHz-30KHz  
MUIRHEAD D-669-A Frequency Analyser. 30Hz-30KHz. 6 Ranges

**ATTENUATORS**  
S T C 74600 Attenuators 0-9dB & 0-80dB

**BRIDGES**  
Evershed & Vignole Bridge Megger  
General Radio 1432-M Decade Resistance Box. 5 Decade  
Marconi TF 868B Universal Bridge  
Wayne Kerr BB018, R161, S161 Bridge with Source & Detector

**COUNTERS**  
Racal 836 Universal Counter / Timer 6 Digit  
Racal 835 & 810 Universal Counter & Decade Divider DC-124MHz

**DIGITAL MULTIMETERS**  
Solartron 7040 Digital Multimeter 4 Digit  
Syston Donner 7050 Digital Multimeter

**DIGITAL VOLTMETERS**  
Micro Instruments 5203 Memory Voltmeter  
Solartron 1402 Digital Voltmeter 4 Digit  
Solartron A 223 Digital Voltmeter Master Series  
Solartron LM 1867 Digital Voltmeter 5 Digit

**METERS**  
A-Yu 405H Precision Phase Meter. Freq. 8Hz-500KHz  
Airmec 210 Modulation Meter  
Avo Precision Avometer. Portable  
Elliott 5999 Portable Reflecting Voltmeter  
Hewlett-Packard 412A DC Volt/Ohm Meter  
Hewlett-Packard 430C Power Meter  
Marconi TF 791D Deviation Meter. Freq. Range 4MHz-1024MHz  
Marconi TF 2342 P.C.M. Regenerator Tester  
Marconi TF 2600 / S Sensitive Valve Voltmeter. 12 Ranges  
Marconi TF 893 A.F. Output Power Meter 0-10 Watts  
Marconi TF 102DA R.F. Power Meter 0-100Watts DC-250MHz  
Marconi TF 2604 Electric Voltmeter 20MHz-1500MHz  
Marconi 1041B Vacuum Tube Voltmeter

**OSCILLOSCOPES**  
Solartron CD1400 Oscilloscope DC-15MHz. Dual Beam  
Tektronix 585 & 585A Plug Ins 82 or 86 DC-80MHz  
Tektronix 545A Oscilloscope with C.A. Plug In  
Tektronix 555 Oscilloscope Dual Beam DC-33MHz. Main Frame  
Tektronix 561A Oscilloscope DC-10MHz  
Tektronix M Plug in DC-20MHz 4 Channel 20mv-10v/cm  
Tektronix Various Plug Ins & Probes available  
Telegquipment D.53 Oscilloscopes DC-25MHz Dual Trace

**POWER SUPPLY UNITS**  
Advance DC 302 P.S.U. 0/P 5V 7A £15.00  
Advance C.V.T's 120W & 250W From £15.00  
Isotope Dev. 532 A.V. D.D. 3KV From £60.00  
Wier 3001 Variable P.S.U. 0-25V 0-0.5A £25.00  
Variacs from 8 Amp upwards From £12.50

**SIGNAL SOURCES**  
Advance S663FFM / AM Generator 4MHz-230MHz £175.00  
Advance J1A Signal Source 15Hz-50KHz £50.00  
Advance 81A L.F. Signal Generator 15Hz-200KHz £85.00  
Feedback UPO 230 Variable Phase Oscillator. 1Hz-100KHz £95.00  
Heathkit 1G-1B Oscillator 1Hz-100KHz £50.00  
Hewlett-Packard 608A Signal Generator 10MHz-500MHz £160.00  
E-H 132L Pulse Generator £150.00  
Marconi TF 8010 / 1 Signal Generator 10MHz-470MHz £285.00  
Marconi 605B Signal Generator 7-12.5GHz £575.00  
Muirhead D-890 A Decade Oscillator £95.00

**RECORDERS**  
Hewlett Packard 2D-2AM X-Y Plotter £700  
Hewlett Packard 7035B X-Y Recorder £650  
Honeywell 520 X-Y Plotter £750  
Honeywell Visicorder 1705 U-V Recorder £350  
Oxford Instruments 3000 Potentiometric Recorder £575  
S.E. Labs SE-2005 U-V Recorder 6 Channel £250  
S.E. Labs SE-2100 U-V Recorder 12 Channel £600

**MISCELLANEOUS**  
E.E. 7285 Ionisation Tester 0-10KV £70  
Hewlett-Packard 805C Coaxial Slotted Line 0-5-4GHz £700  
**OVENS**  
Griffin & Tallock 1ft cube Oven Ambient 100 £50

*Hundreds more items in stock!*

**MARTIN ASSOCIATES**  
34, Crown Street  
Reading, Berks. RG1 2SE  
Tele: Reading (0734) 51074

WW-035 FOR FURTHER DETAILS

## ELECTRONIC INDUSTRIAL THERMOMETER

**THE MODERN WAY TO MEASURE TEMPERATURE**  
A Thermometer designed to operate as an Electronic Test Meter. Will measure temperature of Air, Metals, Liquids, Machinery, etc., etc. Just plug-in the Probe, and read the temperature on the large open scale meter. Supplied with carrying case, Probe and internal 1½ volt standard size battery.

Model "Mini-Z 1" measures from -40° C to + 70° C. Price £25.00  
Model "Mini-Z 2" measures from -5° C to + 105° C Price £25.00  
Model "Mini-Z Hi" measures from + 100° C to + 500° C £27.50 (VAT 8% EXTRA)

Write for further details to  
**HARRIS ELECTRONICS (LONDON)**  
138 GRAY'S INN ROAD, LONDON, WC1X 8AX  
(Phone 01-837 7937)

WW-027 FOR FURTHER DETAILS

# Keep holes neat or stop them up.

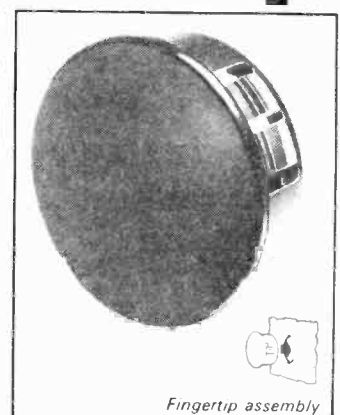
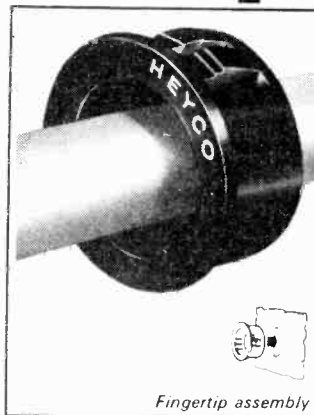

**HEYCO NYLON SNAP BUSHINGS** convert sharp edges to smooth, insulated holes, quickly and easily. Snap lock into panels. 56 sizes to fit holes from  $\frac{3}{16}$ " to 3" diameter.

**HEYCO NYLON HOLE PLUGS** seal unwanted holes neatly, quickly and easily. Low cost. Rattle-free fit. 25 sizes to fit holes from  $\frac{3}{16}$ " to 2" diameter.

**FREE SAMPLES**  
and catalogue showing our full range of bushings on request.



**Heyco Manufacturing Co. Ltd.**

Uddens Trading Estate,  
Nr. Wimborne, Dorset BH21 7NL  
Tel: Ferndown (STD: 0202) 871411/2/3

Telegrams: HEYCOMAN Wimborne. Telex: 41408

WW-071 FOR FURTHER DETAILS

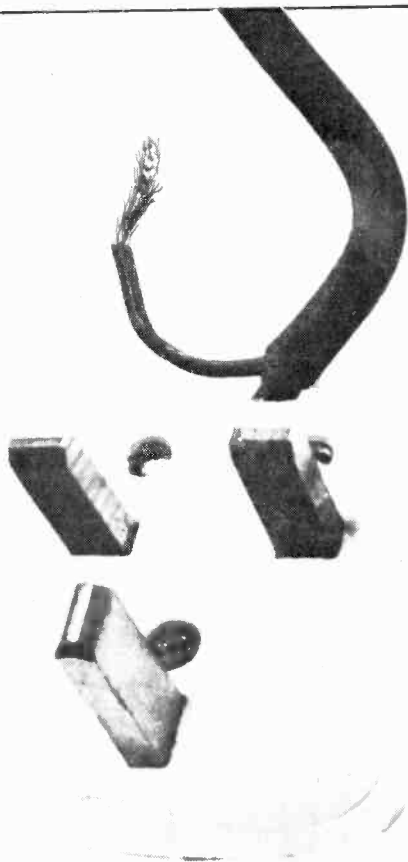

It's easy enough checking this end, but what about the other?

...and that's where NEAL FERROGRAPH test sets come in. All of the professional measuring equipment necessary to test and calibrate a wide range of audio apparatus, compactly combined, and designed to function with minimum effort.

**The RTS 2**, a unique concept. Simplifies measurements of gain, noise, frequency response, input sensitivity, output power, distortion and the parameters relating to recording equipment, such as wow and flutter, crosstalk, drift and erasure. Its range of measurements can be extended even further by the addition of the Auxiliary Test Unit **ATU1**.

Send today for full technical information relating to these instruments, and other high quality products in the combined NEAL FERROGRAPH range.

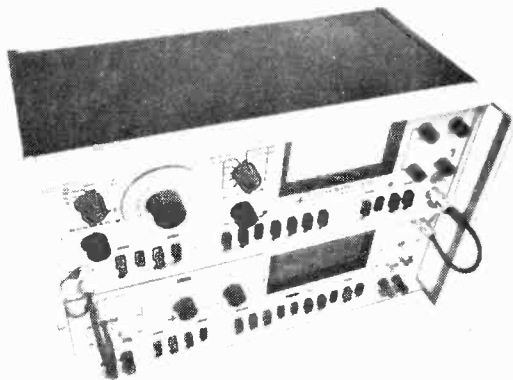

**NEAL FERROGRAPH**  
TOTAL TAPE TECHNOLOGY

SIMONSIDE WORKS · SOUTH SHIELDS · TYNE & WEAR NE34 9NX  
Telephone: SOUTH SHIELDS (0632) 566321 Telex: 537227

WW-069 FOR FURTHER DETAILS

# Introducing the new Quick Charge Cordless Soldering Iron

- Solder heat in five seconds
- No wires to restrict use
- Completely recharges in only 4 hours!
- No need for earthing
- Capacity to solder up to 125 joints

This new rechargeable soldering iron from Greenwood brings added freedom to professional soldering. The Quick Charge recharges so fast that completely dead battery cells can be brought to full charge in about 4 hours - three times faster than before. In its stand the Quick Charge is, of course, being continually charged. A wide range of tips and now also a P.C. Drill attachment make this the most 'versatile' professional soldering iron available.

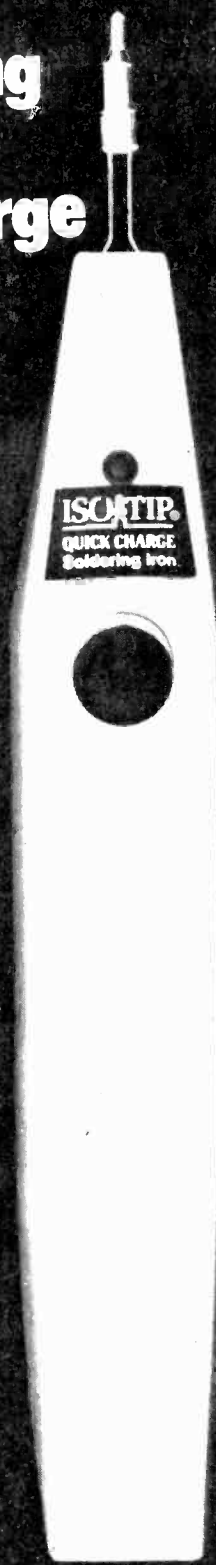

Illustration actual size



**Greenwood Electronics**

Greenwood Electronics, Portman Road, Reading RG3 1NE  
Telephone: 0734 595844 Telex 848659

WW - 026 FOR FURTHER DETAILS

**NEW**

from 

# 3 & 3½ DIGIT LCD DMMS

Non Linear Systems, the originators of the DVM in 1952, introduce two low cost LCD DMMs to their existing range of LED multimeters.



- ★ Overload Indication
- ★ Autopolarity
- ★ Fully Protected on Ohms & Current Range
- ★ Optional Rechargeable Cells & Adapter
- ★ 12 Months' Warranty

**SPECIFICATIONS**

MODE	RANGE	ACCURACY (LM-300)	ACCURACY (LM-350)	RESOLUTION	INPUT RESISTANCE	TEST CURRENT
VOLTS DC*	1	±1% Reading†	±0.5% Reading†	1 mV	10 MΩ	1 mA
	10			10 mV		
	100			100 mV		
	1000			1 V		
VOLTS AC*	1	±1% Reading†	±0.7% Reading†	1 mV	10 MΩ, 20 pF	1 mA
	10			10 mV		
	100			100 mV		
	1000			1 V		
KILOHMS**	1	±1% Reading†	±0.5% Reading†	1 Ω	10 MΩ	1 mA
	10			10 Ω		100 μA
	100			100 Ω		10 μA
	1000			1 kΩ		1 μA
	10000			10 kΩ		100 nA
CURRENT	1 mA	±2% Reading†	±2% Reading†	1 μA	10 MΩ	1 mA
	10 mA			10 μA		
	100 mA			100 μA		
	1 A			1 mA		

\* 1000 vdc or peak ac maximum range. 1/2 digit.  
 \*\* Test Voltage (ohms) 1 vdc Full Scale = 1.31-300.2 mΩ Full Scale = 1 MΩ  
 † 1M-350 has 10% over-range - full scale readings are 1.999, 19.99, etc.

- Stockists
- AUDIO ELECTRONICS, 301 Edgware Road 01-724 3564
  - MARSHALLS, 40 Cricklewood Broadway 01-452 0161
  - MARSHALLS, 325 Edgware Road 01-723 4242
  - MARSHALLS, 85 West Regent Street, Glasgow 041-332 4133
  - MARSHALLS, 1 Straits Parade, Bristol 0272 654201
  - FENWICK ELECTRONICS, Maxwell Road, Glasgow 041-429 7155
  - HAVANT INSTRUMENTS, 20 Portsmouth Road, Horndean 596020
  - SEMICONDUCTOR SUPPLIES, Church Lane, Wallington 01-647 1006

or direct from UK distributors  
 Send Company Order or CWO  
 LM300 **£80.50** inc. VAT P&P  
 LM350 **£94.50** inc. VAT P&P

(Optional rechargeable cells and adaptor **£8.64** inc.)

Send Company Order, CWO, ACCESS or BARCLAYCARD No.

# Lawtronics

139 High Street, Edenbridge, Kent 0732 865191  
 Telex 95415  
 Trade enquiries invited

WW-085 FOR FURTHER DETAILS

**EXPORT ENQUIRIES INVITED!**

## pocket-sized 500 MHz FREQUENCY COUNTER

(CM 7044)

for UHF/VHF or CB mobile radio

- \* ± 2ppm accuracy (0.0002%)
- \* Overload protected
- \* Built-in Ni-Cad battery pack
- \* Exceptional value

Frequency Ranges (Switched)  
 (a) 10 Hz - 50 MHz  
 (b) 40 MHz - 500 MHz

Sensitivity  
 50 MHz range, 30 mV  
 500 MHz range, 50 mV

Display  
 7 digit, 7 segment LED display

Dimensions  
 4 1/4" x 2 1/4" x 1 1/4"  
 (10.8 x 5.7 x 3.2 cm)



# Labgear

Labgear Limited Abbey Walk  
 Cambridge CB1 2RQ England  
 Telephone: 0223 66521 (7 lines) Telex: 81105 LAB  
 Telegrams: Labgear, Cambridge

WW-018 FOR FURTHER DETAILS

**RADFORD**

## AUDIO MEASURING INSTRUMENTS

**NEW ITEMS**

**DMS4 Distortion Measuring Set. Precision**

**DMS5 Distortion Measuring Set. General Purpose.**

The DMS4 is a precision instrument intended for laboratory use capable of measuring total harmonic distortion to better than 5 parts per million (0.0005%).

The DMS5 is intended for general purpose use in the studio, test department, or factory and can measure to 0.001% T.H.D.

Both instruments cover the frequency range 10Hz-100kHz and are semi-automatic nulling.

The instruments will operate from any signal source. Nulling to zero is automatic after the DMS has been accurately tuned to the test frequency. The instrument will thus continually read distortion whilst adjustments are made to equipment under test providing the test frequency is not changed.

**EXISTING ITEMS**

**LDO3 Low Distortion Oscillator**

A continuously variable frequency laboratory oscillator with a range 10Hz to 100kHz having virtually zero distortion over the audio frequency band with a fast setting time.

**LDO3B Low Distortion Oscillator, balanced output**

As LDO3 but additionally fitted with output amplifier and screened transformer providing a 600 ohm floating balanced output and 150 ohms unbalanced

Unbalance -80dB 1kHz -60dB 10kHz.

**ANM1 Audio Noisemeter, Average sensing.**

**ANM2 Audio Noisemeter, True r.m.s. reading.**

**ANM3 Audio Noisemeter, Quasipeak / True r.m.s. reading.**

The noisemeters have 16 measurement ranges from 10μV f.s.d. to 300V f.s.d. and incorporate a 5" mirror scale of excellent linearity calibrated in Volts and dBv or dBm. The instruments are in accordance with DIN 45.405 and include recommended weighting characteristics

WIDE BAND (flat response voltmeter)

DIN AUDIO BAND

IEC/DIN CURVE A

CCIR

**RADFORD LABORATORY INSTRUMENTS LTD.**

4 High Street, Nailsea, Bristol BS19 1BW

Tel: Nailsea 6637

U.S.A.: Patrick McVeigh. Tel: 201-746-5461

WW-073 FOR FURTHER DETAILS

# How to generate confidence

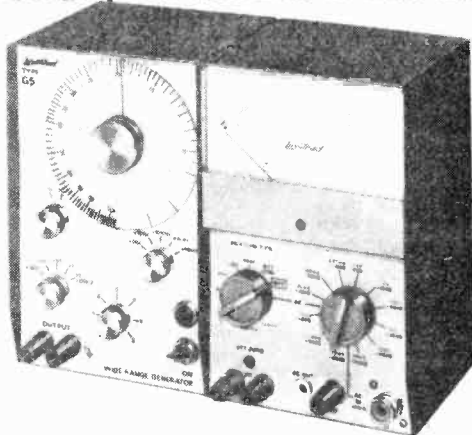

**G5**  
£76.14  
inc. VAT  
and P.&P.

**M2B**  
£76.14  
inc. VAT  
and P.&P.

Produce instruments with a high specification at a low price — put them in steel cases for rugged reliability and guarantee the results. The G5 is a low distortion 10Hz to 1 MHz sine/square signal generator with a 600 ohm switched attenuator and a low impedance output of up to 3 watts. Coupled with the M2B millivoltmeter, with its 1.2 mV full scale maximum sensitivity, you have the ideal test set. Calibrated in true RMS on the a.c. ranges it will measure up to 400 volts ac or dc and has a db range from - 70 db to + 54 db. Send your Order now to Linstead Manufacturing Co. Ltd., Roslyn Road, London N15 5JB.

# Linstead

Telephone: 01-802 5144

WW-065 FOR FURTHER DETAILS

# QUARTZ CRYSTALS - FAST!



**AEL CRYSTALS LIMITED**  
Gatwick House, Horley, Surrey, England RH6 9SU  
Telephone: Horley (02934) 5353 Telex: 87116 (Aerocon Horley)  
Cables: Aerocon Telex Horley

WW-047 FOR FURTHER DETAILS

**NEW**

# Formula 4<sup>®</sup>

Mk III

The best sounding universal tone arm  
**PROFESSIONAL LABORATORY**  
Silicone Damped Pick-up Arm

We believe irrespective of price no better or more versatile arm exists. All theory and practical needs provided. Aluminum low Q absorbs energy and vibration best, exotic alternatives high Q — inferior sonics. Arm geometry optimised for 12" Discs not compromised for 7". Optional variable inertia ensures correct frequency for High or Low Compliance styli. New removable Headshell 'easi-sight' alignment. Improved rigidity, lower height with optimal pivot damping capacity provides natural musical sound, preferable to after thought add-on devices. The Mk. III enables your cartridge to retrieve maximum groove information. Adaptor plates for SME cutout. Also Universal Alignment Protractor, and Stylus Pressure Gauge. Leaflets on request

**MAYWARE LTD.** (Dept WW 6-78)  
15 Heather Walk, Edgware, Middlesex HA8 9TS, England

WW-074 FOR FURTHER DETAILS

## J E S AUDIO INSTRUMENTATION



Illustrated the Si 451 Millivoltmeter — pk-pk or RMS calibration with variable control for relative measurements. 50 calibrated ranges  
**£60.00**

Si452	£48.00	Si453	£60.00
Distortion Measuring Unit		Low distortion Oscillator, Sine	
15 Hz — 20 KHz — 0.1%		— Square — RIAA	

PRICES plus VAT

**J. E. SUGDEN & CO. LTD.** Tel. Cleckheaton (0274) 872501  
CARR STREET, CLECKHEATON, W. YORKS BD19 5LA

WW-052 FOR FURTHER DETAILS

# we wondered why....

The BBC, British Rail, B.A.C., Decca Acoustics, Institute of Sound and Vibration Research, I.C.L., Post Office Telecommunications, Philips Research, U.K. Atomic Energy Authority, and many Universities were among our customers.

Maybe they liked the competitive prices of our modules, or the fact that all modules have a frequency response from 20Hz to 22kHz, 0.2dB, damping rate of 8 volts per microsecond, input sensitivity of 0dB/10 775V, damping factor greater than 100 at 1kHz and a total harmonic distortion less than 0.05% at 1kHz.

Or could it be that they want for the reliability and the comprehensive protection circuitry. Then there is the full 2 year guarantee which accompanies our complete modules.

OR PERHAPS ... THEY JUST LIKED THE SOUND OF US!

J.P.S. 60 60 Watt  
J.P.S. 100 100 Watt  
J.P.S. 150 150 Watt



Power supplies available for all modules. Send for further information our range of pre-amplifier modules. J.P.S. products are now stocked at all distributors shown below. Further information on all products available direct from J.P.S. Associates via reader reply service. All modules are made in the United Kingdom.

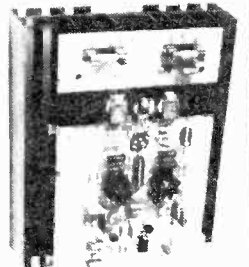

J.P.S. ASSOCIATES  
(ASTONKILN LTD.)  
BELMONT HOUSE  
STEELE ROAD  
PARK ROYAL  
LONDON NW10 7AR  
Tel: 01-961 1274 5



**DENMARK**

THE RADIO  
Baksgaardsvej 36  
3300 Frederiksberg  
Denmark  
Tel: 03 12 07 39  
Wk: 300 200 1000

**BELGIUM**

IATA  
Kerstraat 1b  
Wilmans 3020  
Willebroek  
Tel: 016 44 33 77  
Wk: 300 200 1000

**ENGLAND Midlands**

CROXFORD CUSTOM EQUIP  
14, London Road  
Croxford, Warwick  
Tel: 0531 5 0500  
Wk: 300 200 1000

**ENGLAND West**

SEVERN-SIDE AUDIO & LTD  
29 The Promenade  
St. Austins Road  
Worcester  
W.C.2  
Tel: 01905 21722  
Wk: 300 200 1000

**ENGLAND South**

R.E.W. AUDIO VISUAL  
126 Charing Cross Road  
London  
W.C.2  
Tel: 01 914 2172  
Wk: 300 200 1000

**SCOTLAND**

STANFORD PELETTI & SOUND  
57 Leith Street  
Aberdeen  
Tel: 01224 22100  
Wk: 300 200 1000

WW-033 FOR FURTHER DETAILS

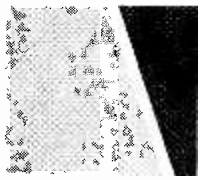

# fact: the IV does more... *much more!*

**new!**

Shure V15 Type IV  
**SUPER TRACK IV™**  
Stereo Dynetic® Pickup Cartridge

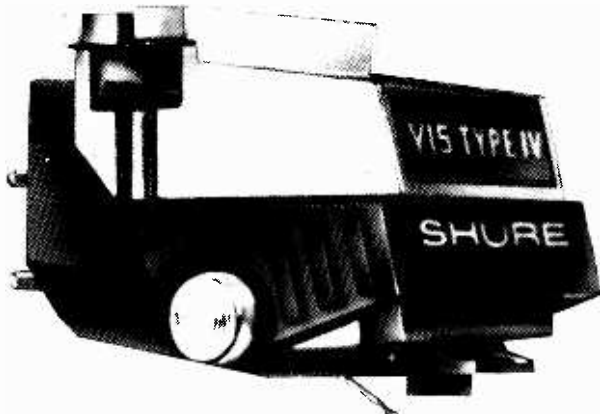

The creation of the new V15 Type IV is a tour de force in innovative engineering. The challenge was to design a cartridge that would transcend all existing cartridges in musical transparency, technical excellence, and uniformity. The unprecedented research and design disciplines that were brought to bear on this challenge over a period of several years have resulted in an altogether new pickup system that exceeds previous performance levels by a significant degree—not merely in one parameter, but in totality.

In fact, this pickup system has prevailed simultaneously over several extremely difficult music re-creation problems which, until now, have defied practical solutions. Most of all, this is an eminently musical cartridge which is a delight to the critical ear, regardless of programme material or the rigorous demands of today's most technically advanced recordings.



Shure Electronics Limited, Eccleston Road, Maidstone ME 15 6AU—Telephone: Maidstone (0622) 59881

## THE V15 TYPE IV OFFERS:

- Demonstrably improved trackability across the entire audible spectrum—especially in the critical mid- and high-frequency areas.

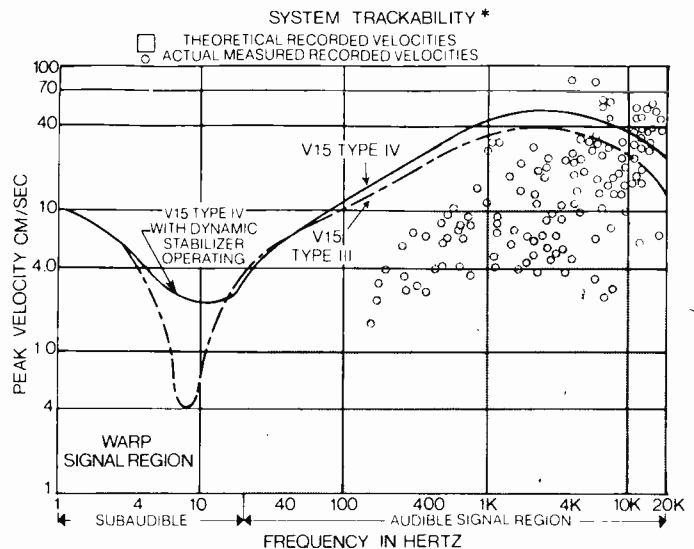

\*Cartridge-tone arm system trackability as mounted in SME 3009 tone arm at 1 gram tracking force

- Dynamically stabilized tracking overcomes record-warp caused problems, such as fluctuating tracking force, varying tracking angle and wow.
- Electrostatic neutralization of the record surface minimizes three separate problems: static discharge; electrostatic attraction of the cartridge to the record; and attraction of dust to the record.
- An effective dust and lint removal system.
- A Hyperelliptical stylus tip configuration dramatically reduces both harmonic and intermodulation distortion.
- Ultra-flat response—individually tested to within  $\pm 1$  dB.
- Lowered effective mass of moving system results in reduced dynamic mechanical impedance for superb performance at ultra-light tracking forces.

For more information on this remarkable new cartridge write for the V15 Type IV Product Brochure and read for yourself how far Shure research and development has advanced the state of the art.

# wireless world

## The spectrum and society

**Editor:**

TOM IVALL, M.I.E.R.E.

**Deputy Editor:**

 PHILIP DARRINGTON  
Phone 01-261 8435

**Technical Editor:**

 GEOFFREY SHORTER, B.Sc.  
Phone 01-261 8443

**Projects Editor:**

 MIKE SAGIN  
Phone: 01-261 8429

**Communications Editor:**

 RAY ASHMORE, B.Sc., G8KYY  
Phone 01-261 8043

**News Editor:**

 JOHN DWYER  
Phone 01-261 8620

**Drawing Office Manager:**

ROGER GOODMAN

**Production:**

D. R. BRAY

**Advertisement Controller:**

G. BENTON ROWELL

**Advertisement Manager:**

 BOB NIBBS  
Phone 01-261 8622

CHRIS PRIER

Phone 01-261 8037

**Classified Manager:**

 BRIAN DURRANT  
Phone 01-261 8508 or 01-261 8423

 EDDIE FARRELL (*Classified Advertisements*)  
Phone 01-261 8508

 JOHN GIBBON (*Make-up and copy*)  
Phone 01-261 8353

**Publishing Director:**

GORDON HENDERSON

While the Home Office's judgements on the assignment of radio frequencies remain "classified" there is little chance of the public getting to know what the issues are and how they affect them and forming any opinions on the matter. Maybe the man in the street doesn't really care. Satisfied with his one vote, he is content to leave such matters to parliament and the technocrats that advise it. But the opinions of those people who really do care, the socially responsible, are in fact badly needed for a task that can be accomplished from no other source of information — the assessment of social values. For more than a decade it has been recognized that the present "law of the jungle" method of carving up frequency space only between those who are powerful enough to make vociferous claims for it is not good enough in civilized societies — and that is what those who use the spectrum most intensively claim to be. It has also been recognized that very little is known about the effects of spectrum decisions on interests other than those of the claimants and on such important issues as energy, pollution and poverty. In 1970 a telecommunications panel of the US National Academy of Engineering declared: "The allocation of any national resource must finally be made in what is deemed to be in the public interest by those responsible for its management. As the physical resources are exhausted, the social and economic considerations will become paramount and the limited resources must be allocated with greater attention to these factors."

Social factors of course are qualitative issues that deeply concern the community — about health, housing, education, amenities, racial harmony and so on — and are evident in its pattern of organization. They are often influenced by myths, religions or

political ideologies. In some countries the social criteria are imposed arbitrarily by a totalitarian government, but elsewhere they seem to be derived from innate personal values (e.g. the idea of good) with no empirical basis. As such, social factors are extremely difficult to pin down and introduce into practical affairs, although they are in fact the criteria of many political decisions. Economic factors, on the other hand, being essentially matters of quantity, are comparatively easy to handle.

If portions of the spectrum are to be assigned fairly in accordance with social needs, and not merely in response to the emotional appeals of pressure groups, some objective method of measuring these needs, comparing them and establishing priorities will have to be found. And this is where the co-operation of an informed public is essential. The aim of such an objective method would be a rationalization of different types of service. It would be possible to establish, for example, that xMHz of bandwidth for a given time of television broadcasting in central Birmingham was equivalent to yMHz of bandwidth for a given time of mobile radio operation in the suburbs of London. Such precision may never be attained in practice, but this is the ideal towards which recent studies have been directed.

Some progress in this kind of investigation has been made in the USA, where of course the work of the spectrum managers is open for all to see and the public can take an interest in it. The British public should also be made aware of what the electromagnetic spectrum means to them, because it is only through the free expression of opinions on social issues which are affected by this resource that researchers can obtain the objective assessments they need.

# Current dumping — does it really work?

Theory and practice

by J. Vanderkooy and S. P. Lipshitz University of Waterloo, Ontario

This article endorses the soundness of the current dumping principle, though querying whether it should be called feedforward error correction in the feedback loop. In several respects the distortion reduction appears due to a passive bridge balance. It shows that dumper  $\beta$ -variation results in distortion, fortunately very low, which cannot be balanced out in present circuits. Readers are challenged to produce a circuit which nulls out such current distortion as well.

Measurements, in part 2, show that the amplifier performs very well, and analyses of the distortion oscillograms and wave analyser measurements show that, qualitatively, much of this data can be understood. We both heartily agree that the current dumping principle as embodied in the Quad 405 amplifier has significantly advanced the state of the art in class B power amplifier design.

A FLURRY OF EXCITEMENT and controversy has occurred since the article on the current dumping amplifier by P. J. Walker<sup>1</sup>. A class B audio amplifier capable of low crossover distortion, with no quiescent current, seems too good to be true! We have followed the letters to the editor with great interest, and noted that the situation seems to be a stalemate as regards the conventional-feedback versus feedforward argument. Each of us has changed his mind regarding the operation of the amplifier several times. It was in this framework that we decided a more careful analysis was necessary. We present first a view of the theory as we see it, and later on deal with some corrobor-

rating measurements made on a Quad 405 amplifier.\*

Early letters have been adequately handled by Mr Walker<sup>2</sup>, and we feel there is value in the equivalent circuit of Peter Baxandall<sup>3</sup>. But we fail to see how the independence of output impedance under two limiting conditions (dumpers on with infinite mutual conductance, off with zero gain) can imply distortionless behaviour.

There seems to be an advantage in the circuit, but it is precisely in the region of output transistor turn-on that such arguments are inapplicable. Accordingly, we were sceptical of the results, not having really taken the pains to work out all the details presented in Mr Walker's article and the letters. Referring to Fig. (d) of Mr Baxandall's letter, we were led to conclude that the distortion voltage created by the dumpers must somehow find its way out of the otherwise linear components. Mr Olsson's letter<sup>3</sup> also requires an answer.

## Simplified analysis

An illuminating but incomplete analysis of the amplifier is possible. The effect of the dumpers can be looked on as a distortion voltage applied between the input and output of the dumper stage. In Fig. 1 assume for now that A has zero output impedance and has infinite gain (both conditions are related later). Labelling  $v_1$ ,  $v_2$ ,  $e_0$ ,  $v_s$ ,  $i_3$  and  $i_4$  as in Fig. 1

$$\frac{v_1}{Z_1} + \frac{v_2}{Z_2} + \frac{v_s}{R_s} = 0,$$

\*As a result of the widespread advertising campaign for the Quad 405, we have heard it referred to as the "currently dumped amplifier." (We trust that the Acoustical Manufacturing Co. will forgive us for this levity.)

**Fig. 1.** Simplified equivalent circuit of the current dumping principle considering only dumper voltage distortion.

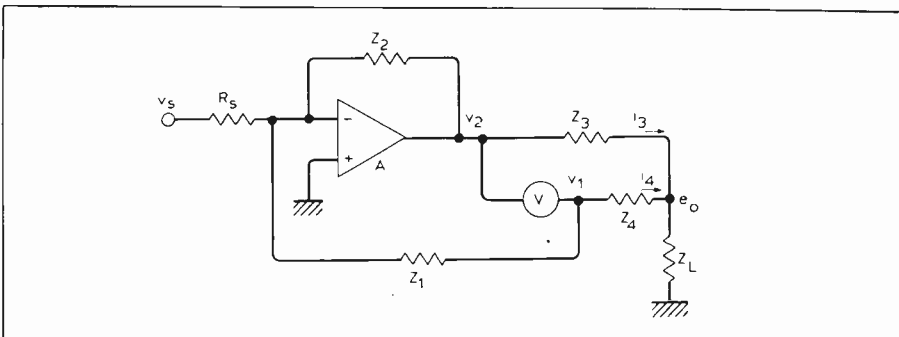

and summing  $i_3$  and  $i_4$  for the total current

$$\frac{v_2 - e_0}{Z_3} + \frac{v_1 - e_0}{Z_4} = \frac{e_0}{Z_L}.$$

These two equations are easily solved for  $e_0$  in terms of  $v_s$  and either one of  $v_1$  or  $v_2$  (we give both for didactic reasons):

$$e_0 \left( \frac{1}{Z_L} + \frac{1}{Z_3} + \frac{1}{Z_4} \right) = -\frac{Z_2}{Z_3 R_s} v_s + v_1 \left( \frac{1}{Z_4} - \frac{Z_2}{Z_1 Z_3} \right),$$

or

$$e_0 \left( \frac{1}{Z_L} + \frac{1}{Z_3} + \frac{1}{Z_4} \right) = -\frac{Z_1}{Z_4 R_s} v_s + v_2 \left( \frac{1}{Z_3} - \frac{Z_1}{Z_2 Z_4} \right). \quad (1)$$

Either equation shows that  $e_0$  will not depend on  $v_1$  or  $v_2$ , which have distortion, if  $Z_1 Z_3 = Z_2 Z_4$ , just the Walker balance condition. Under this condition the output  $e_0$  depends only on  $v_s$  (with the same coefficient now) and not on the distortion voltage  $v = v_2 - v_1$ .

If the gain A is made finite, a balance condition will still follow (messy algebra) as long as the amplifier A has zero output impedance, so that the dumper input current can be ignored<sup>†</sup>. This has been discussed by Bennett and Walker<sup>2</sup>.

Another slant on a simplified analysis is to consider the output of the class A amplifier to be a true current source, with infinite output impedance. Then the equivalent circuit can be redrawn as in Fig. 2, with the dumpers again approximated by a voltage source, which admittedly is not very realistic with the current source approximation.

The class A amplifier has been characterised by a transconductance  $G_m$  with the output connected to the point  $v_2$ . To avoid getting dumper voltage distortion ( $v$ ) into the output, any signal due to  $v$  at the inverting input of the class A amplifier should be zero. This requires  $Z_1 Z_3 = Z_2 Z_4$  independent of the value of  $G_m$ , because the criterion is simply a passive balance of the bridge. It

<sup>†</sup>For finite gain A, the dumper distortion  $v$  cannot be balanced to zero if the bridge is destroyed by shorting  $Z_4$  in the circuit of Fig. 1. This fact also follows from our more general analysis below.



might be considered passive feedforward error correction in the amplifier with judicious feedback applied.

Naturally the effect of the dumpers is to amplify current, and then such a simple analysis is not warranted. Passive balance is lost and a more general analysis is necessary to establish if a balance condition still exists.

**Balance condition**

If the balance condition  $B=0$  can be achieved (see boxed item) the output  $e_o$  will contain no dumper distortion contributions. The condition  $B=0$  is the counterpart of the Walker balance condition  $Z_1Z_3=Z_2Z_4$  which followed from setting the coefficient of  $v_2$  equal to zero in our earlier equation (1). This condition is analysed next in some detail as it really contains all the information we have been seeking.

Firstly, returning to a remark made earlier \*\* suppose that  $Z_4$  is omitted (i.e. short-circuited), thus destroying the bridge. Solving the equation  $B=0$  for  $G_m$  in this case  $G_m =$

$$\frac{\beta \{ (Z_1 + Z_2 + Z_3)R_s + Z_1(Z_2 + Z_3) \} + Z_1Z_3}{(\beta + 1)Z_1Z_3R_s}$$

which is negative†. For d.c. stability, we must assume  $G_m$  to be positive so that the overall feedback around the amplifier be *negative* feedback. Thus no bridge balance condition is possible when  $Z_4=0$ .

Secondly the possibility of achieving bridge balance *does* exist in the general case. Rearranging the equation  $B=0$ ,

$$Z_2Z_4 - Z_1Z_3 = \frac{\beta \{ (Z_1 + Z_2 + Z_3 + Z_4)R_s + Z_1(Z_2 + Z_3) \}}{(\beta + 1)G_mR_s + 1} \dots (3)$$

Provided  $Z_2Z_4 > Z_1Z_3$  and assuming these impedances to be real for the moment, balance can be achieved for finite transconductance  $G_m$  as long as  $\beta$  can be assumed to be constant. In fact, equation (3) gives the value of  $G_m$  re-

†Unless explicitly stated otherwise, we assume that  $Z_1, Z_2, Z_3, Z_4$  are real.

**More detailed analysis**

The Quad 405 contains a class A amplifier which has a current output. Referring to Fig. 4 of Peter Walker's article<sup>1</sup>, the collector of  $Tr_7$  is the output of this amplifier. The resistor  $R_{30}$  is not a significant load as it is "bootstrapped away" by  $C_{10}$ . Other connections to this point are the dumper bases,  $Z_2$  and  $Z_3$ . Capacitors  $C_9$  and  $C_{11}$ , presumably to prevent r.f. instability, are ignored. Hence in an improved modelling circuit we consider the class A amplifier to have a current output and a traconductance  $G_m$  from input (emitter of  $Tr_2$ ) to output (collector of  $Tr_7$ ). Capacitor  $C_8$  ( $Z_2$ ) does not really connect to the same point as  $R_{20-21}$  ( $Z_1$ ), something about which more will be said later. Consider now the circuit shown in Fig. 3, ignoring  $Z_0$  for the moment.

Dumper current gain is set at  $\beta + 1$ , but of course  $\beta + 1$  will change from about 20 when  $Tr_9$  conducts to about 2000 when  $Tr_8$  and  $Tr_{10}$  conduct.

The defining equations and their meaning are all given below.

- Setting amplifier input current to zero:

$$\frac{v_s - v_1}{R_s} + \frac{v_2 - v_1}{Z_2} + \frac{v_1 - v_1}{Z_1} = 0$$

- Setting class A output current equal to  $-G_m v_1$ :

$$-G_m v_1 = \frac{v_2 - v_1}{Z_2} + \frac{v_2 - e_o}{Z_3} + i_b$$

- If dumper output current is properly accounted for:

$$(\beta + 1)i_b = \frac{v_1 - e_o}{Z_4} + \frac{v_1 - v_1}{Z_1}$$

- Using the currents in  $Z_3$  and  $Z_4$  to calculate  $e_o$ :

$$\frac{v_2 - e_o}{Z_3} + \frac{v_1 e_o}{Z_4} = \frac{e_o}{Z_1}$$

Here there are six variables ( $v_s, v_1, v_1, v_2, i_b, e_o$ ) and four equations, so three of our variables can

be eliminated. Choosing to calculate  $e_o$  as a function of only  $v_s$  and  $i_b$  and manipulating gives

$$\begin{aligned} & [(Z_1 + Z_2 + Z_3 + Z_4)(Z_L + R_s + Z_L R_s G_m) \\ & + (Z_1 + Z_4)(Z_2 + Z_3 + Z_3 R_s G_m)] e_o \\ & = [(\beta + 1) \{ (Z_1 + Z_2 + Z_3 + Z_4)R_s \\ & + Z_1(Z_2 + Z_3) - (Z_2 Z_4 - Z_1 Z_3)R_s G_m \} \\ & - \{ (Z_1 + Z_2 + Z_3 + Z_4)R_s \\ & + (Z_1 + Z_4)Z_2 \} Z_L i_b \\ & + [(Z_1 + Z_2 + Z_3 + Z_4) \\ & - (Z_1 + Z_4)Z_2 G_m] Z_L v_s \end{aligned} \dots (2)$$

which we write as

$$A e_o = B Z_L i_b + C Z_L v_s$$

where the coefficients A, B and C are represented by the expressions in square brackets ††.

These equations are all linear, and it is good to pause awhile to ponder whether the distortion has been properly considered. The voltage across the dumpers  $V_2 - V_1$  will control  $i_b$  for the output  $(\beta + 1)i_b$  in a complex way related to the turn-on curve of the dumpers. In choosing to eliminate  $v_1$  and  $v_2$ , the distortion must appear in our equations as a distorted  $i_b$  which is not a copy of  $e_o$  or  $v_s$ . We deliberately chose to eliminate  $v_1$  and  $v_2$  from our equations so that all the dumper distortion contributions to  $e_o$  occur in the single term  $B Z_L i_b$ . Now  $e_o$  can still be made rigorously proportional to  $v_s$ , if the large bracket B multiplying  $i_b$  can be set equal to zero for all signals. (The parameter  $\beta$  occurs only in the coefficient B in equation 2). The balance condition for the new equivalent circuit of Fig. 3 is thus  $B=0$ .

††This is essentially a d.c. analysis of the circuit, and as such will remain valid only for frequencies low enough that time delay effects through the class A amplifier and bridge components can be ignored.

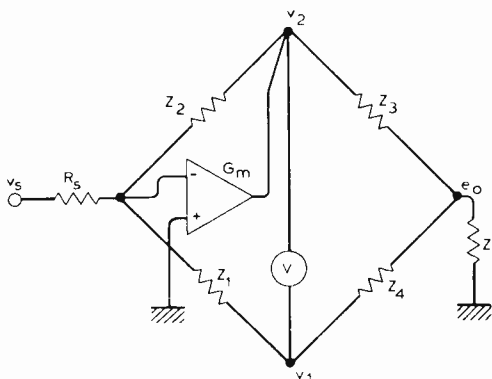

Fig. 2. Simplified equivalent circuit showing that passive bridge balance can remove dumper voltage distortion.

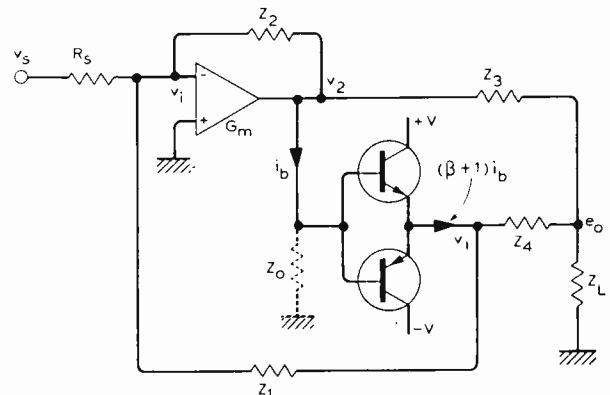

Fig. 3. Equivalent circuit for more complete analysis, see box.

quired for perfect bridge balance, and hence complete independence of the output from dumper distortion. A vital requirement that this be completely achievable in practice is that  $\beta$  be constant. (The extent to which non-constancy of  $\beta$  contributes to the presence of dumper distortion in the output is examined later.)

Thirdly, from equation (3), if  $G_m$  tends to infinity then the balance condition reduces to precisely the Walker condition  $Z_2 Z_4 = Z_1 Z_3$  which appeared in the simple analysis of Fig. 1. So for large transconductance in the class A stage, the balance condition is precisely that obtained before. Moreover,  $Z_2$  and  $Z_4$  can be respectively capacitive and inductive without affecting our argument.

Fourthly, we can now answer the claims by Olsson and others that the (non-linear) dumper input current  $i_b$  prevents the attainment of perfect bridge balance in the case of finite  $G_m$ . The analysis of Fig. 3 shows that no matter how non-linear  $i_b$  may be, if  $\beta$  is constant perfect balance can be achieved with finite  $G_m$ . Lest Fig. 3 is thought unrealistic, in that in practice a perfect current source is not available for the class A amplifier, we have made a more complete analysis. Taking into account the shunting effect of a load  $Z_o$  shown broken in Fig. 3 across this stage in any practical case, and we find that it has absolutely no effect upon the balance condition  $B=0$ . The only effect of  $Z_o$  in equation (2) is to add further terms to the coefficient  $A$  of  $e_o$ , but it does not change the other coefficients. As a perfect current generator shunted by  $Z_o$  is equivalent to a voltage source with a finite output impedance, by including  $Z_o$  in Fig. 3 we have shown that balance is achievable even with an imperfect class A stage, provided  $\beta$  is constant and assuming  $Z_2$  and  $Z_4$  to be real.

Next, we must answer the question which we have thus far begged: To what extent will variations of  $\beta$  in the dumper stage (which certainly are present to considerable extent in the Quad 405 circuit, and at least to a certain extent in any realizable class B output stage) contribute to dumper distortion appearing in  $e_o$  through the incomplete cancellation of the term  $BZ_L i_b$ ? From the balance equation (3) provided  $\beta$  does not fall too low and provided  $G_m$  is large, the effect of changing  $\beta$  will be small.

To quantify this conclusion, return to equation (2). Assume that  $\beta$  varies from say  $\beta_{\min}$  to  $\beta_{\max}$  as the dumpers operate. The dumper output current  $\beta i_b$ , denoted by  $I_D$  can be assumed to be constant to a first order approximation and independent of  $\beta$  in the operation of the circuit. If  $\Delta e_o$  represents the peak-to-peak distortion in the output signal  $e_o$  due to changing  $\beta$  in the dumpers, then

This formula can be further approximated assuming (as in the Quad 405) that the bulk of the load current is furnished by the dumpers, so that  $I_D = e_o/Z_L$ , and that  $Z_2$  and  $G_m$  dominates the terms on the right-hand side. Then

$$\frac{\Delta e_o}{e_o} \approx \frac{(Z_1 + R_s) \left( \frac{1}{\beta_{\min} + 1} - \frac{1}{\beta_{\max} + 1} \right)}{G_m Z_L R_s} \dots (4)$$

This distortion has the shape of a half-wave-rectified sine wave. That due to changing dumper current gain can be reduced to insignificance by making  $\beta_{\min}$  and  $G_m$  adequately large. This component of distortion then is being reduced by conventional feedback on account of the appearance of  $G_m$  in the denominator of equation (4). This distortion percentage is independent of the output signal provided it is large enough to cause both dumpers to operate and is also frequency-independent. We comment later on the possibility of removing such distortion entirely.

In the Quad 405, where approximately  $Z_1$  is  $500\Omega$ ,  $R_s$   $180\Omega$  ( $R_{16}$  in the circuit diagram, Fig. 4 or ref. 1)  $Z_1$   $8\Omega$ ,  $\beta_{\min}$   $20$ , and  $G_m$   $50,000A/V$ , the distortion expected due to changing  $\beta$  is of the order of  $10\mu V$  peak or about 132dB below full output and hence negligible.

Further interesting conclusions can be drawn from equation 2. For instance, it can be shown rigorously that for large  $G_m$ , the output impedance of the amplifier is that of  $Z_3$  and  $Z_4$  in parallel. The voltage gain of the amplifier equivalent circuit  $e_o/v_s$  can also be shown to be approximately  $-R_1/R_s$ .

More interesting, perhaps, is an estimate of the effect of bridge unbalance on the output distortion. Returning to equation (2) to calculate the effect,  $\Delta e_o$ , on  $e_o$  of a change  $\Delta Z_1$  of any one of the bridge impedances  $Z_1, Z_2, Z_3$  or  $Z_4$  (assuming  $Z_2, G_m$  large), and considering that the dumper notch distortion ( $\Delta V \approx 1.5V$ ) results in a peak-to-peak fluctuation  $\Delta I_D$  in  $I_D$  of approximately  $1.5/R_3$  amps then

$$\Delta e_o \approx \frac{1.5Z_1}{Z_2} \cdot \frac{\Delta Z_1}{Z_1}$$

The dumper distortion voltage approximates a square wave of amplitude 1.5 volts, whose transition time is determined by the signal frequency and amplitude, the dumpers and  $Z_4$ . Our formula for bridge error shows that if  $Z_2 = 1/j\omega C$ , then the distortion seen from bridge unbalance will be the time derivative of this, which would appear as sharp spikes whose amplitude depends directly on the speed of the transition.

## Further thoughts

Recapitulating on the operation and analysis of the current dumping amplifier, the dumpers produce a distortion voltage which is completely removed by a balance condition which approximates to  $Z_1 Z_3 = Z_2 Z_4$ , and which becomes progressively less dependent on the gain  $G_m$  of the class A amplifier as it is made large. A second kind of distortion is the asymmetry of the dumper current gain, and any non-linearity of this gain with signal. This current distortion cannot be balanced out, and its effects vary as  $1/G_m$ , so they are reduced by conventional feedback. In the Quad 405 amplifier this distortion appears to be low but perhaps not negligible.

In electronics, the concept of duality allows a voltage source to be transformed to a current source and vice versa. We feel it is possible that a bridge configuration exists such that the current distortion can be nulled as well as the voltage distortion. It may be possible to superimpose the two bridges with one class A amplifier. We have devised several theoretical methods for removing current distortion entirely, maintaining the normal bridge components, by applying positive current feedback to the class A amplifier to give it zero output impedance. The value of  $\beta$  then disappears from the analysis. However, the amount of feedback required depends on  $G_m$ . We feel a better solution is possible and challenge the readers of this journal to produce one. *Results of measurements will appear in part 2.*

## References

1. Walker, P. J. Current dumping audio amplifier. *Wireless World* vol. 81, December 1975, pp. 560-562.
2. Letters to the editor. *Wireless World* vol. 82, April 1976, pp. 54-55.
3. Letters to the editor. *Wireless World* vol. 82, July 1976, pp. 60-62. □

## BOOKS RECEIVED

**Small Craft Radar** by John French. Although this publication is primarily of interest to small craft users, anyone, technically qualified or not, who is interested in radar will find the book interesting. The first two chapters cover the evolution of small radars and their principle. Operation and interpretation are then described with the help of numerous radar display photographs. Final chapters discuss the practical use of radars, their installation, and fault finding. Price £4.50 hardback, pp.207. Stanford Maritime Ltd. 12 Long Acre, London WC2E 9LP.

**Cable television** by John E. Cunningham is a practical guide aimed at engineers and technicians who want a working knowledge of c.t. systems. The book is an American publication. Price £8.35 paperback, pp.352. Prentice Hall International, 66 Wood Lane End, Hemel Hempstead, Herts.

$$\Delta e_o \approx \frac{\left\{ (Z_1 + Z_2 + Z_3 + Z_4)R_s + (Z_1 + Z_4)Z_2 \right\} \left( \frac{1}{\beta_{\min} + 1} - \frac{1}{\beta_{\max} + 1} \right) Z_L I_D}{(Z_1 + Z_2 + Z_3 + Z_4)(Z_L + R_s + Z_L R_s G_m) + (Z_1 + Z_4)(Z_2 + Z_3 + Z_3 R_s G_m)}$$

## Pity the newcomer?

Comments from the Papakura Radio Club of New Zealand reprinted recently in *Break-in* show a concern with a problem for newcomers that is far from parochial. Only a decade ago, it suggests, newcomers could buy surplus military equipment and get on the air with c.w. or a.m. phone quickly, easily and economically — “even 17-year-old school-leavers” — and were made welcome. Before long, interference, receiver noise and weak signal reports would become annoying and the new amateur would often build, buy or modify equipment “learning as he did so”. This process would continue until the amateur achieved an “adequate” station.

Then, the report continues, came the 1970s and good, reasonably-priced, off-the-shelf, Japanese s.s.b. equipment and “who could afford not to buy?” So now, it believes, “we have sold the amateur fraternity down the drain. The dealers may eat, drink and be merry for they have us over a barrel; they have created a need, a “status” that only commercial s.s.b. rigs fulfil. So now they (or the manufacturers or the currency rates) load the price on — over \$1,000 New Zealand for a transceiver, what school leaver can afford that? What family-man can? What hope have they of getting on the air? And if they were to do so with a.m. who would work them? Why do perfectly good but valve-type ex-taxi v.h.f. radios get laughed off the table at junk sales? What have we done to our hobby? At age 32 I am one of the youngest (active) amateurs in our club,” the writer concludes.

Is this an exaggerated, unduly pessimistic viewpoint that ignores the second-hand equipment market and the simpler c.w./n.b.f.m. rigs and the considerable enthusiasm for direct-conversion receivers and low-power transmitters? Possibly, but very few amateurs in the UK or elsewhere would not recognise the problems described by the New Zealand club.

## Examination woes

In a recent Amateur Radio Operator's Certificate examination in South Africa only one-third of the 242 candidates were successful, 66.9% failing. The PMG comments: “we gain the impression that candidates come ill-prepared and unable to answer the questions in the manner expected . . . very few attempted the calculations which were very simple and could have earned them good marks in relatively short time. The descriptive questions were answered rudimentarily and important points missed . . . candidates apparently do not read the questions carefully and do not answer what the examiner really requires . . . time is wasted by the examiners in an effort to decipher



ambiguous handwriting.” One or more candidates received a total mark of 0 per cent; the highest was 80.6 per cent. The percentages of passes varied significantly at different centres, ranging from only 18% in Cape Town, 27% in Pretoria to 32% in Durban and 40% in Johannesburg. The copy of the examination paper reprinted in “Radio-ZS” shows that the standard required is high — and that Part 1 of the paper on regulations is in Afrikaans, with Part 2 (technical) in English.

## Up and down the bands

Following the successes in South America, 144MHz transequatorial-mode contacts have been reported between Australia and Japan. Australian amateurs have also recently claimed two “world records” for u.h.f. contacts: between VK6KZ and VK3ZBJ on 432MHz during January, a distance of 2460km; and between VK5QR and VK6WG on 2.3GHz during February, a distance of 1185km.

European amateurs have been re-examining the opportunities for “moonbounce” (earth-moon-earth) working on 144MHz, despite the rigorous requirements for high-gain aerials. Douglas Parker, G4DZU has received signals from the West Coast of the USA and from Sweden using a 56-element array based on four 14-element Parabeam arrays. Dr Pieire Aubry, HB9XM, has had good moonbounce contacts with West Coast Americans W6PO and W7FN using a very large array providing about 21-22dB gain. Harwell & District Amateur Radio Society recently experimented with a 680ft rhombic aerial intended for 144MHz moonbounce operation.

Vaughan Henderson, ZL2TGH has reported that the VHF Coordination Committee of the New Zealand society has expressed concern at the “massive interference caused by scanning transceivers when transmitting with the equipment switched to the scan

mode.” The committee would like to see this type of transceiver modified so that they are incapable of transmitting in this way. One possibility, it is suggested, is to ground the scan pulse generator output from the press-to-talk switch.

Radical changes introduced by FCC in American amateur callsign practices seem bound to blur the traditional “call-district” identification. Amateurs will be permitted to retain their callsigns when moving to a different call area. Other changes include, for new stations, call prefixes in the KH1/KH9 series for various US territories in the Pacific; KP1/KP4 in the Caribbean. The “N” prefix will be used for three-letter callsigns issued to general and technician classes.

It is hoped soon to extend the r.t.t.y. teleprinter news bulletins (GB2ATG) to include transmissions on 14MHz to provide coverage in Australia, New Zealand and North America. Two or three transmission periods on Sundays may be introduced, possibly at 0800, 1500 and 1600 GMT. Arthur Gee, G2UK, has become President of the British Amateur Radio Teleprinter Group.

## In brief

A blind amateur, Ted John, G3SEJ, of Wallasey who lost his sight while serving with the Royal Navy in World War II and now works for the Merseyside Police, has received the Wally Waldrop Silver Cup Award of St Dunstan's Amateur Radio Society in recognition of his services to war-blinded radio amateurs. The Society, with about 30 members, meets regularly at Ian Fraser House near Brighton where an amateur station is permanently installed. Many St Dunstaners are now reaching retirement age and St Dunstan's state that “radio work has proved to be an ideal occupation and means of communication with friends at home and abroad.” . . . The RSGB has reported that a large amount of Japanese amateur-type 144-148MHz equipment is in use in the Middle East for defence purposes and is suggesting that amateurs may be asked not to buy equipment made by the firms concerned in view of the threat this poses to amateur frequencies. . . . The ITU callsign series J2A-J2Z has been allotted to the Republic of Djibouti. . . . The Norwegian beacon LA4UHF is now operational on 432.89MHz. . . . Headquarters of the Royal Signals Amateur Radio Society has moved back to Catterick Camp in North Yorkshire from the School of Signals, Blandford, Dorset. . . . The Edgware society is holding a 40-year celebration dinner on May 20. . . . The UK FM Group London is proposing that the GB2RS news bulletins should be broadcast over the GB3LO London Repeater on Sunday mornings.

PAT HAWKER, G3VA

# Radiating cables

by R. Johannessen, B.Sc., M.I.E.E., Standard Telecommunication Laboratories Ltd

During the past ten years radiating cables have found increased use in a number of applications. Many aspects of their performance can be specified simply, once they have been derived either empirically or from theory. For the communications engineer with a problem either of coverage or of frequency spectrum conservation, the article sets out where radiating cables may be useful and the aspects to which he needs to pay particular attention.

IN MOST MOBILE RADIO applications the base station aerial and the base station electronics are physically separated, so that the best possible coverage from the aerial is combined with easy access to the transceiver equipment. The link between the two is generally a coaxial cable, such as the UR67 and it is usually assumed that all energy transmitted from the base station goes to the transmitting aerial, no energy being transmitted from the coaxial cable. It is also assumed that the energy received by the base station has been picked up by the aerial, not by the coaxial cable itself. These assumptions are sufficiently valid where the mobile is some distance away from the cable, but are unacceptable if the propagation path between mobile and base station aerial is obstructed. If the obstruction is considerable and the mobile is only a few metres away from the cable, then the coupling between the mobile and cable could exceed the coupling between the aerials. In a radiating cable\* system the cable is designed to couple with the surroundings and there are at least three ways in which this may be achieved: the outer conductor is made as a solid continuous sheet, but with a part missing in the form of a long slot, the edges of which run parallel to the cable axis; the outer conductor is constructed as a braid, woven loosely; or the outer conductor is constructed as a long sheet covering the entire cable circumference but with a series of holes or slots punched in the sheet.

## Path loss components

In designing a communication system in which the base station aerial has been replaced by a radiating cable, the path loss between base and mobile can be

\*sometimes called "leaky feeders".

conveniently split up into three components.

**Coupling.** This is the difference in dB between the power entering the radiating cable and the power picked up by a tuned dipole located some 2 to 5 metres from the cable's axis and close to the transmitter end. Due to the variations in the received power (see 'standing waves' below) the coupling tends to be the mean difference as the dipole is moved about in the region of the location indicated. Different sources quote coupling at different ranges, hence the 2-5 metres bracket. Cree and Giles tested eight different cables and give the measured coupling<sup>1</sup> in the region 50-110dB, depending upon cable type, carrier frequency and mounting method. The cable manufacturer will usually specify the coupling for his own cable, though care should be taken in interpreting the conditions under which that coupling is valid. In general, as the frequency is increased the coupling loosens, giving a weaker received signal. The results of Cree and Giles indicate a change of 6dB per octave over the range 42MHz-460MHz. Similar tests at STL over the range 69MHz-156MHz have given 4.8dB per octave, and tests on one particular cable at low and medium frequencies gave a relationship suggesting 3.5dB per frequency octave in the region 155kHz-790kHz with a very good fit to this curve, as shown in Fig. 1. Harms *et al*<sup>2</sup> studied the effect on cable coupling as the method of cable mounting is altered. Based on two different cable types (one with five small slots per inch of cable, and the other a 64° slot running along the cable axis) the path loss relative to a cable suspended one metre above ground was found to increase by the following amounts:

cable laid on grass	4dB
cable laid on concrete	6dB
cable located in stone drain	7dB
cable buried in soil inside a 3-inch plastic pipe	14dB
cable buried in soil with protecting pipe (moisture dependent)	13-22dB

Tests have shown that as the degree of moisture in the ground increases, the coupling loss drops. A number of tests have been carried out to establish the

rate at which the coupling loss increases as the radial range is increased. Typical values for v.h.f. are 5dB/distance doubling for ranges 3 metres to 15 metres, increasing to some 10dB/distance doubling for 60 to 100 metres. At l.f./m.f. the rate of decay is greater, typical values being 8.5dB/distance doubling around 5 metres, increasing to 20.2dB/distance doubling around 10 metres. In all cases there is a fair spread between configurations, as shown in Fig. 2, the curves being based on some 63 v.h.f. combinations of cable type, mounting method, range and frequency.

**Insertion loss.** The definition and characteristics are as for standard coaxial cables. For radiating cables there is a wide choice, with typical values from 20 to 50dB/km at 100MHz. In general, the loss increases as the diameter is reduced, and cost is reduced. The loss increases with frequency at a rate which is similar to typical conventional cables such as the UR67. With some radiating cables the loss increases significantly when the cable is laid directly on a conducting or lossy surface such as concrete or iron. This is particularly so with some of the cables where the outer conductor is removed for more than 1/3 of the surface.

**Standing waves.** If the path loss is measured between a radiating cable and a mobile aerial which is moving in a direction parallel to the cable axis, a number of variations will be observed. Neighbouring path loss maxima are separated by a distance which is generally just under the free-space wavelength and the difference between such a maximum and the next minimum may be of the order of 30dB. The loss maxima are, however, very narrow and a small movement of the aerial will reduce the loss substantially. These standing waves are repeatable and can be found in different degrees with any frequency and on many sites. The author has studied many different cables but has never found a cable which is completely without them, although Yoshida suggests<sup>3</sup> that with a particular cable design this phenomenon may be removed. It is the presence of the standing waves which makes it imperative to average the coupling over some distance, as suggested above.

**Modulation effects**

The deep minima of signal level will give rise to an amplitude modulation which can be very noticeable in a moving a.m. receiver. It is sometimes assumed that this modulation effect can be completely bypassed by using f.m. transceivers and operating the receiver in the limiting condition. Recent work at STL has investigated the r.f. phase variation experienced by a receiver moving parallel to a cable energized at 105MHz. Figure 4 shows the result of some of this work, indicating large excursions from a linear phase relationship the average deviation being around 115°/metre. With a receiver moving at a speed of 150km/hour, this yields a modulation with a deviation of 0.013kHz. If the transceivers operate with a maximum deviation of ±2.5kHz this small f.m. noise still imposes an upper bound on the achievable s/n ratio. It is an improvement on the a.m. case, but may nevertheless prove unacceptable for some tone signalling applications where the broadening of the tone spectrum might introduce errors.

**Applications**

Propagation conditions in many tunnels are such that reliable v.h.f. or u.h.f. propagation is difficult to achieve with conventional base station dipoles or Yagi arrays. A much better result can be expected with a properly designed radiating cable system connected to the base station transceiver and laid along the tunnel wall or roof. Such systems have been successfully designed in many cities. Breitenbach<sup>4</sup> refers to the use of cables for the S-Bahn in Munich and for the U-Bahn at Hanover. Martin and Webster<sup>5</sup> describe work done for coal mines in Britain, and Yoshiyasu *et al*<sup>6</sup> describe test results from railways in Japan using radiating cables. Above ground a number of other applications exist. Harms and Martin<sup>7</sup> show that the UK Transport and Road Research Laboratory have been considering the feasibility of using radiating cables as a means of achieving a well-controlled radiation field for transmitting information from the roadside to drivers.

Johannessen and Blair<sup>8</sup> show how cables installed in a building can achieve a good coverage inside the building with minimum frequency spectrum occupancy. In this building a freely radiating antenna was considered as an alternative, but it was found that a conventional aerial located on the roof and giving the same coverage inside the building would pollute the spectrum well outside the required geographical coverage area, by an amount which was in the region of 50-70dB stronger than in the radiating cable case. Deane has shown<sup>9</sup> the remarkable feature of radiating cables, which is the rapid decay in signal beyond the cable end — one of the reasons for using the cables where pollution must be minimized. The cases quoted above substantiate the argument that a radiating cable can be

used to advantage where it is known that the movements of the mobiles enable the cable always to be positioned within some 20-100 metres of them.

**Power loss calculation**

By way of an example of the kind of calculation necessary for an installation, consider a building with two floors and a ground floor layout as shown in Fig. 3. It is proposed to use a radiating cable with coupling at 3m of 80dB and insertion loss 50dB/km at 450MHz. The receiver is assumed to need -132dBW from an aerial which has a loss of 8dB relative to a dipole. Reasonable coverage should be achieved by locating the base station in the security area and locating a radiating cable in the ceiling of the ground floor with one arm towards each of the extremes of the building. In the factory area the cable is looped to overcome the extensive shadowing likely to exist with large machinery and extra shelving. Maximum distance from the cable becomes 25 metres, giving a coupling of around 100dB. Maximum cable length will be 150 metres, with an insertion loss of  $0.15 \times 50 = 8$ dB. From Fig. 1 of reference 8 is obtained a one-sigma variation of 6dB which must be increased to 12dB to give 95% probability of coverage. This factor is realistic, since extensive tests indicated that the distribution approximates closely to a normal distribution at least up to the 95% values. Allowing for a 3dB loss where the transmitter power is split into the two cable paths, we get a transmitter requirement of  $-132\text{dBW} + 8 + 80 + 6 + 6 + 8 + 8 + 12 + 3 = -1\text{dBW}$ , which is well within what a standard base station transmitter provides. A 10 watt transmission provides some margin for internal obstructions.

**Measurement**

Before measuring the performance of a radiating cable it is important to ensure that the transmitter connected to the cable is properly screened, so that the path between the transmitter and receiver is not bypassed. If it is bypassed, then the results will not allow extrapolation to other site conditions. It may be found convenient to derive the statistically best fitting straight line to a plot of received signal level against distance from the transmitting end of the cable, since the intercept of this line conveniently yields the coupling, and the slope approximates to the insertion loss. The paper in reference 2 indicates the weakness of this approach and outlines a more accurate method, using the probability distribution, which also includes an allowance for the standing waves.

**Installation**

Some cable manufacturers provide special connectors, since the cable dimension is likely to be different from standard coaxial cables. Where connectors are not available, small diecast

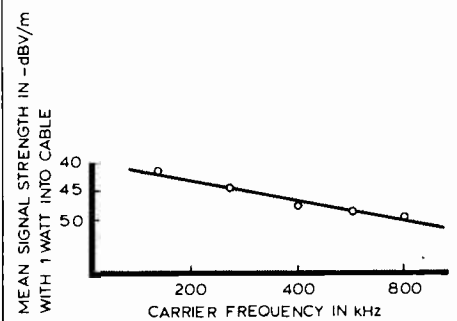

Fig. 1. Variation of coupling with frequency in the l.f./m.f. region.

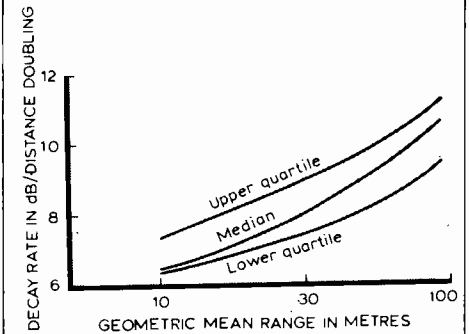

Fig. 2. Changes in decay rate as the mean radial distance is increased.

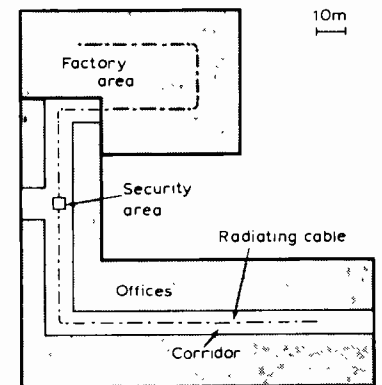

Fig. 3. Example of layout of radiating cable in a building with mixed contents.

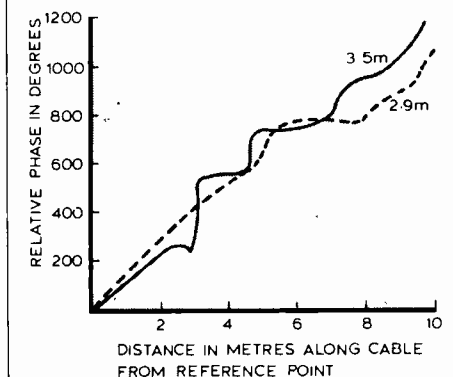

Fig. 4. Phase variation along a radiating cable.

boxes have been used. The end of the cable away from the base station may be terminated in a resistor to keep down standing waves on the cable itself. In some cases it is useful to connect the end of the cable to an aerial via a suitable attenuator if, for instance, a small yard or area outside the building is to be included in the coverage area. Many buildings will have an artificial ceiling to hide service ducts for feed cables to electric lights and gas pipes, heating pipes, etc., which can often be used for the radiating cables. If, after installation, it is found that a part of the building has too low a field strength, it will often be sufficient to break the radiating cable at the nearest point, form a T-junction and lay another arm of the cable into the area with the weak signal. A simple form of T is a hybrid, made up of standard cable with the same  $Z_0$  as the radiating cable and three arms at 0.15 and one at 0.65 times the cable wavelength.

### Cable costs

Cable cost is highly dependent on insertion loss, and from some cable manufacturers the radiating cable sells at about the same price as a coaxial feed cable of similar insertion loss. 1978 prices quoted for cables with a loss in the bracket 20–40dB/km at 100MHz are generally in the range £500-£2500 for one kilometre length.

### The author

Mr Johannessen graduated from the University of St Andrews in 1962. For three years he worked with the Radio Division of Standard Telephones and Cables developing navigational aids for aviation. This was followed by a period at ICL, where he was particularly concerned with the efficient interfacing between computers and their peripherals. From 1969 he has been with Standard Telecommunication Laboratories where he is a principal research engineer. Recent responsibilities have included the study of more efficient use of communication and navigation systems, the development of low cost navigational aids and the evaluation of radiating cables for applications where spectrum conservation is of particular importance.

Much of the information presented in this paper forms part of a study carried out by STL for the Transport and Road Research Laboratory and is published by permission of the Director. The author also acknowledges the cooperation from many colleagues both at TRRL and STL have taken part in the work relating to this paper.

### References

1. Cree, D. J. and Giles, L. J., "Practical Performance of Radiating Cables." Proceedings of the Colloquium on Leaky Feeder Radio Communication Systems, University of Surrey, 8-10 April 1974.

2. Harms, P. L., Johnnesen, R. & Fernandes, A. S. C. "Some Engineering Considerations Affecting the Use of Radiating Cables in Communications between Vehicles and Traffic Control Centres." Colloquium at 1.
3. United States Patent Specification 3795915.
4. Breitenbach, O., "Leaky Coaxial Cables for Radio Communications to Traffic Services." Colloquium as at 1.
5. Martin, D. & Webster, R. "The Use of Radio in British Coal Mines." International Conference on Radio for Roads, Tunnels and Mines. Leige, 1-5 April 1974.
6. Yoshiyasu, T., Hatta, T., Mikoshiba, K., Okada, S. and Hanaoka, T. "Leaky Coaxial Cable at VHF Band and its Application to Vehicular Communications". Proceedings of the 19th International Wire and Cable Symposium, Atlantic City, 1-3 December 1970.
7. Harms, P. L. and Martin, J. A. "Research into Radio Communication with Drivers at the Transport and Road Research Laboratory". England. Conference as at 5.
8. Johannessen, R. & Blair, P. K. "Radiating Cables in Buildings and City Streets". *Wireless World*, September 1975.
9. Deane, P. M. "The Possible Impact on Spectrum Conservation of Radiating Cable Systems Carrying Speech and Data to Road and Rail Transportation". Conference on Civil Land Mobile Radio, 18-20 November 1975. IERE Conference Proceedings No. 33.

□

## CHIP MAKERS GO UP-MARKET

SEMICONDUCTOR MANUFACTURERS have learnt their lesson from the collapse of the digital watch market over the past two years. Fairchild's latest annual report, just published, for 1977 shows that the company made a loss of \$25 million on consumer products. National Semiconductor's last annual report, for the year to the end of March 1977, showed a similar picture, digital watches causing a fall in corporate profits to only \$10 million on sales of nearly \$300 million.

This may be an example of the effects of miniaturisation. The more devices are produced the cheaper they become, but the more have to be sold to bring in the same return. It's a fact of economics that the chip makers will have to learn to deal with.

National's new factory, just opened in Greenock, outside Glasgow, has been built with the intention of better serving the European market which is, they estimate, going to become extremely important in the near future. By 1979, when it comes fully on stream, National will have spent more than \$10 million on it. The markets they will be going for are telecommunications, which they believe has only been held back temporarily by economic circumstances and which is about to benefit from the need for a new generation of equipment, and the top end of the consumer market, including video recording. They estimate that the needs of the European consumer are, in equipment such as hi-fi and colour tv, many years ahead of those of his counterpart in the United States, and National want to be ready to pounce when the market improves. They are now making the M1011 Dolby noise reduction

chip and expect to produce 300,000 of them a month by October, though most of them will go to Japan.

All eyes in hi-fi now seem turned to the upper end of the market. A recent new product launch by ITT made it clear that they are about to abandon the cheaper, mass market end with which they have been connected and go for the better-heeled customer. Renewed interest in home video recording, with launches of the Video Home Recorder from JVC and the Betamax from Sony following one another in quick succession, indicates that consumer product makers want to make products with a higher unit price that will sell to those less affected by changes in economic conditions. Allied with that, the benefits of North Sea oil, though perhaps less than had once been thought, will make the European market more attractive.

The colour tv market will become particularly important to National. European makers, they say, "incorporate up to ten times more value in integrated circuits than their US counterparts." because more digital functions are being put on the set. The Germans, for example, are interested in microprocessor control of tv sets to plan up to a week's viewing, and the display of time in one corner of the screen.

National also expect the European data processing industry to provide them with a lot of business from companies of all sizes.

National European marketing director Tom Reynolds told *Wireless World*, however, that the only market segment they did not expect much from is the military and communications market. "It's growing, but it's

far slower, and we don't see that changing. The avionics sector may grow but it still has a boundary on how much it can grow."

National estimate that the European market and the Japanese market are about equal for semiconductor chips, but regard the market in Japan as closed: "We've broken a few fingernails trying to get into that market," said European general manager Charles Arkebauer. Both Japan and Europe are currently about half the size of the American market and growing at 12% a year.

What is extraordinary about the National plant at Greenock is that it produced the first known 4in linear bipolar wafer in the world last December, only eight months after a fire which completely destroyed the wafer fabrication area. The fire cost them \$30 to \$40 million in sales last year. The capacity of the plant will, when it is fully equipped and manned next year, reach 30,000 to 40,000 wafers a month, amounting to between 40 and 50 million chips a month. One advantage of the increase in wafer size is that the yield, the number of chips per slice, increases because the number of wasted chips around the periphery of the slice becomes a smaller proportion of the total. National intend to introduce 5in wafer production once the present investment programme has been completed but with each size increase above 4in the advantages become smaller.

There is no mask production at Greenock. "That would mean another massive investment, and there are excellent mask-making resources in the UK already," said Tom Reynolds. The Greenock plant already represented 30 or 40% of National investment programme. The chips made in Greenock will be shipped out to various assembly plants around the world. □

# NEWS OF THE MONTH

## Microwave landing — the decision

THE ALL WEATHER Operations Divisional meeting, held by the International Civil Aviation Organization in Montreal to decide on the microwave landing system to be used world-wide from the 1980s has recommended the international adoption of the Australian-American system — the time-referenced scanning beam. The British-developed Doppler system was voted out by 39 votes to 24, with eight abstentions. Voting was by means of a secret ballot — a French suggestion to reduce the possibilities of "horse-trading."

A statement issued by the British Civil Aviation Authority who had proposed the Plessey Doppler system, reads "The UK delegation is naturally disappointed that the ... meeting did not select Doppler m.l.s., since it believes that this is the better and more mature system." It points out that the delegates had to plough through about 2000 papers of highly technical matter in a very short time — a task not easy for those who had not been directly involved with m.l.s. The statement goes on to say that a good deal of work remains to be done before m.l.s. can be used to full advantage and concludes "The delegation congratulates the USA and Australia, the joint proposers of the TRSB/Interscan system and wishes them every

success in its continuing development."

This rather waspish valediction is explained by the feeling, held by the CAA and Plessey (and some Americans), that TRSB is not yet a complete system. The original proposal and relevant costing submitted to ICAO entailed the use of a Compact aerial (a "thinned," lower-cost type). Most testing has, however, been carried out using a "fully-filled" array and the results given to ICAO have been obtained using this aerial. Several other types, the AMSCAN, developed by Texas Instruments, a Rotman lens and Compact were all developed to reduce the cost of TRSB, but only the expensive fully-filled phased array seems capable of effective landing guidance.

In view of the fact that interest has, in the last few years, been almost exclusively concentrated on TRSB/Interscan and Doppler, it is surprising that the German DLS (D.m.e.-based Landing System) began to rally considerable support during the meeting. Its advantages are its relatively low cost, its simplicity and its use of a smaller spectrum allocation than the US/Australian/British systems, and it attracted a great deal of support from the smaller countries, some of which have not yet been able to install the much older instrument landing system (i.l.s.).

It is, therefore, even more surprising that towards the end of the ICAO meeting the Germans withdrew their proposal, issuing a joint paper with the Americans and Australians supporting TRSB. A Plessey spokesman told WW that a hybrid TRSB/DLS system will be discussed, and it seems possible that those countries who voted for TRSB will have supported a system other than the one for which they voted.

Commercial considerations must now be examined, since it has often been said that, whichever system was adopted, manufacturers anywhere could make the equipment. But no indication of the royalties payable has been expressed by the Americans. They are on record as saying that, since the original Doppler patents are American, they could impose large royalties, but would waive them if Doppler were chosen. There would be no royalties payable on TRSB, they have said. So it would appear that they cannot now change their minds and ask for royalties on a non-patented system, and Plessey expect to make TRSB equipment freely, without licence problems. They already use the electronically-scanned beam in the AR3D three-dimensional radar. Prospects therefore look reasonably good for Plessey.

## Electrets may reduce chances to hide radiation risks

A MATCHBOX-SIZED warning device may make those living and working in areas where there is a risk of radioactive contamination less reliant on official, possibly self-interested, reports of contamination levels.

The equipment which measures radioactive dosage has, until now, been too expensive and cumbersome for the man in the street to use. Now the French Laboratoire d'Electricité Générale de l'école Supérieure de Physique at de Chimie Industrielles in Paris has developed and licensed a cheap device which will provide a pocket alarm once a given radiation dose has been exceeded.

There are two main types of radiation measurement device. One measures the equivalent doses received over a period by people in or near irradiated areas. These dosimeters may use photographic films sensitive to X, gamma and beta radiation which are developed at regular intervals, radio-flourescent glasses whose flourescent emissions are proportional to the absorbed ultra-violet dose, and stylodosimeters with ionisation chambers, which are electrometers whose charge decreases as a function of the irradiation dose. The first two cannot be read directly by the user and accidents may be detected only after a time. The third device provide instant readings but they are fragile, expensive and, if the electrometer is accidentally discharged, unreliable.

The second type of device, called flow-

meters, give an instantaneous measurement of the radiation intensity, and can trigger an alarm once a set threshold has been reached. The Geiger counter is an early example. They are expensive and bulky so tend to be used only for checking and decontamination.

The device developed by the LEGde l'ESPCI measures the dose absorbed but is also able to trigger an alarm if the dose threshold is reached. The principle is that the external field around an electret (a permanently polarised dielectric material) decreases in the presence of ionising radiations. This is because they alter the conductivity of the electret, and the electret attracts surrounding ions.

The electret is sandwiched between two electrically-connected electrodes. The electret is bonded to one of them but insulated from the other by a layer of air into which any radiation ions may enter. Initially the electret attracts the electrode to which it is not connected, and a restoring force is applied by a spring. But as ions enter the air gap the attractive force lessens and the spring moves the electrode away from the electret, setting off the alarm.

The absorbed dose may be measured by applying a voltage between the two electrodes cancelling the electret field, the value of voltage needed to move the electrode away from the electret being related to the absorbed dose. The device's sensitivity depends on the initial charge of the electret, the

strength of the spring and the thickness of the air gap. The triggering threshold may be adjusted between 1 and 40 Rem (Rontgen equivalent man). The device does not use any energy from its three nickel cadmium rechargeable cells as long as the sound and vision alarms are not triggered. The device will sell for less than \$20, according to LEG de l'ESPCI.

The ESPCI belongs to the City of Paris, and the Laboratory of less than a dozen people who developed the device is one of ten within the School. Initially they had been doing basic research on the properties of dielectrics and, in 1972, they noticed what they thought was a new effect, the electret effect. It turned out to be fairly well-known, but Bell Labs, who discovered it in 1962, thought so little of it that they didn't patent it.

The first industrial devices to use the effect were microphones, where the high quality of capacitor microphones was desirable but the inconvenient polarising power supplies they required were not. Electret microphone production has risen to 1000 million units in about five years, and is likely to increase if postal and telephone authorities begin to use them in telephone handsets.

The nuclear debate is as active in France as in Britain, and it is bound to take a new turn if methods of measuring radiation become so easily and cheaply available to workers and environmental lobbyists. What the device cannot do, however, is decide what radiation dosage these groups should accept before the alarm is triggered. The levels that we were told were safe ten years ago are now being treated with some scepticism and a great deal of anxiety. [ ]

# Engineering education may be the political battleground of the '80s

ANY RECOMMENDATIONS the Finniston inquiry makes for the education of engineers will not be implemented if they do not meet the collective approval of the engineering professors at Britain's universities.

Although the Engineering Professors' Conference, which represents Britain's 500 professors of engineering in 55 universities, is unlikely to state this quite so baldly in its evidence to the Finniston Committee of inquiry into the engineering profession, the 120 professors who attended the annual meeting of the conference at King's College, London, in early April seemed united on the needs of engineering as well as on the need to present to Finniston a unanimous view.

The conference, which met in closed session for most of its three days, heard some tough talking, but the degree of willingness to abandon cherished viewpoints was, according to some of those present, remarkable for a group of men not usually noted for either reticence or the ability to compromise. Most of the arguments appeared to be about means, not ends, and if true this means that Finniston is likely to receive a submission from the elite of the science teaching profession that will burn a hole in his desk.

The chairman of the Conference committee, Professor Chisholm of Salford University, seemed pleased with the way the meeting had gone, though he was unwilling to say what proposals they would put to Finniston until they had approved a final draft and submitted it to the inquiry, probably in mid-May.

Nevertheless it appears that the evidence is likely to contain a proposal for increasing the length of engineering degree courses from three years to four. The extra year should be aimed especially at more able students. The degree should be retained as the qualification for entry to the engineering profession. There should be greater contact between industry and the universities. Students should start periods of industrial training earlier in their courses than they now do, and university departments should be more willing to offer their skills and facilities to industry.

Students should have a trial period of industrial training before their degrees, and this should come early in the course, preferably between leaving school and going to university, and certainly before starting their third year. The experience would be valuable, say the professors, in teaching students the way industry is "organised, or disorganised," the way the trade unions operate and so on. It is difficult, they say, to teach engineering design to students who have never seen anything manufactured.

The conference is aware that there are not enough training places in industry for the students that want them, and they say that university departments will have to make a greater effort to persuade firms, particularly the smaller and middle-sized companies, that it would be in their interest to provide the places. The trade unions should also realise that the students undergoing training must be allowed to try their hands at tasks normally done by others. The government, in their turn, must provide the money to make the four year courses both possible and worthwhile.

But the professors have laid greatest stress on their own part in the improving of engineering education standards, which they see as the key to the rejuvenation of British industry and the economy. As well as acknowledging the extra work involved in greater contact with industry, the professors call for a halt to the freezing of university posts. Additional staff will be needed with considerable industrial experience, they say, and industrial experience should be accorded greater importance as a qualification for senior lectureships and even chairs in engineering than it now is. At the moment there is too much emphasis on research and published papers as qualifications for university posts. Higher pay would be needed to attract the talent the universities wanted.

The submission is also going to contain some strongly-worded proposals on secondary education. For example, Denis Healey's budget proposals for increased spending on the training of mathematics teachers is unlikely to go far enough for the professors, who think that maths teaching, as well as that of science and modern languages, is of the first importance if engineering is to benefit. In addition, they support the Standing Conference for University Entrance in proposing a common core syllabus in sixth form mathematics. They see no advantage in the proposed introduction of N and F level exams, and say that A level should be retained as the basis for entrance to university. Schools should have closer links with local industry, the universities and professional institutions to give a more informed picture of industry than pupils seem currently to absorb. There should be no common system of examinations at 16 plus.

More broadly, the professors were anxious to stress that they were keen to increase the quality of engineers, not necessarily the quantity. They identify three classes of engineers: the high fliers, with "real creative or management potential", who would benefit from the degree's extra year; the average engineer "with sound knowledge of engineering practice and responsible experience" whose education so far has been too academic; and the technician, who would not need a degree, but would provide vital, highly-skilled support for the other two. More technicians need to be trained, they say.

The meeting was addressed by Sir Kenneth Berrill, head of the Government "think tank," at one of the closed sessions. He told the meeting that the problems of industry in general and education in particular were so complex that no ready solutions could easily be found. But he urged that the professors arm themselves with a closely-argued case to put forward to both Finniston and, in the debate that would follow it, the Government. It appears that his off-the-record remarks revealed a rather gloomy future for the British economy.

The responsibility for implementing Finniston will belong to the Government of the day. Those proposals affecting education will be the responsibility of the Minister for Education and Science, whoever that will be. There's little doubt that the professors have got the bit between their teeth. In the four

years since the Engineering Professors' Conference succeeded an earlier 20-year old body it has grown from what one committee member described as "a social club" to a fairly militant, active and determined pressure group.

How effective they will be remains to be seen. One is reminded of the 1947 battle over the introduction of the health service, especially when delegates seem so self-conscious about their lack of standing compared with that of the medical profession — in a single hour medicine or branches of it were mentioned half a dozen times.

In the late '40s, of course, the doctors lost. But there are important differences. Firstly the doctors had wanted to avoid change which, as they saw it, would erode status they had already attained. The professors want to institute changes which will bring them, and hence they believe engineering, a status it currently lacks. Secondly, the education ministry has never been the source and inspiration of much political ambition. The DES is something of a backwater for an aspiring Prime Minister. But even in the event that the Prime Minister of the day were to break with precedent and appoint as Secretary for Education the best of the talent available to him there seems no-one on either front bench who matches even remotely the ability of an Aneurin Bevan. The Professors' chances of getting their way look good. □

## Renewed attack on Hitachi

The electronic components working party of the National Economic Development Council has produced a report saying that, had Hitachi's application proved successful, 5,000 jobs would have been lost in the UK electronics industry.

Largely repeating arguments put forward before Hitachi were forced to withdraw their application, the working party, whose members include Jack Akerman of Mullard and five representatives of trade unions, including the chairman, said that the plan would have added capacity to an industry which already had too much.

Particular attention is drawn to "Hitachi's operating methods." Hitachi would not keep promises to buy a certain proportion of British made components for its tv sets, and there were no sanctions which could be applied if the company did not keep its promises. The company would have pleaded "technological problems" in reverting to its normal sources of supply.

The party calls for greater management skills and greater capital investment to halt the rise in imports and increase exports. Imports must be reduced by 5 per cent a year, producing a trade surplus in the industry of £270m by 1980. The current deficit is £170m. Imports must be reduced to a quarter of the UK market. British output would need to double. Because of over-capacity this implies somewhat less than double the capital investment. □



# New signs of activity in the s.a.w. market

THE PARIS Electronics Components Show in April was the scene of some furious lobbying by the makers of surface acoustic wave (s.a.w.) devices. GTE, for example, seemed anxious to make it known that they were ahead in s.a.w. technology, while Plessey were stressing their ability to produce reliably in quantity. Others in the ring include Philips/Mullard, Siemens and Plessey.

S.a.w. filters for use in tv sets are now cheap enough to compete with conventional LC filters. That is why most tv makers have started or are about to start using them in tv i.f. strips. Rank say they now use them in teletext decoders but, from July, they will be phasing Mullard and Plessey s.a.w.s into all their sets. Decca say they have just produced a circuit design and will be using them well within a year. Thorn are not using them yet but hope to start production within a month or so using Plessey devices.

GEC say they are unlikely to put them into any of their sets this year, though they are looking at various designs. New receivers will have provision for s.a.w, but they are waiting for newer devices to arrive which do not present such a great reflection problem. They are interested in the GTE devices, though they will have to wait for one that is suitable for use in British sets. The devices, say GEC, would be best suited to use in teletext decoders through their present decoders do not use them.

There have been a number of reasons for the expense until now: the low yields achieved from each batch of devices; the expense of the material used; and the cost of the equipment needed to produce the circuits. Now yields have improved, cheaper material is used and the equipment cost can be written off.

Suppliers admit privately that the s.a.w. market has not so far lived up to the hopes expressed for it when devices first began to appear a couple of years ago. Demand may be as low as half capacity, less in some cases. Plessey announced the delivery of their millionth chip, to GTE subsidiary Saba, in Paris, but clearly they had expected to have sold the millionth device some time before that. Plessey, who independent sources agree seem to be up at the front of the field, began deliveries at the beginning of May, 1977.

There seems no clear reason why there should be a sudden rush for s.a.w. other than what one source described as a bandwagon effect. Once one maker begins to use them, as they have on the Continent, the others follow. The price is now competitive and there is the additional advantage that the sets do not need alignment either before despatch or, vitally important for our traditionally rental market, after they leave the factory.

Teletext is one reason for the change. It requires more stable circuitry, with better phase response, which would be difficult to achieve using conventional i.f. strips. One reason for all the activity in Paris may have been that the German Bildschirmtext service may begin before the autumn. Many eyes were on Siemens, who might be expected to have an advantage in the German market, but it appears that their market will be fairly local, whereas Plessey and the rest will have their eyes on the world market, with all the

complexity of different standards that that involves. Siemens were content to announce that they were now making their s.a.w. devices on lithium niobate, which the others are already using.

In general, four types of material are used: quartz, zinc oxide, bismuth germanium oxide, and lithium niobate. The first is used where temperature stability is of over-riding importance, bismuth germanium oxide offers a delay of around  $6\mu\text{s}/\text{cm}$ , about twice that for other materials, and this makes it useful where the wavelength at the lower frequencies used would otherwise increase the size of the chip. Lithium niobate, however, has a much greater coupling co-efficient than the others, around 5% compared with 1% or less.

Siemens originally intended to use a ceramic material with piezo-electric properties as the substrate for the comb-like filter structures. "However, the high cost of manufacture and low constancy of this material were not in keeping with the low price level demanded for television sets.  $\text{LiNbO}_3$ , single crystals, in contrast, open the way to economical batch production with optimum filter characteristics and the highest possible frequency accuracy."

In addition the devices have not been easy to design into a tv set. The insertion loss of a conventional LC filter is around 5dB, while that for an s.a.w. filter is at least 10dB greater. For that reason they have to be supplied with a preamplifier to supply the right level and preserve the signal-to-noise ratio, but the higher the gain of the preamplifier the more likely it will be that breakthrough will occur from the tuner's input to its output, diminishing the sharpness of the traps at either side of the fundamental frequency of the filter. The output impedance of the tuners is also complex, with a modules which may vary with frequency from 30 to 40 ohms at angles of  $\pm 75^\circ$  or so. This has made them difficult to match into the following i.f. i.c. causing reflections.

Plessey, besides offering s.a.w. filters to suit NTSC and British and European PAL systems, have produced a new preamplifier, the SL1430, for their s.a.w. devices. It

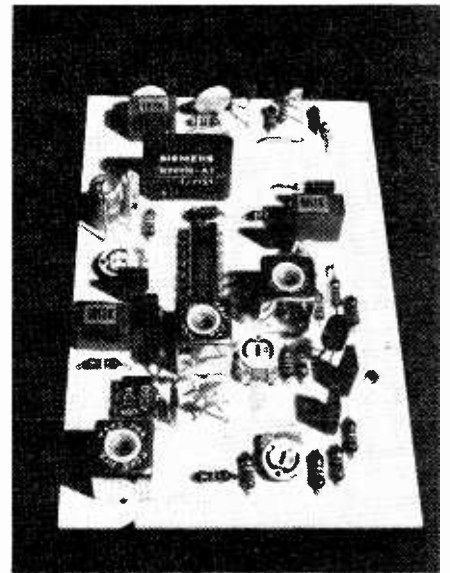

A television picture i.f. stage using a Siemens B39936 surface acoustic wave filter, at top left of the board.

requires only an external capacitor, they say, and its balanced differential output couples straight into the s.a.w. filter, which then goes into the video i.f. i.c. input.

All the makers now stress that the techniques now in use make available devices which are consistent in performance in large quantities. GTE are also stressing the importance of making the devices to CCIR PAL standards.

There seems no reason why s.a.w. devices should be confined to tv sets.

The military market for s.a.w. is well ahead of the consumer market. Cost is less of an object than performance, and s.a.w. is used, for example, in the British Airborne Early Warning System (AWACS) and other projects.

One outcome of the slow start has been that rival makers have been talking earnestly to one another when selling the idea of the technology to the outside, buying, world, but are prepared to cut one another's throats now that orders can be landed. And once the customers start to get on the bandwagon we may expect to see further rapid improvements in their performance. The next stage will be to combine the preamplifier and i.f. stages in a single package. □

## MAVIS—assistance for the handicapped

At a recent colloquium on home television data systems, Julia Howlett of the National Physical Laboratory described MAVIS, which is a microprocessor/television set combination intended as an extremely versatile teletext display and aid for motor-handicapped people.

A Zilog Z80 micro, with 16k r.a.m. and 14K p.r.o.m. for short-term and programme storage, a bubble memory for bulk storage and a cassette facility, is contained in a small unit attached to a domestic television receiver.

The applications of the system are such that severely handicapped children and adults who are able to do hardly anything for themselves are able to play, draw, write, calculate, control peripheral equipment, operate toys, control fires, lights, etc., using a puff/suck tube, pedal, joystick or one of

several arrangements of keys or switches.

The system is essentially a word processor with additional commands for the control of external equipment (fires, lights, etc). In its application as a controller, a command can be "typed" on the screen, using any of the methods of input, and the word "command" selected from a matrix of available instructions, whereupon the desired action will be carried out.

Work is currently being carried out on the simulation of speech and many suggestions have emerged from demonstrations already given for further application, not only for the handicapped, but as a straightforward information system for domestic use.

MAVIS is the result of cooperation between the NPL and Loughborough University of Technology. Ferranti Ltd at Moston are currently building the second prototype.

## FCC produces ideas for better spectrum use

LABORATORY AND field test results show that the existing mobile radio bands could hold seven to ten times more channels using technology that exists today, according to a study commissioned by the FCC. News of the still unfinished study, by Dr Bruce Lusignan of Stanford University, came in a report, "Spectrum-efficient technology for voice communications" by Raymond M. Wilmotte, plans and policy co-ordinator of the FCC's task force (See WW News, February '77, p.41). Lusignan's study was undertaken to see whether the existing US mobile radio bands could be used more effectively to allow greater traffic.

These test results have now given the force sufficient confidence to brief the Commission about a spectrum-efficient technology and its implications. The spectrum-efficient technology referred to is a narrow-band system which uses s.s.b. rather than f.m. It employs an amplitude compandor and a newly-developed frequency compandor, which enable voice signals to be transmitted using a channel bandwidth of 2.5kHz, instead of the 15 to 30kHz currently required. Although the cost is estimated to be up to \$90 more per system than current f.m. systems, the signal quality is just about the same as that using current f.m. systems, and under high-interference conditions it is usable where the f.m. systems, and under high-interference conditions it is usable where the f.m. signal is unintelligible.

As a result, using the narrow band technology exclusively, the number of land mobile channels possible below 470MHz could increase from 1,586 to 12,390 and the channels above 800MHz could increase from

600 to 6,000. By interlacing the narrow band channels with the existing channels, these numbers could increase to 3,434 and 2,400 respectively. The 470 to 512MHz band was not included because of the relatively small areas available for use by land mobile services.

Currently, 56MHz is allocated for land mobile radio use, and if narrow band technology is used exclusively, the existing land mobile radio service could be accommodated in 6MHz, thus freeing 50MHz (not including the 800MHz domestic public land mobile or general reserves).

Wilmotte's reasons for the non-appearance of this technology until now is that market forces have required manufacturers to place a much higher emphasis on cost per unit than on spectrum efficiency and that, for the last two decades, attention and money for research has been largely focused on digital rather than analogue techniques. For these reasons, the task force focused its attention on analogue techniques.

According to Wilmotte, in introducing a new technology into the national communications system, the FCC will be entering areas in which it is relatively inexperienced. A procedure could be established by reserving spectrum space for each service, to be used exclusively by new technology having specified spectrum-saving characteristics. This space would be gradually filled by the new users, switching from operations using current, less efficient technology. The space vacated by the less efficient technology would then be available in which to introduce even more efficient spectrum-saving technology. □

## Sony close on Matsushita's heels in home video

Though Sony's Betamax was announced three years ago — six months before its VHS competition — its UK debut followed that of Matsushita's VHS by weeks. Obviously concerned at the timing of JVC's UK introduction of VHS at the end of February, Sony brought forward its "launch" (though not apparently its deliveries) from later in the year, staging a very professional show that was led by Sony chairman Akio Morita.

Betamax actually had a one year lead in the market, but Akira Hirada of Matsushita's overseas operations division told journalists some eight months ago that they were "catching up fast in Japan and especially in the U.S." claiming a 40 to 50 per cent for VHS. By 1980 JVC recently said they expect VHS to have 65 per cent of the U.S. MARKET. Sony say they have already sold 500,000 Betamax units in the U.S.A. and Japan. (At the Berlin radio exhibition they quoted a figure of 300,000, which indicates a selling rate of around 25,000 per month.)

At the VHS launch at the end of February JVC put the UK market at 250,000 machines by 1980 and said that they expect the UK to absorb 100,000 units (all makes) in the next 12 months. Others are less optimistic. Marketing executive Joe Clarkin of 3M reckons that is "a little excessive" and at a recent press visit to 3M's tape manufacturing plant at Gorseinon estimated 15,000 VHS units will be in the UK by the year end. Peter Hutch-

ings, director of the recording materials division at 3M, told *Wireless World* that while he saw a steady increase in video tape sales, that was in the educational market, and that current domestic sales are insignificant "and will stay so until the (recorder) price drops to around £500." Perhaps this will come sooner rather than later. Either way, 3M expects to have Betamax cassettes available — they are already a licensee in the US — when the machines arrive in June and is currently negotiating with Matsushita over VHS cassette manufacturing.

Main point of difference between these long-play machines and their predecessors is higher recording density, leading to longer playing time and lower tape consumption. At around £13 to £14 recommended retail for a three-hour cassette, tape cost works out at 7p per minute (if the tape is used once). It is in response to this situation that Philips dramatically cut the price of their cassettes in the UK — their N1700 plays for 2½ hours, earlier models one hour — so much that other tape makers say they can't make it at that price and make a profit: "margins are trimmed to dangerous levels," Peter Hutchings recently told journalists. The machines themselves are similarly priced, the Sony SL8000UB at £750 "expected" retail and the

## News in brief

Scenic Sounds of London are now selling the Transamp LZ differential input-output amplifier module for recording console microphone input circuitry and medical and industrial use. Noise figure can be less than 1dB, say Transamp. Price say Scenic Sounds is £20.

The Recording Industry of America (RIAA) have suggested a new playback curve which reduces disc rumble. The present RIAA curve exaggerates rumble by lifting the bass, some 20dB at 20Hz. The new curve rolls off below 30Hz with a relative level of reference to 1kHz of -0.2dB at 2Hz.

Voyager 2, launched last summer to fly past Jupiter in 1979, has developed a fault in its radio receivers. One of the two receivers may have failed and the other may have difficulty receiving commands from earth. The craft switches receivers if a command is not received from Earth for seven days. Engineers are trying to study telemetry from Voyager 2 (there are no transmission problems) to simulate conditions and rectify the fault. By mid-April the two Voyagers were about 300 million miles from Earth.

The ESA Meteorat 1 has been transmitting meteorological data daily since the end of March to the European space operations centre at Darmstadt from the French naval vessel Henri Poincaré. Every three hours the ship's position, wind and sea temperatures, and other information is sent via satellite from special equipment which future ships may carry as standard.

The replacement for OTS 1, destroyed last year (WW News Nov. '77 p.53, Jan. '78 p.35) may now be launched on or after May 4. It has already been delayed because of technical problems with the Japanese communications satellite which had been due to precede it, and because of that old favourite, faulty cable connectors.

The Soviet Union launched its 1000th Cosmos satellite on March 31. Cosmos 1000 will supply navigational information, constantly sending out signals of fixed frequency to allow ships accurately to determine their position when weather conditions make this impossible using coastal and global ground systems, or the stars. The initial period of revolution is 104.9 minutes, apogee 1,024 km, perigee 978 km, and orbit inclination 83°.

According to Tass Correspondent Nikolai Zheleznov, writing in *Soviet News*, "In establishing the co-ordinates, use is made of the Doppler effect. The frequency of the signals changes because of the speed of the satellite. Using this data an electronic navigator can produce navigational information in a convenient form — geographical co-ordinates and precise astronomical time."

The principle appears to be similar to that of the Transit satellites used in the US Navy's navigation satellite system (WW Feb. 1975, pp.52-57). Such satellites should make possible a large degree of automatic navigation.

Mr Ken Jolly, who retired as director of the British Radio Equipment Manufacturers' Association and the Radio Industry Council on March 31, has been succeeded by Mr Oliver Sutton CBE.

continued on page 77

# The Morsemaker

A digital instrument for producing random Morse signals

by Murray Ward, B.Sc., M.Sc. Ed.

This unit uses c.m.o.s. i.c.s powered from a 9V battery to produce a continuous and random string of Morse numbers or letters. Because the speed can be varied over a wide range, the instrument enables anyone learning Morse to practise at their own pace. A rotary switch selects numbers, short letters only, or any letter. Other controls are for pitch and volume. A key jack is also provided so that the instrument can function as an audio oscillator for sending practice.

MORSE characters can be generated digitally with one clock pulse by making use of the time relations in the code. A dot is one unit of time, a dash is three units, the space between dots and dashes within a character is one unit and the space between characters is three units.

For numbers, the Morsemaker takes advantage of two characteristics. Each number contains five elements, and within each number there is at most one changeover from dots to dashes or vice-versa. Numbers are produced by selecting at random the first element, either a dot or dash, and one changeover point after the first, second, third or fourth element, or no changeover for numbers 5 and 0. The number is then ended after the fifth element.

For letters a different strategy has to be used because they vary in length from one element to four, and most of them change over from dots to dashes more than once. Therefore, letters are generated by selecting at random the first element, the changeover points, and the end of the letter after the first, second, third or fourth element. In this way all of the possible combinations of two elements taken 1, 2, 3, or 4 at a time are produced. Because only 26 combinations are required, the four extra groups have to be eliminated. A block diagram of the Morsemaker is shown in Fig. 1. The complete instrument only uses NOR gates and D type flip-flops as shown in Fig. 2. A tone oscillator, which is formed by two NOR gates, provides the audio output and also a means of

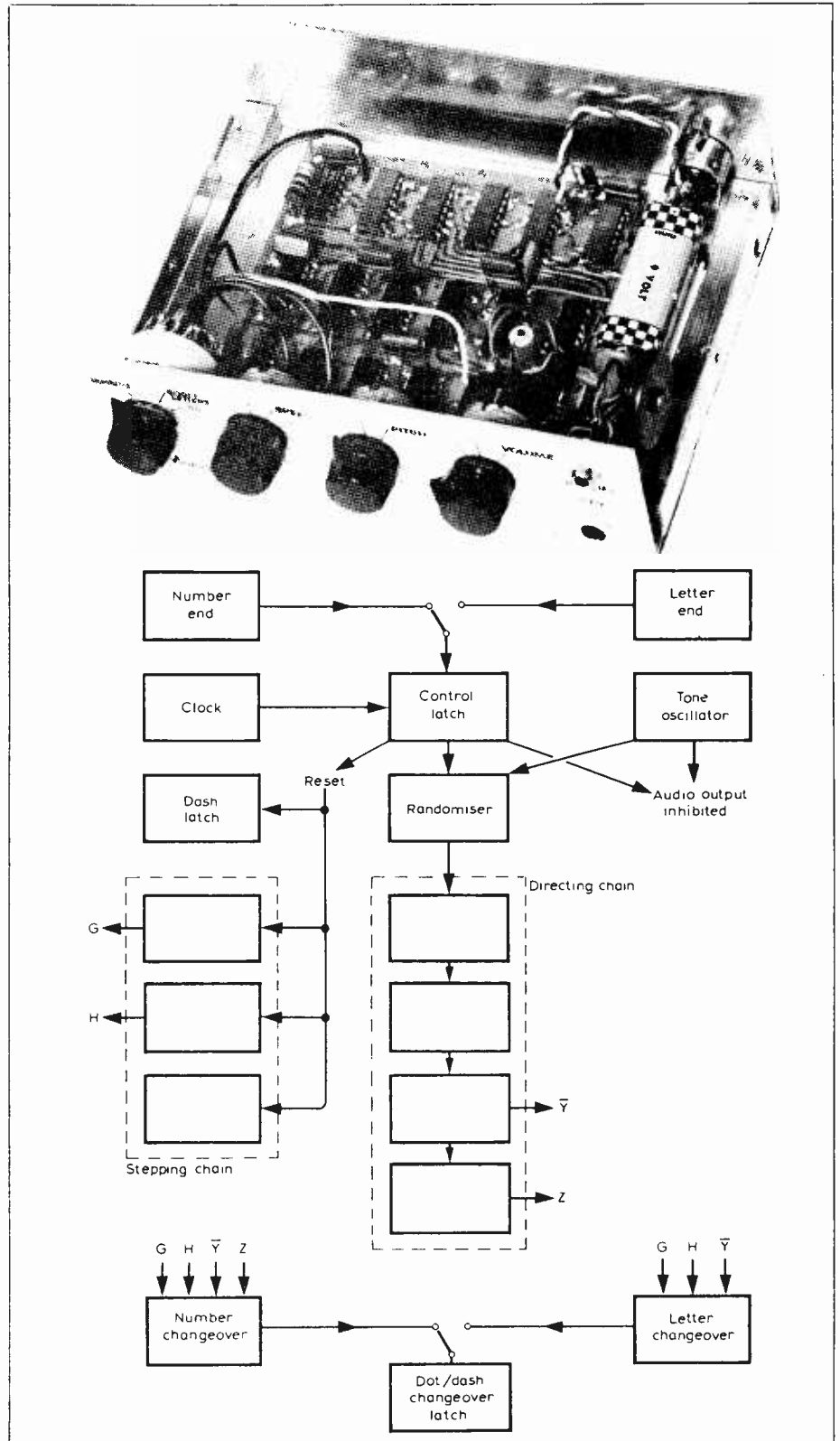

Fig. 1. Block diagram of the Morsemaker. All of the circuit operations are carried out by NOR-gates and D-type flip-flops.

"randomising" the sequence of characters. A similar circuit with a longer time constant forms the clock which operates at the dot frequency. In the randomising circuit a diode modifies the duty cycle of the oscillator by altering the charge and discharge time of the capacitor. This ensures that the string of characters is random.

The dash latch uses a D type flip-flop arranged to divide by two. The Q output is recombined with the clock pulses through an OR gate to fill the gap between alternate dots as shown in Fig. 3. This produces dashes that are 3 dots long and separated by the length of a dot. Any voltage spikes on the output of the latch are removed by a 10nF capacitor.

If clock pulses feeding the NOR gate are prevented from reaching the flip-flop, a string of dots is produced. This happens when both inputs to gate 4001/2b are low which in turn is dependent on the state of the dot/dash changeover latch. Therefore, the initial state of 4013/1a determines whether the character to be generated begins with a dash or a dot.

The output of the dash-latch is con-

nected to a stepping chain composed of three divide-by-two flip-flops whose outputs form a six step binary count as each element in a character is produced. At the beginning of each character these flip-flops, together with the dash-latch, are reset so that outputs G, H, and K are high. In practice it is not necessary to use all of the 3 digits in the binary output, see table 1. For example, in step 6 which is used to signal the end of a number  $\bar{G} \bar{H} \bar{K}$  is never reached, so H can be left out and step 6 defined by  $\bar{G} \bar{K}$ . Similarly, step 5 is used to end the longest letters and to effect the dot/dash changeover for the numbers 4 and 9. Steps 1 to 4 all contain K so  $\bar{K}$  on its own will define step 5.

A second chain of four flip-flops forms the directing chain which determines the particular number or letter to be generated. Unlike the stepping chain whose state changes as a character is being generated, this one changes only

**Table 1 Boolean control expressions**

Stepping chain		full version	short version	
1		G H K	[G H]	reset position
2		$\bar{G}$ H K	[ $\bar{G}$ H]	
3		G $\bar{H}$ K	[G $\bar{H}$ ]	
4		$\bar{G}$ $\bar{H}$ K	[ $\bar{G}$ $\bar{H}$ ]	
5		G H $\bar{K}$	[ $\bar{K}$ ]	
6		$\bar{G}$ H $\bar{K}$	[ $\bar{G}$ $\bar{H}$ ]	

**End of number**

[ $\bar{G} \bar{K}$ ]

**End of letter**

$$X Y Z [G H] + \bar{X} \bar{Y} Z [G \bar{H}] + \bar{Y} Z [\bar{G} \bar{H}] + [\bar{K}]$$

$$= (X [\bar{G} H] + \bar{X} [G \bar{H}]) Y Z + \bar{Y} Z [\bar{G} \bar{H}] + [\bar{K}]$$

**Dot/dash changeover**

number  
 $(Y Z [\bar{G} H] + \bar{Y} Z [G \bar{H}] + Y \bar{Z} [\bar{G} \bar{H}] + \bar{Y} \bar{Z} [\bar{K}]) \bar{W} \bar{X}$

letter  
 $W [\bar{G} H] + X [G \bar{H}] + Y [\bar{G} \bar{H}]$

**Blocked letter combinations**

$$(\bar{V} W X Y + \bar{V} \bar{W} X \bar{Y} + V \bar{W} \bar{X}) [G H]$$

The square brackets have been included to make the stepping expressions easier to pick out; they have no mathematical significance.

**Fig. 2. Complete circuit of the Morse-maker.**

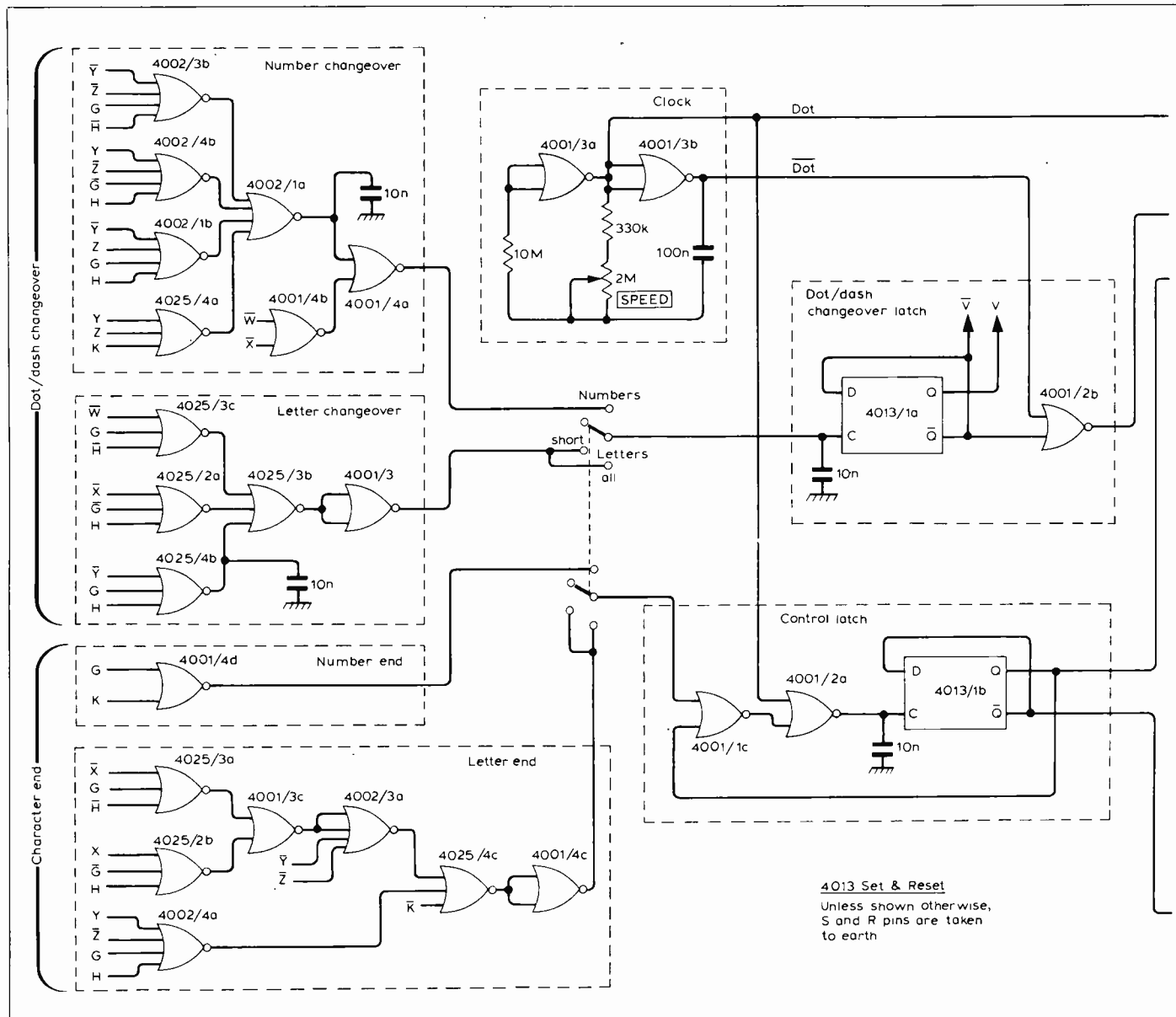

**4013 Set & Reset**  
 Unless shown otherwise, S and R pins are taken to earth

between characters and its state is "randomised" by a burst from the tone oscillator.

**Production of characters**

Table 2 shows the Boolean expressions for Morse characters. Number 2, which in Morse code is . . — — —, starts with a dot so at the beginning V must be low. At step 3 there is a changeover from dots to dashes, brought about by  $\bar{Y} Z$  from the directing chain together with  $G \bar{H}$  from the stepping chain.

Other numbers are produced in a similar way, except for 5 and 0 where W X prevents any changeover. The outputs of W and X can be combined in four ways,  $W X \bar{W} X W \bar{X} \bar{W} \bar{X}$ , so there is a 1 in 4 chance of a 5 or 0 in a long string of numbers. This is higher than the 1 in 5 needed for equal probability of all numbers, but in practice it is not noticeable. There is no particular reason for using WX as any one of the four combinations would serve equally well.

In the case of letters, for example X, the V output from the dot/dash

changeover latch is high. Because X starts with a dash the change step from dash to dot is brought about by  $W [G \bar{H}]$ .

This produces a pulse at the C input of the changeover latch which changes state, and prevents dot pulses from the clock reaching the dash-latch. In this instance only two dots are produced because at step 4 the expression  $Y [G \bar{H}]$  re-activates the changeover from dots to dashes. The letter X ends at step 5 with the term  $\bar{K}$ .

**Between characters**

Several things happen in the period between one character coming to an end and the next starting as shown in the block diagram. While a number or letter is being produced the Q output of the control-latch is low. At the rotary switch that selects either numbers or letters, the character-end signal is a positive pulse. When this reaches the control-latch via two gates the latch changes state and four operations follow. One input of 4001/1c goes low to

prevent any further pulses reaching the latch from the character-end circuits. The centre input of 4025/2c goes high to silence any audio output. The dash-latch and the latches in the stepping chain are reset. A burst of tone enters the directing chain via the "randomiser." This burst continues until the next pulse reaches the control-latch via 4001/2a, resetting it to the Q high state ready for the next character to begin. There are short breaks in the tone supplied to the directing chain due to the diode in the "randomiser" oscillator. This prevents any possibility of the Morse-maker getting into a groove and repeating the same sequence of character. All of these operations take place on a period equal to three dots between the end of one character and the beginning of the next.

During this period the state of the changeover-latch is also made random so that the next character may begin with a dot or a dash. When the control-latch resets the stepping-chain, G and H go high. At various times during the "randomising" of the directing-chain,  $\bar{Y}$  and Z are high and pulses reach the changeover-latch.

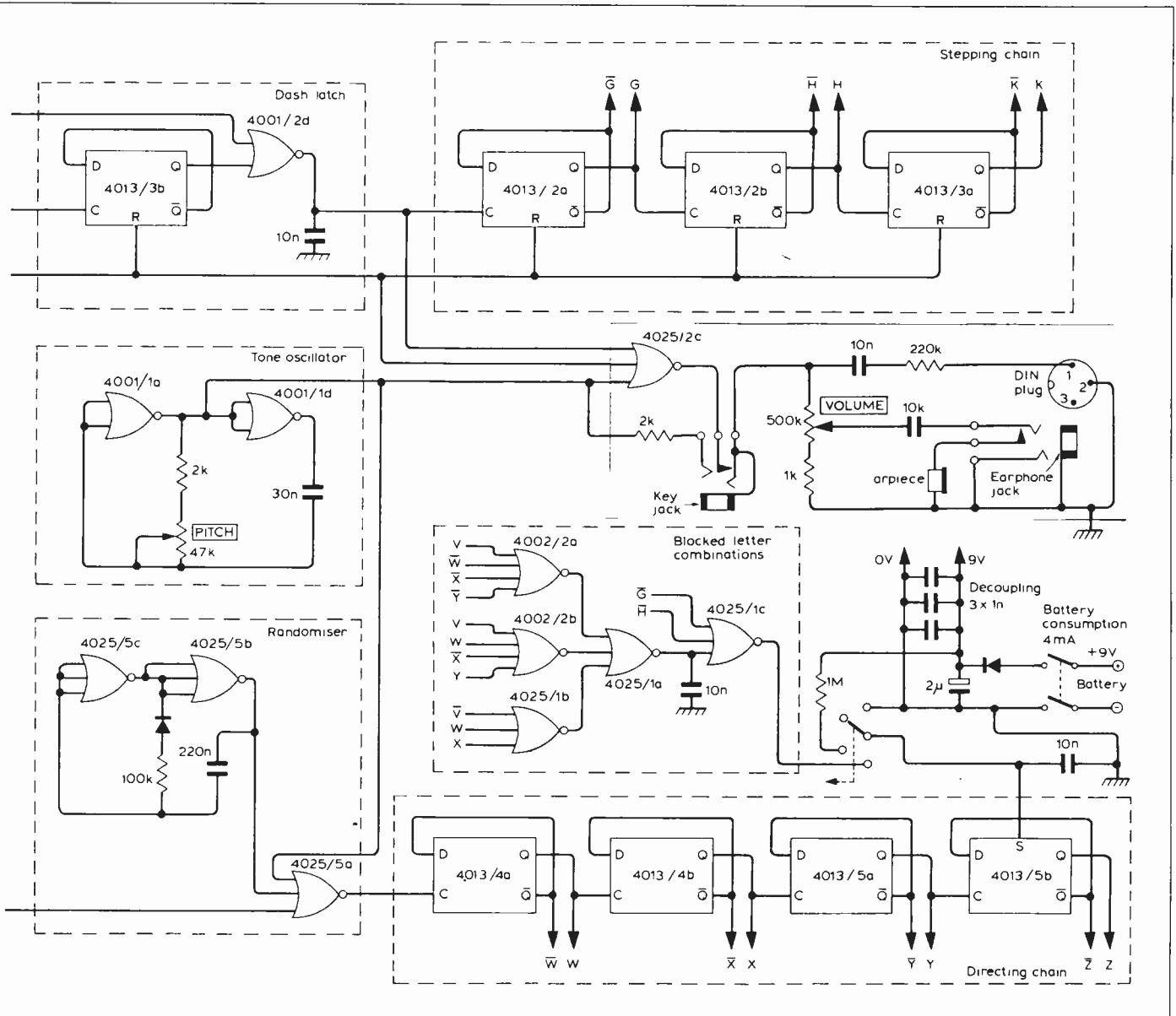

**Table 2 Boolean expressions for Morse characters**

Morse character numbers		Boolean expression	
		dot/dash changeover	end of character
1 - - - - -	6 - . . . . .	$Y Z [\bar{G} H]$	
2 . - - - -	7 - - - - .	$\bar{Y} Z [G \bar{H}]$	
3 . . - - -	8 - - - . .	$Y \bar{Z} [\bar{G} \bar{H}]$	$[\bar{G} \bar{K}]$
4 . . . . -	9 - - - . .	$\bar{Y} \bar{Z} [\bar{K}]$	
5 . . . . .	0 - - - - -	$\bar{W} \bar{X}$ inhibits changeover	
Morse character letters			
1 element			
E . . . . .	T - - - - .	$X Y Z [\bar{G} H]$	
2 elements			
A . - - - .	N - . . . .	W	$\bar{X} Y Z [G \bar{H}]$
I . . . . .	M - - - .	$\bar{W}$	
3 elements			
R . . . . .	K - - - .	W X	
U . . . . .	G - - - .	$\bar{W} X$	$\bar{Y} Z [\bar{G} \bar{H}]$
W - - - .	D - . . .	$\bar{W} \bar{X}$	
S . . . . .	O - - - .	$\bar{W} X$	
4 elements			
(blocked)			
. - - - .	C - - - .	W X Y	
F . . . . .	Q - - - .	$\bar{W} X Y$	
P - - - .	X - . . .	$W \bar{X} Y$	
V . . . . .	(blocked)	$\bar{W} \bar{X} Y$	$[\bar{K}]$
L . . . . .	Y - - - .	W X $\bar{Y}$	
(blocked)			
. . . . .	Z - - - .	$\bar{W} X \bar{Y}$	
J - - - .	B - . . .	$W \bar{X} \bar{Y}$	
H . . . . .	(blocked)	$\bar{W} \bar{X} \bar{Y}$	
First element			
$\bar{V}$	V		



**The author**

Murray Ward graduated from Southampton University in 1953 and taught for 15 years in schools. After completing an M.Sc in educational research at the University of Surrey, he worked on curriculum evaluation for the Schools Council. At present he is employed by the National Foundation for Educational Research and monitors the standards of mathematics in schools for the Assessment of Performance Unit of the DES. He holds the amateur radio callsign G3KZB.

two reasons — it is always available, so a few moments' practice can be taken at any time, and its speed is continuously variable so, together with the short-words-only mode, the unit has an effective "difficulty control."

**Acknowledgement**

I am grateful to D. G. Martin, University of Reading, for his helpful comments on the first draft of this article.

**References**

- Holdsworth, B. & Zissos, D. Logic Design, *Wireless World*, January 1977 onwards.
- Dean, J. A. & Rupley, J. P. Astable and monostable oscillators, in *COS/MOS Digital Integrated Circuits*, RCA, 1974.
- Grist, E. B. A fourth generation cw keyer using cmos ICs, *Radio Communication*, September 1976, p.660.
- Trusson, C. I. B. Morse keyboard and memory, *Wireless World*, January 1977, p.55.
- Irving, M. R. An experimental self-tutor for morse code using the SN74S387 prom. *Radio Communication*, January 1978, p.24. □

From table 2 it can be seen that the expressions controlling the ends of letters are  $X Y Z [\bar{G} H]$ ,  $\bar{X} Y Z [G \bar{H}]$ , and  $\bar{Y} Z [\bar{G} \bar{H}]$  for letters containing one, two and three elements respectively. Each of these contains the term Z. For letters of four elements Z is low. This enables the Morsemaker to output only short letters by preventing Z from going low. To do this the set input of flip-flop 4013/3b is taken to +9V via a 1MΩ resistor.

There are four combinations of dots and dashes that are not used in Morse code for English. All of these consist of four elements. If one of them is generated by the randomising process, it is detected at step 1 and converted to a short letter by changing  $\bar{Z}$  to Z.

As noted previously, the numbers 5 and 0 occur slightly more often than is required. There are some similar variations for letters. The proportions of 1, 2, 3 and 4 element letters is determined by the respective end-of-character expressions from the directing-chain. Letters consisting of just one element, E and T, are generated more frequently than the others. Furthermore, the blocked letter combinations are converted to E, U, O

and M. In practice, however, this is not obtrusive.

**Conclusion**

The Morsemaker has been designed to supplement rather than replace other sources of Morse code, such as cassettes, discs and RSGB slow Morse transmissions. The device is useful for

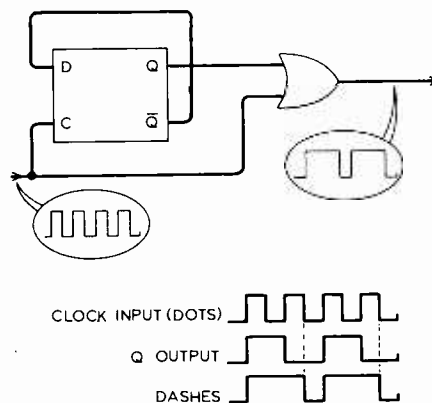

**Fig. 3. Producing a dash from three dots.**

**Printed circuit board**

A double-sided p.c.b. for the Morsemaker will be available for £3.85 inclusive from M. R. Sagin, at 23 Keyes Road, London N.W.2.

# Mobile radio bandwidths

The case for 12.5kHz channels and a way of dealing with data

by W. M. Pannell, Pye Telecommunications Ltd

The article begins by showing the disadvantages of widening an existing bandwidth to accommodate new techniques which could easily change over the next decade or so. Many of the arguments advocating the use of wider band f.m. techniques are concerned with environments not typical of the UK and other countries, and include theories based on ideal situations. Similarly, arguments against the narrow band a.m. equipment used in the UK are often conditioned by tests in different environments. The article concludes by proposing a common channel bandwidth unit, a single unit which on its own is suitable for speech transmission but which can be used for high speed data by employing two or more adjacent units.

The systematic reduction of mobile radio channel bandwidths has been pursued vigorously in the United Kingdom over a number of years, resulting in a reduction of channel spacing — by successive factors of two — from 100kHz in the 1950s to the channel spacing of 12½kHz currently in use in the v.h.f. bands. During the same period, amplitude modulation has been the predominant mode of operation, although more recently, the use of frequency (phase) modulation in the v.h.f. bands has been increasing. This trend has possibly been influenced by the exclusive use of f.m. in the u.h.f. bands which use, at the present, 25kHz channelling.

During the same period, bandwidths in the USA have also been steadily reduced, but have tended to stop short of those adopted by the UK. The difference in policy can be attributed to the almost exclusive use of f.m. in the USA, although the use of single frequency simplex may also have influenced the decision. Currently in use in the USA are v.h.f. bandwidths of 20kHz below 50MHz and 30kHz above. U.h.f. channels are now based on 25kHz increments.

As the channel spacings have become smaller, the adverse effects of such reductions on the performance of systems employing frequency modulation have been seen to increase, while with a.m. the reduction in the performance involving some parameters has been considerably less. It could be broadly stated, that, with frequency modula-

tion, it is the channel bandwidth rather than the "state of the art" limitation, which restricts the performance, whereas with a.m. the reverse tends to be true. It is for these reasons that in the UK, with the predominantly a.m. market, the trend has been towards narrower channels, while the USA, and the other countries which use f.m. almost without exception, halted the channel splitting process when a measurable loss of performance using the f.m. mode became obvious.

There are, of course, some disadvantages or restrictions incurred by reducing bandwidths with both modulation modes, but certain of these can be overcome by improved techniques and by observing basic rules when planning systems.

One restriction made increasingly obvious by the introduction of narrower channels — f.m. or a.m. — is that of sideband radiation, on which the limits necessary to achieve adequate protection in the adjacent channel become much tighter as bandwidth decreases. Consequently, while normal speech can be accommodated with little difficulty, the transmission of high speed digital intelligence, with its attendant larger sideband spectrum, introduces limiting factors. Thus we now have a situation where, with *high speed* digital techniques, it may be necessary *at the moment* to increase channel bandwidths rather than to retain the existing spacings.

Arguments have also been advanced that even with speech modulation the wider bandwidth f.m. systems exhibit considerable advantages over narrow band systems, either a.m. or f.m.<sup>1</sup>, while it has been stated elsewhere that the use of less than 25kHz is a backward step<sup>2</sup>. It may be concluded from these reports therefore that such opinion considers that mobile radio would appear to benefit from the use of a common channel bandwidth suitable for data and speech, and that the bandwidth should be of the order of 25kHz.

## Against a common 25kHz channel plan

At this point it is as well to consider the implications of using, in the UK and many other countries, a common channel bandwidth plan for both speech and data and to examine why the arguments advanced for a minimum of 25kHz channelling do not necessarily apply in the real world.

First of all, it is as well to remember that the existing 12½kHz channel bandwidth in the v.h.f. band has been in actual use for a considerable period of time. A paper was read by P.A. Webster<sup>3</sup> at an IEE convention in 1966 on the subject of 12½kHz operation and subsequently such equipments were being manufactured and operated well before 1970. Thus experience of such a band-

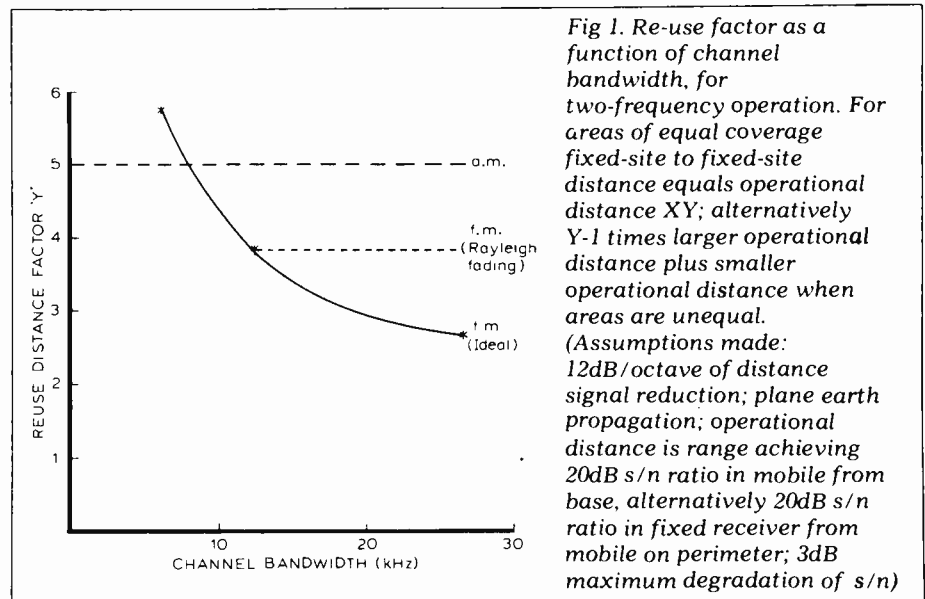

Fig 1. Re-use factor as a function of channel bandwidth, for two-frequency operation. For areas of equal coverage fixed-site to fixed-site distance equals operational distance XY; alternatively Y-1 times larger operational distance plus smaller operational distance when areas are unequal. (Assumptions made: 12dB/octave of distance signal reduction; plane earth propagation; operational distance is range achieving 20dB s/n ratio in mobile from base, alternatively 20dB s/n ratio in fixed receiver from mobile on perimeter; 3dB maximum degradation of s/n)

width in the UK extends over nearly 10 years and its success cannot surely be open to question.

On the other hand references still quoted in support of wider bandwidths include a theoretical paper by Buesing in 1970<sup>1</sup>, previously written for FCC Docket 15398 (1965), both of these dates being prior to work in the UK which proved the feasibility of narrow channel systems.

Briefly therefore, the UK has the experience of 12½kHz operation in the v.h.f. bands — both a.m. and f.m. — while the USA, apart from tests at 15kHz in the vastly different single frequency environment of the USA, have not ventured below 20kHz and in the main, consider 30kHz as the preferred bandwidth.

In addition, the use of f.m. has been universal in the USA and — possibly of greater significance — the experience of the USA has been coloured in the v.h.f. bands by the predominant use of single frequency simplex.

Capture effect and its advantages is the theme of many an argument supporting the use of f.m. and while it is agreed that substance for such an argument exists with the use of the wider bandwidths operating under certain ideal conditions, some of the gains derived by using 25kHz channelling can be disputed, particularly in a mobile environment.

Undoubtedly if ideal conditions — no fading — exist, then the capture effect obtained with 25kHz channelling when compared with narrower channel spacings could result in the theoretical (two frequency) re-use factors postulated by Magnuski<sup>4</sup> and made possible by the improved protection ratio. However, the real world is not ideal and the presence of fading introduced over the circuit by various causes can reduce, or even eliminate, the so-called capture effect. Gans and Yeh<sup>5</sup> state: "although

co-channel interference without fading could be markedly reduced by increasing the modulation index, it remains approximately constant with index, for indices greater than unity when fading is present".

Summarising this statement, it means that with a 2.5kHz audio bandwidth, any greater deviation than 2.5kHz — the deviation associated with a 12½kHz system — will not benefit the co-channel performance of the system under fading conditions.

Fig. 1 has been plotted to show the relative two frequency re-use distances based on the paper by Magnuski<sup>4</sup>. It shows the constant re-use distance over plane earth which can be attributed to the use of a.m. operating in the two frequency mode: the improvement in re-use distance with bandwidth is shown for the *ideal non-fading f.m. conditions* also in the two frequency mode; whilst the dotted curve illustrates the effect of Rayleigh fading on the effective re-use distance as the capture effect is lost. It can be seen therefore that if fading is included, the re-use distances, based on the level of co-channel interference suggested by Magnuski, are not so appreciably different for a.m. and f.m. over the range of bandwidths shown.

It must be emphasised that the re-use distances shown in Fig. 1 are based on two-frequency simplex operation. If we consider single frequency operation, the re-use distance must be related to the levels of signal between the fixed sites and consequently a different expression must be considered.

For example, in two frequency operation the level of unwanted signal (f.m. or a.m.) must be XdB down at the input of a mobile receiver located on the perimeter of the distant area, relative to the level of wanted signal into that receiver from its own fixed station. The required value of XdB determines the

re-use distance, which, in turn, for two similar areas, can be expressed as  $n$  times the operational radius of either area (fixed to mobile). See Fig. 2.

In the single frequency case we must consider the fixed receivers, their antennae being correspondingly higher than in the mobile case. Let us imagine therefore that the mobile antenna is elevated to a height equal to that used at the distant fixed station. The "operational" range is naturally extended from that obtained with the mobile antenna at vehicle height, and "C", shown in Fig. 3 suggests a point where the same wanted signal level as received at the perimeter of area "A" in the mobile situation might be obtained.

Based on the average level of signal attenuation over plane earth following a "12dB per doubling of distance" law, the point where the signal level (now unwanted) should equal the noise level into the receiver at base station B will be at 4 times the "operational" distance (A to C). At this point the unwanted signal will therefore be 24dB below the wanted signal from a mobile on perimeter B and thus the signal-to-noise ratio at base B receiver will be 21dB, i.e. a degradation of 3dB relative to the s/n ratio without the interfering unwanted signal (a.m. case assumed).

As an example, if we take a typical situation involving fixed a.m. equipments with antennae at 100 feet and mobile units operating with antennae heights of 5 feet, it can be shown that over plane earth the "operational" radius will approximate to 17 miles. Thus, with the two-frequency re-use factor of 5, as shown in Fig. 1, the distance between two fixed stations with similar coverage should be of the order of  $5 \times 17$  miles (85 miles).

If we now raise the antenna of a mobile to 100 feet from the original 5 feet, the "operational" radius will increase to 28 miles and, applying the factor of 4 previously discussed, we arrive at an equivalent fixed-to-fixed station re-use spacing of 112 miles.

Thus, in the example given, it can be seen that by using the single frequency mode the fixed-station to fixed-station re-use distance must be increased to 112 miles from the two-frequency re-use distance of 85 miles.

Reducing the re-use factor, however, for example by considering the *ideal f.m. 25kHz case* (Fig. 1) decreases the difference between re-use distances for the single and two-frequency modes, and in fact at the re-use factor of 2.68, as given by Magnuski, the two modes show similar spacings at the antenna heights quoted above. However, increasing the antenna heights will again restore a spacing difference between single and two-frequency operation.

Where such a difference exists, the greater distance needed in the single frequency case must be implemented and this naturally improves the fixed-to-mobile performance. If not implemented then fixed-to-fixed interference

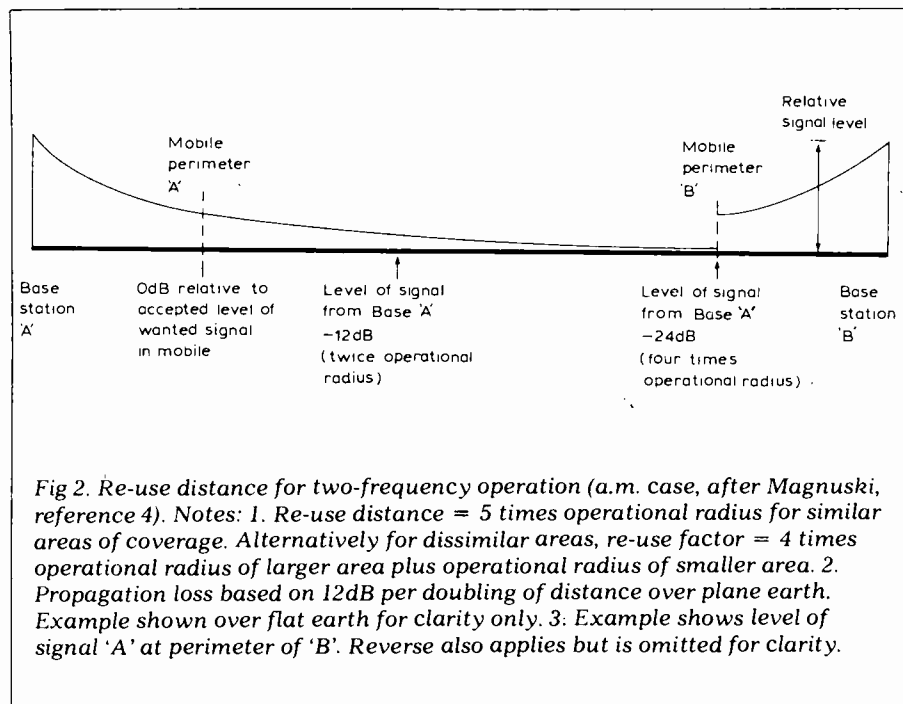



must necessarily be of a higher order, and the degradation of the mobile signal into the base receiver will consequently be greater.

The implication of the need to increase re-use distance when single frequency operation is employed is therefore obvious from the above.

Continuing, although capture under ideal conditions can permit a shorter re-use distance between co-channel users to be considered, the protection afforded by such capture is only present when a wanted signal is transmitting and its level relative to any unwanted signal is in excess of any protection ratio achieved by the capture effect.

When the wanted signal is not available then unwanted signals will be heard unless tone squelch is fitted. Thus the satisfactory use of the smaller re-use distance is based in the ideal case on the fitting of tone squelch to all systems.

Under fading conditions, when capture is virtually non-existent, unwanted signals will be heard when the squelch is opened by a wanted signal unless the re-use distances are extended to approximately those of a.m. Capture can also introduce other unwanted hazards in the communication circuit and there is, for example, a conflict between channel loading, in terms of busy hour occupancy, and capture effect.

Let us assume full capture is possible. As channel loading increases, and in particular in cases where coverage is required of, say, a town in which the greater proportion of mobiles operate, and surrounding rural districts where the number of mobiles may be low, the probability of a mobile on the perimeter of the coverage obtaining access falls sharply with traffic loading<sup>6</sup>. For example, if it is assumed that mobiles awaiting access exceed one, then, if capture effect is present, the nearer mobile will always tend to gain access, and with signals having a difference considerably in excess of the 9dB postulated by Magnuski<sup>4</sup> the likelihood of a weak station obtaining access is poor. A.m. will not suffer so markedly in this respect and weaker signals will have a better chance of accessing the channel.

Obviously as and when fading of the stronger signal occurs and capture becomes relatively non-existent, then the ability of a distant mobile to access the channel will improve. The effect of fading on such a circuit therefore will be to introduce an element of uncertainty into the ability to access the channel, an uncertainty which will worsen as channel loading increases.

**Re-use in practice**

The ideal degree of re-use as postulated by Magnuski<sup>4</sup> is shown as a function of bandwidth in the graph Fig. 1. The dotted curve on the same graph indicates the limitation which is imposed on f.m. under fading conditions.

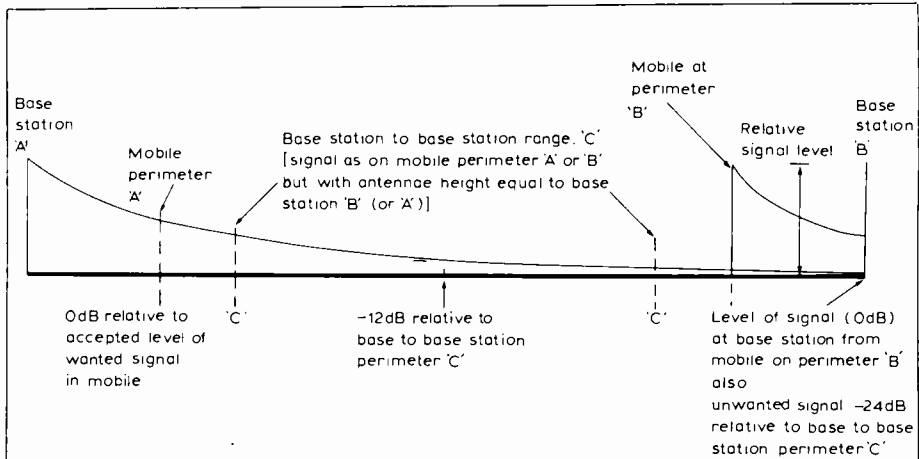

Fig 3. Re-use distance for single frequency simplex (a.m. case, after Magnuski). Notes: 1. Re-use distance = 4 times base to base range 'C'. Range is where signal level equals that required on perimeter 'A' (or 'B') for mobile case, but with antenna height at 'C' equal to base station 'B'. 2. Propagation loss based on 12dB per doubling of distance over plane earth. Example shown over flat earth for clarity only. 3. Example shows level of signal 'A' at perimeter of 'B'. Also level from mobile (at perimeter 'B') into base 'B' receiver. Reverse also applies but is omitted for clarity. 4. Example also shows base-to-base range 'C' for signal level equal to mobile requirement at perimeter of either area. 5. Solution to any situation. 'A' to 'B' must equal or exceed re-use distance for two-frequency condition.

However, even if the greater deviation of 25kHz channels could always be accompanied by the ideal non-fading situation, and a higher protection ratio would therefore be made possible, the degree of re-use would, nevertheless, be much reduced from that indicated theoretically where the theoretical model assumes plane earth, uniform propagation and an infinite usable area. Regardless of the mode or bandwidth the reasons are:

- The need for channels is not uniform in space: the areas of high demand being very bunched.
- In countries having the general geographical configuration of the UK, many of the re-use areas would fall in the sea.
- In London, the degree of re-use would be extremely limited — only small coverage systems falling into the desired category — and this limitation could tend to restrict any possible gains using 25kHz f.m. even under ideal conditions.
- Propagation anomalies lead to irregularly shaped service areas and cause the actual packing of re-use areas to be less than theoretical.

It is therefore considered that 25kHz f.m. systems, operating with a normal degree of fading and located in areas having average geographical hazards, irregularly spaced areas of usage and with varying degrees of packing density, cannot take full advantage of the gains argued by the US sources, and the resultant gains postulated by them are unlikely therefore to be achieved with any marked degree of consistency.

Existing re-use parameters in the UK — for both a.m. and f.m. — have been determined, on the other hand, over many years of experience and have

been developed bearing the foregoing shortcomings in mind.

**Intermodulation potential**

Buesing<sup>1</sup> indicates the order of increase in intermodulation products which will occur as the number of channels increase with decreasing channel spacing. Undoubtedly doubling the number of channels by halving the bandwidth will increase the number of third order products by a factor of some seven to eight times. Is this likely to be a major problem, however?

If one considers, say, 10 adjacent channels on a single site, then, as an approximation, there will be some 470 third order 2- and 3-signal products possible, although less than half will fall on-channel. Obviously this is a problem which, to eliminate, requires suitable planning and technical safeguards.

Doubling the number of adjacent channels on that site (by halving the channel bandwidth) would increase the third order products from 470 to some 3760, resulting in a formidable array of on-channel products to eliminate.

However, would such a situation be allowed to arise in a correctly planned environment? In practice, channels would be chosen from the total spectrum available and suitable well-known intermodulation precautions observed. Certainly off-channel radiated products would be reduced to a low level as a matter of course, whilst planning procedures would ensure that in the immediate vicinity where receiver overload could generate i.m. products, other systems were not allocated critical frequencies. It is submitted therefore that, far from increasing the intermodulation interference potential, the ability to be able to choose from twice

the number of channels would often enable freedom from interference to be practised with greater effect.

It is further submitted that this ability would be enhanced still further by our use of two-frequency operation in the UK as undoubtedly the single frequency environment encountered in some countries is often a major contributor to the high level of spectrum pollution, involving intermodulation, existing in the urban complexes of those countries.

### Impulsive noise

The impulsive interference aspect of any argument often tends to be subjective. While the degree of interference worsens by some 3dB on each occasion the channel bandwidth is halved, there are conflicting views as to the actual degrees of annoyance value, in particular, where the equipments and systems involved are "tailored" to minimise this annoyance value.

Where the range extremes tend to be in electrically quiet rural areas, most interference present will only be high in high signal areas and thus the effect upon reception will be much less than if the reverse is true. Here the systems parameters dictate the result.

If the equipments are optimized to reduce the effects of impulsive interference, e.g. adequate noise limiting, tailored audio/loudspeaker responses, attention to phase response and filter ringing susceptibility in receivers, the actual effect upon the listener will be much less than if such points are not considered.

It is suggested that, although theoretically 25kHz f.m. systems, when

correctly tuned, should be less affected by impulsive noise compared with narrower band systems, the different character of the noise pulse under aural conditions often makes the difference much less obvious. For equal orders of frequency stability, any frequency drift will worsen the interference effects with f.m. to a greater extent than with a.m.

### Effect of bandwidth on effective range

The reduction in effective range as the bandwidth is reduced is necessarily affected by the type of modulation, degree of impulsive noise present and the minimum acceptable signal. Fig. 4 shows the effect of introducing such variations into the calculation. Variations in the parameters are likely to be as follows: (a) at threshold, there could be up to a 3dB gain in s/n in f.m. systems each time the bandwidth is halved; (b) impulsive interference will worsen at the rate of approximately 3dB each time the bandwidth is halved; and (c) signal/noise will drop by up to 6dB in the f.m. case each time the deviation (bandwidth) is halved. Calculations have been based, however, on 5dB which has been obtained in practical tests<sup>7</sup>.

It must be highlighted at this point that the result shown in Fig. 4 must be interpreted in relation to the type of system used, and indications are that confusion often exists concerning the two quite different levels of signal required from mobile telephone service and private mobile radio. In practice, the tendency will be for private mobile radio levels to approach threshold at the

service area perimeter and thus, for the present argument, the curves at threshold only should be considered.

In addition, the general results shown in Fig. 4 are, as is emphasised, theoretical, and in practice the results will be modified by a number of other factors, for example, geographical considerations, equipment and system design, degree of mandatory impulsive noise suppression, acoustic considerations. However, locating the base station so that the coverage perimeter is generally in an electrically quiet, rural type environment tends to allow curves 2 and 6 to apply. Similarly, the implementation of suitable laws against the generation of excessive electrical noise will also favour results towards curves 2 and 6. Suitable suppression circuits and/or tailoring of the acoustic parameters — loudspeaker, listening environment — will reduce the actual effect of impulsive interference insofar as it affects the listener, and again the trend will be towards curves 2 and 6.

It is, therefore, strongly advanced that, although Fig. 4 indicates quite appreciable losses of range under certain "above threshold" conditions, these conditions are not necessarily so important in private mobile radio use. The curves tend to show that, at extreme range, a.m. will exhibit some advantages relative to f.m. and is possibly a point in favour of its use in private mobile radio.

### Data transmission

Let us now consider mobile radio as a means of carrying data traffic.

First of all, we have the simpler data systems. In this category we can include conventional tone methods, on-off, sequential, f.s.k., d.p.s.k. etc, where the rate is relatively slow — effectively less than 1200bit/s. There is no difficulty in accommodating these systems in the normal radio audio pass band and, together, with the sideband radiation, such intelligence can be handled by a 12½kHz system with little difficulty. Bit rates, in any case, will be limited by the characteristics of any normal telephone line feeding a radio system, and unless special grades of line are used the top limit handled would appear to be around 1200bit/s. Thus any system configuration employed for data transmission could well be affected by its associated land line.

Indications are, however, that 12½kHz channels will readily support up to 4800bit/s and it is submitted that this speed is more than adequate for normal data needs.

A 25kHz channel, on the other hand, can support >9600bit/s, which is (i) not practical when fed by a normal telephone line owing to the limitations of that line; the use of radio links as a substitute for telephone lines in order to increase the bit rate is contrary to

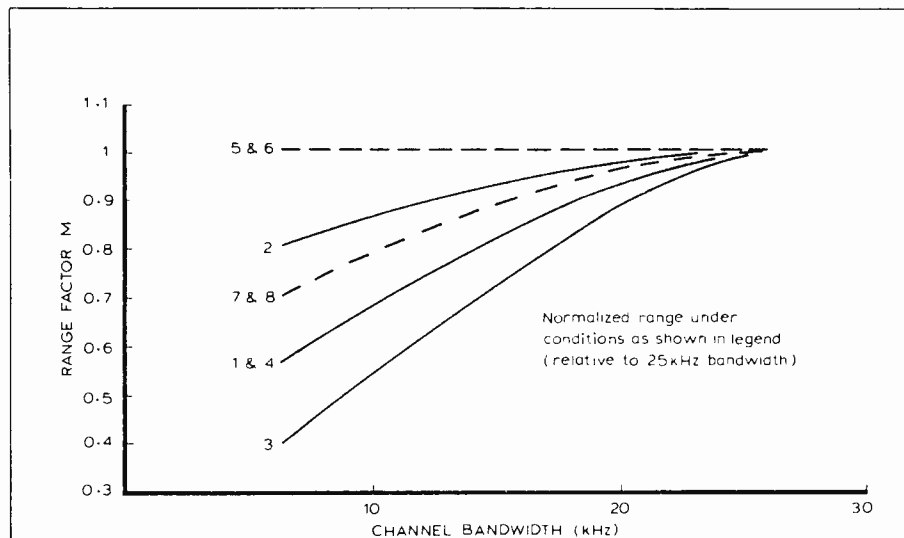

Fig 4. Effect of bandwidth on range (based on reference 7). Curve 1, f.m. above threshold. No impulsive interference ( $-5$  dB per halving of bandwidth). 2, f.m. at threshold, no impulsive interference ( $-5 + 3$  dB =  $-2$  dB per halving of bandwidth). 3, f.m. above threshold, impulsive interference ( $-5 - 3$  dB =  $8$  dB per halving of bandwidth). 4, f.m. at threshold. Impulsive interference ( $-5 + 3 - 3$  dB =  $-5$  dB per halving of bandwidth). 5, a.m. above threshold, no impulsive interference ( $0$  dB per halving of bandwidth). 6, a.m. at threshold. No impulsive interference ( $0$  dB per halving of bandwidth). 7, a.m. above threshold. Impulsive interference ( $-3$  dB per halving of bandwidth). 8, a.m. at threshold. Impulsive interference ( $-3$  dB per halving of bandwidth).

continued on page 65

## CIRCUIT ACTION AND PROGRAMME SIGNALS

High fidelity enthusiasts claim to have heard differences in the performance of wide-range amplifiers. In recent issues Mr Peter Baxandall and Mr James Moir have tried to show that the claims are ill-founded; but mathematical physics suggests that this may not always be so.

If a potential difference  $V = E e^{j\omega t}$  be applied across a capacitance  $C$ , then the current flowing at time  $t = C dV/dt$

$$\text{is } VC \left\{ \frac{1}{E} \frac{dE}{dt} + j(\omega + t \frac{d\omega}{dt}) \right\}$$

and so the capacitance's complex impedance

$$Z = \frac{1}{C \left\{ \frac{1}{E} \frac{dE}{dt} + j(\omega + t \frac{d\omega}{dt}) \right\}}$$

Hence, if the amplitude is small but rising rapidly, or if the frequency has a high rate of variation, then  $Z$  may differ considerably from  $1/j\omega C$  - a formula often used in the design of RC circuits for amplifiers and measuring instruments.

The complex impedance of an inductance contains somewhat similar terms with further complications arising from the non-linear relationship between current and associated magnetic flux.

I tried to take account of all this recently when designing variable high-pass and low-pass filters with a slope of some 40 dB per octave and a plateau variation within + 0.5 dB; but the mathematics became impossible; and although I achieved my objectives, I came to realise how little is known about the actual behaviour of electric circuits.

Variations from steady-state values depend upon programme material in ways that defy exact analysis. It has not yet been proved mathematically or otherwise that their effect upon the performance of wide-range amplifiers must always be inaudible. Until it has, the possibilities remain that the high fidelity enthusiasts are right in their claims, that distorted sound from gramophone records and loudspeakers has characteristics that reveal this effect to a sensitive ear, and that specifications which appear to be unnecessary tend to cause its decline.

Peter Hannam  
Colne  
Lancs

## DIGITAL ELECTRONICS THEORY

In reply to Mr Forcer (May Letters) my analysis of the digital electronics industry indeed contains "many sweeping statements" which at first glance do appear to be "unjustified". However, having spent over seven years in digital electronics it does not need much awareness on my part to see that the majority of engineers are incompetent at putting together fast logic. The industry is littered with complex computer systems that crash regularly, service engineers not knowing the reasons why. Too many students and engineers do not have a coherent set of design techniques to apply in their work.

In an attempt to rectify this catastrophic, myopic, situation I am working with two colleagues under the title of CAM Consult-



ants and we regularly give seminars on digital techniques and we have written the first volume of a book on the subject to be published in May 1978.

The proof of the pudding is always in the eating and I ask Mr Forcer to name projects or systems which do not suffer from catastrophic failures from time to time. I must repeat that engineers today use analogue techniques (taught by the colleges) to solve digital problems, and thus they cannot solve them in a scientific fashion. For example, no company I have ever visited knows how to lay out a p.c.b. for high-speed logic applications. Because of this systems suffer from data dependent faults which one can only see by the failure of the system itself.

Finally, I would like to see any Post Office course notes on mains filters and power supply decoupling. Also I would be interested in hearing from other engineers who (mis)believe that digital electronics is based upon an adequate set of scientific principles and mathematical techniques, which lead to efficient reliable digital systems. If they exist show me!

Malcolm F. Davidson  
CAM Consultants  
South Mimms  
Herts

## LONG RUNNING C-D IGNITION

I thought you might be interested to know that I have been operating R. M. Marston's capacitor-discharge ignition system (January 1970 issue) for eight years. It has been installed in a Ford Cortina, two Humber Sceptres, one Ford Capri, one Triumph Dolomite and now in a Citroen GS, and in that period I have done about 200,000 miles, which means that the 2N3525 thyristor must have fired about 1500,000,000 times. The system has worked faultlessly and no component has been changed.

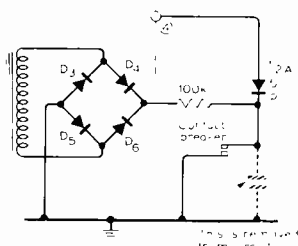

In the early days I did have trouble with the contact breaker becoming dirty and to some extent it still tended to become pitted. I decided to disconnect the distributor capacitor as I believed the instantaneous heavy current when it becomes short circuited was the cause. I soon found, however, that the contact breaker became much worse from the point of view of failure through dirty contacts. I decided, therefore, to adopt the old trick, very common in telephony, of wetting the contacts. On a negative earth system this was very easily achieved by the accompanying circuit.

Referring to Fig. 5 in the 1970 article, a diode is connected in series with the wire from the contact breaker and 400V d.c. is connected to the contact breaker via a 100kΩ resistor.

Since doing this modification the contact breakers on all cars were never changed, cleaned or adjusted. Each car averaged about 30,000 miles. The plugs on all cars were not changed. The only maintenance was that at about 15,000 miles the plug gaps were reset to 0.30in purely to prevent overstress on the coils.

Incidentally, I have a switch for reverting back to the old system and, of course, it reconnects the capacitor, but I have never had to use it except in the early days before I carried out the above contact wetting.

S. S. Joseph  
Felixstowe  
Suffolk

## BREATHALYSER SUBSTITUTE

With reference to the first item by "Mixer" in your April issue - the breathalyser substitute. There may be people "who can knock back four or five doubles without turning a hair", but it wouldn't matter if the alcohol did have that peculiar effect. What does seriously matter is that it makes the drinkers quite sure they can drive better than ever, whereas the reverse is the case - a very dangerous state to be in. An investigation of motorists leaving pubs showed that even those who were clearly unfit to drive were quite sure of their capability.

But use of a reaction-time meter is a very interesting idea and worth looking into. Alcohol as a major cause of road accidents is already well established; probably greater than all the other causes "Mixer" mentioned put together, though I admit that reliable figures on some of them would be difficult to obtain. Bad temper is certainly conducive to bad driving, but persons who display it are those who react too quickly! Old age is a doubtful starter. I am 76, and my wife and I have both been driving for 54 years. My driving has steadily become safer during that period. During the last 20 years I've had no police criticism, nor have I as much as dented our own or any other car, and rarely have to brake hard, though when the need arose one soporific afternoon, owing to a farm vehicle unpredictably turning across our path, I reacted swiftly and effectively; while a child owes her life to similarly quick reaction by my wife. By contrast, the young and inexperienced would have no difficulty with a reaction test, but apart from drinkers are perhaps the most dangerous class of drivers, as the insurance premiums testify. A combination of alcohol and youth is the worst of

all, evidenced by the multiple fatal accidents so often following weddings and other parties.

One other weakness of the reaction-time criterion is that being pulled up by the police, like the prospect of hanging, "concentrates the mind wonderfully".

A combination of both tests might be effective, provided evidence could be produced of clear correlation between reaction time and liability to drive dangerously. Experience, observation and anticipation may largely or even more than compensate for some slowing of measured reaction.

M. G. Scroggie  
Bexhill  
Sussex

$$f(t) = u(t) \cdot \sin(\omega_c t + h) = \sum C_n \cos(n\omega_c t - \theta_n)$$

n	h = 0° (of f <sub>c</sub> )		h = 10°		h = 20°	
	C <sub>n</sub>	θ° <sub>n</sub>	C <sub>n</sub>	θ° <sub>n</sub>	C <sub>n</sub>	θ° <sub>n</sub>
1(f <sub>c</sub> )	.039	0	.039	-6.18	.038	-1.26
3	.041	0	.041	-1.86	.040	-3.79
7	.049	0	.049	-4.35	.048	-8.82
9	.058	0	.058	-5.55	.057	-11.28
11	.075	0	.075	-6.81	.074	-13.80
15	.328	0	.328	-9.36	.327	-18.76
16(f <sub>c</sub> )	.500	+90	.500	+80.04	.500	+70.01
17	.308	0	.308	-10.61	.309	-21.21
19	.097	0	.097	-11.86	.098	-23.62
21	.055	0	.055	-13.12	.056	-26.01
25	.027	0	.027	-15.62	.028	-30.70
33	.012	0	.012	-20.62	.013	-39.70
37	.009	0	.009	-23.14	.010	-44.06
43	.006	0	.006	-26.92	.007	-50.30
45	.005	0	.005	-28.18	.006	-52.31

### I.C. SOCKETS

Mr B. R. Smith in his letter in the March issue argued the case for i.c. sockets to fit 0.15in strip boards. I suggest that it might be possible to adapt sockets having wire wrapping pins (such as Vero Miniwrap sockets) by bending the pins to fit the 0.15in matrix. These pins can be quite neatly formed as necessary.

B. P. Castle, G4DYF  
Sevenoaks, Kent

### SPECTRA OF TONE BURSTS

Mr Coleman, in your October 1977 letters, tells us again that tone burst signals have amplitude spectra of different shapes if the carrier phase or framing is varied, and that the phase spectra are also changed, "in a non-linear fashion." He avers that he is correct, questions my grasp of basic principles and suggests that I ask one of my (brighter!) students to "check the calculations." What better way of answering him than by testing his own advice?

Accordingly, one of my undergraduates has been considering the matter, and has now given me his results. His view, like my own, is that Mr Coleman's claim makes up in theoretical precision for what it lacks in practical significance. I think the student will go far, but let me now explain.

Suppose a carrier,  $\cos(\omega_c t + h)$ , is modulated by a pulse function,  $P(t)$ . Then the spectral amplitude density,  $C(\omega)$ , of the function  $P(t) \cdot \cos(\omega_c t + h)$  will be

$$C(\omega) = \int_{-\infty}^{\infty} P(t) \cdot \cos(\omega_c t + h) \cdot e^{-i\omega t} dt,$$

giving precisely,

$$C(\omega) = \frac{e^{ih} P(\omega - \omega_c) + e^{-ih} P(\omega + \omega_c)}{2}$$

where  $P(\omega)$  is the Fourier Transform of  $P(t)$ .

Hence the spectral density of the modulated pulse is the result of two curves, and is not symmetrical about  $\omega_c$ . In theory, both the amplitude and argument of  $C(\omega)$  will depend upon  $h$ , the point which Coleman, without qualification, considers it important to make.

Now  $P(\omega - \omega_c)$  has a predominant maximum at  $\omega_c$  whereas  $P(\omega + \omega_c)$  does not, and if  $\omega_c \gg 0$ , this latter term has even a negligible value. This is so for a variety of forms of  $P(t)$  e.g. rectangular (as for the tone burst), triangular, parabolic or sinusoidal, or even a "wavy" function. When there are several

cycles in each pulse (or when the period of the carrier is much shorter than the period of repetition, for a periodic function) the spectral density of the modulated carrier becomes very similar in form to the spectral density of its envelope, a fact known and exploited by communications engineers over more than 30 years past.

Mathematically, with the above provisions,

$$C(\omega) = \frac{e^{ih} P(\omega - \omega_c)}{2},$$

which shows that  $C(\omega)$  is essentially unaffected in amplitude by a change in  $h$  whilst the phase shift produced is almost exactly proportional to  $h$ . This was the point taken for granted in my letters of December 1976 and July 1977.

It is, of course, important to demonstrate (as Coleman did not) the practical value of this result, and this my undergraduate has done. With the help of our digital computer, he obtained the amplitude and phase spectra of a periodic, 1kHz sine-wave burst, of unit height, with onset angles ( $h$ ) 0°, 10° and 20° on for 8 complete cycles and off for the same interval. The fundamental spectral line is therefore at 62.5 Hz and the carrier ( $f_c$ ) is the 16th harmonic, though all other terms are odd harmonics (due to half-wave symmetry) with a spacing of 125 Hz.

To save space I have not listed, in the accompanying table, all the results obtained, but those shown are entirely representative of the whole spectrum. They confirm that the effect of changing  $h$  (by the amounts I used in my earlier work) on the amplitude spectrum is inconsiderable, whilst the phase spectra show essentially linear shifts to within a few tenths of a degree, or much less for most harmonics.

For example, the listing for  $h = 10^\circ$  shows an additional 1.25° linear shift with increasing frequency for each neighbouring harmonic, i.e.  $(2 \times 1/16 \times 10^\circ)$ .

Note that these results are not invalidated if the off interval is increased so as to make each burst distinct. Mr Coleman would seem to have learned something here, for in answer to James Moir, in your September 1976 letters, he claimed, again without qualification, that "no feature of a periodic waveform observed in (a normally lively) room can be a transient."

The trouble with Mr Coleman is that his arguments are either false or dead, and his naive concept of correctness is in keeping with the tone and content of all his earlier correspondence. We are not surprised, or advised, by his empty praise for the techniques of others, or by his impertinent war-

nings. An educationalist, however, does not reject those who do not understand, so I am always ready to answer him. Several of my students are just waiting to be called now, as I write.

Roger C. Driscoll  
The Polytechnic of North London  
London N7

### RECEIVING AFRTS TV IN GERMANY

The American Forces Radio and Television Service (AFRTS) in the Federal Republic of Germany is well known for its chain of radio transmitters. Less well known is the fact that it has a large number of low power television transmitters, broadcasting English language programmes from 1200 to 2400 hours each weekday, and 0900 to 0100 h at weekends. Programme quality in general is fairly high and many English speaking persons living in Germany have converted standard television sets to receive these programmes. The main differences between AFRTS and German television standards are: NTSC is used for colour encoding instead of PAL; scanning frequencies are based on 60Hz instead of 50Hz; different number of lines per picture (less than 625); and different spacing between sound/vision carriers (4.5 MHz instead of 5.5MHz).

Most people install a small converter to deal with the last problem; this costs between Dm20-45 (about £5-12). The 60Hz frequency and number-of-lines per picture differences may be dealt with by adjusting the vertical hold control. NTSC colour is compatible with monochrome tv sets, and most people accept the fact that they will only receive AFRTS programmes in monochrome. (Or buy a NTSC receiver!). The main financial cost, therefore, is that of the sound/vision carrier spacing. However, on most tv sets this is unnecessary. Sony, Hitachi, and Sanyo all accept the following modification:

Between the sound i.f. detector and the sound i.f. i.c. stage is an adjustable transformer. If this is bridged on the detector i.f. side by a 150pF trimmer and switch in series (see Fig. 1), AFRTS sound may be received when the 150pF capacitor is in circuit by adjusting this trimmer and the transformer core. Normal (German) sound may be received by switching the capacitor out of circuit. Some tweaking of both capacitor and transformer will be necessary to find optimum points for both systems but the

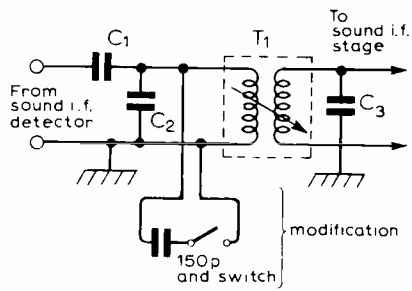

Fig. 1

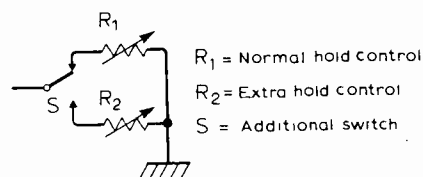

Fig. 2

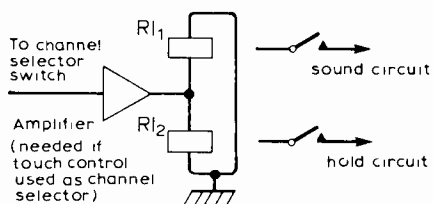

Fig. 3

final result (at least on my Sanyo) is better than that achieved with a converter unit.

If one doesn't want to have to adjust the vertical hold control when switching back and forth from AFRTS to German standards, an extra trimmer pot can be inserted in parallel with the normal hold control and switched as required, (see Fig. 2). It is not recommended to have both hold control and sound control on the same switch as one then hears the sync/line pulses on sound. However, two relays could be used instead of switches and driven from the channel selector switch as shown in Fig. 3.

The end result of the conversion is that one has German first, second, and as many of the local (third) programme as are in the region, plus English language AFRTS. Almost as good as being able to receive BBC1 and 2!

Robin A. Flood  
Eastbourne  
Sussex

## AUDIO EQUIPMENT REVIEWS

A certain amount of attention has been paid in your pages of late to matters concerning reviewing in general and *Hi-Fi Choice* in particular, so an "official" comment from ourselves is perhaps overdue. The "British hi-fi scene drama" in the February issue is largely of your own making, and your sensationalist writing has merely succeeded in fomenting and fueling a very minor controversy. Certain of the parties mentioned in the report felt that they had been misrepresented, and this has had the no doubt desired effect of stimulating both correspondence and the "curiously bitter storm . . .

raging in the hi-fi teacup." There has always been argument and debate within hi-fi circles and certainly equipment reviewing is one of the more sensitive areas; but to imply a conspiratorial boycott is a little far-fetched. Manufacturers and distributors have refused to submit equipment for a *Hi-Fi Choice* book in the past, and it then becomes an editorial matter to decide to what extent the absence of such equipment will reduce the value of the publication to its purchaser. If the product concerned is widely available, popular, and heavily promoted, we would not be doing our duty to our readership if we did not obtain samples by other means for inclusion.

However, the responsibility of a magazine is twofold, and the need to ensure fairness towards a manufacturer is equally important. The reviewer is best able to achieve a fair review of a product if he is aware of what the designer is trying to achieve. If he can discuss points arising from his investigations without fear of reprisal, the whole project is likely to benefit. All manufacturers and distributors submitting equipment are consulted as a matter of course if we feel we may have received a faulty sample, and the opportunity to inspect gaileys to correct errors of fact is also made available. (This naturally does not imply that value judgements based on criteria qualified within the book are susceptible to change at a manufacturer's behest.) Unfortunately, it is obviously not normally possible to extend these courtesies to a manufacturer who has declined to submit his product, and although extra care is taken to ensure that the review is fair and representative, things are inevitably made more difficult.

I do not propose to dwell at any length on the vituperative points raised in Mr Cooke's letter in your April issue; suffice it to say that I regard them as the inevitable result of inadequate communication. I will, however, take issue on the matter of our name, which he criticises strongly on philosophical grounds. I can only speak for myself and the future editorial policy of the magazine, but my interpretation of our name and function is that we should try to provide comprehensive and comparable data on a significant proportion of the available products in whatever category we are examining, to enable the reader to make his own choice according to his particular needs. Despite many years of international standards bodies, this is something that manufacturers have singularly failed to achieve. Any attempt by an individual to compare simple performance specifications of several audio products is doomed to failure because of the lack of standardisation in manufacturers' supplied data. As far as possible *Choice* will use "standard" measurements, as this will at least help in its own small way towards wider acceptance of such standards. But I don't believe that anyone would seriously suggest that such "objective" testing on its own is all that is necessary to enable the consumer to formulate his own choice. The reviewer must assemble data and provide an interpretation for the lay reader. He must also place himself in the position of the consumer and examine the product in relation to its intended use, which may involve developing new test methods or setting up controlled listening panels.

By the time this letter is printed the *Loudspeaker* book should have appeared, and I hope that interested parties will endeavour to form their own judgements and criticisms of the project. Although far from perfect, I do believe that we have succeeded

in undertaking a daunting task at least as well as, and in many ways considerably better than, our contemporaries. One unfortunate result of the *Hi-Fi Choice* format is its inability to publish manufacturers' feedback in the wake of publication, so it might be in the best interests of the industry as a whole if *Wireless World*, who are largely responsible for starting this controversy in the first place, could make space available for frank and open discussion of the results of the project.

Paul Messenger  
Editor, *Hi-Fi Choice*  
London, W1

## PENNY-PINCHING IN AUDIO AMPLIFIERS

After following the running battle on types and relative importances of amplifier distortions, we have decided to release our own findings on this matter. Assuming that the source is of such characteristics as to avoid those problems caused purely by gross mismatching, we have found that the much-discussed differences in sound fall into two simple categories: frequency response deviations, and penny-pinching. The first is the easiest to visualise and test, although surprisingly small variations in response can cause a significant difference in the perceived sound — and not always where one might expect. A slightly "fat" bass is often mistaken for muffled treble, and weak bass for clarity.

The penny-pinching is the more insidious, however. One well-known American amplifier of 200 watts per channel has filter capacitors more appropriate to a 30 watt per channel amplifier. The power supply, as a result, is significantly modulated by the varying load placed upon it by the signal. If the input stages are in perfect balance, it has little effect; but if there is a mismatch in any of four long-tailed pairs, the sound becomes purest mud. Many other amplifiers appear to have had their driver and output transistors selected purely on the basis of peak voltage and current into a resistive load, and a cost book. Nobody seems to notice (or care) that the load won't be a resistor, that the current gain of the transistor is not what the tidy little number in the catalogue says (except under those conditions) but varies wildly with collector current, or that the drivers and pre-drivers have to handle fairly high current themselves if they are to drive the output devices well enough to supply the heavy peak currents often needed. The worst offenders have cut down on these devices to such a point that their 250 watt per channel amplifier, when connected to a speaker, clips at only 70% of the peak voltage developed by the Quad 303 bench amplifier. This test was conducted again with the current limiting disconnected and with another amplifier from the same firm, with identical results.

Other pinchpenny dodges include aluminium electrolytics whose impedance rises dramatically with frequency, cheap speaker switches that make better diode detectors than switches, crude output meters that merely put a series diode and the meter coil across the output, fuseholders and wire grippers that neither hold nor grip, and a special award to the miser who ordered 3-amp mains switches — for a 350 watt per channel amplifier. The distortions introduced defy all description!

Pre-amps and speaker cables are under test

and evaluation by this group now, and initial results are surprising. The cable that was supposed to "clear up transients" made the amplifiers ring severely on high slew-rate input signals. Impressive sound, but unreal. Back to the bench and listening room to sort this out further.

Keir Jones  
California Audio Society  
Covina  
California, USA

## F.M. TRANSCEIVER SYNTHESIZER

I have recently completed construction of the synthesizer portion of T. D. Forrester's f.m. transceiver (November and December 1977) which works very well now that the following modifications have been incorporated.

1. The v.c.o. was found to oscillate at a minimum frequency of 30MHz (i.e. 0V on  $D_{17}$ ,  $L_1$  slug fully in) with 10 turns on  $L_1$ . Turns have been increased to 20 and  $D_{18}$  removed.
2. The 4059 was not being clocked by the 74LS74, even at 15V. Experiment showed that the 4059 required a pulse input of at least 70%  $V_{cc}$  before it would clock, which could not be directly supplied by the t.t.l. The accompanying buffer circuit was therefore introduced between the t.t.l. output and the 4059 input.

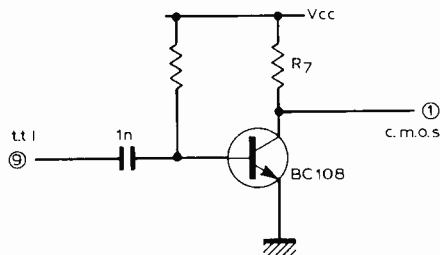

3.  $R_{39}$  has been reduced to  $1k\Omega$  (in my particular case). The sine wave input to  $IC_1$  was not dropping close enough to the 0V rail to properly trigger the t.t.l. Reducing  $R_{39}$  gave an input between 0V and 4V.

As soon as these interface modifications had been made the entire synthesizer was powered from a stabilized 12V supply and the v.c.o. locked to around the programmed frequency. A trimmer was then inserted in one leg of the crystal to set the v.c.o. to exactly the required frequency.

I hope these suggestions may help others constructing this project and would be interested to hear of other modifications. Also, thanks to G4DPM who assisted with the above work.

G. J. Hankins, G8EMX  
Acocks Green  
Birmingham 27

## LOUDSPEAKER POLARITIES

Referring to "Mixer's" mention in Sidebands (January issue) of the Sheffield record sleeve, the inexplicable note suggesting reversal of polarities of both playback speakers may have a sound reason running directly along the lines of "Mixer's" thinking. In my

research into fidelity and imaging of stereo systems I have noted audible differences between normal and reversed polarity. It seems that for impulsive sounds the ear prefers a negative pressure impulse. This has been noted by Madsen and Hansen<sup>1</sup>, and perhaps is the basis for Sheffield's note, although polarity in multi-way speakers is often not constant. So "Mixer" is half right, but the idea is to have the speakers suck when the drum goes bang.

Mark Logies  
Master I Systems  
Eastlake,  
Ohio, USA

### Reference

1. "On aural phase detection," by Villy Hansen and Erik Rorbaek Madsen, *J. Audio Eng. Soc.*, vol. 22, No. 1 (1974).

"Mixer" replies: Well, I must say it's very nice to be told that one is even half-right, sometimes. But, if the reason for Sheffield's sleeve note is to be discovered, maybe they should be asked - it does save such a lot of theorizing.

## BIRDS' GEOMAGNETIC SENSE

What an interesting contribution Professor Dawson and Dr Dawson have made towards the resolution of the mechanism of birds' geomagnetic sense (February Letters). Let me review some evidence for the "electrodynamic" model.

As M. Bookman (M.I.T.) has pointed out, the literature contains no evidence for avian geomagnetic sensing in the "wings restrained" configuration. There is evidence for absence of this sense when birds are tested with wings fixed<sup>1</sup>. Yet, there is good evidence for the sense in the "wings free" condition<sup>2</sup>. Hence a connection between wing movement and geomagnetic sense is likely.

Out of respect for the researchers who have taken pains to present the case for this avian orienting ability, using rigorous experimental technique and statistical tests for high probability (and for at least one who lost his life in the work), may I urge the verification of the Emperor Penguins' sense by experiment. I would be most interested to find the effect of a "strait-jacket" on the orientation of experimental subjects. The penguin apparently uses vigorous flipper movements during his characteristic "tobogganing" mode of cross-country movement.

Now, a response to the serious objection that physiological "noise" would mask the required signal. If we describe the logic element of biological systems (in computer jargon) as a wide fan-in, low-level analogue integrating gate with "inhibit" and "assert" inputs, sometimes with, sometimes without, a pulsed, regenerative, digital, variable repetition rate transmission line driver; then system design considerations demand that the low-level analogue element be shielded from the effects both of adjacent transmission lines and of actuator noise. For, if this were not the case, the system would be dangerously unstable. Hence the nervous system seems to have the properties required to handle low-level signals in the presence of high-level noise.

In the standard demonstration of nerve

action-potential transmission speed in the human arm, A. M. Brown (Open University) used a 200V, 50 $\mu$ s pulse in shocking electrodes spaced about 1cm apart, applied to the wrist, following S. Rose's method. This skin potential gradient of 20kV.m<sup>-1</sup> indicates the effectiveness of the shielding.

In the context of flying birds, R. H. J. Brown (Cambridge) has suggested that after the high-energy take-off phase of flight the wing up-stroke may be largely passive (private communication). This would reduce the amount of masking noise, which is of course in "common mode" between the wings (or using the alternative jargon, is bilaterally symmetrical) in contrast to the electrodynamic signal which is unidirectional across the wings at any given time.

B. A. Whatcott  
Addlestone  
Surrey

### References

1. M. E. Meyer and D. R. Lambe. *Psychon. Sci.* 1966, vol. 5 (9), pp. 349-350.
2. W. Wiltschko and R. Wiltschko. *Science*, 1976, pp. 62-64.

## PROGRAMMING MICROCOMPUTERS

If I may take the liberty of commenting on Mr Pittman's thorough and systematic approach to programming (March issue), I hope it will encourage potential programmers if I say that one soon learns to dispense with flow diagrams, for all but the trickiest operations. Also I take an essentially optimistic view of errors. The machinery will discover some of them. But with problems involving real data, if the programme produces correct answers on the first five runs, there is a good chance it will continue that way. If it doesn't, then one can then start to test for likely errors in likely places.

As for the hardware, like W. Trapman writing in January Letters, I too have long nursed the hope that the naked microprocessor and its adjuncts will go away, and only return when properly dressed. The articles by Mr Pittman and Dr Shelton show only too clearly how primitive it all is compared with even a £5 pocket calculator.

However, one can take heart from the development of computers over the last fifteen years. Since I first wrote occasional blocks of machine code for a Ferranti Sirius (1000 words of storage, nine accumulators and less than 100 instructions) there have appeared with bewildering rapidity bigger stores, faster processors, more powerful languages, sophisticated operating systems, interactive facilities, remote terminals - the list is endless. All these are intended to be user beneficial, though users contest this vociferously when something goes wrong. Somewhere of course there still lurk expert programmers composing important software in machine code and assembly languages, but the user himself can be thankful that computers *did* go away and get properly dressed. It surely won't be very long before the microprocessor also matures.

D. P. C. Thackeray  
Department of Chemical Physics  
University of Surrey

# Interconnection of logic elements

The transmission line, t.t.l. and tri-state devices

by I. Catt,\* M. F. Davidson\* & D. S. Walton†, \*CAM Consultants † Icthus Instruments Limited

This article outlines the concepts required when designing a complex logic system and describes the fundamental principles of connection between basic logic gates.

A digital system is composed of logic gates and interconnections between them. To ensure correct functioning of the system it is important to consider a model of this connection. The simplest case is a logic gate driving another single gate with no fanout as shown in Fig. 1. It is impossible to consider the interconnection without a ground or  $V_{cc}$  return path, and when this is present there is a distributed capacitance and inductance which forms a transmission line.

## Properties of a transmission line

To characterise a transmission line a step propagating along a two-wire line is considered as shown in Fig. 2. Using Faraday's law of  $V = d\phi/dt$  around loop abcd,  $L$  is defined as the inductance per unit length of the wire pair so  $L = \phi/i$ . In time  $t$ , the step will advance a distance  $s$  so that  $s/t = c$  and the change of flux will be  $\phi = L s i$ . Substitution into Faraday's law gives the voltage applied to the line to overcome back e.m.f;  $V_{AD} = L i ds/dt = L i c$ . From  $Q = VC$ ,  $i = vC c$  where  $C$  is the capacitance per unit length of the wire pair, so  $c = \pm 1/\sqrt{LC}$  and  $v/i = Z_0 = \sqrt{L/C}$ . Therefore, a step may propagate in either direction.

The two parameters which characterise a transmission line are the velocity of propagation  $c$ , and the impedance  $Z_0$  which relates the voltage difference across the line to the current in the line. Thus,  $v = iZ_0$  where  $Z_0$  is a property of the geometry, and medium,  $\mu$  and  $\epsilon$ , in which the wires are embedded.

To use the formulae for  $Z_0$  and  $c$  it is necessary to calculate  $L$  and  $C$  for any geometry that may be used. In general it is impossible to solve analytically for  $L$  and  $C$  and so other methods are used. Values for most practical cases are in the literature. It is common to represent a lossless transmission line as the model shown in Fig. 3 which allows the equations of step propagation to be derived. This method has little to recommend it especially as it appears to lead to a spurious high frequency cut-off. There is, of course, no high frequency cut-off inherent in any transmission line

geometry and the only factor which can cause this is a frequency dependent behaviour of the dielectric. If the dielectric is vacuum, there is no frequency dependence and no cut-off.

The sinewave concept can be very misleading in digital electronics and it is invalid to think of a single step as being composed of a superposition of sinewaves. The diagram in Fig. 4 shows a step which is propagating along a transmission line with velocity  $c$  ( $c = 1/\sqrt{\mu\epsilon}$ ), the velocity of light in the

medium surrounding the conductors. A true sinewave signal is infinite in both time and distance, i.e. it can only exist in an infinitely long transmission line, and any practical situation is an approximation to this ideal. Because the step is travelling at the velocity of light there can be no energy or information ahead of it and there can be no effect at any point P in front of the step. This consideration alone is sufficient to demonstrate that such a step cannot be analysed into a superposition of sine-

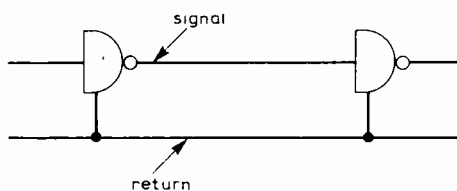

Fig 1. Simple example of a logic gate driving another gate.

Fig 2. A step propagating along a two-wire line.

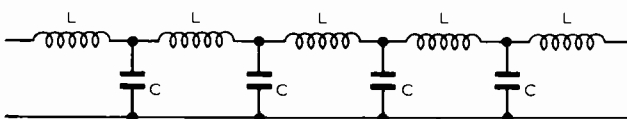
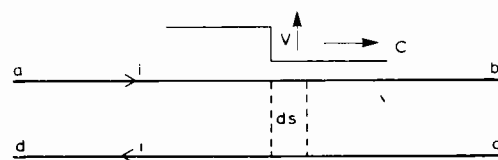

Fig 3. Model of a lossless transmission line.

Fig 4. A simple step should not be considered as a superposition of sinewaves.

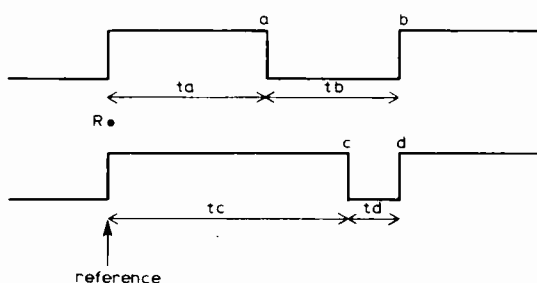
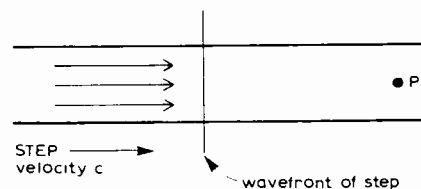

Fig 5. Two digital signals, illustrating edges as separate events in time.

waves because these sinewaves would have to exist both ahead of and behind the step. Also, if the transmission lines were cut before the step arrived at P, any effect which was already at P would have to vanish instantaneously, again impossible. Mathematics indicate that if we superpose many sinewaves of appropriate amplitudes and phase relationships we would obtain a step waveform. This is undeniably true but its converse, that we can analyse a step into a superposition of sinewaves, does not follow logically and is in fact not true. The sinewave is responsible for much confusion particularly in the discussion of factors affecting the choice of capacitors for logic decoupling. It is important to remember that a step is a shock wave, formed by a transverse electromagnetic wave front travelling at the speed of light, and all digital signals are combinations of either positive or negative going edges. Any observer can only see the signal as it passes him on the transmission line.

The important parameter of the two digital signals in Fig. 5 is the time delay between the edges. Each edge a, b, c or d must be considered as a separate event in time which is completely unconnected with any other transition. A logic gate cannot predict the arrival of any edge until the shock wave actually arrives. It then responds to the amplitude of the signal and by the time the next shock wave arrives it has settled down to the steady state condition.

**Transistor transistor logic**

Before discussing t.t.l. circuits it is worth considering the evolutionary process which lead up to them. In early d.t.l., transistors were only capable of sustaining a 1mA collector current which resulted in the circuit arrangement shown in Fig. 6 where a 10kΩ resistor was used in the collector. One problem with this circuit is its inability to drive stray capacitance. Consider the output waveform in Fig. 7 which is obtained when a pulse is applied to the input. The transistor switches on and the stray capacitance is discharged through the saturated transistor to produce a rapid falling edge. When the transistor switches off it cannot supply current so the stray capacitance charges through the 10kΩ resistor to produce an exponential rise which corresponds to a time constant of RC. Therefore, this type of gate is not very good at driving long signal lines. In practice the load is not strictly capacitive, but is a transmission line with a characteristic impedance of around 100Ω. However, in this case because R is much greater than 100Ω it makes very little difference and the slow edge masks any transmission line effects.

Logic designers attempted to circumvent this problem by using a "push-pull" output stage to give rapid transitions in both directions as shown in Fig. 8. Here the output is driven by a "phase splitter" so that while the top transistor

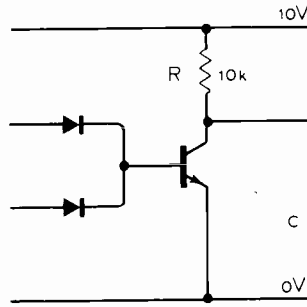

**Fig 6.** Early form of logic, diode-transistor logic.



**Fig 7.** Output waveform from d.t.l. in Fig 6.

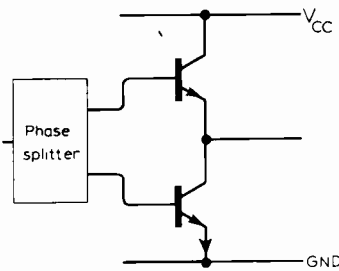

**Fig 8.** Push-pull output stage to give rapid transitions.

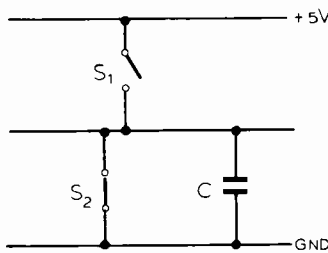

**Fig 9.** Basis of t.t.l. circuit required to drive a capacitive load.

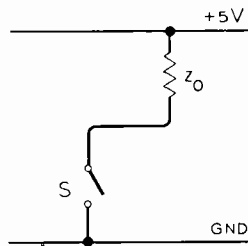

**Fig 10.** Only one switch required for a resistive load.

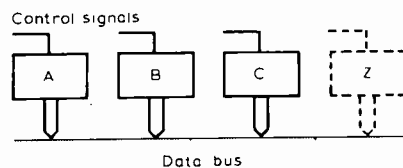

**Fig 11.** Tri-state devices connected to a bus.

is on the bottom one is off and vice versa, but in practice there is an overlap of a few ns. This causes a low impedance across the supply rails which produces a current spike. This type of output was used in the unpopular 73 series of logic. The final step in the evolution of t.t.l. was the insertion of a series limiting resistor in the collector of the upper transistor.

Unfortunately, during the evolution of t.t.l. the way impedance levels and device speeds have changed has not been considered fully. While d.t.l. worked initially with a 10kΩ output impedance we now have t.t.l. devices with an internal pull-up resistor of around 100Ω. This means that the transmission line behaviour cannot now be ignored. In fact, when the connection to a t.t.l. device is considered as a transmission line the upper transistor in the output is redundant and serves no useful purpose. A capacitive load requires a circuit as shown in Fig. 9 because, to produce a voltage across the capacitor, a charge must be fed into it via S<sub>1</sub>. Discharge of the capacitor must take place through S<sub>2</sub>. As already mentioned, a t.t.l. gate must drive a transmission line with an impedance of about 100Ω. The current and voltage are related by  $V = iZ_0$ , where V is the voltage applied to the line and i is the resulting current. In this case the load is essentially resistive and only one switch is required as shown in Fig. 10. When S is closed the output is low and when it is open the output is high. If the interconnection is terminated with a resistor  $R = Z_0$ , effects due to stray capacitance and inductance will not affect the output rise or fall times. Therefore, under certain conditions the t.t.l. "push-pull" configuration is unnecessary and an open collector gate will suffice.

**Tri-state devices**

Common data-bus structures are widely used in mini computer systems but because conventional t.t.l. cannot be wire-ORed it cannot be used. To overcome this limitation tri-state devices have been produced and are rapidly becoming standard components for bus drivers and memory outputs. A tri-state device has an additional control input which determines whether or not the device is enabled. When enabled, its outputs are in the high or low states as normal. When disabled, its outputs assume the high-impedance or off state and the device behaves almost as though its outputs are disconnected from the package pins. In this system only the device which is driving the bus is enabled, so active pull-up is achieved with the benefits of wire ORing. However, even with these apparent advantages it must be considered whether tri-state t.t.l. is necessary and desirable.

With regard to its necessity, the answer is definitely no. Any function which is possible with tri-state devices can be implemented more simply with



open-collector t.t.l. Tri-state is an unfortunate development caused by a misunderstanding of the requirements for transmission line driving. The answer is also no for desirability because it has a failure mode which can lead to the progressive collapse of all the tri-state devices driving a bus. For example, in Fig. 11 if device A becomes enabled at the wrong time due to a fault in the circuitry it could place all lows on a bus to which another device is quite legitimately outputting all highs. This leads to catastrophic power dissipation in the good device and the process can then repeat until all of the devices are destroyed. For the Ti 74365 hex bus-driver, power dissipation in this failure mode can be calculated as follows. The output short-circuit current is specified as 40-130mA so the power dissipation per gate for a 15V rail will be between 0.2 and 0.65W, and the total dissipation for a package of six gates will be 1.2 to 3.9W. The quiescent power dissipation of 0.3 to 0.4W per package means that the total worst case figure is 4.3W. This is about ten times the rated dissipation of a d.i.p. and will destroy the device. □

*This article is based on material from a book "Digital Electronic Design", by the above authors, published by C.A.M. Publishing, 17 King Harry Lane, St Albans, Herts, price £8.00 including postage.*

## LITERATURE RECEIVED

**"Modern Instrumentation Tape Recording"** booklet available free from SE Labs (EMI) Ltd, Spur Road, Feltham, Middlesex TW14 OTD ..... WW401

**Power devices** from RCA and specimen circuits for many applications described in booklet 2M1169 from RCA Ltd, Solid State-Europe, Sunbury-on-Thames, Middx TW16 7HW ..... WW402

**Trimmer capacitors** described in six Voltronics leaflets, free from ITT Components Group, Capacitor Product Group, Brixham Road, Paignton, Devon T24 7BE ... WW403

**Video filters**, including new range for use with d-a or a-d converters, is published by Matthey Electronics, William Clowes Street, Burslem, Stoke-on-Trent ST6 3AT WW404

**"Electronic Components Buyers' Guide"** is published by the Electronic Components Industry Federation. Free from ECIF, Liberty House, Regent Street, London W1R 5EE. WW405

**Alarm systems applications and equipment** descriptions in catalogue from Highland Electronics Ltd, Highland House, 8 Old Steine, Brighton, East Sussex BN1 1EJ WW406

**Components catalogue** from Jack Evans Distribution is now available from JED at 244 Bath Road, Hayes, Middx UB3 5AX WW407

**Remote computing facilities** provided by EMI's PIX for users of IBM360/370 and 3030 are simply described in a brochure, obtainable from Data Comms, Division, EMI Technology, North Feltham Trading Estate, Feltham, Middx ..... WW408

**Time interval measurement** is the subject of three application notes from Hewlett-Packard, in which time calibration, the 5359A synthesizer and 3570A counter are described. AN 191-1/2/3. Hewlett Packard Ltd, King Street Lane, Winnersh, Wokingham, Berks RG11 5AR ..... WW409

**Instrument repair and calibration** — the business of IEC Ltd—is described and illustrated in a brochure, obtainable from Instrument House, 212 Ilderton Road, London SE15 1NT ..... WW410

**Tools**, for electronics and electrical work, are listed in a catalogue produced by Toolrange, Upton Road, Reading RG3 4JA ... WW411

**Altair microcomputer systems** are described by Compelec in their new brochure. Copies from Compelec Electronics Ltd, 107 Kilburn Square, London N.W.6 ..... WW412

**Infra-red emitters and injection lasers** from RCA are featured in the OPT-113C product guide, available from RCA Solid State-Europe, Sunbury, Middx ..... WW413

## Mobile radio bandwidths *continued*

frequency conservation; and (ii) unnecessary except for digital speech, which in turn should be justified on its own merits; it is not a reason for making all channels broad and thus wasting spectrum.

Any trends in technique which are likely to be developed in the future and which may enable higher bit rates to be achieved within the limitations of a normal speech band, line and radio, are not within the scope of this article. The rate of progress over the past two decades, however indicates a real possibility that before the 1999 World Administrative Radio Conference we could well be in possession of techniques which could require a totally different approach to frequency planning. Is it therefore wise at this stage to put all our eggs in one basket and use a common, and probably wider bandwidth, for high speed data or speech?

Such a move not only reduces channel availability within the spectrum, it implies the exclusive use of frequency modulation and tone squelch. Furthermore it implies a period of chaos whilst the various existing systems and users are "sorted out."

Use of the split channel technique — 25kHz equipment allocated on a 12½kHz channel basis but relying upon geographical separation — would tend to restore the channel availability insofar as quantity is concerned, but in practice, owing to the geographical

separation requirement, could result in but a small increase in availability — particularly in the type of urban area associated with the United Kingdom.

### Alternative data/speech possibility

Let us now consider the inevitable. Speech systems will be with us for a long time and will tend to predominate for some time. The use of data technique will, however, increase. Existing "state of the art" high speed data techniques, where justified, will require a minimum of 25kHz channel width to accommodate the sidebands etc associated with existing techniques.

The solution proposed for this situation is quite simple, it merely advocates remaining with 12½kHz channel allocations and using the channels in the same manner for speech as at present. The channels would also be suitable for the simpler data transmission systems of 1200bit/s and up to 4800bit/s if suitable lines are used.

Above this speed, where high speed is justified two or more adjacent 12½kHz channels would be allocated, possibly from a discrete section of the spectrum to simplify sideband cut-off problems. Such a wide band system could be required for digital speech.

As and when techniques improve, it would be a simple matter to insert conventional narrow band users into vacated 12½kHz slots, thus making full use of the available spectrum.

It may well be that technical changes involving, for instance, 6¼kHz operation for speech, would enable further channel allocations to be made available in the future. In this case the allocation of channel units would be in 6¼kHz multiples with data possibly requiring up to three or four such units.

By such a technique we are not penalizing the small user requiring speech communication only, neither are we limiting the data user to bandwidths which could be restrictive.

### References

1. Modulation methods and channel separation in the land mobile services, Richard T. Buesing, I.E.E.E. *Transactions of Vehicular Technology*, Vol. VT19, No. 2, May 1970.
2. Home Office sifts WARC evidence, *Wireless World*, October, 1977
3. Mobile radiotelephone equipment for very narrow channels, P. A. Webster, V.h.f. and u.h.f. Mobile Communication Systems and Equipment, I.E.E. conference paper, January 1966.
4. Improving spectrum utilization in mobile radio communication, Henry Magnuski, 26th Annual Conference I.E.E.E. Vehicular Tech. Group, Washington D.C., March 1976.
5. Microwave Mobile Communications, edited by Wm. Jakes Jr.
6. Spectrum engineering — the key to progress, the Joint Technical Advisory Committee 1968.
7. Report on tests to determine the feasibility of 12.5kHz channel spacing for the public radiotelephone service, British Post Office, POTHQ/TD6 4.2, 2nd August, 1976.

# CIRCUIT IDEAS

## Modifying the K.B.6 ASCII encoded keyboard

This keyboard does not have a lower case character output and fails to provide the parity bit required for some applications. Although it is quite easy to sense the seven bits of the ASCII output, the TMS 5000 NC encoder chip provides the parity bit on pin 6 which can be hard-wired to the redundant segment 2 on the outlet.

Cut the track leading from switch "P" to the plated-through hole near pin 20 of the TMS 5000 r.o.m., close to the switch. Trace the track from pin 22 of the r.o.m. to the contacts of the ";" + switch, and

hard-wire this to the disconnected contact of the "P" switch. Lower case characters will now be obtained by simultaneously pressing the "shift" and "ctrl" keys together with the requisite character key. The keyboard however contains sufficient hardware to implement a separate lower case key, and the redundant "here is" key may be used for this purpose. Wire the non-earthly side of the "here is" key to pins 4 and 5 of the 7400 marked X4, and connect a 5.6kΩ resistor from these pins to pin 14 of the 7486 marked X5. Connect a wire from

pin 6 of the 7400 to pin 4 of the 7486. Finally, cut the connection between pin 4 of the 7486 and the ground line on the key side of the printed circuit board. The consequential loss of the "@" character and the "NUL" ASCII output from the "P" as previously connected, can be made good by borrowing another redundant key and wiring it into the r.o.m. lines which previously yielded the "P" and "@" characters.

Dr. F. Schild,  
Fortis Green,  
London.

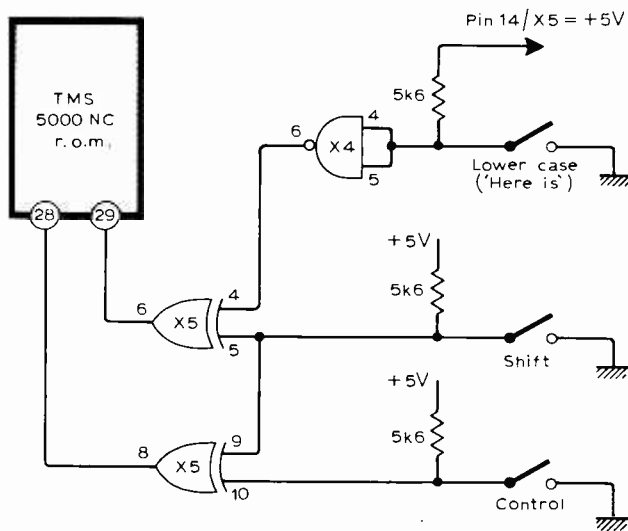

Pin 28	Pin 29	Output
0	0	Lower case
0	1	Upper case
1	1	Control
1	0	Shift

TRUTH TABLE

## Earth referenced V-to-I

The circuit idea for Earth referenced V-to-I which appeared in *Wireless World* December 1977, required one op-amp and three transistors. This simpler circuit uses one op-amp to produce a current source referenced to ground.

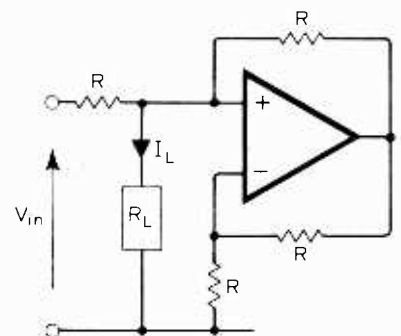

It can be shown that the load current  $I_L = V_{in}/R$ . If  $R_L$  is replaced by a capacitor, a ground referenced integrator is formed and the resulting voltage ramp may be taken via a buffer stage across C or alternatively from the output of the op-amp. For the last mentioned connection, the output ramp is modified to become

$$V_o = \frac{2}{CR} V_{in} dt$$

The maximum load resistance that may be used is  $\leq V_{OH}/2I_L$  where  $V_{OH}$  is the peak output or the op-amp before saturation commences.

M. Applebaum,  
Chubb Alarms Manufacturing,  
Middx.

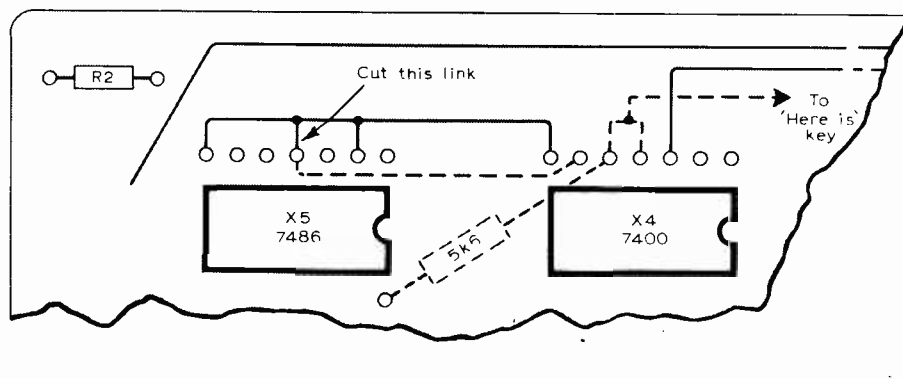

## Standby battery for dynamo lighting

An a.c. bicycle dynamo can be provided with standby battery power by using the circuit shown. The battery supplies current via  $Tr_3$  which should have an  $h_{fe}$  of greater than 40 and a  $V_{CEsat}$  below 100mV at 0.5A collector current. The circuit is activated when the peak dynamo output falls below the battery voltage. The 100 $\mu$ F isolating capacitor,  $C_2/C_3$ , provides power factor correction for the dynamo by cancelling its internal inductive reactance. The correction covers a large speed range because the internal inductance falls with increasing dynamo speed. This raises the typical output of a bicycle dynamo, around 4.5V r.m.s., to about 5.5V r.m.s. The optimum value of  $C_2/C_3$  should be found by experimentation.

Brian J. Pollard,  
Coventry.

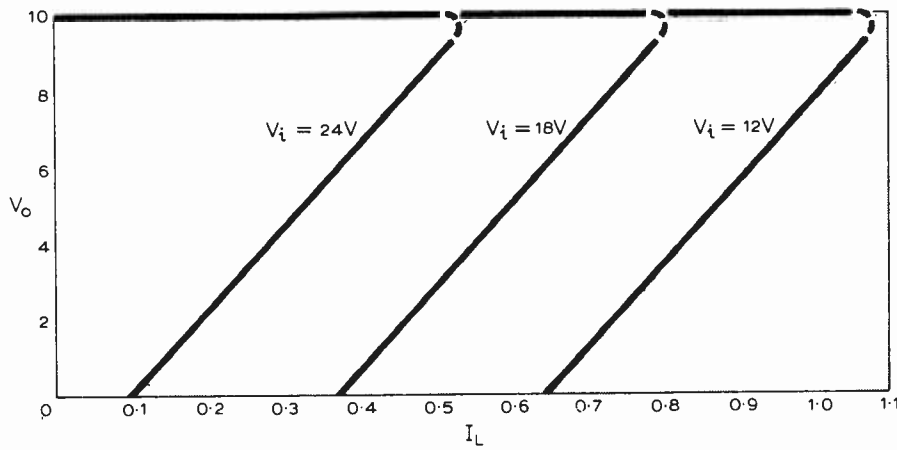
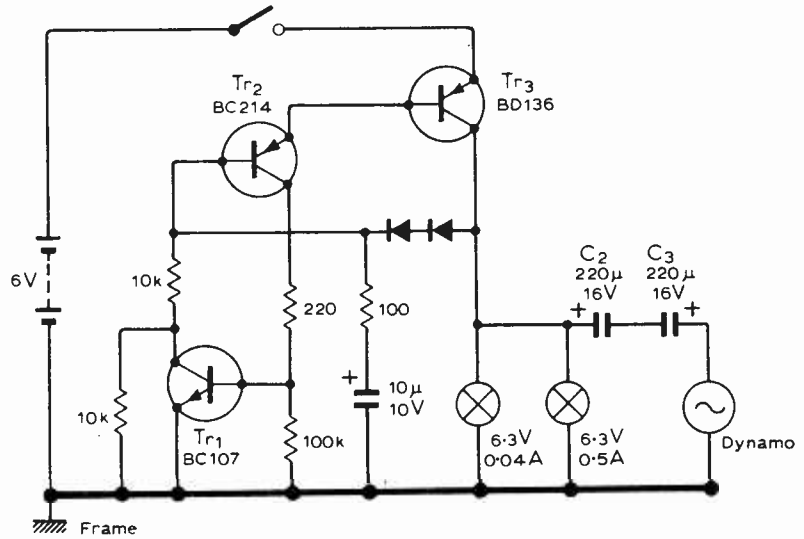

## Fold-back current limiter

This design has been found useful when supplying series regulated circuits from a wide range of input voltages. By choosing suitable values for the current limiting components,  $R_1$ ,  $R_2$ ,  $R_3$  and  $R_L$ , fold-back current limiting characteristics can be achieved that will protect the series regulating transistor from over dissipation when  $V_i - V_o$  is high, and allow higher values of load current to flow when  $V_i - V_o$  is low. Current limiting takes place when  $Tr_1$  conducts. With the values shown and the  $V_{be}$  of  $Tr_1$  assumed to be 0.65 volts, the current limiting characteristics will be similar to those in the graph.

A. J. Ewins,  
North Harrow,  
Middx.

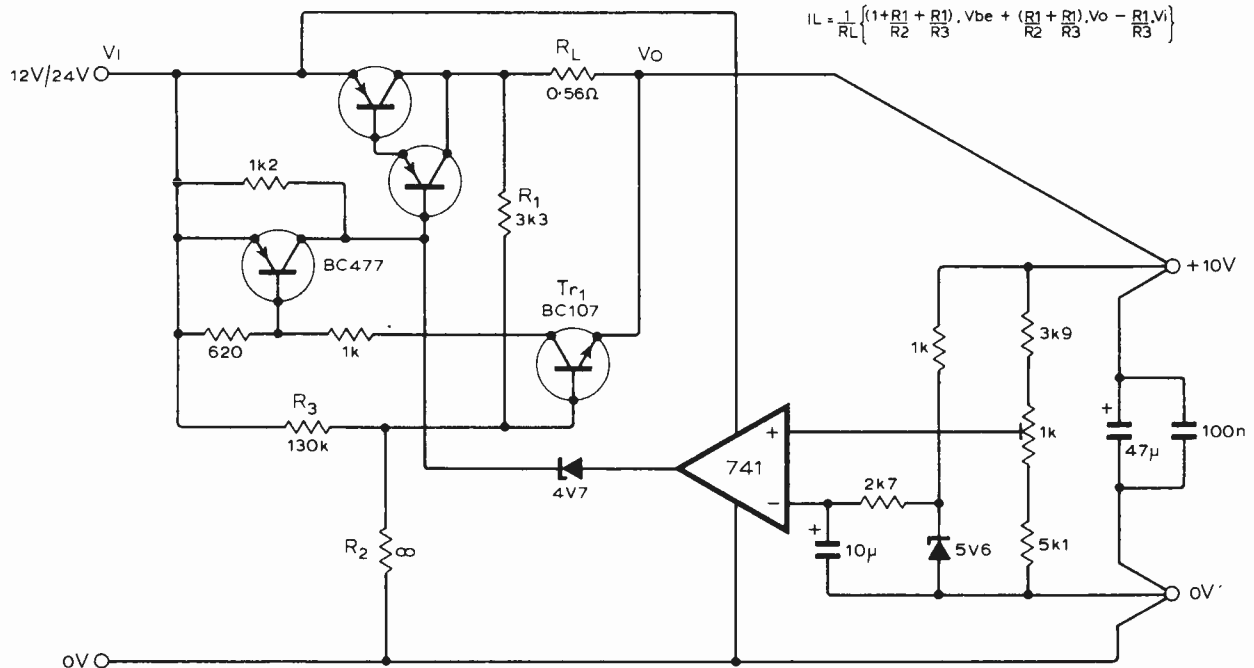

$$I_L = \frac{1}{R_L} \left\{ \left( \frac{1+R_1}{R_2} + \frac{R_1}{R_3} \right) V_{be} + \left( \frac{R_1}{R_2} + \frac{R_1}{R_3} \right) V_o - \frac{R_1 V_i}{R_3} \right\}$$

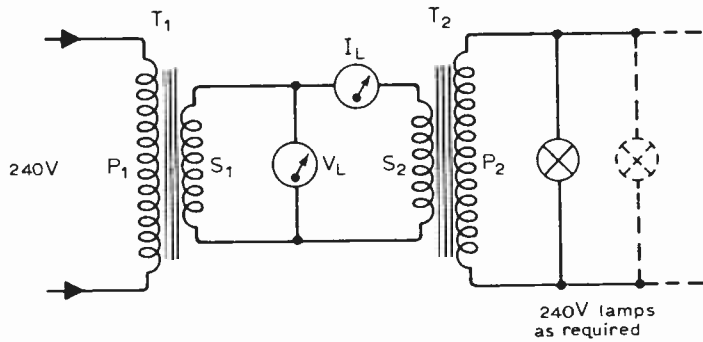

### High a.c. loads

A shortage of high-current loads presented a problem when it was necessary to soak-test two identical mains transformers. The test conditions were satisfied by using a reflected load technique with the two transformers back-to-back as shown. Readily available 240V domestic lamps provided highly suitable loads. With a little care and adaptation this principle can be applied to dissimilar transformers. Also, suitable resistors can be used in conjunction with the lamps for fine load trimming.  
Geoffrey T. Edwards,  
Woodley,  
Reading.

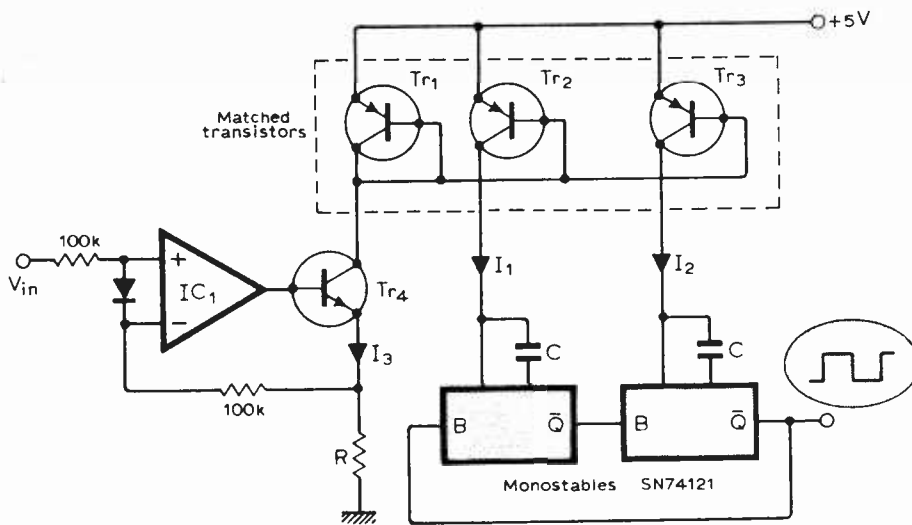

### Linear v.c.o. operates from 5V

When designing hybrid analogue/digital systems, it is often necessary to use a voltage controlled oscillator operating from a 5V supply rail. This circuit uses a standard current differencing amplifier IC<sub>1</sub> together with t.t.l. monostables to achieve this. The amplifier is biased as a voltage follower so that a current V<sub>in</sub>/R flows through Tr<sub>1</sub>. Because Tr<sub>2</sub>, Tr<sub>3</sub> and Tr<sub>4</sub> are connected in a current mirror configuration, equal currents I<sub>1</sub> and I<sub>2</sub> are injected into the monostables. The monostables, which are connected back to back, oscillate at a frequency defined by the current in Tr<sub>1</sub>. Care should be taken in choosing the current defining resistor R because thermal considerations limit the current to 2.5mA. The centre frequency may be chosen by  $f_c = 1/(4CR)$  for V<sub>in</sub> = 2.5V. Nonlinearities in the emitter base junction of Tr<sub>1</sub> are removed by feedback. In practice the main deviations in V-to-F occur because of a mismatch between the current mirror transistors. This mismatch is most significant at currents above 1mA.  
Kirit Patel,  
London Business School,

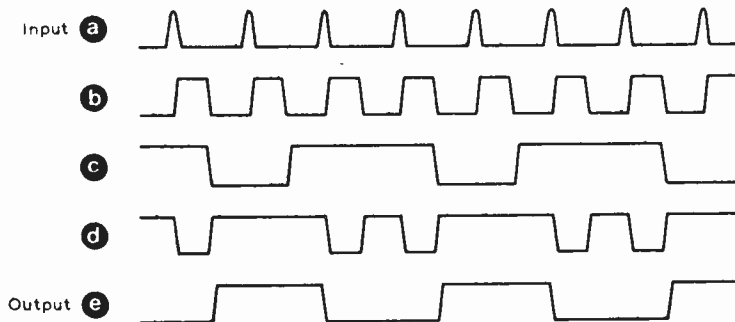
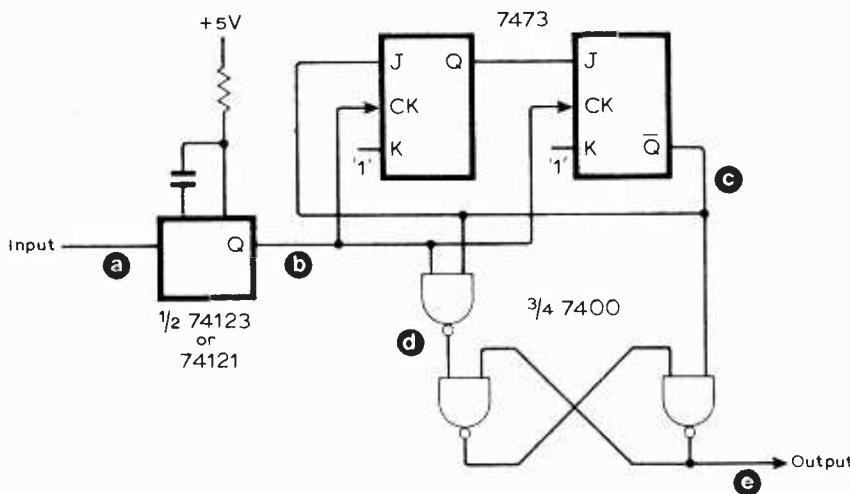

### Divide by three

This circuit uses only three t.t.l. i.c.s to divide an input signal by three and provide an equal mark-to-space ratio output. The monostable is adjusted to produce an equal mark-to-space ratio from any input signal.  
D. J. Eaton,  
St. Leonards on Sea,  
E. Sussex.

# Loudspeaker system design

## Three-enclosure system with active delay and crossovers — part 2

by Siegfried Linkwitz Dipl. Ing.

This is not the "ultimate loudspeaker", but in the first part of this article in the May issue Mr Linkwitz says that "the recording is the next weak link in the chain." The equalized system incorporates electronic crossovers and delay compensation. Part one describes the enclosure design and this article gives sufficient information for the experienced constructor to duplicate or to adapt the electronic design to other needs.

THIS SPEAKER DESIGN project was started with the idea of mounting the boxes flush with the surrounding wall. Positioning the box in front of a wall causes a severe dip in amplitude response when the distance from the front of the box to the wall equals a quarter wavelength. For a typical 300mm enclosure depth the dip occurs around 250Hz, Fig. 2 (ref. 7).

If one imagines the walls near the speakers to be made of mirrors then one can easily visualize the images of the box in these mirrors. At frequencies where the radiation from the box is omnidirectional, each of these images can be thought of as a separate sound source, whose output will add or subtract from the original source, depending upon how far the image source is removed in terms of wavelengths. For a half wavelength distance to the image source, corresponding to a quarter wavelength distance from the speaker to the mirror, the output from the real and the imagined source will cancel each other.

This description of virtual sound sources is valid provided that the speaker is radiating sound towards the walls and that the walls, floors and ceiling act as acoustically reflecting surfaces, i.e. mirrors. Mounting the boxes flush with the reflecting surface eliminates the virtual image behind the speaker and produces a smooth frequency response. The completed system with flush mounted boxes performed very satisfactorily. In particular it gave a good sense of depth perspective for some stereo material.

It was discovered later that by moving the speaker out into the room and at least 0.5-1m away from walls and floor, a significant improvement in sound perspective was obtainable, see photograph in part 1. On appropriate

program material it now became quite easy to pinpoint the location of individual instruments both laterally and in their distance behind the speaker plane. It might be said that the whole sound stage moved into focus.

Furthermore, tape hiss and record surface noise became spatially separated from the musical material. The noise originated definitely at the speaker boxes while the musical instruments assumed their own space between and behind the boxes. In this sense the noise and ticks from a record surface are comparable to the coughing and shuffling of people at a live concert where one can concentrate on the performance and not be side-tracked by unrelated acoustical events<sup>8</sup>.

It is not clear why the placement only a relatively short distance away from the walls should give such a marked

improvement, particularly in light of the just-mentioned frequency response interferences from virtual images. It might be that the ear-brain combination performs a time domain analysis and is able to allocate the wall reflections which occur 4 to 6ms later than the direct sound to the characteristic of the listening room and to the program material.

Mounting of the speakers away from the walls was accomplished by hanging them from the ceiling with a nylon monofilament. Electrical connections run from the back of the enclosure to the wall behind it and also serve to keep the speaker aiming forward. The small hanging units might be appropriately called satellites to the woofer box. The woofer itself is located halfway between the satellites, which are 2.5m apart.

The listening room is 5 × 8 × 4m (w × l × h), with the speakers in front of the narrow walls and the typical listening positions 5 to 6m away from the satellites.

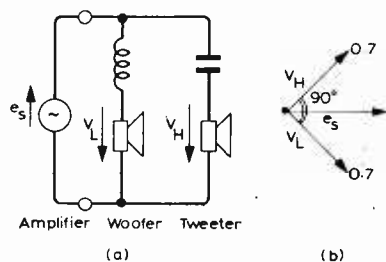

Fig. 7. Schematic network with 6dB per octave slopes and voltage phasor diagram at the crossover frequency.

### Crossover design

The simplest crossover network is the -6dB per octave slope filter of Fig. 7. Assuming idealized components, the current from the generator will split in such a way that the vector sum of the voltages across the low and high frequency driver terminals is equal to the source voltage at all frequencies  $V_L + V_H = e_s$ .

Correspondingly the vector sum of the sound pressures  $p_L$  and  $p_H$  generated by the drivers will be directly proportional to the generator voltage  $p_L + p_H = k e_s$  and independent of frequency, provided that the distance from the listener to each of the drivers is identical. The B110 and T27 drivers though are a wavelength apart, which means that equidistance is obtained only for a plane in space, Fig. 8. For points outside this plane the sum of the two driver outputs will vary with frequency.

Furthermore, because the two drive voltages already have a 90° phase difference the summation will be different for symmetrical points above and below the plane of equidistance. In the crossover frequency region where both drivers contribute equally the system will radiate its maximum pressure at a 14-degree angle below the plane, Fig. 9. This simple dividing network has a wide

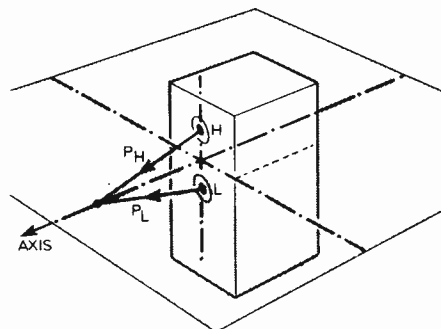

Fig. 8. Plane of points are equidistant from the high frequency and low frequency drivers. The sum of the sound pressures is proportional to the sum of the electrical drive signals only in this plane.

range of overlap between the two drivers and therefore a tilted radiation pattern over at least two octaves.

A seemingly attractive feature of this network is its complete lack of phase distortion for points which are equidistant from H and L, Fig. 8. At these points perfect square-wave reproduction is achievable under free-field conditions or in an anechoic chamber. In a living room the increased radiation towards the floor and the reduced radiation upwards will produce a coloration in sound due to the frequency-selective change of the reverberant field. The ear is more sensitive to the amplitude response than to phase shift. Therefore this filter and related designs with even greater than 90° phase difference between the drive signals and correspondingly greater off-axis intensity peaks are not used for the satellite system<sup>9</sup>.

A 24dB per octave slope filter was chosen which has no off-axis peaks in the radiation pattern<sup>10</sup>, Fig. 9. The steep filter cut-off narrows the overlap region where the B110 and T27 interact. The T27 has its fundamental resonance at 1.4 kHz and the highpass provides 27dB of attenuation at this frequency. At 5kHz where the B110 exhibits a cone resonance the filter has reduced the drive voltage by 18dB, Fig. 10. A 6 or even 12dB per octave filter would have insufficient attenuation to minimize exciting these resonances. The 18dB per octave filter was not considered because it tilts the polar pattern.

All these filters, with the exception of the 6dB per octave network, have a frequency-dependent phase shift and consequently some phase distortion. Only a network of linearly increasing

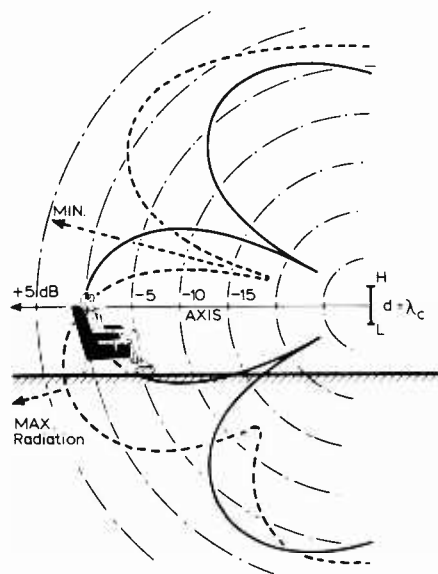

Fig. 9. Radiation of a 6dB per octave crossover network at the cross-over frequency (3dB peak occurs below the plane of equidistance for non-coincident drivers) and the symmetrical pattern of a 24dB per octave crossover network at the crossover frequency (ref. 10).

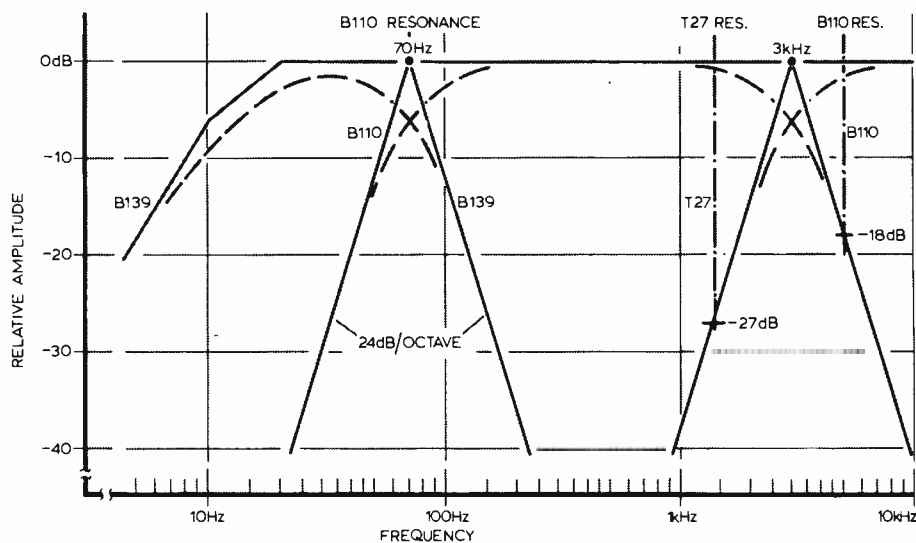

Fig. 10. Schematic response for crossover points and driver resonances.

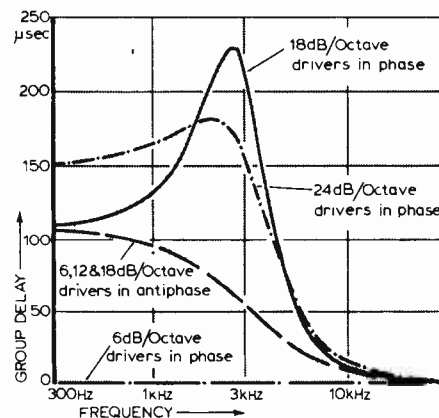

Fig. 11. Group delay frequency response of a speaker system due to a 3kHz crossover between midrange and tweeter with conventional first and third-order Butterworth networks, and with second and fourth-order cascaded Butterworth sections (ref. 10).

phase shift with increasing frequency will have no phase distortion. The slope of the phase curve is constant in this case. Any deviation from the constant slope indicates that some amount of phase distortion is present. The question arises how much slope variation can be tolerated before it becomes audible and not merely visible on an oscilloscope. The slope of the phase curve, usually referred to as envelope delay or group delay, has been plotted for typically used Butterworth crossover networks and the new network function<sup>10</sup>, Fig. 11. Merely changing the polarity to one of the drivers drastically changes the group delay for the summed driver outputs as in the case of the first and third-order Butterworth crossovers. Their on-axis amplitude response is unchanged, unless the drivers are separated some distance from each other. Then the polar pattern will tilt either up or down with the change in driver polarity.

To investigate the audibility of phase distortion an all-pass network was built which duplicates the group delay of the new second and fourth-order crossover networks (12 and 24dB per octave curves in Fig. 11). Listening with headphones to stereo and mono program material, no audible difference could be detected with either one of the all-pass networks switched in or out.

Therefore it seemed safe to use the fourth-order filter with its sharp cut-off behaviour which minimizes the overlap between drivers.

**Crossover and equalizer circuits**

The crossover networks and equalizers consists of a variety of active filter circuits. The overall block diagram of Fig. 12 gives an indication of the system complexity. Design formulas are presented for each functional block so that the experienced constructor should be able to duplicate the circuits of Fig. 13 or adapt the design to particular needs.

**3kHz crossover networks**

The fourth-order high and low-pass filters are made up from cascaded second-order Butterworth sections, Fig. 14. The outputs  $V_H$  and  $V_L$  are in phase with each other at all frequencies and the voltage sum is equal to  $V_{IN}$ . At the crossover frequency  $f_c$ , therefore, the output from each filter will be  $V_{IN}/2$  or 6dB down, which is different from the typical 3dB crossover point for filters where  $V_H$  and  $V_L$  are in phase quadrature<sup>10</sup>.

**Delay compensation**

The B110 and T27 drivers do not radiate from the same acoustical plane even though they are mounted on the same

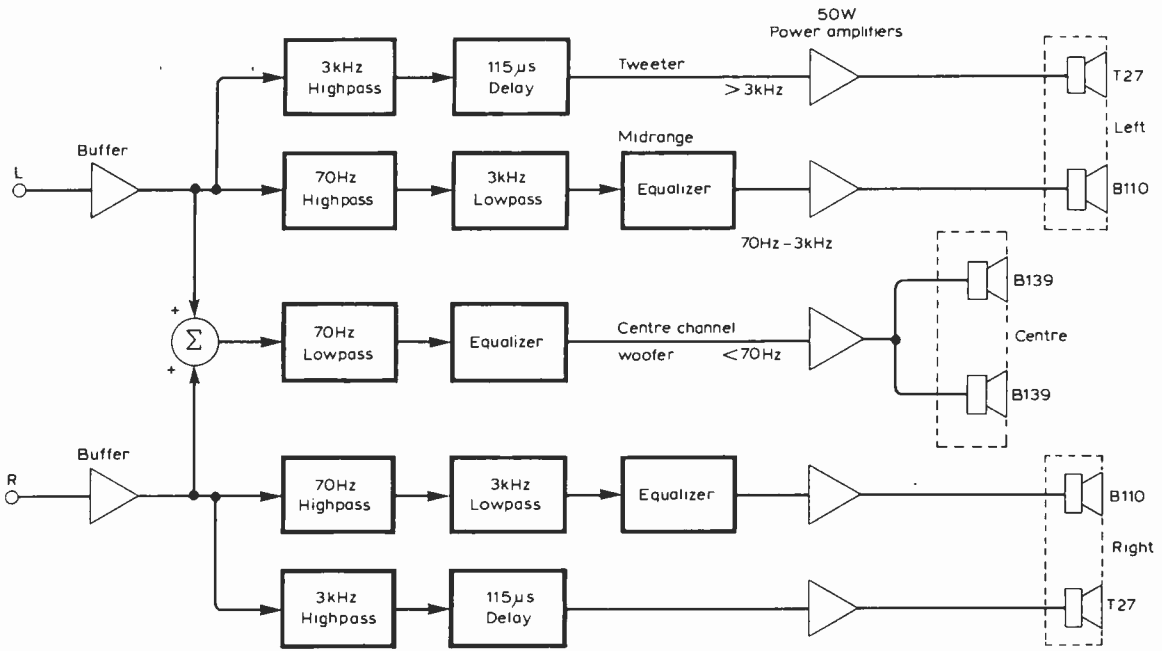
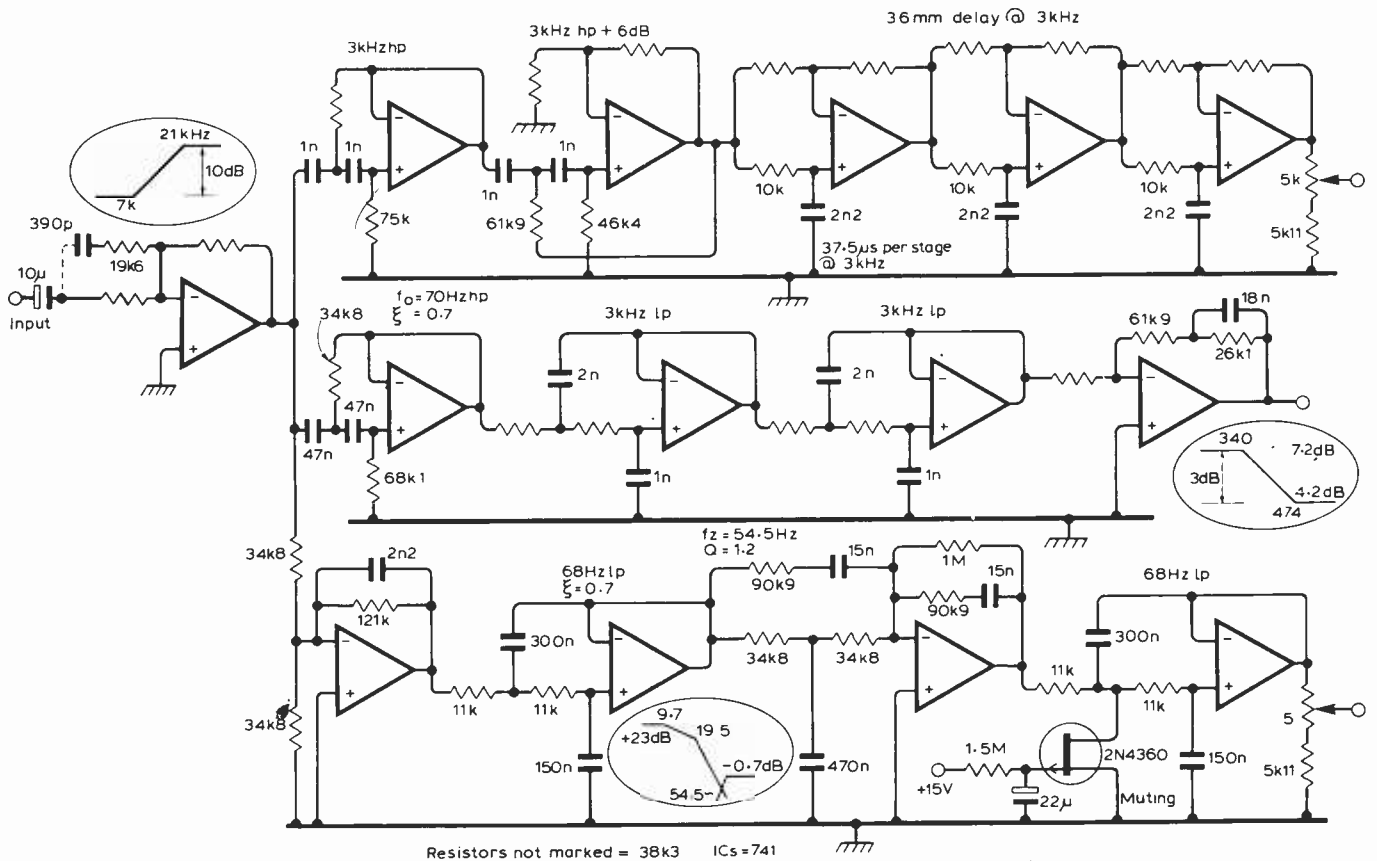

Fig. 12. System block diagram. Design formulas for each functional block are given to allow adaptation of the circuits of Fig. 13.

Fig. 13. Circuit diagram of crossover networks and equalizers incorporating delay compensation. Broken lines show optional h.f. boost components.



baffle. The electrical signals arrive at each voice coil at the same time but because the T27 voice coil is located in front of the B110 voice coil the sound pressure wave generated by the T27 will be advanced relative to the B110. The 40mm driver off-set may seem insignificant unless it is related to the 144mm wavelength of a 3kHz tone where it corresponds to a 100° phase difference between the two driver outputs.

The effect of driver off-set on the on-axis frequency response can be quite significant, particularly if both drivers contribute almost equally over a wide frequency range, Fig. 15. The frequency region of overlap is significantly narrower for higher-order filters because of their steeper cut-off.

The driver offset can be compensated for by adding electrical delay to the tweeter drive signal, or by mounting the tweeter in a different plane.

Mechanically moving the tweeter back is feasible provided care is taken to avoid sharp cabinet edges and their associated scattering of sound. For electrical delay an all-pass network has been used, Fig. 16. Its delay varies with frequency from  $\tau = 2RC$  at low frequencies, approaching zero delay at very high frequencies. To reduce the frequency dependency in the crossover region of around  $f_c$  the component values should be chosen such that  $RC \leq 1/20f_c$ . Several delay stages are cascaded to obtain the required total delay. This delay has to be determined experimentally, but the spatial driver offset gives a reasonable starting point.

**70Hz crossover network**

The transition between the woofer and the satellite uses 24dB per octave slope filters similar to the 3kHz crossover. A transition frequency of 70Hz was chosen because the B110 output is 3dB

down at this frequency due to the small internal volume of the satellite enclosures. The output continues falling off at a 12dB per octave rate below this frequency with approximately second-order Butterworth response shape. Therefore the driver in the closed box can be used as one half section of the required high-pass filter. The other half is implemented with an active second-order Butterworth filter section — the first stage in the centre channel of Fig. 13. The low-pass filter for the B139 is again the two amplifier fourth-order network design — the second and fourth stages of the lower channel in Fig. 13.

**Woofer equalization**

The response of the woofer does not extend sufficiently far down in frequency. The fall-off in acoustic output will therefore be compensated with a properly increasing drive signal. Over the frequency range where the driver acts like a rigid piston its frequency response when mounted in a closed box (ref. 11) is

$$F_w = \frac{\left(\frac{f}{f_0}\right)^2}{\sqrt{\left[\left(\frac{f}{f_0}\right)^2 - 1\right]^2 + \left(\frac{1}{Q_0} \frac{f}{f_0}\right)^2}}$$

This is a high-pass function with a corner frequency near the closed box resonance  $f_0$  and some peaking depending on  $Q_0$ , Fig. 17. The two parameters  $f_0$  and  $Q_0$  can be conveniently determined from the frequency response of the driving point impedance<sup>11</sup> of the speaker system, Fig. 18. If the system is driven from a generator with an internal impedance much larger than  $R_{max}$ , then the terminal voltage becomes proportional to the system impedance and  $Q_0$ ,  $f_0$  can be determined from the voltage response as in Fig. 19.

For the two B139 woofers in their closed box, the resonance occurs at 54Hz with a  $Q_0$  of 1.2. The response can now be compensated with a network which exactly complements the woofer roll-off and extends it to a lower cut-off frequency, Fig. 20. This design approach can be used to equalize other speaker systems if careful attention is given to

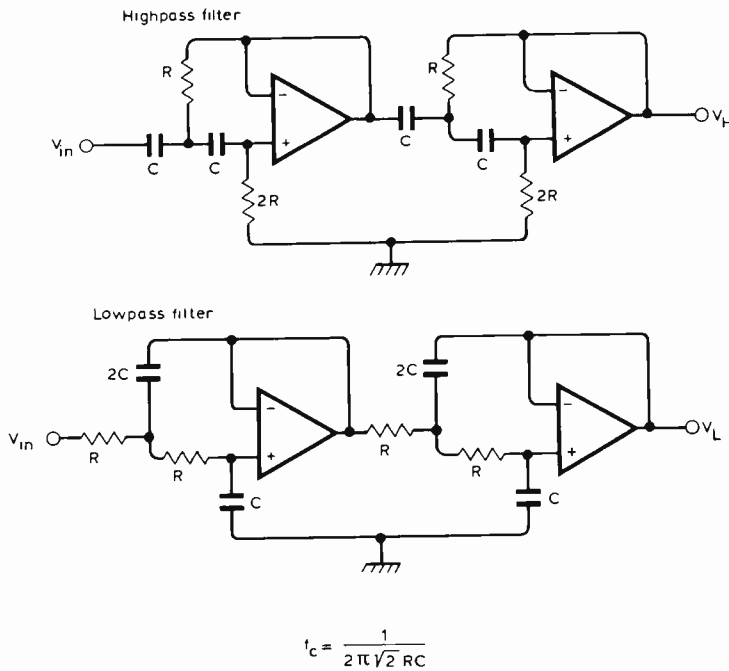

Fig. 14. Fourth-order 24dB per octave crossover filter sections are made up from cascaded second-order sections in both high and low-pass forms.

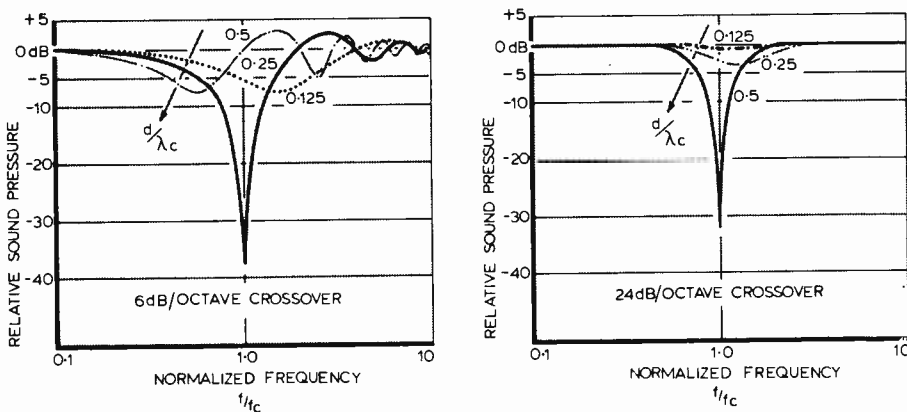

Fig. 15. On-axis response when the tweeter is positioned acoustically in front of the midrange by  $d/\lambda_c$  with 6dB per octave crossover, and 24dB per octave crossover.

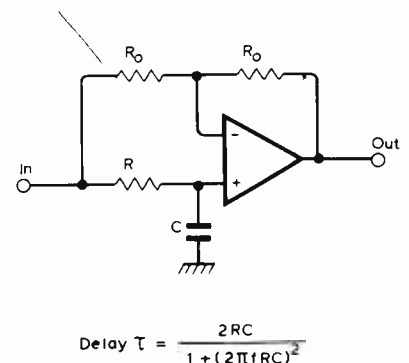

Fig. 16. Several all-pass phase shift networks are cascaded to obtain the required delay compensation.



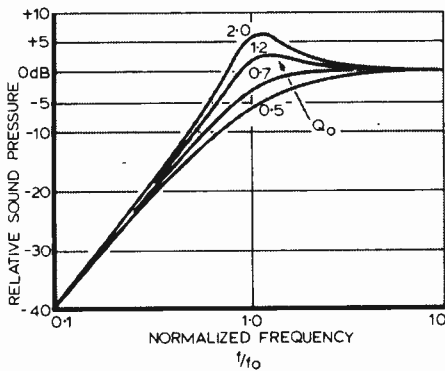

Fig. 17. Fall-off in response of a rigid piston in a closed box (ref. 11). Box resonance  $f_0$  and  $Q$  are determined as in Figs. 18 and 19.

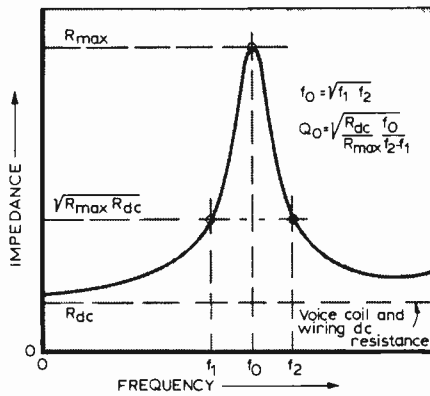

Fig. 18. Schematic response of the woofer driving point impedance measured as in Fig. 19 from which  $f_0$  and  $Q_0$  of Fig. 17 are derived (ref. 11).

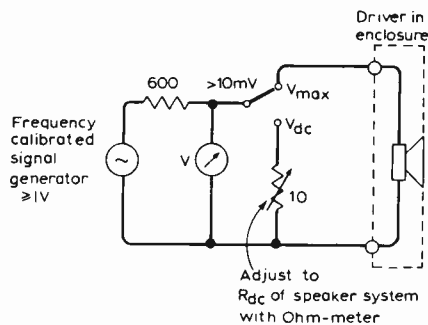

Fig. 19. Measurement setup for Fig. 18 to determine  $R_{DC}/R_{MAX}$  from  $V_{DC}/V_{MAX}$  and the frequencies  $f_1$  and  $f_2$  from  $V = \sqrt{V_{MAX} \times V_{DC}}$ .

the cone excursion capability and the power amplifier output voltage swing limitations. Both increase by a factor of four when the cut-off frequency is lowered by an octave.

For the playback of records much of the linear excursion range of the woofer is used to reproduce the large amplitudes of record rumble. This wastes driver linearity. Fortunately the left and right-channel vertical rumble outputs from the pickup are out of phase and therefore cancel when the left and right channels are summed for a center channel woofer, as in this design. Separate left and right channel woofers can easily be tied together electrically to eliminate the unnecessary movement of air at subsonic frequencies from one speaker box to the other<sup>12</sup>.

The corrected response of the woofer can be verified by placing a microphone about 1cm away from the cone to determine the near-field sound pressure which for a uniformly moving piston is proportional to the far-field sound pressure<sup>13</sup>.

**System equalization**

As active networks are already used for the crossover filters it seems attractive to also use them to equalize the complete speaker system for a flat amplitude response at the preferred listening location. A microphone at that position will pick up the direct sound coming from the speakers and a large number of reflections from various objects and the walls of the room. The microphone cannot distinguish between the different sources. The microphone output voltage which corresponds to the direct sound from the speakers will be masked by the voltage due to the reverberant sound field. The ear-brain combination seems to be taking its clues for locating the details of the stereo image from the direct sound even when the reverberant sound energy is much larger than the direct sound. This might explain why attempts to equalize for a flat response at the listening location gave unsatisfactory results.

The response at one metre from the speaker measured in the room appears to be a better starting point for equalization. But even for this location a completely flat response does not seem to give the most natural-sounding reproduction. Some form of shelving or sloping response seems necessary<sup>14</sup>.

In this design a 3dB low-frequency boost is applied to the B110 signal to obtain flat acoustic output over its range (last stage in the centre channel of Fig. 13). The T27 is allowed to follow its own gradual roll-off, but if a flat high-end response seems desirable then the simple network shown with broken

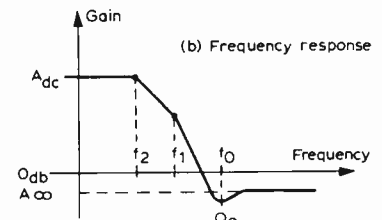
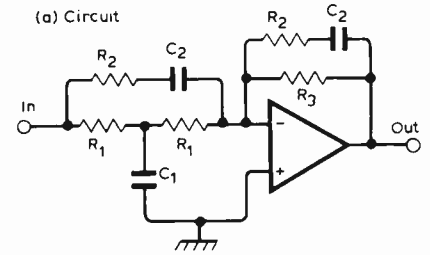

(c) Design formulas

$$f_0 = \frac{1}{2\pi R_1 \sqrt{C_1 C_2}}$$

$$Q_0 = \frac{1}{2\xi} = \frac{R_1}{2R_1 + R_2} \sqrt{\frac{C_1}{C_2}}$$

$$\frac{R_2}{R_1} = \frac{1}{Q_0} \sqrt{\frac{C_1}{C_2} - 2}$$

$$f_1 = \frac{1}{\pi R_1 C_1}$$

$$f_2 = \frac{1}{2\pi (R_2 + R_3) C_2}$$

$$A_{dc} = \frac{R_3}{2R_1}$$

$$A_{\infty} = \frac{R_3}{R_2 + R_3} < 1$$

$$\frac{A_{dc}}{A_{\infty}} = \frac{R_2 + R_3}{2R_1}$$

Fig. 20. Network extends the woofer low frequency response to  $f_1$  by providing exact compensation for  $Q_0$  and  $f_0$  with schematic amplitude response, and design formulas.

Fig. 21. Measured voltages at the driver terminals of the complete system. A flat response does not seem to give natural-sounding reproduction.

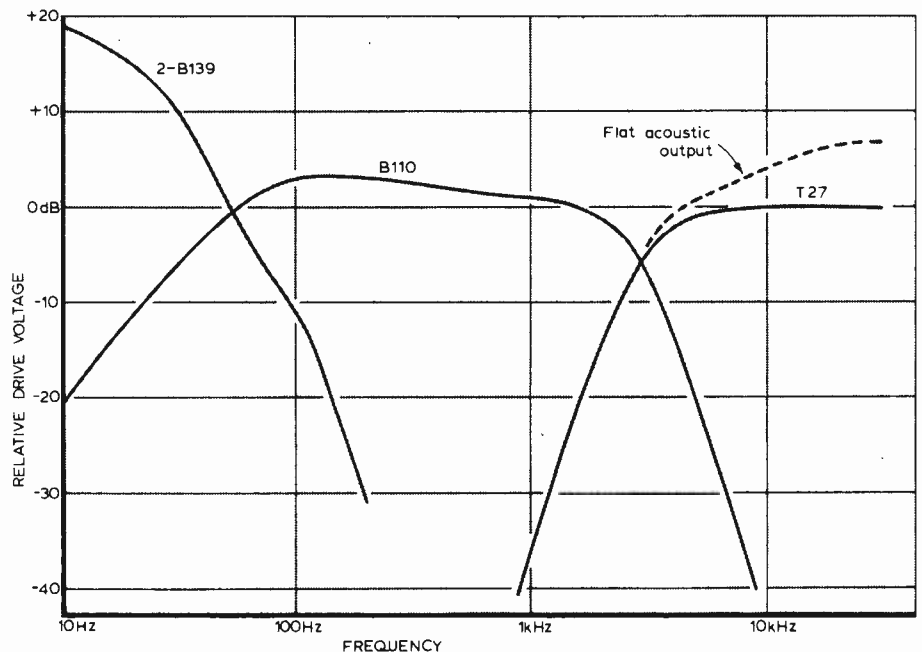

lines at the input stage will give the necessary high-frequency boost.

An analogy might help to describe the subjective impression of a properly designed and equalized system by comparing it to the colour photograph of a familiar scene. A fair sound system might correspond to an out-of-focus picture, possibly with the wrong reds and blue or an overall colour tint. Comparing two such systems to each other is like looking at two blurry pictures of reality, where one might prefer one over the other because of its colour balance but there is no question of either being a realistic reproduction. A high accuracy sound system corresponds to a photograph which is focused and without unnatural emphasis on any colour. When a high standard of reproduction is being approached it becomes possible to hear clearly areas of slight imperfection like in a picture which is not exactly focussed or has just a slight colour tint. For the high-frequency equalization of the speakers this means that too much output shifts the sound image out of focus. The image depth becomes blurred because the high frequency overtones seem to be less distant than the virtual sources which generated them.

The chosen speaker equalization appears to match the greatest variety of program material. A properly functioning treble control in the pre-amplifier is needed though to correct for differences in recordings. The final response of the drive voltages for the three speaker units, Fig. 21, could have been generated or approximated with passive networks. The practical implementation might prove to be difficult though and no attempt has been made to design a passive crossover/equalizer. The design flexibility of active networks far outweighs the possible cost saving of passive networks when only a single system is being built.

### Conclusion

It is hoped that some of the design techniques and ideas expressed here will stimulate a more rational design of loudspeaker systems. Certainly the drivers will be continuously improved

for reduced spurious resonances but even more so the enclosure design, materials and shapes will need further study and development<sup>15</sup>. Nevertheless it is possible to design a highly satisfactory system even with today's standard components.

### References

- Allison R. F., Influence of room boundaries on loudspeaker power output, *JAES*, vol. 22, June 1974, p. 314.
- Heyser R.C., Geometry of sound perception, 51st AES Convention, Los Angeles, May 1975.  
Heyser R.C. Some new audio measurements, 51st AES Convention, Los Angeles, May 1975.
- Pramanik S.K., Crossover networks and phase response, *Wireless World*, vol. 81, November 1975, p. 529.  
Ashley J.R. and Henne L.M., Operational amplifier implementation of ideal electronic crossover networks, *JAES*, vol. 19, January 1971, p. 7.
- Linkwitz S.H., Active crossover networks for non-coincident drivers, *JAES*, vol. 24, January 1976, p. 2.
- Small R.H., Closed-box loudspeaker systems, part 1: analysis, *JAES*, vol. 20, December 1972, p. 798.  
Hunt F.V., *Electroacoustics*, Harvard U.P., Wiley, 1954.
- Oldfield M.L.G., Stereo rumble filter, *Wireless World*, vol. 81, October 1975, p. 474.
- Keele D.B., Low-frequency loudspeaker assessment by nearfield sound-pressure measurement, *JAES*, vol. 22, April 1974, p. 154.  
Jacobsen O., Some aspects of the self and mutual radiation impedance concept with respect to loudspeakers, *JAES*, vol. 24, March 1976, p. 82.
- Harwood H.D., Some factors in loudspeaker quality, *Wireless World*, vol. 82, May 1976, p. 45.
- Berman M.J., Cooke R.E. and Fincham L.R., Loudspeaker testing using digital techniques, KEF Electronics Ltd, March 1975

## System X speed-up

An Integrated Systems Development (ISDD) has been set up by the Post Office to accelerate the development of System X, the electronic exchange equipment "that will revolutionise the nation's phone system." (*Wireless World*, *passim*). The department is to be headed by Mr John Martin, who has worked on electronic exchange equipment for 15 years, and on System X for four.

In a statement the BPO said they intended to place contracts for the first production exchanges before the end of the year. The first exchanges would come into service by the early 80s. The new department is an offshoot of the TSSD (Technical Systems Strategy Department), set up in 1974 which, under Roy Harris, has been responsible for the overall design of the system. ISDD will liaise with Plessey, GEC and STC, who are developing System X with the PO, and other Post Office departments.

The Carter Committee on the running of the Post Office criticised the slow development of System X, which it feared would arrive too late to be competitive in world markets.

The Post Office revealed some of the ideas underlying System X at the Communications 78 exhibition and conference at Birmingham.

System X will use integrated digital transmission and switching, stored programme control and common channel signalling. The devices used would be based on low power Schottky t.t.l., c.m.o.s. and n.m.o.s. □

## IERE hits out at "degree obsession"

"The national obsession with education to 'degree standard' has deprived the traditional technician engineer training pattern (ONC/HNC) of both its status and much of its best raw material; this, coupled with the inflexibility of CEI's qualification rules and procedures which has robbed the technician engineer of the facility to proceed by practical achievement to chartered engineer status, has divided the electronic engineering profession into a rigid two-class structure to the detriment of the profession and of the national interest."

This broadside was delivered in the IERE's evidence to the Finniston Committee on the future of the engineering profession. In other respects, however, the IERE seems to agree with the views of the Engineering Professor's Conference that degree courses should be longer and that there should be more co-operation with industry. The IERE recommends that there should be an extensive publicity campaign aimed at raising degree course entry standards to restore the status of ONC, HNC, HND and TEC courses and the associated work levels, to stimulate recruitment and to boost the morale of "this vital element of the engineering workforce."

➔ This, as we said in our September, 1977 leading article, is more like it. □

## Nabbed by satellite

American GEC has demonstrated a system for preventing drugs being smuggled over remote parts of the Mexican-US border which uses mobile radio and a geostationary satellite.

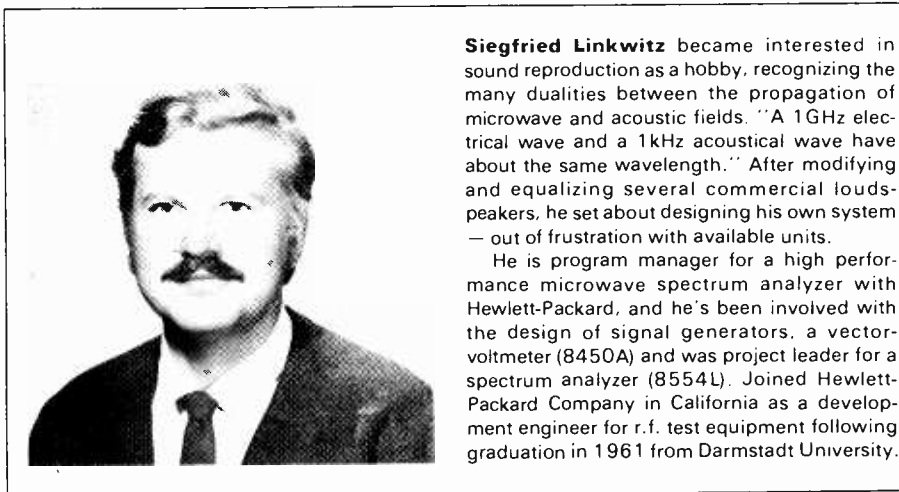

**Siegfried Linkwitz** became interested in sound reproduction as a hobby, recognizing the many dualities between the propagation of microwave and acoustic fields. "A 1GHz electrical wave and a 1kHz acoustical wave have about the same wavelength." After modifying and equalizing several commercial loudspeakers, he set about designing his own system — out of frustration with available units.

He is program manager for a high performance microwave spectrum analyzer with Hewlett-Packard, and he's been involved with the design of signal generators, a vector-voltmeter (8450A) and was project leader for a spectrum analyzer (8554L). Joined Hewlett-Packard Company in California as a development engineer for r.f. test equipment following graduation in 1961 from Darmstadt University.

# KEEP YOUR COOL

WITH ANTEX SOLDERING IRONS...

THIS UNIQUE SAFETY STAND - PART OF THE ANTEX SOLDERING KITS SK3 and SK4

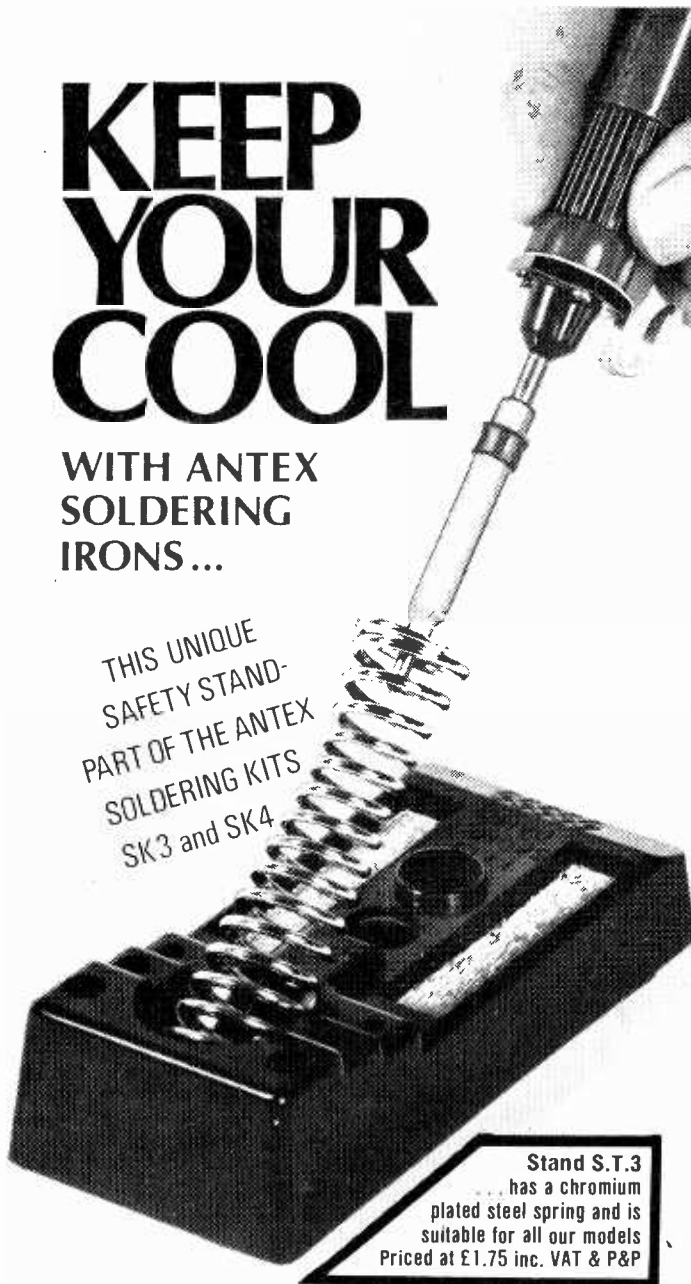

**Stand S.T.3** has a chromium plated steel spring and is suitable for all our models. Priced at £1.75 inc. VAT & P&P

With the new Antex soldering stand you have the assurance that with the iron tucked neatly into the strong angled spring coil you have maximum safety when preparing or waiting for the iron to heat. Moulded into this stand is provision for six alternative bits, and two small sponges for cleaning bits.

This sturdy plastic stand is a useful addition to any household or workshop. The SK3 and SK4 kits comprise of a full instruction card mounted with either the CX miniature soldering iron or the larger X25 general purpose iron. Included in both of these kits is the safety stand.

All the range of Antex soldering irons are made on the principle of putting the heating element inside a shaft, then the desired bit is eased over the shaft, giving maximum heat transfer, this is why so often a small Antex iron can do the job of a larger conventional iron. The precision made slide on bits are slit to make them easily interchangeable.

Our comprehensive range is sure to meet your need.

**Model CX-17**  
watts

a miniature iron with the element enclosed first in a ceramic shaft, then in stainless steel. Virtually leak-free. Only 7 1/2" long. Fitted with a 3/32" bit. £3.91 inc. VAT & P&P. Range of 5 other bits available from 1/4" down to 3/64".

**Model X25-25 watts**

A general purpose iron also with a ceramic and steel shaft to give you toughness combined with near-perfect insulation. Fitted with 1/8" bit and priced at £3.91 inc. VAT & P&P. Range of 4 other bits available. **B.E.A.B. APPROVED**

**Model SK3 KIT**

Contains both the model CX soldering iron and the stand S.T.3. Priced at £5.62 inc. VAT & P&P. An excellent present for the radio amateur, model-maker or hobbyist.

**Model SK4 KIT**

With the model X25 general purpose iron and the S.T.3 stand and its B.E.A.B. safety label, this kit is a must for every tool kit in the home. Priced at £5.62 inc. VAT & P&P.

**Model SK1 KIT**

This kit contains a 15-watt miniature soldering iron, complete with 2 spare bits, a coil of solder, a heat sink and a booklet. "How to solder". Price £6.18 inc. VAT & P&P.

**Model MLX KIT**

The soldering iron in this kit can be operated from any ordinary car battery. It is fitted with 15 feet flexible cable and battery clips. Packed in a strong plastic envelope it can be left in a car, a boat or a caravan ready for soldering in the field. Price £4.59 inc. VAT & P&P.

Stocked by most of the well-known wholesalers and many retailers. Or direct from us if you are desperate.



Please send the following  I enclose cheque P.O. Giro No258 1000

Name

Please send the ANTEX colour brochure  Address

**ANTEX LTD. FREEPOST, PLYMOUTH PL1 1BR TEL. 0752 67377**

WW - 104 FOR FURTHER DETAILS

ww 6.78



# YAESU MUSEN

FOR THE FINEST VALUE IN THE WORLD

## THE FRG7 Synthesised General Coverage Communications Receiver



**The FRG7 is a solid state mains and 12v. receiver offering continuous coverage 0.5—30 MHz with specifications unparalleled in its price range.**

Its advanced circuitry provides superb performance for professional or amateur alike: search, monitor, test, amateur or broadcast band applications.

The use of a Wadley loop (using the same VHF oscillator to mix up, then after pre-mixing with a stable crystal source down again (this cancelling all drift from the variable oscillator). It provides equivalent performance to 30 crystal controlled converters feeding a low IF, but without the image problems of such an arrangement.

The signal path starts with the choice of 3 antenna connectors: for 1.6-30 MHz, a 50/75 ohm feed (to a SO239 (UHF) coax socket and a binding post) and for 0.5-1.6 MHz (medium wave) a separate high impedance binding post. A 3 position 0-40dB switchable attenuator aids reception of very strong signals and reduces adjacent channel interference. The low noise MOSFET RF amplifier provides a SSB sensitivity of 0.25µV (for 10dB N+S/N at 10.5 MHz) and is sharply tuned by a well calibrated "pre-selector" capacitor with 4 band switched coils. Its output is low pass filtered (fc= 35 MHz) removing VHF image problems from the following mixer. This comprises a pair of JFETs, driven by the "MHz set" 55.5—84.5 MHz. oscillator, which upconverts the signal to the band pass first IF to 55 MHz ± 500 KHz where it is MOSFET amplified. The second IF of 2-3 MHz is produced by a FET mixer by heterodyning with the synthesiser derived 52.5 MHz signal. A 1 MHz crystal oscillator and diode harmonic generator produces a 3-32 MHz comb spectrum. This, with the first heterodyne oscillator (MHz set) is fed to a dual balanced i.c. pre-mixer. The output is expurgated by a multiple stage selective amplifier producing the 52.5 MHz second oscillator. A small fraction of this is rectified, DC amplified and lights the 'lock' LED (saving power) when the MHz oscillator is malset. The 2-3 MHz signal is MOSFET amplified and fed to the third mixer (a JFET whose input and output are tuned by capacitors ganged to the main tuning control) where it is heterodyned to the final IF by the main VFO which covers a 1 MHz range (2.455-3.455), is clearly calibrated, to 5 kHz (or better), well buffered and highly stable. The third (455 kHz) IF starts with the ceramic selectivity element and is followed by two stages of bipolar (the first in the signal path) amplification before the choice of detectors; twin diodes for AM, or a 4 diode product detector,

with well buffered switched frequency (for selectable sidebands) B.F.O. A diode rectifies, a fraction of the output from the final IFT, this is boosted to drive the illuminated "S" meter and automatically gain control the MOSFET amplifier in the RF, second and third IF stages, reducing fading and distortion. Immediately following the demodulator is an automatic noise limiter, highly effective in suppressing pulse type interference on AM signals, and a three position "tone" switch a (high, low or band pass) audio filter, reducing the bandwidth to that required. A transformerless AF amplifier delivers a generous 2W to the internal 5" x 3", or external speaker, drives a phone jack, and a "volume" independent output for tape recorder. The receiver is, mains (234VAC), external (12v DC) or internal dry cell powered, the most economic source being automatically chosen. This is reduced to a stable regulated 10v. (or 9v. for oscillator and the harmonic generator). A dial lamp switch is provided to conserve power on battery operation.

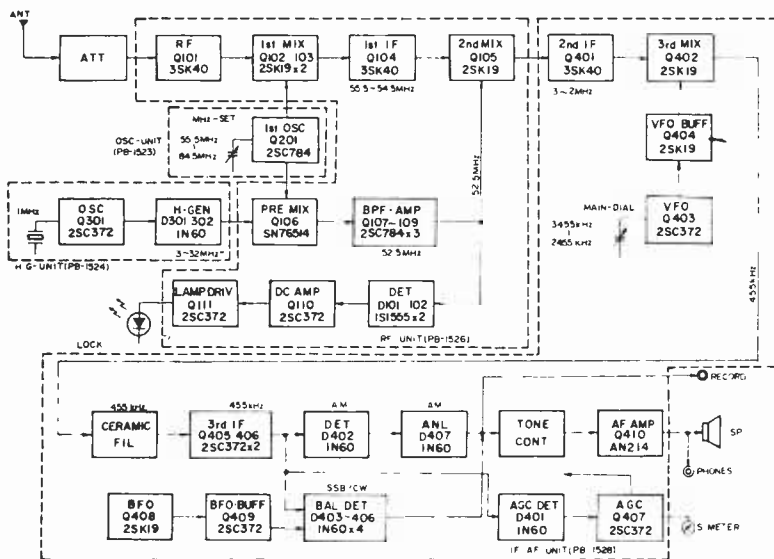

### PERFORMANCE WITH ECONOMY WORLD WIDE WIRELESS

### CONSERVATIVE SPECIFICATIONS

FREQUENCY RANGE 0.5-30MHz  
General coverage in 4 bands  
AUDIO DISTORTION less than 10% at 2W output  
AUDIO OUTPUT more than 2W.  
ANTENNA IMPEDANCE 50-75 ohms. Unbalanced for 1.6-30MHz. High impedance for 0.5-1.6MHz.

MODES SSB (selectable USB&LSB) AM, AM / ANL, or CW  
CIRCUITRY 13 bipolar and 9 field effect transistors  
2 ICs and 16 diodes  
SIZE 13½" W x 6" H x 11½" D  
POWER REQUIREMENTS 13.5V DC Neg ground or 8 off HP11 or 100/110/117/220/234V AC 50/60 Hz.

FREQUENCY STABILITY within .500Hz during any 30 mins after warm up.  
SELECTIVITY ± 3KHz at 6dB (nominal) and ± 7KHz at -60dB down.  
WEIGHT 15½lbs without batteries.  
SENSITIVITY 0.25 µV for 10dB N+S:N ratio for SSB and CW. 0.7µV for 30% modulated AM at 10.5 MHz.

### OUR AGENTS

Amateur Electronics  
508-514 Alum Rock Road  
Alum Rock  
Birmingham B8 3HX

South Midlands Communications Ltd.  
S.M. House, Osborne Road  
Totton  
Southampton, Hampshire SO4 4DN

Western Electronics (UK) Ltd.  
Fairfield Estate  
Louth  
Lincolnshire LN11 0JH

WW—095 FOR FURTHER DETAILS

# Optimising Viewdata

Determining the maximum number of simultaneous users of the system

by **S. Fedida** B.Sc(Eng.), M.Sc., F.I.E.E., A.C.G.I. Post Office Research Centre

For the Viewdata information retrieval system to operate economically it has to deal with as many simultaneous users as possible. This article explains how the characteristics of the computer (April and May issues), and in particular the moving-head disc store, place a limit on this number, and how simulation studies have been made to establish the maximum rate of user requests the disc store can satisfy.

IN AN EARLIER article it was mentioned that one of the criteria used for the selection of a computer and its associated software for Viewdata was its ability to support as many simultaneous users as possible in order to reduce the cost per user per unit time. Two approaches were considered. In the first, the computer would poll and service the users in turn, any spare time remaining being used for "housekeeping" duties or to support interactive services not related to information retrieval, e.g. calculations and messages. This scheme introduced the complications of interleaving a polling algorithm, involving many unnecessary computer enquiries, with random scheduling. The alternative approach uses a wholly interrupt-based mechanism, with a fast hardware micro-programme,

Fig. 1. Graph of cost per port plotted against number of simultaneous users.

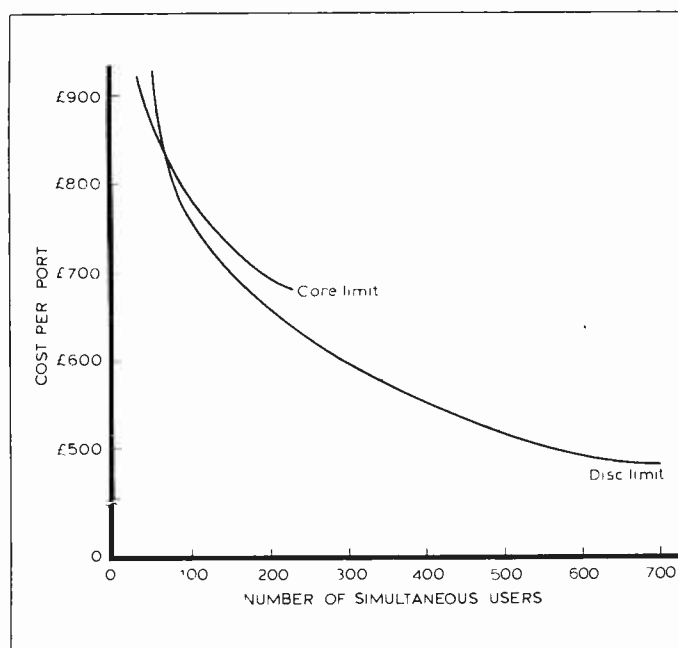

for all work. Also, in order to facilitate the information retrieval process, a direct correlation was established between the numbered prompt and the physical address of the data required on the random access storage medium.

In order to assess the capability of the Viewdata computer to support a number of simultaneous users, assumptions were made regarding the number of requests per minute a user was likely to make in the information retrieval mode and the size of the data page in terms of the number of characters which a computer response might involve. For the purpose of the study a cycle time of 12 seconds was selected, 2 seconds of which were accounted for by the maximum response time of the computer which was initially imposed as a desirable constraint. The size of the data page was settled at 960 characters maximum to ensure compatibility with teletext.

With these premises a study was carried out to find out which features of the computer place a limit on the number of simultaneous users. Three features were considered: c.p.u. power; amount of internal store; and disc store access. The result of the study is illustrated in Fig. 1. This shows that, as the number of simultaneous users increases, the cost per port is reduced until a limit is reached at about 200 users when the internal store limit of the GEC 4080

computer is reached and precludes further increases. This is because each user requires about 1 kbyte of buffer storage in the main memory.

If one assumes that the internal store limit is overcome in some way, it is possible to increase the number of simultaneous users and at the same time reduce the cost per port. In the GEC 4082 the maximum internal store is 1 Mbyte. The next limit to be reached is that of disc throughput, at about 700 users, given that the whole data bank is stored on a single disc. The amount of c.p.u. mill-time per user is only about 1ms, thus placing the c.p.u. limit well beyond 700 users if they are all engaged in information retrieval.

There are a number of ways which may be used to overcome the core limit and the disc limit, but one has to keep in mind a further limitation which so far has not been introduced explicitly, i.e. that of the network. Clearly a computer centre with a 1400-line telephone capability (assuming working and standby equipment are used to support users) is a major centre and it may well be questioned whether it is desirable to go much beyond this point. The internal storage limit of the computer used may be easily overcome by taking the users' buffers outside the main frame and

Fig. 2. Seek time of moving head disc.

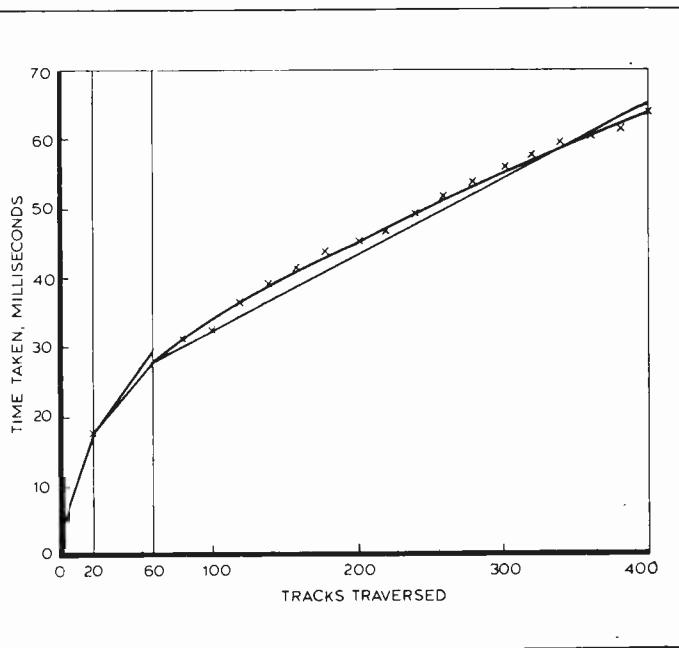

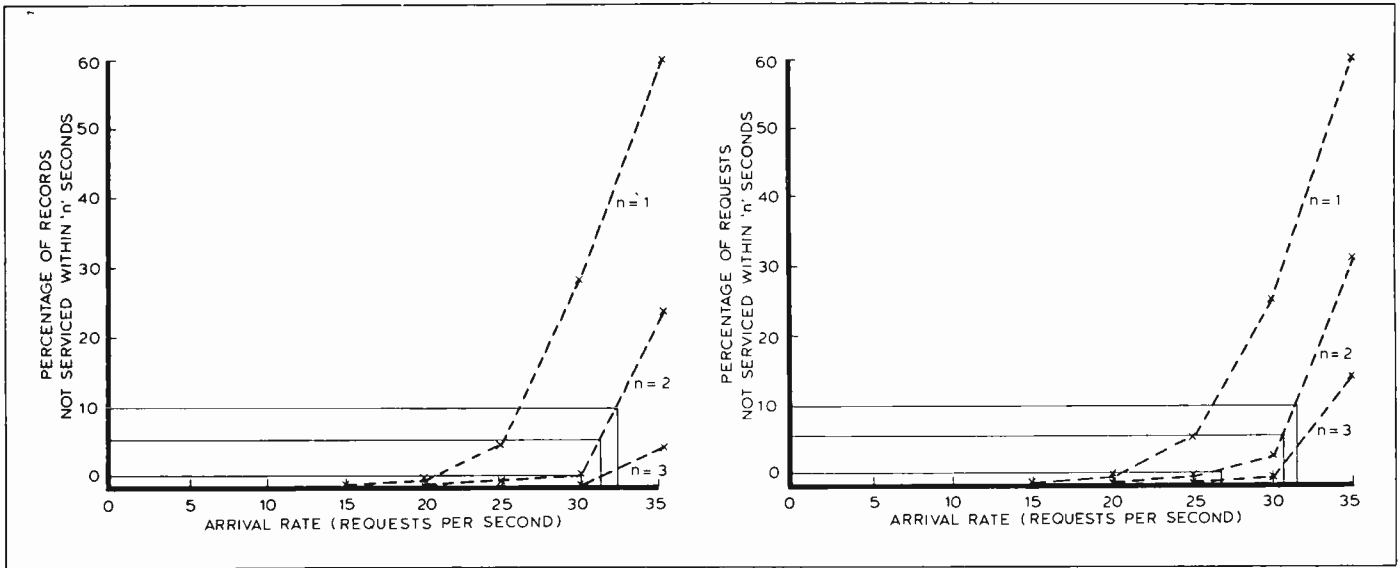

Fig. 3. The "sawtooth" method for disc optimisation.

using the direct memory access channel of the machine to transfer data frames at high speed from internal memory direct to line buffers. Indeed this may be more economic than increasing internal memory.

We have seen above that the major item of equipment placing a limit on the number of simultaneous users is likely to be the moving-head disc, once the limit imposed by the main frame memory is removed as indicated above. Taking average values for the parameters of the disc currently tested as: 12.5ms average latency; 6.0ms for the transfer of 1kbyte page from disc to internal memory; and 33.0ms average seek time (see April issue for definition of these terms); we find that the average access time is about 52.2ms, thus giving a rate of acceptance of requests of 19 per second.

The rate at which users are likely to make requests is clearly highly variable and statistics will have to be taken on a sampling basis, at least in the initial stages of the current trials of Viewdata, and possibly subsequently at regular intervals, to ascertain the distribution of user response times and establish long-term trends. Nevertheless it is possible to derive some figure on which to build a number of likely scenarios.

Given that the transmission rate from computer to terminal is at 120 characters per second (1200 bit/s) a full page requires about 8 seconds to be transmitted. The time taken by the user to read a full page and to respond with a further request depends obviously on the reader, but a good average time is about 30 seconds. Thus the build-up of one scenario is as follows:

Transmission time	8s
Reading and response time, say	30s
Maximum user waiting time	2s
	—
Total	40s

The time to transmit a 1-character response from terminal to computer (133ms), the time to return the first character at 1200 bit/s (9ms) and the c.p.u. processing time (1ms) have been neglected.

A count of a number of typical data pages and lead-in pages on Viewdata has shown that on the average the page content is about 500 characters. Thus the average cycle time for the average user is probably about 20 seconds. The initial system design process has tended to err on the conservative side and has assumed an average cycle time of about 12 seconds, thus allowing 10 seconds for disc retrieval for all the users connected to the computer at any one time. In fact this time could be between 10 and 18 seconds. Given these assumptions it would appear that a Viewdata computer using a single moving-head disc with the specification mentioned above would be able to service between 190 and 350 users within the stipulated maximum response time of 2 seconds.

While the use of average disc access time gives a rough approximation to the maximum rate of requests the moving-head disc can satisfy, it is necessary to do a computer simulation to establish the disc capability with a higher degree of accuracy, under different assumptions than complete randomness of disc searches. Accordingly a model of disc access time versus number of tracks traversed, obtained from the manufacturers, was approximated to by a number of straight line segments giving the relationship in an explicit form. The form of the model (which relates to the seek time) is shown in Fig. 2. It shows the seek time as a function of the number of tracks to be traversed and reflects the design of the head movement servomechanism which provides a measure of anticipation in feeding head movement acceleration according to the total track number to be traversed.

The disc latency (the delay incurred while the reading head waits until the sector required rotates to a position where it may be read) is also simulated

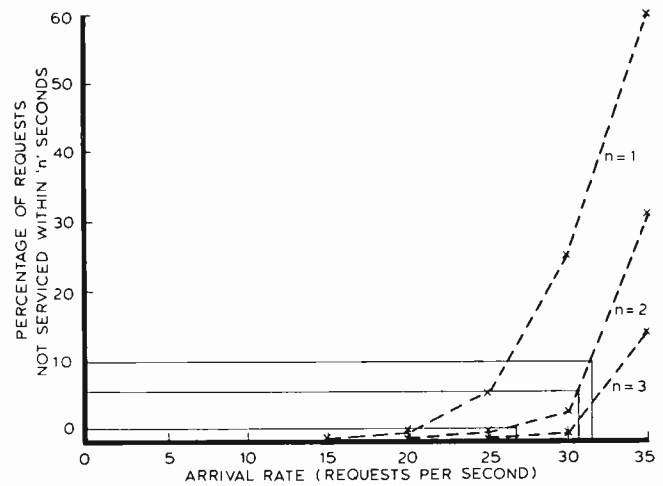

Fig. 4. The "triangular" method for disc optimisation.

randomly in steps of 1/6 of a disc revolution, each complete revolution taking 24ms in the model studied. The arrival of requests is assumed to take place at random times, each request specifying a track number in the range 1 to 400 and a frame number within the track in the range 1 to 12, also selected randomly. Two disc retrieval strategies were simulated. In the first, the "sawtooth" method, it is assumed that the moving-head traverses the disc from the centre to the periphery. As each request arrives it is placed in an ordered list of increasing track numbers. The first request to be satisfied having a track number higher than the track numbers 2, 15, 25, 72 arrives while the head is moving towards track number 17, requests 25 and 72 are placed in the lists of next requests, while requests 2 and 15 are held to await the next traverse of the head. This continuous update of the request-ordered lists implies that the head satisfies requests at progressively higher track numbers as it sweeps across the disc surface. When the head reaches the last track, track number 400, it returns to track 0 and repeats the procedure, no attempt being made to satisfy requests on the return journey.

In the "triangular sweep" method, which was also simulated, the head satisfies requests both on the outward journey and on the return journey according to the same method.

The results of the disc simulation are shown in Figs. 3 and 4. The performance criterion selected to compare the two methods is defined as:  $N$  = arrival rate of requests 99% of which are satisfied within 2 seconds of arrival. It may be seen from these figures that the sawtooth method is capable of coping adequately with an arrival rate of 30 requests per second, while the triangular method can only manage about 26 requests per second. It is interesting to

note that the triangular method gives better mean service times than the sawtooth method at all arrival rates up to 30 per second. Clearly the performance criterion is important in selecting the optimum search strategy.

Assuming that the sawtooth disc search algorithm is chosen, we see that the system performance is now upgraded to a capability of 30 requests per second. Thus a Viewdata system using this strategy is capable of supporting a simultaneous user population of between 300 and 540 depending on the user response time.

The current Viewdata system uses improved double density discs, capable of storing about 70Mbytes per disc drive, distributed on five surfaces, each surface containing 823 tracks. There are 34 sectors per track and 512 data bytes per sector. The average cylinder seek, latency, and transfer times are also improved to 27.5ms, 8.3ms and 2ms respectively, giving an improvement in total average access time from 52.5ms to 38ms.

A new disc simulation is now in progress to assess the maximum request arrival rate that may be satisfied by this disc, within 2 seconds. However, on the basis of the average values quoted above it is anticipated that arrival rates of approximately  $30 \times 52.5/38 = 40$  per second may be satisfied. This is equivalent to supporting 400 to 720 simultaneous users.

### Conclusion

This series of articles (February-May 1977, April-June 1978) has described in some detail the various aspects of the Post Office's Viewdata system, including the terminal, the computer and the associated software, the network and communications system and most importantly the way the whole system has been designed as an entity to meet the needs of a potentially huge user population.

As already reported in *Wireless World* the Viewdata market trial is due to begin in the middle of 1978, and soon that sector of the public which will be invited to participate and represent the silent majority will be able to make its views known and, it is hoped, confirm the enthusiasm of the professional and business communities for this new and potentially immeasurably powerful and beneficial medium. The full public service will start early in 1979

### Acknowledgements

The author wishes to thank the Director of Research, PO Research Centre, Martlesham, for permission to publish this series of papers and the Director of Marketing, GEC Computers Ltd, for permission to publish information on the GEC4080. Thanks are also due to the members of the Viewdata research development teams who have all contributed to make this design a success. Particular thanks are due to the helpful

advice of Mr S. Crammond, who has been primarily responsible for the design of the terminal, and to Mr G. Turner, who has been responsible for the design of the Viewdata software (jointly with Mr W. Izatt, until about the end of 1975).

### Further reading

1. Fedida S, (1975), Proc European Computing Conference on Communications Networks, 261-282.
2. Fedida S, (1976), IEE Colloquium on Broadcast and Wired Teletext Systems - Ceefax, Oracle, Viewdata.
3. Fedida S, (1976), Screened Information at the touch of a button, *PO Telecommunications Journal*, Winter 1976/76, vol. 27, p4.
4. Fedida S, (1976), Viewdata - Development of Computer-based Information Media for the General Public, 2nd International Sym-

posium on Subscriber Loops and Services, 3-7 May 1976, The Institution of Electrical Engineers.

5. Fedida S, (1976), Viewdata - An Interactive Information Medium for the General Public, using the Telephone Network, 6th International Broadcasting Convention, 20-24 September 1976, The Institution of Electrical Engineers.
6. Fedida S, (1977), Viewdata display characteristics and future enhancements, Eurocon 77, Venice.
7. Fedida S, (1977), Viewdata System Optimisation, International Conference on Communications - Chicago, 1977. Conference record vol. 2, p.41.
8. Fedida S, (1977), Viewdata - A Post Office interactive information medium for the general public. *Electronics & Power*, June, p.467.
9. Fedida S, (1977), Viewdata Networks, Nato Telecommunications Symposium - University of Bergamo, 5-9 September 1977.

## Sony close on Matsushita's heels in home video

*Continued from p48*

JVC HR3300 EK £710 recommended retail, exclusive of V.A.T.

Sony's three-hour European-standard Betamax, first previewed at last year's Berlin exhibition as a two-hour version (Toshiba, Sanyo also announced models) began life as a one-hour NTSC machine three years ago. The decreased running costs - then one third if the Sony U-matic cassettes - was achieved mainly as a result of eliminating guard bands between tracks on the helically-scanned tape and also by improving the U-wrap tape transport mechanism, particularly the tape guides. The better mechanism meant that both tape thickness and track width could be reduced. Increasing coercivity of the (chromium dioxide) tape from 500 to 600 oersteds improved the h.f. characteristics of the tape.

At high frequencies azimuth loss is relatively high and Sony engineers found that tilting the two heads +7 and -7° respectively gave enough loss between adjacent tracks to reduce crosstalk sufficiently, at the frequency of the f.m. luminance carrier anyway. (Crosstalk is at least 30dB down at 4MHz for a 15° error.) Crosstalk reduction at the lower frequency of the chrominance carrier relies on reversing the colour phase polarity on alternate lines and only on alternate tracks. On playback the video signal is added to, or subtracted from, a one-line delayed version of itself, this cancelling crosstalk from the adjacent tracks.

Then JVC, a Matsushita subsidiary, launched the two-hour VHS parallel-loading or "M" format in 1976, developed with the assistance of its parent. Sony were forced to extend their playing time for Betamax, especially in view of the televised sports events and films that last over an hour. This they did by halving tape speed and reducing video head width from 60 to 40µm (NTSC).

To keep things easily interchangeable, tracks were "overwritten" using a 40µm head, the tracks overlapping by 10µm to give a 30µm track width. In this case, when standard-format normal-speed tape is played on a long-play machine the long-play head traces the standard track with a good interchangeability allowance, and with a signal drop of 2 or 3dB. There is also a small reduction with playing a standard format tape made on a long/normal-play machine, some recording zone remaining unused. A recording made with a long-play head but at normal speed can be played back by a normal play

machine, gaps remaining between tracks.

Of course the same technique can apply to VHS and indeed last year Matsushita introduced a four-hour version, perhaps more in a game of marketing one-upmanship than in response to a real need.

For the new PAL versions of Betamax and VHS, playing time, tape speed and track width are different from the earlier versions. A European-system prototype from Matsushita (and Hitachi) at the Berlin show advertised a 33.4mm/s tape speed - the same as the NTSC version - giving a playing time of two hours. But speeds and widths were changed for both formats.

Last October JVC, on behalf of Matsushita, Mitsubishi, Hitachi, Akai and Sharp announced agreement on the new VHS format with a 23.39mm/s tape speed, giving three hours playing time with their E180 cassette, and a track width of 49µm. Betamax now has a 33µm track width, a tape speed of 18.7mm/s and a maximum playing time of 3¼ hours with the new thinner L750 tape (750 feet).

VHS uses an azimuthal slant of ±6° to reduce h.f. crosstalk, while phase coding with successive 90° shifts for each line on alternate tracks is adopted for i.f. crosstalk. Then on playback a two-line delay is used to bring about crosstalk cancellation, instead of the one-line delay of Betamax. Pre-emphasis improves signal-to-noise ratio which, by itself, could run into trouble when limiting in the presence of large-amplitude low-frequency components by losing h.f. detail. To avoid this JVC band-split and limit the h.f. portion separately from the l.f. component, which is then added back prior to further limiting.

▲ **Thorn Hire VHS.** Home video recorders are to be available on a rental basis from Thorn in the UK. Announcing this at the May trade radio shows are Thorn Consumer Electronics whose VHS rental will be £18 a month (a figure which could make sense with frequent use, but which might prove excessive after the novelty has worn off).

Also marketing VHS are Akai (already in the UK), General Electric, GTE-Sylvania, Hitachi, Mitsubishi, Normende, Saba, Sharp, Thomson-Brandt, as well as the Matsushita brands. Behind Beta format are Aiwa, NEC, Pioneer, Zenith, Sanyo, Toshiba, the last two reportedly dropping their V-cord machines for Betacord models.

Also at the May radio shows, Grundig are expected to announce a four-hour version of the Philips VCR system. □

# Logic design — 13

## Flags and flag sorters

by B. Holdsworth\* and D. Zissos† \*Chelsea College, University of London

†Dept. of Computing Science, University of Calgary, Canada.

When a student in a classroom environment wishes to ask a question, he raises his hand, and waits for the teacher to ask him to speak. On being told to go ahead, the student lowers his hand and proceeds to ask his question. Similarly when a device wishes to communicate with another device in the same system, it raises a flag in order to attract attention.

A SIMPLE communication system is shown in Fig. 1 where *f* represents a flag signal, which is, in this case, equivalent to the student raising his hand in the classroom. If and when the called device is able to communicate with the calling device, it sends back, as in the case of the teacher, a 'go-ahead' signal. The calling device then clears its flag and the two devices communicate.

A typical example of the use of flags occurs when a peripheral device such as a paper tape reader is ready to transfer data to another device, such as the c.p.u. of a digital computer. Firstly, it makes the data available for transfer and secondly, it generates a signal — the flag — to inform the c.p.u. that the data is available for transfer.

If device 2 in Fig. 1 is dealing with a situation during which it must not be interrupted, the flag of device 1 is disabled, that is, it is prevented from being raised. When the restriction is removed, the circuit is enabled. In the classroom analogy this corresponds to the teacher first not allowing his students to interrupt him to ask him a question and then at some later time removing this restriction.

Summarising, a flag is a signal generated and used by a device to inform some other device that it wishes to communicate with it. A disable signal prevents the flag from being raised and an enable signal allows it to be raised. A clear signal turns the flag off without disabling it.

### Flag circuits

The block diagram of a flag circuit with turn-on, clear, enable, and disable facilities is shown in Fig. 2. A signal on terminal *e* enables the circuit, whereas a signal on terminal *d* disables the circuit. Clearly, the two signals must not be applied simultaneously. When the circuit is enabled, a signal on terminal *p* generates a flag, which is cleared by a signal on terminal *c*. When the circuit is

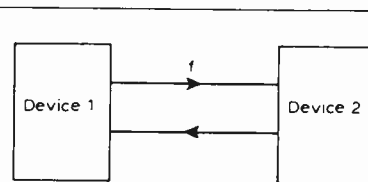

Fig. 1. Two communicating devices, with a flag signal.

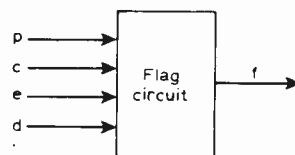

Fig. 2. Elements of a flag circuit.

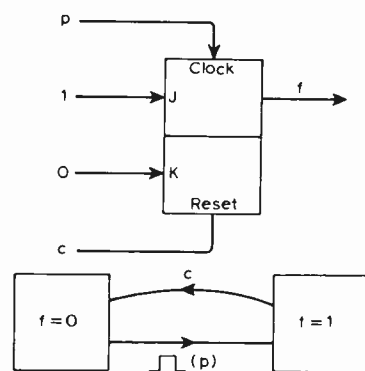
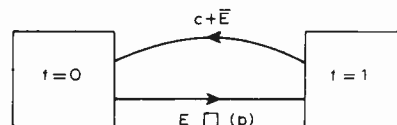
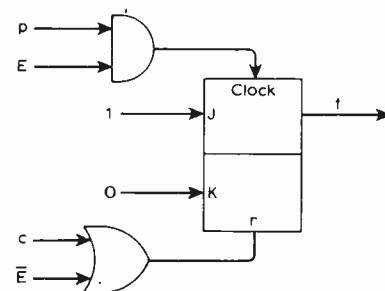

Fig. 3. Simplest flag circuit (a) and its state diagram (b).

Fig. 4. Circuit 2, with an additional flip-flop to enable or disable the flag. State diagrams are at (b).



disabled, the presence of signal *p* does not turn the flag on. If enable and disable facilities are not needed, terminals *e* and *d* are omitted.

**Flag circuit 1.** The simplest circuit consists of a single JK flip-flop, which uses signal *p* as its clock pulse and signal *c* as the reset signal, as shown in Fig. 3(a). Since  $J = 1$  and  $K = 0$  a pulse on terminal *p* will set the flip-flop, whilst a signal *c* on the reset terminal resets the flip-flop unconditionally. The state diagram for this circuit is shown in Fig. 3(b).

**Flag circuit 2.** The flag circuit in Fig. 4 is basically the same as circuit 1, with the addition of a second flip-flop, the function of which is to enable and disable the flag flip-flop. If the second or E flip-flop is set, the circuit reduces functionally to that in Fig. 3. When  $E = 0$  the flag flip-flop is unconditionally reset and cannot be turned on. The E flip-flop is set by the enable pulse on its clock line and reset by a disable signal *d* on its unconditional reset terminal *r*.

**Flag circuit 3.** Alternatively a flag circuit can be described by the two state diagrams shown in Figs. 5(a) and 5(b). From the state diagrams, the following equations are obtained.

$$\begin{aligned} \text{turn-on set of } E &= e, \\ \text{turn-off set of } E &= d, \\ \text{hence } E &= e + E\bar{d}, \\ \text{Turn-on set of } A &= BE, \\ \text{turn-off set of } A &= \bar{p}\bar{c}\bar{B}, \\ \text{hence } A &= BE + A\bar{p}\bar{c}\bar{B}, \\ &= BE + A(p + c + B). \end{aligned}$$

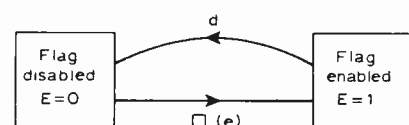
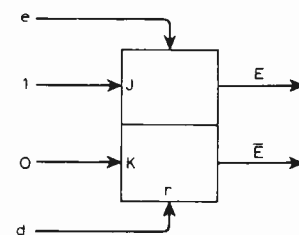



Turn-on set of  $B = p\bar{A}$ ,  
 turn-off set of  $B = \bar{A}c$ ,  
 hence  $B = p\bar{A} + B\bar{A}c$ ,  
 $= p\bar{A} + B(\bar{A} + \bar{c})$ ,  
 $f = AB$ .

Diagrams corresponding to these equations are shown in Fig. 5(c).

**Identification of flags**

In a computer system, each of the peripherals can communicate directly with the computer. As explained earlier, every device generates its own flag when it needs to communicate with the central equipment. These flags are ORed to generate a master flag: when the central device is a computer or a microprocessor the master flag is called an interrupt request because it is used to request the computer or the microprocessor to interrupt its current activity and service the peripheral's needs. The master flag or the interrupt request simply informs the central device that one of the peripherals in the system wishes to communicate with it. It is the function of the called device to identify which of the peripherals wishes to communicate with it.

There exists two basic methods for identifying flags – the polling method and the vectored method.

**Polling method.** In this method, also known as the rest and skip method, the central device, when it receives an interrupt, sequences through the peripherals looking for the individual device that needs servicing, as illustrated in Fig. 6. When it finds such a device, it stops sequencing and calls the corresponding service routine, at the end of which the polling of the devices continues until they have all been polled. At this point the main programme is resumed.

The flow chart of a polling routine for  $n$  devices is shown in Fig. 6(b). The counter in the flow chart is an internal counter in the central device. In this system no hardware assistance is provided for determining which device is requesting service. Whilst this method saves in hardware cost, considerable processor time is used in test loops and system performance is degraded.

**Vectored method.** In this method, the presence of a flag is automatically detected and identified by means of a circuit known as a flag sorter. The basic arrangement of the system incorporating the flag sorter is shown in Fig. 7.

**Flag sorters**

A flag sorter (alternatively called a priority encoder) is defined as a device that automatically detects the presence of a signal at its input and identifies it, producing an interrupt signal  $I$ , and the identity of the signal being automatically generated on address lines  $A$  and  $B$ . The interrupt signal  $I$  is the OR function of all the input signals,  
 $I = f_0 + f_1 + f_2 + f_3$

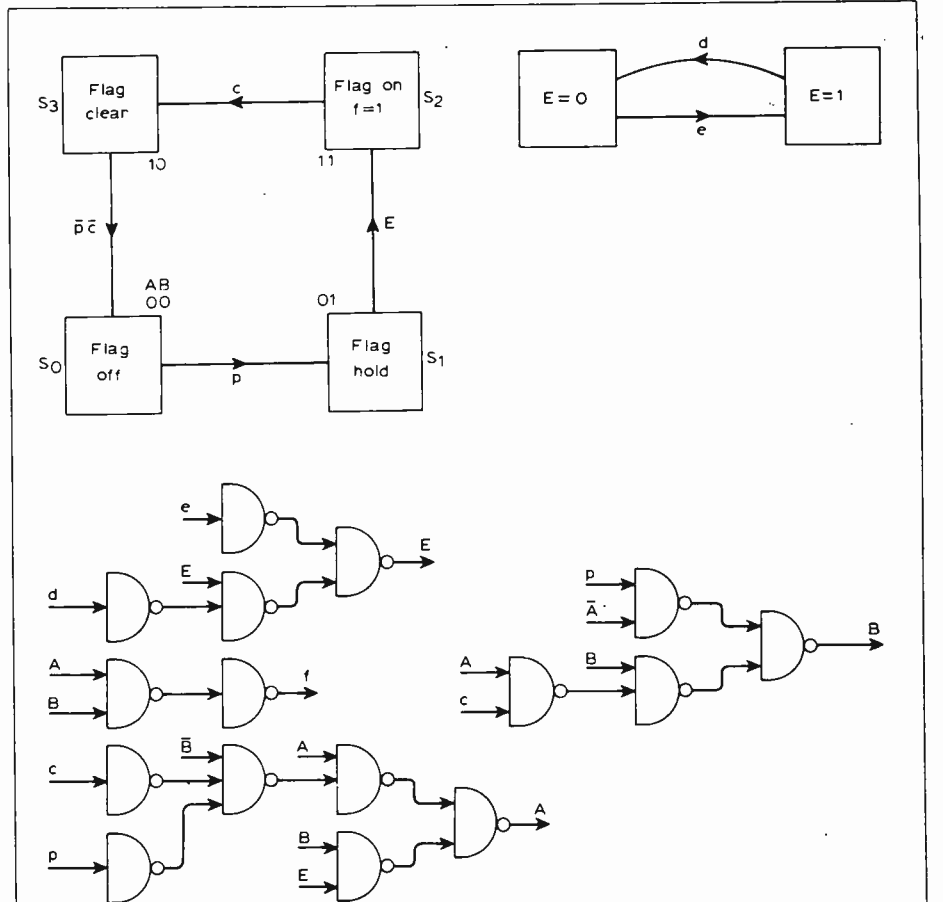

Fig. 5. State diagram for circuit 3 enable (a) and flags (b). Circuit diagram is at (c).

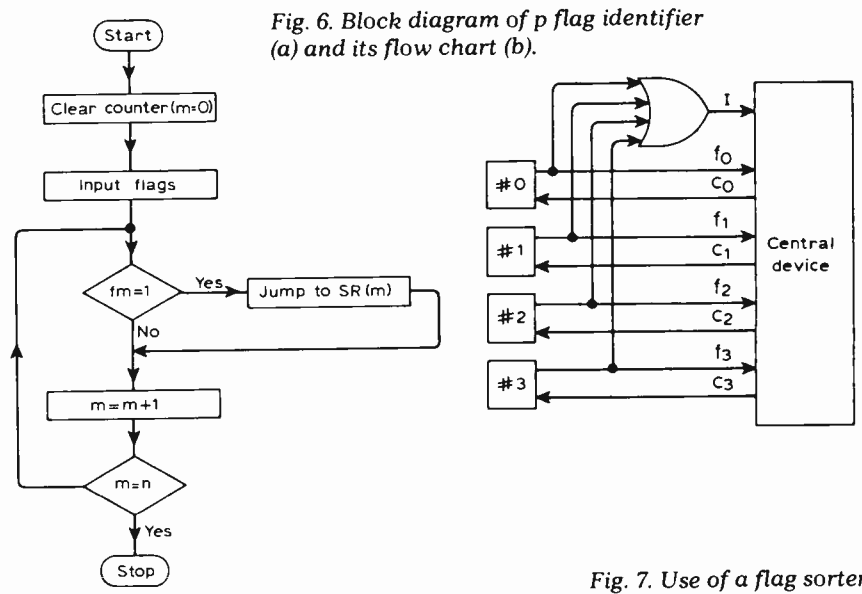

Fig. 6. Block diagram of p flag identifier (a) and its flow chart (b).

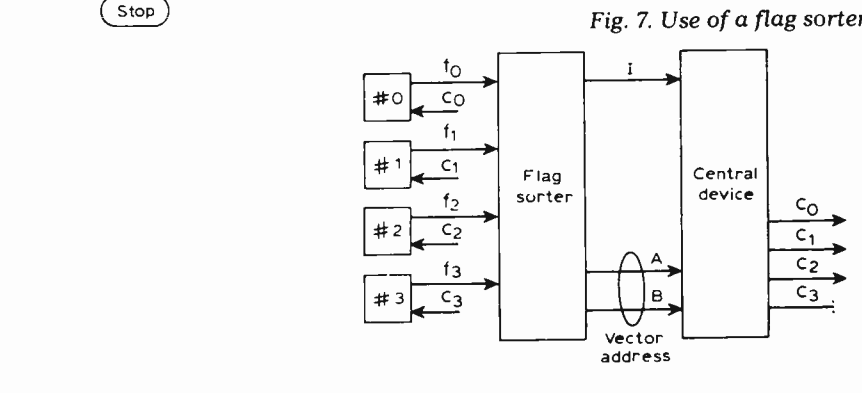

Fig. 7. Use of a flag sorter.

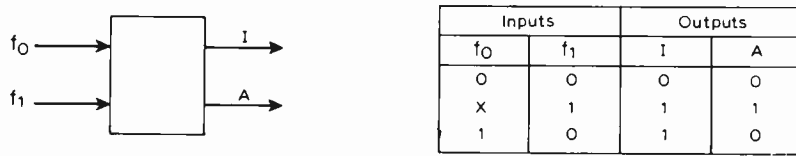

Fig. 8. Block diagram (a), truth table (b) and circuit (c) for a two-flag sorter.

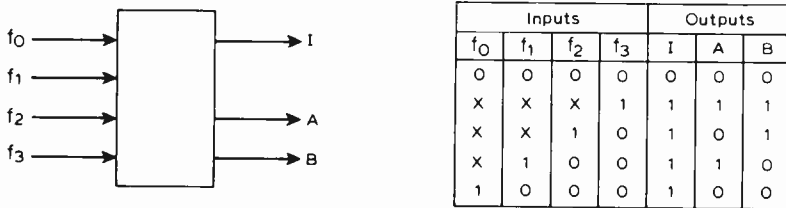
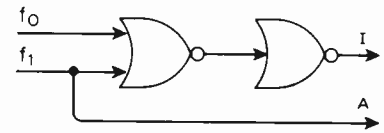

Fig. 9. Four-flag sorter.

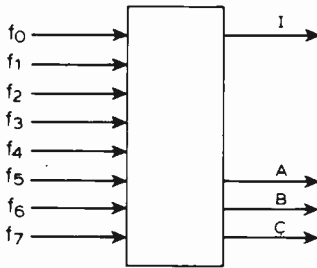
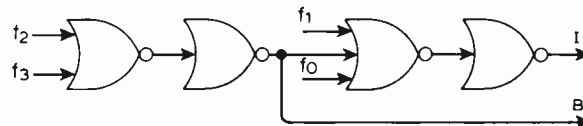
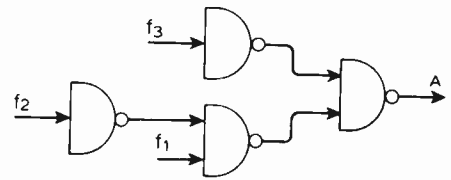
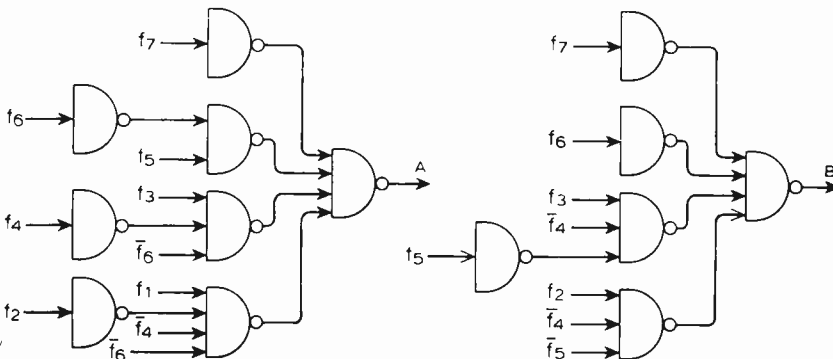
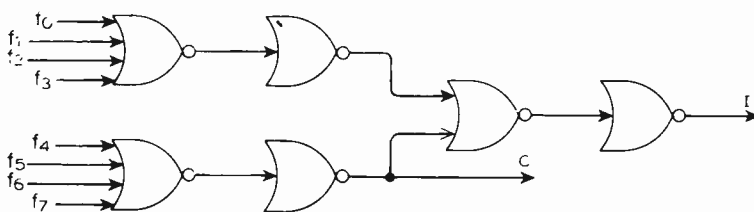

Fig. 10. Eight-flag sorter.

Inputs								Outputs			
f <sub>0</sub>	f <sub>1</sub>	f <sub>2</sub>	f <sub>3</sub>	f <sub>4</sub>	f <sub>5</sub>	f <sub>6</sub>	f <sub>7</sub>	I	A	B	C
0	0	0	0	0	0	0	0	0	0	0	0
X	X	X	X	X	X	X	1	1	1	1	1
X	X	X	X	X	X	1	0	1	0	1	1
X	X	X	X	X	1	0	0	1	1	0	1
X	X	X	X	1	0	0	0	1	0	0	1
X	X	X	1	0	0	0	0	1	1	1	0
X	X	1	0	0	0	0	0	1	0	1	0
X	1	0	0	0	0	0	0	1	1	0	0
1	0	0	0	0	0	0	0	1	0	0	0



in the case of the four-flag sorter shown in Fig. 7. For convenience, the address signals are generated in the binary (8-4-2-1) code, although any other code may equally well be used.

The design and implementation of flag sorters is straightforward, using conventional methods, either combinational or sequentially. There are practical situations where a given flag signal must be given priority over the others. If it is present with other flag signals, its address must be given at the output, regardless of the state of the flag sorter: this is particularly the case in automatic plants, where certain alarm signals are given priority over other alarms. Unless it is otherwise specified, the higher the suffix of a flag the higher its priority.

**Combinational flag sorters.** The block diagram of a simple two-flag sorter is shown in Fig. 8(a). This circuit is required to generate an interrupt signal I to indicate one or more flags are present and an address signal A which can have the value 0 or 1 and is able to identify the two flag signals f<sub>0</sub> and f<sub>1</sub>, where f<sub>1</sub> is the flag signal with the highest priority. A truth table for the circuit is shown in Fig. 8(b). In this table the X entry is used to denote a 0 or a 1, and its use in the second row indicates that A=1 if f<sub>1</sub>=1 irrespective of whether flag signal f<sub>0</sub> is present or not.

From the truth table the logic equations for A and I can be derived. They are:

$$\begin{aligned}
 I &= \bar{f}_0 f_1 + f_0 f_1 + f_0 \\
 &= f_1 + f_0 \\
 A &= \bar{f}_0 f_1 + f_0 f_1 \\
 &= f_1
 \end{aligned}$$

The implementation of these equations is shown in Fig. 8(c).

The block diagram of a combinational four-flag sorter is shown in Fig. 9(a). In

this case, to identify the four flags, two address signals are required. A truth table for the circuit is shown in Fig. 9(b), and the logic equations for I, A and B are derived directly from the entries in this table. The equations are:

$$I = f_0 + f_1 + f_2 + f_3$$

$$A = f_3 + \bar{f}_3 \bar{f}_2 f_1 = f_3 + \bar{f}_2 f_1$$

$$B = f_3 + \bar{f}_3 f_2 = f_3 + f_2$$

As the number of flags to be sorted increases so does the complexity of the logic equations for the address signals. In the case of an eight-flag sorter three address signals A, B and C are required. The block diagram of the sorter is shown in Fig. 10(a) and the corresponding truth table is shown in Fig. 10(b). The logic equations for I, A, B and C derived from the truth table are:

$$I = f_0 + f_1 + f_2 + f_3 + f_4 + f_5 + f_6 + f_7$$

$$A = f_7 + f_5 \bar{f}_6 \bar{f}_7 + f_3 \bar{f}_4 \bar{f}_5 \bar{f}_6 \bar{f}_7 + f_1 \bar{f}_2 \bar{f}_3 \bar{f}_4 \bar{f}_5 \bar{f}_6 \bar{f}_7$$

$$= f_7 + f_5 \bar{f}_6 + f_3 \bar{f}_4 \bar{f}_6 + f_1 \bar{f}_2 \bar{f}_4 \bar{f}_6$$

$$B = f_7 + f_6 \bar{f}_7 + f_3 \bar{f}_4 \bar{f}_5 \bar{f}_6 \bar{f}_7 + f_2 \bar{f}_3 \bar{f}_4 \bar{f}_5 \bar{f}_6 \bar{f}_7$$

$$= f_7 + f_6 + f_3 \bar{f}_4 \bar{f}_5 + f_2 \bar{f}_4 \bar{f}_5$$

$$C = f_7 + f_6 \bar{f}_7 + f_5 \bar{f}_6 \bar{f}_7 + f_4 \bar{f}_5 \bar{f}_6 \bar{f}_7$$

$$= f_7 + f_6 + f_5 + f_4$$

**Sequential flag sorters.** The main disadvantage of the combinational flag sorter is that the address signals may change whilst being read by the central device. For example, in the case of the eight-flag sorter, if the interrupt signal is raised by flag 3, and flag 4 subsequently arrives, the output of the flag sorter will be changing from ABC = 110 to ABC = 001. During the change signal C has to turn on whilst signals A and B have to turn off. If C changes more rapidly than A and B the output is momentarily ABC = 111 and, assuming this occurs when the central device is reading the address of the flag sorter, address ABC = 111 will be recorded in error, resulting in circuit misoperation. It is for this reason that sequential flag sorters have been introduced.

The sequential circuit, whose block diagram is shown in Fig. 11(a), has to generate an interrupt signal if any of the three flags  $f_1, f_2,$  or  $f_3$  are raised and in this case it will be arranged that the flag signals are serviced in cyclic order. The flag signals may be regarded as if they are arranged in a circle which is scanned whenever a flag signal is raised. When there is no flag signal present, the circuit rests in a homing state.

A suitable internal state diagram is shown in Fig. 11(b) where the addresses corresponding to flag signals  $f_1, f_2,$  and  $f_3$  are AB = 01, AB = 10 and AB = 11. In order to avoid races between secondary signals, it is convenient to take these addresses in an order in which only one secondary signal changes at a time, allowing the use of the secondary signals directly as the address signals, and stipulating the cyclic order of the

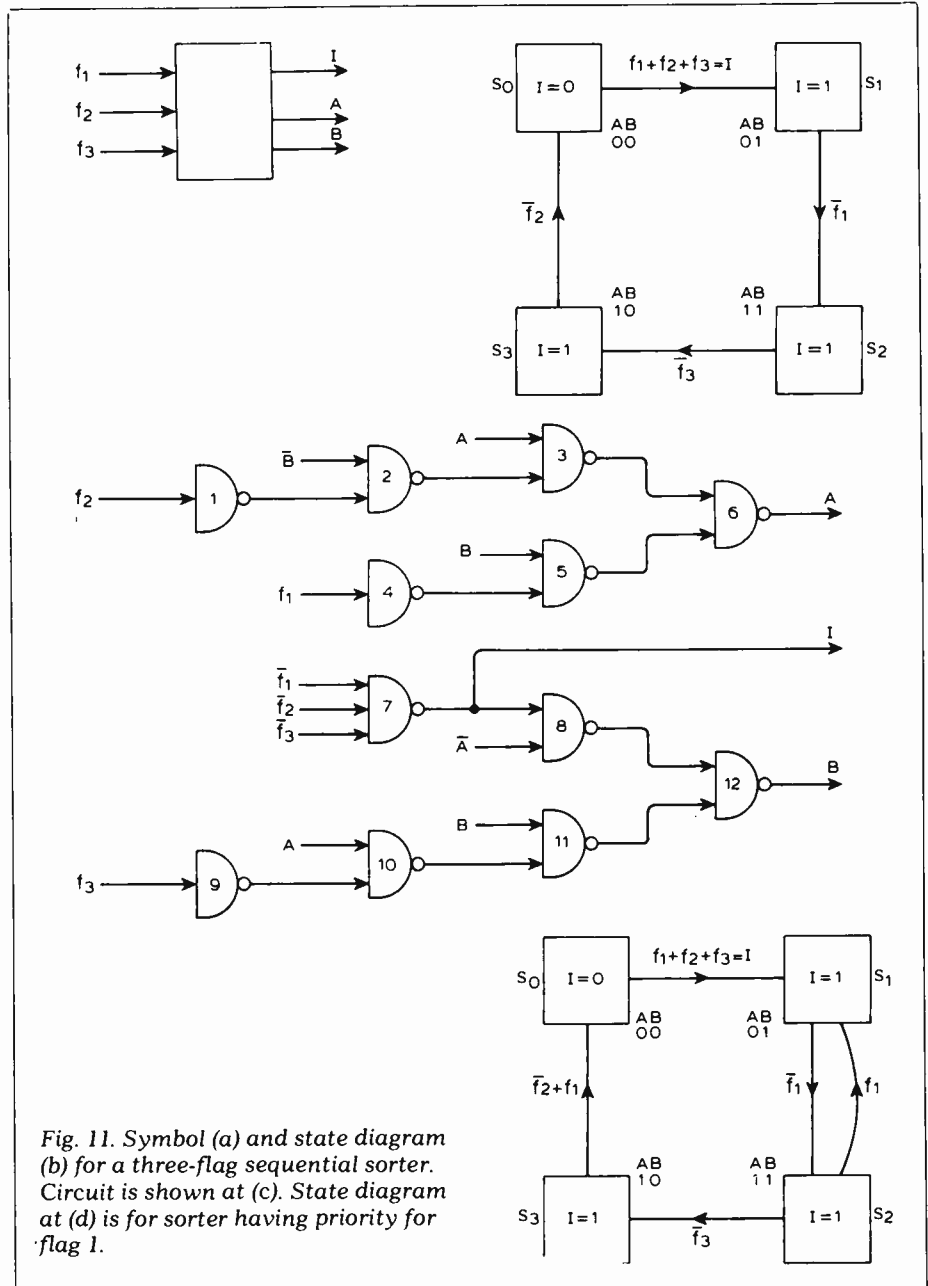
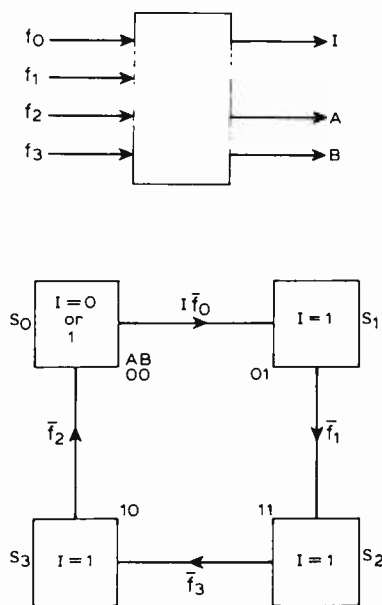

Fig. 11. Symbol (a) and state diagram (b) for a three-flag sequential sorter. Circuit is shown at (c). State diagram at (d) is for sorter having priority for flag 1.

Fig. 12. Four-flag sequential sorter.



flags as  $f_1, f_3$  and  $f_2$ .

Assuming there are no flag signals present, the circuit takes up the homing state  $S_0$  and the circuit outputs are  $I = 0$  and  $AB = 00$ . If one or more flag signal is present at the input,  $I = f_1 + f_2 + f_3 = 1$  and the circuit makes a transition from state  $S_0$ . For  $f_1 = 1$  the circuit assumes the state  $S_1$  where  $I = 1$  and  $AB = 01$ . On the other hand, if  $f_1 = 0$ , the circuit assumes state  $S_2$ ,  $I = 1$  and  $AB = 11$ . Similarly if  $f_3 = 0$  the circuit makes a transition to state  $S_3$ ,  $AB = 10$  and  $I = 1$ . The circuit will then return to the homing state when  $f_2 = 0$ .

$$\text{Turn-on set of } A = \bar{B} \bar{f}_1$$

$$\text{Turn-off set of } A = \bar{B} f_2$$

$$\text{Turn-on set of } B = \bar{A} (f_1 + f_2 + f_3)$$

$$\text{Turn-off set of } B = A \bar{f}_3$$

$$A = \bar{B} f_1 + A (B + f_2)$$

$$B = \bar{A} (f_1 + f_2 + f_3) + B (\bar{A} + f_3)$$

$$= \bar{A} I + B (\bar{A} + f_3)$$

$$I = f_1 + f_2 + f_3$$

The implementation of these equations is shown in Fig. 11(c).

If it is stipulated that the flag  $f_1$  must always be given priority, then to satisfy this requirement, the internal state diagram must be modified as shown in Fig. 11 (d). An examination of this state diagram indicates that the modifications only change the turn-off conditions of the secondary signal A which now becomes:

$$A = B\bar{f}_1 + A(\overline{B(\bar{f}_2 + f_1)} + Bf_1) = B\bar{f}_1 + A(B + f_2)\bar{f}_1.$$

The implementation of this equation only requires an additional signal  $\bar{f}_1$  at the input of gate 3 in Fig. 11(c).

A suitable arrangement for the detection of four flags is shown in Fig. 12(a) and the corresponding internal state diagram in Fig. 12(b). The presence of any incoming flag signal causes signal I to be generated. If flag  $f_0$  is raised, the circuit remains in state  $S_0$  and the flag sorter outputs are  $I=1$ ,  $A=0$  and  $B=0$ .

State  $S_0$  is a homing state, because the flag sorter automatically assumes this state when the incoming signals  $f_0, f_1, f_2$  and  $f_3$  are cleared. The order in which the signal addresses are generated depends on the current state of the sorter. For example, when address  $AB=00$  is at the output, with  $I=1$ , the incoming signals have the following priorities: priority No 1- $f_1$ , priority No 2- $f_3$ , priority No 3- $f_2$ .

The flag sorter logic equations which can be developed from the internal state diagram are;

$$I = f_0 + f_1 + f_2 + f_3$$

$$A = B\bar{f}_1 + A(B + f_2)$$

$$B = \bar{A}f_0I + B(\bar{A} + f_3),$$

and the implementation of these equations is left to the reader.

Clearly, the state diagram and implementation of an eight-flag sorter can be developed in a similar manner, the state diagram being shown in Fig. 13.

**Modular expansion**

In the case of flag sorters for more than eight flags, it is more convenient to use a modular construction, which allows any number of flag signals to be identified. The design principle will be demonstrated for the case of 64 flags.

The incoming flags are arranged into eight groups of eight flags each, as shown in Fig. 14, the flags in each group being connected to an eight-flag sorter. Each flag sorter generates a signal  $g$  independently of the other sorters. Thus  $g_0 = 1$  if any of the flags in group 0 are present, similarly for group flags  $g_1, g_2, g_3, g_4, g_5, g_6$  and  $g_7$ . Individual flags are identified by six binary suffices, the first three indicating the flag number and the second three the group number, for example,  $f_{010111}$  refers to flag 2 in group 7. The second set of three digits is generated directly by the group selector, while the first three digits are generated by the flag sorter, whose

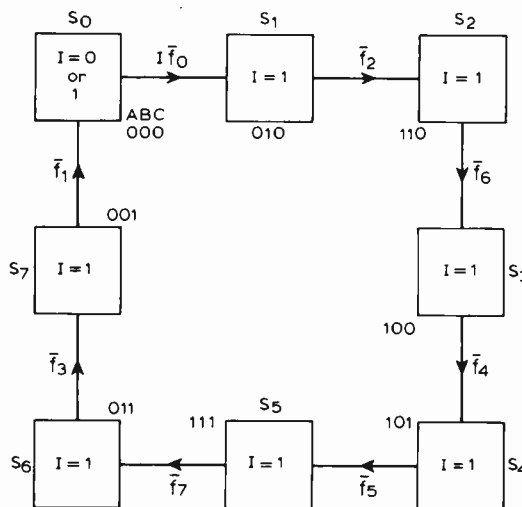

Fig. 13. State diagram for eight-flag sequential sorter.

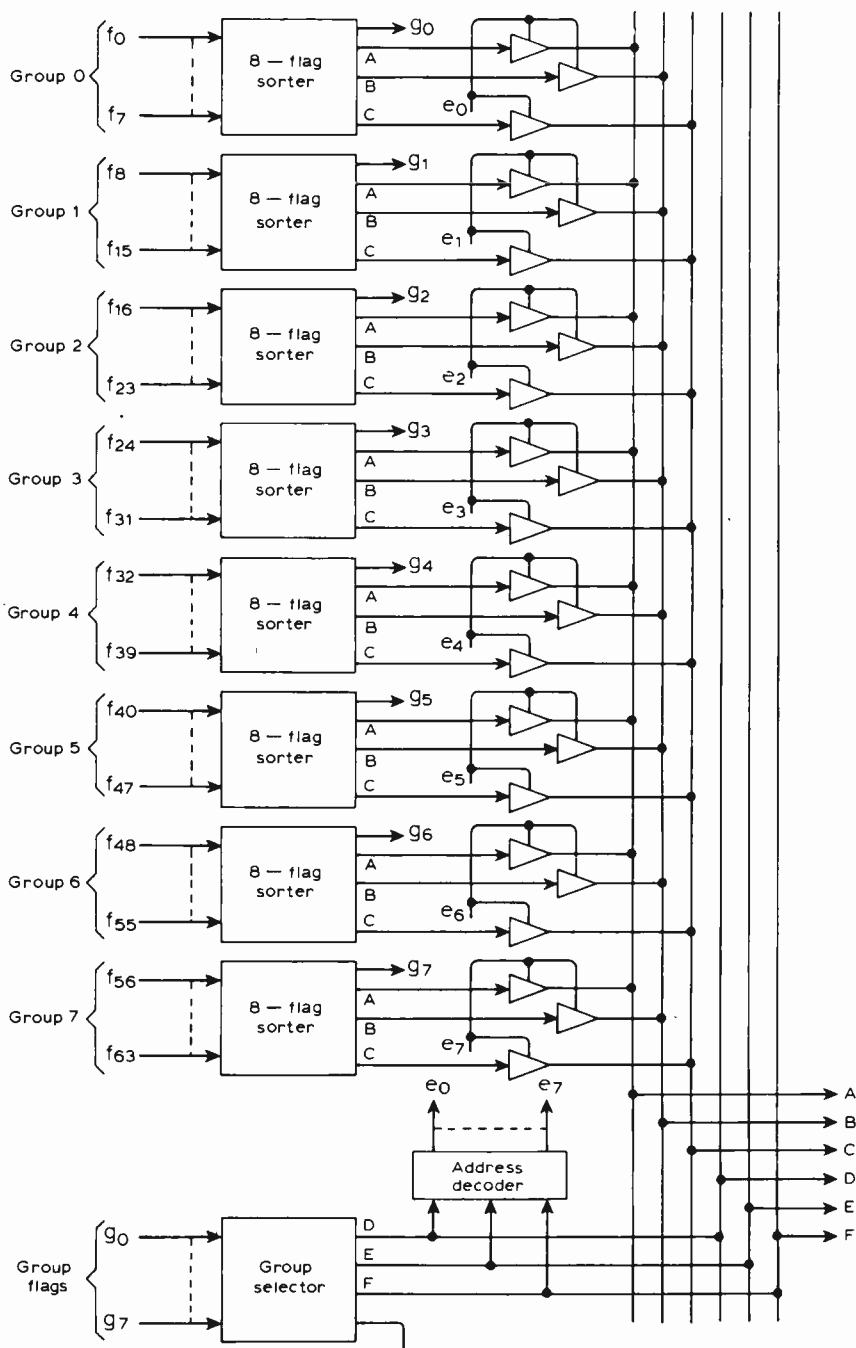

Fig. 14. 64-flag modular sorter.

# The new Sinclair DM 235 digital multimeter.

## 3½ digits...6 functions... fully portable. Under £50!

The new Sinclair DM235 is yet another example of outstanding Sinclair value-engineering. Developed from the Sinclair DM2 and world-beating PDM35 (already outselling all other digital multimeters), the DM235 provides full facilities for every application, including field servicing, testing and laboratory work. At a price no comparable digital meter can approach.

### A new dimension in styling

Up till now, choosing a meter suitable for use on the bench *and* in the field hasn't been easy. Either you bought a bulky bench instrument (awkward to carry around) or a hand-held portable (difficult to use on the bench). The Sinclair concept is different. By keeping the thickness down to only a fraction over 1½ in,

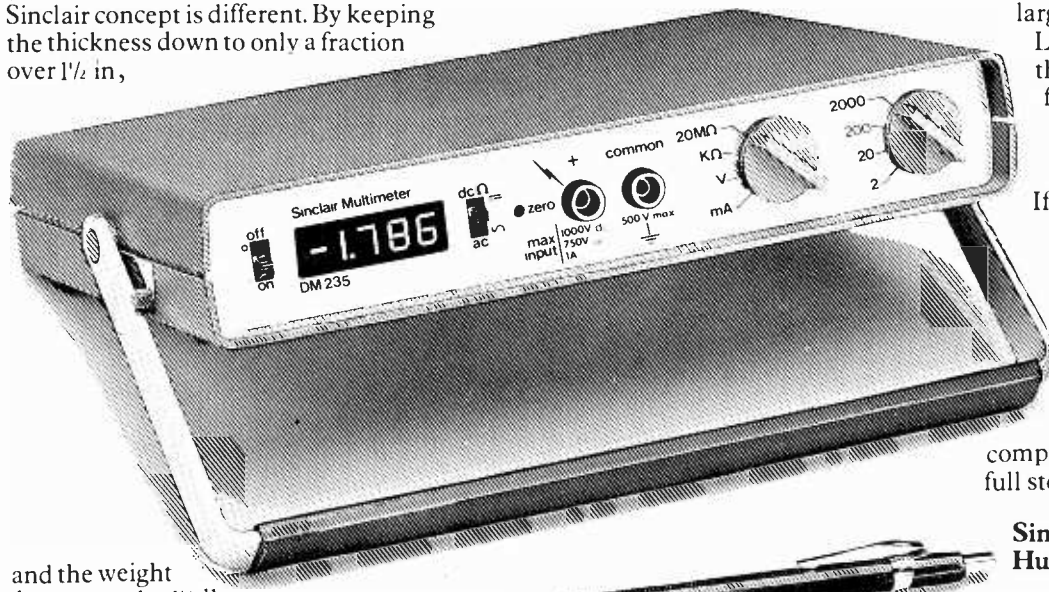

and the weight down to under 1½ lb, we've produced an instrument that has all the advantages of conventional bench meters, but that packs neatly into any tool kit or brief case.

### A big, bright, unambiguous display

The DM235 has a full 3½ digit display reading to ±1999. Large, high-brightness 8 mm LEDs give clear, unambiguous readings with an ultra-wide angle of view. And an LED display means proven lifetime reliability.

### Six functions in 26 ranges

- DC Volts..... 1 mV to 1000 V
- AC Volts..... 1 mV to 750 V
- DC Current..... 1 µA to 1 A
- AC Current..... 1 µA to 1 A
- Resistance..... 1 Ω to 20 MΩ
- Diode test..... 0.1 µA to 1 mA
- 10 MΩ input impedance

### High accuracy

Basic accuracy of 0.5% (2V DC range), other DC ranges and Resistance 1.0%, AC ranges 1.5% 30 Hz-10 kHz  
Temperature coefficient <0.05 of applicable accuracy per °C.

### Easy to use by anyone, anywhere

Automatic polarity operation, automatic placement of decimal point, and automatic out-of-range indication. Unambiguous reading of function and range selected from a single input terminal pair.

### The Sinclair credentials

Sinclair have pioneered a whole range of electronic world-firsts from programmable pocket calculators to miniature TVs – holding a world lead in innovative electronics. The DM235 embodies six years' experience in digital multimeter design, in which time Sinclair have become one of the world's largest producers.

Like every other Sinclair product, the DM235 comes to you with a full 12 month repair-or-replacement guarantee.

### Find out more!

If you'd like full details of the DM235, its operation and its performance, and a complete distributor list, just send the coupon below. We'll send you all the facts by return.

The DM235 has all the performance you need – at around half the price of its competitors. Send the coupon for the full story.

Sinclair Radionics Ltd, St Ives, Huntingdon, Cambs, PE17 4HJ.

# sinclair

World leaders in fingertip electronics

### A rugged construction giving total portability

Very rugged mechanical construction using all solid-state components.

Protected against accidental overload.

Size only 10 in x 5.8 in x 1.6 in, weight less than 1½ lb.

Basic operation from four standard C size disposable cells, providing complete independence of AC supply.

Line operation available via optional AC adaptor/charger.

### A full range of optional accessories

DM235 meter complete with test leads and prods..... £49.80

Eveready carrying case with lead stowage compartment..... £8.50

Rechargeable battery units..... £8.00

AC adaptor/charger 240 V 50 Hz.. £3.50

30 KV high voltage probe..... £15.00

(All prices subject to 8% VAT)

WW-081 FOR FURTHER DETAILS

To: Sinclair Radionics Ltd, St Ives, Huntingdon, Cambs, PE17 4HJ.

Please send me full illustrated details of the new Sinclair DM235.

Name \_\_\_\_\_

Position \_\_\_\_\_

Company \_\_\_\_\_

Address \_\_\_\_\_

\_\_\_\_\_

\_\_\_\_\_

\_\_\_\_\_

\_\_\_\_\_

WW/6

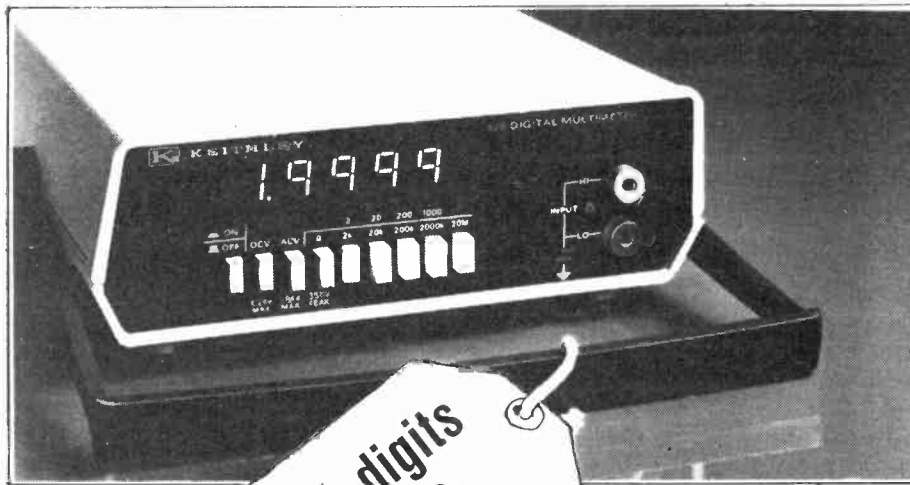

Model 178

## Now . . . the next generation of bench DMMs!

Two New Keithley Models offer uncompromising performance and outstanding value!

- Accuracy 3½'s can't match: 0.4% + 1 digit on dc volts and ohms
- Large, bright, 20,000-count LED display that's quick and easy to read.
- Convenient bench size that won't get "lost" yet doesn't crowd.
- Exceptional reliability.

Model 178 offers functions and ranges for most measurement needs 100 $\mu$ V to 1200V dc, 100 $\mu$ V to 1000V ac, 0.1 $\Omega$  to 20M $\Omega$ .

Model 179 is a full-function, multi-feature model offering the same advantages as the 178. Plus

**TRMS AC; 10 $\mu$ V Sensitivity; Hi and Lo Ohms; AC and DC Current** Yet it's still half the price you'd expect. Only £199.

Both models feature designed-in reliability. Rugged circuits use a minimum of parts — high quality, off-the-shelf parts — carefully assembled and tested by Keithley. Outstanding overload protection and rugged mechanical design keep both units going even after severe abuse. One-year accuracy specifications minimise recalibration costs. A battery option, user installable, gets you off "line" for critical measurements or for field use.

**For complete specifications on the 178 and 179, call Keithley Instruments, 1 Boulton Road, Reading. Phone 0734 861287**

# KEITHLEY

The measurement engineers.

WW—031 FOR FURTHER DETAILS

## 'Wenden' range modular amplifiers

A range of communications amplifiers having power ratings from 15 to 200 watts, plug-in input facilities ensure individual requirements can be provided.

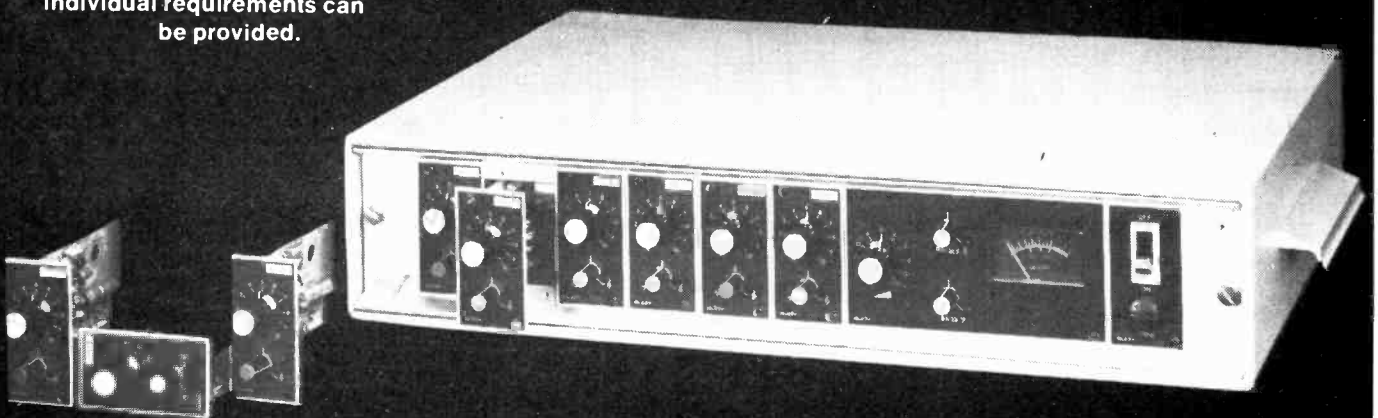

Manufacturers of  
sound systems  
and electronics

Station Road, Wenden  
Saffron Walden  
Essex CB11 4LG  
Saffron Walden  
(0799) 40888

# audix

# Generating ultra-short microwave pulses

Cancellation technique using readily-obtainable components

by Alan G. Hood M.Sc., M.I.E.E.

During an investigation into the behaviour of microwave radar receivers in the presence of high energy leakage spikes from the transmitter via the duplexer, a generator of very short pulses of microwave energy was needed. Standard magnetrons and modulators are not capable of producing directly the six to seven nanosecond pulses available by the method described.

THE PROBLEM OF GENERATING consistent-energy pulses at microwave frequencies a few nanoseconds long was approached by employing a pulse cancellation technique. The frequency employed was in X-band (8.2 to 12.4GHz), but the technique is also applicable to other microwave bands. A 160ns-long r.f. pulse was split in a "magic T", and the two halves recombined in antiphase after travelling different path lengths. Fig. 1 shows how this was achieved by using two short-circuited arms of different lengths on a magic T. The result was that the centre portion of the magnetron pulse cancelled leaving short pulses corresponding to the leading and trailing edges of the

original pulse. The trailing edge pulse was removed by means of a pulsed p-i-n diode switch. A CV370 magnetron supplied 5kW peak pulses at 1,000 pulse/sec.

The electric field of the magnetron pulse may be represented by

$$E(t) = 2A(t)\sin(\omega t + \theta)$$

where  $2A$  is the amplitude of the magnetron pulse, and is a function of time,  $\omega$  is the angular frequency, and  $\theta$  is an arbitrary phase angle. After travelling different path lengths, the two cancelling pulses are displaced in time by  $\Delta t$ , and the cancelled pulse is then

$$\frac{1}{2}[E(t + \Delta t) - E(t)]$$

where the factor  $\frac{1}{2}$  allows for the 6dB

loss of power in the magic T. Substitution gives

$$(A + a)\sin(\omega t + \theta + \alpha) - A\sin(\omega t + \theta)$$

where  $a$  is the instantaneous amplitude difference between the two pulses and  $\alpha$  their phase difference, nominally  $2n\pi$  but which varies over the pulse length due to phase and frequency modulation. By appropriate manipulation this can be shown to be of the form  $B\sin(\omega t + \beta)$ , with

$$B = \sqrt{4A(A + a)\sin^2(\alpha/2) + a^2}$$

$$\text{and } \beta = \theta + \tan^{-1} \left[ \frac{(A + a)\sin\alpha}{A(\cos\alpha - 1) + a\cos\alpha} \right]$$

All the terms  $A$ ,  $a$ ,  $\alpha$ ,  $\theta$  and therefore  $B$  and  $\beta$  are functions of time. The situation is illustrated in the diagrams of Fig. 2. The trailing edge pulse is longer and of lower amplitude than the leading edge pulse because the magnetron fall time is much slower than its rise time.

The amplitude of the short pulse is given by the expression for  $B$  and in the

Fig. 1. Waveguide layout for generating ultra-short pulses by cancelling differentially delayed pulses.

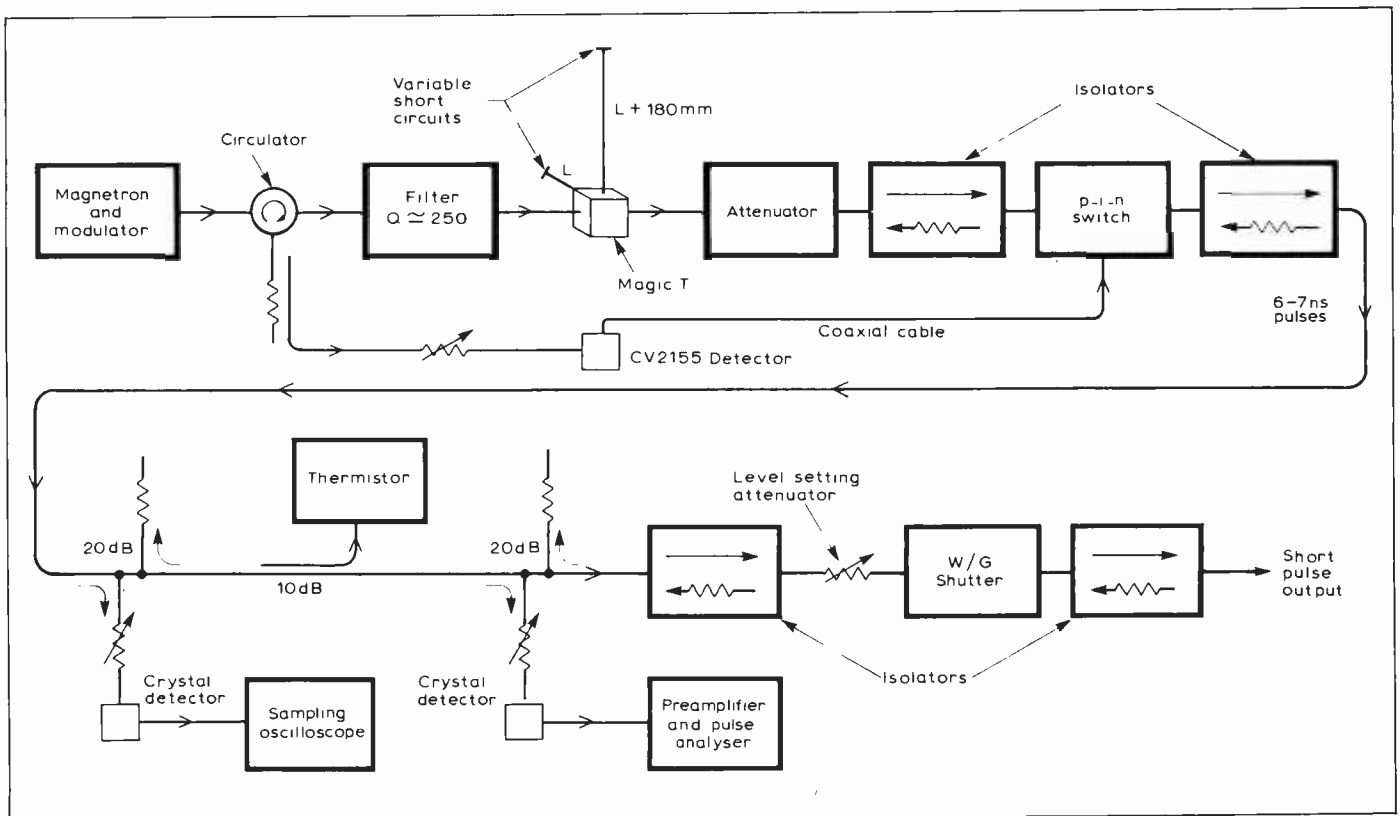

ideal case of no phase or frequency modulation,  $\alpha = 2n\pi$  and then  $B = a$ ; otherwise  $B > a$ . In the region where  $a = 0$ , cancellation may be incomplete due to phase differences and the output will then be  $B = 2A\sin(\alpha/2)$ .

For high amplitude and minimum pulse length a fast rate of rise and minimum phase modulation of the magnetron pulse are required. The short pulse is centred on the region of maximum rate of change of the magnetron pulse's electric field. This is likely to be near the 50% field (25% power) level and there will not be a simple relation between the magnetron rise time from 10 to 90% power levels and the length of the short pulse.

In practice the apparently simple cancellation technique was complicated by significant direct leakage between the decoupled arms of the magic T, the phases of both reflected pulses had to be adjusted so that all three signals cancelled. The poor match of the magic T for the reflected pulses in the short circuited arms made the first re-reflected pulses significant, and modified the pulse shape.

It should be possible by the use of suitably placed mismatches to change the magnetron output coupling during the build-up of oscillation and hence modify the leading edge of the pulse. This was tried but results were inconclusive and the matter was not pursued.

Among the problems encountered were the elimination of the second or trailing edge pulse, and the reduction of the spread of pulse energies. A varactor diode switch was initially tried for the attenuation of the trailing edge pulse and behaved well at low levels. However it proved to have inadequate attenuation at the power levels required and was replaced by a p-i-n diode switch which has proved satisfactory. The switching pulse for this was obtained from the magnetron output via a CV2155 negative polarity crystal detector and a suitable delay.

A filter was added to guard against the possibility of "moding". If the magnetron generated power at different frequencies, proper cancellation would not be achieved. By selecting magnetrons and modulators the energy spread was reduced so that one pulse in  $10^6$  exceeded the mean level by 1.25dB. A further improvement to 0.5dB was obtained by using a servo-controlled stabilizer for the supply voltage. Previously a slight drop in supply voltage (240 to 230V) changed the shape of the generated pulse and introduced noticeable jitter in addition to varying the magnetron output level.

A sampling oscilloscope is necessary to view pulses of such short duration. A tracing of an oscilloscope photograph showing the leading and trailing-edge pulses resulting from cancellation is shown in Fig. 3 (top) and the effect of the p-i-n switch is shown middle. The bottom trace is the short pulse on a reduced time scale.

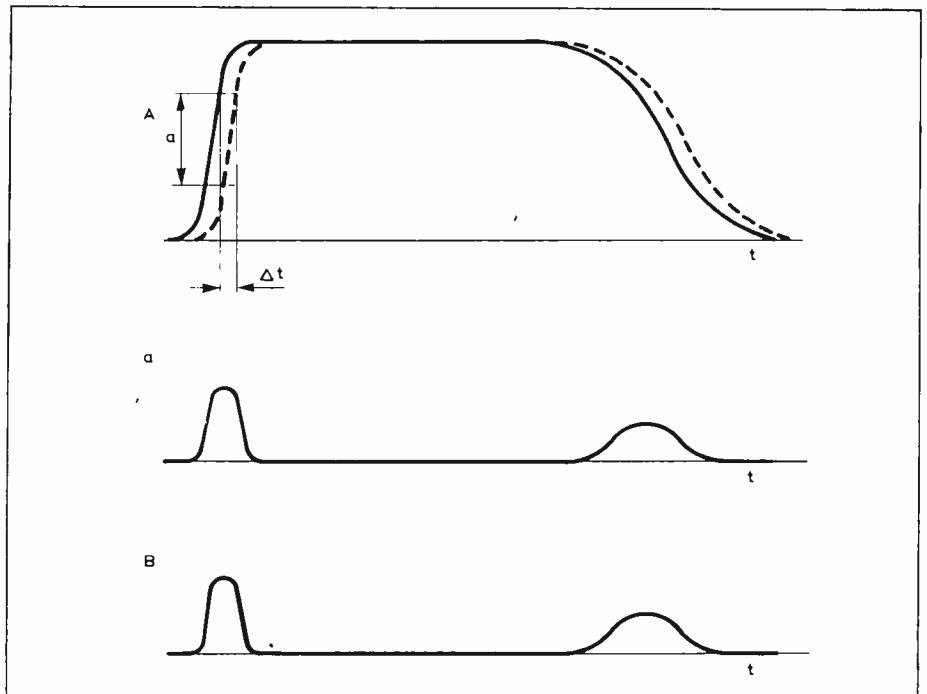

**Fig. 2.** Diagrams show two r.f. pulses with a time difference  $\Delta t$  and the resulting leading and trailing-edge short pulses due to cancellation. (Diagrams show rectified envelopes of r.f. pulses.)

**Fig. 3.** Sampling oscilloscope displays showing leading and trailing-edge pulses resulting from cancellation (top, time scale 20ns/div), removal of trailing-edge pulse by p-i-n switch (middle trace, time scale 20ns/div), and the short pulse on expanded time scale (4ns/div). Diagrams show rectified envelopes of r.f. pulses.

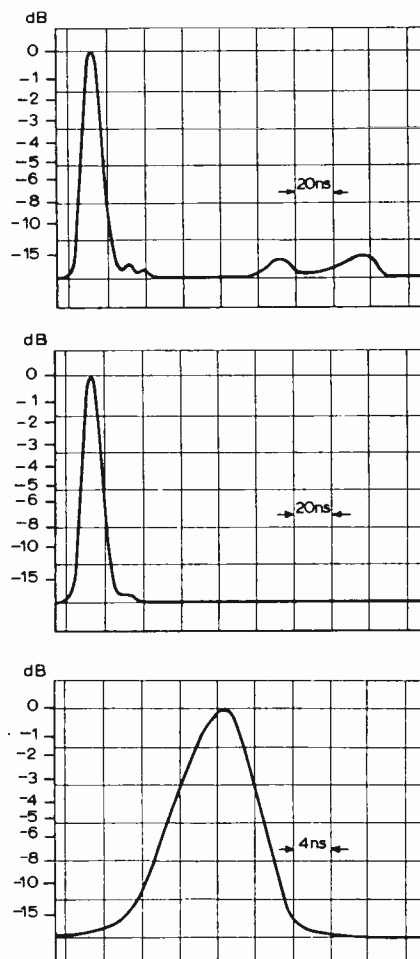

The short-pulse energy was measured as follows. The sampling oscilloscope was calibrated in amplitude using rectangular pulses of known duration together with an average power measurement using a thermistor bridge. The short pulse amplitude was then measured by means of this amplitude calibration. An accurate rotary-vane waveguide attenuator brought the short pulse amplitude on the oscilloscope to the reference level, thus eliminating any errors due to detector non-linearity. Amplitude was then calculated knowing the reference level power, and the number of dB difference in waveguide attenuation. The short pulse energy was then the product of short-pulse power and pulse width at half power (-3dB level).

The pulse generator had a useful output of 6 to 7 ns pulses with an energy of 1,000nJ and, on average, one pulse in  $10^6$  had an energy of 0.5dB above the mean. □

This article reflects a small part of the work that led to a degree thesis at Dundee University. Alan Hood studied for his M.Sc. part time whilst working with Ferranti Ltd on microwave radar system components. He became a part-time lecturer at Dundee College of Technology in electrical engineering and is now a lecturer at Kingsway Technical College, Dundee and a tutor/counsellor with the Open University.



# How good are I.e.ds?

## Ageing characteristics of infra-red emitters

by J. Skinner Leafields Engineering Ltd

The GaAs infra-red emitter has been in use for over ten years, and is now widely used throughout industry. Because the author wanted high performance from a relatively simple system it was decided to examine several devices to find out how their degradation characteristics behaved.

The size of paired modules such as opto-couplers made them impractical to test so discrete emitters with light outputs from 1 to 10mV were used. Tests were also carried out on suitable sensors but the results from these showed no significant variation with age.

The amount of forward current is

important in practical applications and in tests. A report from NASA<sup>1</sup>, which describes an exhaustive examination of the TIL31 device, confirms that degradation is reduced by conservative operation, and shows that no degradation occurs at 25% rating. A paper produced by Hafo<sup>2</sup> contains this interpreted statement:

"A substantially more rapid result of the operational test could be obtained if the I.e.ds were measured at a current lower than the operating current. The deterioration could occur somewhat faster with a low operating and measuring current than with a high one. This result had hardly been expected."

A second statement concludes, "the rate of deterioration may be greater at low rather than high currents." Hafo is one of the few manufacturers who have openly admitted that ageing of I.e.ds is a problem although they now claim to have eliminated the problem completely but have not explained how this has been achieved.

The rated current for a device under consideration is usually specified as 100mA. Because our application required a forward current of around 20mA, burn-in tests were run at 50mA and the tests run at 20mA per device, thus accelerating the running life. The NASA report suggests that light output increases for a period and then falls off continuously. It is therefore necessary to operate for a period which will contain any peak that may occur. Devices were tested for periods up to 1000hrs with a minimum burn-in period of 200hrs. The results obtained are summarized in the tables.

As the tests have been carried out over a 1000hr period it is important to know whether the degradation process continues. In the light of our field experience it does, apparently at a logarithmic rate, similar to that in the short period. Therefore, a device having low degradation during a short period will continue to degrade at a low rate for a long time. These remarks can only be taken as generalisations; nevertheless, short term burn-in can raise q.a. confidence enormously. Measurements of output, before and after burn-in, are however tedious and expensive. We have found that an acceptable compromise is to measure the output after a 200hr burn-in period. A minimum threshold is determined for each application and devices are graded accordingly. Both output and degradation characteristics thus require consideration in selecting suitable devices.

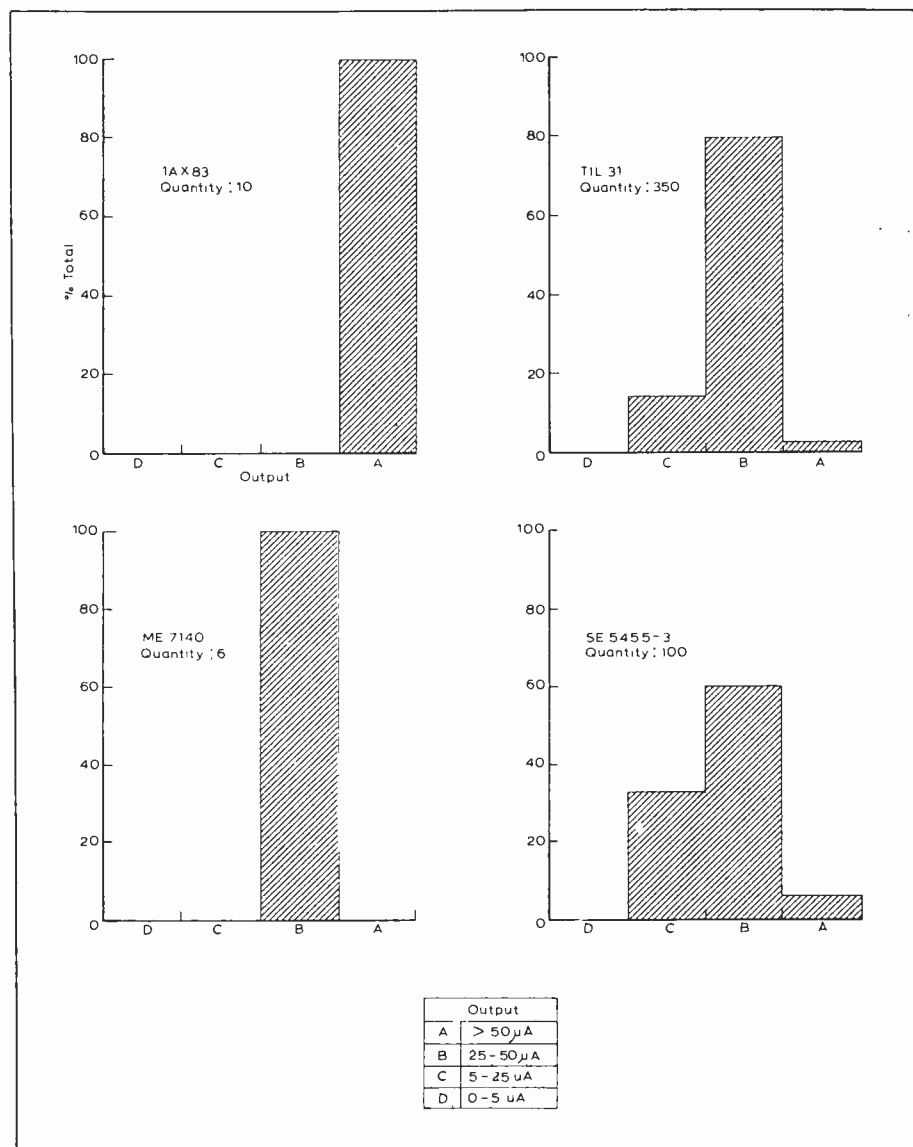

Fig. 1. I.e.d. outputs prior to burn-in. The outputs were measured with an Optron light standard type OP666 mounted in a blackened tube at a fixed distance from the emitter. Forward current in all cases was 20mA.

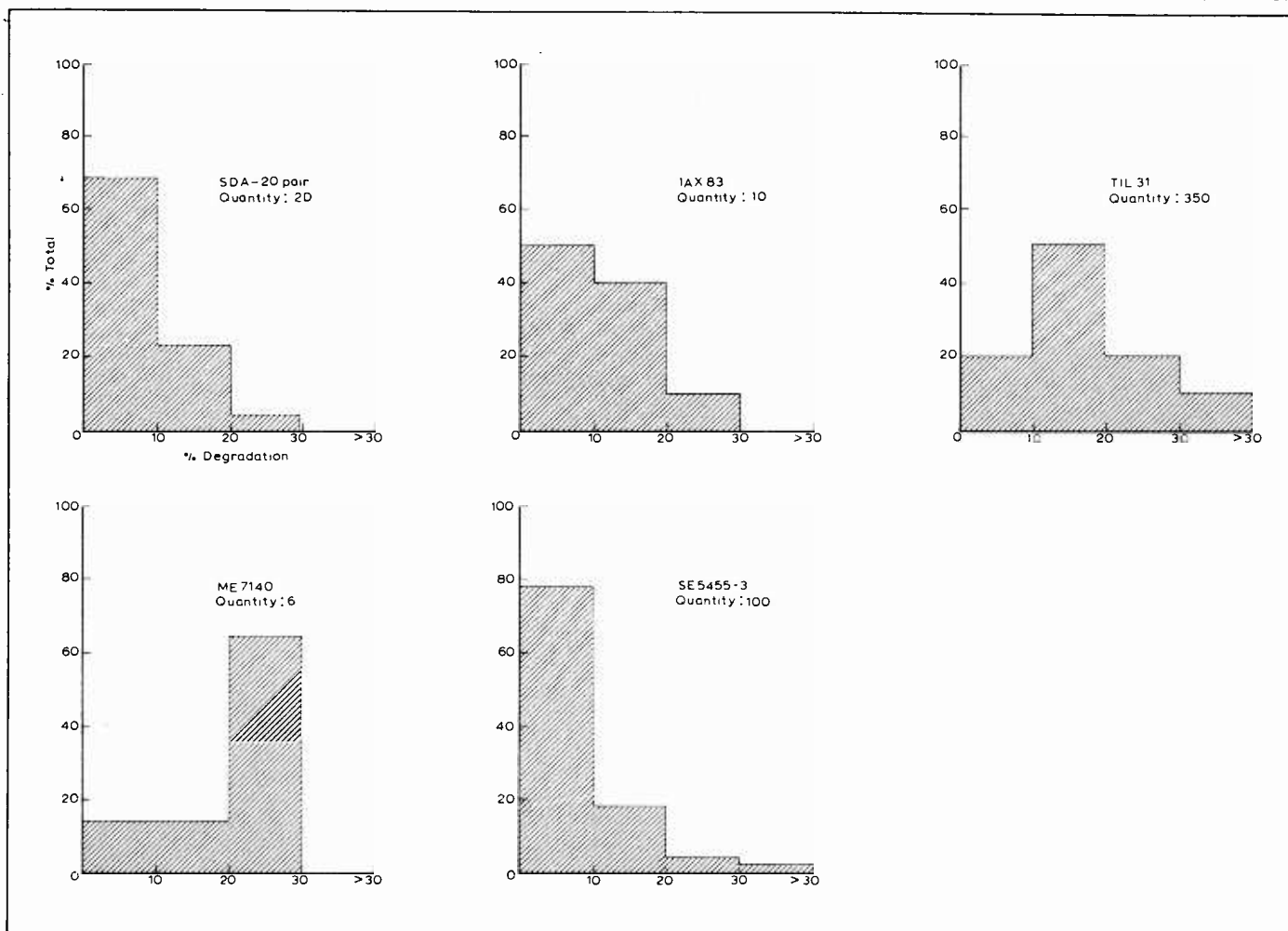

Fig. 2. Degradation of l.e.ds with ageing. The devices were operated for 1000hrs at a forward current of 20mA except for the SDA-20 which was operated at 50mA for comparison.

#### References

1. Thomas, E. F. Changes in the performance characteristics of GaAs near infra-red l.e.ds when exposed to various current and thermal stresses, Goddard Space Flight Center, ref. 08-005, June 1974.
2. Nettelbladt, H. Hur lange lever Lysdioden? eltenik med aktuell elektronik 3/74. (See also *Electronics Weekly*, March 10, 1976, p.13.)

#### Further notes from the Paris Show

There was a great deal of emphasis at the Paris Components Show on opto-electronics, particularly for the secure transmission of data. Well over 100 of the 1,100 exhibitors were showing fibre-optic or opto-electronic devices of some kind. When the notorious urban Parisian telephone system begins to reach saturation, between 1981 and 1985, optical fibre will be used to increase capacity, and the authorities expect that they will be using 10,000km a year by the end of the decade for that purpose.

Displays seem to be getting bigger and more detailed. Thomson CSF are now offering plasma panels for alpha-numeric and graphic displays. The larger of the two ranges has 256 by 256 dot and 512 by 512 dot matrices with 0.64mm pitch. All elements are

addressable individually. The electronics and character stores are built into the devices, though they could hardly be described as flat. The French Commissariat a l'Energie Atomique appear to have developed a liquid crystal matrix display which can show pictures with 16,384 elements and an eight level grey scale which can be changed from five to ten times a second. Each line is scanned sequentially with an alternating voltage of 50V. The video signal is 6V applied to the columns in parallel, the relative phase of the column voltage to that of the line signal determining the grey level.

The Zyklomat universal tachometer caused quite a bit of interest. It is a light gun with a meter on the back. You fire it at a piece of rotating machinery whose speed is read immediately on the meter.

#### Logic design 13 continued from page 82

group number is that specified by the output of the group selector.

The operation of this flag sorter will be explained by direct reference to Fig. 14. Since more than one group signal may be present at any one time, an eight-flag sorter is used to lock out all but one of the group signals. This flag sorter is called the group selector. It will be assumed that two flags in group 1 (say  $f_3$  and  $f_5$ ) and one flag (say  $f_6$ ) in group 4 are raised, that is  $g_1 = 1$  and

$g_4 = 1$ . By direct reference to Fig. 13 it can be seen that the group selector leaves the homing state  $S_0$  and assumes state  $S_3$ . When in state  $S_3$  the group selector's output is 100. This output is decoded, causing signal  $e_4$  to assume 1, thus enabling the group 4 flag sorter. The output of flag sorter 4(110) is connected to lines A, B and C of the data bus, whilst the output of the group selector 100 are connected to lines D, E and F of the data bus. The signals on

these six lines ABCDEF = 110100 will identify the flag to be served, namely flag 6 in group 4. At the same time the group selector will also generate the interrupt signal I.

#### References

1. "Problems and solutions in Logic Design" D. Zissos, Oxford University Press 1976.
2. "Digital Interface Design" D. Zissos and F. G. Duncan, Oxford University Press 1973. □

# NEW PRODUCTS

## Dual-trace oscilloscope

One of the products introduced at the Instruments, Electronics and Automation Exhibition earlier this year was the LBO-508 dual-trace oscilloscope. This instrument, which has a bandwidth of 20MHz and a sensitivity of 10mV/cm, uses a display screen measuring 8 × 10cms and its stabilized power supplies ensure a measuring accuracy of ±3%. Fixed and variable controls on the instrument provide a sensitivity range from 10mV/cm to 50V/cm, and an add function and a second-channel trace invert facility enable the inputs to be added or subtracted. Triggering may be selected from both channels and the circuit will extract sync signals from tv line and frame signals. The timebase allows adjustment from 0.5µs/cm to 0.2s/cm and includes a variable control and a times-five magnification. Other features include automatic and normal triggering, an external trigger input and a function switch for changing one input to the horizontal axis for X-Y display. Martron Limited, 20 Park Street, Princes Risborough, Bucks. WW 301

## Noise and exposure time meter

At a push of a single switch the maximum-permissible noise exposure time for employees is shown direct on the scale of the Pulsar 85E, an industrial sound level meter. The maximum time for which an employee may be safely exposed to high noise levels in a working day is defined by the Department of Employment's code of practice. At 90dBA an employee may work a full eight hours but if the level increases to 93dBA, a barely audible increase, the energy content is doubled and hence the safe working time is reduced to only four hours. Similarly, the time is halved for every further increase of 3dBA. At a typical discotheque level of 110dBA, the exposure limit is under five minutes per day. The main feature of the Pulsar 85E is its measuring range of 85dBA to 114dBA with the Code



of Practice exposure times shown on the same scale from 8h at 90dBA to 3.75 min at 114dBA. To ensure measuring accuracy the electret condenser microphone is mounted on a pull-out boom to

minimise case reflections. The 85E meets the requirements of not only IEC 123 and BS 3489 but also the more stringent American, ANSI S1.4 Type S2A. Price is £125. Pulsar Instruments, 40-42 Westborough, Scarborough, North Yorks YO11 1UN. WW 302

## Universal bridge

The Marconi TF2700 is a self-contained battery-powered bridge for testing resistance, capacitance and inductance. Although traditional bridge configurations are used, with an internal 1kHz source, provision has been made for the connection of many external facilities, enabling more specialised measurements to be undertaken. It has eight ranges for each of the three parameters and includes a

separate, loss balance-control giving indications of D and Q values. The capacitance ranges are from 100pF to 1000µF full scale, the inductance ranges are from 10µH to 100H full scale, and the resistance ranges extend from 1Ω to 10MΩ. External sources of between 20Hz and 20kHz, may be used for all measurements, and resistance may also be measured with direct current. In addition, the bridge may be biased for measurements that require polarisation. Electroplan Limited, P.O. Box 19, Orchard Road, Royston, Herts SG8 5HH. WW 303

## Miniature frequency standards

Oven crystal oscillators in the PMTP5 range, from CEPE, have ageing rates down to  $5 \times 10^{-11}$  per day and retraceability characteristics which ensure that the frequency is within  $5 \times 10^{-9}$  sixty minutes after switching on from cold. Nine varieties of ageing rates and ambient temperature ranges are available, five which function at 5MHz, and the remainder which function at any specified frequency between 4 and 6MHz. All of the oscillators are the same size, 67 × 60 × 40mm, and weigh approximately 180g. Frequency adjustment is provided by external potentiometer and by a control voltage permitting recalibration for at least seven years. The oscillators, which are powered by a 12V ± 5% negative-earth supply, consume 8W at switch-on and 1.5 to 2.4W at 25°C. Thomson-CSF Components and Materials Ltd, Ringway House, Bell Road, Daneshill, Basingstoke, Hants RG24 0QG. WW 304

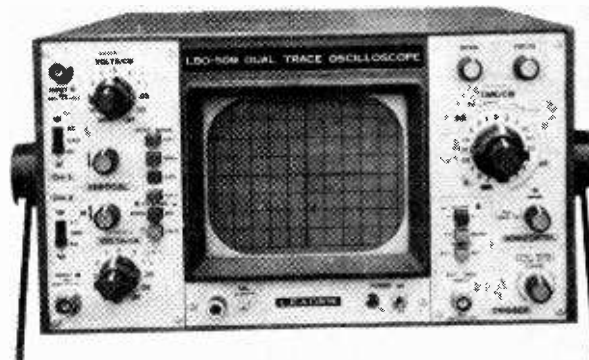

WW 301

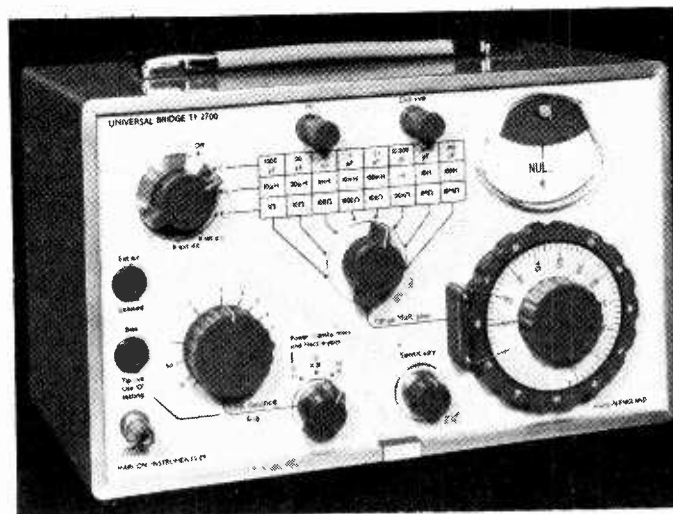

WW 303

## Intrinsically safe pocket phone

The PF2UBIIC, a personal radiotelephone introduced by Pye Telecommunications Ltd, is the first two-way private mobile radio to receive the BASEFA certificate of approval to SFA3012. This standard, which is for equipment used in hazardous atmospheres, replaces the older



BS1259/1958 standard and is considerably more stringent – in particular, the risk of auto ignition is considered for the first time. The introduction of this standard brings the British intrinsic safety standard into line with IEC groupings and markings. The PF2UBIIC, which is designed for three-channel working in the 405 to 470MHz u.h.f. band, is certified for use in zones 1 and 2 with gases in groups IIA, IIB and IIC. It measures only 194 × 85 × 36mm. Pye Telecommunications Ltd, St. Andrews Road, Cambridge CB4 1DP. **WW 305**

**Sound-system i.c.**

The TDA 1190Z i.c. incorporates the functions of two devices in one chip. It is designed for use in televisions and provides the i.f. amplifier, the low-pass filter, the

f.m. detector, the audio preamplifier, the power amplifier and the d.c. volume control. The system is sensitive to an input limiting threshold-voltage of 40µV. Its harmonic distortion is typically 0.75% for an output power of 50mW and its carrier frequency is 4.5MHz (for a Δf of ± 7.5kHz), with a modulating frequency of 400Hz. The signal-to-noise ratio is typically 65dB for an input threshold of greater than 1mW and an audio voltage of 4V. It may be supplied from a 9 to 28V supply and drives a 16Ω loudspeaker. Motorola Limited, Semiconductor Products Division, York House, Empire Way, Wembley, Middlesex HA9 0PR. **WW 306**

**Electric screwdriver**

An electric screwdriver, called the Electrodriver DMS1, is claimed to be unique in that it is the only model on the market to

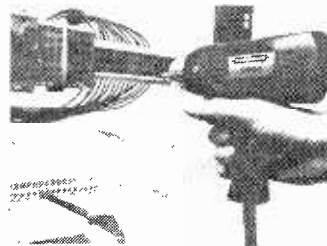

combine continuously-variable speed control, direction reversal, and preselectable torque settings. The tool, from Klippon Electricals Ltd, is suitable for applications throughout industry where the fast repetitive inser-

tion and removal of screws up to M4 size is required. The Electrodriver is mains operated and weighs only 1.35kg, enabling it to be held in one hand, leaving the other free to support components. Power consumption is only 45W and the speed is continuously variable up to 700rev/min. Klippon Electricals Ltd, Terminal Works, Power Station Road, Sheerness, Kent ME12 3AD. **WW 307**

**Protective pads**

Small-profile, self-adhesive pads, which will protect items from scuffing, sliding or vibrating, have been added to the Bumpon range of products available from 3M. The pads, designated as SJ5008 Bumpons, are 12.7mm square by 3mm high and are made from resilient elastomeric material. They are available in black, white or grey colours in boxes of 1000. Industrial Specialities Group, 3M United Kingdom Limited, 3M House, P.O. Box 1, Bracknell, Berkshire RG12 1JU. **WW 308**

**Sinad meter**

The Sinadder 3 combines the well-known Sinadder, from Helper Instruments, with an audio voltmeter. In addition, it has an internal loudspeaker for audible monitoring in both the sinad and audio volts modes of measurement. An internal 1kHz tone is provided for modulating the operator's signal generator in



the sinad mode, or as a test tone for setting transmitter modulation and remote control levels. A 115/230V transformer and a 12V plug are supplied as standard. Lyons Instruments Limited, Hoddesdon, Herts EN11 9DX. **WW 309**

**Alphanumeric keyboards**

The Model EA alphanumeric keyboard, which is the latest addition to Steatite's Chomerics range of keyboard systems, has 59 keys and a space bar. Its keys have a "soft-touch" feel, according to the makers, and a 3.18mm key travel. This model is based on long-life (10 million operations) screened Mylar switch technology, and it is suitable for data



TYPICAL TV SOUND SYSTEM USING TDA1190Z

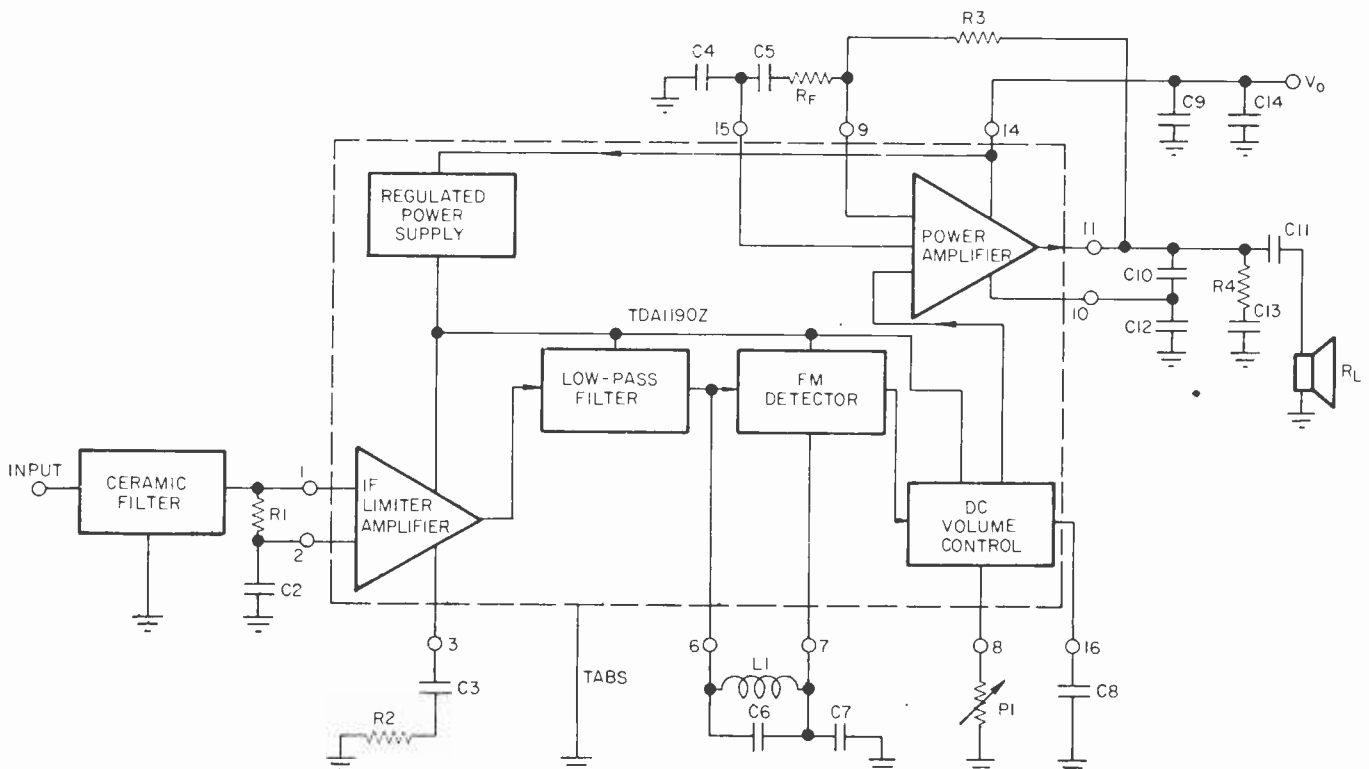

entry terminals and house computer systems. It has two flex-tail terminations with 18 output lines encoded in an  $18 \times 10$  matrix (basically an  $8 \times 8$  matrix plus two extra rows for shift and control outputs) allowing it to be directly connected to an ASCII encoder chip or a programmable keyboard interface chip. As such, the standard EA model is particularly suitable for microprocessor systems designed around an 8-bit bus structure. Steatite Group of Companies, Hagley House, Hagley Road, Birmingham B16 8QW.

WW 310

### Analysers store

The ADS1 is a digital store which has been introduced by Wayne Kerr to complement their RA200 a.f. response analyser. The RA 200/ADS1 provides a continuous response curve which is continuously updated so that there is no chance of missing a sharp spike at one point and there is no need for internal filters or integrators which can distort the response pattern. Up to four complete curves may be recorded by the store, and retained for at least two weeks, even with the RA200 switched off. The contents of any store can be updated at any time, either wholly or in selected parts of the spectrum, without interrupting the display. Any two stores can be selected, and their difference displayed, and if necessary amplified and stored. Wilmot Breeden Electronics Ltd, 442 Bath Road, Slough SL1 6BB.

WW 311

### Viewdata module

Two p.c.b.s. constituting a Viewdata module for inclusion in tv sets have been introduced by GEC Semiconductors. One is a self-displaying page store, comprising four l.s.i. circuits (one MA406 display circuit, one MA401 store address and control circuit, and two MA414 r.a.ms) and is designed with address, data and control buses. The 11-bit address bus determines any store location to be accessed while the 7-bit data bus carries the content of the store location determined by the particular address. The control bus is a 5-bit bus. Outputs from the page store include red, green and blue video and blanking signals. The MA406 display circuit is an n-channel silicon gate device and generates outputs at 14Mbit/s. The Viewdata system can be controlled via a standard keypad or a hard wired teleprinter keyboard and is fully compatible with the GEC Viewdata Line Unit LTU11. GEC Semiconductors Ltd, East Lane, Wembley, Middlesex HA9 7PP.

WW 312

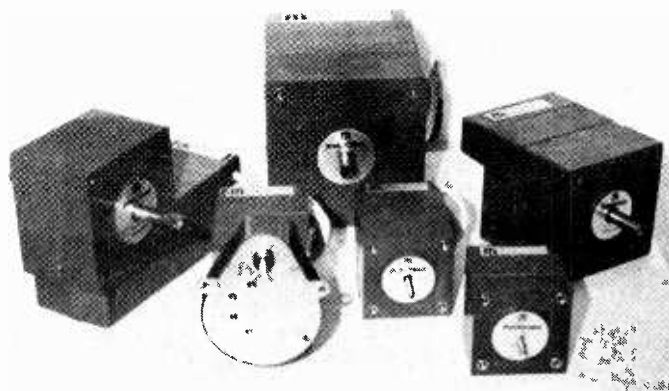

WW 313

### Synchronous stepping motors

Synchronous/stepping motors in the All-Square series, from Memotrace Controls Ltd, range in size from 40 to 78mm square and produce torques from 80 to 3000g.cm without gearing. All of the motors can be stalled against an end-stop without risk of overheating, and reversed without switching when used in the random mode. The motors will operate synchronously at 250, 375 or 500 rev/min on a 50Hz supply and start using a capacitor. When used in the d.c.-hold and stepping mode, for variable-speed operation, steps per rev of 24, 32 or 48 are available up to 250 steps per second. Memotrace Controls Limited, 13 The Avenue, Spinney Hill, Northampton NN3 1BA.

WW 313

### Fibre-core resistors

A range of low-cost, wirewound fibre-core resistors, the FC series from The CGS Resistance Co. Ltd, specifies the range  $0.33\Omega$  to  $12k\Omega$ , with standard tolerances of  $\pm 10\%$ , and power dissipations from 2 to 10W. The resistors are available with two different heights of tag for use in printed circuit boards giving a maximum back-of-board temperature, on

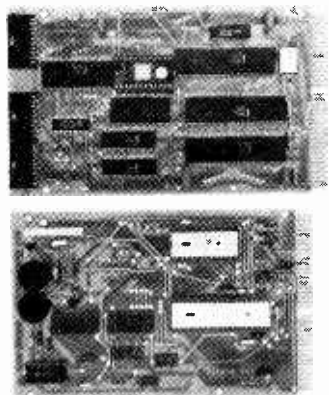
0 1 2 3 4 5 6  
cm

WW 312

the FCB type, of  $60^\circ\text{C}$ . They meet the flammability requirements of BS 415, clause 20.1, and the solderability test of IEC 68-2-20, 1A. The temperature coefficient is  $\pm 200\text{ppm}$ , and the maximum change after 1000h is  $\pm 3\%$ . After 10 times nominal wattage loading for five seconds the change is  $\pm 2\%$ . The CGS Resistance Company Limited, Marsh Lane, Gosport Street, Lymington, Hampshire SO4 9YQ.

WW 314

### Storage cabinets

A range of component storage cabinets has been introduced by Quiller Components Ltd of Bournemouth. The standard cabinets, which can be wall-mounted or stacked, consist of a robust steel



frame and a choice of three sizes of transparent plastic trays. There are seven types, ranging from an all-plastic 9-tray unit, to the standard metal-and-plastic 50-tray unit. Prices range from £3.40 to £15.80 and, according to the makers, their appearance makes the cabinets suitable for office, home or workshop. Quiller Components Limited, Cardigan House, Winton, Bournemouth, Dorset BH9 1AU.

WW 315

### Pocket terminal

Based on the Intel 8048 device, this pocket terminal from GR Electronics is an improvement on their existing hand held keyboard which was announced in 1976. The new unit, which has been designed for use by computer engineers and programmers, contains 40 keys and is capable of sending/receiving data in eight-bit serial ASCII code. The ter-

terminal has eight 16-segment displays which can generate all 64 ASCII upper case alphanumerics. Selectable baud rates are also provided and a 30-character internal memory may be accessed for display in blocks of eight adjacent characters.

Two versions of the terminal are available; one is interfaced for operation with a 20mA current loop, the other is interfaced for V24/RS232 levels. Both types are fitted with an internal bleeper for an audio response to the "BEL" code.

The complete terminal requires a regulated power supply of  $+5\text{V} \pm 5\%$  with a current rating around 400mA. G.R. Electronics Ltd, Fair Oak House, Church Road, Newport, Gwent NP7 7EJ.

WW 316

### Soldering bits for thick film

At the request of a Marconi company, Light Soldering Developments Ltd have developed two long-life soldering bits specially for soldering thick-film circuits. Long, thin extensions on the bits overcome the access problem in high density applications. The bits will fit Litesold ETC/2 and PC/2 soldering systems and the Conqueror soldering iron. Light Soldering Developments Ltd, 97-99 Gloucester Road, Croydon, Surrey.

WW 317

### 100A transistors

Devices in the 100SC series, announced by GPD, are claimed to be the first single-chip power transistors with collector current ratings of 100A. The design is based on an unusually large germanium junction — a  $0.475\text{in}$ -diameter chip. Typical applications for the transistors, which are available with various operating voltages, are in inverters, switching regulators, power amplifiers and similar high-current circuits. Wintronics, Southon House, Edenbridge, Kent.

WW 318

### Correction

The Mk IX family of colour television cameras recently announced by Marconi Communications Systems Ltd as a successor to the Mk VIII uses three lead-oxide camera pick-up tubes, of which several varieties can be fitted, and not four Plum-bicons as stated in our last issue. The quantity and quality of integrated circuits used in the Mk IX family has been increased over those in the Mk VIII range, which did not use any thin-film circuitry.

## Big is beautiful

Has anyone noticed how enormous some of the latest portable radio receivers are? Funny how fashions change, isn't it? When transistors were first used to make life miserable the idea was to make the radios as small as possible or to make them look like something else. (I remember a dog, with a speaker in its mouth, a tuning knob for its left eye and the volume/on-off control as its right. It didn't wag its tail much, if memory serves me).

The newer ones, though, seem to get bigger every time I look in a shop window, which isn't very often because I get this pain in the head when I see the prices. Some recent designs are nearly as big as the "table wireless sets" we used to have before the war, which had to be that size because of the valves, big electrolytics and transformers they used. That necessity was a blessing in disguise, because it meant that a decent-sized loudspeaker could be used, and the cabinet was big enough to handle it.

Transistors need no large components and tended, at first, to be used in a gimmicky way simply for a size reduction — and to blazes with the sound. So I see it as encouraging that radio designers are overcoming this imagined need for small, tinny trannies and are trying to provide a decent sound at last. At least, I hope they are. Doubts are raised, though, by the description of some of these sets as "stereo" receivers. Given a pair of headphones and a jack on the receiver this is fine, but some of them have two speakers, indicating that one is intended to sit there, solemnly gazing at the set about a foot away. I haven't checked, but if any of these sets don't provide for headphone listening, there could be a violation of the trade descriptions regulations.

## Peel me a grape

These youngsters go too fast for me. Once again I have to report a conversation which took place in our brainstorm generation department — the Dorset House canteen. The talk deviated slightly, from rhetorical enquiry into the precise nature of the late animal we were coping with, to a demand for information on computer programming from our gadgeteer (he's the only man I know with a laser in his living room, and now he wants a computer).

It isn't that he doesn't understand it, but he does feel that the "stupid great list" of instructions is far too much like work to be tolerated. Instead of feeling immeasurably grateful that several pages of algebra and arithmetic can be reduced to a few computer instructions, he feels that the instructions ought to be done away with as well. Well, that's youth for you! What he wants to do, it seems, is to write the question out, in



Queen's English, show it briefly to a microcomputer and tell it to get on with it. Languages don't come much higher in level than that and it makes me wonder if he isn't forgetting something. If the computer is bright enough to understand an instruction to stop gazing into space and do something constructive, it might just come back and ask him if he's paralysed or something, and why not do the job himself, if he's so keen?

## A clash of symbols

Someone is usually cross with us about something — a thick skin is as much an essential to this line of work as big feet are to a policeman — and, as often as not, the subject that seems to get up peoples' noses is graphic symbols. Some readers have only to spot an OR gate drawn in a way they disagree with to get their nether underwear all of a twist.

Now, we all have our own ideas about symbols — logic symbols in particular. Some like semicircles, some still use circles and others, including the British Standards Institution, use rectangles. Respectful as we are of that august body, it seems to all of us here that since BSI stopped consulting *Wireless World* on symbol design some time ago the state of graphic symbology has become akin to that of Denmark. Regular readers will have noticed that diagrams in *Wireless World* use the semicircle and spearhead for logic symbols, the preference being for symbols which are clear, unambiguous and logical, if you will pardon the expression.

But, whichever symbols are shown in a diagram, I refuse to believe that anyone would be so completely put off by unfamiliar drawings as to be in difficulties with the logic diagram. Greater degrees of departure from the familiar are encountered whenever, for example, an American "upside-down" circuit diagram is seen or a European diagram with "rectangular" resistors and single-turn mains transformers is used, and yet I don't think the differences are great enough to cause anyone difficulty.

## Avos into space

There are times when a leaning towards the technical can be a drawback and can also gain you a reputation as a know-all wet blanket, if you can visualize such a creature. Film-makers are much better at maintaining accuracy than they used to be, but one can still see the odd Messerschmitt 108B masquerading as an Me 109E, and nothing is more liable to release carefully built-up tension than a squadron of sinister Mitsubishi Zeros being revealed as innocent Harvard trainers in wolf's clothing.

As I have already mentioned, I am a pushover for sci-fi series on the box; and I become very annoyed with myself when a character is desperately trying to activate a rocket's main drive motor by means of a highly technical-looking piece of gear which I immediately recognize as a Marconi audio signal generator. I once saw an alien life form being held at bay by a small grid-dip oscillator — a procedure only marginally more effective as a deterrent than a soldering gun with its bit missing. All this is very distracting and I do wish the producers of these series would begin to draw on some other discipline for their hardware. I should think any decent toolmaker's workshop could supply a few menacing-looking gizmos and chemical laboratories are full of highly entertaining bits of gadgetry. Knowing little of these black arts, I could then experience a full measure of terror without wondering how a BC109 with its legs bent up is going to work as the heart of an anti-gravity machine.

## More haste — more speed

That the imminent arrival in one's island home of a million or so gentlemen singing the Horst Wessel song is quite enough to concentrate the mind has been made very clear by the BBC "Secret War" television series. Once our physicists and engineers had got the idea that it was largely up to them there was no stopping them; the inventions came forth in a steady stream. The astonishing feature, though, was not the amount of stuff churned out, but the sheer speed of development from the nutty idea stage to the point where the Heinkels didn't know whether they were coming or going.

In an age in which gestation periods of electronic equipment designs extend into years it is truly remarkable that complete systems were conceived, developed and bolted into aircraft in a matter of weeks. The radar bombing aid which probably influenced the course of the war more than any other, H<sub>2</sub>S, was taken from bright idea to prototype in eight months. A further seven months sufficed for the production of enough sets to enable Pathfinders of Bomber Command to flatten Hamburg.

# THE DYNAMIC DUO



The C15/15 is a unique Power Amplifier providing Stereo 15 watts per channel or 30 watts Mono and can be used with any car radio/tape unit. It is simply wired in series with the existing speaker leads and in conjunction with our speakers S15 produces a system of incredible performance.

A novel feature is that the amplifier is automatically switched on or off by sensing the power line of the radio/tape unit hence alleviating the need for an on/off switch.

The amplifier is sealed into an integral heatsink and is terminated by screw connectors making installation a very easy process.

The S15 has been specially designed for car use and produces performance equal to domestic speakers yet retaining high power handling and compact size.

**C15/15**  
 15 Watts per channel into 4Ω  
 Distortion 0.2% at 1KHz at 15 watts  
 Frequency response 50Hz - 30KHz  
 Input Impedance 8Ω nominal  
 Input sensitivity 2 volts R.M.S. for 15 watts output  
 Power line 10 - 18 volts  
 Open and Short circuit protection  
 Thermal protection  
 Size 4 × 4 × 1 inches

**Data on S15**  
 6" Diameter  
 5¼" Air Suspension  
 2" Active Tweeter  
 20oz Ceramic magnet  
 15 Watts R.M.S. handling  
 50 HZ - 15KHz frequency response  
 4Ω Impedance

C15/15 Price £17.74 + £2.21 VAT P & P free

S15 Price per pair £17.74 + £2.21 VAT P & P free

*TWO YEARS GUARANTEE ON ALL OF OUR PRODUCTS*

**I.L.P. Electronics Ltd**  
**Crossland House**  
**Nackington, Canterbury**  
**Kent CT4 7AD**  
**Tel (0227) 63218**

Please Supply \_\_\_\_\_  
 Total Purchase Price \_\_\_\_\_  
 I Enclose Cheque  Postal Orders  Money Order   
 Please debit my Access account  Barclaycard account   
 Account number \_\_\_\_\_  
 Name & Address \_\_\_\_\_  
 Signature \_\_\_\_\_

WW-028 FOR FURTHER DETAILS

THE **baker** QUALITY



## 150 watt mixer amplifier

**£85.32**

- All purpose Bass Lead Rhythm Guitars Discotheque Vocal, Public Address etc
- Amplifier Mains switch for instant sound or muting
- Three loudspeaker outlets for 4 8 or 16 ohms operation
- Four high gain inputs each 28 mv 50K ohm for full output
- Individual volume controls with Four channel mixing facilities
- 150 watts into 8 ohms R M S Music Power
- Distortion less than 1% at full output
- Slave output 500 M V 25 K ohm
- Accepts loudspeakers from 4 ohms upwards Standard jack sockets
- Frequency Response 25 Hz — 20kHz ± 3dB integral Hi Fi preamp
- 32dB Variation on wide range separate Bass & Treble controls
- Fully Short and Open circuit proof electronic and fused
- Compact — 16" x 8" x 5 1/2" approximately
- Lightweight — Only 14lb — approximately
- Blue wording on Black fascia
- Made in England 12 months guarantee
- 200/250v A C mains or 120V to order
- All transistor and solid state devices

**Distributors required in certain countries and parts of UK.**

**Baker Loudspeakers Limited**

## NEW! Star sound

A high power full range quality loudspeaker produced to give exceptional reproduction. Ideal for electronic guitars, organs, public address or discotheques. This loudspeaker is recommended where high power handling is required with quality results. The high flux ceramic magnet assembly ensures clear treble response so necessary for today's musician.



### GROUP 50/12 inch

**£22.68**

Voice Coil Impedance 4 or 8 or 16 ohms  
 Maximum Power 60 watts (120 watts U.S.A.)  
 Bass Resonance 55 c.p.s.  
 Useful Response 30-16 000 c.p.s.  
 Flux Density 15 000 lines  
 Voice Coil 1 1/2" / 38 mm  
 Overall diameter 12 1/2" / 310 mm  
 Overall depth 4 3/4" / 120 mm  
 Fixing holes diagonal 13" / 330 mm  
 Baffle aperture 11" / 280 mm  
 Nett weight 10 lbs / 4.5 kg.

### GROUP 25 12 inch

**£12.96**

Voice Coil Impedance 4 or 8 or 16 ohms  
 Maximum Power 30 watts (60 watts U.S.A.)  
 Bass resonance 55 c.p.s.  
 Useful Response 30-13,000 c.p.s.  
 Flux density 12,000 lines  
 Voice coil 1 1/2" / 38 mm  
 Overall diameter 12 1/2" / 310 mm  
 Overall depth 4 3/4" / 120 mm  
 Fixing holes diagonal 13" / 330 mm  
 Baffle aperture 11" / 280 mm  
 Nett weight 5 lbs / 2.3 kg

### GROUP 35 12 inch

**£15.12**

Voice Coil Impedance 4 or 8 or 16 ohms  
 Maximum Power 40 watts (80 watts U.S.A.)  
 Bass Resonance 55 c.p.s.  
 Useful Response 30-13,000 c.p.s.  
 Flux Density 14,000 lines  
 Voice coil 1 1/2" / 38 mm  
 Overall diameter 12 1/2" / 310 mm  
 Overall depth 4 3/4" / 120 mm  
 Fixing holes diagonal 13" / 330 mm  
 Baffle aperture 11" / 280 mm  
 Nett weight 6 lb s / 2.7 kg.

### GROUP 50 15 inch

**£28.08**

Voice Coil Impedance 8 or 16 ohms  
 Maximum Power 75 watts (150 watts U.S.A.)  
 Bass Resonance 45 c.p.s.  
 Useful Response 30-13,000 c.p.s.  
 Flux Density 15 000 lines  
 Voice coil 2" / 51 mm  
 Overall diameter 15 1/2" / 390 mm  
 Overall depth 6" / 153 mm  
 Fixing holes diagonal 16 3/4" / 417 mm  
 Baffle aperture 11" / 280 mm  
 Nett weight 15 lbs / 6.8 kg

**337 Whitehorse Road, Croydon, Surrey, England**

Telephone: 01-684 1665

## HAVE YOU DONE IT LATELY!

Fit a new tape head and transform the performance of your tape recorder

**MONOLITH**  
THE MONOLITH ELECTRONICS CO. LTD.

QUALITY REEL TO REEL AND CASSETTE TAPE HEADS



Full Catalogue 25p

Please enclose 20p P&P with order

B24—RP stereo cassette glass/ferrite record/playback £9.84  
 B12—01 mono cass. playbk. £1.60 B24—01 stereo cass. playbk. £2.80  
 A28—05 stereo Btk cartridge £1.80 E12—09 stereo/mono cass. erase £1.80

5/7 Church St, Crewkerne, Som. Tel. (0460) 74321

WW—066 FOR FURTHER DETAILS

## carbon film RESISTORS

ON BANDOLIERS OR PREFORMED 12.5mm AT NO EXTRA COST

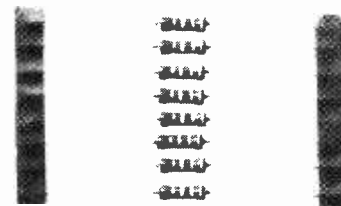

**Z & I**

**AERO SERVICES LTD.**

42-44A-46 Westbourne Grove  
 London W2 5SF  
 Tel. 01-727 5641 Telex 261306

WW—084 FOR FURTHER DETAILS

INSTANT CIRCUIT CONSTRUCTION

# SOLDERLESS BREADBOARDING

THE SK 10 BREADBOARDING SOCKET OFFERS THESE ADVANTAGES:

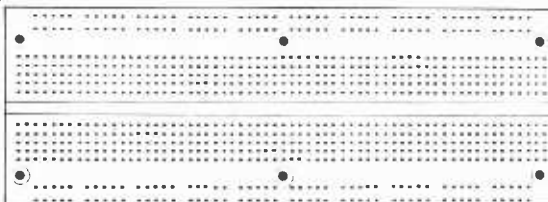

Multi-power busses  
 64 pairs of nickel silver contact  
 5 milliohm standard contact resistance  
 20-26 gauge wire

All SK 10 sockets carry a lifetime guarantee. If a unit ever fails in normal usage,

return it to us for a free replacement.  
 No questions asked  
 Ask for full catalogue of E & L digital learning products



Special offer to cash with order customers

**£12.50** inc VAT & P&P

**E & L INSTRUMENTS UK.**  
 62, Queen Anne St, London W1M 9LA. Tel: 01-486-3589.

WW—010 FOR FURTHER DETAILS



# WILMSLOW AUDIO

## The firm for Speakers

### HI-FI DRIVE UNITS



### PA GROUP & DISCO UNITS



### WILMSLOW AUDIO

KITS FOR MAGAZINE DESIGNS etc.



### SPEAKER KITS



Audax HD12 9 D25	£7.50
Audax HD13 D34H	£12.50
Audax HD20 B25H4	£14.65
Audax HD20B25J4	£10.95
Audax HD11 P25EBC	£6.95
Baker Superb	£22.50
Castle 8RS/DD	£11.95
Chartwell CEA205 8 bass matched pairs only	£59.90
Coles 4001	£6.25
Coles 3000	£6.25
Celestion HF1300 II	£8.25
Celestion HF2000	£9.75
Dalesford D20/105 4	£10.95
Dalesford D30/110 5	£10.95
Dalesford D50/153 6 1/2	£11.95
Dalesford D50/200 8	£11.95
Dalesford D70/250 10	£24.95
Dalesford D100/310 12	£34.95
Decca London	£37.25
Decca CO/1000/8	£7.95
Decca DK30	£24.50
E.M.I. type 350 4 ohm	£9.25
E.M.I. 14A/770 14 x 9	£12.50
E.M.I. 8 x 5 d/c 10 watt	£3.95
Isophon KK10/8	£8.25
Isophon KK8 8	£7.50
Jordan Watts Module	£17.95
Jordan 50mm Unit	£22.50
Jordan CB Crossover	£22.50
KEF T27	£8.50
KEF T15	£10.75
KEF B110	£10.95
KEF B200	£11.95
KEF B139	£24.95
KEF DN13	£4.95
KEF DN12	£7.25
Lowther PM6	£43.75
Lowther PM6 MKI	£45.90
Lowther PM7	£78.95
Peerless DT10HFC	£9.50
Peerless K010DT	£8.25
Peerless K040MRF	£10.50
Radford BD25 II	£26.95
Radford MD9	£14.50
Radford MD6	£17.95
Radford FN8/FN831	£19.95
Richard Allan CG8T	£8.95
Richard Allan CG12T Super	£19.95
Richard Allan HP88	£13.50
Richard Allan LP88	£9.25
Richard Allan HP12B	£21.50
Richard Allan DT20	£6.75
Richard Allan DT30	£6.95
Shackman Electrostatic C/W polar network & X/O pair	£99.95
Tannoy HPD 295A	£91.50
Tannoy HPD 315A	£102.95
Tannoy HPD 385A	£119.95

Baker Group 25	£13.00
Baker Group 35	£14.50
Baker Group 50/12	£21.00
Baker Group 50/15	£25.75
Celestion G12M	£12.95
Celestion G12H	£16.95
Celestion G18C	£41.95
Celestion G12/75 (alum. dome)	£22.50
Celestion G12/75 (d/cone)	£24.50
Celestion G12M/50 (cambric edge)	£16.95
Celestion G15/100 (alum. dome)	£32.50
Celestion MH1000	£13.50
Celestion Powercell 12/100	£45.95
Celestion Powercell 15/100	£48.95
Celestion Powercell 15/125	£51.95
Fane Pop 40	£10.95
Fane Pop 50H	£12.50
Fane Pop 75	£16.95
Fane Pop 65	£19.95
Fane Pop 80	£21.95
Fane Pop 100	£35.95
Fane J44 horn	£6.50
Fane J104 horn	£13.75
Fane J73 horn	£9.75
Fane Guitar 80L	£19.75
Fane Guitar 80B	£19.95
Fane Disco 80	£21.50
Fane PA80	£19.50
Fane Bass 85	£29.95
Fane Crescendo 12A	£42.95
Fane Crescendo 12B	£44.95
Fane Crescendo 15/100	£54.95
Fane Crescendo 15/125	£64.95
Fane Crescendo 18	£75.95
Fane 920 II Horn	£45.95
Fane HPX1/HPX2	£2.50
Fane PH50	£6.50
Goodmans 8PA	£3.95
Goodmans 10P	£6.95
Goodmans 12P	£16.95
Goodmans 12PD	£19.95
Goodmans 12PG	£19.50
Goodmans 18P	£39.95
Goodmans 50HX	£18.95
McKenzie Forte 12	£22.95
Motorola Piezo Horn	£8.50
Richard Allan HD8T	£12.95
Richard Allan HD10T	£13.25
Richard Allan HD12T	£18.75
Richard Allan HD15	£29.95
Richard Allan HD15T	£30.50

Kits include drive units, crossovers, BAF/Long fibre wool, etc. for pair of speakers. Carriage £3.50

Practical HiFi & Audio PRO9-TL (Rogers) £118.00

Felt panels for PRO9-TL £5.50 + £1.50 p&p

Hifi Answers Monitor (Rogers) £129.00

Hifi News State of the Art (Atkinson) £161.00

Hifi News No Compromise (Frisby) £126.00

Popular Hifi Mini Monitor (Colloms) £63.00

Popular Hifi Round Sound (Stephens) including complete cabinet kit £65.00

Practical Hifi & Audio Monitor (Giles) £119.00

Practical Hifi & Audio Triangle (Giles) £76.00

Practical Hifi & Audio BSC3 (Rogers) £60.00

Hifi News Tabor (Jones) £57.75

Hifi News Tabor (with H4 bass units) £65.00

Wireless World Bookshelf (Wilkinson) £56.50

Wireless World T L / KEF (Bailey) £112.00

Wireless World T L / Radford (Bailey) £154.00

SMART BADGES FREE WITH ALL ABOVE KITS (TO GIVE THAT PROFESSIONAL TOUCH TO DIY SPEAKERS!)

Send 3 x 7p stamps for reprints/construction details of any of above designs.

CARRIAGE & INSURANCE	
Tweeters/Crossovers	40p each
Speakers up to 10	75p each
Speakers 12	£1.25 each
Speakers 15	£2.00 each
Speakers 18	£2.95 each
Speaker Kits	£2.50 pair
Mag. design kits	£3.50 pair

Prices per pair. Carriage £2.50

Dalesford System 1	£52.90
Dalesford System 2	£55.75
Dalesford System 3	£101.75
Dalesford System 4	£108.00
Dalesford System 5	£139.00
Dalesford System 6	£93.00

Eagle SK210	£13.90
Eagle SK215	£23.50
Eagle SK320	£33.50
Eagle SK325	£59.90
Eagle SK335	£79.90

Goodmans DIN20	£31.50
Goodmans Mezzo Twinkit	£51.95

Lowther PM6 Kit	£91.75
Lowther PM6 MKI Kit	£96.50

Peerless 1060	£66.95
Peerless 1070	£115.00
Peerless 1120	£129.50
Peerless 2050	£45.95
Peerless 2060	£60.95

Radford Studio 90	£154.00
Radford Monitor 270	£208.00
Radford Studio 270	£275.00
Radford Studio 360	£390.00
Richard Allan Twin	£29.90
Richard Allan Triple 8	£45.50
Richard Allan Triple 12	£55.90
Richard Allan Super Triple	£65.90
Richard Allan RA8	£42.75
Richard Allan RA82	£67.75
Richard Allan RA82L	£73.50

Seas Mini	£17.90
Seas 203	£35.50
Seas 302	£43.90
Seas 303	£73.90
Seas 503	£111.90

Wharfedale Denton 2XP	£26.95
Wharfedale Linton 3XP	£41.95
Wharfedale Glendale 3XP	£56.95

Everything in stock for the speaker constructor! BAF, long fibre wool, foam, crossovers, felt panels, components, etc. Large selection of grille fabrics (Send 15p in stamps for fabric samples) (Prices correct at 12/4/78)

**SWIFT**  
OF WILMSLOW  
The firm for Hi-Fi  
5 Swan Street,  
Wilmslow, Cheshire.

Send 15p stamp for free 38 page catalogue "Choosing a Speaker"

Telephone: Speakers, Mail Order and Export: Wilmslow 29599 Hi-Fi: Wilmslow 26213

Lightning service on telephoned credit card orders!

**WILMSLOW AUDIO**  
The firm for Speakers  
Swan Works, Bank Square,  
Wilmslow, Cheshire.



# S500-D

It is unique. Meet the new leader from H.H.

- \* High Power capability, up to 500 watts per channel output.
- \* Two channel stereo, or bridged output.
- \* Superb audition performance, ultra low intermodulation and T.I.M. distortion.
- \* Modular construction, integral force cooled dissipators (FCD).
- \* High efficiency Toroidal Power Supply
- \* Compact size, only 3½" high x 19" rack mounting.

Send for detailed information:  
 H.H. ELECTRONIC,  
 Viking Way, Bar Hill,  
 Cambridge, CB3 8EL.  
 Telephone: Crafts Hill (0954) 81140  
 Telex: 817515 HH ELEC G

WW—070 FOR FURTHER DETAILS

## TWO NEW SUPERMODULES: 170W INTO 4 OR 8 OHMS

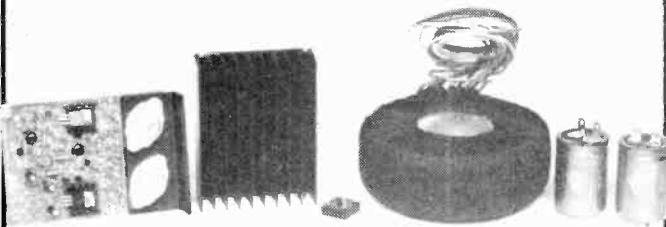

By popular demand we have designed higher powered versions of our well known modules. The CE 1704 which gives 170W into 4 ohms and the CE 1708 which gives 170W into 8 ohms are physically similar to the original types and have the same combination of compatible performance features which makes CRIMSON amplification audibly superior to the competition and the only choice if you have an ear for music. We have also produced suitable power supplies which again use our superb TOROIDAL TRANSFORMERS only 50mm high with a 120:240 primary and single bolt fixing. Write or phone for more information and biased opinions.

POWER AMPLIFIER MODULES	Home	Europe
CE 608 60W/8 ohms 35-0-35V	£16.30	£16.60
CE 1004 100W/4 ohms 35-0-35V	£19.22	£19.30
CE 1008 100W/8 ohms 45-0-45V	£23.22	£23.00
CE 1704 170W/4 ohms 45-0-45V	£29.12	£28.46
CE 1708 170W/8 ohms 60-0-60V	£31.90	£31.04

TOROIDAL POWER SUPPLIES	Home	Europe
CPS 1 for 2xCE or 1xCE 1004	£14.47	£18.40
CPS 2 for 2xCE 1004 or 2/4xCE 608	£16.82	£20.57
CPS 3 for 2xCE 1008 or 1xCE 1704	£17.66	£21.35
CPS 4 for 1xCE 1008	£15.31	£19.18
CPS 5 for 1 x CE 1708	£22.58	£26.50
CPS 6 for 2 x CE 1704 or 2 x CE 1708	£23.98	£27.70

HEATSINKS	Home	Europe
Light Duty 50mm 2 C/W	£0.90	£1.30
Medium Power 100mm 1 1/2 C/W	£1.60	£2.40
Disco/Group 150mm 1.1 C/W	£2.30	£3.65

THERMAL CUT-OUTS	Home	Europe
Recommended for improved reliability	£1.60	£1.90
70 C for use with free air heatsink	£1.60	£1.90
40 C for use with the cooled heatsink	£1.60	£1.90

T.H.D.	Typically 02 any power: 1kHz, 8 ohms
T.J.D.	Insignificant
Slew rate limit	20V $\mu$ S
S/N ratio	1100B
Freq. response	10W-35kHz 3dB
Stability	Unconditional
Protection	Drives any load safely
Sensitivity	775mV (250mV or 100mV on request)
Size	120 x 80 x 25mm

### CRIMSON ELEKTRIK

Please note our new address and telephone number:  
 Stamford House, 1A Stamford Street,  
 Leicester LE1 6NL. Telephone: (0533) 537722

Home prices include V A T & postage. C O D 90p extra. £100 limit. Export no problem. European prices include carriage, insurance and handling. Payment in Sterling by bank draft, P. O. International Giro or Money Order. Outside Europe, please write for specific quote by return. Send SAE or two International Reply Coupons for full literature. Favourable trade quantity price list on request. High quality pre-amp circuit 20p.

WW—043 FOR FURTHER DETAILS

## a fully built & tested microcomputer system ONLY £159 +VAT

### KIM-1 CARD

- \* COMPLETE WITH KEYBOARD & DISPLAY
- \* AUDIO CASSETTE INTERFACE FOR PROGRAM STORAGE
- \* TELETYPE INTERFACE
- \* PROGRAM DEVELOPMENT SOFTWARE
- \* R6500 PROGRAMMING MANUAL
- \* R6500 HARDWARE MANUAL

### IDEAL FOR THE HOME USER, STUDENT AND ENGINEERS

Fully built & tested, with keyboard & display for editing, debugging and running programs. Complete with 1K bytes of RAM and 2K bytes of ROM—resident monitor and executive software controlling operation & de-bug modes. Interface circuitry for program storage on a cheap audio cassette and teletype connection, with baud-rate determined automatically.

An additional 15 unused 1/0 lines for use as inputs or outputs and 8 bit programmable Interval Timer. De-bug facilities to 'single-step' the program and trace the actions of the registers. 16-bit address bus, data and control buses brought to an edge connector for extending the system to 65K memory locations. Comes complete with full Rockwell R6500 programming and user manuals for only £159 +VAT. Available Ex-Stock.

## Pelco (Electronics) Ltd

Enterprise House,  
 83-85 Western Road, Hove, Sussex BN3 1JB  
 Telephone Brighton (0273) 722155

Buy it with your Access or Barclaycard.

WW—088 FOR FURTHER DETAILS

# TRUE PROFESSIONALS

Including: EMI, Decca (UK), BBC, Pink Floyd, Hawker Sidley, Metropolitan Police, The Who, Queen, Thames TV, ITN, Capital Radio, Decca (France), Ministry of Defence, Birds Eye, Rolls Royce, Crown Agents, Madame Tussaud's, Island Music, Chappells, Dick James Music, Neve, Alice, Israel Defence Ministry, Yes Music, University of Bucharest, Pye TVT, Avon Health Authority, Government of Seychelles, Philippines Radio, London Broadcasting, Rolling Stones, Thin Lizzie, British Railways, Natural History Museum, Virgin Records, Kirilo Savic Institute of Belgrade, all British Universities, London Weekend TV, BOC, Wings, IBM, every Local Radio Station, Post Office Research, Rank Organisation, and many others.

## ACKNOWLEDGE

That ITA has more to offer:

- **Location.** In Central London - easy parking.
- **Delivery.** Large stockholding covering 500 versions for immediate delivery.
- **Servicing** By ITA factory trained staff. Quickest turnaround time. Machines supplied or rebuilt for special requirements.
- **Pricing.** Check our prices - you will find them lowest ALWAYS.

## ITA'S ADVANTAGES

1-7 Harewood Avenue, Marylebone Road, London NW1. Tel: 01-724 2497.  
Telex: 21879.

WW - 107 FOR FURTHER DETAILS  
[www.americanradiohistory.com](http://www.americanradiohistory.com)



**REVOX**  
A wide range of two channel recorders from this famous manufacturer, with tape speeds from 15 / 16 ips to 30 ips. Options include variable speed and sel-sync. Models include A77, B77 and 377 with 3 speeds and editing (designed and modified by ITA specifically for professional applications).

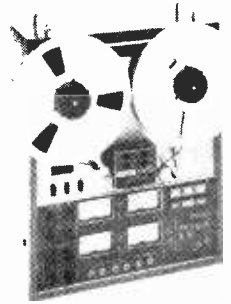

**TEAC**  
Recorders for logging and studio use - tape speeds from 1 1/2 to 15 ips. 2, 4 or 8 channel. A range of mixers is also available.

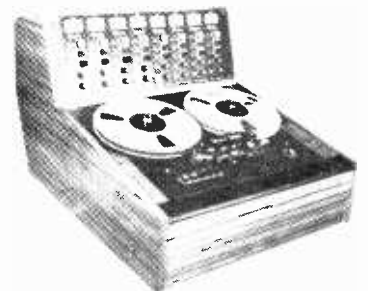

**ITAM**  
4 and 8 channel recorders for studio use. Any tape speed from 1 1/2 ips for logging and data recording

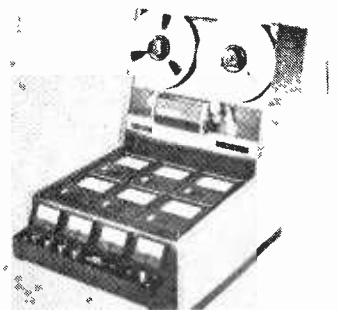

**OTARI**  
Duplicating equipment for high speed cassette copying, including the DP4050 model - the world's finest in-cassette copier, with 6 slave units.

# Z & I AERO SERVICES LTD.

Head Office: 44A WESTBOURNE GROVE, LONDON W2 5SF  
Tel.: 727 5641 Telex: 261306

RETAIL SHOP  
85 TOTTENHAM COURT ROAD, W 1  
Tel 580-8403

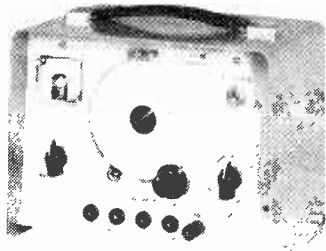

## R.C. OSCILLATOR G3-36A

Made in USSR  
Portable transistorized R-C oscillator providing sinewave and 50/50 squarewave. Four separate output sockets give attenuation ratio of 1/10, 1/100 and 1/1000. Output 0-5 volts R.M.S. Frequency range 20Hz-200KHz in four bands. Output impedance 600Ω for sinewave and 4000Ω for squarewave. Harmonic distortion 1-2%. Power supplies 200-240V AC.  
Price **£37.00**  
Packing and delivery **£2.00**  
(VAT 8% to be added to the above figure)

## TAUT SUSPENSION MULTIMETERS

Made in USSR



TYPE	U4313	U4315
Sensitivity D C	20,000 Ω p v	20,000 Ω p v
Sensitivity A C	2,000 Ω p v	2,000 Ω p v
D C Current	60 μA-1.5A	50 μA-2.5A
A C Current	0.6mA-1.5A	0.5mA-2.5A
D C Volts	75mV-600V	75mV-1000V
A C Volts	15V-600V	1V-1000V
Resistance	1K-1M	300Ω-500kΩ
Capacity	0.5 μF	0.5 μF
Accuracy	1.5% D C 2.5% A C	2.5% D C 4% A C

Price complete with pressed steel carrying case and test leads. Packing and postage

	<b>£17.50</b>	<b>£15.85</b>
	<b>£1.50</b>	<b>£1.50</b>
	Plus VAT at 8%	

### FULLY GUARANTEED



### VALVES

0A2	0.55	6J5GT	0.80	EY51	0.60	PL802	2.80
0A3	0.75	6J6	0.55	EY81	0.50	PY31	0.50
0B2	0.60	6L6GT	0.85	EY87	0.50	PY33	0.63
0C3	0.75	6SL7GT	0.70	EY88	0.55	PY80	0.60
1B3GT	0.65	6SN7GT	0.70	EY900A	1.50	PY81	0.70
1R5	0.50	12AL5	0.65	EZ80	0.50	PY82	0.55
1X2B	1.20	12AT5	0.55	EZ81	0.50	PY83	0.70
5R4CY	1.10	12AT6	0.60	KT66	4.50	PY88	0.75
5U4G	0.60	12AT7	0.50	KT88	5.80	PY500A	1.30
5U4G8	0.95	12AU6	0.65	PC86	0.85	TT21	7.80
5V4G	0.60	12AU7	0.47	PC88	0.85	TT22	7.80
5Y3GT	0.65	12AV6	0.85	PC92	0.85	UA8C80	0.58
5Z4GT	0.65	12AV7	1.00	PC96	0.50	UAF41	0.80
6A84	0.55	12AX7	0.55	PC97	0.95	UAF42	0.70
6A5	0.65	12AY7	0.85	PC98A	0.50	UBC41	0.70
6A5S	0.55	12BA6	0.65	PC98S	0.60	UBC41	0.70
6AL5	0.40	12BE6	0.80	PC989	0.75	UBF80	0.60
6AL5	0.40	12BE6	0.80	PC989	0.75	UBF89	0.60
6AM6	0.70	12BH7	0.75	PC989	1.00	UBF89	0.60
6AS5	0.75	12X4	0.50	PCF80	0.65	UCB84	0.75
6AS8	1.00	19A05	0.75	PCF82	0.45	UCB85	0.55
6AT6	0.75	35A3	0.70	PCF84	0.65	UCF80	0.75
6AV6	0.75	35S5	0.65	PCF201	1.10	UCH81	0.65
6AV6	0.75	35S5	0.70	ECF801	0.95	EL36	0.95
6AW8A	0.75	35W4	0.70	ECF802	0.95	EL41	0.80
6AU6	0.50	50C5	1.00	ECM42	1.10	EL81	0.65
6AV6	0.75	50C5	1.00	ECH81	0.55	EL82	0.60
69A6	0.45	EAC80	0.55	ECH83	0.60	EL83	0.60
69A6	0.45	EAF42	0.70	ECH84	0.55	EL84	0.45
69E6	0.48	EAF801	0.70	ECH200	0.80	EL86	0.75
69J6	1.20	EAF801	0.70	ECL80	0.60	EL95	0.70
69N6	0.80	EBC41	0.75	ECL81	0.75	EL504	0.80
69Z6	0.60	EBC31	0.70	ECL82	0.60	EM80	0.65
69Z7	0.70	EBF80	0.50	ECL83	1.15	EM81	0.60
6C4	0.55	EBF83	0.50	ECL84	0.70	EM83	0.50
6C8B	0.55	EBF89	0.45	ECL85	0.65	EM84	0.60
6C06	2.20	EC06	0.75				
66K5	0.70	EC08	0.75				
66K6	0.90	EC91	2.80				
6J4	1.20	ECC84	0.60				

All prices are exclusive of VAT [12%] PL504 1.05 UY85 0.60 PL508 1.30

When ordering by post please add (unless otherwise indicated) 30p in £ for packing and postage, plus appropriate rate of VAT

Minimum order charge for approved credit customers is £20.00. Any order below £20.00 (before VAT) should be accompanied by remittance

Minimum transaction charge for cash order, regardless of the value of goods is £1.00

Our new 1978 Catalogue is now ready. Please send P.O. or stamps for 30p for your copy

WW—083 FOR FURTHER DETAILS

## MARCONI TEST EQUIPMENT

MARCONI TF1064B/5 VHF Signal Generator  
TF455E Wave analyser. New **£135**  
TF1101 RC oscillators. **£65**  
TF1099 20MHz sweep generators  
TF1041B & C VT Voltmeters  
TF1102 Amplitude modulator. 500MHz  
TF1020A Power meter. 100W. 250MHz **£85**  
TF1152A/1 Power meter. 25W 500MHz **£75**  
TF890A/1 RF test set **£425**  
TF801B/3S Signal generator **£175**  
TF1417 200MHz counter (imperfect)  
TF1400 Pulse generator  
TF675F Pulse generator  
TF1370 Wide-range RC oscillator **£125**  
TF2904 Colour gain delay test set  
TF1058 UHF/SHF signal generator  
TF 995A/4 AM/FM signal generator  
TF1066 AM/FM signal generator.

ZENITH 8 AMP VARIACS **£28.50** (carr. 150p)

### ADVANCE CONSTANT VOLTAGE TRANSFORMERS

Input 190-260V AC Output constant 220 Volts. 250W **£25** (£2 carriage)

### POLARAD TYPE TSA. SPECTRUM ANALYSER. C/w type STU/2M plug-in unit covering from 950 to 4500 MHz

### EVER-READY NICKEL CADMIUM BATTERIES

Size 'F' 7 OAH. 1.24 Volts **£2.75** (post 25p)

### POWER SUPPLIES

ADVANCE PM51 0-30V @ 5 Amps **£36**  
ADVANCE PMA20 0-7V @ 20 Amps **£39**  
Both brand new, boxed, with book  
APT 10459/11. 10-15V @ 7.5A **£25**  
APT 10459/13. 24V (var) 5A **£25**  
(All items + £1 carr.)

### BECKMAN TURNS COUNTER DIALS

Miniature type (22mm diam.) Counting up to 15 turn 'Helipot'. Brand new with mounting instructions. Only **£2.50** each  
Wandel & Gotterman Equipment  
Level Meter 0-2-1600KHz  
Level Oscillator 0-2-1600KHz  
Level Transmitter. 3-1350 KHz  
Carrier Frequency Level Meter

## P. F. RALFE ELECTRONICS

10 CHAPEL STREET, LONDON, NW1  
TEL: 01-723 8753

### TEST EQUIPMENT

LEADER TV FM Sweep and marker generator  
ADVANCE HR100 X-Y Recorder **£105.00**  
HEWLETT-PACKARD 302A Wave-Analyser.  
RACAL type 801R 100mHz digital frequency meter  
TEXSCAN X-Y oscilloscope. 9-inch CRT  
TELETYPE ASR33 now in stock.  
SOLARTRON 1420.2 digital voltmeter. 6 ranges to 1KV  
AIRMEC 254 High-power oscillator/amplifier  
BOONTON 80 Signal generator 2-400MHz **£105**  
BOONTON 230A RF Power Amplifier **£325**  
BPL Capacitance decade (5) CD133 100pf-1uF **£45**  
GERTSCH Frequency meter and deviation meter 20-1000MHz **£250**  
HEWLETT PACKARD 693D sweep oscillator **£350**  
DERRITRON Digital Wheatstone Bridge **£110**  
MUIRHEAD K-134-A Battery op. wave analyser  
PYE EHT scalamp voltmeter 0-40KV **£125**

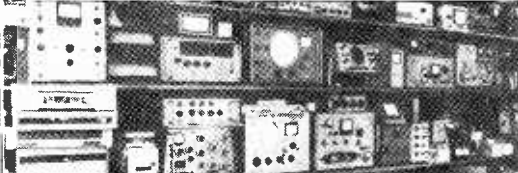

RADIO CORPS PB1 pulse & bar generator **£45**  
SIEMENS Level oscillator 12-160KHz  
SCHOMANDL type FD1 frequency meter **£125**  
Bruel & Kjoer type 3301 Automatic Frequency Response Recorder 200Hz-20KHz  
MUIRHEAD-PAMETRADA D489EM Wave Analyser  
TEKTRONIX 555 scope with plug-ins types CA (2 off) 21 and 22  
TEKTRONIX 545 main frames **£210**. Choice of plug-in units extra

TEKTRONIX 585A oscilloscope with 82 P1 DC-80MHz **£110**  
TEKTRONIX type 180A Time-mark generator  
TELEQUIPMENT D53 Oscilloscope.  
TEKTRONIX 556 50MHz Oscilloscope.

**NOTICE.** All the pre-owned equipment shown has been carefully tested in our workshop and reconditioned where necessary. It is sold in first-class operational condition and most items carry our three months' guarantee. Calibration and certificates can be arranged at cost. Overseas enquiries welcome. Prices quoted are subject to an additional 8% VAT

## RÖHDE & SCHWARZ EQUIPMENT

HUZ Field Strength Meter 47-225MHz  
AMF TV Demodulator 470-790MHz.  
Selective UHF v/meter. bands 4&5. USVF.  
Selectomat RF Voltmeter USWV BN 15221. **£450**  
Standard attenuator 0-100db 0-300 mHz DPR  
UHF Sig gen type SDR 0 3-1 GHz **£750**  
UHF Signal generator type SCH **£175**  
UHF Test receiver type USVD **£325**  
POLYSKOP SWOB I.

### PAPER TAPE READERS

Tally model 1806 **£150**  
NCR with sound-proof case **£55**

### TEKTRONIX TYPE 561A OSCILLOSCOPES

Supplied in first-class condition complete with types 3A1 and 3B3 plug-in units DC-10MHz double-beam 10mV/div. Calibrated sweep delay and single-shot. Time-base 0.5us/div **£350.00**

### MUFFIN INSTRUMENT COOLING FANS

Made by Rotron Holland. These are very high quality, quiet running fans, specially designed for the cooling of all types of electronic equipment. Measures 4.5x4.5x1.5 115V AC 11 Watts. The list price of these is over £10 each. We have a quantity available brand new for only **£4.50** each

### 500V TRANSISTORISED INSULATION TESTER

Lightweight small size (13x7x4cms) Reads insulation from 0.2-100MΩ! at 500V pressure. Runs from standard 9V PP3. Brand new **£16.50**

### TELEVISION MONITORS

Phillips studio quality precision colour monitors and Pye monochrome 405/525/625 lines

PACE ELECTRONICS VARI PLOTTER Type 1100E **£175**

### MUIRHEAD DECADE OSCILLATORS type 890A.

1Hz-110kHz in four decade ranges. Scope monitored output for high accuracy of frequency. Excellent generator.

# the indispensable BIRD43

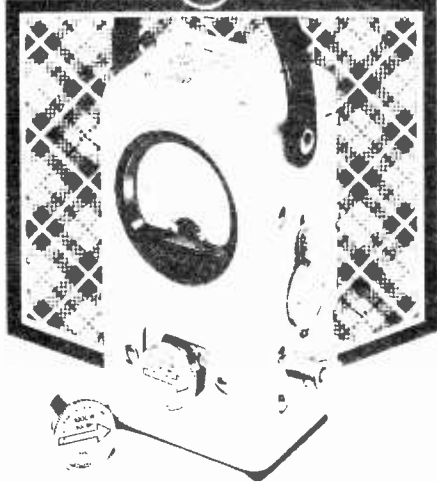

## THRULINE WATTMETER

0.45-2300 MHz / 0.1-10,000 watts

The Standard of the Industry  
What more need we say...

Exclusive UK representative

### aspen electronics limited

2 KILDARE CLOSE, EASTCOTE, MIDDX. HA4 9UW  
TELEPHONE: 01-868 1188 — TELEX 8812727

WW-048 FOR FURTHER DETAILS

## Catronics

### REMOTE CONTROL FOR WW TELETXT DECODER

A modification kit is now available to give Remote Control selection of all functions except setting the time select thumbwheel switches. The Remote Control Unit is housed in a cabinet approx. 6" x 3" x 2" and connected to the main decoder by approx. 5 yds. screened cable.

PRICE ONLY £14.60 + 40p P&P

'Board 3' is also available as an additional unit to update the 'Wireless World' Teletxt Decoder to give double height characters, colour background, conceal/reveal, etc., as described in December and January issues of 'Wireless World'.

Our Kit includes plated-through hole P.C.B., all components and installation instructions. Price £33.68 + VAT (£3.47) + P&P (30p) = £37.45 total. P.C.B. available separately at £19.30.

Our main kits contain all the printed circuit boards and components necessary to build the complete decoder

A reprint of the series of articles is available at £1.50 + large 15p SAE (included free in complete kit)

#### PRICES INCLUDE VAT

Set of 5 PCBs	£23.40	Standard version using 2513	£23.40	Post & Packing	30p
Component Kit (incl. PCBs)	£122.65	New version with Texas X887	£135.40		£1.50
Add-on Unit for lower case PCB	£2.70				
Component Kit (incl. PCB)	£13.75				
Cabinet	£18.00		£18.00		£1.00

PLATED THROUGH hole PCBs for TEXAS version only at additional cost of £25.50

FULL FAULT-FINDING AND REPAIR SERVICE AVAILABLE.

COMPONENTS ALSO AVAILABLE SEPARATELY - SAE for price list

READY BUILT & TESTED DECODERS - £241.87 + £5 Carr.

DE LUXE VERSION WITH NEW FACILITIES - £292.50 + £5 Carr.

### CHARACTER GENERAT., MEMORY, 7400 I.C.S.

TEXAS 74S262N (X887) NOW ONLY £14.50

SIGNETICS 2513 £8.50; NATIONAL 2102/2602 £2.25

7400	19p	7420	19p	7473	40p	74107	52p	74175	£1.30
7402	19p	7421	28p	7474	36p	74121	43p	74177	£1.40
7403	19p	7422	34p	7475	56p	74123	£1.05	74180	£1.30
7404	24p	7428	47p	7483	£1.00	74150	£2.49	74196	£1.62
7406	44p	7430	27p	7486	£1.33	74153	90p	74221	£1.55
7408	26p	7432	38p	7486	35p	74157	90p	75107	£1.82
7410	22p	7440	27p	7490	58p	74164	£1.38	74100	35p
7411	22p	7442	34p	7492	60p	74165	£1.70	74104	44p
7412	27p	7447	£1.00	7493	65p	74174	£1.19	74110	39p

Quantity discount on 7400 Series only:  
Orders over £10 less 10%; over £20 less 20%

THESE PRICES INCLUDE VAT. PLEASE ADD 30p P&P



CATRONICS LTD. (Dept. 826)  
Communications House  
20 WALLINGTON SQUARE  
WALLINGTON, SURREY  
Tel 01-669 6700

WW - 826 FOR FURTHER DETAILS

## RECHARGEABLE BATTERIES

AA pencil (HP7) £1.32, Sub 'C' £1.64 'D' (HP11) £2.43. 'D' (HP2) £3.56. PP3 £4.98. Matching chargers £6.98 each, except PP3 charger £5.82. Charging holders for 2, 3, 4, 5 or 6 pencil cells 50p. 'C' and 'D' size holders. 4 cell only 80p. Prices include VAT. Add 10% post-package and insurance orders under £20 (5% over £20)

SAE for full details plus 75p for 'Nickel Cadmium Power' booklet 250/12 volt inverters now available

Mail orders to

SANDWELL PLANT LTD.

Dept. W/W, 201 Monmouth Drive, Sutton Coldfield  
West Midlands. Tel. 021-354 9764

Callers to T.L.C. 37 Craven Street, Charing Cross, London WC2

WW-062 FOR FURTHER DETAILS

## Audio Connectors

Broadcast pattern jackfields, jackcords, plugs and jacks.

Quick disconnect microphone connectors  
Amphenol (Tuchel) miniature connectors with coupling nut.

Hirschmann Banana plugs and test probes. XLR compatible in-line attenuators and reversers.

Low cost slider faders by Ruf.

### Future Film Developments Ltd.

36-38 Lexington Street  
London W1R 3HR  
01-437 1892/3

WW-023 FOR FURTHER DETAILS

<p>All prices include V.A.T. (Company &amp; packing only) Add extra for overseas. Cash with order only. Discounts over £5 less 5% over £10 less 10% over £25 less 15% over £50 less 20%</p>			<h2>ASTRA-PAK</h2> <p>92 GODSTONE ROAD WHYTELEAF SURREY CR3 0EB</p>										<p>* NEW * FULLY GUARANTEED COMPONENTS * FULL SPEC SEMICONDUCTORS * QUANTITY DISCOUNTS * SEND S.A.E. FOR COMPLETE LIST *</p>									
<h3>BEAD TANTALUM</h3> <p>1 22 33 47 64 100 150 220 330 470 640 1000 1500 2200 3300 4700 6400 10000 15000 22000 33000 47000 64000 100000 150000 220000 330000 470000 640000 1000000 1500000 2200000 3300000 4700000 6400000 10000000 15000000 22000000 33000000 47000000 64000000 100000000 150000000 220000000 330000000 470000000 640000000 1000000000 1500000000 2200000000 3300000000 4700000000 6400000000 10000000000 15000000000 22000000000 33000000000 47000000000 64000000000 100000000000 150000000000 220000000000 330000000000 470000000000 640000000000 1000000000000 1500000000000 2200000000000 3300000000000 4700000000000 6400000000000 10000000000000 15000000000000 22000000000000 33000000000000 47000000000000 64000000000000 100000000000000 150000000000000 220000000000000 330000000000000 470000000000000 640000000000000 1000000000000000 1500000000000000 2200000000000000 3300000000000000 4700000000000000 6400000000000000 10000000000000000 15000000000000000 22000000000000000 33000000000000000 47000000000000000 64000000000000000 100000000000000000 150000000000000000 220000000000000000 330000000000000000 470000000000000000 640000000000000000 1000000000000000000 1500000000000000000 2200000000000000000 3300000000000000000 4700000000000000000 6400000000000000000 10000000000000000000 15000000000000000000 22000000000000000000 33000000000000000000 47000000000000000000 64000000000000000000 100000000000000000000 150000000000000000000 220000000000000000000 330000000000000000000 470000000000000000000 640000000000000000000 1000000000000000000000 1500000000000000000000 2200000000000000000000 3300000000000000000000 4700000000000000000000 6400000000000000000000 10000000000000000000000 15000000000000000000000 22000000000000000000000 33000000000000000000000 47000000000000000000000 64000000000000000000000 100000000000000000000000 150000000000000000000000 220000000000000000000000 330000000000000000000000 470000000000000000000000 640000000000000000000000 1000000000000000000000000 1500000000000000000000000 2200000000000000000000000 3300000000000000000000000 4700000000000000000000000 6400000000000000000000000 10000000000000000000000000 15000000000000000000000000 22000000000000000000000000 33000000000000000000000000 47000000000000000000000000 64000000000000000000000000 100000000000000000000000000 150000000000000000000000000 220000000000000000000000000 330000000000000000000000000 470000000000000000000000000 640000000000000000000000000 1000000000000000000000000000 1500000000000000000000000000 2200000000000000000000000000 3300000000000000000000000000 4700000000000000000000000000 6400000000000000000000000000 10000000000000000000000000000 15000000000000000000000000000 22000000000000000000000000000 33000000000000000000000000000 47000000000000000000000000000 64000000000000000000000000000 100000000000000000000000000000 150000000000000000000000000000 220000000000000000000000000000 330000000000000000000000000000 470000000000000000000000000000 640000000000000000000000000000 1000000000000000000000000000000 1500000000000000000000000000000 2200000000000000000000000000000 3300000000000000000000000000000 4700000000000000000000000000000 6400000000000000000000000000000 10000000000000000000000000000000 15000000000000000000000000000000 22000000000000000000000000000000 33000000000000000000000000000000 47000000000000000000000000000000 64000000000000000000000000000000 100000000000000000000000000000000 150000000000000000000000000000000 220000000000000000000000000000000 330000000000000000000000000000000 470000000000000000000000000000000 640000000000000000000000000000000 1000000000000000000000000000000000 1500000000000000000000000000000000 2200000000000000000000000000000000 3300000000000000000000000000000000 4700000000000000000000000000000000 6400000000000000000000000000000000 10000000000000000000000000000000000 15000000000000000000000000000000000 22000000000000000000000000000000000 33000000000000000000000000000000000 47000000000000000000000000000000000 64000000000000000000000000000000000 100000000000000000000000000000000000 150000000000000000000000000000000000 220000000000000000000000000000000000 330000000000000000000000000000000000 470000000000000000000000000000000000 640000000000000000000000000000000000 1000000000000000000000000000000000000 1500000000000000000000000000000000000 2200000000000000000000000000000000000 3300000000000000000000000000000000000 4700000000000000000000000000000000000 6400000000000000000000000000000000000 10000000000000000000000000000000000000 15000000000000000000000000000000000000 22000000000000000000000000000000000000 33000000000000000000000000000000000000 47000000000000000000000000000000000000 64000000000000000000000000000000000000 100000000000000000000000000000000000000 150000000000000000000000000000000000000 220000000000000000000000000000000000000 330000000000000000000000000000000000000 470000000000000000000000000000000000000 640000000000000000000000000000000000000 1000000000000000000000000000000000000000 1500000000000000000000000000000000000000 2200000000000000000000000000000000000000 3300000000000000000000000000000000000000 4700000000000000000000000000000000000000 6400000000000000000000000000000000000000 100 15000000000000000000000000000000000000000 22000000000000000000000000000000000000000 33000000000000000000000000000000000000000 47000000000000000000000000000000000000000 64000000000000000000000000000000000000000 1000 1500 2200 3300 4700 6400 100 15000 22000 33000 47000 64000 1000 1500 2200 3300 4700 6400 100 15000 22000 33000 47000 64000 1000 1500 2200 3300 4700 6400 100 15000 22000 33000 47000 64000 1000 1500 2200 3300 4700 6400 100 15000 22000 33000 47000 64000 1000 1500 2200 3300 4700 6400 100 15000 22000 33000 47000 64000 100000000</p>																						

The Only Firm for Quality Audio Kits

# HART ELECTRONICS

Are proud to offer the only  
DESIGNER APPROVED kit for the

## J. L. Linsley-Hood High Quality Cassette Recorder

Now offered with Super Quality Sendust Alloy Head at no extra cost, and incorporating noise reduction modifications given in the postscript article.

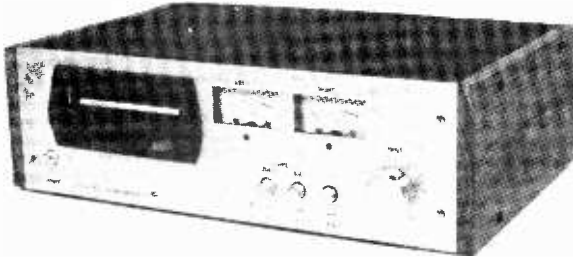

As these circuits are capable of such an excellent performance we feel that it is not sensible to sacrifice this potential by designing a kit down to a price. We have therefore spent a little more on professional hardware allowing us to design a very advanced modular system. This enables a more satisfactory electrical layout to be achieved, particularly around the very critical input areas of the replay preamps. These are totally stable with this layout and require no extra stabilising components. Many other advantages also come from this system which has separate record and replay amps for each channel plugging in to a master board with gold-plated sockets. The most obvious is the reduction of crosstalk and interaction which could cause trouble on a single plane board, with our modular system the layout is compact but there is no component crowding. Testing is very easy with separate identical modules and building with the aid of our component-by-component instructions is childishly simple, but the finished result is a unit designed not to normal domestic standards but to the best professional practice.

All printed circuits are of glassfibre material, fully drilled with a tinned finish for easy and reliable soldering. Component locations are printed on the reverse side of the board and are arranged so that all identification numbers are still visible after assembly.

71x Complete set of parts for Master Board, includes bias oscillator, relay controls etc. £9 83 + £1 23 VAT

72x Parts for Motor Speed and Solenoid Control for Lenco CRV deck. This is the proper board layout as given in the articles. £3 52 + 44p VAT

73x Complete set of parts for stereo Replay Amps and VU Meter drive. £8 12 + £1 02 VAT

74x Complete set for stereo Record Amps. £6 74 + 84p VAT

75x Complete set of parts for Stabilised Power Supply to circuit given in Article. This uses a special low hum field transformer with better characteristics than the commonly used toroid. £8 79 + £1 10 VAT

700M2 Individual High Quality VU Meters with excellent ballistics. £8 48 + £1 06 VAT Per Pair

700C/2 High Quality Custom built steel Case. Complete with Brushed aluminium front plate, mains switch, record microswitch, turned record level knob, plastic cabinet feet, all bolts, nuts and mounting hardware. All necessary holes are punched and all surfaces are electroplated. Complete step-by-step assembly instructions are included. The cover is finished in an attractive black crackle surface. £16 50 + £2 06 VAT

### LENCO CRV CASSETTE MECHANISM — Now fitted with Super Quality Sendust Alloy Head.

High Quality, robust cassette transport for Linsley-Hood recorder. Features fast forward, fast rewind, record pause and full auto stop and cassette ejection facilities. Fitted with Record / play and erase heads and supplied complete with Data and extra cassette ejection spring for above horizontal use. Price £21 60 + £2 70 VAT

Total cost of all parts £83 58

Special offer for Complete Kits £81 50 + £10 19 VAT

Complete with data and set up notes to achieve best results with the Super Head. Optional extra solid teak end cheeks, £3 pair + 38p VAT

Reprint of 3 Linsley Hood Cassette Recorder articles. 45p post and VAT free

### OTHER CASSETTE SPECIALITIES

LENCO MECHANISMS For industrial or domestic use. We have in stock SPFF, FFR and CRV with DC and AC motors. Mini TB500, 502, 504 and Mini TB 'U' for endless loop cassettes. Send for details. Super Quality Sendust Alloy R/P Stereo Head for replacement use. £6 50 + 81p VAT

Set of components and data for optimising L-H Cassette circuits for use with this head. 50p + 6p VAT

Standard Quality Stereo R/P Head. £4 50 + 56p VAT

Economy Cassette Stereo R/P Head. £2 80 + 35p VAT

4-track Cassette R/P Head. £7 40 + 93p VAT

TEST CASSETTE to enable the user without instruments to easily set up the Head. Azimuth, tape speed and VU level. £1 50 inc VAT

Blank Cassettes, reliable mechanics and Super Ferric Low Noise tape. C90 80p inc VAT. C10 35p inc VAT

## Penylan Mill, Oswestry, Salop

Personal callers are always welcome  
but please note we are closed all day Saturday

# TIME PEACE £9.45\*



Not a spelling mistake, but another descriptive term for the National MA1012 complete clock & display module.

Featuring sleep and snooze timers, 24 hour alarm format, fast and slow setting, alarm output switch.

Display area 76 x 20 mm. Total size 3½x8x2 cm.

The MA1012 is non-strobed, with direct drive to the display LEDs, thus causing none of wideband RFI noise associated with earlier clock IC designs. It is suitable for any tuner or radio timing applications, plus all the usual clock applications. Help reduce noise pollution with our MA1012 clock module! The module requires only switches and mains transformer. A suitable 240v AC input transformer is available for £1.50 + 8%vat. Two modules, with two transformers, for £20.00 + 8% VAT.

### REFERENCE SERIES TUNER MODULES

EF5803 2 MOSFET AGC RF stages, with low noise selected MOSFETs, MOS mixer, Buffered local oscillator output for counter and synthesizer purposes, 6 tracked tuned circuits, IF and image < 100dB down. £19.75  
Ref. FMIF Selectable 2 or 3, 6 pole linear phase IF filters, two MOS IF preamps, twin detector coil for 0.07% THD Δf 22.5kHz. Noise mute, deviation mute, adjustable range AFC, meter output. £16.25  
Ref. MPX With the incomparable HA1196 PLL low noise, wide range decoder IC, preamp and LC low pass filter on input, twin LC pilot and base-bandpass filters on the output. With 2 x LM380N ICs for monitor amp purposes available on the board. £16.45

Our other ranges of FM and AM tuner modules available as before

EF5801 17.45 EF5600 12.95 7252 26.50 7122 13.22  
7030 10.95 EC3302U 7.50 7253 26.50 Most also available in kits.  
91196 12.99 8319 11.45 91197 11.35 details in catalogue & price list

COILS FOR LW, MW, SW 1,2, and 3 now listed in catalogue 30 & 33p ea  
TOKO 10k series coils now for 1.5 to 30MHz, giving a total coverage in osc and rf coils

Low cost meters: Internally illuminated edgewise covers 200uA, and back lit flat face meters 200uA. A wide choice of scales - or material to DIY.

Equipment boxes: These must be the best value in ABS (black) equipment boxes with close fitting (flanged) lids. 8x6x4 (cms) 54p ea\*, 10x7.5x4 (cms) 66p ea\*, and 12x10x4.5 (cms) 76p ea\*. Also new stackable component storage boxes and trays.

DETECKNOWLEDGEY: theory and practise of metal locator principles including BFO IB, phase angle, pulse induction. A unique reference for users and constructors. £1.00

Our usual unique range of coils, filters etc for radio: from TOKO; 350,000 in stock. The best in linear ICs for RF, HA1137:£2.20; HA1196:£4.20; HA1197:£1.40, plus all common radio and multiplex devices, audio ICs (TBAB10AS £1.09), MOSFETs, a unique line in varicap diodes for AM tuning :: see the latest catalogue for details. 45p

Postage 25p per order, VAT 12.5% except where otherwise indicated (\*8%). Send to: 2 Gresham Road, Brentwood, Essex. tel (0277) 216029. Only 200m from station!

# ambit international

WW/056 FOR FURTHER DETAILS

## LOWE ELECTRONICS LTD.

119 CAVENDISH ROAD, MATLOCK, DERBYSHIRE

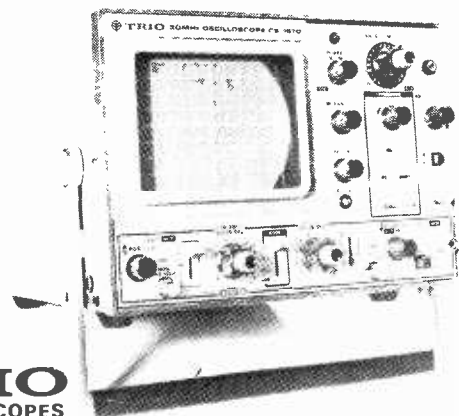

### TRIO OSCILLOSCOPES

The Trio CS1500 series oscilloscopes offer top performance at moderate cost. The specifications show the performance features that have made these oscilloscopes firm favourites in all parts of the world - with a selection of bandwidths to 30 MHz and sensitivities down to 5mV/cm on a 130mm screen. Prices are very realistic and more so when you learn that the price includes two full bandwidth X10/X1 dual purpose probes - normally offered as expensive options. Delivery is even better - ex stock and we intend to keep it that way.

### CS-1570

130mm DUAL TRACE  
TRIGGERED SWEEP  
OSCILLOSCOPE

£430 + 8% VAT  
including two X10  
Full Bandwidth Probes

- 130mm mesh PDA
- DC-30MHz 5mV
- Delay line
- Auto level triggering
- Display modes (CH1 CH2 DUAL ADD)
- Trigger modes (AC LF Rej HF Rej DC)

### ■ SPECIFICATION

Bandwidth DC to 30MHz / 3dB  
Deflection factor 5mV div to 5V div  
Input R/C 1MΩ 24pF  
Risettime 11.7nsec  
Overshoot Better than 3%  
Signal delay 160nsec  
Polarity CH2 can be inverted  
Sweep time 0.2us/div to 0.5s/div  
Magnifier x5  
Linearity Better than 3%  
Calibrator 0.5Vpp 1kHz square wave  
Intensity modulation More than 5Vpp  
Phosphor P.31  
Power AC100 120 220 240V  
50 60Hz 25W  
Dimensions W260 x H190 x D375 (mm)  
Weight 8.5kg

Also available  
CS1560A 15MHz £300 And many more items of Trio Equipment  
CS1562 10MHz £250 55p for full catalogue and price list

TEL. 0629 2430 OR 2817. TELEX 377482 LOWLEC G

WW-064 FOR FURTHER DETAILS

# 15 — 240 Watts!

## HY5 Preamplifier

The HY5 is a mono hybrid amplifier ideally suited for all applications. All common input functions (mag Cartridge, tuner etc.) are catered for internally, the desired function is achieved either by a multi-way switch or direct connection to the appropriate pins. The internal volume and tone circuits merely require connecting to external potentiometers (not included). The HY5 is compatible with all I.L.P. power amplifiers and power supplies. To ease construction and mounting a P.C. connector is supplied with each pre-amplifier.

**FEATURES:** Complete pre-amplifier in single pack — Multi-function equalization — Low noise — Low distortion — High overload — two simply combined for stereo

**APPLICATIONS:** Hi-Fi — Mixers — Disco — Guitar and Organ — Public address

**SPECIFICATIONS:**

**INPUTS:** Magnetic Pick-up 3mV, Ceramic Pick-up 30mV, Tuner 100mV, Microphone 10mV, Auxiliary 3 100mV, input impedance 47k $\Omega$  at 1kHz  
**OUTPUTS:** Tape 100mV, Main output 500mV R.M.S.

**ACTIVE TONE CONTROLS:** Treble  $\pm$  12dB at 10kHz, Bass  $\pm$  at 100Hz

**DISTORTION:** 0.1% at 1kHz, Signal/Noise Ratio 68dB

**OVERLOAD:** 38dB on Magnetic Pick-up, **SUPPLY VOLTAGE:**  $\pm$  16.50V

**Price £5.22 + 65p VAT P&P free**  
 HY5 mounting board B1 48p + 6p VAT P&P free.

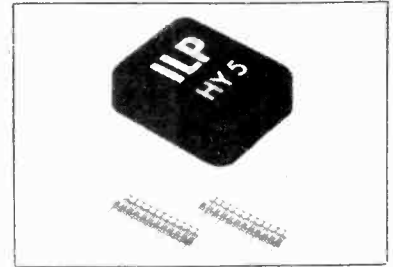

## HY30 15 Watts into 8 $\Omega$

The HY30 is an exciting New kit from I.L.P. it features a virtually indestructible I.C. with short circuit and thermal protection. The kit consists of 1 C, heatsink, P.C. board, 4 resistors, 6 capacitors, mounting kit, together with easy to follow construction and operating instructions. This amplifier is ideally suited to the beginner in audio who wishes to use the most up-to-date technology available.

**FEATURES:** Complete kit — Low Distortion — Short, Open and Thermal Protection — Easy to Build.  
**APPLICATIONS:** Updating audio equipment — Guitar practice amplifier — Test amplifier — Audio oscillator

**SPECIFICATIONS:**

**OUTPUT POWER:** 15W R.M.S. into 8 $\Omega$ , **DISTORTION:** 0.1% at 15W,  
**INPUT SENSITIVITY:** 500mV, **FREQUENCY RESPONSE:** 10Hz-16kHz  $\pm$  3dB  
**SUPPLY VOLTAGE:**  $\pm$  18V

**Price £5.22 + 65p VAT P&P free.**

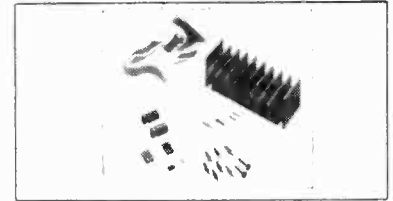

## HY50 25 Watts into 8 $\Omega$

The HY50 leads I.L.P.'s total integration approach to power amplifier design. The amplifier features an integral heatsink together with the simplicity of no external components. During the past three years the amplifier has been refined to the extent that it must be one of the most reliable and robust High Fidelity modules in the World.

**FEATURES:** Low Distortion — Integral Heatsink — Only five connections — 7 Amp output transistors — No external components

**APPLICATIONS:** Medium Power Hi-Fi systems — Low power disco — Guitar amplifier

**SPECIFICATIONS:** **INPUT SENSITIVITY:** 500mV

**OUTPUT POWER:** 25W RMS into 8 $\Omega$ , **LOAD IMPEDANCE:** 4-16 $\Omega$ , **DISTORTION:** 0.04% at 25W at 1kHz  
**SIGNAL/NOISE RATIO:** 75dB, **FREQUENCY RESPONSE:** 10Hz-45kHz  $\pm$  3dB  
**SUPPLY VOLTAGE:**  $\pm$  25V, **SIZE:** 105 50 25mm

**Price £6.82 + 85p VAT P&P free**



## HY120 60 Watts into 8 $\Omega$

The HY120 is the baby of I.L.P.'s new high power range, designed to meet the most exacting requirements, including load line and thermal protection, this amplifier sets a new standard in modular design.

**FEATURES:** Very low distortion — Integral Heatsink — Load line protection — Thermal protection — Five connections — No external components

**APPLICATIONS:** Hi-Fi — High quality disco — Public address — Monitor amplifier — Guitar and organ

**SPECIFICATIONS:**

**INPUT SENSITIVITY:** 500mV  
**OUTPUT POWER:** 60W RMS into 8 $\Omega$ , **LOAD IMPEDANCE:** 4-16 $\Omega$ , **DISTORTION:** 0.04% at 60W at 1 kHz  
**SIGNAL/NOISE RATIO:** 90dB, **FREQUENCY RESPONSE:** 10Hz-45kHz  $\pm$  3dB, **SUPPLY VOLTAGE:**  $\pm$  35V  
**Size:** 114 x 50 x 85mm

**Price £15.84 + £1.27 VAT P&P free.**

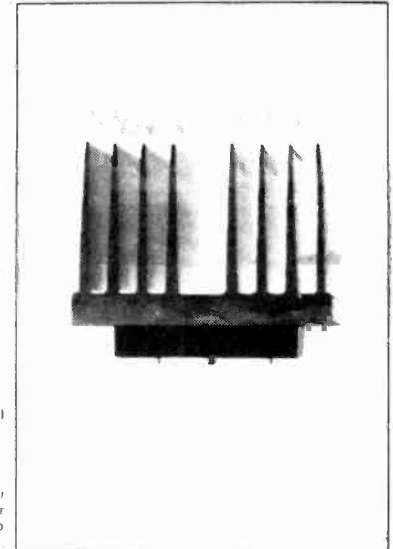

## HY200 120 Watts into 8 $\Omega$

The HY200, now improved to give an output of 120 Watts, has been designed to stand the most rugged conditions, such as disco or group while still retaining true Hi-Fi performance.

**FEATURES:** Thermal shutdown — Very low distortion — Loadline protection — Integral heatsink — No external components

**APPLICATIONS:** Hi-Fi — Disco — Monitor — Power Slave — Industrial — Public address

**SPECIFICATIONS:**

**INPUT SENSITIVITY:** 500mV  
**OUTPUT POWER:** 120W RMS into 8 $\Omega$ , **LOAD IMPEDANCE:** 4-16 $\Omega$ , **DISTORTION:** 0.05% at 100W at 1kHz  
**SIGNAL/NOISE RATIO:** 96dB, **FREQUENCY RESPONSE:** 10Hz-45kHz  $\pm$  3dB, **SUPPLY VOLTAGE:**  $\pm$  45V  
**SIZE:** 114 x 100 x 85mm

**Price £23.32 + £1.87 VAT P&P free.**

## HY400 240 Watts into 4 $\Omega$

The HY400 is I.L.P.'s "Big Daddy" of the range producing 240W into 4 $\Omega$ ! It has been designed for high power disco or public address applications. If the amplifier is to be used at continuous high power levels a cooling fan is recommended. The amplifier includes all the qualities of the rest of the family to lead the market as a true high power hi-fidelity power module.

**FEATURES:** Thermal shutdown — Very low distortion — Load line protection — No external components

**APPLICATIONS:** Public address — Disco — Power slave — Industrial

**SPECIFICATIONS:**

**OUTPUT POWER:** 240W RMS into 4 $\Omega$ , **LOAD IMPEDANCE:** 4-16 $\Omega$ , **DISTORTION:** 0.1% at 240W at 1 kHz  
**SIGNAL/NOISE RATIO:** 94dB, **FREQUENCY RESPONSE:** 10Hz-45kHz  $\pm$  3dB, **SUPPLY VOLTAGE:**  $\pm$  45V  
**INPUT SENSITIVITY:** 500mV, **SIZE:** 114 x 100 x 85mm

**Price £32.17 + £2.57 VAT P&P free.**

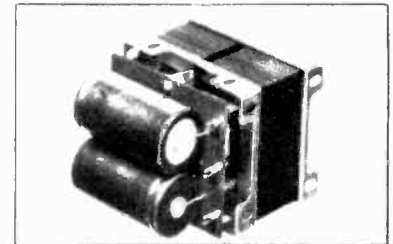

### POWER SUPPLIES

PSU36 suitable for two HY30's **£5.22** plus 65p VAT P. P. free  
 PSU50 suitable for two HY50's **£6.82** plus 85p VAT P. P. free  
 PSU 70 suitable for 2 HY 120's **£13.75** plus £1.10 VAT P. P. free  
 PSU90 suitable for one HY200 **£12.65** plus £1.01 VAT P. P. free  
 PSU180 suitable for two HY200's or one HY400 **£23.10** plus £1.85 VAT P. P. free

48p

TWO YEARS' GUARANTEE ON ALL OF OUR PRODUCTS

I.L.P. Electronics Ltd  
 Crossland House  
 Nackington, Canterbury  
 Kent CT4 7AD  
 Tel (0227) 63218

Please Supply \_\_\_\_\_  
 Total Purchase Price \_\_\_\_\_  
 I Enclose Cheque  Postal Orders  Money Order   
 Please debit my Access account  Barclaycard account   
 Account number \_\_\_\_\_  
 Name & Address \_\_\_\_\_  
 Signature \_\_\_\_\_



# NEW PRODUCTS!

## NRDC-AMBISONIC UHJ



### SURROUND SOUND DECODER

The **first ever** kit specially produced by Integrex for this British NRDC backed surround sound system which is the result of 7 years' research by the Ambisonic team. W.W. July, Aug., '77.  
 The unit is designed to decode not only UHJ but virtually all other 'quadrophonic' systems (Not CD4), including the new BBC HJ 10 input selections.  
 The decoder is linear throughout and does not rely on listener fatiguing logic enhancement techniques. Both 2 or 3 input signals and 4 or 6 output signals are provided in this most versatile unit. Complete with mains power supply, wooden cabinet, panel, knobs, etc.

Complete kit, including licence fee **£45.00 + VAT**  
 or ready built and tested **£61.50 + VAT**

### INTRUDER 1 RADAR ALARM



**With Home Office Type approval**

As in "Wireless World", designed by Mike Hosking, 240V ac mains operated and disguised as a hardbacked book. Detection range up to 30 feet.

Complete exclusive designer approved kit **£46.00 + VAT**  
 or ready built and tested, **£54.00 + VAT**

## Wireless World Dolby<sup>TM</sup> noise reducer

Trademark of Dolby Laboratories Inc.

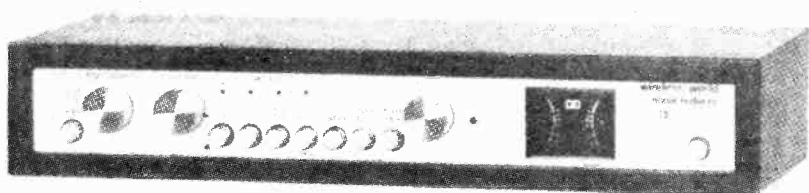

#### Featuring

- switching for both encoding (low-level h.f. compression) and decoding
- a switchable f.m. stereo multiplex and bias filter.
- provision for decoding Dolby f.m. radio transmissions (as in USA).
- no equipment needed for alignment.
- suitability for both open-reel and cassette tape machines.
- check tape switch for encoded monitoring in three-head machines.

#### Typical performance

Noise reduction better than 9dB weighted  
 Clipping level 16.5dB above Dolby level (measured at 1% third harmonic content)

Harmonic distortion 0.1% at Dolby level typically  
 0.05% over most of band, rising to a maximum of 0.12%

Signal-to-noise ratio: 75dB (20Hz to 20kHz, signal at Dolby level) at Monitor output

Dynamic Range >90dB

30mV sensitivity

Complete Kit **PRICE: £39.90 + VAT**

Also available ready built and tested

**Price £54.00 + VAT**

Calibration tapes are available for open-reel use and for cassette (specify which) **Price £2.20 + VAT**

Single channel plug-in Dolby<sup>TM</sup> PROCESSOR BOARDS (92 x 87mm) with gold plated contacts are available with all components **Price £8.20 + VAT**

Single channel board with selected fet **Price £2.50 + VAT**

Gold Plated edge connector **Price £1.50 + VAT**

Selected FETs **60p** each + VAT, **100p** + VAT for two, **£1.90** + VAT for four

Please add VAT @ 12½% unless marked thus\*, when 8% applies (or current rates)

We guarantee full after-sales technical and servicing facilities on all our kits, have you checked that these services are available from other suppliers?



# INTEGREX LTD.

Please send SAE for complete lists and specifications  
**Portwood Industrial Estate, Church Gresley,  
 Burton-on-Trent, Staffs DE11 9PT  
 Burton-on-Trent (0283) 215432 Telex 377106**



# INTEGREX

## S-2020TA STEREO TUNER/AMPLIFIER KIT

**SOLID MAHOGANY CABINET**

*A high-quality push-button FM Varicap Stereo Tuner combined with a 24W r.m.s. per channel Stereo Amplifier.*



**Brief Spec.** Amplifier Low field Toroidal transformer, Mag. input, Tape In/Out facility (for noise reduction unit, etc.), THD less than 0.1% at 20W into 8 ohms. Power on/off FET transient protection. All sockets, fuses, etc., are PC mounted for ease of assembly. Tuner section uses 3302 FET module requiring no RF alignment, ceramic IF, INTERSTATION MUTE, and phase-locked IC stereo decoder. LED tuning and stereo indicators. Tuning range 88—104MHz. 30dB mono S/N @ 1.2 $\mu$ V. THD 0.3%. Pre-decoder 'birdy' filter.

**PRICE: £58.95 + VAT**

## NELSON-JONES STEREO FM TUNER KIT

*A very high performance tuner with dual gate MOSFET RF and Mixer front end, triple gang varicap tuning, and dual ceramic filter/dual IC IF amp.*

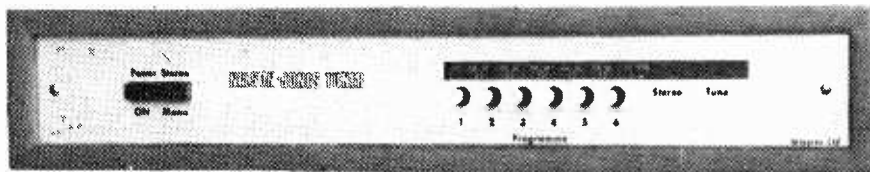

**Brief Spec.** Tuning range 88—104MHz. 20dB mono quieting @ 0.75 $\mu$ V. Image rejection — 70dB. IF rejection — 85dB. THD typically 0.4%.

IC stabilized PSU and LED tuning indicators. Push-button tuning and AFC unit. Choice of either mono or stereo with a choice of stereo decoders.

*Compare this spec. with tuners costing twice the price.*

**Mono £32.40 + VAT**

**With ICPL Decoder £36.67 + VAT**

**With Portus-Haywood Decoder  
£39.20 + VAT**



Sens. 30dB S/N mono @ 1.2 $\mu$ V  
THD typically 0.3%  
Tuning range 88—104MHz  
LED sig. strength and stereo indicator

## STEREO MODULE TUNER KIT

*A low-cost Stereo Tuner based on the 3302 FET RF module requiring no alignment. The IF comprises a ceramic filter and high-performance IC Variable INTERSTATION MUTE. PLL stereo decoder IC. Pre-decoder 'birdy' filter Push-button tuning*

**PRICE: Stereo £31.95 + VAT**



## S-2020A AMPLIFIER KIT

*Developed in our laboratories from the highly successful "TEXAN" design. PC mounting potentiometers, switches, sockets and fuses are used for ease of assembly and to minimize wiring*

*Power 'on/off' FET transient protection.*

**Typ Spec.** 24+24W r.m.s. into 8-ohm load at less than 0.1% THD. Mag. PU input S/N 60dB. Radio input S/N 72dB. Headphone output. Tape In/Out facility (for noise reduction unit, etc.). Toroidal mains transformer.

**PRICE: £33.95 + VAT**

**ALL THE ABOVE KITS ARE SUPPLIED COMPLETE WITH ALL METALWORK, SOCKETS, FUSES, NUTS AND BOLTS, KNOBS, FRONT PANELS, SOLID MAHOGANY CABINETS AND COMPREHENSIVE INSTRUCTIONS**

BASIC NELSON-JONES TUNER KIT	£14.28 + VAT	PHASE-LOCKED IC DECODER KIT	£4.47 + VAT
BASIC MODULE TUNER KIT (stereo)	£16.75 + VAT	PUSH-BUTTON UNIT	£5.00 + VAT
PORTUS-HAYWOOD PHASE-LOCKED STEREO DECODER KIT			£8.00 + VAT

**DRAKE** Radio Shack Ltd

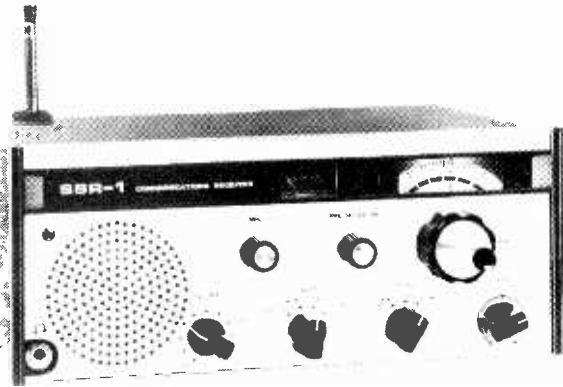

**DRAKE SSR-1  
GENERAL COVERAGE RECEIVER  
0.5-30MHZ 30 BANDS  
10KHZ READOUT**

**£149.85** ACCESS OR BARCLAYCARD  
Details 15p stamps or 4 I.R.C. Foreign

AS WELL AS DRAKE EQUIPMENT WE ARE THE DIRECT IMPORTERS OF HAL  
RTY AND MICROPROCESSORS ATLAS, NYE MORSE KEYS, PRESTEL VHF/UHF  
PROFESSIONAL FIELD STRENGTH METERS, HAM RADIO CIR ASTRO 200  
HY-GAIN, CDR ROTORS, HUSTLER, OMEGA-T SYSTEMS, MFJ FILTERS AND  
SPEECH PROCESSORS, SUPPREX, WE ALSO STOCK SHURE MICROPHONES  
YAESU MICROWAVE MODULES, SOLID STATE MODULES, ICOM COPAL  
CLOCKS, G-WHIPS, BANTEK, MOSLEY DAIWA, ASAHY JAYBEAM DECCA AND  
THE USUAL ACCESSORIES—COAX CONNECTORS, INSULATORS, VALVES Etc.  
We are situated just around the corner from West Hampstead Underground Station  
(Bakerloo line). A few minutes walk away is West Hampstead Midland Region station  
and West End Lane on the Broad Street Line. We are on the following Bus Routes  
28 59 159. Hours of opening are 9.5 Monday to Friday. Closed for Lunch 1-2  
Saturday. We are open 9-12.30 only. World wide exports.

DRAKE \* SALES \* SERVICE

**RADIO SHACK LTD.**

188 BROADHURST GARDENS, LONDON NW6 3AY  
Giro Account No. 588 7151. Telephone: 01-624 7174. Cables: Radio Shack,  
London, N.W.6. Telex: 23718

**SINCLAIR PRODUCTS\***  
PDM35 digital multimeter £25.95 Mains adaptor  
£3.24 Deluxe padded carry case £3.25 30kV  
probe £18.36 New DM235 digital meter 10 A  
Cambridge scientific programmable calculator  
£13.15 Prog. library £4.65 Mains adaptor  
£3.20

**CUT PRICE TELETEXT**  
**Texas Instruments XM11** tifax module £120  
**Labgear 7026** ready to use attractively cased  
complete unit. Plugs into TV aerial socket. Full  
colour. Remote control page select £323

**TV GAMES KITS**  
Send SAE for free data. Tank battle chip AY 3  
8710 plus economy kit £17.95 Stunt motor/cycle  
chip AY-3-8760-1 plus economy kit £17.95 10  
game paddle 2 chip AY-3-8600 plus economy kit  
£14.70 AY-3-8500 chip plus economy kit £8.95  
Modified shoot kit £4.95 Rifle kit £4.95 Colour  
generator kit £7.50 Joystick controls £1.90  
4.43MHz pal crystals 90p

**ASSEMBLED TV GAMES**  
All attractively cased. 4 game black and white  
model (tennis, football, squash and pelota)  
£11.95 6 game colour model with pistol  
attachment £21.95 Tank battle game £39.95  
Stunt motor cycle game £39.95 Stabilized mains  
adaptor for all games £3.10

**MAINS TRANSFORMERS**  
6.0-6V 100ma 79p 1 1/2a £2.35 6.3V 1 1/2a  
£1.89 9.0-9V 75ma 79p 1a £1.99 2a £2.60  
12.0 12V 50ma 79p 100ma 90p 1a £2.49  
13V 1/2a 95p 15.0-15V 1a £2.79 30.0-30V 1a  
£3.59

**JC12, JC20 AND JC40 AMPLIFIERS**  
A range of integrated circuit audio amplifiers  
supplied with free data and printed circuits. JC12  
6 watts £1.60 JC20 10 watts £2.95 JC40 20  
watts £4.20 Send SAE for free data on our range  
of matching power and preamp kits

**FERRANTI ZN414**  
IC radio chip £1.05 Extra parts and pcb for radio  
£3.85 Case £1 Send SAE for free data

**PRINTED CIRCUIT MATERIALS**  
PC etching kits Economy £1.70 Standard £3.82  
50 sq ins pcb 40p 1 lb FeCl £1.05 Etch resist  
pens Economy 45p Dalo 73p Small drill bit 20p  
Etching dish 68p Laminator cutter 75p

**BATTERY ELIMINATOR BARGAINS**  
**TV games power unit** stabilized 7.7V 100ma  
£3.10 **3-way models** with switched output and  
4-way multi-jack 3.4V 6V 100ma £2.92  
6.7V 9V 300ma £3.30 100ma radio models  
same size as a PP9 battery with press stud  
connectors 9V £2.85 6V £2.85 4 1/2V £2.85  
9V+9V £4.50 6V+6V £4.50 4 1/2V+4 1/2V  
£4.50 **Cassette recorder mains unit** 7 1/2V  
100ma with 5 pin din plus £2.85 **Fully**  
**stabilized model** switched output 3.6V 7 1/2V 9V  
400 ma £3.40 **Car converters** 12V dc input  
output 9V 300ma £1.50 Output 7 1/2V 300ma  
£1.50

**BATTERY ELIMINATOR KITS**  
Send SAE for free leaflet on range. **100ma radio**  
**types** with press stud connectors 4 1/2V £1.80 6V  
£1.80 9V £1.80 4 1/2+4 1/2V £2.50 6+6V  
£2.50 9+9V £2.50 **Cassette type** 7 1/2V 100ma  
with din plug £1.80 **Transistor stabilized**  
**8-way types** for low hum 3.4V 6.7V 9.12V  
15V 18V 100ma £3.20 1Amp £6.40 **Heavy-**  
**duty 13 way types** 4 1/2V 6.7V 8V 11V 13V 14V  
17V 21V 25V 28V 34V 42V 1Amp £4.65 2Amp  
£7.25 **Car converter kit** input 12V dc output  
6.7V 9V 1A stabilized **Stabilized power kits**  
3.18V 100ma £3.60 3.30V 1A £9.95 3.30V 2A  
£14.95

**S-DECS AND T-DECS\***  
S-DeC £2.23 T-DeC £3.98 u-DeCa £3.97  
u-DeCb £6.67 16 dl or 10T05 adaptors with  
socket £1.91 plain 99p New 5 de kit £4.95

**CONTINENTAL SPECIALITIES PRODUCTS\***  
EXP300 £6.21 EXP350 £3.40 EXP600 £6.80  
EXP650 £3.89 EXP48 £2.48 PB6 £9.94  
PB100 £12.74 LM1 £30.99 LP1 £33.48  
LP2 £19.44

**BIPAK AUDIO MODULES**  
Send SAE for data. S450 tuner £23.51 AL60  
L4.86 PA100 £16.71 SPM80 £4.47 BMT80  
F5.95 MK60 £38.74 Stereo 30 £20.12

**COMPONENTS**  
**Resistors** 5% carbon £12.10 to 10M 1/4W 1p  
1W 2p **Polyester capacitors** 250V E6 01 to  
068mF 3 1/2p 0.1mf 2p 15mf 5p 22mf 4p  
33 47mf 6p **Polystyrene capacitors** £12.63V  
15pF to 6800pF 2 1/2p **Ceramic capacitors** 50V  
£12.22pF to 1000pF 2 1/2p E6 1500pF to 47000pF  
2 1/2p **Mylar capacitors** 100V 001 003  
005mf 4p 01 02mf 4 1/2p 04 05mf 5 1/2p  
**Electrolytic 50V** 47 1 2mf 5p **25V 5mf 5p**  
10mf 4p **16V 22mf 5p** 33 47 100mf 6p 220  
330mf 9p 470mf 11p 1000mf 8 1/2p **Zeners**  
400mV £24.2V 7 to 33V 79p **Preset pots**  
sub miniature 0.1W 10k or vert 100 to 4M 7  
8 1/2p **Potentiometers** 1/4W 4K7 to 2M2 log or  
1in single 28p dual 76p

**SWANLEY ELECTRONICS**

DEPT. WWW, PO BOX 68, 32 GOLDSL ROAD, SWANLEY, KENT BR8 8TQ  
Mail order only. Please add 30p to total cost of order for postage. Prices include VAT. Overseas  
customers deduct 7% on items marked and 11% on others. Official credit orders welcome.

**£100 off**  
this super Hi-Fi system the  
**MATSI TFS60**  
from the **£3 off**

**Lion House**  
**BUDGET HI-FI DEPARTMENT**

You can now purchase this fantastic Hi-Fi system complete for only  
£152.00 at what must be a fraction of its value today.  
System consists of:—the famous MATSI TFS60 Tuner/AMP; a really  
top quality receiver from one of Japan's leading manufacturers, 15  
watts per channel FM/MW/LW, two LH6 speakers fitted with AR  
units and a Goldring belt-drive turntable with magnetic cartridge  
complete with an attractive plinth & cover of ultra modern design.  
Leads, etc. supplied free.  
**LION PRICE: Complete MATSI System £152.00**  
or purchased individually:  
**TF60 Receiver: £69.90. LH6 Twin Speakers £55.**  
**Goldring Turntable (cartridge Plinth & Cover) £29.95**

Leading suppliers of TELEVISIONS, RADIOS, TAPE RECORDERS, BUDGET HI-FI, CASSETTE  
RECORDERS, TUNERS, AMPLIFIERS, TUNER, AMPS, VIDEO and MUSIC CENTRES and  
ACCESSORIES EXPORT TELEVISIONS and MUSICAL INSTRUMENTS. ALL AT KEEN PRICES.



**Lion House**

THE BEST for the world's top Hi-Fi music  
LONDON'S HI-FI SUPERSTORE  
107/108 NORTHAMPTON ROAD, LONDON W1  
Tel: 01 582 7483 and 01 637 1601  
Telex: 283941 LON G  
Open 10.00 to 6.00 Monday to Saturday (Thursday until 7 pm)

WW—032 FOR FURTHER DETAILS

**DATEST 1  
TRANSISTOR AND  
OP. AMP. TESTER**

**Simplifies semiconductor testing  
Saves time and errors**

- \* Tests are automatic and unambiguous
- \* Tests devices in and out of circuit
- \* Handles bipolars, FETs (all types) LEDs diodes op  
amps (out of circuit only)
- \* Automatically displays device polarity and, for devices  
out of circuit, device type
- \* Checks for gain, leakage, input offset

Price, including test probes, full instructions and delivery  
(UK only) £49 plus VAT (8%) Data sheet on request

**DATONG ELECTRONICS LIMITED**  
Spence Mills, Mill Lane, Bramley, Leeds LS13 3HE  
Telephone: Pudsey (0532) 552461

WW—021 FOR FURTHER DETAILS

**TELERADIO SPECIALISTS IN DESIGNS by John Linsley Hood**

Example 25 to 75 watt Very Low Distortion HIGH FIDELITY  
STEREO AMPLIFIER D.C Coupled T.H.D. hardly  
measurable. £73 in kit form (+ 1 1/2% VAT)

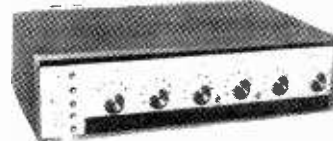

PP extra  
£2.50

Supplied as a Kit of parts or in ready assembled module form

Also available Phase Locked Loop, FM Tuner, Millivoltmeter,  
Audio Signal Generators, TH Analyser, FM  
Signal Generator, Wobbulator

Send SAE for comprehensive illustrated lists and up-to-date prices

**TELERADIO ELECTRONICS**  
325 Fore Street, Edmonton, London N9 0PE

Telephone: 01-807 3719 Closed Thursdays

# BOOKS AND COMPONENTS

## BOOKS BY BABANI

Purchase books to the value of £5.00 from the list below and choose any 60p pak from this page **FREE**

BP2	Handbook of Radio, TV & Industrial & Transmitting Tube & Valve Equivalents	60p†
BP3	Handbook of Tested Transistor Circuits	40p†
BP6	Engineers and Machinists Reference Tables	40p†
BP7	Radio & Electronic Colour Codes Data	15p†
BP10	Modern Crystal and Transistor Set Circuits for beginners	95p†
BP16	Construction Manual of Electronic Circuits for the Home	50p†
BP16	Handbook of Electronic Circuits for the Amateur Photographer	60p†
BP18	Boys and Beginners Book of Practical Radio and Electronics	60p†
BP22	79 Electronic Novelty Circuits	75p†
BP23	First book of Practical Electronic Projects	75p†
BP24	52 Projects Using IC741 (or equivalents)	75p†
BP26	Radio Antenna Handbook for Long Distance Reception and Transmission	85p†
BP27	Giant Chart of Radio Electronic Semiconductor and Logic Symbols	60p†
BP29	Major Solid State Audio Hi-Fi Construction	85p†
BP32	How to Build Your Own Metal & Treasure Locators	85p†
BP34	Practical Repair & Renovation of Colour TVs	95p†
BP35	Handbook of IC Audio Pre-amplifier & Power Amplifier Construction	95p†
BP36	50 Circuits Using Germanium, Silicon & Zener Diodes	75p†
BP37	50 Projects Using Relays, SCRs and TRIACS	1.10†
BP39	50 (FET) Field Effect Transistor Projects	1.25†
129	Universal Gram-motor Speed Indicator	8p†
150	Coil Design and Construction Manual	75p†
161	Radio, TV and Electronics Data Book	60p†
196	AF-RF Reactance — Frequency Chart for Constructors	15p†
202	Handbook of Integrated Circuits (ICs) Equivalents and Substitutes	75p†
205	First Book of Hi-Fi Loudspeaker Enclosures	75p†
213	Electronic Circuits for Model Railways	85p†
214	Audio Enthusiasts Handbook	85p†
216	Electronic Gadgets and Games	85p†
217	Solid State Power Supply Handbook	85p†
219	Solid State Novelty Projects	85p†
220	Build Your Own Solid State Hi-Fi and Audio Accessories	85p†
222	Solid State Short Wave Receivers for Beginners	95p†
223	50 Projects Using IC CA3130	95p†
224	50 CMOS IC Projects	95p†
225	A Practical Introduction to Digital ICs	95p†
226	How to Build Advanced Short Wave Receivers	1.20†
RCC	Resistor Colour Code Disc Calculator	10p†

## BOOKS BY NEWNES

No 229	Beginners Guide to Electronics	Price £2.25†
No 230	Beginners Guide to Television	Price £2.25†
No 231	Beginners Guide to Transistors	Price £2.25†
No 233	Beginners Guide to Radio	Price £2.75†
No 234	Beginners Guide to Colour Television	Price £2.25†
No 235	Electronic Diagrams	Price £1.80†
No 236	Electronic Components	Price £1.08†
No 237	Printed Circuit Assembly	Price £1.08†
No 238	Transistor Pocket Book	Price £3.90†
No 225	110 Thyristor Projects Using SCRs & Triacs	Price £2.50†
No 227	110 COS/MOS Digital IC Projects for the Home Constructor	Price £2.25†
No 226	110 Operational Amplifier Projects for the Home Constructor	Price £2.50†
No 242	Electronic Pocket Book	Price £3.90†
No 239	30 Photoelectric Circuits & Systems	Price £1.80†

## NUTS AND BOLTS

**BA BOLTS** — packs of BA threaded cadmium plated screws slotted, cheese head

Supplied in multiples of 50

Type	No.	Price	Type	No.	Price
1/16in 08A	839	£1.20	1/16in 48A	846	£0.32
1/16in 08A	840	£0.75	1/16in 48A	847	£0.25
1/16in 28A	842	£0.65	1/16in 68A	848	£0.40
1/16in 28A	843	£0.45	1/16in 68A	849	£0.21
1/16in 28A	844	£0.52	1/16in 68A	850	£0.25
1/16in 48A	845	£0.44			

**BA NUTS** — packs of cadmium plated full nuts in multiples of 50.

Type	No.	Price	Type	No.	Price
08A	855	£0.72	48A	857	£0.30
28A	856	£0.48	68A	858	£0.24

**BA WASHERS** — flat cadmium plated plain stamped washers supplied in multiples of 50.

Type	No.	Price	Type	No.	Price
08A	859	£0.14	48A	861	£0.12
28A	860	£0.12	68A	862	£0.12

**SOLDER TAGS** — hot tinned, supplied in multiples of 50.

Type	No.	Price	Type	No.	Price
08A	851	£0.40	48A	853	£0.22
28A	852	£0.28	68A	854	£0.22

## SWITCHES

Description	No.	Price
DPDT miniature slide	1973	£0.10*
DPDT standard slide	1974	£0.12*
Toggle switch SPST		
1 1/2 amp 250V a.c.	1975	£0.33*
Toggle switch DPDT		
1 amp 250V a.c.	1976	£0.36*
Rotary on-off mains switch	1977	£0.42*
Push switch — Push to make	1978	£0.13*
Push switch — Push to break	1979	£0.18*

ROCKER SWITCH	Colour	No.	Price
A range of rocker switches	RED	1980	£0.26*
SPST — moulded in high insulation material available in a choice of colours, ideal for small apparatus	BLACK	1981	£0.26*
	WHITE	1982	£0.26*
	BLUE	1983	£0.26*
	YELLOW	1984	£0.26*
	LUMINOUS	1985	£0.22*

Description	No.	Price
Miniature SPST toggle. 2 amp 250V a.c.	1958	£0.50*
Miniature SPST toggle. 2 amp 250V a.c.	1959	£0.55*
Miniature DPDT toggle. 2 amp 250V a.c.	1960	£0.70*
Miniature DPDT toggle, centre off. 2 amp 250V a.c.	1961	£0.85*
Push button SPST. 2 amp 250V a.c.	1962	£0.78*
Push button SPST. 2 amp 250V a.c.	1963	£0.83*
Push button DPDT. 2 amp 250V a.c.	1964	£0.98*

**MIDGET WAFER SWITCHES**  
Single bank wafer type — suitable for switching at 250V a.c. 100mA or 150V d.c. in non-reactive loads make-before-break contacts. These switches have a spindle 0.25in dia. and 30° indexing

Description	Order No.	Price
1 pole 12 way	1965	£0.48*
2 pole 6 way	1966	£0.48*
3 pole 4 way	1967	£0.48*
4 pole 3 way	1968	£0.48*

MICRO SWITCHES	Order No.	Price
Plastic button gives simple on-off action		
Rating 10 amp 250V a.c.	1969	£0.20
Button gives 1 pole change over action		
Rating 10 amp 250V a.c.	1970	£0.25

## FUSE HOLDERS AND FUSES

Description	Order No.	Price
20mm x 5mm chassis mounting	506	£0.07*
1 1/2in x 1/4in chassis mounting	507	£0.12*
1 1/2in car inline type	508	£0.15*
Panel mounting 20mm	509	£0.20*
Panel mounting 1 1/2in	510	£0.30

QUICK BLOW 20mm	Type	No.	Type	No.
150mA	611	1A	615	3A
150mA	612	1.5A	616	4A
550mA	613	2A	617	5A
800mA	614	2.5A	618	621

616 to 7p ea. All remainder 5p ea

ANTI-SURGE 20mm	Type	No.	Type	No.
100mA	622	1A	625	2.5A
250mA	623	2A	626	3.15A
500mA	624	1.6A	627	5A
All 7p each				

QUICK BLOW 1 1/2in	Type	No.	Type	No.
250mA	631	500mA	632	800mA
All 7p each				
Type	No.	Type	No.	No.
1A	635	2.5A	638	4A
1.6A	636	3A	639	5A
2A	637	All 6p each		

## CASES AND BOXES

**INSTRUMENT CASES.** In two sections vinyl covered top and sides, aluminium bottom, front and back.

No.	Length	Width	Height	Price
155	8in	5 1/2in	2in	£1.40*
156	11in	6in	3in	£1.80*
157	6in	4 1/2in	1 1/2in	£1.25*
158	9in	5 1/2in	2 1/2in	£1.60*

**ALUMINIUM BOXES.** Made from bright all., folded construction each box complete with half inch deep lid and screws.

No.	Length	Width	Height	Price
159	5 1/2in	2 1/2in	1 1/2in	62p*
160	4in	4in	1 1/2in	62p*
161	4in	2 1/2in	1 1/2in	62p*
162	5 1/2in	4in	1 1/2in	74p*
163	4in	2 1/2in	2in	64p*
164	3in	2in	1in	44p*
165	7in	5in	2 1/2in	£1.04*
166	8in	6in	3in	£1.32*
167	6in	4in	2in	86p*

## MIDGET WAFER SWITCHES

1965	— 1 pole 12 way	48p*
1966	— 2 pole 6 way	48p*
1967	— 3 pole 4 way	48p*
1968	— 4 pole 3 way	48p*

## TRANSFORMERS

### MINIATURE MAINS Primary 240V

No.	Secondary	Price
2021	6V-0.6V 100mA	90p*
2022	9V-0.9V 100mA	90p*
2023	12V-0.12V 100mA	95p*

### MINIATURE MAINS Primary 24V

with two independent secondary windings

No.	Type	Price
2024	MT280-0.6V 0.6V RMS	£1.50*
2025	MT150-0.12V 0.12V RMS	£1.50*

### 1-AMP MAINS Primary 240V

No.	Secondary	1 amp	Price	P&P
2026	6V-0.6V	1 amp	£2.50*	45p
2027	9V-0.9V	1 amp	£2.00*	45p
2028	12V-0.12V	1 amp	£2.60*	55p
2029	15V-0.15V	1 amp	£2.75*	66p
2030	30V-0.30V	1 amp	£3.45*	86p

### STANDARD MAINS Primary 240V

Multi-tapped secondary mains transformers available in 1/2 amp, 1 amp and 2 amp current rating. Secondary taps are 0-19-25-33-40-50V

Voltages available by use of taps

4, 7, 8, 10, 14, 15, 17, 19, 25, 31, 33, 40, 50, 25-0-25V

No.	Rating	Price	P&P
2031	1/2 amp	£5.50*	86p
2032	1 amp	£6.60*	86p
2033	2 amp	£8.40*	£1.10

## AUDIO LEADS

107	FM Indoor Ribbon Aerial	£0.60*
113	3.5mm jack plug to 3.5mm jack plug. Length 1.5m	£0.75*
114	5 pin DIN plug to 3.5mm Jack connected to pins 3 & 5 Length 1.5m	£0.85*
115	5 pin DIN plug to 3.5mm Jack connected to pins 1 & 4 Length 1.5m	£0.85*
116	Car aerial extension. Screened insulated lead. Fitted plug and ski	£1.10*
117	AC mains connecting lead for cassette recorders and radios 2 metres	£0.68*
118	5 pin DIN phono plug to stereo headphone jack socket	£1.05*
119	2+2 pin DIN plug to stereo jack socket with attenuation network for stereo headphones. Length 0.2m	£0.90*
120	Car stereo connector, variable geometry plug to fit most car cassette. 8-track cartridge and comb-nation units. Supplied with inline fused power lead and instructions	£0.60*
123	6.6m Coiled Guitar Lead mono jack plug to mono jack plug. BLACK	£1.50*
124	3 pin DIN plug to 3 pin DIN plug. Length 1.5m	£0.75*
125	5 pin plug to 5 pin DIN plug. Length 1.5m	£0.75*
126	5 pin DIN plug to unred open end. Length 1.5m	£0.75*
127	5 pin DIN plug to 4 phono plugs. All colour coded. Length 1.5m	£1.30*
128	5 pin DIN plug to 5 pin DIN socket. Length 1.5m	£1.80*
129	5 pin DIN plug to 5 pin DIN plug mirror image. Length 1.5m	£1.05*
130	2 pin DIN plug to 2 pin DIN inline socket. Length 5m	£0.68*
131	5 pin DIN plug to 3 pin DIN plug. 1 & 4 and 3 & 5 Length 1.5m	£0.83*
132	2 pin DIN plug to 2 pin DIN socket. Length 10m	£0.98*
133	5 pin DIN plug to 2 phono plugs. Connected pins 3 & 5 Length 1.5m	£0.75*
134	5 pin DIN plug to 2 phono sockets. Connected pins 3 & 5 Length 23cm	£0.68*
135	5 pin DIN socket to 2 phono plugs. Connected pins 3 & 5 Length 23cm	£0.68*
136	Coiled stereo headphone extension lead. Black. Length 6m	£1.75*
178	A.C. mains lead for calculators etc	£0.68*

## AVDEL BOND CYANOACRYLATE G2

The wonder adhesive which works in seconds. Bonds plastic, rubber, transistors, components, permanently — immediately!  
**OD 143 ONLY 70p for a 2 gm phial**

## BI-PAK CATALOGUE NEW EDITION NOW AVAILABLE

Send for your copy of our revised catalogue and price list NOW! It contains 127 pages packed with literally hundreds of semiconductor components and our famous range of BI-KITS audio modules.

**Only 65p POST FREE**

**ORDERING.** Do not forget to state order number and your name and address.  
**V.A.T.** Add 12 1/2% to prices marked\*. 8% to those unmarked. Items marked are zero rated.  
**P&P.** 35p unless otherwise shown



Dept. WW6, P.O. Box 6, Ware, Herts

COMPONENTS SHOP 18 BALDOCK STREET, WARE, HERTS.

KENYA  
HOLLAND  
JAMAICA  
ARAB EMIRATES  
UNITED ARAB EMIRATES  
FALKLAND ISLANDS  
PORTUGAL  
GUYANA  
INDIA  
GREECE  
JORDAN  
AMERICA  
UNITED STATES OF AMERICA  
YUGOSLAVIA  
ASCENSION ISLAND

EIRE  
GRENADA  
SAUDI ARABIA  
NEW ZEALAND  
NORWAY  
SINGAPORE  
ICELAND  
SWEDEN  
MALAYA  
INDONESIA  
BRAZIL  
SWITZERLAND  
ZAMBIA  
GIBRALTAR  
CHILE  
SPAIN

# AUDIO KITS OF DISTINCTION FROM NEW! DE LUXE EASY TO BUILD LINSLEY-HOOD 75W AMPLIFIER

# POWERTRAN

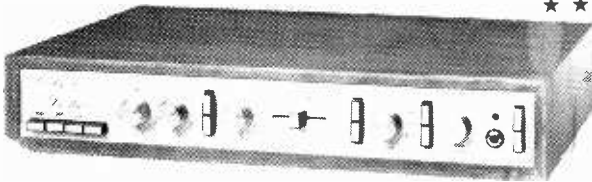

AVAILABLE AS SEPARATE PACKS  
PRICES IN OUR FREE CATALOGUE

**SPECIAL PRICE FOR COMPLETE KIT £99.30**

**PACK PRICES FOR STANDARD KIT**

Pack	Price	Pack	Price
1. Fibreglass printed circuit board for power amp	£1.15	11. Fibreglass printed-circuit board for power supply	£0.85
2. Set of resistors, capacitors, pre-sets for power amp	£2.50	12. Set of resistors, capacitors, secondary fuses, semiconductor for power supply	£5.40
3. Set of semiconductors for power amp	£6.50	13. Set of miscellaneous parts including DIN skts., mains input skt., fuse holder, interconnecting cable, control knobs	£6.20
4. Pair of 2 drilled, finned heat sinks	£1.10	14. Set of metalwork parts including silk screen printed fascia panel and all brackets, fixing parts, etc.	£8.20
5. Fibreglass printed-circuit board for pre-amp	£1.90	15. Handbook	£0.30
6. Set of low noise resistors, capacitors, pre-sets for pre-amp	£4.10	16. High Quality Teak Veneer cabinet 18.3" x 12.7" x 3.1"	£10.70
7. Set of low noise, high gain semiconductors for pre-amp	£2.40	2 each of packs 1-7, 1 each of packs 8-16 inclusive are required for complete stereo amplifier. Total cost of individually purchased packs	£92.80
8. Set of potentiometers (including mains switch)	£3.50		
9. Set of 4 push-button switches, rotary mode switch	£5.40		
10. Toroidal transformer complete with magnetic screen/ housing primary: 0 117-234 V; secondaries: 33-0-33 V, 25-0-25 V	£12.95		

The standard model of our kit for Mr Linsley-Hood's 75 watt design has for a long time offered exceptional performance at a very modest cost with high quality high power ready built units of comparable quality generally being over three times the price

Features of the amplifier include very low distortion (less than 0.01% 75W rms per channel power output) rumble filter, variable slope scratch filter, variable transition frequency tone controls, tape monitoring facilities and individually adjustable inputs. This model is based on 5 circuit boards which not having the controls mounted on them can be effectively used separately in high performance audio systems not based on our metalwork

Our new De Luxe model uses 14 boards which interconnect with gold plated contacts and are designed to have the potentiometers and switches mounted upon them. This system almost eliminates internal wiring, making installation after their assembly delightfully straightforward and as each board can be easily removed in seconds from the chassis, checking and maintenance is so simple that even newcomers to electronics will be able to cope competently with the kit. Additional features of our new model are inclusion of the latest circuit improvements, generously sized heat sinks for heavy duty use, even in tropical climates, and metal oxide resistors throughout for long term stability and reliability.

**STANDARD LINSLEY-HOOD 75W AMPLIFIER**

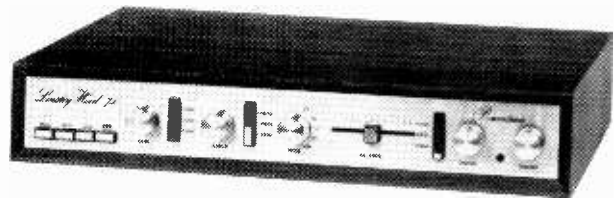

**SPECIAL PRICE FOR COMPLETE KIT £79.80**

Designed in response to demand for a tuner to complement the world-wide acclaimed Linsley-Hood 75W Amplifier, this kit provides the perfect match. The Wireless World (Skingley and Thompson) published original circuit has been developed further for inclusion into this outstanding slimline unit and features a pre-aligned front end module, excellent a.m. rejection and temperature compensated varicap tuning, which may be controlled either continuously or by push-button pre-selection. Frequencies are indicated by a frequency meter and sliding LED indicators, attached to each channel selector pre-set. The PLL stereo decoder incorporates active filters for "birdy" suppression and power is supplied via a toroidal transformer and integrated regulator. For long term stability metal oxide resistors are used throughout.

AVAILABLE AS SEPARATE PACKS — PRICES IN OUR FREE CATALOGUE

Pack	Price	Pack	Price
1. Stereo PCB (accommodates 2 rep. amps, 2 meter amps, bias/erase osc. relay)	£3.35	10. Set of capacitors, rectifiers, I.C. voltage regulator P.C.B. for power supply (Powertran design)	£2.80
2. Stereo set of capacitors, M.O. resistors, potentiometers for above	£7.95	11. Set of miscellaneous parts, including sockets, fuse holder, fuses, interconnecting wire, etc.	£3.40
3. Stereo set of semiconductors for above	£8.50	12. Set of metalwork including silk screened fascia panel, internal screen, fixing parts, etc.	£7.10
4. Miniature relay with socket	£2.90	13. Construction notes	£0.25
5. PCB, all components for solenoid, speed control circuits	£3.80	14. High Quality Teak Veneer cabinet 18.3" x 12.7" x 3.1"	£10.70
6. Goldring-Lenco mechanism as specified	£18.50	One each of packs 1-14 inclusive are required for complete stereo cassette deck. Total cost of individually purchased packs	£83.00
7. Function switch, knobs	£1.90		
8. Dual VU meter with illuminating lamp	£6.95		
9. Toroidal transformer with E.S. screen prim. 0-117V, 234V, Sec. 15V	£4.90		

Matsushita WY 436 AZ head (optional extra) £4.50 (free with complete kit)

**WIRELESS WORLD FM TUNER**

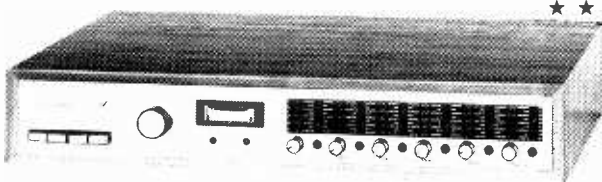

**SPECIAL PRICE FOR COMPLETE KIT £70.20**

**LINSLEY-HOOD CASSETTE DECK**

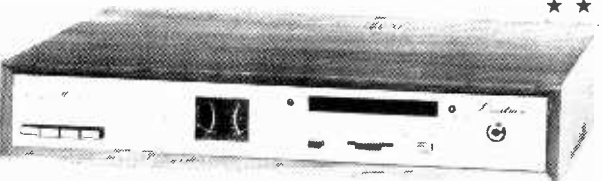

**SPECIAL PRICE FOR COMPLETE KIT £79.60**

Published in Wireless World (May, June, August 1976) by Mr Linsley-Hood, this design, although straightforward and relatively low cost, nevertheless provides a very high standard of performance. To permit circuit optimization separate record and replay amplifiers are used. The latter using a discrete component front-end designed such that the noise level is below that of the tape back ground. Push button switches are used to provide a choice of equalization time constants, a choice of bias levels and also an option of using an additional pre-amplifier for microphone use. The mechanism used is the Goldring-Lenco CRV, a unit distinguished in its robustness and ease of operation. Speed control and automatic cassette ejection are both implemented by electronic circuitry. This unit which is powered by a toroidal transformer and uses metal oxide resistors throughout offers an excellent match for the Wireless World Tuner and the Linsley-Hood 75 Watt Amplifier. Circuit changes as published in February, 1978, follow-up article are included in the kit AT NO EXTRA COST! A higher performance head (Matsushita WY 436 AZ head as recommended in the follow-up article) is offered as an optional extra but this will be automatically supplied FREE OF CHARGE with all orders for complete kits!

Pack	T20	T30	Pack	T20	T30
1. Set of low noise resistors	£1.60	£1.70	9. Fibreglass PCB	£3.50	£3.90
2. Set of small capacitors	£2.60	£3.40	10. Set of metalwork, fixing parts	£5.20	£6.20
3. Set of power supply capacitors	£2.20	£2.50	11. Set of cables, mains lead	£0.40	£0.40
4. Set of miscellaneous parts	£3.50	£3.50	12. Handbook	£0.25	£0.25
5. Set of slide, mains, P.B. switches	£1.50	£1.50	13. High quality teak veneer cabinet 15.4" x 6.7" x 2.8"	£4.50	£4.50
6. Set of pots., selector switch	£2.80	£2.80	One each of Pack 1-13 are required for complete stereo amplifier. Total cost of individually purchased packs T20+20	£40.90	T30+30 £45.60.
7. Set of semiconductors, I.C.s, skts.	£7.25	£7.75			
8. Toroidal transformer—240V prim. e.s. screen	£5.60	£7.20			

Designed by Texas engineers and described in Practical Wireless, the Texan was an immediate success. Now developed further in our laboratories to include a Toroidal transformer and additional improvements, the slimline T20+20 delivers 20W rms per channel of true Hi-Fi at exceptionally low cost. The easy to build design is based on a single F. Glass PCB and features all the normal facilities found on quality amplifiers including scratch and rumble filters, adaptable input selector and headphones socket. In a follow up article in Practical Wireless further modifications were suggested and these have been incorporated into the T30+30. These include RF interference filters and a tape monitor facility. Power output of this model is 30W rms per channel.

## EXPORT A SPECIALITY!

Our Export Department can readily despatch orders of any size to any country in the world. Some of the countries to which we sent kits last year are shown in this advertisement. To assist in estimating postal costs our catalogue gives the weights of all packs and kits. This will be sent free on request by airmail together with our Export Postal Guide, which gives current postage prices.

## T20 + 20 AND T30 + 30 20W, 30W AMPLIFIERS

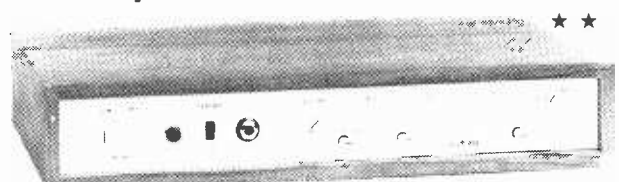

**SPECIAL PRICES FOR COMPLETE KITS**

**T20+20 KIT PRICE £33.10**

**T30+30 KIT PRICE £38.40**

**EXPORT ORDERS:** No minimum order charge! Prices same as for U.K. customers but no Value Added Tax charged. Postage charged at actual cost plus 50p documentation and handling. Please send payment with order by Bank Draft, Postal Order, International Money Order or cheque drawn on an account in the U.K. Alternatively for orders over £500 we will accept Irrevocable Letter of Credit payable at sight in London.

MUSCAT & OMAN  
FRANCE  
DENMARK  
GAMBIA  
AUSTRALIA  
HONG KONG  
NAURU  
GERMANY  
TUNISIA  
LUXEMBOURG  
NIGERIA  
SOUTH AFRICA  
FINLAND  
SOUTH AFRICA  
CZECHOSLOVAKIA  
AUSTRIA

NEW GUINEA  
ISRAEL  
GUERNSEY  
CYPRUS  
BELGIUM  
UGANDA  
BRUNEI  
TRINIDAD  
SOUTH WEST AFRICA  
ITALY  
JAVA  
SIERRA LEONE  
WINDWARD ISLANDS  
CANADA  
MALTA

**WWII TUNER** ★ ★

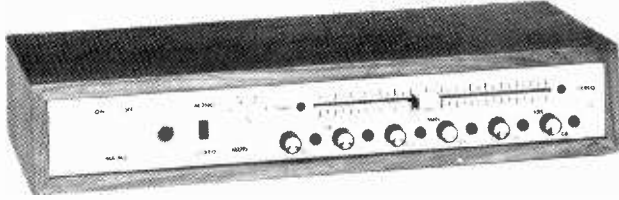

**SPECIAL PRICE FOR COMPLETE KIT £47.70**

AVAILABLE AS SEPARATE PACKS — PRICES IN OUR FREE CATALOGUE

Following the success of our **Wireless World FM Tuner Kit** this cost reduced model was designed to complement the **T20+20** and **T30+30** amplifiers and the cabinet size front panel format and electrical characteristics make this tuner compatible with either. The frequency meter of the more advanced model has been omitted and the mechanics simplified however the circuitry is identical and this kit offers most outstanding value for money. Facilities included are switchable a/c adjustable switchable muting LED tuning indication and both continuous and push-button channel selection (readily adjusted by controls on the front panel)

**POWERTRAN SFMT TUNER** ★ ★

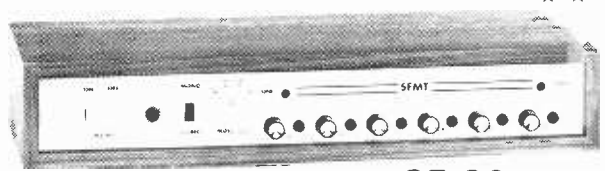

**PRICE FOR COMPLETE KIT £35.90**

AVAILABLE AS COMPLETE KIT ONLY

The requirement was a simple low cost design which could be constructed easily without special alignment equipment but which still gives a first class output suitable for feeding any of our very popular amplifiers or any other high quality audio equipment. Not finding a suitable published circuit the requirement was met by design and development work in our own laboratories and this tuner which uses a pre-aligned front end module can be set up with the aid of nothing more sophisticated than a multi-meter. A phase-locked-loop is used for stereo decoding and controls include switchable a/c switchable muting and push-button channel selection (adjustable by controls on the front panel). This unit matches well with the **T20+20** and **T30+30** amplifiers.

**INTERNATIONAL POWERSLAVE  
200+200 watt AMPLIFIER**

**NEW!**

**COMPLETE KIT AS FEATURED IN ELECTRONICS TODAY INTERNATIONAL**

Super-Fi performance for studio/monitoring/h-fi use with the inherent reliability and ruggedness for the most demanding group/disco applications.

**Features**

- ★ over 200W rms continuous from each of 2 totally independent DC coupled amplifiers — over 800W peak power!
- ★ highly original fully complementary high linearity o/p stage utilizing the inherent symmetry of no less than 4 differential pairs!
- ★ ultra low feedback (an incredible low 14dB overall!) together with super high slewing rate (20V/μs) banish ricochet effects and TID!
- ★ distortion only 0.03% at FULL power 1KHz rising to only 0.07% at 10KHz (how many high power amplifier producers dare to quote at this frequency?)
- ★ independent stabilized power supplies driven by custom designed TOROIDAL transformers
- ★ inherent reliability — monster heat sinks for cool running at the hottest venues — electronic open and short circuit protection — 4 rugged power transistors/amplifier — each 250W rating
- ★ professional quality — metal oxide resistors cermet adjusters fibre glass boards sturdy 19" rack mounting cabinet complete with sleeve and feet for free standing work too
- ★ easy to build — plenty of working space with ready access to all components minimal wiring extensive instructions suitable for both experienced constructors and newcomers to electronics — can be purchased one channel at a time
- ★ value for money — quality and performance comparable with ready-built amplifiers costing over £600!



**PSI 4001 SLAVE MODEL**

- |  |              |
|--|--------------|
| <b>Pack</b>  | <b>Price</b> |
| 1. Fibre glass printed circuit board for power amp   | £4.20        |
| 2. Set of capacitors, metal oxide resistors, thermistor, cermet pre-sets for power amp   | £6.40        |
| 3. Set of semiconductors for power amp with mounting hardware, cooling tabs  | £27.60       |
| 4. Pair of monster black drilled heat sinks, transistor mounting bracket   | £6.90        |
| 5. Toroidal transformer, Primary 0-117V-234V, Secondaries 42-0-42V, 0-15V, 0-15V, Electrostatic screen   | £19.20       |
| 6. Set of all parts for stabilized power supply including fibre glass printed circuit board, mounting bracket, semiconductors, resistors, capacitors, etc.               | £20.50       |
| 7A. Set of all parts for buffer/overdrive unit including fibre glass printed circuit board, semiconductors, resistors, capacitors, controls — required for PSI 4001 only | £3.80        |

**OVER 800W  
PEAK POWER!**



**PSI 4002 STUDIO MODEL**

- |  |                                      |
|--|--------------------------------------|
| <b>Pack</b>  | <b>Price</b>                         |
| 7B. Set of parts for peak power meter including professional quality meter, fibre glass printed circuit board, components, controls — required for PSI 4002 only | £11.50                               |
| 8. Set of all miscellaneous parts including sockets, illum. mains switches, fuse holders, fuses, cut-outs, cable, etc.   | £12.10                               |
| 9. Cabinet, including chassis, anodised silver on black panels, fixing parts etc. Please state whether Slave or Studio model required                            | £27.50                               |
| 10. Handbook £0.50 or free on request when ordering any of above packs.  |                                      |
| 2 each of packs 1-7 (A or B), 1 each 8, 9 and 10 are required for complete 200 + 200W professional amplifier.  |                                      |
| Total cost of individually purchased packs (200 + 200W)  | PSI 4001 £216.00<br>PSI 4002 £232.20 |

PSI 4001 kit price **£205.00**

PSI 4002 kit price **£220.00**

**SPECIAL OFFER PRICES FOR COMPLETE KITS —**

**Wireless World Designs:** Full kits are not available for the projects below but PCBs and component sets are stocked. Further details of these and other packs are in our Free Catalogue

- |  |  |
|--|--|
| <b>30W Bailey Amplifier</b>                    | <b>Regulated Power Supply for Bailey Amplifier</b> |
| BAIL Pk 1 F Glass PCB                          | 60VS Pk 1 F Glass PCB                              |
| BAIL Pk 2 Resistors Capacitors                 | 60VS Pk 2 Resistors Capacitors                     |
| BAIL Pk 3 Semiconductors                       | 60VS Pk 3 Semiconductors                           |
|  | 60VS Pk 6A Toroidal transformer                    |
| <b>Bailey Burrows Stereo Pre-Amp.</b>          | <b>Stuart Tape Recorder</b>                        |
| BBPA Pk 1 F Glass PCB (stereo)                 | TRRC Pk 1 Replay Amp F G PCB (stereo)              |
| BBPA Pk 2 Resistor capacitors (stereo)         | TRRC Pk 1 Record Amp F G PCB (stereo)              |
| BBPA Pk 3P Rotary potentiometers (stereo)      | TROS Pk 1 Bias Erase F G PCB (stereo)              |
| BBPA Pk 4H Rotary switches (stereo)            |  |
| <b>Linsley-Hood Low Distortion Oscillator.</b> | <b>E. F. Taylor Pre-Amplifier</b>                  |
| LDO Pk 1 Fibreglass PCB                        | EFTP Pk 1 Fibreglass PCB (stereo)                  |
| LDO Pk 2 M.O Resistors capacitors              | EFTP Pk 2 M.O Res. caps (stereo)                   |
| LDO Pk 3 Semiconductors                        | EFTP Pk 3 Semiconductors (stereo)                  |

**Value Added Tax not included in prices  
UK Carriage FREE**

**SERVICING FACILITIES:** Available for all ★★complete kits  
**PRICE STABILITY:** Order with confidence irrespective of any price changes we will honour all prices in this advertisement until July 31st, 1978, if this month's advertisement is mentioned with your order. Errors and VAT rate changes excluded

**U.K. ORDERS:** Subject to 12½% surcharge for VAT (i.e. add ½ to the price). No charge is made for carriage, or current rate if charged  
**SECURICOR DELIVERY:** For this optional service (U.K. mainland only) add £2.50 (VAT inclusive) per kit  
**SALES COUNTER:** If you prefer to collect your kit from the factory call at Sales Counter (at rear of factory) Open 9 a.m - 4.30 p.m. Monday Thursday

**QUALITY.** All components are brand new first grade full specification guaranteed devices. All resistors except where stated as metal oxide are low noise carbon film types. All printed circuit boards are fibreglass drilled roller tinned and supplied with circuit diagrams and construction layouts

**FOR FURTHER INFORMATION PLEASE WRITE OR  
TELEPHONE FOR OUR FREE CATALOGUE**

DEPT. WW6

**POWERTRAN ELECTRONICS**

PORTWAY INDUSTRIAL ESTATE, ANDOVER  
ANDOVER HANTS SP10 3NN (0264) 64455

**NEW!** Improved stereo decoder (as described in April 1978 W W) F/Glass PCB M.O Res. Caps Cermet pre-sets IC IC socket **£6.30**

- SQ QUADRAPHONIC DECODERS**
- These state of the art circuits described by CBS are offered as kits of superior quality with class tolerance capacitors, metal oxide resistors and Fibreglass PCBs designed for edge connector insertion. Further information on these kits is given in our FREE CATALOGUE
- M1 Basic matrix decoder £5.90
  - L1 Full logic decoder £17.20
  - L2A Full logic decoder with variable blend £22.60
  - L3A As L2A but with high performance discrete component front end or with carbon film resistors £25.90
  - SQMT 30 Decoder complete with 30W rear channel amplifiers. Complete kit matches T30+30 amplifier £40.75



# THE NEWBEAR COMPUTING STORE



<b>SYSTEMS S-50 bus</b> MSI 6800 Microcomputer kit (2MHz clock 8K bytes RAM) <b>£375.00</b> Floppy discs, fully built and tested SMOKE SIGNAL BROADCASTING Single drive <b>£522.00</b> ; Double drive <b>£785.00</b> ; Treble <b>£1045.00</b>		<b>S-100 bus</b> Cromenco Z-2 kit (C P U & CARD FRAME Z-80 based) <b>£395.00</b> Bytesave programming board kit (2708) <b>£95.00</b> TU-ART-Interface kit <b>£130.00</b> 16K byte Dynabyte ram card (fully tested) <b>£415.00</b> North Star Mini Floppy kit <b>£490.00</b>	
---	--	--	--

## NEWBURY LABORATORY Visual display units from £520.00

Demonstrations by appointment only during June. The above items are cash with order or pro forma invoice only. VAT 8%

## SOFTWARE AND LITERATURE

### COMPUTER DESIGNS

77-68 6800 Microcomputer	Price	p 8p
Spare diagram set for 77-68	<b>£7.50</b>	<b>£0.50</b>
WB-1 TTL Microcomputer	<b>£1.50</b>	<b>£0.50</b>
Spare diagram set for WB-1	<b>£8.50</b>	<b>£0.50</b>
	<b>£1.00</b>	<b>£0.50</b>

### FROM ADAM OSBORNE ASSOCIATES

Introduction To Microcomputers		
Volume 0 The Beginners Book	<b>£5.95</b>	<b>£0.50</b>
Volume 1 Basic Concepts	<b>£5.95</b>	<b>£0.50</b>
Volume 2 Some Real Products June 1977 Revision	<b>£11.95</b>	<b>£1.00</b>
8080A/8085 Assembly Language Programming	<b>£6.95</b>	<b>£0.50</b>
Some Common Basic Programs	<b>£5.95</b>	<b>£0.50</b>
6800 Programming for Logic Design	<b>£5.95</b>	<b>£0.50</b>
8080 Programming for Logic Design	<b>£5.95</b>	<b>£0.50</b>
Payroll with Cost Accounting in Basic	<b>£9.95</b>	<b>£1.00</b>

### SCELBI

Understanding Microcomputers & Small Computer Systems	<b>£7.56</b>	<b>£0.50</b>
Scelbi 6800 Software Gourmet Guide & Cook Book	<b>£7.95</b>	<b>£0.50</b>
Scelbi 8080 Software Gourmet Guide & Cook book	<b>£7.95</b>	<b>£0.50</b>
8080 Standard Assembler	<b>£15.95</b>	<b>£0.50</b>
The Scelbi Byte Primer (replaces Best of Byte)	<b>£9.95</b>	<b>£1.00</b>
The 8080 Programmers Pocket Guide	<b>£2.35</b>	<b>£0.30</b>

### ZILOG

Z-80 Technical Manual	<b>£4.00</b>	<b>£0.50</b>
Z-80 PIO Technical Manual	<b>£2.50</b>	<b>£0.50</b>
Z-80 Programming Manual	<b>£4.00</b>	<b>£0.75</b>

### MOTOROLA

Understanding Microprocessors	<b>£2.75</b>	<b>£0.30</b>
M6800 Microprocessor Programming Manual	<b>£4.50</b>	<b>£0.50</b>
M6800 Microprocessor Applications Manual	<b>£9.50</b>	<b>£1.00</b>

### SYBEX

Microprocessors C201	<b>£8.00</b>	<b>£0.75</b>
Microprocessors Interfacing Techniques C207	<b>£8.00</b>	<b>£0.75</b>

### BASIC

Learning Basic fast De Rossi	<b>£6.30</b>	<b>£0.50</b>
Instant Freeze-Dried Computer Programming in Basic, by Jerald R Brown	<b>£5.45</b>	<b>£0.75</b>
Basic Programs that Work Lee Beech Lee	<b>£2.40</b>	<b>£0.75</b>

### MOS TECHNOLOGY (the Pet's processor!)

KIM1 User Manual	<b>£5.00</b>	<b>£0.75</b>
6500 Programming Manual	<b>£5.00</b>	<b>£0.75</b>
6500 Hardware Manual	<b>£5.00</b>	<b>£0.75</b>

### SOFTWARE LIBRARY FOR 6800 (with papertape 8% VAT)

Volume 1 Editor and Assembler	<b>£10.00</b>	<b>£0.50</b>
Volume 2 3K BASIC	<b>£5.00</b>	<b>£0.50</b>
Volume 3 4K BASIC	<b>£5.00</b>	<b>£0.50</b>
Volume 4 8K Basic Version 2.0	<b>£10.00</b>	<b>£0.50</b>
Volume 5 Space Voyage	<b>£10.00</b>	<b>£0.50</b>
Volume 7 Games for 6800 Pack 1	<b>£10.00</b>	<b>£0.50</b>
Volume 8 Games for 6800 Pack 2	<b>£10.00</b>	<b>£0.50</b>
Volume 10 Subroutine Package	<b>£5.00</b>	<b>£0.50</b>
Volume 12 CO-RES	<b>£10.00</b>	<b>£0.50</b>
Volume 13 Disassembler and Mini assembler Version 2	<b>£15.00</b>	<b>£0.50</b>
Volume 14 TSC Text Editing System	<b>£25.00</b>	<b>£0.50</b>
Volume 15 TSC Monomatic 6800 Software Assembler	<b>t.b.a.</b>	<b>£0.50</b>
6800 Software Assembler	<b>t.b.a.</b>	<b>£0.50</b>

### GAMES

The Bear Game	<b>£2.00</b>	<b>£0.50</b>
The Well Tempered Microprocessor	<b>£2.00</b>	<b>£0.50</b>

### Z-80 SOFTWARE

ZM-PT Z80 Control Monitor (Paper Tape)	<b>£15.00</b>	<b>£0.50</b>
ZM-108 Z80 Control Monitor (PROM)	<b>£35.00</b>	<b>£0.50</b>
CB-PT 3K Control Basic (Paper Tape)	<b>£15.00</b>	<b>£0.50</b>
ZA-PT Assembler/Resident O System (Paper Tape)	<b>£30.00</b>	<b>£0.50</b>
16KB-PT 16K Z-80 Basic (Paper Tape)	<b>£75.00</b>	<b>£0.50</b>

### NATIONAL SEMICONDUCTORS

TTL Data Book	<b>£2.50</b>	<b>£0.75</b>
Memory Data Book	<b>£2.50</b>	<b>£0.75</b>
CMOS Data Book	<b>£2.50</b>	<b>£0.75</b>
SC/MP Applications handbook	<b>t.b.a.</b>	<b>£0.50</b>
Data Acquisitions book	<b>t.b.a.</b>	<b>£0.50</b>

Home Computers by Dithium - Volume 1 Hardware	<b>£5.95</b>	<b>£0.75</b>
Volume 2 Software	<b>£5.95</b>	<b>£0.75</b>
Your Home Computer by James White	<b>£4.95</b>	<b>£0.50</b>
The 8080A Bugbook (Microcomputer Interfacing & Programming)	<b>£8.95</b>	<b>£0.75</b>

Games, Tricks and Puzzles for a hand calculator by W Judd	<b>£2.49</b>	<b>£0.50</b>
---	--------------	--------------

How to buy and use Microcomputers by W Barden Jr.	<b>£7.45</b>	<b>£0.75</b>
The best of Creative Computing Volume 1	<b>£6.95</b>	<b>£1.00</b>
The best of Creative Computing Volume 2	<b>£6.95</b>	<b>£1.00</b>
PCC's Reference book of Personal & Home Computing	<b>£4.95</b>	<b>£0.50</b>
2650 Microprocessor Handbook	<b>t.b.a.</b>	<b>£0.50</b>

### COMPUTER TITLES

SAMS PUBLICATIONS Active Filter Cookbook, Lancaster	<b>£10.45</b>	<b>£0.75</b>
CMOS Cookbook, Lancaster	<b>£6.95</b>	<b>£0.75</b>
Computer Dictionary, 2/E, Sippel	<b>£6.30</b>	<b>£0.75</b>
Computer Dictionary & Handbook (ABC's of Capacitors), 2/E, Sippel	<b>£13.65</b>	<b>£1.00</b>

Computers & Programming Guide for Engineers, Spencer	<b>£9.05</b>	<b>£0.75</b>
How to Buy and Use Minicomputers and Microcomputers, Barden	<b>£6.95</b>	<b>£0.75</b>

How to Program Microprocessors (not yet published), Barden	<b>£6.30</b>	<b>£0.75</b>
IC OP-AMP Cookbook, Jung	<b>£9.05</b>	<b>£0.75</b>
IC Timer Cookbook, Jung	<b>£6.95</b>	<b>£0.75</b>
Microcomputer Primer, Waite/Pardee	<b>£5.55</b>	<b>£0.75</b>
TTL Cookbook, Lancaster	<b>£6.30</b>	<b>£0.50</b>
TV Typewriter Cookbook, Lancaster	<b>£6.95</b>	<b>£0.75</b>
RTL Cookbook, Lancaster	<b>£4.05</b>	<b>£0.75</b>

## HARDWARE COMPONENTS SECTION

**PETITEVID VDU KIT £85**

- ★ 110 to 1200 baud V24
- ★ 64ch x 16 line, scrolling
- ★ All on 8" x 4" pcb

Needs TV set UHF modulator, ASCII keyboard and power supply.

### NEW ITEMS

UHF Modulator	<b>£4.50</b>
8K Exorciser, Computable Kit	<b>£160.00</b>
SC, MP Mark II	<b>£10.30</b>
U/V From Eraser	<b>£56.00</b>
Cassette Memorex C60	<b>£0.90</b>
Cassette Memorex C90	<b>£1.20</b>
9368 7 Segment Display decoder	<b>£2.45</b>
FWD 500 1/2 7 Segment Displays	<b>£11.25</b>
Hexadecimal unencoded keyboard (19 positions)	<b>£27.50</b>
QWERTY 10P keyboard 63 key	<b>£76.50</b>
ASC II encoded keyboard	<b>(£1.50 p&amp;p)</b>

### MEMORIES

2102-1	<b>£1.50</b>	4027 (250ns)	<b>£6.00</b>
2102L-1	<b>£1.60</b>	2114 (450ns)	<b>£10.00</b>
2112	<b>£3.04</b>	4116 (250ns)	<b>£29.50</b>
2513	<b>£6.85</b>	2708 (450ns)	<b>£10.50</b>

### MOTOROLA MICROCOMPUTING ICs

MC6800P	<b>£13.00</b>	MC6830L7	<b>£11.33</b>
MC6820P	<b>£6.20</b>	MC6802P	<b>£2.88</b>
MC6850P	<b>£6.74</b>	MC14536P	<b>£3.69</b>
MC6810AP	<b>£3.81</b>	MC3459	<b>£2.93</b>

### ZILOG MICROCOMPUTING ICs

Z-80 CPU 2.5MHz	<b>£15.50</b>	Z-80 PIO PS	<b>£10.00</b>
		Z-80 CTC PS	<b>£10.00</b>

### MICROPROCESSORS

SC MP Mk II	<b>£10.30</b>	6502	<b>£14.93</b>	2650	<b>£17.50</b>
-------------	---------------	------	---------------	------	---------------

### INTERFACING ICs

SFF96364	<b>£16.20</b>	VDU	81LS95	<b>£1.43</b>
MC1488P	<b>£1.40</b>		81LS96	<b>£1.43</b>
MC1489P	<b>£1.40</b>		81LS97	<b>£1.43</b>
75150P	<b>£1.30</b>	For V24	81LS98	<b>£1.43</b>
75150N	<b>£1.20</b>	RS232C	8126	<b>£1.84</b>
75154	<b>£2.50</b>		8195	<b>£1.60</b>
4N33	<b>£1.95</b>		8197	<b>£1.60</b>
AY 5 1013	<b>£5.30</b>		74367	<b>£1.30</b>

### BUFFERS

### LOW POWER SCHOTTKY TTL PRICE LIST

74LS00	<b>.18</b>	74LS30	<b>.29</b>	74LS109	<b>.38</b>
74LS01	<b>.21</b>	74LS32	<b>.24</b>	74LS112	<b>.38</b>
74LS02	<b>.21</b>	74LS33	<b>.40</b>	74LS113	<b>.38</b>
74LS03	<b>.21</b>	74LS37	<b>.30</b>	74LS114	<b>.38</b>
74LS04	<b>.26</b>	74LS38	<b>.30</b>	74LS125	<b>.56</b>
74LS05	<b>.26</b>	74LS40	<b>.27</b>	74LS126	<b>.56</b>
74LS08	<b>.21</b>	74LS42	<b>.88</b>	74LS132	<b>.90</b>
74LS09	<b>.21</b>	74LS47	<b>.96</b>	74LS136	<b>.38</b>
74LS10	<b>.21</b>	74LS48	<b>.96</b>	74LS138	<b>£1.05</b>
74LS11	<b>.26</b>	74LS51	<b>.21</b>	74LS139	<b>£1.05</b>
74LS12	<b>.21</b>	74LS54	<b>.21</b>	74LS151	<b>.96</b>
74LS13	<b>.55</b>	74LS55	<b>.21</b>	74LS153	<b>.96</b>
74LS14	<b>£1.26</b>	74LS73	<b>.34</b>	74LS154	<b>£1.98</b>
74LS15	<b>.21</b>	74LS74	<b>.38</b>	74LS155	<b>£1.05</b>
74LS20	<b>.21</b>	74LS75	<b>.55</b>	74LS156	<b>£1.05</b>
74LS21	<b>.26</b>	74LS76	<b>.34</b>	74LS157	<b>.96</b>
74LS22	<b>.21</b>	74LS78	<b>.34</b>	74LS158	<b>.88</b>
74LS26	<b>.31</b>	74LS83	<b>£1.05</b>	74LS160	<b>£1.22</b>
74LS27	<b>.21</b>	74LS86	<b>.38</b>	etc -	
74LS28	<b>.40</b>	74LS107	<b>.38</b>		

### CONNECTORS & SOCKETS

Subminiature D Type			
9 way plug	<b>.58</b>	25 way socket	<b>.82</b>
9 way socket	<b>.88</b>	25 way socket	<b>£1.50</b>
9 way cover	<b>.74</b>	25 way cover	<b>.85</b>
15 way plug	<b>.74</b>	37 way plug	<b>£2.10</b>
15 way socket	<b>£1.09</b>	37 way socket	<b>£3.11</b>
15 way cover	<b>.83</b>	37 way cover	<b>£1.19</b>

### EDGE CONNECTORS

80 way 0 1 single sided	<b>£1.80</b>
45 way 0 1 single sided	<b>£1.30</b>
43 way 0 156 double sided (for Motorola excorsor, D1, 02 kit bus)	<b>£4.20</b>
64 way plug for Eurocard to DIN41612	<b>£1.65</b>
64 way socket for Eurocard to DIN 41612	<b>£2.99</b>
10 way plug Molex for S-50 bus (SWTPC6800)	<b>£0.30</b>
10 way socket Molex for S-50 bus (SWTP6800)	<b>£0.32</b>

### D-I-L SOCKETS

(low profile gold plated)				
14 pin	<b>.24</b>	24 pin	<b>.36</b>	D-I-L PLUGS 16 pin <b>.60</b>
		24 pin low in force	<b>£3.80</b>	
16 pin	<b>.25</b>	40 pin	<b>.66</b>	24 pin <b>£1.20</b>

### SCOTCHFLEX CONNECTORS

40 way plug	<b>£2.40</b>	40 way socket	<b>£2.02</b>
-------------	--------------	---------------	--------------

### PRINTED CIRCUIT BOARDS

For 77-68 (8 x 8 0 1 edge 78 way)	
CPU board	<b>£10.00</b>
4K RAM board	<b>£10.00</b>
Bootstrap loader board	<b>£9.95</b>
Prototyping p c b	<b>£6.25</b>
4K RAM board (For S-50 bus (SWTPC6800))	<b>£7.52</b>
Prototyping p c b (low pack density)	
For 3U 43 way systems (4 1/2 x 8 )	
2K RAM board	<b>£8.50</b>
Back plane (Verob) board approx 10 x 4	<b>£1.47</b>
4K RAM board (For S-50 bus (SWTPC6800))	<b>£12.00</b>
4K RAM board (For S-100 bus)	<b>£15.00</b>
4K RAM board (For Exorciser bus (D1 D2 MOT))	<b>£10.00</b>

Goods are normally shipped within 24 hours, subject to availability. Barclaycard & Access VAT at 8% for Hardware Components. 30p postage and packing unless otherwise stated. Cheques to be made out to The Newbear Computing Store. Send for an up-to-date catalogue to The Newbear Computing Store, 7 Bone Lane, Newbury, Tel: 0635-46898. Callers welcome Monday to Saturday 9.00 a.m. - 5.30 p.m. The Newbear Computing Store is a division of Newbury Laboratories Ltd.

WW-118 FOR FURTHER DETAILS

# NEW FROM PITMAN FOR TEC STUDENTS

AND FOR THOSE SERIOUS ENTHUSIASTS  
WHO WISH TO CONSOLIDATE AND  
EXTEND THEIR KNOWLEDGE

## Telecommunication Systems I

P.H. SMALE

Explains and describes the fundamental make-up of the systems used in all telecommunication processes. 120pp./113 line figures/ISBN 0 273 01123 5/Cat. No.0010:32/£2.50

## Transmission Systems II

D.C. GREEN

A complete introduction to the principles of both line and radio communication systems. 144pp./121 line drawings/ISBN 0 273 01124 3/Cat. No.0011:32/£3.20

## Radio Systems II

D.C. GREEN

A basic course in the fundamentals and practice of radio communication systems. 120pp./103 line figures/ISBN 0 273 01126 X/Cat. No.0014:32/£3.00

## Electronics II

D.C. GREEN

A comprehensive and concise descriptive treatment of the primary elements of electronic devices and circuits. 168pp./166 line figures/ISBN 0 273 01125 1/Cat. No.0016:32/£3.50

The coverage is based on the syllabuses of the Technician Education Council and completely covers the requirements of the units, offering coherent and complete treatment of the subject topics.

## Further Principles and Systems for Radio and TV Mechanics

K.F. IBRAHIM

A good textbook for all radio, television and electronic technicians who desire to learn, and consolidate their practical knowledge with, a theoretical basis. 256pp./320 line figures/ISBN 0 273 01122 7/Cat. No.0006:32/£3.20

PLACE AN ORDER WITH YOUR BOOKSELLER TODAY.

In case of difficulty available from  
Pitman Publishing Limited, 39 Parker Street,  
London WC2B 5PB  
adding 20p as a small order surcharge.

# Pitman

## TRANSFORMERS

ALL EX-STOCK — SAME-DAY DESPATCH

MAINS ISOLATING VAT 8% 12 and/or 24-VOLT

PRI 120/240V SEC 120/240V Separate 12V windings Pri 220/240V

Centre Tapped and Screened

Ref.	VA (Watts)	£	P&P
07*	20	4.40	79
149	60	6.20	96
150	100	7.13	114
151	200	11.16	114
152	250	12.79	150
153	350	16.28	184
154	500	19.15	215
155	750	29.06	OA
156	1000	37.20	OA
157	1500	45.60	OA
158	2000	54.80	OA
159	3000	79.05	OA

\*15 or 240 sec only State volts required

Ref.	Amps	£	P&P
111	0.5	0.25	2.20
213	1.0	0.5	2.64
71	2	1	3.51
18	4	2	4.03
70	6	3	5.35
108	8	4	6.98
72	10	5	7.67
116	12	6	8.99
17	16	8	10.39
115	20	10	13.18
187	30	15	17.05
226	60	30	26.82

### 50 VOLT RANGE

Primary 220/240V  
SEC TAPS 0-20-25-33-40-50V  
20V 0-70V or 25V 0-25V available by connection to appropriate taps

Ref.	Amps	£	P&P
102	0.5	3.41	78
103	1.0	4.57	96
104	2.0	6.98	114
105	3.0	8.45	132
106	4.0	10.70	150
107	6.0	14.62	164
118	8.0	17.05	208
119	10.0	21.70	OA

### 30 VOLT RANGE

Primary 220/240V  
SEC TAPS 0-12-15-20-24-30V  
12V 0-12V or 15V 0-15V available by connection to appropriate taps

Ref.	Amps	£	P&P
112	0.5	2.64	78
79	1.0	3.57	96
3	2.0	5.27	96
20	3.0	6.20	114
21	4.0	7.44	114
51	5.0	8.37	132
117	6.0	9.92	145
88	8.0	11.73	164
89	10.0	13.33	184

### 60 VOLT RANGE

Primary 220-240V  
SEC TAPS 0-24-30-40-48-60V  
24V 0-24V or 30V 0-30V available by connection to appropriate taps

Ref.	Amps	£	P&P
124	0.5	3.88	96
126	1.0	5.58	96
127	2.0	7.60	114
125	3.0	10.54	132
123	4.0	12.23	184
40	5.0	13.95	164
120	6.0	15.66	184
121	8.0	20.15	OA
122	10.0	24.03	OA
189	12.0	27.13	OA

### AUTO TRANSFORMERS

Ref.	VA (Watts)	TAPS	£	P&P
113	15	0-115-210-240V	2.48	71
64	75	0-115-210-240V	3.95	96
4	150	0-115-200-220-240V	5.35	96
66	300		7.75	114
67	500		10.99	164
84	1000		18.76	208
93	1500		23.28	OA
95	2000		34.82	OA
73	3000		48.00	OA

### SCREENED MINIATURES

Ref.	mA	Volts	£	P&P
238	200	3-0-3	1.99	55
212	1A 1A	0-6-0-6	2.85	78
13	100	9-0-9	2.14	38
235	330 330	0-9-0-9	1.99	38
207	500 500	0-8-9-0-8-9	2.59	71
208	1A 1A	0-8-9-0-8-9	3.53	78
236	200 200	0-15-0-15	1.99	38
239	50MA	12-0-12	1.99	38
214	300 300	0-20-0-20	2.56	78
221	700(DC)	20-12-0-12-20	3.41	78
206	1A 1A	0-15-20-0-15-20	4.63	96
203	500 500	0-15-27-0-15-27	3.99	96
204	1A 1A	0-15-27-0-15-27	5.39	96
S112	500	0-12-15-20-24-30	2.64	78

### HIGH VOLTAGE

MAINS ISOLATING  
Pri 200/220 or 400/440  
Sec 100/120 or 200/240

VA	Ref.	£	P&P
60	243	5.89	132
350	247	14.11	184
1000	250	41.76	OA
2000	252	54.25	OA

### BRIDGE RECTIFIERS

200v	2A	45p
400v	2A	55p
200v	4A	65p
400v	4A	80p
400v	6A	£1.05
500v	10A*	£2.35

\*P&P 15p VAT 12½% \*VAT 8%

### TEST METERS

AV08 Mk 5	£77.10
AV071	£31.30
AV073	£42.50
AV0MM5 MINOR	£26.10
WEE MEGGER	£64.00
AVO TT169 (tests transistors to circuit, no soldering)	£32.50
U4315 budget meter (42 ranges) 20K $\Omega$ /VDC 1000V AC/DC (9 ranges) 2.5A AC/DC 500K $\Omega$ resistance, in robust steel case with leads, full instructions	£15.85
EM272	£50.70
DA116 Digital	£100.00
Megger BM7 (Battery)	£42.50

Avo Cases and Accessories Ex-stock P&P £1.15 VAT 8%

### MINI-MULTIMETER

DC1000V AC1000V AC DC1000 $\Omega$ /V DC100mA Res - 150K Bargain at £5.86 VAT 8% P&P 62p
--

### PLASTIC BOXES

ABS Slotted brass inserts	
PB1 80mm x 62 x 40	56p
PB2 100mm x 75 x 40	63p
PB3 120mm x 100 x 45	70p
PP 29p VAT 8%	

### SPECIAL OFFER

Avo Meter (107) Ranges DC to 1000V current to 1 amp AC to 1000V 3 ohmic ranges to 10M ohms 10 000 DC 1 000 AC safety cut out £40.00

### CASED AUTO TRANSFORMERS

15VA	£4.96	96	113W
75VA	£6.03	114	64W
150VA	£8.48	114	4W
200VA	£9.92	145	65W
500VA	£15.73	164	67W
750VA	£18.55	176	83W
1000VA	£22.88	OA	84W
1500VA	£26.02	OA	93W
2000VA	£37.65	OA	95W

### PANEL METERS

2 0-50 $\mu$ A	£5.50	4 0-50V A	£6.70
2 0-100 $\mu$ A	£5.50	4 0-100 $\mu$ A	£6.70
2 0-1000 $\mu$ A	£5.50	4 0-500 $\mu$ A	£6.70
2 0-1mA	£5.50	4 0-1mA	£8.40
2 50V	£5.50	0-50V	£8.40
VU Indicator Panel 48-45 250V a FSD			£2.60
VU Indicator Edge 54x14 Carriage 65p VAT 8%			£2.60

### NEW RANGE HIGH QUALITY TRANSFORMERS

Sec. 45 36-0-36, 45 sec to give 36-0-36 45-0-45 72v or 90v.  
2A 9-89-1-38 5A 16-74 2 15  
3A 11-47-1-48 6A 20-77 2-30  
4A 13-90-1-84

### PLUG-IN — SAVE BATTERIES

3300. 6, 7, 5 9v at 300mA plugs direct into 13A socket (fused)  
STABILISED 3, 6, 7, 5, 9v at 400mA £3.30 £6.61

### ANTEX SOLDERING IRONS

15W £3.75, 18W £3.75, 25W £3.95  
Stand for above £1.40, P&P 46p VAT 8%

PLEASE ADD VAT AFTER P&P  
SEMICONDUCTOR RESISTOR CAPACITOR SEMI CONDUCTOR  
FOR AUDIO ACCESSORIES & BARGAIN PAKS. SAVE POS.  
PAGE CALLERS WELCOME MON-FRI. OR SEND 15p STAMP  
FOR LISTS.

PRICES CORRECT AT 25/12/77

## Barrie Electronics Ltd.

3, THE MINORIES, LONDON EC3N 1BJ

TELEPHONE: 01-488 3316/8

NEAREST TUBE STATIONS: ALDGATE & LIVERPOOL ST.

# NASCOM I Z80 MICROCOMPUTER

## Starts at £197.50 + VAT

Immediately a Market Leader.  
Greater expansion potential announced in April.  
RAM Boards up to 32K.  
Special I/O Boards.  
High-level Language Boards.  
Proposed Mini Floppy Disc.  
Centronics Printer at NASCOM Price.

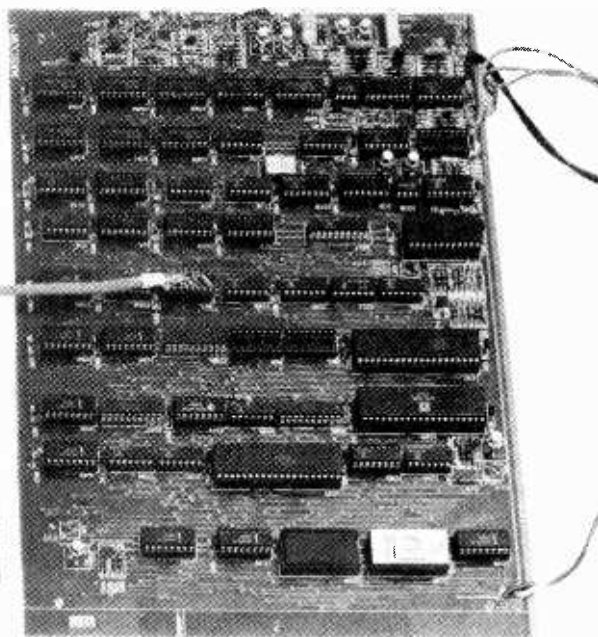

**Electronics**  
(LONDON) LTD.

92 BROAD STREET  
CHESHAM, BUCKS.  
Tel: Chesham (02405) 75154  
Telex: 837571

**TRANSISTORISED 3cm RADAR AMPLIFIER SWITCH:** with 24v waveguide switch, .9 x .4 cm ins. with crystal CV.2355 and spark gap VX.1046. **£16.20 + £1.00 post.**

**TRANSISTORISED VIDEO INDICATOR** (used with above amplifier): 1½" C.R.T. **£10.80 + £1.00 post.**

**VACUUM & PRESSURE SEAL TEST EQUIPMENT:** Complete with 3 x 4" gauges indicating 0-20lbs p.s.i. 0-30lbs vacuum. With stand, hand pump, etc., **£32.40 + £3.00 carr.**

**INSULATION TEST SET 0 to 10 KV.** negative earth. with Ionisation Amplifier, 100/230 Volts. AC **£45.90, carr. £3.00.**

**RACAL RA-17 RECEIVER 500KHz-30MHz,** s/hand, good condition. **£365.00** (including VAT 12½%).

**AVO TRANSISTOR ANALYSER CT.446: £37.80, carr. £2.20.**

**MARCONI FREQUENCY METER 1026/4:** 2000-4000mHz 'as new' condition. **£32.40** or secondhand condition **£24.30.**

**1026/2: 100-160mHz £32.40** 'as new' or s/hand **£24.30.** Carriage for all type **£2.00.**

**BURGLAR ALARM BELL:** 6-8v. d.c. **£3.24 + £1.00 post.**

**MUIRHEAD ATTENUATORS:** 75 ohms 0-8Mc/s 3V MAK 3 ranges 0-5, 0-25, 0-50dB. **£3.24 + 75p post.**

**TELEPRINTER TYPE 7B:** Pageprinter 24v. d.c. power supply, speed 50 bauds per min. S/hand cond. (excellent), no parts broken **£21.60, carriage £3.50.**

**AUTO TRANSFORMER:** 230v. 50c/s, 1000 watts. Mounted in strong steel case 5" x 6½" x 7". Bitumen impregnated. **£12.96, carr. £2.00.**

**CRYSTAL TEST SET TYPE 193:** Used for checking crystals in freq. range 3,000-10,000kHz. Mains 230v 50hz. Measures crystal current under oscillatory conditions and the equivalent resistance. Crystal freq. can be tested in conjunction with a freq. meter. **£27.00, carr. £2.00.**

**ELECTROLYTIC CAPACITOR REFORMING UNIT NO. 1.** 230v a.c. input 0-100mfd 6 to 450 volts in 10 ranges complete with leads and plugs. **£15.00, Carriage £3.00.**

**FIELD FLUID SAMPLING SET TYPE TP/SKP/10,000** with thermal control millipore oil sampling kit. **£125.00, Carriage £4.00.**

**JERROLD VC12 Voltage Comparator £65.00, £3.00 carriage.**

**JERROLD MODEL 707 FREQUENCY METER.** 7.5mHz to 39mHz. **£85.00, Carriage £3.00.**

**RING TOROIDAL DUST CORES:** Size 2½" outside, 1¾" inside, 5/16" thick. Box of two **£1.10 + 30p post.**

**ROTARY INVERTERS TYPE PE-218E:** Input 24-28v. d.c. 80 amps. 4,800rpm. Output 115v. a.c. 13 amp 400 c/s. 1Ph. P.F.9 **£21.60 + £3.00 carr.**

**R.F. POWER RADIATION METER CT.477.** Covering X, S and L bands, **£125.00, Carriage £4.00.**

**RECTIFIER UNIT:** 200-250v. a.c. input, 24v. d.c. at 26 amps output continuous rating. **£37.80, carr. £5.00.**

**MARCONI SIGNAL GENERATOR 801/DS:** 10-480mHz. **£318.60.**

**ROTARY CONVERTER:** 24 volts d.c. input, 230 volts. 100 watts output. **£27.50, carriage £4.00.**

**SIEMENS POWER METER 0-12kmHz 1mw to 500mw,** 6 ranges 0-17dB 50 ohms. **£85.00, Carriage £3.00.**

**RADIO TELETYPE TERMINAL SET SG1A** 115 volts a.c. **£17.50, carriage £3.00.**

**TELEGRAPH DISTORTION TEST SET TYPE 5CBV** 230 volts a.c. **£25.00, carriage £3.00.**

**RESONATOR PERFORMANCE CT.424** 8.5 to 9.0 kmc/s 3cm. **£75.00, post £2.00.**

**ALUMINIUM TRIPOD** (extra strong) will support 50lb. Extends to 56in. **£10.00, carriage £3.00.**

**INVERTER** 24 volts d.c. input 400 cycles 1pH 6600 r.p.m. 200-volts peak. **£7.50, £1.50 post.**

**OXYGEN BOTTLE** 1800lb. w.p. **£10.00, carriage £3.00.**

**VOLTAGE REGULATOR** 120 volts 62 amps. **£17.50 each or two for £32.50, carriage £4.00 each.**

**NOISE SOURCE UNIT** with CV.1881 noise source mount. Produces thermal noise 15.5dB 200/250 a.c. **£75.00.**

**LOW SPEED TAPE COMPARATOR** (Datronic) ¾" tape. **£45.00, £5 carr.**

**ADDO 1" TAPE REPRODUCER:** **£65.00, carriage £5.00.**

**MUIRHEAD D514 T.M.S.:** 12v d.c. or 100-250v a.c. volts input. Range 100-40,000Hz. **£15.00, carriage £4.00.**

**AUTOTUTOR MARK II:** (Viewer Training Aid) 230v a.c. Designed for use in intrinsic programming method, info stored on microfilm and projected through optical system onto viewing screen. **£120.00.**

### BARGAIN MAPS

Large stocks of unused U.S.A.F. surplus maps, weather charts, etc. including:-

ONC-E1 — U.K. in full and part N.W. Europe. Scale 1:1,000,000.

JNC-9N — N. Europe, U.K., Scandinavia. Scale 1:2,000,000.

JN-21N — Europe (Mediterranean). Scale 1:2,000,000.

SIZE: 58" x 42", colour. Many others. Please send S.A.E. for list.

Price each 70p (inc. p + p)

25 x Maps (either same type OR assorted) **£10.00 + £1.00 p + p.**

10 x Maps (either same type OR assorted) **£6.00 (inc. p + p).**

Above prices include VAT at 8% (except where stated)

Carriage quotes given are for 50-mile radius of Herts.

Visit our new shop in Ware High Street (old A10) opposite Church. 100s of individual bargains for callers. If you wish to collect any of the above items please telephone prior to calling to avoid disappointment.

**W. MILLS**

**3 & 3a BALDOCK STREET, WARE, HERTS. SG12 9DT**  
WARE 66312 (STD 0920)



# DIY HI-FI From the USA

**THE AUDIO AMATEUR** magazine, now eight years old, is totally dedicated to good sound for the do-it-yourself audiophile. TAA's thoroughly tested construction articles range from simple overload indicators to hand-made electrostatic speakers with their own direct drive power amplifiers to mixers and much, much more. Our authors include *Reg Williamson, B. J. Webb, and Alan Watling.*

Fill in the coupon, enclose cheque or money order payable to *The Audio Amateur* and send to TAA Dept. WW1, Yellow Oak Cottage, Tillingington, Nr. Hereford HR4 8LQ.

Enter my subscription to TAA for one year/four issues for £3.

I want to know more. I enclose 75p plus 25p for postage for a sample issue of *The Audio Amateur.*

Send free prospectus.

Name \_\_\_\_\_  
Street \_\_\_\_\_  
Town \_\_\_\_\_ County \_\_\_\_\_  
Post Code \_\_\_\_\_

These rates are for the U.K. only.

Subscribe now on a satisfaction guaranteed basis or send for a FREE descriptive folder.

Rates for other areas available from head office TAA, P.O. Box 176, Peterborough N H 03458 USA.

## RADFORD HD250 High Definition Stereo Amplifier

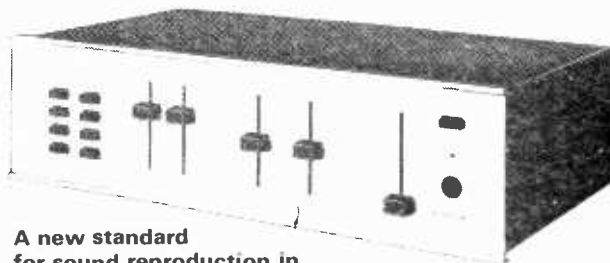

**A new standard for sound reproduction in the home! We believe that no other amplifier in the world can match the overall specification of the HD250.**

Rated power output: 50 watts av. continuous per channel into any impedance from 4 to 8 ohms, both channels driven

Maximum power output: 90 watts av. per channel into 5 ohms.

Distortion, preamplifier: Virtually zero (cannot be identified or measured as it is below inherent circuit noise.)

Distortion, power amplifier: Typically 0.006% at 25 watts, less than 0.02% at rated output (Typically 0.01% at 1 KHz)

Hum and noise: Disc.—83dBV measured flat with noise band width 23 KHz (ref 5mV); —88dBV "A" weighted (ref. 5mV)

Line —85 dBV measured flat (ref 100v)  
—88d BV "A" weighted (ref 100v)

Hear the HD250 at

**SWIFT OF WILMSLOW**  
Dept. WW, 5 Swan Street, Wilmslow, Cheshire  
(Tel: 26213)

Mail Order and Personal Export enquiries: Wilmslow Audio, Swan Works, Bank Square, Wilmslow (Tel. 29599)

Now available ZD100 power amplifier and ZD22 pre-amplifier

WW—040 FOR FURTHER DETAILS

**NEW** **ITW FGM POLYESTER RADIAL LEAD MINIATURES**

01 250V	10Mm	05.0
01 400V	10Mm	05.0
015 250V	10Mm	05.5
022 250V	10Mm	06.0
033 250V	10Mm	06.5
047 250V	10Mm	06.5
047 400V	10Mm	07.0
088 250V	10Mm	07.0
1 250V	10Mm	08.0
1 400V	10Mm	09.0
15 250V	15Mm	08.5
22 250V	15Mm	09.5
1mfd 250V	21Mm	25.0

ALTERNATIVE TO C280

**CAPACITORS**

**CERAMIC CAPACITORS EDPU 63 V**

**Stock Values PF**

4 7	10	12	15	18	22	4 7—
27	33	39	47	56	82	1000pf 04
100	120	150	180	220		2200pf 045
270	330	390	470	560		3300pf 06
680	820	1000/2200				4700pf 08
3300	4700	10.000				10 000 04

**TANTALUM BEAD**

47	35V	09	15	25V	15
1	35V	09	22	10V	15
22	16V	09	22	15V	16
22	35V	10	47	15V	18
33	16V	10	220	1V	10
47	10V	09	100	6V	18
10	16V	11	100	10V	32
10	25V	15			

T.W.O. V.A.T. included  
P & P 20p — Overseas extra

**GREENWAY ELECTRONIC COMPONENTS (EAST GRINSTEAD) LTD.**  
62 Maypole Road, Ashurst Wood, East Grinstead, Sx. RM19 3RB.  
Tel. 034-282 3712

WW—024 FOR FURTHER DETAILS

## ASTONISHING STEREO DISC AMPLIFIER 2

FOR BROADCASTING, DISC MONITORING AND TRANSFER WITH THE HIGHEST QUALITY. Stereo Disc Amplifier 2 is a self-contained mains-powered unit which accepts cartridge inputs and produces balanced line level outputs. Permanent rumble filtering and switched scratch filtering is included.

**FURTHER SPECIFICATIONS:** (For THD IMD etc. see February advertisement)  
1KHz at 6mV set for 0dBV 7 output. Loaded 600 ohms

<b>Frequency Response RIAA Accuracy</b> 30Hz-20KHz	Within 0.5dB
<b>Cartridge impedance interaction on frequency response.</b> High inductance cartridge. 1H	Less than 0.2dB
<b>Low frequency response</b> 18dB/octave Group delay relative to 1KHz	— 3dB 24Hz — 15ms @ 30Hz
<b>H.F. Filter</b> Front panel switch Change in response at BKHz or below	10KHz 18dB octave Less than 0.5dB 2.8-13mV for 0dBV 7 output Presets adjustable through holes
<b>Sensitivity @ 1KHz</b>	Source impedance 50 ohms

**Outputs** — Electronically balanced  
Protected against mains or static voltages applied to lines.

**SURREY ELECTRONICS**  
The Forge, Lucks Green, Cranleigh, Surrey GU6 7BG (STD 04866) 5997

# The SEMICON INDEXES

INTERNATIONAL SEMICONDUCTOR DEVICE DATA

VOLUME 1 TRANSISTORS £10  
ISBN 0 904944 04 2 (7th Edition)

VOLUME 2 DIODES/SCRs 1.80  
ISBN 0 904944 02 6 (1st Edition)

VOLUME 3 ICs (including  $\mu$ Ps) Publication soon  
ISBN 0 904944 03 4

MAKE SURE YOU FIND OUT ABOUT THE NEW INDEXES BEFORE JULY.

SEND AN ENQUIRY OFF TO-DAY.

Each volume has a unique easy reference alpha-numeric listing of the maximum ratings and essential characteristics of more than 25,000 devices of international origin—European, USA & Japanese. Accepted worldwide by Engineers, Technicians and Buyers. 12 months guarantee of validity. Descriptive folders available.

**SEMICON INDEXES LIMITED**  
7 King's Parade, King's Road, Fleet, Hants. GU13 9BW  
Tel: Fleet (02514) 28526 Telex: 858855G  
WW—053 FOR FURTHER DETAILS

# TEN GOOD REASONS FOR BUYING THE NEW FLUKE 8020A DMM.

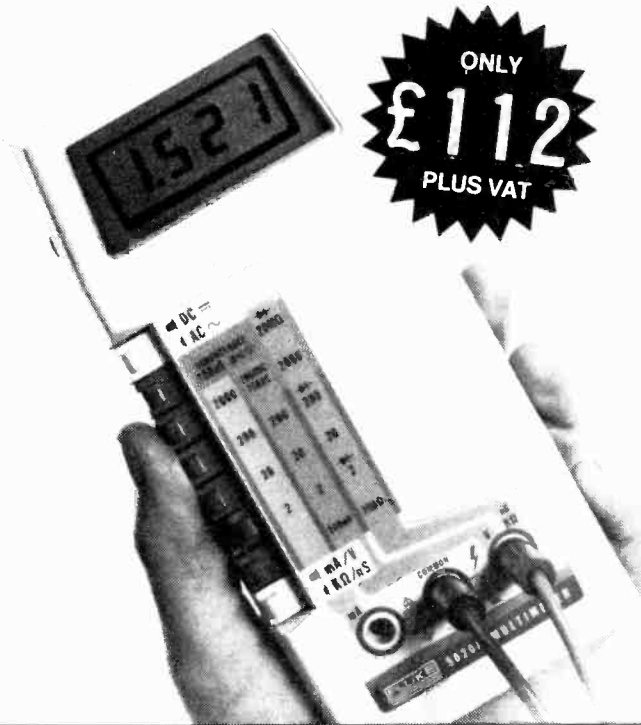

1. 26 ranges of AC/DC volts and amps, ohms and conductance.
2. 0.25% vdc accuracy over 10°C range for 1 year.
3. 'High power' ohms for diode testing.
4. 'Low power' ohms for in-circuit resistance measurement.
5. Conductance ranges allow leakage measurement to 10,000 MΩ.
6. 9v battery gives typically 200 hrs. life.
7. Protected to 250v dc or rms on any range, any function.
8. Protects to 6kv for 10µs on any range, any function.
9. 2 year warranty on parts and labour.
10. Large liquid crystal display.

**Harlow(0279)29522**

**ITT instrument services**

Edinburgh Way, Harlow, Essex. CM20 2DF. Telex: 81525

**The only way to buy.**

WW-034 FOR FURTHER DETAILS

**STOP the SEARCH!**



**SCOPEX**  
**4D 10 A**  
**OSCILLOSCOPES**

**... Will TRACE it**

**3% Measuring Accuracy  
Stabilised Power Supplies  
10 MHz Dual Trace  
10 mV Sensitivity**

Price  
**£180**  
UKex VAT

**SCOPEX**

For YOUR Personalised Demonstration.  
Scopex Instruments Ltd, Pixmore Industrial Estate, Pixmore Avenue,  
Letchworth, Hertfordshire. SG6 1JJ. Letchworth 72771(STD 046 26)

WW - 099 FOR FURTHER DETAILS

® Regd Trade Mark

# 'UL6 the best budget loudspeakers I've heard' says Philip Mount

Reproduced from Practical Hi-Fi Sept '77

is pro- and ncy mis- mit- tical inal ays

're- in .om d to int at leph nals s the

ali- ctly pu- ve flat' l-off, gain g an 'ncy The ects dge und es- /as ara-

and dern other A401

Har- ified, vays and- end. s over asises vrn — quality rice, the id is ud- ing was than

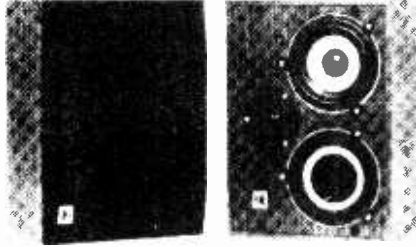

Celestion's UL6s

Up to this point you could say the products described are competent by present standards, or even very good. Celestion's UL6 loudspeakers hooked up to the end are unequivocally the best budget loudspeakers I have heard - or in some particular respects the best loudspeakers I have heard without the qualification of price. Around the time of their introduction a small group of audio journalists was asked by an importer of a certain well-known Japanese brand to give opinions on the quality of a loudspeaker they were about to import. For comparison, about eight popular British loudspeakers had been assembled and connected to a comparator. At the end of the session there was one point on which everybody seemed agreed, and that was the fact that Celestion's UL6 appeared to sound significantly smoother and more evenly balanced than any of the other makes. Since the difference appeared so great, even against significantly more expensive models, I at least wondered whether the particular listening conditions had by some dark favoured the UL6's by an unusually large degree.

Now, about one year later I find that it wasn't providence and that the speaker easily beats most others into second place by means of ability. It was suggested to me, for instance, and I think this is true, that the UL6 can be recommended irrespective of taste. Because it's so completely natural and free from major imbalances or defects I believe most people would admit to 1) liking it, and 2) finding that they could live with the (in the matter what they had been previously used to. According to taste, you may prefer another loudspeaker with its own peculiar sound, but you would have to admit that this sounds right.

It is common when describing the sound of a loudspeaker to split the audio band into bass, midrange and treble regions, then deal with each separately. This is often provoked by the loudspeaker itself, because most do the same thing and don't present a coherent picture, but a fractured programme where

bass output might be say soft and distant whilst treble is bright and forward.

This split in quality and relative levels is, as usual, fairly well compensated for by the brain after a short learning and adjustment process. Since it is so common the effect is also tolerated and one does expect to adjust to a speaker's own peculiar sound quality. The most immediately striking feature of the UL6 and the one that caused it to sound superior to all others on that group listening test described earlier is the fact that adjustment rarely seems necessary or called for. There aren't splits, suck-outs or imbalances. The treble doesn't leap out or disappear and you don't have to decide whether you like such-and-such an effect or not. At a broad fundamental level the UL6 just sounds, unobtrusively, right. I cannot say that behind this overall feeling detail criticisms are impossible, but the UL6 certainly transcends its price category and cannot be approached, at least by most speakers costing around £100 or less.

If you want to hear a speaker with the whole of the audio range present and transmitted as a smooth whole, or what I listen to, the UL6. It is as detailed as any of the best speakers but doesn't achieve this by false upper midrange or treble prominence. An ABR (Auxiliary Bass Radiator) is used to augment bass response and for the first time I can recall it doesn't produce soggy, indefinite bass quality. The main weakness that was some woollen nasal quality in bass, but this was the only form of detail I could identify.

Celestion instruments were astonishingly powerful and realistic for a speaker of the size, and perhaps just a small amount of resonant behaviour contributed to this very large and excellent performance, which will, I assure you make a majority of budget equivalents sound like muffled cats, which they are, in spite of being by some that real bass can be wrought from a tarted up shoe box.

## Extremely good

It was the loudspeaker that I had been around from so long that it was my first introduction to a whole lot of far greater cartridge and amp sound balance and as I said at first things became of price the result extremely good. There's no the

## Now listen to this...

We don't expect you to take everything you see in the hi-fi magazines about speakers as read. Relying on someone else's ears - even when they are as expert and sensitive as Philip Mount's - isn't quite the same as getting the "message" first hand! But we're more than confident that you will find very little to disagree with once you've heard the UL6 demonstrated.



www.americanradiohistory.com

Why not take one of your own records or tapes along to a Celestion dealer and listen.

name \_\_\_\_\_  
address \_\_\_\_\_

07.15.06  
Rola Celestion Ltd., Ditton Works, Foxhall Road, Ipswich, Suffolk IP3 8JP. Telephone: (0473) 73131. Cables: Voicecoil Ipswich, Telex: 98365.

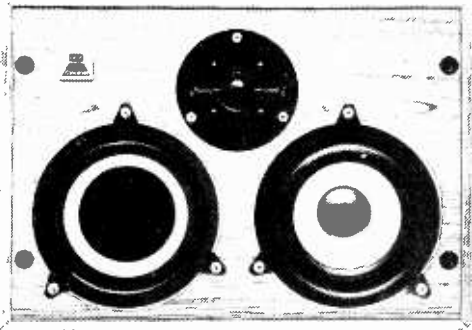

**U.K. RETURN OF POST MAIL ORDER SERVICE, ALSO WORLDWIDE EXPORT SERVICE**

**BSR HI-FI AUTOCHANGER STEREO AND MONO £21.50** Post £1

Plays 12" 10" or 7" records Auto or Manual A high quality unit backed by BSR reliability with 12 months guarantee. A.C. 200/250V. Size 13 1/2 x 11 1/4 x 3 speeds. Above motor board 3 3/4 in. Below motor board 2 1/2 in with Sonotone V100 magnetic cartridge

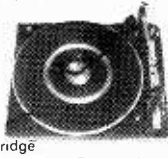

BSR P128/MP60 with magnetic cartridge Balanced arm Cueing device Bias Compensator £24.50. Post £1

**NEW BSR SINGLE PLAYER £19.95**

Model P182 3-speeds flared aluminium turntable Post £1 S' shaped arm, cueing device, stereo ceramic cartridge B.S.R. Budget Autochanger with stereo cartridge, £12.95 Post £1

**HEAVY METAL PLINTHS £6.50**

With P.V.C. Cover. Cut out for most BSR or Garrard decks Silver grey finish Post £1.50 Model 'A' Size 12 1/2 x 14 3/4 x 7 1/2 in Model 'B' Size 16 x 13 3/4 x 7 in

Extra large plinth & cover, teak wood base Size 20 x 17 1/2 x 9 £18.50. Shop callers only

**BSR SINGLE PLAYER**

Ideal replacement or disco deck with cueing device and stereo ceramic cartridge. 3 speeds Large turntable, modern design



£17.50 Post 75p

**ELAC HI-FI SPEAKER 8in. TWIN CONE**

Dual cone plastic roll surround Large ceramic magnet 50-16,000 c/s Bass resonance 40 c/s 8 ohm impeded ance 10 watts RMS £5.95 Post 35p



**SMITH'S CLOCKWORK 15 AMP TIME SWITCH**

0-6 hours £3.30 Post 35p Single pole two-way. Surface mounting with fixing screws Will replace existing wall switch to give light for return home garage, automatic anti-burglar lights, etc



Variable knob. Turn on or off at full or intermediate settings. Brand new

**TEAKWOOD LOUDSPEAKER GRILLES**

will easily fit to baffle board. Size 10 1/2 x 7 1/4 in - 45p.

**R.C.S. "MINOR" 10 watt AMPLIFIER KIT**

This kit is suitable for record players, guitars, tape playback, electronic instruments or small P.A. systems Two versions available. Mono £12.50; Stereo £20. Post 45p. Specification 10W per channel; input 100mV; size 9 1/2 x 3 x 2 in. approx S.A.E. details. Full instructions supplied. AC mains powered.

**VOLUME CONTROLS**

5kΩ to 2MΩ. LOG or LIN L/S 35p. D.P. 60p. STEREO L/S 85p. D.P. £1. Edge 5K S.P. Transistor 45p.

**80 Ohm Coax 8p yd.**

FRINGE LOW LOSS 15p yd. Ideal 625 and colour. PLUGS 10p. SOCKETS 10p. LINE SOCKETS 18p. OUTLET BOXES 50p. 300 ohm FEEDER 5p yd

**ELAC 9 x 5in HI-FI SPEAKER TYPE 59RM**

Post 35p This famous unit now available. 10 watts. 8 ohm

**E.M.I. 13 1/2 x 8in. SPEAKER SALE!**

With tweeter and crossover. 10 watt 3 or 8 ohm Ditto 15 watts. 8 ohm.

£7.95 Post 45p £10.50 Post 65p

With tweeter and crossover 20 watt. Bass res. 25 c.p.s Flux = 11,000 gauss. Post 75p 8 or 15 ohm. 20 to 20,000 c.p.s.

£11.50 Post 75p

**Bookshelf Cabinet**

Teak finish. For EMI 13 x 8 speakers. Post £1.00

**THE "INSTANT" BULK TAPE ERASE AND HEAD DEMAGNETISER**

Suitable for cassettes, and all sizes of tape reels. A.C. mains 200/250V. Leaflet S.A.E. Will also demagnetise small tools £4.95 Post 50p

**RELAYS. 12V D.C. 95p. 5V D.C. 85p. 240V A.C. 95p.**

BLANK ALUMINIUM CHASSIS. 6 x 4 - 95p; 8 x 6 - £1.40; 10 x 7 - £1.55; 12 x 8 - £1.70; 14 x 9 - £1.90; 16 x 6 - £1.85; 16 x 10 - £2.20. ANGLE ALI. 6 x 3/4 x 3/4 in - 15p.

ALUMINIUM PANELS. 6 x 4 - 24p; 8 x 6 - 38p; 14 x 3 - 40p; 10 x 7 - 54p; 12 x 8 - 70p; 12 x 5 - 44p; 16 x 6 - 70p; 14 x 9 - 84p; 12 x 12 - £1; 16 x 10 - £1.16.

ALI BOXES IN STOCK. MANY SIZES VARICAP FM TUNER HEAD with circuit & connections £4.95. TAG STRIP 28-watt 12p.

TAPE OSCILLATOR COIL. Valve type. 35p. BRIDGE RECTIFIER 200V PIV 1/2 amp 50p. 8 amp £2.50. TOGGLE SWITCHES S.P. 30p. D.P. S.T. 40p. D.P. D.T. 50p.

MANY OTHER TOGGLES IN STOCK PICK-UP CARTRIDGES ACOS. GP91 £1.50. GP95 £2.50. SONOTONE stereo £2.00. SHURE M75 ECS £8.

WIRE-WOUND RESISTORS 5 watt, 10 watt, 15 watt 15p ea.

**R.C.S. SOUND TO LIGHT KIT Mk. 2**

Kit of parts to build a 3 channel sound to light unit 1,000 watts per channel Suitable for home use. Easy to build. Full instructions supplied. Cabinet £4. Will operate from 20MV to 100 watt signal. £17 Post 35p.

**R.C.S. LOW VOLTAGE STABILISED POWER PACK KITS**

All parts and instructions with Zener diode, printed circuit rectifiers and double wound mains transformer Input 200/240V a.c. Output voltages available, 6 or 7.5 or 9 or 12V d.c. up to 100mA or less Size 3 x 2 1/2 x 1 1/2 in Please state voltage required. £2.95 Post 45p

**R.C.S. POWER PACK KIT**

12 VOLT, 750mA. Complete with printed circuit board and assembly instructions. 12 VOLT 300mA KIT. £3.35 Post 30p

**R.C.S. GENERAL PURPOSE TRANSISTOR PRE-AMPLIFIER - BRITISH MADE**

Ideal for Mike, Tape, P.U., Guitar, etc. Can be used with battery 9-12V or H.T. line 200-300V d.c. operation. Size 1 3/4 x 1 1/4 x 3/4 in. Response 25 c/s to 25 kc/s. 26 dB gain For use with valve or transistor equipment. Full instructions supplied Details S.A.E. £1.45 Post 30p

**R.C.S. DRILL SPEED CONTROLLER/LIGHT DIMMER KIT.**

Easy to build kit. Will control up to 500 watts AC mains. £3.25 Post 35p

**R.C.S. STEREO PRE-AMP KIT.**

All parts to build this pre-amp. Inputs for high, medium or low imp per channel, with volume control and P.C. Board. £2.95 Post 35p

**MAINS TRANSFORMERS**

250.0-250V 70mA 6.5V 2A	ALL POST 75p	£3.45
250.0-250V 80mA 6.3V 3.5A, 6.3V 1A		£4.80
350.0-350V 80mA 6.3V 3.5A, 6.3V 1A		£5.80
300.0-300V 120mA 2 x 6.3V 2A C.T. 5V 2A		£8.50
220V 45mA 6.3V 2A		£1.75
HEATED TRANS 6.3V 1/2 amp		£1.00
Ditto 3 amp		£1.75
GENERAL PURPOSE LOW VOLTAGE Tapped outputs		
2 amp 3 4.5 6 8 9 10 12 15 18 25 and 30V		£5.30
1 amp 6 8 10 12 16 18 20 24 30 36 40 48 60		£5.30
2 amp 6 8 10 12 16 18 20 24 30 36 40 48 60		£8.50
3 amp 6 8 10 12 16 18 20 24 30 36 40 48 60		£11.00
5 amp 6 8 10 12 16 18 20 24 30 36 40 48 60		£14.50
12V 100mA	£1.00	20V 40V 60V 1 amp £3.50
12V 750mA	£1.30	12V 300mA £1.00
20V 3 amp	£2.45	10V 30V 40V 2 amp £2.75
30V 5 amp and 17V-0-17V	£3.45	40V 2 amp £2.95
2 amp	£3.45	20V 1 amp £2.20
0 5 10 16V 1/2 amp	£1.95	20V-0-20V 1 amp £2.95
9V 3 amp	£2.75	30V-0-30V 2 amp £7.00
24V 3 amp + 48V 1/2 amp	£3.50	2 of 18V 6 amp £9.00
30V 1 1/2 amp	£2.75	12-0-12V 2 amp £2.95

**AUTO TRANSFORMERS. 115V to 230V or 230V to 115V 150W**

250W £6.00 400W £7.00 500W £8.00

**FULL WAVE BRIDGE CHARGER RECTIFIERS**

6 or 12V outputs, 2 amp 75p. 4 amp £1.00

**CHARGER TRANSFORMERS 1 1/2 amp**

£3.50 £6.80 25p

**12V 1 1/2 amp Half Wave Selenium Rectifier**

£2.75

**BOOKSHELF SPEAKERS**

Teak or White 13 x 10 x 6 in approx 50 to 14,000 cps 10 watts rms. 4 ohms £16 pair Post £1.30

**EXTENSION SPEAKERS £3.95 ea.**

These little marvels of modern sound reproduction are ideally suited for today's domestic audio set-up. Two of these smart spheres, each with 5 watt deep throated ceramic magnets, will produce superb stereo reproduction.

The globe shaped cases in high gloss mouldings of red or green, are finished with chrome frontal trim and provided with screw-on rubber inset protective bases In addition 2 1/2 metres of strong lead already fitted with phono plug is supplied Full Range Frequency Response Impedance 8 ohms Power Peak 5 watts

**LOW VOLTAGE ELECTROLYTICS**

1, 2, 4, 5, 8, 16, 25, 30, 50, 100, 200mF 15V 10p.
500mF 12V 15p; 25V 20p; 50V 30p;
1000mF 12V 17p; 25V 35p; 50V 47p; 100V 70p.
2000mF 6V 25p; 25V 42p; 420mF/500V £1.30.
2500mF 50V 62p; 3000mF 25V 47p; 50V 65p.
3900mF 100V £1.60. 4700mF 63V £1.20. 2700mF/76V £1.
5000mF 6V 25p; 12V 42p; 35V 85p. 5600mF/76V £1.75

**MANY OTHER ELECTROLYTICS IN STOCK**

SHORT WAVE 100pF air spaced gangable tuner. 95p.

TRIMMERS 10pF, 30pF, 50pF, 5p, 10pF, 150pF, 15p.

CERAMIC, 1pF to 0.01mF, 5p, Silver Mica 2 to 5000pF, 5p.

PAPER 350V-0.1 7p; 0.5 13p; 1mF 150V 20p; 2mF 150V

20p; 500V-0.001 to 0.05 12p; 0.1 15p; 0.25 25p; 0.47 35p.

MICRO SWITCH SINGLE POLE CHANGEOVER 20p.

SUB-MIN MICRO SWITCH, 25p. Single pole change over

TWIN GANG, 385 + 385pF 50p; 500pF standard 75p.

365 + 365 + 25 + 25pF. Slow motion drive 85p.

120pF TWIN GANG, 50p; 365pF TWIN GANG, 50p.

NEON PANEL INDICATORS 250V. Amber or red 30p.

RESISTORS. 10Ω to 10M 1/4W, 1/2W, 1W, 20% 2p; 2W, 10p.

HIGH STABILITY. 1/2W 2% 10 ohms to 6 meg. 12p.

Ditto 5% Preferred values 10 ohms to 10 meg., 5p.

**ELECTRO MAGNETIC PENDULUM MECHANISM**

1.5v d.c. operation over 300 hours continuous on SP2 battery, fully adjustable swing and speed. Ideal displays, teaching electro magnetism or for metronome, strobe, etc. 95p Post 30p

**BAKER MAJOR 12" £15.00**

Post £1.00 30-14,500 c/s. 12in. double cone, woofer and tweeter cone together with a BAKER ceramic magnet assembly having a flux density of 14,000 gauss and a total flux of 145,000 Maxwells. Bass resonance 40 c/s Rated 25W. NOTE: 4 or 8 or 16 ohms must be stated.

Module kit, 30-17,000 c/s with tweeter, crossover, baffle and instructions. Post £1.60 each Please state 4 or 8 or 16 ohms £19.00

BAKER "BIG-SOUND" SPEAKERS. Post £1.00 each. 'Group 25' 12in 30W £12.00 'Group 35' 12in 40W £14.00 'Group 50/15' 15in 75W £26.00 4 or 8 or 16 ohm 4 or 8 or 16 ohm 8 or 16 ohm

BAKER LOUDSPEAKER, 12 INCH, 60 WATT. GROUP 50/12, 4 OR 8 OR 16 OHM HIGH POWER. FULL RANGE PROFESSIONAL QUALITY. RESPONSE 30-16,000 CPS £21.00 MASSIVE CERAMIC MAGNET Post £1.60 WITH ALUMINIUM PRESENCE CENTRE DOME

TEAK VENEERED HI-FI SPEAKERS AND CABINETS For 12in or 10in speaker 20x13x12in £14.50 Post £2 For 13x8in or 8in speaker £8.50 Post £1 For 6 1/2in. speaker and tweeter 12x8x6in £5.95 Post 75p Many other cabinets in stock. Phone your requirements.

SPEAKER COVERING MATERIALS. Samples Large S.A.E. LOUDSPEAKER CABINET WADDING 18in wide 20p ft

**R.C.S. 100 watt VALVE AMPLIFIER CHASSIS**

Four inputs. Four way mixing, master volume, treble and bass controls Suits all speakers This professional quality amplifier chassis is suitable for all groups, disco, P.A., where high quality power is required. 5 speaker outputs A/C mains operated. Slave output socket Produced by demand for a quality valve amplifier 100V line output to order. Send for leaflet. Suitable carrying cab £16.50 Price £94 carr. £2.50

Horn tweeters 2-16kc/s. 10W 8 ohm or 16 ohm £3.60. Audax Tweeters 3-18kc/s. 50W 8 ohm £7.50. CROSSOVERS. TWO-WAY 3000 c/s 3 or 8 or 15 ohm £1.90. 3-way 950 cps/3000 cps. £2.20. LOUDSPEAKERS P.M. 3 OHM 7x4in. £1.50; 6 1/2in. £1.80; 8x5in. £1.90; 8in. £1.95. SPECIAL OFFER: 80 ohm 2 1/4in., 2 3/4in., 35 ohm, 3in., 25 ohm, 2 1/2in., 3in., 5x3in., 7x4in., 8 ohm, 2 1/2in., 3in., 3 1/2in., 5in., 15 ohm, 3 1/2in., dia. 6x4in., 7x4in., 5x3in., 3 ohm, 2 1/2in., 2 3/4in., 5in dia £1.50 each.

PHILIPS LOUDSPEAKER, 8in., 4 ohms, 4 watts. £1.95 RICHARD ALLAN TWIN CONE LOUDSPEAKERS 8in diameter 4W £2.50, 10in. diameter 5W £2.95; 12in. diameter 6W £3.50. 3/8/15 ohms, please state.

MOTOROLA PIEZO ELECTRIC HORN TWEETER. £7.95 Handles up to 100 watts No crossover required

Black Plastic Construction Box with brushed aluminium fascia. Sturdy job. Size 6 1/4 x 4 3/4 x 2 in. £1.50

**BAKER 150 WATT PROFESSIONAL MIXER AMPLIFIER**

All purpose transistorised Ideal for Groups, Disco and P.A. 4 inputs speech and music. 4 way mixing. Output 4 8/16 ohms. a.c. Mains. Separate treble and bass controls. Master volume control. Guaranteed. Details S.A.E. £75 £1.50 carr.

**100 WATT DISCO AMPLIFIER**

volume, treble, bass controls, 500 M.V. or 1 volt input. Four loudspeaker outputs 4 to 16 ohm. All transistor £59

**GOODMANS COMPACT 12-INCH BASS WOOFER**

Standard 12in. diameter fixing with cut sides 10 3/8 square 14 000 Gauss magnet. 30 watts R.M.S 4 ohm imp Bass resonance = 30 c.p.s Frequency response 30-8000 c.p.s £10.95 each Post £1

**ALUMINIUM HEAT SINKS. FINNED TYPE.**

Sizes 6 1/2" x 4 1/2" x 2 1/4" 95p. 6 1/2" x 2 1/4" 65p.

BALANCED TWIN RIBBON FEEDER 300 ohms. 5p yd.

JACK SOCKET Std. open-circuit 20p. closed circuit 25p;

Chrome Lead-Socket 45p. Mono or Stereo.

Phono Plugs 8p. Phono Socket 8p.

JACK PLUG Std. Chrome 30p; Plastic 25p; 3.5mm 15p.

STEREO JACK PLUG 30p. SOCKET 25p.

DIN SOCKETS Chassis 3-pin 25p; 5-pin 10p.

DIN SOCKETS FREE 3-pin 25p; 5-pin 25p; DIN PLUGS 3-pin 25p; 5-pin 25p. VALVE HOLDERS, 10p; CANS 10p.

TV CONVERSION POTS 15p each

VALVES = 5, 7, 10, 20, 50, 100, 200, 250, 470, 2000 ohms

**MONO PRE-AMPLIFIER.**

Mains operated solid state pre-amplifier unit designed to complement amplifiers without low level phono and tape input stages. This free-standing cabinet incorporates circuitry for automatic R.I.A.A. equalisation on magnetic phono input and N.A.B. equalisation for tape heads Power ON/OFF, PHONO/TAPE switches and pilot lamp are on the front panel, phono socket input and output are rear located.

£4.50 each or £8 pair. Post 50p.

**337 WHITEHORSE ROAD, CROYDON**

Open 9-6. Wed. 9-1. Sat. 9-5 (Closed for lunch 1.15-2.30)

Tel. 01-684 1665

**RADIO COMPONENT SPECIALISTS**

Radio Books and Components Lists 10p. (Minimum posting charge 30p.) Cash prices include VAT. (We accept Access or Barclaycard. Phone your Order)

SEND FOR SINTEL FREE CATALOGUE

SINTEL

FAST SERVICE We guarantee that Telephone Orders for goods in stock, received by 4.15 p.m. (Mon-Fri) will be despatched on the same day by 1st Class Post (some heavy items by parcel post) and our stocking is good. Private customers should telephone and pay by giving their Access or Barclaycard number, with a minimum order value of £5. Official orders, no minimum.

RESEARCH MACHINES 380Z COMPUTER SYSTEM AVAILABLE THROUGH SINTEL. RESEARCH MACHINES 380Z SYSTEM 16 + K. Ready built with 16K RAM, 2K ROM Monitor with Keyboard. As above but with 32K RAM £1448 With 48K Ram £1081.00 £1895.00

DATA BOOKS £8.20 Intel Memory Design Handbook £5.25 Intel 8080-Microcomputer System User's Manual £5.15 Intel 8085 Microcomputer System User's Manual £1.80 Motorola Booklet From the Computer to the Microprocessor £3.50 Motorola CMOS Databook (Vol 5 Series B) £12.95 Motorola M6800 Microprocessor Applications Manual £6.35 Motorola M6800 Programming Manual £0.75 National SC/MP Intro Kit User's Manual £1.80 National SC/MP Technical Description £2.10 National Semiconductor TTL Databook £6.45 RCA CMOS and Linear IC Databook £2.95 Texas Instruments Pin Configuration Guide: A very useful set of gloss cards showing top and bottom pinout views of 7400 ICs plus many others (T.I. Memories Op Amps, etc) £7.50 Z80 Assembly Language Programming Manual £6.80 Zilog Z80-CPU Technical Manual £0.80 Zilog Z80-CTC Product Specifications £3.30 Zilog Z80-P10 Technical Manual £1.45 DATASHEETS at 75p each on IM6100, 6800, SC/MP, CDP1802, 2650, TMS5501, TMS8080, 9131, Z80, P, Intel 8085. Also free data on some components

MICROPROCESSORS A SELF-CONTAINED MICROCOMPUTER KIT: THE MEK6800D2. Keyboard Data Entry 6 Digit Hex Display. Integral Cassette Interface. 256 Words of RAM. Single +5V Power Supply. Order as MEK6800D2 £190.00 MC6800 £15.97 MC6820 £8.02 Z80-CPU (2.5MHz) £28.44 Z80A-CPU (4MHz) £36.98 Z80-CTC £12.80 Z80-PIO £12.80

SINTEL ACK CLOCK KITS CODE PRICE 6 Red Digit ALARM CLOCK w. 205mm h. 40mm d. 140mm ACK £28.90 4 Red Digit DESK CLOCK w. 154mm h. 40mm d. 85mm 111-222 £18.50 4 Green Digit DESK CLOCK w. 154mm h. 40mm d. 85mm GCK £12.95 6 Red Digit CAR CLOCK WITH TIMER w. 205mm h. 40mm d. 140mm CCK £41.90 4 Red Digit CAR CLOCK w. 154mm h. 40mm d. 85mm AUT-CK £18.85 50H: CRYSTAL TIMEBASE KIT XTK £6.45

COMPONENTS SOLDERCON CLOCK CHIPS DISPLAYS CRYSTALS MEK6800D2 190.00 PINS AY1202 3.10 TYPE MC6800 15.87 100 0.50 AY1224 3.50 FDS00 C.C. 1.30 MC6820 8.02 1000 4.00 MK50253 5.90 TYPE Z80-CPU 28.44 3000 10.50 TL021 C.A. 1.40 MEMORIES/Ps Z80A-CPU 36.90 TL101 4.80 Z102A-6 2.05 Z80-CTC 12.80 TL124 2.90 Z80-PIO 12.80 Free data is available on some of these items. SEND FOR FREE CATALOGUE.

A RANGE OF SINTEL INDUSTRIAL MODULE KITS Latched Counter modules are now available from SINTEL using both CMOS and TTL ICs. These kits will give you a very compact unit at less than the cost of the components bought separately and will save you considerable design, purchasing, building and de-bugging time. Each kit has a set of red LED displays, two PCBs, and the appropriate number of TTL or CMOS ICs, plus brackets, etc., resistors, capacitors, single in-line plug and sockets and instructions. KITS FOR LATCHED COUNTER MODULES

CMOS Mainly RCA CD4014 1.04 CD4031 2.30 CD4048 0.58 CD4071 0.23 CD4098 1.13 CD4015 1.04 CD4032 1.02 CD4049 0.58 CD4072 0.23 CD4099 1.90 CD4016 0.58 CD4033 1.44 CD4050 0.58 CD4073 0.23 CD4502 1.24 CD4017 1.04 CD4034 1.97 CD4051 0.94 CD4075 0.23 CD4510 1.41 CD4018 1.00 CD4035 1.22 CD4052 0.94 CD4076 1.34 CD4511 1.72 CD4019 0.58 CD4036 3.29 CD4053 0.94 CD4077 0.48 CD4514 2.84 CD4020 1.28 CD4037 0.98 CD4054 1.20 CD4078 0.23 CD4515 3.24 CD4021 1.04 CD4038 1.10 CD4055 1.38 CD4081 0.23 CD4516 1.40 CD4022 0.94 CD4039 3.20 CD4056 1.36 CD4082 0.23 CD4518 1.26 CD4023 0.23 CD4040 1.11 CD4059 4.93 CD4085 0.74 CD4520 1.18 CD4024 0.80 CD4060 0.44 CD4086 0.74 CD4527 1.84 CD4025 0.23 CD4061 0.88 CD4063 1.13 CD4089 1.60 CD4532 1.39 CD4026 1.78 CD4043 1.01 CD4066 0.83 CD4093 0.92 CD4555 0.90 CD4027 0.58 CD4044 0.96 CD4067 3.85 CD4094 1.94 CD4556 0.90 CD4028 0.92 CD4045 1.45 CD4068 0.23 CD4095 1.08 MC14528 1.22 CD4029 0.18 CD4069 0.23 CD4096 1.08 MC14553 6.88 CD4030 0.58 CD4047 1.04 CD4070 0.51 CD4097 3.85 IM6508 8.08

Our offices are at 209 Cowley Road, Oxford, but please do not use this as a postal address.

OFFICIAL ORDERS ARE WELCOME FROM Companies, Govt. Depts., Natn. Inds., Univs., Polys., etc. ORDERS: C.W.O. add VAT at 8% + 35p p&p TELEPHONE and CREDIT (Invoice) Orders add VAT at 8% + 60p p&p (minimum charge, the balance will be added at cost). FAST SERVICE: EXPORT Orders welcome, no VAT but add 10% (Europe), 15% (Overseas) for Air Mail p&p. For Export postage rates on heavy items - contact us first. ORDERS TO: SINTEL PO BOX 75C, OXFORD Tel: 0865 49791

Marshall's Come and get a great deal Call in and see us 9-5.30 Mon-Fri 9-5.00 Sat Express Mail Order Tel orders on credit cards £10 min. Trade and export enquiries welcome A. Marshall (London) Ltd, Dept. WW London: 40-42 Cricklewood Broadway, NW2 3ET Tel: 01-452 0161/2 Telex: 21492 & 325 Edgware Rd, W2 Tel: 01-723 4242 Glasgow: 85 West Regent St, G2 2QD Tel: 041-332 4133 Bristol: 1 Straits Parade, Fishponds Rd, BS16 2LX. Tel: 0272 654201

POPULAR SEMICONDUCTORS. [A very small selection from our vast stocks, please enquire about devices not listed.] 2N697 0.31 2N3402 0.45 2N4036 0.72 2N5190 0.85 ACY17 1.00 BC171B 0.17 2N698 0.49 2N3414 0.18 2N4058 0.82 2N5210 0.38 ACY22 0.88 BC172C 0.15 2N700 0.28 2N3415 0.18 2N4059 0.17 2N5220 0.15 ACY30 0.60 BC173C 0.17 2N914 0.38 2N3416 0.21 2N4060 0.22 2N5225 0.16 ACY50 3.10 BC177C 0.22 2N929 0.37 2N3417 0.25 2N4061 0.19 2N5232 0.22 AD161 1.00 BC178B 0.35 2N930 0.37 2N3439 0.85 2N4062 0.20 2N5245 0.37 AD162 1.00 BC179B 0.25 2N1131 0.32 2N3441 0.92 2N4121 0.27 2N5248 0.14 AF106 0.60 BC182A 0.12 2N1303 0.80 2N3442 1.45 2N4122 0.27 2N5293 0.44 AF109 0.82 BC182L 0.15 2N1305 0.36 2N3565 0.25 2N4123 0.19 2N5294 0.44 AF114 0.70 BC183A 0.12 2N1501 0.36 2N3567 0.25 2N4124 0.19 2N5401 0.44 AF115 0.70 BC183A 0.15 2N1613 0.30 2N3568 0.26 2N4125 0.19 2N5416 1.65 AF118 0.70 BC184 0.12 2N1637 0.72 2N3638 0.17 2N4126 0.19 2N5447 0.16 AF124 0.70 BC184L 0.15 2N1890 0.30 2N3639 0.38 2N4235 1.35 2N5448 0.16 AF139 0.75 BC205 0.17 2N1893 0.30 2N3644 0.40 2N4236 1.65 2N5449 0.20 AF200 1.30 BC212A 0.15 2N1991 1.10 2N3662 0.25 2N4237 1.65 2N5457 0.35 AF201 1.30 BC212A 0.13 2N1993 0.50 2N3663 0.29 2N4240 1.70 2N5458 0.35 AF239 0.70 BC213B 0.18 2N2194 0.42 2N3702 0.14 2N4250 0.26 2N5555 0.65 AF240 1.25 BC213A 0.17 2N2217 0.55 2N3703 0.14 2N4266 0.32 2N6109 0.55 AF279 0.88 BC214 0.17 2N2218 0.35 2N3704 0.14 2N4284 0.38 2N6122 0.44 AF280 0.95 BC214L 0.18 2N2219 0.38 2N3705 0.14 2N4286 0.32 2N6123 0.48 ASY28 1.30 BC237B 0.15 2N2221 0.25 2N3706 0.14 2N4287 0.22 2N6124 0.45 ASY95 0.70 BC238B 0.13 2N2222 0.25 2N3707 0.14 2N4288 0.22 2N6125 0.47 BC107 0.15 BC239C 0.17 2N2270 0.49 2N3708 0.12 2N4292 0.27 2N6288 0.50 BC108 0.15 BC256A 0.29 2N2368 0.27 2N3709 0.12 2N4302 0.31 2S702 3.30 BC109 0.16 BC257A 0.18 2N2369 0.27 2N3710 0.12 2N4303 0.33 2S703 3.95 BC113 0.22 BC258B 0.24 2N2483 0.30 2N3711 0.12 2N4342 0.80 40232 0.60 BC114 0.22 BC259B 0.19 2N2613 0.90 2N3712 1.39 2N4401 0.20 40311 0.55 BC115 0.22 BC261A 0.25 2N2646 0.80 2N3714 1.55 2N4402 0.20 40316 0.95 BC116 0.21 BC262B 0.26 2N2848 1.10 2N3716 1.70 2N4403 0.20 40363 1.45 BC118 0.22 BC263B 0.28 2N2904 0.31 2N3794 0.21 2N4822 0.83 40389 0.70 BC135 0.22 BC264A 0.85 2N2905 0.31 2N3819 0.36 2N4870L 0.58 40408 0.82 BC136 0.21 BC307B 0.16 2N2906 0.25 2N3820 0.39 2N4871L 0.51 40440 0.70 BC137 0.22 BC308B 0.16 2N2907 0.25 2N3821 0.95 2N4901 0.85 40512 1.70 BC138 0.44 BC309C 0.16 2N2923 0.17 2N3827 0.27 2N4901 1.85 40594 0.87 BC140 0.30 BC327 0.22 2N2924 0.17 2N3854 0.30 2N4902 2.20 40595 0.98 BC141 0.32 BC328 0.20 2N2925 0.19 2N3855 0.30 2N4903 2.75 40573 0.80 BC142 0.32 BC337 0.20 2N3011 0.37 2N3856 0.19 2N4904 1.85 AC126 0.48 BC147 0.13 BC414 0.17 2N3020 0.75 2N3858A 0.20 2N4905 2.40 AC127 0.48 BC148 0.15 BC415 0.16 2N3053 0.25 2N3859 0.22 2N5130 0.83 AC128 0.48 BC149 0.15 BC416 0.17 2N3055 0.75 2N3866 1.98 2N5086 0.30 AC151 0.43 BC153 0.30 BC547A 0.13 2N3108 0.75 2N3901 0.30 2N5087 0.30 AC152 0.54 BC154 0.30 BC547B 0.13 2N3133 0.50 2N3904 0.18 2N5088 0.30 AC153 0.59 BC157A 0.15 BC548 0.13 2N3242 0.68 2N3905 0.18 2N5129 0.62 AC155K 0.59 BC158B 0.15 BC549B 0.14 2N3250 0.35 2N3906 0.18 2N5130 0.22 AC176 0.54 BC159B 0.17 BC558 0.13 2N3301 0.45 2N3962 0.95 2N5131 0.22 AC187 0.50 BC167B 0.33 BC554 2.40 2N3302 0.39 2N4031 0.55 2N5137 0.22 AC187K 0.65 BC168B 0.13 BC565 0.27 2N3392 0.17 2N4032 0.65 2N5143 0.22 AC188 0.54 BC169B 0.13 BC570 0.21 2N3394 0.17 2N4033 0.85 2N5180 0.58 AC188K 0.65 BC170B 0.19 BC571 0.28 2N3397 0.19 ALL PRICES NOW INCLUDE VAT CORRECT AT 4.5.78 BC572 0.18

Our range covers over 8,000 items. The largest selection in Britain. Top 200 ICs, TTL, CMOS & LINEARS MICROPROCESSOR SUPPORT CHIPS RAM ROM TRISTATE BUFFER 8080 SUPPORT 2101-2 £3.83 1702AQ £8.10 5M81L595 £1.36 8274 £1.58 2102-2 £1.94 5204Q £11.00 DM81L598 £1.36 8278 £5.85 2111-2 £3.83 2708Q £13.00 DM81L597 £1.36 8229 £3.10 2112-2 £3.63 2716 £40.00 DM81L598 £1.36 8212 £3.10 2107 £8.47 2108 £8.47 8216 £2.60 2106 £36.55 VAT INCLUSIVE PRICES 8226 £2.60 8253 £1.38 8154 RAM I/O chip £8.83 8254 £4.50 8255 £6.27 8250 £8.19 8251 £8.18 DIL SKTS Low profile IC skts 8 pin 15p 22 pin 30p 14 pin 16p 24 pin 35p 16 pin 18p 28 pin 45p 18 pin 27p 40 pin 55p EXTRAS MM5300 £8.85 MM5307 £13.89 DM857B £18.40 AY3251-J £8.75 FULL RANGE OF Capacitors Resistors Plugs/skts Meters Clocks Diodes Cables Cases In our new catalogue

CONVERT TV SET TO TELETYPE The new CRT control chip from Thomson CSF SF96364 Convert your TV set into an electronic teletype - 16 lines x 64 characters - requires RAM Character generator and little else for a basic teletype. Available as chip or full display card. NEW Full cursor control: 5 volts TTL compatible, penable, line erase, full card includes FULL CARD £17.20 UART Modem, Char. gen, etc Comp CHIP CARD £15.11 video out from encoded keyboard in. LEDS + OPTO Displays 7 seg Com. anode or Large 5mm Small 3mm 18 .19 .19 Red 8mm HT £1.50 Extra .20 .20 .20 10mm HT £1.55 Bright 40 .40 .40 14mm HT £1.57 1 red LD271 £0.55 18mm HT £1.85 IR receiver £1.45 Opto coupler £1.55 NEW 1978 CATALOGUE 40 page catalogue - new enlarged micro section - largest range of quality components from franchised suppliers available in UK All VAT inclusive prices. Over 8,000 line items plus lots more. 45p post paid or 35p to callers at any of our four branches

# BENTLEY ACOUSTIC CORPORATION LTD.

7A GLOUCESTER ROAD, LITTLEHAMPTON, SUSSEX. TEL. 6743  
ALL PRICES SHOWN INCLUDE V.A.T. AT 12 1/2 %

0A2 1.20	6AX4 0.75	6L12 0.50	6PL12 0.62	6V8 0.60	E1B12 2.80	N339 1.25	PY31 0.50	UY42 0.70	X63 1.40	ACV28 0.35	BYZ12 0.30	OC38 0.50
0B2 0.40	6B8G 0.75	6L18 0.50	6PL18 0.62	6V8 0.60	E1C32 2.80	N379 0.50	PY33/2 0.50	UY85 0.70	X65 2.00	AD140 0.50	BYZ13 0.30	OC41 0.58
0C3 0.55	6B8E 0.65	6L19 0.50	6PL19 0.62	6V8 0.60	E1C33 1.00	N709 0.45	PY80 0.50	U10 1.00	X66 2.00	AD161 0.58	BYZ15 0.30	OC42 0.73
0Z1 0.55	6B8C 0.90	6L1D2 0.48	6Z1A7 0.52	30P11.5 1.30	EC54 1.00	P81 0.60	PY82 0.40	U16 1.00	X19 0.60	AF102 1.04	OC64H 0.23	OC43 1.37
1A3 0.80	6BFE 0.70	6L1D20 0.80	6Z1A6 0.50	30A3 1.00	EC66 0.84	P86C 0.45	PY83 0.60	U17 1.00	X142 1.00	AF106 0.58	ESY11A 0.26	OC45 0.13
1A5GT 0.55	6B6G 1.00	6N7GT 0.70	6Z1E6 0.85	35C5 0.80	D1 0.50	P86 0.40	PY84 0.60	U18/20 2.50	X150 1.00	AF114 0.30	FSY41A 0.26	OC65 1.31
1A7GT 0.60	6B46 1.10	6B7GT 0.70	6Z1H7 0.65	35I8 0.90	D63 0.50	P86 0.40	PY85 0.60	U22 0.50	U19 4.00	AF115 0.30	GD4 0.38	OC70 0.14
1B3GT 0.55	6B36 0.75	6P15 0.48	6Z1Y7 1.15	35L6GT 0.80	DAC32 0.80	P86 0.40	PY86 0.60	U25 1.00	Z145 1.00	AF117 0.23	GD5 0.32	OC71 0.13
1C2 1.00	6B7A 0.85	6Q7G 0.75	6Z1E1 1.50	35W4 0.55	DAF91 0.35	P86 0.40	PY87 0.60	U26 0.90	Z329 0.70	AF124 0.36	GD8 0.23	OC72 0.13
1D6 1.00	6B8N 0.45	6Q7GT 0.75	6Z1A2 0.40	35Z3 0.80	DAF96 1.00	P86 0.40	PY88 0.60	U31 0.50	Z719 0.40	AF125 0.50	GD9 0.23	OC74 0.26
1G6 1.00	6B0E 0.48	6Q7M 0.75	6Z1J7 0.70	35Z4GT 0.70	DC90 0.70	P86 0.40	PY89 0.60	U37 0.50	Z759 0.50	AF128 0.58	GD12 0.23	OC75 0.13
1HSGT 0.80	6B07A 1.00	6R7G 0.70	6Z1K7 1.50	35Z5GT 0.80	D14 0.80	P86 0.40	PY90 0.60	U43 0.90	Z759 0.50	AF178 0.79	GD12 0.23	OC77 0.32
1L4 0.25	6BR7 1.00	6R7(M) 1.00	6Z1K7GT 0.50	30B5 0.95	DF33 0.75	P86 0.40	PY91 0.60	U45 1.20	Z759 0.50	AF180 0.56	GD14 0.28	OC78 0.18
1LD5 0.70	6BR8 1.25	6B7A 0.70	6Z1H7 0.65	30C5 0.70	DF91 0.30	P86 0.40	PY92 0.60	U47 1.00	Z759 0.50	AF180 0.56	GD15 0.47	OC79 0.47
1LN5 0.70	6C6 0.45	6S4GT 1.00	6Z1Q7GT 0.50	30C6GT 1.00	DF96 0.50	P86 0.40	PY93 0.60	U49 0.80	Z759 0.50	AF180 0.56	GD16 0.23	OC81 0.13
1NSGT 0.75	6B7 0.65	6S7 0.70	6Z1S7GT 0.50	30E45 0.85	DH63 0.75	P86 0.40	PY94 0.60	U51 0.50	Z759 0.50	AF180 0.56	GD17 0.23	OC82 0.13
1RS 0.50	6B8X 0.60	6S7GT 0.70	6Z1S7GT 0.50	30E45 0.85	DH76 0.50	P86 0.40	PY95 0.60	U53 0.90	Z759 0.50	AF180 0.56	GD18 0.23	OC83 0.13
1S4 0.40	6B7 0.65	6S7 0.70	6Z1S7GT 0.50	30E45 0.85	DH77 0.60	P86 0.40	PY96 0.60	U55 1.00	Z759 0.50	AF180 0.56	GD19 0.23	OC84 0.13
1S5 0.35	6B2E 1.50	6S7 0.70	6Z1S7GT 0.50	30E45 0.85	DH81 1.00	P86 0.40	PY97 0.60	U57 0.90	Z759 0.50	AF180 0.56	GD20 0.23	OC85 0.13
1T4 0.30	6C4 0.50	6S7GT 0.70	6Z1S7GT 0.50	30E45 0.85	DK32 0.80	P86 0.40	PY98 0.60	U59 0.80	Z759 0.50	AF180 0.56	GD21 0.23	OC86 0.13
1U4 0.40	6C6 0.45	6S7GT 0.70	6Z1S7GT 0.50	30E45 0.85	DK40 1.00	P86 0.40	PY99 0.60	U61 0.90	Z759 0.50	AF180 0.56	GD22 0.23	OC87 0.13
1U5 0.85	6C9 2.00	6UG4T 1.00	6Z1S7GT 0.50	30E45 0.85	DK91 1.00	P86 0.40	PY100 0.60	U63 0.90	Z759 0.50	AF180 0.56	GD23 0.23	OC88 0.13
2D21 0.55	6C10 1.00	6U7G 0.55	6Z1S7GT 0.50	30E45 0.85	DK92 1.00	P86 0.40	PY101 0.60	U65 0.90	Z759 0.50	AF180 0.56	GD24 0.23	OC89 0.13
2GK5 0.75	6C86A 0.65	6U8 0.50	6Z1S7GT 0.50	30E45 0.85	DK96 1.00	P86 0.40	PY102 0.60	U67 0.90	Z759 0.50	AF180 0.56	GD25 0.23	OC90 0.13
2X2 0.70	6C12 0.55	6V6G 0.50	6Z1S7GT 0.50	30E45 0.85	DL33 0.70	P86 0.40	PY103 0.60	U69 0.90	Z759 0.50	AF180 0.56	GD26 0.23	OC91 0.13
3A4 0.55	6C86G 1.00	6X2 0.50	6Z1S7GT 0.50	30E45 0.85	DL37 0.70	P86 0.40	PY104 0.60	U71 0.90	Z759 0.50	AF180 0.56	GD27 0.23	OC92 0.13
3B7 0.55	6C86A 0.90	6X4 0.95	6Z1S7GT 0.50	30E45 0.85	DL42 1.00	P86 0.40	PY105 0.60	U73 0.90	Z759 0.50	AF180 0.56	GD28 0.23	OC93 0.13
3C6 0.40	6C8 0.75	6X5GT 0.70	6Z1S7GT 0.50	30E45 0.85	DL42 1.00	P86 0.40	PY106 0.60	U75 0.90	Z759 0.50	AF180 0.56	GD29 0.23	OC94 0.13
3Q4 0.80	6C1A 0.95	6Y6G 0.95	6Z1S7GT 0.50	30E45 0.85	DL42 1.00	P86 0.40	PY107 0.60	U77 0.90	Z759 0.50	AF180 0.56	GD30 0.23	OC95 0.13
3Q6GT 0.70	6C7M 0.70	6Y7 1.25	6Z1S7GT 0.50	30E45 0.85	DL42 1.00	P86 0.40	PY108 0.60	U79 0.90	Z759 0.50	AF180 0.56	GD31 0.23	OC96 0.13
3S4 0.65	6C56 1.75	6Y7 1.00	6Z1S7GT 0.50	30E45 0.85	DM70 1.25	P86 0.40	PY109 0.60	U81 0.90	Z759 0.50	AF180 0.56	GD32 0.23	OC97 0.13
3V4 1.00	6C5 0.90	6Y8 1.00	6Z1S7GT 0.50	30E45 0.85	DM71 1.75	P86 0.40	PY110 0.60	U83 0.90	Z759 0.50	AF180 0.56	GD33 0.23	OC98 0.13
4C86 0.75	6D3 0.75	6Y7 2.00	6Z1S7GT 0.50	30E45 0.85	DM71 1.75	P86 0.40	PY111 0.60	U85 0.90	Z759 0.50	AF180 0.56	GD34 0.23	OC99 0.13
4GK5 0.75	6D3 0.75	6Y7 2.00	6Z1S7GT 0.50	30E45 0.85	DM71 1.75	P86 0.40	PY112 0.60	U87 0.90	Z759 0.50	AF180 0.56	GD35 0.23	OC100 0.13
5C8 0.75	6D7A 0.85	6Y8 2.00	6Z1S7GT 0.50	30E45 0.85	DM71 1.75	P86 0.40	PY113 0.60	U89 0.90	Z759 0.50	AF180 0.56	GD36 0.23	OC101 0.13
5R4G 1.00	6E6W 0.85	6Y7 2.00	6Z1S7GT 0.50	30E45 0.85	DM71 1.75	P86 0.40	PY114 0.60	U91 0.90	Z759 0.50	AF180 0.56	GD37 0.23	OC102 0.13
5T4 2.00	6E5 1.00	6Y7 2.00	6Z1S7GT 0.50	30E45 0.85	DM71 1.75	P86 0.40	PY115 0.60	U93 0.90	Z759 0.50	AF180 0.56	GD38 0.23	OC103 0.13
5U4G 1.00	6F1 0.80	6Y7 2.00	6Z1S7GT 0.50	30E45 0.85	DM71 1.75	P86 0.40	PY116 0.60	U95 0.90	Z759 0.50	AF180 0.56	GD39 0.23	OC104 0.13
5V4G 1.00	6F4G 0.80	6Y7 2.00	6Z1S7GT 0.50	30E45 0.85	DM71 1.75	P86 0.40	PY117 0.60	U97 0.90	Z759 0.50	AF180 0.56	GD40 0.23	OC105 0.13
5Y3GT 0.65	6F12 0.70	6Y7 2.00	6Z1S7GT 0.50	30E45 0.85	DM71 1.75	P86 0.40	PY118 0.60	U99 0.90	Z759 0.50	AF180 0.56	GD41 0.23	OC106 0.13
5Z3 1.40	6F14 0.80	6Y7 2.00	6Z1S7GT 0.50	30E45 0.85	DM71 1.75	P86 0.40	PY119 0.60	U101 0.90	Z759 0.50	AF180 0.56	GD42 0.23	OC107 0.13
5Z4G 0.75	6F15 0.85	6Y7 2.00	6Z1S7GT 0.50	30E45 0.85	DM71 1.75	P86 0.40	PY120 0.60	U103 0.90	Z759 0.50	AF180 0.56	GD43 0.23	OC108 0.13
5Z4GT 1.00	6F16 1.00	6Y7 2.00	6Z1S7GT 0.50	30E45 0.85	DM71 1.75	P86 0.40	PY121 0.60	U105 0.90	Z759 0.50	AF180 0.56	GD44 0.23	OC109 0.13
6 30L2 0.90	6F18 0.60	6Y7 2.00	6Z1S7GT 0.50	30E45 0.85	DM71 1.75	P86 0.40	PY122 0.60	U107 0.90	Z759 0.50	AF180 0.56	GD45 0.23	OC110 0.13
6A8G 1.40	6F18 0.60	6Y7 2.00	6Z1S7GT 0.50	30E45 0.85	DM71 1.75	P86 0.40	PY123 0.60	U109 0.90	Z759 0.50	AF180 0.56	GD46 0.23	OC111 0.13
6AC7 0.70	6F24 0.90	6Y7 2.00	6Z1S7GT 0.50	30E45 0.85	DM71 1.75	P86 0.40	PY124 0.60	U111 0.90	Z759 0.50	AF180 0.56	GD47 0.23	OC112 0.13
6AG5 0.35	6F25 1.00	6Y7 2.00	6Z1S7GT 0.50	30E45 0.85	DM71 1.75	P86 0.40	PY125 0.60	U113 0.90	Z759 0.50	AF180 0.56	GD48 0.23	OC113 0.13
6AG7 0.70	6F26 0.45	6Y7 2.00	6Z1S7GT 0.50	30E45 0.85	DM71 1.75	P86 0.40	PY126 0.60	U115 0.90	Z759 0.50	AF180 0.56	GD49 0.23	OC114 0.13
6AH6 0.70	6F28 0.85	6Y7 2.00	6Z1S7GT 0.50	30E45 0.85	DM71 1.75	P86 0.40	PY127 0.60	U117 0.90	Z759 0.50	AF180 0.56	GD50 0.23	OC115 0.13
6A5 0.70	6F32 1.00	6Y7 2.00	6Z1S7GT 0.50	30E45 0.85	DM71 1.75	P86 0.40	PY128 0.60	U119 0.90	Z759 0.50	AF180 0.56	GD51 0.23	OC116 0.13
6A3 0.55	6G6G 1.00	6Y7 2.00	6Z1S7GT 0.50	30E45 0.85	DM71 1.75	P86 0.40	PY129 0.60	U121 0.90	Z759 0.50	AF180 0.56	GD52 0.23	OC117 0.13
6AK5 0.45	6G8BA 0.80	6Y7 2.00	6Z1S7GT 0.50	30E45 0.85	DM71 1.75	P86 0.40	PY130 0.60	U123 0.90	Z759 0.50	AF180 0.56	GD53 0.23	OC118 0.13
6AK6 1.50	6K5 0.75	6Y7 2.00	6Z1S7GT 0.50	30E45 0.85	DM71 1.75	P86 0.40	PY131 0.60	U125 0.90	Z759 0.50	AF180 0.56	GD54 0.23	OC119 0.13
6AK8 0.48	6K6 1.00	6Y7 2.00	6Z1S7GT 0.50	30E45 0.85	DM71 1.75	P86 0.40	PY132 0.60	U127 0.90	Z759 0.50	AF180 0.56	GD55 0.23	OC120 0.13
6AL5 0.25	6G7 0.90	6Y7 2.00	6Z1S7GT 0.50	30E45 0.85	DM71 1.75	P86 0.40	PY133 0.60	U129 0.90	Z759 0.50	AF180 0.56	GD56 0.23	OC121 0.13
6AM6 0.70	6H6GT 0.50	6Y7 2.00	6Z1S7GT 0.50	30E45 0.85	DM71 1.75	P86 0.40	PY134 0.60	U131 0.90	Z759 0.50	AF180 0.56	GD57 0.23	OC122 0.13
6AM8A 0.70	6J6GT 0.65	6Y7 2.00	6Z1S7GT 0.50	30E45 0.85	DM71 1.75	P86 0.40	PY135 0.60	U133 0.90	Z759 0.50	AF180 0.56	GD58 0.23	OC123 0.13
6AN8 0.70	6J6 0.35	6Y7 2.00	6Z1S7GT 0.50	30E45 0.85	DM71 1.75	P86 0.40	PY136 0.60	U135 0.90	Z759 0.50	AF180 0.56	GD59 0.23	OC124 0.13
6AQ5 0.75	6K7 0.90	6Y7 2.00	6Z1S7GT 0.50	30E45 0.85	DM71 1.75	P86 0.40	PY137 0.60	U137 0.90	Z759 0.50	AF180 0.56	GD60 0.23	OC125 0.13
6AQ8 0.50	6M7 0.65	6Y7 2.00	6Z1S7GT 0.50	30E45 0.85	DM71 1.75	P86 0.40	PY138 0.60	U139 0.90	Z759 0.50	AF180 0.56	GD61 0.23	OC126 0.13
6AR5 1.05	6JURA 0.90	6Y7 2.00	6Z1S7GT 0.50	30E45 0.85	DM71 1.75	P86 0.40	PY139 0.60	U141 0.90	Z759 0.50	AF180 0.56	GD62 0.23	OC127 0.13
6AS7 1.50	6K7G 0.50	6Y7 2.00	6Z1S7GT 0.50	30E45 0.85	DM71 1.75	P86 0.40	PY140 0.60	U143 0.90	Z759 0.50	AF180 0.56	GD63 0.23	OC128 0.13
6AT6 0.60	6K8G 0.50	6Y7 2.00	6Z1S7GT 0.50	30E45 0.85	DM71 1.75	P86 0.40	PY141 0.60	U145 0.90	Z759 0.50	AF180 0.56	GD64 0.23	OC129 0.13
6AU6 0.62	6K8GT 0.55	6Y7 2.00	6Z1S7GT 0.50	30E45 0.85	DM71 1.75	P86 0.40	PY142 0.60	U147 0.90	Z759 0.50	AF180 0.56	GD65 0.23	OC130 0.13
6AV8 0.65	6L1 1.20	6Y7 2.00	6Z1S7GT 0.50	30E45 0.85	DM71 1.75	P86 0.40	PY143 0.60	U149 0.90	Z759 0.50	AF180 0.56	GD66 0.23	OC131 0.13
6AW8A 1.15	6L7(M) 1.50	6Y7 2.00	6Z1S7GT 0.50	30E45 0.85	DM71 1.75	P86 0.40	PY144 0.60	U151 0.90	Z759 0.50			







# LANGREX SUPPLIES LTD

Climax House, Fallsbrook Rd., Streatham, London SW16 6ED

RST

Tel: 01-677 2424 Telex: 946708

RST

### SEMICONDUCTORS

AA119 0.20	ASZ15 1.25	BC177 0.19	RD136 0.35*	BF336 0.57*	GJ3M 1.75	OAZ207 0.65	OC205 1.75	ZTX504 0.20*	2N1671 1.50	2N3773 2.65
AA390 0.13	ASZ16 1.25	BC178 0.18	BD137 0.37*	BF337 0.53*	GM0378A 0.50	OC216 1.25	OC206 1.75	ZTX531 0.20*	2N1893 0.33	2N3819 0.36*
AA393 0.13	ASZ17 1.25	BC179 0.20	BD138 0.40*	BF338 0.55*	KS100A 0.40*	OC220 2.00	OC207 1.25	ZTX550 0.16*	2N2147 1.40	2N3820 0.46*
AA394 0.15	ASZ20 0.75	BC182 0.11*	BD140 0.47*	BF521 2.57	MJE340 0.58*	OC222 2.50	OC212 1.25	1N9154 0.16*	2N2148 1.65	2N3823 0.60*
AAZ15 0.31	AU113 1.70*	BC183 0.11*	BD141 2.00	BF528 1.38	MJE370 0.65	OC223 2.75	OC217 0.83	1N9196 0.07	2N2218 0.35	2N3866 1.00
AAZ17 0.25	AU170 1.70*	BC184 0.12*	BD142 2.00	BF561 0.25*	MJE371 0.81	OC226 1.50	OC218 1.25	1N9401 0.06	2N2219 0.42	2N3904 0.21*
AC107 0.75	BA145 0.15*	BC212 0.14*	BD181 1.38	BF598 0.25*	MJE520 0.65	OC225 0.90	R2008B 2.25*	1N4002 0.07	2N2220 0.33	2N3905 0.22*
AC125 0.30	BA148 0.15*	BC213 0.14*	BD182 1.48	BFW10 0.90	MJE521 0.75	OC226 0.90	R2010B 2.25*	1N4003 0.08	2N2221 0.22	2N3906 0.22*
AC126 0.25	BA154 0.10*	BC214 0.17*	BD237 0.80	BFW11 0.90	MJE2955 1.25	OC228 2.00	T1C44 2.35*	1N4004 0.09	2N2222 0.25	2N4058 0.20*
AC127 0.25	BA155 0.12	BC217 0.17*	BD238 0.85	BFY84 0.48	MJE3065 0.75	OC229 2.50	T1C226D 1.30	1N4005 0.13	2N2223 0.27	2N4059 0.15*
AC128 0.25	BA156 0.13	BC238 0.12*	BDX10 0.75	BFY85 0.48	MPS102 0.30*	OC235 1.50	T1L200 0.25	1N4006 0.15	2N2238 0.17	2N4060 0.20*
AC141 0.20	BAW62 0.05	BC301 0.45	BDY20 1.42	BFY88 0.32	MPE102 0.30*	OC236 1.50	T1P25A 0.50*	1N4007 0.15	2N2369A 0.21	2N4061 0.17*
AC141K 0.35	BAX13 0.07	BC307 0.20*	BDY60 0.75	BFY90 0.32	MPE105 0.30*	OC241 0.50	T1P30A 0.60*	1N4009 0.15	2N2484 0.21	2N4062 0.18*
AC142 0.20	BAX16 0.07	BC308 0.18*	BDY60 0.75	BFY91 0.32	MPE106 0.30*	OC242 0.50	T1P31A 0.62*	1N4148 0.07	2N2646 0.50	2N4124 0.17*
AC124K 0.30	BC107 0.12	BC327 0.22*	BF115 0.39	BFY92 0.26	MPSA06 0.25*	OC243 1.50	T1P32A 0.75	1N5400 0.15	2N2904 0.35	2N4126 0.17*
AC176 0.25	BC108 0.12	BC328 0.22*	BF152 0.25	BFY93 0.30	MPSU01 0.32*	OC245 0.50	T1P33A 1.00	1N5401 0.16	2N2905 0.35	2N4286 0.20*
AC187 0.25	BC109 0.13	BC329 0.19*	BF153 0.25	BFY94 0.34	MPSU02 0.32*	OC247 0.45	T1P34A 1.20	1S54 0.06	2N2906 0.25	2N4288 0.25*
AC188 0.25	BC113 0.15*	BC338 0.18*	BF159 0.25	BFY95 0.35	MPSU06 0.40*	OC271 0.45	T1P41A 0.70	1S520 0.08	2N2907 0.21	2N4289 0.25*
AC171 0.65	BC114 0.18*	BCY30 1.00	BF160 0.30	BFY98 0.30	NKT401 2.70	OC73 1.00	T1P42A 0.90	1S921 0.08	2N2924 0.15	2N5457 0.35*
AC178 0.65	BC115 0.18*	BCY31 1.00	BF167 0.39	BFY99 0.34	NKT403 1.70	OC74 1.75	T1P2955 1.00	2G301 1.00	2N2925 0.17*	2N5458 0.35*
AC179 0.65	BC116 0.18*	BCY32 1.00	BF173 0.39	BFY99 0.34	NKT404 1.70	OC75 0.60	T1P3055 1.50	2G302 1.00	2N2926 0.13*	2N5459 0.35*
AC180 0.65	BC117 0.22*	BCY33 1.00	BF177 0.39	BFY99 0.34	NKT404 1.70	OC76 0.60	T1P3055 1.50	2G306 1.00	2N3053 0.25	3N125 1.75
AC181 0.65	BC118 0.16*	BCY34 1.00	BF178 0.45	BFY99 0.34	NE555 0.45	OC77 0.50	T1P3055 1.50	2N3140 0.25*	2N3054 0.50	2N5017 6.50
AC182 0.65	BC119 0.16*	BCY35 1.00	BF179 0.45	BFY99 0.34	NE555 0.45	OC77 0.50	T1P3055 1.50	2N3170 0.25*	2N3056 0.50	2N5019 6.50
AC183 0.65	BC120 0.16*	BCY36 1.00	BF180 0.45	BFY99 0.34	NE555 0.45	OC77 0.50	T1P3055 1.50	2N3170 0.25*	2N3056 0.50	2N5019 6.50
AD149 0.70	BC126 0.25*	BCY40 1.25	BF181 0.45	BFY99 0.34	NE555 0.45	OC77 0.50	T1P3055 1.50	2N3170 0.25*	2N3056 0.50	2N5019 6.50
AD181 0.75	BC135 0.15*	RCY42 0.30	BF182 0.45	BFY99 0.34	NE555 0.45	OC77 0.50	T1P3055 1.50	2N3170 0.25*	2N3056 0.50	2N5019 6.50
AD182 0.75	BC136 0.16*	RCY43 0.32	BF183 0.45	BFY99 0.34	NE555 0.45	OC77 0.50	T1P3055 1.50	2N3170 0.25*	2N3056 0.50	2N5019 6.50
AF106 0.45	BC137 0.16*	RCY44 0.32	BF184 0.45	BFY99 0.34	NE555 0.45	OC77 0.50	T1P3055 1.50	2N3170 0.25*	2N3056 0.50	2N5019 6.50
AF114 0.25	BC147 0.18*	RCY45 0.32	BF185 0.45	BFY99 0.34	NE555 0.45	OC77 0.50	T1P3055 1.50	2N3170 0.25*	2N3056 0.50	2N5019 6.50
AF115 0.25	BC148 0.18*	RCY46 0.32	BF186 0.45	BFY99 0.34	NE555 0.45	OC77 0.50	T1P3055 1.50	2N3170 0.25*	2N3056 0.50	2N5019 6.50
AF116 0.25	BC149 0.18*	RCY47 0.32	BF187 0.45	BFY99 0.34	NE555 0.45	OC77 0.50	T1P3055 1.50	2N3170 0.25*	2N3056 0.50	2N5019 6.50
AF117 0.25	BC157 0.12*	RCY48 0.32	BF188 0.45	BFY99 0.34	NE555 0.45	OC77 0.50	T1P3055 1.50	2N3170 0.25*	2N3056 0.50	2N5019 6.50
AF139 0.40	BC158 0.11*	RD115 0.60	BF197 0.14*	CRS1105 0.65	OA200 0.11	OC170 0.75	ZTX304 0.19*	2N1303 0.47	2N3706 0.14*	2N5745A 0.35
AF186 1.50	BC159 0.13*	RD121 1.50	BF200 0.32	CRS1105 0.65	OA202 0.11	OC171 0.75	ZTX304 0.19*	2N1303 0.47	2N3706 0.14*	2N5745A 0.35
AF239 0.45	BC167 0.13*	RD123 1.50	BF201 0.32	CRS1105 0.65	OA202 0.11	OC171 0.75	ZTX304 0.19*	2N1303 0.47	2N3706 0.14*	2N5745A 0.35
AF241 2.75	BC170 0.25*	RD124 1.50	BF202 0.32	CRS1105 0.65	OA202 0.11	OC171 0.75	ZTX304 0.19*	2N1303 0.47	2N3706 0.14*	2N5745A 0.35
AF242 2.75	BC171 0.14*	RD131 0.51	BF257 0.37	CRS1105 0.65	OA202 0.11	OC171 0.75	ZTX304 0.19*	2N1303 0.47	2N3706 0.14*	2N5745A 0.35
ASV26 0.45	BC172 0.13*	RD132 0.51	BF258 0.42	CRS1105 0.65	OA202 0.11	OC171 0.75	ZTX304 0.19*	2N1303 0.47	2N3706 0.14*	2N5745A 0.35
ASV27 0.50	BC173 0.13*	RD135 0.35*	BF259 0.45	CRS1105 0.65	OA202 0.11	OC171 0.75	ZTX304 0.19*	2N1303 0.47	2N3706 0.14*	2N5745A 0.35

### VALVES

A1834 6.00	E92CC 4.97	FF55 2.50*	GU50 9.66	PC881 1.75*	QV08-100 85.60	UCL183 1.44*	3V4 1.00*	6H26 1.73*	12AU6 0.50	5544 54.00
A2081 10.48	E99F 5.51	EFM01 0.45*	GU51 9.80	PC89 0.70*	QY3 65 42.80	UF41 0.75*	4A5A 25.35	6C4 0.40*	12AU7 0.45*	5545 59.00
A2134 4.81	E130L 16.85	EF83 1.75*	GXU1 10.43	PC97 1.08*	QY125 12.00	UF42 1.25*	4A25A 12.00	6CB6A 0.50*	12AV6 0.60*	5551A 62.70
A2293 4.10	E160C 5.36	EF85 0.50*	GXU2 17.20	PC90 0.75*	QY4250 51.30	UF801 0.50*	4A250A 36.00	6C106GA 4.00*	12AV7 2.84*	5552A 84.70
A2426 8.20	E188CC 5.06	EF92 0.75*	GXU4 21.42	PC98 0.75*	QY4400 58.30	UF802 0.50*	4A400A 37.00	6C7 1.42*	12AX7 0.45*	5553A 225.30
A2521 8.53	E280F 7.85	EF93 0.50*	GZ32 0.75*	PC889 1.05*	QY5000A 212.00	UF803 0.50*	4B3 10.00	6C16 0.75*	12AX7 0.82*	5562 3.16*
A2900 4.85	E2K3CC 16.90	EF94 0.55*	GZ34 1.52*	PC889 1.05*	QZ06 20 18.40	UL41 1.00*	4CX250B 47.00	6C4 0.40*	12B1 1.90*	5654 3.81*
A3343 18.43	E288CC 12.58	EF95 0.30*	GZ37 4.00*	PC889 1.05*	R10 5.00	UL41 1.00*	4CX350A 31.35	6D21 0.30*	12BE1 0.60*	5670 2.86*
AZ31 1.15*	E317 11.00	EF98 0.60*	KT61 3.50*	PC889 1.05*	R17 1.65*	UL41 1.00*	4CX50A 21.00	6DK6 2.49*	12BH7 1.60*	5675 9.09*
AZ41 1.10*	E376 1.50	EF183 0.30*	KT66 4.50*	PC889 1.05*	R18 1.85*	UL41 1.00*	4CX50A 21.00	6D30B 3.40*	12BY7 0.80*	5687 4.30*
BK48 62.70	E4B0 0.40*	EF184 0.50*	KT88 6.25*	PC889 1.05*	R19 1.00*	UL41 1.00*	5B25M 11.25	6E8B 2.12*	12E1 0.90*	5696 1.94*
BK484 84.70	E4C91 0.50*	EF804S 6.50	KTW61 1.75*	PC889 1.05*	R20 1.44	UL41 1.00*	XG5-500 16.80	5J22 40.00	6EW6 0.80*	5725 3.40*
BS50 27.25	E4F2 1.25*	EF805S 7.00	KTW62 1.75*	PC889 1.05*	R23 250 21.51	UL41 1.00*	XG6-600 64.95	5J180E 495.00	6F6 0.75*	5726 2.10*
BS810 27.75	E4F21 1.25*	EF805S 7.00	KTW63 1.75*	PC889 1.05*	RG3-250 23.28	UL41 1.00*	XG2-600 64.95	5J180E 495.00	6F6 0.75*	5726 2.10*
BT17 55.64	E4F21 1.25*	EF805S 7.00	KTW63 1.75*	PC889 1.05*	RG3-250 23.28	UL41 1.00*	XG2-600 64.95	5J180E 495.00	6F6 0.75*	5726 2.10*
BT19 19.00	E4F21 1.25*	EF805S 7.00	KTW63 1.75*	PC889 1.05*	RG3-250 23.28	UL41 1.00*	XG2-600 64.95	5J180E 495.00	6F6 0.75*	5726 2.10*
BT29 169.70	E4F21 1.25*	EF805S 7.00	KTW63 1.75*	PC889 1.05*	RG3-250 23.28	UL41 1.00*	XG2-600 64.95	5J180E 495.00	6F6 0.75*	5726 2.10*
BT69 173.65	E4F21 1.25*	EF805S 7.00	KTW63 1.75*	PC889 1.05*	RG3-250 23.28	UL41 1.00*	XG2-600 64.95	5J180E 495.00	6F6 0.75*	5726 2.10*
BT75 72.25	E4F21 1.25*	EF805S 7.00	KTW63 1.75*	PC889 1.05*	RG3-250 23.28	UL41 1.00*	XG2-600 64.95	5J180E 495.00	6F6 0.75*	5726 2.10*
BT95 96.80	E4F21 1.25*	EF805S 7.00	KTW63 1.75*	PC889 1.05*	RG3-250 23.28	UL41 1.00*	XG2-600 64.95	5J180E 495.00	6F6 0.75*	5726 2.10*
CLB1 50.00	E4F21 1.25*	EF805S 7.00	KTW63 1.75*	PC889 1.05*	RG3-250 23.28	UL41 1.00*	XG2-600 64.95	5J180E 495.00	6F6 0.75*	5726 2.10*
CL33 2.00*	E4F21 1.25*	EF805S 7.00	KTW63 1.75*	PC889 1.05*	RG3-250 23.28	UL41 1.00*	XG2-600 64.95	5J180E 495.00	6F6 0.75*	5726 2.10*
CY31 1.00*	E4F21 1.25*	EF805S 7.00	KTW63 1.75*	PC889 1.05*	RG3-250 23.28	UL41 1.00*	XG2-600 64.95	5J180E 495.00	6F6 0.75*	5726 2.10*
CIK 10.00	E4F21 1.25*	EF805S 7.00	KTW63 1.75*	PC889 1.05*	RG3-250 23.28	UL41 1.00*	XG2-600 64.95	5J180E 495.00	6F6 0.75*	5726 2.10*
C3A 10.00	E4F21 1.25*	EF805S 7.00	KTW63 1.75*	PC889 1.05*	RG3-250 23.28	UL41 1.00*	XG2-600 64.95	5J180E 495.00	6F6 0.75*	5726 2.10*
C31A 10.00	E4F21 1.25*	EF805S 7.00	KTW63 1.75*	PC889 1.05*	RG3-250 23.28	UL41 1.00*	XG2-600 64.95	5J180E 495.00	6F6 0.75*	5726 2.10*
DA41 16.85	E4F21 1.25*	EF805S 7.00	KTW63 1.75*	PC889 1.05*	RG3-250 23.28	UL41 1.00*	XG2-600 64.95	5J180E 495.00	6F6 0.75*	572

# G.T. ELECTRONICS (ACTON) LTD.

**Trade: 270 Acton Lane, Chiswick, W4 5DG**  
**Retail: 267 Acton Lane, Chiswick, W4 5DG**

**01-994 6275**

Registered in England 1179820

We have for sale the components set out below. All items are new surplus, and the quantities given are correct at today's date. We invite you to make an offer **for the whole of part** in writing or by telephone (and would intimate that offers made on the basis of prompt payment will be accorded preference).

Transistors	Qty
Silicon BD 135	9303
Silicon BD 562 Motorola	965
Silicon BD 561 Motorola	965
Silicon BD 165 Motorola	537
Silicon BF 394B Motorola	12810
Silicon TE 00626 N-P-N- BD165 Eg	59556
Silicon BC 486 Motorola PNP	4180
Silicon BC 328 PNP	12450
Silicon BC 204	760
Silicon BD 183	6023
Silicon BF 273	19150
Silicon BF 274	6910
Silicon BC 207	550
Silicon BC 348A	4700
Silicon MPSA 42 Motorola	133918
Silicon BF 394	41209
Silicon 16083 RCA	7014
Silicon BC 109C	4900

Silicon BC 132	38236
Silicon BC 115	780
Silicon BC 318B Leads to	18 8364
Silicon TIS92	9950
Silicon BC 267B	8930
Silicon BF 156	1306
Silicon BC 267B	2650
Silicon BC 208B/L	4600
Silicon BC205A	2400
Silicon BC 205B	40595
Silicon 205	£820
Silicon BC 205	2920
Silicon PNP BD 436	3488
Silicon BC 209	18882
Silicon BF 259	18550
Silicon MPS H.55 (UHF AMP PNP RF)	5473
Silicon BC 349	14456
Matched MPF 131	6722
Matched MPF 132	7705
Matched MPSH 11	1813
BF 451	51000
BF 154	18500

### Silicon Diodes

BA 164	82955
BA 202	12900
Power XK 3017	3350
Rectifier B400	2650
Rectifier ES 325 B40C	3281
1N 4816	2900

Power 388F	30300
1N 54000 Microelectronics	19600
Rectifier Silicon Bridge Semikron	
SKBB40	1750
Rectifier Selenium TV11 16K70V	415
Rectifier Selenium TV11.2KT	1190

### Diodes

Varicap MV 104	42379
Silicon BZX 61/C18	400
Zener BZX79C6V2	1259
Zener 0F 2299 In POS'N	405 185
Zener ZF7.5	700
Zener Z527	1800
Zener 6.2V IN 753A	14600
Zener 1N4750A Motorola	1820
Zener 1N5266B (68V)	28736
Thyristor XF 7560	584
Thyristor SCR 2N6399	27016
800V 7.6 Amp Plastic	
Transistor MOS FFT 40823	1704
Transistor Field Effect G1 MEM630.008	4957
Transistor Field Effect G1 MEM632.005	5070

### Integrated Circuits

TBA 271B	1100
MC 1352P	948
MC 1350P	2835
µA706BPC 5w Audio Amp	7762
Stereo Decoder MC1307P	9132

**The above advertisement is a fraction of our stock holding. Trade & Export welcome. No Mail Order other than trade. VAT extra 8% or 12%. P&P dependent on article, etc.**

WW-073 FOR FURTHER DETAILS

## G.F. MILWARD — ELECTRONIC COMPONENTS

### RESIST COATED FIBRE-GLASS BOARD

This is first-grade 1/16" board coated with positive resist. The sensitised surface is protected with removable light-proof adhesive film making it possible to handle boards in normal lighting and to cut to exact size prior to exposure

Standard board 204mm x 114mm	£1.50
Double board 204mm x 228mm	£3.00
Quad board 408mm x 228mm	£6.00
Giant board 305mm x 456mm	£9.00

Developer — 40p. Ferric Chloride — 75p

#### Plain Copper-clad Fibre-Glass

Approx. 3.18mm thick	Single sided £1.25 square foot
	Double sided £1.50 square foot
Approx. 2.00mm thick	Single sided £2.00 square foot
	Double sided £2.25 square foot
Approx. 1.0mm thick	Single sided £1.50 square foot
	Double sided £1.75 square foot

#### FOTOLAK Light sensitive lacquer

Positive resist in handy aerosol form. Just spray board, allow to dry, place positive of required circuit on sensitised surface, expose, develop and etch. You can produce your own perfect circuits within minutes rather than weeks! Widely accepted by industry as the perfect medium for all prototype work. One can will coat 1.1 1/2 square metres of board. **£1.80 per can inclusive**

#### 12 Volt Fluorescent Lighting

12" 8-watt fittings	£3.75
21" 13-watt fittings	£5.00
Complete with tube	
Inverter transformers	£1.00

### Computer Boards containing:

21 ICs, 24 Diodes, resistors, capacitors	£1.00
17 ICs, 26 Diodes, 3 Reed relays, etc	£1.00
8 BC107B, 8 BCY 70, approx. 80 other components, 2 for	£1.00
Copper-clad paxolin 245mm x 150mm x 1/16" Pack of 10 sheets	£2.50
Edge Connectors 18 x 2" Pack of 10	£1.00
Vero Boards 90mm x 90mm x 1", pack of 8	£3.00
Colour convergence controls, 10 assorted	£1.00; 1N4005, 15 £1.00; Plastic BC108C, 10 £1.00; 1N4148, 20 £1.00; BY126, 10 £1.00; MEU 22 (PUJ) 8 £1.00; MJE 340, 4 £1.00; 2N3053 equiv. 10 £1.00; Silicon diodes, 100 £1.00; Zener BXY88 type zener, untested, 200 £1.00; Resistors, assorted 100 £1.00; Capacitors, s/mica, ceramic etc. 100 £1.00;
3,000 reels 10" diameter 1/2" magnetic tape, used once only, all in excellent condition, packed in individual tins and cardboard outers. <b>OPEN TO OFFERS!!</b>	

**SPECIAL OFFER!!!** Orders over £10  
 £1 Credit voucher included for each £10 value of order  
 £15 Credit voucher included with £100 orders!!!!  
 This offer is for a limited period only! Order today!

TEL. 021-327-2339

POSTAGE AND VAT INCLUDED

369 ALUM ROCK RD. B'HAM B8 3DR



**EASY BUILD SPEAKER DIY KITS**

Specially designed by RT-VC for cost-conscious hi-fi enthusiasts, these kits incorporate two teak-simulate enclosures, two EMI 13" x 8" (approx.) woofers, two tweeters and a pair of matching crossovers. Supplied complete with an easy-to-follow circuit diagram, and crossover components.

**£2800**

**STEREO PAIR** Input 15 watts rms, 30 watts peak, each unit. + p & p £5.50 Cabinet size 20" x 11" x 9 1/2" (approx.).

**- SPEAKERS AVAILABLE WITHOUT CABINETS.**

It's the units which we supply with the enclosures illustrated. Size 13" x 8" (approx.) woofer (EMI). **£1700** per

tweeter, and matching crossover components. stereo pair. Power handling 15 watts rms, 30 watts peak. + p & p £3.40

**COMPACT FOR TOP VALUE** These infinite baffle enclosures come to you ready mitred and professionally finished. Each cabinet measures approx. per stereo pair 12" x 9" x 5" deep, and is in wood simulate. **£850**

Complete with two 8" (approx.) speakers for maximum power handling of 7 watts. + p & p £2.20

**SPEAKERS** Two models - Duo IIb, teak veneer, 12 watts rms, 24 watts peak, 18 1/2" x 13 1/2" x 7 1/2" (approx.).

Duo III, 20 watts rms, 40 watts peak, 27" x 13" x 11 1/2" approx.

Duo IIb **£17** PER PAIR Duo III **£52** PER PAIR

o & p £6.50 o & p £7.50

**DECCA 20 WATTS STEREO SPEAKER** stereo pair. This matching loudspeaker system is hand made, kit comprises of two 8" diameter approx. base drive unit, with heavy die cast chassis laminated cones with rolled P.V.C. surrounds, two 3 1/2" diameter approx. domed tweeters complete with crossover networks. **£4.00** p & p. **£20.00**



**PORTABLE DISCO CONSOLE** with built-in pre-amp

Here's the big-value portable disco console from RT-VC! It features a pair of BSR MP 60 type auto-return, single play professional series record decks. Plus all the controls and features you need to give fabulous disco performances. Simply connects into your existing slave or external amplifier.

p & p £6.50

**£64.00**



**Tourist IV**

**CAR RADIO KIT** For the experienced constructor only

Output 4 watts into 4 ohms. Complete with speaker, baffle and fixing strip, for the experienced constructor only. The Tourist IV has five push buttons, four medium band and one for long wave band. The tuning scale is illuminated and attractive small aluminium control knobs for manual tuning and volume control. 12 volts pos or neg (altered internally). Size approx. 7" x 2" x 1 1/4".

**£12.50**

**A MOTOR TOP 10 ACCESSORY WINNER** p & p £1.50

**FREE TO PERSONAL SHOPPERS BUYING CAR RADIO KIT** worth

**ELECTROMATE** Rear window heater, modern line element. **£3.00**

**PERSONAL SHOPPERS**

**UNIK** electronic digital alarm clock mains operated, large bright LED display tilted display for easy viewing, silent operation. Alarm and 9 minute repeater, PM and secs display size 105mm x 115mm x 50mm approx. **£7.95**

**16016 VOLT MAINS TRANSFORMER**, 2 1/2 amp. **£2.50**

**BSR** Record auto deck on plinth with stereo cartridge ready wired. **£11.95**

**LED 5** function men's digital watch stainless steel finish. **£5.95**

**LCD 5** function men's digital watch stainless steel finish. **£7.95**

**LCD 8** function **CHRONOGRAPH** men's digital watch stainless steel finish. **£13.95**

**STEREO CASSETTE** record/replay fully built P.C board. Used, without guarantee. (Ex Equipment.) **£1.95**

**AM. FM. TUNER** P.C.B. with Mullard LP 1186, 1185, 1181 modules. **£9.50**

**100K** Multiturn Varicap tuning pots, 6 for **£1.00**

**MUSIC CENTRE CABINET** with hinged smoke acrylic top, finished in natural teak veneers. size 30 1/2" x 14 1/2" x 7 1/4" approx. **£5.95**

**MULLARD** Built power supply **£1.50**

**DECCA DC1000** Stereo Cassette P.C.B. complete with switch oscillator coils and tape-heads. **£2.95**

**FERGUSON**, 3-speed, 7" HiFi tape transport mechanism, complete with top covers. **£15.95**

**Mullard**

**AUDIO MODULES IN BARGAIN PACKS**

**CURRENT CATALOGUE PRICE & AT OVER 25 PER PACK**

**SEE OUR PRICES**

**1** PACK 1. 2 x LP1173 10w RMS output power audio amp modules, + 1 LP1184/2 Stereo pre amp for ceramic and auxiliary input. **OUR PRICE £4.95** p+p £1.00

**2** PACK 2. 2 x LP1173 10w RMS output power audio amp modules + 1 LP1184/2 Stereo pre amp for magnetic, ceramic and auxiliary inputs. **OUR PRICE £6.95** p+p £1.00

**3** PACK 3. 1 x LP1179/2 FM Tuning head with AM gang, 1 x LP1165/1 AM/FM IF module, 2 x LP1173/10w RMS output power audio amp modules + 1 LP1182/2 Stereo pre amp for ceramic and auxiliary input. **OUR PRICE £9.95** p+p £1.00

**TRADE ENQUIRIES INVITED**



**ACCESSORIES**

Suitable power supply parts including mains transformer, rectifier, smoothing and output capacitors. **£1.95** p+p

Recommended set of rotary stereo controls comprising **BASS, TREBLE, VOLUME** and **BALANCE**. **p+p 50p 95p**

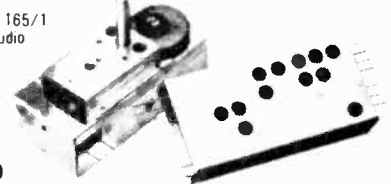

**20 x 20 WATT STEREO AMPLIFIER** **£29.90**

Superb Viscount IV unit in teak-finished cabinet. Silver fascia with aluminium rotary controls and push buttons, red mains indicator and stereo jack socket. Function switch for mic, magnetic and crystal pick-ups, tape, tuner, and auxiliary. Rear panel features two mains outlets, DIN speaker and input sockets, plus fuse. 20 + 20 watts rms, 40 + 40 watts peak. p & p £2.50

**30 x 30 WATT AMPLIFIER KIT** For the experienced constructor complete in every detail. Similar facilities as Viscount IV amplifier. 60 + 60 peak **£29.00** p & p £2.50

**AVAILABLE NOW** built and fully tested with output **£39.00** p & p £2.50

**SPECIAL OFFER PACKAGE PRICE WITH 30 x 30 KIT Mk. II** version, operates into 4 to 15 OHMS speakers. Designed by R & TVC for the experienced constructor. Complete in every detail, facilities as Viscount IV amplifier 60 + 60 peak. Supplied with 2 Goodmans Compact 12" bass woofer with cropped 14,000 Gauss Magnet, 30 watt rms, handling + 3/4" approx. tweeters and crossovers. **£49.00** p & p £4.00

**ADD-ON STEREO CASSETTE TAPE DECK KIT**

Designed for the experienced D.I.Y. man. This kit comprises of a tape transport mechanism, ready built and tested record/replay electronics with twin V.U. meters and level control for mating with mechanism. Specifications: Sensitivity - Mic. 0.85 mV, 20K OHMS; Din, 40mV; a 400K OHMS; Output - 300mV RMS per channel; a 1KHz from 2K OHMS source; Cross Talk - 30db; Tape Counter - 3 Digit; Resettable; Frequency Response - 40Hz - 8KHz ± 6db; Deck Motor - 9 Volt DC with electronic speed regulations; Key Functions - Record, Rewind, Fast Forward, Play, Stop & Eject. p & p £2.50 **£19.95** Oot. Extras: Mains Trans. to suit **£2.50** p.p. £1.



**45 WATT MONO DISCO AMP** **£35.00** p & p £2.50

Size approx. 13 1/2" x 5 1/2" x 6 1/2" 45 watts rms, 90 watts peak output. Big features include two disc inputs, both for ceramic cartridges, tape input and microphone input. Level mixing controls fitted with integral push-pull switches. Independent bass and treble controls and master volume.

**70 & 100 WATT MONO DISCO AMP** **£57**

Size approx. 14" x 4" x 10 1/2" Brushed aluminium fascia and rotary controls. Five vertical slide controls - master volume, tape level, mic level, deck level. PLUS INTER-DECK FADER for perfect graduated change from record deck No. 1 to No. 2, or vice versa. Pre-fade level control 70 watt (PFL) lets YOU hear next disc before fading it in. VU meter monitors output level. 100 watt **£65** Output 100 watts RMS 200 watts peak.

**CHASSIS RECORD PLAYER DECKS** **GARRARD DECK GC10A** **£7.95**

Record changer with ceramic cartridge. **£2.00** BSR MP60 TYPE Single play record player less cartridge. p & p £2.55 Cartridges to suit above. Acos, magnetic stereo **£4.95** Ceramic stereo **£1.95** BSR automatic record player deck cueing device and stereo ceramic head, p & p **£2.55** **£9.95** BSR MP 60 type, complete with magnetic cartridge, diamond stylus, and de luxe plinth and cover. p & p **£4.50** Home 8 Track cartridge player. This unit will match with the Viscount IV 9" x 8" x 3 1/2". p & p **£2.50** **£16.50**



**RTVC** Send stamped addressed envelope for further details Order by giving credit card number **ONLY**

323 EDGWARE ROAD, LONDON W2 21c HIGH STREET, ACTON, W3 6NG **ALL PRICES INCLUDE VAT AT 12 1/2%** All items subject to availability. Price correct at 1.4.78 and subject to change without notice

**EASY TO BUILD RECORD PLAYER KIT** for the D-I-Y man who requires a stereo unit at a budget price, comprising ready assembled stereo amp, module, Garrard auto / manual deck with cueing device, pre-cut and finished cabinet work. Output 4 watts per channel, phones socket and record/replay socket, including **2 SPHERICAL HIFI speakers** **£19.95** p & p **£4.05**



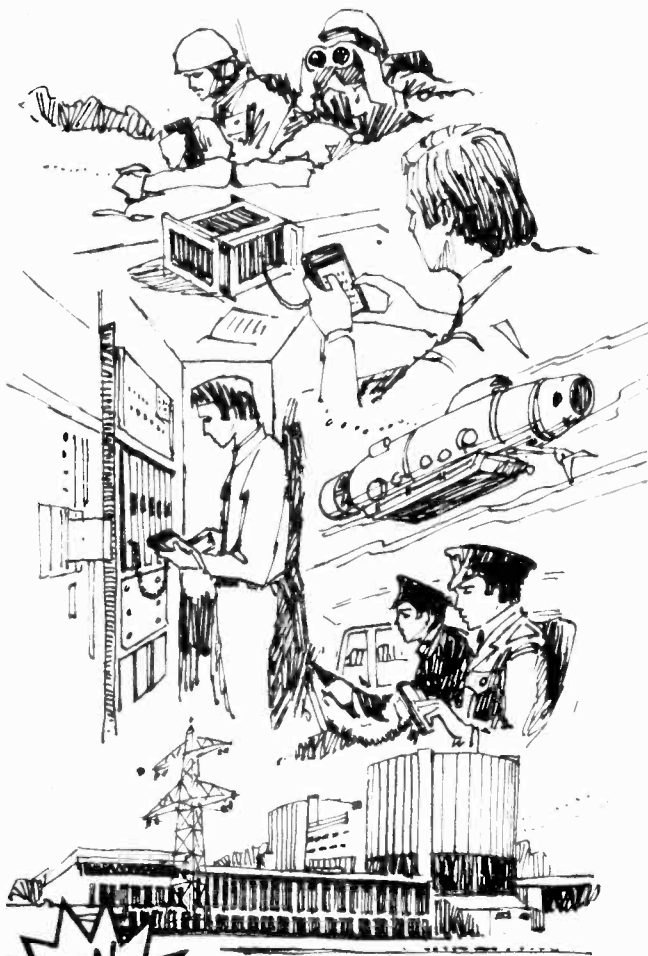

**NEW**

# POCKET TERMINAL

**Midget duplex unit with man-sized facilities**

Until you've tried it, you won't believe how much capability we've packed into the new Pocket Terminal. We've gone all-out to make it the most practical and useful hand-held data communications device available.



Here's just a few of the facilities:

- Transmits 128 ASCII codes.
- Displays full 64 character ASCII set clearly.
- 30 character memory accessible through display.
- Single 5V supply required at 400mA max.
- 110 or 300 baud transmission, selectable.
- 20mA loop or V24/RS232 level versions available.
- Parity codes and stop bits settable to your standard.
- Reacts to bell, cursor and formatting control codes.

Pocket Terminal is a convenient, versatile, totally portable tool for anyone who needs to communicate with computers or their peripherals. Send for details now from:

**GR ELECTRONICS LTD.**  
 Fair Oak House, Church Road, Newport, Gwent NPT 7EJ, UK  
 Telephone: Newport (0633) 67426 Telex: 28604 Ref.1796

WW - 134 FOR FURTHER DETAILS

## BARGAIN OF THE MONTH

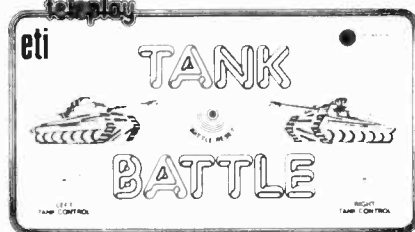

Fascia Plate. (Actual size: 12.6 x 21cm)

### TANK BATTLE T.V. GAME

**★ AN OFFER NOT TO BE MISSED**

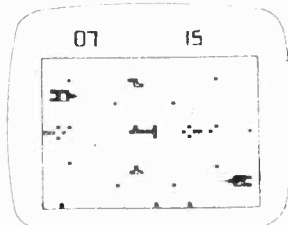

AY-3-8710	£10.90		
Sound & Vision Modulators	£4.90		
P.C.B.	£2.90		
BASIC KIT	£19.90		
Just add controls and case			
COMPLETE KIT	£27.90	COLOUR ADD-ON KIT	£5.90
with FREE Power Supply No extras needed		Blue Tank, Red Tank, Green Background Fits easily to ALL Tank Projects	

OPEN SIX DAYS A WEEK 10am to 7pm  
 at 14 Station Road, New Barnet, Herts EN5 1QW  
 (Close to New Barnet BR Station - Moorgate Line)

Make cheques or postal orders payable to Teleplay, send your order (No stamp needed), to Teleplay, Freepost, Barnet EN5 2BR or telephone your order quoting your Barclaycard or Access number



Trade enquiries Welcome



**teleplay**

## FANTASTIC GOLDRING SAVINGS

### GOLDRING G103 Belt Drive Turntable

Famous name turntable slashed to near half price. Complete with plinth, cover and leads. Accepts any standard cartridge (not included)

FULL 12 MONTH GUARANTEE

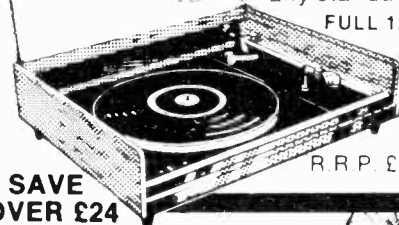

**OUR PRICE**  
**£26.95**

R.R.P. £54 (p/p & Ins £2.50)

SAVE OVER £24

### Build your own GOLDRING CK2 Belt Drive Turntable

Beautifully engineered unit from the famous Goldring company, comes complete with instructions and all necessary parts. Ready to incorporate into your design plinth and cover. The pleasure of assembling your own deck.



**ONLY**  
**£16.95**  
 (+ p/p & Ins. £1.75)

(Plinth, cover and cartridge not included). Usually sold for £54.95 with plinth and cover. Call in or send cheque, P.O., M.O., Access, Barclaycard, Diners Club or American Express Number.

ALL PRICES INC. VAT

**Sonic Sound Audio**  
 248/250 TOTTENHAM COURT ROAD, LONDON W1. TEL: 01-637 1908

WW-092 FOR FURTHER DETAILS

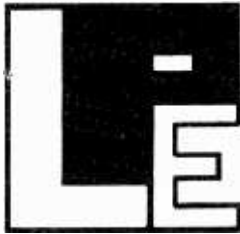

**Room W6**  
**313 Kingston Road, Ilford**  
**Essex, IG1 1PJ England**  
**01-553 1001**

# ENTERPRISES

From the representatives in Europe . . . for America's leading Micro-computer magazines and books, for the hobbyist, educationist and professional alike, we bring you a little light browsing!  
 Reading maketh a full man . . . Francis Bacon (1561-1626)

Tick here or indicate quantity ordered.	
<b>From Adam Osborne Associates</b>	
<b>INTRODUCTION TO MICROCOMPUTERS</b>	
Volume 0: The Beginners Book	£5.95
Volume 1: Basic Concepts	£5.95
Volume 2: Some Real Products (Revised Late 1977)	£11.95
6800 Programming for Logic Design	£5.95
8080 Programming for Logic Design	£5.95
Z80 Programming for Logic Design	£5.95
(Available May 78 approx)	£5.95
8080A/8085 Assembly Language Programming	£6.95
Some Common BASIC Programs	£5.95
<b>BUSINESS PROGRAMS IN BASIC</b>	
Payroll With Cost Accounting	£9.95
Accounts Payable & Accounts Receivable	£9.95
(Available from June 78)	£9.95
General Ledger (Available August 78)	£9.95
<b>From Scelbi Computer Consulting Inc.</b>	
6800 Software Gourmet Guide & Cookbook	£7.95
8080 Software Gourmet Guide & Cookbook	£7.95
8080 Programmers Pocket Guide	£2.25
8080 Hex Code Card	£2.25
8080 Octal Code Card	£2.25
8080 Guide and One 8080 Code Card	£4.20
8080 Guide and Both Code Cards	£6.00
SCELBAL High Level Language for '8008/8080' Systems	£39.25
SCELBAL String Handling Supplement	£8.00
SCELBAL Extended Maths Supplement	£4.00
Understanding Microcomputers & Small Computer Systems	£7.95
SCELBAL 'BYTE' Primer	£9.95
8080 Standard Assembler (In Block Format)	£15.95
8080 Standard Editor (In Book Format)	£9.95
<b>From Peoples Computer Company</b>	
Reference Books of Personal & Home Computing	£4.95
What to Do After You Hit Return	£7.00
Dr. Dobbs Journal Volume I	£10.00
<b>*From Kilobaud/73 Magazine Inc.</b>	
Hobby Computers Are Here	£3.95
New Hobby Computers	£3.95
<b>From Dymax Inc.</b>	
Instant BASIC by Jerald R. Brown	£4.95
Your Home Computer by James White	£4.95
My Computer Like Me . . . When I Speak	£1.65
BASIC By Bob Albrecht	£1.65
Games With A Pocket Calculator by Thiagarajan & Stilovitch	£1.75
Games, Tricks and Puzzles For a Hand Calculator by W Judd	£2.49
<b>*From BYTE Publications Inc.</b>	
Paperbytes:	
Tiny Assmbler for 6800 Systems	£5.75
Bar Code Loader for 6800, 8080, Z80 & 6502 Micros	£1.75
Best of BYTE Volume 1	£8.95

Tick here or indicate quantity ordered	Price UK	Price Overseas If Different
<b>* From Creative Computing Press</b>		
Best of Creative Computing Volume 1	£6.95	
Best of Creative Computing Volume 2	£6.95	
101 BASIC Games (Revised & Reprinted Feb. 78)	£5.50	
The Colossal Computer Cartoon Book	£3.95	
Computer-Rage (A new Board Game)	£6.95	
Artist and Computer	£3.95	
Three Binary Dice	£1.00	
<b>* From Everyone Else</b>		
TV Typewriter Cookbook by Don Lancaster	£7.95	
Magazine storage boxes (Holds 12 minimum)	£1.75	
Sybex: Microprocessors	£7.95	
Sybex: Microprocessors Interfacing Techniques	£7.95	
Dilithium: Home Computers Volume 1: Hardware	£6.50	
Dilithium: Home Computers Volume 2: Software	£5.95	
Getting Involved With Your Own Computer	£4.75	
Computer Programs that Work (in Basic)	£2.55	
<b>* From Basic Software Library</b> (from Scientific Research Instruments)		
Vol 1: Business and Personal Booking Programs	£17.50	
Vol 2: Maths and Engineering Programs	£17.50	
Vol 3: Advanced Business Programs	£26.95	
Vol 4: General Purpose Programs	£7.95	
Vol 5: Experimenters Programs (General Purpose)	£7.95	
Vol 6: General Ledger Program	£32.50	
Vol 7: Professional Programs	£26.95	
<b>Magazines: Back Issues</b>		
Personal Computing	£1.75	
Interface Age	£2.25	
Dr. Dobbs Journal	£1.60	
Computer Music Journal	£2.50	
Peoples Computers	£1.50	
*BYTE	£2.25	
Creative Computing	£1.75	
Calculators & Computers	£1.75	
ROM	£1.50	
Kilobaud	£2.25	
73	£2.00	
<b>MAGAZINES: Subscriptions</b>		
Personal Computing (Twelve Issues Yearly)	£16.00	£17.00
Interface Age (Twelve Issues Yearly)	£20.00	£20.50
Dr. Dobbs Journal / Ten Issues Yearly)	£13.00	£13.50
Computer Music Journal (Four Issues Yearly)	£8.50	£9.00
Peoples Computers (Six Issues Yearly)	£8.00	£8.50
Kilobaud (Twelve Issues Yearly)	£20.00	£21.00
BYTE (Twelve Issues Yearly)	£15.00	£15.00
Creative Computing (Six Issues Yearly)	£8.50	£9.00
Calculators & Computers (Seven Issues Yearly)	£10.00	£10.50
ROM (Twelve Issues Yearly)	£16.00	£17.00
73 (Twelve Issues Yearly)	£20.00	£21.00

ETI/B

**HOW TO ORDER**

Please note our prices include postage and packing, but not insurance, if wanted add 12p for every £10 of Books ordered. Make cheques, PO's etc payable to

**L.P. Enterprises**  
 CREDIT CARDS accepted  
 BARCLAYCARD VISA / ACCESS  
 DINERS CLUB / AMERICAN EXPRESS

Phone 01-553 1001 for Credit Card orders (24-hour service)

Send to address above for the attn. of David, Room W6  
 Indicate Payment Method:

**All Orders must be Prepaid**  
 Total Enclosed £.....

..... My cheque, P.O., I.M.O. is enclosed in Sterling on U.K. Bank

..... Charge to Barclaycard/Visa/Diners/American Express/Access

Credit Card No. .... Expiry date .....

Name .....

Address .....

..... POSTCODE .....

Signature .....

All publications are published in U.S.A. and shipped air-freight by L.P. Enterprises. In unusual cases, processing may exceed 30 days  
 \*BYTE subscriptions are processed in USA and are air-freighted & posted from Amsterdam and will take 3 months to start.

**TRADE ENQUIRIES WELCOME**

Due to fluctuations of the dollar prices are subject to change. Please mention Wireless World when ordering.

<b>TTLs by TEXAS</b>		<b>C-MOS I.C.s</b>		<b>OP. AMPS</b>		<b>TRANSISTORS</b>		<b>DIODES</b>	
7400 14p	74107 36p	CD4000AE 20p	1458 Dual Op Amp Int Comp 8 pin DIL 70p	4011A Ext Comp 8 pin DIL 36p	AC125 35p	BFV50 22p	2N3055 48p	***SIGNAL	0A47 8p
74000 28p	74109 89p	CD4001AE 20p	1130 CMOS Bi-Polar MosFet 8 pin DIL 100p	CA3140 BIMOS 8 pin DIL 70p	AC127 25p	BFV52 22p	2N3439 67p	0A81 20p	
74500 63p	74110 55p	CD4002AE 20p	CA3160 Int Comp 8 pin DIL 110p	CA318N High speed 8 pin DIL 200p	AC128 25p	BF900 30p	*2N3565 30p	0A85 20p	
74LS00 30p	74111 90p	CD4006AE 95p	CA318N High speed 8 pin DIL 200p	CA324N Quad Op Amp 14 pin DIL 125p	AC141 20p	BRV39 45p	*2N3643 48p	0A90 20p	
7401 16p	74116 200p	CD4007AE 20p	LM339N Vol Comp 14 pin DIL 140p	LM340N Quad Op Amp 14 pin DIL 125p	AC142 20p	BSX19 20p	*2N3644 48p	0A91 9p	
7402 16p	74118 84p	CD4008AE 107p	RC4136 Quad Op Amp 14 pin DIL 120p	NE531V High slew rate 8 pin DIL 70p	AC176 25p	BSX20 20p	*2N3702 12p	0A95 9p	
7403 18p	74120 120p	CD4009AE 61p	3900 Quad Op Amp 14 pin DIL 70p	NE543K Servo Amp 14 pin DIL 109p	AC187 25p	*BU105 140p	*2N3703 12p	0A99 9p	
7404 20p	74121 32p	CD4010AE 60p	741 Ext Comp 8 pin DIL 36p	RC4136 Quad Op Amp 14 pin DIL 120p	AC187K 30p	BU108 250p	*2N3704 12p	0A99 9p	
74H04 36p	74122 54p	CD4011AE 20p	741 Int Comp 8 pin DIL 36p	3900 Quad Op Amp 14 pin DIL 70p	AC188 25p	*BU205 200p	*2N3706 12p	0A99 9p	
7405 25p	74123 76p	CD4012AE 20p	747 Quad 741 14 pin DIL 70p	709 Ext Comp 8 pin DIL 36p	AC190 30p	*BU206 200p	*2N3707 12p	0A99 9p	
7406 43p	74125 73p	CD4013AE 55p	747 Int Comp 8 pin DIL 36p	741 Int Comp 8 pin DIL 36p	AD149 85p	*BU207 200p	*2N3708 12p	0A99 9p	
7407 43p	74126 70p	CD4015AE 90p	747 Ext Comp 8 pin DIL 36p	747 Int Comp 8 pin DIL 36p	AD161 45p	*BU208 200p	*2N3709 12p	0A99 9p	
7408 25p	74128 75p	CD4016AE 50p	776 Programmable Op Amp 8 pin DIL 180p	776 Programmable Op Amp 8 pin DIL 180p	AD162 45p	*MJE340 85p	*2N3710 12p	0A99 9p	
7409 27p	74132 70p	CD4017AE 100p			AF114 30p	*MJE341 85p	*2N3711 12p	0A99 9p	
7410 18p	74136 75p	CD4018AE 110p			AF115 30p	*MJE342 85p	*2N3712 12p	0A99 9p	
7411H 28p	74141 75p	CD4019AE 52p			AF116 30p	*MJE343 85p	*2N3713 12p	0A99 9p	
7411 24p	74142 320p	CD4020AE 120p			AF117 30p	*MJE344 85p	*2N3714 12p	0A99 9p	
7412 25p	74145 90p	CD4022AE 100p			AF127 25p	*MJE345 85p	*2N3715 12p	0A99 9p	
7413 36p	74147 190p	CD4023AE 22p			AF139 43p	*MJE346 85p	*2N3716 12p	0A99 9p	
7414 75p	74148 160p	CD4024AE 82p			AF239 8p	*MJE347 85p	*2N3717 12p	0A99 9p	
7416 33p	74150 140p	CD4025AE 22p			BC107 B 48p	*MJE348 85p	*2N3718 12p	0A99 9p	
7417 36p	74151 72p	CD4026AE 170p			BC109 B 48p	*MJE349 85p	*2N3719 12p	0A99 9p	
7420 18p	74153 85p	CD4027AE 65p			BC109C 12p	*MJE350 85p	*2N3720 12p	0A99 9p	
7421 40p	74154 150p	CD4028AE 98p			*BC117 22p	*MJE351 85p	*2N3721 12p	0A99 9p	
7422 22p	74155 90p	CD4029AE 120p			*BC147 9p	*MJE352 85p	*2N3722 12p	0A99 9p	
7423 37p	74156 90p	CD4030AE 55p			*BC148 9p	*MJE353 85p	*2N3723 12p	0A99 9p	
7425 30p	74157 90p	CD4035AE 131p			*BC149C 9p	*MJE354 85p	*2N3724 12p	0A99 9p	
7427 37p	74159 190p	CD4040AE 120p			*BC151 11p	*MJE355 85p	*2N3725 12p	0A99 9p	
7428 22p	74160 100p	CD4042AE 90p			*BC158 10p	*MJE356 85p	*2N3726 12p	0A99 9p	
7430 18p	74161 100p	CD4043AE 100p			*BC159 11p	*MJE357 85p	*2N3727 12p	0A99 9p	
7432 36p	74162 120p	CD4046AE 140p			*BC169C 12p	*MJE358 85p	*2N3728 12p	0A99 9p	
7437 36p	74163 120p	CD4047AE 100p			BC177 18p	*MJE359 85p	*2N3729 12p	0A99 9p	
7438 36p	74164 120p	CD4049AE 63p			*BC178 17p	*MJE360 85p	*2N3730 12p	0A99 9p	
7440 19p	74165 220p	CD4050AE 57p			*BC179 18p	*MJE361 85p	*2N3731 12p	0A99 9p	
7441 75p	74166 160p	CD4054AE 120p			*BC182 12p	*MJE362 85p	*2N3732 12p	0A99 9p	
7442 70p	74167 340p	CD4055AE 140p			*BC183 12p	*MJE363 85p	*2N3733 12p	0A99 9p	
7443 140p	74170 250p	CD4056AE 135p			*BC184 13p	*MJE364 85p	*2N3734 12p	0A99 9p	
7444 140p	74172 720p	CD4059AE 600p			BC187 30p	*MJE365 85p	*2N3735 12p	0A99 9p	
7445 120p	74173 600p	CD4060AE 130p			*BC212 11p	*MJE366 85p	*2N3736 12p	0A99 9p	
7446 100p	74174 120p	CD4069AE 27p			*BC213 11p	*MJE367 85p	*2N3737 12p	0A99 9p	
7447 70p	74175 85p	CD4071AE 27p			*BC214 14p	*MJE368 85p	*2N3738 12p	0A99 9p	
7448 80p	74176 120p	CD4072AE 27p			BC461 36p	*MJE369 85p	*2N3739 12p	0A99 9p	
7450 18p	74177 120p	CD4081AE 21p			BC478 30p	*MJE370 85p	*2N3740 12p	0A99 9p	
7451 20p	74179 160p	CD4093AE 95p			*BC516 65p	*MJE371 85p	*2N3741 12p	0A99 9p	
7453 20p	74180 110p	CD4502AE 138p			BC517 65p	*MJE372 85p	*2N3742 12p	0A99 9p	
7454 18p	74181 288p	CD4510AE 130p			BC518 65p	*MJE373 85p	*2N3743 12p	0A99 9p	
7460 18p	74182 82p	CD4511AE 160p			BC519 65p	*MJE374 85p	*2N3744 12p	0A99 9p	
7470 36p	74184 160p	CD4516AE 112p			BC520 65p	*MJE375 85p	*2N3745 12p	0A99 9p	
7472 30p	74185 150p	CD4518AE 130p			BC521 65p	*MJE376 85p	*2N3746 12p	0A99 9p	
7473 34p	74186 920p	CD4520BE 100p			BC522 65p	*MJE377 85p	*2N3747 12p	0A99 9p	
7474 34p	74190 120p	CD4528AE 120p			BC523 65p	*MJE378 85p	*2N3748 12p	0A99 9p	
74LS74 56p	74191 120p	CD4560BE 250p			BC524 65p	*MJE379 85p	*2N3749 12p	0A99 9p	
7475 45p	74192 120p				BC525 65p	*MJE380 85p	*2N3750 12p	0A99 9p	
7476 36p	74193 120p				BC526 65p	*MJE381 85p	*2N3751 12p	0A99 9p	
7480 50p	74194 120p				BC527 65p	*MJE382 85p	*2N3752 12p	0A99 9p	
7481 95p	74195 95p				BC528 65p	*MJE383 85p	*2N3753 12p	0A99 9p	
7482 90p	74196 120p				BC529 65p	*MJE384 85p	*2N3754 12p	0A99 9p	
7483 90p	74197 120p				BC530 65p	*MJE385 85p	*2N3755 12p	0A99 9p	
7484 110p	74198 250p				BC531 65p	*MJE386 85p	*2N3756 12p	0A99 9p	
7485 120p	74199 250p				BC532 65p	*MJE387 85p	*2N3757 12p	0A99 9p	
7486 34p	74221 160p				BC533 65p	*MJE388 85p	*2N3758 12p	0A99 9p	
7489 320p	74251 140p				BC534 65p	*MJE389 85p	*2N3759 12p	0A99 9p	
7490 36p	74265 90p				BC535 65p	*MJE390 85p	*2N3760 12p	0A99 9p	
7491 85p	74278 290p				BC536 65p	*MJE391 85p	*2N3761 12p	0A99 9p	
7492 55p	74279 140p				BC537 65p	*MJE392 85p	*2N3762 12p	0A99 9p	
7493 36p	74283 190p				BC538 65p	*MJE393 85p	*2N3763 12p	0A99 9p	
7494 90p	74290 150p				BC539 65p	*MJE394 85p	*2N3764 12p	0A99 9p	
7495 70p	74293 150p				BC540 65p	*MJE395 85p	*2N3765 12p	0A99 9p	
7496 84p	74298 200p				BC541 65p	*MJE396 85p	*2N3766 12p	0A99 9p	
7497 34p	74365 150p				BC542 65p	*MJE397 85p	*2N3767 12p	0A99 9p	
74100 120p	74366 150p				BC543 65p	*MJE398 85p	*2N3768 12p	0A99 9p	
74104 65p	74390 200p				BC544 65p	*MJE399 85p	*2N3769 12p	0A99 9p	
74105 65p	74393 225p				BC545 65p	*MJE400 85p	*2N3770 12p	0A99 9p	

**TECHNOMATIC LTD.**  
 54 SANDHURST ROAD, LONDON, NW9  
 Tel: 01-204 4333. Telex 922800

VAT RATES. All items at 8% EXCEPT where marked \* which are at 12 1/2%.

\*\*\* PLEASE SEND S.A.E. FOR OUR CATALOGUE \*\*\*

**COMPUTER APPRECIATION**  
 86 High Street, Bletchingley, Redhill, Surrey RH1 4PA. Tel: Godstone (0883) 843221

LOGABAX Model LX180 dot-matrix printer. 120 c.p.s. In ex-demo condition. £750.00.  
 DIGITAL EQUIPMENT DECwriter II Model LA36 Terminal with matrix printer. New £695.00.  
 PDP 120 c.p.s. dot-matrix with parallel TTL interface. £225.00.  
 IBM model 735 I/O Selectric. £150.00 (Correspondence coded & refurbished. £225.00).  
 TELETYPE model BRPE 110 high speed paper tape punch. £95.00.  
 ROYTRON 50 c.p.s. tape punch (similar to PDP B. 11 punch). £75.00.  
 SINGER 70 c.p.s. tape punch with all electronics, spooling, etc. & fully documented. £68.00.  
 ICL model 250 optical paper tape reader with parallel output. £78.00.  
 DIABLO model 31 exchangeable disc unit. 12 megabit capacity. £495.00.  
 DIGITAL COMPUTER CONTROLS INC. Model D112 4K x 12 memory (substantially PDP 8 compatible). £75.00.  
 DIGITAL EQUIPMENT CO. Model DF 32 fixed disc & controller for PDP 8. £250.00.  
 PERTEC model 6840 9-track NRZ1 tape unit with PDP 8L controller. £550.  
 RACAL Linplex II. High speed data communications unit. New. £1500.00.  
 TEKTRONIX Model 585 oscilloscope DC 800 Hz and sweep delay. £275.00  
 SE LABS DC-100 Mhz portable oscilloscope with sweep delay. £450.00.  
 GOULD ADVANCE model 232C oscilloscope. Double beam. DC-10 MHz. As new £100.00.  
 SOLARTRON model L1604 05 AC 4 1/2 digit DVM with internal standard. £98.00.  
 SFRAM chart recorder. 5-channel. £75.00. (Several other recorders available)  
 FERRANTI Argon-ion LASER with p.s.u. probably in 2-5 mW range. £75.00.

# Electronic Brokers Ltd

## The Test Equipment People

Calibrated & Guaranteed 12 Months

### GOULD ADVANCE

**Modular Pulse Generator PG.52.** System of 5 signal generating & processing units. Repetition freqs. up to 20MHz & output pulses to 20V (50Ω) Rise & Fall times 5 nsec. Its versatility enables the production of complex pulse & ramp waveforms not obtainable from conventional pulse generators. **£425.00**

**Double Pulse Generator PG5002D.** Main pulse width 0.1µsec to 1sec Rise time 12nsecs. Amplitude 50V to 50 volts. Repetition rate 0.1Hz-1MHz. **£150.00**

**Double Pulse Generator PG.56.** Pulse Amplitude 0.1V-10V Sq wave 0-10V Rise Time 10nsec (typically) **£100.00**

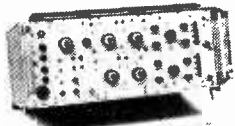

**Pulse Generator PG59 (Type CT600).** Produces a pulse controllable in frequency, width, amplitude, delay and rise and fall times. Also produces prepulse and gate outputs. Repetition frequency. 1Hz to 10MHz. Pulse width 25nsec to 1sec Rise and fall times 12nsec to 1 sec Delay 25µsec to 1sec Trigger. Internal, external and single shot. **£595.00**

**LR100X-Y Plotter.** Specification. Main frame, Frequency response 1Hz Plug-in amplifiers. LR120 general purpose amplifier LR121 time base Full specification on request **£235.00**

**R.F. Signal Generator B4B7.** 30kHz-30MHz, O/p 1µV to 100mV Output z -75Ω Int Mod. 400Hz. 0-80% Provision for Ext. Mod Audio o/p 0-10V at 400Hz into 600Ω **£165.00**

**AF Signal Generator H1E.** Specification. Frequency range. 15Hz-50KHz AF Output. Sine Wave 200µV, to 20V r.m.s. ±2 dB Square Wave 1.4mV to 14V peak to peak approximately **£80.00**

**Signal Generator J3.** Frequency range 10Hz to 100kHz Sine & Square output Metered o/p **£150.00**

**Signal Generator J4.** Frequency range 10Hz to 100kHz Sine and square o/p **£140.00**

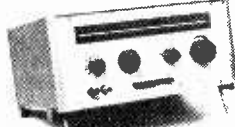

**Wide range oscillator SG 67A.** Frequency range 1Hz to 1MHz Sine and square wave **£95.00**

**Low Distortion Oscillator SG 68A.** 1.5Hz-150kHz Output waveforms Low distortion - <0.01% (40Hz-20kHz) Low distortion - <0.05% (20kHz-150kHz) Square wave. Typically 600Ω impedance Max output 4V (r.m.s.) Battery operated **£175.00**

**True R.M.S. Voltmeter DRM6.** 100mV-1kV (6 ranges) 100% over-range. CM R 90dB (DC-50Hz) **£395.00**

**Frequency Counter TC16.** 5Hz-80MHz 5 digit display, 1MHz crystal Frequency and count functions **£110.00**

**Timer Counter TC17A.** 6 digit DC-80MHz. Gate times 10µs to 10s in decade steps. Sensitivity 25mV (r.m.s.) sine wave Overload protected **£215.00**

**Timer Counter TC18.** Specification. Frequency Measurement Input 1 10Hz to 100MHz Input 2 10MHz-512MHz Both inputs direct counting Sensitivity 35mV r.m.s. to 40MHz, 50mV r.m.s. at 100MHz Input 2 sensitivity 35mV r.m.s. to 40MHz to 400MHz, 50mV r.m.s. to 512MHz Display 6 digit dot matrix L.E.D. **£245.00**

**Timer Counter TC22.** Measures Frequency DC-100MHz 6 digit, time, period, period average, count, totalise, pulse width, ratio **£275.00**

**Digital Multimeter DMM3.** 3½ digit Maximum reading 1999. 25 ranges of measurement. AC and DC volts AC and DC current. Resistance Dual Polarity Remote hold **£115.00**

**STRIP CHART RECORDER OMNISCRIBE A.5000 Series.** One & Two Pen. "As New Condition" Full specification on request **£120.00**

- A 5110-1 **£200.00**
- A 5112-2 **£225.00**
- A 5123-1 **£300.00**
- A 5120-5 **£300.00**
- A 5132-4 **£320.00**
- A 5221-4 **£400.00**
- A 5212-4 **£380.00**
- A 5230-4 **£450.00**
- A 5222-2 **£410.00**

**Off Air Frequency Standard OFS-1** **£120.00**

**VHF Square Wave Generator SG21.** 10KHz-100MHz **£60.00**

**A.F. Signal Generator J2E.** 15Hz-50kHz o/p (600Ω) 0.1mV-1V **£120.00**

**A.C. Millivoltmeter VM77C.** 0.001V-300V t.s.d. (12 ranges) 15Hz-4.5MHz **£55.00**

**Timer Counter TC14.** 9 digit. Display storage DC-250MHz Time gate selectable 0.1µs-100s Multiple period average 10-10<sup>-6</sup> Sensitivity 10mV, 100mV, 500mV. Overload protected **£400.00**

**Timer Counter TC15.** 9 digit with storage and plug-in capability. DC-250MHz. Spec similar to TC14 **£500.00**

**Plug In Unit TC15 P1.** 1MHz-500MHz 10mV-1V Full 500MHz display with 1Hz resolution in only 2 secs **£150.00**

**Portable Oscilloscope OS245A.** Dual trace. DC-10MHz 5mV/div 4" rectangular CRT BRAND NEW **£232.00**

### TEKTRONIX

**Bench Oscilloscope Type 531A** c/w dual trace vertical plug-in unit CA. DC-13.5MHz Sensitivity 50mV-20V/Div Time base ranges 100ns to 5S/Div Timebase modes. A, X5 Internal voltage calibrator 0.2mV-100V 1kHz square wave **£290.00**

**Bench Oscilloscope Type 647A** c/w dual trace vertical plug in unit 10A2A & delayed time base plug in unit 11B2A DC-100MHz Sensitivity 10mV-20V/Div Time base ranges 100ns-5s/Div on A & B Time base modes A only, Intensified, delayed sweep, X10 Internal voltage calibrator 0.2mV-100V 1kHz square wave **£1200.00**

**Bench Oscilloscope Type 585A** c/w dual trace vertical plug in unit Type 82 DC-80MHz Sensitivity 10mV-50V/Div Time base ranges A 50ns-2s/Div, 2µs-1s/Div Time base modes A, B, intensified, delayed, X5 Internal voltage calibrator 0.2mV-100V 1kHz square wave **£775.00**

**Bench Oscilloscope Type 547** c/w dual trace vertical plug in unit 1A1 DC-50MHz Sensitivity 5mV-20V/Div Time base ranges 100ns-5s/Div A and B Time base modes A, B, intensified, delayed sweep, alternate sweep, X 2.5-10 Internal voltage calibrator 0.2mV-100V 1kHz square wave **£775.00**

**Bench Oscilloscope Type 546.** c/w dual trace vertical plug in unit 1A1 As 547, but without alternate sweep **£740.00**

**Bench Oscilloscope 545B** c/w dual trace vertical plug in unit CA DC-24MHz, sensitivity 50mV to 20V/Div Time base ranges A 100ns - 5S/Div B 2µs-1s/Div Time base modes A, B, intensified, delayed sweep, X5 Internal voltage calibrator 0.2mV-100V 1kHz square wave **£555.00**

**Bench Oscilloscope Type 543B** c/w dual trace vertical plug in unit CA As 545B & CA, without B time base With X2-X100 Horizontal gain **£450.00**

**Dual Trace Portable Oscilloscope 485.** DC-350MHz Sensitivity 5mV-5V/Div. Input impedance 1MΩ or 50Ω. Time base ranges 1ns-0.5s/Div on A and B. Time base modes A, B intensified, delayed sweep, alternate sweep **£2,900.00**

**Time Marker Generator 184.** 16 marker intervals, 5 sinewave frequencies 500MHz sinewave output. Crystal controlled oscillator 10MHz ± 0.001% **£275.00**

**2101 5ns Pulse Generator with Delay.** 2.5Hz-25MHz repetition rate Variable baseline offset 5ns risetime and fall time Paired, undelayed, delayed and output latched on modes. External gate input Simultaneous positive and negative going pulses 10volts into 50Ω **£575.00**

**2901 Time Mark Generator.** 16 marker intervals, 4 sinewave frequencies 500MHz sinewave output Crystal controlled oscillator. 8 trigger pulse intervals **£450.00**

**General Purpose Oscilloscope 515A.** DC-15MHz Single trace 50mV-20V/cm **£185.00**

**TV Waveform Monitor 525** **£165.00**

**Plug In Unit Power Supply 132** **£120.00**

**Spectrum Analyser Plug In 3110** (for 560, and 564 series scopes) 1-36MHz **£415.00**

**4-Trace Plug In Unit "M"** (for use with 530, 540 & 580 series) **£250.00**

**Differential Plug In Unit "W"** **£325.00**

**Oscilloscope Camera Unit C12** **£190.00**

**Digital Readout Oscilloscope 567.** Choice of plug-ins available Mainframe price **£510.00**

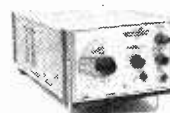

**Constant Amplitude Signal Generator 191.** 350kHz-100MHz Sine wave 5mV-5.5V constant amplitude 50kHz Amplitude reference **£350.00**

### COHU

**Precision DC Voltage Standard 304.** 0-1 kV in 3 decades 0-50mA at any voltage setting Accuracy 10V range 0.003% +10µV 100V range 0.003% +20µV 1kV range 0.003% +40µV **£450.00**

### WAYNE KERR

**Universal Bridge B221A = CT530.** 10S/948-8768 0.1% accuracy Measures R +ve or -ve G +ve or -ve C (x1) L (1592Hz) Source frequency (1592Hz int) 50Hz-20Hz (Ext) Mains operated Weight 11 kg **£275.00**

**Low Impedance Adaptor Q221A.** For use with B221A permitting impedance measurements of <10Ω to be made **£75.00**

**Component Bridge B521** (Ministry Type CT375) A general purpose component bridge for measuring LC & R & combinations of R & Reactance It can be used to measure components in situ Capacitance 1pF to 5F Resistance 1 milliohm to 100Mohm Inductance 1µH to 500kH **£115.00**

**ELECTRONIC BROKERS LIMITED**  
 49-53 Pancras Road, London NW1 2QB  
 Tel. 01-837 7781. Telex: 298694

ADD 8%  
 VAT  
 TO ALL  
 PRICES

Hours of Business: 9 a.m.-5 p.m. Carriage and Packing charge extra on all items unless otherwise stated.  
 Mon.-Fri.: closed lunch 1-2 p.m.

WW-112 FOR FURTHER DETAILS

**Calibrated & Guaranteed 12 Months**

# Electronic

## The Test Equipment People

### ROHDE & SCHWARZ

**Stereocoder Type MSC. BN4192/2.** Superb condition £1,200.00  
**Stereocoder MSDC. BN4193.** Superb condition £850.00  
**Z-g Diagraph ZDU** £860.00  
**Selective Level Voltmeter . USWV.** 30-400 MHz 10µV-3V £800.00  
**U.H.F. Millivoltmeter. URV.** 1 KHz-1.6 GHz £235.00

### HEWLETT PACKARD

**True R.M.S. Voltmeter 3400A.** 1mV-300V (12 ranges) dB range -72-+502 dBm Frequency range 10Hz to 10MHz £415.00  
**D.C. D.V.M. 3430A.** 3 digit 5 ranges 100mV-100V Input Resistance 10MΩ Overload protected £145.00  
**Digital Multimeter 34702A.** C/w 34740 display 4 1/2 digit 4 ranges of A.C. & D.C. & 6 ranges of ohms. A.C. = 45Hz-100kHz. £350.00

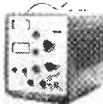

**U.H.F. Signal Generator 612A.** 450-1200MHz in 1 band. Output Voltage 0.1µV to 0.5V. Output impedance 50Ω A.M. 0.90% Ext. A.M. Facility Pulse mod facility. Various modern versions from £900.00-£1250.00

**Frequency Doubler 10515A** £75.00  
**A.M. Signal Generator 606A.** 50kHz-65MHz £550.00  
**Bench Oscilloscope 175A.** C/w Plug Ins 1754A & 1781B. 4 trace 40MHz bandwidth Sweep Delay £550.00  
**Programmable Step Attenuator 355E.** DC-1000MHz 0-12 dB in 1dB steps. Unused £60.00  
**Distortion Analyser 332A.** 5Hz-600kHz. Distortion levels 0.1%-100% are measured full scale in 7 ranges A.M. Detector operating from 550kHz-65MHz £495.00  
**DC Standard/Differential Voltmeter 740B.** Designed for calibrating digital voltmeters, differential voltmeters, potentiometers, voltage dividers and for general standards lab application 6 digit resolution with discrete steps of 1 p.p.m. of full scale. Full specification on request £1,850.00  
**A.C. Voltmeter 400F.** 100V to 300V 1s (14 ranges) Freq. range 20Hz-4MHz. £195.00  
**Microwave Power Meter 430C.** C/w Thermistor mount 477B 10MHz-10GHz Full scale ranges 0.1, 0.3, 1, 3 & 10mW  
**Portable Oscilloscope 1700B.** DC-35MHz 10mV/div sensitivity Dual Channel Solid State £575.00

**A.C. Voltmeter 400EL.** 1 mV-300V 12 Ranges 10Hz-10MHz BRAND NEW £325.00

**S.H.F. Signal Generator 628A.** 15-21GHz 50Ω £495.00

### FLUKE

**Multifunction Counter 1900A-01.** Same spec as 1900A but with battery pack £215.00

**Multifunction Counter 1900A-02.** Same spec as 1900A but with BCD o/p £230.00

**Frequency Synthesiser 6011A.** Performs function of an oscillator, counter and level meter 10Hz-11MHz Output 0.4mV-5V r.m.s. 7 digit LED display Accuracy ±3 parts in 10<sup>6</sup> for one year Freq. storage Full spec. on request £2650.00

**Frequency Synthesiser 6160A/DX.** 4MHz-30MHz in 1Hz steps Output 1V into 50Ω Full spec. on request. UNUSED. BARGAIN PRICE £675.00

**Industrial Counter Totaliser 1941A.** 5Hz-40MHz 40mV sensitivity R.P.M. measurement £150.00

**VHF, UHF Telecomms. Frequency Counter 1980A.** C/w Battery Pack 5Hz-515MHz 6 digit LED Display 50mV sensitivity over whole range £400.00

### MULTIFUNCTION 6 DIGIT AUTORANGING COUNTER 1900A

Modes  
 Frequency period, totalize  
 Frequency range 5Hz-80MHz. Input sensitivity: 25mV  
 BRAND NEW  
 £175.00



### GENERAL RADIO

**Frequency Meter & Discriminator 1142A.** Frequency Range 3Hz to 1.5MHz Accuracy ±0.2% Can be used with a recorder to produce records of frequency change and drift £235.00

**Standard Frequency Multipliers. Type 1112 series.** Providing microwave range standard freqs Output 20mW Output impedance 50Ω Low noise and excellent phase stability  
 Type 1112A £520.00  
 Type 1112B £495.00

**Radio Frequency Bridge 1606A.** 400kHz to 60MHz a generator & detector is required £390.00

**Wave Analyser 1900A.** C/w Graphic Level Recorder 1521B Spec 1900A 20Hz-50kHz 3 band widths 3, 10 and 50Hz Tracking averages 30mV-300V 1s d Input impedance 1MΩ 3 meter speeds. Spec 1521B. 4 5Hz-200kHz. 1mV sensitivity Linear dB plot of r.m.s. ac-voltage level 20, 40 or 80dB range £2000.00

**Electronic Voltmeter 1806A.** AC+DC voltage 9 resistance ranges ±2% accuracy Wide frequency range — up to 1500MHz £175.00

**Adjustable Attenuator 874 GAL.** 100MHz to 4GHz 120 dB range 50Ω Impedance BRAND NEW £150.00

### METRONIX (POLAND)

**Function Generator G432.** 1Hz-1.1MHz Sine, Square & Triangle BRAND NEW Full specification on request £60.00

### RADIOMETER

**FM/AM Signal Generator MS 27G** £385.00

**Stereo Signal Generator SMG1C.** Solid state, pushbutton operation Full specification on request £350.00

### AVO

**Multimeter model 7** £40.00  
 Leads, prods & croc. clips for models 7, 8 & 9 £4.50 set

### PHILIPS

**100MHz Single output Pulse Generator PM5775.** Specification on request £800.00

**100MHz Double Output Pulse Generator PM5776.** Specification on request £900.00

**50MHz Pulse Generator PM5712**

£495.00



Specification on request

**50MHz Pulse Generator PM5715.** Specification on request £600.00  
**Low Frequency Generator PM5105.** 10Hz-100kHz sine & Square wave £156.00

**Sine & Square Wave Oscillator PM5125.** 10Hz-1MHz £145.00  
**U.H.F. TV Generator PM5525A.** 470-850MHz Can be modulated with black & white as well as colour TV £95.00

### RACAL

**Freq. Period Meter 9520.** 5Hz-10MHz. £110.00

**Universal Counter Timer 9838.** Frequency, single and multiple period, time interval Freq range 10Hz-100MHz £285.00

**H.F. Communications Receiver RA117E.** 1-30MHz Full specification on request £350.00

**Modulation Meter 210A.** 2.5-300MHz. A.M. range 0-100%. F.M. range 0 to ±100kHz £245.00-£285.00

**A.M./F.M. Modulation Meter 409.** Freq. 3-1500MHz. A.M. 0-100% F.M. 0-600kHz £345.00

### T.E.S. (Milan)

**L.F. Signal Generator G1165B.** Solid State. 10Hz-100kHz 1mV-10V 800Ω impedance Square Wave facility £195.00

**Wow & Flutter Meter WF971.** DIN & CCIR 1/p signal 20mV-20V Flutter ±0.1% ±0.3% ±1% 1/p impedance 10KΩ £210.00

**A. F. Power Meter MU964.** 1mW-10W (4 ranges) 20Hz-50kHz Load input resistance 40 values £175.00  
 All ex-demonstrators as new condition

### DUMONT

**Portable Scope 1100P.** DC-100MHz at 5mV/cm Dual Trace 5ns/cm Sweep rate Delayed time base Full 8 × 10cm display Calibrated X-Y to 5MHz £825.00



49-53 Pancras Road  
 London NW1 2QB  
 Tel: 01-837 7781. Telex: 298694

ADD 8% VAT  
 TO ALL PRICES



# Brokers Ltd



49-53 Pancras Road, London NW12QB  
Tel: 01-837 7781

## TELEQUIPMENT

**Portable Oscilloscope D75.** DC-50MHz at 5mV/Div Dual Trace. Delay/Mixed Sweep ..... **£575.00**

## MARCONI INSTRUMENTS

**Signal Generator TF867.** 15kHz-30MHz o/p 0.4µV-4V. Int. & Ext. mod. Supplied with Terminating Unit ..... **£185.00**

**F.M./A.M. Signal Generator TF995B/2.** Frequency Range 200kHz to 220MHz in five bands. Output: 0.1µV-200mV. Output Impedance 75Ω. Modulation (F.M.). Normal deviation continuously variable in two ranges ±25kHz and ±75kHz on all bands. Greater deviation is available on most bands. Modulating Frequency Internal FM: 1kHz. External FM: 50Hz to 15kHz. Modulation (A.M.) Internal AM: 1kHz, 0-50%. External AM: 50Hz to 10kHz, 0-50% ..... **£675.00**

**U.H.F. Signal Generator TF1060.** Frequency range 450-1250MHz (1 band). Output 0.15µV to 445mV. Output Impedance 50Ω. Int. sine A.M.-1kHz. Ext. pulse mod. .... **£400.00**

**A.M. Signal Generator TF144H & H/S.** Frequency range 10kHz to 72MHz in twelve overlapping bands. Output Attenuator. 2µV to 2V. Output Impedance 50Ω. Modulation Internal AM: 400Hz & 1kHz to 0 to 80%. External AM: 20Hz to 20kHz, 0 to 80% ..... **£275.00-£400.00**

**A.M. Signal Generator TF144H/4.** A later version of TF144H with similar spec. .... **£375.00-£800.00**

**A.M. Signal Generator TF144H/4S.** Electrical specification, as TF144H/4 ..... **£375.00-£700.00**

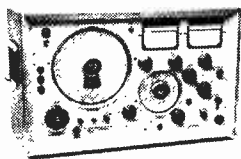

**A.M. Signal Generator TF801D/1.** Frequency Range 10MHz to 470MHz in five bands. Output Attenuator 0.1µV to 1V. Output Impedance: 50Ω (Type N connector). Modulation Internal AM: 1kHz, 0 to 90%. External AM: 30Hz to 20kHz, 0 to 90% ..... **£400.00-£750.00**

**Carrier Deviation Meter TF791D.** Carrier Freq. range 4 to 1024MHz. Deviation range up to ±125kHz. Modulating Frequency range Up to 35kHz. Late models ..... **£295.00**

**20MHz Sweep Generator TF1099.** Video sweep output Lower limit 100kHz fixed Upper limit continuously variable up to 20MHz. 0.3 to 3V p-p. Z=75Ω. Input & Output detector probes. Markers at 1MHz intervals ..... **£295.00**  
**Oscillator TF1247** (can be used with Q Meter TF1245). 20MHz-300MHz **£350.00**

**A.M. Signal Generator TF801D/8S.** Same spec as TF801D/1S + freq. counter o/p facility ..... **£695.00**

**F.M./A.M. Signal Generator TF995A/2M.** 1.5 to 220MHz. 2µV to 200mV. int. & Ext. A.M. Int. F.M. at 1kHz deviation 0-75kHz ..... **£375.00-£475.00**

**Sensitive Valve Voltmeter TF2600.** 12 ranges 1mV-300V f.s.d. 1% accuracy up to 500kHz Usable up to 10MHz ..... **£175.00**

**R.F. Electronic Voltmeter TF2604.** 7 ranges 300mV-300V f.s.d. from 20Hz-1500MHz 8 ranges 300mV-1kV DC. 7 ranges. Resistance 500Ω to 500MΩ ..... **£225.00**

**U.H.F. Signal Generator TF1060/3A.** Frequency range 500 to 1200MHz. Remainder of spec. on TF1060 ..... **£575.00**

**R-C Oscillator TF1101.** Frequency Range 20Hz to 200kHz in four bands. Output Attenuator 1mV to 20V. Maximum Output 20V across external 600Ω load. Output impedance 600Ω ..... **£120.00**

**Phase A.M. Signal Generator TF2003.** 0.4-12MHz ..... **£150.00**



**Two-Tone Signal Source TF2005R.** Frequency Range 20Hz-20kHz in six bands (each oscillation can be adjusted and used independently). Harmonic Distortion. Less than 0.05% between 63Hz and 6kHz when using unbalanced output. Intermodulation Below 80 dB with respect to the wanted signal Amplitude Reference Level Up to +10dBm from each oscillator. Output Attenuator 111dB in 0.1dB steps ..... **£415.00**

**Blanking and Sync Mixer TF2908.** For 405, 525 and 625 line television systems. Reshapes and mixes blanking and sync pulse waveform with video test waveform ..... **£90.00**

**L.F. Extension Unit TM6448.** For use with Spectrum Analyser OA 1094A series 100Hz to 3MHz ..... **£200.00**

**Wide Range R.C. Oscillator TF1370A.** 10Hz to 10MHz sine wave. 10Hz to 100kHz square wave. Output up to 31 6V **£275.00**

**DC Multiplier TM5033A.** HV probe up to 30kV Impedance 3000MΩ for use with TF1041 series or TF2604 ..... **£25.00**

**5 watt Dummy Load TM5582** for use with TF2604 ..... **£25.00**

**A.F. Oscillator TF2100.** 20kc/s to 20Kc/s Extremely low distortion. Output Impedance 600Ω unbalanced ..... **£150.00**

**M.F. Oscillator TF2101.** 30c/s to 550kc/s Stable frequency. Low distortion. Output Impedance 600Ω unbalanced ..... **£115.00**

**F.M./A.M. Modulation meter TF2300S.** Incorporating Oscillator TM8045/1 3.5 to 1000MHz Full specification on request ..... **£825.00**



**M.F. Transmission Measuring Set TF2333.** Frequency range 30Hz to 550kHz. The TF2333 is a transmission measuring set of the conventional type that normally forms part of the essential test gear for audio and baseband equipment of multi-channel telecommunications systems. Signal Source, oscillator-frequency range 30Hz to 550kHz in five ranges Attenuator. Range 70dB in 10dB and 1dB steps ..... **£600.00**

**F.M. Signal Generator TF1066B/6.** 10-470MHz R.F. output 0.2µV-200mV e in I Output Impedance 50Ω. Modulation Internal AM: 1kHz & 5kHz 0-40% External AM: 30Hz to 15kHz 0-40%. Internal FM: 1kHz & 5kHz deviation 0 to 100kHz or up to 200kHz according to carrier freq. range External FM: 30Hz to 100kHz deviation same as int. Crystal Calibrator facility ..... **£685.00**

**Variable Attenuator TF338C.** 0-105dB Freqs. up to 100kHz 600Ω impedance ..... **£90.00**

**M.F. Attenuator TF2162.** DC-1MHz 0-11 dB in steps of 0.1dB ..... **£120.00**  
Also TF1073A Spec as A/2S ..... **£55.00**

**Portable Scope TF2203.** Single beam DC-15MHz Rise time 23 nanosecs. 50mV/cm Z modulation available. X5 expansion ..... **£150.00**

**10-Watt A.F. Power Meter TF893A.** Frequency range 20Hz to 35kHz. Five power ranges: 1mW to 10W full scale Impedance 2.5Ω to 20KΩ in 48 steps Balanced or unbalanced inputs. Direct calibration in watts and dBm ..... **£165.00**

**100-Watt R.F. Power Meter: TF1020A Series.** Frequency range DC to 250 MHz. Two power ranges 50 and 100W full scale. Output Impedance 75Ω ..... **£105.00**

**R.F. Power Meter TF2502.** Range 3 and 10W f.s.d. DC-1GHz Output impedance 50Ω VSWR 1:1.1 ..... **£355.00**

**In Situ Universal Bridge TF2701.** Measures capacitance, capacitance with R in parallel. Resistance & Inductance Int. source 80Hz & 1KHz ..... **£395.00**

**R.F. Power Meter TF1020A/4M1.** 75 ohms. 1-50 watts & 2-100 watts. DC-250MHz ..... **£120.00**

**R.F. Power Meter TF1020A/5M1.** 50 ohms. 1-50 watts. 2-100 watts DC-250MHz ..... **£135.00**

**Output Test Set TF1065A.** AF Power 10uW to 3W (5 ranges) Freq. Range 250Hz-10KHz RF Power 1-25W. FM & AM measurements DC current & voltage measurements Full spec. on request ..... **£225.00**

**Noise Generator TF1106.** 1-200MHz 71 ohm impedance ..... **£150.00**

## DYNAMCO

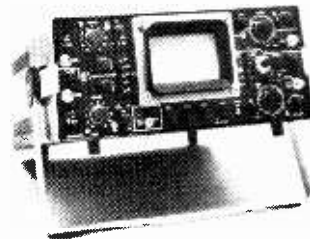

**Portable Solid State Scope 7500.** DC-40MHz 10mV/div sensitivity x10 gain extends sensitivity to 1mV/div (3Hz-5MHz) Mixed & calibrated sweep delay Dual trace AC & DC coupled Z mod BRAND NEW ..... **£495.00**

**Calibrated & Guaranteed 12 Months**

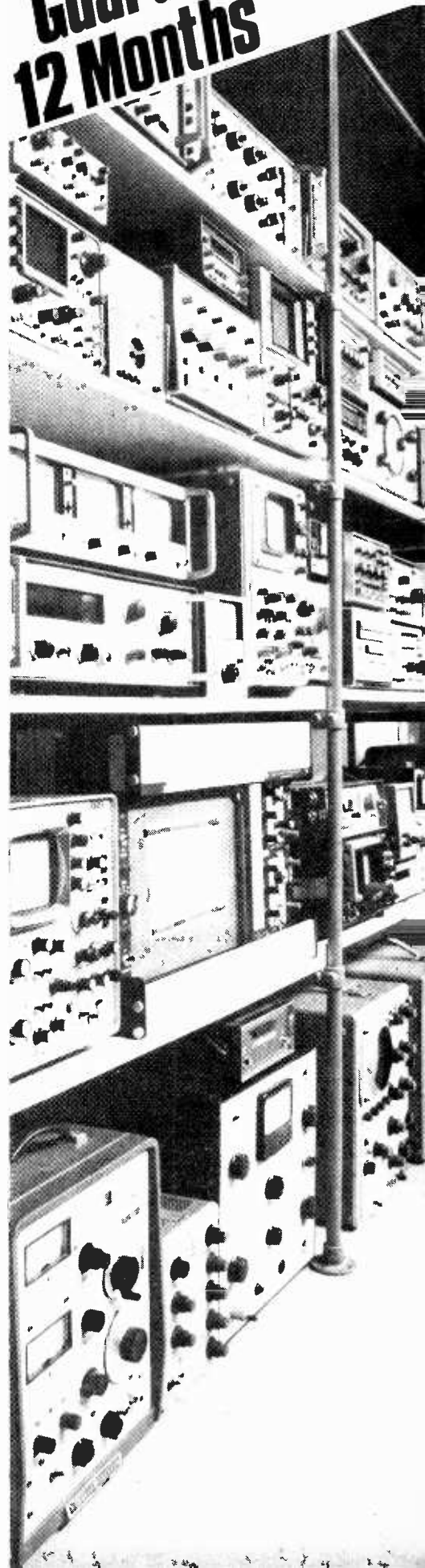

**Carriage and packing charge extra on all items unless otherwise stated**

**Hours of business: 9a.m.-5p.m. Mon.-Fri. Closed lunch 1-2p.m.**

WW-112 FOR FURTHER DETAILS

**Please note: All instruments offered are secondhand and tested and guaranteed 12 months unless otherwise stated**

# Power Supply Units

*Specifically designed for supplying power for up to 4 diskette (floppy disk) drives.*

**INPUT:**

90, 100, 110, 120, 220, 230, 240 v  
50/60 HZ

**OUTPUTS:**

- (1) + 24v 6A Unregulated (± 5%)
- (2) + 5v 5A Regulated (± 0.2v)
- (3) - 5v 1A Regulated (± 0.2v)
- (4) - 12v 1A Regulated (± 0.5v)

All regulated supplies are protected against short circuit and thermal overload. Indicators (LED) are provided for all outputs. Cabinet size is 5" x 12" x 6"

**PRICE: 1 off £85 (includes carriage and VAT)**  
**2-10 less 5% 10-50 less 10%.**

*We shall be pleased to quote for supply units for particular applications.*

## MERLIN COMPUTER PRODUCTS LTD.

18 ALBION WAY, KELVIN IND. ESTATE, EAST KILBRIDE G75 0YH. Telephone 03552 46621

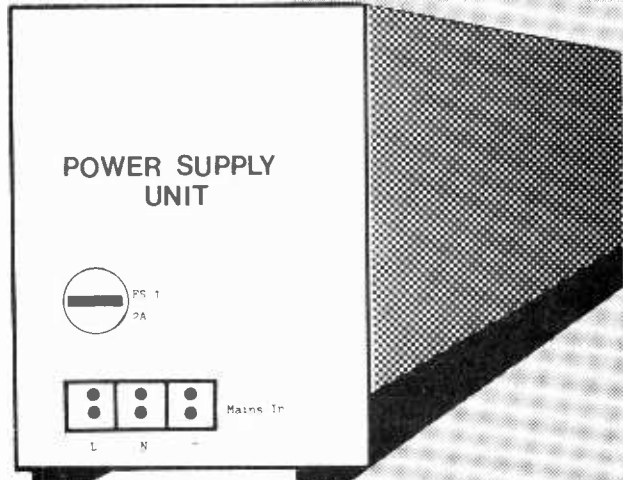

WW 120 FOR FURTHER DETAILS

## Tools that fit the job



**Upson Ball Ended Drivers** — for use on recessed socket head screws, the ball end allowing for the removal of screws from awkward positions, i.e. up to approximately 30° from any angle — as illustrated.

**Upson Hold-E-Zee Screwdrivers** have a spring clip which fits over the screw head holding the screw in position on the driver so that it can be positioned without difficulty in awkwardly placed positions. When the screw is started, the blade can be slipped off the screwhead, the spring holder retracted and the screw tightened in the usual way.

These screwdrivers have a patented **Lok-Block Handle** which makes it virtually impossible, in any circumstances, for the blade to turn independently within the handle.

## UPSON

For All Those Nasty "17" Screws In Awkward Places...

SPECIAL PRODUCT DISTRIBUTORS LTD 81 Piccadilly London W1V 0HL. Tel: 01-629 9556

WW — 114 FOR FURTHER DETAILS

## Sonic HI-FI DISCOUNT CENTRES

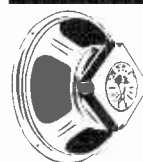

### DISCOUNT SPEAKERS

Imp 8 or 15Ω as app.

Guarantees:  
TITAN 5 years  
FANE 2 years  
OTHERS 1 year

Prices correct at 20.3.78

**ALL PRICES INC. VAT**

HI-FI TYPES	List Value	Sonic Price
5" FANE 501 Mid Full range	Sp Price 4.95	3.35
8" x 5" 15w Various makes	Sp Price 3.35	2.95
8" A F Model 80 Dual Cone	Sp Price 5.95	5.95
8" A F Model 83 Dual Cone	Sp Price 6.95	6.95
FANE B" 80BT Dual Cone	Sp Price 3.95	3.95
WH FEDALE L TON 3 x P kit Pr	60.70	44.95
10" DENTON 2 x P kit Pair	49.15	27.95
10" GLENDALE 3 x P KIT	82.44	59.95
8" FANE MODE ONE KIT	Sp Price Pair	19.99
10" ELAC Model 10RM	Sp Price	3.85
<b>GROUP/DISCO TYPES</b>		
12" TITAN T12 45R 35w	15.80	10.95
12" TITAN T12 60R 60w	22.50	12.95
12" TITAN T12 100A 100w	36.00	22.95
12" CELESTION G12M	16.50	12.99
12" CELESTION G12H 30w	22.00	16.95
12" CELESTION G12 50 50w	25.75	17.50
12" GOODMAN'S 12 PD	Sp Price	21.95
12" GOODMAN'S 12 PG	Sp Price	19.95
12" FANE SPECIALIST P A 80	27.95	18.95
12" FANE SPECIALIST DISCO 80	29.95	19.95
12" FANE SPECIALIST DISCO 100	31.95	21.95
12" FANE SPECIALIST GUITAR 80I	27.95	18.95
12" FANE SPECIALIST GUITAR 100L	28.95	19.95
12" FANE SPECIALIST GUITAR 80B	28.95	19.95
<b>HORN UNITS</b> (Carr 85p)		
CELESTION MH100H 25w	17.00	13.75
FANE 910 MK 1 50w	17.75	10.99
FANE 920 100w	59.95	44.50
FANE 144 30 50w	7.95	4.95
FANE J73 50w	11.75	7.95
FANE J104 50 70w	16.95	10.95
<b>HIGH POWER "CROSS-OVERS"</b> Carr 35p		
FANE HPXIR or HPX7R	3.25	2.25
<b>ADD-ON HIGH FREQUENCY UNITS</b>		
F A 1 Add-on Carr £1	51.84	35.95
TITAN TH 70w Carr £1	31.00	23.95
TITAN 152H 100w Carr £1	33.00	23.95
TITAN 12H Carr £1	39.00	26.95
<b>EXTRA SPECIAL MAIL ORDER OFFER</b>		
TITAN TA 50A 50w AMPLIFIER		
High Quality, Multi-purpose three individually controlled inputs. Controls: Bass, Treble & Presence. Robust well styled compact cabinet. Black vinyl or covered. Attractive Black Silver Fascia. 12 months Guarantee. Carr £1		<b>£39.95</b>
<b>PAIR FANE POP 15 12" SPEAKERS</b> suitable for use with above when wired in series and housed in sealed cabinet		<b>£9.95</b>
<b>SUITABLE TWIN SPEAKER CABINET</b>		<b>£11.95</b>
Also for personal shoppers only. Amps, T. Tables, Jigs & Machines, Disc Consoles, Lighting Cabinets. Credit Terms available. Orders over £20.00.		
Phone orders accepted from Access & Barclaycard holders. Branches at		
24 NEWGATE SHOPPING CENTRE, NEWCASTLE		
TEL 0632 25168		
403 SAUCHIEHALL STREET, GLASGOW		
TEL 041-332 0700		
Mail Orders & Export enquiries to GLASGOW Branch. Add £1.00 carr. on Hi-Fi spkrs. or kits. Otherwise add £1.25 (12" spkr); £1.50 (15") £2.50 (18")		

12 FANE CRESCENDO 12A	57.35	41.95
12 FANE CRESCENDO 12L	59.95	39.95
12 FANE CRESCENDO 12 BASS		
15" TITAN T15 60 60w	56.70	39.95
15" TITAN T15 70 70w	26.00	17.95
15" TITAN T15 100 100w	28.00	19.95
15" TITAN T15 100 100w	41.00	29.95
15" FANE SPECIALIST BASS 85	39.95	29.95
15" FANE SPECIALIST BASS 100	47.00	31.50
15" GOODMANS 15P	Sp Price	23.95
15" CELESTION G15C	36.00	26.95
15" FANE CRESCENDO 15	72.95	51.95
15" FANE CRESCENDO BASS	76.00	51.95
15" FANE 15 100LT	74.69	51.95
15" FANE 15 160 160w	95.00	72.95
15" FANE COLOSSUS 200w	108.00	72.95
18" TITAN T18 100 100w	51.00	38.95
18" GOODMANS 18P	Sp Price	39.95
18" CELESTION G18C	53.00	39.95
18" FANE CRESCENDO 18A	101.05	72.95
18" FANE CRESCENDO BASS	89.95	59.95
18" FANE COLOSSUS 200w	115.00	75.00



High Quality, Multi-purpose three individually controlled inputs. Controls: Bass, Treble & Presence. Robust well styled compact cabinet. Black vinyl or covered. Attractive Black Silver Fascia. 12 months Guarantee. Carr £1

**PAIR FANE POP 15 12" SPEAKERS** suitable for use with above when wired in series and housed in sealed cabinet **£9.95**

**SUITABLE TWIN SPEAKER CABINET** **£11.95**

Also for personal shoppers only. Amps, T. Tables, Jigs & Machines, Disc Consoles, Lighting Cabinets. Credit Terms available. Orders over £20.00.

WW — 085 FOR FURTHER DETAILS

# Electronic Brokers

## The Computer People

### STOP PRESS

Do you want a teletype and a quiet environment?  
New stocks of the ever-popular ASR33 teletype  
with special acoustic cover.

**MARVELLOUS VALUE AT £675.00**  
(fully overhauled with 3 months warranty).

### Catalogue



Send for  
your free  
copy  
including  
latest  
update  
sheets

### Mini-Computer Exchange

SPECIALISTS IN DIGITAL EQUIPMENT, PROCESSORS PERIPHERALS, FEATURES ETC.

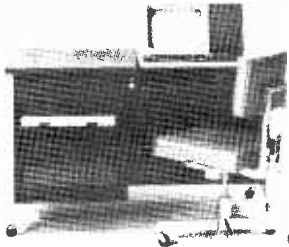

#### PDP8A SERIES

**PDP8A SYSTEM WITH:** MM8-AB 16K core memory. KM8-AA extended option board. DKC8-AA I/O option board. RX8-8D dual floppy disc drive. VT50-AB DEC-scope. LA36 DECwriter. Mounted in console/desk unit.  
**PDP8A SYSTEM (Datasytem 310-FB)** with 8K core dual floppy disc. VT-52 DECscope, console-mounted.  
**PDP8A PROCESSOR** with 3K ROM memory and DKC8-AA I/O option board



#### PDP8E SERIES

**PDP8E** and **PDP8M** Processors 4K to 32K various configurations available. Prices from **£2300**

#### PDP11 SERIES

**PDP11-05, PDP11-10, PDP11-34, PDP11-35** Processors available. 8K to 96K. various configurations available. Prices from **£3250**

#### DISCS

**RK8E/RK05** Disk Drive and control from **£3950**  
**RK11/RK05** Disk Drive and control from **£5250**  
**RK05-BB, RK05-J** and **RK05-F** slave drives  
Prices from **£2700**

#### PAPER TAPE

**PR11** high speed reader complete with PDP11 interface **£1750**  
**PC11A** high speed reader/punch complete with PDP11 interface. **£1950**

### NEW DEC ADD-ON CORE AT BARGAIN PRICES

Large stocks of DEC Parity Core type MFII-UP and MMII-UP-brand new surplus!

**MFII-UP 16K** parity core complete with backplane — **£2,400.00.**  
**MMII-UP 16K** expander core (prerequisite MFII-UP) **£2,000.00**

### Printers and Terminals

**SUPER SAVINGS ON SPECIAL PURCHASE OF PORTABLE TEXAS SILENT 700 TERMINALS.**  
**Our special price £695**

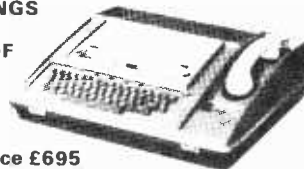

Model 725 KSR ASCII Keyboard Silent high speed operation up to 300 baud 5 x 7 dot matrix electronic printhead Full or half duplex operation Built in acoustic coupler Mounted in integral carrying case Gross weight 35lbs. Dimensions 21 1/2" x 19" x 6 1/2"

#### LARGE STOCKS OF ASR33 AND KSR33 TELETYPE TERMINALS

- \* ASCII Keyboard
  - \* Hard-copy unit (friction or sprocket paperfeed)
  - \* Paper Tape punch and reader (ASR33 only)
  - \* Line Unit (20mA/6V/80V)
- Overhauled in our own workshops to the highest standards and sold with 90-day warranty.

#### DATA DYNAMICS DD390 ASR and KSR TERMINALS

All the features of the well-proven Teletype terminal PLUS attractive acoustic cover — ideal for environments where noise reduction is important. Prices from **£525** (KSR) and **£795** (ASR)

#### CENTRONICS 101 and 101A MATRIX PRINTERS

5 x 7 dot matrix, 132 print positions, 165 cps, ASC11 64 character set. Prices from **£1250**

**CASE CM120** RO Printer, 120 cps, 80 ch/line, 5 x 7 dot matrix standard ASCII 64 character set. CC1TT-V24 Compatible Interface **£725**

**HAZELTINE** Thermal RO Printer 30 cps — for use as hard copy attachment to Hazeltine 2000 Visual Display unit **£495**

#### HAZELTINE VISUAL DISPLAY UNITS

Dramatic new savings on a further bulk purchase of these top quality CRT terminals Fully teletype — compatible with switch-selectable transmission up to 9600 baud and standard CC1TT V 24 interface (current loop adaptor also available if required)

- H-1000** 12 lines x 80 characters
  - H-1200** 24 lines x 80 characters
  - H-2000** 27 lines x 74 characters with full edit facilities detachable keyboard foreground/background data
- Please phone for details

#### SAVE OVER 2/3 of list price on these superb TEKTRONIX 611 STORAGE DISPLAYS

Flicker-free bistable storage of combined alphanumeric and graphic information from digital computers and other data transmission systems 11" Storage CRT Vertical sensitivity 1V/16 2CM (sq for matt) or 1V/21CM (rect format) within 2% FSD Maximum input voltage ±50V DC and peak AC Setting time 3.5 microsec/CM +5 microsec Stored resolution 4000 clearly legible characters (90 x 70mil matrix) viewing time 15 minutes or less Recommended for specified resolution

**OUR PRICE ONLY £950, WITH FULL THREE-MONTH WARRANTY**

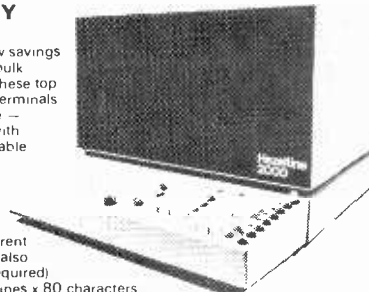

### Keyboards

#### NEW ASCII KEYBOARD MODEL KB756 NOW IN STOCK — BRAND NEW 56-STATION ASCII KEYBOARDS

Full 128 character set with ROM encoder (upper and lower case + control shift) Fully TTL — compatible — power requirements + 5v-12v Supplied with full technical data, code chart, pin connections, circuit diagram and applications notes

#### FANTASTIC VALUE AT £60.00 + £1 50 p 8p + 8% VAT (mail order total £66.42)

Also available — a range of spares and accessories for the KB756 — edge connector, mounting frame, plastic or steel enclosure, spare ROMs Send for data sheet/price list.



### Miscellaneous

#### COSSOR UNITEL—TWO LOW-COST LARGE-SCREEN BUFFERED VDU

- \* 15 diagonal CRT
  - \* 15 lines of 80 characters
  - \* 6 Switch-selectable baud rates (110/2400)
  - \* Full/half Duplex and Batch mode
  - \* Full ASCII Keyboard plus cursor control cluster
  - \* V 24/Current loop Interface
  - \* Printer port for hard copy attachment
  - \* Attractive modern design
  - \* **BRAND NEW SURPLUS!** (limited quantity only)
- ONLY £550.00 + carriage and VAT**

#### LOGABAX LX180 PRINTER — AS-NEW CONDITION

132 column printer with 96 character set (upper & lower case) 180 cps operation, 256 character buffer continuous paperfeed V 24 interface  
**Price £1,250.00.**

#### HAZELTINE THERMAL PRINTERS

Compact 80 column thermal RO printer 30 cps, silent operation Ideal as hard copy attachment for Visual Display Unit Dimensions 15 1/2 x 16 x 6 weight 30lbs  
**Only £495.00.**

#### HAZELTINE

Dual Digital 400 bpi Cassette Drive (Philips type). Standard V 24 Interface enables this unit to be used as direct storage device for mini or micro computers or as a local storage attachment to the Hazeltine 2000 VDU.

**Price £425.00**

#### COMPUTER FLOORING

Large stocks of top quality computer flooring complete with jacks. Tile dimensions 2 x 2 x 3/4 **Bargain prices.**

*All items quoted are refurbished second-user equipment unless otherwise stated.*

### ELECTRONIC BROKERS LIMITED (COMPUTER DIVISION)

49-53 Pancras Road, London NW1 2QB. Tel. 01-837 7781. Telex: 298694

Hours of business:  
9 a.m.-5 p.m. Mon.-Fri. Closed lunch 1-2 p.m.

ADD 8% VAT  
TO ALL PRICES

Carriage & Packing charge extra  
on all items unless otherwise stated

# VALVES

A1065	1.25	EL82	0.60	PY81/800	0.55
ARB	0.60	EL84	0.60	PY82	0.45
ARP3	0.60	EL86	0.70	PY83	0.50
ATP4	0.50	EL90	1.30	PY88	0.65
B12H	3.00	EL91	1.80	PY500	1.35
DAF96	0.60	EL95	0.70	PY859	5.75
DET22	1.50	EL504	0.80	PY301	0.60
DF96	0.50	EL802	1.50	QV03-10	
DK96	0.80	EL822	1.50	QV03-12	2.50
DL92	0.50	EM31	0.75	QV06-40A	2.50
DY86/87	0.55	EM80	0.60	QV03-12	14.00
DY802	0.55	EM81	0.60	SC1/400	4.00
ESSL	7.50	EM84	0.40	SC1/600	4.00
EB9/CC/01		EM87	1.00	SC1/600	4.00
EB9/CC/01		EM87	1.00	SC1/600	4.00
E180CC	1.30	EY81	0.45	SC1/600	4.00
E180E	6.00	EY86/87	0.55	SP61	0.85
E182CC	3.50	EY88	0.55	T121	7.50
EA76	2.00	EZ50	0.45	U25	1.00
EABC80	0.50	EZ81	0.60	U26	0.85
EB91	0.40	GY501	0.90	U27	1.00
EBC33	0.50	GZ32	0.65	U191	0.75
EBF80	0.50	GZ33	3.50	U801	0.80
EBF83	0.50	GZ34	2.00	UABC80	0.60
EBF89	0.50	GZ37	2.50	UBF80	0.55
EC52	0.40	KT66	4.00	UBF89	0.50
ECC81	0.55	KT68	5.75	UB11	1.00
ECC82	0.50	MH4	1.00	UBL21	0.75
ECC83	1.15	ML6	1.00	UCB85	0.50
ECC84	0.45	OA2	0.55	UCF80	0.80
ECC85	0.50	OB2	0.60	UCF81	0.80
ECC86	1.25	PA8C80	0.40	UCL82	0.75
ECC88	0.60	PC85	0.50	UF41	0.80
ECC189	0.80	PC86	0.85	UL41	0.75
ECF80	0.50	PC88	0.75	UL84	0.75
ECF82	0.45	PC900	1.25	UM80	0.60
ECF801	0.75	PC934	0.45	UV82	0.55
ECF83	0.95	PC939	0.55	UV85	0.50
ECF85	1.50	PC189	0.65	VR105/30	1.80
ECF84	0.45	PCF80	0.50	VR150/30	1.80
ECF81	0.45	PCF82	0.40	VR150/30	1.80
ECF84	0.95	PCF84	0.65	X66	1.25
ECL80	0.60	PCF86	0.65	X66	1.25
ECL82	0.55	PCF200	0.90	X61 M	1.50
ECL83	1.20	PCF201	0.90	Z80U	3.00
ECL85	0.65	PCF801	0.55	Z80LU	3.50
ECL86	0.55	PCF802	0.65	Z900T	1.50
EF36	0.75	PCF805	1.80	1A3	0.60
EF37A	1.50	PCF806	0.85	1L4	0.30
EF39	2.90	PCF808	1.00	1R5	0.55
EF40	0.70	PCF200	0.80	1S4	0.40
EF41	0.75	PCLB1	0.60	135	0.40
EF80	0.40	PCLB2	0.65	1T4	0.40
EF83	1.50	PCLB4	0.70	1X2B	1.10
EF85	0.45	PCLB6	0.70	2021	0.55
EF86	0.55	PCLB05	850.75	2K25	9.00
EF91	0.65	PD500	2.25	2X2	0.80
EF92	0.75	PFL200	0.85	3A4	0.60
EF95	0.45	PL36	0.80	306	0.40
EF183	0.55	PLB1	0.75	3021	2.00
EF184	1.60	PLB2	0.50	3E29	5.50
EF804	2.00	PLB3	0.50	354	0.50
EL1200	0.75	PLB4	0.65	3V4	0.85
EL90	0.60	PL504	1.10	5B/25M	6.50
EL32	0.60	PL508	1.30	5B/25M	6.50
EL34	2.20	PL509	2.40	5B/25M	6.50
EL37	3.00	PL802	2.80	5H4GY	1.10
EL41	0.80	PY33	0.60	5U4G	0.95
EL81	0.70	Py80	0.60	5V4G	0.65

# VALVES VAT PLEASE ADD

5Y3Gf	0.85	6X4	0.75	6V6GT	0.75
5Z3	1.00	6X4	0.75	6X4	0.75
5Z4G	0.75	6X5GT	0.55	6X5GT	0.55
6AB7	0.60	6Y5	0.85	6Y5	0.85
6AC7	0.60	6Z4	0.85	6Z4	0.85
6AH6	0.70	6-30L2	0.90	866A	2.80
6AK5	0.55	7B7	0.80	931A	6.00
6AK8	0.40	7V4	0.80	954	0.50
6AL5	0.40	902	0.80	955	0.50
6AL5D	0.65	906	0.75	956	0.50
6AM5	1.50	11E2	11.00	957	0.90
6B0	0.60	1E25	1.00	10B1	1.00
6B6	0.85	12A6	0.65	12A16	0.45
6AN8	0.85	12A16	0.45	1629	0.70
6A05	1.30	12A17	0.55	2051	1.00
6A05W	0.85	12A17	0.55	5763	2.50
6A56	0.80	12A17	0.55	5763	2.50
6A78	0.75	12A17	0.55	5933	3.00
6A86	0.50	12BA6	0.50	6057	0.85
6A86	0.50	12BE6	0.60	6067	0.85
6AX4GT	0.80	12BM7	0.60	6064	0.85
6AX5GT	1.00	12C8	0.55	6065	1.20
6B7	0.75	12E1	4.25	6067	1.00
6B6A	0.40	1215GT	0.40	6080	3.50
6B6G	0.50	12K7GT	0.60	6146	3.80
6B6G	1.00	12K8GT	0.70	6146B	4.20
6B6G	1.10	12Q7GT	0.50	6360	2.00
6B7A	0.80	12SC7	0.55	8020	5.40
6B87	2.30	12SH7	0.70	9001	0.50
6B96	2.80	12SJ7	0.55	9002	0.55
6B97	1.00	12SQ7	0.55	9003	0.70
6C4	0.40	12Y4	0.40	9004	0.40
6C6	0.55	14S7	1.00	9006	0.40
6C6	0.55	19A05	0.75		
6C6	0.75	19G3	10.00		
6C6	0.50	19G6	6.00		
6EAB	0.80	19H5	17.00		
6F8G	0.75	20P3	0.60		
6F12	0.65	20P4	1.10		
6F17	1.00	25L6GT	0.80		
6F33	4.20	30C15	1.00		
6G6	4.20	30C17	1.10		
6J4WA	1.75	30C18	1.10		
6J5	0.75	see PCF805	15.00		
6J5GT	0.55	30F5	1.00		
6K7	0.50	30FL2	1.20		
6K7	0.70	30FL12	1.20		
6K7G	0.35	30L15	1.00		
6K8GT	0.55	30L17	1.00		
6L6M	1.90	30PL1	1.00		
6L6GT	0.90	30PL13	1.10		
6L7G	0.65	30PL14	1.10		
6S47	0.55	35L6GT	0.80		
6S47	0.75	35W4	0.60		
6S47	0.70	35Z4GT	0.70		
6S7GT	0.50	50C5	0.70		
6S7GT	0.60	50C6G	1.20		
6S7GT	0.75	75	1.00		
6S7GT	0.75	75C1	0.80		

# MARCONI SIGNAL GENERATORS

TF 2400/1	Frequency Converter up to 510MHz
TF 894 A	Audio Tester 50cs to 27kHz 2W into 15 Ω
AIRMEC	1.13
MODULATION METER 210A	2.5-300MHz AM 0-100% FMD+100kHz in 4 ranges
HVF WAVE ANALYSER 863	from 30kHz to 30MHz
HVF WAVE ANALYSER 248	Freq from 5MHz to 300MHz
RF D01 D/1/S SIGNAL GENERATOR	Range 10-485MHz in 5 ranges R.F. output 0.1 V/1 V Source C.M. 50Ω output impedance Internal modulation at 1KHz up to 90%
TF 801 B/2	Spec. as for D01D but minor circuit differences. Few only left
TF 995 A/1 or A/2 or A/2M or A5 SIGNAL GENERATORS	Very high class AM/FM 1.5MHz to 220MHz Detailed spec. and price on application
TF 995/3S	with additional amplifier to give extra high output between 1.5 and 6 Mc/s
TF 144 H SIGNAL GENERATOR	HIGH FREQUENCY SPECTRUM ANALYSER. MARCONI TYPE 1094A/S Basic Freq. range 3 to 30 Mc/s and with LF unit from 100Hz to 3 MHz. Measures relative amplitudes up to 60dB
TF1041 6 VALVE MULTIMETER	DC voltage from 300mV to 1000V AC voltage from 300mV to 300V up to 1 000MHz
TF1370 R.C. OSCILLATOR FOR SQUARE & SINE WAVE	Freq. -31.6V rms TF1066 FM/AM SIGNAL GENERATOR.
C.R. Tubes	
MW13-35	35.00
VCR139A	10.00
3B91	8.00
8B1	9.00
8B1	9.00
5F7	10.00
CV1526	10.00
SE3A/831	15.00
Special valves	
CV2339	45.00
M503-2J42	65.00
K301	7.00
KRN2A	6.00
725A	26.00
BR189	250.00
24V32A	75.00
CV5228	17.50
P863B	20.00
C239A	9.00
AVO CT 160 VALVE TESTER	LOW RESISTANCE HEADPHONES TYPE CLB-£1.50. 40p postage. VAT 12 1/2%
ARR8 0 & LF SPARES	We hold the largest stock in UK. Write for list.
RF METERS	0 to 8 amps 2 1/4" dia USA brand new £1.50. P&P 25p
TELEPHONE TYPE "J"	topicalised 10 LINE MAGNETO SWITCHBOARDS
CABLE LAYING APPARATUS No. 11	New production P O A

# VALVES AND TRANSISTORS

A lot of these valves are imported and prices vary for each delivery, so we reserve the right to change prices for new stock when unavailable.

Telephone enquiries for valves, transistors, etc. retail 749 3934; trade and export 743 0899.

**RHODE & SCHWARZ**  
Zg DIAGRAPH TYPE 2DU 30-420MHz 50Ω Model type ZDD Frequency 300-2400MHz Directly measures multiterminal networks, phase shift, phase angle with complementary POWER SIGNAL GENERATOR TYPE SMLW high freq resolution internal external mod. up to 3v out

**SIGNAL GENERATOR H.P. MODEL 880C** High power, stable and high accuracy Frequency 10 to 480MHz Modulation level 0 to 95% at carrier levels 0.5V output level continuously from 0.1V up to 50 ohm Maximum output 1V

**FOR EXPORT ONLY**  
Mullard C11, High power installation 1000W Technical details and prices available on request.

**TEKTRONIX**  
545A, Bandwidth DC to 30MHz  
570 CHARACTERISTIC CURVE TRACE  
517A OSCILLOSCOPES wide band high voltage cathode ray oscilloscope designed for observing and photographically recording wave form having extremely short rise times  
DANA EXACT FUNCTION GENERATOR MODEL 121, Frequency range 0.2Hz to 2MHz (7 ranges) voltage controlled to 10V sweep generator 1ms to 10 sec.  
TEXSCAN ELECTRONIC SYSTEM ANALYSER MODEL 9990, Frequency range 10MHz to 300MHz with marker controls  
FURZEHILL SENSITIVE VALVE VOLTMETER TYPE V200A full scale from 10mV to 1000V in 6 steps with output amplifier  
TRAINING SET for Radio Operators with 10 key terminals and control frequency and volume  
EDDYSON COMMUNICATIONS RECEIVER MODEL 730/1A, Frequency from 500kc/s to 28Mc/s  
HIGH VACUUM VARIABLE CAPACITORS - ceramic envelope - UC 100A/20/150 = VMMHC 1000 60 1000PF, 20kv-150A RF max = 27MHz  
TEST SET FT2 for testing Transceivers A40, A41, A42 and CPCR26  
UNIVERSAL WIRELESS TRAINING SET No 1 Mk 2 YA 8318 to train 32 operators simultaneously on key and phone. Complete installation consists of 3 kits packed in 3 special transit cases  
HARNESS "A" & "B" CONTROL UNITS "A" "R" "J1" "J2" Microphones No 5 6 7 connectors frames carrier sets etc

**VAT FOR TEST EQUIPMENT**  
PLEASE ADD 8%

**COLOMOR**  
[ELECTRONICS LTD.]  
170 Goldhawk Rd., London, W.12  
Tel. 01-743 0899  
Open Monday to Friday  
9-12.30, 1.30-5.30 p.m.

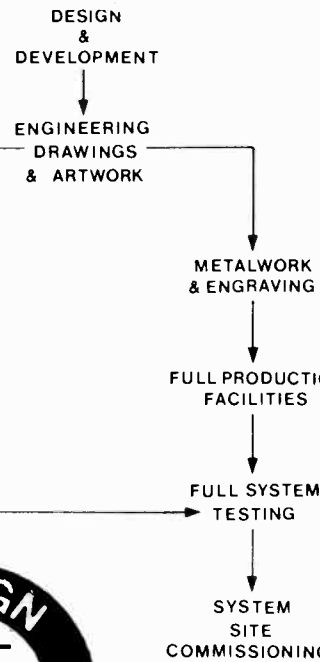

**A COMPLETE TECHNICAL SERVICE TO ASSIST YOU WITH YOUR LATEST PROJECT FROM ITS CONCEPTION, THROUGH PRODUCTION TO SITE COMMISSIONING OF INDUSTRIAL SPECIAL PURPOSE ELECTRONIC EQUIPMENT.**

Our design team has considerable experience in the development of a wide range of process control equipment using the latest technology in the fields of digital and analogue circuitry.

To back up this knowledge we have extensive development capabilities for microprocessor systems which include powerful software aids, high level language capabilities and "in circuit emulation" to rapidly blend the hardware and software together to produce the equipment to your specific requirements as quickly and smoothly as possible.

We offer a complete service under one roof, no more co-ordinating the activities of multiple sub-contractors and suppliers. All this and the most competitive prices around. Let us quote for your next project.

# DESPRO ELECTRONICS LTD.

Dore House, Industrial Estate  
Orgreave Crescent, Handsworth  
Sheffield. Tele: 0742 697361/3

**T.T.L. 74 I.C.'s By TEXAS, NATIONAL, I.T.T., FAIRCHILD ETC.**

7400 14p	7426 25p	7473 30p	74121 30p	74151 65p	74179 140p
7401 14p	7427 25p	7474 30p	74122 40p	74153 65p	74180 100p
7402 14p	7428 40p	7475 30p	74123 60p	74154 120p	74181 200p
7403 14p	7430 15p	7476 40p	74125 50p	74155 70p	74182 75p
7404 14p	7432 25p	7480 15p	74126 50p	74156 70p	74184 150p
7405 14p	7437 25p	7485 100p	74130 30p	74157 70p	74185 150p
7406 40p	7438 25p	7486 30p	74131 100p	74160 90p	74188 350p
7407 40p	7440 15p	7489 250p	74132 65p	74161 90p	74189 350p
7408 20p	7441 65p	7490 35p	74135 100p	74162 90p	74190 140p
7409 20p	7442 65p	7491 75p	74136 80p	74163 90p	74191 140p
7410 15p	7445 80p	7492 45p	74137 100p	74164 125p	74192 120p
7411 20p	7446 80p	7493 40p	74138 125p	74165 125p	74193 120p
7412 20p	7447 75p	7495 60p	74139 100p	74166 125p	74194 100p
7413 30p	7448 70p	7496 70p	74141 60p	74167 325p	74195 100p
7414 60p	7450 15p	74100 95p	74142 270p	74170 200p	74196 100p
7416 30p	7451 15p	74104 90p	74143 270p	74173 150p	74197 100p
7417 30p	7453 15p	74105 40p	74144 270p	74174 100p	74198 185p
7420 15p	7454 15p	74107 30p	74145 75p	74175 75p	74199 185p
7422 20p	7460 15p	74109 50p	74147 230p	74176 100p	
7423 25p	7470 30p	74118 90p	74148 160p	74177 100p	
7425 25p	7472 25p	74120 90p	74150 120p	74178 140p	

<b>C.MOS</b>	4000 14p	4030 55p	IN4148 BY ITT/TEXAS 100 for £1.50.	MM2112-4 256 x 4 BIT 450 NANO SEC. STATIC RAM. £2.95 each. 4/ £11.60. 8/ £22.80.
	4001 14p	4032 95p	UNENCODED HEXADECIMAL 19 KEY-BOARD. 1-10 A.B.C.D.E.F.2 OPTIONAL KEYS. SHIFT KEY £12.50.	2513 CHARACTER GENERATOR UPPER CASE £7.00.
	4006 90p	4033 120p	555 Timer, 10 for £2.50.	2513 CHARACTER GENERATOR. LOWER CASE £7.00.
	4007 16p	4048 55p	7410 Op amp. 10 for £2.00.	MM5204AQ PROM 4096 BIT READ ONLY MEMORY £8.00.
	4009 55p	4049 40p	RCA ACR TO3 case 100V 12.5A £2.50.	8212 8 BIT IN/OUT PORT £3.00.
	4011 14p	4040 40p	MURATA ULTRASONIC TRANSDUCERS M440LR £2.50 each, £4.00 pair.	8831 TRI-STATE QUAD LINE DRIVER £2.00.
	4012 14p	4054 120p	MM2102AN-2L 1024 x 1 BIT 250 NANO SEC. STATIC RAM. £2.60. 4/ £8.40. 8/ £16.00.	8833 TRI-STATE TRANSCIEVER (TRUE) £2.00.
	4013 50p	4055 140p	MM2 102AN-4L 1024 x 1 BIT 450 NANO SEC. STATIC RAM £1.60. 4/ £6.00. 8/ £11.00.	8835 TRI-STATE TRANSCIEVER (INVERTING) £2.00.
	4015 90p	4056 135p		AY5-1013 UAR/T £6.00
	4016 40p	4060 120p		LM309K/LM340K VOLTAGE REGULATOR £1.00 each
	4017 90p	4066 55p		
	4018 90p	4069 20p		
	4020 100p	4071 16p		
	4022 90p	4072 16p		
	4023 16p	4081 16p		
	4024 65p	4082 16p		
	4025 16p	4510 120p		
	4026 160p	4511 150p		
	4027 50p	4516 110p		
	4028 90p	4518 130p		
	4029 110p	4528 100p		

63 KEY KEYBOARD UNENCODED. SUITABLE FOR MPU PROJECTS ETC. £30.00.

**T. POWELL**

(ALL PRICES INCLUSIVE OF POSTAGE AND VAT)

306 ST. PAUL'S ROAD  
HIGHBURY CORNER, LONDON N.1  
Telephone: 01-226 1489

Easy access to Highbury via Victoria Line (London Transport) British Rail

We can accept an Access and Barclaycard

**SINTROM MICROSHOP**



? Has your chosen Microprocessor system? and Supplier these Unique features ?

- \* Motorola 6800 by Southwest Technical
- \* Plug in expansion for memory and I/O
- \* Proven software: Assemblers, editors, floppy disc operating system and BASIC from 4K to 4 user.
- \* Kansas City cassette tape and Shugart minifloppy fully supported
- \* New, system oriented, documentation
- \* Walk-in hobbyshop with experienced staff
- \* Demonstrations always available
- \* Hands-on selection of software
- \* Manuals, Magazines and Data to browse or buy
- \* Ten years experience in minicomputers, disks, cartridge tapes and VDUs

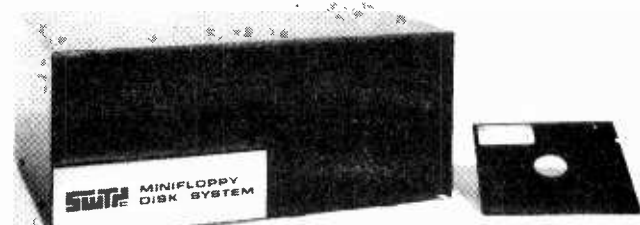

MP-68	M6800 by Southwest Technical. With 4K RAM, Mikbug ROM and TTY/RS232 input output interface	275	353
CT-64	VDU controller with keyboard, serial ASCII	260	345
CT-VM	Video monitor for use with CT 64, 12 volt operation		140
CT-606	Kansas City cassette interface for use with CT-64. Installs inside		50
AC-30	Freestanding dual Kansas-City cassette interface	60	100
MF-68	Twin Shugart minifloppy, controller, interface card, and Disc Operating System with Disc 8K BASIC	800	860
PR-40	40 Column alphanumeric printer, 75 lines per minute	200	250
MP-4	4K memory board	80	107
MP-8	8K memory board	200	240
MP-S	Serial ACIA board	30	37
MP-L	Dual 8-bit parallel interface board	30	37
MF-D10	Pack of ten Diskettes		26.50
SWTBUG	Improved ROM Operating System, Mikbug compatible		16.00

Software on paper tape or Kansas City cassette £10-25 per application. Professional Commercial packages to special quotation. All units include full documentation. All units include full documentation, power supply and case where required and interface directly to MP-68 system. All prices exclude VAT (8%) and carriage.

Write now for Free Catalogue and lists

Microcomputer Hobby Shop Monday to Saturday Tel: 0734 84322  
14 Arkwright Road Reading Berks Telex: 847395  
RG2 0LS

WW - 108 FOR FURTHER DETAILS

**TRAMPUS**

MANUFACTURERS SURPLUS WANTED  
TRAMPUS ELECTRONICS LTD.  
58-60 GROVE ROAD, WINDSOR, BERKS, SL4 1HS  
TELEPHONE: WINDSOR (07535) 54525

Cash and cheque Orders over £5 post free. Credit cards by post or phone £5 min. Post and packing 20p. C.W.O. add VAT to prices marked \* 8%, others 12½%. Free price list of our full range, send addressed envelope. Quote this ad as prices may change. All devices to makers' specifications. Normally 24-hour turnaround on orders for ex-stock product.

<b>LEDS</b> ¼" or 2"	<b>FULL SPEC. PAKS</b>	<b>NEW PAK Q: 50 x 220 mid</b>	<b>REDUCED LINES</b>
Red no clip	PAK A: 12 Red LEDS	E1 6.3v Electrolytics	E1 A small selection from our lists
Pak of 100 LEDS	8 5 x 741 8-pin	E1* DEVELOPMENT PARCELS	7815 1A15V 60p*
TK 209 & clip	C 4 x 2K3055 to 3	E1* All ES	7805/LM309K £5*
0.2" LED Red & clip	PAK D: 12 x BC109	E1* SET 1: 250 x 50v Ceramics 5%, 10	BC107 or BC108 8p*
Color LEDS all	PAK G: 7 x BF751	E1* each 22pf to 0.1uf	ES BC109 10p*
	H 7 x 2K38195 FET	E1* SET 2: Tantalums 1uf to 200uf	BC109C 15p*
	N 40 x 1M4149	E1 20v+0.35vohm, 50 ohm	ES AC176 10p*
	M: 4 x pair 2A NPN/PNP	E1* SET 3: Electrolytics 25V 10 uF	BC122, 3.4 A or L 10p*
	PAK N: 50 x D81191	E1 1/2/1/10 47/100/500/1000	BC212, 3.4 A or L 11p*
	PAK P: 20 x P/BC109	E1 ul	ES 2K3055 90W 29p*
	PAK R: 14 x BC107	E1* SET 4: ½ watt 5% Resistors	2K38195 FET 16p*
	PAK S: 14 x BC108	E1* each 100 to 1 meg., total 500	ES 08P12 21p*
	F: 10 x BD131 Type	E1 SET 5: 2watts 400mW, 5 each, 2%	741 8-pin 29p*
	V: 50 x 5 mid 10v	E1 valves 3v to 33 Volts (100 ohm)	555 Timer 29p*
	X: 4 x 555 Timer	E1 ES 2M414 RX 75p*	
	Z: 20 x PNP 3702 Type	E1 SET 6: Presets PR Vari., 100 mixed	LM380 Amp 75p*
	Y: 4 x LM301/14P	E1 ES LM3900 89p*	
	U: 4 x 1A 50V SCR	E1 SET 7: Heatinks, 10 off each, CMOS 4011	ES 15p*
		E1 TD18, TD5, TV4 small to 3 ES 4013, 4049	39p*

WW-061 FOR FURTHER DETAILS

**CONNECTORS**  
CANNON PAINTON  
BELLING LEE PLESSEY  
GREENPAR AMPHENOL

1,000s in stock from:

**Servo and Electronic Sales**  
SERVO AND ELECTRONIC SALES LTD.  
24 HIGH STREET, LYDD, KENT TN29 9AJ  
TELEPHONE: LYDD (0679) 20252 TELEX: 965265 AB SERVOE G

**sanwa** from Quality Electronics Limited  
At above address

WW-109 FOR FURTHER DETAILS

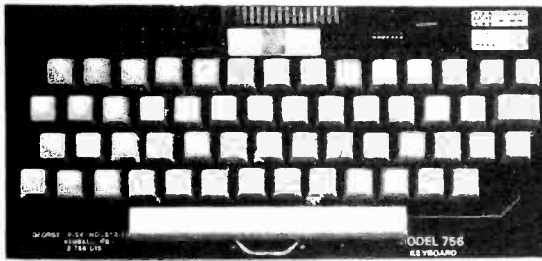

# FULL ASCII KEYBOARD

**LOW COST!**  
Model 756  
Full ASCII  
Keyboard

- \* Intended for professional micro-processor applications.
- \* This one Keyboard will meet most present and future requirements.
- \* Full 128-character ASCII 8-bit code
- \* Tri-mode MOS encoding.
- \* Applications notes for auto repeat, numeric pad, serial output.
- \* Upper and lower case characters generated by keyboard with latching shift-lock.
- \* Selectable polarity.
- \* Size 305 X 140 X 32mm (12 1/4 X 5 1/2 X 1 1/4 in)
- \* MOS/DTL/TTL compatible outputs.
- \* New guaranteed OEM grade components.
- \* Needs +5 and -12V supply

\* Board has space for small low-cost DC/DC converter so that entire unit operates off single 5 V rail.

- \* User selection of positive or negative logic data and strobe output.
- \* Alpha lock .
- \* Extra loose keys available.
- \* Supplied complete with gold-plated PCB connector and full technical data.
- \* Rugged mil. spec. G-10 PCB with plated through holes.
- \* 2-key roll-over
- \* DC level and pulse strobe signal for easy interface to any 8-bit input port microprocessor system, video display or terminal board. Strobe pulse width 1 ms.

PRICED LOWER THAN  
SURPLUS KEYBOARDS

Please write for full technical details and price, and for names and addresses of our UK and European stockists.

## Carter Associates

P.O. Box 11262  
VLAEBERG  
South Africa  
postal code 8018

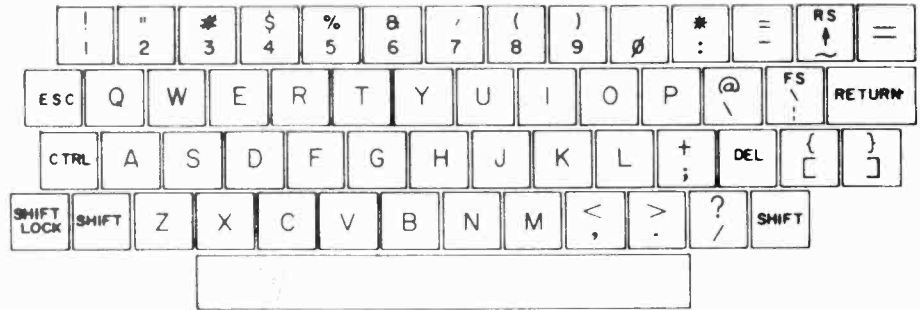

WW-094 FOR FURTHER DETAILS

## SINE WAVE INVERTERS

120-300 VA. 50/60 Hz

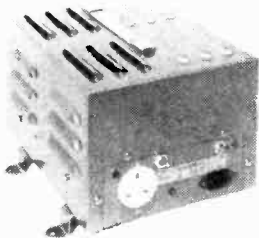

**HIGH QUALITY YET ATTRACTIVELY PRICED A.C. POWER SUPPLIES FOR MOBILE, INDUSTRIAL, COMMUNICATIONS, MARINE AND MANY OTHER USES**

- \* Ruggedly built in welded steel cases
- \* Stabilised low distortion output
- \* Closely controlled frequency
- \* Full overload and short-circuit protection
- \* Battery protection by low voltage warning and automatic cut-out
- \* Automatic standby and remote options

**SERIES A: 12/24 V DC.IP. 240, 220 or 115V. AC. O.P.**

## CARACAL ENGINEERING

42-44 SHORTMEAD ST., BIGGLESWADE, BEDS. Tel: 0767-81361

WW - 101 FOR FURTHER DETAILS

**ANY MAKE-UP OR COPY QUERIES CONTACT JOHN GIBBON OR TONY FAYERS 01-261 8353**

## REDUCED PRICES . . . ONLY LIMITED STOCKS AVAILABLE

TRANSISTORS			DIODES		
Device	10	100	Device	100	1000
BC 107	.89	7.80	AA 119	9.00	65.00
BC 118	1.12	10.00	BA 154	6.50	4.00
BC 132	.95	8.00	BY 127	8.50	70.00
BC 147	.85	7.00	1s 44	4.00	25.00
BC 149	.85	7.00	1s 940	3.00	15.00
BC 204B	.85	7.00	1s 941	3.50	16.00
BC 348	1.00	8.50	<b>DIGITAL I.C.'s</b>		
BC 351	1.00	8.00	<b>TEXAS</b>		
BD 131	3.30	29.00	Device	10	100
BD 695A	5.50	42.00	74L00	2.40	18.00
BD 696A	5.50	42.00	74L04	2.70	21.00
BF 185	2.40	20.00	74L73	4.90	38.00
BF 324	3.30	29.00	74L74	4.30	35.00
BT 106	10.00	72.00	74L91	14.50	105.00
BU 205	16.50	130.00	<b>FAIRCHILD</b>		
BU 208	17.50	139.00	Device	10	100
ME 1075	5.75	4.80	9000	5.90	—
TIP 29	3.40	29.00	9002	3.00	—
XK 1152	.88	3.90	9016	3.80	—
ZTX 2128	1.05	8.50	9304	12.00	85.00
ZTK 302	1.00	8.00	9308	25.00	190.00
ZTX 502	1.10	9.00	9309	10.00	—
ZTX 510	1.10	9.00	9311	21.00	—
2N 2647	8.50	—	9316	18.00	—
2N 3703	.85	6.50	9322	0.00	—
2N 3705	.85	6.50	9324	16.00	—
<b>CAPACITORS</b>			9601	8.50	—
Device	10	100	933	3.20	—
0.01/25	Disc .65	4.50	936	3.40	29.00
0.01/30	Disc .70	4.50	946	3.30	28.00
0.1/200	344 .90	7.00	962	3.00	—
0.1/600	Axial .50	3.50	9099	7.00	—
0.68/100	344 .90	7.00	<b>RAM</b>		
2.2/100	344 .90	7.00	Device	10	100
6.8/6	Tant 1.40	9.00	2102-2N	16.00	—
25/25	Axial .50	4.00	<b>MERCURY RELAY BY C.P. CLARE</b>		
100/250	Axial 3.50	26.00	Device	10	100
680/250	Tag 3.60	27.00	HGRM 55211-TOO	35.00	—
<b>WIREWOUND RESISTORS</b>			24v 1C/O		
Device	10	100	<b>HORIZONTAL PRESET</b>		
2.5W Axial			Device	10	100
0.2 To 2K2 Ohms	.90	6.50	1 M Ohm		
5W Radial			0.25W	.90	6.50
0.47 To 10K Ohms	.80	6.00	<b>Minimum order £5 00 P &amp; P 25p</b>		
10W Axial			VAT please add 8% except those marked * which are 12.5%		
3.3 To 2K2 Ohms	.80	5.50	Export. Wholesale and Manufacturers enquiries welcome.		
15W Radial			K & A. Distributors. 52 Barkby Road, Syston, Leicester LE7 8AF		
1 To 22K Ohms	.85	6.00	Tel. 0533 609391		

# B. BAMBER ELECTRONICS

Dept. WW, 5 STATION ROAD, LITTLEPORT, CAMBS. CB6 1QE  
Tel: ELY (0353) 860185 Tuesday to Saturday

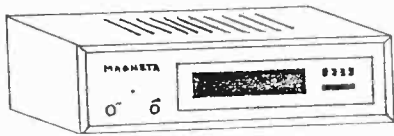

**8-TRACK CARTRIDGE PLAYER UNITS**  
with internal mains psu and 25 watt mono amplifier (100V line). To play standard 8-track cartridges. All contained in a smart veneered wood cabinet, size approx. 14" wide x 5 1/2" high x 11" deep. Supplied with circuits. Brand new and boxed. **SPECIAL OFFER** £35.00 each + 12 1/2% VAT.

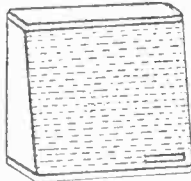

**TYPE L4 PORTABLE SPEAKER CABINET**

Smart woodgrain Formica type finish with nylon grille. 15 high x 14 wide x 7 deep (tapering), containing 10 round, 15 ohm full range speaker + 100V line transformer. £7.00 each + 12 1/2% VAT

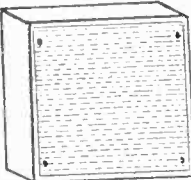

**SPEAKER CABINET TYPE M321**

White matt finish wood cabinet with white sprayed cloth grille 9 x 4 1/2 deep containing 6 1/2" dia. 15ohm full range speaker, with 100V line transformer. £4.50 each or 2 for £8.00. + 12 1/2% VAT

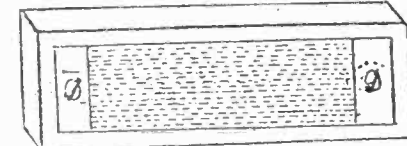

**TYPE HT4 HOTEL SPEAKER CABINET**

Wood veneered, 12 1/4" wide x 5 1/4" high x 3 1/4" deep with aluminium grille + volume control and 4 way + off switch panels on front. Very smart, contains 3 ohm 5" x 3" elliptical speaker + 100V line transformer. £5.00 each + 12 1/2% VAT



**TYPE M704 CEILING SPEAKERS**

White plastic fascia 10" square, for recess mounting into ceiling, with 8" dia. 15 ohm full range speaker. £4.00 each + 12 1/2% VAT.

**TYPE 8079 FULL RANGE SPEAKER**

10" dia. 15 ohm. £5.00 each (or 2 for £9.00) + 12 1/2% VAT



**MAINS ISOLATING TRANSFORMERS**  
Tapped primary, output 240V at 6A, ex-equip. in metal case. £20.00 each + 8% VAT

**PHILIPS LDH2200/00 22" COLOUR MONITOR**

625 line with PAL decoder, unused, but shop-soiled. £220.00 + 8% VAT. Buyer collects

**QTY. OF NEW PYE WESTMINSTER PCBs**  
SAE FOR LIST. Range of Paper Block Capacitors. S.A.E. for list

**10.7 MHz SSB XTAL FILTERS**

(2.4kHz Bandwidth) Low imp. type. Carrier and unwanted sideband rejection min. -40dB (need 10 69835 & 10 70165 xtals for USB/LSB, NOT SUPPLIED) Size approx. 2" x 1" x 1". £10.00 each + 8% VAT.

**CELESTION 8" x 5" ELLIPTICAL SPEAKERS**

20 ohm, 3 watts rated, £1.50 each + 12 1/2% VAT.

All above speakers with 100V line transformers are suitable for use with our 8-track cartridge players.

We stock tools, Electronics books, soldering equip, multimeters, and many surplus items at bargain prices. S.A.E. for lists.

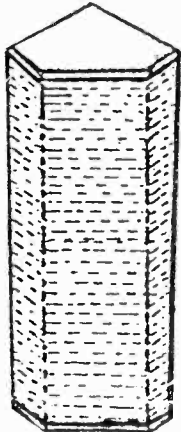

**TYPE L2 TRIANGULAR CORNER CABINETS**

Smart woodgrain Formica type finish with nylon grille. Overall height 23" x 12" wide. Contain three 15 ohm 6 1/2" x 4" full range speakers in parallel + 100V line transformer (easily disconnected for 5 ohm operation). £7.50 each (or 2 for £14.00) + 12 1/2% VAT

**Terms of Business: CASH WITH ORDER. MINIMUM ORDER £2. ALL PRICES INCLUDE POST & PACKING (UK ONLY). SAE with ALL ENQUIRIES Please. PLEASE ADD VAT AS SHOWN. ALL GOODS IN STOCK DESPATCHED BY RETURN. CALLERS WELCOME BY APPOINTMENT ONLY.**

WW-112 FOR FURTHER DETAILS

## PEOPLE WHO KNOW QUALITY AND NEED RELIABILITY

(Military, Industry, RCC's) Demand  
**Pipo Communications For Trouble Free Touch Tone Encoders**

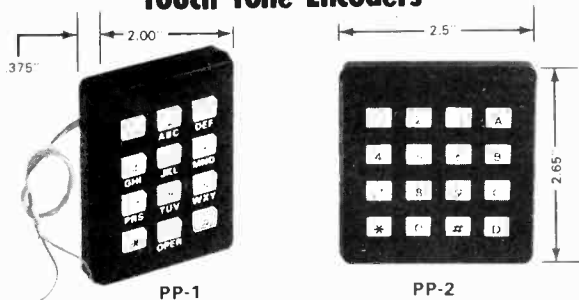

## WANT TO KNOW WHY?

Send for descriptive brochure and dealership details to:  
**STEVE MILLER % INTERNATIONAL SALES**  
or Telex: 18-1059 ELMATEXINT. LSA

**Qualified International Dealers and Distributors Wanted!**

**Pipo Communications**

P.O. Box 3435  
Hollywood, California U.S.A.  
90028 213/852-1515

WW-112 FOR FURTHER DETAILS

240v Plug-In Relays 3 pole c/o 10 amp contacts 85p P.P. 15p

**COAXIAL CRYSTAL DETECTORS.** (Marconi: Saunders). 200 MHz-12 GHz £7.50 (Diode CS98 £1.50)

**FIBREGLASS COPPER-CLAD BOARD**

9x 4 1/2 x 1/16in 40p P&P 10p

9 x 6 x 1/16in 50p P&P 15p

**OFF-CUT PACKS.** 150 sq. ins. £1 P.P. 25p.

Double sided 1/2p per sq. in. extra

**MAGNETIC COUNTERS**

3 Digit Reset (240v A.V.) £1.75 P&P 25p

6 Digit Reset (24v D.C.) £4 P&P 25p

4 Digit Non-Reset (24v D.C.) £1 P&P 25p

6 Digit Non-Reset (240v A.C.) £1.50 P&P 25p

**MULTICORE CABLES**

**4 CORE RIBBON (RAINBOW) CABLE** 4 - 10 / 2m m

Forming 1/4in wide strip 10m-£7.50 50m-£3.10 100m-£6 P&P 1p per metre

**8 CORE RIBBON (RAINBOW) CABLE** 8 x 14 / 76

Forming 1/2in wide strip 10m-£11.50 50m-£6.50 100m-£12 P&P 1p per metre

**10 CORE CABLE** 10 x 7 / 76 (10 colours) P.V.C.

O.D. 7m.m 10m-£2.50 50m-£8.50 100m-£16 P&P 2p per metre

**12 CORE SCREENED CABLE** 12 x 14 / 76 with outer screen -P.V.C. covered O.D.

9m.m 10m-£4.50 50m-£18.50 100m-£35 P&P 2p per metre

**16 PAIR RIBBON CABLE** 16 x 2 core P.V.C.

Double sheathed forming 2in wide strip 10m-£3.50 50m-£13.50 100m-£25 P&P 2p per metre

**E.H.T. MODULES** (Resin encapsulated in metal box)

Input 240v 50hz **Type 1** O/P 8kv @ 15 watts £8.75 P&P £1

**Type 2** O/P 13.7kv @ 7 watts £10 P&P £1

**STABILISED POWER SUPPLY** (APT) 5-14 volts @ 6amp. Pre-Set (with manual)

£20 P.P. £2

**P.C. EDGE CONNECTORS**

32 way (1 pitch) finished ends 40p P&P 10p

56 way (1 pitch) cuttable 65p P&P 15p

64 way (1 pitch) cuttable 75p P&P 15p

64 way gold plated pins 90p P&P 15p

Mounting pillars for 56/64 way 15p per pair

**'DRYFIT' RE-CHARGABLE BATTERIES** (Lead / Acid)

Ex. Equip. Good condition, tested

6v @ 6 A.H. £3.50 P&P 75p

6v @ 7.5 A.H. £4.00 P&P 75p

**"BLEEPTONE" AUDIO ALARMS** (Ex. Equip.) 12v D.C. 75p P.P. 10p.

**EMERGENCY LIGHTING UNITS.** Automatically Switches to stand-by-battery power

(24v) when mains fails. Keeps battery pack fully charged on normal supply £15 (ex. batteries) P.P. £1.50

**VARLEY LEAD-ACID BATTERIES.** 6v. 36 A.H. non-spill £6 ea. P.P. £1.50.

## J. B. PATTRICK

191 / 193 London Road  
Romford, Essex RM7 9DJ  
Romford 44473

# WANTED

## ENGINEERS HIGH REWARDS OFFERED

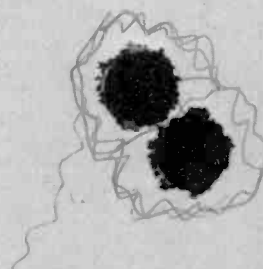

We're a private company with ever increasing worldwide sales in high technology equipment, including HV power supplies, nuclear instrumentation, medical electronics in use throughout the world as teaching aids and a range of static invertors for airborne applications.

To maintain our forefront in the electronics industry, we wish to create a new generation of products, we are therefore expanding our team of development engineers and are looking for:

### Project Engineers (Analogue)

We need experienced Project Engineers, holding a degree in electronics, ideally with a knowledge of civil and military aircraft industry, a flair for solving problems and co-ordinating with our design and production teams.

### Design Engineers (Analogue)

We need engineers with a degree in electronics. Previous experience of the industry is not essential, but the successful candidate – who should be enterprising and ambitious – will be involved in the design and development of new products and equipment.

In addition to salary, we offer four weeks paid annual holiday, non-contributory pension scheme and bonus incentives.

## CAN YOU FIT THE BILL?

If so, please contact Ian Andrews today. He'll tell you more about us and arrange a meeting.

# brandenburg

Brandenburg Limited.

939 London Road, Thornton Heath, Surrey CR4 6JE. Tel: 01-689 0441. Telex: 946149.



# Appointments

Advertisements accepted up to 12 noon Monday, June 5, for the July issue, subject to space being available.

**DISPLAYED APPOINTMENTS VACANT:** £7.50 per single col. centimetre (min. 3cm).  
**LINE advertisements (run on):** £1.10 per line, minimum three lines.  
**BOX NUMBERS:** 50p extra. (Replies should be addressed to the Box Number in the advertisement. c/o Wireless World, Dorset House, Stamford Street, London SE1 9LU.)  
**PHONE: Barry Leary on 01-261 8508**  
*Classified Advertisement Rates are currently zero rated for the purpose of V.A.T.*

## Communications Foremen

**Libya - over £9000 tax free + bonus**

Occidental, one of today's most progressive and rapidly expanding international oil companies, require communications experts to supervise the installation, maintenance and repair of communications equipment in the field production areas in Libya, including VHF/AM/FM equipment, HF-SSB Transceivers, LF radio beacons, TDM alarm systems, teleprinters etc.

Candidates must have at least five years' experience in installing, maintaining and repairing radio, telephone and microwave systems, some of which should be at supervisory level.

The positions are on single status and

carry initial annual salaries of not less than £9,000, tax free, and a signature bonus for direct hire applicants equivalent to 25% of the first year's salary, before tax. The salary is accompanied by comprehensive benefits programme and an attractive field break scheme of 33 days working followed by 21 days off, with air fare paid to your point of origin.

Please send your resume with full personal and work experience to Patricia Conneely, Occidental of Libya Recruiting, Gillingham House, 38-44 Gillingham Street, London SW1V 1HU. Telephone 01-828 7711.



(8196)

**THE BRITISH COUNCIL**  
invites applicants for the following posts

**2 ENGINEER/SUPERVISORS (Germany)**

British Council Language Centres, Munich and Hamburg. Required preferably by June, 1978. To be responsible for the operation and maintenance of colour CCTV equipment and audio recording studios and to assist teachers in the technical aspects of producing programmes for CCTV and the language laboratory

**Qualifications:** Candidates should have HNC or Final City and Guilds (Telecommunications) Certificate and have at least 5 years general all-round working experience in broadcasting or CCTV engineering and production. Colour TV experience desirable. Some knowledge of German useful

**Salary:** £5,210-£7,054 p.a. tax-free  
**Benefits:** Personal and children's allowances; accommodation allowances of £2,300 (single) or £2,900 (married accompanied); employer's share of national insurance and superannuation; travel and baggage allowances. 2 year contract, renewable

**Return fares are paid.** Local contracts are guaranteed by the British Council. Please write briefly stating qualifications and length of appropriate experience, quoting 780045 reference number and title of post, for further details and application form to The British Council (Appointments), 65 Davies Street, London W1Y 2AA

(8125)

**LONDON WEEKEND TELEVISION**  
have vacancies for

### ELECTRONIC ENGINEERS

The successful applicants will be deployed in the Electronic Maintenance section where they will be responsible, as part of a team, for the maintenance and performance of the latest video, sound and control equipments and systems utilising analogue and digital techniques.

One of the vacancies is for a Substantive Engineer working initially on the routine maintenance of the Company's sound equipments. This work will encompass not only studio sound desks and equipment but also the latest digital video and audio machine interlocking systems as well as the performance of two purpose built multitrack dubbing theatres.

Other vacancies are concerned with maintaining an extensive range of video equipments and control systems where an interest in or knowledge of computer techniques could be advantageous.

Working knowledge of broadcast equipment is desirable though due consideration will be given to C.C.T.V. or other related experience. Academic qualifications to H.N.C. or equivalent preferred.

Starting salary will be in the range £3951 per annum to £5310 per annum inclusive.

Please telephone 01-261 3237 for application form.

8176

### ELECTRONIC TECHNICIAN

Can you use your engineering knowledge to serve astronomy?

We build and maintain astronomical instruments, using the most up-to-date techniques over the range from TV to microprocessors to low-noise amplifiers.

We are looking for someone with an ONC or equivalent who has served a recognised apprenticeship to join our Technology Group at Edinburgh.

Applicants should have experience of construction and testing electronic equipment to the highest standards. Some knowledge of minicomputers and microprocessors would be an advantage, but training could be given.

The successful candidate must be willing to work abroad in the support of astronomical observation using advanced instrumentation, both on detached duties of a few single weeks at a time and on postings of two years or more.

Salary on an incremental scale starting at a point between £3040 and £3770, depending on age, with non-contributory pension scheme. Closing date 9 June, 1978.

Application forms from Personnel Officer, Royal Observatory, Blackford Hill, Edinburgh.

(8175)

### ELECTRONIC ENGINEER (TECHNICIAN GRADE 6)

required to design circuitry for, and to supervise operation of, analogue and digital equipment concerned with a wide range of applications including x-ray fluorescence, gamma-spectrometry, SQUID cryogenic magnetometry, thermoluminescence and eventually radocarbon mass-spectrometry. Qualifications HNC, HND, or equivalent plus 9-10 years' experience.

Salary scale £3654 to £4365

Apply in writing to: Professor E. T. Hall  
 Research Laboratory for Archaeology  
 6 Keble Road  
 Oxford OX1 3QJ

(8141)

## MANAGEMENT AND SALES OPPORTUNITIES IN RF SEMICONDUCTORS

TRW RF Semiconductors form a major part of MCP Electronics sales in the United Kingdom.

MCP Electronics, part of a major group of companies, is sole UK agent for TRW Semiconductor devices. In order to maintain the momentum of increased sales into the mobile and military markets, applications are invited to fill two important vacancies in the MCP Electronics sales team, as follows:

1. **PRODUCT MANAGER** TRW RF Semiconductors. This is a technical / administrative job and will involve liaison with TRW and major U.K. users. The Product Manager will work in Wembley but some time will be spent in customer visits. There will be occasional opportunities for visits abroad.

2. **SALES ENGINEER** RF Products. This is also a senior appointment and would be ideally suited to an Engineer wishing to make a long-term career in technical sales. Ideally, applicants should live North East of London, but relocation expenses would be offered where appropriate.

MCP Electronics operate a Group Bonus Scheme in addition to an attractive salary scale, for these interesting job opportunities, which both include a Company Car.

By joining us you will become an important part of TRW's worldwide team and will be working for a recognised Industry Leader.

Interested? Then phone or write to:



Ron Adams  
Sales Manager  
MCP Electronics Ltd  
Alperton, Wembley, Middx HAO 4PE  
Telephone: 01-902 5941

(8195)

## Service Engineer

F. W. O. Bauch Limited require a person to service a range of professional audio equipment. Applicants should have a sound electronics background, and a mechanical aptitude or knowledge of tape recording is desirable.

Applications in writing please, to:  
Mr B. Whittaker  
F. W. O. Bauch Ltd  
49 Theobald St., Borehamwood  
Herts WD6 4RZ

8131

### SULTANATE OF OMAN

#### Air Force Appointment

Applications are invited from suitably qualified Senior N.C.O.s of the British Armed Forces, who have recently left the Services or shortly complete full-time service, to fill an **immediate** vacancy for a

#### Rapier Squadron Signals N.C.O. (Sergeant)

He will be responsible for the continuation training of all radio operators and Command post radio personnel in a Rapier Missile Squadron and for advising on the setting up and operation of Command posts at Squadron Base and detachment locations.

Applicants must be signals trained and have had wide experience in the training of Command post personnel associated with weapons systems control (artillery or missiles). Some first-hand knowledge of working in a Command post in LLAD systems (L.40/70 guns or Rapier) is desirable.

This is a uniformed contract appointment of 3 years' duration initially unaccompanied (although short family visits to Oman are possible), and the age limit is strictly 49. Conditions of service include:

- (a) tax free annual emoluments commencing at Rials Amani 4062 (equivalent to approx. £6320 at the rate of exchange prevailing on 12/4/78);
- (b) an attractive end-of-contract gratuity;
- (c) normal Service mess facilities with bachelor accommodation and services free of charge; and
- (d) 60 days home leave annually (usually taken in two periods of 30 days) with air passages paid.

For further details, write immediately quoting reference 27/D, to:

Senior Personnel Officer (WW/6/78)  
**AIRWORK SERVICES LIMITED**  
Bournemouth (Hurn) Airport  
Christchurch, Dorset BH23 6EB

(8136)

**Airwork Services Ltd.**

## Electronics Engineers on the move

**INVEST  
5 MINUTES  
IN YOUR  
FUTURE**

**DESIGN, TEST, Q. A; FIELD SERVICE, MANAGEMENT, ETC.**  
 Take advantage of the best opportunities being offered in the Electronics Industry from amongst over 3000 U.K. Companies with whom we deal. We are seeking all categories of Electronics Engineers for equipment ranging from computers to communications.  
 By returning the application form below, your job requirements will be matched against our clients' numerous vacancies, many of which are not advertised. Your application will be treated in strict confidence and no approaches will be made to existing employers or to any other companies you care to specify. Please remember, our service is completely FREE to applicants.  
 So don't delay - act now to give yourself the best chance of finding the perfect job.  
 If you wish to discuss any aspect of the Electronics job market, you are welcome to phone anytime. Please ask for Brian Cornwell.

**Capital Appointments Ltd. 29/30, Windmill St. London, W.1. ☎ 01-637 5551**

PLEASE WRITE IN BLACK INK.

NAME: \_\_\_\_\_ ADDRESS: \_\_\_\_\_

Tel: (Home): \_\_\_\_\_ (Office): \_\_\_\_\_

Date of Birth: \_\_\_\_\_ Place of Birth: \_\_\_\_\_ Nationality now: \_\_\_\_\_ If not British, is a

Marital Status: \_\_\_\_\_ Car Driver: \_\_\_\_\_ Car Owner: \_\_\_\_\_ Work Permit req'd?

Type of Position required: \_\_\_\_\_ Approx. Salary level: \_\_\_\_\_

Please indicate areas in which you are prepared to work:				Are you a houseowner?	Are you willing to relocate?
Cent. London	S. Coast	E. Midlands		Are you prepared to travel - In U.K?	Overseas?
S. E. London	West Country	W. Midlands		State of health:	
S. W. London	N. E. Engld.	E. Anglia		Notice Period required:	
N. E. London	N. W. Engld.	Wales		Availability for Interview:	
N. W. London	Scotland	Overseas			
Home Counties: N. W.	N. E.	S. W.	S. E.		

EDUCATION:  
 Secondary School Qualifications:  
 College or University Qualns:  
 Any Professional Membership:

INDUSTRIAL EXPERIENCE:	Period of Employment	Company & Location	Products	Job Title	Responsibilities	Reason for leaving	Final Salary
1. Current or last employment	From:						
	To:						
2. Previous employment	From:						
	To:						
3. Previous employment	From:						
	To:						

ELECTRONICS PROFILE: Indicate extent of experience- A-Extensive; B-Moderate; C-Limited; If Nil experience, leave blank.

- |  |   |   |  |
|--|---|---|--|
| <input type="checkbox"/> Telephone Eqpt.     | <input type="checkbox"/> Data Comms.      | <input type="checkbox"/> Radio/Hi-Fi/T.V.     | <input type="checkbox"/> Broadcast Eqpt.       |
| <input type="checkbox"/> Digital/Logic       | <input type="checkbox"/> Analogue Eqpt.   | <input type="checkbox"/> Software/Programming | <input type="checkbox"/> Minis/Microprocessors |
| <input type="checkbox"/> Computers/Periphls. | <input type="checkbox"/> Test Gear/ ATE.  | <input type="checkbox"/> Process Control      | <input type="checkbox"/> Power Supplies        |
| <input type="checkbox"/> UHF/VHF. Comms.     | <input type="checkbox"/> Microwave        | <input type="checkbox"/> Radar/Nav aids       | <input type="checkbox"/> Medical Electronics   |
| <input type="checkbox"/> Signalling Systems  | <input type="checkbox"/> Security Eqpt.   | <input type="checkbox"/> Avionics             | <input type="checkbox"/> Simulators            |
| <input type="checkbox"/> Weapons             | <input type="checkbox"/> Scientific Eqpt. | <input type="checkbox"/> Data Recorders       | <input type="checkbox"/> Photocopiers          |
| <input type="checkbox"/> Phototypesetting    | <input type="checkbox"/> Servo-mechs.     | <input type="checkbox"/> Components-Active    | <input type="checkbox"/> Components-Passive    |
| <input type="checkbox"/> Production Eng.     | <input type="checkbox"/> Electrical Eng.  | <input type="checkbox"/>                      | <input type="checkbox"/>                       |

Others - Please state.

Please indicate any Companies you do not wish us to contact.

If you wish to detail further aspects of your experience or job requirements, please enclose on a separate sheet. WW2 (8159)

# The job you're now looking for we've probably already found.

We're in touch with over 3000 major companies who are continually looking for key personnel like you - but who don't always advertise.

Instead, they send us a brief which we compare to the requirements of candidates on our register. Then we draw up a shortlist.

The next time we're asked, we could mention your name.

All you have to do is clip the coupon, we'll send you a confidential application form... consider it an interview and give us relevant details about yourself. There's no risk, no cost, no obligation and no time-wasting. Simply send us the form and we'll do the rest.

We'll find you one of those jobs you usually hear about after they've been filled.

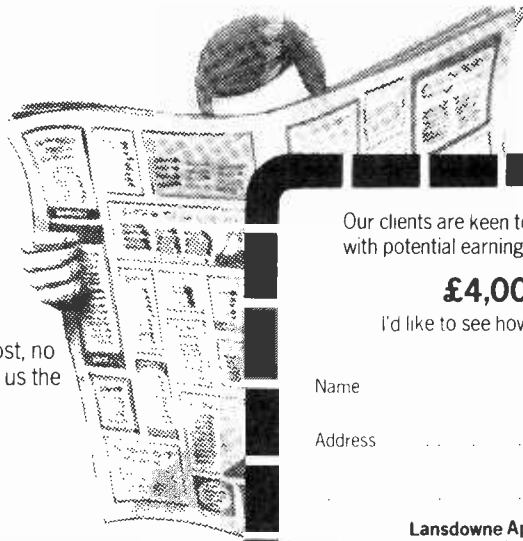

## Lansdowne

For those too busy doing a good job to find a better one.

Our clients are keen to meet men and women, aged 20-40 years with potential earnings of between

**£4,000 and £7,000 p.a.**

I'd like to see how Lansdowne can help further my career.

Name .....

Address .....

WW 19/5

Lansdowne Appointments Register, Design House,  
The Mall, London W5 5LS. Tel: 01-579 2282 (24 hour answering service).

Lansdowne Appointments Register, Design House,  
The Mall, London W5 5LS. Tel: 01-579 2282 (24 hour answering service).

Foreign and Commonwealth Office  
has a vacancy for an

## Electrical/Electronic Draughtsman/Woman

Based at Kingstanding, near Crowborough, Sussex

The work is involved in Sound Broadcasting and associated services, including Power Supply Systems at HV and LV.

The successful applicant will have abilities in solid state and vacuum tube circuitry, PCB design, electrical control and power distribution systems.

**Qualifications required:**

ONC in Electrical or Electronic Engineering or an equivalent or higher qualification acceptable to the Civil Service Commissioners.

All candidates must have served an apprenticeship, or have had equivalent training of at least 3 years' appropriate to the duties of the post. In addition, they must have had not less than one year's full time experience of drawing office work.

**SALARY:** Starting salary is according to age, eg age 21—£2425 per annum; age 25—£2785 per annum and age 27 (or over on entry)—£2970 per annum. The maximum of the scale is £3450 per annum. In addition, all points on the salary scale attract Pay Supplements of £313.20 per annum and 5% of total salary with a minimum of £10.88 per month and a maximum of £17.40 per month.

Please apply to:

Recruitment Section, Foreign and Commonwealth Office  
Hanslope Park, Hanslope, Milton Keynes MK19 7BH

(8185)

## WE'VE TRIED SEX

facetiousness, flamboyant statements, and downright vulgarity to attract attention to our company's advertisements

### WHAT HAS IT BROUGHT US??

- The nickname "Charlie's Angels"
  - Considerably more applicants and vacancies than before
  - Unsolicited praise from the Sunday Times, Sunday Telegraph, Observer and Titbits for our seductive prose and eye-catching panache
  - Charlie's Angels don't play, they mean business Try us
- Like those illustrious ladies, we don't reveal all (our vacancies) — just sufficient to whet the appetite

#### 1 PROJECT DESIGN ENGINEER

RF equipment particularly frequency synthesisers and spectrum analysers. To £7,000

South Coast

#### 2 COMPUTER ENGINEERS

Vacancies throughout UK for field service, permanent site, systems test or technical support. Salaries vary enormously, but up to £11,000 for IBM 360/370 experience

#### 3 SYSTEMS APPLICATIONS ENGINEERS

Modems and multiplexers for dynamic group marketing US projects. To £6 500

Middlesex

#### 4 DESIGN DEVELOPMENT ENGINEERS

For advanced projects group working on application of advanced technology to the widest range of communications imaginable. DC-Blue Light To £7,000

Berkshire

Always in demand

**TEST ENGINEERS, COMMISSIONING ENGINEERS, TRIALS ENGINEERS, TECHNICIANS.**

Also:

**NEW GRADUATES, COLLEGE LEAVERS and H.M. FORCES PERSONNEL.**

For further details of qualifications and experience required, salary levels and precise geographical locations, telephone 01-581 0286, or write to

(8173)



**Charles Airey Associates**

RECRUITMENT CONSULTANTS TO THE INDUSTRY, 155 Knightsbridge, LONDON SW1. Tel: 01-581 0286

# Interested in Electrical/ Electronic Engineering

The Electrical/Electronic Function of Leyland Cars designs and develops a complete range of installations and components for our current and future models, ensuring they stringently adhere to performance and reliability standards and comply with company and world market legal requirements. Our existing engineers are involved with vehicle lighting, switchgear, fascia instruments, in-car entertainment and photometrics.

Do you have the qualifications or relevant experience to compliment our existing team?  
Our need is for .....

## Design and Development Electrical/ Electronic Engineers

As we are prepared to consider "on the job" training applications are invited from people who have a fundamental knowledge of electrical circuitry, wiring installation design, automotive electrical/electronic systems or similar technologies practised in other fields.

### Appointments are available at...

Longbridge (a) Solihull (b) and Coventry (c) establishments in the Birmingham area.

### Conditions of employment...

relocation assistance, discounts for car purchase and accessories, generous holiday entitlement and other benefits appropriate to a large company.

### Current rates of pay...

salaries will be in accordance with academic background and experience. Excellent prospects for promotion. We do have a few vacancies at the more senior level for which exceptional candidates may be considered.

### Amenities...

all the establishments are close to attractive rural surroundings with a wide range of available housing, Schools, Universities and facilities for leisure pursuits are all locally available.

### How to apply...

Please write for an application form or post the coupon to me. Local interviews can then be arranged.



# Leyland Cars

Name:..... Age:.....  
 Address:.....  
 Area: a b c \*  
 Electrical/Electronic Design/Development \*  
 \*Please delete as appropriate. (8192)

**M. D. Ray, Recruitment Co-ordinator, Product Engineering Division, Leyland Cars,  
 Broad Oaks, 550 Streetsbrook Road, Solihull, West Midlands B91 1QX.**  
 These vacancies are open to both male and female applicants.

**DEPARTMENT OF CHEMICAL AND  
 BIOCHEMICAL ENGINEERING**  
**ELECTRONIC TECHNICIAN**  
 Grade 6  
 required for the electronic workshop. Good knowledge of fault-finding and servicing standard electronic instruments required, together with the ability to work on prototype circuits. Salary in the range £4,119-£4,830 including London Weighting.  
 Application form and further details from Personnel Officer, (Technical Staff EB10), University College London, Gower Street, WC1E 6BT (8143)

**STUDIO  
 MAINTENANCE**  
 A new Studio Complex at Dick James Music requires an experienced person to work on our MCI recording equipment. JH 500 desks, JH 16, 24 tracks JH 110 four and two tracks. The complex includes main control room, mix down room, tape copy conference room and workshop. Salary negotiable.  
 If you are interested telephone **Terry Ralph-Knight on 01-242 6886, Ext. 265.** 8154

**THE UNIVERSITY OF HULL**  
**VISION / LIGHTING SUPERVISOR**  
**AUDIO VISUAL CENTRE**  
 Applications are invited for the above post which is available immediately. Candidates should have an HNC or equivalent qualification, and relevant experience in operations and maintenance in broadcast and/or educational television. Salary will be on the Grade 7 scale for University Technical Staff (£4,254 x 4 increments — £4,782).  
 Applications, giving details of age, qualifications, experience, and the names of two referees, should reach the Personnel Officer, University of Hull, HU6 7RX, by 2nd June. Further particulars are available (8184)

**UNIVERSITY OF ABERDEEN**  
**THE DEPT. OF BIO-MEDICAL PHYSICS AND  
 BIO-ENGINEERING**  
**SCIENTIFIC OFFICER**  
 for well equipped Electronic Section (staff 15 total) associated with design, servicing and maintenance of modern electronic equipment (including Nucleonics) Work in hospital as well as laboratory environment. Expected to guide technicians.  
 Salary on research and analogous scale R.A.S. (R.I.A.) £3660-£6178 per annum, with appropriate placing.  
 Further particulars from the Secretary, The University of Aberdeen with whom applications (2 copies) should be lodged not later than 10th June 78. (8198)

## Radio Officers Sea Sick?

If you've seen quite enough of the sea, and are thinking now of a shore-based job that suits your qualifications, the Post Office Maritime Service can offer you interesting work, job security, good pay, plus the pleasure of enjoying all the comforts of home where you appreciate them most - at home!

Vacancies exist at several coast stations for qualified Radio Officers to carry out a variety of duties that range from Morse and teleprinter operating to traffic circulation and radio telephone operating. And for those with ambition, the prospects of promotion to senior management are excellent.

You must have a United Kingdom Maritime Radio Communication Operator's General Certificate or First Class Certificate of proficiency in Radio-telegraphy or an

equivalent certificate issued by a Commonwealth Administration or the Irish Republic. And, ideally, you should have some sea-going experience.

At 25 or over, salary starts around £4093 and after three years, rises to around £5093. (Starting salary for those between 19-24 varies between £3222-£3732.) Overtime is additional, and there is a good pension scheme, sick-pay benefits and at least 4 weeks' holiday a year.

For further information, please telephone Andree Trionfi on Freefone 2281 or write to her at the following address: ETE Maritime Radio Services Division ( ), ETE17.1.1.2, Room 643, Union House, St. Martins-le-Grand, London EC1A 1AR.

### Post Office Telecommunications



## Service and Test Engineers

As aircraft and electronics equipments become more sophisticated and our servicing programme expands, the need for experienced Service and Test Engineers increases.

At Stanmore, we are involved in the provision of spares and the repair, maintenance and overhaul of a variety of British and American airborne electronic equipment.

We need Engineers who can successfully maintain the high standards and efficiency required both in the aircraft and the workshop.

It's skilled work, calling for sound practical experience of radio and electronics theory, ranging from audio to microwave and including the use of advanced test equipment for fault diagnosis. Training in this field will be given to suitable, less experienced engineers.

The Company offers excellent salaries and benefits together with first-class working conditions in well-equipped workshops. This Unit is conveniently situated in pleasant surroundings within easy reach of the A1 and M1.

If the job sounds interesting and you'd like to put us to the test, write with details of experience to:  
Mrs. E. Wagg  
Marconi Avionics Ltd.  
22-26 Dalston Gardens, Stanmore, Middlesex  
HA7 1BZ.  
Tel: 01-204 3322

# MARCONI AVIONICS

A GEC-Marconi Electronics Company

**We pay top salaries for  
the right engineers  
Starting at £4000 p.a.  
for Bench Engineers  
Increasing appreciably for  
Field Service Engineers**

London's largest independent radio-telephone company is expanding fast! We have built a reputation for reliable efficient service. If you have the capability we need you urgently

Knowledge or experience of mobile V.H.F. equipment is what we're looking for. Call Mike Rawlings or Bill Clarke on 01-328 5344 Now! (7994)

**London  
Communications**

(Equipment) Ltd  
30 Boundary Road London NW8 01 328 5344

**IMPERIAL  
COLLEGE**  
TECHNICAL STAFF  
Grade 5 Electronics

Vacancy for a competent technician in a university computing department. Candidates should have ONC or City and Guilds Electrical Technicians Part 1 Certificate or equivalent and have experience with construction and maintenance of computing equipment and peripherals. Salary in the range £3651-£4185 per annum. Five-day week 9.00 to 17.30 hours. Four weeks paid annual leave plus additional days at Christmas and Easter.

Please apply in writing with full details of qualifications and experience to Mr M. D. Cripps, Department of Computing and Control, Imperial College, London SW7 2BZ, as soon as possible.

(8129)

# We like to think we're perfect. With your skills we could keep it that way.

As the ICL success story continues our Spares Division Operations Centre in Stevenage becomes even more important. We provide a computerised spares service for some 126,000 live line items to customers and engineers worldwide, along with our nationwide network of stores and workshops. Essential to our operation are the following people.

## **Project Leader Test System Software c£5500**

We have an elite team of young graduates writing test programs for our Computer Aided Repair System F.I.Ts. This is a unique opportunity for a logic or circuit designer who is seeking a first management appointment in the field of microprocessor test equipment development. You will have a degree in physics, electronics or electrical engineering, understand the concepts of microprocessor techniques and have the ability to comprehend the hardware and software requirements in this field. Probably around 26 with good communication skills you should be able to motivate and work with the team already established. Ref. WW1785/A.

## **Spares Analyst c£5200**

Your main responsibility will cover forward planning for equipment. As well as having a formal electrical engineering qualification, your experience will have equipped you to handle the long-term strategic planning and logistics of spares within economic constraints. We will be looking for someone with initiative and a high standard of literacy and accuracy, and preferably experience in the electronics industry. Ref WW1785/B.

In addition to the salaries (which are due for review in June) you will be eligible to participate in our 1978 Productivity Bonus Scheme. We'd also like to tell you about our first-class training schemes, our subsidised canteen and our thriving local sports and social activities. Relocation assistance will be given in appropriate cases.

**Interested?** Send brief career details, quoting the appropriate reference, to: Jeff Neal at ICL, Spares Division, Cavendish Road, Stevenage or telephone him on Stevenage (0438) 3361 ext 555.

# International Computers

think computers – think ICL



(8122)

### **WAREHOUSE MANAGER**

experienced in the electronics industry, required by small export company, to supervise usual warehouse activities, particularly branding, boxing, packing and testing of electronic values. Salary dependent on experience. Minimum £4 000 p.a. plus possible use of car.  
**PLEASE RING: 01-348 3438 (8161)**

THE ROYAL FREE HOSPITAL

### **MEDICAL PHYSICS TECHNICIANS (ELECTRONICS)**

2 vacancies exist in the Electronics Workshop of this new major Teaching Hospital. Applicants should hold the City and Guilds Full Technological Certificate or an equivalent qualification. Experience in analogue and digital circuit techniques essential.

Salary on scale £3,776-£4,708 dependent on qualifications and experience and including all allowances.

Application form and Job Description from the Personnel Department, The Royal Free Hospital, 21 Pond Street, Hampstead, London, NW3 2PN. Tel: 01-794 0431. Please quote refs: 0758 and 0760.  
Camden and Islington A.H.A. (T) (8150)

### **VTR ENGINEERS**

for Africa and  
Middle East  
Up to

**£24,000 p.a.**

Box No. WW8177

—(8177)

## POSTDOCTORAL AND PREDOCTORAL OPENINGS

### INTERDISCIPLINARY RESEARCH IN VISION, HEARING AND SOMATOSENSATION APPLIED TO MEDICAL AND AVIATION PROBLEMS

There are postdoctoral openings for candidates with a Ph.D. in physics, electrical (electronic) engineering, physiology or psychology (psychophysics).

There are predoctoral openings (M.A. and Ph.D. research for candidates with a strong quantitative background in one or more of the following areas: psychology (psychophysics), physiology, physics, electrical (electronic) engineering, medical physics, computer science.

Working within a Research Unit of Applied Psychology attached to the Medical School, postdoctoral fellows and graduate students learn to combine the skills of psychophysics, physics, electronics and physiology. They have the opportunity to work with patients, applying the results of basic research in vision, hearing and somatosensation to solving practical problems in neurology, ophthalmology, and otolaryngology. Contrasting research is directed towards identifying the ways in which the eye and visual pathway in skilled flyers, drivers and gamesplayers are better than average.

The three available areas of research are:

(1) Applying sensory psychophysics and techniques for recording electrical brain signals (evoked potentials) to aiding the diagnosis and management of organic diseases that affect sensory pathways (e.g., multiple sclerosis, squint, deafness).

(2) The development of psychophysical and evoked potential methods to detect damage to the sensory nervous system caused by exposure to toxic environmental pollutants.

(3) The application of fundamental research on visual psychophysics to improving safety and performance in aviation and road transport.

Further details from Dr. D. Regan, Research Unit of Applied Psychology, Department of Psychology, Dalhousie University, Halifax, Nova Scotia, B3H 4J1, Canada. Telephone: (902) 424-2552

# Electronics Research and Development with Ferranti



Expansion and re-organisation within the Aircraft Equipment Department has created a number of interesting positions in the R & D laboratories at Bracknell.

The Department which is active in both Civil Aviation and Defence fields, with airborne and ground based equipment, covers a broad range of activities extending from medium/high power electronics to work with low power microcircuits.

The following positions have arisen:

**SENIOR ENGINEER** to lead a small group associated with light current equipment. The candidate should have at least two years experience in industry with a good knowledge of signal processing and use of digital techniques in the communications field.

Ref: A/174/WW

**SENIOR ENGINEER** to work with control systems. The candidate should have proven design experience with low power circuits. A knowledge of the use of microprocessors would be an advantage.

Ref: A/175/WW

The above positions are open to professionally qualified Electronics Engineers.

**IN ADDITION** we have a number of other interesting vacancies for candidates of graduate experience.

These posts should be regarded as stepping stones to higher positions within a technically orientated company. Highly competitive salaries will be paid. The laboratories are located in a pleasant manor house situated on the outskirts of Bracknell.

Application forms may be obtained by writing to Mrs. J. Hunt, Ferranti Limited, Lily Hill House, Lily Hill Road, Bracknell, Berkshire, or telephoning Bracknell 24001 ext. 8.

## FERRANTI

Selling technology

(8152)



# Marconi Instruments

## ELECTRONIC TECHNICIANS

Opportunities for the experienced and sometimes inexperienced in St. Albans and Luton.

Work situations range from fault finding on PCB's and components, to batch product testing of equipment that utilise very advanced techniques including microprocessors and the repair/calibration of all manner and types of test instruments.

Attractive salaries and, where appropriate, relocation are offered for the right candidates. Further information may be obtained in confidence from John Prodger

**Marconi Instruments Limited,**  
Longacres, St. Albans, Herts. tel: St. Albans, 59292



A GEC-MARCONI ELECTRONICS COMPANY

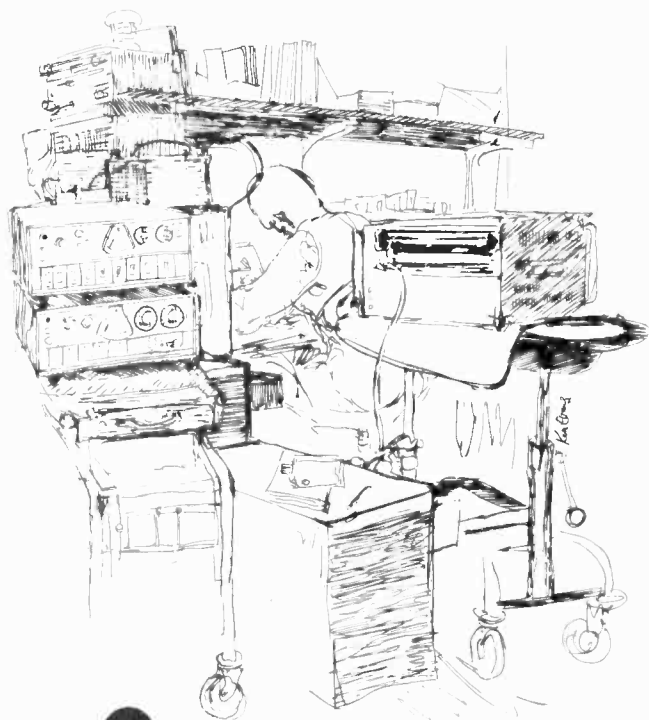

**mi**

**UNIVERSITY OF SUSSEX**  
School of Engineering and Applied Sciences

### RESEARCH VACANCIES

involving

Microprocessors  
Displays  
Software Engineering  
Control and Instrumentation  
Distributed Computing  
Electrical Machines  
Control of Magnetic Suspension

A small number of research studentships are available for well qualified applicants. Application forms and further details from

**P. Cooke**  
Postgraduate Admissions Tutor  
School of Engineering and Applied Sciences  
University of Sussex  
Falmer, Brighton, Sussex  
BN1 9QT (8179)

#### THE BRITISH COUNCIL

invites applications for the following post

King Abdul Aziz University, Jeddah, Saudi Arabia  
English Language Centre

#### ELECTRICAL ENGINEER

to help service the language laboratories and studios.

The English Language Centre, which is fully established with its own graphic, photographic, reprographic, television and sound studios and two language laboratories, trains students in English medium study skills, mainly for the Colleges of Engineering and Medicine.

Salary scales depend on family circumstances. The following monthly scales may be taken as a guide:  
Single: SR 3895 to SR 4465

Married with two children over 5 years old at post: SR 6480 to SR 7070

At the end of the first year's service staff are eligible for an increment.

Free furnished accommodation is provided. Return air fares are provided at the beginning and end of each year of contract for the staff member and up to three members of his family. The contract, which is for one year, and is renewable, is guaranteed by the British Council.

Please write briefly stating qualifications and length of appropriate experience, quoting relevant reference number 78 W/69 and title of post. For further details and application form to The British Council (Appointments), 65 Davies Street, London W1Y 2AA (8149)

## Teaching Telecommunications in Saudi Arabia

### can earn you at least £14,400 tax free per two year contract.

Lockheed Aircraft International are responsible for a large number of major contracts covering telecommunication services throughout Saudi Arabia. There is now a requirement for a Technical Instructor to provide classroom, laboratory and on-the-job training covering a broad telecomms spectrum with particular emphasis on SHF, line of sight links and associated multi-channel equipment. Other areas will include HF, VHF, and UHF band equipments and FSK, VFT and message switching equipment. Responsibilities will include preparation of all course material, syllabuses, training aids and student handouts as well as evaluation of student performance.

It requires an HNC or equivalent qualification with a good practical broad based telecommunications background and a minimum of three years' technical teaching experience.

There are excellent prospects of employment beyond the contract period. Benefits include:

- \* free bachelor accommodation, food and laundry,
- \* free medical care and life insurance,
- \* good recreational facilities,
- \* two free flights home to the UK annually.

Write with brief details, quoting Ref. 184, to International Aeradio Limited, Aeradio House, Hayes Road, Southall, Middlesex. Telephone: 01-574 5000.

**IAL**



## AUTOMATIC TEST EQUIPMENT PROGRAMMER

Crosfield Electronics Limited, a division of the De La Rue Company Limited, design, develop and manufacture a wide variety of sophisticated printing press control products and the Magnascan range of Electronic Colour Scanners for the printing industry.

This Company is due shortly to take delivery of a GENRAD GR1799 ATE which will supplement the existing MEMBRAN ATE operation. As a direct result of this expansion an additional Programmer, who should ideally have at least one year's previous experience in ATE programming, is currently sought. However, applicants with a background in Test Equipment Design or Electronic Testing that has involved some degree of Software Application would also be of interest to the Company.

The responsibilities of the successful candidate, either male or female, will include involvement in generating Test Programmes for Analogue and Digital Hybrid PCB's and the design of Interface Adaptors, all of which will require close positive liaison with the Research and Development Department. The position also entails providing a supporting role to the overall Test function.

In addition to an excellent salary, there are attractive fringe benefits and relocation costs will be met by the Company, where appropriate. Good career development prospects also exist in this rapidly growing Company.

Please write or telephone for an application form to:— Mrs. A. Ellis, Personnel Department, Crosfield Electronics (Westwood) Limited, Bretton Way, Bretton, Peterborough PE3 8YB. Telephone Peterborough (0733) 267504

8172

**Crosfield  
Electronics**



A De La Rue Company



### PAPUA NEW GUINEA UNIVERSITY OF TECHNOLOGY

invites applications for the post of

### TECHNICAL INSTRUCTOR (Communication)

in the Department of Electrical and Communication Engineering at the above-mentioned university.

Applicants should be qualified to at least technician engineer level and should be experienced in broadcasting, digital or microwave systems. Applicants with teaching experience at technician or technician engineering level are preferred.

Salary, which is paid in Kina, will commence at K8943 (K1 = 69p). In addition an allowance of K1300 (single), K2300 (married), plus K156 (per child), is payable annually. Conditions of appointment, which will be for a 3 year period, will also include furnished housing at a nominal rental, six weeks leave per year with fares assistance provided. Generous education allowance (including fares) for children undergoing secondary education overseas, and super-annuation benefits.

Applications, which should be in duplicate, should state age, family particulars, qualifications, experience, present post and names and addresses of three referees from whom confidential enquiries may be made, and should be directed to The Registrar, The Papua New Guinea University of Technology, PO Box 793, Lae, Papua New Guinea. An additional copy of the application should be sent to the Association of Commonwealth Universities (Apts.), 36 Gordon Square, London WC1H 0PF, from whom further information can be obtained.

(8127)

### APPOINTMENTS IN ELECTRONICS

Take your pick of the permanent posts in:

MISSILES — MEDICAL  
COMPUTERS — COMMS  
MICROWAVE — MARINE  
HARDWARE — SOFTWARE

For expert advice and immediate action on career improvement, phone, or write to, Mike Gernat BSc

**Technomark**  
Engineering and Technical Recruitment

11 Westbourne Grove  
London W2 0J 229 9239

7008



### Senior Engineers VTR Operations Salary £5920 per annum

Independent Television News Ltd. has vacancies for Senior Engineers in the ITN Facilities Centre in Central London. Applicants should have several years experience of broadcast VTR operation including editing and preferably maintenance.

The work covers a wide variety of programmes including news, commercials and feature material.

Contributory pension scheme and free life assurance.

Please telephone the Personnel Office  
01-637 3144

for an application form quoting reference number 8302

8205

Guy's Health District

### Medical Physics Technician Grade III

for the DEPARTMENT OF CLINICAL PHYSICS AND BIOENGINEERING based at Guy's Hospital. The Technician will join a team of Physicists and Technicians engaged on design, development, maintenance and repair of a wide range of electromedical equipment. Minimum qualifications are an O.N.C. and at least 3 years' experience as a qualified electronics/electrical technician.

Salary £3,776 p.a. rising to £4,708 p.a. inclusive (increase pending).

Apply to Mrs. C. Drew, Personnel Officer, Guy's Hospital, London, SE1 9RT. Telephone: 01-407 7600, Ext. 3462.

8151

**TELEVISION ENGINEERS**

The Media Department of the British Council has two vacancies for broadcast engineers in its studios in Tavistock Square, London. The studios are used to train personnel from countries overseas in broadcasting techniques and for the production of videotapes, films and other audio-visual programmes.

For the more senior post we are looking for someone who will be responsible for the operation and maintenance of the TV Studio and its associated equipment. Experience in TV studio operations, vision control and camera line-up is essential, and experience in quad videotape and lighting operations desirable. Applicants should have broadcast engineering training, or be in possession of a full City and Guilds Telecommunications Certificate, HNC or equivalent. Annual starting salary is £4767 rising by three annual increments to £5202. (Pay rise pending.)

For the less senior post we require someone with some studio experience who will be responsible for the operation and maintenance, under supervision, of the TV sound area. Experience of camera, videotape and lighting equipment would be an advantage. Applicants should have the City and Guilds Telecommunications Intermediate Certificate, or ONC or broadcast engineering training. Annual starting salary is according to age ranging from £3489 at 21 to £4462 at 28 and over. Thereafter salary rises by annual increments to £4767. (Pay rise pending.)

Some of the training takes place overseas and there may be occasional opportunities for travel. Annual leave for both posts is 22 days plus 2½ privilege days and there is a non-contributory pension scheme.

For further details and an application form telephone 01-499 8011 extension 3028 or write to Staff Recruitment Department, The British Council, 65 Davies Street, London W1Y 2AA, quoting reference HS/7.

(8132)

**ORBITRON ELECTRONICS LTD.**

require an

**AUDIO ENGINEER**

Small Audio Manufacturing Company requires young electronics engineer with interest in Audio effects and amplifiers, capable of taking projects from prototype through to production. The Company is growing and requires someone to grow with it. Salary negotiable.

Apply in writing to

**ORBITRON ELECTRONIC PRODUCTS LTD.**

449B Alexandra Avenue

South Harrow, Middx. (8158)

**TECHNICAL ASSISTANTS  
TRANSMITTER DEPARTMENT**

We have vacancies for Technical Assistants to work as members of engineering teams based at Radio, Television Transmitting Stations throughout Great Britain.

These staff will be involved in the operation and maintenance of a wide range of transmitting and receiving equipment. They will receive full time training, successful completion of which they will qualify internally as BBC Engineers and will have received a BBC certificate.

Applicants, male or female, should be aged between 18 and 26 and have normal colour vision and hearing and a good general education offering 'O' levels (grades A, B, or C) in English, Mathematics and Physics and have read up to 'A' level in Mathematics and Physics. Alternatively an ONC or Part 1 of the City & Guilds T.T.C. (No. 271) would be acceptable.

Candidates should have a relevant practical interest in transmission or electronic techniques and be able to demonstrate their ability to apply their knowledge of electrical principles to practical problems.

Salary: Depending upon experience will be in the range of £2,500 - £2,720 p.a. Additional payments may be made for shift working irregular hours and overtime.

For further details and application form write to **The Engineering Recruitment Officer, BBC Broadcasting House, London W1A 1AA** quoting reference No. 78.E.(TX)4042/WW and enclose an addressed envelope at least 9" x 4." Closing date for completed application forms is 14 days after publication.

**BBC**

8144



**THE DECCA NAVIGATOR,**  
one of the Decca Group of Companies  
specialising in sophisticated avionic  
navigation systems, require experienced

**ENGINEERS**

for repair and overhaul of airborne, avionic equipments. To be based West of London.

Applications will be considered from engineers with experience of complex Electronic equipment.

These positions provide a support to customers both in UK and abroad and successful applicants may be required to travel within the UK and for short visits overseas.

Generous remuneration depending upon experience and qualifications.

Please write, giving details of age, experience and present salary, to:

**Miss B. J. Eatly-Hunt**  
**DECCA NAVIGATOR COMPANY LIMITED**  
**Spur Road, Feltham, Middlesex**

(127)

**Microprocessor Development**

An Engineer with Microprocessor and CMOS/TTL design experience is required to undertake the development of an automatic batch weighing system. It is intended that the successful candidate will be uniquely responsible for this particular project within the development team.

**Control Systems Engineers**

Isca Electronics is an expanding Company in the field of automatic batch weighing and process control. Vacancies exist for Project Engineers and Assistant Project Engineers with an electronics background. The positions offer good salary, interesting and varied work and include some travelling.

Please contact Mr. P. Avon.

(8153)

**Isca Electronics Limited,**

Newtown Industrial Estate,  
Crosskeys, Newport, Gwent.  
NP1 7PX Great Britain.  
Tel: Crosskeys (0495) 270871  
Telex: 497437

We are broadening the scope of the technical services to our engineering laboratories and need to appoint an additional

## STANDARDS ENGINEER

### The Job

To provide a total component selection service to our development engineering staff from a well established standards base.

Our immediate objective is to publish internally a range of catalogues of preferred components and the control of working party activities in this role is important.

A working knowledge of BS9000 and CECC specification systems is required and success in the job may lead to representation in appropriate Trade Association and BSI activities

### The Person

Applicants (men/women) should have a sound engineering background and a thorough knowledge of electro-mechanical components and their applications, allied to experience and understanding of the role of standards in engineering. Formal qualification to HNC level in electronics is desirable, although this is secondary to the main attributes outlined.

### The Company

Designs and manufactures a wide range of capital electronics equipment for both civil and military environments. We are based in Chelmsford, the County town of Essex, which is situated within easy reach of London, the coast and countryside. Locally there are good facilities for education and recreation and housing is relatively plentiful.

For more information concerning the job please ring TED ELLIS on CHELMSFORD 53221 Ext. 80.

Application forms are available from Mr R STANNARD, Personnel Officer, Marconi Communication Systems Ltd., New Street, Chelmsford, Essex, CM1 1PL. Telephone Chelmsford 53221 Ext. 474.

A GEC-Marconi Electronics Company



8138

## YOUNG T.V./AUDIO ENGINEER

required  
at our New Watford premises

We are looking for a young engineer with experience of practical Radio and Television servicing, who will be capable after training at our Woolwich Department of dealing with repairs to complete receivers, PCB panels, car radios and Hi-Fi equipment.

Some technical qualifications are desirable but not essential.

Excellent starting salary is offered, and the benefits include

- ★ Office hours Monday to Friday
- ★ Three weeks' holiday rising to four weeks
- ★ Pension Scheme, Life Assurance ★ Yearly bonus
- ★ Luncheon vouchers 60p per day

If you have the above experience, and are seeking a really progressive position please write or telephone

John Daniel  
Senior Engineer

**Mitsubishi Electric (UK) Ltd.**

Engineering & Service Dept.  
17 Westfield Street, Woolwich, S.E.18  
Tel: 01-317 9049/7696/0582

(8168)

## Gilbert Islands Technical Officer- Telecommunications

If you hold a City and Guilds, Telecommunications Technician's Certificate or equivalent with radio specialisation, and have experience in the installation and maintenance of MF, HF and VHF equipment, you are invited to apply for the following post in these attractive Pacific Islands.

You would be responsible for the installation, maintenance and repair of telecommunications equipment throughout the group, and for the supervision and practical training of local staff.

Salary is up to the equivalent of £7372 pa including a substantial tax-free allowance paid under Britain's overseas aid programme. Basic salary attracts 25% tax-free gratuity.

Benefits include free passages, generous paid leave, children's holiday visit passages and education allowances, outfit allowance, subsidised housing, appointment grant and interest-free car loan.

For full details and application form write quoting MX/320/WD

**Crown Agents**

The Crown Agents for Oversea Governments and Administrations, Recruitment Division  
4 Millbank, London SW1P 3JD

8147

## SEISMIC ENGINEERS

We are looking for two young electronics engineers with degree or equivalent qualifications, to join our marine seismic acquisition company.

This is a field position, with the successful applicants joining the technical crew of our exploration vessel M/V GOEL EGEDE for on-board training in seismic techniques. They will start as Assistant Technicians with a salary of £6,000+ per annum, and one month's leave after each two months on the crew.

The seismic industry offers an interesting career with world-wide travel, and rapid promotion for the right person.

Geophysical Offshore Exploration is a member of the Sefel Group, which has seismic processing centres in Houston, Denver, Calgary and London.

Please write with full curriculum vitae to



General Manager  
Geophysical Offshore Exploration  
Turriff Building  
Great West Road  
Brentford  
Middlesex TW8 9HY

(8182)

## TECHNICIANS

Skilled staff required for the workshop overhaul of electronic equipment installed in civil aircraft.

Applicants not familiar with aircraft equipment should have experience with industrial electronics. City and Guilds or O.N.C. qualifications desirable.

Apply: Mrs. E. J. Bramley,  
Canford Aircraft Equipment,  
Stansted Airport, Stansted,  
Essex.

(8174)

## AUDIO VISUAL ENGINEER

A.V. Service incl. Systems Form Electrosonic, Wollensak, Revox, Kodak, Teac, JVC Video, etc.

Phone or write  
Ian Cuthbertson  
Sound And Vision  
Communications  
23 Redan Place  
London W2  
Tel. 01-229 4406

(8197)

Polytechnic of Central London  
Educational Development Unit  
Audio Visual Services

**TECHNICIAN**  
**GRADE 4 / LANGUAGE LABS**  
**£3441-£3891**

Duties will involve responsibility for day to day servicing and maintenance of language labs in PCL and will also include some work with basic audio visual equipment. Good working knowledge of tape recorders and preferably experience of language laboratory work is required. Qualifications C & G and/or between 7/9 years' experience. From from the Establishment Officer

PCL 309 Regent Street  
London W1R 8AL  
01-580 2020 ext. 212

(8216)

**TRAINEE ELECTRONICS ENGINEER**

Geller Business Equipment Ltd. require a young person (18 yrs. approx.) with some experience or qualification in digital electronics.

The successful applicant will be trained to work in micro-processor based cash registered and calculators. Every opportunity for further advancement in this career opportunity. Good starting salary.

Phone Mr Norman on 01-580 1614  
**GELLER BUSINESS EQUIPMENT LTD.**  
15 Percy St., Tottenham Court Rd., London W1

(8204)

**ARMAGH OBSERVATORY**

Armagh, Northern Ireland  
Applications are invited for the newly created post of

**TECHNICAL OFFICER**

(Computers / Electronics)

The successful candidate will assume responsibility for the development and maintenance of digital and other electronic equipment in our small but dynamic research institute and will also assist the research staff in programming and computer operation.

Applicants should have a degree in electronic engineering or H.N.C. with a keen interest in computer programming and with a minimum of 3 years' relevant experience.

Salary on the IB or IA scales for Research and Analogues Staff.

Further particulars are available from The Secretary, Armagh Observatory, Armagh BT61 9DG, Northern Ireland. Applications close on 30 June, 1978

(8170)

**MACHINE TOOLS**

Electrical / Electronic Service Engineer required to install and service CNC lathes, die sinking and spark erosion machines. The applicant should be London based but prepared to travel nationwide. A good electrical / electronic background essential but product training will be given.

Salary will be commensurate with experience, company car provided, pension and life assurance scheme

Apply in writing giving full details of experience to

Mr. B. C. F. Serjent  
**ELGAR MACHINE TOOL COMPANY LTD.**

BEC House, Victoria Road  
London NW10 6NY (8181)

**ROYAL NATIONAL INSTITUTE FOR THE BLIND AUDIO TECHNICIAN**

(for our new premises in Goswell Rd.)

Our Student Tape Library needs an experienced person to maintain REVOX, NEAL and other equipment and to maintain and operate Telex 300 cassette duplicators. Hours 9.00-5.15. Salary circa £3,200 p.a. plus free lunch in staff restaurant.

Written applications with details of experience including present post and salary to Personnel Officer, 224 Great Portland Street, London W1N 6AA. (8126)

# Senior Electronics Service Engineer

A SENIOR MAINTENANCE ENGINEER IS REQUIRED FOR THE REPAIR AND CALIBRATION OF PROFESSIONAL EQUIPMENT USED IN THE EXECUTION OF RESEARCH PROGRAMMES AT THE LABORATORY.

This involves the maintenance of oscilloscopes, pulse generators, counters, digital voltmeter, precision high power magnet controller and analysers of

various kinds. Experience in fault finding on some of the equipment is necessary.

It is hoped to gradually extend the maintenance capability to include microprocessors, computers and associated peripherals.

Please send for an application form to M. L. Malpass, Personnel Manager, Philips Research Laboratories, Cross Oak Lane, Redhill, Surrey, quoting reference 113.



Research Laboratories

# PHILIPS

8203

# Controls Engineers [Electronic]

Location: E. Midlands

To join a team of engineers responsible for the design and development of electronic control units for aero-powered and industrial gas turbines.

We are now progressing from analogue to digital systems using mini computers and microprocessors, so there is ample opportunity to diversify.

He or she should be conversant with the latest codes and practices of

engineering drawing. Experience in electrical/electronic engineering, particularly with light current semi conductors plus a relevant HNC is essential.

Write today, or telephone, quoting ref. S244, to  
H.P. Cross  
GEC GAS TURBINES LIMITED  
Whetstone Leicester Tel: Leic. 863434

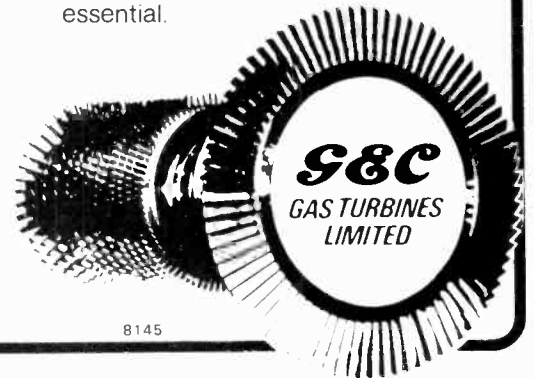

8145

**UNIVERSITY OF WARWICK**  
**Electronics Technician**  
Grade 6 / 7

A first-class practical Electronics Technician is required to take charge of the Electronics Workshop in the Department of Physics, and be responsible for detailed design, construction, maintenance and application of a wide range of electronic equipment. Ability to carry out detailed design work from outline instructions is essential. The successful applicant will probably hold an appropriate HNC or equivalent and have considerable practical experience, partly in a supervisory capacity. Appointment in Grade 6 (£3,654-£4,365 p.a.) or Grade 7 (£4,254-£4,782 p.a.); grade and starting point depending on age, qualifications and experience. Applications should be made by letter giving full details of past experience, age, etc., and the names of two referees. Further particulars may be obtained from and letters of application should be addressed to the Academic Registrar, University of Warwick, Coventry CV4 7AL, quoting Ref. No. 34/T/78. (8148)

**RUFFLER & DEITH LTD.**

A major computer and distributor of electronic video games have the following vacancies in the electronics dept

**ELECTRONIC WORKSHOP MANAGER**

To take charge of the day to day running of the electronics workshop, controlling a small team of bench engineers engaged in the trouble shooting and repair of all types of TTL and microprocessor videogames

Experience in the amusement industry would be an advantage but is not strictly necessary. Salary will be commensurate with qualifications and experience.

**ELECTRONICS ENGINEER**

The troubleshoot and repair of all types of TTL and microprocessor and video games to component level. The successful applicant will ideally be between the ages of 20 to 35 years and possess a working knowledge of at least 3 of the following Power supplies, televisions, TTL logic and microprocessor systems.

Salary commensurate with experience.

For both appointments telephone Adrian Shaw on 870-5224 for an interview.

(8171)

## SITUATIONS VACANT

SURREY EDUCATION COMMITTEE  
GUILDFORD COUNTY COLLEGE OF TECHNOLOGY  
Slade Park, Guildford, Surrey  
Principal: E. L. Ellison, B.Sc. ARCS, C.Eng, MIInstE

Applications are invited for the following posts:  
Appointments will be from 1st September, 1978

### DEPARTMENT OF SCIENCE AND ELECTROTECHNOLOGY

#### SENIOR LECTURER

To be responsible for the running and continuing development of the College's high quality CLOSED CIRCUIT TELEVISION UNIT. Someone with adequate technical knowledge and experience is sought who is able to promote CCTV as a teaching aid, and to help integrate this service into the overall media resources of the College. The successful applicant will also be expected to teach for a significant number of hours.

Salary scales (currently under review).

Senior Lecturer £5,523-£6,909. Plus £150 Fringe Area Allowance.

Generous relocation expenses.

Further details and application form available from the Principal, on receipt of a S.A.E. Completed forms should be returned to the College within two weeks of the appearance of this advertisement.

(8186)

### UNIVERSITY OF CAPE TOWN

#### MARINE ELECTRONICS TECHNICAL OFFICER

An electronics Technical Officer is required to assume duty as soon as possible in the Marine Geoscience Group of the Department of Geology. Duties will include the maintenance and development of marine geophysical equipment both in the laboratory and at sea. Some experience in this field would be a recommendation. The successful applicant will spend several 2-3 week cruises per year aboard the University's research vessel "Thomas B. Davie".

The salary will be on the scale R4 020 x 180 - 5 100 x 240 - 5 580 // x 240 - 6 300 // x 360 - 6 660 per annum plus a pensionable allowance of 15.5% of salary (i.e. maximum monthly salary of R641). In addition, the University offers a housing subsidy, plus medical and pension schemes.

Further details may be obtained from the Professor of Marine Geoscience, Department of Geology, University of Cape Town, Rondebosch, 7700 South Africa.

Applications giving names of two referees must reach the Registrar, University of Cape Town, Private Bag 18, Rondebosch 7700, by 30th June, 1978.

The University's policy is not to discriminate in the appointment of staff or the selection of students on the grounds of sex, race, religion or colour. Further information on the implementation of this policy is set out in a memorandum which is obtainable from the Registrar. (8178)

### ELECTRONIC INSTRUMENT MAINTENANCE.

Rank Research Laboratories Ltd., a Company within the Rank Organisation require a TECHNICIAN with an electrical/electronics background. The successful applicant man or woman will be required to maintain all instruments, test gear and electrical apparatus in working order. The person we are looking for will have already spent some years in industry or the Services in a similar capacity. Salary will be negotiable according to age and experience, backed up by the Rank Organisation benefits package. Write or phone in the first instance for an application form to: W. A. Palmer, Rank Research Laboratories Ltd., PO Box 33, Phoenix Works, Great West Road, Brentford, Middlesex, TW8 9AG. Tel: 01-568 9766 ext 13. (8194)

### BUSINESS OPPORTUNITIES

**BOARD FINANCE COMPANY EXECUTIVE** based in the East Midlands and with some spare capital seeks electronics genius with marketable idea and preferably some capital as business partner. Any sphere of electronics considered especially audio. Write in confidence to W. E. Lyon, 36 Clippson Walk, Peterborough PE3 7EE. (8167)

## VICKERS SHIPBUILDING GROUP LIMITED

Barrow Shipbuilding Works  
Barrow-in-Furness

[A member company of British Shipbuilders]

# INSTRUMENT TECHNICIANS

Instrument Technicians are required by the Barrow Shipbuilding Works Instrumentation Laboratory.

Candidates should be qualified to at least O.N.C. standard in Electrical Engineering or Physics, and will have suitable technical backgrounds. They will have experience in the setting to work and operation of multichannel data recording systems, signal conditioning equipment and transducers, and/or the repair of electronic test and measuring equipment.

Applicants, of either sex, should apply in writing, giving relevant career and personal details to:

Personnel Officer,  
Vickers Shipbuilding Group Limited, (S280/IT/DQ),  
Barrow Shipbuilding Works, P.O. Box 6,  
Barrow-in-Furness, Cumbria LA14 1AB.

## Vickers Shipbuilding Group Limited

A member company of British Shipbuilders

8130



## Recruitment Division

### c. £5000 pa for DESIGN DRAUGHTSMEN

Our clients are a major British company in East Anglia with advanced Development Laboratories and extensive overseas markets. They are currently seeking PRINTED CIRCUIT DESIGN DRAUGHTSMEN (male and female) who can convert a circuit diagram into a printed circuit of the analogue nature, to the level required in product development for the specialised market of professional broadcast equipment. Applicants should have an up to date knowledge of electronic component technology and HNC or equivalent experience. Salaries are negotiable but will range around £5000 per annum. In addition generous relocation expenses are available plus the benefits normally associated with a progressive multi-national company.

To obtain an application form, please write in the first instance, stating any companies to whom your application should not be forwarded, to:

Recruitment Division, Lovell & Rupert Curtis Limited,  
30 Bouverie Street, London EC4Y 8DQ

### THE UNIVERSITY OF MANCHESTER. TECHNICIAN IN THE DEPARTMENT OF PSYCHOLOGY.

A vacancy exists in the Department of Psychology for an Electronics Technician (Grade 5). The successful applicant will be required to develop and construct specialised electronic equipment for research and teaching purposes. He/she will also be expected to maintain a wide range of electronic equipment, and assist in the training of junior staff. Applicants should have ONC or equivalent qualification and at least seven years' relevant experience. Salary scale £3,186-£3,720 p.a. Applications with full details of age, qualifications and previous experience should be sent to Professor J. T. Reason, Department of Psychology, The University, Manchester M13 9PL. (8160)

**EXPERIENCED TECHNICIAN**, 13 years civil/infl. HF/VHF comms. digi./analogue, field/prod. conscientious, competent in design, supervision, training. CG quals. 31 yrs. UK national. radio amateur. African contract expires Sept '78. Open to offers Middle East/Europe. etc. 8166

**V.H.F. SERVICE TECHNICIAN** required by Loudon Car Telephones to work on base station and mobile radio equipment. Very well equipped busy workshop in Croydon, but also held service engineers required in the home counties. Ample opportunities for unlimited overtime. Experienced persons only. Salary and bonuses commensurate with ability. Contact J. S. CLARK, 01-680 1010. (7987)

### ARTICLES FOR SALE

**WE INVITE ENQUIRIES** from anywhere in the world. We have in stock several million carbon resistors  $\frac{1}{2}$ , 1, 2, and 1 watt,  $\frac{1}{2}$  million wire wound resistors 5 and 10 watt - 1 million capacitors - 1 million electrolytic condensers -  $\frac{1}{2}$  million transistors and diodes, thousands of potentiometers, and hosts of other components. Write, phone or call at our warehouse - Broadfields and Mayco Disposals Ltd., 21 Lodge Lane, North Finchley London, N.12. 01-445 0749, 445 2713. (5997)

**OSCILLOSCOPE TEKTRONIX** 545 time delay. Two plug-ins L - CA 33 MHz. £215. Tel. 0273-731391 Hove. (8200)

**SITUATIONS VACANT**

# Electronic Instruments Test & Service

To £5,000+ N. London

- + Bonus
- + Day Release
- + Job Variety
- + Regular Salary Reviews
- + Fast Promotion
- + Free Lunch

These are just some of the benefits you could receive working with our client, a really progressive Company dealing with almost every test instrument on the market - from a 'simple' DVM to computer based ATE and Integrated Circuit test systems

If you have experience in the Test/Calibration or Field Service of analogue or digital test instruments, and are interested in a progressive job with a great future, then contact: Mike Genrat (Ref. MB3)



5-11 Westbourne Grove, London W2.  
Telephone 01-229 9239

8193

# CALIBRATION ENGINEER

We require an experienced Calibration Engineer to calibrate and repair proprietary and special to purpose test gear. Previous experience of microwave calibration would be useful.

If you are interested in furthering your career in the marine electronics field with the excellent benefits a large company group can offer, please write giving brief details of your career to Lesley Buckland, Personnel Officer, Kelvin Hughes, New North Road, Hainault, Ilford, Essex.



**KELVIN HUGHES**  
A DIVISION OF SMITHS INDUSTRIES LIMITED

(8214)

**ARTICLES FOR SALE**

**HALLICRAFTERS** frequency synthesizers. Ex-USAF, 2-34 MHz in 25Hz steps. Variable r.f. output in 5 volts. 1 MHz and 100Hz frequency standard outputs. Circuit diagram and technical information supplied. £50 plus carriage. New plug-ins for CD1212 Scopes. Dualbeam 24 MHz CX1252 £25 plus p & p. Single beam 40 MHz CX1251 £15 plus p & p. Wide range miscellaneous modern electronic supplies callers welcome. Closed all day Tuesday. Skipton Electronic Supplies, 29 Keithley Road, Skipton, Yorks. Tel: 0756 4397.

**SEEN MY CAT?** 5000 odds and ends. Mechanical. Electrical. Cat free. Whiston Dept. WW, New Mills, Stockport. (7983)

**SPECIAL OFFER:** If you can buy the same for less, we will refund the difference. Brand new and full specification pots, switches, transformers, linears, TTL, CMOS, transistors, and other semiconductors. Send large SAE for catalogue. Delta Tech (W) & Co., 62 Naylor Road, London N20. (8140)

**AUTOMATIC TRANSISTOR TESTER** model 1500 by Optimised Devices, Inc. Fully automatic with manual programming and data-logging are possible but not included. Offers: Hughes Micro Electronics Limited, Fuller-ton Road, Glenrothes, Fife. Tel: (0592) 754311. (8115)

# SENIOR VIDEO ENGINEER

A vacancy will shortly occur at the Distributive Industry Training Board's Knutsford Video Centre for a Senior Video Engineer answerable to the Technical Manager.

The Knutsford Centre is a custom-built television studio equipped with Philips LDH.20 cameras and RCA 2 quad TR600 VTR's. Its function is to produce training programmes for the Board and films within the distributive industry.

The successful applicant will have a sound knowledge of the operation and first line maintenance of broadcast television equipment with several years' experience in one or more of the following specialised fields.

Studio Lighting, Sound or Racks Engineering.

The commencing salary is £3873 per annum rising to £4989 per annum by annual increments.

**Please write for an application form quoting REF: ID/25 to the Personnel Manager, Distributive Industry Training Board, MacLaren House, Talbot Road, Stretford, Manchester M32 0FP, within the next SEVEN days.**

(8206)

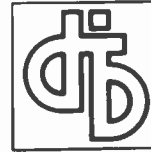

**ARTICLES FOR SALE**

### INVERTERS

To operate mains equipment from 12v to 24v DC on automatic stand-by



Charging safety control to 2kVA at 2.35v per cell 3-60 amp.

### MAINS-STORE

Send for information to  
**Interport Mains-Store Ltd**  
30 Old Bond Street, London W1  
Tel: 01-727 7042 or 0225 310916  
(7979)

### QUARTZ CRYSTAL UNITS from

- 1.0-30.0 MHz
- FAST DELIVERY
- HIGH STABILITY
- TO DEF 6271-A

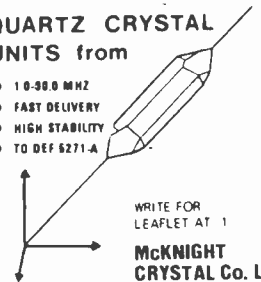

WRITE FOR LEAFLET AT 1

**McKNIGHT CRYSTAL Co. Ltd.**

HARDLEY INDUSTRIAL ESTATE HYTHE SOUTHAMPTON SO4 6ZY

TEL HYTHE 848961 STD CODE 0703

(6044)

**LOGIC PROBE** suitable TTL/CMOS 5-15V indicates logic states and trigger pulses £12 inc. C. Marshall. 22 Oakfield Road, Croydon, Surrey, CRO 211A. (8207)

**NATIONAL 81L595 OCTAL TRI-STATE BUFFERS.** One-up 105p. Ten-up 95p. Postage 20p/order. J. Hawthorne, 23 Iver Lane, Cowley, Middx. UB8 2JD. (8167)

**DYMAR "LYNX" RADIO-TELEPHONES,** brand new, with fitting kit and six month warranty £220 each (H.B. 20 watt). Nolton Communications, Cheshunt. Phone Waltham Cross 33555. (8164)

**PHILIPS EL3400A** 1in VTR VID/HF output. 24 tapes, spares, slight attention required £80. Jacobs. Tel: 04548-207 business hours only. (8162)

**BATTERY INDICATOR/level meters,** moving coil. Flush mounting. Large quantity surplus 50p each in 100's. Sample £1. Also quarter ton new reeled Nichrome resistance wire. 0076 350 HMS per foot. Offers all or part. EES Ltd, Clifford Road, Monks Road, Exeter. Phone 56280 36489. (8199)

**SCREWS** 0-16 BA brass steel cadmium nickel plated. List R3 Clerkenwell Screws. 109 Clerkenwell Road, London EC1 405-6504. (8165)

**ADAPTOR AERIAL TO TRANSMITTER** ZA56234 MWB/XB/940- highwattage, first class engineering, wide communications frequency range, £45. CT423 Calorimeter power meter for radar frequencies, ex W.D. 10AF/6625-99-943-9347, £50. Seam Clark 40ft pneumatic mast, superb quality in unopened original pack, £300. 10 way 300 volt max. cable 7/010 max temp. 80°C. All prices plus carriage and V.A.T. will negotiate for quantity. Many wholesale and retail bargains for callers. Surplus purchased - established over 20 years. G. W. M. Radio Ltd., 40/42 Portland Road, Worthing, Sussex. Tel. 34897.

**TELETYPE KSR33,** complete unit includes ASCII coded keyboard, stand, P.S.U., excellent working condition, £200. - Phone Upminster 28233, evenings. (8188)

**OSCILLOSCOPE,** tel equipment D65 £240. Waveform generator, feedback TWG 501, £65. Dual power supply, advance PMD 18-1, £35. All as new, privately used only. - Tel 0305 52136. (8190)

## ARTICLES FOR SALE

### EXCLUSIVE OFFER

#### HIGHEST QUALITY 19" RACK MOUNTING CABINETS

Over 60 types available from 12" to 90" high Also twins, triples & consoles. Below are only a few types. Please send for full list.

Ref	Ht"	Width"	Depth"	Price
PE	10	21	13	£10.00
LL10	54	21	18	£20.00
TT	64	25	26	£45.00
SL	71	25	26	£50.00
PT	72	20	21	£20.00
TL	75	22	21	£20.00
ST	85	22	24	£70.00

Rack cabinets for RA 17 117 £30.00

#### AUDIO AND INSTRUMENTATION TAPE RECORDER-REPRODUCERS

- \* Plessey ID33 Digital Units, 7 tracks 1/2"
- \* Plessey M5500 Digital Unit, 7 tracks 1/2"
- \* Ampex FR-1100, 6 speeds, stereo 1/2"
- \* Ampex FR600, 4 speeds, 7 tracks 1/2"
- \* D.R.I. RM1, 4 speeds, 4 tracks 1/2"
- \* EMI TR90 2 speeds, 1 track 1/2"
- \* Mincom CMP-100, 6 speeds, 7 tracks 1/2", 1 1/2"
- \* Leavers Rich DA-2P, 2 speeds, 2 tracks 1 1/2"
- \* Leavers Rich Console 2 track 1 1/2", 2 speeds

Prices of above £70 to £500

Also Transport Decks only available

We have a large quantity of "bits and pieces" we cannot list — please send us your requirements, we can probably help — all enquiries answered

#### All our aerial equipment is professional MOD quality

- \* Ficord 101S Tape Recorders £24.00
- \* Stenorette L Tape Recorders £29.00
- \* DG-7-32 C.R.T.s £4.00
- \* DG-7-5 C.R.T.s £4.00
- \* EMI R-301 Tape Recorders for parts £15.00
- \* Rascal SA Counters Several types P.U.R.
- \* Uniselectors, 10 Bank 25-way £3.50
- \* Solartron LM 1420 D.V.M.s £140.00
- \* Marconi O.A.1094A Spectrum Analysers £190.00
- \* 40ft. Sectional Aluminium Masts, complete £55.00
- \* Rascal MA-79 Universal Drive Units £450.00
- \* Rascal RA-17P Receivers (new) £950.00
- \* Tone Coded Voice Frequency Teleprinters P.U.R.
- \* Rhode & Schwarz ESM Tunable VHF Receivers £285.00
- \* Rhode & Schwarz HFH Field Strength HF Loop Aerials £140.00
- \* Narda 504 Freq. meters 200/500 M/c/s £45.00
- \* Corsor CT454 Electronic Volt ohm meters £50.00
- \* B&K 2409 Electronic Multimeters £55.00
- \* Multi-purpose Trolleys with Jacks 19" x 17" £18.00
- \* Rascal RA-17L Receivers £325.00
- \* Rhode & Schwarz fibreglass HA Diversity Dipoles £120.00
- \* Ion pump power supply, E.H.T. £44.00
- \* E4-2B CRTs £16.00
- \* SE5ZA CRTs £18.00
- \* 3AZP 2 (DMN/9/11) CRTs £18.00
- \* E.M.I. Documents CCTV Outfit £250.00
- \* Advance 3KVA CV Transformers £150.00
- \* Grainger HF Log Aperiodic Aerial P.U.R.
- \* Metal V.D.U. Tables 30" x 36" x 30" £20.00
- \* Davian Logic Testers £28.00
- \* General Radio Strobotacs £30.00

#### MANUALS

We have a quantity of Technical Manuals of Electronic Equipment, not photostats, 1940 to 1960, British and American. No lists. Enquiries invited.

- \* Data Efficiency Responsters 240v £28.00
- \* Belling Lee 100 Amp Interference Filters £76.00
- \* Airtec 702 Sig. Gen. 30/300KCS £35.00
- \* Oscilloscope Trolleys from £12.00
- \* I.B.M. Video Display Units 4 col £48.00
- \* Solartron CD 524 Oscilloscopes £95.00
- \* AVO VT Voltmeters CT-471A £75.00
- \* Rascal MA197B pre-Selectors £65.00
- \* Collins 500 watt 2-18 mcs. Transmitters £1000.00
- \* Collins KWT6 SSB 500w Transceivers £1250.00
- \* Collins KWT6 200 m/w AM Transceivers £750.00
- \* STC RA5 2/25 mcs Receivers Diversity £140.00
- \* Rack Mounting Operator Tables £18.00
- \* Gaumont Kalee 564 Flutter Meters £75.00
- \* Hewlett Packard 618B Sig. Gen. 3 8/72 GHz £120.00
- \* 10ft Lightweight Lattice Sections, 6" sides £18.00
- \* 30ft Lattice Masts, 14" sides £55.00
- \* Heavy Aerial Rotators P.U.R.
- \* 75ft Aluminium Lattice Masts, 20" sides £400.00
- \* Rhode & Schwarz SBR sig gen. 1.6/2.4 gmc £470.00
- \* Large Aerial Turning Units P.U.R.
- \* 45 feet Uniradio C-Coax 50 ohms £2.00
- \* Baluns Professional E exterior 600/75 ohms £8.00
- \* Addo 5/8 Track Tape Punches £48.00
- \* Quality Weather Vanes 8 contacts (unused) £25.00
- \* Rascal MA-175 I.S.B. Modulators (new) £45.00
- \* Inside Cabinet Shelf Sliders £3.00
- \* Tally 5/8 Track Tape Readers 60 cps £48.00
- \* Tally 5/8 Track Tape Readers Track Spooling £65.00

We have a quantity of Power Transformers 250 watts to 15KVA at voltages up to 40KV. Best quality at low prices. Lists available

- \* Rascal RA-63 SSB Adaptors, new £70.00
- \* Rascal RA-298 L.S.B. Transmitted Converter (new) £120.00

We have a varied assortment of industrial and professional Cathode Ray Tubes available. List on request

PLEASE ADD CARRIAGE AND V.A.T.

**P. HARRIS**  
ORGANFORD  
DORSET

BH16 6BR  
BOURNEMOUTH (0202) 765051

#### SOWTER TRANSFORMERS

MAKE YOUR OWN MICROPHONE SPLITTER WITH SOWTER TRANSFORMER TYPE 4079. This transformer has a high impedance nominal 200 ohm primary, balanced and centre-tapped, and two secondaries each for 200 ohm loading. Suitable for most types of microphones requiring loads up to 1200 ohms. It will handle 2.3 volts (rms) at 30 Hz so that normal levels DISTORTION IS NEGLIGIBLE. When each secondary is loaded with any values of resistance from 200ohms to 2500 ohms THE FREQUENCY RESPONSE IS PLUS/MINUS 1/4dB FROM 20 Hz to 20kHz.

The transformer is contained in a Muesal Can 33 mm. diameter x 27 mm high with two tapped holes in the lid for fixing. (The height is increased to 85 mm if a one hole fixing bush is required. The hum reduction of the can is at least 30 dB and the colour coded end leads are normally 20 cm. in length. Further details of THE CONSTRUCTION OF A SPLITTER USING THIS TRANSFORMER ARE AVAILABLE ON REQUEST.

The following price breakdown is valid for three months. In lots of 1-5 6-12 13-24

PRICE EACH £7.55 £7.25 £7.05

STRICTLY NETT. EX WORKS IPSWICH

Extras are 20p per transformer for postage and packing, and VAT is 8% overall. Dispatch for small quantities is EX STOCK but otherwise not more than 2 weeks from receipt of remittance. FOR EXPORT add as AT COST and there is no VAT. The weight of one transformer and packing is approx. 200 gms.

We also invite your enquiries for PRACTICALLY ANY TYPE OF AUDIO TRANSFORMER and will quote by return

KINDLY NOTE OUR NEW ADDRESS AND TELEPHONE NUMBER

E. A. SOWTER LTD.  
Transformer manufacturers and designers  
The Boatyard, Cullingham Road, IPSWICH,  
Suffolk IP1 2EG, ENGLAND.  
Tel: 0473 52794 and 0473 219 390

#### AIR LINK TRANSFORMERS

Transformer Manufacturer

Try us first

Competitive price quotations given for large or small quantities, fast deliveries.

Phone: Exning (063877) 321

AIRLINK TRANSFORMERS

White Hall, 75 Chapel St., Exning

Newmarket, Suffolk

8059

#### TRANSFORMER PROBLEMS?

1VA-1KVA Prototypes in 7-10 days. Phone Vince Sellar on 06076-66716.

#### TRENT TRANSFORMERS LTD

Chapel Street

Long Eaton, Nottm.

7909

#### FOR SALE

As a going concern, small East London business specialising in selling Public Address Sound Installations direct to clubs, pubs, churches, factories, and other non-domestic users. Certain amount of manufacturing. Old established and highly regarded. Staff, few in number but very competent and loyal. Excellent potential. Sale through ill-health of owner. Principals only. Write Box WW8187.

(8187)

#### EQUIPMENT WANTED

#### BROADFIELDS AND MAYCO DISPOSALS

21 Lodge Lane, N. Finchley

London, N12 8JG

Telephone:

01-445 2713

01-445 0749 01-958 7624

MAY WE ASSIST YOU TO DISPOSE OF YOUR SURPLUS AND REDUNDANT STOCKS

We will call anywhere in the British Isles, and pay SPOT CASH for Electronic Components and Equipment.

#### A.R. Sinclair

Electronic Stockholders  
Stevenage 812193

We purchase all types of Mechanical and Electronic Equipment and Surplus stocks.

(8189)

COLOUR, UHF AND TV SPARES. CEEFAX, ORACLE IN COLOUR. MANOR SUPPLIES "EASY TO ASSEMBLE" TELETEXT KIT. Including TEXAS Decoder, Aerial Input, completely external unit, no further connections to set. Full facilities, mixed TV programme and Teletext, Newsflash, Update, and many special features not found in other units. Demonstration model in operation at 172 West End Lane, NW6. Phone or write for further information.

TEXAS TIFAX XM11 Decoder module, new, £130, p/p £10.00. NEW COMBINED COLOUR BAR GENERATOR PLUS CROSS HATCH KIT (Mk4) UHF Aerial input type.

Eight vertical colour bars plus R-Y, B-Y, Luminance combinations, Grey scale etc. Pushbutton controls. Battery operated £35\*, De Luxe case £4.80\*, aluminium case £2.40\*, battery holders £1.50\*, mains supply kit £5.78\*, p/p £1.00. Built and tested (battery) £58\*, p/p £1.20.

CROSS HATCH KIT, UHF Aerial input type, also gives peak white and black levels. Battery operated, £11\* p/p 45p. Add-on Grey Scale kit £2.90\* p/p 35p. Aluminium case £2\*, p/p 85p. Cross Hatch Unit, complete and tested in De Luxe case £20.80\*, p/p £1.

"WIRELESS WORLD" TV Tuner and FM Tuner Projects by D. C. Read. Kits of parts available, CRT test and reactivator kit for colour and mono £19.80 p/p £1.20. UHF Signal Strength Meter kit £18\* p/p 90p. 625 TV IF Unit for Hi-fi amps or tape recording £6.80 p/p 70p. Decca Colour TV Thyristor Power Supply Unit, incl. H.T., L.T., etc. Incl. circuits £3.80 p/p £1.20 Bush AR23 (A807) decoder panel £7.50, p/p £1. Bush 161 T-B panel A634 £3.80, IF panel A583 £3.80 p/p 90p. Bush Portable TV 11V stab power supply unit £4.80 p/p £1. Bush CTV 25 Convergence Panel plus yoke, blue lateral £3.60 p/p 90p. Philips Single Standard Convergence Units, complete, incl. 16 controls £3.75 p/p 85p. Colour Scan Coils, Mullard or Plessey, £6 p/p 90p. Mullard AT 1023/05 Converg. Yoke £2.50 p/p 75p. Mullard or Plessey Blue Laterals 75p p/p 35p. BRC 3000 type Scan Coils £2 p/p 90p. Delay Lines: DL20 £3.50. DL50 £3.50. DLIE, DLI 85p p/p 45p. Lum delay lines 50p p/p 40p. G8 Tripler £6. BRC 300 Tripler £6.80 p/p 75p. Others available.

Philips G8 Decoder part-complete £2.50 p/p 75p. GEC 2040 EX-Rental Panels. Decoder £5.00. Time Base £5.00, p/p 90p. VARICAP TUNERS UHF: Gen. instr. £3.50. ELC 1043 £4.50. ELC 1043/05 £5.50. VHF: ELC 1042 £4.80, Philips VHF £3.80. Salvaged UHF & VHF Vari-caps £1.50 p/p 35p. VARICAP CONTROL UNITS, 3 position, £1.20. 4 PSN £1.50, 5 PSN £1.80, 7 PSN £2.80. Special offer 6 position £1, p/p 35p. UHF Transd. Tuners incl. slow motion drive £2.80. 4 position push button £2.50. 6 psn. £4.20, p/p 90p. Helical Pots 100K, 4 for £1.20 p/p 30p. Thorn 850 Dual Std. Time Base panels 50p. Philips 625 IF panel incl. oct. 50p p/p 70p. Mullard Mono Scan Coils for Philips Stella, Pye, Ekco, Ferranti, Invicta £2.00 p/p 85p. Large selection LOPTS, FOPTS available for most popular makes. MANOR SUPPLIES 172 WEST END LANE, LONDON, N.W.6. Shop Premises. Callers welcome. Thousands of additional items available not normally advertised. (Nos. 28, 159 buses or West Hampstead-Bakerloo Line and British Rail). Mail Order: 64 Golders Manor Drive, London, N.W.11. Tel: 01-794 8751. V.A.T. Please ADD 12 1/2% TO ALL PRICES (EXCEPT WHERE MARKED\*. V.A.T. 8%).

(60)

#### AN INTRODUCTION TO MICROCOMPUTERS

VOL 0 — BEGINNERS BOOK

Price: £5.30

written for the complete beginner explains what a computer system consists of — its component parts and what they can do for you.

VOL 1 — BASIC CONCEPTS

Price £5.30

takes you by the hand from elementary logic and simple binary arithmetic, every aspect of microcomputers is covered.

VOL II — SOME REAL PRODUCTS

Price: £10.80

covers real microcomputers in considerable detail. Every major microcomputer 4 bit, 8 bit or 16 bit is described. More than 20 microcomputers in all.

8080 PROGRAMMING

Price: £5.30

for logic design.

SOME COMMON BASIC PROGRAMS

Price: £6.30

describes 76 short programs.

6800 PROGRAMMING

Price: £5.30

for logic design.

★ ALL PRICES INCLUDE POSTAGE ★

#### THE MODERN BOOK CO.

SPECIALISTS IN SCIENTIFIC & TECHNICAL BOOKS

19-21 PRAED STREET

LONDON W2 1NP

Phone 723 4185

Closed Sat. 1 p.m.

44:

SOLAR CELLS: bits, books, and bargains. Send stamp or list of 95p for Solar Cell booklet and Data sheets. Edencombe Ltd, 134 Nathans Road, North Wembley, Middlesex HA0 3RX. (8061)

TV TUBE rebuilding. For all supplies, equipment plant and training — Western Whybrow Engineering, Praa Sands Cross, Penzance (073 676) 2265. (8048)

LAB CLEARANCE: Signal Generators; Bridges; Waveform, transistor analysers; calibrators; standards; millivoltmeters; dynamometers; KW meters; oscilloscopes; recorders; Thermal, sweep, low distortion tone RMS, audio FR deviation. Tel. 040-376236. (8092)

THE SOUTHERN ELECTRICITY BOARD has for disposal radio telephone equipment — Pye, boat mounted 'Cambridge' type AM10B. Write or telephone: 7 Oxford Road, Newbury, Berks, telephone 40840 (Mr F. G. Read), for further details.

PROJECTION TV OPTICAL UNITS ex-White Ibbotson TV, circa 1930, including parts EHT and power unit. — Offer to 070 559 4821. (8156)

LINSLEY-HOOD 75 WATT POWER AMP MODULES, built and tested, from £13.50 each. Complete module kit £10.50. Large range of spares in stock. Linsley-Hood 75 watt amps constructed and repaired. SAE for list. I. G. Bowman, 59 Fowey Avenue, Torquay, S. Devon. (8183)

LOGIC PROBE suitable TTL/CMOS 5-15V indicates logic states and trigger pulses, £12 inc. C. Marshall, 22 Oakfield Road, Croydon, Surrey, CR0 211A. (8207)



## ARTICLES FOR SALE

### ENAMELLED COPPER WIRE

s.w.g.	1lb reel	1/2lb reel
10 to 19	£2.95	£1.60
20 to 29	£3.15	£1.80
30 to 34	£3.45	£1.90
35 to 40	£3.65	£2.10

All the above prices are inclusive of postage and packing in UK

### COPPER SUPPLIES

102 Parrawood Road, Withington, Manchester 20  
Telephone 061-445 8753

**OLIVETTI PROGRAMMA** calculator with handbooks and magnetic cards cost £1,200, accept £100. Small photocopier 3M, cost £160, accept £60 o.n.o. Telephone Walton on Thames 40087. Buyer collects. (£180)

**FILM RECORDER 16 MM 2** or 16 frame sec 24v DC motor with cassette used to record from gunsight via prism ass., good cond., £16. **HANDSETS** No. 3 M.C. type rubber covered with press to talk swt. suit 19 or 62 set, elec okay, store soiled, £2.50. **DYNAMOTOR UNIT** 27.5v to 220/400v DC, can be used as powerful DC motor after removing ext fan ass., 1 x 1/2 in shaft, approx size 6 1/2 x 3 1/2 in, will run from 6v DC up, new, £6.50. **SOLID STATE SWT**, opto, coupled control, 5 to 15v DC, will swt 240v at 5 amps 10 on h/s, £2.40. **X. BAND ATTEN** var. approx. 40Db w.g. 16 size, new, £4.50. **E.H.T. UNITS** 200/250v I/P provides stab o/p of 12 to 15Kv stab at 300Ua, adjustable provision for metering o/p new cond. with circ. 19in panel at £25. **PANEL METERS** 1 Ma FSD special scale 2in dia. £1.30. 100 Ua FSD scale 0 to 100, 2in dia. £3, both new. **VHF PWR TRANSIS** 2N3375 stud type, new, £1.80. **I.F.F. TRANS-PONDERS** type APX-6 tune around 1 Km/c band with cavities, 60 Mc/s IF strip large number of misc parts less valves, ext. soiled with circ £10.80, front panel only with cavities and IF strip £6.50. **BATTERIES** sealed lead acid type 6v 1.8 A/Hr size 2 1/2 x 2 x 2in, new, £5.40. **H.F. AIRCRAFT Rx** type R4187 with control box, 2.8 to 18Mc/s crystal controlled 24 chan 15 min valves double conversion 24/19v I/P with H/Bk £18.30. **U.H.F. Rx** R361 ex USAF 2225 to 400Mc/s single chan crystal controlled, dual conversion, 230v I/P 19in rack mt with circ 30. **AERIAL SYSTEM** for 183.6Mc/s 8 element yagi, 11ft long, new, £21.60. **C.R.T. VISOR** with magnifier padded eyepiece size 5 x 4 x 7in, okay colour slide, viewer, new cond., £3. **PULSE GENERATORS** (UPM-15) I/P 115v 50 c/s O/P range 50c/s to 10Kc single or double pulse o/p, var width, var delay, o/p 0 to 200v + in transit case with leads £25. **SIG GEN** portable battery operated used to test VHF & UHF D.F. equip crystal controlled O/Ps on 105, 125, 150, 230, 300, 390Mc/s uses int 6v batt., new cond., with accs. & H/Bk £65. **AERIAL DRIVE UNIT** & 360ft Ind small radio compass Ac drive unit 24v DC about 6 RPM max. suitable 2mt & up beam complete with 360ft Desyn type remote Ind. again 24v. £13. **TEST SETS**, special purpose, type 5G in case, size 17 x 12 x 7in, contains 4 panel meters 500Ma x 2, 0 to 40v DC, 0 to 1 amp DC misc parts etc £9. Type 69 mains I/P with HT P.U. 30Mc/s IF strip, 4in 100 Ua lin scale meter etc in case £10.80. Type 56 mains I/P with freq conv unit, pair of 50 ohm atten 0 to 10 & 0 to 50Db, coax fittings BNC etc in case with circ £12. Type AWM-33 American equipment contains plugs & sks, HD rotary swts, power filters, relays, trips, swt, larger number of high grade parts in carrying case, size 14 x 16 x 10in, £16. A fuller description of these test sets is given on our stock list. The following for callers sold as is with circs Sig Gens CT218 85Kc to 30Mc/s AM/FM mains £33 Advance Freq Counters 10Mc/s 7 digit also count & period £42. Marconi spec analyzers 3/30 Mc/s OA1094 £55. Special purpose K band Rx units with trav wave tube etc £45. Equipment listed ex equipment unless stated new, prices include carr. and Vat. SAE for list 19 or enquiry. A. H. SUPPLIES, 122 HANDSWORTH RD, SHEFFIELD, S9 4AE. Ph 444278 (0742). (8123)

### THE FABULOUS D2 MICROPROCESSOR EVALUATION KIT FROM MOTOROLA

Featuring '24 key keyboard 'Seven segment display 'Cassette interface 'Erom & Ram Expandable 'Interface Capability 'Full Documentation '5 Volt power supply required 'One year's FREE membership of The Amateur Computer Club with every purchase' £176 + £1.50 P&P + 8% VAT

### ENAMELLED COPPER WIRE

SWG	1lb	8 oz	4 oz	2 oz
14-19	2 60	1 40	66	55
20-29	2 80	1 60	85	65
30-34	3 00	1 70	95	70
35-40	3 35	1 90	1 10	79
40-43	4 50	2 50	1 90	1 25
44-46	5 00	3 00	2 10	1 65
47	8 00	5 00	3 00	1 76
48	15 00	9 00	6 00	3 30

Tinned Copper. Even Gauges 14-30 £3 per lb Multicore 60/40 Solder 18SWG £3 24 per lb Prices include P&P and VAT SAE brings list of copper and resistance Wires

THE SCIENTIFIC WIRE COMPANY  
PO Box 30 London E.4 (7771)

### INVERTERS

Highest quality OC-AC. Also "no break" (2ms) static switch, 19" rack.

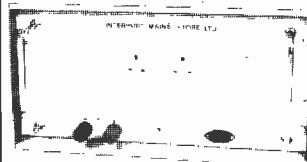

Also for thyristor chargers a separate

### CHARGE CONTROLLER

Variable 2.35v per cell to max 2 kVA.

Interport Mains-Store Ltd.  
POB 51, London W11 3BZ  
Tel: 01-727 7042 or 0225 310916 (8142)

### SERVICES

**CIRCUIT DESIGN** and prototype construction. Instrumentation, test rigs, production run designs to your requirements. Professional audio, analogue, digital, SC/MP microprocessor circuits our specialities. **HAMILL ELECTRONICS LTD.**, Box BCM-2090, London WC1V 6XX. Tel.: 01-542 9203. (7984)

### VIDEO EQUIPMENT

May we assist in your purchase or disposal? We specialise in the sale and purchase of all Video equipment both new and secondhand. We maintain a register in order to quickly and efficiently cross reference both disposal and wants.

\* Ring Derek Pattinson now and discuss your requirements.

### Crofton Electronics Ltd.

35 Grosvenor Road,  
Twickenham, Middlesex.  
Tel. 01-891 1923 (8211)

### EURO CIRCUITS

Printed Circuit Boards — Master layouts — Photography — Legend printing — Roller tinning — Gold plating — Flexible films — Conventional fibre-glass — No order-charge or too small — Fast turnaround on prototypes. All or part service available NOW 7669

### EURO CIRCUITS TD.

Highfield House  
West Kingsdown  
Nr. Sevenoaks, Kent. WK2344

### FOR INDUSTRIAL MICROCOMPUTER APPLICATIONS

Complete systems inc. software and interfaces. Very competitive prices

### WESTEK ENG. LTD.

Ibstock (0530) 60981 (8139)

## COURSES

### The Polytechnic of Central London

School of Engineering and Science

### Part-time MSc Course linked with Industry in Communication Systems

Students attend on one day a week for two years and undertake a detailed study in which the fundamental theoretical topics are considered alongside their practical implementation involving both traditional and newly-emergent digital techniques.

Further details and application forms from The Registry, School of Engineering and Science, PCL, 115 New Cavendish Street, London W1M 8JS. Tel. 01-486 5811. (8169)

## ARTICLES WANTED

### WANTED IN LARGE QUANTITIES

Electronic components, resistors, capacitors, potentiometers, chassis loudspeakers, semi-conductors, diodes, TV tubes, especially colours, etc., etc. First or second grades. Finished or incomplete products, record players, amplifiers, radios, tuners, tape recorders, enclosures, etc., etc. etc

We will buy complete factories and pay cash

TEL. 01-491 4636  
E.C.E. AVON HOUSE  
360/366 OXFORD STREET  
LONDON, W.4 (7950)

### ★ MINICOMPUTERS ★ PERIPHERALS ★ INSTRUMENTATION

For fastest, best CASH offer, phone

COMPUTER APPRECIATION  
Godstone (088 384) 3221 7677

### MINICOMPUTERS PERIPHERALS INSTRUMENTATION

For fastest, better CASH offer  
Phone:

CHILTMead LTD.  
Reading (0734) 586419

**TURN YOUR SUPPLUS** Capacitors, transistors, etc., into cash. Contact **COLES-HARDING & Co.** 103 South Brink, Wisbech, Cambs. 0945-4188. Immediate settlement. We also welcome the opportunity to quote for complete factory clearance. (7439)

**B.D. ELECTRONICS** offer prompt settlement for surplus electronic components, t.v./audio spares are of particular interest. Contact Miss Hughes, 9 Westhawe, Bretton, Peterborough. Tel 265219. (7632)

**WE PURCHASE FOR CASH** the following: R. F. Power Transistors, Varactor Diodes, and all special components normally used in VHF/UHF Transmitting equipment. **MODULAR ELECTRONICS**, 95 High Street, Selsey Sussex. PO20-0QL. Tel. Selsey 2916. (7696)

### SERVICES

**PRECISION SHEET METAL** work, chassis, panels, etc., steel, stainless or aluminium, long/short runs, good deliveries. **EES Ltd.**, Clifford Rd Monks Road, Exeter 52280 36489. (8060)

**MICROPROCESSOR KIT** building, fast turnaround 10% price. **Sunderland**, 47 Eastern Ave, Reading, Berks. (8163)

### SURPLUS WANTED

**Fasteners** — nuts, bolts, screws, threaded inserts, washers, cable clips, plastic fasteners, all kinds of rivets — Pop, Avex, etc

**Small components** — Terminals, switches, gears, springs, ball races, counters and other mechanical and electrical parts.

**Small materials** — off-cuts and short lengths of metal and plastic sheets, tubes and sections.

**Small engineers' tools** — taps, dies, drills, reamers, abrasives, etc

**Small hand tools** — all kinds.

**A. C. TOWNLEY LIMITED**  
Harehill, Todmorden, Lancs, OL14 5JY  
Telephone: 070-681 2601 & 070-681 5246 8155

### WE PURCHASE ALL FORMS OF ELECTRONIC EQUIPMENT AND COMPONENTS, ETC.

SPOT CASH  
**CHILTMead LTD.**  
7, 9, 11 Arthur Road  
Reading, Berks.  
Tel. (0734) 582 605

**WANTED**, all types of communications receivers and test equipment. Details to R. T. & I. Electronics Ltd., Ashville Old Hall, Ashville Rd., London, E.11. Ley 4986. (63)

**WILL BUY ANYTHING**, any quantity if price is right. Ring Stan Willetts, West Bromwich, 021-553 0186. (7813)

**WANTED**. All types Pye radio telephone equipment. Top prices paid. Telephone (Cambridge) 0223 860555 or 50668. (7944)

**ELECTRONIC SCRAP**. Components, etc., Receivers, Transmitters Test Equipment wanted. Ferrographs from £15 in stock. Contact M & B Radio, 86 Bishopgate Street, Leeds 1. Tel. Leeds 35649. (8011)

**WANTED SEMICONDUCTORS** and clean new components. Quotations by return. — Hewitts, 52 Barkby Road Syston, Leics. LE7 8AF. (8201)

**STORAGE SPACE** is expensive, why store redundant and obsolete equipment? For fast and efficient clearance of all test gear, power supplies, PC boards, components, etc., regardless of condition or quantities. Call 01-771 9413. (8209)

**WANTED** — up to ten EC.80 or 6Q4 valves, Harris, 5 Glenferness Avenue, Bournemouth BH4 9ND. (8124)

# I.C.E. MULTIMETERS

## TWICE the information in HALF the size

The I.C.E. range of multimeters provides an unparalleled combination of maximum performance within minimum dimensions, at a truly low cost. Plus, a complete range of add-on accessories for more ranges, more functions.

All I.C.E. multimeters are supplied complete with unbreakable plastic carrying case, test leads, etc., and a 50-plus page, fully detailed and illustrated Operating and Maintenance Manual

Now available from selected stockists. Write or phone for list, or for details of direct mail-order service

### Supertester 680R (illustrated)

20k $\Omega$ /V - 1% f.s.d. on d.c.  
4k $\Omega$ /V - 2% f.s.d. on a.c.  
80 Ranges - 10 Functions  
140 x 105 x 55mm

**£32.00 + VAT**  
(For Mail Order add 80p P&P)

### Supertester 680G

20k $\Omega$ /V - 2% f.s.d. on d.c.  
4k $\Omega$ /V - 2% f.s.d. on a.c.  
48 Ranges - 10 Functions  
109 x 113 x 37mm

**£24.50 + VAT**  
(For Mail Order add 80p P&P)

### Microtest 80

20k $\Omega$ /V - 2% f.s.d. on d.c.  
4k $\Omega$ /V - 2% f.s.d. on a.c.  
40 Ranges - 8 Functions  
Complete with case - only 93 x 95 x 23mm

**£16.60 + VAT**  
(For Mail Order add 80p P&P)

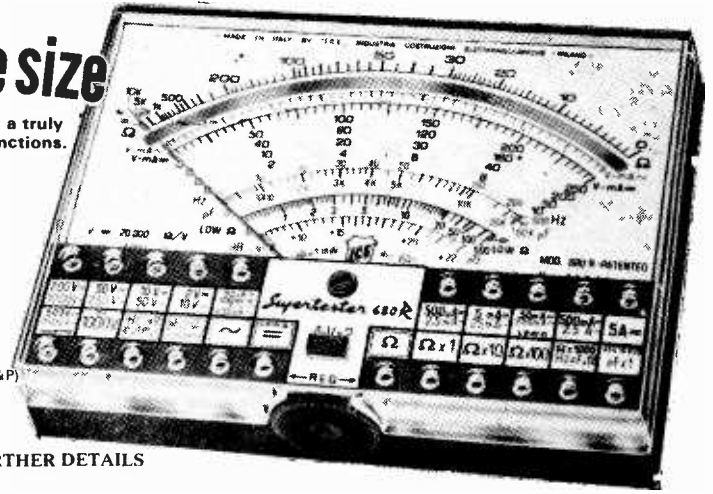

Electronic Brokers Ltd.  
49-53 Pancras Road, London NW1 2QB  
Tel. 01-837 7781

WW - 106 FOR FURTHER DETAILS

## INDEX TO ADVERTISERS

Appointments Vacant Advertisements appear on pages 135-151

	PAGE		PAGE		PAGE
Adcola Products	30	H/H Electronics	96	Powertran Electronics	106, 107
AEL Crystals Ltd.	35	Harmsworth Townley Co. Ltd.	28	Pye Electro Devices	24
Ambit International	100	Harris Electronics (London) Ltd.	14, 32	Pye Unicam Ltd	Cover iii, 17
Antex Ltd.	73	Hart Electronics	100		
Aspen-Electronics Ltd.	99	Heyco Mfg. Co. Ltd.	32	Q-Max Electronics Ltd	20
Astra-Pak	99	Hilomast Ltd	22		
Audio Amateur	111				
Audix Ltd.	84	Icon Designs	10	Racal Thermionic	7
Baker Loudspeakers Ltd.	94	ILP Electronics Ltd.	93, 101	Radford Lab. Insts. Ltd.	34
Bamber Electronics	134	Industrial Tape Applications	97	Radio Components Specialists	114
Barrie Electronics Ltd.	109	Integrex Ltd.	102, 103	Radio Shack Ltd.	104
Bayliss, A. D. & Sons Ltd.	25	Interport Mains-Store Ltd.	151	Ralfe P. Electronics	98
Bell & Howell	12, 13	ITT Comp. Resistors	28	R.C.S. Electronics	30
Bentley Acoustic Corp. Ltd.	116	ITT Instrument Services	112	Rola Celestion Ltd.	113
Beyer Dynamics (GB) Ltd.	23			R.S.T. Valves Ltd.	119
Bi-Pak Semiconductors Ltd.	105	JPS Associates	35	RTVC	121
Boss Industrial Mouldings Ltd.	8				
Brandenburg	133	K&A Distributors	132	Sandwell Plant Ltd.	99
Cambridge Learning	27	Keithley Instruments Ltd.	84	Scopex Instruments Ltd.	112
Caracal Eng.	132	Labgear Ltd.	25, 34	Scott, James (Elec. Eng. Ltd.)	22
Carter Associates	132	Langrex Supplies Ltd.	119	Semicon Indexes	111
Catronics	99	Lawtronics Ltd.	34	Servo & Elec. Sales Ltd.	134
CEC Corporation	18	Levell Electronics Ltd.	3	Service Trading Co.	118
Chiltmead Ltd.	117	Light Soldering Developments Ltd.	16	Shure Electronics Ltd.	36
Chromasonics	30	Linstead Mfg. Co. Ltd.	35	Sinclair Radionics	83
Colomor (Electronics) Ltd.	130	Lion House	104	Sintel	115
Computer Appreciation	124	Logic Leisure	122	Sintrom Electronics Ltd.	131
Continental Specialities Corp.	11	Lowe Electronics Ltd.	100	Sonic Hi-Fi Discount	128
Cramer	5	L.P. Enterprises	123, 132	Sonic Sound Audio	122
Crimson Elektrik	96	Lynx (Electronics) London Ltd.	110	Southwest Technical Prods. Ltd.	26
C.T. Electronics	120			Sowter, E. A.	150
Danavox (GB) Ltd	4	McKnight Crystals	149	Special Products Ltd.	128
Datong Electronics Ltd.	104	MacInnes Laboratories Ltd.	31	Strumech Engineering Ltd.	14, 24
Despro	130	Magnum Audio Ltd.	23, 25	Sugden, J. E. & Co. Ltd.	35
Doram Electronics	15	Maplin Electronic Supplies	9	Surrey Electronics Ltd.	111
Drake Transformers Ltd	16	Marconi Instruments Ltd	Cover ii	Swanley Electronics Ltd.	104
		Marconi Communication Systems Ltd.	20	Swift of Wilmslow	111
Eagle International	27	Marshall, A. (London) Ltd.	115		
E.L. Instruments	94	Martin Associates	32	Technomatic Ltd.	124
Electronic Brokers Ltd.	125, 126, 127, 152	Mayware	35	Teleradio Hi Fi	104
Electronic Brokers Ltd. (Second User Computer Div.)	129	Merlin Computer Prods.	128	Thomson-CSF	21
Eraser International	28	Milward, G. F.	120	Trampus Electronics	131
European S/Agency	31	Mills, W.	110		
		Modern Book, The	150	Vero Electronics Ltd.	23
Farnell Instruments Ltd.	Readers Card, 14	Monolith Electronics Co. Ltd.	94		
Future Film Developments	99	Multicore Solders Ltd.	Cover iv	West Hyde Developments Ltd.	116
GEC Semiconductors Ltd.	13	Neal Ferrograph	33	Wilmot Breeden Electronics	19, 29
Genrad Ltd.	2	Newbear, Computer Stores	108	Wilmslow Audio	95
Greenway Elec. Comps.	111				
Greenwood Electronics	33	Patrick, J. B.	134	Xerosa/Powell	131
Gould Advance	6	Pelco	96	Yaesu Musen	74
G.R. Electronics	122	Pitman Publications Ltd.	109	Z. & I. Aero Services Ltd.	18, 94, 98
		Pipo Communications	134		

### OVERSEAS ADVERTISEMENT AGENTS:

**Hungary:** Mrs. Edit Bajusz, Hungexpo Advertising Agency, Budapest 15, Varosliget Telephone. 225 008 - Telex Budapest 22-4525 INTFOIRE

**Italy:** Sig. C. Epis Etas-Kompass, S.p.a. - Servizio Estero, Via Mantegna 6, 20154 Milan Telephone: 347051 - Telex. 37342 Kompass

**Japan:** Mr. Inatsuki, Trade Media - (IBPA Japan), B 212, Azabu Heights, 1-5-10 Roppongi, Minato-ku, Tokyo 106 Telephone. (03) 585-0581

**United States of America:** Ray Barnes, IPC Business Press, 205 East 42nd Street, New York, NY 10017 - Telephone (212) 689 5961 - Telex. 421710 Mr. Jack Farley Jnr., The Farley Co. Suite 1584, 35 East Wacker Drive, Chicago, Illinois 60601 - Telephone (312) 63074  
Mr. Richard Sands, Scott, Marshall, Sands & Latta Inc. 5th Floor, 85 Post Street, San Francisco, California 94104 - Telephone (415) 421 7950 - Telephone Dascotcco. San Francisco  
Mr. William Marshall, Scott, Marshall, Sands & Latta Inc. 1830 West Eighth Street, Los Angeles, California 90057 - Telephone (213) 382 6346 - Telegrams Dascotcco., Los Angeles.

Mr. Jack Mentel, The Farley Co., Suite 650, Ranna Building, Cleveland, Ohio 44115 - Telephone. (216) 621 1919  
Mr. Ray Rickles, Ray Rickles & Co., P.O. Box 2008, Miami Beach, Florida 33140 - Telephone. (305) 532 7301.  
Mr. Jim Parks, Ray Rickles & Co., 3116 Maple Drive N.E., Atlanta, Georgia 30305 Telephone. (404) 237 7432  
Mike Loughlin, IPC Business Press, 15055 Memorial, Ste 119, Houston, Texas 77079 - Telephone (713) 783 8673

**Canada:** Mr. Colin H. MacGulloch, International Advertising Consultants Ltd., 915 Carlton Tower, 2 Carlton Street, Toronto 2 - Telephone: (416) 364 2269

Also subscription agents.

# SPOT ON!



## that's the new, highly accurate RF signal generator from Philips which offers everything you've ever asked us for.

Precise frequency selection between 100 kHz and 125 MHz has never been easier than with the new PM 5326 RF signal generator. Its built-in five digit display allows spot-on frequency setting to one part in 10,000 in nine push-button ranges. Specially designed for everyone involved with receiver sensitivity and selectivity measurements, this exceptionally well screened instrument also provides four wobulator ranges for the alignment of IF amplifiers and FM receivers and even enables the counter to be used on its own for measuring external signals. It adds yet again to the highly-successful range of Philips instruments (some of which are shown here) for the radio, audio and TV workshop. Write today for full information on the new PM 5326 and a 16 page brochure on radio and TV service.



### 1 PM5509 PAL TV Pattern Generator

The ultimate in pattern generators. Full IF coverage: band I, III, IV and V. Electronic tuning with preset channels.

### 2 PM5501 PAL TV Pattern Generator

Extremely light, portable instrument for service in customer's home. Five different test patterns available.

### 3 PM6456 FM Stereo Generator

The PM6456 gives a complete stereo signal, L and R signal. Internal L.F. modulation: 1 and 5 kHz.

### 4 PM5324 HF Generator

Frequency range 100 kHz-110 MHz. X-tal calibration. Special bandspread ranges. High frequency stability.

### 5 PM5334 TV Sweep Generator

Ideal for overhauling rental sets. 8 frequency ranges. 3 MHz-860 MHz. Sweep width continuously adjustable. One variable and three fixed markers.

### 6 PM6307 Wow and Flutter Meter

High degree of accuracy and stability from X-tal controlled oscillator. Very easy to use.



### Pye Unicam Ltd

Philips Electronic Instruments Dept  
York Street, Cambridge, England CB1 2PX  
Tel: Cambridge (0223) 58866 Telex: 817331



**Test & Measuring Instruments**

WW-002 FOR FURTHER DETAILS

AUDIO AND VIDEO SERVICE EQUIPMENT  AUTOMATIC TEST AND MEASURING EQUIPMENT  COUNTERS AND COUNTER/TIMERS  DC POWER SUPPLIES AND AC STABILIZERS  
 LOW FREQUENCY EQUIPMENT  MICROWAVE EQUIPMENT  MULTIMETERS  OSCILLOSCOPES  PROFESSIONAL TV EQUIPMENT  PULSE GENERATORS  RECORDERS

www.americanradiohistory.com

# PHILIPS

# Ersin Multicore- the international solder

## Ersin Multicore 5-Core Solder

The proved superiority of ERSIN Multicore Solder for over thirty years is due to many factors. We have specialised throughout this period in the manufacture of cored solders. Consequently our research and manufacturing staff have been able to devote all their energies to the development of Multicore Solders. All alloys are of highest purity, carefully formulated and checked.

Our unsurpassed ERSIN flux is rigorously tested before and after it is incorporated in the solder wire. Our five separate cores of flux ensure flux continuity, leave only an ultra-thin layer of solder separating flux from work for instant wetting and provide a more accurate ratio of flux to solder. It is therefore possible to

use less solder and obtain greater reliability.

Our Quality Control at all stages of manufacture is guaranteed and recorded by the batch number on every reel.

## Needle fine gauges

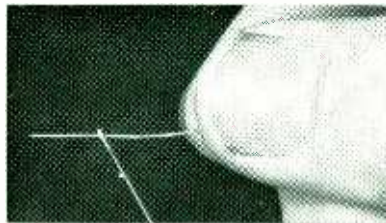

In addition to our standard range of wire diameters (10-22 swg: 3.2-0.7 mm) supplied on 2½ kg and ½ kg reels we also mass-produce needle-fine gauges (24-34 swg: 0.56-0.23 mm) on 250 g reels for microminiature soldering applications—still with 5 Cores of flux.

## Savbit Solder

One of our most popular special ERSIN Multicore Solder alloys is SAVBIT alloy. Compared with ordinary tin/lead solders it dramatically reduces the erosion of soldering iron bits, copper wires and printed circuit conductors. It also saves costs and increases reliability. SAVBIT alloy containing 5-Cores ERSIN 362 flux has received special Ministry approval—under DTD. 900/4535A for Military applications.

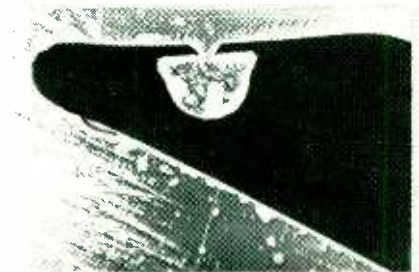

Sectioned iron-plated bit, after 40,000 simulated operations using 60/40 Solder.



Sectioned iron-plated bit, after 40,000 simulated operations using SAVBIT Solder.

ALLOY Composition (nominal major elements)	Grade	Melting Temperature		Specification
		Solidus °C	Liquidus °C	
50/32/18 Sn/Pb/Cd	TLC	145	145	B.S.219
62/36/2 Sn/Pb/Ag	LMP	179	179	B.S.219
62/35.7/2/0.3 Sn/Pb/Ag/Sb	Sn62	179	179	QQ-S-57 1E
63/36.7/0.3 Sn/Pb/Sb	Sn63	183	183	QQ-S-57 1E
60/40 Sn/Pb	KP	183	188	B.S.219
60/39.7/0.3 Sn/Pb/Sb	Sn60	183	188	QQ-S-57 1E
50/50 Sn/Pb	F	183	212	B.S.219
50/49.7/0.3 Sn/Pb/Sb	Sn50	183	212	QQ-S-57 1E
50/48.5/1.5 Sn/Pb/Cu	Savbit 1	183	215	DTD 900/4535A DIN 1707
45/55 Sn/Pb	R	183	224	B.S.219
40/60 Sn/Pb	G	183	234	B.S.219
30/70 Sn/Pb	J	183	255	B.S.219
20/80 Sn/Pb	V	183	275	B.S.219
96/4 Sn/Ag	96S	221	221	B.S.219
15/85 Sn/Pb	W	225	290	B.S.219
Pure Tin	P.T.	232	232	B.S.3252
95/5 Sn/Sb	95A	236	243	B.S.219
5/93.5/1.5 Sn/Pb/Ag	H.M.P.	296	301	B.S.219



For full information on these and any other MULTICORE products please write on your Company's letterhead direct to:

**Multicore Solders Limited**, Maylands Avenue, Hemel Hempstead,  
Hertfordshire HP2 7EP. Tel: Hemel Hempstead 3636 Telex: 82363

Suppliers to the British and many overseas Post Offices for over 30 years. Current users also include the Ministry of Defence, Government Departments etc.