

# wireless world

MARCH 1977 35p

**Rhythm unit**

**TV test generator**

Australia \$A1.20  
Canada \$1.50  
Denmark Kr. 11.00  
Finland Fmk. 6.20  
Germany Dm. 4.50  
Greece Dr. 45.00  
Holland Dfl. 4.50  
Italy L. 900  
Malaysia M\$3.25  
New Zealand \$NS1.40  
Norway Kr. 10.00 incl. moms  
Portugal Esc. 40.00  
South Africa R. 1.10  
Spain Ptas 80.00  
Sweden Kr. 6.90 incl. moms  
U.S.A. \$1.50

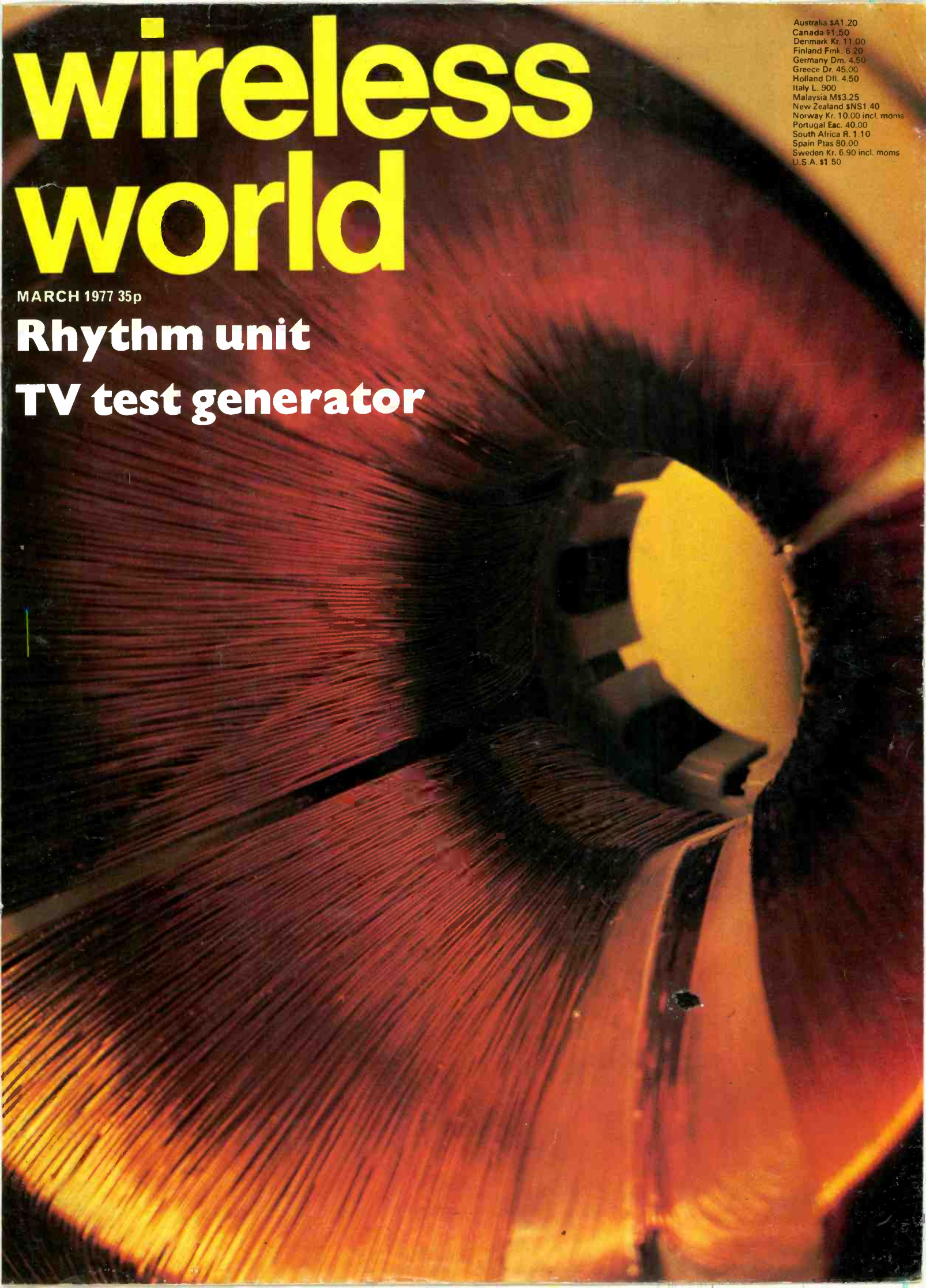

# mi COUNTER-REVOLUTION

There's been a revolution in **mi**'s design and production departments at St. Albans to bring you a new range of low cost high-quality frequency meters up to 560MHz.

The revolution in design is a new LSI chip built for **mi** by an associated GEC Company, which incorporates all the LF circuitry to reduce the total i/c component count below any competitor. Result: quick and easy to make, very reliable and easy to service.

The revolution in production is our new high volume production line which uses "Autotest" at both module and final test stages to enable **mi** to produce high quality counters at low cost.



See the benefits of the **mi** counter-revolution and reap them for yourselves:

- 10Hz to 80MHz Model TF2430
- 10Hz to 200MHz Model TF2431
- 10Hz to 560MHz Model TF2432
- All direct counting—no prescaling to slow down readings
- Easy to use—few controls
- AGC on all channels—no sensitivity controls
- Wide dynamic range
- Resolution switchable to 0.1Hz
- LSI chip contains all LF circuitry—high reliability
- Bright 7 or 8 digit LED display with leading zero suppression
- Meets IEC 348 and BS4743 safety requirements
- Choice of frequency standards
- Will accept mains voltage on all high impedance inputs

Two-year guarantee

Counter-plot with us! Circle our number on the reader service card (or ring or write) our counterintelligence is at your service.

**mi**

MARCONI INSTRUMENTS LIMITED  
Longacres, St. Albans, Hertfordshire, England, AL4 0JN  
Telephone: St. Albans 59292 Telex: 23350  
AGEC-Marconi Electronics Company

# LOW COST TESTERS



## LEVELL

### PORTABLE INSTRUMENTS

#### INSULATION TESTER

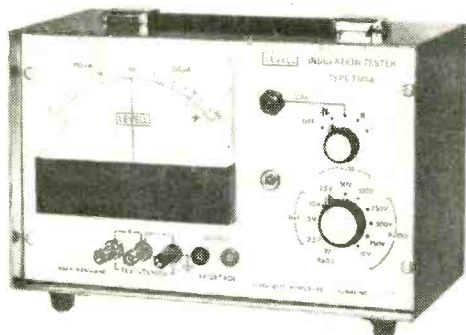

A logarithmic scale covering 6 decades is used to display either insulation resistance or leakage current at a fixed stabilised test voltage. The current available is limited to a maximum value of 3mA for safety and capacitors are automatically discharged when the instrument is switched off or to the CAL condition. The instrument operates from a 9V internal battery.

##### RESISTANCE RANGES

10M  $\Omega$  to 10T  $\Omega$  ( $10^{13}$   $\Omega$ ) at 250V, 500V, 750V and 1kV.

1 M  $\Omega$  to 1T  $\Omega$  at 25V, 50V and 100V.

100k  $\Omega$  to 100G  $\Omega$  at 2.5V, 5V and 10V.

10k  $\Omega$  to 10G  $\Omega$  at 1V.

Accuracy  $\pm 15\%$  + 800  $\Omega$  on 6 decade logarithmic scale.

Accuracy of test voltages  $\pm 3\%$   $\pm 50$ mV at scale centre.

Fall of test voltages  $< 2\%$  at 10 $\mu$ A and  $< 20\%$  at 100 $\mu$ A.

Short circuit current between 500 $\mu$ A and 3mA.

##### CURRENT RANGE

100pA to 100 $\mu$ A on 6 decade logarithmic scale.

Accuracy of current measurement  $\pm 15\%$  of indicated value.

Input voltage drop is approximately 20mV at 100pA, 200mV at 100nA and 400mV at 100 $\mu$ A.

Maximum safe continuous overload is 50mA.

##### MEASUREMENT TIME

$< 3$ s for resistance on all ranges relative to CAL position.

$< 10$ s for resistance of 10G  $\Omega$  across 1 $\mu$ F on 50V to 500V.

Discharge time to 1% is 0.1s per  $\mu$ F on CAL position.

##### RECORDER OUTPUT

1V per decade  $\pm 2\%$  with zero output at scale centre.

Maximum output  $\pm 3$ V. Output resistance 1k  $\Omega$ .

type  
TM14

**£110**

#### TRANSISTOR TESTER

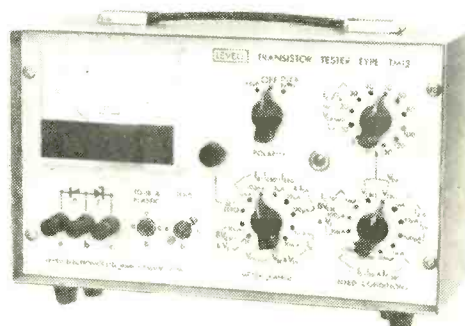

Tests bipolar transistors, diodes and zener diodes. Measures leakage down to 0.5 nA at 2V to 150V. Current gains are checked from 1 $\mu$ A to 100mA. Breakdown voltages up to 100V are measured at 10 $\mu$ A, 100 $\mu$ A and 1mA. Collector to emitter saturation voltage is measured at 1mA, 10mA, 30mA and 100mA for  $I_C/I_B$  ratios of 10, 20, 30. The instrument is powered by a 9V battery.

##### TRANSISTOR RANGES (PNP OR NPN)

$I_{CBO}$  &  $I_{EBO}$ : 10nA, 100nA, 1 $\mu$ A, 10 $\mu$ A and 100 $\mu$ A f.s.d. acc.  $\pm 2\%$  f.s.d.  $\pm 1\%$  at voltages of 2V, 5V, 10V, 20V, 30V, 40V, 50V, 60V, 80V, 100V, 120V, and 150V acc.  $\pm 3\%$   $\pm 100$ mV up to 10 $\mu$ A with fall at 100 $\mu$ A  $< 5\%$  + 250mV.

$BV_{CBO}$ : 10V or 100V f.s.d. acc.  $\pm 2\%$  f.s.d.  $\pm 1\%$  at currents of 10 $\mu$ A, 100 $\mu$ A and 1mA  $\pm 20\%$ .

$I_B$ : 10nA, 100nA, 1 $\mu$ A... 10mA f.s.d. acc.  $\pm 2\%$  f.s.d.  $\pm 1\%$  at fixed  $I_E$  of 1 $\mu$ A, 10 $\mu$ A, 100 $\mu$ A, 1mA, 10mA, 30mA, and 100mA acc.  $\pm 1\%$ .

$h_{FE}$ : 3 inverse scales of 2000 to 100, 400 to 30 and 100 to 10 convert  $I_B$  into  $h_{FE}$  readings.

$V_{BE}$ : 1V f.s.d. acc.  $\pm 20$ mV measured at conditions on  $h_{FE}$  test.

$V_{CE(sat)}$ : 1V f.s.d. acc.  $\pm 20$ mV at collector currents of 1mA, 10mA, 30mA and 100mA with  $I_C/I_B$  selected at 10, 20 or 30 acc.  $\pm 20\%$ .

##### DIODE & ZENER DIODE RANGES

$I_{DR}$ : As  $I_{EBO}$  transistor ranges.

$V_Z$ : Breakdown ranges as  $BV_{CBO}$  for transistors.

$V_{DF}$ : 1V f.s.d. acc.  $\pm 20$ mV at  $I_{DF}$  of 1 $\mu$ A, 10 $\mu$ A, 100 $\mu$ A, 1mA, 10mA, 30mA and 100mA.

type  
TM12

**£105**

## LEVELL ELECTRONICS LTD.

Moxon Street, High Barnet, Herts. EN5 5SD  
Tel: 01-449 5028/440 8686

Prices are ex-works with batteries. Carriage and Packing extra. VAT extra in U.K. Optional extras are leather cases and mains power units. Send for data covering our range of portable instruments.

# From

# to

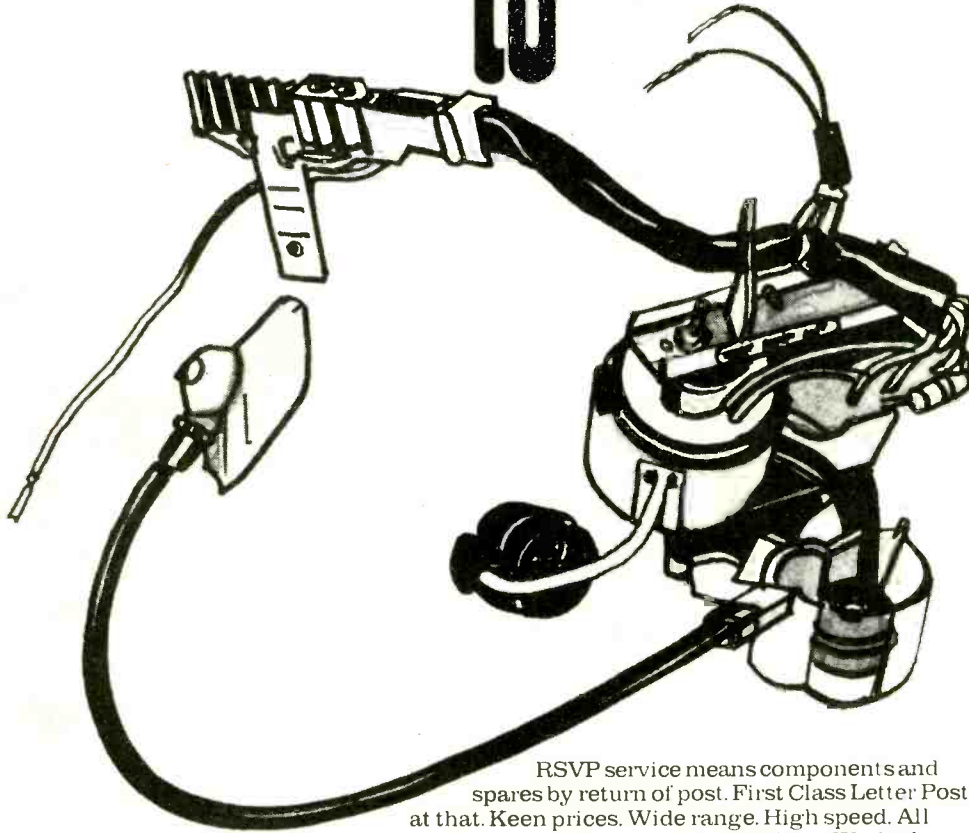

RSVP service means components and spares by return of post. First Class Letter Post at that. Keen prices. Wide range. High speed. All you do is get your order to us before 3.30 pm. We do the rest. You'll need an RSVP Directory of Components & Spares. If you don't have one yet, it's yours for the asking.

## to you by return-that's what we mean by **RSVP**



Telephone, telex or write for your FREE RSVP Directory

# RSVP

**RAPID SOUND & VISION PARTS**

Rank Radio International Limited, RSVP Service, PO Box 23, Bramfield, Hertford SG14 2YD. Telephone: 0992 50601. Telex: 81344.

*Remember-RSVP means 1st Class return-of-post service*

Send me FREE your RSVP Directory of Electronic Components and Spares.

My name is

Position

Company

Address

Post Code

Mail today to: Rank Radio International Limited, Watton Road, Ware, Hertfordshire SG12 0DY.

# NAGRA complete the picture...



## ...with their new NAGRA E

A dilemma Nagra were suffering for some time, was how to produce a self-contained Professional Tape Recorder which incorporated all the qualities of their highly acclaimed Nagra 4.2, but could be marketed in the lower price range. Almost anyone can manufacture a cheaper version of a successful product but Nagra were determined not to sacrifice standards for economy. Well, we are happy to announce they have achieved the perfect solution with the new Nagra E.

The astounding saving of around 50% has been principally achieved by the simplification of the speed stabiliser—a single operating speed of 7½ ips is provided. The tape deck and transport mechanism are closely similar to that

used on the Nagra 4 Series, which has become renowned worldwide for its reliability and performance.

Good news, for the operator in the field, is that the new model is slimmer and lighter than the 4.2 and comes complete with a measuring probe, circuit diagram and some essential spares. This means that bias adjustment resulting from tape type change can be easily carried out away from base. A single microphone input is provided which can be switched to accept dynamic or condenser types.

A sound level meter may be directly connected if required.

### TECHNICAL DATA

Dimensions: 13.8 x 9.3 x 4 in (351 x 336 x 104 mm)

Weight: 12.6 lbs (5.75 kg) with tape and batteries

Wow and flutter: ± 0.1%

Reels: 7 in cover open, 5 in cover closed.

Loudspeaker: 1.0W both switchable Tape/Direct

Headphones output

Frequency response recorded at -20 dB: 30-15,000 Hz ± 2 dB

S/N ratio, ASA "A": better than 66dB

Temperature range: 4°-158°F (-30 to + 70°C)

Please send me further details of the new NAGRA E and other models in the range.

Name

Address

**HAYDEN**

HAYDEN LABORATORIES LTD  
Hayden House, Churchfield Road, Chalfont St. Peter,  
Bucks, SL9 9EW Tel: Gerrards Cross 88447

WW3/NAG

# Build up the network you need with Barr & Stroud Active Filter Modules

For maximum flexibility, the EF Series Active Filter Modules\* are well worth your consideration. They give Bessel, Butterworth or Chebyshev responses, high-pass, low-pass, band-pass or band-stop filtering, are solid-state, compact and fully encapsulated. They are equally suitable for general laboratory functions or incorporation into standard equipment. Your own external components are used for tuning and response selection. Complete details are in pamphlets 1700 and 1732; ask for your copies today.

BARR & STROUD LIMITED  
London Office: 1 Pall Mall East,  
London SW1Y 5AU  
Tel: 01-930 1541 Telex: 261877

**BARR AND  
STROUD**  
Glasgow and London

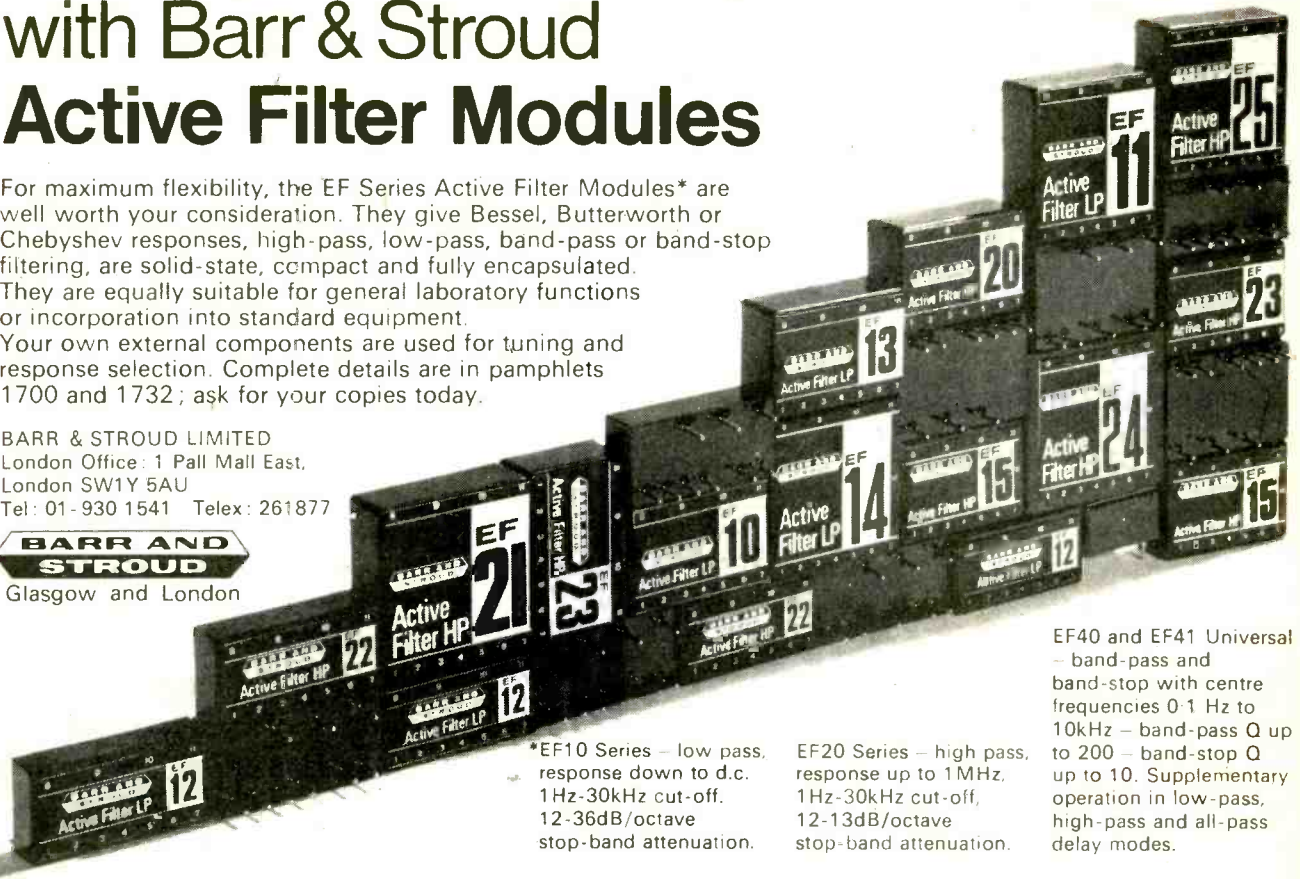

\*EF10 Series – low pass,  
response down to d.c.  
1Hz-30kHz cut-off,  
12-36dB/octave  
stop-band attenuation.

EF20 Series – high pass,  
response up to 1MHz,  
1Hz-30kHz cut-off,  
12-13dB/octave  
stop-band attenuation.

EF40 and EF41 Universal  
– band-pass and  
band-stop with centre  
frequencies 0.1 Hz to  
10kHz – band-pass Q  
up to 200 – band-stop Q  
up to 10. Supplementary  
operation in low-pass,  
high-pass and all-pass  
delay modes.

WW—076 FOR FURTHER DETAILS

## F. M. TUNER MODULES BY

These modules are fully assembled, tested and guaranteed units, as featured in our tuner. Designed by experts in integrated circuit technology and applications, they represent the finest available modules, ideal for incorporation into top quality home built systems.

*Icon Design*

**The Electronic Design Specialists**

M1, M2, M3, M4, M5, AND NOW:—

### **M6 DIGITAL FREQUENCY METER**

(WATCH FOR FURTHER ADDITIONS)

- ★ CMOS CIRCUITRY
- ★ FULL POWER SUPPLY
- ★ MOUNTS INSIDE TUNER
- ★ 4 DIGIT L.E.D. DISPLAY
- ★ NO TAMPERING WITH FRONT END REQUIRED
- ★ MONEY BACK GUARANTEE

We are very pleased to be able to announce this new module which has been in development for over 12 months. It has been designed to suit the specific requirements of F.M. tuners, to provide accurate station identification at a glance, at a sensible price and a sensible size. The complete outfit, which is NOT a kit, consists of the transformer, logic and display module and local oscillator take-off board. This latter fits directly to our main receiver board, and requires NO direct connections or modifications to the LP1186 front end module. If you are interested drop us a line for full details and prices of all our modules.



Correction and Diagnostic Sheets for the original article design (W.W. April/May '74) still available



A **booklet** is available for 50p (post free U.K.) Fully describing the completely **updated** tuner. Prices subject to 12.5% VAT

To:

*Icon Design*

**33 Restrop View  
Purton, WILTS  
SN5 9DG**

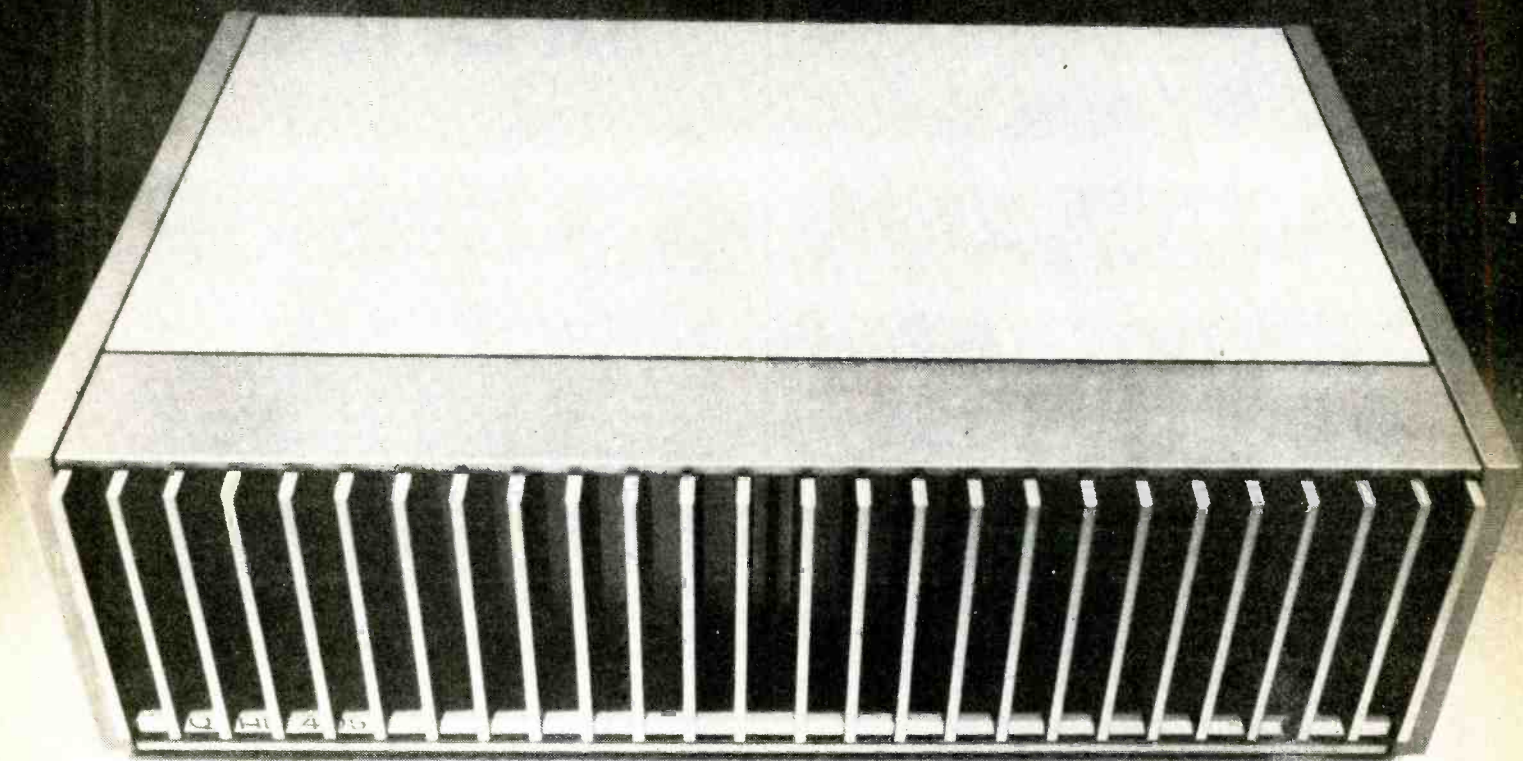

## Sweet sixteen

The Quad 405 is only the sixteenth product to carry the Quad name, each of which, has made a significant contribution to the development of sound reproduction and acquired a following of loyal and satisfied customers

The Quad 405 current dumping amplifier represents another step forward in amplifier technology, executed with the attention to engineering and aesthetic detail,

and manufactured with the concern for reliability which have been the hallmarks of Quad equipment for twenty-five years.

For further details on current dumping and other Quad products write to

Dept. WW  
The Acoustical Manufacturing Co.  
Ltd., HUNTINGDON, Cambs.,  
PE18 7DB Telephone (0480) 52561

# QUAD

**Design Council  
Award 1976**

**for the closest approach to the original sound for twenty-five years**

*QUAD is a Registered Trade Mark*

WW—058 FOR FURTHER DETAILS



**It's not just  
a pretty case**

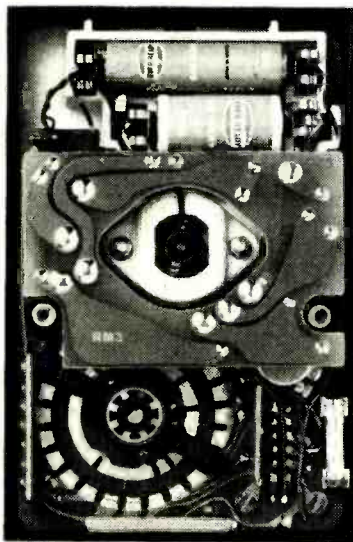

The main difference between our new low price multimeter and most multimeters is that ours is an AVO. Through and through. It starts with some innovations—most of them unique at the price: real overload protection, sensitivity of 20,000  $\Omega$ /VDC, a really useful set of ranges including AC current. If you try to measure the 240V mains on the 75  $\mu$ A DC range, it's only the instrument fuse that blows. Then there's the case—really rugged enough to take the toughest knocks. And in this case, beauty's more than skin deep—inside you'll find it orderly and well laid out. That means that, if servicing is ever necessary, it'll be worth doing. Because when AVO make an instrument, they make one that's worth keeping.

In short, the new AVO Model 73 is much more multimeter for your money—and that's what makes it an AVO.



UK Trade Price £33 — VAT from Distributors.

**AVO Limited**, Archcliffe Road, Dover Kent.  
Telephone: Dover (0304) 202620

Thorn Measurement Control and Automation Division.

WW—013 FOR FURTHER DETAILS

**Gardners**

# The Best of British

Where performance  
is paramount, professionals prefer Gardners...

We, at Gardners, have been in the communications business for many more years than we care to remember — so have our Audio Transformers. Used throughout the world by leading broadcasting and recording companies or wherever only the highest technical standards and levels of reliability are good enough our products are still preferred by professionals who know...

From microphone to tape (or film), speakers or headphones, studio consoles, manpacks, amplifiers, modems, we at Gardners have tried to anticipate your needs. Miniaturisation (yes!) plus good performance (yes!) through to exceptional performance (of course!). Impedance changing, coupling, isolation, bridging, low and high power, with or without D.C. Choose from our standard range of 95 models! Every one an example of sheer professionalism.

All have low loss, low distortion, low phase-shift, low pick-up, BUT wide frequency range.

| Cat. No. | Impedance Input | (OHMS) Output | Turns Ratio Sec/Pri | Operating Level dBm at 50Hz | Frequency Response   |
|----------|-----------------|---------------|---------------------|-----------------------------|--|
| MU 7501  | 0.3/15          | 100k          | 83/188 1            | 8                           | ± 1 dB<br>50Hz - 10kHz                                     |
| MU 7503  | 0.200/600       | 100k          | 13/23 1             |                             |  |
| MU 7514  | 600             | 600/2.4k      | 1 - 1.1             |                             |  |
| MU 7518  | 10k CT          | 10k           | 1.1 CT              |                             |  |
| MU 7521  | 3.75/15         | 600 CT        | 6.32/12.64 1        | 16.5                        | ± 0.5 dB<br>30Hz - 20kHz<br>( <sup>1</sup> ± 1dB at 20kHz) |
| MU 7522  | 3.75/15         | 100k*         | 82/164 1            |                             |  |
| MU 7524  | 150/600         | 600 CT        | 1/2 1               |                             |  |
| MU 7525  | 600 CT          | 300/1.2k      | 1 - 1.1 4:1 CT      |                             |  |
| MU 7530  | 10k CT          | 10k           | 1.1 CT              | 12                          | ± 0.5dB 10Hz - 100kHz                                      |
| MU 7534  | 50/200          | 100k*         | 22.4/44.8 1         |                             |  |
| MU 7566  | 600 CT          | 10k/2.5k      | 4.08/2.04 1         |                             |  |
| MU 7567  | 600/150         | 50k           | 9.13/18.26 1        |                             |  |
| MU 7582  | 200/50          | 600 CT        | 1.73/3.46 1         | 20                          | ± 1dB 30Hz - 22kHz   |
| VM 7461  | 15/3.75         | 600           | 6.35/12.7 1         |                             |  |
| VM 7464  | 600/150         | 600           | 1/2 1               |                             |  |
| VM 7465  | 600             | 10k/2.5k      | 4.14/2.07 1         |                             |  |
| VM 7468  | 50/12.5         | 50k           | 32/64 1             | 4.75                        | ± 1dB 30Hz - 12kHz   |

We would emphasise that the above is a representative selection only.

Send for Brochure GT5 for complete listings.  
All units described are normally AVAILABLE FROM STOCK.

**SPECIAL DESIGN SERVICE.**  
If your requirements cannot be met by our standard range, then we will gladly design for your production needs.

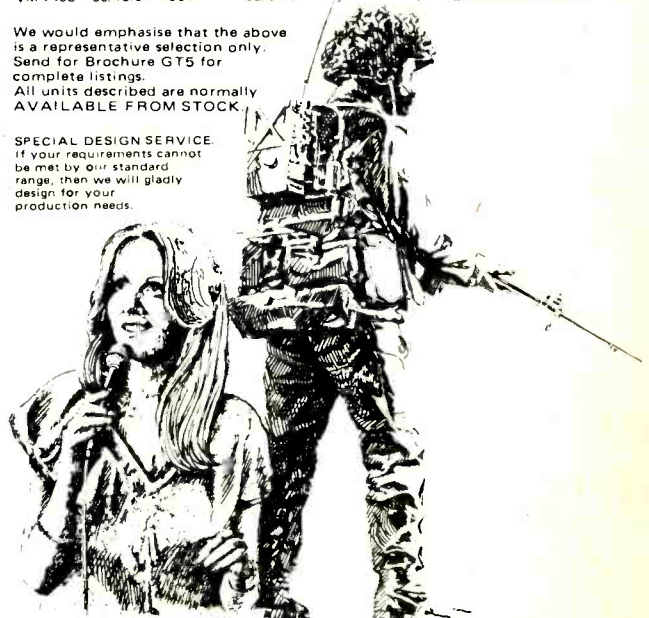

**Gardners**

Gardners Transformers Ltd.  
Christchurch Dorset BH23 3PN  
Telephone 02015-2284  
Telex 41276 Gardners XCH

Approved manufacturers of  
electronic transformers, modular power supplies, inverters and  
converters to Defence Standard 05-21

WW 2/77

WW—072 FOR FURTHER DETAILS



# 40 years



INTERNATIONAL

DANAVOX (GT. BRITAIN) LTD.  
"BROADLANDS" BAGSHOT ROAD,  
SUNNINGHILL, ASCOT, BERKS.  
TEL: 0990 23732/6 TELEX: 84584

of research... "on components and accessories for dictating machines, tele-communications, hearing aids and electroacoustic equipment etc."



STETOCLIP JUNIOR 60 HEADSET



STETOCLIP LIGHTWEIGHT HEADSET



SENIOR STETOCLIP HEADSET

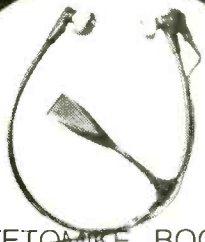

STETOMIKE BOOM MICROPHONE HEADSET

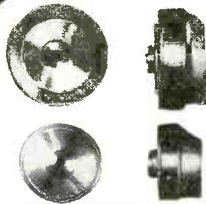

STANDARD & SUB-MINOR EARPHONES



PLASTIC EARHANGERS



DANAMIC FIDELITY EARSET



STETOTUBE HEADSET

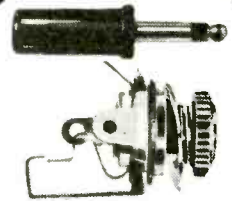

2,5 mm and 3,5 mm JACK PLUGS & SOCKETS



DANASOUND HEADSET



DANASONIC INDUCTION AUDIO LOOP RECEIVER

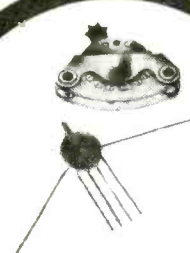

SUBMINIATURE SWITCHES

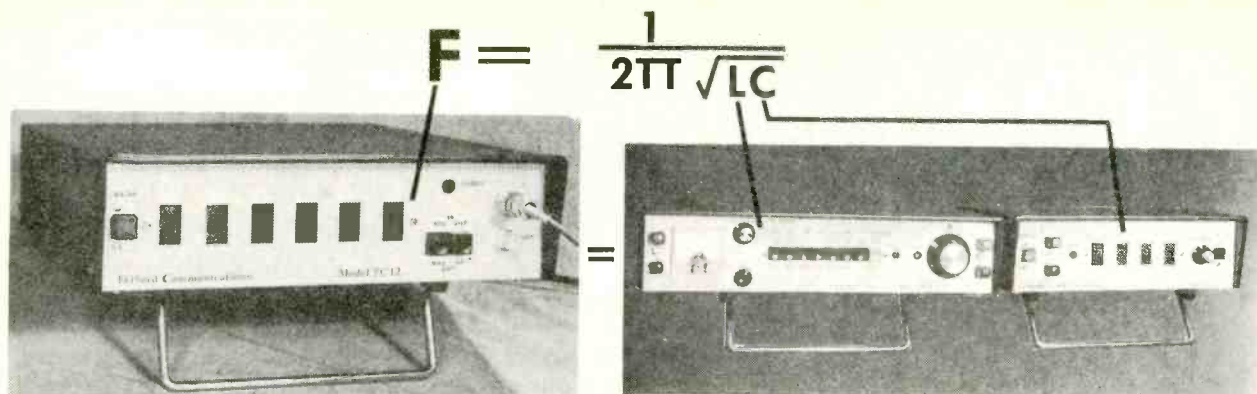

## MEASUREMENTS BECOME CHILD'S PLAY — WITH — TELFORD DIGITAL TEST EQUIPMENT

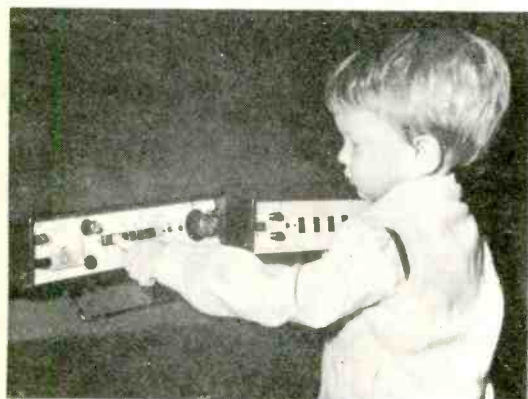

TC12. Frequency to better than 200MHz.

TC15. In conjunction with TC14 as readout covers  $1\mu\text{H}$  to 20H.

TC14. Capacitance from 1pF to  $1\mu\text{F}$ .

### TELFORD COMMUNICATIONS

78B High Street, BRIDGNORTH, WV16 4DS, SALOP, ENGLAND  
Tel. 074-62 4082

Suppliers of digital electronic test equipment to major U.K. capacitor manufacturers, and Universities, Technical Colleges, and Schools World Wide.

WW-067 FOR FURTHER DETAILS

# INTRODUCING A NEW TAPE DECK FROM A COMPANY THAT NEEDS NO INTRODUCTION.



Besides the standard 1 inch 8 track you see here, there's a  $\frac{1}{2}$  inch 8 track and a 2 inch 16 and a 24 track.

Their features include fully solenoid transport functions. Full sync facilities. Full modular electronics. Silent drop-ins. Instant start cue. N.A.B. and C.C.I.R. equalisation.

See and hear it at our demo studio, Pembroke House, Campsbourne Road, Hornsey, London, N8.

Where you can also take the opportunity to look over the Allen & Heath Mod II mixer. It's offered with the tape deck in a uniquely priced package deal.

Or for more information call Andrew Stirling 340 3291.

**brenell**

WW 073 — FOR FURTHER DETAILS

# We measure up to your standards

**B900**  
Automatic Digital Bridge 1kHz 0.1%



**B224**  
Wide-range Audio Bridge 1592Hz  
(200Hz - 20kHz external)

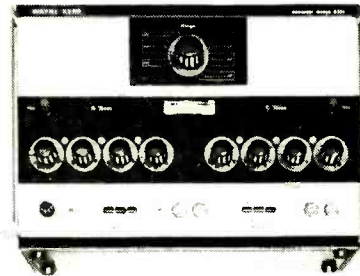

**B331**  
Self-balancing 0.01% Precision Bridge

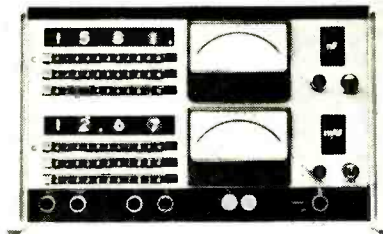

**B642**  
Autobalance Universal Bridge 0.1%

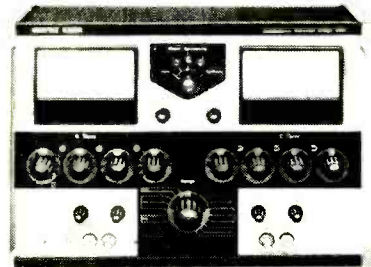

**B421**  
Direct-reading Component Meter 0.25%



Whether you check components at Goods Inwards, during production or on Final Test, Wayne Kerr has the bridge you need. For fast measurements of resistance, capacitance and inductance, or for continuous monitoring of changing values, you can select the ideal instrument from our comprehensive range.

All models—AF, RF and VHF—have a wide measurement range and are easy to use. Many have automatic readout and automatic lead compensation; most will measure components *in situ*.

Only part of our range is illustrated. Send in the coupon for further information.



**Wilmot Breeden Electronics**  
Ferroglyph Rendar Wayne Kerr

Wilmot Breeden Electronics Limited,  
442 Bath Road, Slough,  
SL1 6BB, England.  
Telephone: Burnham (06286) 62511  
Telex: 847297

Please send me the Wayne Kerr short form catalogue.

Name \_\_\_\_\_

Position \_\_\_\_\_

Company \_\_\_\_\_

Address \_\_\_\_\_

\_\_\_\_\_

Telephone \_\_\_\_\_ (WW 3/77)

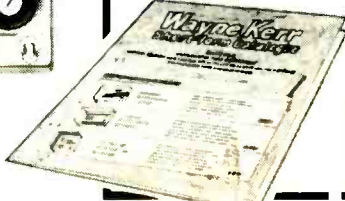

Wilmot Breeden Electronics Limited,  
442 Bath Road,  
Slough, SL1 6BB,  
England.

## WAYNE KERR BRIDGES

# Z & I AERO SERVICES LTD.

Head Office: 44A WESTBOURNE GROVE, LONDON W2 5SF  
Tel.: 727 5641    Telex: 261306

Retail Branch:  
85 Tottenham Court Road  
London W1. Tel: 580 8403

## MULTIMETER F4313 (Made in USSR)

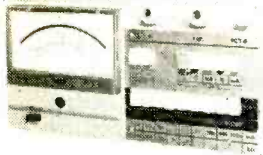

**SENSITIVITY**  
1200V DC range: 10,000 Ω/V  
Other DC ranges: 20,000 Ω/V  
1200 AC range: 6,000 Ω/V  
600V AC range: 15,000 Ω/V  
300V AC range: 15,000 Ω/V  
Other AC ranges: 20,000 Ω/V

AC/DC current ranges: 60-120-600μA-3-12-300mA-1.2-6A  
AC/DC voltage ranges: 60-300mV-1.2-6-30-120-300-600-1200V  
Resistance ranges: 300Ω-10-100-1000K  
Accuracy: 1.5% DC; 2.5% AC (of full scale deflection)

Mirror scale and knife edge pointer. Taut suspension of movement. Transistor amplifier is used for all AC ranges thus achieving a common linear scale for both AC and DC ranges.

Meter is protected by a transistorised cut-out relay circuit. Range selection is achieved by clearly marked piano keys. Power source: 5 1.5V dry cells. Dimensions: 95 x 225 x 120mm

**PRICE £37.50 plus VAT**  
Packaging and postage £1.10

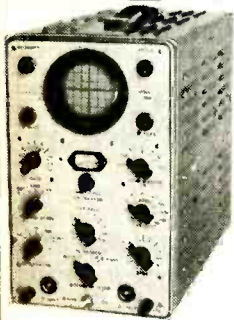

## OSCILLOSCOPE CI-5 Made in USSR

Extremely simple and easy to use single beam oscilloscope. Well proved design based on standard octal valves makes servicing and maintenance straightforward and inexpensive. Because of its bandwidth of 10 MHz the instrument is suitable for general electronic applications and educational purposes where a sophisticated instrument would be both too expensive and delicate. 3in. tube giving a 50 x 50mm clear display. Amplitude and time base calibrations. Sensitivity 30mm/v max. Triggered and free-running time base, suitable for displaying pulses from 0.1 μsec. to 3 m sec. A.C. mains operation.

**Price £55.00 ex. works, plus VAT**  
Packing and carriage (U.K. only £2.50)

## A SELECTION FROM OUR LARGE STOCKS

### TRANSISTORS

|         |      |         |      |         |      |         |      |               |      |
|---------|------|---------|------|---------|------|---------|------|---------------|------|
| 2N896   | 0.15 | *2N3705 | 0.10 | AF239   | 0.36 | BF177   | 0.18 | *1N4004       | 0.05 |
| 2N897   | 0.15 | *2N3706 | 0.10 | ASY26   | 0.25 | BF178   | 0.32 | *1N4005       | 0.05 |
| 2N706   | 0.10 | *2N3707 | 0.10 | ASY27   | 0.30 | BF179   | 0.35 | *1N4006       | 0.06 |
| 2N706A  | 0.10 | *2N3708 | 0.10 | ASY28   | 0.30 | BF180   | 0.31 | *1N4007       | 0.06 |
| 2N753   | 0.23 | *2N3709 | 0.10 | BC107   | 0.10 | BF181   | 0.35 | *1N4148       | 0.04 |
| 2N929   | 0.14 | *2N3710 | 0.10 | BC107A  | 0.12 | BF184   | 0.29 | *1N5408       | 0.20 |
| 2N930   | 0.14 | *2N3711 | 0.10 | BC107B  | 0.12 | BF185   | 0.30 | *BY101        | 0.15 |
| 2N1131  | 0.25 | *2N3819 | 0.35 | BC108   | 0.10 | *BF191  | 0.08 | *BY105        | 0.15 |
| 2N1132  | 0.25 | *2N3901 | 0.20 | BC108A  | 0.12 | *BF195  | 0.08 | *BY126        | 0.10 |
| 2N1302  | 0.17 | *2N3905 | 0.25 | BC108B  | 0.12 | *BF196  | 0.10 | *BY127        | 0.13 |
| 2N1303  | 0.15 | *2N3906 | 0.25 | BC109   | 0.12 | *BF197  | 0.11 | *BY130        | 0.10 |
| 2N1304  | 0.20 | AC125   | 0.20 | BC109A  | 0.12 | BF200   | 0.28 | *BY164        | 0.50 |
| 2N1305  | 0.20 | AC126   | 0.20 | BC109B  | 0.12 | BFX88   | 0.20 | BZX81         | 0.20 |
| 2N1306  | 0.27 | AC127   | 0.17 | *BC137  | 0.12 | BFY50   | 0.19 | series        |      |
| 2N1307  | 0.25 | AC132   | 0.25 | *BC149  | 0.08 | BFY52   | 0.20 | series        | 0.10 |
| 2N1308  | 0.25 | AC176   | 0.22 | *BC158  | 0.10 | *BU208  | 2.00 | *OA70         | 0.07 |
| 2N1309  | 0.25 | AC187   | 0.20 | BC171   | 0.10 | OC36    | 0.65 | *OA79         | 0.07 |
| 2N1613  | 0.17 | AC188   | 0.18 | BC178   | 0.18 | OC41    | 0.25 | *OA81         | 0.07 |
| 2N1711  | 0.18 | ACY21   | 0.20 | *BC182  | 0.11 | OC45    | 0.20 | *OA85         | 0.07 |
| 2N2221  | 0.20 | ACY22   | 0.14 | *BC187A | 0.10 | OC70    | 0.15 | *OA90         | 0.07 |
| 2N2222A | 0.20 | AD161   | 0.38 | BC186   | 0.25 | OC71    | 0.15 | *OA91         | 0.07 |
| 2N2369A | 0.25 | AD162   | 0.38 | BC187   | 0.25 | OC72    | 0.18 | *OA95         | 0.07 |
| 2N2646  | 0.40 | ADZ11   | 1.25 | *BC212  | 0.11 | OC75    | 0.15 | *OA200        | 0.07 |
| 2N2905  | D.25 | ADZ12   | 1.25 | BC237   | 0.11 | OC76    | 0.18 | *OA202        | 0.08 |
| 2N2906  | 0.20 | AF106   | 0.25 | BC238   | 0.11 | OC81    | 0.20 | RAS310AF      | 0.35 |
| 2N2907  | 0.20 | AF114   | 0.17 | BCY32   | 1.20 | OC83    | 0.30 | RAS508AF      | 0.40 |
| 2N2926  | 0.10 | AF115   | 0.17 | BCY70   | 0.15 | OC84    | 0.30 |               |      |
| 2N3053  | 0.20 | AF116   | 0.17 | BCY71   | 0.20 | OC204   | 0.60 |               |      |
| 2N3054  | 0.65 | AF117   | 0.17 | BCY72   | 0.15 | OC206   | 0.70 |               |      |
| 2N3055  | 0.55 | AF118   | 0.25 | BD115   | 0.39 | OC771   | 0.90 | Russian made  |      |
| 2N3391  | 0.17 | AF124   | 0.25 | BD116   | 0.59 | ORP12   | 0.60 | Special offer | 0.09 |
| 2N3392  | 0.17 | AF125   | 0.25 | BD132   | 0.39 | *IP30A  | 0.50 | 7400          | 0.09 |
| 2N3393  | 0.15 | AF126   | 0.25 | BD133   | 0.45 |         |      | 7401          | 0.09 |
| 2N3414  | 0.20 | AF127   | 0.25 | BD137   | 0.30 |         |      | 7410          | 0.11 |
| 2N3415  | 0.15 | AF139   | 0.30 | BF115   | 0.28 | *1N914  | 0.05 | 7422          | 0.20 |
| *2N3702 | 0.10 | AF178   | 0.50 | BF152   | 0.20 | *1N4001 | 0.04 | 7430          | 0.11 |
| *2N3703 | 0.10 | AF180   | 0.50 | BF167   | 0.25 | *1N4002 | 0.05 | 7440          | 0.11 |
| *2N3704 | 0.10 | AF181   | 0.50 | BF173   | 0.25 | *1N4003 | 0.05 | 7450          | 0.11 |

### TTL SERIES

**P&P 25p min. (U.K. only). Please add 8% VAT\* 12.5%**

**MINIMUM EXPORT ORDER £100**

**FULLY GUARANTEED**



**1976/1977  
CATALOGUE  
AVAILABLE 30p**

WW-071 FOR FURTHER DETAILS

## ELECTRONIC INDUSTRIAL THERMOMETER

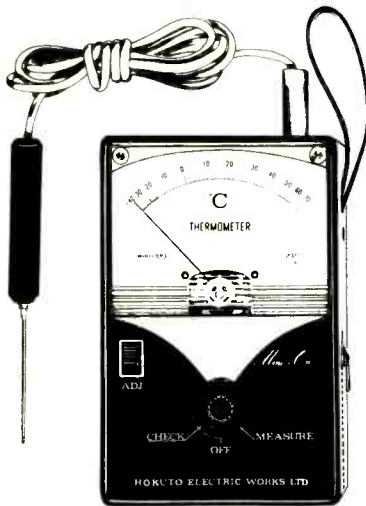

### THE MODERN WAY TO MEASURE TEMPERATURE

A Thermometer designed to operate as an Electronic Test Meter. Will measure temperature of Air, Metals, Liquids, Machinery, etc., etc. Just plug-in the Probe, and read the temperature on the large open scale meter. Supplied with carrying case, Probe and internal 1 1/2 volt standard size battery.

Model "Mini-Z 1" measures from -40° C to + 70° C Price £25.00  
Model "Mini-Z 2" measures from -5° C to + 105° C Price £25.00  
Model "Mini-on Hi" measures from + 100° C to + 500° C £20.00  
(VAT 8% EXTRA)

Write for further details to

**HARRIS ELECTRONICS (LONDON)**  
138 GRAY'S INN ROAD, LONDON. WC1X 8AX  
(Phone 01-837 7937)

WW-036 FOR FURTHER DETAILS

## Litesold Cut/Bend Tool

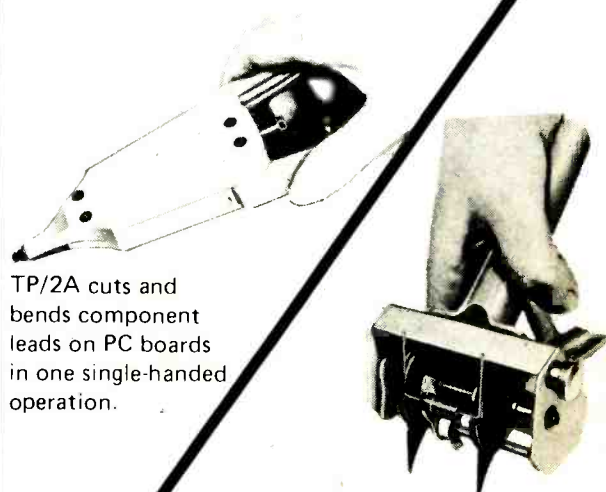

TP/2A cuts and bends component leads on PC boards in one single-handed operation.

PR/1 accurately bends component leads 90° for PCB insertion. Micrometer adjustment of spacing.

**LIGHT SOLDERING DEVELOPMENTS LTD.**

97-99 Gloucester Road, Croydon, Surrey.

Tel: 01-689 0574 Telex: 8811945

WW-012 FOR FURTHER DETAILS

Barr & Stroud are pleased to announce a further advance in the continued development of their acclaimed EF3 Electronic Filter System. The new

# BARR & STROUD MODULAR FILTERING

modules 05 and 06 so extend the capabilities of the system that it could well meet all your filtering requirements.

Now 6 Modules for the EF3

Write for technical literature giving full specifications.



**EF3-01 High Pass**  
Cut-off frequency variable from 0.01Hz to 10kHz



**EF3-02 Low Pass**  
Cut-off frequency variable from 0.01Hz to 10kHz

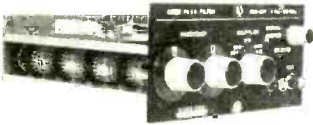

**EF3-03 HighPass**  
Cut-off frequency variable from 0.1Hz to 100kHz



**BARR AND STROUD**

London & Glasgow

Barr & Stroud Limited  
1 Pall Mall East, London SW1Y 5AU  
Telephone 01-930 1541 Telex 261877.



**EF3-04 LowPass**  
Cut-off frequency variable from 0.1Hz to 100kHz



**EF3-05 High Pass**  
Cut-off frequency variable from 1Hz to 1MHz



**EF3-06 Low Pass**  
Cut-off frequency variable from 1Hz to 1MHz

WW 077 — FOR FURTHER DETAILS

## New low cost microcomputer for learning the 'how' of microprocessors ....

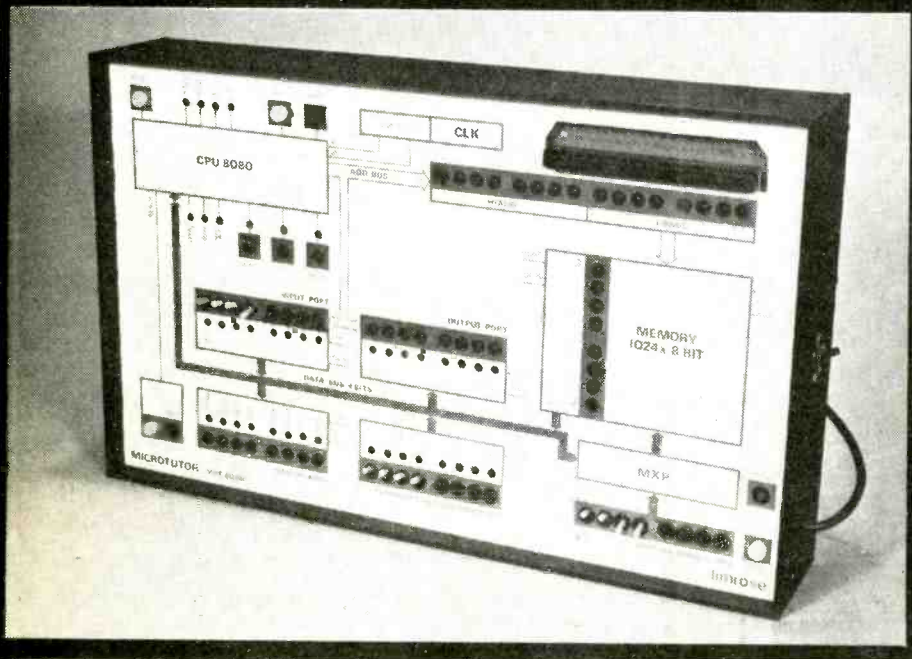

Now, there is a new Microcomputer to provide "hands on" experience to master and apply microprocessors - the Limrose MPT8080.

It comes ready to use. Nothing else to buy, debug or assemble. Just plug it in and you have a powerful microcomputer ready to use. No need for a Teletype, but if you have one, it can be hooked on using a plug-in card.

The comprehensive instruction manual is so straight-forward that even a person with limited technical knowledge can rapidly learn how microprocessors work.

The Microtutor MPT 8080 is not just a learning module - it's a full 8-bit, parallel, microcomputer with an 8080 CPU, 1K RAM, and various input and output ports. It can be single-stepped or run continuously to facilitate a thorough understanding of hardware/software interaction and programming of microprocessors.

The MPT 8080 can also be used as a prototyping computer and expanded with additional memory and ports.



For instant information, please contact :

**limrose electronics limited**  
241-243 Manchester Road, Northwich, CW9 7NE Tel. 0606 41696/7

prices from **£249**

WW-035 FOR FURTHER DETAILS

# KGM TV MONITORS

## the big choice



Type 222A — the ruggedized monitor for those really demanding situations — extremes of weather, temperature, vibration and frequent change of site.

Standard KGM monitors range from 12" — 24". Our long experience of CCTV enables us to meet almost any special requirement.

VDU's — visual display units have also been supplied in large numbers to suit customers' requirements. Tell us your needs and we will gladly quote.

Send for your data sheets on the full range of CCTV monitors and cameras designed and manufactured by KGM. KGM also supply an extensive range of ancillaries and distribution units.

**KGM** ELECTRONICS LIMITED

Clock Tower Road, Isleworth,  
Middlesex TW7 6DU  
Tel: 01-568 0151. Telex: 934120

WW — 062 FOR FURTHER DETAILS

## FREQUENCY COUNTERS

1/10 Hz to 1.2GHz.

High performance instruments measuring frequency, period, time, freq./ratio and calibrated output facility. Fast delivery. Specials by arrangement.

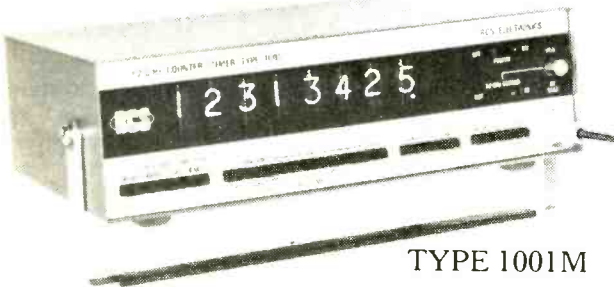

TYPE 1001M

CRYSTAL OVEN  
OPERATING MANUAL  
TWO TONE BLUE CASE

£670 **1.2** GHz

Sensitivity 10mV. Stability 5 parts 10.<sup>10</sup>

Resolution ± 1 Count

|        |                     |       |                     |
|--------|---------------------|-------|---------------------|
| 301M   | 32MHz 5 Digit £95   | 401A  | 32MHz 6 Digit £132  |
| 501    | 32MHz 8 Digit £188  | 701A  | 80MHz 8 Digit £205  |
| 801A/M | 400MHz 8 Digit £305 | 901M  | 520MHz 8 Digit £375 |
| 801B/M | 250MHz 8 Digit £274 | 1001M | 1.2GHz 8 Digit £670 |

Start/Stop versions plus £12

Memory versions available if not suffixed M £25 extra

Type 101 1MHz 100KHz 10KHz Crystal Standard £95

Type 103 Off/Air Standard £95

All prices exclusive of V.A.T.

SUPPLIERS TO: Ministry of Defence, G.P.O., B.B.C., Government Depts., Crystal Manufacturers and Electronic Laboratories world-wide

**RCS**

**R.C.S. ELECTRONICS**  
6 WOLSEY ROAD, ASHFORD  
MIDD. TW15 2RB  
Telephone: Ashford (Code 69)  
53661/2

WW—027 FOR FURTHER DETAILS

## Switching problems? Rely on Zettler.

Producing 30 basic types of relay and 15,000 variants with regard to contact stacks, terminals, energizing current and contact material, Zettler is among the largest manufacturers of electro-mechanical components.

Our product range comprises:  
Low profile (platform) · Timing · Miniature · Low contact capacity · Hermetically sealed · Stepping · Mains switching · Latching Contact stacks · Solenoids

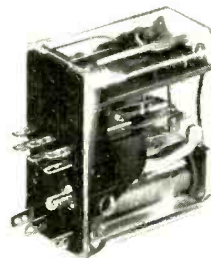

### Hybrid Relays AZ 1435...1441

AZ 1435 Voltage monitor (9... 30 V)  
AZ 1436 Pick-up retarder (1... 30 s)  
AZ 1437 Drop-out retarder (1... 30 s)  
AZ 1438 Pulse time limiter (50... 1500 ms)  
AZ 1439 Pulse shaper (monoflop) (50... 1500 ms)  
AZ 1440 Pulse generator (multiflop) (0.1... 30 s)  
AZ 1441 Pulse-operated relay (flip-flop) (24 V + 10% - 15%, approx. 30 mA max.)

We resolve your switching problems rapidly and expertly. Please contact us for further details.



**ZETTLER** Zettler  
UK Division  
Brember Road  
Harrow Middx. HA2 8AS. Tel. (01) 422 0061

A member of the worldwide ZETTLER electrical engineering group, est. 1877

WW—070 FOR FURTHER DETAILS

# POWER UNITS

**Valradio**

**PRODUCTION TESTING ★ DEVELOPMENT  
SERVICING**

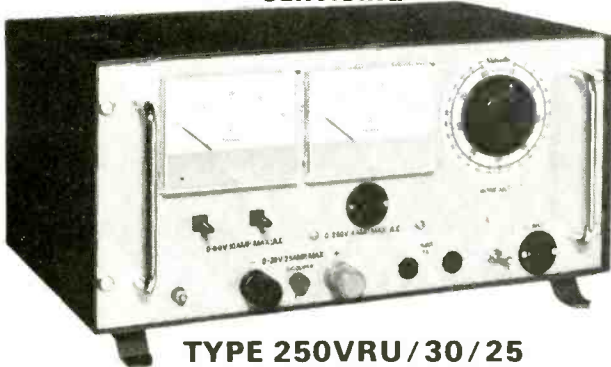

## TYPE 250VRU/30/25

Input 200-250v 50Hz or 100-120v 60Hz to order Output 1: 0-30v 25A DC. Output 2: 0-70v 10A AC. Output 3: 0-250v 4A AC.

PRICE: £233.60 excluding VAT

Regulated and unregulated outputs with output voltages of 12, 24, 50, 110 or 220v DC are also available at very competitive prices.

Send for further details of these versatile units to:-

**Valradio**

**BROWELLS LANE, FELTHAM, MIDDX.  
TW13 7EN**

**PHONE: 01-890 4242 or 4837**

WW-044 FOR FURTHER DETAILS

*Contractors to H.M. Govt. P.O.*

# REPAIRS

OF ELECTRICAL MEASURING INSTRUMENTS  
**7-14 DAYS SERVICE**

◀ MODEL 8 MK.V



**STOCKISTS**  
ALSO SUPPLIERS OF GEC  
RISSO AND OTHER  
MULTI-RANGE TEST SETS

WE SPECIALISE IN ASSEMBLIES, AND IN THE  
REPAIR, CALIBRATION AND CONVERSION  
OF ALL TYPES OF INSTRUMENTS, INDUSTRIAL  
AND PRECISION GRADE

## LEDON INSTRUMENTS LTD.

**GLADSTONE WORKS, GLADSTONE RD,  
FOLKESTONE, KENT.  
TEL: (STD) 0303 57555**

WW-046 FOR FURTHER DETAILS

# If it's good enough for us....

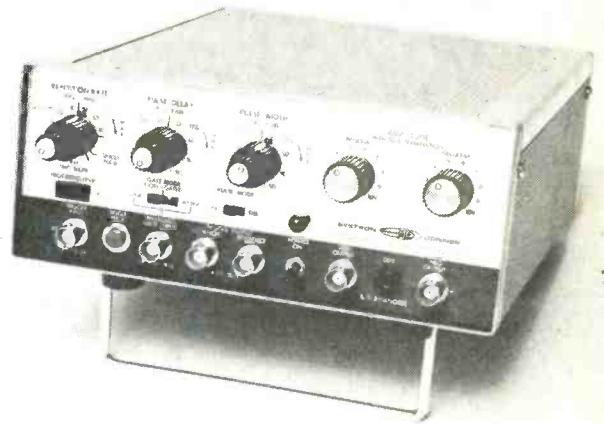

## the Systron-Donner 100A could solve YOUR pulse generation problems

Systron-Donner has gained an international reputation for exceptional price/performance ratio with the Datapulse family of pulse generators. The Model 100A with its 10MHz frequency range and 5ns risetime is a typical example of Systron-Donner's expertise in this field.

Continuously variable (0.5V to 10V into 50Ω) simultaneous positive and negative DC coupled outputs make this one of the most versatile generators available. Single and double pulse operation is possible with repetition rates from 1 cycle over 10 seconds to 10MHz with effective 20MHz rates in the double pulse mode. Single shot facilities are provided together with external AC coupled triggering with slope polarity and level controls.

Continuously variable pulse width and pulse delay controls cover the range 35ns to 10 seconds. Outputs are selectable as non-gated (continuous), synchronously gated or asynchronously gated with both advance and reference triggering.

Please contact Electroplan for details of the 100A and the whole range of Pulse Generators available from stock.

Electroplan Ltd., P.O. Box 19,  
Orchard Road, Royston, Herts, SG8 5HH.  
Tel: Royston (0763) 41171 Telex: 81337

**electroplan**  
a service to measurement

An Electrocomponents Group Company.

WW-99 FOR FURTHER DETAILS

Rechargeable power sources, calibration and potentiometric measurement, d.c. power supplies, tools and accessories, frequency counter-timers, digital multimeters, digital panel meters

temperature measurement, laboratory instruments, hard copy recording, oscilloscopes and accessories, analogue multimeters, signal sources, logic test equipment, computer peripherals

*"They  
want **safety  
isolation**  
for their  
voice band  
circuits"*

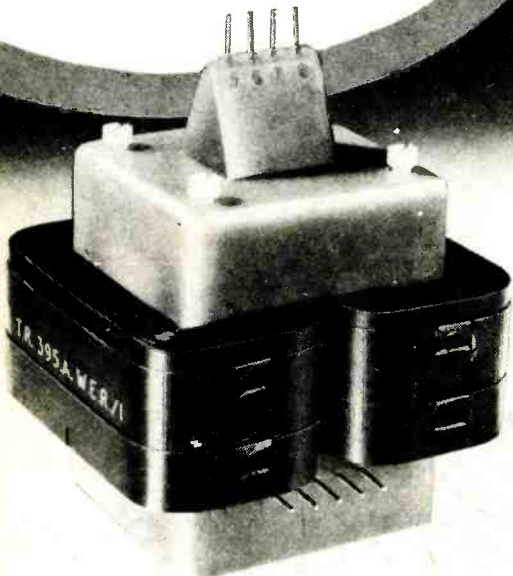

One more request item. We met it with a neat little transformer. Now, in two versions, it joins the list of useful Whiteley products, and everyone involved in communications system design will be interested in the protection they provide. Inserted in voice band circuits, they effectively isolate equipment from the hazards of adjacent high voltage power circuits on the 'line' side. High isolation level between line and equipment windings gives protection against voltage surges, lightning strikes and fault conditions. One version is designed for 17Hz signalling circuits, the other with several voltage ratios also suits a 50Hz ringing circuit. All are Post Office and C.E.G.B. approved, and the second version is also approved with extra protection diodes added. Requests for data sheets welcome. Or if you want to request a product spec of your own — we're always interested!

*Surprising how often you'll find*

**Whiteley  
make it.**

Whiteley Electrical Radio Co. Ltd  
Mansfield, Notts NG18 5RW, England. Tel: 0623 24762.

WW—084 FOR FURTHER DETAILS

## DATA AND COMMUNICATIONS TERMINALS

Teletype 28, 32, 33, 35, 40  
TermiNet 30, 300 & 1200 (30 and 120 cps)  
Teleterm 1132 and 1200 series (portable/fixed 30 cps)  
with integral coupler and RS 232C)  
Other page printers (by Siemens, ITT Creed, etc.)

- ★ Spares, repairs, overhauls and maintenance
- ★ Other types and models available
- ★ Refurbished units also available
- ★ Short and long period rentals
- ★ Minicomputer interfaces
- ★ Quantity discounts
- ★ Immediate delivery

**TELEPRINTER EQUIPMENT LTD.**  
70-80 AKEMAN STREET  
TRING, HERTS., U.K.

Telephone 0442-82-4011  
Cables RAHNO Tring  
Telex 82362  
A/B Batelcom Tring



WW—024 FOR FURTHER DETAILS

## METER PROBLEMS?

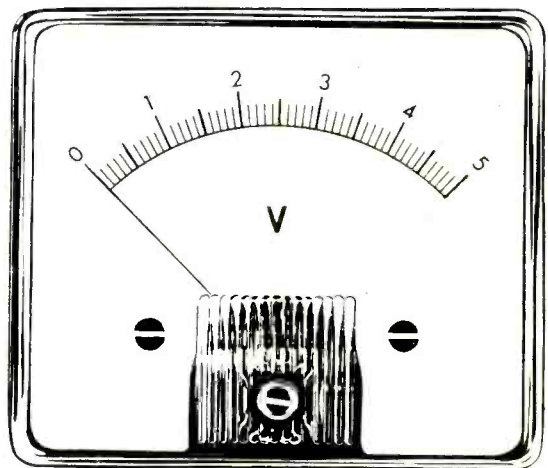

137 Standard Ranges in a variety of sizes and stylings available for 10-14 days delivery. Other Ranges and special scales can be made to order.

Full Information from:

**HARRIS ELECTRONICS (London)**

138 GRAYS INN ROAD, W.C.1 Phone: 01/837/7937

WW—037 FOR FURTHER DETAILS



# Hi-Fi Systems that GROW with you

**MAGNUM III** System as well as the features illustrated, has 20W r.m.s. per channel (you could have 40), with typical distortion of only 0.07%. The magnetic input has >70dB. S/N ratio (Ref. 3mV) and an overload margin of 43dB.

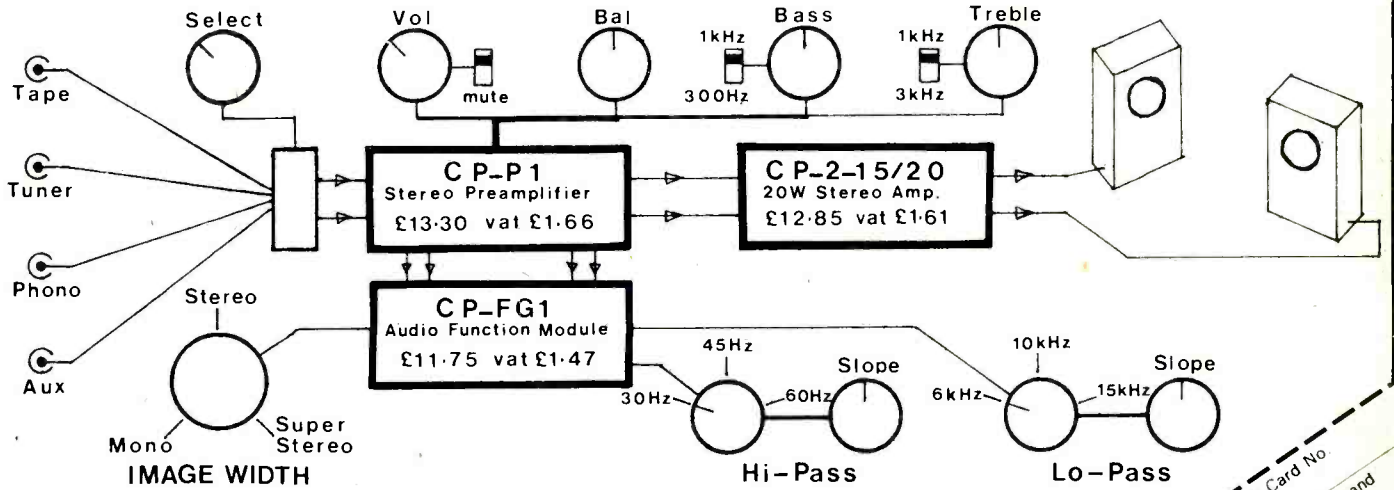

For details of **CLIFFPALM AUDIO MODULES** send large s.a.e. or see ad. in Feb. W.W. **NOW EX STOCK.** All other parts required—knobs, pots (rotary and linear) switches, sockets, etc. **NEW THIS MONTH.** P.C.B.s on which to build your MAGNUM I, II or III system. **POWER MODULE CP-PS-18/2D. £6.50 +72p V.A.T.**

Prices include full application data, post and packaging. These products carry a 2 year guarantee

**Cliffpalm Ltd.**

DEPT. HW, 13 HAZELBURY CRESCENT  
LUTON, BEDS. LU1 1DF. Tel. 0582-415832

Phone your order quoting Credit Card No.  
Please rush me I enclose a cheque/postal order crossed and made payable to Cliffpalm Ltd for: £

NAME \_\_\_\_\_ ADDRESS \_\_\_\_\_

WW—097 FOR FURTHER DETAILS

# nombrex

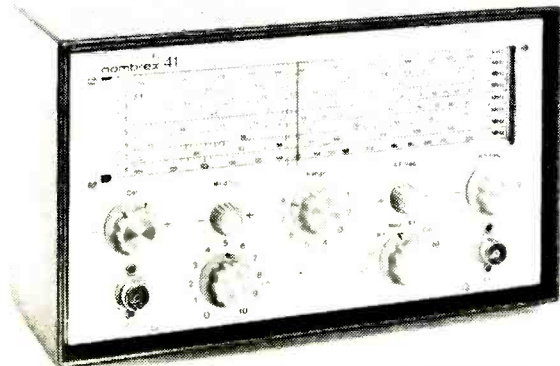

**MODEL 41**  
**R.F. SIGNAL GENERATOR**  
**Price £54.85**

PLUS V.A.T.

- ★ 150 KHz — 220 MHz on fundamentals.
- ★ 8 clear scales — Total length 130mm.
- ★ Spin-Wheel Slow Motion Drive 11 — 1 ratio.
- ★ Overall Accuracy — 2½%.
- ★ Modulation, Variable depth and frequency.
- ★ Internal Crystal Oscillator providing calibration checks throughout all ranges.
- ★ Mechanical scale adjustment for accurate alignment against internal 1MHz crystal oscillator.
- ★ Powered by 9V Battery.

Trade and Export enquiries welcome.

Send for full technical leaflets

Post and Packing £1.00 extra

**NOMBREX LTD., POUND PLACE, WOLBOROUGH STREET,  
NEWTON ABBOT, DEVON, TQ12 1NE  
Tel. Newton Abbot 68297**

WW—080 FOR FURTHER DETAILS

# the indispensable BIRD 43



**THRULINE® WATTMETER**

0.45-2300 MHz / 0.1-10,000 watts

The Standard of the Industry  
What more need we say...

Exclusive UK representative

**aspen electronics limited**

2 KILDARE CLOSE, EASTCOTE, MIDDX. HA4 9UW  
TELEPHONE: 01-868 1188 — TELEX 8812727

WW—052 FOR FURTHER DETAILS

# Join the Digital Revolution

Understand the latest developments in calculators, computers, watches, telephones, television, automotive instrumentation . . .

Each of the 6 volumes of this self-instruction course measures 11¼" x 8¼" and contains 60 pages packed with information, diagrams and questions designed to lead you step-by-step through number systems and Boolean algebra, to memories, counters and simple arithmetic circuits, and on to a complete understanding of the design and operation of calculators and computers.

Design of Digital Systems.

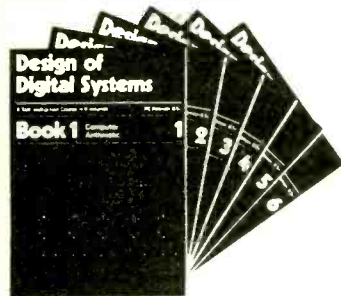

## £6.20

plus 80p packing and surface post anywhere in the world.

Payments may be made in foreign currencies.

Quantity discounts available on request.

VAT zero rated.

Also available — a more elementary course assuming no prior knowledge except simple arithmetic.  
Digital Computer Logic and Electronics.

In 4 volumes

1. Basic Computer Logic
2. Logical Circuit Elements
3. Designing Circuits to Carry Out Logical Functions
4. Flipflops and Registers

## £4.20

plus 80p P. & P.

Offer Order both courses for the bargain price £9.70, plus 80p P. & P.

**Designer  
Manager  
Enthusiast  
Scientist  
Engineer  
Student**

These courses were written so that you could teach yourself the theory and application of digital logic. Learning by self instruction has the advantages of being quicker and more thorough than classroom learning. You work at your own speed and must respond by answering questions on each new piece of information before proceeding to the next.

### Guarantee—no risk to you

If you are not entirely satisfied with Design of Digital Systems or Digital Computer Logic and Electronics, you may return them to us and your money will be refunded in full, no questions asked.

To Cambridge Learning Enterprises, Dept. COM, FREEPOST Rivermill House, St. Ives, Huntingdon, Cambs. PE17 4BR  
\*Please send me . . . set(s) of Design of Digital Systems at £7.00 each, p & p included

or . . . set(s) of Digital Computer Logic and Electronics at £5.00 each, p & p included

or . . . combined set(s) at £10.50 each, p & p included

Name

Address

\*delete as applicable

No need to use a stamp — just print FREEPOST on the envelope

WW1

## FYLDE

### TRANSDUCER and RECORDER AMPLIFIERS and SYSTEMS

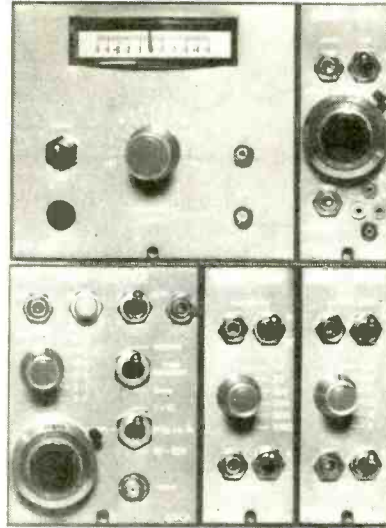

reliable high performance & practical controls. individually powered modules—mains or dc option single cases and up to 17 modules in standard 19" crates small size—low weight—realistic prices.

## FYLDE

**Fylde  
Electronic  
Laboratories  
Limited.**

49/51 Fylde Road Preston  
PR1 2XQ  
Telephone 0772 57560

WW-047 FOR FURTHER DETAILS



## SHEET METAL PUNCHES

for quick, clean holes

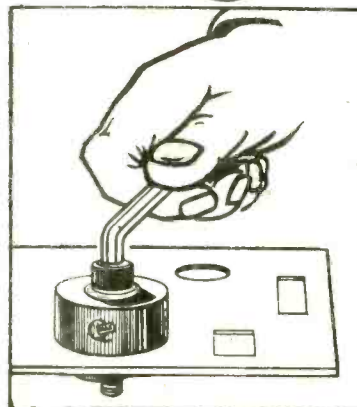

- Easiest and quickest way of punching holes in sheet metal (up to 1.625mm)
- Simple operation
- 100% British
- Burr-free holes — no jagged edges
- 57 Metric and Linear sizes (Lists on application)

Used all over the world by Government services — Atomic, Military, Naval, Air, G.P.O. and Ministry of Works; Radio, Motor and Industrial manufacturers, Plumbing and Sheet Metal Trades, Garages, etc.

Wholesale and Export enquiries to:

**"Q-MAX" (ELECTRONICS) LTD**  
44 PENTON STREET · LONDON N19QA Tel: 01-278 2500

WW-045 FOR FURTHER DETAILS

# The new Maplin Catalogue is no ordinary catalogue...

Hundreds of fascinating new lines.

Several major new projects to build.

**MAPLIN ELECTRONIC SUPPLIES**

**SUPERSONIC SAME DAY SERVICE!**

**QUALITY COMPONENTS FAST!**

Super Discount Voucher - saves you pounds!

Hundreds of photo-graphics and illustrations.

The new tools section includes a range of soldering irons and equipment whilst the test gear section includes a selection of multimeters from 1000Ω/V to 100,000Ω/V to suit your requirements

Find out about our major electronics projects you can build. Our catalogue will help you choose one of our many leaflets and booklets giving full constructional details of such exciting projects as a stereo graphic equaliser, or an electronic piano, a sophisticated electronic organ, our advanced synthesisers — and many more

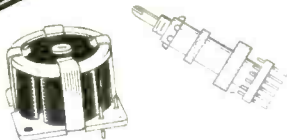

Component section includes a wide range of coils, pot cores, ready-wound coils and chokes from microHenries to Henries, plus ranges of Oenco coils and i.f. transformers, etc

Catalogue includes a very wide range of components: hundreds of different capacitors; resistors; transistors; I.C.'s; diodes; wires and cables; discotheque equipment; organ components; musical effects units; microphones; turntables; cartridges; styli; test equipment; boxes and instrument cases; knobs, plugs and sockets; audio leads; switches; loudspeakers; books; tools — AND MANY MANY MORE.



\* Our bi-monthly newsletter keeps you up to date with latest guaranteed prices — our latest special offers (they save you pounds) — details of new projects and new lines. Send 30p for the next six issues (5p discount voucher with each copy).

SEND THIS COUPON FOR YOUR COPY OF OUR CATALOGUE ON APPROVAL! Price 50p — SEND NO MONEY NOW. Please rush me a copy of your brand new 1977/78 catalogue by return of post. Only if I am completely satisfied that it is worth every penny will I send 50p within 14 days of receipt. If I am not satisfied, I may return the catalogue to you within 14 days without obligation. I understand that I need not purchase anything from your catalogue should I choose to keep it.

NAME \_\_\_\_\_  
ADDRESS \_\_\_\_\_

Maplin Electronic Supplies P.O. Box 3, Rayleigh, Essex, SS6 8LR

DON'T DELAY  
POST COUPON NOW  
IT COULD BE THE BEST 50p YOU'VE EVER SPENT

# MAPLIN

ELECTRONIC SUPPLIES  
P.O. BOX 3, RAYLEIGH, ESSEX SS6 8LR

Telephone: Southend (0702) 715155  
Call at our shop: 284 London Road, Westcliff-on-Sea, Essex  
(Closed all day Monday) Telephone: Southend (0702) 47379

# NEW The British Plot!

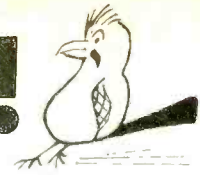

Bringing further versatility to the range of low cost Chart Recorders and XYt Plotters.  
Designed and manufactured in the U.K. at our Southampton plant:-

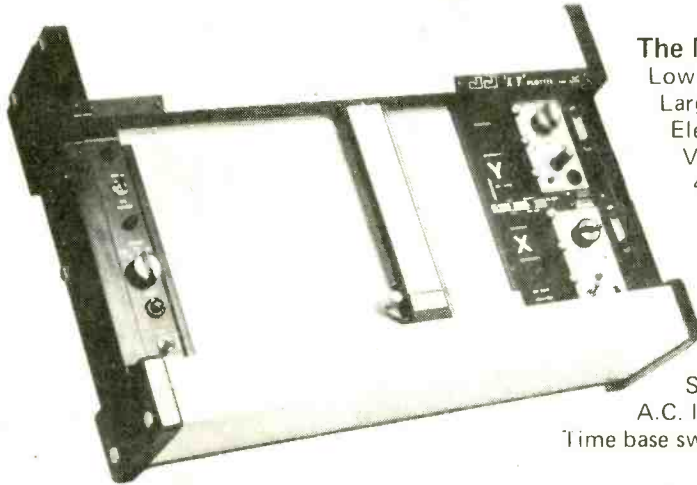

## The NEW PL200 PLOTTER OFFERS:-

- Low cost main frame
- Large writing area (228 x 305mm)
- Electric (remote or local) pen lift
- Vertical or horizontal mounting
- 400 mm/sec. Y axis writing speed
- Variable sensitivity down to approx. 1V F.S.D.
- Variable damping
- Simple, uncalibrated time base
- Stabilised supply for resistance transducers

### PLUS (optional plug-ins)

- D.C. single ended and differential amplifiers
- Sensitivities down to 50  $\mu$ V/cm
- A.C. linear and logarithmic level amplifiers
- Time base sweep times from 5 seconds to 500 minutes



For complete details or a demonstration contact:-

**J.J. LLOYD INSTRUMENTS LIMITED**

Brook Avenue, Warsash, Southampton SO3 6HP, England.

Tel: Locks Heath 4221 (STD 048 95)

Telex: 477042 - JAY JAY - SOTON. Cables: Eddymes, Southampton.

WW—068 FOR FURTHER DETAILS



## HIGH PERFORMANCE AMPLIFIERS for the enthusiast and professional

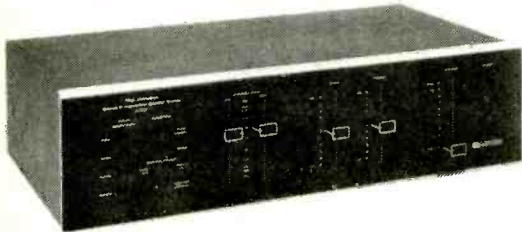

### ZD22 Stereo Pre-amplifier Control Unit

A stereo pre-amplifier of virtually zero distortion. Inputs for disc, tuner, and two tape machines, providing comprehensive recording and reproducing facilities. Sensitivities: Disc 1mV, and Auxiliaries 50mV, for 1V output. Exceptional signal/noise ratio. Output at clip level 18V r.m.s.

### ZD50 Power Amplifier

A stereo power amplifier of all aluminium construction. Output of 110 watts per channel into 4 ohms and 70 watts into 4 ohms at typically less than 0.002% distortion.

### ZD100 Power Amplifier

A stereo power amplifier of all aluminium construction with high thermal mass and designed for continuous operation at high output level. Provides 150 watts per channel into 4 ohms and 90 watts per channel into 8 ohms at virtually zero distortion.

### ZD200 Power Amplifier

Characteristics as ZD100 amplifier but provides an output of 250 watts per channel into 4 ohms and 150 watts per channel into 8 ohms.

### HD250 Stereo Integrated Amplifier

Uses ZD22 pre-amplifier with a power amplifier having a power output in excess of 50W per channel into 4-8 ohms. Distortion: less than 0.02% at rated power, typically less than 0.01%. True complementary symmetry output. Headphone output. Inputs: Disc, tuner, and two tape machines. Sensitivities: Disc 1mV. Auxiliaries 50mV for 20W output.

Full descriptive leaflets available from:

**RADFORD ELECTRONICS LTD.**

Audio Division

Ashton Vale Road, Bristol, Avon BS3 2HZ. Tel: 0272-662301

WW—028 FOR FURTHER DETAILS

*Keep those  
Contacts CLEAN*

BY USING A

## DIACROM SPATULA



*Manufactured in France  
British Patents applied for*

**No other cleaner has all these advantages:—**

1. Only 100% pure, natural diamond grains are utilised.
  2. Blades are treated with hard chrome to reinforce the setting of the diamond grains, to obviate loosening or breakaway during use. This process also prevents clogging of the diamond surface by residues resulting from use.
  3. All diamond blades are rectified to ensure an absolutely smooth surface by eliminating diamond grains which may rise above the surface. This eliminates all excessive scratching during use.
  4. All diamond grains are rigidly calibrated to ensure a perfectly uniform grain size of either 200, 300 or 400.
  5. The chrome gives a very weak co-efficient of friction and the rigidity of the nylon handle is calculated to permit proper utilisation and yet pliant enough to avoid undue pressures on highly delicate relays.
- Grain size 200, thickness 55/100 mm., both faces diamonded. For quick cleaning of industrial relays and switching equipment, etc.
  - Grain size 300, thickness 55/100mm., both faces diamonded. For smaller equipments, like telephone relays, computer relays, etc.
  - Grain size 400, thickness 25/100 mm., one face diamonded. For sensitive relays and tiny contacts. Two close contacts facing each other can be individually cleaned, because only one face of the spatula is abrasive.

**Sole Distributors for the United Kingdom**

**SPECIAL PRODUCTS (DISTRIBUTORS) LTD**

**81 Piccadilly, London W1V 0HL. Phone: 01-629 9556**

As supplied to the M.O.D., U.K.A.E.A., C.E.G.B. British Rail and other Public Authorities; also major industrial and electronic users throughout the United Kingdom.

WW—074 FOR FURTHER DETAILS

# INTRODUCING INTERLAB<sup>®</sup>

## type MP51 low cost PULSE GENERATOR

a new model in LI's INTERLAB<sup>®</sup> series of versatile, economical, instruments for laboratory, test and education

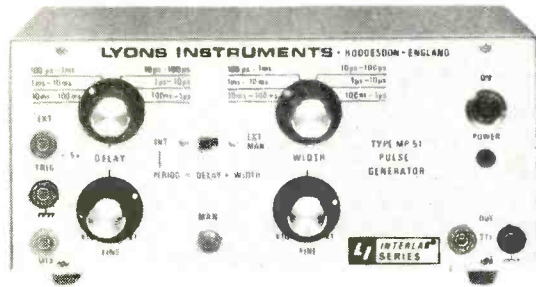

### TYPE MP51 PULSE GENERATOR

- PRF 5Hz – 5MHz
- External trigger
- Delay 100ns – 100ms
- Manual one-shot
- Width 100ns – 100ms
- TTL compatible
- Mixing input for double/multi-pulse
- Price — only £60 ex works (plus VAT)

Also available in the INTERLAB<sup>®</sup> series:

### TYPE SQ10 SINE/SQUARE OSCILLATOR

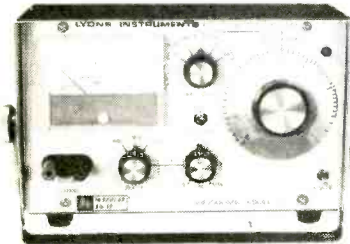

- 10Hz – 1MHz
- 10V p-p output
- 0.05% typical distortion
- 50Ω source impedance

### TYPE D10 AF DISTORTION METER

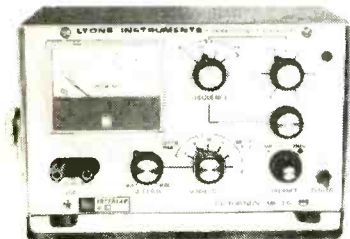

- 0.1% – 10% THD
- Fundamental 10Hz – 100kHz
- Intrinsic distortion less than 0.05%

# INTERLAB<sup>®</sup>

series from



## LYONS INSTRUMENTS

Hoddesdon Herts EN11 9DX  
Telephone 67161 Telex 22724

A Claude Lyons Company

WW—008 FOR FURTHER DETAILS

## Introducing the new Quick Charge Cordless Soldering Iron

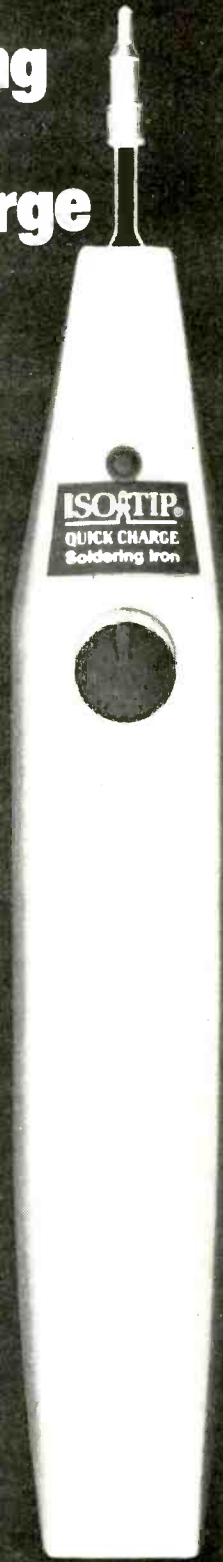

Illustration actual size.

- Solder heat in five seconds
- No wires to restrict use
- Completely recharges in only 4 hours!
- No need for earthing
- Capacity to solder up to 125 joints

This new rechargeable soldering iron from Greenwood brings added freedom to professional soldering. The Quick Charge recharges so fast that completely dead battery cells can be brought to full charge in about 4 hours – three times faster than before. In its stand the Quick Charge is, of course, being continually charged. A wide range of tips and now also a P.C. Drill attachment make this the most 'versatile' professional soldering iron available.



## Greenwood Electronics

Greenwood Electronics, Portman Road, Reading, RG3 1NE  
Telephone: 0734 595844. Telex 848659

# A. D. BAYLISS & SON LTD.

## Behind this name there's a lot of real POWER!

Illustrated right is a **TITAN DRILL**

Mounted in a multi-purpose stand. This drill is a powerful tool running on 12v DC at approx. 9000 rpm with a torque of 350 gm. cm. Chuck capacity 3.00 m/m. The multi-purpose stand is robustly constructed of steel and aluminium. The base and bracket are finished in hammer blue. Also available for use in the stand is the **RELIANT DRILL** which is a smaller version of the Titan. Approx. speed 9000 rpm. 12v DC. torque 35 gm. cm. Capacity 2.4 m/m.

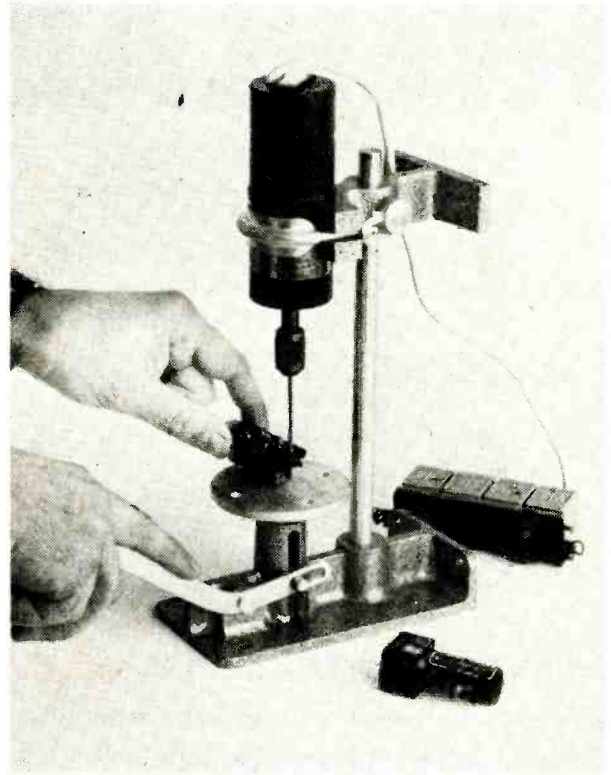

|                                  |                             |
|----------------------------------|-----------------------------|
| <b>TITAN DRILL &amp; STAND</b>   | <b>£19.50</b>               |
|                                  | + 8% VAT = £21.06 + £1 P&P  |
| TITAN DRILL ONLY                 | <b>£8.90</b>                |
|                                  | + 8% VAT = £9.61 + 35p P&P  |
| <b>RELIANT DRILL &amp; STAND</b> | <b>£16.27</b>               |
|                                  | + 8% VAT = £17.52 + £1 P&P  |
| RELIANT DRILL ONLY               | <b>£5.22</b>                |
|                                  | + 8% VAT = £5.64 + 35p P&P  |
| <b>TITAN MINI KIT DRILL</b>      | <b>£13.95</b>               |
| Plus 20 Tools                    | + 8% VAT = £15.07 + 50p P&P |
| <b>RELIANT MINI KIT DRILL</b>    | <b>£11.20</b>               |
| Plus 20 Tools                    | + 8% VAT = £12.10 + 50p P&P |
| <b>TRANSFORMER UNIT</b>          | <b>£8.55</b>                |
|                                  | + 8% VAT = £9.23 + 75p P&P  |

These are examples of the extensive range of power tools designed to meet the needs of development engineers, laboratory workers, model makers and others requiring small precision production aids.

To back up the power tools, Expo offer a comprehensive selection of Drills, Grinding Points and other tools.

SEND STAMP for full details to main distributors

**A. D. BAYLISS & SON LTD.,** Pfera Works, Redmarley, Glos. GL19 3JU

Stockists: Richards Electric, Worcester and Gloucester; Hoopers of Ledbury; Hobbs of Ledbury; D&D Models, Hereford; Bertella, Gloucester

WW-094 FOR FURTHER DETAILS

# itam

ITAM 805 (8TRACK)  
MASTER RECORDER

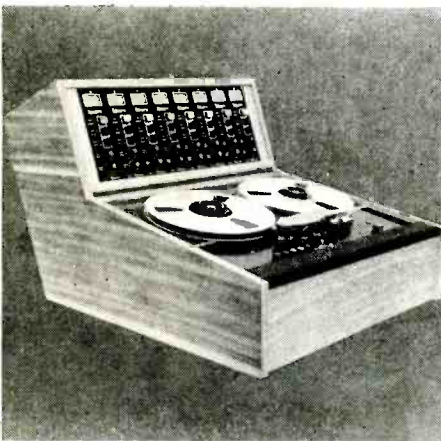

Fully modular electronics using plug-in PCB's throughout. Separate sync and replay amps give identical levels. Switchable VU's with slow decay. Individual oscillator for each channel. Dolby A switching facility. Comprehensive facilities include sync on all channels, servo controlled capstan, modular electronics, variable speed (optional), relay-solenoid operation. Compact presentation for easy portability.

**£1790** + VAT Full console optional extra.

Compatible 8-output Mixer available

**£1260** + VAT

# OTARI

OTARI DP-4050  
CASSETTE COPIER



Ideal for one copy or ten thousand. Eight times copy speed, foolproof operation for non-skilled personnel, modular construction, servo-controlled direct capstan drive.

Immediate delivery.

THESE ITEMS ARE INDUSTRIAL PRODUCTS AND SUBJECT TO 8% VAT

**Industrial Tape Applications**



1/7 Harewood Avenue, Marylebone Rd., London, NW1  
Telephone: 01-485 6162. Telex: 21879

WW-096 FOR FURTHER DETAILS

# Everyone just says . . .

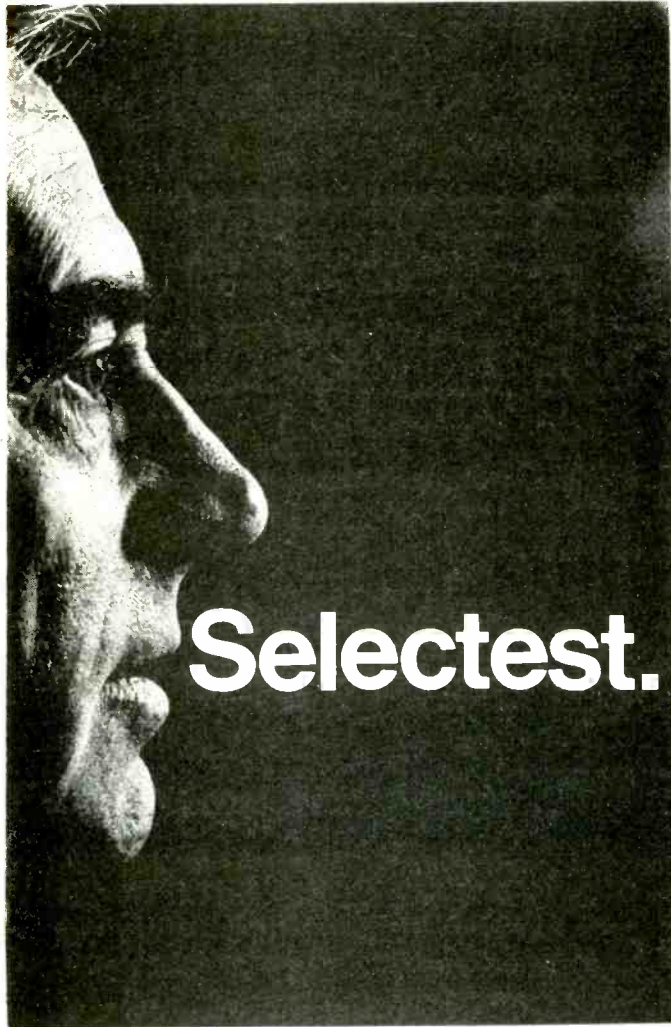

## Good job we know what they mean

The MK. 3 Selectest has every facility you need built into it, accuracy, sensitivity and robustness. The case is made of wipe-clean, tough, light-weight melamine. Terminals accept 4mm push-in plugs on the front panel, enabling the Selectest to be used horizontally or vertically. The scale incorporates an inset mirror and knife edge pointer.



## SALFORD ELECTRICAL INSTRUMENTS LIMITED

Peel Works, Barton Lane, Eccles, Manchester M30 0HL  
 Telephone 061 789 5081 Telex 667711  
 A member company of GEC Electrical Components Ltd.



WW-081 FOR FURTHER DETAILS

The world's most famous company in communication, the Nippon Electric Company Ltd., Tokyo, has developed the famous NED CQ radio amateur gears, being with regard to design, quality, reliability and price real pace-setters for today's communicators. First in history of amateur radio, such a big and famous company with more than 80 years of experience in construction of communication facilities, made its experience available to radio amateurs around the world. The NEC, which has declared microwave space communication to its speciality, knows perfectly which attributes equipments must have for becoming bestsellers.

Today we present:

## NEC CQ 110 E DIGITAL



allband, HF, 300 watt transceiver, 160 / 80 / 40 / 20 / 15 / 11 / 10A / 10B / 10C / 10D / WWV, modes FSK, USB, LSB, CW, AM, with separate 8 pole X-tal lattice filters for each mode fitted. Further features: Side tone at CW, VOX (automatic transmit-receive by talking into microphone), 11 meter CB band, all channels easily selectable through digital counter, excellent receiver sensitivity at extreme crossmodulation security by application for the 7360 low noise beam, deflection mixer tube. This feature alone makes of the NEC CQ 110 E a top rider. Fixed channel communication on 22 channels is possible. A 60 page manual and a high quality dynamic microphone are supplied with the transceiver. Speaker, AC 100-235 volts and DC 13.5 volts power supplies are built in of course

## NEC CQ 301

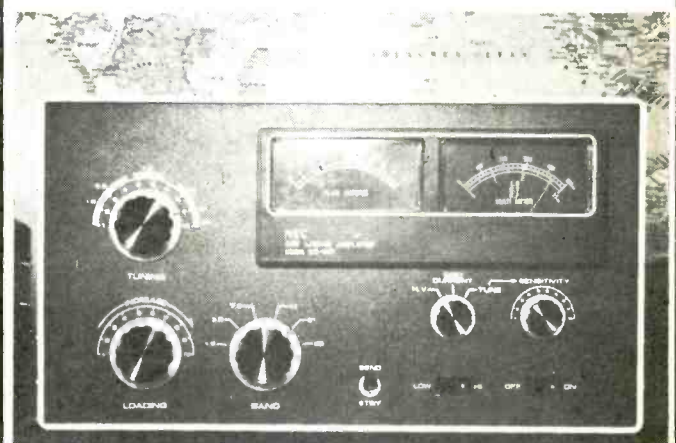

allband HF, 3KW, linear amplifier, 160/80/40/20/15/11/10 meter, for modern amateur communication. Two EIMAC 3-500 Z triodes, in zero bias grounded grid application guarantee long trouble free communication. The NEC CQ 301 can be driven by our CQ 110E or other excitors capable of about 50-100 watts of drive. AC power supply 100-235 volts is built in of course.

RETAILERS: Do not hesitate to accept our offer. Join us in selling these bestsellers!

Sole distributor in Europe:

**CEC** Corp., Via Valdani 1—CH 6830 CHIASSO—SWITZERLAND  
 Phone: (091) 44 26 51. Telex. 79959 CH

WW 064 — FOR FURTHER DETAILS

# HIGH POWER DC-COUPLED AMPLIFIER



- ★ UP TO 500 WATTS RMS FROM ONE CHANNEL
- ★ DC-COUPLED THROUGHOUT
- ★ OPERATES INTO LOADS AS LOW AS 1 OHM
- ★ FULLY PROTECTED AGAINST SHORT CCT, MISMATCH, ETC.
- ★ 3 YEAR WARRANTY ON PARTS AND LABOUR

The DC300A Power Amplifier is the successor to the world famous DC300 which is so widely used in Industrial, and Research applications in this country. It is DC-coupled throughout so providing a power bandwidth from DC to over 20,000Hz. The ability of the DC300A to operate without fuss into totally reactive loads while delivering its full power, and maintaining its faithful reproduction of Pulse or complex waveforms has established the DC300A as the world's leading power amplifier. Each of the two channels will operate into loads as low as 1 ohm, and the amplifier can be rapidly connected as a single ended amplifier providing over 650 watts RMS into a 4 ohms load, and still providing a bandwidth down to DC. Below is a brief specification of the DC300A, but if you require a data sheet, or a demonstration of this fine equipment please let us know.

|   |                                    |                               |                                       |
|---|------------------------------------|-------------------------------|---------------------------------------|
| Power Bandwidth                                       | DC 20kHz @ 150 watts + 1db 0db     | Slewing Rate                  | 8 volts per microsecond               |
| Power at clip point (1 chan)                          | 500 watts rms into 2.5 ohms        | Load impedance                | 1 ohm to infinity                     |
| Phase Response  | +0. -15 DC to 20kHz 1 watt 8Ω      | Input sensitivity             | 1.75 V for 150 watts into 8Ω          |
| Harmonic Distortion                                   | Below 0.05% DC to 20kHz            | Input Impedance               | 10K ohms to 100K ohms                 |
| Intermod. Distortion                                  | Below 0.05% 0.01 watt to 150 watts | Protection                    | Short, mismatch & open cct protection |
| Damping Factor  | Greater than 200 DC to 1kHz at 8Ω  | Power supply                  | 120-256V, 50-400Hz                    |
| Hum & Noise (20-20kHz)                                | At least 110db below 150 watts     | Dimensions                    | 19" Rackmount, 7" High, 9 1/4" Deep   |
| Other models in the range: D60 — 60 watts per channel |                                    | D150A — 150 watts per channel |                                       |

Other models available from 100 watts to 3000 watts



## MACINNES LABORATORIES LTD.

MacInnes House, Carlton Park Industrial Estate  
Saxmundham, Suffolk IP17 2NL. Tel: (0728) 2262 2615

## MACINNES FRANCE

45 Rue Fessart  
Paris 75019, France  
Tel: 203-30-01

WW-034 FOR FURTHER DETAILS

**QUARTZ  
CRYSTALS  
-FAST!**



**AEL**

AEL CRYSTALS LIMITED  
Gatwick House, Horley, Surrey, England RH6 9SU  
Telephone: Horley (02934) 5353 Telex: 87116 (Aerocon Horley)  
Cables: Aerocon Telex Horley

WW-042 FOR FURTHER DETAILS

## JES AUDIO INSTRUMENTATION

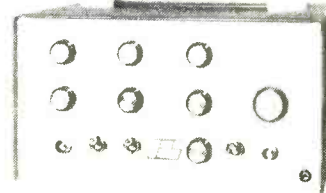

Illustrated the Si452 Distortion Measuring Unit—low cost distortion measurement down to .01% £48.00

|                              |           |                           |                        |
|------------------------------|-----------|---------------------------|------------------------|
| Si451                        | £60.00    | Si453                     | £60.00                 |
| Comprehensive Millivoltmeter | 20 ranges | Low distortion Oscillator | square — square — RIAA |

prices plus VAT

J. E. SUGDEN & CO. LTD. Tel. Cleckheaton (0274) 872501  
CARR STREET, CLECKHEATON, W. YORKSHIRE B19 5LA

WW-025 FOR FURTHER DETAILS

# Audio versatility by **TWEED**

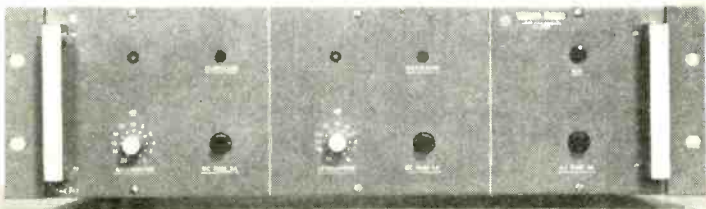

The Tweed Twin-100 Monitor Power Amplifier — designed for a high peak output capability, this robust amplifier delivers 100 watts per channel into 8 ohms. Full performance specification on request.

If you require superb quality, top performance, proven reliability and electronics designed with music in mind, write or phone:



## TWEED AUDIO

HOSEWOOD INDUSTRIAL ESTATE KILSO  
ROXBURGHSHIRE SCOTLAND PHONE 2981 STD 09132

Specialists in Audio Control Equipment for the Broadcast and Sound Recording Industries

WW-085 FOR FURTHER DETAILS



**RADFORD**

**AUDIO LABORATORY INSTRUMENTS**  
for the professional

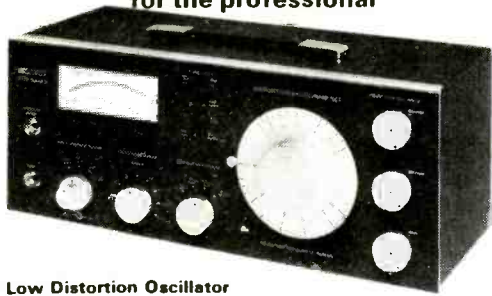

**LDO3 Low Distortion Oscillator**

A continuously variable-frequency laboratory oscillator with a range 10Hz-1.00kHz, having virtually zero distortion over the audio frequency band with a fast settling time.

**LDO3.B Low Distortion Oscillator, balanced output.**

A LDO3 but fitted with an output amplifier and screened balanced transformer providing a 600 ohm floating / balanced output, and 150 ohms unbalanced output.

**DMS3 Distortion Measuring Set (Illustrated)**

Measures total harmonic distortion down to 0.001% speedily and accurately. Direct reading from calibrated meter.

**HSV1 High Sensitivity Voltmeter**

An accurate voltmeter with 16 ranges, 10µV-300V f.s.d. Average responding.

**HSV2 High Sensitivity Voltmeter.**

As HSV1 but true r.m.s. reading.

**ANM1 Audio Noisemeter**

An accurate voltmeter and noisemeter with 16 ranges, 10µV-300V f.s.d. Fitted weighting characteristics: Wide band, DIN Audio Band, IEC/DIN Curve 'A', and CCIR. Average responding.

**ANM2 Audio Noisemeter**

As ANM1 but true r.m.s. reading.

**ANF1 Audio Noisefilter**

An active filter to CCIR weighting characteristic for use with external voltmeter. (Ref. Dolby Laboratories Inc., Bulletin No. 43, Mar. 76).

Full descriptive leaflets available from:

**RADFORD ELECTRONICS LTD.**

Laboratory Instruments Division

Ashton Vale Road, Bristol, Avon BS3 2HZ Tel. 0272 662301

WW-029 FOR FURTHER DETAILS

**643 FUNCTION GENERATOR**  
SINE, SQUARE + TRIANGLE  
0.01 to 1 MHz  
10v PP ±5v DC OFFSET  
50Ω OUTPUT IMPEDANCE  
1000:1 VCO RANGE

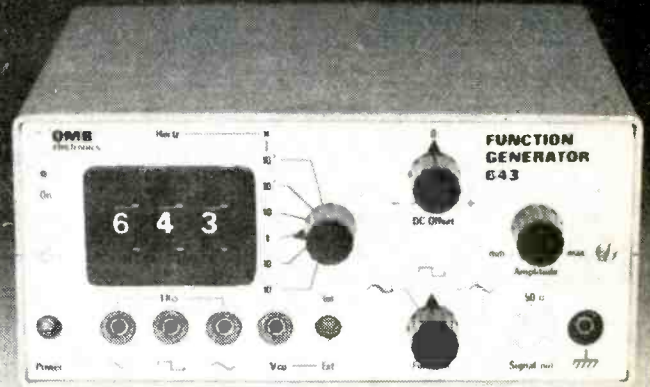

643 Function Generator . . . . . £95 + £2 P&P WW.015

Other products include:

- 643A Function Generator . . . . . £79 WW.016
- 745 Counter Timer . . . . . £88 WW.017
- 744 Counter Timer . . . . . £79 WW.018
- 631 Filter Oscillator . . . . . £98 WW.019

Delivery is normally ex-stock — telephone for confirmation  
Prices correct at time of going to press, subject to change without notice

**OMB, Electronics, Riverside, Eynsford, Kent. Tel. 0322 863567**

**Edicron**  
For Quality  
and Reliability

Edicron Limited  
Redan House 1 Redan Place  
London W2 4SA  
Tel: 01-727 0101  
Telex: 265531  
Cables: Edicron London W2

Electronic  
Valves/Tubes

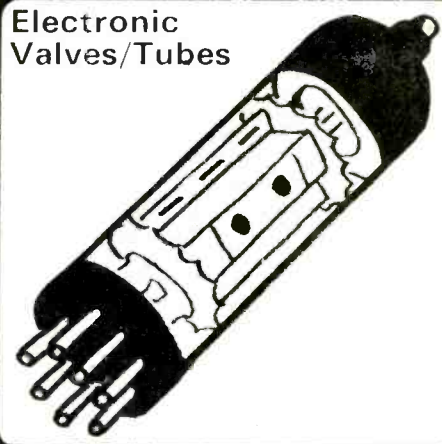

Resistors and  
Capacitors

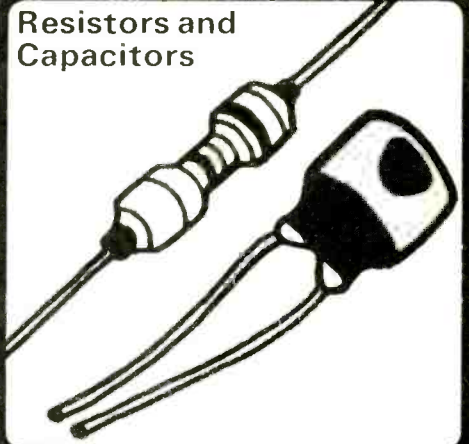

TV Picture  
Tubes

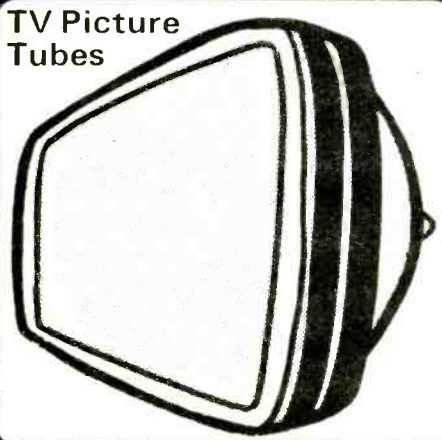

Transistors

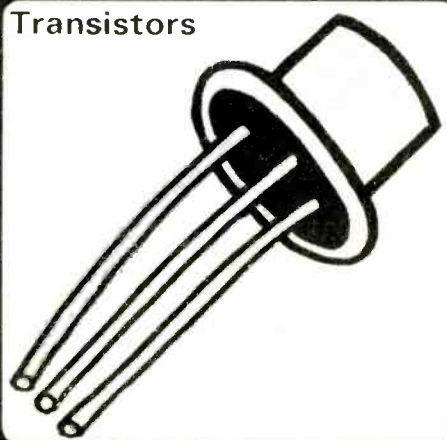

CR Gun  
Assemblies

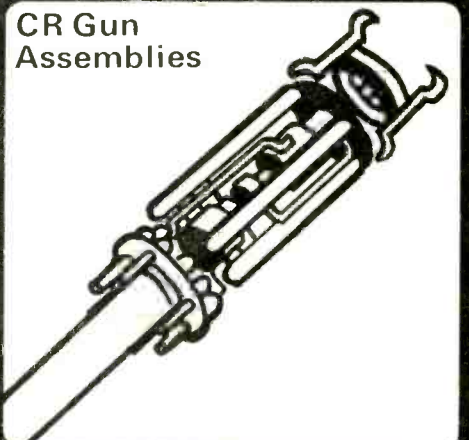

**EXPORT — INDUSTRY — WHOLESALE**

WW-040 FOR FURTHER DETAILS

# ambit INTERNATIONAL Trade Mark

The Wireless Specialists for components & modules.

EF5800, 7030 & 91196 - .9uV/30dB S/N., 0.2% THD  
Our top three FM tunermodules. (EF5800 shown with can off).

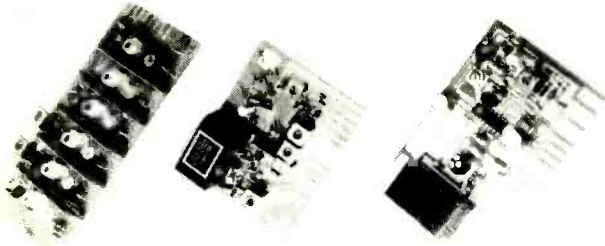

From left to right, the EF5800 6 circuit varicap FM tunerhead with the 7030 linear phase IF and the 91196 PLL stereo decoder with integral 55kHz 'birdy' filter. The system provides afc muting, meter drives, agc, auto stereo switch, & a specification that exceeds broadcast requirements. Now available with a new EF5801 tunerhead, with FET buffered oscillator output for synthesiser/frequency readout facilities.

EF5801...£17.45; EF5800...£14.00; 7030...£10.95; 91196...£12.99

Complete FM tuner kits/systems (Carriage £3 extra.)

*The Mark 8 Signalmaster - by Larsholt Electronics*

This tuner is based on the popular 7252 tuner set, and provides an incomparable combination of style and performance that can be built by even the relatively inexperienced constructor. Complete kit...£85.00; matching 25+25W amplifier...£79.00.

*International Mark 2 Tuner kits:*

Complete tuner kit, based around the 7253 tuner set, £65.00. Or just the chassis, cabinet, heavy aluminium front panel — for your own choice of modules— see our new info. leaflet on the International Tuner. (SAE please)

## NEW NEW NEW NEW NEW NEW NEW NEW BIONIC FERRET METAL LOCATOR

Ambit has designed a new approach to cost effective sensitive metal locators, and now we proudly present the first of the family of 'Bionic Ferrets'. Details OA, but we can say it will detect a 10p piece at 8-10 inches. Coupled with low power consumption and many innovations, this is the first radically advanced detector that can be made from a kit. £37.99

Radio module selection: (Prices for kits in our catalogue & PL)

|        |  |        |
|--------|--|--------|
| EF5800 | Ambit 6 stage varicap 88-108MHz tunerhead  | £14.00 |
| EF5600 | TOKO 5 stage varicap   | £12.95 |
| EC3302 | TOKO 3 stage varicap   | £7.50  |
| 7020   | Dual ceramic filter FM IF system module  | £6.95  |
| 92310  | MPX decoder, with stereo filter and preamp   | £6.95  |
| 93090  | MPX decoder with CA3090AQ + filter stage   | £7.35  |
| 91197  | MW/LW varicap AM tuner module  | £11.35 |
| 771    | New 'Off-Air' UHF varicap TV sound tuner module with mute, AFC, dual conversion, PSU | £27.00 |
| 9014   | MW/LW/Stereo FM tuner chassis. Mech. tuned   | £26.00 |

Components: ICs, coils, filters, trimmers, diode law pots etc.

|                           |       |   |      |
|---------------------------|-------|---|------|
| HA1137W/3089E FM IF       | 1.94  | TOKO AM IF TS:                                  |      |
| TBA120 FM IF and demod    | 0.75  | 455/470kHz types                                | 0.30 |
| MC1350 FM IF preamp       | 0.97  | 10.7MHz types                                   | 0.33 |
| SN76660N FM IF and det.   | 0.75  | (10mm square, with int. cap.)                   |      |
| MC1310/4400 PLL MPX       | 2.20  | 455kHz Mechanical filters                       |      |
| CA3090AQ PLL MPX          | 3.75  | 4 or 7 kHz bandwidths                           | 1.95 |
| HA1196 PLL MPX            | 3.20  | 455kHz ceramic IF filters                       |      |
| UA720 AM radio system     | 1.40  | 6 or 8 kHz bandwidth CFT                        | 0.55 |
| TBA651 AM radio system    | 1.81  | SFD455 (Murata)                                 | 0.75 |
| HA1197 AM radio system    | 1.40  | 455kHz dual ceramic CFX                         | 1.80 |
| LM1496 balanced mixer     | 1.25  | 10.7MHz filters for WBFM:                       |      |
| 11C90 600MHz decade ctr   | 14.00 | 3132A 6 pole lin phase                          | 2.25 |
| LM380N 2 W Audio          | 1.00  | 3125N 4 pole lin phase                          | 1.30 |
| LM381N audio preamp st.   | 1.81  | CFS ceramic filters:                            |      |
| TDA2020 20W audio amp     | 2.99  | Pilot tone (MPX) filters:                       |      |
| TCA940 10W audio amp      | 1.80  | BLR3107N stereo                                 | 1.90 |
| NE723 voltage reg IC      | 0.80* | BLR2007N  | 1.95 |
| TDA1412 12v 600mA reg     | 0.95* | BLR3152/mono                                    | 0.97 |
| 78M20 20v 500mA           | 1.20* | BLR3172N tape bias trap, with 85 or 100kHz pole | 0.97 |
| TAA550B varicap regulator | 0.50* | various chokes etc. see price list              |      |
| NE560/1/2B PLL ICs        | 3.50* |   |      |
| ICL8038CC function gen    | 4.50* |   |      |

22turn 100k diode law trim pots, with integral knob 40p  
270° rotary 100k diode law tuning pot 32p  
Also...meters for tuners, AM tuning varicaps, MOSFETs etc....

post/packing 22p per order - except where indicated

General: All prices shown here exclude VAT, which is generally 12½%. (Except where marked\*). The latest price leaflet is available FOC with an SAE. Please send a (large) SAE with any enquiries. Full catalogue still 40p.

37 High Street, Brentwood, Essex. CM14 4RH.  
TELEPHONE (0277) 216029 - after 3pm if possible please.

WW — 090 FOR FURTHER DETAILS

## BIMBOARD

Stop Ruining Your I.C.'s And Wasting Time Soldering  
Plug Into The Revolutionary New

## BIMBOARD

The Only Professional Quality Breadboard That  
Accepts All DIL Packages With 6 To 40 Pins

Incorporates Bus Strips For Vcc And Ground

Includes A Component Support Bracket

Has Over 500 Individual Sockets

And Allows You To Use And Re-Use  
IC's, Transistors, LED's, 7 Segment Displays,  
Diodes, Resistors, Capacitors

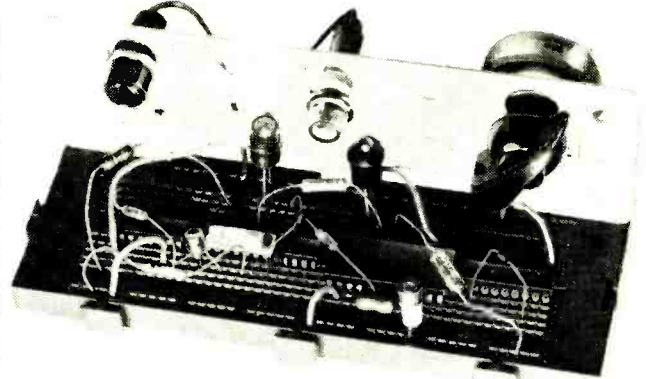

Only £9.72 (cheque with order) Including VAT and P.P.  
Special Quantity Discounts Available For  
Radio Clubs, Retail Outlets, Distributors

## BOSS INDUSTRIAL MOULDINGS LTD

Higgs Industrial Estate, 2 Herne Hill Road, London, SE24 0AU, England  
Telephone 01-737 2383 Telex 919693

## ELECTRONORGTECHNICA

## carbon film RESISTORS

1/8 and 1/4w 70°C 5% tol. E.12

EX-STOCK

**£4.90 PER 1,000** PLUS V.A.T. & POSTAGE  
OF ONE VALUE

Minimum export order £100

Contact John Gingell



## AERO SERVICES LTD.

44A Westbourne Grove  
London W2 5SF  
TEL 01-727 5641 TELEX 261306

WW—053 FOR FURTHER DETAILS

## T 100 NAB CARTRIDGE PLAYER



Only  
£129.50  
+VAT



FITCH TAPE MECHANISMS

7a Balham Grove, London, SW12. 01-673 1362

Audiopak  
NAB 'A'  
Cartridges  
also available  
direct from  
us.

WW—038 FOR FURTHER DETAILS

# NEW FOR HOME CONSTRUCTOR TT-Dec Breadboard

Worth 36p

TT-Dec, The New Versatile breadboard for integrated circuits which require a considerable amount of discrete circuitry. Buy now and receive a Free I.C. Blob Board. Worth 36p.

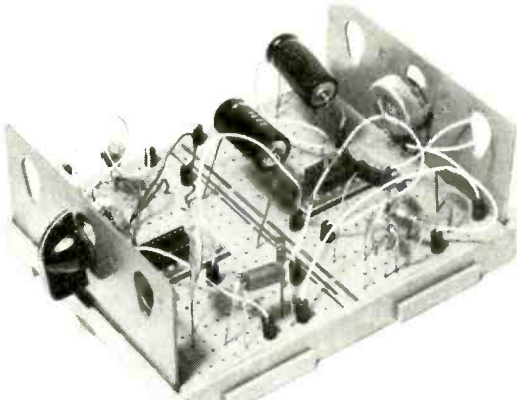

Design and build circuits directly onto the TT-Dec; plug components in and out; Re-use components; No soldering.

TT-Dec's have 416 contact points, 2-16 DIL holders, a facility for 4-10 lead TO51.C.'s, 2 component support brackets, 10 double ended leads and step by step instructions of exciting I.C. projects to build. Contacts are linked electrically in rows with 5mm gaps, enabling short lead devices to be inserted directly into the contacts.

Special price £7.26 + (64p for post and V.A.T.) + FREE I.C. Blob Board.

PB

P.B. Electronics (Scotland) Ltd.  
57 High Street, Saffron Walden, Essex.

Mr. Trader please exchange for 1 I.C. Blob Board worth 36p to any purchaser of a TT-Dec. Trade phone 01-228 9227 36p

WW-033 FOR FURTHER DETAILS

## Crimson Elektrik

### MINIMUM TID POWER AMPLIFIER MODULES

WE BELIEVE OUR MODULES ARE UNEQUALLED IN SOUND QUALITY, OVERALL PERFORMANCE & VALUE FOR MONEY

★S/N > 110dB ★120x80x25mm ★Fully protected ★250mw/56kn ★12Hz-35kHz >3dB ★14Trs 4D  
It has recently been shown that an amplifier with some traditionally desirable features (eg heavy feedback wide bandwidth) can actually sound worse than one with a poorer spec. This has been attributed to distortion caused by transients (T.D.). Carefully positioned compensation, a rise-time of 10µs setting-time of 10µs (8...2µs) and slewing-rate of 6v/µs ensure minimum T.D. while T.H.D. is reduced to typically 0.1% (0.4max) at 1kHz by ultra-linear output triples, not by feedback. This approach has yielded one of the cleanest sounding amplifiers available regardless of cost.

- CE60B 60Wrms/8v, ±35v £14.55
- CE100A 100Wrms/4v, ±35v £17.55
- CE100B 100Wrms/8v, ±45v £21.55
- H/sinks: 50mm 8Sp, H/ctly 100mm £1.50

Cheque/P.D. to: CRIMSON ELEKTRIK  
S.A.E. for full details 74 STATION ROAD  
Tel: (0533) 386211 RATBY, LEICESTER



CE100B - Domestic heatsink, 50mm

WW-041 FOR FURTHER DETAILS

## INSTANT SINAD MEASUREMENTS

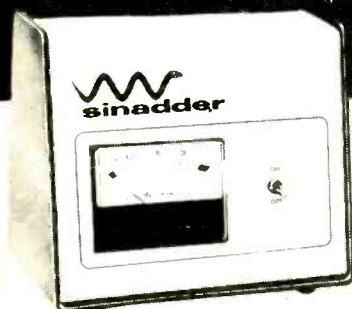

with the **SINADDER™**

The SINADDER is a specialized distortion meter for Sinad Measurements. Just connect it to the audio output and read SINAD directly. No adjustments to make. Automatic circuitry does the level setting for you.

£120 + p. & p. & VAT



**LYONS INSTRUMENTS**

Hoddesdon Herts EN11 9DX Tel: 67161 Telex 22724

A Claude Lyons Company

WW-009 FOR FURTHER DETAILS

# How to double your output

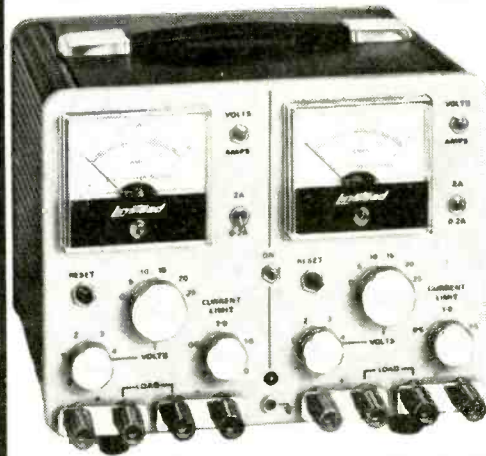

£149.30

INC VAT & P & P

S10

without losing all your bench space. The overall size of the S10 isolated twin power supply is only 20.5cm x 20cm x 17.5cm high. Each half of the S10 is capable of supplying 0-30 volts at 2 amps with line regulation much better than 0.01% and an output resistance less than 0.005 ohms. A coarse control provides 5 volt steps and a fine control 0-5 volts giving very accurate setting. Total ripple and noise is less than 300 microvolts r.m.s.

Send your Order now to Linstead Manufacturing Co. Ltd., Roslyn Road, London N15 5JB.



Telephone: 01-802 5144

WW-092 FOR FURTHER DETAILS

The All-Electronics Show,  
Grosvenor House, Park Lane, London, W.1.  
19th - 21st April.

## We're name dropping!

- |                               |                            |                           |
|-------------------------------|----------------------------|---------------------------|
| Advance Micro Devices         | T. Foxall & Sons Ltd       | Philcom Electronics Ltd   |
| AMP of Great Britain Ltd      | GEC Semiconductors Ltd     | Phoenix Electronics Ltd   |
| Arcoelectric Switches Ltd     | Gemini                     | Pinnacle Electronics Ltd  |
| Avdel Ltd                     | Giltech Components Ltd     | Plastronics Ltd           |
| Avo Ltd                       | W.L. Gore & Associates Ltd | Plessey Aerospace         |
| Belix Company Ltd             | Gould Advance Ltd          | Plessey Semiconductors    |
| Bell & Howell Ltd             | Hartley Measurements       | Plessey Traffic &         |
| Berg Electronics Ltd          | Havant Instruments Ltd     | Instrumentation           |
| C. Brandauer & Co             | Highland Electronics Ltd   | Powertron Ltd             |
| Brandenburg Ltd               | Hunting Hivolt Ltd         | Practical Electronics     |
| Britec Elesta Ltd             | Icthus Instruments Ltd     | Pye Unicam Ltd            |
| British Central Electrical Co | Imhof Bedco Ltd            | Raytheon Semiconductors   |
| Bryans Southern Instruments   | Intel Group of Companies   | Reading Windings Ltd      |
| Cliffpalm Ltd                 | Intime Electronics Ltd     | Redpoint Ltd              |
| Comark Electronics Ltd        | ITT Component Group        | Ritro Electronics Ltd     |
| Compstock Ltd                 | ITT Electronic Services    | Ross Courtney             |
| Consort Power Sales           | ITT Microprocessors        | Roxburgh Electronics      |
| Coutant Electronics Ltd       | Journal of ATE             | R.S. Components Ltd       |
| Cramer Components             | Kemo Ltd                   | S.A.S.C.O.                |
| Crow of Reading Ltd           | KGM Electronics Ltd        | Semiconductor Specialists |
| Data Laboratories Ltd         | Labhire Ltd                | Setab Electronics         |
| Datron Electronics Ltd        | Lambda Electronics Ltd     | Siliconix Ltd             |
| Davu Wire & Cables Ltd        | Lan Electronics Ltd        | Sprague Electric U.K.     |
| Diamond H Controls Ltd        | F.C. Lane Electronics Ltd  | H.W. Sullivan Ltd         |
| Digital Devices Ltd           | Lascar Electronics         | Symot Ltd                 |
| Dymar Electronics Ltd         | Lawtronics Ltd             | Synchro Services          |
| Electron                      | Lemo U.K. Ltd              | Tektronix U.K. Ltd        |
| Electronic Engineering        | Littelfuse (GB) Ltd        | Teledyne Semiconductor    |
| Electronic Equipment News     | Littex                     | Tequipment                |
| Electronics Industry          | Lipa & Isostat (GB) Ltd    | Telonic Altair            |
| Electronic Visuals Ltd        | J.J. Lloyd Instruments Ltd | Texas Instruments         |
| ENI Power Systems Ltd         | Malden Electronics         | Toko U.K. Ltd             |
| Erie Electronics Ltd          | Molex Ltd                  | Unimatic Engineering Ltd  |
| European Electronic Contact   | New Electronics            | Variohm Components        |
| Exel Electronics Ltd          | Nortronic Associates       | Vero Electronics          |
| Farnell Instruments Ltd       | Normalair Garrett          | Walter Logan & Co Ltd     |
| Ferranti Connectors           | Oakleigh Engineering       | Wavetek                   |
| Ferranti Semiconductors       | Oxford Electronic          | Weir Electronics Ltd      |
| Fieldtech Ltd                 | Instruments                | Zettler U.K.              |
| Fluke International Corp      |                            |                           |

## You'll come?

**NEW**

## SUPERB LIQUID CRYSTAL DISPLAY WATCHES FROM NATIONAL SEMICONDUCTOR

Five function LCDs with backlight at  
lowest prices ever from **£23.90**

|   |               |   |
|---|---------------|---|
| DAC5 WS Chrome plated                     | <b>£23.90</b> | } Leather<br>strap                      |
| DAC5 YS Gold plated                       | <b>£26.90</b> |   |
| DAC5 WB Chrome                            | <b>£25.90</b> | } On matching<br>adjustable<br>bracelet |
| DAC YB Gold                               | <b>£29.90</b> |   |
| DAB5 WB Stainless steel case and bracelet | <b>£35.50</b> |   |
| DAB5 YB Gold plated                       | <b>£39.50</b> |   |



### FAIRCHILD TIMEBAND LCDs

TC411 Chrome **£28.90**; TC410 Gold **£31.90** on leather strap; TC413 Chrome **£33.90**; TC412 Gold **£36.90** with matching bracelet (illustrated).

CASIO CASIOTRON X-1 probably THE BEST WATCH IN THE WORLD. R.R.P. **£129.95**. OUR PRICE **£98.50**. Full range of CASIO LCDs from **£44.50**.

IBICO. The full range of these quality Swiss LCDs from **£42.50**. LADIES' Electronic watches from **£19.95**.

SEND 10p for our CATALOGUE. Probably the widest range of electronic watches in Britain at the LOWEST PRICES. Prices include VAT at 8% and P&P. Free battery/s. No quibble one-year guarantee.

Access and Barclaycards welcome.

# TEMPUS

*Talk of the town*

19/21 Fitzroy Street, Cambridge CB1 1EH  
Telephone: (0223) 312866

## MORE POWER— MORE TORQUE

with the

### • NEW MK. II DRILL •

**SPEED**  
10,000 r.p.m.

**TORQUE**  
120 cmg

**VOLTAGE**  
9-14v d.c.

**DRILL ONLY £8.79**  
(p&p 35p)

**STAND £4.40**

(p&p 35p)  
Inc. VAT

(Together 50p p&p)

Send a 9" x 4"  
SAE for illustrated  
leaflet and order form  
to:

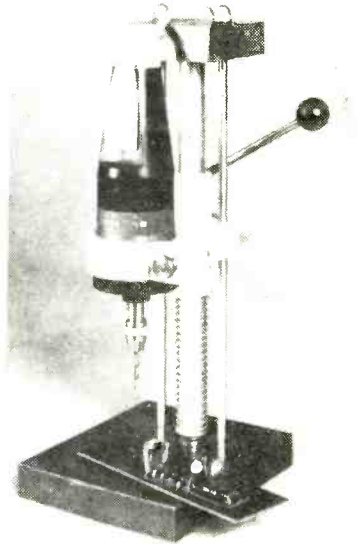

## PRECISION PETITE LTD.

119A HIGH STREET, TEDDINGTON, MIDDX.

TEL. 01-977 0878  
(24-hour answering service)

For those who  
appreciate Quality...

a complete electronic kit  
**The Forgestone 400**  
high quality

colour television receiver

**SUPERB PICTURE QUALITY  
TOGETHER WITH PROVEN RELIABILITY**

- 9 integrated circuits
- Thick film resistor units
- Ready-built and aligned IF module
- Glass epoxy printed circuit panels
- High quality components
- Fully isolated power supply
- Plugs and sockets for easy panel removal
- Each module kit available separately
- Full technical construction manual
- LT supply regulator

The isolated chassis makes the receiver ideal for the addition of Teletext decoders, remote controls etc. Please send stamp for further details of these quality products.

**Forgestone Colour Developments Limited**

Ketteringham, Wymondham, Norfolk, NR18 9RY, U.K.

Telephone: Norwich 810453 (STD 0603)

MAIL ORDER - Barclaycard & Access accepted



WW-054 FOR FURTHER DETAILS

## Audio Connectors

Broadcast pattern jackfields, jackcords, plugs and jacks.

Quick disconnect microphone connectors  
Amphenol (Tuchel) miniature connectors with coupling nut.

Hirschmann Banana plugs and test probes  
XLR compatible in-line attenuators and reversers.

Low cost slider faders by Ruf.

**Future Film Developments Ltd.**  
90 Wardour Street  
London W1V 3LE  
01-437 1892/3

WW-039 FOR FURTHER DETAILS



**CROFTON  
FOR  
USED VIDEO  
EQUIPMENT**



Used Video Equipment bought and sold daily. If we do not have what you want, we enter your requirements on our register and advise you when it is available.

U.H.F. Modulators supplied for connecting a camera directly to a domestic TV or Philips V.C.R. Camera Kits for the enthusiast also in stock.

Fujinon lens available.

Repairs of all types of Video equipment undertaken.

WHATEVER YOUR VIDEO REQUIREMENTS

FIRST CONTACT CROFTON

**CROFTON ELECTRONICS LTD.**

35 Grosvenor Road

Twickenham

Middx. TW1 4AD 01-891 1923

WW-095 FOR FURTHER DETAILS

# Unique full-function 8-digit wrist calculator... available only as a kit.

A wrist calculator is the ultimate in common-sense portable calculating power. Even a pocket calculator goes where your pocket goes – take your jacket off, and you're lost!

But a wrist-calculator is only worth having if it offers a genuinely comprehensive range of functions, with a full-size 8-digit display.

This one does. What's more, because it is a kit, supplied *direct* from the manufacturer, it costs only a very reasonable £9.95 (plus 8% VAT, P&P). And for that, you get not only a high-calibre calculator, but the fascination of building it yourself.

### How to make 10 keys do the work of 27

The Sinclair Instrument wrist calculator offers the full range of arithmetic functions. It uses normal algebraic logic ('enter it as you write it'). But in addition, it offers a % key; plus the convenience functions  $\sqrt{x}$ ,  $1/x$ ,  $x^2$ ; plus a full 5-function memory.

All this, from just 10 keys! The secret? An ingenious, simple three-position switch. It works like this.

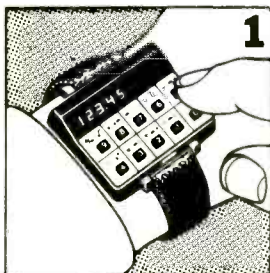

1. The switch in its normal, central position. With the switch centred, numbers – which make up the vast majority of key-strokes – are tapped in the normal way

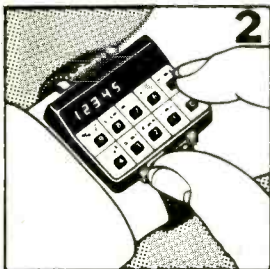

2. Hold the switch to the left to use the functions to the left above the keys...

3. and hold it to the right to use the functions to the right above the keys.

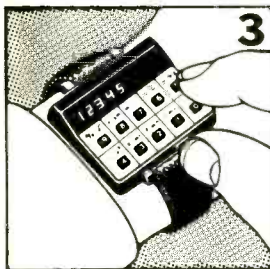

The display uses 8 full-size red LED digits, and the calculator runs on readily-available hearing-aid batteries to give weeks of normal use.

Dimensions:  
1 1/4" (46 mm) wide,  
1 7/16" (37 mm) deep.  
Weight:  
less than 1oz (28g).

### Assembling the Sinclair Instrument wrist calculator

The wrist calculator kit comes to you complete and ready for assembly. All you need is a reasonable degree of skill with a fine-point soldering iron. It takes about three hours to assemble. If anything goes wrong, Sinclair Instrument will replace any damaged components *free*: we want you to enjoy assembling the kit, and to end up with a valuable and useful calculator.

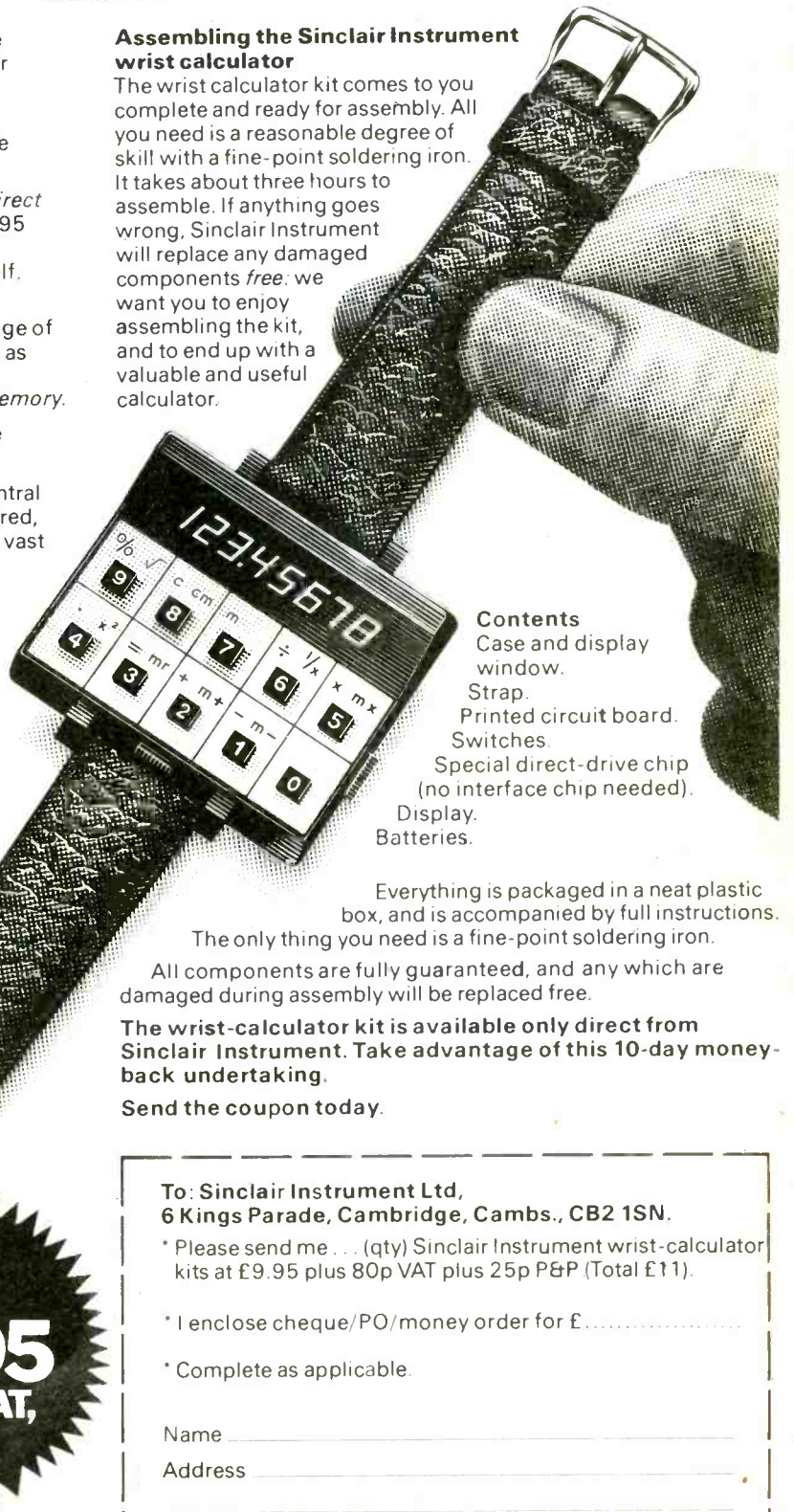

### Contents

- Case and display window.
- Strap.
- Printed circuit board.
- Switches.
- Special direct-drive chip (no interface chip needed).
- Display.
- Batteries.

Everything is packaged in a neat plastic box, and is accompanied by full instructions.

The only thing you need is a fine-point soldering iron.

All components are fully guaranteed, and any which are damaged during assembly will be replaced free.

The wrist-calculator kit is available only direct from Sinclair Instrument. Take advantage of this 10-day money-back undertaking.

Send the coupon today.

**KIT ONLY**  
**£9.95**  
**PLUS VAT, P&P**

Sinclair Instrument Ltd,  
6 Kings Parade, Cambridge,  
Cambs., CB2 1SN.  
Tel: Cambridge (0223) 311488.

To: Sinclair Instrument Ltd,  
6 Kings Parade, Cambridge, Cambs., CB2 1SN.

\* Please send me . . . (qty) Sinclair Instrument wrist-calculator kits at £9.95 plus 80p VAT plus 25p P&P (Total £11).

\* I enclose cheque/PO/money order for £.....

\* Complete as applicable.

Name \_\_\_\_\_

Address \_\_\_\_\_

\_\_\_\_\_

(Please print)  
I understand that you will refund my money in full if I return the kit undamaged within 10 days of receipt.

WW/3

# this 25MHz dual trace, dual sweep, clear display, highly versatile royal performance scope

## The D67A a WORLD PREMIÈRE

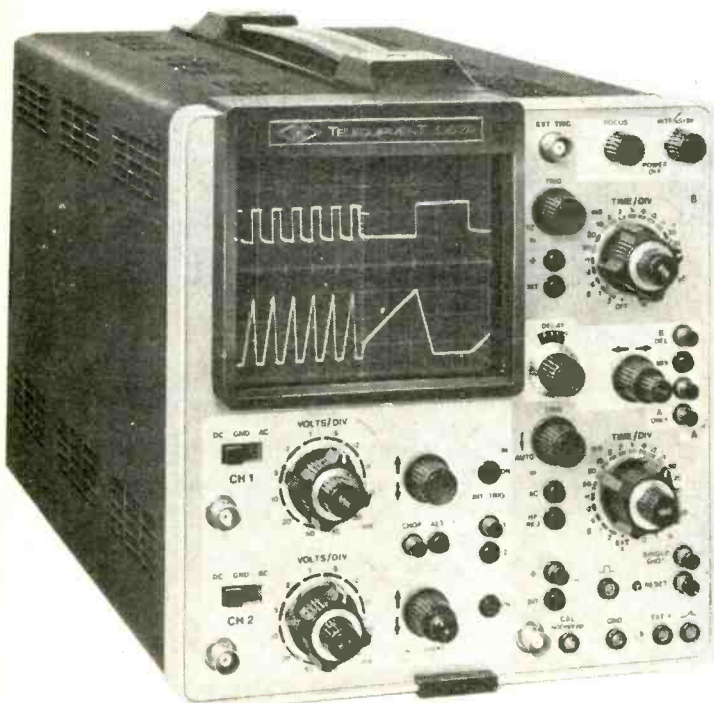

If you use oscilloscopes, you should know about the D67A, one of the newest in a strong cast of star performers from Telequipment.

Superbly engineered, elegantly styled, this robust and compact oscilloscope captures the spotlight with its 25MHz bandwidth, its dual trace dual time base versatility and an extensive repertoire which includes delayed and mixed sweep routines. Sensitive, (up to 1mV/div) yet without a trace of temperament, due to F.E.T. input circuitry. High speed presentation, (up to 40ns/div) with excellent timing ( $\pm 3\%$  to  $\pm 5\%$ ) — a blending of talent and technical expertise that could come only from a Telequipment production.

You will applaud it on performance and encore it on price. Secure your front row seat today, ask us for a brochure and a demonstration.

Tektronix U.K. Limited,  
P.O. Box 69, Beaverton House, Harpenden, Herts.  
Tel: Harpenden 63141 Telex: 25559

**TELEQUIPMENT**



Capable~that's our scope

# wireless world

**Electronics, Television, Radio, Audio**

MARCH 1977 Vol 83 No 1495

## Contents

- 31 **The consciousness industry**
- 32 **Electronic rhythm unit** by A. Battaiotto and G. Ronzi
- 37 **News of the month**
  - UK to consult on frequency allocations
  - Miniature television set
  - Government support for electronics industry
- 41 **Circuit ideas**
  - Octal display for microprocessors
  - Semiconductor tester
  - Linear voltage controlled amplifier**
- 43 **H.F. predictions**
- 44 **Interference from amateur stations** by I. Jackson
- 48 **EEC data-processing cash**
- 49 **Television pattern generator** by R. A. Owen and D. Brenkley
- 52 **Viewdata — 2** by S. Fedida
- 55 **Logic design — 3** by B. Holdsworth and L. Zissos
- 59 **Letters to the editor**
  - Advanced pre-amplifier design
  - Circular insert generator
  - Industry to study Citizens' Band
- 62 **Can oscillators be "common"?** by "Cathode Ray"
- 64 **Identifying European television — 2** by G. Smith and K. Hamer
- 67 **Weather satellite facsimile machine — 4** by G. R. Kennedy
- 69 **Special-purpose amplifiers — Circards 33** by J. Carruthers, J. H. Evans, J. Kinsler and P. Williams
- 73 **Mobile radio communication — 3** by D. A. S. Drybrough
- 77 **Wireless World index, binding and p.c. boards**
- 78 **World of amateur radio**
- 79 **New products**
- 122 **APPOINTMENTS VACANT**
- 136 **INDEX TO ADVERTISERS**

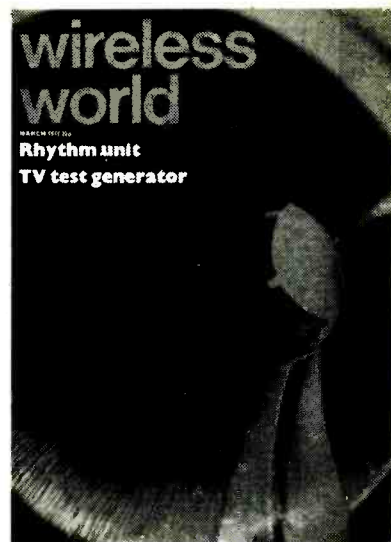

Front cover shows the interior of a Mullard scanning coil assembly for a colour television tube.  
Photographer Paul Brierley

## IN OUR NEXT ISSUE

**Sensitive metal detector** constructional design using beat frequency oscillator principle but with beat oscillator frequency mixed with 5th harmonic of search oscillator frequency.

**Power semiconductor survey** on construction and characteristics of transistors, thyristors, power Darlington's and f.e.t.s and related devices with applications and circuits.

**Stereo coder.** Instrument providing a signal for testing stereo receivers and tuners or distributing programmes in showrooms, etc. The design uses no inductors, thus simplifying construction.

Current issue price 35p, back issues (if available) 50p, at Retail and Trade Counter, Paris Garden, London SE1. By post, current issue 55p, back issues (if available) 50p, order and payment to Room 11, Dorset House, London SE1 9LU.

Editorial & Advertising offices: Dorset House, Stamford Street, London SE1 9LU.

Telephones: Editorial 01 261 8620; Advertising 01 261 8339.

Telegrams/Telex. Wiworld Binespres 25137 London. Cables. "Eithaworld, London SE1."

Subscription rates: 1 year: £7.00 UK and overseas (\$18.20 USA and Canada). Student rate: 1 year: £3.50 UK and overseas (\$9.10 USA and Canada).

Distribution: 40 Bowling Green Lane, London EC1R 0NE. Telephone 01-837 3636.

Subscriptions: Oakfield House, Perrymount Rd, Haywards Heath, Sussex RH16 3DH. Telephone 0444 59188. Subscribers are requested to notify a change of address. © I.P.C. Business Press Ltd, 1977

**ibpa**  
International Business  
Press Associates

**ABC**  
ASSOCIATION OF  
BUSINESS PRESS

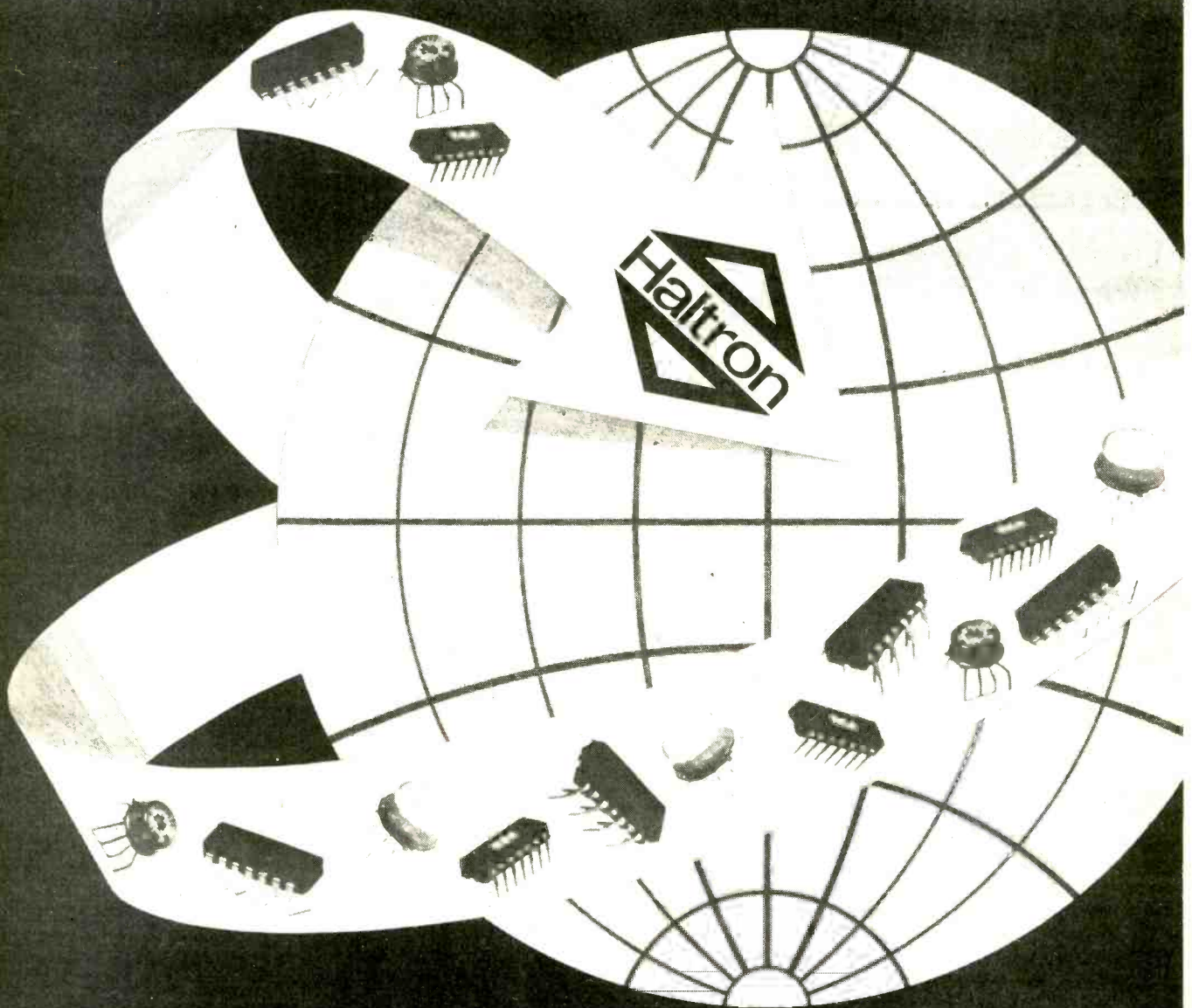

**The world over-  
You get the  
best service  
from Haltron**

For high quality electronic valves, semiconductors and integrated circuits – and the speediest service – specify Haltron. It's the first choice of Governments and many other users throughout the world. Haltron product quality and reliability are clearly confirmed. The product range is very, very wide. And Haltron export expertise will surely meet your requirements. Wherever you are, get the best service. From Haltron.



Hall Electric Limited,  
Electron House,  
Cray Avenue, St. Mary Cray,  
Orpington, Kent BR5 3QJ.  
Telephone: Orpington 27099  
Telex: 896141



# wireless world

## The consciousness industry

**Editor:**  
TOM IVALL, M.I.E.R.E.

**Deputy Editor:**  
PHILIP DARRINGTON  
Phone 01-261 8435

**Technical Editor:**  
GEOFFREY SHORTER, B.Sc.  
Phone 01-261 8443

**Assistant Editors:**  
MIKE SAGIN  
Phone 01-261 8429  
RAY ASHMORE, B.Sc., G8KYY  
Phone 01-261 8043  
JOHN DWYER  
Phone 01-261 8620

**Production:**  
D. R. BRAY

**Advertisement Controller:**  
G. BENTON ROWELL

**Advertisements:**  
PHILIP NOSSEL (*Manager*)  
Phone 01-261 8622

LEO KEMBERY  
Phone 01-261 8515

OWEN BAILEY (*Classified Advertisements*)  
Phone 01-261 8508 or 01-261 8423

JOHN GIBBON (*Make-up and copy*)  
Phone 01-261 8353

**Publishing Director:**  
GORDON HENDERSON

James Hillier, an executive vice-president and senior scientist of RCA, recently warned "Every individual today is suffering from an information overload. We have more information than we can absorb . . ." If an important member of a large corporation that lives by processing and selling information can admit this publicly it must be serious. No doubt Mr Hillier's main concern is the effect of such saturation on his business. But there is another aspect of this saturation which deeply concerns us all: its effect on our consciousness and, by introjection, on the very nature of our being.

For information is not just an extraneous thing. As Norbert Wiener once pointed out, information is "the content of what is exchanged with the outer world as we adjust to it, and make our adjustment felt upon it." Similarly, the anthropologist Gregory Bateson has postulated that what we call "mind" is the process of information transfer within closed loops, not only those circuits which are completed within the brain or brain-plus-body but those which extend through the larger system of man-plus-environment. Nowadays electronics technology is increasingly involved in this man/world exchange process. Beyond the telephone and broadcasting one can see a whole host of new systems becoming part of our environment: teletext and Viewdata (see this issue), radio paging, video telephones, conference television, programmed learning, electronic transmission of mail and newspapers, selection of goods and services by two-way cable television, and personal communication through satellites and wrist radio sets. All these systems introduce special constraints into the exchange process — of time, space, power, bandwidth and so on — and in using them we have to submit to the disciplines imposed by these constraints. Together with the well known mass media they form what has been described as "the consciousness industry."

There are two things we must watch. The first is who controls the consciousness industry — whether the state, business monopolies or a middle-class elite with assumptions of superiority — and for what purposes. The second is how this industry is modifying our central beliefs of what a human being should be. What sort of people is the consciousness industry manufacturing to satisfy the wishes of its masters? There are some interests, for example, that would wish to create man in the image of the ideal consumer.

It is true that the new two-way information systems, such as public information retrieval and "access" programmes on radio and tv, seem to give the individual a greater sense of autonomy and free will, but in the end what a person can select or say is restricted to a certain range or context by those who edit or control the systems.

The ecological movement has been successful in showing us that man cannot go on ravaging the biosphere without in the end impoverishing himself. We may soon have another movement to teach us that man cannot go on making himself even more of a slave to deterministic systems — from clocks and machines in the 19th century to information mills in the 20th — without impoverishing his own humanity.

# Electronic rhythm unit

## Up to 15 programmable rhythms for electronic organs

by A. Battaiotto and G. Ronzi *SGS-Ates Application Laboratory, Agrate, Italy*

Two m.o.s. integrated circuits designed to drive eight electronic musical instruments according to a programmed rhythm are described. With these i.cs, a rhythm section based on simulated percussion instruments can be incorporated into an electronic organ. Type M252 has 15 programmable rhythms. A general introduction to the rhythm generator is followed by device details and their principal electrical characteristics. A second article deals with the application of the devices and gives circuitry for inclusion of a rhythm section in an electronic organ.

The description rhythm generator is used to refer to a system which generates trigger or excitation pulses for oscillators, whose amplified, damped outputs simulate the acoustic sensation of the musical instruments in the rhythm section. The rhythm generator is not itself a source of sounds, but only a means of timing the switch-on of the oscillator circuits which constitute the sources.

To realize such a system each cycle of the complete rhythm must be divided into a number of "elementary times" using a counting technique. A fixed memory then determines whether or not a given instrument should be triggered during each of these elementary times. The elementary times or counter states, which constitute the smallest subdivisions of the rhythm can be grouped into bars or measures, usually 1, 2, 3 or 4. Within the complete rhythm, each of these bars can be programmed differently.

Each bar, then, consists of  $n$  elementary times in which the beats of each instrument will be programmed to occur. In musical notation the length of these beats is described as a fraction of a known reference period see Fig. 1. When the sum of the beats in any bar comes to  $4/4$ , the rhythm is described as  $4/4$ .

The number of elementary times in the bar fixes the minimum duration of each beat; in other words, the greater the number the elementary times the shorter will be the minimum length of

the beats and the richer the resulting rhythm. For example, a  $4/4$  rhythm programmed in four bars over 32 elementary times, i.e. eight per bar, can only use musical beats of length 1,  $1/2$ ,  $1/4$  or  $1/8$  and not of  $1/16$ ,  $1/32$ ,  $1/64$ . If the same rhythm is programmed in two bars of 16 elementary times each, musical beats of length 1,  $1/2$ ,  $1/4$ ,  $1/8$  and  $1/16$  can be used,  $1/32$  and  $1/64$  being still excluded. The basis of such a rhythm generator is illustrated by the block diagram of Fig. 2.

Table 1. Count requirement

|           |  |
|-----------|--|
| 1st case: | Rhythm $4/4$<br>Minimum duration of each beat $1/16$<br>Number of bars per rhythm 2<br>∴ Count is $16 \text{ elementary times} \times 2 \text{ bars} = 32$ |
| 2nd case: | Rhythm $3/4$<br>Minimum duration of each beat $1/16$<br>Number of bars per rhythm 2<br>∴ Count is $16 \times 3/4 \times 2 = 24$                            |
| 3rd case: | Rhythm $5/4$<br>Minimum duration of each beat $1/16$<br>Number of bars per rhythm 1<br>∴ Count is $16 \times 5/4 \times 1 = 20$                            |

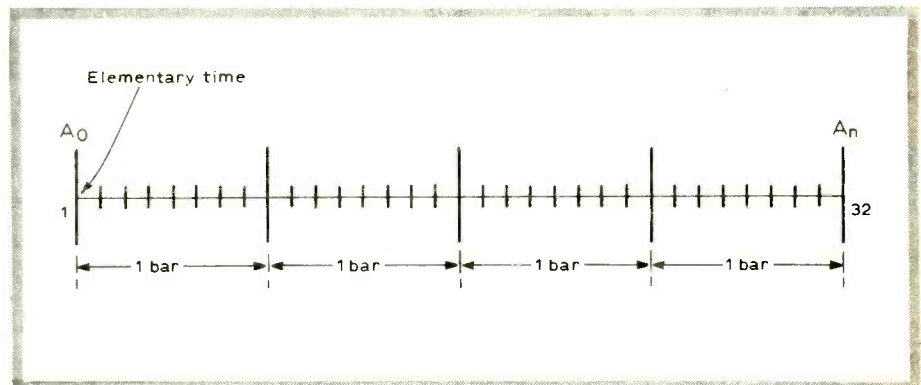
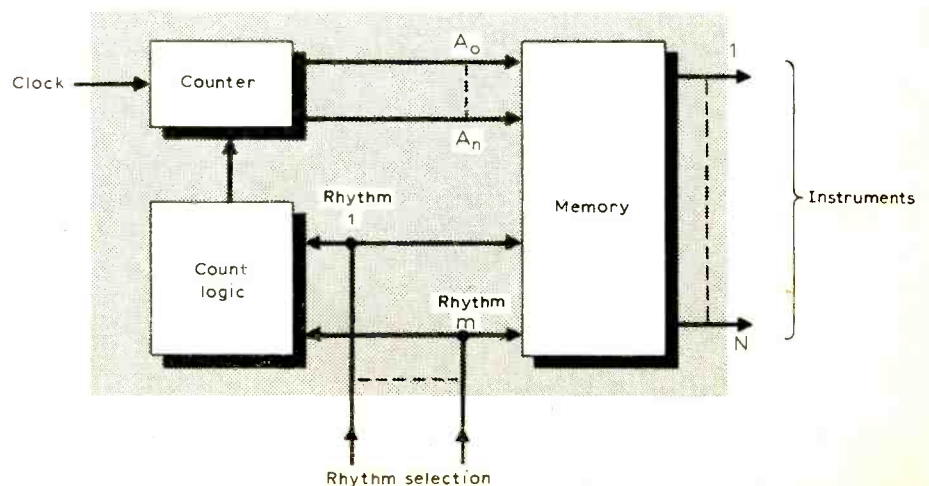

Fig. 1. Division of the rhythm into elementary times and bars.

Fig. 2. Block diagram of a trigger generation system for the oscillator circuits.



**Counter**

The counter must be able to count the number of elementary times corresponding to rhythms of 3/4, 4/4 and 5/4. This means that the counter must stop and reset to its initial position (to repeat the rhythm) after a certain number of counts which depends on the selected rhythm.

Two characteristics of the rhythm determine the count requirement i.e. the minimum beat of the rhythm, and the number of bars in the complete rhythm Table 1.

**Making a practical rhythm generator**

The system described in principle above can be realized with integrated circuits or discrete devices, illustrated in Fig. 3. If i.c.s are used the counter can be produced in t.t.l. although due to the large amount of storage required, the memory will almost certainly have to be in m.o.s. Using a 4096-bit memory such as the M240, organized in 512 words of 8 bits, it is possible to program 16 rhythms selected by lines A5, A6, A7 and A8, each consisting of 32 elementary times (the counter drives lines A0, A1, A2, A3 and A4). As the r.o.m. outputs are not of the reset-to-zero type they must be reset by an external clock before being applied to the instrument oscillators. If the generator were to be built with discrete components both the memory and the count decoder could be realized with a diode matrix. The return to zero of the outputs can be achieved by resetting the decoder. But such a system would lead to the use of a very large number of diodes. As a result the reliability would be poor and the assembly cost very high.

**The ideal rhythm generator**

The characteristics of an ideal rhythm generator can be summarized in the following points.

1 The entire system described above would be contained in a single device thereby achieving maximum reliability in the minimum space. The labour required for assembly is also reduced.

2. The counter should have the highest count possible. For a rhythm containing a fixed number of bars this means that the rhythm can be subdivided into shorter beats and will consequently be musically more interesting. Similarly for a given number of elementary times the rhythm can be made-up of a greater number of bars, possibly different, resulting in a more interesting musical effect.

3. The system should provide a large number of rhythms. Here it is necessary to make a distinction between rhythms which can be superimposed and those which cannot, as the concept of superimposition is closely linked to the number of available rhythms. Two rhythms are said to be superimposed

when, selecting both simultaneously at the system input, the output commands for each instrument correspond to a combination of the commands that would have been produced by the rhythms selected separately, see Figs 4 & 5. Technically, rhythms can only be superimposed if they are selected by means of separate lines and not by a coding technique. Superimposition, therefore, involves a greater number of input pins (one for each rhythm), but does not call for a very high number of rhythms because the organist can choose any combination of those available.

Fig. 3. System realized with i.c.s (right) and with discrete devices (below).

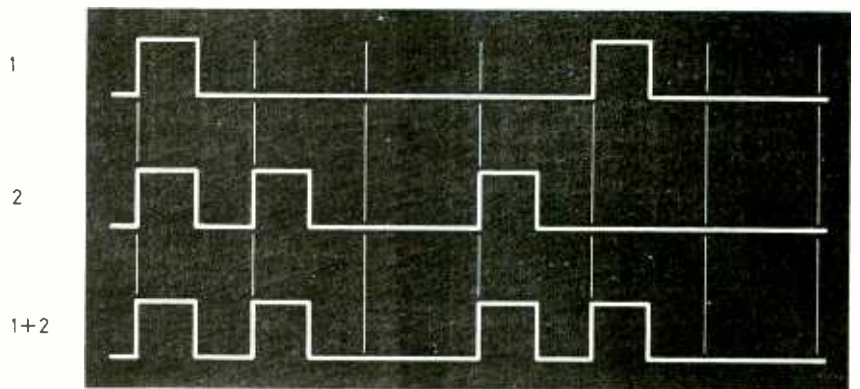
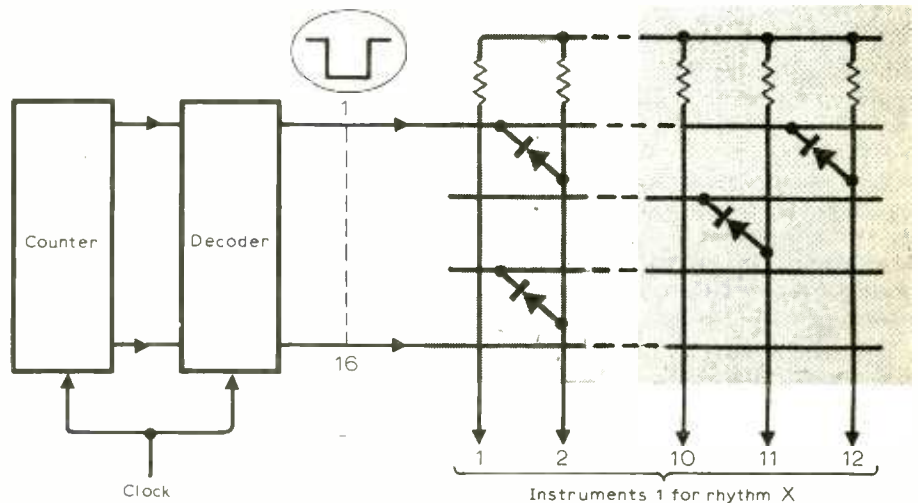
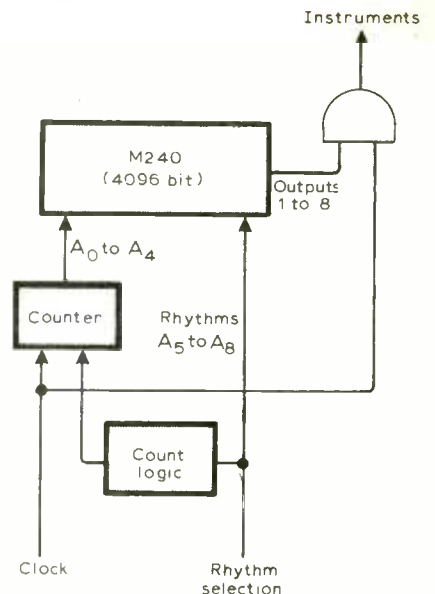
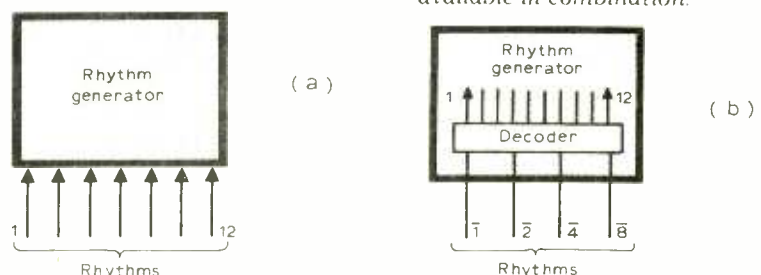

Fig. 4. Instrument trigger for combination of two rhythms.

Fig. 5. Rhythms superimposed and not. At (a) 12 rhythms are available in combination, at (b) 2<sup>12</sup> rhythms not available in combination.



In general, 12 is a sufficient number of rhythms if they can be superimposed, but there have to be more if superimposition is not possible, usually 15 or 16.

4. The system must have a large number of outputs (instruments). The number of instruments programmed for each rhythm will generally vary between 3 and 6. Eight represents a maximum number which is rarely used.

5. The system must be programmable in any time, 3/4, 4/4, 5/4, 6/8. It must therefore be possible to intervene at the mask programming stage, on the reset of the elementary time counter for each rhythm.

6. The system must produce no spikes on the memory outputs caused by successive decoded counter states. This creates undesired triggering of the instrument oscillators.

7. The system must provide the possibility of externally resetting the elementary time counter, so that it restarts from the first elementary time of the first beat. This enables key or touch operation in which the rhythm generator remains reset until at least one key is played.

8. The system should supply a down-beat output signal corresponding to the first elementary time of the first beat of each rhythm. This signal allows synchronization between the organist and the device's internal counter.

9. The system must be realized with a static form of logic designed for the low frequency operation of a rhythm generator (20 Hz).

**Table 2: Rhythm selections**

The following binary code must be generated to select each rhythm (logic positive)

| Rhythm             | 8 | 4 | 2 | 1 |            |     |
|--------------------|---|---|---|---|------------|-----|
| 1                  | 1 | 1 | 1 | 0 | Waltz      | 3/4 |
| 2                  | 1 | 1 | 0 | 1 | Jazz Waltz | 3/4 |
| 3                  | 1 | 1 | 0 | 0 | Tango      | 2/4 |
| 4                  | 1 | 0 | 1 | 1 | March      | 2/4 |
| 5                  | 1 | 0 | 1 | 0 | Swing      | 4/4 |
| 6                  | 1 | 0 | 0 | 1 | Foxtrot    | 4/4 |
| 7                  | 1 | 0 | 0 | 0 | Slow Rock  | 6/8 |
| 8                  | 0 | 1 | 1 | 1 | Rock Pop   | 4/4 |
| 9                  | 0 | 1 | 1 | 0 | Shuffle    | 2/4 |
| 10                 | 0 | 1 | 0 | 1 | Mambo      | 4/4 |
| 11                 | 0 | 1 | 0 | 0 | Beguine    | 4/4 |
| 12                 | 0 | 0 | 1 | 1 | Cha Cha    | 4/4 |
| 13                 | 0 | 0 | 1 | 0 | Bajon      | 4/4 |
| 14                 | 0 | 0 | 0 | 1 | Samba      | 4/4 |
| 15                 | 0 | 0 | 0 | 0 | Bossa Nova | 4/4 |
| No selected rhythm | 1 | 1 | 1 | 1 |            |     |

10. The system must be input compatible with t.t.l. and d.t.l. level signals so that it can be interfaced with an oscillator realized with such devices.

11. The system must have low dissipation — 150 to 300 mW.

12. The system must have a single standardized supply.

Points 2, 3 and 4 together create a single requirement, namely that the system must have a maximum memory capacity in terms of the number of bits. The maximum number of bits is limited by the die-size of the device which in turn is determined by the cost of the device itself.

Once the memory capacity has been established by economic factors, it follows that a compromise between the

number of rhythms, the number of instruments and the number of elementary times will be made. An effective solution is

- a maximum of 32 elementary times
  - 8 instruments
  - 15 rhythms
- with a memory capacity of 3840 bits (32x8x15).

**The SGS-ATES solution**

Rhythm generators type M253 and M252 fulfil all the requirements of the ideal system, see Fig. 6.

- The M 253 has:
  - 12 rhythms which can be superimposed
  - 3 instruments for 3/4 or 4/4 tme or 7 instruments for any time
  - a maximum of 32 elementary times
  - external reset

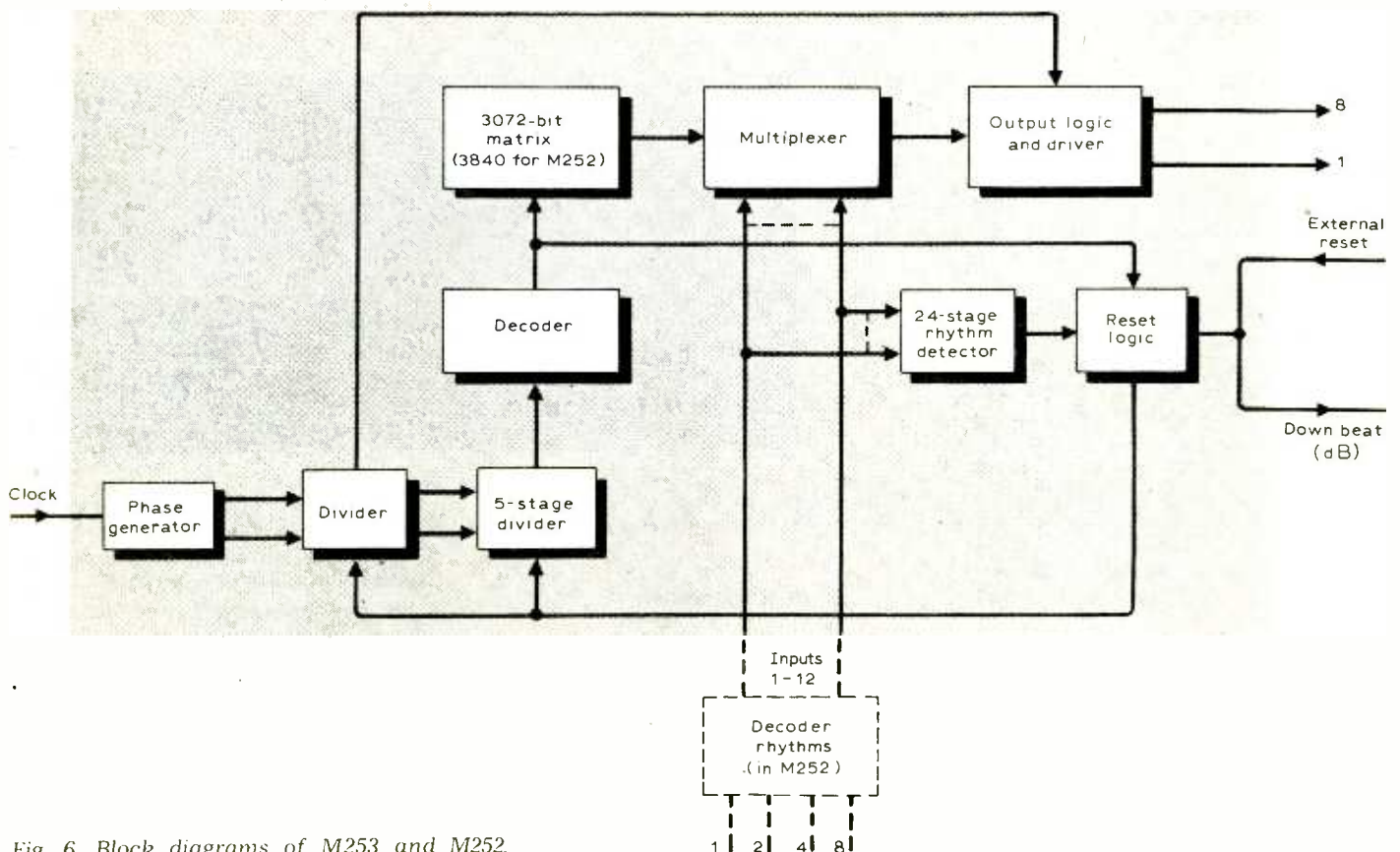

Fig. 6. Block diagrams of M253 and M252.

- down-beat output
- internal anti-spike circuit
- single supply
- low dissipation, typically 100 mW
- pin-to-pin compatible with the M250
- directly coupled
- 24-pin plastic or ceramic package

- The M 252 has:
  - 15 rhythms which cannot be super-imposed
  - 8 instruments for 3/4 or 4/4 time or 7 instruments for any time
  - maximum of 32 elementary times
  - external reset
  - down-beat output
  - internal anti-spike circuit
  - single supply
  - low dissipation, typically 100 mW
  - can be directly interfaced (input) with t.t.l., d.t.l.
  - directly coupled
  - 16-pin plastic or ceramic package.

Both of these devices are derived from the same chip which, during the processing stages, is provided with the memory pattern specified by the customer and the ancillary functions that distinguish the particular system.

**How the M 253 works**

The phase generator uses the incoming clock signal to produce the two non-over-lapping phases at regenerated levels which are required for driving the following divider.

This divider has to create a reset signal for the return to zero of the outputs. Width of this pulse is independent of the duty cycle of the incoming clock. The divider's outputs also serve as timing signals for the first stage of the five-stage counter, which uses master-slave static flip-flops.

The counter states are decoded to drive the rows of the memory matrix. The columns of the matrix are divided into 12 groups of 8, representing the 12 rhythms and the 8 instruments. One particular state, the 24th is decoded, logically combined with the rhythms in 3/4 time and is used as the counter's

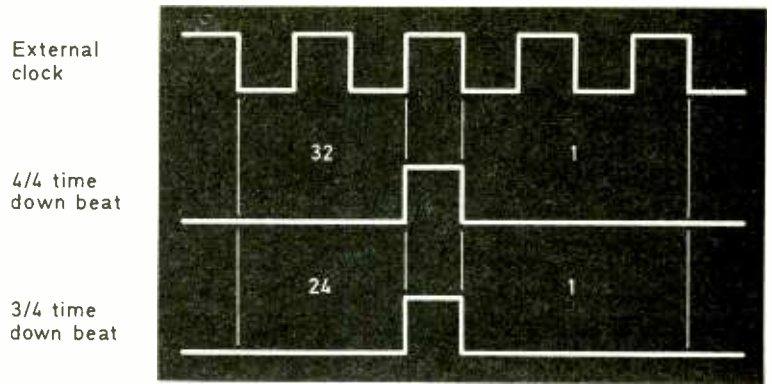

Fig. 7. Down-beat timing and duration.

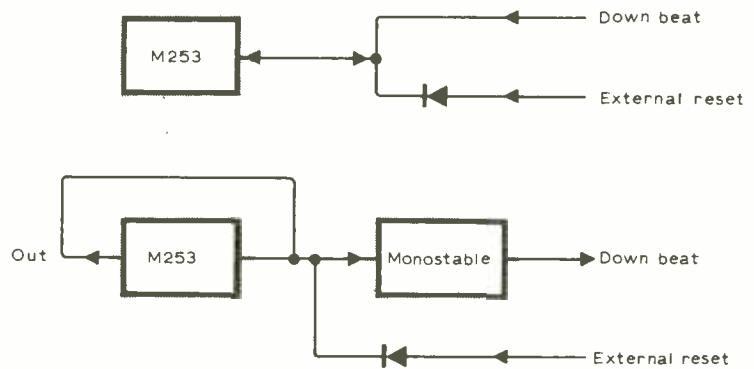

Fig. 8. Use of the down-beat signal.

internal reset for rhythms programmed in this time. This device is therefore suitable for programming any rhythm in 4/4 time over 32 elementary times or in 3/4 time over 24 elementary times. This means that when a rhythm is programmed over a single bar the intervals can be as short as 1/32 allowing great musical flexibility.

The counter can also be reset by an external signal which, when driven

directly by an output of the M253 itself, sacrificing one instrument, can be used to reset the counter to any position for times other than 3/4 or 4/4. If, for example, we want to reset at the state  $n$  for a rhythm X, a beat must be programmed at the elementary time  $n + 1$  at the output of the rhythm to be used as reset. This output, connected at the input of the external reset, immediately zeroes the counter and therefore causes the disappearance of the reset signal; other than the  $n + 1$  beat there should be no program on the output used as the reset.

The columns of the matrix are

Fig. 9. Timing waveforms.

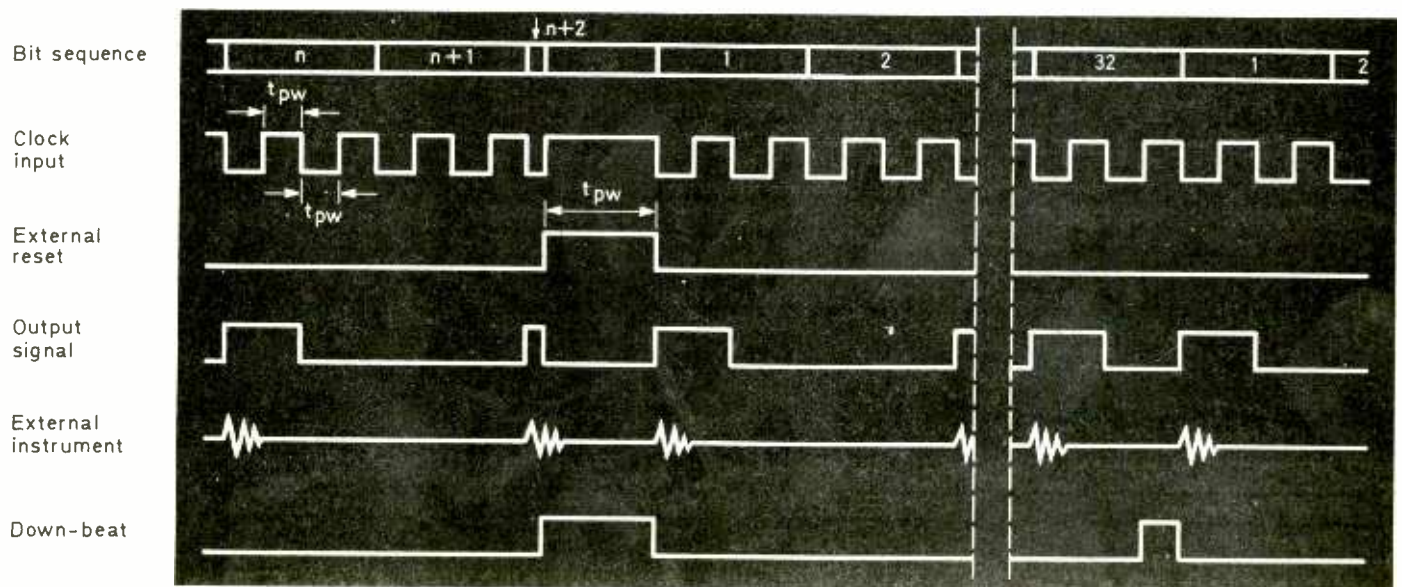

enabled, singly or in groups (the rhythms can be superimposed) via the buffer according to the rhythm or rhythms selected. The presence of one rhythm, therefore, does not exclude the possibility of another rhythm being selected contemporarily, and the result on the output of each instrument for each rhythm is the sum of the beats of the single rhythms, see Fig. 4. One particular case is when the rhythms are selected contemporarily with a different matrix, eg a 3/4 or 4/4 rhythm. In this case the count cycle will correspond to the rhythm with the lowest number of elementary times, in the example the cycle will be of 24 elementary times.

The delayed, decoded signal from the 24th state (3/4 rhythms) and the 32nd (4/4 rhythms) are used as down-beat signals, i.e. as starting signals to indicate the first beat of the first bar, see Fig. 7. This signal, whose usefulness will be seen in the application section, was brought out to a pin already used for an input signal — the external reset signal — since no supplementary pin was available in the package used. In reality, the presence of an external reset signal is compatible with a down-beat signal although the reverse is not true as a down-beat signal must not have the effect of an external reset. This can be achieved by using a diode to separate the two signals as shown in Fig. 8.

For rhythms other than 3/4 or 4/4 the pulse present at the output connected to the external reset can be used to trigger a monostable circuit, whose output will be the down-beat signal. When no rhythm is selected the down-beat signal is present and the counter counts to 32.

### Operation of the M252

The phase generator, the counter, the matrix, the output and reset logic, and the 24th state decoder for the reset in 3/4 time, operate in the same way as in the M253. The difference is in the rhythm command inputs, which are in binary logic using the code shown in Table 2. Given that it is impossible to select two different codes at the same time, it follows that it will be impossible to superimpose these rhythms.

One code word has been used to indicate "no rhythm selected." In this state, there are no instrument output signals, the down-beat signal is present and the counter counts to 32.

For the dynamic characteristics note that a duty cycle of 50% is not required for the clock signal. The width of the "mark" of the clock waveform need only be as great as the width of the down-beat impulse internally generated.

### Supplies and absolute maximum ratings

All the supplies and levels shown in Tables 3 and 4 are expressed as a function of  $V_{SS}$ . As  $V_{SS}$  can have any value, various power supply formats can be used, e.g.  $V_{GG}$  0V,  $V_{SS}$  17V;

**Table 3: Static electrical characteristics** (positive logic,  $V_{GG}$  -11.4 to -12.6V,  $V_{SS}$  4.75 to 5.25V,  $T_{amb}$  0 to 70°C unless otherwise specified)

| Quantity  | Test conditions                 | Min.                            | Typ.                   | Max.         | Unit       |
|---|---------------------------------|---------------------------------|------------------------|--------------|------------|
| <b>Clock input</b>  |                                 |                                 |                        |              |            |
| $V_{IH}$  | Clock high voltage              | $V_{SS}-1.5$                    |                        | $V_{SS}$     | V          |
| $V_{IL}$  | Clock low voltage               | $V_{GG}$                        |                        | $V_{SS}-4.1$ | V          |
| <b>Data inputs (<math>\overline{IN1}</math> ... <math>\overline{IN12}</math>)</b> |                                 |                                 |                        |              |            |
| $V_{IH}$  | Input high voltage              | $V_{SS}-1.5$                    |                        | $V_{SS}$     | V          |
| $V_{IL}$  | Input low voltage               | $V_{GG}$                        |                        | $V_{SS}-4.1$ | V          |
| $I_{IL}$  | Input leakage current           | $V_i = V_{SS}-10V$              | $T_{amb} = 25^\circ C$ | 10           | $\mu A$    |
| <b>External reset</b>   |                                 |                                 |                        |              |            |
| $V_{IH}$  | Input high voltage              | $V_{SS}-1.5$                    |                        | $V_{SS}$     | V          |
| $V_{IL}$  | Input low voltage               | $V_{GG}$                        |                        | $V_{SS}-4.1$ | V          |
| $R_{IN}$  | internal resistance to $V_{GG}$ | $V_o = V_{SS}-5V$               | 400                    | 600          | k $\Omega$ |
| <b>Data outputs</b>   |                                 |                                 |                        |              |            |
| $R_{ON}$  | Output resistance               | $V_o = V_{SS}-1$ to $V_{SS}$    |                        | 250          | $\Omega$   |
| $V_{OH}$  | Output high voltage             | $I_L = 1mA$                     |                        | $V_{SS}-0.5$ | V          |
| $I_{LO}$  | Output leakage current          | $V = V_{IH}$ $V_o = V_{SS}-10V$ | $T_{amb} = 25^\circ C$ | 10           | $\mu A$    |
| <b>Consumption</b>  |                                 |                                 |                        |              |            |
| $I_{GG}$  | Supply current                  |                                 | $T_{amb} = 25^\circ C$ | 7            | 15 mA      |

**Table 4. Dynamic electrical characteristics** (positive logic,  $V_{GG}$ ,  $V_{SS}$  -16 to -18V,  $T_{amb}$  0 to 70°C unless otherwise specified)

| Quantity              | Min.                  | Max. | Unit |         |
|-----------------------|-----------------------|------|------|---------|
| <b>Clock input</b>    |                       |      |      |         |
| f                     | clock repetition rate | 0    | 100  | kHz     |
| $t_{pw}$              | pulse width           | 5    |      | $\mu s$ |
| $t_r$                 | rise time             |      | 100  | $\mu s$ |
| $t_f$                 | fall time             |      | 100  | $\mu s$ |
| <b>External reset</b> |                       |      |      |         |
| $t_{pw}$              | pulse width           | 5    |      | $\mu s$ |

Measured at 50% of the swing  
Measured between 10% and 90% of the swing

**Table 5. Absolute maximum ratings**

|           |                             |              |
|-----------|-----------------------------|--------------|
| $V_{GG}$  | Source supply voltage       | -20 to 0.3V  |
| $V_i$     | Input voltage               | -20 to 0.3V  |
| $I_o$     | Output current (at any pin) | 3mA          |
| $T_{stg}$ | Storage temperature         | -65 to 150°C |
| $T_{op}$  | Operating temperature       | 0 to 70°C    |

\*This voltage is with respect to  $V_{SS}$  pin voltage

$V_{GG}$  -12V,  $V_{SS}$  +5V, and so on as long as  $V_{SS}-V_{GG} = 17 \pm 1V$ . This makes it very simple to solve the problem of interfacing with input and output devices. The user, however, must always respect the limits imposed by the absolute maximum ratings, Table 5. These voltages, temperatures or currents are values which must never be exceeded, not even momentarily, as the device can be permanently damaged should this occur.

It is of particular importance that a check is kept on the positive overshoot at all the pins with respect to  $V_{SS}$  (see Fig. 10). If the positive overshoot, which, on the oscilloscope will always appear limited to one  $V_{BE}$  when measured on an in-circuit device, exceeds the values quoted in the absolute maximum ratings it causes a parasitic which discharges the surrounding negative nodes, causing incorrect circuit operation. More seriously, a fixed positive level more than 300 mV above  $V_{SS}$  will probably damage the circuit.

(To be continued)

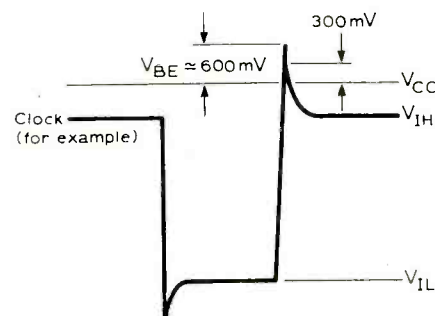

Fig. 10. Positive overshoot.

### Low-noise, low-cost cassette deck

Several readers have found that the erase and bias oscillator in this design (May, June and August issues, 1976) can be reluctant to work. The cure is to reduce the value of  $C_{21}$  in Fig. 5 of the May 1976 issue from 2.2 $\mu F$  to 1 $\mu F$ .

# News of the Month

## UK to consult on frequencies

The Home Secretary has invited comment on frequency allocations for the 1979 World Administrative Radio Conference. In a Commons written reply on January 26 he said: "We have already undertaken a substantial measure of consultation with both users and manufacturers of radio equipment during the preliminary phase of our work for the conference; but at this stage, before the United Kingdom's proposals for the conference are formulated, we think a rather wider programme of consultation is desirable. . . . In the circumstances we consider it right to make every effort to ensure that any whose interests may be affected should have an opportunity to state their views before our decisions are made. Those known to have an interest will be specifically invited to comment; but comments will be welcomed from any members of the public. They should be in writing and should reach the Home Office Radio Regulatory Department, Waterloo Bridge House, Waterloo Road, London SE1 8UA by 30th April 1977."

The announcement follows meetings between the Home Office and the electronics industry, themselves partly a result of an editorial and other articles in *Wireless World*, revealing parts of still secret Home Office reports on matters to come before the 1979 WARC, and calling for greater consultation.

## Tiny tv: now you see it . . .

After years of rumour and many confident predictions that "next year" would see the launch, Clive Sinclair showed his 2in television receiver to a large collection of professional cynics – the press – on Monday, January 10.

Let it be said at once that the Microvision is a remarkable piece of design. Most of the components, including three of the five integrated circuits and the tube, were developed

for the receiver, which measures  $6 \times 4 \times 1\frac{1}{2}$ in. It is most certainly not a toy – with a £200 price tag it is certainly free of that connotation – since most of the design compromises appear to have been made with low power consumption in mind.

The tube was developed by AEG Telefunken, who based their development on a design by A. V. de V. Krause (*Wireless World*, July 1974, p.259). The screen diagonal is 2in, and the tube length about 4.5in. Electrostatic deflection is used to reduce power consumption. The e.h.t. is about 2kV, derived from an oscillator which provides barely acceptable brightness. (We were not able to look at the picture out of doors because the Sinclair staff seemed so nervous that some acquisitive scribe might make off with the set that we weren't allowed to hold it, let alone go outside with it.) Sinclair were unsure of the heater power – at one time the Krause tube consumed 30mW – but that of a similar AEG Telefunken tube advertised in German and Danish magazines is quoted as being 35mW.

Sinclair's notion that the receiver could be of use to travelling businessmen is supported by the flexibility of tuning and standards. The own-design bipolar tuners cover Bands I, III, IV and V with the aid of p-i-n diode switching and varicap-diode tuning. Line standards of 625 and 525 at field rates of 50 or 60Hz are provided, with i.f. selection of 4.5, 5.5 or 6MHz. Tuner sensitivity, assisted by separate, folding v.h.f. and u.h.f. aerials, was good enough to give a reasonable picture in the steel-framed Savoy Hotel. Gated a.g.c. and a.f.c. are included, as is flywheel sync.

Sinclair decided to use two SGS i.cs for sound i.f. and 50mW audio output, but vision functions are performed by

*Sinclair's Microvision. Sinclair say the final assembly "requires only the connection of four printed circuit boards, insertion and connection of the tube, and housing the whole in a three-piece black steel case." The circuit uses 300 transistors. The heater needs 15s to warm up as a contribution to its low power consumption.*

three chips designed by Sinclair and a further 20 transistors. Attention to power-saving in the design has yielded a truly amazing consumption of 750mW from 4.8V. Four 1.2V rechargeable cells are used. These last four hours but an external a.c. adaptor will charge them and run the set as well. A 40-hour battery pack can be used, as can a car battery, which will also charge the internal cells.

It may be said that the size of the picture is too small for comfortable viewing. It is little bigger than a 35mm slide, which is usually projected or seen through a magnifier. Sinclair say that 2in was selected after tests with many people and point out that 2in at a viewing distance of a foot – the distance, they say, at which most people read a paperback book – is equivalent to a 24in screen 12 feet away, provided that the spot size is reduced to enable the resolution of the big picture to be retained, which they claim to have done.

However, the angle subtended at the eye is not the only important measurement. Normally two eyes will be used, and the way they converge, together with apparent size, is part of the process which gives the viewer an appreciation of distance. The brain will recognise a big picture, placed farther away than a small picture, as being bigger than the small one and will automatically assume that the bigger one is more detailed, even though it may not be. C. Burns, in an article in *Wireless World* in January 1953, pointed out that a magnifying lens not only increases the subtended angle but makes the screen look farther away, thereby adding to the apparent increase in size. Sinclair have probably considered the use of a lens, but if so they made no mention of one as an accessory.

The scepticism which has arisen as a result of the previous frequency of false alarms about the Sinclair set's imminent appearance in the shops was compounded by the secrecy which still surrounds its production. At the Savoy press conference on January 10, Clive Sinclair said that they first started the project 14 years ago and had produced

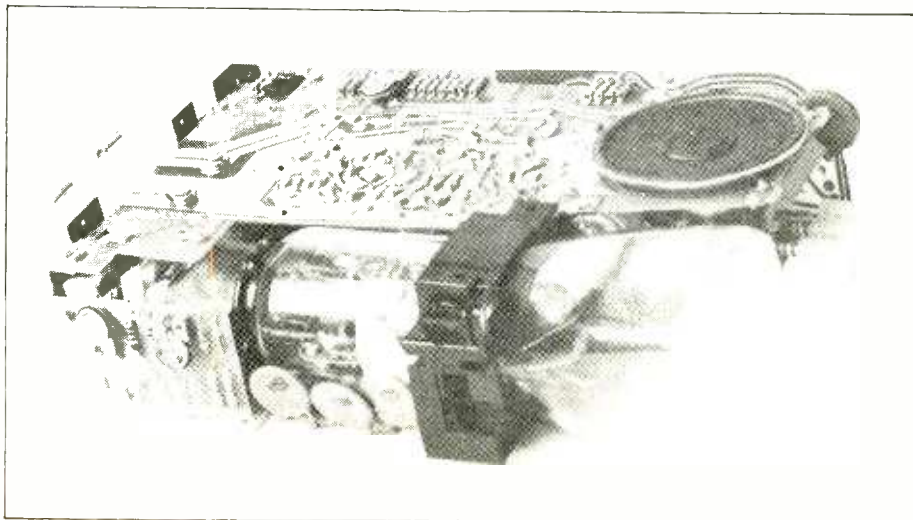

several complete receivers in that time "but they all lacked something and we wanted to do it properly. We have spent £½ million of our own money to do this in research and development". Yet the National Enterprise Board, which last November took a 43% stake in Sinclair, worth an injection of another £650,000, on the basis of a three-year profit forecast on the Microvision, have not, Sinclair says, committed the company to any production schedule. He would not say when production would start, how many staff would be making them, or what the initial number made would be, yet he insisted that the sets would be in the shops "next month". Who would be stocking the set? He couldn't say: "We haven't invited any orders because we haven't shown before." He would show it to the trade first. "Existing customers are interested in taking sets," he said. (Lasky's have since confirmed that they have ordered an unspecified number of sets for delivery when they become available. An order for the sets has been outstanding for some time.)

Although he asserted that "To the best of our knowledge nobody else is even remotely close to doing what we are doing," Sinclair added during questions that to give a production figure "would be valuable information for our competitors." What competitors? "Any that care to come along." They had had pilot models for some time, he said, and had been conducting field trials in various parts of the world since last August. There were "dozens of sets in existence," he said. But since they

would not be able to supply the demand until the middle of the year any of the £¼ million of advertising they planned would not be spent till then. Later he said he didn't know what the volume of production would be because "we don't yet have it as a viable product".

In one or two years' time they would produce a single-standard, lower-priced model for the mass market, but the main aim was to reach the prestige, executive market, particularly in the US. Most of the current sets would be exported and it would eventually account for half Sinclair's turnover. "The market is comparable with the market for pocket calculators, about 50 million units a year; comparable bearing in mind that it's a more expensive item." He had "no clear idea" what the simpler sets would cost.

In his opening remarks Sinclair said, "We have no plans for colour. It is technologically possible but would add greatly to the cost and we can't see any justification for such an increase." When asked later how much a colour set would cost he said, "We can't put a figure on a colour system." Most of the cost would be in the tube: "We haven't looked at this in great detail. The use of a shadow mask tube would be impossible on such a small screen so it would have to be non-standard."

The price of the black and white set has been fixed at £175 plus VAT. Sinclair says there is no prospect of a reduction: "Firstly because it is such a complicated product and, secondly, we have a monopoly."

---

## Tiny transceivers and satellites

---

A ten-dollar wrist radio using l.s.i. techniques could be used for personal communications within ten years, according to reports from the United States. *Communications News* reported in September that the National Space Institute predicted "within ten years a new generation of communications satellites could provide the public with highly-reliable interference-free personal communications via a wrist radio which could be used for pleasure, business, emergency situations, rescue, health monitoring." The NSI's executive director, Charles Hewitt said, "With adequate public interest and support, such a satellite system could be developed to service millions of people with the ability to talk directly to each other from wherever they are on land and sea, or enter the telephone networks through the microphone on their wrist radio for a new era in communication flexibility." These radios could use the same techniques now used in digital watches and, if produced in large enough numbers, could sell for less than \$10 each.

The NSI is a non-profit-making educational and scientific body chaired by Wernher von Braun, who was in charge of the Apollo space programme. Its function is to communicate the benefits of the US space programme to the American public.

In a speech to the Conference on Satellite Communication and Public Service on December 9, NASA administrator James Fletcher said: "Studies have been made of a personal communications system which involves direct broadcast from a "wrist watch radio" to a high-capacity, multibeam satellite for retransmission to ground communications centrals. The satellite might be 150 feet in diameter with the capacity of handling up to 25,000 switched channels. The ground transmitter could be small and low power, perhaps 1/25 mW. With large scale integrated circuit techniques, the ground transmitter need not cost much more than \$10." Such a system would allow the growth of a large number of ground stations, making space technology available to the man in the street. The basis of the technique was to put large aerials on high power transmitters in space, allowing a reduction in the size of the equipment needed below.

The Federal Communications Commission, according to a report in *The Times*, approved in January a new satellite communications service for business use. The service, first put forward in 1971, will cost an estimated \$406.9 million (£239m) and will start in 1986. The proposal was opposed by AT&T and Western Union.

---

## Home and small business computers

---

According to a summary of a \$950 report by Venture development corporation, 24,164 computers will be bought for home use in the US this year. The market will increase annually by over a third up to 1981. Over 70% of the hobbyist owners used them for games. The study was conducted over seven months, and was compiled by asking questions of users, makers, retail stores and hobby groups in the United States.

Most of the sales in the five-year period will be of mainframes. The income to computer stores, from whom hobbyists get 61.6% of their equipment, will increase annually by 46.3%, representing unit increases of 47.8%. Mainframe revenues will increase by 42.5% annually, while software, main memory, peripheral and other products will increase only 35.1%. Software will show the biggest increase of those groups, an average 81% up to 1981. The summary does not give a value for any of these figures.

Creative Strategies Inc has produced another report, on the small business market. In 1972 deliveries to this market were worth \$794 million in the US.

Three years later the figure was nearly double at \$1.4 billion. By 1980, they say, it will be worth \$2.2 billion. The figures for units shipped in those years are 20,300, 38,000, and about 75,000.

Confirming EEC views of our own position, Creative Strategies say that although IBM, Burroughs and NCR have a large share of the market, their study shows that market is far from "sewed up". "The most explosive action in the small business computer industry is coming from minicomputer-based systems."

Creative Strategies seem to have the same view of the market as the EEC. Although the market is dominated by IBM, Burroughs and NCR, there are about 100 makers in the fray, including system houses. It will take about three years for the market to sort itself out: "The most explosive action in the small business computer industry is coming from minicomputer-based systems and this segment has attracted most of the participants . . . In 1975, 8,500 minicomputer-based systems were shipped and in 1976, 16,000 are expected to be shipped." By 1980, they say, the figure will be 46,000.



## Cash aid to electronics industry

£20 million has been provided under section 8 of the 1972 Industry Act for "a scheme of selective assistance for the electronic components industry". If the industry response to the scheme warrants it, said a Department of Industry statement, the amount may be increased.

The scheme is to encourage UK based firms in the radio and electronic components industry to increase their efficiency. "It is designed to promote the design, development and production launching of new products and production technologies, the restructuring of a company or group of companies . . . and independent studies by consultants to identify opportunities for improving efficiency of a company or merged companies . . ."

The money is for up to a quarter of the total eligible cost of a new project (or half with a royalty agreement). Eligible projects are those where costs are £50,000 or more. Loans for up to half the project cost will also be available in the case of restructuring.

Besides these, 20% will be available for new equipment, plant and machinery; 15% for new buildings, extension or modification to buildings.

In all cases, says the DI, "The Department would have to be satisfied that the company had the capability to carry out the propositions to a successful commercial conclusion." Applications must be in by July next year.

The announcement, made on January 24, follows an active campaign by sections of the electronics industry for cash aid, notably Mr Jack Akerman of Mullard. He has pointed out, in an article in *Electronics and Power* in September, that the components sector alone employs 125,000 people and has a turnover of £650 million.

The Electronics Components Board has issued a statement welcoming the scheme "as a most important step towards strengthening the capacity of the British electronic components industry and as a clear demonstration of its importance to the economy . . . Many proposals by companies have already been submitted to enable the scheme to get off to a good start without any delay."

## New computerised sound mixer

Air Studios in Oxford Street, London, have installed the first Neve computerised mixing console to go into production. The system was demonstrated last March and had been described by Neve managing director Derek Tilsley at an American digital audio techniques conference in April, 1975.

NECAM, as it is called, consists of a sound mixing console, a 3M 24-track



*The Comsat General terminal in the radio room of the QE2. The terminal links the world's Telex and telephone system with the ship via the Marisat communications satellite chain. The equipment was supplied by STC subsidiary International Marine Radio Company.*

tape machine (in Air's case), Computer Automation LSI220 mini-computer, floppy disc store, code reader, display and control panels, transport and control interfaces. An SMPTE time code is recorded on to one track of the multitrack tape, and it is this which enables the engineer to refer to and update any section of the tape. Various takes may be stored and reassembled into a final take by manipulating data through a keypad on the mixing console.

An 8kbyte core store houses the Neve programme and transient data, and is supplemented by two floppy discs. The left-hand disc stores "scratch pad" information and the right-hand disc stores permanent information. It is the latter that the producer takes away along with the master tape. Neve technical director Martin Jones said: "In testing we pile in the data and fill the disc in the equivalent of a couple of takes, but in normal studio use there is more than enough room to store the mixing of a whole l.p. side."

As well as storing mixing information the tape can be labelled in up to 999 places, he said, so that if the engineer wants to identify a particular place on the tape he can give it a number by operating the keypad and later instruct the tape to go to that place. There are other systems which do this, such as the 3M Selectake, but less automated studios may have to identify the beginning and end of different sections of music by inserting strips of paper into the tape reel as it turns.

The installation of the system meant closing studio three for a month. Air, part of the Chrysalis group, has a consistent record of investment in new equipment and, as studio manager Dave Harries put it, "It's better than giving it

to Healey." Neve too have persevered with the development of NECAM even though the economic health of the world, the nation and the recording industry have deteriorated steadily since they first gave serious thought to the project three years ago. During that time their holding company, Energy Services and Electronics, have been forced to contract from a fast-expanding electronics group in the days when, as Bonochord, its takeover of Neve provided the company with badly-needed capital, to just two companies, Neve and Livingston Hire.

The market for NECAM may justify the investment. EMI are installing a system at Abbey Road and another is going to De Lane Lea/CTS Studios at Wembley. The use of the SMPTE code makes the system well suited to its use in film and television studios, a market that Neve have done well in over the years with conventional equipment. Neve still appear to do well abroad, and say they have orders in Brunei, Nigeria and South Africa.

## Teletext on sale

A teletext add-on adaptor first demonstrated as a prototype at the Home Electronics and Domestic Appliance Exhibition in Birmingham last May is now on sale, "in Harrods" among other places. It is made by Labgear, a Pye subsidiary, who say it was first despatched to customers before Christmas. At first they are making 200 a month but the managing director, Mr S. R. R. Kharbanda, said in a statement that the number would increase as the year went on. The adaptor connects with the aerial socket on a receiver.

The British Electrotechnical Approvals Board (BEAB) has tested and approved the first commercial colour tv set with an integral teletext decoder, the Rank Bush 22 inch BC6333 receiver. BEAB says the set has passed British Safety Standard BS415. Rank say the set is not available to the public yet, though some have been despatched to the trade and broadcasting organisations for appraisal.

The export prospect for both these units is an interesting one: Labgear say in their statement that they have been invited "overseas" to demonstrate the adaptor. Although the European countries have carried out a great deal of work on their own systems — Sweden for example developed an "Extratext" system which would take into account certain language difficulties which exist there — most of them seem quietly to have dropped their own systems in favour of the British teletext. At a CCIR meeting to discuss various systems in Geneva last year only one other system was advanced besides the British one.

The odd country out, predictably was France. "They're doing another SE-

CAM," muttered one source. Their system is called Antiope, after two Greek mythological figures. Sweden is now using the British system and the Germans and the Dutch are appraising it. Perhaps the only difficulties in the way of its adoption might be those which would accompany the adoption of any system, namely the objections of newspaper proprietors and others unsure of the effect of teletext on their own industries.

---

## NASA in 1977

---

Of NASA's 23 spacecraft launches scheduled for 1977, 17 will be for paying customers other than NASA. They include NATO, Indonesia, European Space Agency, National Oceanic and Atmospheric Administration, COMSAT Corporation, US Navy, Japan, Italy, RCA and the United Kingdom. In 1976 the number of launches was 16, four of which were NASA launches. The UK launch, the UK-6 high energy physics and astronomy satellite, is tentatively scheduled for October from Wallops Flight Centre, Virginia. The launch vehicle will be a Scout rocket.

The first launch of the year, at the end of January, is a NATO communications satellite, but NASA say the emphasis this year is on applications satellites 'for the direct benefit of people on earth.' 17 of the launches are in the communications, geodetic, environmental, navigation, meteorological or earth resources fields.

---

## 'Send no money!'—FCC

---

The Federal Communications Commission in Washington has stopped the collection of fees for licences from January 1. On December 16 the District of Columbia appeal court released a verdict on four actions taken by the National Cable Television Association, the Electronic Industries Association, the National Association of Broadcasters and Capital Cities Communications Inc, all of whom had appealed against the fees they were charged. The court directed the FCC to justify each fee assessment and to calculate "the cost basis for each fee". The Commission has therefore suspended all fees and will study the "legal and administrative implications of refunding fees in order to determine the extent and nature of any refunds that might be necessary." They would make any necessary refunds "as soon as possible."

The decisions mean that the FCC's authority to assess any fees is in doubt. The Commission says it had urged the congress to pass legislation clearing the matter up when it had adopted its 1975 scale of fees but nothing had been done.

On December 30 the FCC issued a notice urging the public not to send money, particularly for c.b. licences,

though the court's decision also affects fees from tv stations and telephone companies. But the FCC also warned that purchasers of c.b. equipment must send in licence applications since operation without a licence was illegal. At the end of the year about 7.8 million people (1.8 million more than we forecast in our article on citizens' band in January) held c.b. licences, and applications were coming in at 400,000 a month.

Any cheques coming in after the beginning of 1977 would be destroyed, said the Commission. Postal orders and cashiers' cheques would be returned but there would be a delay. It is not yet clear what will happen to fees sent in before then.

Some sources in the UK have attributed the refusal of the FCC to collect c.b. fees as a sign of the chaos resulting from the large number of applications. There seems no basis for this interpretation.

---

## Canadian satellite broadcasts television

---

In spite of early power supply difficulties (August 1976 issue) the Canadian-American Communications Technology Satellite "Hermes" is now successfully demonstrating direct broadcasting of television programmes at 12GHz to home-type installations in Montreal, Ottawa and Toronto. Ground aeriels of 60cm, 1m 1.2m, 1.6m and 2m diameter are being used. According to a report by C. A. Siocos in the *ABU Technical Review* for January 1977, the satellite's effective isotropic radiated power achieved is 59dBW. Representative values for weighted single-to-noise ratio are 47dB with the 2m receiving station, which has a noise figure of 6.5dB, and 40dB with the 60cm station which has a noise figure of 4.5dB. "Other transmission impairments are very small and . . . there are no ghost reflections received in any of the sites." Fading due to rain is short-lived. "Observed fadings . . . resulted in a visible increase of noise (more so with the smaller antennas) but no interruptions, except for some five minutes."

Earlier the CTS was demonstrated as an outside broadcast relay station (Bromont, Quebec, to-CTS-to-Montreal) during the 1976 Olympic Games. Also, in a co-operative Canadian-American experiment, engineering classes at Stanford University, California have been televised to Carleton University 2,500 miles away in Ottawa and vice versa. In this experiment a NASA developed technique called real-time digital video signal compression was used to reduce transmission bandwidth and power requirements. NASA say that ". . . initial student response has been favourable". Broadcasting by satellite to schools is considered a possibility.

---

## The year's Commons c.b.

---

In a written answer on October 19 Mr John R. Rathbone, the Conservative member for Lewes, asked the Secretary of State for the Home Department "whether he will review his policy regarding establishment of a v.h.f. citizens' radio band and if he will make a statement."

Mr Brynmor John (Lab, Pontypridd), a Home Office Minister, replied for the Home Secretary: "No".

On October 21, under the heading "Walkie-talkie equipment", former BBC and ITV producer Phillip Whitehead (Lab, Derby North) asked: "Is my honourable friend aware of the great concern that exists about the amount of interference caused in the 27 and 28MHz band by illegal walkie-talkie equipment? Is it not absurd that the Home Office, which has a responsibility here, will not impound such equipment or ban its importation when by definition it can only be used illegally? Can we not take some action now instead of waiting for the formation of policy on a citizens' waveband?"

Mr John: "I share my honourable friend's concern about the use of walkie-talkie equipment, and particularly about the interference with equipment systems which are located on this frequency, many of which systems are performing a useful function. But it would be wrong to legislate piecemeal when in 1979 there will be a world administrative radio conference which may well put forward many more general recommendations which will need legislation to gather them all together, and that may be a more appropriate time to act."

Mr Rathbone: "Will the minister explain why he gave such a peremptory "no" to my question for written answer a few days ago, seeking the establishment of a citizens' band on v.h.f.? Is he aware that the establishment of such a band would meet exactly the exigencies of the problem which the honourable member for Derby North (Mr Whitehead) raised? It would have the additional advantage of raising money for the government and an even greater advantage to citizens wishing to use such a band in being able to do so."

Mr John: "I gave a peremptory answer "no" because the honourable member asked, as I recalled, whether it was the government's intention to set up such a citizens' band. Our answer is still "no" but I shall consider these matters, and if the honourable member has further representations to make to me perhaps he will do so."

In another answer on the same day Mr Whitehead was told that in 1974 there had been ten prosecutions for the illegal use of walkie-talkies. In 1975 the figure was four.

# Circuit Ideas

## Two terminal circuit breaker

The unit functions by sensing a load current across the base-emitter junction of the output transistor (voltage sensing requires a third terminal). Resistors  $R_1$  and  $R_2$  control the off and on times respectively provided  $V_{cc}$  and  $I_{load}$  do not change. The capacitor undergoes a small amount of reverse bias ( $\sim 0.7V$ ). Good tantalum capacitors will stand this and, unofficially, so will most electrolytics with voltage ratings above 16V.  
M. Faulkner,  
New South Wales,  
Australia.

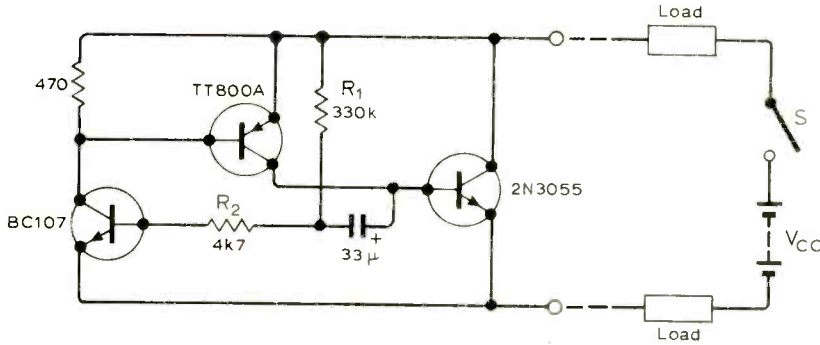

## Simple ring oscillator

This i.c. oscillator can be disabled by applying a 0 at either input, and will be retriggered when the low input is returned to a logic 1. Although under normal operation there are only two outputs, when the oscillator is disabled only one pair of outputs undergoes a further transition before oscillation stops. Therefore, this circuit is suitable for applications where it is necessary to have control of the stop and start point in the duty cycle.  
A. R. Ward,  
Bassett,  
Southampton.

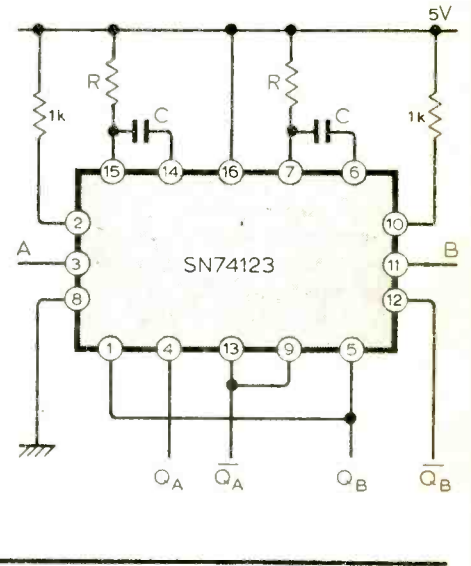

## Octal display for microprocessors

The function of this circuit is to display an eight-bit data word in conventional octal form. This is useful in microprocessor prototyping, where it is usual to use the octal representation. Digit and data selection is effected by a three state counter built around synchronously

operated JK flip-flops. The two or three bits appropriate to each display are steered to the seven segment decoder by wired AND open-collector gates, and inverters. A segment current of about 3mA was found adequate for most lighting conditions, with a multiplexing oscillator frequency of approximately 2kHz.  
Dr R. D. Mount,  
Romsey, Hants.

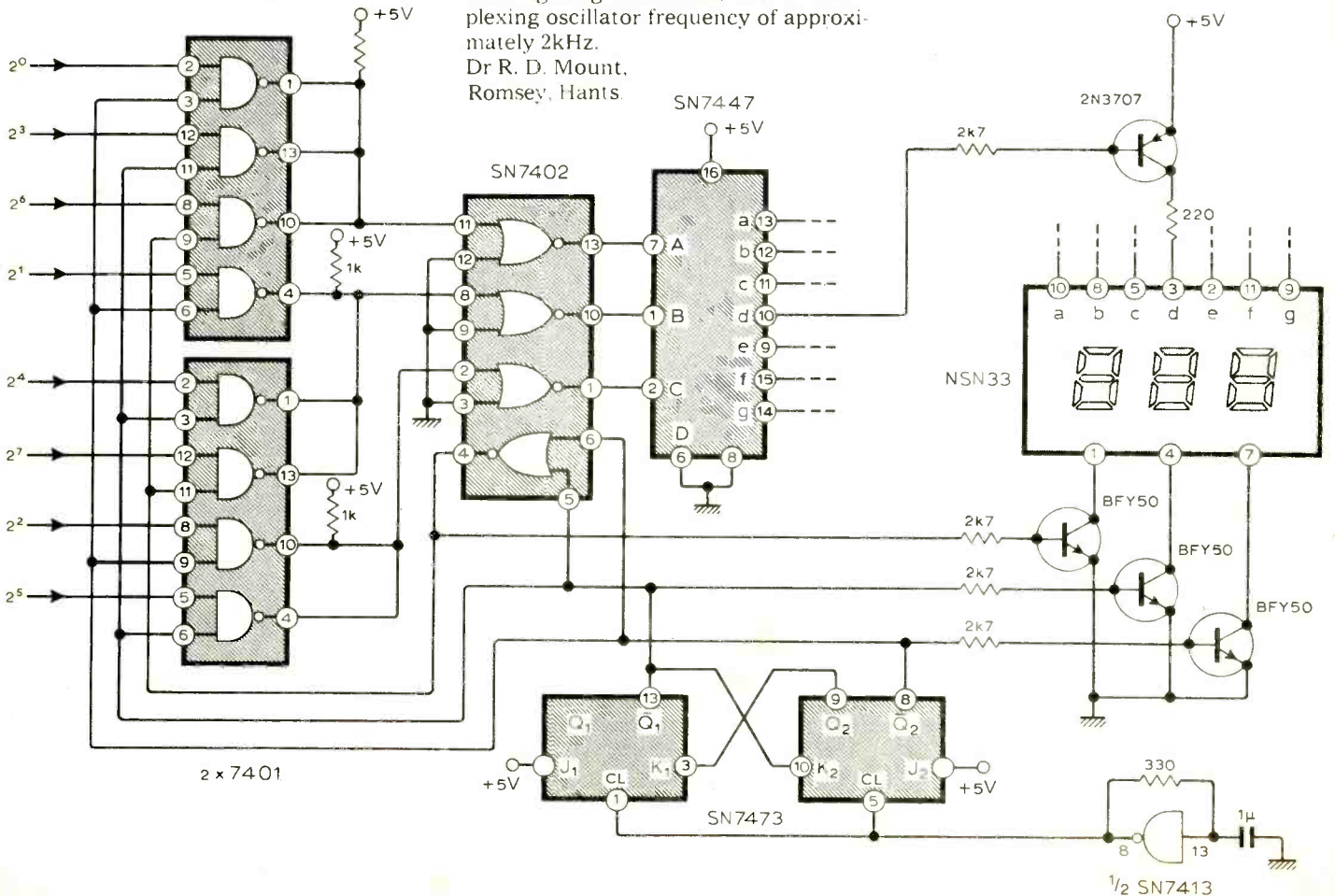

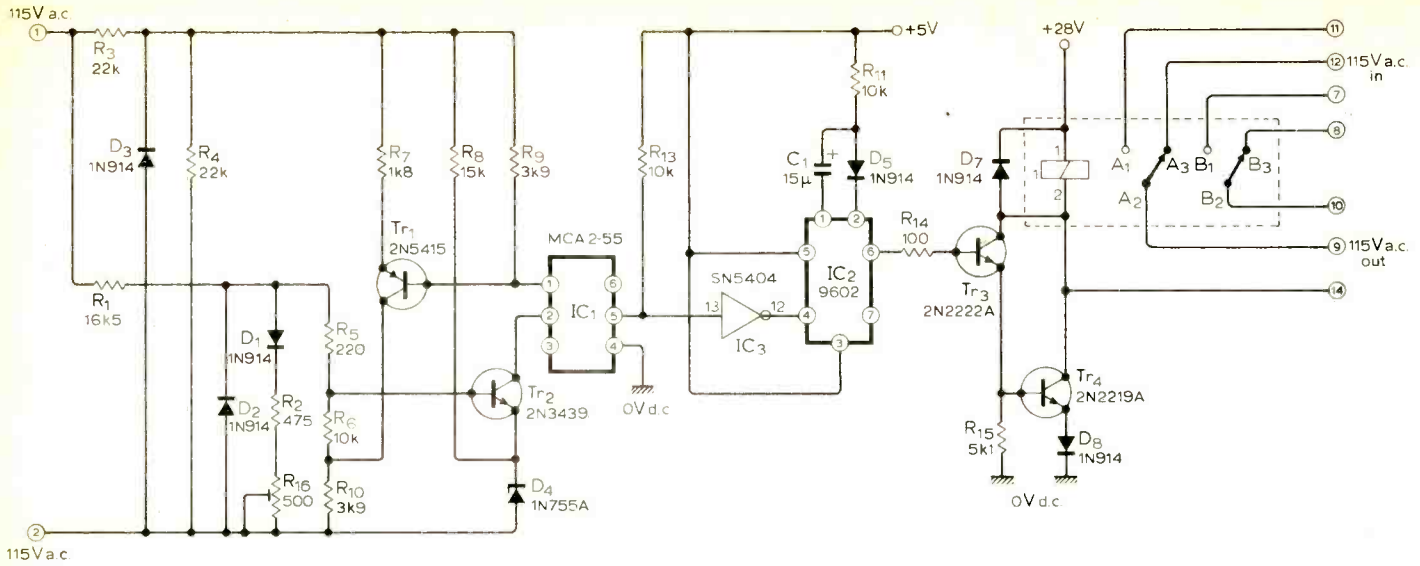

**A.c. line sensor**

A line sensor is used to protect delicate equipment from sustained over-voltage. This circuit will disconnect the supply if it exceeds a pre-set level.

Transistor  $Tr_2$  senses the input, which can be varied by  $R_{16}$ , and turns on if the base voltage exceeds  $V_{be} + 7.5V$ . When this occurs the opto-coupler IC

conducts and switches  $Tr_1$  on. Positive feedback produces a fast switching action and the circuit remains on until the alternating voltage falls below the pre-set level. The output pulse is shaped by  $IC_3$  and used to trigger the monostable  $IC_2$ . As long as the time constant  $C_1R_{11}$  is longer than the duration of the pulse, pin 6 is high so the relay is

activated which disconnects the alternating supply. When the a.c. falls below the pre-set level the monostable reverts to the stable state and switches on the supply.

F. E. George,  
College of Arts, Science and  
Technology,  
Jamaica.

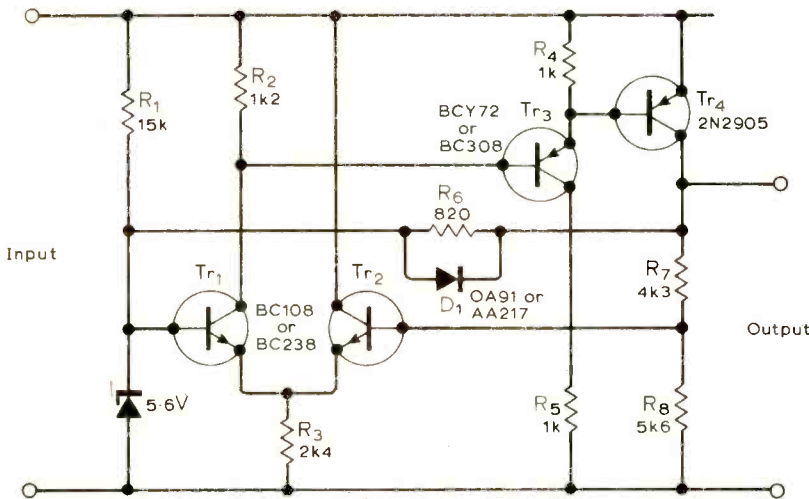

**Germanium diode for regulator protection**

Power regulator protection is a perennial problem and this circuit offers a simple and economical solution. Under normal conditions,  $D_1$  is reverse biased by the voltage across  $R_6$  and does not affect the regulator operation. When the output is shorted, however,  $D_1$  turns on and draws current through  $R_1$  which removes the reference voltage across the zener diode. Because  $D_1$  is a germanium type,  $Tr_1$  is held off which also turns  $Tr_3$  and  $Tr_4$  off. When the short is removed, the circuit recovers and resumes normal operation.

D. E. O'N. Waddington,  
St Albans,  
Herts.

**Op-amp integrator**

Two 741 op-amps can be combined as shown to produce a circuit with a selected input resistance of  $2 \times 10^8$  ohms and a drift time, 0 to 10V, of 90 min. Resistor  $R_3$  is equal to  $R_1R_2/R_{in} - (R_1 + R_2)$  where  $R_{in}$  is the required input resistance. For the values shown  $R_{in}$  is  $10^7\Omega$ .

N. G. Boreham,  
Teignmouth,  
Devon.

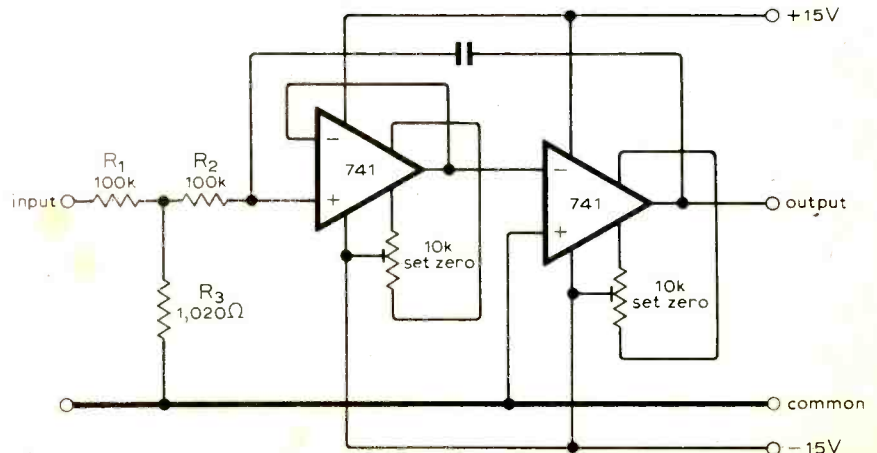

### Semiconductor tester

This circuit tests transistors and diodes for polarity, and short/open circuits in one measurement. The same tests using a multimeter would require at least four operations.

A three-phase waveform is derived from the low-frequency ring-of-three oscillator, and applied to the device under test via the l.e.d.s. The oscillator waveform enables each pair of device terminals to be forward, reverse and unbiased for one third of a cycle. Current flowing into the device will turn the appropriate red l.e.d. on and current flowing out will turn on the green l.e.d. Thus, the position of the

base lead and the polarity of a transistor may be deduced.

Voltage drop across the l.e.d.s and device under test is typically 4.5V. A t.t.l. "1" will not source current at this voltage, so 270Ω resistors have been added to source and limit the diode current. Frequency of operation, defined by the CR network, is not critical, but the resistor should not exceed 1kΩ for reliable operation. Oscillator frequency with the values shown is about 2kHz.

N. E. Thomas,  
Balham,  
London.

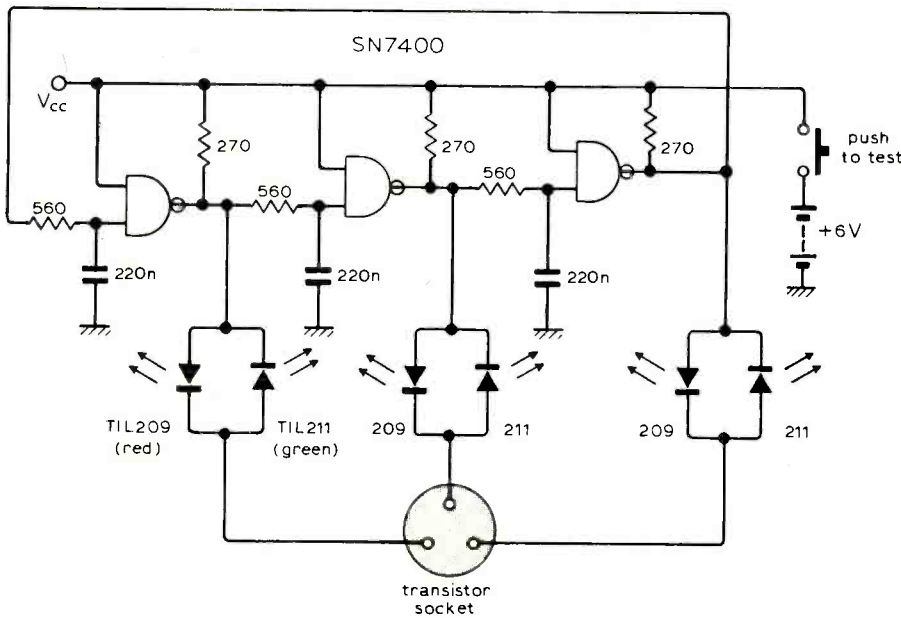

## HF predictions

Solar and magnetic activity 1976 from data supplied by the Royal Greenwich Observatory:

|     | A  | B  | C  | D  | E  | F |
|-----|----|----|----|----|----|---|
| Jan | 14 | 26 | 9  | 18 | 6  | 0 |
| Feb | 18 | 29 | 3  | 11 | 8  | 0 |
| Mar | 21 | 34 | 17 | 27 | 6  | 1 |
| Apr | 14 | 28 | 16 | 27 | 2  | 0 |
| May | 14 | 34 | 11 | 26 | 6  | 1 |
| Jun | 9  | 32 | 11 | 27 | 9  | 4 |
| Jul | 11 | 31 | 2  | 31 | 24 | 2 |
| Aug | 8  | 34 | 16 | 26 | 1  | 1 |
| Sep | 12 | 27 | 13 | 22 | 4  | 7 |
| Oct | 10 | 34 | 20 | 19 | 3  | 6 |
| Nov | 5  | 14 | 3  | 15 | 10 | 2 |
| Dec | 7  | 36 | 14 | 21 | 5  | 5 |

A, magnetically disturbed days. B, C, highest and mean of daily sunspot numbers. D, number of days that observations possible. E, number of observed days having zero sunspots. F, new cycle spots.

There were 5 large sunspots and only one solar flare during the year.

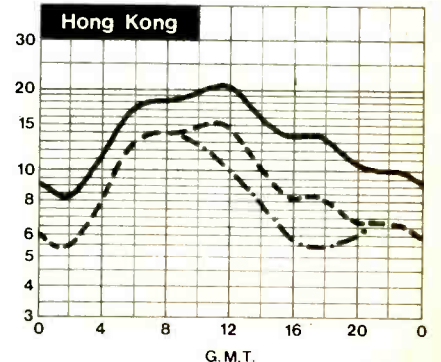
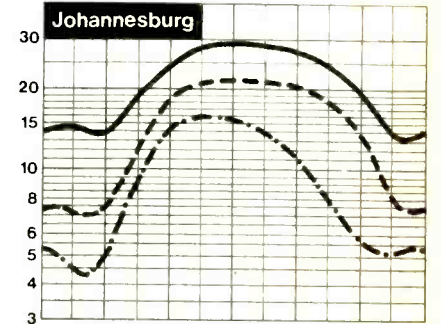
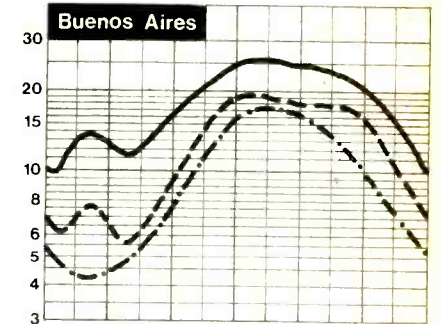
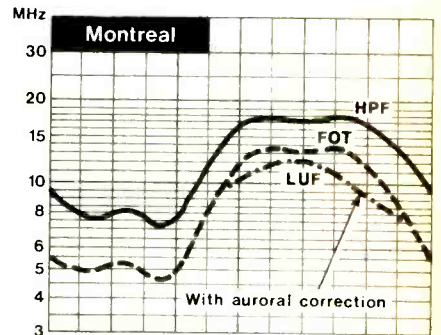

### Linear v.c.a.

This circuit is based on dual matched f.e.t.s. and can be used in applications such as linear voltage-controlled amplifiers and two-quadrant multipliers. The resistance of the f.e.t. in the feedback loop is adjusted automatically to source the current demanded by  $V_{in}$ . This resistance, and therefore the resistance

of the other f.e.t., varies inversely with input voltage. The gain of the amplifier stage is given by  $R_f/V_{ref}R \times V_{in}$  and is variable over about 80dB.

B. Turner & J. Custo,  
Tewkesbury,  
Glos.

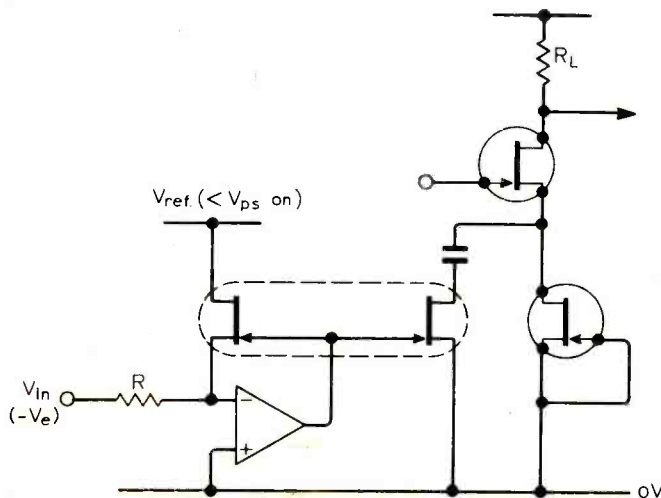

# Interference from amateur stations

An investigation by the Radio Society of Great Britain

by I. Jackson G3OHX

**This report, released in 1976, describes a survey carried out by the Radio Society of Great Britain which investigated interferences caused by radio amateurs. The survey was based on questionnaires (see pages 45 and 46) answered by more than a thousand licensed RSGB members. The report also discusses the results of the survey and the recommendations and conclusions made by the society.**

Each year the Home Office issue figures about the number of cases of interference to television and radio reception. Various sources of interference are identified, among which are amateur radio transmitters. For several years recorded cases of television interference (t.v.i.) have fluctuated, but have averaged about 1,000 (with a sudden drop of 30 per cent in 1974). These figures represent only those cases dealt with by Home Office officials and no indication is given as to the technical reasons for such interference, neither is any estimation made of the number of cases of interference which never come to the attention of the Home Office.

For a long time it has been obvious in amateur circles that a major cause of interference is the inadequate immunity of domestic electronic entertainment equipment to the strong r.f. fields near amateur radio stations. The expression "electromagnetic compatibility" (e.m.c.) is used to describe the susceptibility of this equipment to such interference.

When interference is cause to television, radio and hi-fi installations with low e.m.c., the cure is not a question of the suppression of radiation on unwanted frequencies by the amateur. Usually the affected equipment must be altered in some way. Amateur equipment, while not completely blameless, has become much less of a cause of interference for the traditional reasons, such as harmonic radiation.

For several years the RSGB Interference Committee has been making approaches to the British Radio Equipment Manufacturers' Association

(BREMA) to try to induce a more realistic attitude to the concepts of television, radio and hi-fi design so that e.m.c. might be improved. So far the response has been disappointing. While it might be considered unfair to say that there has been downright resistance to any proposals made, arguments against them indicate that the true interference situation is not appreciated. Despite technical evidence, it is often considered that the amateur is still the real culprit.

Another reason for not making any improvements in domestic equipment design is that the number of cases of interference which occur, when compared with yearly sales, are not considered sufficient to warrant such action. It is felt that it is uneconomical to increase the e.m.c. of all equipment when only a small proportion of it is likely to be used in the inhospitable environs of an amateur radio station. It is thought that it is better to treat on an individual basis those cases of interference which do occur. While this may seem to be a perfectly reasonable compromise solution, it is the experience of the RSGB Interference Committee that such pious intentions sometimes seem to take a lot of putting into practice. In any case, curing interference after it has occurred does not prevent amicable neighbourly relations from becoming strained as a

result of the inconvenience and misunderstandings which often arise. The social consequences of interference are numerous and far-reaching.

It would be foolish to argue that amateurs never cause interference in the technical sense. One of the principle reasons for this survey is to try to apportion the blame for such interference, and to make an assessment of the true number of cases which occur each year. In addition, questions are asked to find out the amateur's attitude to interference and its effect on his operating habits. This is likely to influence band occupancy, not only during "sensitive hours" but also at other times of day.

## The ideas behind the questions

The questions in the Interference Survey were framed so that the answers would be in a form most useful to the Interference Committee. Other surveys containing more or fewer questions were considered, but it was felt that the survey chosen was a reasonable compromise between the need to obtain detailed information and the possibility of reducing the number of returns because the questions were too complicated or lengthy.

Despite careful working, some questions yielded answers which indicated that some amateurs were confused. However, suitable corrections have been made where it is obvious that misinterpretation has occurred.

The questions were asked for the following reasons:

In section 1 the class of licence was asked for in case there was a marked difference in the answers given by the two classes.

The time at the present location was required for various reasons. One was to avoid stretching memories too far. It was felt that this was preferable to asking for periods such as "the last five years", "since you received your licence", etc. To have stipulated limited time periods would have biased the survey towards the newly licensed amateurs.

Question 3 was asked to assess the emotional attitude of the amateur to interference. It was intended that he

**Table 1.** Total number of amateurs who answered the questionnaire (see questions 1 and 6 of section 1).

| Class | Non-wired | Wired | Total |
|-------|-----------|-------|-------|
| A     | 765       | 64    | 829   |
| B     | 228       | 22    | 250   |
| "A+B" | 132       | 10    | 142   |
| Total | 1125      | 96    | 1221  |

**Table 2.** Answers to question 2, section 1 — number of years licence held at present location.

| Class | Total Years | Average period |
|-------|-------------|----------------|
| A     | 6676        | 8.05           |
| B     | 804         | 3.22           |
| "A+B" | 501         | 3.53           |
| ALL   | 7981        | 6.54           |

# RSGB Interference Survey

## INTERFERENCE TO TELEVISION, RADIO, AND AUDIO EQUIPMENT

### SECTION 1—GENERAL

1. Indicate with a tick the class of licence you hold. If you now hold a Class A but have held a Class B then tick both squares.

|   |  |
|---|--|
| A |  |
| B |  |

2. For how many years have you held a licence *at your present location* ?

3. How severely do you *feel* worried by interference problems ? For example, do you restrict your operation in any way because you cause interference, or *think* that you might do so ? Do you avoid certain frequencies or certain times of the day ? Do you transmit knowing full well that interference *is* being caused ? Just how do you *feel* ? Indicate by using a *number only* as follows : 0—not at all worried ; 1—slightly worried ; 2—moderately worried ; 3—severely worried.

4. Are there any bands (which your transmitting equipment covers) on which you are unable to operate without restrictions, voluntary or enforced, because of known interference problems ? These restrictions could be, for example, on time, transmitting mode, power, beam heading etc. Please tick the relevant boxes.

|         |         |       |        |        |        |        |         |         |                  |
|---------|---------|-------|--------|--------|--------|--------|---------|---------|------------------|
| 1.8 MHz | 3.5 MHz | 7 MHz | 14 MHz | 21 MHz | 28 MHz | 70 MHz | 144 MHz | 432 MHz | 1296 MHz upwards |
|         |         |       |        |        |        |        |         |         |                  |

5. Are there any bands (which your transmitting equipment covers) on which you have not made a determined effort to operate, because you believe that interference problems will arise ? Please tick the relevant boxes.

|         |         |       |        |        |        |        |         |         |                  |
|---------|---------|-------|--------|--------|--------|--------|---------|---------|------------------|
| 1.8 MHz | 3.5 MHz | 7 MHz | 14 MHz | 21 MHz | 28 MHz | 70 MHz | 144 MHz | 432 MHz | 1296 MHz upwards |
|         |         |       |        |        |        |        |         |         |                  |

6. State the tv channel numbers normally received in your area. If you do not know the channel numbers please state the name(s) of the transmitting station(s). If "wired" tv is used please tick the relevant box.

|      |  |  |     |  |  |
|------|--|--|-----|--|--|
| VHF  |  |  |     |  |  |
| BBC1 |  |  | ITV |  |  |
|      |  |  |     |  |  |

|       |
|-------|
| Wired |
|       |

|      |  |      |  |     |  |
|------|--|------|--|-----|--|
| UHF  |  |      |  |     |  |
| BBC1 |  | BBC2 |  | ITV |  |
|      |  |      |  |     |  |

### SECTION 2—TELEVISION INTERFERENCE

*This section covers interference caused to tv sets only, where interference affects vision and/or sound.*

1. How many tv sets have suffered from interference due to the operation of your amateur radio station (either when transmitting or receiving) ? Indicate the number of sets affected, *not* the number of separate complaints. Include your own tv set if applicable.

2. (a) How many of the tv sets in Question 1 suffered from interference when tuned to a broadcast transmission in VHF Band 1 ? (See note below).

(b) How many of the tv sets in Question 1 suffered from interference when tuned to a broadcast transmission in VHF Band 3 ? (See note below).

(c) How many of the tv sets in Question 1 suffered from interference when tuned to a broadcast transmission in UHF Bands 4 or 5 ? (See note below).

3. In how many cases of interference to tv sets in Question 1 were the Post Office called in to investigate ? Indicate the number of sets, *not* the number of visits made to carry out tests etc.

4. How many of the tv sets in Question 1 were cured of interference *without* the Post Office being called in to investigate ?

5. How many of the tv sets in Question 1 were cured of interference by modifications to your station ? Modifications include fitting of filters, screening, re-positioning aerials etc, but do *not* include a change of modulation mode or transmitted power.

6. How many of the tv sets in Question 1 were cured of interference by modifications to the tv installation? Modifications include fitting of filters, screening, re-positioning aerials, repairing faulty joints etc.
7. How many of the tv sets in Question 1 were cured of interference by the fitting of *external devices* to the tv set (eg aerial or mains filters, "braid-breakers", transformers, stubs, traps, earthing braid etc)?

**Note (Question 2):** In the UK the VHF Bands 1 and 3 are used for 405-line transmissions. Band 1 (Channels 1 to 5) is always BBC1, Band 3 (Channels 6 to 13) is usually ITV, but in certain areas it may carry BBC1 transmissions also. UHF Bands 4 and 5 (Channels 21 to 68) are used for 625-line transmissions (including colour) for all programmes (BBC1, BBC2 and ITV).

### SECTION 3—RADIO INTERFERENCE

*This section covers interference caused to radio sets only. This includes radio tuners fitted to hi-fi systems, radiograms etc.*

1. How many radio sets have suffered from interference due to the operation of your station (either when transmitting or receiving)? Indicate the number of sets affected, *not* the number of separate complaints. Include your own radio set if applicable.
2. (a) How many of the radio sets in Question 1 suffered from interference when tuned to a broadcast transmission on the long and/or medium wavebands?
- (b) How many of the radio sets in Question 1 suffered from interference when tuned to a broadcast transmission on vhf/fm (Band 2)?
3. In how many cases of interference to radio sets in Question 1 were the Post Office called in to investigate? Indicate the number of sets, *not* the number of visits made to carry out tests etc.
4. How many of the radio sets in Question 1 were cured of interference *without* the Post Office being called in to investigate?
5. How many of the radio sets in Question 1 were cured of interference by modifications to your station? Modifications include fitting of filters, screening, re-positioning aerials etc, but do *not* include a change of modulation mode or transmitted power.
6. How many of the radio sets in Question 1 were cured of interference by modifications to the radio installation? Modifications include fitting of filters, screening, re-positioning aerials, repairing faulty joints etc.
7. How many of the radio sets in Question 1 were cured of interference by the fitting of *external devices* to the radio set (eg aerial or mains filters, "braid-breakers", transformers, stubs, traps, earthing braid etc)?

### SECTION 4—AUDIO INTERFERENCE

*This section covers interference caused to all types of audio equipment such as hi-fi systems, record players, tape recorders, public address systems, electronic organs etc. Note that this section does not include the audio sections of television or radio receivers.*

1. How many audio installations have suffered from interference due to the operation of your station (either when transmitting or receiving)? Indicate the number of installations affected, *not* the number of separate complaints. Include your own audio installation if applicable.
2. In how many cases of interference to audio installations in Question 1 were the Post Office called in to investigate? Indicate the number of installations, *not* the number of visits made to carry out tests etc.
3. How many of the audio installations in Question 1 were cured of interference *without* the Post Office being called in to investigate?
4. How many of the audio installations in Question 1 were cured of interference by modifications to your station? Modifications include fitting of filters, screening, re-positioning of aerials etc, but do *not* include a change of modulation mode or transmitted power.
5. How many of the audio installations in Question 1 were cured of interference by modifications to the audio installation? Modifications include fitting of filters, screening, re-positioning of interconnecting leads, repairing faulty joints etc.
6. How many of the audio installations in Question 1 were cured of interference by the fitting of *external devices* to the audio installation (eg filters on mains, loudspeaker or other interconnecting leads etc)?



**Table 3.** Answers to question 3, section 1 — feelings of amateurs worried by interference problems

| Class | Not worried | Slightly worried | Moderately worried | Severely worried | % | Average "feel" |
|-------|-------------|------------------|--------------------|------------------|---|----------------|
| A     | 24.61       | 37.88            | 26.73              | 10.25            |   | 1.22           |
| B     | 32.8        | 32.00            | 21.2               | 9.2              |   | 1.02           |
| "A+B" | 21.83       | 35.92            | 27.46              | 10.56            |   | 1.23           |
| ALL   | 25.96       | 36.45            | 25.75              | 10.07            |   | 1.18           |

**Table 4.** Answers to question 4, section 1 — Bands "unworkable" due to interference.

| Class      | A     |       | B     |      | "A+B" |       | ALL   |       |
|------------|-------|-------|-------|------|-------|-------|-------|-------|
| Band (MHz) | Cases | %     | Cases | %    | Cases | %     | Cases | %     |
| 1.8        | 43    | 5.19  |       |      | 6     | 4.23  | 49    | 5.05  |
| 3.5        | 169   | 20.39 |       |      | 22    | 15.59 | 191   | 19.67 |
| 7          | 113   | 13.63 |       |      | 16    | 11.27 | 129   | 13.29 |
| 14         | 176   | 21.23 |       |      | 30    | 21.13 | 206   | 21.22 |
| 21         | 200   | 24.13 |       |      | 29    | 20.42 | 229   | 23.59 |
| 28         | 169   | 20.39 |       |      | 25    | 17.61 | 194   | 19.98 |
| 70         | 61    | 7.36  |       |      | 9     | 6.30  | 70    | 7.21  |
| 144        | 78    | 9.41  | 78    | 31.2 | 29    | 20.42 | 185   | 15.15 |
| 432        | 13    | 1.57  | 24    | 9.6  | 4     | 2.82  | 41    | 3.36  |
| 1296       | 6     | 0.70  | 3     | 1.2  | 1     | 0.70  | 10    | 0.82  |

**Table 5.** Answers to questions 5, section 1 — Bands avoided by amateurs because of interference problems.

| Class      | A     |       | B     |     | "A+B" |      | ALL   |       |
|------------|-------|-------|-------|-----|-------|------|-------|-------|
| Band (MHz) | Cases | %     | Cases | %   | Cases | %    | Cases | %     |
| 1.8        | 18    | 2.17  |       |     | 4     | 2.82 | 22    | 2.27  |
| 3.5        | 63    | 7.60  |       |     | 10    | 7.04 | 73    | 7.52  |
| 7          | 43    | 5.10  |       |     | 7     | 4.90 | 50    | 5.15  |
| 14         | 79    | 9.50  |       |     | 10    | 7.04 | 89    | 9.17  |
| 21         | 113   | 13.63 |       |     | 14    | 9.86 | 127   | 13.08 |
| 28         | 95    | 11.46 |       |     | 10    | 7.04 | 105   | 10.81 |
| 70         | 40    | 4.83  |       |     | 13    | 9.15 | 53    | 5.46  |
| 144        | 23    | 2.77  | 11    | 4.4 | 5     | 3.52 | 39    | 3.19  |
| 432        | 7     | 0.84  | 13    | 5.2 | 4     | 2.82 | 24    | 1.97  |
| 1296       | 2     | 0.24  | 3     | 1.2 | 1     | 0.70 | 6     | 0.49  |

**Table 6.** Television interference — results for section 2, bold figures are the average number of cases (tv sets) per amateur.

| Class                                       | A     |             | B     |            | "A+B" |             | ALL   |             |
|---|-------|-------------|-------|------------|-------|-------------|-------|-------------|
| Question/Interference                       | Cases | %           | Cases | %          | Cases | %           | Cases | %           |
| 1 Total number of sets                      | 2257  | <b>2.72</b> | 576   | <b>2.3</b> | 401   | <b>2.83</b> | 3234  | <b>2.65</b> |
| 2a To sets in v.h.f. Band 1                 | 1018  | 45.10       | 103   | 17.88      | 95    | 23.69       | 1216  | 37.6        |
| 2b To sets in v.h.f. Band 3                 | 584   | 25.88       | 134   | 23.26      | 85    | 21.19       | 803   | 24.83       |
| 2c To sets in u.h.f. Bands                  | 1208  | 53.52       | 378   | 65.63      | 275   | 68.58       | 1861  | 57.54       |
| 3 Cases seen by Post Office                 | 682   | 30.22       | 180   | 31.25      | 113   | 28.18       | 975   | 30.15       |
| 4 Cases cured by amateur — not seen by P.O. | 1044  | 46.26       | 265   | 46.01      | 184   | 45.89       | 1493  | 46.17       |
| 5 Cases cured by mods to station            | 214   | 9.48        | 49    | 8.51       | 25    | 6.23        | 288   | 8.91        |
| 6 Cases cured by mods to tv set             | 1293  | 57.29       | 332   | 57.64      | 244   | 60.85       | 1869  | 57.97       |
| 7 Cases cured by external mods to tv set    | 1211  | 53.66       | 270   | 46.88      | 215   | 53.62       | 1696  | 52.44       |
| No t.v.i.                                   | 133   | 16.04       | 60    | 24.00      | 19    | 13.38       | 212   | 17.36       |

**Table 7.** Radio interference — results for section 3, bold figures are the average number of cases (radio sets) per amateur.

| Class                                       | A     |             | B     |             | "A+B" |             | ALL   |             |
|---|-------|-------------|-------|-------------|-------|-------------|-------|-------------|
| Question/Interference                       | Cases | %           | Cases | %           | Cases | %           | Cases | %           |
| Total number of sets                        | 728   | <b>0.88</b> | 171   | <b>0.68</b> | 147   | <b>1.04</b> | 1046  | <b>0.86</b> |
| 2a Sets on l.w. and/or m.w.                 | 423   | 58.10       | 60    | 35.09       | 85    | 57.82       | 568   | 54.30       |
| 2b Sets on v.h.f. f.m.                      | 347   | 47.66       | 119   | 69.59       | 82    | 55.78       | 548   | 52.39       |
| 3 Cases seen by Post Office                 | 104   | 14.29       | 24    | 14.04       | 15    | 10.20       | 143   | 13.67       |
| 4 Cases cured by amateur — not seen by P.O. | 193   | 26.51       | 60    | 35.09       | 37    | 25.17       | 290   | 27.72       |
| 5 Cases cured by mods to station            | 36    | 4.95        | 11    | 6.43        | 4     | 2.72        | 51    | 4.88        |
| 6 Cases cured by mods to radio set          | 195   | 26.79       | 60    | 35.09       | 37    | 25.17       | 292   | 27.92       |
| 7 Cases cured by external mods to radio set | 98    | 13.46       | 20    | 11.69       | 16    | 10.88       | 134   | 12.81       |
| No b.c.i.                                   | 458   | 55.24       | 159   | 63.6        | 62    | 43.66       | 679   | 55.61       |

should express his feelings, regardless of any actual incidence of interference.

Question 4 was included to find out if any bands (on which the amateur really wanted to operate) were particularly troublesome.

Some amateurs never even try to use certain bands because of fears of interference. Question 5 was required to find out whether the traditionally troublesome bands deserved their reputation (as indicated by the answers to question 4).

Question 6 was asked with the intention of establishing any connection between the tv channels received and operating problems. Wired tv (c.a.t.v., m.a.t.v.), which has no official protection against amateur interference, was included for completeness and to find out if it posed extra problems. No attempt was made to find out the wired tv frequencies, which could be quite different from those received locally "off-air".

Section 2 was worded to be as compatible as possible with sections 3 and 4. A lot had to be left to the discretion of the amateur; for example, the number of cures was asked for. In some cases a "cure" may be effective

**Notes on the tabulated results**

Most of the figures recorded in the tables are self-explanatory. However, as most of the results are expressed as averages or percentages, the following notes will make it clear how these were arrived at.

**Section 1.**

Q2 The average period of operation is the total number of years recorded in 1.2 divided by the total of survey forms returned.

Q3 The average "feeling" is the sum of the numbers recorded in 1.3 divided by the total returns. The percentage of amateurs with a particular feeling is the number recording that feeling divided by the total returns.

Q4 & Q5. The percentage of amateurs with restrictions on or avoiding a particular band is the total recording that band divided by the total returns. As Class B licencees cannot use the bands below 144MHz, when relevant, the percentages of questions 4 and 5 in section 1 are calculated using a total of 1125 amateurs (i.e. the number of Class B licencees are deducted).

**Section 2.**

Q1 The average number of tv sets suffering t.v.i. from each amateur is the total of answers in question 2.1 divided by the total of returns. Q2 to Q7. The percentages are the totals of answers to the appropriate question divided by the total of answers to 2.1.

**Sections 3 and 4.**

The averages and percentages calculated for these sections are calculated on the same basis as for section 2.

It must be pointed out that although many of these results are calculated to two decimal places this does not imply that they are accurate to this degree. It merely facilitates the subsequent rounding-off of figures, as necessary.

**Table 8.** Audio interference — results for section 4, bold figures are the average number of cases (installations) per amateur

| Question | Class<br>Interference                   | A     |             | B         |             | A+B   |             | ALL   |             |
|----------|---|-------|-------------|-----------|-------------|-------|-------------|-------|-------------|
|          |   | Cases | %           | Cases     | %           | Cases | %           | Cases | %           |
| 1        | Total number of installations           | 1026  | <b>1.24</b> | 264       | <b>1.06</b> | 230   | <b>1.62</b> | 1520  | <b>1.24</b> |
| 2        | Cases seen by P.O.                      | 139   | 13.55       | 34        | 12.88       | 28    | 12.17       | 201   | 13.22       |
| 3        | Cases cured by amateur not seen by P.O. | 324   | 31.58       | 92        | 34.85       | 83    | 36.09       | 499   | 32.83       |
| 4        | Cases cured by mods to station          | 33    | 3.22        | 26        | 9.85        | 4     | 1.74        | 63    | 4.14        |
| 5        | Cured by mods to installation           | 353   | 34.41       | 75        | 28.41       | 72    | 31.30       | 500   | 32.89       |
| 6        | Cured by external mods to installations | 210   | 20.47       | <b>30</b> | 11.36       | 36    | 15.65       | 276   | 18.16       |
|          | No a.f.i.                               | 273   | 32.93       | <b>97</b> | 38.8        | 32    | 22.54       | 402   | 32.93       |
|          | No t.v.i., b.c.i. or a.f.i.             | 63    | 7.6         | 35        | 14.0        | 9     | 6.4         | 107   | 8.76        |

only on some tv channels or for some amateur bands.

The number of tv sets affected was asked for in preference to the number of complaints received. It was felt that this would give more realistic answers. Most of the cases recorded by the Home Office are probably "one set — one complaint", especially if the time period is short.

Question 2 is intended to amplify question 1. It was thought that in most cases the amateur would remember if BBC1, BBC2 or ITV was affected, or which line standard — hence the note at the end of the question.

It was realised that the amateur might not know all the facts of the cases of t.v.i. The Home Office do not always disclose who or what is suffering interference. In some circumstances (e.g., in cases of multiple t.v.i.) the number given in the reply to question 3 may be lower than the true value. It is also possible that, over a period of time, one set could be responsible for several cases being recorded by the Home Office. As a result, it is possible that the number of cases recorded by the Home Office and those reported in question 3 may not agree exactly.

In question 4 the judgment of the amateur is relied upon for what he calls a "cure". However, it enables a ratio of "amateur cures" to the number of times the Home Office is involved to be calculated. Of course, these two events are not totally of the same character as the Home Office may not always effect a cure. In consequence, this ratio does not exaggerate the amateur role in curing t.v.i.

Question 5 tries to discover how often the amateur station is technically responsible for causing t.v.i. "Repositioning of aerials" is included as a modification, but this does not imply that a badly sited transmitting aerial is really a technical fault. However, the RSGB Interference Committee recommends that amateurs should consider the possibility of reducing field strengths by attention to aerial position or design. A change of modulation mode is excluded as this is considered to be avoiding t.v.i. rather than curing it.

When interference is cured by modifying the affected tv installation it is

reasonable to conclude that in most cases the amateur is not to blame. In question 6 it is intended that any modification (including those in question 7) should be counted.

Question 7 specifically limits modifications to the usual amateur methods of adding external filters, etc. It was considered important to find out what proportion of the cures of question 6 were achieved without having to resort to difficult modifications, such as internal modifications to the tv set. The Interference Committee recommend against tampering inside neighbours' equipment.

Sections 3 and 4 were worded similarly to section 2 and were chosen for similar reasons.

(To be continued)

Part 2 of this article will discuss the survey results, as tabulated, suggesting possible reasons for the figures obtained.

#### Editor's note

QST, the official journal of the American Radio Relay League (ARRL), reported in their November 1976 issue: "In the United States, with the recent increase in popularity of c.b. radio and a commensurate increase in the number of privately owned transmitters, the FCC is now receiving interference complaints at a rate of over 100,000 a year. Of the complaints of interference to home-entertainment devices, only seven per cent involve amateur radio operators. Further analysis shows that of these complaints, almost 90 per cent would not have occurred at all if the manufacturers of the home-entertainment devices had provided adequate filtering or shielding in their products. These statistics suffer a severe limitation in that they record only reported cases of interference. . . . It is clear that even though amateurs are involved in only a small percentage of all reported interference cases, the overall effect on amateur radio operation is unknown."

## EEC DATA-PROCESSING CASH

The EEC Commission is making available 103 million units of account (about £43 million) to help the data-processing industry. The money will go to "joint developments and new products in many areas mainly related to distributed computers," according to Christopher Layton, director for technology in the Commission's Directorate-General for Industrial Policy in Brussels, "or new products in the field of peripherals, terminals, etc." Between 20 and 50% of the cost of collaborative projects would be provided as long as they involved at least three member states. Any new application so funded would involve repayment if successful.

The Commission is concentrating on making stronger the mini- and micro-computer sectors, where large foreign competitors have not yet gained a foothold. Similar proposals to strengthen the telecommunications and electronic component sectors will follow later. The present scheme, a four-year programme, should be in operation by 1978, say the Commission. They are anxious that the European industry should adopt common standards, that the member states should become more aware of one another's products, that public buying in the member states, about 30% of all purchases, should be directed towards helping the native European industry, that agreement should be reached about the privacy of computer data, particularly that crossing frontiers, and that a European users' association be set up.

Previous public support for the data-processing industry has been given on a national basis. In 1971-75 member states spent about £76 million a year. "This enabled the European-based industry to survive but, unless co-ordinated in future, the nationalist bias, the Commission believes, could prove dangerous." Manufacturers have found it difficult to obtain a Europe-wide return on their investments, have been unable to find the resources to attack all sectors of the market, and have wasted the resources they can find in duplicated effort. This is why the Commission's financial help is for collaborative projects put forward by users of at least three member states or industrial companies from at least two.

Earlier attempts to persuade the three largest European computer firms to co-operate in developing and marketing a common range of computers, the Unidata project, have failed, and support for creating a community leasing fund along Japanese lines, managed by the European Investment Bank and provided with an initial 100 million units of account (£40 million) has not met enough support to be included in the four-year programme.

# Television pattern generator

Simple design providing crosshatch / dot matrix, colour bars and grey scale

by R. A. Owen, M.Sc. and D. Brenkley, B.Sc., *University of Essex*

The unit generates the waveforms corresponding to the standard test patterns using inexpensive, readily available, t.t.l. integrated circuits. Line synchronization is necessary, ideally using line blanking pulses, and output buffering circuitry may be needed, depending on the required amplitude, d.c. level and isolation of the output signal(s). Component values are for use with the 625-line system.

### Waveforms

The crosshatch/dot-matrix waveform is composed of two sets of pulses, producing the vertical and horizontal components of the pattern. The vertical component pulses are some 200ns wide and of period approximately 3µs, while the 52µs horizontal component pulses

recur every twenty-five lines. The colour-bar waveforms are square-wave pulses providing the separate RGB drives and weighted summing of these three drive signals forms the grey scale waveform. Gating during the line blanking period ensures that the pulse sets exist only during the active line time, preventing serious

foldover. Provision is made for adjustment of the vertical line/bar spacing of the patterns.

### Input pulse shaper

In the circuit diagram of Fig. 1, R<sub>1</sub>, C<sub>1</sub>, D<sub>1</sub> limit the amplitude of the negative-going line input pulses applied to the two-input schmitt-trigger NAND gate, whose input/output hysteresis helps to provide jitter-free operation with slow rise-time inputs. The cleaned-up pulses then provide synchronization and gating.

### Crosshatch

A second two-input schmitt-trigger NAND gate serves as a gated RC astable multivibrator, in which R<sub>3</sub> alters the frequency of oscillation. The output

Fig. 1. Main circuit diagram. The output inverters are a 7406, the other inverters a 7404, the three-input gates part of a 7400, two-input gates are two 7400s and the Schmitt two-input gates are a 74132. The link in the second 7490 reset line is in place of the circuit of Fig. 4.

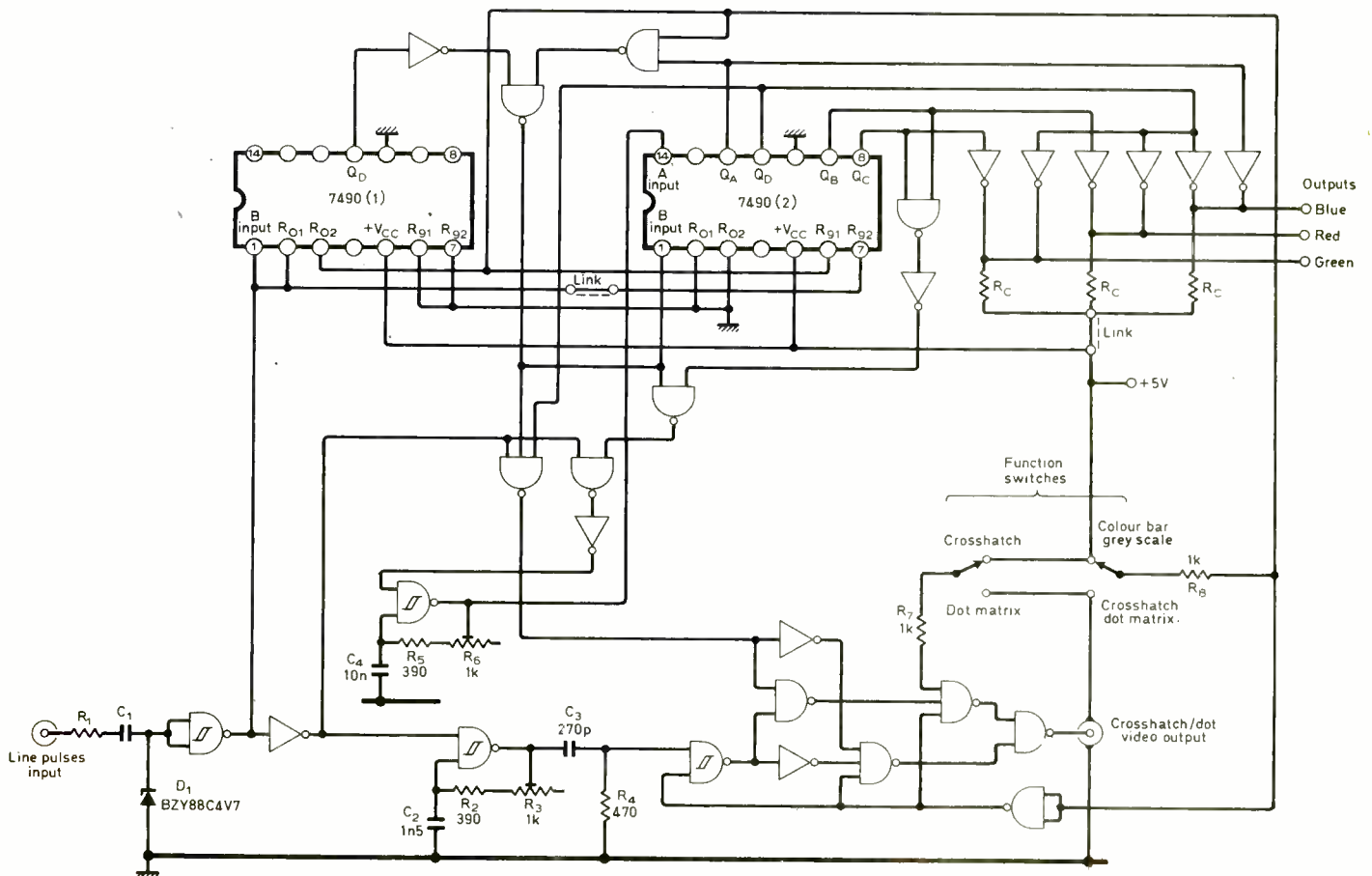

waveform, a rectangular pulse train of 2:1 duty cycle, is differentiated by  $C_3, R_4$  and shaped by a schmitt-trigger NAND gate. The internal input diode of the NAND gate limits the negative excursion of the differentiated waveform. The width of the negative-going output pulses for the vertical cross hatch component are related to the time constant  $C_3, R_4$ . To reduce pick-up, the differentiated output is gated off in the colour bar mode. For the horizontal component of the crosshatch, the two 7490 decade counters function as a divide-by-25 counter, as in Fig. 2(a) the reset functions being inhibited. The negative-going pulses of one active line length ( $52\mu s$ ) are fed from a three-input NAND gate to the output gating circuitry.

Essentially, an OR type function is employed for crosshatch and an AND type function for dot matrix in the output circuitry, with a switchable interchange between the two.

**Colour bar/grey scale**

$R_5, R_6, C_4$  and the associated schmitt-trigger NAND gate form the colour bar astable oscillator.  $R_6$  alters the oscillation frequency, and when optimally adjusted produces an oscillation period of  $6.5\mu s$ . Subsequent division by 2, 4 and 8 produces inverted drive waveforms, available at the A, B, C outputs of the second 7490 counter, which are inverted to provide positive-going video signals. Buffer circuitry may be added externally if the t.t.l. outputs are incompatible. Weighted summing of the drive signals, as in Fig. 2(b) provides the eight-level grey scale in Fig. 2(c), sequentially from peak white to black. A simple resistor summing network can be used as a compromise as in Fig. 2(d). Summing resistors are selected to give a 100% amplitude, 100% saturation waveform, the amplifier output being a grey scale of about 1V p-p.

**Gating**

In the crosshatch mode, the three-stage binary counters of the 7490's in Fig. 1, for which the count cycle length is divided by five, are used and the resets are inhibited.

In the colour bar mode, the second 7490 functions as a 0 to 7 counter with the appropriate external gating, set to a count of nine in the line blanking period. The  $Q_D$  output of the first 7490 assumes a static logical 0 in this mode, since the counter is reset every line. The colour bar oscillator is gated off by the line blanking pulses or by the output of a NAND gate structure responding to a logical 111 presented from the outputs  $Q_A, Q_B, Q_C$  of the second 7490 (corresponding to a count of seven). So, the second 7490 counts, generating the bar waveforms, to 0111, inhibiting the oscillator. The line blanking pulse then continues to gate off the oscillator and sets the counter outputs to a logical 1001 (a count of nine). By virtue of the

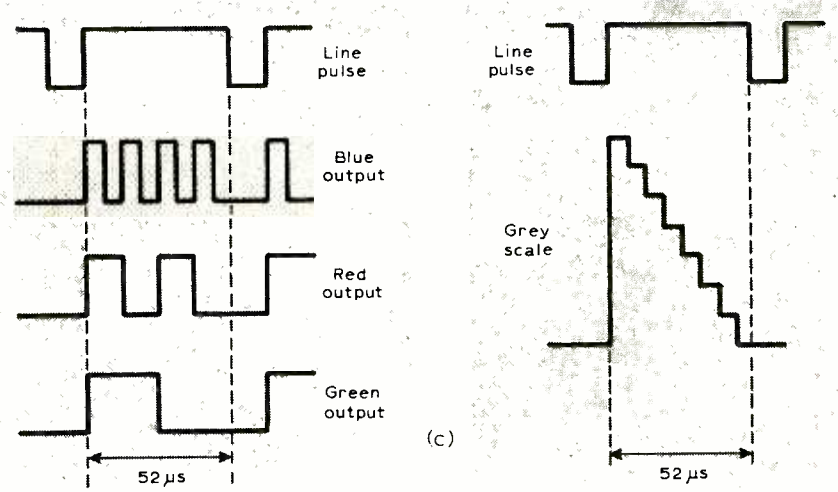
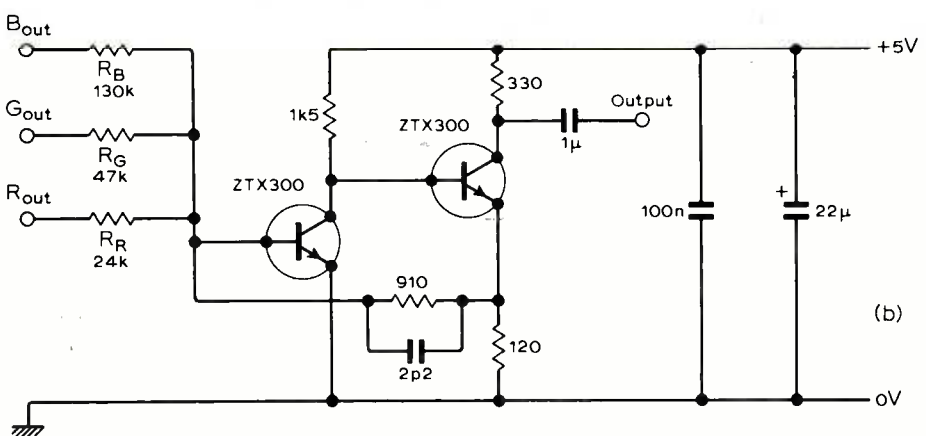
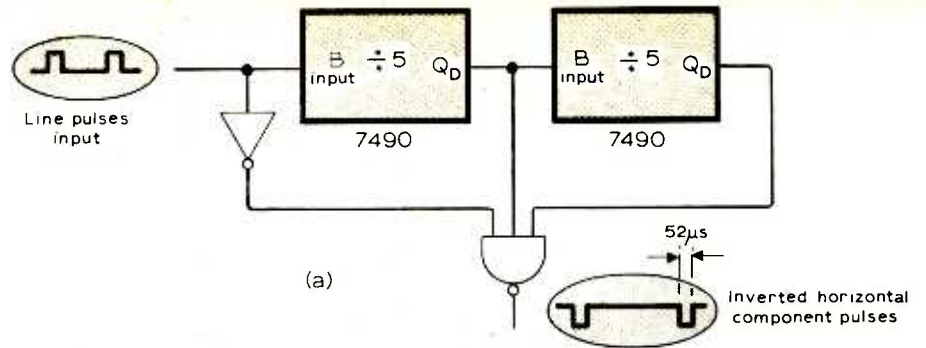
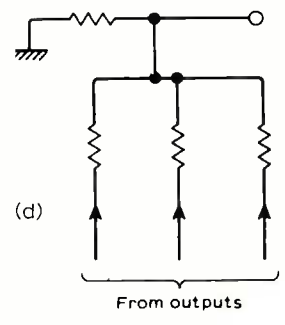
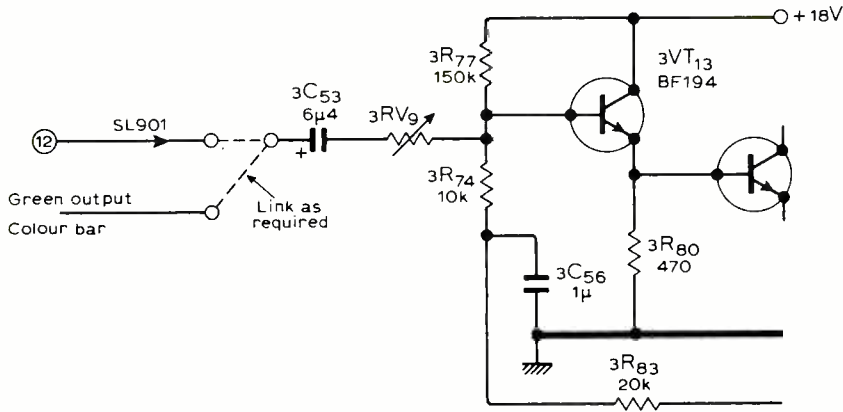

Fig. 2(a). The configuration of 7490s required to divide by 25. The summing circuit for the grey scale is shown at (b) and the waveforms involved at (c). The simple resistor network at (d) can be used as a compromise.

INVERT — AND nature of the open collector outputs,  $Q_D$  maintains black level during the line blanking period. On completion of the blanking pulse, the counter and oscillator are enabled and the colour bar oscillator follows rapidly with a negative-going edge, which effects a count increment to 0000. After completion of a blanking pulse, the difference in propagation delays,





between the counter being enabled and the colour bar oscillator providing the first negative-going edge is some 20ns. If tolerances in propagation delays cause a black bar to be produced first in the line scan, then a differentiating network shown in Fig. 4, can be interposed between  $R_{92}$  of the second 7490 and the blanking pulse line. This ensures that the counter is enabled before the end of the blanking pulse. The output gating is removed and peak white is the first bar. The count cycle is repeated.

In using open-collector gates, high-voltage output types, such as the 7406, provide a measure of protection against overvoltage. The inputs of gates requiring a static logical 1 are connected via  $1k\Omega$  resistors to +5V, to protect their inputs from supply transients.

**Additional circuitry and interfacing**

Because of the wide range of conditions and applications, no one interface or buffer circuit is sufficient for general application. An example of connection to a single standard set type CTV 184S is shown in Fig. 3(a); further interfaces were discussed in *Wireless World*, May 1976, pp.64-67.

**Construction and test**

A prototype was constructed using Veroboard, and with minimal lead lengths no spurious operation was found. A double-sided printed circuit board was later used, with few wired linkages.

The +5V supply should be well decoupled close to the integrated circuit packages.  $R_1$ ,  $C_1$  must be adjusted in accordance with the amplitude of the available source of line-blanking/flyback pulses, ensuring that  $D_1$  operates within its ratings. For example, with blanking/flyback pulses of  $-80V$  amplitude,  $R_1$ ,  $C_1$  were chosen to be  $10-k\Omega$   $0.1-\mu F$ . The hex buffer output collector resistors are connected via a link to +5V, provision thereby being made for a secondary supply to be used. Assuming that a suitable +5V supply and output circuitry have been added, then the output signal(s) may be fed into the relevant positive-going amplifier stage(s). Preset resistor,  $R_3$ , is adjusted for a suitable number of vertical lines in the crosshatch pattern and preset,  $R_6$ , such that the eight bar pattern accurately fits the screen. The control range of  $R_6$  allows a compressed grey scale or expanded partial grey scale to be produced at the extremes.

*A printed board for this design will be made available by Mike Sagin, one of our assistant editors. A note will be published when it is ready - Editor.*

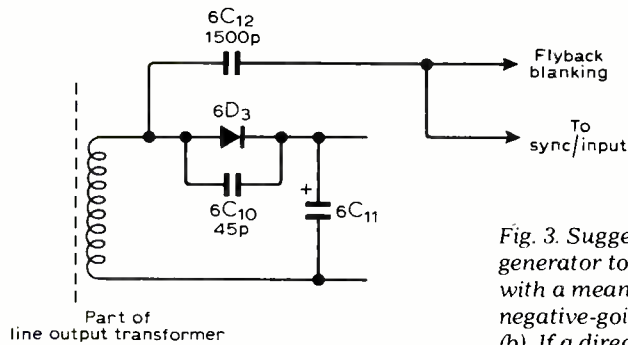

Fig. 3. Suggested circuit to connect the generator to a Bush CTV 184S is at (a), with a means of obtaining the negative-going flyback pulses shown in (b). If a direct connexion is not available, 3-4 turns of very well-insulated cable near the line output transformer should suffice.

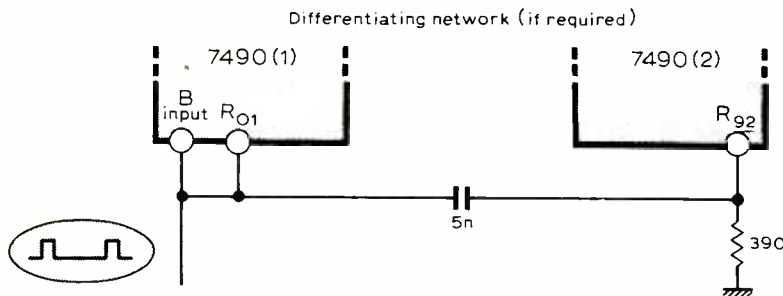

Fig. 4. Differentiating circuit, which may be needed to avoid blanks at the beginning of the line scan.

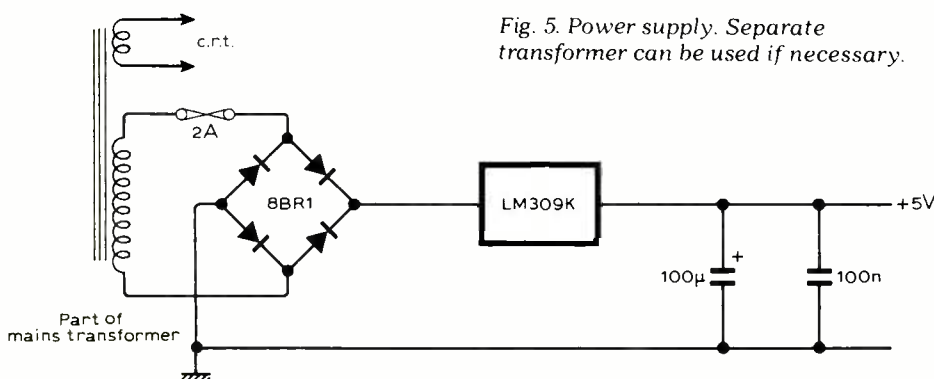

Fig. 5. Power supply. Separate transformer can be used if necessary.

# Viewdata

## 2 — Applications of the system

by S. Fedida, B.Sc.(Eng.), M.Sc., F.I.E.E., A.C.G.I.  
Post Office Research Centre

Before dealing with the possible applications of Viewdata I will conclude the discussion started last month (February issue) on the problem of ensuring adequate communication between the user and the computer — what I have called the computer dialogue.

While the index principle is clearly adequate for the information service as such, a fuller dialogue is needed to cater for the very wide range of services provided by Viewdata, in particular a message facility, calculation and games facilities and a range of interactive services such as requests for advertising literature or other documentation and bookings of holidays and hotels.

The design of the computer dialogue is very important. Information put out by the computer to guide the user must be simple to understand, it must not be ambiguous and must not appear to demand more than one reply at a time. Furthermore the action to be taken by the user following the display of a frame of information must be clearly indicated, i.e. the prompt must always be inserted to ensure that the user does not lack guidance regarding the next step.

An example of part of a dialogue in the message service is shown in Fig. 1. It gives the flavour of the requirement and indicates some of the pitfalls.

A third aspect of the communications arrangements between user and computer concerns the general purpose set of non-indexed or dialogue instructions which may be needed by the user in the course of a session. The object of these instructions, which are only five in number, is to assist the user to recover from errors real or imagined and thus enable him to maintain control of the situation whatever happens.

The set of instructions selected for Viewdata for recovery from errors and more generally for coping with unforeseen problems is as follows:

1. To return to the top of the selection tree: \*N  
This instruction is mainly used at the completion of one enquiry, when it is desired to start a new one. Alternatively if the user finds himself perhaps on the wrong track, or



Office version of a Viewdata terminal, known as Viewdataphone. Note the integral keypad and telephone handset.

'cannot interpret the dialogue, he uses this to make a fresh start. In other words, it provides a fall back option for all unexpected situations.

2. To recall the previous page: \*01

The purpose of this instruction is to enable the user to check the contents of the previous page, in case of miskeying errors, real or imaginary.

3. To recall the current page: ~00

The purpose of this instruction is to cause the computer to retransmit the current page, in case some of the information has been corrupted. Interestingly enough, little evidence has been seen so far of serious data corruption during transmission.

4. To jump to a known page (number N): \*Nz

The purpose of this instruction is to enable the user to jump straight to the required page, if he knows its number, thus by-passing the step by step approach.

5. To correct a miskeying error: \*\*

If an entry is in error it may be erased by keying \*\* and a fresh start made.

These instructions are normally engraved on the keypad associated with Viewdata, thus providing a constant reminder of what action is needed to cope with the unforeseen.

### Applications of Viewdata

The range of applications of Viewdata is theoretically unlimited. In practice it will be determined primarily by the market — what users want and what they are prepared to pay for. There are six distinct service areas, each with its own specific requirements and each using the interactive capability of the system to some degree:

- general information services
- message communications
- education
- calculation
- personal services
- in-house and private systems.

**Information.** The largest area capable of immediate development is the information service area. It has a number of subdivisions, with differing characteristics and treatments, e.g.: topical information; reference information, divided into general and professional; classified advertisements; and shopping aids.

The range of topical information itself covers a number of different items, such as news, sports results and weather information, each item in turn comprising a very wide spectrum such as local news, national and international events, business news, items of interest

to the domestic viewer, to the business viewer, etc. This section of the information data base is the one most closely related to that of teletext. The major difference is that whereas in teletext the information is more likely to be in abbreviated or headline form because of the obvious limitation of the restricted total amount of information available, in Viewdata the information is in much more detailed form and of course has a considerably greater scope and variety.

Reference information is a large field which could cover items such as train and bus time tables, and perhaps air time tables, telephone directories and "Yellow pages" of local and national interest. It could also cover information on leisure activities such as games, hobbies and sports, do-it-yourself and gardening information, recipes and holiday and tourist information. Other topics of interest could be money matters and savings, tax information, jobs and careers information, and a wealth of specialist reference information for the businessman and professional user.

Classified advertisements are potentially a very important sector of the

information spectrum, since, given adequate coverage, classified advertisements may be available in everybody's home at the touch of a button when required, with an immediacy unrivalled by any other medium. By the same token items no longer available may be removed instantly from the data base, thus avoiding unnecessary enquiries and potential frustration. A major benefit of the classified advertisement is that it could provide a useful revenue which, as in the case of newspapers, could be used to counterbalance a proportion of the expenses.

The interactive capability of Viewdata adds an important dimension to the scope of the information services. It could be used, for example, to request further details about a product advertised or discussed, and in certain cases to actually place a purchase order. Potentially it is possible to do this without the need to place an additional telephone call.

**Message communication.** Viewdata is clearly not only an information medium, but also a message communication medium, indeed a "store and

forward" system, for use by the general public. The message, once entered in the computer, would be transmitted as soon as communication to the intended recipient can be established.

The simple message facility so far experimented with provides a number of options. In the simplest option the user may select one or more out of a number of standard messages, mainly greetings messages, but clearly many others are possible. After message selection the user needs to supply the Viewdata number of the intended addresses. Thereafter the action of the system is entirely automatic.

The message is now automatically routed to the local Viewdata computer which places a telephone call to the addressee. If the telephone number is engaged the computer tries again; the number of tries may be specified by the sender. If the number is not engaged but no reply is obtained to the call, after a short ringing interval, a red light fitted to the Viewdata receiver is switched on to indicate that "somebody has called." Indeed arrangements may be made for the local computer to attempt a call several times, and for the visual indica-



Fig. 1. Example of part of a dialogue in the message services provided by Viewdata.

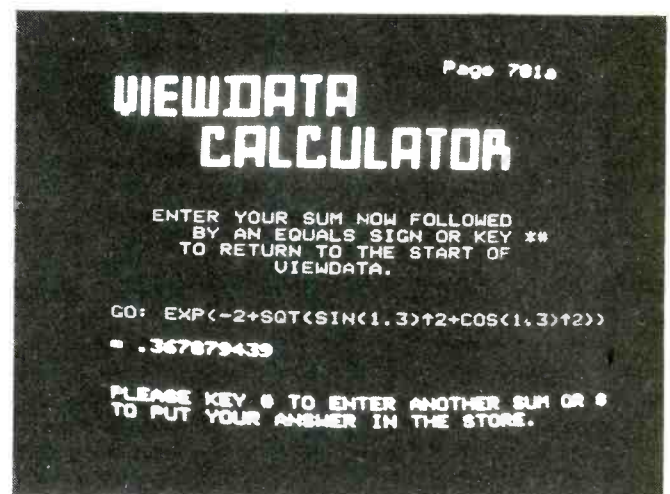

Fig. 3. Example of facilities offered by the calculator service.

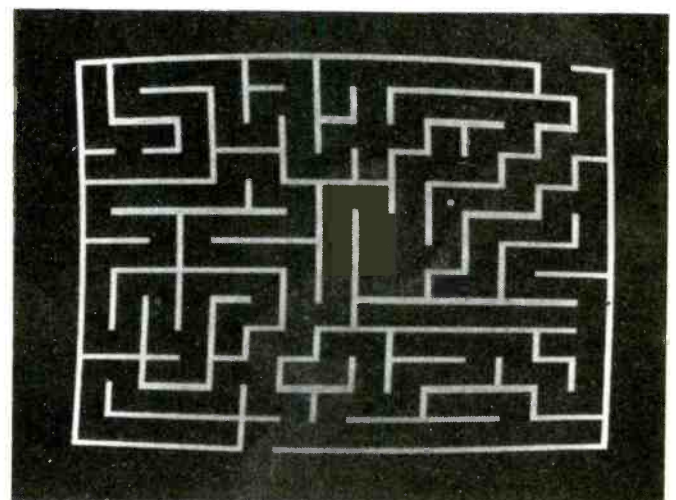
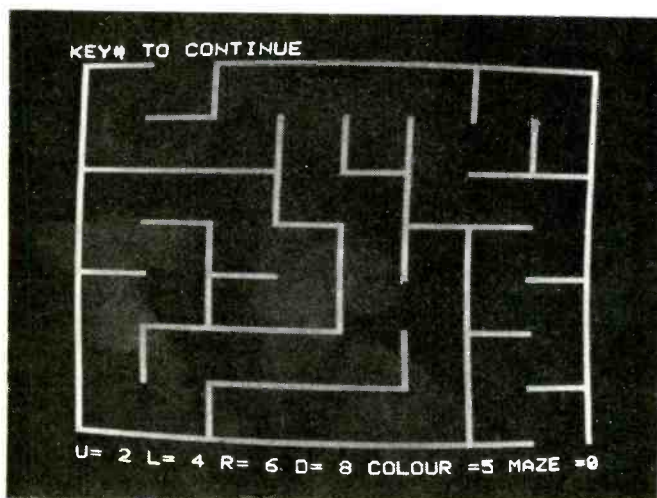

Fig. 2. A maze game which can be played through the system: two mazes of differing complexity.

tor on the Viewdata set to give a count of the unanswered calls.

When the call is answered, the computer places a high pitched tone on the line (1300 Hz), which indicates to the user that the Viewdata computer is calling. Pushing the data button on the telephone set causes the computer to send the message frame preceded by introductory frames to ascertain user number, etc.

A similar procedure applies when the addressee, on returning to his Viewdata set, finds the "somebody has called" light on. On dialling Viewdata and after entering his user number the message is delivered.

Another message option provides the user with the facility of inserting in the standard text one or more words, numeric or alphanumeric, e.g. times of arrival in a "I shall be arriving on the . . . train" message.

Finally, users who have the alphabetic keypad may be able to compose their own messages.

All these message options use the same method of delivery illustrated above and all provide the facility for sending one or more messages to one or more addressees, in a single transaction, thus saving the user a very considerable amount of time, particularly when the same message has to be sent to several people.

A simple extension of the message facility is the interconnection with telex<sup>1</sup>. Viewdata benefits in the enhancement of its communication facilities by its interconnection with an extensive telex network with an international coverage. Telex benefits in three ways: it acquires a powerful store and forward capability; it acquires an additional number of customers, not normally on the telex network; and it could relieve congestion in the telex room at peak hours by repeating a telex message direct to an executive's Viewdataphone on his desk.

A further potential extension of the Viewdata message service is in the case of business mail. This could provide a useful load to the Viewdata computer network, during the night, for example, when its facilities are mostly unused.

Finally because Viewdata displays messages visually on the domestic tv receiver, it could provide a cheap and convenient way for deaf people to communicate at a distance, among themselves and with other people.

**Education.** Viewdata may be applied to the education field in three areas. The first is the conventional information services providing details of educational facilities, e.g. what courses are available and where, details of qualifications required, and who to apply to. This service could be structured under a number of different headings, such as subject titles and local facilities, and the usual method of access would be applied.

The other areas are the more exciting

possibilities of using Viewdata to assist in the learning process. Many attempts have been made recently, particularly in the United States, to introduce this system of learning (computer assisted learning), which has many obvious advantages. It could relieve very considerably the day to day pressure on teachers and lecturers, who would then be able to devote more of their time to the individual requirements and difficulties of their pupils. The potential of this education medium for home-learning is also of great importance.

Unlike conventional methods of learning, Viewdata, by taking advantage of interactive working, can provide the student with assistance when required and a method of self-monitoring and self-testing which could greatly increase the speed of learning and provide the necessary intellectual stimulus to the student.

Viewdata in education could also be invaluable to parents in enabling them to follow the educational progress of their children and thus possibly enable them to help and encourage them more effectively.

A related aspect of education is the games facility where again the interactive capability of the computer is called for. The field for educational games is vast and so far two programmes have been experimented with. One is MOO, which is an exercise in logical thinking, wherein the user has to guess a four digit number selected at random by the computer. The guessing or deduction is made as a result of clues given by the computer in response to a "guess". The other is a maze game, increasing in complexity from the very simple to the more complex, which is a good example of pattern recognition (see Fig. 2).

**Calculations.** The primary purpose of Viewdata is not to provide a calculations service, but as illustrated earlier an information and message service. Nevertheless the availability of a number of distributed computers a local call distance away suggests that for very little extra cost a useful calculation service could be provided to students, small businesses and indeed all who might need its fairly limited but potentially very useful facilities.

Little would be gained if the calculator facilities were limited to those provided by the small mass-produced calculators. Such a service would be hopelessly uncompetitive. Neither would a great deal be gained by providing the sophisticated facilities of the now well established computer bureaux. The professional user of extensive computational facilities is already well catered for.

Rather it is intended to fill the gap between the two, some of which is at present covered by the more expensive hand or desk calculator. Unlike these more complex and powerful machines, however, the Viewdata approach is to

eschew all manuals and complicated instructions and so to organise the dialogue that users may, without any specialised training whatever, carry out the calculations they desire. Instructions for entering requirements are given by the system as and when they are needed and the dialogue is so arranged that errors may be caught quite simply as they occur (Fig. 3).

An additional feature of the calculation programme is a curve or histogram plotting facility related to the computations carried out.

**Personal services.** We have seen that Viewdata users are able to enter information into the system for example for message purposes. This clearly could be extended by arranging that this information is only accessible to the user or to one or more other persons nominated by him.

We now enter a fairly sensitive area of security (or privacy) of information. Much study will need to be done to ensure that information thus entered is indeed reasonably well protected. Initially, however, the studies are concentrated on information which, in the individual's opinion is not too sensitive. A user may enter perhaps reminders to himself of meetings, dates, telephone numbers, data for his own private use and the like. A typical one may be a reminder to send flowers to the wife on her birthday! Even in such fairly innocuous cases, passwords are provided to ensure that accidental disclosure of private information does not occur.

**In house and private data banks.** An extension of the personal information service is the use of the Viewdata network to store and provide access to information of interest to closed user groups on certain specific topics, e.g. employees of a business house. Also a minimum degree of privacy will need to be provided, although absolute privacy is not an objective of the system, at least in the initial stages.

In the case of closed user groups, information and data might be collected for the benefit of groups having similar interests. For example the source of supply of certain commodities used in certain categories of business, e.g. building supplies with current prices, availability etc.

Clearly the range of potential services of this nature is open ended. Development will no doubt take place in this area as the capability of this new medium becomes apparent through usage and experimentation.

*The next article will deal with the operation of the Viewdata system in detail*

## Reference

I. S. Fedida — Development of Computer-based Information Media for the General Public. Paper presented at 2nd International Symposium on Subscriber Loops and Services 3-7 May, 1976. The Institution of Electrical Engineers, London.



# Logic design — 3

## Event-driven circuits

by B. Holdsworth\* and D. Zissos†

**A four-step procedure based on the sequential equations, for the design and implementation of event-driven logic circuits is described in this article. Realistic circuit constraints are automatically taken into account by the design process.**

The principal factors to be considered in the design of event-driven circuits are:

- Circuit reliability. The circuit must operate correctly and reliably.
- Gate fan-in and fan-out restrictions. These must be observed.
- Speed tolerances. Gate speed tolerances of  $\pm 33\frac{1}{3}$  per cent are automatically accommodated by the design process used.

Generally speaking, the solutions obtained do not necessarily use a minimum number of gates, but the design requires minimum effort. The design steps are easy to apply and require no specialist knowledge.

### State diagrams

State diagrams can be used to describe both the external and internal operations of event-driven sequential circuits. In a state diagram, states can be represented by squares, rectangles or circles and lines linking the states represent transitions between states. The direction of a transition is indicated by an arrow pointing in the direction of the destination state, and the signal condition that initiates the transition is indicated by its Boolean function inserted either above or below the line. For example the part of a state diagram shown in Fig. 1 indicates that the circuit moves from state  $S_0$  to  $S_1$  when  $XY = 1$ , i.e. when  $X = 1$  and  $Y = 0$ .

The external and internal-state diagrams of a circuit in which the activation of a switch  $X$  in Fig. 2(a) operates, in turn, two lights  $L_1$  and  $L_2$  are shown in Figs. 2(b) and 2(c) respectively. Variables  $X_n$  and  $X_{n+1}$  are used to indicate the  $n^{\text{th}}$  and  $(n+1)^{\text{th}}$  activation of the switch. The external-state diagram closely resembles a flow chart, which can be drawn with very little

regard to circuit implementation.

There are no hard-and-fast rules for developing internal-state diagrams. Since such diagrams describe the internal operation of a circuit, the designer usually makes arbitrary choices depending on past experience, his understanding of the problem and availability of components, which can lead to different but equivalent results.

The following example is used to illustrate typical variations in the internal-state diagrams of the relatively simple light circuit shown in Fig. 3(a). The function of the circuit is to turn lamp  $L_1$  on when the two switches  $X$  and  $Y$  are made in that order, and lamp  $L_2$  on when the switches are made in the reverse order. Two different but correct versions of the internal operation of the circuit are shown in Figs. 3(b) and 3(c).

Most persons attempting this problem would probably derive internal-state diagram 3(b) which uses five internal states. State  $S_1$  is used to record that switch  $X$  has been made and state  $S_3$  that switch  $Y$  only has been made. In both cases there is no change in the circuit output, although clearly there is a change in the internal-state of the circuit. Very few designers, if any, would arrive at Fig. 3(c) the first time round.

As might be expected the circuit

implementation of the state diagram of Fig. 3(c) is the simplest. This state diagram can be obtained by constructing a state table from the state diagram shown in Fig. 3(b), the state table then being reduced by the application of Caldwell's merger procedure. This technique will be described later in this article.

### State variables

Each state of an event-driven logic circuit is defined by a unique combination of logic signals called state variables or secondary signals. Clearly one state variable  $A$ , defines two states, one by  $A = 0$  and the other by  $A = 1$ . Two state variables define four circuit states each state corresponding to a combination of their values, i.e. 00, 01, 11, and 10. In general,  $n$  variables will define  $2^n$  circuit states. As an example of state allocation, the states  $S_0, S_1, S_2$  and  $S_3$  in Fig. 2(c) can be defined by the state variables  $AB = 00, 01, 11, 10$ . In allocating state variables to states in event-driven circuits it is necessary to ensure that each circuit transition involves a change in the value of a single variable only. The reasons for

\* Chelsea College, University of London  
† Dept of Computing Science, University of Calgary, Canada

Fig. 1. Elements of a state diagram.

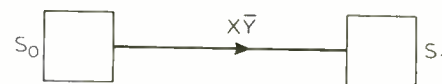
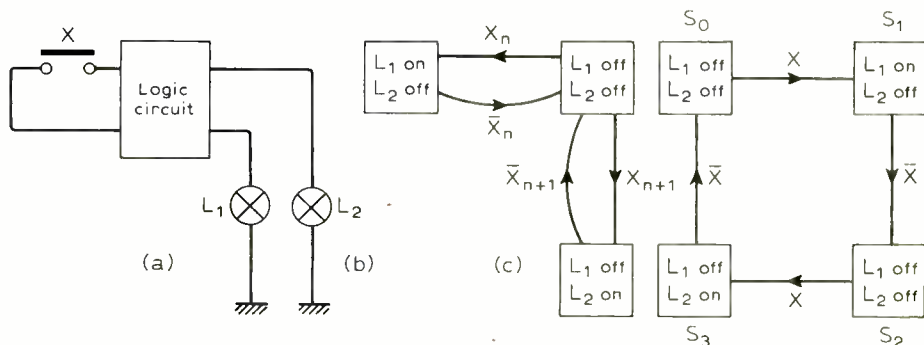

Fig. 2. Internal and external state diagrams of a logic circuit.



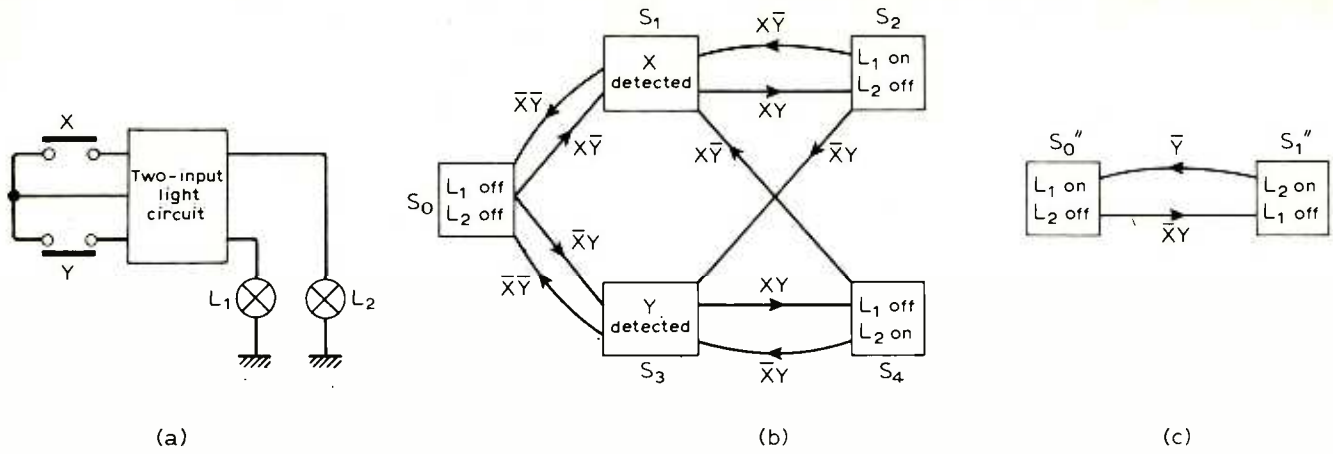

Fig. 3. Internal state diagrams of a two-switch logic circuit.

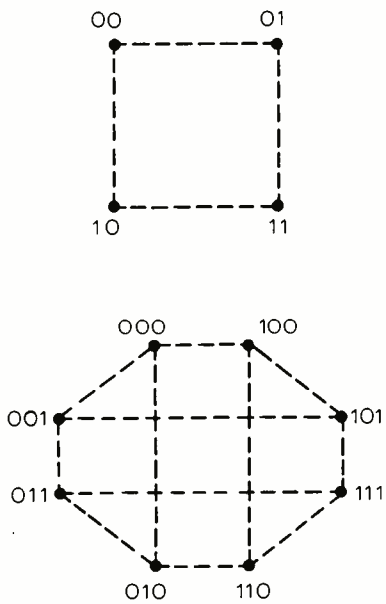

Fig. 4. Race-free diagrams for two and three variables.

doing this is to ensure that races between state variables or secondary signals are automatically avoided.

A race-free assignment of states can be achieved with the aid of a race-free diagram. This is a two-dimensional diagram containing  $2^n$  coded nodes, where all nodes whose codes differ in one variable only are joined by interrupted lines. Hence, races between secondary signals are automatically avoided if each circuit transition lies on a race-free line. Race-free diagrams for two and three variables are shown in Fig. 4.

**Dummy states**

There are certain patterns of internal-state diagrams that cannot be assigned race-free codes. Such a pattern is shown in Fig. 5(a). If the state codes for  $S_0, S_1,$  and  $S_2$  are  $AB = 00, 01,$  and  $11$  respectively the direct transition from state  $S_2$  to  $S_0$  cannot be implemented as this would involve the simultaneous change of two variables. In this case the link between  $S_2$  and  $S_0$  can be turned into a race-free link by interposing a

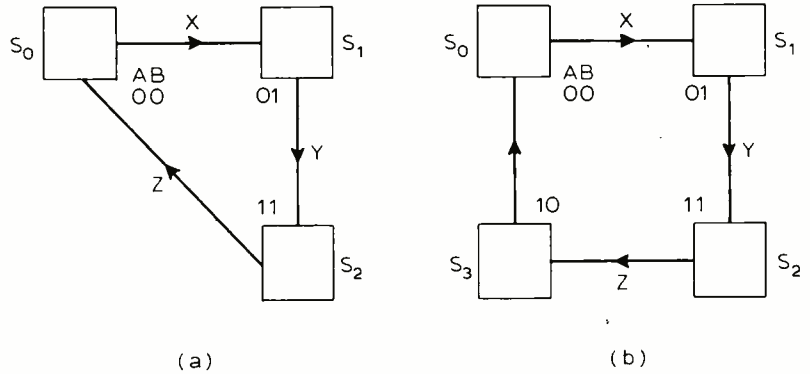

Fig. 5. Use of a dummy state ( $S_3$ ) avoids simultaneous two-variable change from  $S_2$  to  $S_0$ .

fourth state  $S_3$  between  $S_2$  and  $S_0$ , coded  $A = 1$  and  $B = 0$ . This is called a dummy state and replaces line  $S_2-S_0$  with race-free links  $S_2-S_3$  and  $S_3-S_0$ , as shown in Fig. 5(b). The  $S_3-S_0$  transition is unconditional and once the circuit assumes state  $S_3$  it moves automatically to  $S_0$ . In terms of state variables this ensures that signal  $B$  is turned off first and this automatically turns signal  $A$  off.

**Unused states.**

If the number of states to be implemented is  $N$ , where  $2^{n-1} < N < 2^n$ , there will be  $2^n - N$  unused or redundant states. For example, in the case of the three-state diagram shown in Fig. 5(a) there will be one unused state. It can never be assumed in practice that a circuit will not move into an unused state either when switching the circuit on or due to the interference of a noise signal. For example, when in state  $S_0 = 00$ , a noise signal may turn  $A$  on and the circuit enters the unused state  $S_3 = 10$ . The circuit may be operating in conjunction with other circuits and moving into state  $S_3 = 10$  may result in the incorrect behaviour of the overall system.

The designer is therefore strongly advised to take such a possibility into account at the design level and take the necessary action. For example, if the misoperation of the above circuit can result in the jamming of a production

| XY    | 00    | 01    | 11                 | 10    |
|-------|-------|-------|--------------------|-------|
| $S_0$ | $S_0$ | $S_3$ |                    | $S_1$ |
| $S_1$ | $S_0$ |       | $S_2$              | $S_1$ |
| $S_2$ |       | $S_3$ | $S_2$<br>$L_1 = 1$ | $S_1$ |
| $S_3$ | $S_0$ | $S_3$ | $S_4$              |       |
| $S_4$ |       | $S_3$ | $S_4$<br>$L_2 = 1$ | $S_1$ |

(a)

| XY        | 00        | 01       | 11                     | 10        |
|-----------|-----------|----------|------------------------|-----------|
| $S_{012}$ | $S_{012}$ | $S_{34}$ | $S_{012}$<br>$L_1 = 1$ | $S_{012}$ |
| $S_{34}$  | $S_{012}$ | $S_{34}$ | $S_{34}$<br>$L_2 = 1$  | $S_{012}$ |

(b)

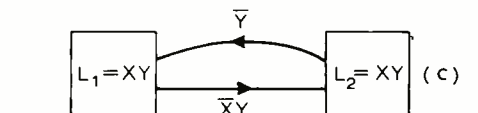

Fig. 6. State-table reduction.

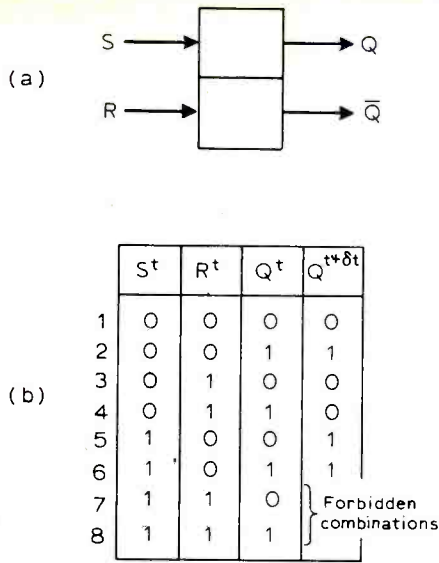

Fig. 7. SR flip-flop and its truth table.

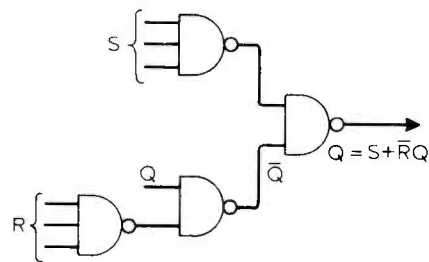

Fig. 8. Implementation of the NAND sequential equation for S and R primary signals.

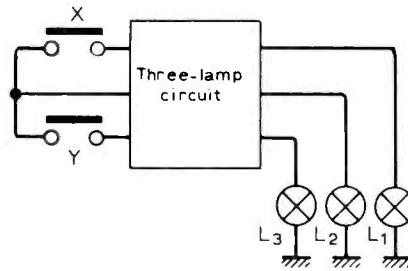

Fig. 11. Three-lamp circuit and its state diagram.

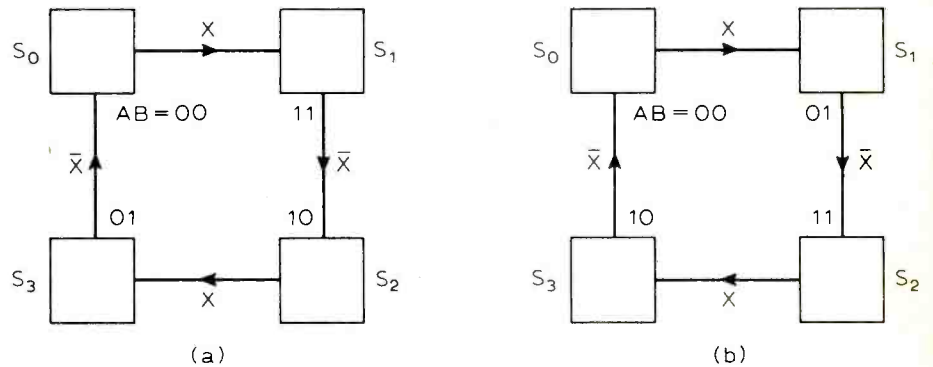

Fig. 12. Elimination of races between secondary signals.

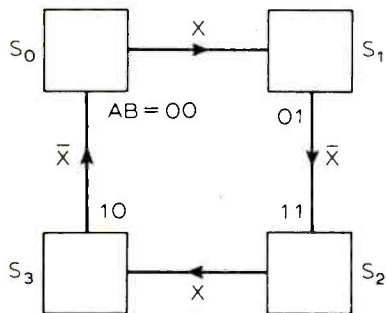

Fig. 9. Determination of turn-on and turn-off sets.

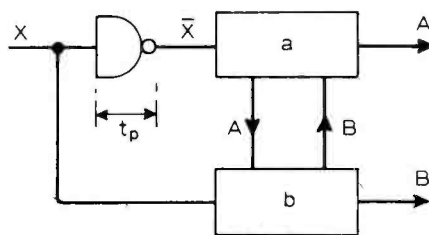
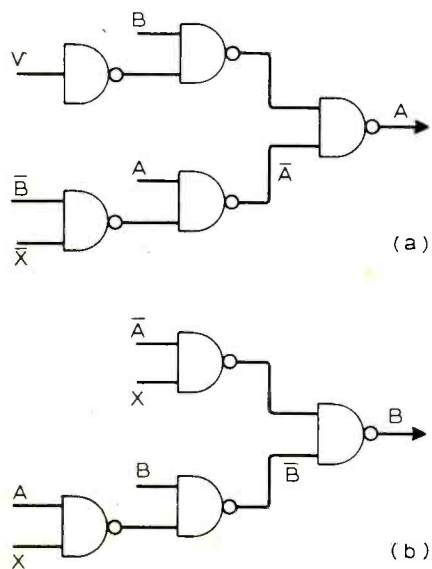

Fig. 13. Races between primary and secondary signals.



line, a possible action would be to use the signal  $A\bar{B}$ , which defines the unused state, to turn off all machines and raise an alarm.

Frequently, such states are referred to as "don't-care" states. Boolean expressions defining the "don't care" conditions are used as optional products to reduce the circuit equations and hence the complexity of the circuit. This is based on the assumption that a "don't care" condition does not arise in practice, which is only valid for normal operation. Since one cannot exclude the possibility of circuit misoperation, the designer is strongly advised not to leave undefined the response of the circuit under such conditions. In other words

Fig. 10. Implementation of NAND sequential equations for turn-on and turn-off sets obtained from state diagram of, for example, Fig. 9.

the designer "cares" about all circuit conditions.

Summarizing, no state diagram containing other than  $2^n$  states should be implemented. Referring to the light circuit of Fig. 3, only the state diagram in Fig. 3(c) can be implemented. The implementation of the state diagrams in Fig. 3(b) would require the addition of three states. Additionally the reader is strongly advised against the mathematically convenient use of "don't care" states for circuit simplification.

**State tables**

The design restriction of always implementing  $2^n$  states can be met either by introducing dummy states or by reducing the number of internal states. State reduction is carried out by using Caldwell's merging procedure which is based on the state table. Such a table has a row for every state of the circuit and a column for every combination of the input signals. The rows and columns are headed by labels representing the corresponding states and inputs. In each cell the circuit destination is entered, i.e. the next state assumed by the circuit when it is in a state corresponding to the row heading, and it receives input signals defined by the column heading. If the designer does not wish to specify the next state the entry in the appropriate cell is left blank. A second entry is made in each cell which specifies the circuit output,

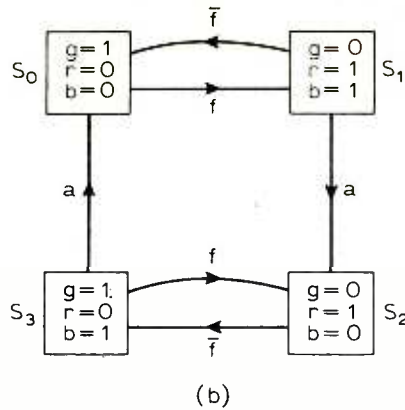
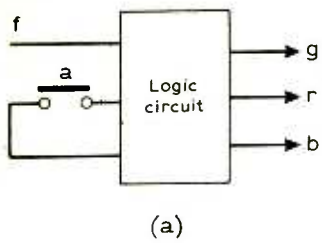

|                |                                     |                                      |                                      |                          |
|----------------|-------------------------------------|--------------------------------------|--------------------------------------|--------------------------|
| fa             | 00                                  | 01                                   | 11                                   | 10                       |
| S <sub>0</sub> | (S <sub>0</sub> )<br>g=1 r=0<br>b=0 | (S <sub>0</sub> )<br>100             | ∅ <sub>1</sub> S <sub>2</sub><br>010 | S <sub>1</sub><br>011    |
| S <sub>1</sub> | S <sub>0</sub><br>100               | S <sub>0</sub><br>100                | S <sub>2</sub><br>010                | (S <sub>1</sub> )<br>011 |
| S <sub>2</sub> | S <sub>3</sub><br>101               | ∅ <sub>3</sub> S <sub>0</sub><br>100 | (S <sub>2</sub> )<br>010             | (S <sub>2</sub> )<br>010 |
| S <sub>3</sub> | (S <sub>3</sub> )<br>101            | S <sub>0</sub><br>100                | S <sub>2</sub><br>010                | S <sub>2</sub><br>010    |

|                 |                                      |                           |                           |                           |
|-----------------|--------------------------------------|---------------------------|---------------------------|---------------------------|
| fa              | 00                                   | 01                        | 11                        | 10                        |
| S <sub>01</sub> | (S <sub>01</sub> )<br>g=1 r=0<br>b=0 | (S <sub>01</sub> )<br>100 | S <sub>23</sub><br>010    | (S <sub>01</sub> )<br>011 |
| S <sub>23</sub> | (S <sub>23</sub> )<br>101            | S <sub>01</sub><br>100    | (S <sub>23</sub> )<br>010 | (S <sub>23</sub> )<br>010 |

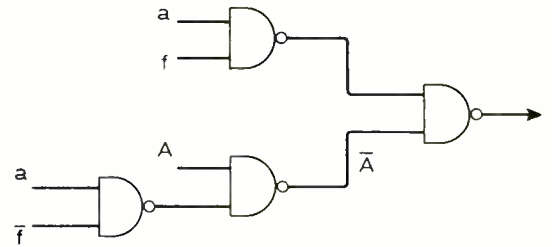
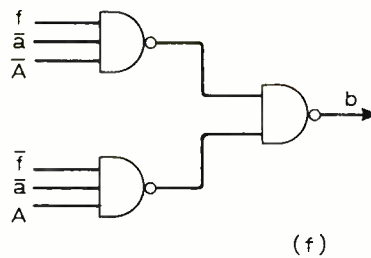
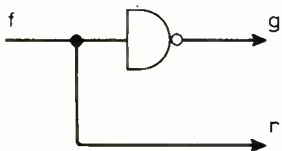
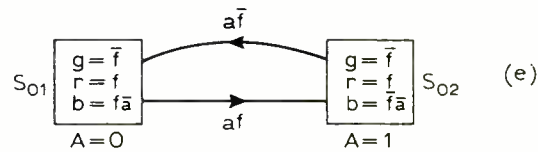

Fig. 14. Function to be realized in Example 1 is at (a) and its state diagram is at (b), while the state table is shown in (c) and in merged form at (d). Initial state diagram based on (d) is shown at (e) and realization of the circuit is (f).

unless it is a blank cell. If the circuit destination is the same as its current state, the circuit is stable and the entry is encircled. The state table corresponding to Fig. 3(b) is shown in Fig. 6(a).

**State reduction**

The process of combining the rows of a state table is made in accordance with Caldwell's merging rules.

Two rows may be merged if the state numbers and the circuit outputs appearing in corresponding columns of each row are alike, or if the entry in one or both of the rows is blank.

When circled and uncircled entries of the same state number are to be combined, the resulting entry is circled. Thus the two rows

3 (5)  
3 5 6 (8)  
combine into 3 (5) 6 (8)

A change of state from 5 to 8 now involves a change of the input state only.

When a row S<sub>m</sub> is combined with row

S<sub>n</sub> the new row is marked S<sub>mnr</sub>.

Examination of Fig. 6(a) indicates that rows S<sub>0</sub>, S<sub>1</sub>, and S<sub>2</sub> can be merged to give a new row S<sub>012</sub> and also that rows S<sub>3</sub> and S<sub>4</sub> can be merged to give a new row S<sub>34</sub>. The reduced state table is shown in Fig. 6(b) with its corresponding state diagram in Fig. 6(c), and this is identical to the state diagram of Fig. 3(c).

**Sequential equations**

The sequential equations, allow a state diagram to be translated directly into a circuit, as a consequence, lead to a much simpler solution of event-driven circuit problems. These equations can be obtained directly from a consideration of the logical behaviour of an SR flip-flop.

The SR flip-flop is shown symbolically in Fig. 7(a), the set and reset inputs being labelled S and R respectively, whilst the complementary outputs are labelled Q and Q-bar. The truth table for the flip-flop is shown in Fig. 7(b).

In the first three columns of this table, all combinations of the present states of S, R, and Q, i.e. their states at time t, are tabulated. In the fourth column the next state of the flip-flop, i.e. its state at time t + δt, is tabulated.

Examination of this table shows that a change of flip-flop state occurs in rows 4 and 5 only. In row 4 the flip-flop is being reset, i.e. its state is being changed

from 1 to 0, by the application of inputs S=0 and R=1. In row 5 the flip-flop is being set, i.e. its state is being changed from 0 to 1, by the application of inputs S=1 and R=0. The reader should also notice that with this type of flip-flop it is inadmissible for S and R both to be logical 1 simultaneously. This restriction can be expressed algebraically as SR=0.

One form of the sequential equations is obtained by taking the logical sum of the combinations in the truth table for which Q<sup>t+δt</sup>=1 and adding in the product SR=0. This does not affect the value of Q<sup>t+δt</sup> but leads to a simpler equation for it.

Hence:  
Q<sup>t+δt</sup> = (S-bar R Q + S R-bar Q + S R Q + SR)!

Minimizing:  
Q<sup>t+δt</sup> = (S + R-bar Q)!

The second form of the sequential equations is obtained by excluding the product SR from the equation for Q<sup>t+δt</sup> so that

Q<sup>t+δt</sup> = (S-bar R Q + S R-bar Q + S R Q)!

Minimizing:  
Q<sup>t+δt</sup> = [(S + Q) R-bar]!

Time is inferred in these equations and they are written

Q = S + R-bar Q

and Q = (S + Q) R-bar

where S is referred to as the turn-on set of Q and R is referred to as the turn-off set of Q.

The most general form of the equations is:

$$Q = \sum \text{turn-on sets of } Q + \sum \text{turn-off sets of } Q$$

$$\text{and } Q = (\sum \text{turn-on sets of } Q + Q) + \sum \text{turn-off sets of } Q$$

The first of these two equations is used when the design is to be implemented with NAND gates and the second equation when NORs are to be used.

The implementation of the NAND sequential equation,  $Q = S + \bar{R}Q$ , is shown in Fig. 8. In this circuit S and R, the turn-on and turn-off signals respectively, are the primary signals, whilst Q is the secondary signals which is turned

either on or off by the primary signals. When designing an event-driven logic circuit the turn-on and turn-off sets are derived directly from the state diagram; for example, by reference to Fig. 9.

$$\text{Turn-on set of } A = B\bar{X}$$

$$\text{Turn-off set of } A = \bar{B}\bar{X}$$

$$\text{Turn-on set of } B = \bar{A}X$$

$$\text{Turn-off set of } B = AX$$

Substituting these values in the NAND equations

$$A = B\bar{X} + A(B + X)$$

$$B = \bar{A}X + B(\bar{A} + \bar{X})$$

and the implementation of these equations is shown in Fig. 10.

### Causes of misoperation

Circuit misoperation is said to occur when a circuit assumes an internal state other than the one intended. For example, if on leaving state  $S_1$  in Fig. 11; with  $X=1$  and  $Y=1$  it assumes a state other than  $S_2$ , circuit misoperation occurs. Excluding component failure, the causes of circuit misoperation in event-driven circuits are races between primary signals, secondary signals or both. The above three causes will be examined in turn and solutions suggested in the next article.

# Letters to the Editor

## CIRCULAR INSERT GENERATOR

I read the article by D. E. Burgess in your January issue, entitled "Circular insert generator for television" with interest but feel that the use of two multiplier/divider circuits is rather extravagant.

The circuit of Fig. 1 outlines a cheaper and simpler solution, eliminating the multipliers and using a single rather than a dual comparator. The circuit generates the functions  $(x-a)^2$  and  $(y-b)^2$  by integrating the sawtooth waveforms of the original design and d.c.-restoring the resultant parabolae to prevent the shape of the circle varying as its position is adjusted. The

parabolae are added and compared to a constant giving the circular area  $(x-a)^2 + (y-b)^2 \leq c^2$ .

There is a possible disadvantage in that the field rate d.c.-restorer will cause slight lag on the action of the Y shift control. In most applications this would not be serious.

I also note that the video input signals are d.c.-coupled. Unless the black levels of both have been fixed (e.g. by clamping) immediately prior to the unit the black level of the circular insert will be uncontrollable and will depend on the average levels of the two input signals. This problem is commonly found on inexpensive commercial units and is extremely frustrating when producing tv programmes.

J. Borin,  
Student Television of Imperial College,  
London, SW7.

Dr Burgess replies:

I certainly accept that Mr Borin's suggested circuit is a cheaper solution to the problem. Since submitting the article for publication a number of other circle generators have been built using the two parabolae idea, but not suffering from the lag problem of Mr Borin's circuit. The simplest solution found so far used 10 transistors and a 709 as a comparator, running from a single 9-volt power supply, mounted on a 3in x 1½in p.c.b.

The d.c. coupling of video signals is certainly a problem, but since equipments with which this circuit might be used are so varied, only a simple video circuit was

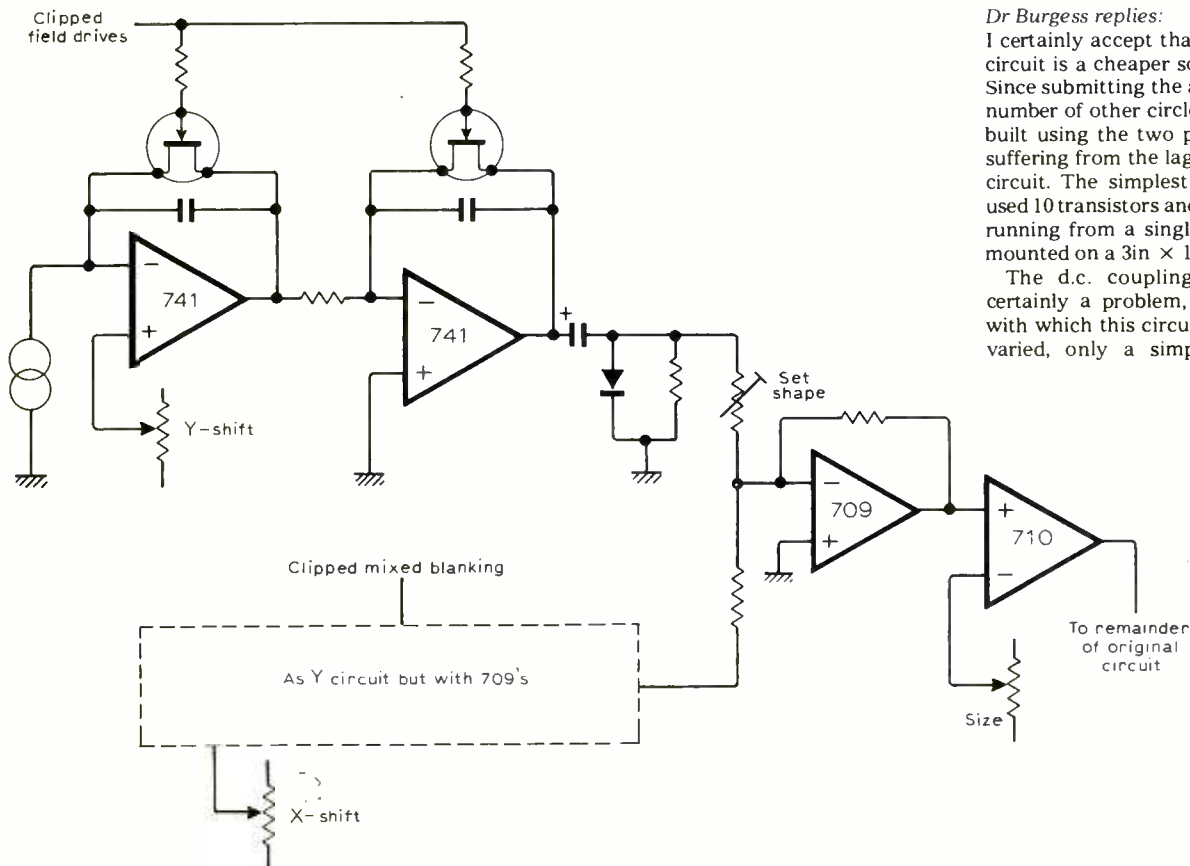

described, to be used as a guide for potential users

Could I point out an omission from the circuit diagram, as published? The junction of R<sub>15</sub>, R<sub>45</sub> and R<sub>46</sub> should be connected to earth.

Mr Canning's article in the December issue of *Wireless World* draws attention to one of the more scandalous aspects of modern scientific-engineering but I wonder why he limits his comments to the resuscitation of forgotten ideas? Many have innocently made reputations and money from re-invention right alongside the originals.

Perhaps the best example of this is the super cathode-follower which, worldwide, operates happily in the same equipment as its prototype the stabilized power supply.

But we are all fallible and Mr Canning falls into his own trap of non-recognition when he talks of two-terminal negative-resistance tube oscillators. A basic proposition of oscillator theory is that any frequency-selective device can oscillate when its losses are zero. Electronic oscillators consist of a frequency-selective circuit (which, in practical form, has losses) and an active device which provides an effective negative resistance to cancel those losses. The circuit configuration is irrelevant to an oscillator except that, in the completed device, it determines the desired performance characteristics.

K. H. Green,  
Tintagel,  
Cornwall.

---



---

## SHORTWAVE BAND CONGESTION

---



---

In his article "Congestion in the shortwave bands" in your November 1976 issue Mr Vastenhoude has forgotten to mention the United Kingdom. The BBC External Services have been using "out of band" broadcasting frequencies such as 15.070MHz, 12.095MHz and 9.410MHz for a long time.

G. Davydov (ex U1VB),  
Moscow,  
USSR.

*The BBC confirms that, because of overcrowding in the international short-wave bands, External Services has, for many years, used a number of frequencies which are outside the agreed band limits. The frequencies have been used with the agreement of the UK regulatory authority for English and foreign language transmissions - Ed.*

---



---

## THE INVENTORS

---



---

As a postscript to your very interesting article, "The inventors" (August, 1976), it might interest you to know that Great Britain lost another invention, which not only now has a yearly turnover of approximately \$1,000m (it was already \$500m in 1967), but which Britain could have had for nothing. I refer to inertial navigation.

After conceiving the "U-Plane" — a submarine craft which could outmanoeuvre and outspeed all existing ships or submarines during the mid-thirties, I was searching for a means of automatic position indication which was not only independent of radio, but also jam-proof, and found it in the principle

now known as Inertial Navigation—"IN" for short.

When World War 2 was approaching, I decided to offer the design to the Government. I was at the time in Palestine, and discussed the matter with Mr M. Offner, the engineer in charge of the Palestine Broadcasting Service, who agreed with my thoughts, that this was too revolutionary to offer as such, might fall into the wrong hands, or be not appreciated. I therefore decided, as a trial balloon, to first offer a similar position indication by means of a light point on a moving transparent map (other versions had crossed light lines on a transparent map which changed automatically when the indicated position reached its sides), but instead of "IN" used radio as the input and thus was more conventional, the intention being, to update it to the "IN" version when in England, and when sure its military value would be appreciated.

Thus, in 1939, when employed by the Meteorological Service, I submitted the design to the Director of Civil Aviation, Mr D. W. Gumbley, who decided to pass it on to London. While waiting for a reply, I constructed a simplified "IN" system for eventual demonstration purposes.

A quarter year later, my boss, the Director of C.A., received a letter from Marconi's in London, stating that they were not interested in the invention, as the need to make the light sources moveable for adjustment under a map when changing station and/or map would render the whole apparatus too elaborate and expensive. I was never given a chance to reply and point out that maps could in fact be projected without this need; and, furthermore, had indicated other solutions. I was not even considered worthy of a direct reply, nor of course was I invited to London.

I therefore concluded, that most people will rather die, live in misery, or see their cities destroyed, than make a rational assessment of advanced technology when presented by an individual person and give credit where it is due.

H. Lipschutz,  
Rhoose,  
Glamorgan.

---



---

## ADVANCED PREAMPLIFIER DESIGN

---



---

The advanced preamplifier design featured in the November 1976 issue showed many useful design techniques for reducing distortion. However, the use of capacitors in the feedback loops for equalization and tone control must introduce some measure of transient distortion and I wonder if Mr Self has made any evaluation of this distortion.

I have recently compared some RIAA stage designs by listening tests and I have observed that taking the treble de-emphasis out of the feedback loop and substituting a passive network gives a better sound quality in terms of definition of voices in choral works for example, and better stability and location of stereo images.

It is necessary, in making such comparisons to have high quality equipment and I used power amplifier modules designed by Crimson Elektrik (designed for low transient distortion and comparing very favourably with some better-known commercial designs), an Empire 2000 E III cartridge and Monitor Audio MA3 loudspeakers.

I have since designed and built the preamp shown here. I have not been able to test whether taking the bass equalization out of the feedback loop makes any further improvement, though I would expect it to be less of an improvement than initially taking the treble equalization out of the feedback. This design does have the drawback that the overload margin is reduced, but the overall sound quality is certainly better than conventional RIAA stages.

I feel that this is an area of design which merits further attention and it is my impression that hardly anyone who designs amplifiers is aware of it.

Graham Nalty,  
Borrowwash,  
Derby.

### Mr Self replies:

I cannot see why Mr Nalty feels that the use of capacitors in equalization and tone-control feedback loops should generate transient distortion. While it is now largely accepted that an amplifier with a poor open-loop bandwidth and a low slew rate will generate transient intermodulation distortion when presented with high-frequency signals of large amplitude, despite the fact that a high negative-feedback factor has apparently greatly improved its performance, this shortcoming is due to the open-loop characteristics of the amplifier itself, and not the feedback network.

I am puzzled as to why Mr Nalty feels that executing the RIAA treble roll-off outside the negative-feedback loop gives superior subjective sound quality, since if the time-constant is correctly chosen the amplitude/frequency and phase/frequency responses will be identical in both cases. Furthermore, as he admits, the overload margin at high frequencies is greatly reduced (for example by about 12dB at 10kHz) and since the highest recorded velocities tend to occur at these frequencies, overloading of the stage becomes very much more likely, with an inevitable deterioration of quality. Another drawback is that the first amplifying stage now handles a signal with a much greater high frequency content. Hence the harmonic distortion is likely to be higher, and unless the maximum slew rate is very high, any transient distortion will be a great deal worse.

I can see no benefit in using a passive bass-boost configuration; one inevitable result will be a severe reduction in the overload margin available at mid-frequencies.

---



---

## LOGIC DESIGN

---



---

The method of Boolean reduction presented by Holdsworth and Zissos is needlessly complex at one point (*Wireless World*, Jan. 1977). This complexity originates in an insufficiently general "race hazard" rule. I should like to offer a simpler method.

A *tautology* is any function that receives the value true (1) whatever values are assigned to its component variables.  $A + \bar{A} + B$  is a tautology, as is  $AB + \bar{A}B + AB + \bar{A}\bar{B}$ , since whatever we assign to A and B at least one term in the "sum" (disjunction) is true, and so the whole sum is.

Two rules are used which I term *introduction* and *elimination*. The elimination rule is just redundancy: "If a term in a sum is part of another term, eliminate the

larger." Introduction is based on the following theorem: *Let the sum  $A_1 + \dots + A_n$  be a tautology. Then the sum  $A_1 B_1 + \dots + A_n B_n$  is equivalent to the sum  $A_1 B_1 + \dots + A_n B_n + B_1 \dots B_n$ .*

**Proof.** If the first sum is true then some term  $A_i B_i$  is true, and this term occurring in the second sum, that is true too. If the second sum is true then if (i) some term  $A_i B_i$  is true this occurs in the first sum which is therefore true. If (ii) the term  $B_1 \dots B_n$  is true then each  $B_i$  must be true. Since  $A_1 + \dots + A_n$  is a tautology some  $A_i$  must be true. Hence  $A_i B_i$  is true and so the first sum is true. The two sums thus always have the same value and are equivalent.

The two rules may be applied mechanically as follows: (1) Locate a largest tautology. (2) Introduce the resulting term ("optional product"). (3) Eliminate original terms using the introduced term. To illustrate with the example given: Reduce: (1)  $A + \bar{A}B + BC + \bar{A}BD$ . The largest tautology is  $A + \bar{A} + BC + \bar{A}BD$ . So introduction gives (1) = (2). (2)  $A + \bar{A}B + BC + \bar{A}BD + B$  and then elimination of terms containing B gives (2) = (3). (3)  $A + \bar{A}BD + B$ . A largest tautology is  $A + \bar{A} + B$ . So introduction gives (3) = (4). (4)  $A + \bar{A}BD + B + \bar{B}D$  and then elimination of terms containing BD gives (4) = (5). (5)  $A + B + \bar{B}D$ . The largest tautology here is  $A + B + \bar{B}$  so introduction gives (5) = (6). (6)  $A + B + \bar{B}D + D$  and then elimination of terms containing D gives (6) = (7). (7)  $A + B + D$

There is thus no need for the concepts of "parent-product" and "non-parent product," nor indeed for any theorems. Rules are emphasised, since transformations are the only concern and we achieve this emphasis by relying exclusively on truth tables (the theorem is of course a statement about these).

Peter Mott,

Department of Philosophy,  
University of Lancaster.

## WAS BAIRD FOOLING THE PUBLIC

F. H. Haynes comments at length on J. L. Baird on page 52 of the December, 1976 issue. Mr Haynes states that Baird's April 1925 television equipment, used at Selfridge's store in London, was not synchronized and did not have a light sensitive cell. How could Mr Haynes possibly know of these details if the equipment was completely "boxed in"? Baird is also accused of not giving out details on his recently-patented apparatus; he obviously couldn't divulge this information for the simple and obvious reason that he would not have been granted patents for previously having disclosed the same information. Of course, Mr Haynes is quite wrong in both of his statements. Baird's equipment was seen "unboxed" at Selfridges and some details were reported<sup>1</sup>. In reference 1 the photograph is of Baird's equipment at 22 Frith Street, not Selfridges. Various other people reported on Baird's equipment at this period<sup>2, 3</sup> and<sup>4</sup>. References 1 to 4 all state quite clearly that the equipment was synchronized and used light-sensitive cells, Mr Haynes will see a photograph of Baird's synchronized, eight-line receiver at 22 Frith Street, March 1925, in a recent article of my own in *New Scientist*<sup>5</sup>. Reference 4 gives details of Baird's phasing arrangements, his provisional patent for which dates to 1924, which indicates that he was capable of phase control of the image in April 1925. References

from late 1926 onwards indicate that the British government had requested that Baird disclose no details of his photocell, since he had just given demonstrations of long range infra-red and reflected radio-wave location of objects to the armed services of several countries. Any person wishing more information from Baird could have read his patents or made suitable business arrangements to purchase the same, i.e. normal business procedure. Since all the television pioneers were very secretive, it is unfair to single out Baird.

Mr Haynes' comment on Dr Burn's letter of October, 1976, that to cite experienced senior officials (who all praised Baird's efforts) is not appropriate, is a nonsense. If Baird was "fooling the public", how can Mr Haynes explain Baird's long friendships with Sir J. A. Fleming (diode valve inventor and scientific adviser to Marconi's), Sir Oliver Lodge (radio pioneer before Marconi, scientific adviser to Marconi's), Sir Edward Appleton (Nobel Prize winner, pioneer of modern radar), George Bernard Shaw, A. Russell (President of I.E.E.), Professor W. Bragg (President, Royal Institution) and many others who had reputations to preserve. As Mr Haynes says, so much was published (true) yet so little is known of essentials (not true), that one must find and read the published information before passing any comments.

Regarding Vector's comments on Baird, in the December 1976 issue, the following points should be noted. Baird was engaged in television and sound film research from 1912. His commercial exploits were to raise money for his experiments. Regarding diamond manufacture, Baird in fact was copying Sir Charles Parsons' many experiments in which he was occasionally helped by A. A. Campbell Swinton. In trying to make diamonds in Glasgow, Baird displayed a higher level of intelligence than Swinton who was actively destroying diamonds<sup>7</sup>. Concerning Baird's Trinidad jam factory, this was no abysmal failure as was suggested. After trial and error, Baird produced mosquito-free jam, returning to London in September 1920 to establish trade outlets for the factory. From private letters of Baird it transpires that his factory manager absconded to America with all of Baird's money, leaving him destitute and broken hearted in London, hence the exploits with Baird's "Speedy Cleaner" to raise more money. Baird was also no "unqualified crank"; his Associateship of the Royal Technical College in Glasgow (the world's first technical college and technical university) was an excellent technical qualification for its day and with Baird's final track record of achievement he was most certainly no "crank". He was "unqualified" in television engineering I agree, but perhaps Vector could inform me of anyone who was so qualified in 1924/25?

In surveying the comments on Baird to date in *Wireless World*, excluding Dr Burn's letter which I thoroughly enjoyed for its objectiveness and immaculate referencing of the facts, it could yet prove to be the case that it is not Baird who "is on trial" but anyone who comments on J. L. Baird and has not first checked their facts.

P. Waddell,  
East Kilbride,  
Glasgow.

*This correspondence is now closed. - Editor.*

1. Bird, P. R. "Wireless Television, a Review of the Baird System", *Popular Wireless and Wireless Review*, May 23, 1925 P662-623.
2. Russell, A. *Nature*, 115 No 2892, April 4, 1925, P305.

3. Baird, J. L. "Wireless Television", *Engineering*, CXIX, 1 May 29, 1925, P661/2.
4. Dinsdale, A. "The Problem of Synchronisation in Television". *Radio News (USA)*, January 1928, P750-1.
5. Waddell, P. "Seeing by Wireless". *New Scientist*, 72, 1026. November 11, 1976, P342-4
6. Kaempfert, W. "How Baird sees Through Space by Radio". *New York Times*, Sunday, March 6, 1927, PXX-5.
7. Parsons, C. A. and Campbell-Swinton, A. A. "The Conversion of Diamond into Coke in High Vacuum by Kathode Rays". *Proc. Royal Soc. A*, 80. 1908, P184.

## ADVANCED RADIO MONITORING

In the article Advanced Radio Monitoring in your November 1976 issue reference was made to computer-controlled receivers. From inquiries we have received it appears that confusion has arisen in the minds of some of your readers concerning the manufacture of these receivers.

To clarify the situation, I would like to emphasise that these are RA1780 series receivers, manufactured by Racal Communications Limited of Bracknell.

E. A. Carey,  
The Racal Electronics Group,  
Wokingham,  
Berks.

## CITIZENS' BAND IN THE UK?

We read with interest your editorial and the article by Mr Dwyer on the question of a Citizens' band in the UK in the future.

We feel it might be of interest to you to know that the EEA have recently set up a working party on Citizens' band with the object of making an industry recommendation on the introduction of such a service. This will involve a careful study of the present use in other countries of equipment operating in the 27MHz band and the advantages to be gained by employing a higher frequency part of the spectrum.

The industry is anxious to see that any introduction of such a service should be undertaken with due regard to the needs of the citizen, the effect upon other users of the spectrum, and the implementation of a "sensible" degree of control by the Home Office.

M. S. Ollivant,  
Director,  
Electronic Engineering Association.

## WAVEFORMS IN QUADRATURE

The issue of *Wireless World* for December 1976, p.43, Fig. 2 contains a circuit to produce wave forms in quadrature. This circuit suffers from lead/lag ambiguity. This can be prevented if the D input to one of the flip-flops is connected not to its own Q output but to the Q output of the other flip-flop.

C. Rashbass,  
Institute of Psychiatry,  
Denmark Hill,  
London.

# Can oscillators be "common"?

Does it make sense to classify them in the same way as amplifier circuits?

by "Cathode Ray"

I want to make clear from the start that the above title has no reference to social status. If it hadn't been abbreviated it would have been too long for a title – in the electronic though perhaps not in the theatrical world. In full it would have had to be something like this: You know how one of the first things you learn about transistor circuits (and used to learn about valve circuits) is that they come in three kinds, common-emitter, common-base and common-collector (common cathode, common-grid and common-anode)? Well, does it make sense to classify oscillator circuits in this way?

So much for the title. Before going on to the subject itself, may I first be allowed to dispose of those who talk about "grounded-base", etc. Genuine Americans are entitled to use the word "grounded" because what we call "earth" they have always called "ground." So fair enough. But to accept "earth" like a true Briton and yet to say "grounded" instead of "earthed" is just silly. Much more important than this nationalistic consideration, however, is the fact that both "grounded" and "earthed" and any other words there may be that mean the same thing are wrong in this particular context, because earthing has nothing necessarily to do with it.

The context referred to is amplification. Every amplifier has (in principle), a pair of input terminals and a pair of output terminals. That makes four terminals altogether. So if the amplifier is drawn as a box, we get Fig. 1. Let us suppose that this amplifier has only one stage, or that it is a single stage of a larger amplifier. Then the essential thing that the box contains is a transistor (or a valve), which has three terminals, so is known as a triode. Therefore one of the three terminals must be connected to both input and output. In a word, it is *common* to both input and output. Obviously it mustn't be common to both input or to both output terminals, because that would short-circuit them. Another point: the triode's common terminal is still effec-

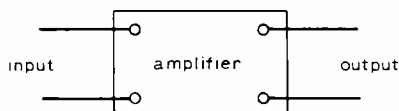
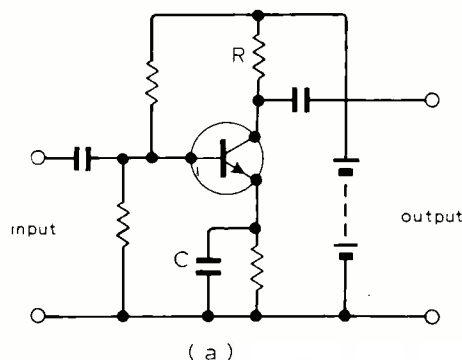

Fig. 1. Any amplifier has a pair of input terminals and a pair of output terminals, even if they consist only of positions on the wiring.

tively common even when there is a constant potential between it and the input or output or both. For example, Fig. 2 (a) shows a perfectly typical amplifier stage. If you take away all the components that are required simply to maintain the electrodes at the correct steady potentials for proper working, you are left with (b). This is a signals-only circuit diagram, which helps us to see that the lower input and output terminals are connected to one another and to the emitter, so it is a common-emitter circuit. Even in the form of Fig 2 (a) it is not very hard to identify as a common-emitter circuit, especially if the component values are given, because the capacitance of C would be

Fig. 2 (a) is a typical complete circuit diagram of a one-stage amplifier, and (b) shows the same circuit after all components concerned only with d.c. have been removed.



large enough to tell us that it is practically a short-circuit to signals.

This amplifier stage might well be part of some small portable equipment in which case there would be no earth connection and the term "earthed (or "grounded") would be altogether inappropriate. It is true that if the circuit was earthed anywhere it would most likely be at the common input/output point. But it would make no difference in principle if somebody decided, just to be different or for some better reason, to earth the collector. It would still be a common-emitter circuit. One would be perfectly correct, but exceedingly misleading, to describe it as an earthed-collector circuit.

*Common*, then; not earthed or grounded.

What about oscillators? Perhaps the clearest way of explaining them to people who already know what amplifiers are is to tell them to tap off a fraction of an amplifier output, equal to the input, and arrange the circuit so that this reduced output is exactly in phase with the input. It is then a perfect copy of the input and can be substituted for it, giving a circuit that generates its own signal continuously; in a word, an oscillator. This conversion is shown in Fig. 3. Usually the magnitude and phase of the output fed back will be correct at only one frequency; that, then, will be the frequency of oscillation.

The only snag I can think of about this neat introduction to oscillators is that on the basis of what has gone

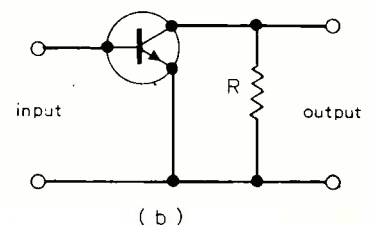



before it is almost bound to lead one to suppose that if (for example) the amplifier is of the common-emitter variety the resulting oscillator will also be common-emitter. But this is a fallacy.

Why? Fig. 3 presumably has one input and one output terminal common, and if they are connected to the emitter then surely it is a common-emitter oscillator circuit?

The three different configurations work as amplifiers in different ways: the common-emitter gives both voltage and current gain, with phase inversion; the common-base gives voltage gain and current loss, without phase inversion; and the common-collector gives voltage loss and current gain, also without phase inversion. Surely one can tell which is which in an oscillator as well as an amplifier?

Plausible, but it won't stand examination. We have been making too many assumptions about the parts of the circuit needed to make the output equal to the input in magnitude and phase. We shall have to draw the whole circuit, including what is inside the box in Fig. 3. But, as we saw in Fig. 2, there is no need to include the d.c. feeds which just confuse us when we are concerned only with signals. Fig. 4 shows the best-known of all oscillator circuits, the Hartley. Which is the common electrode?

After a pause for deep thought, the verdict must be that of the Dodo at the end of the caucus race: all have won, so all must have prizes.

Having so far had in mind chiefly the popular common-emitter configuration, we may perhaps try to get Fig. 4 into the Fig. 3 form in such a way as to show that it is a common-emitter circuit. Very well, then; Fig. 5 is exactly the same

circuit as Fig. 4, and it is clearly a common-emitter circuit.

But before the common-emitter supporters cheer themselves hoarse let them take a look at Fig. 6. This too is exactly the same circuit as Fig. 4 (and Fig. 5) and it is clearly a common-collector circuit. Similarly the same circuit can be drawn as in Fig. 7, proving that it

is a common-base circuit. But in case common-base enthusiasts try to get one up on the others by pointing out that Fig. 7 is the only one that really looks like Fig. 3, we must tell them that Fig. 3 could have been drawn to favour either of the other two.

So, going back to Fig. 4, we can say that any of the three electrodes has just as much and just as little right to be called the common one as either of the others. In other words, the question as to which of the three this oscillator circuit is should not be asked, for it has no useful meaning. And that this is true of the Hartley circuit can be shown to be true of any other oscillator circuit. Showing this is more difficult for the RC oscillator, but it can be done.

Before we leave the subject let us look again at Fig. 4, and regarding each electrode in turn as the common one see how the circuit fulfils the conditions required by that configuration. First the emitter. The common-emitter amplifier circuit is the only one of the three that inverts the phase, so as an oscillator circuit it must include means for inverting it again. Fig. 4 (and Fig. 5) show how the tuning coil serves as an auto-transformer to do just that. If the transistor gives a considerable voltage gain, as it can well do in the common-emitter configuration, the correct tapping point is quite near the base end of the coil. But even if it were used at such a high frequency that there was no voltage gain at all, the output being no more than equal to the input, it could still be made to work as an oscillator by tapping at the centre of the coil.

Next the common-collector. This gives a voltage loss and no phase inversion, and Fig. 4 (and Fig. 6) show that the coil now appears as a voltage step-up autotransformer with no phase inversion. Lastly, if Fig. 4 (and Fig. 7) are regarded as common-base circuits, we see that the coil is again a non-inverting autotransformer, but this time with a step-down in proportion to the voltage gain, thus compensating for the current loss in a common-base amplifier.

Was S. W. Amos therefore wrong in stating\* that one of the two essential requirements of an oscillator was signal inversion? Not if one looks at the maintaining amplifier part of the complete oscillator circuit as a common-emitter type as he did and was entitled to do. But he or we are entitled alternatively to look at the same complete oscillator circuit from a different point of view, embodying a common-base or common-collector amplifier, in which cases inversion is not a requirement.

So it is all a matter of point of view. And different points of view make no difference to the actual oscillator circuit or its working.

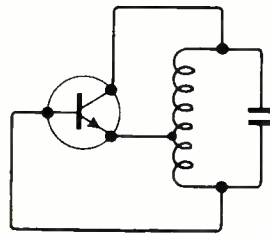

Fig. 4. The familiar Hartley oscillator circuit in the signals-only form.

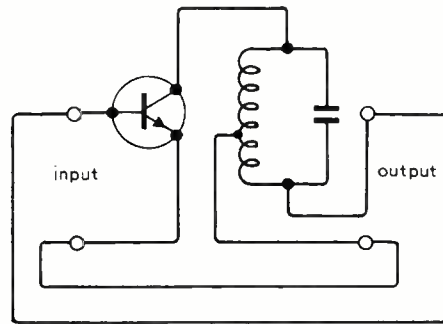

Fig. 5. The same circuit as Fig. 4, redrawn in the form of Fig. 3 (b) to look like a common-emitter circuit.

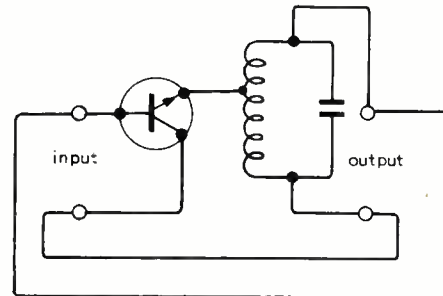

Fig. 6. Looks like a common-collector circuit, but is actually identical with Figs. 4 and 5.

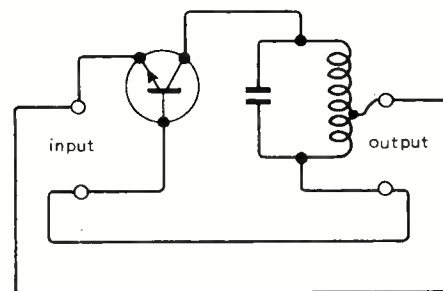
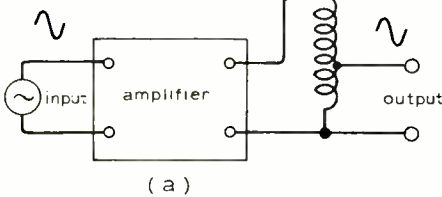
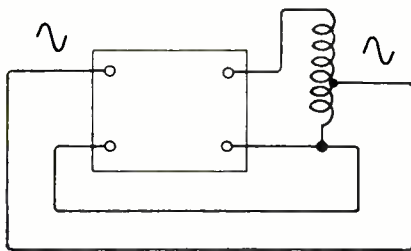

Fig. 7. Again the same as Figs. 4, 5 and 6, though looking like a common-base circuit.



(a)



(b)

Fig. 3 (a) is the same as Fig. 1 plus a device for making the final output signal equal in magnitude and phase to the input. So this output can be substituted for the input signal generator, as at (b) to make an oscillator.

\*"Antiphase or 180° phase shift?", W.W., June 1976, p.47.

# Identifying European television — 2

## A further selection of test cards and identification captions

by G. Smith and K. Hamer

The reception of European television signals is generally dependent upon the prevailing weather conditions. One of the best methods is reception by sporadic E between mid-May and late August when the earth's E layer is ionized by the sun. This ionized layer refracts television signals back to earth and the duration of reception can range from a few minutes to several hours.

If a British television receiver is used, simple modifications are necessary. The vision detector diode should be reversed because the British system "A" has positive vision modulation and the receiver must be adapted for negative-going signals. A reduction in cathode bias on the video amplifier is necessary as a result of this. The line oscillator may run up from 405 to 625 lines without further modification, but it may be necessary to reduce the value of the series resistor to the line hold control. If any modifications are undertaken it must be remembered that the chassis is live. These modifications are not necessary if the signals are received on u.h.f.

Sporadic "E" signals can also be fed through a v.h.f./u.h.f. converter which enables an unmodified u.h.f. receiver to be used.

There is another method of signal propagation which affects u.h.f. and band III transmissions from Europe. This is known as Tropospheric Propagation. The troposphere extends from the Earth's surface to about 20,000 feet. If an anticyclonic system develops, also called a high-pressure system, and remains centred over Scandinavia for a few days, it is likely that enhanced u.h.f. reception will occur provided that a cold front stretching from Norway to England is present. The cold front will cause a temperature inversion to take place which will tend to duct the signals. Unlike Sporadic "E", Tropospheric Propagation does not occur annually but can be a source of reception at any time. Normally, distances involved during tropospheric conditions are shorter than for Sp.E, usually up to 1000 miles. During good conditions, transmissions can be received in colour

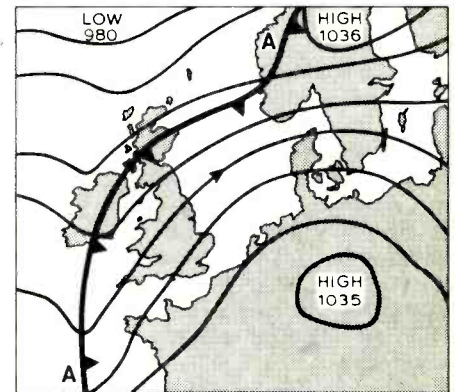

except for France, Monaco and certain eastern European services which use SECAM.

A typical weather chart for enhanced tropospheric reception is shown with the pressure indicated in millibars. The extent of the high-pressure system is shown by the isobars which indicate equal points of pressure. Line AA shows the cold front.



Algeria RTA (B) — The EBU bar is used by many members of the European Broadcasting Union.

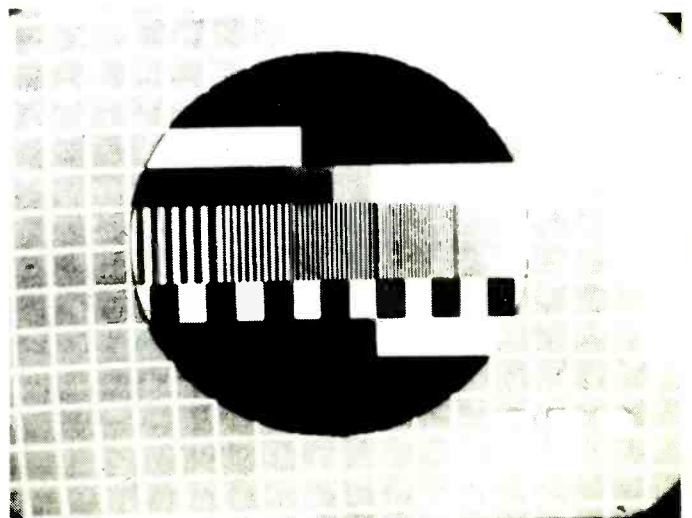

West Germany DBP (G) PAL colour — An electronically generated test card.



West Germany A.R.D. (B, G) PAL colour — Bayerischer Rundfunk operate three high-powered Band I transmitters.

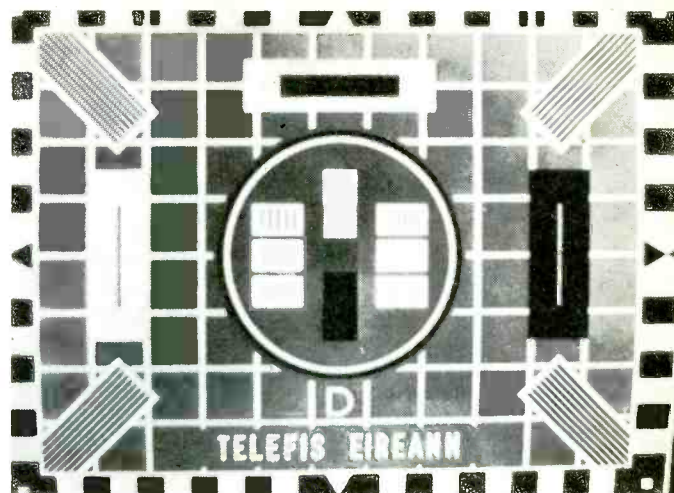

Eire RTE (A, I) PAL colour — Radio Telefis Eireann now use the Philips PM5544 electronic test card.

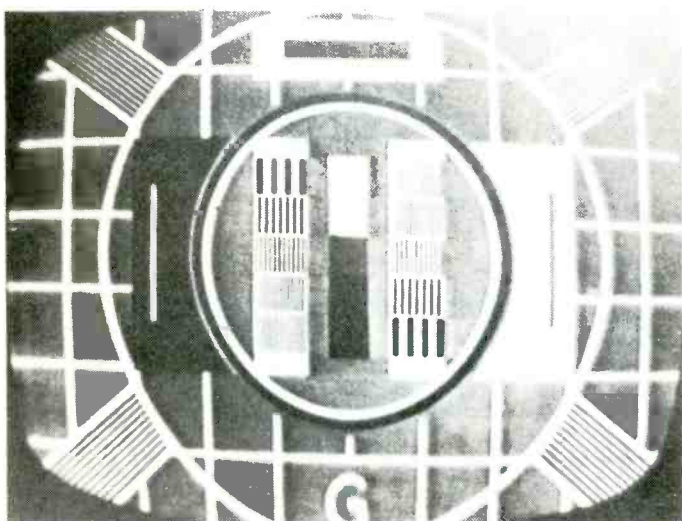

Bulgaria B.T. (D) — Test card "G" as radiated from B.T.'s low-powered transmitters. This is an off-air photograph.

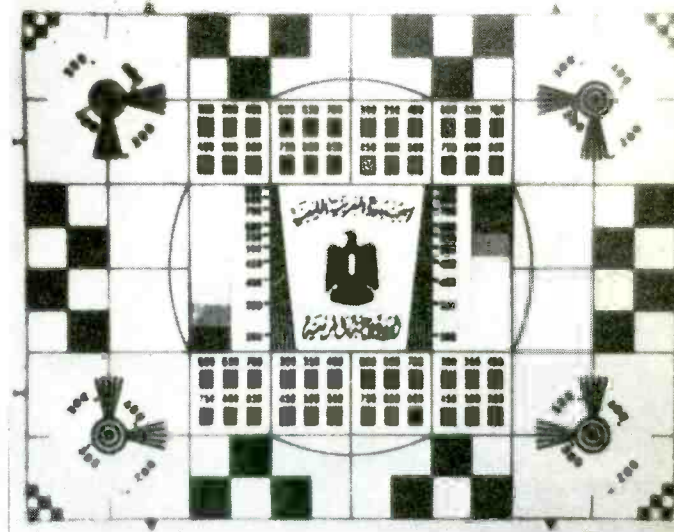

Libya PRB (B) — This type of test card is usually referred to as being an "ORTF-type" after the name of the old French service which first introduced it.



East Germany DDR-F (B, G) SECAM colour — There are several different identifications used with this electronic test card.



West Germany DBP (G) PAL colour — The DBP transmit identification captions, or "Senderdias", at regular intervals during test transmissions.



Eire RTE (A, I) PAL colour — Identification caption as used by Radio Telefís Éireann.



Jordan JTC (B) — The Jordan Television Corporation operates a 100kW transmitter in Band I which has been received in the U.K.



East Germany (B, G) — Radio programmes are relayed with this electronic test card.



Luxembourg RTL (L) PAL (Band III) & SECAM (u.h.f.) colour — Radio-Tele-Luxembourg also uses the FUBK electronic test card with the identification "ECOUTEZ RTL."



East Germany DDR-F (B, G) SECAM colour — The clock caption as used by Deutscher Fernsehfunk.



East Germany DDR-F (B, G) SECAM colour — The Second Network on u.h.f. is occasionally received in the United Kingdom.

# Weather-satellite picture facsimile machine — 4

## Setting up procedures and operation

by G. R. Kennedy

Setting up procedures for the weather-satellite picture facsimile machine are as follows:

The v.c.o. and the input level to the **clock-rate detector** are set to obtain a steady clock rate from the satellite signal with full picture modulation.

**Motor drive (Fig. 12).**  $C_{27}$  is set as previously explained.  $S_4$  is left open and a d.c. ammeter, on the 400mA, or 1A range, is placed across it.  $RV_{11}$  is increased so that 200V r.m.s. is obtained across the motor. The drive at  $C_{24}$  is then removed and  $RV_{11}$  is backed off until the standing current on the meter is not more than 50% of that with drive applied.

**Sample pulse generator (Fig. 8).** A satellite signal is fed into the machine and a few cycles of the demodulated signal monitored on one beam of an oscilloscope. This is triggered from the clock rate signal. The sample pulse is then applied to the second beam of the oscilloscope and  $RV_9$  is adjusted to give a pulse width of approximately 2% of the demodulated subcarrier period.  $RV_8$  is adjusted so that each sample pulse coincides with each positive peak of the signal. Note that if the phase-lock-loop v.c.o. is adjusted the phase of the clock signal will alter and  $RV_8$  will have to be reset.

**Signal detector and light source driver (Fig. 7).** First set  $RV_7$  to maximum. Set  $RV_5$  (the brightness preset) to minimum, i.e. the wiper to the  $R_{23}$  end. This is the normal running setting of  $RV_5$  and it will only need altering for special purpose pictures.  $RV_6$  is adjusted to give a peak-white to peak-black excursion of 36 to 40V at  $Tr_8$  base/ $Tr_7$  collector. Reduce  $RV_7$  while monitoring  $Tr_9$  emitter waveform across  $R_{37}$  with the input subcarrier signal on the second beam, until distortion and drop-out of long white sections occurs. Then increase  $RV_7$  slightly to remedy this.

**Strobe generator (Fig. 14).** An accurate oscilloscope or a digital time/frequency meter are the best instruments to use, if available, to set up the strobe generator. Trigger the start of the oscilloscope timebase or the digital counter from the negative leading edge of the 0.8Hz input pulse into  $C_{34}$ . Set  $S_{35}$  to 1/5th line division. Adjust  $RV_{15}$  to give the trailing

(positive going) edge of the pulse at  $IC_{22}$  pin 1 ( $\bar{Q}$  output) 250ms after the start. Switch to 1/4 line and adjust  $RV_{14}$  for a pulse length of 312.5ms. Switch to 1/3rd line and adjust  $RV_{13}$  for a pulse length of 416.6ms. These pulses set the writing period for SR pictures; they are exactly as long as one drum revolution. If set too short, the picture will be too narrow, and if too long, overlap and double imaging will occur. If accurate equipment is not available, the strobe pulses may be viewed together on an oscilloscope and the appropriate pot ( $RV_{13}$ - $RV_{15}$ ) adjusted for coincidence.

**Drum position sensor.** Mark the drum with white painted lines or similar to indicate precisely the position of the sticky tape which holds the paper around the drum, so that the strip can be freshly applied when required to exactly the same place. It is assumed

that the picture wrap-around — and hence the edge — will be halfway across the strip. Temporarily, stick a small piece of "rubber magnet" to the edge of the drum near the position sensor (tape head) with a small piece of the sticky tape. Rotate the drum in the normal direction and print a rough picture sufficient to show the picture borders. Mark the correct magnet position and cement it firmly in place. The process can be speeded a little by monitoring the picture and the drum pulse on an oscilloscope, but before cementing the magnet a picture should be printed so that the borders are in exactly the right position. Adjust  $RV_{12}$  (Fig. 13) to give sufficient pulse height for Z-modulating the beam of an oscilloscope. If double pulses are produced, the sensor is too near the drum magnet and must be moved slightly further away.

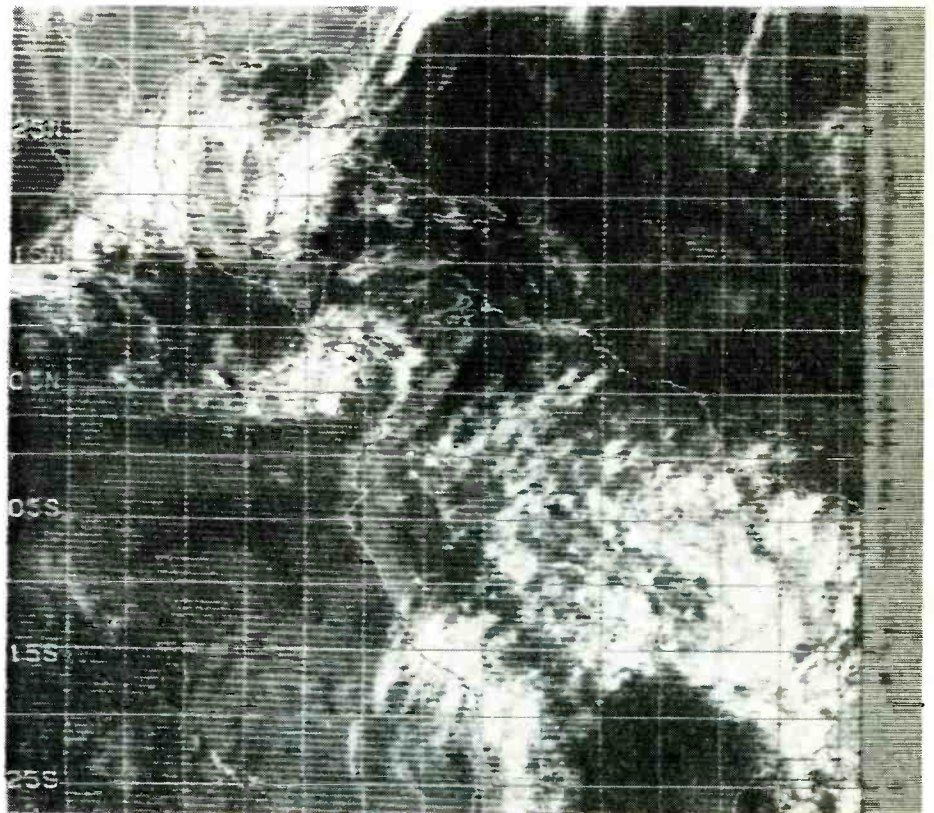

ATS-3 satellite picture, 2nd March 1975 at 09.00z. Computer processed infra-red data from NOAA-4 satellite, showing South America and the U.S.A. The dark marks in the edge band indicate that the received signal was marginal and that picture data was being lost as the satellite rotated. Note the cloud typical of the hot jungle around the Amazon Basin.

**Picture slip oscillator (Fig. 11).** Monitor the picture line signal at the input or at the crater-tube monitor socket and trigger the oscilloscope from the drum rotation pulse. Switch the picture slip switch on and adjust  $RV_{10}$  to give a slip rate which is comfortable for setting the edge position, but not too slow. A good starting rate is a slip of one line in five seconds.

**Picture contrast adjustment (Fig. 7).** Initially  $RV_6$  should be set for 5mA crater tube current on the meter with a peak white signal, and the contrast potentiometer preceding the expander should be adjusted to give 35mA or so (dark grey). When the satellite signal is to be printed these controls should be balanced against each other to give an undistorted demodulated signal at the crater-tube monitor socket, with peak black and white just beginning to clip. For special emphasis of, say, cloud or land the balance between expander input and total crater-tube excursion can be varied. These settings can be critical, and multi-turn pots with turns-counting dials should be used and the settings noted. Once a standardized level of reception and/or recording is carried out, printing of the pictures should not require much adjustment of the contrast and gain controls, and familiarity will lead to consistent results.

### Routine operation

The machine does not run hot and should not need a warm-up period. For normal pictures the expander will be set at a minimum (direct) for APT and WEFAX and at a maximum for SR pictures. Set up the machine in a dark room with a red safe light and developing dishes etc, to hand. *Remember to keep the machine, which runs at mains voltages, away from any liquids. Ensure that the machine is well earthed with its*

*mains lead in good condition and do not operate with wet hands.*

Set the traverse to the start position and place the paper on to the roller by wrapping it tightly around the drum and sticking both ends to the strip of tape. Start the drum and then switch on and monitor the signal using a one beam oscilloscope. To do this the drum pulse is applied to the Z-axis of the oscilloscope to give a bright blip on the trace. The picture slip switch is then operated until the edge of the picture line and blip coincide. Switch on the crater tube and traverse so that a picture is produced. At the end, switch off the crater tube, peel off the paper and develop the picture.

Should it be necessary to produce reversed pictures, such as transparencies, the drum motor connections can be reversed and the drum will rotate in the opposite direction giving pictures transposed left to right.

### Scanning radiometer pictures

If SR pictures are to be printed the second beam of the oscilloscope must show the SR strobe pulse and the phase lock loop must be slipped until the correct portion of the SR line (VIS or IR) is in the strobe period. Edge setting can be carried out before or after this since the process is independent of the relative phase relationship of clock and picture.

If the whole width of the IR or VIS channel is to be printed, the line division switch should be set to 1/3rd line. The resultant picture will show 'milk-bottle' distortion due to the rotation of the satellite scanning radiometer, and the scene at the left and right hand edges will be distorted and will appear to run off to infinity. However, the pictures obtained will have close line spacings and will appear to be of reasonable contrast. Also, with the drum dimensions given, a complete NOAA-4 pass

(for example) can be produced on the one print. At the other extreme, if 1/5th line division is selected, the picture can be arranged so that only the relatively non-distorted part is shown. In this case the line spacing is very wide, being four times wider for example than that for the APT of ESSA-8 at the same expansion, since the lines are strobed (switched on) one in every five of the corresponding ESSA-8 lines. Due to the newsprint effect, no matter how black the inscribed line, the overall effect is of a grey and white as opposed to 'soot and whitewash'. Generally, the 1/5th line SR pictures are rather insipid viewed close-to, and are only really useful for viewing from a distance, such as in lecturing. SR pictures on v.h.f. are essentially low definition, with a sub-point discrimination not finer than 7.4km. With a real-time scan of only 48 revolutions per minute, the 1/3rd line division pictures probably give the best all round results for meteorological work.

### Further developments

As the machine stands, operator skill is required to set the picture edge and to select the required SR portion to be printed. Since a clock signal is available and the operations are signal time dependent, it should be possible to make the major part of the picture writing process automatic. The setting of picture contrast could no doubt be done with a type of a.g.c. system, but is probably best left for operator control.

The SR signal strobing and the traverse movement could be co-ordinated and improved by using a stepping motor for traverse drive. In this case, reset could be effected by applying a high frequency reversed phase supply to the motor.

### Applications

The machine may be used for the production of routine cloud cover pictures from the satellites mentioned earlier. As the input is a demodulated signal, the original radio frequency is immaterial and the WEFAX transmissions from the S-band SMS/GOES satellites can be printed<sup>12</sup>. The ATS and SMS/GOES TBUS prediction messages, which comprise orbital parameters in words and figures, can be produced as well as Mercator and polar projection world maps.

Lastly, the machine can be used to produce pictures and written data from any source providing it can be amplitude modulated on to a 2.4kHz carrier and presented to the machine in real time or from a tape recording.

**Editor's note.** *Following articles will describe modifications to the basic design of the weather-satellite facsimile machine so that it may be used specifically for meteorological purposes. The modifications will enable both weather satellite and radio facsimile broadcasts to be printed.*

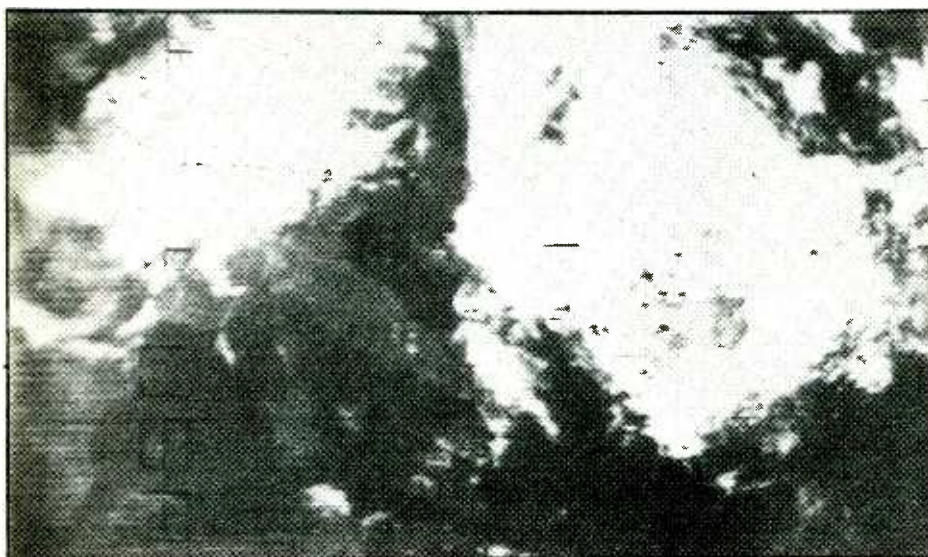

ESSA-8 satellite picture, 3rd May 1975, revolution 29247. This picture was produced when the satellite optics were already mis-aligned and five months before the satellite finally failed. It is a tv-type APT visible-light image and shows Italy in the centre of the picture.

# Special-purpose amplifiers

Using norators and nullators to classify the balanced, push-pull and bridge amplifiers described in set 33 of Circards

by J. Carruthers, J. H. Evans, J. Kinsler and P. Williams,  
Paisley College of Technology

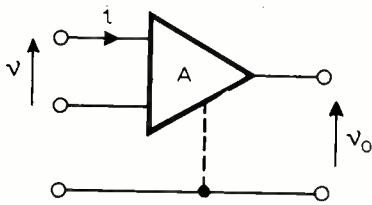

1. For an operational amplifier, as  $A \rightarrow \infty$  then  $v_i \rightarrow 0$  for any finite  $v_o$ . One terminal of the output port is common to the supply.

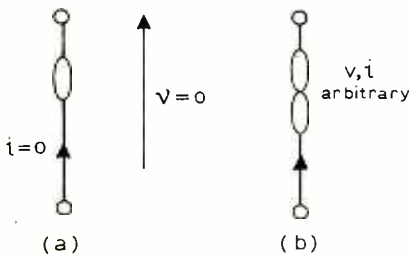

2. Two one-ports have been proposed: the nullator having simultaneously zero voltage and current; the norator sustaining arbitrary voltage and current. Neither has a real separate existence.

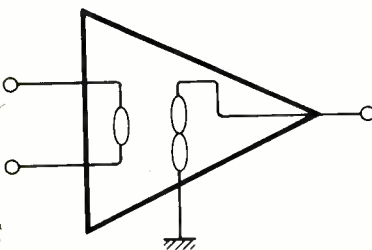

3. Infinite gain operational amplifier can be represented by a nullator the combination of a nullator and a norator.

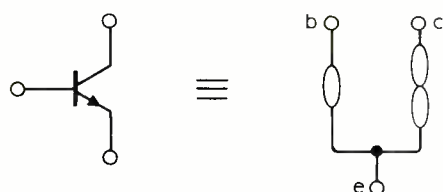

4. High-gain transistor can also be represented by a nullator; the constraint is a common point between nullator and norator.

It might seem that amplifiers are too familiar to need further investigation. Straightforward amplifier design is well understood; the budding circuit designer happily gurgles 'voltage follower' almost in the same breath as he (or in this enlightened age, she) first says 'Dada'. Feedback configurations follow naturally on from the 'four-times tables', soon to be abandoned in favour of programmable calculators anyway.

But one area with unquestioned answers as well as unanswered questions is that of special-purpose amplifiers. An inadequate description, this, to cover a multiplicity of functions. When the inputs and outputs are in voltage form no problem arises; if either or both are currents, if either or both are floating balanced or differential the problems start. If more than one of these conditions are imposed the solutions become even more devious. To steer a way through these problems, we offer a technique we have found helpful in the accompanying diagrams. It has been widely used in active filter design, but is surprisingly useful in relating these often confusing alternatives. As to the practical solutions, Set 33 of Circards contains some standard circuits re-evaluated, recently published ideas, and some suggestions of our own.

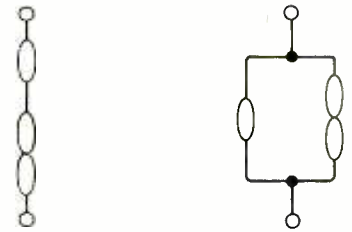

5. Nullator and norator in series sustain arbitrary voltage while drawing no current; the parallel combination has the opposite characteristics. They are equivalent to an open-circuit and a short circuit respectively.

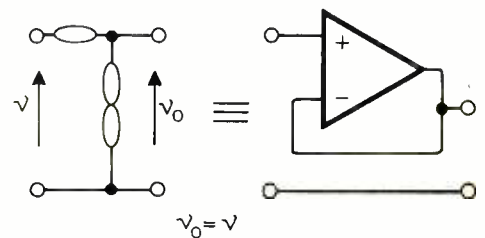

6. Voltage follower is equivalent to a nullator with no additional resistors. An emitter follower is a less accurate approximation in that the input current may be significant.

### Topics in set 33

- Differential amplifiers
- Differential input/single-ended output amplifiers
- Differential input/balanced output current amplifiers
- Floating amplifier/increasing c.m.r.r.
- Bridge amplifiers
- Broken/floating bridge
- Offset/drift cancellation
- Feedforward/feedback compensation
- Lowdrift wideband amplifiers

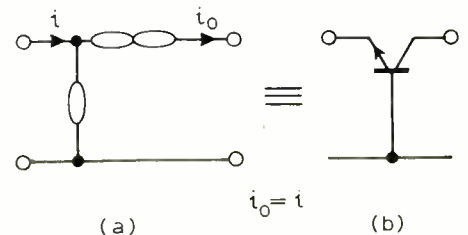

7(a). Dual of the voltage follower, the current follower, requires a norator with no ground connection.

7(b). Common-base stage approximates to this ideal of unity current-gain with negligible input voltage and very high output impedance.

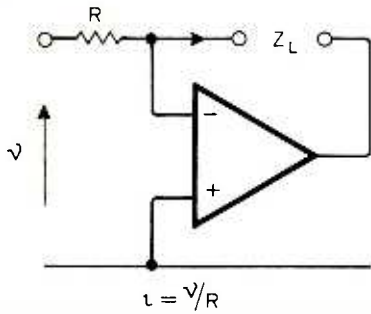

8. Usual circuit for converting an input voltage into a proportional output current, again has a floating load.

9. Drawing the circuit in nullor form and shifting the ground point to the other side of the norator leads to an unfamiliar form of the circuit.

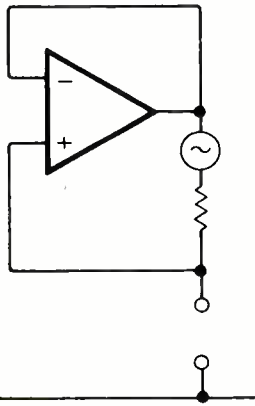
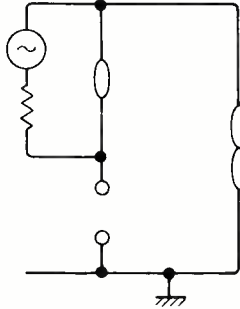
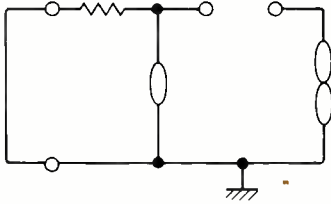

10. This leads to simple and obvious conclusion – one which may even be correct! For a voltage-current or transconductance circuit of this form source nullor and load are in series around a loop. Only one point can be grounded. If the nullor is so constrained then either the load or the source must be ungrounded.

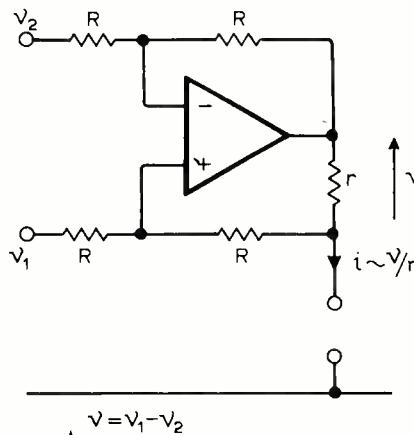

11. Novel way of injecting a voltage across a resistor so as to define the current in a grounded load. This is indicative of the flexibility of the bridge of resistors in its many forms.

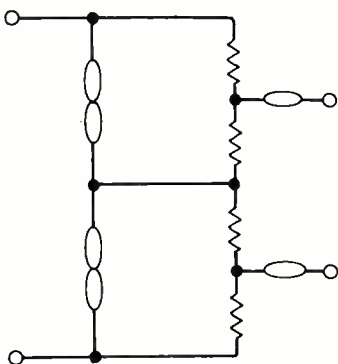

12. Nullor form of the circuit. While Figs 10 & 11 have visual similarity, each redrawing can reveal new modifications even though (or perhaps because) the new form is unfamiliar. Figs 9 and 12 are related in the same way but are more difficult to relate visually.

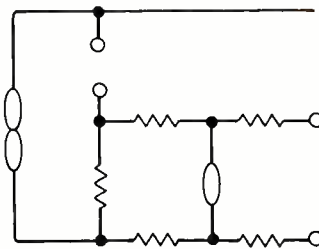

13. When two or more amplifiers are used, the inputs may be in a single-ended, balanced or differential form. Similarly the output may be single-ended voltage or current, push-pull etc. Nullors are just one of a number of techniques for devising new variants and of understanding the inter-relationships of known circuits.

Issue no. 35 will be the last in the present series of Circards, the final two sets covering analogue gate circuits. A wide range of subjects in electronics communication and control have now been covered in Circards by Peter Williams and colleagues Jack Carruthers, John Evans and Joe Kinsler (all of Paisley College of Technology) who have selected hundreds of circuits – sifted out of many thousands – tested them and presented the results, together with circuit modifications, in Circards.

The first 20 sets of the award-winning scheme are now reprinted in book form, though some individual sets are still available, together with background articles and additional circuitry (Circuit Designs 1 & 2).

The books are obtainable through booksellers or, in case of difficulty, from IPC Electrical-Electronic Press Ltd, General Sales Dept (Room 11), Dorset House, Stamford Street, London SE1 9LU, for £10.40 vol. 1 and £12.50 vol. 2 post included, from which individual sets can also be obtained for £2 post included.

#### Circard subjects

- 1 active filters
- 2 switching circuits (comparator and Schmitt circuits)
- 3 waveform generators
- 4 a.c. measurement
- 5 audio circuits (equalizers, etc.)
- 6 constant-current circuits
- 7 power amplifiers (classes A, B, C, D)
- 8 astable multivibrator circuits
- 9 optoelectronics: devices and uses
- 10 micropower circuits
- 11 basic logic gates
- 12 wideband amplifiers
- 13 alarm circuits
- 14 digital counters
- 15 pulse modulators
- 16 current-differencing amplifiers – signal processing
- 17 c.d.as – signal generation
- 18 c.d.as – measurement and detection
- 19 monostable circuits
- 20 transistor pairs
- 21 voltage to frequency converters
- 22 amplitude modulators
- 23 reference circuits
- 24 voltage regulators
- 25 RC oscillators-1
- 26 RC oscillators-2
- 27 linear c.m.o.s.-1
- 28 linear c.m.o.s.-2
- 29 analogue multipliers
- 30 non-linear functions
- 31 digital multipliers
- 32 transistor arrays
- 33\* special-purpose amplifiers
- 34\* analogue gate applications – 1
- 35\* analogue gate applications – 2

\* available shortly



# 3009+SL150

Performance, appearance, and attractive price are all firsts with the new SL150 from National Technics and it comes ready to accept our precision pick-up arms. Their use with this deck is detailed in information sheet No 19 and the SL1500 in information sheet No 20. Either will be sent to you on request.

Write to Dept 0641 · SME Limited · Steyning · Sussex · BN4 3GY

**SME**

The best pick-up arm  
in the world

# Our Radio/TV Programme

If you service radio or television receivers, Avo has Signal Generators to meet your requirements.

Pride of place goes to the new HF136 which goes one step further than the widely used HF135 (an AM Signal Generator which gives coverage up to 240MHz and 30% am at 1kHz).

The Avo HF136 combines an AM Generator and FM Generator in one case. Covering 4-120 MHz, it has a choice of outputs cw, am, fm, or sweep + cw, or sweep + am and also 400Hz for modulation or as an af signal for servicing audio stages.

One of these units, incorporated into your re-equipment programme, could increase your throughput and optimise the use of your skilled manpower.

If you would like to know more about our AM and AM/FM Signal Generators, get in touch.

We will gladly put you in the picture.

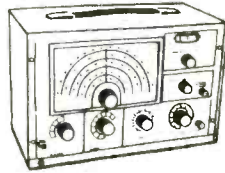

**Avo Limited,**  
Archliffe Road, Dover, Kent. CT17 9EN.  
Tel: 0304 202620  
Telex: 96283



Thorn Measurement and Components Division.



WW-014 FOR FURTHER DETAILS

# Mobile radio communication — 3

## Range, interference and a comparison of a.m. and f.m. systems

by D. A. S. Drybrough, B.Sc., M.I.E.E., *Drybrough Communication Services Ltd*

The following factors govern the range of effective communication between two stations in the v.h.f. and u.h.f. mobile services.

**Frequency.** The frequency affects the propagation loss between aerials, transmission-line losses, receiver noise factor, ambient noise and interference, the effect of movement and of mistuning. An increase in operating frequency increases the losses, the noise factor and the effects of movement and mistuning but decreases noise and interference.

**Modulation.** The type of modulation has an effect on the signal/noise ratio at the input to the receiver for the required communication quality. Theoretical studies of the relationship between the commonly used modulation types, a.m. and f.m., show the latter to have a good margin of superiority over the former for all but very low signal/noise ratios. Field trials have not entirely confirmed such a clearcut advantage, probably due to the different behaviour of the two types of modulated signals when they fluctuate at low average levels. This discussion is limited to amplitude modulation and frequency modulation, using speech or sinewave modulating signals.

**Depth of modulation.** For a sinewave signal, it is easy to define a 100% modulation level in an a.m. system or to set an agreed maximum deviation in an f.m. system. Modulation depth for speech, with its high and indeterminate peak/mean ratio, is not so easy to set but, by experiment and experience, it has been found that peaks can be clipped or compressed to within 6 dB of the mean without excessive distortion or loss of naturalness in the voice. A.g.c. circuits can be used to keep the mean level of speech from all operators constant to within a few decibels at the transmitter modulator stage. Excessive distortion in the audio circuits of transmitters and receivers degrades intelligibility and, hence, the communication range.

**Effective radiated power.** Systems models assume, in most cases, that



*Low-power a.m. mobile unit (GEC-Marconi)*

half-wavelength dipoles are used as aerials. It is possible to concentrate more power in a given direction by using a directional aerial or, when omnidirectional propagation is essential, by stacking aerials to reduce the vertical beamwidth of the aerial. Such gains over a dipole must be taken into account when calculating the effective radiated power. Although r.f. losses in aerial elements are low, feeder, filter and changeover relays reduce the effective radiated power (e.r.p). Typical values in the mobile services are 25 W for high-power mobile and base stations, 5 W for low-power sets and 0.5 W for portables.

**Effective transmitting-aerial height.** This parameter is a difficult one to settle in any given location because it depends to a large extent on the path profile between the transmitting and receiving aerials as well as the height above local ground level. CCIR recommend that this height be taken as that above the average height of the ground along the path towards the receiver between 3 and 15 km from the transmitting aerial.

**Propagation loss.** CCIR give curves for field strengths for a radiated power of 1 kW and various aerial heights and paths, and from these the propagation

loss can be calculated. These curves are drawn for 50% of locations and varying time percentages. Corrections are given for path roughness and for different percentages of locations. Height/gain corrections are also discussed by CCIR. These curves are averages and should not be relied on for high accuracies, especially when ground constants differ from the average values they assume.

**Effective receiving aerial height.** CCIR recommend that this be taken as the actual height above local ground.

**Receiving-aerial gain.** As with the transmitting aerial, the receiving aerial can be more directional than a dipole. If this directivity is in the vertical plane, it may also result in higher noise pickup. The usual quarter-wavelength whip for 'low' band v.h.f. mobiles has a small loss compared with a half-wavelength dipole, but aerials with gain relative to a dipole may be used for the higher frequencies.

**Receiver sensitivity.** CCIR recommend a minimum ratio of 15 dB as output signal/noise ratio, measured by means of a volume-unit (v.u.) meter, for a speech signal set to give an average modulation depth (amplitude modulation) of 6 dB below peak at the source transmitter. The signal/noise ratio for 100% modulation is thus 21 dB. For a.m. receivers this is the i.f. signal/noise ratio required at the detector. For

frequency modulation, the required i.f. signal/noise ratio depends on the relative bandwidths of the i.f. and a.f. sections and, for low ratios, on the peak deviation also when, as is necessary, so great an allowance has to be made for frequency inaccuracies due to temperature changes and mistuning that the deviation does not fill the whole channel. For 25 kHz channels the average crystal filter in the i.f. stages has a bandwidth of about  $\pm 8$  kHz and the peak deviation is  $\pm 5$  kHz, with an audio bandwidth of about 2800 Hz. For 12.5 kHz channels, the figures are  $\pm 3.75$  kHz,  $\pm 2.5$  kHz and about 2400 Hz, respectively. No correction for unused bandwidth is necessary above an output signal/noise ratio of about 20 dB for these figures (a.m. and f.m.). The input signal/noise ratio is determined by the level of the wanted signal field around the aerial, the aerial gain, the losses between the aerial and the receiver, the noise factor of the receiver and the ambient noise and interference picked up by the aerial within the passband and spurious response bands of the receiver. Good mobile receivers of recent design have noise factors of about 2.5 (4 dB) and losses between aerial and set as low as 1-2 dB, usually rising with frequency.

**Ambient noise** varies widely and has not been quantified recently for all conditions of service of mobile radio units. Generally, it reduces with increasing frequency and is almost negligible at u.h.f. There may be several paths between transmitting and receiving aerials and losses and phase angles in each path may change as the mobile changes position and therefore the resultant signal to the receiver input also varies. Such changes are large in urban areas where no direct line-of-sight path exists. The effect of large obstructions is not allowed for in CCIR data but smaller irregularities are covered by alteration of a terrain factor. Losses caused by large obstructions can be estimated using a parameter related to their height in wavelengths above an unobstructed datum. In a.m. sets, the output signal/noise ratio follows closely the fluctuations in input signal level but, in f.m. sets, there is a threshold below which the output signal/noise ratio deteriorates rapidly, more rapidly as the deviation ratio\* increases. The average output signal/noise ratio therefore falls below that for a notional average in the absence of fluctuation at these low levels, and degradations of some 8dB for 25 kHz u.h.f. channels and 4 dB for 12.5 kHz v.h.f. channels may be caused by this effect.

**Effect of tuning inaccuracies.** A.m. systems are more tolerant to detuning than f.m. systems in which the result is harmonic distortion rather than the amplitude distortion of the a.m. systems. Noise also increases more rapidly with detuning in f.m. systems because

Table 3. Typical ranges in mobile radio systems

| Band        | Receiver noise figure, dB | Mobile aerial gain, dB | Range in kilometres for ambient noise |      |                   |             |      |                   |           |      |                   |
|-------------|---------------------------|------------------------|---------------------------------------|------|-------------------|-------------|------|-------------------|-----------|------|-------------------|
|             |                           |                        | low                                   |      |                   | medium      |      |                   | high      |      |                   |
|             |                           |                        | a.m.                                  | f.m. | f.m. with flutter | a.m.        | f.m. | f.m. with flutter | a.m.      | f.m. | f.m. with flutter |
| Low v.h.f.  | 5                         | —                      | 37                                    | 55   | 45                | 33          | 46   | 39                | <b>20</b> | 30.5 | <b>25</b>         |
|             | 12                        | —                      | 36                                    | 52   | 43                | 32          | 45   | 38                | 19.5      | 30   | 25                |
| Mid v.h.f.  | 5                         | —                      | 38                                    | 53   | 34                | <b>31.5</b> | 44   | <b>26.5</b>       | 23        | 34   | 19.5              |
|             | 12                        | —                      | 34                                    | 49   | 29.5              | 30          | 42   | 25.5              | 22.5      | 33   | 19                |
| High v.h.f. | 5                         | —                      | 39                                    | 60   | 34                | 33          | 47   | 27.5              | 24        | 35   | 19.5              |
|             | 12                        | —                      | 32                                    | 46   | 27                | 30          | 42   | 24.5              | 23.5      | 34.5 | 19                |
|             | 5                         | 3                      | 45                                    | 68   | 37                | <b>37</b>   | 54   | <b>31.5</b>       | 27        | 39   | 22.5              |
|             | 12                        | 3                      | 36                                    | 53   | 31                | 33          | 48   | 28                | 28        | 38   | 22                |
| u.h.f.      | 5                         | —                      | 26                                    | 41.5 | 29                | 24          | 38   | 28                | 17.5      | 29   | 20                |
|             | 12                        | —                      | 19                                    | 32   | 21.5              | 18          | 30.5 | 20.5              | 16        | 28   | 18.5              |
|             | 5                         | 6                      | 33                                    | 53   | <b>38</b>         | 32          | 49.5 | 35                | 24        | 38   | 26.5              |
|             | 12                        | 6                      | 26                                    | 42   | 29                | 25          | 39.5 | 28.5              | 22        | 35   | 25                |

Note: Flutter allowances are -4dB for v.h.f. and -8dB for u.h.f.

of the resulting asymmetry of the noise sidebands with respect to the centre frequency of the i.f. and discriminator circuits.

Using the CCIR data and assigning typical figures to the various parameters, typical ranges when using the four main frequency bands are given in Table 3. Ranges with and without the flutter allowance discussed above are shown and the most likely conditions for urban systems are shown in bold type. Results are given for a.m. in the u.h.f. band although this type of modulation is not used in that band.

The beneficial effect of aerials with gain at the mobile for the higher bands is evident. The small effect of a substantial degradation in noise figure in mobile low-band receivers can also be seen. If the flutter allowances are not applied, the ranges for f.m. are considerably greater than for a.m. but the flutter allowance brings them more towards equality, in line with field results.

### Interference problems

All present-day mobile radio transmitters, using crystals as frequency-determining elements, are constrained by the availability of crystals and the need to avoid large power gains at the output frequency to use multiplying stages to obtain the final frequency from a lower crystal frequency. A wide range of harmonics of that crystal frequency are generated and all but the wanted one have to be filtered out before the signal reaches the aerial. The limit specified in the UK is  $2.5 \mu\text{W}$  (11.2mV across 50 ohms) which is about 70dB below the wanted output level in a high power set. Even this level of unwanted harmonics, if fed to a resonant aerial, could cause trouble to, or open the mute of, a receiver at a distance of up to about 3km.

In other types of transmitter using synthesizer drive, spurious emissions and noise can be derived from the side

chains or frequency-correcting and stabilising circuits. Noise or signals on supply lines may also modulate the wanted output and good filtering is again necessary. Other unwanted signals can be produced in the output stages of transmitters, spaced at multiples of the spacings between the various signals present. Such spurious signals are especially likely in multiple transmitter installations and can severely restrict the choice of operating frequency for new additions.

As mixing is a feature of all receivers used at present in mobile radio services, the existence of spurious responses is unavoidable. Other unwanted outputs can be produced in a receiver which is overloaded or has insufficient selectivity. Receivers can generate interfering signals at harmonics of the crystal frequency and also at the i.f. Spurious responses can be reduced in number by using the highest practicable injection frequency for the first and only mixer — using more than one mixer adds to their number. The required spurious response ratio with respect to the wanted signal is about 70dB and this can be attained with relatively inexpensive and efficient r.f. tuned circuits for r.f. to i.f. ratios up to about 25. There is therefore a case for a higher i.f. than the conventional 10.7MHz for the u.h.f. band or for the use of double superhets with a much higher first i.f.

Reductions in the overload spurious responses, intermodulation, cross modulation and blocking, are difficult to achieve as they depend on the linearity of the r.f. amplifier and mixer stages unless extremely selective circuits, such as crystal filters, are fitted in the r.f. section. Co-channel signals also cause a great deal of interference and are more likely to cause difficulties in data systems than in those employing speech when they can, to some extent, be ignored. In a.m. receivers, a protection ratio of about 17dB for interfering a.m. signals and 8 to 17dB for f.m.

signals may be necessary for good reception while in f.m. receivers the ratios may be about 10dB and 8dB respectively.

Noise can be generated in transmitters, where it appears as sidebands accompanying the carrier. Noise generated in the crystal stage or subsequent phase modulator in f.m. sets is usually preponderant because of the high following power gain but other sources may be the power lines or the audio circuits which can pick up hum or converter noise. External devices, such as the ignition system, regulator, horn, windscreen wiper and even brakes originate unwanted noise and can usually be made innocuous by suitable decoupling, screening or earthing. In duplex systems, any poor electrical contact between sizable metal parts will produce noise when the transmitter is in use and extensive bonding of all such parts is advisable. In receivers, noise originates mainly in the input stage and aerial, though some may again be fed into audio circuits from noisy supply lines or be picked up by direct radiation from the noisy devices listed above. External noise, not originating in the set or vehicle, is picked up by the aerial and varies widely with frequency and location. Some American measurements of the effects of noise and flutter, in terms of the increase in signal level necessary to restore a specified communication quality, are given in *Table 4*. The degradations tend to a minimum at 470MHz and above showing the reduction of ignition noise with frequency and the residual allowance for flutter.

### Avoiding interference

When only a few stations are sparsely scattered over a given area the main precautions to be taken in choosing frequencies and setting up stations are the avoidance of spurious emission or response frequencies and the reduction of noise. In single frequency systems it may not be possible to operate transmitters and receivers from the same site when more than one channel is involved and they may have to be spaced apart by a few kilometres. Frequency selection becomes more and more difficult as the numbers of closely-sited stations increase because the numbers of third, fifth and higher odd-order intermodulation frequencies increase rapidly with the numbers of stations involved.

If one base station transmitter is shared by a number of small users the channel can be more fully used and fewer base stations are then needed in a given area. This has the obvious limitation that one channel is incapable of serving more than about 60 mobile units using normal procedures. In shared systems, each group of mobile units is selectively-called, individually or as a group, and time limitations are set for base station transmissions to ensure fair sharing of air time.

Where the source of an interfering

Table 4. Degradation of mobile signals by noise and flutter

Signal increase necessary to restore communication quality (dB above 0.7  $\mu$ V).

| Band   | Grade | Mobile stationary in noisy area | Mobile moving in noisy area | Mobile moving in low noise |
|--------|-------|---------------------------------|-----------------------------|----------------------------|
| Low    | 4     | 25                              | 18.5                        | 11.5                       |
| Mid    | 4     | 21                              | 15.5                        | 11                         |
| High   | 4     | 17.5                            | 13.5                        | 10.6                       |
| U.h.f. | 4     | 11                              | 10.5                        | 10                         |
| Low    | 5     | 18                              | 15                          | 8                          |
| Mid    | 5     | 13                              | 11.5                        | 7                          |
| High   | 5     | 10                              | 9                           | 6.5                        |
| U.h.f. | 5     | 6.5                             | 5.5                         | 5.5                        |

Notes: Grade 4 is for noticeable interference, Grade 5 is for annoying interference.

signal is known, a direction aerial can be fitted as a base station with a null in that critical direction. Such minima are usually sharper than the maxima and so the sacrifice of coverage in the direction of the unwanted signal can be small. Conversely, the gain aerial can be used to override an unwanted signal at a mobile from a transmitter located outside the normal coverage area but this method should be used with caution to avoid increasing interference in the neighbouring area.

When sufficient frequency spacing exists between the wanted and the interfering signals, filters can be used to give additional selectivity. Bandpass filters, based on cavity resonators or similar devices offering very high working Q factors, will yield losses of about 30 dB at 2% off centre frequency with an insertion loss of about 1 dB. More complex filters, designed according to conventional techniques, can be

Fig. 6. Typical integrated sideband plot for an a.m. transmitter.

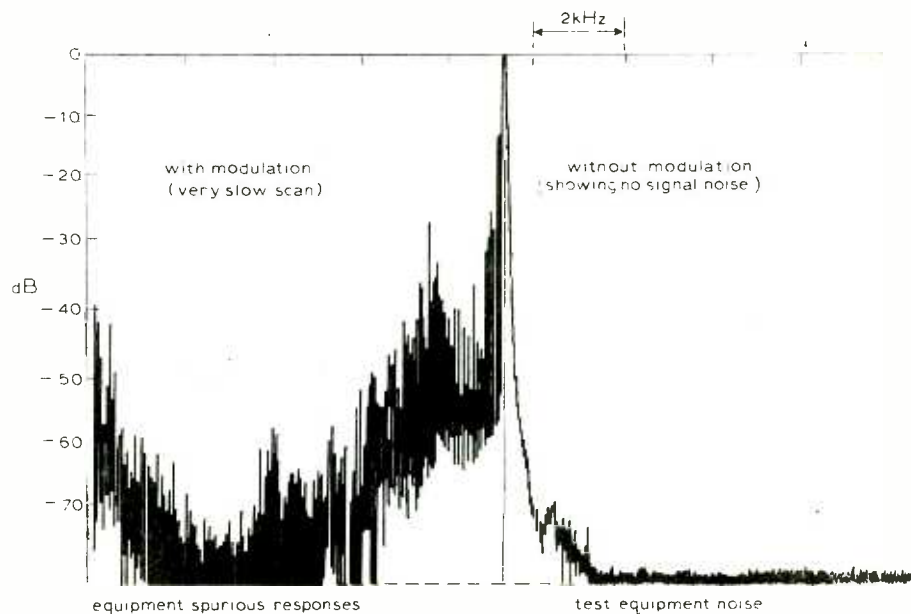

built up from such elements for both bandpass and band-stop functions. In all cases, attention is required to the effect of temperature changes to avoid tuning drifts.

### Comparison of modulation systems

Amplitude modulation has stood the test of time in the UK as a system of modulation which gives good practical results. The process of modulation and detection are readily visualized by servicemen and can be checked with an oscilloscope when desired, making for simple servicing. The use of peak limiters in transmitters has increased the mean level of speech modulation, giving longer ranges or improved signal/noise ratios. Some tailoring of the responses of microphones and audio amplifiers has cut out unnecessary bass, without entirely removing individuality from the operator's voice.

Frequency modulation is still used exclusively in some services and is coming into increasing use in the land-mobile services, owing partly to its exclusive adoption in the u.h.f. band. The usual modulation characteristic is neither pure frequency modulation nor pure phase modulation, but a hybrid whose proportions vary with the degree of limiting imposed in the transmitter audio circuits. In theory, the present 12.5 kHz channel widths are inadequate for faithful transmission of frequency modulation with the full permitted deviation of  $\pm 2.5$  kHz, but the distortion in properly tuned sets resulting from any loss in sidebands has been found, in practice, to be small. Frequency modulation has a considerably wider spread of significant sidebands than amplitude modulation when modulated by a sinewave but, for speech modulation, set to the same peak, the sideband levels are lower for both types of modulation and distortion adds to both, so that the difference between the two is less marked, as shown in Figs. 6 and 7.

In f.m. receivers, an improvement is obtained in output signal/noise ratio above a certain threshold input signal level when compared with an equivalent a.m. receiver but, in practice, flutter and man-made noise mask this effect in mobile service. In point-to-point links, the superior signal/noise ratio in f.m. systems, operating at the higher and more constant signal levels and in the wider channels generally available, makes frequency modulation the usual choice. Fig. 8 shows a typical low-power f.m. mobile unit.

Noise limiters have been developed effective in reducing the nuisance value of impulsive noise in mobiles. In f.m. sets, the width of the i.f. passband limits the height of impulses passed to the audio amplifier after demodulation, but, as the i.f. bandwidth must include some allowance for drift in frequency, these impulse peaks can exceed the peak of the wanted modulation envelope, whereas, for a.m. sets, the peak limiter can be set to clip down to 50% modulation or less without distortion of speech. F.m. limiting is therefore not as effective as a.m. limiting, and suffers more from mistuning. So far, attempts to design an f.m. limiter on the same basis as the a.m. type have not yet yielded sufficient improvement to merit their inclusion in standard mobiles.

F.m. transmitters make better use of an available r.f. output device than an a.m. transmitter. In the last-mentioned,

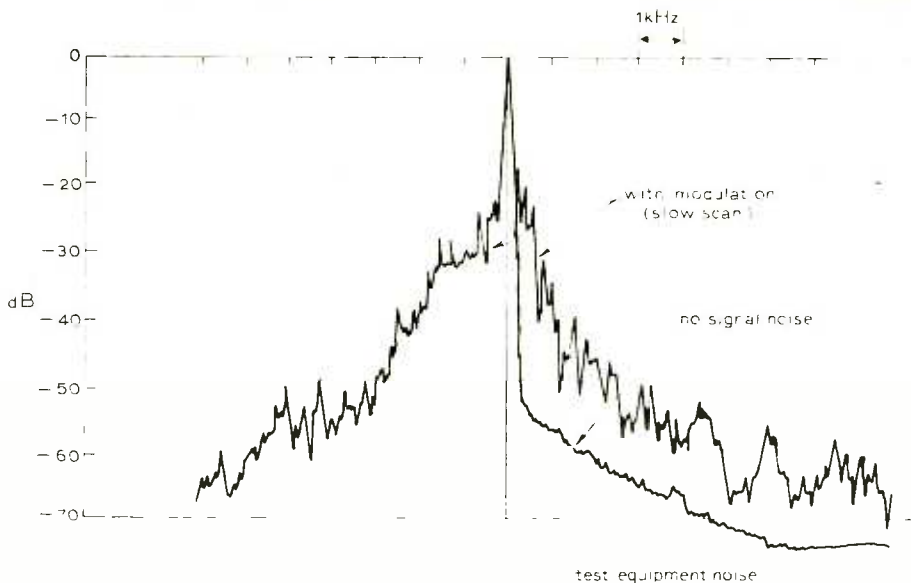
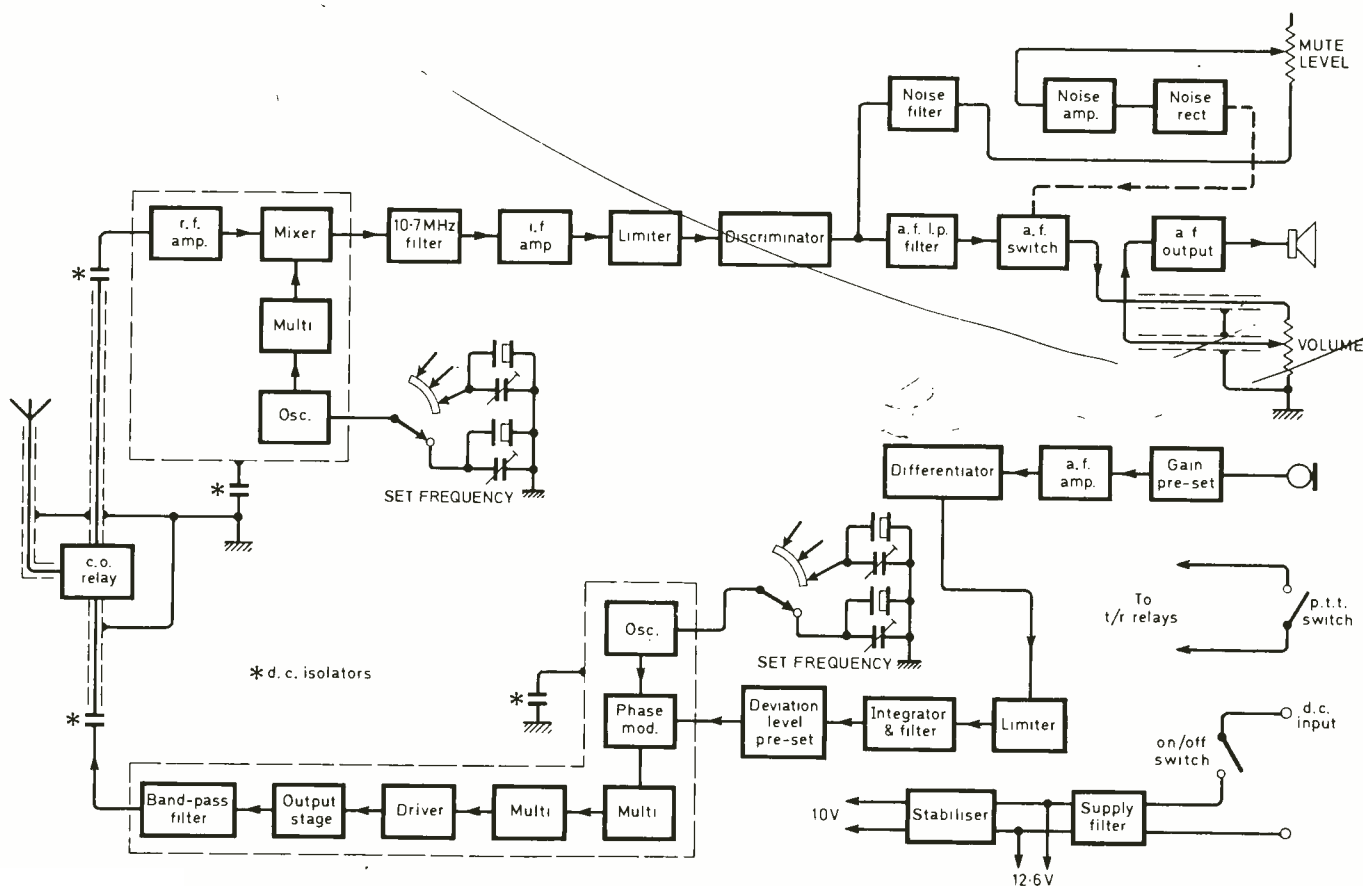

Fig. 7. Typical integrated sideband plot for an f.m. transmitter.

allowance must be made for the upward swing of the modulating voltage and the increased power dissipation under modulated conditions, whereas the f.m. output stage works permanently under steady carrier conditions. The difference in the low-power transmitters used

in the mobile radio services is not very significant however, being less than 2.5 dB in most cases. Power conversion efficiency is also slightly better for f.m. transmitters in this power range, the need for more multipliers or modulators off-setting the absence of the high-level modulator stage. Care is necessary in the design of the supply circuits to the modulated stages in an a.m. transmitter, to ensure that parasitic oscillations cannot occur at any point in the modulation cycle owing to parametric effects in the collector capacitances.

Fig. 8. Block diagram of typical low-power f.m. mobile transceiver.



Single sideband (s.s.b.) operation has been largely ignored in the UK for mobile radio in the v.h.f. and u.h.f. bands, although its use has grown very rapidly in similar bands used by radio amateurs. Reports of trials in the USA in the 1960s were not encouraging and, in particular, revealed poor performance in s.s.b. receivers in the presence of even modest levels of impulsive noise. More recently, it has become apparent that one of the possible advantages of single sideband, that of narrower bandwidth, is not as real as might be supposed, because of the limited rejection of the unwanted sideband achieved in practical transmitters, especially when modulated by speech. Rejections of 40-50 dB are not adequate to free the adjacent channel for use in the same location, and so the number of available channels would not increase in proportion to the nominal reduction in occupied bandwidth. Nevertheless, channel famine may have grown to such an extent that s.s.b. will have to be reconsidered.

In recent years double-sideband suppressed-carrier (d.s.b.s.c.) and double-sideband diminished-carrier (d.s.b.d.c.) systems have been investigated in depth by the University of Swansea on behalf of the UK Home Office in pursuit of a system which would allow area coverage in narrower channels than the present 25 kHz ones, and which would increase the range of the power-conversion efficiency of portable sets. Theoretical and bench studies showed that the original idea of using d.s.b.s.c. was not very practicable, because of difficulties in reinserting the carrier, especially when two signals of comparable strength were being received, and in providing effective a.g.c. It was found that a diminished carrier, set about 16 dB below the equivalent a.m. carrier, would greatly reduce these problems without losing the benefits of beat reduction and transmitter d.c.-to-r.f. efficiency coupled to a degree of secrecy, achieved in the d.s.b.s.c. system.

Double side-band diminished-carrier was preferred to s.s.b., despite its apparent increase in occupied bandwidth, because it did not suffer to the same degree from impulsive noise, being a balanced system, or from a.g.c. problems in receivers, and it can be introduced into an a.m. system with fewer changeover difficulties. Receivers are phase-locked to transmitters, reducing the overall frequency drift to that of the base transmitter, which can be made very stable at little expense. The required channel width can be reduced to about  $25/3$ , or 8.33 kHz. It is expected that d.s.b.d.c. systems will accept data signals readily, but full confirmation of this and other aspects await the results of a large-scale field trial now in progress.

Whereas this system may be suitable for the police and fire service, with their special problems of wide-area coverage

with centralised control, the advantages do not seem to outweigh the disadvantages of initial higher costs and integration difficulties for established commercial systems using amplitude modulation or frequency modulation. In particular, the cautious claim that the channel width could be reduced to 8.3 kHz would not be very attractive in the v.h.f. bands, where channel widths are already 12.5 kHz and the next division in the same tradition as previous splits would be to 6.25 kHz. Such a channel width might be usable by a.m. d.s.b. systems, using phase-locking techniques and the referencing of mobile transmitters to the base station frequency to remove all differential drift, but the chances of a competitive f.m. system seem to be bleak, although the same was once said of the 12.5 kHz system now in general and successful use.

At present, there are no practical alternative systems on offer in which direct speech modulation is replaced by some form of speech coding. It is possible that some such arrangement can be devised which will still further compress the bandwidth required for intelligible speech or which will multiplex many conversations into one channel of present width, allowing present frequency allocations to remain untouched.

The successive reductions in bandwidths over the years have resulted in a worsening in the quality of communication in individual systems, and this has generated a certain amount of dissatisfaction in users taking over new equipment, operating in narrower channels, after having experienced using wider channels. The overall problem, however, is still one of accommodating the large number of users in a limited radio spectrum and so, as in many other fields, quality of communication has to be sacrificed to some degree for quantity.

### Testing and test equipment

Normal routine testing in the field is usually carried out using simple, specialized meters to check important voltages and currents, discriminator operation, when relevant r.f. output and similar parameters. In these days of integrated circuits, first-line servicing can be carried out by interchanging plug-in boards and so a full set of test equipment is needed only at the base workshop. Such equipment must, however, be of a high standard if full scale tests are to yield results related to the performance of the set rather than to the test gear itself.

When the number of sets to be serviced is high, automatic test equipment is sometimes used. Special jigs are necessary to connect the equipment to the sets unless, as is becoming a feature in some sets, a special connector is provided externally for this purpose.

Acceptance testing is carried out by the licensing authority on prototype

units, representative of the subsequent production run. These tests are very exhaustive and are carried out over a range of temperature and supply voltage and demand test gear of a very high standard, especially in respect of adjacent channel noise and frequency stability.

\*deviation ratio = ratio between half the i.f. bandwidth and the a.f. bandwidth.

## Printed-circuit boards

An increasing number of construction designs published in *Wireless World* require the use of printed-circuit boards. Since we are not entirely a constructors' journal, we have not made official arrangements for the supply of boards for our designs. However, we do realize that this leaves many would-be constructors in difficulties and one member of our staff, Mike Sagin, has felt so strongly about this that, entirely independently he has arranged a supply of certain boards himself. To assist him in this work, which is considerable, we would now ask that all enquiries should be sent to this office marked "PCB", whereupon they will be passed to him immediately.

### WW index and binding

The *Wireless World* index for Volume 82 (1976) has been published separately and is now available, price 50p including postage, from the *General Sales Department, IPC Electrical-Electronic Press Ltd, Room 11, Dorset House, Stamford Street, London SE1 9LU*.

**Binding.** Volumes of *Wireless World* including the appropriate index can be bound by our publishers. Send the copies to *Press Binders Ltd, 4-4a Iliffe Yard, Crampton Street, Walworth, London SE17*, with your name and address enclosed. Confirm your order and send it with the remittance (£6.05 including index for each volume) to the *General Sales Department, IPC Electrical-Electronic Press Ltd, Room 11, Dorset House, Stamford Street, London SE1 9LU*.

In both cases, cheques should be made payable to IPC Business Press Ltd.

# World of Amateur Radio

## US prepares for 1979 WARC

Although the United States, like all other countries, will have only one vote at the 1979 World Administrative Radio Conference which may (or may not) rewrite the entire ITU Table of Frequency Allocations, there is little doubt that the proposals of the US delegation will carry considerable weight. Some idea of the attitudes likely to be taken by US delegates on allocations for amateur radio has been revealed recently, although these may not prove to be the final proposals.

Two entirely new allocations for amateurs are suggested: a low-frequency band of 160 to 190 kHz (the United States has no "long-wave" broadcasting); and a u.h.f. band from 902 to 938 MHz.

No entirely new bands are suggested for h.f. (this will disappoint those seeking support for new bands at 10.1, 18.1 and 24 MHz) but existing bands would be extended downwards to: 1750kHz (instead of 1800kHz); 6950kHz (instead of 7000kHz); 13,950kHz (instead of 14,000kHz); and 20,700kHz (instead of 21,000) but the following frequencies would be lost to amateurs: 1920 to 2000kHz and 21,200 to 21,450 kHz. The 220MHz band of Region 2 would be shared with "land mobile" thus opening the way to its use also for Class E Citizens' Band operation.

## Miniaturizing h.f. beams

With so many British amateurs now using factory-built transmitters, receivers and transceivers, one of the remaining areas where a good deal of individual experimentation and home projects continue is that of aerials, where the home product still vies in popularity with the commercial triband yagi beams and multiband verticals. At h.f. few amateurs are in a position to put up beam arrays for bands below 14MHz and even on 14MHz the full-sized arrays based on elements up to 34ft long are often too large to fit the average suburban garden or the urban rooftop.

Several years ago Leslie Moxon, G6XN, showed that for h.f. operation most amateurs come firmly up against a

"gain barrier" of about 6dB (reference dipole), even assuming a three-element yagi or two-element cubical quad, correctly adjusted for optimum performance.

Over many years amateurs have tried to reduce the size, or at least the turning radius of h.f. beams, though most "mini-beam" designs have proved of limited value and not easy to reproduce successfully. Most amateurs thus believe that "mini-beams" are at best a compromise that leaves much to be desired in terms of gain or operational bandwidth or both. Many designs have depended on loading coils which, with a low radiation resistance, are lossy components.

A few years ago a design for an easy-to-construct triband "X" beam using wire elements with a turning radius of 12ft was evolved by Fred Caton, VK2ABQ (formerly G30NC), and more recently he has shown that this can be miniaturised for an 8ft turning radius. Forward gain is about 3dB.

Leslie Moxon, G6XN, believes strongly that miniature beams could become competitive with full-sized units and should be capable of achieving 4dB gain (plus in many cases additional "height gain" since their size and weight should allow them to be raised higher than full-size units without undue difficulty). He has in fact recently been developing a modified form of the VK2ABQ "X" beam using neutralising capacitors to achieve correct balance of currents and phasing in the two elements, and preliminary results are highly promising.

The development of compact high-performance mini-beams that could be built and erected quite easily would represent an important incentive for h.f. long-distance operation among the considerable number of amateurs who are at present discouraged by feeling that they have little hope of consistent success when competing for dx contacts with stations using full-sized arrays.

## Secret listening

Looking through the newsletter of the Derby and District Amateur Radio Society, I see that Tom Douglas, G3BA, recently talked to the society about how, during the 1939-45 war he built and concealed radio receivers while in a Japanese prisoner-of-war camp.

One of the few detailed accounts of such activities by radio amateurs that have been committed to paper is that of Herb Dixon, ZL2BO, who as a lieutenant in the RNZNVR was taken prisoner in Hong Kong. He played a leading role in the construction and operation of three h.f. receivers which successfully picked up news broadcasts from Britain until September 1943.

In one camp a derelict Austin 7 provided wire, nuts and bolts, and the rim of the horn formed part of a vernier tuning dial; headphones were constructed; flux obtained from pine-gum;

solder scrounged from tag boards of defunct power equipment; fellow prisoners contributed more than 300 precious torch batteries. Valves were located in and smuggled out of a prison operating theatre (an unwitting PoW who complained of a pain lost a perfectly sound appendix but brought out three valves in his bandages).

In one camp the receiver was hidden in a watertight container in a lavatory cistern; at North Point a hole was dug under a hut under cover provided by the Canadian Brass Band.

Unfortunately on September 21, 1943, after a four-hour search a receiver was discovered and Herb Dixon was one of nine officers interrogated and sentenced to long terms of imprisonment (of which he served two) under extremely harsh conditions. The set was regarded by the Japanese as a "museum piece" though it is not known if any of these receivers survived the war (as did some of those made in German camps).

## Here and there

The latest Home Office statistics on interference complaints (1975) show a further decrease of 8.5% compared with 1974, with those relating to television down by 13%. Amateur transmitters accounted for 785 of the 40,000 or so complaints, the lowest figure for many years: 1969, 1442; 1970, 1161; 1971, 1027; 1972, 1242; 1973, 1169; 1974, 886. Most amateurs however accept that the official statistics represent only part of the tv problem as many cases of interference are dealt with by the amateurs without involving Post Office investigation.

Many amateurs will greatly regret the death of Bob Palmer, G5PP, for long an ardent member — and former president — of the Midland Amateur Radio Society. He was a well-known Coventry amateur with great interest in 1.8MHz operation, in construction, and in the organization of mobile rallies.

BARTG reports that plans are being formulated for an r.t.t.y.-only repeater in the UK, although much work remains to be done; it is also hoped to add r.t.t.y. identification signals to the new 23cm beacon at Andover, Hampshire (1296.87MHz, 5 watts e.r.p.) which is now operational.

Leslie Fraser, GM3GNX (37 Witchill Road, Fraserburgh, Aberdeen), is seeking support for a Braille magazine for visually handicapped amateurs. The callsign G5LK for long held by a well-known blind amateur, the late Leslie Knight, has been re-issued to the Reigate Amateur Transmitting Society to perpetuate his memory.

At November 30, 1976 some 22,450 people held Home Office amateur licences. A revival of interest in 144MHz amplitude modulation has been reported: for several years this mode has been fast losing support in favour of n.b.f.m. and s.s.b.

PAT HAWKER, G3VA



# New Products

## Monitoring system

A surveillance and monitoring system, from Eddystone Radio Ltd, consists of the 1990R v.h.f./u.h.f. communications receiver and the EP961 Mk IIB panoramic receiver mounted in one compact cabinet. The system allows both visual and aural examination of signals in the range 25 to 500MHz. The 1990R receiver is capable of identifying and locking on to a signal with an accuracy of 100Hz. A range of omnidirectional discone aerials, suitable for use with the system, is also available. Eddystone Radio Limited, Alvechurch Road, Birmingham B31 3PP.

WW 401 for further details

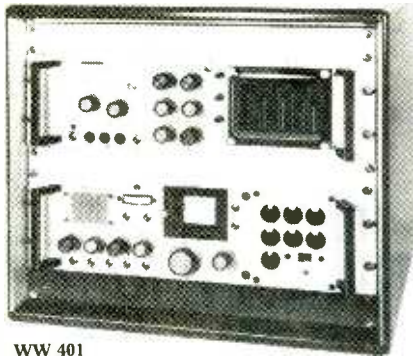

WW 401



WW 402

## Filters to users' specifications

A range of filters, available to users' specifications from Lexor Electronics Ltd, extends from sub-audio frequencies to over 20MHz. The range includes passive inductor-capacitor networks, active filters and high discrimination quartz filters, having high pass, low pass, bandpass or bandstop characteristics. These include high and low pass filters with Butterworth, Tchebycheff or elliptical characteristics, and filters having shaped pass and stop bands. Lexor Electronics Limited, 25/31 Allesley Old Road, Coventry CV5 8BW.

WW 402 for further details

## Audio power meter

An audio-output power meter, from Genrad, is suitable for load impedances, from  $0.6\Omega$  to  $32k\Omega$ . The GR 1840 uses true r.m.s. techniques and is able to measure power as a function of frequency and impedance, from  $0.1mW$  to  $20W$ , in the range  $20Hz$  to  $20kHz$ . Using this instrument the output impedance of a device can be measured by simply plotting for maximum output. True r.m.s. is readable with as much as 20% second and third harmonic present. Accuracy is within 1dB between  $30Hz$  and  $10kHz$  and is better than 0.5dB between  $50Hz$

and  $6kHz$ . Newstech Communications Limited, 22/24 Bell Street, Henley-on-Thames, Oxfordshire, RG9 2BG.

WW 403 for further details

## 20MHz pulse generator

A pulse generator, designed primarily for use with t.t.l. circuits, gives a maximum of 5V output into a  $50\Omega$  load, with a 40mA sink capacity. The instrument, called the Systron Donner model 99, has a variable repetition rate from  $2Hz$  to  $20MHz$  and variable pulse width from 20ns to 200ms, both in seven overlapping ranges. This unit is available ex-stock at a cost of £235 from Electroplan Limited, P.O. Box 19, Orchard Road, Royston, Herts SG8 5HH.

WW 404 for further details

## Transmission/noise tester

The TTI 1110A is a transmission and noise test set with a built-in tunable oscillator. It is designed for measuring signal transmission level, frequency, metallic noise, notched noise and noise to ground. Twin digital displays allow simultaneous measurement of the level and frequency of an incoming test tone. Separate transmission and receiver circuits allow the instrument to send test tones while it is measuring various

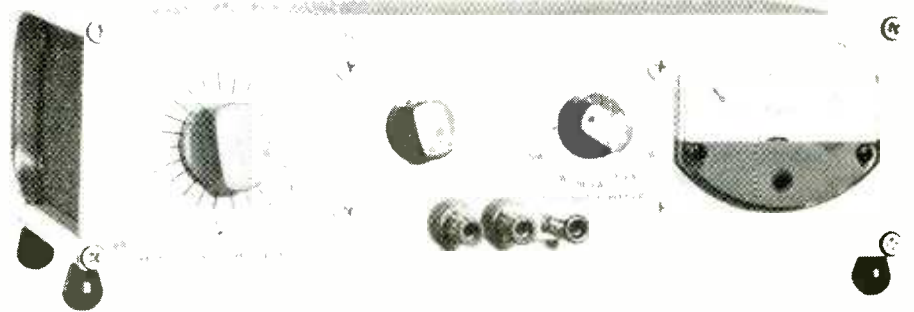

WW 403

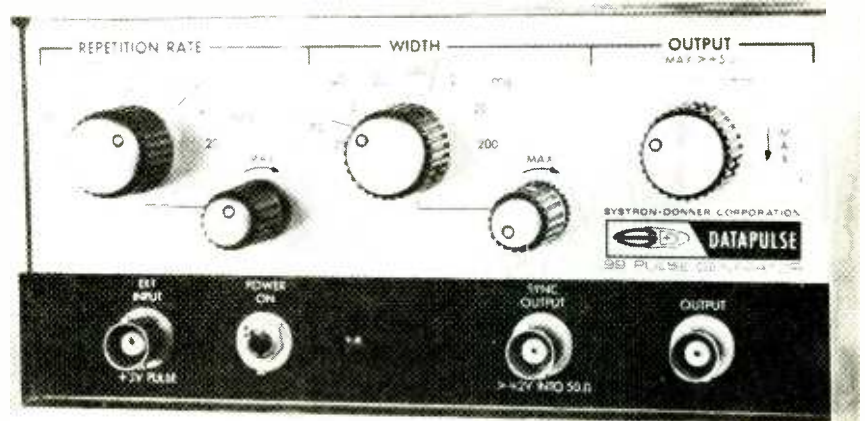

WW 404

received parameters. Other features include a 1010Hz notch filter, an 80dB dynamic range, 100dB longitudinal balance and switch-selectable noise weighting networks. Wandel and Golltermann (UK) Limited, 40-48 High Street, Acton, London W3.

**WW 405 for further details**

### Miniature relays

Miniature two-pole power relays, designated in the MGP(FEME) series, have been updated to offer 8A contact capacities and maximum switching voltages of 360V. Nominal operating times are 10ms and nominal release times are 5ms. Other features include 5mm minimum spacing between pins, large contact areas and long life. Quiller Components Limited, Cardigan House, Wilton, Bournemouth, Dorset BH9 1AU.

**WW 406 for further details**

### Dual h.v. supply

A dual high-voltage power supply, the N1414, has been added to the NIM range of nuclear instrumentation modules. This unit is designed for supplying pre-amplifiers in multiple arrays of proportional counters. Each output is variable by 2000V in the range 0 to 2.8kV d.c., and each voltage is pre-set by the manufacturer to customer requirements. The unit is compatible with



**WW 405**

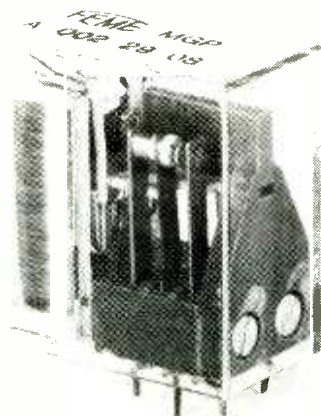

**WW 406**

CAMAC data-handling equipment. Brandenburg Limited, Nuclear Engineering Division, 939 London Road, Thornton Heath, Surrey CR4 6JE.

**WW 407 for further details**

### U.h.f. pre-amplifiers

Three low noise, high gain u.h.f. television pre-amplifiers, designated in the CM6051 series, are available from Labgear Ltd for frequency groups A (470-581MHz), B (615-717MHz), and C/D (695-860MHz). This series offers higher reliability than the CM6000 series which it replaces. The amplifiers, which are in weatherproof plastic cases, measure 45 x 85 x 120mm and have gains of 16, 14 and 12dB respectively. Other characteristics include typical noise figures of 5dB, maximum outputs of 28dB (mV) and input/output impedances of 75Ω. Labgear Limited, Abbey Walk, Cambridge CB1 2RQ.

**WW 408 for further details**

### Instrumentation recorder

The DA1432-4 analogue cassette recorder provides four separate channels, each of which may be operated in the direct mode in the range 50Hz to 8kHz and in the f.m. mode from 0 to 1.25kHz. Each channel has a choice of three carrier filter cut-off frequencies on f.m. and switched record sensitivity covering the range 0.1 to 10V. A choice



**WW 407**



of f.m. carrier frequencies corresponding to I.R.I.G. operation is also provided. Other facilities include monitoring, "voice interrupt" and low-frequency noise compensation on f.m. Price is £1200. Data Acquisition Limited, Brookfield House, Hopes Carr, Stockport, Cheshire SK1 3BQ.

**WW 409 for further details**

### Laser modulator

The model 401 modulator, which is claimed to be suitable for use with a He-Ne laser, is supplied complete with an ultrasonic cell, modulation and driver electronics and a power supply, all housed in one compact unit. Details for five basic experiments are also included in the package, enabling functions such as laser beam intensity, frequency modulation, laser beam steering, acoustic imaging and velocity measurements and r.f. spectrum analysis to be observed. Microwave and Electronics Division, REL Equipment & Components Limited, Croft House, Bancroft, Hitchin, Hertfordshire.

**WW 410 for further details**

### Paper take-up unit

A paper take-up unit, called the P99, is intended for use with miniature drum print heads. This unit has been designed as an ancillary to the Roxburgh MP11

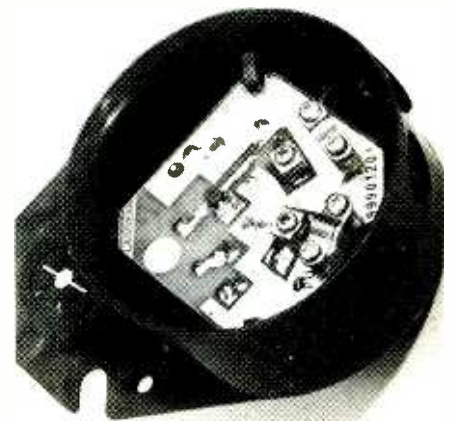

**WW 408**

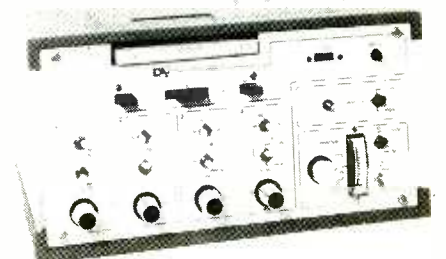

**WW 409**

drum to rewind paper as it is printed. It can also be used with any printing device having a paper width of 58mm. The unit, which operates from a 6.5V d.c. supply at 500mA, has a minimum operating torque of 70gcm. It has a capacity of 100mm diameter. Roxburgh Electronics Ltd, 22 Winchelsea Road, Rye, Sussex.

**WW 411 for further details**

### Microwave signal source

Three klystron sources, types PCLL, PCLS and PCLX, cover the frequency ranges 0.8 to 3.0GHz, 1.5 to 5.0GHz and 4 to 12GHz respectively. Each source has a plug-in klystron in a tunable coaxial cavity and solid state modulators and power supplies. The internal reflector and resonator voltages are automatically tracked to apply the correct potentials to the klystron at any frequency in the range. Readings on the frequency dial are accurate to 1% and the minimum outputs are 10, 5 and 2mW respectively. Flann Microwave Instruments Limited, Dunmere Road, Bodmin, Cornwall PL31 2QL.

**WW 412 for further details**

### Auto-ranging counter

The model 8837, from Malden Electronics, is claimed to be the first all-British fully automatic counter. It is a seven-digit instrument capable of measuring frequencies between 10Hz and 250MHz, and accepting sine, square or pulse

input waveforms having amplitudes from 10mV to 30V (from 10Hz to 2000MHz). At 300MHz an input of about 100mV is required. The instrument accuracy depends upon the choice of crystal unit selected. The standard model uses a 1MHz crystal having a stability of  $\pm 55$ ppm, but models are also available using 10MHz temperature-compensated crystals or oven-controlled oscillators. Price is £250. Malden Electronics Limited, Malden House, 579 Kingston Road, Raynes Park SW20 8SD.

**WW 413 for further details**

### 120 to 420°C soldering

Variable temperature control is accurately maintained in a new soldering unit from Adcola by using a proportional control technique.

As more and more semiconductor manufacturers recommend a soldering temperature of 280°C, Adcola were faced with the possibility of reducing power input to their thermally-balanced irons to reduce bit temperature, which would have meant that fewer joints could be made. Instead they chose a thermocouple sensor, to BS1829, positioned at the rear of the soldering bit and, through a comparator, zero-voltage switching and triac circuitry, which provides proportional control of the heater to within  $\pm 2\%$  of the chosen temperature.

Adcola say the effective power can be increased with this technique, but in practice power increase is limited to 100% because of limitations of the insulating materials. Heating time from 24 to 420°C is less than two minutes and the Noryl handle is virtually cold to the touch during idling.

Safety features, designed to meet world wide standards (Adcola sells 50% of its production overseas), include an earthing system to give maximum safety against leakage currents and to allow "earthing" to associated equipment via a jack socket. The silicone rubber lead is burnproof to at least 420°C. Supply to the iron is 24V, from a toroidal transformer. Adcola Products Ltd, Gauden Road, London SW4.

**WW 414 for further details**

### Noise cancelling microphone

Two microphones, models 3500 and 4500 from Selsound, utilize the characteristics and high magnetic energy of recently-available rare earth materials to achieve small size and good sensitivity. The devices are pressure-gradient, moving-coil transducers which are claimed to be able to discriminate between speech in close proximity and very high levels of environmental noise, even approaching the pain threshold. The largest, type 3500, is 16.5mm diameter by 11 mm deep and weighs 7.5g. Both devices have impedances of

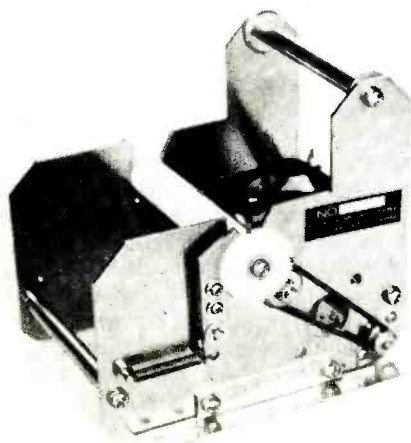

WW 411



WW 412

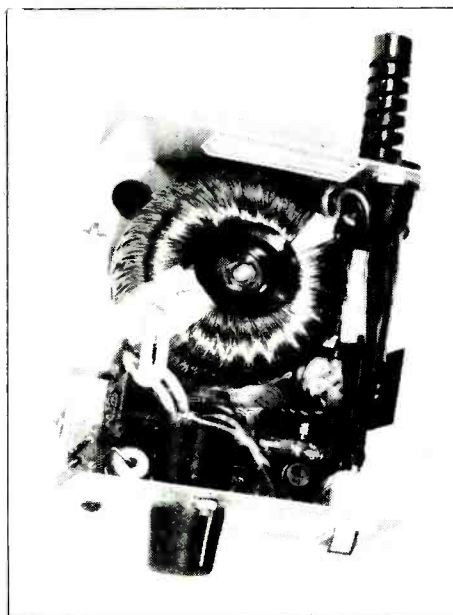

WW 414



WW 413

3000 and hypercardioid polar responses. Frequency responses are substantially flat from 300 to 3500Hz for the model 3500 and 300 to 5000Hz for the model 4500. Sensitivities with respect to 1V for a pressure of 0.1N/m<sup>2</sup> are -89 and -94dB respectively. Selsound, Victory Close, Industrial Estate, Chandlers Ford, Hants.

WW 415 for further details

### R.f.i. filters

Filters in a range made by Axel Electronics Incorporated are specifically designed to exhibit high attenuation under full load conditions, in the frequency range 14kHz to 10GHz. The filters meet all environmental requirements of MIL-F-15733. For the reduction of current spikes in power supplies, Axel produce filters designed to give high current attenuation at the third harmonic of the power line frequency and above, to meet MIL-Std-461/1-4. JVN Components Limited, Bermuda Road, Nuneaton CV10 7QG.

WW 416 for further details

### Keyboard switch

The RSM82 series is a range of low profile keyboard switches which utilize reed switches for reliability. Single pole and double pole switches are available, with or without latching, and an illuminated version may also be obtained. Each unit is designed for p.c.b. mounting and is 0.7in high from the top of the plunger to the base. A large range of button tops, space bars and mechanisms is also available. FR Electronics, Wimborne, Dorset, BH21 2BJ.

WW 417 for further details

### Three-core wire stripper

The Rush model RW3 wire stripper is a hand-operated, bench-mounted machine designed to strip the inner conductor and outer sheath insulations of a three-core mains cable in one operation. This tool, made by Eraser International, may be easily adjusted for different strip lengths and cable sizes. Eraser International Ltd, 2/3 Hampton Court Parade, East Molesey, Surrey.

WW 418 for further details

### Broadband amplifier

The Model 1W1000 is a broadband r.f. amplifier suitable for r.f. measurement and research applications. This unit, made by Amplifier Research, gives a linear 1W output for an input of 1mW over the frequency range 1MHz to 1GHz. The amplifier is untuned and unconditionally stable and will work into any phase or magnitude of load impedance without damage. Texscan Instruments Ltd, 1 North Bridge Road, Berkhamsted, Herts.

WW 419 for further details

## Solid State Devices

Names of suppliers of devices in this section are given in abbreviation after each entry and in full at the end of the section.

### Detector diode

The DC1550 is a low-barrier-height silicon Schottky detector-diode intended for zero bias operation as a detector in broadband levelling systems up to 18GHz. It can also be used as an effective replacement for the germanium point contact diode. The tangential sensitivity is -47dBm, the video impedance is 40k $\Omega$  and the detection efficiency at -10dBm is 150mV. Continuous wave power is rated at 250mW.

WW 420 AEI Semiconductors

### Microprocessor series

The 6500 series of microprocessors extends the 6800 series of eight-bit microprocessors to include high frequency devices. Type 6502 is the basic unit; this operates at 1MHz and is capable of working up to 65k-bytes. Price for one-off is £17.50. 4MHz and 8MHz units are also available.

WW 421 Aardalect

### D.c.-d.c. inverter

The AE1012/AA4580, from Astec, is a small-size, low-cost d.c.-d.c. inverter. It is designed for an input of +5V  $\pm$  10%, from a t.t.l. supply for example, and gives an output of +12V  $\pm$  5% for loads up to 20mA. This unit measures 29  $\times$  13  $\times$  7mm and, for small quantities, is priced at £2.29.

WW 422 GDS

### Sample-hold amplifier

A high performance sample-hold amplifier, designated as SH703, is claimed to meet the requirements for speed and accuracy of nearly all 12-bit data acquisition systems. The unit consists of an op-amp, a low-leakage analogue switch and a m.o.s.f.e.t. unity-gain amplifier. An external holding capacitor is required to match the characteristics to the user's application. The amplifier, which can be used for either inverting or non-inverting, has acquisition and settling times of 4 $\mu$ s, a droop rate of 50mV/s (max), an aperture time of 50ns and a signal range of  $\pm$  10V.

WW 423 Hybrid Systems

## Power transistors

Three pairs of n-p-n silicon power transistors, designated 2N6542 to 2N6547, are continuously rated at 5, 8 and 15A. Each pair has a sustaining  $V_{CE0}$  of either 300 or 400V d.c. (at 25°C) and d.c. current gains of more than 60. The devices, in TO-3 packages, are suitable for high speed switching in inductive circuits, where fall times may be lower than 800ns. Power dissipation figures for the three pairs are 100, 125 and 175W.

WW 424

Jermyn

## Priority encoders

Two eight-line-to-three-line priority encoders are available from Advanced Micro Devices Incorporated. The AM25LS148 is a 16-pin device which performs priority decoding from eight inputs and provides a binary weighted code of the priority order of the inputs. The AM25LS2513, in a 20-pin package, is a gated three-state output version of the above and is suitable for priority interrupt systems. Both of the low-power Shottky devices have been processed to MIL-STD-883 requirements.

WW 425

AMD

## C.m.o.s. circuits

Seventeen digital i.c.s have been added to the standard CD4000 range from RCA. The devices have quiescent currents specified to 20V, maximum leakage currents of 1 $\mu$ A at 20V, 1V noise margin, standardized symmetrical output characteristics and 5, 10 and 15V parametric ratings. This range includes a shift register, a synchronous down-counter, a buffer driver, an arithmetic logic unit and a "look-ahead" carry generator. In addition there are pre-settable counters, registers, buffers, multiplexers, a dual 4-bit latch and a hex Schmitt trigger inverter.

WW 426

RCA

## Suppliers

AEI Semiconductors Ltd, Carholme Road, Lincoln LN1 1SG.

Aardalect Electronics Ltd, Suite E, Georgian House, Trinity Street, Dorchester, Dorset.

Advanced Micro Devices Inc., 901 Thompson Place, Sunnyvale, California, 94086, U.S.A.

GDS Sales Ltd, Michaelmas House, Salt Hill, Bath Road, Slough, Berks.

Hybrid (Component) Systems U.K. Ltd, 12a Park Street, Camberley, Surrey.

Jermyn Distribution, Sevenoaks, Kent.  
RCA Solid State-Europe, Sunbury-on-Thames, Middlesex TW16 7HW.

# KEF gain a new dimension

KEF engineers today are working with radically new techniques. Their computer-based analysis gives them a deeper insight, a more precise three-dimensional vision of speaker performance than was previously possible. They knew that KEF drive units, with their advanced laminated diaphragms, offered a high level of performance. So research looked even harder at the equally vital dividing networks, at cabinet construction and power handling capability. Yesterday's 'try it and see' methods were too imprecise — but the new KEF techniques revealed more. Enclosure materials were studied by impulse response, and network designs refined to get precisely the right response shape from each drive unit.

Applied to *your* speaker needs, the KEF programme has created three important new systems. You will be getting to know them well — Corelli, Calinda and Cantata. A 2 way shelf-mounting system, 3 way reflex free-standing enclosure, and larger 3 way system handling 150 watts. All three have the new computer-designed filter circuits. You can *clearly* hear the difference — better transient response. Lower coloration. All three have redesigned cabinets, weighty with high-density internal damping laminations. All three handle today's power amplifier outputs with confidence and lower distortion. New speakers from KEF always make headlines. Watch for the reviews.

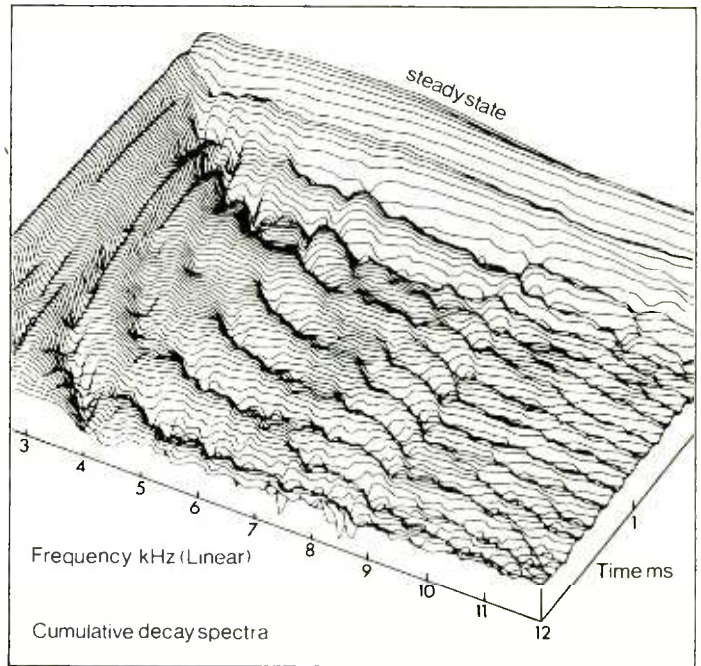

Result: **three** new speakers, Corelli, Calinda, Cantata.



Send me advance information on the new KEF speakers — bookshelf **Corelli**, free-standing reflex **Calinda** and big 3 way **Cantata**.

Stamps for return postage appreciated.

Name \_\_\_\_\_

Address \_\_\_\_\_



KEF Electronics Limited  
Tovil Maidstone ME15 6QP Kent  
Telephone 0622 57258 Telex 96140

WW3/77

# 15 — 240 Watts!

## HY5 Preamplifier

The HY5 is a mono hybrid amplifier ideally suited for all applications. All common input functions (mag Cartridge, tuner etc.) are catered for internally, the desired function is achieved either by a multi-way switch or direct connection to the appropriate pins. The internal volume and tone circuits merely require connecting to external potentiometers (not included). The HY5 is compatible with all I.L.P. power amplifiers and power supplies. To ease construction and mounting a P.C. connector is supplied with each pre-amplifier.

**FEATURES:** Complete pre-amplifier in single pack — Multi-function equalization — Low noise — Low distortion — High overload — two simply combined for stereo.

**APPLICATIONS:** Hi-Fi — Mixers — Disco — Guitar and Organ — Public address.

**SPECIFICATIONS:**

**INPUTS:** Magnetic Pick-up 3mV, Ceramic Pick-up 30mV, Tuner 100mV, Microphone 10mV.

Auxiliary 3-100mV, input impedance 47k $\Omega$  at 1kHz.

**OUTPUTS:** Tape 100mV, Main output 500mV R.M.S.

**ACTIVE TONE CONTROLS:** Treble -12dB at 10kHz, Bass + at 100Hz.

**DISTORTION:** 0.1% at 1kHz, Signal/Noise Ratio 68dB.

**OVERLOAD:** 38dB on Magnetic Pick-up. **SUPPLY VOLTAGE:** 16.50V.

**Price £4.75 + 59p VAT P&P free.**

HY5 mounting board B1 48p + 6p VAT P&P free.

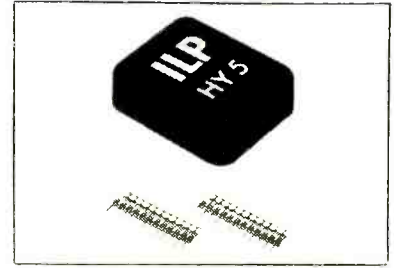

## HY30 15 Watts into 8 $\Omega$

The HY30 is an exciting New kit from I.L.P. it features a virtually indestructible I.C. with short circuit and thermal protection. The kit consists of I.C., heatsink, P.C. board, 4 resistors, 6 capacitors, mounting kit, together with easy to follow construction and operating instructions. This amplifier is ideally suited to the beginner in audio who wishes to use the most up-to-date technology available.

**FEATURES:** Complete kit — Low Distortion — Short, Open and Thermal Protection — Easy to Build.

**APPLICATIONS:** Updating audio equipment — Guitar practice amplifier — Test amplifier — Audio oscillator.

**SPECIFICATIONS:**

**OUTPUT POWER:** 15W R.M.S. into 8 $\Omega$ , **DISTORTION:** 0.1% at 15W.

**INPUT SENSITIVITY:** 500mV, **FREQUENCY RESPONSE:** 10Hz-16kHz — 3dB.

**SUPPLY VOLTAGE:** 18V.

**Price £4.75 + 59p VAT P&P Free.**

**Available  
Ex-stock**

## HY50 25 Watts into 8 $\Omega$

The HY50 leads I.L.P.'s total integration approach to power amplifier design. The amplifier features an integral heatsink together with the simplicity of no external components. During the past three years the amplifier has been refined to the extent that it must be one of the most reliable and robust High Fidelity modules in the World.

**FEATURES:** Low Distortion — Integral Heatsink — Only five connections — 7 Amp output transistors — No external components.

**APPLICATIONS:** Medium Power Hi-Fi systems — Low power disco — Guitar amplifier.

**SPECIFICATIONS:** **INPUT SENSITIVITY:** 500mV.

**OUTPUT POWER:** 25W RMS in 8 $\Omega$  **LOAD IMPEDANCE:** 4-16 $\Omega$ , **DISTORTION:** 0.04% at 25W at 1kHz.

**SIGNAL/NOISE RATIO:** 75dB, **FREQUENCY RESPONSE:** 10Hz-45kHz — 3dB.

**SUPPLY VOLTAGE:** +25V, **SIZE:** 105.50 x 25mm.

**Price £6.20 + 77p VAT P&P free.**



## HY120 60 Watts into 8 $\Omega$

The HY120 is the baby of I.L.P.'s new high power range, designed to meet the most exacting requirements including load line and thermal protection, this amplifier sets a new standard in modular design.

**FEATURES:** Very low distortion — Integral Heatsink — Load line protection — Thermal protection — Five connections — No external components.

**APPLICATIONS:** Hi-Fi — High quality disco — Public address — Monitor amplifier — Guitar and organ.

**SPECIFICATIONS:**

**INPUT SENSITIVITY:** 500mV.

**OUTPUT POWER:** 60W RMS into 8 $\Omega$ , **LOAD IMPEDANCE:** 4-16 $\Omega$ , **DISTORTION:** 0.04% at 60W at 1kHz.

**SIGNAL/NOISE RATIO:** 90dB, **FREQUENCY RESPONSE:** 10Hz-45kHz — 3dB.

**SUPPLY VOLTAGE:** 35V.

**Size:** 114 x 50 x 85mm.

**Price £14.40 + £1.16 VAT P&P free.**

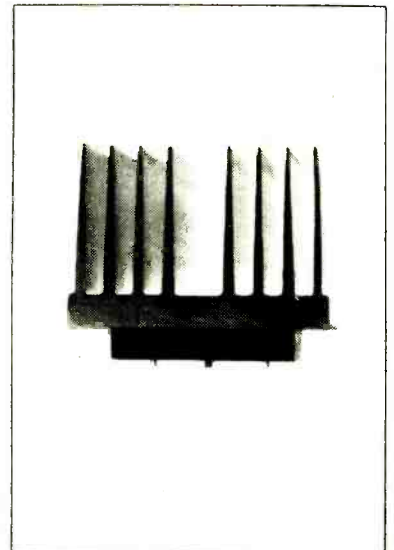

## HY200 120 Watts into 8 $\Omega$

The HY200, now improved to give an output of 120 Watts, has been designed to stand the most rugged conditions, such as disco or group while still retaining true Hi-Fi performance.

**FEATURES:** Thermal shutdown — Very low distortion — Load-line protection — Integral Heatsink — No external components.

**APPLICATIONS:** Hi-Fi — Disco — Monitor — Power Slave — Industrial — Public address.

**SPECIFICATIONS:**

**INPUT SENSITIVITY:** 500mV.

**OUTPUT POWER:** 120W RMS into 8 $\Omega$ , **LOAD IMPEDANCE:** 4-16 $\Omega$ , **DISTORTION:** 0.05% at 100W at 1kHz.

**SIGNAL/NOISE RATIO:** 96dB, **FREQUENCY RESPONSE:** 10Hz-45kHz — 3dB.

**SUPPLY VOLTAGE:** 45V.

**SIZE:** 114 x 100 x 85mm.

**Price £21.20 + £1.70 VAT P&P free.**

## HY400 240 Watts into 4 $\Omega$

The HY400 is I.L.P.'s "Big Daddy" of the range producing 240W into 4 $\Omega$ ! It has been designed for high power disco or public address applications. If the amplifier is to be used at continuous high power levels a cooling fan is recommended. The amplifier includes all the qualities of the rest of the family to lead the market as a true high power hi-fidelity power module.

**FEATURES:** Thermal shutdown — Very low distortion — Load line protection — No external components.

**APPLICATIONS:** Public address — Disco — Power slave — Industrial.

**SPECIFICATIONS:**

**OUTPUT POWER:** 240W RMS into 4 $\Omega$ , **LOAD IMPEDANCE:** 4-16 $\Omega$ , **DISTORTION:** 0.1% at 240W at 1kHz.

**SIGNAL/NOISE RATIO:** 94dB, **FREQUENCY RESPONSE:** 10Hz-45kHz — 3dB.

**SUPPLY VOLTAGE:** 45V.

**INPUT SENSITIVITY:** 500mV, **SIZE:** 114 x 100 x 85mm.

**Price £29.25 + £2.34 VAT P&P free.**

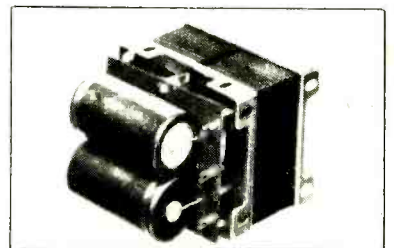

### POWER SUPPLIES

PSU36 suitable for two HY30's £4.75 plus 59p VAT P. P. free.

PSU50 suitable for two HY50's £6.20 plus 77p VAT P. P. free.

PSU70 suitable for two HY120's £12.50 plus 1.00 VAT P. P. free.

PSU90 suitable for one HY200 £11.50 plus 92p VAT P. P. free.

PSU180 suitable for two HY200's or one HY400 £21.00 plus 1.68 VAT P. P. free.

TWO YEARS GUARANTEE ON ALL OF OUR PRODUCTS

I.L.P. Electronics Ltd  
Crossland House  
Nackington, Canterbury  
Kent CT4 7AD  
Tel (0227) 63218

Please Supply \_\_\_\_\_  
Total Purchase Price \_\_\_\_\_  
I Enclose Cheque  Postal Orders  Money Order   
Please debit my Access account  Barclaycard account   
Account number \_\_\_\_\_  
Name & Address \_\_\_\_\_  
Signature \_\_\_\_\_

**DECLON**

# Sculptured foam speaker fronts allow creative design flexibility! Cost savings can be effected

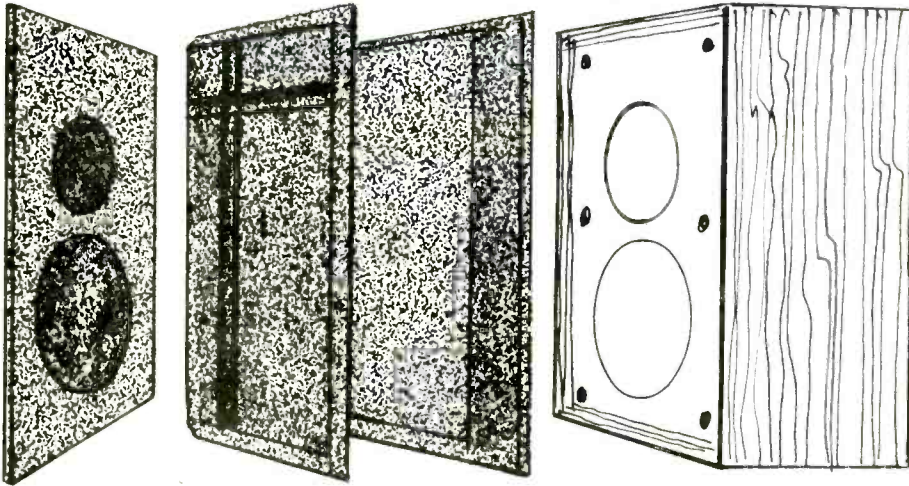

If your aim is to produce an eye-catching styled speaker the fitting of a Declon front could realise that objective. Individual designs can be created for specific purposes and reserved for one purchaser only, thus allowing considerable scope for identification with a particular model or manufacturer. Declon fronts can be back sculptured to allow for cone movement thus

making sub-baffles optional rather than obligatory. New look cabinets can be readily achieved by simply altering the design of a Declon front. Cost savings can be effected in terms of labour and materials when fixing to the speaker cabinet. The material being flexible allows some latitude in the matter of finished cabinet dimensions

- Acoustically Transparent
- Wide Design Scope
- Colour Options

Declon Speaker Fronts are made from reticulated foam which is acoustically transparent over all audible frequencies.

Other Declon products for the Hi Fi Industry: Speaker Gaskets, Damping Foam and Packing Pieces.

**DECLON**

**Declon Foam Plastics Limited**  
Humphrys Road, Woodside Estate  
Dunstable, Beds., LU5 4TW  
Phone: 0582 605141. Telex: 826749  
Trade enquiries only

Member of the  
Airfix Group



WW-083 FOR FURTHER DETAILS

## NEW! Sine-square oscillators

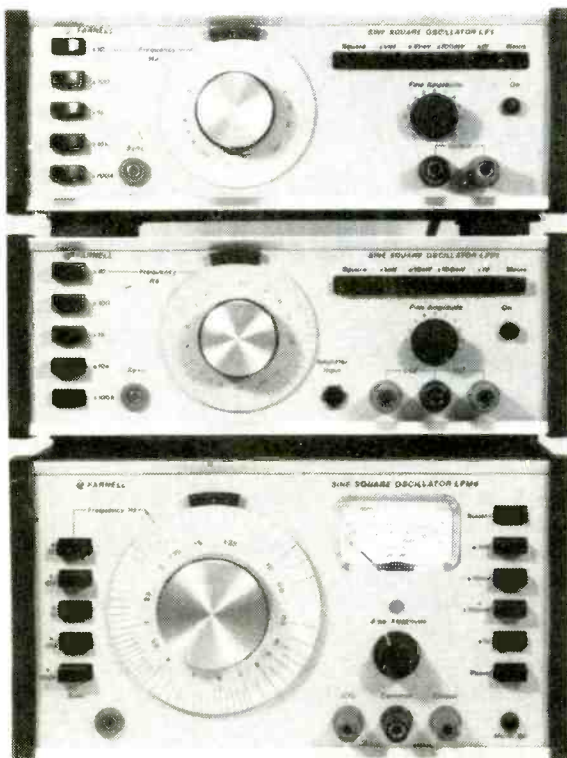

- 10Hz to 1MHz
- Up to 12V p-p
- 3W into  $3\Omega$  - LFP1
- Low audio distortion
- Low bounce
- Mains/battery operation, meter

and TTL output - LFM4



FARNELL INSTRUMENTS LIMITED  
SANDBECK WAY, WETHERBY, WEST YORKSHIRE LS22 4DH  
TELEPHONE 0937-3541 TELEX 557294

LONDON OFFICE: TELEPHONE 01-864 7433 and 7434

WW-104 FOR FURTHER DETAILS

# Put new life into your equalising ....

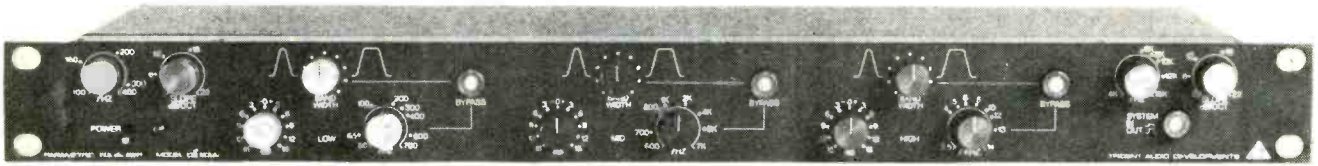

## With the Trident Parametric.

THE TRIDENT MODEL CB9066 PARAMETRIC EQUALISER/FILTER is a comprehensive equaliser offering the user a degree of flexibility in tone correction hitherto unavailable. The five sections of the Equaliser can be used simultaneously. Silent switch operation enables the facility to be used during critical applications such as Disc Mastering, Re-Mixing, etc.

### FEATURES:

- \* Low, Mid and High range, continuously variable control of Frequency, Amplitude and Q.
- \* Separate High-Pass and Low-Pass Filters with continuously variable control of Cut-off frequency and slope.
- \* Silent IN/OUT switching of ranges and system.
- \* Automatic compensation for sharp and broad Q settings adjusts for apparent loss of loudness in sharp Q modes.
- \* Compact 19in. x 1 3/4in. x 8in. rack mountable.
- \* Built-in Power Supply

Send for details to  
**Trident Audio Developments Ltd.**  
**Sales Office: 36-44 Brewer Street**  
**London, W.1**  
**Tel. 01-439 4177. Telex 27782 Tridisc.**



WW — 100 FOR FURTHER DETAILS

### United States Agents:

**East Coast:**  
**Audiotechniques Inc.**  
**142 Hamilton Avenue, Stamford, Conn. 06902**  
**Tel. (203) 359 2312**  
**Contact: Adam Howell.**

### West Coast:

**Studio Maintenance Service**  
**2444 Wilshire Blvd., Suite 214, Santa Monica**  
**Ca. 90403**  
**Tel. (213) 990 5855**  
**Contact: David Michaels**

## The Finest —

## KEYBOARDS

The "S.K.A." Plastic Keyboard was developed by Kimber Allen Ltd in co-operation with a Swedish company and the manufacturers state that in their opinion it is the finest moulded plastic keyboard made and is not to be confused with cheaper keyboards available.

The keys are moulded in Acrylic plastic, a material chosen for its hard wearing properties and ideal feel to the touch. They are moulded in two parts, the key face, which has to be perfect in appearance and finish, and the action, which has to be strong and carry the mechanism. The strong section of aluminium extrusion upon which they are mounted is specially designed to take all the pressures of playing. Springs, felts, and contact actuators are supplied ready-fitted.

The contact assemblies are constructed of laminated bakelite, thus giving smooth slot walls and completely free movement of the gold-clad contact wires. Types available as follows (Contact pairs normally open)

|                    |                 |                              |                   |
|--------------------|-----------------|------------------------------|-------------------|
| <b>GJ-SPCO:</b>    | <b>24p each</b> | <b>GE-4 pairs</b>            | <b>: 45p each</b> |
| <b>GB-2 pairs:</b> | <b>27p each</b> | <b>GH-5 pairs</b>            | <b>: 57p each</b> |
| <b>GC-3 pairs:</b> | <b>36p each</b> | <b>4PS-SPCO &amp; 3 prs:</b> | <b>53p ea</b>     |

We also stock kits and PCBs for the P.E. Synthesiser, P.E. Joanna (electronic piano), P.E. Minisonic, and other sound synthesising and modifying projects published in Practical Electronics. Send SAE for full list (Overseas send 40p).

## PHONOSONICS

**DEPT. WW73, 22 HIGH STREET**  
**SIDCUP, KENT DA14 6EH**

## & CONTACTS



**U.K. POST & HANDLING:**  
**Keyboards: £1.50 each**  
**Contacts:**  
**Orders under £15.00: 25p**  
**Orders over £15.00: 50p**

**37 Note C-C Keyboard :**  
**£24.85**  
**49 Note C-C Keyboard :**  
**£29.50**  
**61 Note C-C Keyboard :**  
**£34.50**

**VAT: Add 12 1/2 % to final total on all U.K. orders**  
**EXPORT ORDERS ARE WELCOME but please see our price list for Export Postage Rates. N.B. EIRE, CHANNEL ISLES & B.F.P.O. classify as Export.**

**MAIL ORDER AND C.W.O. ONLY — SORRY BUT NO CALLERS PLEASE**  
**Prices are correct at time of Press, E. & O.E. Delivery subject to availability**

WW—031 FOR FURTHER DETAILS





# AMPLIFIER MODULES

25-100 W rms  
FROM TAMBA ELECTRONICS

LOW COST QUALITY POWER AMPLIFIER MODULES, POWER SUPPLIES & MIXERS FOR HI-FI, DISCO, P.A. GROUP & CLUB APPLICATIONS

**TAM1000** 100 watts rms into 4 ohms, 65v supply **£9.80**

**TAM500** 50 watts rms into 4 ohms, 45v supply **£7.50**

**TAM250** 25 watts rms into 8 ohms, 45v supply **£4.75**



- 20-20,000HZ ± 1dB
- SILICON CIRCUITRY THROUGHOUT
- High sensitivity (100mV 40K)
- Low distortion (typically 0.1%)
- Low profile (1in. high x 3½ x 3in.)
- Four simple connections
- Glass fibre P C B

High grade components used throughout. e.g. Texas, Mullard, R.C.A., Plessey, etc.

**POWER SUPPLIES:**  
For one TAM 1000 **£9.80**  
For one or two TAM 250/500 **£7.50**  
(Carr. 50p on supplies)

## MODULAR MIXER PRE-AMP £6.50

- 60 mm slider volume
- Full range bass & treble controls
- Built-in supply smoothing
- Operates from main supply
- Modular style anodised aluminium fascia
- High & medium sensitivity inputs
- Form up to 10 channel systems
- Accepts a wide variety of inputs

ADD 8% VAT TO ALL PRICES except TAM 250 & Mixer Modules (12½%)

Access & Barclaycard accepted. Write or telephone (01) 684 0098. Callers welcome COD 60p extra

# TAMBA ELECTRONICS

Bensham Manor, Road Passage, Bensham Manor Road, Thornton Heath, Surrey.

# CRYSTAL CONTROLLED OSCILLATOR TTL COMPATIBLE

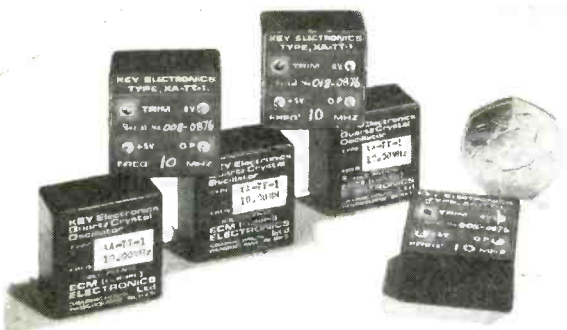

The XA-TT-1, TTL compatible Quartz Crystal Oscillator Module is designed for high accuracy applications such as time bases, clock generators and counter timers. All modules have a built in trim facility and operate over the voltage range 4-12 volts DC, standard range is 4 to 15 MHz, supply current 10mA max at 5 volts. Temperature coefficient less than 0.5 ppm/°C. Fan out of 10 standard TTL loads.

**ECM (EUROPE) ELECTRONICS LTD**



GRAPHIC HOUSE  
PANGBOURNE, BERKS

Telephone 07357 4611  
Telex 847544

WW-091 FOR FURTHER DETAILS



# Distributors for Plessey - Remo

## Valves

| Type   | Price (p) | Type   | Price (p) |
|--------|-----------|--------|-----------|
| DY87   | 43        | PCF802 | 52        |
| DY802  | 43        | PCL82  | 54        |
| ECC82  | 44        | PCL84  | 55        |
| EF80   | 34        | PCL85  | 57        |
| EF183  | 39        | PCL86  | 52        |
| EF184  | 39        | PFL200 | 65        |
| EH90   | 40        | PL36   | 63        |
| PC86   | 58        | PL84   | 30        |
| PC88   | 58        | PL504  | 90        |
| PC900  | 30        | PL508  | 85        |
| PCC89  | 46        | PL509  | £1.35     |
| PCC189 | 47        | PY88   | 43        |
| PCF80  | 41        | PY500A | £1.25     |
| PCF86  | 44        | PY800  | 47        |
| PCF801 | 46        |        |           |

## Semi Conductors

| Type   | Price (p) | Type   | Price (p) |
|--------|-----------|--------|-----------|
| AF126  | 38        | BC214L | 15        |
| AF127  | 38        | BC237  | 11        |
| AF139  | 39        | BC238  | 11        |
| AF178  | 69        | BC301  | 30        |
| AF180  | 69        | BC303  | 30        |
| AF181  | 69        | BC327  | 13        |
| AF239  | 45        | BC328  | 13        |
| AF240  | 20        | BC337  | 12        |
| AL102  | £1.40     | BC338  | 12        |
| AL103  | £1.30     | BC546  | 13        |
| AU107  | £1.35     | BC547  | 12        |
| AU110  | £1.20     | BC548  | 12        |
| AU113  | £1.05     | BC549  | 13        |
| BC107  | 10        | BC550  | 14        |
| BC107B | 15        | BC557  | 13        |
| BC108  | 10        | BC558  | 12        |
| BC109  | 12        | BCY72  | 16        |
| BC109C | 14        | BD115  | 39        |
| BC113  | 15        | BD116  | 59        |
| BC114  | 15        | BD124  | 75        |
| BC115  | 17½       | BD131  | 35        |
| BC116  | 17½       | BD132  | 39        |
| BC116A | 25        | BD133  | 45        |
| BC117  | 14        | BD135  | 29        |
| BC118  | 15        | BD136  | 30        |
| BC119  | 27        | BD137  | 30        |
| BC125  | 17½       | BD138  | 33        |
| BC125B | 18        | BD139  | 37        |
| BC126  | 15        | BD140  | 39        |
| BC132  | 15        | BD144  | £1.99     |
| BC135  | 15        | BD160  | £1.65     |
| BC136  | 16        | BD181  | 80        |
| BC137  | 20        | BD182  | 90        |
| BC138  | 30        | BD183  | 80        |
| BC139  | 28        | BD184  | £1.10     |
| BC140  | 32        | BD222  | 47        |
| BC141  | 28        | BD225  | 47        |
| BC142  | 20        | BD232  | 50        |
| BC143  | 25        | BD233  | 43        |
| BC147  | 8         | BD234  | 49        |
| BC147A | 11        | BD235  | 49        |
| BC148  | 9         | BD236  | 53        |
| BC149  | 10        | BD237  | 49        |
| BC153  | 20        | BD238  | 55        |
| BC154  | 20        | BDX32  | £2.40     |
| BC157  | 11        | BDY20  | 80        |
| BC158  | 10        | BF115  | 38        |
| BC159  | 11        | BF152  | 20        |
| BC160  | 30        | BF158  | 20        |
| BC161  | 33        | BF160  | 35        |
| BC171  | 10        | BF167  | 24        |
| BC172  | 10        | BF173  | 25        |
| BC173  | 15        | BF178  | 33        |
| BC178  | 18        | BF179  | 38        |
| BC178B | 20        | BF180  | 31        |
| BC179  | 22        | BF181  | 35        |
| BC182  | 11        | BF182  | 30        |
| BC182L | 12        | BF183  | 30        |
| BC183L | 12        | BF184  | 29        |
| BC184  | 12        | BF185  | 30        |
| BC186  | 25        | BF186  | 26        |
| BC187  | 25        | BF194  | 8         |
| BC204  | 14        | BF195  | 8         |
| BC212  | 11        | BF196  | 10        |
| BC212L | 11        | BF197  | 11        |
| BC213  | 11        | BF198  | 23        |
| BC213L | 11        | BF199  | 25        |
| BC214  | 13        | BF200  | 28        |

## Integrated Circuits

| Type              | Price (p) | Type     | Price (p) |
|-------------------|-----------|----------|-----------|
| MC1351P           | 70        | TA 7072P | £1.53     |
| ML 231B           | £4.20     | TA 7074P | £1.34     |
| (Equip. ETTR6016) |           | TA7124P  | 73        |
| ML 232B           | £4.20     | TA7141AP | £1.40     |
| SL 414A           | £1.68     | TA 7171P | £1.65     |
| SL 415A           | £2.20     | TA 7172P | £1.65     |
| SL 1310           | £1.54     | TA 7173P | £2.20     |
| SL 3046           | 73        | TA 7176P | £1.30     |
| SL 76544          | £1.50     | TAA550   | 32        |
| SN76003N          | £2.35     | TAA 570  | £1.30     |
| SN76013N          | £1.43     | TAA 661B | 81        |
| SN76013ND         | £1.25     | TAA700   | £2.56     |
| SN76023N          | £1.43     | TBA120S  | £1.14     |
| SN76023ND         | £1.20     | TBA120AS | 60        |
| SN76033N          | £2.15     | TBA120SQ | £1.00     |
| SN76110N          | £1.75     | TBA480Q  | £1.40     |
| SN76226N          | £2.20     | TBA520Q  | £2.06     |
| SN76227N          | £1.45     | TBA530Q  | £1.30     |
| SN76532N          | £1.45     | TBA540Q  | £2.00     |
| SN76533N          | £1.50     | TBA550Q  | £2.56     |
| SN76544N          | £1.70     | TBA560CQ | £2.56     |
| SN76650N          | £1.15     | TBA750Q  | £1.43     |
| SN76660N          | 60        | TBA800   | £1.10     |
| SN76666N          | 90        | TBA920Q  | £2.64     |
| TA 7050P          | £1.13     | TBA990Q  | £2.56     |
| TA 7051P          | £1.45     | TCA270Q  | £2.64     |
|                   |           | TCA 800  | £4.60     |

## Semi Conductors

| Type   | Price (p) | Type      | Price (p) |
|--------|-----------|-----------|-----------|
| AC107  | 25        | AC188     | 18        |
| AC126  | 24        | AC188K    | 30        |
| AC127  | 20        | AC193K    | 36        |
| AC128  | 15        | AC194K    | 35        |
| AC128K | 24        | AD140     | 65        |
| AC141  | 24        | AD142     | 62        |
| AC141K | 28        | AD143     | 65        |
| AC142  | 18        | AD149     | 65        |
| AC142K | 31        | AD161     | 47        |
| AC151  | 28        | AD161/2PR | £1.00     |
| AC154  | 18        | AD162     | 38        |
| AC155  | 18        | AF114     | 25        |
| AC156  | 28        | AF115     | 22        |
| AC176  | 22        | AF116     | 22        |
| AC176K | 34        | AF117     | 20        |
| AC187  | 20        | AF118     | 52        |
| AC187K | 33        | AF124     | 38        |
|        |           | AF125     | 27        |

# low cost - top quality COMPONENTS

• Siemens • A.E.G. Telefunken • Teleng and Toshiba Components

## Semi Conductors

| Type     | Price (p) | Type        | Price (p) |
|----------|-----------|-------------|-----------|
| BF218    | 40        | BU205       | £1.67     |
| BF224    | 20        | BU206       | £1.95     |
| BF240    | 17        | BU208       | £2.20     |
| BF241    | 17        | BU208/02    | £2.75     |
| BF257    | 28        | BUY69B      | £2.50     |
| BF258    | 26        | BUY69A      | £2.65     |
| BF259    | 30        | E1222       | 38        |
| BF336    | 37        | MJE340      | 45        |
| BF337    | 35        | MJE520      | 44        |
| BF338    | 34        | 2N696       | 30        |
| BF355    | 50        | 2N706       | 15        |
| BF457    | 37        | 2N3053      | 20        |
| BF458    | 37        | 2N3054      | 65        |
| BF459    | 38        | 2N3055      | 55        |
| BF742    | 35        | 2N3702      | 12        |
| BFT43    | 35        | 2N3703      | 12        |
| BFX29    | 29        | 2N3704      | 10        |
| BFX84    | 29        | 2N3705      | 10        |
| BFX85    | 30        | 2N3706      | 10        |
| BFX86    | 28        | 2N3819      | 38        |
| BFX88    | 25        | 2N5296      | 40        |
| BFY50    | 19        | 2N5496      | 53        |
| BFY51    | 19        | OC71        | 29        |
| BFY52    | 20        | OC72        | 29        |
| BFY90    | £1.10     | R2008B      | £1.90     |
| BR100    | 32        | R2010B      | £1.90     |
| BR101    | 38        | RCA16334    | 80        |
| BRC4443  | 80        | RCA16335    | 80        |
| BRY39    | 38        | S2802       | £2.99     |
| BSY52    | 30        | S6080 A KIT | £4.90     |
| BT106    | £1.20     | TIP31A      | 52        |
| BT108    | £1.50     | TIP32A      | 62        |
| BT116    | £1.25     | TIP41A      | 60        |
| BU105/02 | £1.60     | TIP42A      | 75        |
| BU108    | £1.80     | TIS91       | 27        |
| BU126    | £1.49     |             |           |
| BU204    | £1.80     |             |           |

## Diodes

| Type      | Price (p) | Type   | Price (p) |
|-----------|-----------|--------|-----------|
| BA115     | 9         | OA90   | 6         |
| BA145     | 16        | OA91   | 7         |
| BA148     | 16        | OA95   | 5 1/2     |
| BA154/201 | 12        | OA202  | 8         |
| BA155     | 15        | IN914  | 6         |
| BAX13     | 6         | IN4001 | 4         |
| BAX16     | 6         | IN4002 | 5         |
| BY126     | 11        | IN4003 | 5         |
| BY127     | 10        | IN4004 | 5         |
| BY199     | 25        | IN4005 | 5         |
| BY206     | 17        | IN4006 | 6         |
| BYX10     | 14        | IN4007 | 6         |
| OA47      | 8         | IN4148 | 4         |

★20p or less. Minimum 5 items

## EHT Multipliers

| Type                                  | Order Code | Price |
|---------------------------------------|------------|-------|
| Thorn 950 MK II 1400                  | D101P      | £2.07 |
| Thorn 1500 3 stick                    | D102Y      | £1.98 |
| Thorn 1500 5 stick                    | D103G      | £2.17 |
| Thorn 1590 Stick                      | D104E      | £0.35 |
| ITT, Philips Mono Large Screen        | D105C      | £0.61 |
| Rank Z 718                            | D106A      | £1.54 |
| Thorn 3000/3500                       | D107J      | £5.34 |
| Thorn 8000                            | D108H      | £1.98 |
| Thorn 8500                            | D109F      | £4.14 |
| Thorn 9000                            | D110Y      | £6.50 |
| Decca Doubler                         | D111G      | £2.74 |
| Decca 30 Series                       | D112E      | £4.96 |
| Decca 80 Series                       | D113C      | £5.30 |
| G.E.C. Hybrid                         | D114A      | £4.96 |
| G.E.C. Solid State                    | D115J      | £5.30 |
| ITT CVC 1-5                           | D116H      | £4.96 |
| ITT CVC 20                            | D117F      | £5.30 |
| Philips G8                            | D118D      | £4.96 |
| Philips 550                           | D119B      | £4.96 |
| Pye 691/693                           | D120E      | £3.66 |
| Pye 731                               | D121C      | £4.92 |
| Rank A823                             | D122A      | £4.96 |
| Korting                               | D125F      | £4.96 |
| Telpro/Carnival/Hamilton/ Steepletone | D126D      | £5.35 |

## New Mono Tubes (110)

| Screen Type   | Equivalent | Price      |        |
|---------------|------------|------------|--------|
| 12" Toshiba   | TMT 31/101 |            |        |
| E2117A        | A31/250W   | £17.75     |        |
| 14" Toshiba   | M6529 FZP  | TMT 34/101 | £17.95 |
| 20" A50-120WR | CME 2013   | £15.50     |        |
| 24" A61-120WR | CME 2413   | £17.30     |        |

## New Colour Tubes (90)

| Screen Type   | Equivalent           | Price  |
|---------------|----------------------|--------|
| 19" A49-191X, | A49-192 and A49-120X | £57.70 |
| 20" A51-110X  |                      | £66.95 |
| 22" A56-120X  |                      | £69.90 |

## Aerial Accessories

| Type  | Price       |
|---|-------------|
| Coax Plugs                                    | each 10.5p  |
| Standard Superverters                         | each £13.50 |
| Superverters with variable gain               | each £15.95 |
| Superverters with variable gain and frequency | each £17.45 |
| Broad Band Amplifier DY7331                   | each £16.50 |

● All Teleng products available through C.P.C.

## DISTRIBUTORS

Contact your local distributor for fast local service. Regular calls arranged to meet your requirements

### SCOTLAND

Elcomatic Ltd.  
Kirktonfield Road,  
Melliston, Glasgow G78 3PL  
Tel. 041-881 5825

### N.IRELAND

Electronic Sales  
(Ulster) Limited,  
465 Antrim Road  
Belfast BT15 2BJ  
Tel Belfast (0232) 772611

### LANCASHIRE

Moorside Electrical Co.,  
70 Moorside Avenue,  
Smithills  
Bolton. Tel. 0204 40918

### WEST YORKSHIRE

Briden Components  
Brearton Street  
Manningham Lane  
Bradford  
Tel. 0274-29375

### M'SIDE CHESHIRE SALOP

Scientific Instrument  
Distributor Services  
29b Beam Street  
Nantwich, Cheshire  
Tel: Nantwich (0270) 626853

### WALES

Swansea Aerial Co. Ltd.,  
Siloh Road,  
Landore,  
Swansea SA1 2NT  
Tel. Swansea 50393/54836

### WEST MIDLANDS

Geetavision  
85 Far Gosford Street  
Coventry  
Tel. Coventry 56476-503598

### EAST MIDLANDS

Belvoir TV & Audio  
Components,  
66 Mill St., Melton Mowbray,  
Leicestershire LE13 1AZ  
Tel. 0664 5666

### CAMBS. BEDS. HERTS.

Cambridge Electronic  
Components  
236 High Street  
Cottenham Cambridge  
Tel. 0954 50292

### EAST ANGLIA

Norwich Electronic Components  
16 Denbigh Road,  
Norwich. NR2 3AA  
Tel. 0603 28625

### S. LONDON & S. EAST

Paul Electrical Ltd.,  
250/252 Grand Drive,  
Raynes Park,  
London. SW20  
Tel. 01 542 6546

### DORSET HANTS. I O W

Double D. Distributors,  
16 Highfield Road,  
Bournemouth BH9 2SG  
Tel. 0202 519562

### SOUTH WEST

D. B. Components,  
1 Devonshire Street,  
Greenbank, Plymouth, Devon  
Tel. (0752) 24369

## \*PRICE

Highly competitive

## \*QUALITY

Leading manufacturers

## \*RELIABILITY

Fast efficient service



Good people to deal with

# COMBINED PRECISION COMPONENTS LTD.

C.P.C., Dept. EET 194-200 NORTH ROAD, PRESTON, LANCASHIRE, ENGLAND  
Phone: Preston (STD 0772) 55034. Telex 677122

WORLD WIDE EXPORT SERVICE ask for ROBIN PRATT New price list 1.12.76

## 30 x 30 WATT AMPLIFIER KIT

Specially designed by RT-VC for the experienced constructor, this kit comes complete in every detail. Same facilities as Viscount IV amplifier. Chassis is ready punched, drilled and formed Cabinet is finished in teak veneer. Black fascia and easy-to-handle aluminium knobs. **£29.00**  
Output 30 + 30 watts rms, 60 + 60 peak.



+ p & p £2 10

## STEREO CASSETTE DECK KIT

Again, this kit is specially designed for the experienced constructor - for mounting into his own cabinet. Features include solenoid-assisted AUTO-STOP, 3-digit counter, record/replay PC board mains transformer and input and output controls. AC BIAS AND ERASE **£32.50**  
+ p & p £1.50

## DELUXE ACCESSORY KIT

Comprises of a matched pair of dynamic mics. and two replacement slider level controls. P & P **£3.95**  
FREE WHEN PURCHASED TOGETHER. £1.00

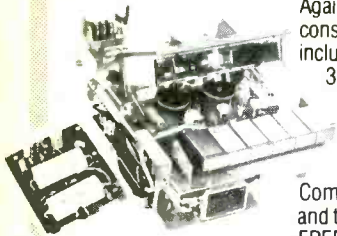

FANTASTIC SAVING

## sinclair NEW I.C. 20, 20 WATTS STEREO AMPLIFIER KIT WITH PZ 20 POWER UNIT

A build-it-yourself stereo power amplifier with latest integrated circuitry. 10W RMS per channel output, full short-circuit and overheat protection. **£4.95** OUR PRICE  
Complete with PZ20 Power Supply LIST £14.50

## 35-WATT DISCO AMP

Here's the mono unit you need to start off with. Gives you a good solid 35 watts rms, 70 watts peak output. Big features include two disc inputs, both for ceramic cartridges, tape input and microphone input. Level mixing controls fitted with integral push-pull switches. Independent bass and treble controls and master volume. **£27.50**  
+ p & p £1.50



## PORTABLE DISCO CONSOLE with built-in pre-amplifiers

Here's the big-value portable disco console from RT-VC! It features a pair of BSR MP 60 type auto-return, single-play professional series record decks. Plus all the controls and features you need to give fabulous disco performances. Simply connects into your existing slave or external amplifier. **£55.00**  
+ p & p £6.50



## DIY SPEAKER KITS

### EASY-TO-BUILD WITH ENCLOSURE

Specially designed by RT-VC for cost-conscious hi-fi enthusiasts, these kits incorporate two teak-simulate enclosures, two EMI 13" x 8" (approx.) woofers, two tweeters and a pair of matching cross-overs. Easily constructed, using a few basic tools. Supplied complete with an easy-to-follow circuit diagram, and crossover components. Input 15 watts rms, 30 watts peak, each unit. Cabinet size 20" x 11" x 9 1/2" (approx.) **£25.50**  
PER PAIR + p & p £5.50



### 'COMPACT' FOR TOP VALUE

How about this for incredible bookshelf value from RT-VC! A pair of high efficiency units for only £7.50 - just what you need for low-power amplifiers. These infinite baffle enclosures come to you ready mitted and professionally finished. Each cabinet measures 12" x 9" x 5" (approx.) deep, and is in wood simulate. Complete with two 8" (approx.) speakers for max. power handling of 7 watts. **£7.50**  
per pair + p & p £1.70

### 15-WATT KIT IN CHASSIS FORM

When you are looking for a good speaker, why not build your own from this kit. It's the unit which we supply with the above enclosures. Size 13" x 8" (approx.) woofer, (EMI) tweeter, and matching crossover. Power handling capacity 15 watts rms, 30 watts peak. **£8.50**  
PER SET + p & p £1.70

### DECCA 20 WATTS STEREO SPEAKER

This matching loudspeaker system is hand-made, as only Decca know how, built to a specification, not down to a price. The kit comprises of two 8" diameter approx. base drive unit, with heavy die cast chassis laminated cones with rolled PVC surrounds. Two 3 1/2" diameter approx. domed tweeters complete with crossover networks. **£30.00**  
+ p & p £4.00



Our price per stereo pair **£30.00**  
+ p & p £4.00

## 20 x 20 WATT STEREO AMPLIFIER

**£29.90**  
+ p & p £2 10



Superb Viscount IV unit in teak-finished cabinet. Silver fascia with aluminium rotary controls and pushbuttons, red mains indicator and stereo jack socket. Function switch for mic, magnetic and crystal pick-ups, tape, tuner, and auxiliary. Rear panel features two mains outlets, DIN speaker and input sockets, plus fuse. 20 + 20 watts rms, 40 + 40 watts peak.

## HOW YOU CAN SAVE

**SYSTEM 1B** For only £80, you get the 20+20 watt Viscount IV amplifier, a pair of our 12-watt-rms Duo Type 1b matched speakers; a BSR MP 60 type deck complete with magnetic cartridge, de luxe plinth and cover. **£80.00**  
+ p & p £6.50  
Carriage surcharge to Scotland

**SYSTEM 2** Comprising our 20+20 watt Viscount IV amplifier; a pair of our large Duo Type III matching speakers which handle 20 watts rms each, and a BSR MP 60 type deck with magnetic cartridge, de luxe plinth and cover. **£92.00**  
+ p & p £7.60

**SPEAKERS** Two models - Duo 1b, teak veneer, 12 watts rms, 24 watts peak, 18 1/2" x 13 1/2" x 7 1/4" approx. **£34**  
PER PAIR + p & p £6.50  
Duo III, 20 watts rms, 40 watts peak, 27" x 13" x 11 1/2" approx. **£48**  
PER PAIR + p & p £7.50



**TURNTABLE** Popular BSR MP 60 type, complete with magnetic cartridge, diamond stylus, and de luxe plinth and cover. **£24.00**  
+ p & p £3.50



Special offer to personal shoppers only  
**PYE STEREO GRAM CHASSIS** complete with circuit diagrams **£35.00**

Complete ready to install. Wave bands L, M, VHF STEREO, VHF MONO. Controls for tuning volume, balance, bass and treble. Power output 7 watts R.M.S. per channel 14 watts peak into 8 ohms. 2 x 8" approx chassis speakers and BSR C141 auto record player deck.

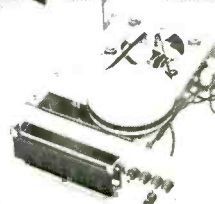

**BSR T145 8-TRACK CARTRIDGE PLAYER MECHANISM** Requires some attention. Complete with built in pre-amp, A.C. 240V **£6.95**  
+ p & p £1.50  
**SPECIAL OFFER**

## CAR RADIO KIT



**MOTOR TOP 10 AWARD**

Complete with speaker, baffle and fixing strip. The Tourist IV for the experienced constructor only. The Tourist IV has five push buttons, four medium band and one for long wave band. The tuning scale is illuminated and attractive small aluminium control knobs are used for manual tuning and volume control.

The modern style fascia has been designed to blend with most car interiors and the finished radio will slot into a standard car radio aperture. Size approx 7" x 2" x 4". Power Supply Nominal 12 volts positive or negative earth (altered internally) Power Output 4 watts into 4 ohms. **£10.50**  
+ p & p £1.50

## ALL PRICES INC. VAT. AT 12 1/2%

GOODS NOT DESPATCHED OUTSIDE UK  
All items subject to availability. Price correct at 1.7.77 and subject to change without notice.  
We are unable to show all our products, so please send stamped addressed envelope for our fully descriptive catalogue and any further information.

Minimum order on Access and Barclaycards £15  
**DO NOT SEND CARD** Just write your order giving your credit card number



**21 E HIGH STREET, ACTON, LONDON W3 6NG**  
**323 EDGWARE ROAD, LONDON W2**  
Personal Shoppers EDGWARE ROAD 9.30am-5.30pm. Half day Thurs.  
ACTON: Mail Order only. No callers

# click

### Light on the scene.

Local lighting just where you want it with Click's elegant, adjustable Spotlight or snake-arm Reading Lamp.

### Tidy wires.

With Click you can hide all your leads and wires inside the uprights, with a neat, snap-in cover strip.

### Keeping it steady.

With shelves fixed firmly to the wall, you eliminate floor vibration problems.

### Finding a level.

Click brackets are infinitely adjustable for height so you can always get your shelves level.

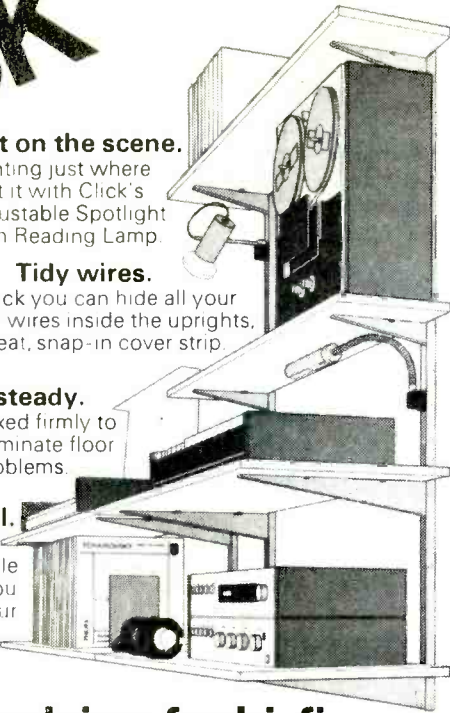

## Shelving for hi-fi. We've solved the problems.

**FREE** Post this ad. with your name and address for a 10-page leaflet to **Click Shelving Ltd.**  
Lowmoor Rd, Kirkby in Ashfield, Notts, NG17 7LH

WW-032 FOR FURTHER DETAILS

## Wilkinsons

### RELAYS B.P.O. TYPE 3000 AND 600

Built to your own specifications and requirements. The best known of all relays with a large variety of contact arrangements. Known throughout the world. Complete banks of contacts made to order and component parts supplied. Highest quality at competitive prices with a quick delivery service. Quotations by return home and overseas. Twin relays. Latching Relays and Relays with high voltage contacts made to order. We are suppliers of mountings to house B.P.O. Type 3000 Relays and associated components B.P.O. Uniselectors, Relay sets and Relay Selector units B.P.O. 2000 and 4000 type.



**LEDEX DC OPERATED SOLENOID OPERATED WAFER SWITCHES** 24-pole, 11 Way and Off and 54 Pole On, Off, Waters, both types, £10 each  
**SINGLE EQUIPMENT WIRE P.V.C.** covered dual colours, 52,000 metres available at a special price of £200 collected



**HIGH SPEED COUNTER.** 10 counts per second with four or five digits, size 3 1/2" x 1" available in the following DC voltages 6, 12, 24, 50 or 100 volts £1.75 each

**B.P.O. TYPE 2 UNISELECTOR** 10 Bank 5 Pole 50 Way all non-bridging wipers, 50 volts £10 each  
**TUNING FORK** for 45/50 band teleprinter speeds 125Hz £3 each  
WE ARE STOCKISTS OF STUART TURNER MAINS OPERATED WATER PUMPS, NO. 12 IN STOCK  
**L. WILKINSON (CROYDON) LTD., LONGLEY HOUSE, LONGLEY ROAD, CROYDON, CRO 3LH** Phone: 01-684 0236. Grams: WILCO CROYDON

WW-078 FOR FURTHER DETAILS

**INJECTION AND COMPRESSION MOULDING TO YOUR REQUIREMENTS ALSO INDELIBLE PRINTING OF G.R.P. ALUMINIUM AND COATED PANELS. GLASS FIBRE CASES. D.M.C. OR S.M.C. GREY, BUT OTHER COLOURS BY ARRANGEMENT.**

| SIZES        | BOX   |                |
|--------------|-------|----------------|
|              | ALONE | WITH ADDITION* |
| 8"x5 1/2"x5" | £1 94 | £2 71          |
| 9"x4"x3"     | £1 30 | £2 07          |
| 6"x4"x4"     | £1 10 | £1 96          |
| 5"x3"x1 1/2" | £0 51 |                |
| 4"x4"x1 1/2" | £0 54 |                |

\* Plus VAT and carriage  
**WITH FRONT PANEL, INSIDE PANEL (BOTH ALUMINIUM) AND 4 RUBBER FEET**

**TRADE PRICES ON REQUEST**  
Polythene Bags to your requirement, Dept. DP

**THOMAS MAUGHAN & ASSOCIATES**  
(DEPT. AW)  
CLARENCE MILL, BOLLINGTON, NR. MACCLESFIELD, CHESHIRE  
Tel: BOLLINGTON 74294

WW-038 FOR FURTHER DETAILS

### TRANSFORMERS

**ALL EX-STOCK — SAME-DAY DESPATCH**

**MAINS ISOLATING VAT 8% 12 and/or 24-VOLT**  
PRI 120/240V SEC 120/240V  
Centre Tapped and Screened

| Ref. | VA (Watts) | £     | P&P | Separate 12v windings |     | P&P  |       |      |
|------|------------|-------|-----|-----------------------|-----|------|-------|------|
|      |            |       |     | 12v                   | 24v |      |       |      |
| 07   | 20         | 3.57  | 66  | 111                   | 0 5 | 0 25 | 1.77  | .36  |
| 149  | 60         | 5.39  | 80  | 213                   | 1 0 | 0 5  | 2.14  | .65  |
| 150  | 100        | 6.13  | 95  | 71                    | 2   | 1    | 2.77  | .65  |
| 151  | 200        | 9.82  | 125 | 18                    | 4   | 2    | 3.42  | .80  |
| 152  | 250        | 11.87 | 153 | 70                    | 6   | 3    | 5.09  | .80  |
| 153  | 350        | 14.34 | 153 | 108                   | 8   | 4    | 5.85  | .95  |
| 154  | 500        | 16.48 | 179 | 72                    | 10  | 5    | 6.33  | .95  |
| 155  | 750        | 25.23 | OA  | 116                   | 12  | 6    | 6.67  | 1.10 |
| 156  | 1000       | 35.16 | OA  | 17                    | 16  | 3    | 8.60  | 1.10 |
| 157  | 1500       | 40.12 | OA  | 115                   | 20  | 10   | 12.55 | 1.73 |
| 158  | 2000       | 44.76 | OA  | 187                   | 30  | 15   | 16.33 | 1.73 |
| 159  | 3000       | 70.70 | OA  | 226                   | 60  | 30   | 20.32 | OA   |

\*115 or 240 sec only

### 50 VOLT RANGE

Primary 220-240V  
SEC TAPS 0-19-25-33-40-50V

| Ref. | Amps | £     | P&P |
|------|------|-------|-----|
| 102  | 0 5  | 3.12  | 65  |
| 103  | 1 0  | 4.08  | 80  |
| 104  | 2 0  | 5.69  | 95  |
| 105  | 3 0  | 7.02  | 110 |
| 106  | 4 0  | 9.18  | 125 |
| 107  | 6 0  | 14.62 | 137 |
| 118  | 8 0  | 15.56 | 173 |
| 119  | 10 0 | 20.41 | OA  |

### 30 VOLT RANGE

Primary 220-240V  
SEC TAPS 0-2-15-20-25-30V

| Ref. | Amps | £     | P&P |
|------|------|-------|-----|
| 112  | 0 5  | 2.27  | 65  |
| 79   | 1 0  | 2.90  | 80  |
| 3    | 2 0  | 4.34  | 80  |
| 20   | 3 0  | 5.41  | 95  |
| 21   | 4 0  | 6.39  | 95  |
| 51   | 5 0  | 7.74  | 110 |
| 117  | 6 0  | 8.65  | 125 |
| 88   | 8 0  | 11.73 | 137 |
| 89   | 10 0 | 11.91 | 153 |

### 60 VOLT RANGE

Primary 220-240V  
SEC TAPS 0-24-30-40-48-60V

| Ref. | Amps | £     | P&P |
|------|------|-------|-----|
| 124  | 0 5  | 2.85  | 80  |
| 126  | 1 0  | 4.23  | 80  |
| 127  | 2 0  | 6.13  | 95  |
| 125  | 3 0  | 9.09  | 110 |
| 123  | 4 0  | 10.57 | 153 |
| 40   | 5 0  | 11.78 | 137 |
| 120  | 6 0  | 13.88 | 153 |
| 121  | 8 0  | 18.11 | BRS |
| 122  | 10 0 | 22.31 | BRS |
| 189  | 12 0 | 23.30 | BRS |

### AUTO TRANSFORMERS

| Ref. | VA (Watts) | TAPS               | £     | P&P |
|------|------------|--------------------|-------|-----|
| 113  | 20         | 0-115-210-240V     | 2.01  | 59  |
| 64   | 75         | 0-115-210-240V     | 3.51  | 80  |
| 4    | 150        | 0-115-210-220-240V | 4.98  | 80  |
| 66   | 300        |                    | 7.03  | 95  |
| 67   | 500        |                    | 10.76 | 137 |
| 84   | 1000       |                    | 16.51 | 173 |
| 93   | 1500       |                    | 21.87 | BRS |
| 95   | 2000       |                    | 29.22 | BRS |
| 73   | 3000       |                    | 42.37 | BRS |

### SCREENED MINIATURES

Primary 240V

| Ref. | mA       | Volts            | £    | P&P |
|------|----------|------------------|------|-----|
| 238  | 200      | 3-0-3            | 1.86 | 46  |
| 212  | 1A, 1A   | 0-5-0-6          | 2.22 | 65  |
| 13   | 100      | 9-0-9            | 1.79 | 32  |
| 235  | 330, 330 | 0-9-0-9          | 1.89 | 32  |
| 207  | 500, 500 | 0-8-9-0-8-9      | 2.32 | 59  |
| 208  | 1A, 1A   | 0-8-9-0-8-9      | 3.53 | 65  |
| 236  | 200, 200 | 0-15-0-15        | 1.79 | 32  |
| 214  | 300, 300 | 0-20-0-20        | 2.33 | 65  |
| 221  | 700 (DC) | 0-12-0-12-20     | 2.74 | 65  |
| 206  | 1A, 1A   | 0-15-20-0-15-20  | 4.17 | 80  |
| 203  | 500, 500 | 0-15-27-0-15-27  | 3.62 | 80  |
| 204  | 1A, 1A   | 0-15-27-0-15-27  | 4.76 | 80  |
| S112 | 500      | 0-12-15-20-24-30 | 2.27 | 65  |

### CASED AUTO. TRANSFORMERS

240V cable input USA 2-pin outlets

| Ref.   | VA     | TAPS      | £        | P&P |
|--------|--------|-----------|----------|-----|
| 20VA   | £3.78  | P&P 80p   | Ref 113W |     |
| 75VA   | £5.51  | P&P 95p   | Ref 64W  |     |
| 150VA  | £7.33  | P&P 95p   | Ref 4W   |     |
| 300VA  | £10.81 | P&P £1 15 | Ref 66W  |     |
| 500VA  | £12.62 | P&P £1 37 | Ref 67W  |     |
| 750VA  | £16.80 | P&P £1 53 | Ref 83W  |     |
| 1000VA | £21.15 | OA        | Ref 84W  |     |
| 2000VA | £33.02 | OA        | Ref 95W  |     |

### HIGH QUALITY MODULES VAT 12 1/2%

|                                  |        |
|----------------------------------|--------|
| 5 watt RMS Amplifier             | £2.65  |
| 10 watt RMS Amplifier            | £2.95  |
| 25 watt RMS Amplifier            | £3.95  |
| Pre-Amp for 3.5-10w              | £6.50  |
| Pre-Amp for 25w                  | £13.87 |
| Power Supplies for 3.5-10w       | £1.20  |
| Power Supplies for 25w           | £3.00  |
| Transformer for 5-10w            | £2.30  |
| Transformer for 25w (one module) | £2.90  |
| P&P Amps Pre-Amps Power Supplies | 18p    |
| P&P Transformers                 | 58p    |

### TI MINI-MULTIMETER

DC-1000V AC-1000V  
AC-DC-1000V V  
DC-100mA Res - 150K  
Bargain at £5.30  
VAT 8% P&P 15p

### STEREO F.M. TUNER

4 Pre-selected stations  
Switched AFC  
Supply 20-35v 90Ma Max  
£19.95. P&P 25p VAT 12 1/2%

### MAGNETIC TO CERAMIC CARTRIDGE CONVERTER

Operating Voltage 20/45v  
ONLY £2.65 P&P 18p  
VAT 12 1/2%

### GARRARD SP25 Mk. IV

(Chassis) £19.23  
BSR 128 (Chassis) with G850 cartridge £23.25  
P&P £1 10. VAT 12 1/2%

## Barrie Electronics Ltd.

3, THE MINORIES, LONDON EC3N 1BJ  
TELEPHONE: 01-488 3316/8  
NEAREST TUBE STATIONS: ALDGATE & LIVERPOOL ST.

WW-079 FOR FURTHER DETAILS

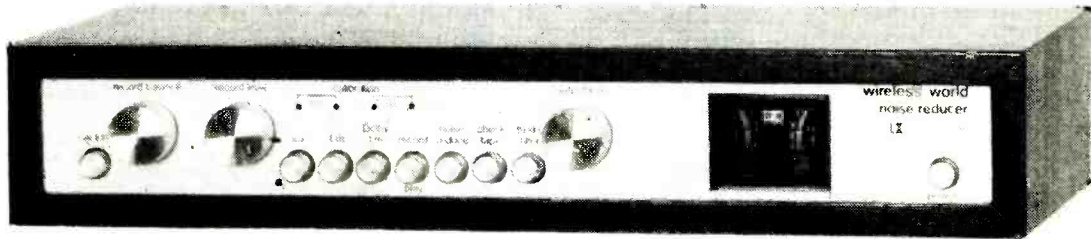
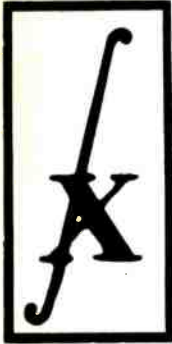

# Wireless World Dolby<sup>TM</sup> noise reducer

Trademark of Dolby Laboratories Inc.

We are proud to announce the latest addition to our range of matching high fidelity units.

### Featuring:

- switching for both encoding (low-level h.f. compression) and decoding
- a switchable f.m. stereo multiplex and bias filter
- provision for decoding Dolby f.m. radio transmissions (as in USA)
- no equipment needed for alignment
- suitability for both open-reel and cassette tape machines
- check tape switch for encoded monitoring in three-head machines

### The kit includes:

- complete set of components for stereo processor
- regulated power supply components
- board-mounted DIN sockets and push-button switches
- fibreglass board designed for minimum wiring
- solid mahogany cabinet, chassis, twin meters, front panel, knobs, mounting screws and nuts

### Typical performance

Noise reduction: better than 9dB weighted

Clipping level: 16.5dB above Dolby level (measured at 1% third harmonic content)

Harmonic distortion 0.1% at Dolby level typically 0.05% over most of band, rising to a maximum of 0.12%

Signal-to-noise ratio 75dB (20Hz to 20kHz, signal at Dolby level) at Monitor output

Dynamic Range > 90dB

30mV sensitivity.

**PRICE: £37.90 + VAT**

Also available ready built and tested ..... **Price £52.00 + VAT**

Calibration tapes are available for open-reel use and for cassette (specify which) ..... **Price £2.00 + VAT\***

Single channel plug-in Dolby<sup>TM</sup> PROCESSOR BOARDS (92 x 87mm) with gold plated contacts are available with all components ..... **Price £7.20 + VAT**

Single channel board with selected fet ..... **Price £2.20 + VAT**

Gold plated edge connector ..... **Price £1.40 + VAT\***

Selected FET's. **60p** each + VAT, **100p** + VAT for two, **£1.90** + VAT for four

Please add VAT 12½% unless marked thus\*, then 8% applies  
We guarantee full after-sales technical and servicing facilities on all our kits, have you checked that these services are available from other suppliers?

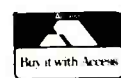

# INTEGREX LTD.

Please send SAE for complete lists and specifications  
**Portwood Industrial Estate, Church Gresley,  
Burton-on-Trent, Staffs DE11 9PT  
Burton-on-Trent (0283) 215432 Telex 377106**

# INTEGREX

## S-2020TA STEREO TUNER / AMPLIFIER KIT

**SOLID MAHOGANY CABINET**

*A high-quality push-button FM Varicap Stereo Tuner combined with a 24W r.m.s. per channel Stereo Amplifier.*

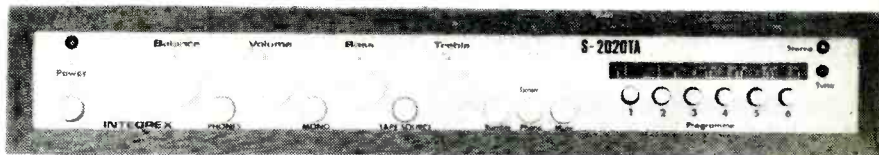

**Brief Spec.** Amplifier: Low field Toroidal transformer, Mag. input, Tape In/Out facility (for noise reduction unit, etc), THD less than 0.1% at 20W into 8 ohms. Power on/off FET transient protection. All sockets, fuses, etc., are PC mounted for ease of assembly. Tuner section: uses 3302 FET module requiring no RF alignment, ceramic IF, INTERSTATION MUTE, and phase-locked IC stereo decoder. LED tuning and stereo indicators. Tuning range 88—104MHz. 30dB mono S/N @ 1.2 $\mu$ V. THD 0.3%. Pre-decoder 'birdy' filter.

**PRICE: £53.95 + VAT**

## NELSON-JONES STEREO FM TUNER KIT

*A very high performance tuner with dual gate MOSFET RF and Mixer front end, triple gang varicap tuning, and dual ceramic filter / dual IC IF amp.*

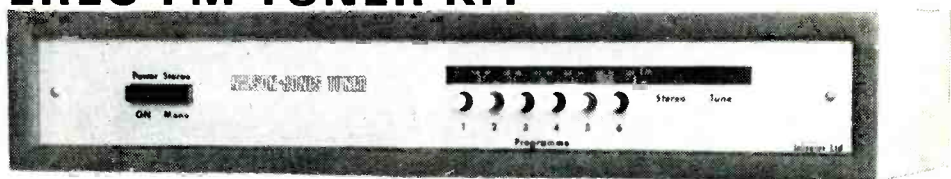

**Brief Spec.** Tuning range 88—104MHz. 20dB mono quieting @ 0.75 $\mu$ V. Image rejection — 70dB. IF rejection—85dB. THD typically 0.4% IC stabilized PSU and LED tuning indicators. Push-button tuning and AFC unit. Choice of either mono or stereo with a choice of stereo decoders.

*Compare this spec. with tuners costing twice the price*

**Mono £29.15 + VAT**

**With ICPL Decoder £33.42 + VAT**

**With Portus-Haywood Decoder  
£35.95 + VAT**



Sens. 30dB S/N mono @ 1.2 $\mu$ V  
THD typically 0.3%  
Tuning range 88—104MHz  
LED sig. strength and stereo indicator

## STEREO MODULE TUNER KIT

*A low-cost Stereo Tuner based on the 3302 FET RF module requiring no alignment. The IF comprises a ceramic filter and high-performance IC Variable INTERSTATION MUTE. PLL stereo decoder IC. Pre-decoder 'birdy' filter*

**PRICE: Mono £26.85 + VAT**

**Stereo £29.95 + VAT**

## S-2020A AMPLIFIER KIT

*Developed in our laboratories from the highly successful "TEXAN" design. PC mounting potentiometers, switches, sockets and fuses are used for ease of assembly and to minimize wiring*  
**Power 'on/off' FET transient protection.**



**Typ Spec.** 24+24W r.m.s. into 8-ohm load at less than 0.1% THD. Mag. PU input S/N 60dB. Radio input S/N 72dB. Headphone output. Tape In/Out facility (for noise reduction unit, etc.). Toroidal mains transformer.

**PRICE: £31.95 + VAT**

**ALL THE ABOVE KITS ARE SUPPLIED COMPLETE WITH ALL METALWORK, SOCKETS, FUSES, NUTS AND BOLTS, KNOBS, FRONT PANELS, SOLID MAHOGANY CABINETS AND COMPREHENSIVE INSTRUCTIONS**

**BASIC NELSON-JONES TUNER KIT £14.28 + VAT**  
**BASIC MODULE TUNER KIT (stereo) £16.75 + VAT**

**PHASE-LOCKED IC DECODER KIT £4.47 + VAT**  
**PUSH-BUTTON UNIT £4.50 + VAT**

**PORTUS-HAYWOOD PHASE-LOCKED STEREO DECODER KIT £8.00 + VAT**









# MXT-1000 AUDIO MIXING SYSTEM

The new MXT-1000  
A unique system enabling  
your own requirements to  
be built from standard  
equipment

8 channel, 2 group MXT-  
1000 - each channel fitted  
with compressor

Manufacturers of  
sound systems  
and electronics

Station Road, Wenden  
Saffron Walden  
Essex CB11 4LG  
Saffron Walden  
(0799) 40888

## audix

3% Measuring Accuracy  
Stabilised Power Supplies  
10 MHz Dual Trace  
10 mV Sensitivity

# SCOPEX 4D10A

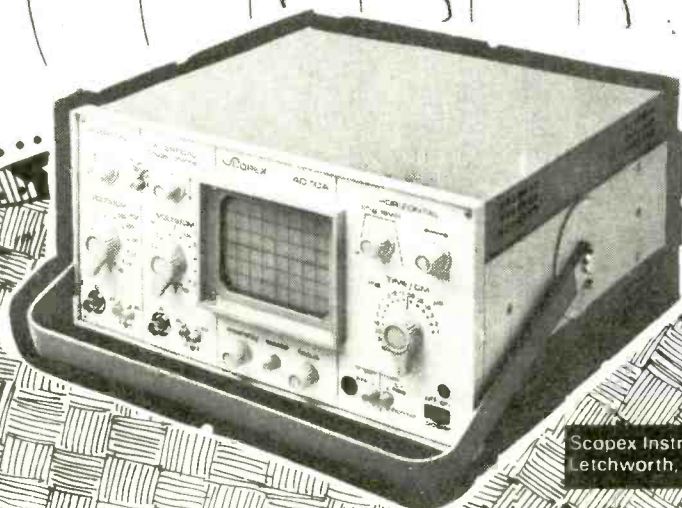

Now YOU can afford  
the Best at

**£150**  
UK ex VAT

## SCOPEX

Scopex Instruments Limited, Pixmore Industrial Estate, Pixmore Avenue,  
Letchworth, Herts. SG6 1JJ Letchworth 72771 (STD 046 26)



# The magnificent nine... an open and closed case for selecting Celestion.

| Model     | Measurements  |                      | Sensitivity<br>Pink Noise W<br>at 1M = 90 dB | Power Handling<br>Peak Music | Suggested<br>Amp Watts RMS |     | Frequency<br>Response |
|-----------|---------------|----------------------|--|------------------------------|----------------------------|-----|-----------------------|
|           | Centimetres   | Inches               |  |                              | Min                        | Max |                       |
| Ditton 11 | 35 x 20 x 25  | 14 x 8 x 10          | 9.9  | 25 W                         | 15                         | 30  | 35 Hz - 28 KHz        |
| Ditton 15 | 53 x 28 x 23  | 21 x 9 1/2 x 9 1/2   | 4.2  | 30 W                         | 10                         | 30  | 30 Hz - 15 KHz        |
| Ditton 33 | 61 x 35 x 26  | 24 x 14 x 10 1/2     | 5.5  | 40 W                         | 20                         | 50  | 40 Hz - 28 KHz        |
| Ditton 44 | 76 x 37 x 25  | 30 x 14 1/2 x 10     | 4.0  | 44 W                         | 20                         | 50  | 30 Hz - 40 KHz        |
| Ditton 25 | 81 x 36 x 28  | 32 x 14 x 11         | 2.9  | 60 W                         | 15                         | 60  | 20 Hz - 48 KHz        |
| Ditton 66 | 100 x 38 x 29 | 40 x 15 x 11 1/2     | 4.1  | 80 W                         | 20                         | 80  | 16 Hz - 40 KHz        |
| UL 8      | 29 x 41 x 22  | 11 1/2 x 16 x 8 1/2  | 13.0   | 40 W                         | 20                         | 40  | 35 Hz - 28 KHz        |
| UL 6      | 58 x 28 x 23  | 23 x 11 x 9 1/2      | 8.4  | 50 W                         | 15                         | 50  | 30 Hz - 28 KHz        |
| UL 10     | 67 x 31 x 38  | 25 1/2 x 12 1/2 x 15 | 18.9   | 100 W                        | 25                         | 100 | 20 Hz - 40 KHz        |

Send this coupon for literature or ask your dealer for a demonstration. I am interested in large, medium, small speakers.

Name \_\_\_\_\_

Address \_\_\_\_\_

Relea Celestion Ltd, Ditton Works, Foxhall Road, Ipswich, Suffolk IP3 8JP  
Telephone: Ipswich (0473) 73131 Cables: Voicecol Ipswich Telex: 98365

**Celestion**



**the sound to be  
experienced!**

07.01.03



# Professional Performance at Popular Prices!

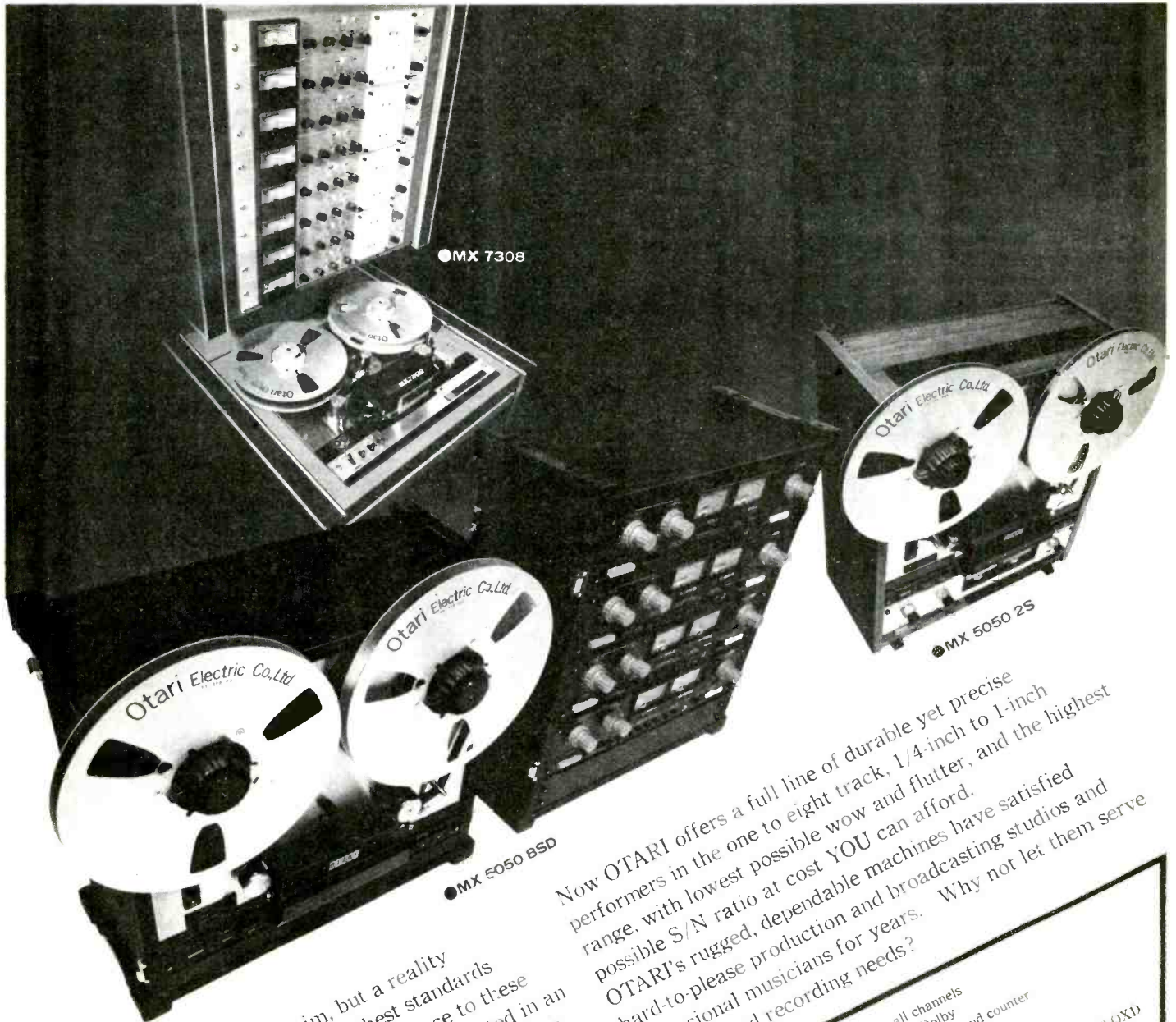

At OTARI, this is not just a claim, but a reality brought by the application of the highest standards of technology and precision. And adherence to these standards by OTARI sound specialists has resulted in even greater lineup of full capability, professional tape recorders in compact packages with all the performance, features, and reliability you expect from more expensive machines.

Now OTARI offers a full line of durable yet precise performers in the one to eight track, 1/4-inch to 1-inch range, with lowest possible wow and flutter, and the highest possible S/N ratio at cost YOU can afford. OTARI's rugged, dependable machines have satisfied hard-to-please production and broadcasting studios and professional musicians for years. Why not let them serve YOUR sound recording needs?

**●MX 5050 2S**

- \* Exceptional S/N ratio and crosstalk
- \* Motion sensing control logic prevents tape damage
- \* Selective reproduce for overdubbing (standard)
- \* Front accessible bias, EQ, and operating level
- \* Built-in test and cue oscillator
- \* Professional 600 ohm + 4 dB outputs (standard)
- \* Front panel edit and cue controls
- \* DC servo capstan option

**Four heads**

- Bias adjustable for new high energy master tapes
- MX 5050 8SD**
- \* 1 1/2-inch eight channel recorder
- \* XLR line input and output connectors
- \* Test and calibration oscillator
- \* Variable speed DC servo capstan
- \* Plug-in card electronics and head assembly
- Motion sensing control logic prevents tape damage

- Selective reproduce on all channels
- Interface jack for dbx and Dolby
- Accessible heads, minute and second counter
- Front adjustable cue and edit control
- Easily accessible electronics adjustments

Also available in four channel 1/4" and 1/2" MX 5050 QXD

\* Exclusive OTARI features



Contact OTARI today for full information

Otari Electric Co., Ltd., Otari Bldg., 4-29-18, Minami Ogikubo, Sugiyama-ku, Tokyo 167, Japan. Phone: (03)333-9631

U. S. A.: Otari Corporation, 981 Industrial Road, San Carlos, California 94070, Phone: 415 593-1648

- Canada: Noresco Manufacturing Co., Ltd., 100 Floral Parkway, Toronto, Ontario M6L2C5 Phone (416) 249-7316
- U. K.: C. E. Hammond & Co., Ltd. 105/109 Oyster Lane, Byfleet, Surrey KT14 7LA. Phone: Byfleet 4 1131
- France: Reditec 62-66, Rue Louis Ampère (Zone Industrielle des Chanoux), 93360 Neuilly-Plaisance, Phone: 935-9786
- Belgium: Trans European Music S. A. Koeivijverstraat 105, 1710 Dilbeek, Phone: (02) 569 1823
- Netherlands: Selectronic B. V. Sluisplein 3-4, Ouderkerk aan de Amstel, Postbus 28, Phone: 02963/4838/4966
- Australia: Klarion Enterprises (Pty.) Ltd. Regent House, 63 Kingsway, South Melbourne, 3205, Phone: 61 3801
- Singapore: Otari Electric Co., Ltd., Singapore Representative Office, 2701-A 27th Floor, International Plaza, Anson Road, Singapore (2)









# FAST RESPONSE STRIP CHART RECORDERS

Made in USSR

## Series H3020



Basic error 2.5%  
Sensitivity 8mA FSD  
Response 0.2 sec  
Width of each channel:  
Single and three-pen  
recorders: 80mm  
Five-pen recorders: 50mm

Chart speeds, selected by push buttons: 0.1-0.2-0.5-1.0-2.5-5.0-12.5-25 mm/sec  
Chart drive 200-250V 50Hz  
Recording Syphon pen directly attached to moving coil frames.  
Curvilinear co-ordinates.  
Equipment: Marker pen, timer pen, paper footage indicator, 10 rolls of paper, connectors, etc.

**H3020-1 (Single pen):** 285mm wide x 384mm deep x 165mm high **PRICE £108.00**  
**H3020-3 (Three pen):** 475mm wide x 384mm deep x 165mm high **PRICE £160.00**  
**H3020-5 (Five pen):** 475mm wide x 384mm deep x 185mm high **PRICE £295.00**

## Series H327

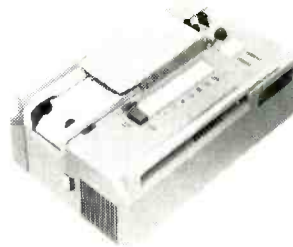

Polarized moving iron movements with syphon pens directly attached. Built-in solid state amplifier (one per channel) provides 8 calibrated sensitivity steps. Two marker pens are provided.  
Basic error 4% Frequency response from DC to 100Hz 2dB.

Sensitivity 0.02 - 0.05 - 0.1 - 0.2 - 0.5 - 1 - 2 - 5 volts/cm  
Width of each recording channel: 40mm  
Chart drive 220-250V 50Hz  
Chart speeds 1.2-5-10-50-125-250mm/sec

**Type H3271-1. Single pen:** Dimensions: 259 x 384 x 165mm  
Weight 15 kilos **PRICE £265.00**  
**Type H327-3. Three pen:** Dimensions 335 x 384 x 165mm  
Weight 20 kilos **PRICE £520.00**  
**Type H327-5. Five pen.** Dimensions: 425 x 385 x 165mm  
Weight 25 kilos **PRICE £770.00.**

Note: Prices are exclusive of VAT

Available for immediate delivery

# Z & I AERO SERVICES LTD.

44A WESTBOURNE GROVE, LONDON W2 5SF

Tel. 01-727 5641

Telex: 261306

WW-066 FOR FURTHER DETAILS



# TRAMPUS ELECTRONICS LTD

58-60 GROVE RD.  
WINDSOR, BERKS.  
SL4 1HS.  
TEL. 54525

ADD 8% VAT TO PRICES MARKED \*  
ADD 12% TO ALL OTHER PRICES.  
OR AS CURRENT VAT LEGISLATION  
SEND C.W.O. (EXCEPT GOV'T DEPT)  
POST & PACKING 20P FOR THE U.K.  
BARCLAYCARD & ACCESS BY POST  
OR £5 MIN ON TELEPHONE ORDERS.  
NEW CATALOGUE LIST FREE S.A.E.  
MONEY BACK IF NOT SATISFIED.

## FAST SERVICE



NORMALLY 24 HOURS  
ON EX STOCK ITEMS



SEVEN SEGMENT LED DISPLAYS  
BRIGHT DL707 COM ANODE &  
DL704 COM CATH. 0.3" £1\*  
DL747 0.6" JUMBO CA £1.25\*

DIGITAL CLOCK IC 51224 £1\*  
ZENON STROBE TUBES £4 & £7\*

## RED LEDS 10P.

RED LEDS 209 STYL 0.125"  
OR 0.2" DIA. NO CLIP 10p\*

TIL209 RED LED & CLIP 12p\*  
BIG 0.2" RED LED & " 14p\*  
GREEN OR ORANGE LEDS 29p\*  
ORP12 54p\* 2N5777/OCP71 34p\*

TRAMPUS  
THE GREAT  
BRITISH  
DISTRIBUTOR



INDUSTRIAL, EDUCATIONAL, TRADE &  
EXPORT SUPPLIED. SEND FOR  
OUR FREE CATALOGUE LIST SAE  
MANUFACTURERS EXCESS STOCKS  
PURCHASED. DISCOUNTS 10% OFF  
100 up. 15% OFF 1000 up....

## TOP DISCOUNTS.

### INTEGRATED CIRCUITS

|                     |       |                    |     |
|---------------------|-------|--------------------|-----|
| 555 TIMER           | 34p*  | LM380(60740) £1    |     |
| 556 2 x 555         | 90p*  | LM381 Preamp £2    |     |
| 703 RF/IF AMP       | 29p   | LM3900 4xOPA 53p*  |     |
| 709 T099 or DIL26p* |       | MC1303 2XPre £2    |     |
| 710 DIL14           | 35p*  | MC1310 stereo£2    |     |
| 723 Regulator       | 14p*  | MC1312P SQ £1.70   |     |
| 741 DIL 8pin        | 21p*  | MC1330             | 75p |
| 741 DIL 14pin       | 31p*  | MC1339 Preamp£2    |     |
| 741 T099            | 33p*  | MFC4000B 1W        | 72p |
| 747 DUAL 741        | 69p*  | MFC6030            | £1  |
| 748 DIL 8 pin       | 32p*  | NE536 FETOPA £2*   |     |
| 7805 5V1A-reg£1.35* |       | NE540 or 550 £2*   |     |
| 7812 & 7815ea£1.40* |       | NE555 TIMER 34p*   |     |
| 76013 6W AF         | £1.50 | NE556 2x555 90p*   |     |
| AY51224 CLOCK £4*   |       | NE560/1/2/5/6/7/£3 |     |
| CA8046              | 54p*  | SN72741 as 741     |     |
| ICL8038 Sigen £4*   |       | SN76660 IF 74p     |     |
| LM300H              | £1*   | SN76611 IF £1*     |     |
| LM301A DIL 8        | 33p*  | TBA800 5W AF 84p   |     |
| LM309K 5V reg £2*   |       | TBA810 7W AF 91p   |     |
| LM309H T05 can £1*  |       | ZN414 Radio £1.19  |     |
| LM318 70VusOPA £3*  |       | NEW 1466/69 £4     |     |

### CMOS TTL

|            |      |         |      |         |        |
|------------|------|---------|------|---------|--------|
| 4000       | 14p* | 7400    | 12p* | 7490    | 39p*   |
| 4001       | 15p* | 7401    | 13p* | 7491    | 75p*   |
| 4002       | 16p* | 7402    | 15p* | 7492/93 | 45p*   |
| 4007       | 16p* | 7404    | 19p* | 7495/96 | 72p*   |
| 4009       | 50p* | 7408/10 | 18p* | 74100   | £1.25* |
| 4011       | 16p* | 7413    | 29p* | 74107   | 32p*   |
| 4012       | 17p* | 7414    | 16p* | 74121   | 29p*   |
| 4049       | 50p* | 7441    | 71p* | 74123   | 69p*   |
| 4069       | 20p* | 7442    | 72p* | 74141   | 74p*   |
| 4501       | 26p* | 7447    | 79p* | 74145   | 85p*   |
| 4511£1.65* |      | 7470/72 | 27p* | 74147   | £2.50* |
| 4528 £1*   |      | 7473/74 | 31p* | 74151   | 75p*   |
| 4543 £2*   |      | 7475/36 | 35p* | 74154   | £1.40* |
| 4553 £5*   |      | 7486    | 35p* | 74196   | £1.50* |

DIL SOCKETS PROFESSIONAL QUALITY  
8pin, 14pin & 16pin ALL 12p ea\*  
SOLDERCONS 100 49p\* 1000 £3.95\*

## NEW LOW PRICES.

### TRANSISTORS AND DIODES

|                     |               |                 |      |
|---------------------|---------------|-----------------|------|
| 1WS BUSH SET 5p ea* | TIP31/32      | 50p*            |      |
| MATCHING 50p Pr*    | TIP31c32c68p* |                 |      |
| AC127/8 176 15p*    | TIP41/42ea    | 66p*            |      |
| AD161/162 ea36p*    | TIP41c42c     | £1.50*          |      |
| BC107               | 8p*           | TIP2955         | 69p* |
| BC107B              | 13p*          | TIP3055         | 65p* |
| BC108               | 8p*           | TIS43 UJT       | 26p* |
| BC108B or C         | 13p*          | 1N914/4148      | 4p   |
| BC109               | 9p*           | 1N4001/2        | 4p*  |
| BC109B or C         | 12p*          | 1N4004          | 5p*  |
| BC147/8/9           | 8p*           | 1N4007          | 7p*  |
| BC157/8/9           | 11p*          | 2N706/8         | 14p* |
| BC167/8/9           | 12p*          | 2N2646 UJT      | 40p* |
| BC177/8/9           | 16p*          | 2N2904/5pnp29p* |      |
| BC182/3/4a/£10p     |               | 2N2926 ory      | 7p*  |
| BC212/3/4a/£12p     |               | 2N3053          | 17p* |
| BCY70/1/2           | 15p*          | 2N3055 90W      | 33p* |
| BD131/132ea         | 36p*          | 2N3055 115W     | 45p* |
| BFY50/51            | 15p*          | 2N3614 T03      | £1*  |
| BFY52/53            | 16p*          | 2N3702/3/1      | 7p*  |
| BSX 19/20/21£9p*    |               | 2N3705/6/7      | 9p   |
| BZ188 ZENER 10p     |               | 2N3705/6/7      | 9p   |
| C106D SCR           | 54p*          | 2N3708/9        | 9p   |
| MJ2955 T03          | 99p*          | 2N3710/11       | 15p  |
| MJE2955             | 99p*          | 2N3819 &23e17p  |      |
| MJE3055             | 65p*          | 2N3820 PPE£40p  |      |
| OAR1/91             | 5p            | 2N3904/5/6      | 15p  |
| TIP29 & 30          | 40p*          | 2N5457 FET      | 32p  |
|                     |               | BRIDGE1A50      | 20p* |

### BARGAIN PAKS FULL SPEC £1ea

PAK A: 11 RED LEDS full spec £1\*  
PAK B: 5 741C 8 PIN OP AMP £1\*  
PAK C: 4 2N3055 £1\* D 12 BC109 £1\*  
PAK E: 11 BC182 £1 F 11 2N3704 £1  
PAK G: 7 BFY51 £1\* H 8 2N3819 £1  
PAK J: 6 2N3053 £1\* K 40x1N914 £1  
PAK M: 3 T099 3055 £1\*N 25 OA91 £1  
PAK P: 20 PLASTIC BC109 TYPEnpn£1

10-365PF TUNER SINGLE GANG FOR  
MED/SHORT WAVE. XTAL SET etc £1\*  
SET3/IF CANS 455/470KHZ TOKO £1\*

## Full spec devices

# DALO pen 75p

PCR ETCH KIT 3 ITEMS £2\*  
ETCH RESIST PEN 2TIPS 75p\*  
FEC ETCH PAK TUB 600gm £1\*  
6x4" SRBP 45p\* NYLON F/G £1\*

SCR AND TRIACS BR100 25p\*  
TAG 1A400V 50p\* 1A600V 69p\*  
1A50V 37p\*. C106D 4A400 60p\*  
TRIACS: SC146D 10A-400V £1\*  
DISCO TRIAC 15A400V £2\*  
AUDIBLE WARNING BLEEPER  
12V35mA £1.20:10 off £1\*  
CAPACITORS 22pf - .01 5p  
ELECTROLYTIC 1N 10 & 25V  
1/2/10/50/100 7p 50V 10p  
200/500 10p. 1000/25 20p

## vero

VERO 0.1" PITCH COPPERCLAD  
2 1/2"x5" 40p\* 3 1/2"x5" 45p\*  
2 1/2"x3 1/2" 36p\* 3 1/2"x3 1/2" 40p\*  
3 1/2"x7" £2 FACE CUTTER 65p\*  
DIL BREARBOARD 2"x4" £1 or  
6"x4" £2. VERO PINS 36 30p\*  
BLACK PLASTIC CASES 42mmx  
80x60 50p\* 100x75 60p\* 99x  
120 70p. DESOLDER BRAID 50p

Zambia Gibraltar Chile Spain United Arab Emirates Singapore New Guinea Israel

Falkland Islands  
Portugal  
Guyana  
India  
Greece  
Jordan  
United States of America  
Yugoslavia  
Ascension Island  
Malaya

# POWERTRAN ELECTRONICS

INCORPORATING

# AMBIENTACOUSTICS

## HI-FI NEWS 75W/CHANNEL AMPLIFIER

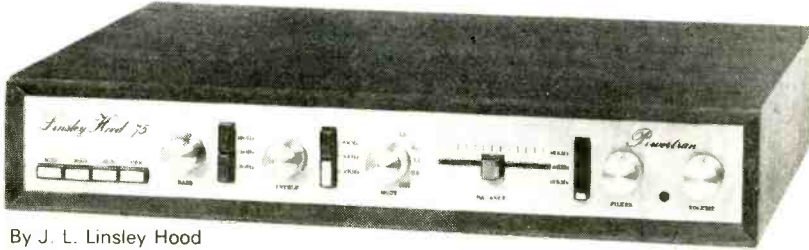

By J. L. Linsley Hood

In Hi-Fi News there was published by Mr. Linsley-Hood a series of four articles (November, 1972-February, 1973) and a subsequent follow-up article (April, 1974) on a design for an amplifier of exceptional performance which has as its principal feature an ability to supply from a direct coupled fully protected output stage, power in excess of 75 watts whilst maintaining distortion at less than 0.01% even at very low power levels. The power amplifier is complemented by a pre-amplifier based on a discrete component operational amplifier referred to as the Linciac which is employed in the two most critical points of the system, namely the equalization stage and tone control stage, positions where most conventional designs run out of gain at the extremes of the frequency spectrum. Unusual features of the design are the variable transition frequencies of the tone controls and the variable slope of the scratch filter. There is a choice of four inputs, two equalized and two linear, each having independently adjustable signal level. The attractive slimline unit pictured has been made practical by highly compact PCBs and a specially designed Toroidal transformer.

- | Pack   | Price  |
|--|--------|
| 1. Fibreglass printed-circuit board for power amp  | £1.15  |
| 2. Set of resistors, capacitors, pre-sets for power amp  | £2.15  |
| 3. Set of semiconductors for power amp   | £6.50  |
| 4. Pair of 2 drilled, finned heat sinks  | £1.10  |
| 5. Fibreglass printed-circuit board for pre-amp  | £1.75  |
| 6. Set of low noise resistors, capacitors, pre-sets for pre-amp  | £3.40  |
| 7. Set of low noise, high gain semiconductors for pre-amp  | £2.40  |
| 8. Set of potentiometers (including mains switch)  | £3.15  |
| 9. Set of 4 push-button switches, rotary mode switch   | £4.50  |
| 10. Toroidal transformer complete with magnetic screen/housing primary: 0-117-234 V; secondaries: 33-0-33 V, 25-0-25 V | £10.95 |

- | Pack   | Price |
|--|-------|
| 11. Fibreglass printed-circuit board for power supply  | £0.85 |
| 12. Set of resistors, capacitors, secondary fuses, semi-conductors for power supply                                    | £4.60 |
| 13. Set of miscellaneous parts including DIN skts, mains input skt, fuse holder, inter-connecting cable, control knobs | £5.35 |
| 14. Set of metalwork parts including silk screen printed fascia panel and all brackets, fixing parts, etc.             | £7.30 |
| 15. Handbook   | £0.30 |
| 16. Teak cabinet 18.3" x 12.7" x 3.1"  | £9.85 |
- 2 each of packs 1-7 inclusive are required for complete stereo system. Total cost of individually purchased packs ..... £83.75

Designed in response to demand for a tuner to complement the world-wide acclaimed Linsley Hood 75W Amplifier, this kit provides the perfect match. The Wireless World (Skingley and Thompson - April, May 1974) published original circuit has been developed further for inclusion into this outstanding slimline unit and features a pre-aligned front end module, excellent m rejection and temperature compensated varicap tuning, which may be controlled either continuously or by push button pre-selection. Frequencies are indicated by a frequency meter and sliding LED indicators, attached to each channel selector pre-set. The PLL stereo decoder incorporates active filters for "birdy" suppression and power is supplied via a toroidal transformer and integrated regulator. For long term stability metal oxide resistors are used throughout.

- | Pack   | Price |
|--|-------|
| 1. Fibreglass printed board for front end IF strip, demodulator, AFC and mute circuits   | £2.15 |
| 2. Set of metal oxide resistors, thermistor, capacitors, cermet preset for mounting on pack 1  | £4.30 |
| 3. Set of transistors, diodes, LED, integrated circuits for mounting on pack 1   | £5.25 |
| 4. Pre-aligned front end module, coil assembly, three section ceramic filter   | £8.50 |
| 5. Fibreglass printed circuit board for stereo decoder   | £1.10 |
| 6. Set of metal oxide resistors, capacitors, cermet preset for decoder   | £2.60 |
| 7. Set of transistors LED, integrated circuit for decoder  | £2.90 |
| 8. Set of components for channel selector switch module including fibreglass printed circuit board, push-button switches, knobs, LEDs, preset adjusters etc. | £8.80 |
| 9. Function switch, 10 turn tuning potentiometer, knobs  | £5.30 |
| 10. Frequency meter, meter drive components, fibreglass printed circuit board  | £9.45 |

- | Pack   | Price |
|--|-------|
| 11. Toroidal transformer with electrostatic screen, Primary 0-117V-234V  | £4.45 |
| 12. Set of capacitors, rectifiers, voltage regulator for power supply  | £2.95 |
| 13. Set of miscellaneous parts, including sockets, fuse holder, fuses, inter-connecting wire, etc.   | £1.50 |
| 14. Set of metal work parts including silk screen printed fascia panel, acrylic silk screen printed tuning indicator panel insert, internal screen, fixing parts, etc. | £7.50 |
| 15. Construction notes (free with complete kit)  | £0.25 |
| 16. Teak cabinet 18.3" x 12.7" x 3.1"  | £9.85 |
- One each of packs 1-16 inclusive are required for complete stereo FM tuner. Total cost of individually purchased packs ..... £76.85

Published in Wireless World (May, June, August 1976) by Mr. Linsley-Hood, this design, although straightforward and relatively low cost nevertheless provides a very high standard of performance. To permit circuit optimization separate record and replay amplifiers are used, the latter using a discrete component front-end designed such that the noise level is below that of the tape background. Push button switches are used to provide a choice of equalization time constants, a choice of bias levels and also an option of using an additional pre-amplifier for microphone use. The mechanism used is the Goldring-Lenco CRV, a unit distinguished in its robustness and ease of operation. Speed control and automatic cassette ejection are both implemented by electronic circuitry. This unit which is powered by a toroidal transformer and uses metal oxide resistors throughout offers an excellent match for the Wireless World Tuner and the Linsley-Hood 75 Watt Amplifier.

### PRICE STABILITY

Order with confidence! Irrespective of any price changes we will honour all prices in this advertisement for two months from issue date provided that this advertisement is quoted with your order. E&OE VAT rate changes excluded. All components are brand new first grade full specification devices. All resistors (except where stated) are low noise carbon film types. All printed circuit boards are fibre-glass, drilled, roller tinned and supplied with circuit diagrams and construction layouts.

EXPORT ORDERS No VAT charged. Postage charged at actual cost plus 50p packing and handling. Please make payment by Bank Draft, Postal Order, International Money Order in sterling.  
SECURICOR DELIVERY: For this optional service (U.K. Mainland only) add £2.50 (VAT INC.) per kit.  
U.K. ORDERS Subject to 12½% \* surcharge for VAT. Carriage free.  
MAIL ORDER ONLY (\*at current rate if changed)

**FREE** TEAK CASE WITH FULL KITS  
KIT PRICE ONLY **£73.90**

## WIRELESS WORLD FM TUNER

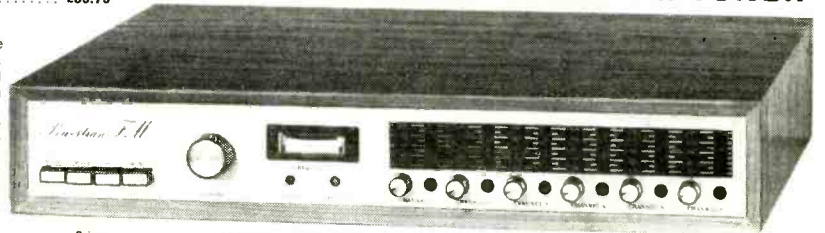

**FREE** TEAK CASE WITH FULL KITS  
KIT PRICE ONLY **£66.75**

## NEW KIT! LINSLEY-HOOD CASSETTE DECK



- | Pack   | Price  |
|--|--------|
| 1. Stereo PCB (accommodates 2 rep. amps, 2 rec. amps, 2 meter amps, bias/erase osc. relay) | £3.35  |
| 2. Stereo set of capitors, M.O. resistors, potentiometers for above                        | £9.80  |
| 3. Stereo set of semiconductors for above  | £8.90  |
| 4. Miniature relay with socket   | £2.45  |
| 5. PCB, all components for solenoid, speed control circuits                                | £3.20  |
| 6. Goldring Lenco mechanism as specified   | £21.95 |
| 7. Function switch, knobs  | £1.60  |
| 8. Dual VU meter with illuminating lamp  | £7.20  |
| 9. Toroidal transformer with E.S. screen prim. 0-117V, 234V, Sec. 15V                      | £4.45  |

- | Pack  | Price |
|---|-------|
| 10. Set of capacitors, rectifiers, I.C. voltage regulator for power supply (Powertran design)     | £2.80 |
| 11. Set of miscellaneous parts, including sockets, fuse holder, fuses, interconnecting wire, etc. | £2.50 |
| 12. Set of metalwork including silk screened fascia panel, internal screen, fixing parts, etc.    | £7.10 |
| 13. Construction notes  | £0.25 |
| 14. Teak cabinet 18.3" x 12.7" x 3.1"   | £9.85 |
- One each of packs 1-14 inclusive are required for complete stereo cassette deck. Total cost of individually purchased packs ..... £85.40

**SPECIAL PRICE FOR COMPLETE KITS £81.35**

Further details of above given in our FREE LIST

DEPT. WW3

# POWERTRAN ELECTRONICS

PORTWAY INDUSTRIAL ESTATE  
ANDOVER, HANTS SP10 3NN

Indonesia Brazil Switzerland Canada Saudi Arabia New Zealand Norway Iceland Sweden

Guernsey Cyprus Belgium Uganda Brunei Trinidad South West Africa Italy Java Grenada

# AUDIO KIT SUPPLIERS TO THE WORLD



## T20 + 20 and our new T30 + 30 20W, 30W AMPLIFIERS

Designed by Texas engineers and described in Practical Wireless the Texan was an immediate success. Now developed further in our laboratories to include a Toroidal transformer and additional improvements, the slimline T20 + 20 delivers 20W per channel of true Hi-Fi at exceptionally low cost. The design is based on a single F/Glass PCB and features all the normal facilities found on quality amplifiers, including scratch and rumble filters, adaptable input selector and head phones socket. In a follow up article in Practical Wireless further modifications were suggested and these have been incorporated into the T30 + 30. These include RF interference filters and a tape monitor facility. Power output of this new model is 30W per channel.

| Pack                                  | T20  | T30  |
|---------------------------------------|------|------|
| 1. Set of low noise resistors         | 1.40 | 1.50 |
| 2. Set of small capacitors            | 2.20 | 2.80 |
| 3. Set of power supply capacitors     | 1.90 | 2.30 |
| 4. Set of miscellaneous parts         | 3.20 | 3.20 |
| 5. Set of slide, mains, P.B. switches | 1.20 | 1.20 |
| 6. Set of pots, selector switch       | 2.80 | 2.80 |
| 7. Set of semiconductors, ICs, etc.   | 7.25 | 7.75 |

| Pack                                  | T20  | T30  |
|---------------------------------------|------|------|
| 8. Toroidal transformer - 240V prim.  |      |      |
| e.s. screen                           | 4.95 | 6.80 |
| 9. Fibreglass PCB                     | 3.20 | 3.60 |
| 10. Set of metalwork, fixing parts    | 4.20 | 4.80 |
| 11. Set of cables, mains lead         | 0.40 | 0.40 |
| 12. Handbook (free with complete kit) | 0.25 | 0.25 |
| 13. Teak cabinet 15.4" x 6.7" x 2.8"  | 4.50 | 4.50 |

### SPECIAL PRICES FOR COMPLETE KITS!

T20+20  
KIT PRICE only **£31.10**

T30+30  
KIT PRICE only **£35.90**

### 2 NEW TUNERS!

#### WW SFMT II

Following the success of our Wireless World FM Tuner kit we are now pleased to introduce our new cost reduced model, designed to complement the T20 and T30 amplifiers. The frequency meter of the more advanced model has been omitted and the mechanics simplified, however the circuitry is identical and this new kit offers most exceptional value for money. Facilities included are switchable afc, adjustable, switchable muting, channel selection by slider or readily adjustable pre-set push-button controls and LED tuning indication. Individual pack prices in our free list.

KIT PRICE  
**£45.50**

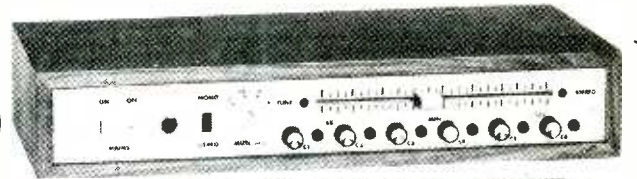

#### POWERTRAN SFMT

This easy to construct tuner using our own circuit design includes a pre-aligned front end module, PLL stereo decoder, adjustable, switchable muting, switchable afc and push-button channel selection. As with all our, full kits, all components down to the last nut and bolt are supplied together with full constructional details.

KIT PRICE  
**£32.60**

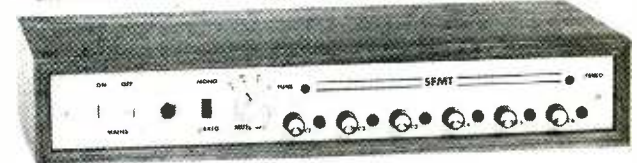

### CONVERT NOW TO QUADRAPHONICS!



SQM1 - 30 KIT PRICE **£37.15**

**Wireless World Amplifier Designs.** Full kits are not available for these projects but component packs and PCBs are stocked for the highly regarded Bailey and 20W class AB Linsley Hood designs, together with an efficient regulated power supply of our own design. Suitable for driving these amplifiers is the Bailey Burrows pre-amplifier and our circuit board, for the stereo version of it features 6 inputs, scratch and rumble filters and wide range tone controls which may be either rotary or slider operating. For those intending to get the best out of their speakers we also offer an active filter system, described by O.C. Read, which splits the output of each channel from the pre-amplifier into three channels each of which is fed to the appropriate speaker by its own power amplifier. The Read/Texas 20W or any of our other kits are suitable for these. For tape systems a set of three PCBs have been prepared for the integrated circuit based, high performance stereo Stuart design. Details of component packs are in our free list.

|   |              |
|---|--------------|
| 30W Bailey Amplifier  |              |
| BAIL Pk 1 F/Glass PCB   | <b>£1.00</b> |
| BAIL Pk 2 Resistors, Capacitors, Potentiometer set                  | <b>£2.35</b> |
| BAIL Pk 3 Semiconductor set   | <b>£4.70</b> |
| 20W Linsley Hood Class AB   |              |
| LHAB Pk 1 F/Glass PCB   | <b>£1.05</b> |
| LHAB Pk 2 Resistor, Capacitor, Potentiometer set                    | <b>£3.20</b> |
| LHAB Pk 3 Semiconductor set   | <b>£3.35</b> |
| Regulator Power Supply  |              |
| 60VS Pk 1 F/Glass PCB   | <b>£0.85</b> |
| 60VS Pk 2 Resistor, Capacitor set                                   | <b>£2.20</b> |
| 60VS Pk 3 Semiconductor set   | <b>£3.10</b> |
| 60VS Pk 6A Toroidal transformer (for use with Bailey)               | <b>£8.80</b> |
| 60VS Pk 6B Toroidal transformer (for use with 20W LH)               | <b>£7.25</b> |
| Bailey Burrows Stereo Pre-Amp                                       |              |
| BBPA Pk 1 F/Glass PCB   | <b>£2.80</b> |
| BBPA Pk 2 Resistor, capacitor semiconductor set                     | <b>£8.70</b> |
| BBPA Pk 3R Rotary Potentiometer set                                 | <b>£2.85</b> |
| BBPA Pk 3S Slider Potentiometer set with knobs                      | <b>£3.10</b> |
| Active Filter   |              |
| FILT Pk 1 F/Glass PCB   | <b>£1.40</b> |
| FILT Pk 2 Resistor, Capacitor set (metal oxide 2%, polystyrene 2½%) | <b>£4.20</b> |
| FILT Pk 3 Semiconductor set   | <b>£2.25</b> |
| 2 off Pks 1, 2, 3 reqd for stereo active filter system              |              |
| Read/Texas 20W Amp  |              |
| READ Pk 1 F/Glass PCB   | <b>£1.00</b> |
| READ Pk 2 Resistor, Capacitor set                                   | <b>£1.20</b> |
| READ Pk 3 Semiconductor set   | <b>£2.30</b> |
| 6 off pks 1, 2, 3 required for stereo active filter system          | <b>£2.30</b> |
| TRIP Pk 1 Replay Amp F/Glass PCB                                    | <b>£1.30</b> |
| TRRC Pk 1 Record Amp F/Glass PCB                                    | <b>£1.70</b> |
| TROS Pk 1 Bias/Erase/Stallizer F/Glass PCB                          | <b>£1.20</b> |

Further details of above and additional packs given in our FREE LIST

With 100s of titles now available no longer is there any problem over suitable software. No problems with hardware either. Our new unit the SQM1-30 simply plugs into the tape monitor socket of your existing amplifier and drives two additional speakers at 30W per channel. A full complement of controls including volume, bass, treble and balance are provided as are comprehensive switching facilities enabling the unit to be used for either front or rear channels by-passing the decoder for stereo-only use and exchanging left and right channels. The SQ matrix decoder is based upon a single integrated circuit and was designed by CBS whilst the power and tone control sections are identical to those used in our T30 + 30 amplifier which the SQM1-30 matches perfectly. Kit price includes CBS licence fee.

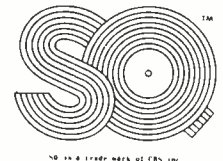

**Special offer to T20 + 20 and Texan owners!**  
Owners of T20 + 20 and Texan amplifiers, which have no tape monitor outlet, purchasing an SQM1-30 will be supplied on request, a free conversion kit to fit a tape monitoring facility to the existing amplifier. This makes simple the connection to the highly adaptable SQM1-30 quadraphonic decoder/rear channel amplifier.

### SQ QUADRAPHONIC DECODERS

Feed 2 channels (200-1000mV as obtainable from most pre-amplifiers or amplifier tape monitor outlets) into any one of our 3 decoders and take 4 channels out with no overall signal level reduction. On the logic enhanced decoders Volume, Front-back, LF-RF balance, LB-RB balance and Dimension controls can all be implemented by simple single gang potentiometers.

These state-of-the-art circuits used under licence from CBS are offered in kits of superior quality with close tolerance capacitors, metal oxide resistors and fibre-glass PCBs designed for edge connector insertion. All kit prices include CBS licence fee.

|  |               |
|--|---------------|
| M1 Basic matrix decoder with fixed 10-40 blend. All components PCB   | <b>£5.90</b>  |
| L1 Full logic controlled decoder with "wave matching" and "front back logic" for enhanced channel separation. All components PCB   | <b>£17.20</b> |
| L2A More advanced full logic decoder with "variable blend" for increased front back separation. All components PCB   | <b>£22.60</b> |
| L3A Decoder similar to L2A but with discreet component front end with high precision 6-pole phase shift networks for increased frequency response. All components (carbon film resistors), PCB | <b>£25.90</b> |
| Also available with M.O. resistors, cermet pre-set - add   | <b>£4.20</b>  |

### SEMICONDUCTORS as used in our range of quality audio equipment.

|         |       |        |       |          |       |          |       |           |       |
|---------|-------|--------|-------|----------|-------|----------|-------|-----------|-------|
| 2N699   | £0.20 | 40361  | £0.40 | BD529    | £0.55 | MJE521   | £0.60 | TIP29C    | £0.55 |
| 2N1613  | £0.20 | 40362  | £0.45 | BD530    | £0.55 | MPSA05   | £0.25 | TIP30C    | £0.60 |
| 2N1711  | £0.25 | BC107  | £0.10 | BDY56    | £1.60 | MPSA12   | £0.35 | TIP41A    | £0.70 |
| 2N2926G | £0.10 | BC108  | £0.10 | BF257    | £0.40 | MPSA14   | £0.30 | TIP42A    | £0.80 |
| 2N3055  | £0.45 | BC109  | £0.10 | BF259    | £0.47 | MPSA5R   | £0.25 | TIP41B    | £0.75 |
| 2N3442  | £1.20 | BC109C | £0.12 | BFR39    | £0.30 | MPSA65   | £0.35 | TIP42B    | £0.90 |
| 2N3711  | £0.09 | BC125  | £0.15 | BFR79    | £0.30 | MPSA66   | £0.40 | 1N914     | £0.07 |
| 2N3904  | £0.17 | BC126  | £0.15 | BFY51    | £0.20 | MPSU05   | £0.50 | 1N916     | £0.07 |
| 2N3906  | £0.20 | BC182  | £0.10 | BFY52    | £0.20 | MPSU55   | £0.50 | 1S920     | £0.10 |
| 2N4062  | £0.11 | BC212  | £0.12 | CA3046   | £0.70 | SBA750A  | £1.90 |           |       |
| 2N4302  | £0.60 | BC182K | £0.10 | LP1186   | £6.50 | SL301    | £1.30 |           |       |
| 2N5087  | £0.25 | BC212K | £0.12 | MC1310   | £2.20 | SL3045   | £1.20 |           |       |
| 2N5210  | £0.25 | BC182L | £0.10 | MC1351   | £1.05 | SN72741P | £0.40 | FMA       | £1.00 |
| 2N5457  | £0.45 | BC184L | £0.11 | MC1741CG | £0.65 | SN72748P | £0.40 | SFG10 7MA | £1.50 |
| 2N5459  | £0.45 | BC212L | £0.12 | MFC4010  | £0.95 | TIL209   | £0.20 |           |       |
| 2N5461  | £0.50 | BC214L | £0.14 | MJ481    | £1.20 | TIP29A   | £0.40 |           |       |
| 2N5830  | £0.35 | BCY72  | £0.13 | MJ491    | £1.45 | TIP30A   | £0.45 |           |       |

### EXPORT NO PROBLEM

Our Export Department will be pleased to advise on postal costs to any country in the world. Some of the countries to which we sent kits in 1976 are shown surrounding this advertisement.

Tunisia Germany Nauru Hong Kong Australia Eire Gambia Denmark France Muscat & Oman

Sierra Leone Jamaica Holland Kenya Malta Windward Isles Austria Czechoslovakia South Africa Finland Nigeria Luxembourg



# 8 DECADE RESISTANCE BOX

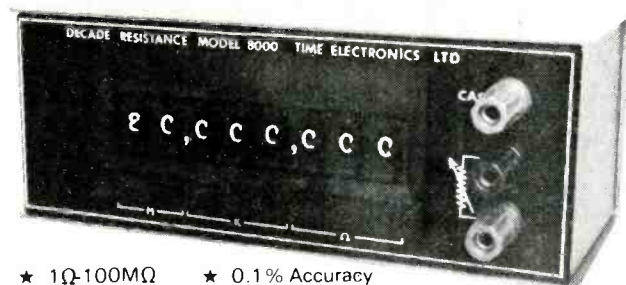

- ★ 1Ω-100MΩ      ★ 0.1% Accuracy
- ★ Colour coded digits, Ω yellow, KΩ white, MΩ red

**TIME ELECTRONICS LTD.**  
Botany Industrial Estate Tonbridge, Kent  
Tel. Tonbridge (0732) 355993

WW—023 FOR FURTHER DETAILS

# PCB DESIGN SERVICE

- All types of Artwork
- Assembly & Drilling drawings
- Component Identity 'screens'
- Solder resist masters
- Multilayer

**PADS Electrical Ltd**  
45 SOUTHWOOD RD.  
NEW ELTHAM, LONDON SE9  
TEL. 01 850 6516



WW-089 FOR FURTHER DETAILS

# Formula 4

The best sounding universal tone arm  
PROFESSIONAL LABORATORY

## Silicone Damped Pick-up Arm



most impressed with its performance

Micro-Acoustics Corp., U.S.A.  
Works exceptionally well with our cartridge Win Labs., U.S.A.  
my Shure V15/3 has never sounded better, superb arm, speakers suddenly in phase' C. Tchalekian, Canada  
'using Sonus Blue Label the sound was best of all by a very wide margin over the finest other arms tried' R. S. Golombeck, U.S.A.  
'finest tonearm to date with ADC XLM Mk 2 & SUPEX MMC' Louis Kalamaras, U.S.A.  
'World's best tonearm, makes a Decca track (that ought to be enough)' Audiogram, U.S.A.  
'JVC X-1 fitted at last someone has designed a pick-up arm complementary to the best cartridge available' B. B. Collyer, London  
'more listening pleasure than with any other tone arm used Stanton 681 eee ADC 26 & Fidelity Research' Au Chu Chung, Singapore

Leaflet on request

**MAYWARE LTD. (Dept. WW3)**

15 Heather Walk, Edgware, Middlesex HA8 9TS, England

WW—082 FOR FURTHER DETAILS

# BENTLEY ACOUSTIC CORPORATION LTD.

7A GLOUCESTER ROAD, LITTLEHAMPTON, SUSSEX. Tel. 6743  
ALL PRICES SHOWN INCLUDE V.A.T. AT 12 1/2 %

|             |            |               |               |                |              |           |             |            |              |          |           |            |             |           |
|-------------|------------|---------------|---------------|----------------|--------------|-----------|-------------|------------|--------------|----------|-----------|------------|-------------|-----------|
| 0A2 0.85    | 688G 0.35  | 6L6CC 0.70    | 12A7 0.34     | 30PL12 0.40    | B729 0.79    | EC52 1.00 | EM85 1.20   | PC889 0.49 | Q895/10 1.00 | U19 4.00 | Z152 0.59 | AF102 1.04 | CG12E 0.23  | OC42 0.73 |
| 0B2—0.40    | 68A6 0.40  | 6L7(M) 0.60   | 12A06 0.50    | 30PL13 1.00    | BI63 2.00    | EC53 1.00 | EM87 1.00   | PC890 0.52 | Q895/15 1.00 | U49 0.60 | Z209 0.29 | AF106 0.58 | CG64H 0.23  | OC43 1.37 |
| 0A3 0.55    | 68C8 0.90  | 6L12 0.39     | 12A07 0.34    | 30PL14 1.29    | CL33 1.75    | EC54 1.00 | EMM803 2.50 | PC895 0.75 | QV03/12 1.85 | U50 0.55 | Z719 0.70 | AF114 0.30 | FSY11A 0.26 | OC44 1.02 |
| 1A5GT 0.55  | 68E6 0.40  | 6L18 0.35     | 12A08 0.34    | 30PL15 0.75    | CV16 0.60    | EC86 0.84 | EY51 0.45   | PC896 0.70 | QV04/7 3.00  | U76 0.70 | Z729 0.45 | AF115 0.30 | FSY11A 0.26 | OC45 1.03 |
| 1A7GT 0.60  | 68G6 1.00  | 6L19 2.00     | 12A09 0.34    | 35A3 1.00      | CV63 1.00    | EC88 0.84 | EY81 0.45   | PC897 0.40 | QV06/20 3.50 | U78 0.45 | Z759 5.85 | AF117 0.23 | G104 0.38   | OC46 0.18 |
| 1R3GT 0.55  | 68H6 0.70  | 6L1D12 0.40   | 12A11 1.00    | 35C5 0.40      | CV98A 0.25   | EC92 0.55 | EY83 0.60   | PC898 0.45 | QV07/20 3.50 | U81 1.00 |           | AF124 0.38 | G06 0.32    | OC65 1.31 |
| 1C2 1.00    | 68K7A 0.85 | 6L2D0 0.80    | 12B6 0.50     | 35D5 0.90      | CY1C 1.00    | EC93 1.00 | EY84 1.26   | PC899 0.45 | R16 2.00     | U81 1.00 |           | AF125 0.50 | G08 0.23    |           |
| 1D5 0.75    | 68Q5 0.34  | 6P12 0.40     | 12B7 0.55     | 35W4 0.55      | CY1C 1.00    | EC94 1.00 | EY85 0.70   | PC899 0.45 | R17 1.00     | U81 1.00 |           | AF126 0.50 | G09 0.23    |           |
| 1G6 1.00    | 68Q7A 0.60 | 6P15 2.34     | 12B8 0.55     | 35Z3 0.40      | DM3 0.50     | EC95 1.00 | EY86 0.70   | PC899 0.45 | R18 1.00     | U81 1.00 |           | AF127 0.50 | G10 0.23    |           |
| 1H5GT 0.80  | 68R7 1.00  | 6Q7G 0.50     | 12E1 3.50     | 35Z4GT 0.70    | DAC32 0.60   | EC96 1.00 | EY87 0.45   | PC899 0.45 | R19 1.00     | U81 1.00 |           | AF128 0.50 | G11 0.23    |           |
| 1L4 0.25    | 68R8 1.25  | 6Q7G 0.50     | 12E2 3.50     | 35Z5GT 0.40    | DAF91 0.35   | EC97 1.00 | EY88 0.45   | PC899 0.45 | R20 0.60     | U81 1.00 |           | AF129 0.50 | G12 0.23    |           |
| 1LD5 0.70   | 68S7 1.70  | 6Q7M 0.65     | 12E3 0.70     | 42 1.50        | DAF96 0.55   | EC98 1.00 | EY89 0.45   | PC899 0.45 | R21 0.60     | U81 1.00 |           | AF130 0.50 | G13 0.23    |           |
| 1LN5 0.70   | 68W6 1.00  | 6R7G 0.70     | 12K5 1.50     | 50B5 0.95      | DC90 0.50    | EC99 1.00 | EY90 0.45   | PC899 0.45 | R22 0.60     | U81 1.00 |           | AF131 0.50 | G14 0.23    |           |
| 1N5GT 0.75  | 68W7 0.85  | 6R7(M) 1.00   | 12K7GT 0.50   | 50C5 0.70      | DI4 0.80     | EC99 1.00 | EY91 0.50   | PC899 0.45 | R23 0.60     | U81 1.00 |           | AF132 0.50 | G15 0.23    |           |
| 1R5 0.50    | 68X6 0.29  | 6SA 7 0.55    | 12K8 0.75     | 50CDBG 1.20    | DH1 0.50     | EC99 1.00 | EY92 0.45   | PC899 0.45 | R24 0.60     | U81 1.00 |           | AF133 0.50 | G16 0.23    |           |
| 1S4 0.40    | 68Y7 0.36  | 6SC7GT 0.75   | 12Q7GT 0.50   | 50EHS 1.50     | DF91 0.20    | EC99 1.00 | EY93 0.45   | PC899 0.45 | R25 0.60     | U81 1.00 |           | AF134 0.50 | G17 0.23    |           |
| 1S5 0.35    | 68Z6 0.60  | 6SG7 0.55     | 12SA7 0.75    | 50L6GT 1.00    | DF96 0.60    | EC99 1.00 | EY94 0.45   | PC899 0.45 | R26 0.60     | U81 1.00 |           | AF135 0.50 | G18 0.23    |           |
| 1T4 0.40    | 6C4 0.40   | 6SH7 0.55     | 12SCT 0.50    | 66KUC 1.50     | DH2 0.50     | EC99 1.00 | EY95 0.45   | PC899 0.45 | R27 0.60     | U81 1.00 |           | AF136 0.50 | G19 0.23    |           |
| 1U5 0.85    | 6C5G 0.60  | 6S17 0.60     | 12S7 0.55     | 72 0.70        | DH7 0.50     | EC99 1.00 | EY96 0.45   | PC899 0.45 | R28 0.60     | U81 1.00 |           | AF137 0.50 | G20 0.23    |           |
| 1L7 0.40    | 6C8 0.45   | 6SK7GT 0.55   | 12S87 0.75    | 77.5 0.45      | DH77 0.50    | EC99 1.00 | EY97 0.45   | PC899 0.45 | R29 0.60     | U81 1.00 |           | AF138 0.50 | G21 0.23    |           |
| 1G4 0.25    | 6C9 2.00   | 6SCTGT 0.75   | 12S97 0.60    | 85A2 0.75      | DH81 0.50    | EC99 1.00 | EY98 0.45   | PC899 0.45 | R30 0.60     | U81 1.00 |           | AF139 0.50 | G22 0.23    |           |
| 2GK5 0.75   | 6C10 0.71  | 6U4G 0.80     | 12SK7 0.60    | 85A3 0.75      | DK32 0.60    | EC99 1.00 | EY99 0.45   | PC899 0.45 | R31 0.60     | U81 1.00 |           | AF140 0.50 | G23 0.23    |           |
| 2X2 0.70    | 6CB6A 0.50 | 6U7G 0.55     | 12SN7GT 0.75  | 90CV 2.80      | DK40 0.70    | EC99 1.00 | EY99 0.45   | PC899 0.45 | R32 0.60     | U81 1.00 |           | AF141 0.50 | G24 0.23    |           |
| 3A4 0.55    | 6C12 0.35  | 6U8 0.50      | 12SQ7 0.80    | 108C1 0.40     | DK91 1.50    | EC99 1.00 | EY99 0.45   | PC899 0.45 | R33 0.60     | U81 1.00 |           | AF142 0.50 | G25 0.23    |           |
| 3B7 0.55    | 6CD6G 1.64 | 6V8G 0.30     | 12SQ7GT 0.90  | 150B12 1.00    | DK92 1.50    | EC99 1.00 | EY99 0.45   | PC899 0.45 | R34 0.60     | U81 1.00 |           | AF143 0.50 | G26 0.23    |           |
| 3D6 0.40    | 6CG8A 0.96 | 6V9GT 0.55    | 12S87GT 0.75  | 150C2 0.85     | DK96 1.10    | EC99 1.00 | EY99 0.45   | PC899 0.45 | R35 0.60     | U81 1.00 |           | AF144 0.50 | G27 0.23    |           |
| 3Q4 0.80    | 6C16 0.75  | 6X4 0.45      | 14H7 0.75     | 215SG 1.00     | DL36 0.60    | EC99 1.00 | EY99 0.45   | PC899 0.45 | R36 0.60     | U81 1.00 |           | AF145 0.50 | G28 0.23    |           |
| 3Q5GT 0.70  | 6CL8A 0.55 | 6X5GT 0.45    | 1457 1.00     | 30J2 1.20      | DL82 0.80    | EC99 1.00 | EY99 0.45   | PC899 0.45 | R37 0.60     | U81 1.00 |           | AF146 0.50 | G29 0.23    |           |
| 354 0.45    | 6CM7 1.00  | 6Y6G 0.95 1.8 | 1.25 303 1.20 | DL92 0.40      | DL94 0.40    | EC99 1.00 | EY99 0.45   | PC899 0.45 | R38 0.60     | U81 1.00 |           | AF147 0.50 | G30 0.23    |           |
| 3V4 0.80    | 6CS6 0.45  | 6Y7G 1.25     | 19AQ5 0.65    | 305 1.20       | DL96 0.40    | EC99 1.00 | EY99 0.45   | PC899 0.45 | R39 0.60     | U81 1.00 |           | AF148 0.50 | G31 0.23    |           |
| 4CB6 0.75   | 6C5 0.90   | 7A7 1.00      | 19BG1 1.00    | 807 1.10       | DL96 0.40    | EC99 1.00 | EY99 0.45   | PC899 0.45 | R40 0.60     | U81 1.00 |           | AF149 0.50 | G32 0.23    |           |
| 5CG8 1.00   | 6D3 0.75   | 7B8 0.80      | 19CG 1.00     | 956 0.50       | DM70 0.80    | EC99 1.00 | EY99 0.45   | PC899 0.45 | R41 0.60     | U81 1.00 |           | AF150 0.50 | G33 0.23    |           |
| 5R4GT 1.00  | 6DE7 0.90  | 7B7 0.80      | 19H1 4.00     | 1625 2.50      | DM71 1.75    | EC99 1.00 | EY99 0.45   | PC899 0.45 | R42 0.60     | U81 1.00 |           | AF151 0.50 | G34 0.23    |           |
| 5Y7 1.00    | 6DTR6 0.85 | 7D6 2.00      | 19Y3 0.40     | 1821 1.00      | DWA/350 1.50 | EC99 1.00 | EY99 0.45   | PC899 0.45 | R43 0.60     | U81 1.00 |           | AF152 0.50 | G35 0.23    |           |
| 5U4G 0.60   | 6E6 0.85   | 7F8 2.00      | 20Y1 0.70     | 5702 1.20      | DY87/6 0.35  | EC99 1.00 | EY99 0.45   | PC899 0.45 | R44 0.60     | U81 1.00 |           | AF153 0.50 | G36 0.23    |           |
| 5V4G 0.60   | 6E5 1.00   | 7H7 0.80      | 20P4 2.50     | 5763 1.65      | DY802 0.45   | EC99 1.00 | EY99 0.45   | PC899 0.45 | R45 0.60     | U81 1.00 |           | AF154 0.50 | G37 0.23    |           |
| 5Y3GT 0.55  | 6F1 0.80   | 7I7 2.00      | 20P5 1.50     | 6067 1.00      | ER8CC 2.50   | EC99 1.00 | EY99 0.45   | PC899 0.45 | R46 0.60     | U81 1.00 |           | AF155 0.50 | G38 0.23    |           |
| 3Z3 1.50    | 6F6G 0.90  | 7A7G 0.90     | 20L1 1.20     | 6060 1.00      | ER8CC 2.50   | EC99 1.00 | EY99 0.45   | PC899 0.45 | R47 0.60     | U81 1.00 |           | AF156 0.50 | G39 0.23    |           |
| 5Z4G 0.48   | 6F12 0.50  | 7Y4 0.80      | 20P1 1.00     | 6067 1.00      | ER8CC 2.50   | EC99 1.00 | EY99 0.45   | PC899 0.45 | R48 0.60     | U81 1.00 |           | AF157 0.50 | G40 0.23    |           |
| 5Z4GT 0.55  | 6F13 0.90  | 7Z4 0.80      | 20P3 1.00     | 6146 3.50      | ER8F 1.20    | EC99 1.00 | EY99 0.45   | PC899 0.45 | R49 0.60     | U81 1.00 |           | AF158 0.50 | G41 0.23    |           |
| 6B30L2 0.79 | 6F14 0.90  | 8D2 0.50      | 20P4 1.84     | 7025 1.50      | ER8G 1.20    | EC99 1.00 | EY99 0.45   | PC899 0.45 | R50 0.60     | U81 1.00 |           | AF159 0.50 | G42 0.23    |           |
| 6A8G 1.40   | 6F15 0.85  | 8D8 0.45      | 20P5 1.50     | 7193 0.60      | ER8H 1.25    | EC99 1.00 | EY99 0.45   | PC899 0.45 | R51 0.60     | U81 1.00 |           | AF160 0.50 | G43 0.23    |           |
| 6AC7 0.55   | 6F16 0.75  | 8I7 0.50      | 25A6G 0.70    | 7475 1.20      | ER8CC 2.50   | EC99 1.00 | EY99 0.45   | PC899 0.45 | R52 0.60     | U81 1.00 |           | AF161 0.50 | G44 0.23    |           |
| 6A65 0.35   | 6F18 0.50  | 9I07 0.70     | 25L6G 0.70    | 9002 0.55      | ER8I 1.15    | EC99 1.00 | EY99 0.45   | PC899 0.45 | R53 0.60     | U81 1.00 |           | AF162 0.50 | G45 0.23    |           |
| 6AG7 0.60   | 6F23 0.65  | 9U8 0.45      | 25Y5 0.80     | 9006 0.45      | ER8J 0.90    | EC99 1.00 | EY99 0.45   | PC899 0.45 | R54 0.60     | U81 1.00 |           | AF163 0.50 | G46 0.23    |           |
| 6AH6 0.70   | 6F24 0.80  | 10C2 0.70     | 25Z4G 0.50    | A1834 1.00     | ER8CC 2.50   | EC99 1.00 | EY99 0.45   | PC899 0.45 | R55 0.60     | U81 1.00 |           | AF164 0.50 | G47 0.23    |           |
| 6AJ5 0.70   | 6F25 1.00  | 10C14 0.45    | 25Z5 0.75     | A2134 3.00     | ER8CC 2.50   | EC99 1.00 | EY99 0.45   | PC899 0.45 | R56 0.60     | U81 1.00 |           | AF165 0.50 | G48 0.23    |           |
| 6AJ8 0.35   | 6F26 0.36  | 10D1 0.85     | 25Z6G 0.80    | A3042 6.00     | ER8CC 2.50   | EC99 1.00 | EY99 0.45   | PC899 0.45 | R57 0.60     | U81 1.00 |           | AF166 0.50 | G49 0.23    |           |
| 6AK5 0.45   | 6F28 0.74  | 10D7 0.80     | 28I7 2.00     | AC2PEN 1.00    | E1A50 0.40   | EC99 1.00 | EY99 0.45   | PC899 0.45 | R58 0.60     | U81 1.00 |           | AF167 0.50 | G50 0.23    |           |
| 6A95 0.50   | 6F18 0.90  | 10E1 0.67     | 30A5 0.75     | AC2PENDD 1.00  | E1B01 1.00   | EC99 1.00 | EY99 0.45   | PC899 0.45 | R59 0.60     | U81 1.00 |           | AF168 0.50 | G51 0.23    |           |
| 6AK8 0.40   | 6G6A 0.60  | 10F9 0.65     | 30C1 0.40     | AC6/PEN 0.00   | E1B0C 0.50   | EC99 1.00 | EY99 0.45   | PC899 0.45 | R60 0.60     | U81 1.00 |           | AF169 0.50 | G52 0.23    |           |
| 6AL5 0.20   | 6GH8A 0.80 | 10F18 0.65    | 30C15 1.77    | AC6/PEN/7 1.50 | E1B0C 0.50   | EC99 1.00 | EY99 0.45   | PC899 0.45 | R61 0.60     | U81 1.00 |           | AF170 0.50 | G53 0.23    |           |
| 6AM6 0.50   | 6GK5 0.75  | 10L14 0.45    | 30C17 0.77    | AC6/PEN/7 1.50 | E1B0C 0.     |           |             |            |              |          |           |            |             |           |

(CONT'D FROM R.H. COL.)

Our 500w Auto Transformer will give voltage increases of 10 20 30 or 50 volts depending on which tapping you use Price £4.50 + 36p Post £1 00 + 8p

Mains Volt Drop Compensation Transformer. Another irritating thing which happens in cold weather is that the mains voltage drops and this can often drop to such a low point as to make soldering irons unusable or very slow in operation and also suppress the work of other instruments. Even in normal weather if you put a long line through to a distant workshop you may find that the voltage is low due to voltage drop along the line so the compensation transformer may be the cheap way of restoring voltage to normal. The other alternative being to install a much heavier cable

Variable Inductance Choke. In an unsaturated core state a choke will oppose the flow of AC very much more than when its core is saturated. Therefore, this choke is built with a separate coil to deliberately saturate the core, a very small current of variable dimension will act as a voltage regulator. Use this for lamp dimming and a multitude of other purposes. We offer such a choke of 8 amps AC rating requiring 75mA DC control current at bargain price of £22.50 plus £1.86 carriage £5 00 + 40p. This choke weighs approx 60lbs

Pencil Meter 0-1 mA. Japanese made full vision perspex front flush mounting Price £2.00 + 16p

Constant Voltage Auto. Transformer for operating 100v equipment off our standard 230 240v mains. Input voltage can be plus or minus 20% and output voltage will be a steady 115 volts. beautifully made by an American Company. Two models available 500w £35 + £2.80 Post £2 + 16p 750w model £50 + £4 Carriage £3 + 24p

Tangential Blower, paddle type metal impeller driven by a powerful but quiet mains operated induction motor. These give a real blow with the mouth of a completely free. The air outlet is 9 1/2" x 1 1/2" approx so they are ideal for fitting into a cooker hood, forced draft heater etc. Price £3.00 + 24p Post 80p + 6p

Tubular Heating Element. Spiral wire element wound on a porcelain tube approx 1 1/2" dia and 3 3/4" long 500w rating at 240 volts with flat tag connectors. Internal diameter of the porcelain tube is 3/4" and it is completely free from obstructions and live parts so this can be slipped over a tube to heat the contents of the tube or the tube could simply be used to support the element for instance if this was being mounted in front of the tangential blower mentioned above. Price 50p + 4p

Rectangular Hot Plate. Polished aluminium panel with ridged top and angles underneath to strengthen it. This is approx 10" x 4 1/2" of flat plate. Beneath plate is 100w element and sensor switch which will maintain the surface of the plate just too hot to touch. With leads and tags. This is ideal if you are making up a fitted warmer or for an airing cupboard, etc. Price 75p + 6p Post 70p + 2p

Humidity Switch, American made by Racor of their type No. J11. The action of this device depends upon the dampness causing a membrane to stretch and dryness causing it to contract. The stretching of the membrane through the dampness will trigger a sensitive microswitch. The actual point of switching is adjustable by a screw within the device. It is quite sensitive, breathing on it for instance will switch it on. On the rating of the micro switch we understand it is 3 amp at 250V AC. Overall size of the device approx 3 1/2" long 1 1/2" wide and 1 1/2" deep Price 60p + 6p

Panel Meter 100mA. Flush mounting 3 1/2" around face moving coil movement. 0-100 divided into single divisions. Made by Taylor Electrical this has long terminals protruding from the back so can be mounted on a thick panel also it would be a relatively simple matter to add shunts to convert this to read amps or tens of amps. etc. Price £1.50 + 12p

Charge/Discharge indication meter. This is a heavy panel mounting instrument made originally for the G.P.O. rather old design but still we feel will fill an urgent need. Basically the operation of this depends upon a Mercury motor which revolves clockwise or anti-clockwise depending upon whether the batteries are being charged or discharged. A pointer shows the state of charge of the batteries at any time. Also fitted within the instrument are auxiliary contacts which could be used to set off alarms like lamps etc. Price £4.50 + 36p Post £1 00 + 8p

Resettable Fuses (thermal trips). Two new types have come in one made by ETC is a 6-amp model which is mounted through a single hole in a panel. The other is a 15-amp model suitable for 250 volts AC or 24 volts DC. Price 50p + 4p

4.5 Amp Model made by AEG is held by two screws thus a bank of these could be mounted between metal strips. Price 50p + 4p

Double Micro Switch Assembly. This has two standard Bonella micro switches riveted together a lever fitted at right angles operates both switches at same time. This lever also protrudes 1/2" beyond the side of the switch so this could be used as a cabinet switch or as a reset switch. Note the contacts are open until the lever is pressed. Price 50p + 2p

Disc Motor, mains operated. This is very thin in fact less than 1/2" thick and only approx 2" dia. Spindle revolves at 250 rpm and the spindle which is approx 1 3/4" dia pushes through so motor could be used to drive clockwise or anti-clockwise. The spindle being a friction fit can be pushed completely out and replaced by your own spindle a knitting needle for instance. Price only 35p + 3p

75 rpm Mains Induction Motor with gearbox. This motor is quite powerful and has 1 1/2" stack and the final 75 rpm drive shaft is 1 1/2" long by 3/4" dia. The motor also has a spindle coming from the opposite end to which could be fitted another pulley. Overall size approx 3" x 5" 2 1/2" x 5" spindles. Price £2.50 Post 80p + 16p

24 Hour Motor, beautifully made by Sangamo. This is 200 240v mains driven motor with gearbox together in one housing size approx 1 3/4" dia by 1 1/2" deep if you are contemplating making a 24 hour switch with a lot of on/off then this is obviously the motor. Price £1.75 + 14p

Vanner Motor, makers ref no. MT A256230. This is 1 rev per hour and is standard replacement for many mains driven time switch and coin operated devices or is very convenient motor for fitting into almost any equipment as the final drive shaft is threaded and has a substantial knurled nut for easily fitting wheel or disc. Overall size of motor approx 2 1/4" dia by 1 1/2" deep. Price £1.50 + 12p

Motor with Gear Box and bicycle chain type sprocket. Final speed 175 rpm. made by GEC their type no. CE 1630. This is for normal mains voltage and is approx 1 1/2" dia. Capacitor start and reversible. Its torque is approx 9lbs to the inch. This should be ideal for pulling curtains and similar applications. Price £7.50 + 60p Post 40p + 8p

Double Ended Mains Motor. Spindle speed 1400 rpm. made by GEC their type No. Q1600. Capacitor run reversible 1/50th h.p. approx. This is a very efficient and versatile motor. Price £5 + 40p Post 40p + 4p

Flat Uncoiled Solenoid, wound with probably the thinnest possible enamelled wire. This coil has a resistance of 3 ohms. When connected to the AC mains it has an appreciable vibratory field and when to high voltage DC a substantial polarised magnetic field is present. This is therefore ideal for many experiments in magnetism, induction heating, transformer effects, etc. size of coils 1 1/2" dia by 5 1/2" thick with 1/4" hole through the centre adequately insulated with tough plastic so quite safe for mains and even higher voltages. Price 50p + 4p

Mains Solenoid with Plunger, made by West Tool part of their Soreng range. This has 1 1/2" pull-stroke when closed approx 2 1/4" long 1 1/4" wide 2 1/2" high. Mounting base has six alternative fixings. Price £1.50 + 12p Post 20p + 2p

Mains Solenoid with Plunger. Small West Tool Soreng type their model TT2. This has 1/2" pull overall size 1 1/2" long 1 1/4" wide 1 1/2" high. We have two models standard mains type 95p + 8p 110 volt type 85p + 7p

MULLARD UNILEX

A mains operated 4+4 stereo system. Rated one of the finest performers in the stereo field this would make a wonderful gift for almost anyone in the easy-to-assemble modular form and complete with a pair of Hi-Fi speakers this should sell at about £30 - but due to a special bulk buy and as an incentive for you to buy this month we offer the system complete at only £14.00 including VAT and postage.



PAPST MOTORS

West German make these fine motors are noted for their performance and reliability. Special features are the rotating heavy outer which acts as a flywheel to eliminate wobble and flutter and switchable reversing.



We have four types in stock all 1 350 revs including starting capacitor. (1) Reference No. KLZ 20 50.4 230 volts 50HZ Price £5.50 (2) Reference No. KLZ 32 50.4 230 volts 50HZ Price £6.50 (3) Reference same as above 115 volts 50HZ Price £2.50 (4) Reference same as above 110 volts 60HZ Price £2.50 Post and VAT 80p each extra

AEROSOL RELEASE LUBRICANT

Dry Film Lubricant in aerosol form for easy application and for putting lubricant into places where the normal oil can't reach. Home and everyday uses. We have purchased a large quantity of these from the Liquidator and are able to offer them to you for about half of the original list price. 88p per 8oz can of 12 cans for £5, post paid. The lubricant is C.I. Fluon L169.

MAINS MOTOR

Precision made - as used in record decks and tape recorders - ideal also for extractor fans, blower heaters etc. New and perfect. Snp at 95p + VAT & Postage 35p stack motor £1.50 + VAT & Postage 35p 1 1/2" stack motor £2 + VAT & Postage 40p

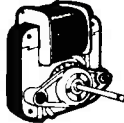

MULTI-SPEED MOTOR

Six speeds are available. 500 850 and 1 100 r.p.m. and 8 000 12 000 and 15 000 r.p.m. Shaft is 1/4" diameter and approximately 1 1/2" long 230 240v. Its speed may be further controlled with the use of our Thyristor controller. Very powerful and useful motor size approx 2 1/2" dia x 5 1/2" long. Price £2.00 including post & VAT. SPEED CONTROL SWITCH 50p + 4p

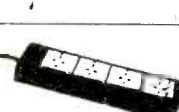

DISTRIBUTION PANELS

Just what you need for work bench or lab. 4 x 13 amp sockets in metal box to take standard 13 amp fused plugs and on/off switch with neon warning light. Supplied complete with 6 feet of flex cable. Wired up ready to work. £2.75, VAT and postage 65p

MAINS RELAYS

With triple 10 amp changeover contacts operating coil wound for 230 volts AC. chassis mounting, one screw fixing, ex unused equipment 60p each, 10 for £5 post and VAT



BATTERY CONDITION TESTER

Made by Mallory but suitable for all batteries made by Ever Ready and others. Most of which are zinc carbon types but also mercury manganese - nicad - silver oxide and alkaline batteries may be tested. The tester puts a dummy load on the battery and the meter scale indicates the condition depending upon which section of the pointer rests. The section reads 'replace weak or good'. The tester is complete in its case. size 3 1/4" x 6 1/4" x 2" with leads and prod. £4.50, post & VAT paid

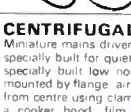

CENTRIFUGAL BLOWER

Miniature mains driven centrifugal type blower unit by Woods. Powerful but specially built for quiet running - driven by cushioned induction motor with specially built low noise bearings. Overall size 4 1/2" x 4 1/2" x 4". When mounted by flange air is blown into the equipment but to suck air out, mount from centre using clamp. Ideal for cooling electrical equipment or fitting into a cooker hood film. Thus preventing the moving flux smoke when soldering etc. A real bargain at £3.30 + 60p post & VAT



BREAK-DOWN UNIT

Contains hundreds of useful parts some of which are as follows - 66 silicon diodes equivalent 0.91 68 resistors mostly 1/2 watt 5% covering a wide range of values. 4 x 1 mfd 400v condensers. 15 x 01 mfd 100v condensers. 2 RF chokes. 8 x B9 valve holders. 1 x 4H choke. 1 x 115v transformer. 1 boxed unit containing 4 delay lines also tag panels, summer condensers suppressors, etc. on a useful chassis sized approx 9" x 5" x 7". Only 75p (the 66 diodes would cost at least 10 times this amount). This is a snip not to be missed. Post & VAT 75p



HONEYWELL PROGRAMMER

This is a drum timing device the drum being calibrated to equal divisions for switch setting purposes with trips which are infinitely adjustable for position. They are also arranged to allow 2 operations per switch per rotation. There are 15 changeover micro switches each of 10 amp type operated by the trips. This 15 circuits may be changed per revolution. Drive motor is mains operated 5 revs per min. Some of the many uses of this timer are: Machinery control. Boiler firing. Dispensing and Vending machines. Display lighting. animated and signs. Signalling etc. Price from makers probably over £20 each. Special snip price £12.50, £1.00 Post & VAT. Don't miss this terrific bargain.



SPEED CONTROLLED 9V MOTOR

This is a motor with a governor. 9v operation intended for record players and tape recorders. These are reversible and electrically magnetically and acoustically screened. Size approx 1 1/2" diameter by 1" deep with good length spindle. Japanese made portable replacement in a good many popular cassette and record players. PRICE 95p inc Post & VAT

15A ELECTRICAL PROGRAMMER

Learn in your sleep. Have radio playing and kettle boiling as you awake - switch on lights to ward off intruders - have a warm house to come home to. All these and many other things you can do if you invest in an electrical programmer. Clock by famous maker with 15 amp on/off switch. Switch on time can be set anywhere to stay on up to 6 hours. Independent 60 minute memory jogger. A beautiful unit. Price £2.95, VAT & postage 60p or with glass front chrome bezel £1.50 extra

250 WATT TRANSFORMER

Heavy duty power transformer which can be used for many purposes. Rated at 250 watts it is well built with frames for upright mounting and is varnish impregnated. Its primary is for 230 240 volts 50 cycles. It has four secondaries each 10v very high current windings. Just a few of the circuits it can power are: 10-0-10v at up to 12 amps. 20-0-20v at up to 6 amps. single 10v at 25 amps. single 20v at 12 1/2 amps. single 30v at 9 amps. single 40v at 6.5 amps. The transformer can be used for power circuits (charging etc.) or for amplifiers, there being an earth screen between primary and secondaries. A transformer like this today would cost at least £15 from the makers. However, we are making a special offer at £4.50 + 36p post £1 + 8p each. Grab some while you can, our stock may not last long.

Terms: When order under £5 please add 40p to offset handling and packing charges. Cash with order except Institutions and Public Companies.

IT'S FREE!

Our monthly Advance Advertising Bargains List gives details of bargains arriving or just arrived - often bargains which sell out before our advertisement can appear - It's an interesting list and it's free - just send S.A.E. Below are a few of the Bargains still available from previous issues.

Radiant Wall Heaters for bathrooms workshops etc. Advantage with this type of heater is that the benefit is felt immediately, there is virtually no warm-up period. Due to a recent large purchase we can offer the Spriglett 750w. This is a 750w heater 20 1/2 inches long. Quite nice design with highly polished reflector and chrome plated wall mounting brackets and pull cord switch. Retail price originally intended to be £6.50 we are able to sell these at £3.95 + 32p Post 70p + 6p

4 Pole Motor. Carefully balanced spindle fitted with belt drive pulley for tape recorders, etc. Normal mains working speed 1 250 r.p.m. Price £1.50 + 19p Post 30p + 13p

5 Band Mains/Battery Radio. This is a portable radio with a built-in mains power pack. Handy size. Approx 9 1/2" high 6 1/2" wide and 3 1/2" deep with carrying strap. This also uses a reasonable size speaker to give a better than average tone. The radio has a conventional glass scale with a pointer travelling behind. The scale is marked in frequencies and has a logging scale and covers the following bands: AM 535-1605 kHz FM 88-108 MHz Aircraft 108-135 MHz Police 147-174 MHz Weather 162.5 MHz. These sets originally related at £200 each. They are new but are faulty on one band. This will be either the AM or FM band otherwise they are in good order. Price £8.50 + £1.07 Post 50p + 6p. When ordering please state preference for AM or FM band.

8-Track Stereo Cassette Deck. Complete mechanism with push button operated track selection. Tape head and pre-amp. Japanese made with front flap for cassette entry. Price £5.50 + 62p Post 40p + 5p

Mains Power Supply to suit deck £2 + 25p

8-Track Stereo Car Cassette Player. 12 volt with polarity reversing switch. Speakers not included. These were sold under the trade name, Elpicco, at just under £20 each. The ones we have were faulty on arrival from Japan but have now been serviced. Price £9.50 + £1.99 Post 50p + 7p. We also have few of these still in need of repair but complete and we believe quite repairable. Price £6.50 + 82p Post 50p + 7p

Shaver Light with isolated socket. As you know normal mains sockets must not be used in bathrooms on account of the danger of an accident through touching the live side when earthed through bath or sink etc. However, provided it is isolated from earth a shaver socket is allowable and the one we are offering complies with this requirement. It is also fitted with a pull cord switch and is ideal for use over the mirror in the bathroom. Price £8.50 + 68p Post £1 50 + 12p

Pressure Control Switch made by Allan Bradley of the U.S.A. their ref no. 836. Completely adjustable from 30" of vacuum to zero then up to 75lbs per square inch of air pressure. This also has an adjustable differential which can be set to pressure tolerance of between 2-15 psi. The switch operates a changeover contact which is capable of breaking up to 15 amps AC. Few only of these. Price £15 + £1.20

Air Flow Sensor. American made by the Foxborough Company. We have two different types. One bears ref. NF B 503A and the other MF B 502B. These are beautifully made precision units obviously intended for fitting into very high pressure air or gas lines. There is an inbuilt turbine and transducer converter with electrical contacts but other than this we have no information on these sensors. Price is negotiable.

Converter Amplifier, again made by the Foxborough Company their part no. N 137 CR. We believe there are for use with the above air flow sensors. Price again negotiable.

Motor with Gearbox made by Klaxon their type no. EK3Q J2 - M21. This is a very popular type of motor. Final drive shaft comes out at right angles to the motor. Final speed is 10 rpm. Approximate size of the motor casing, 0 1/2" x 1 1/2" diameter. These are ex-equipment but guaranteed O.K. supplied complete with transformer for use on standard 230v 50Hz mains. Price £4.00 + 32p Post 80p + 6p

Mains Table Radio. Japanese made. This is a medium wave radio with built-in aerial plenty of volume and very reasonable tone. Will receive all strong and medium powered stations on the wave bands - medium wave. This type of radio is coming back into popularity owing to the very high price of batteries. Price £4.95 + 50p Post £1 50 + 19p

Miniature Mains Transformer. Standard primary centre tap secondary giving 4.5v-0-4.5v 200mA. Price £1 50 + 12p

Mains Transformer 20 volt 1/2 amp. Upright mounting standard primary centre tapped and fixing feet. Price £1.50 + 19p

Auto Transformer. 20 watt 240 volt in 115 volt. This is the same as the transformer above as this has a centre tapped primary. Price £1.50 + 19p

Mains Battery Eliminator. Japanese made. Bakelite encased with two prongs for shaver and adaptor. This has output of 4.5v at 100 mA and is therefore suitable to use in radios or similar equipment that use three 1.5 cells or by small internal alterations the voltage can be stepped up to 6 volts very easily or 9v and 12v. Price £2.00 + 25p. Duro, but 9v £2.50 + 30p

Light for Growing. With the ever increasing price of oil more and more growers are using insulated buildings without any daylight and are using electric lamps for light and heat. Various different types of lamps are recommended amongst these are 9" fluorescent tubes, warm white with internal reflector. We recently acquired a quantity of these with suitable control gear and can therefore make a special offer as follows: if you buy 100 sets each set comprising 8" tube instant start ballast current regulating capacitor, two h.p. tube connectors and two Terry clips for holding the tube. Price £3 + 24p per set. Collected from our depot in Sussex or delivered to you - delivery charge at cost. We have only 1,000 of these sets so this offer should be taken up quickly.

Car Starter. Most drivers who use their car around town find that on a very cold morning they have difficulty in starting because the battery has not any charge left in it. This always seems to happen on the morning when you are in a particular hurry so a charger/starter is well worth having. Our kit for this comprises a heavy duty 250w transformer and full wave rectifier which for short periods will deliver 20 amps. This is usually enough to get the car started directly it has started of course it can be disconnected from the battery as the car's internal charger will take over. Special offer price of this is £6.50 including post and VAT.

Cable Bargains. We have now sold out of all the 7029 3 core and also all the 1 5mm 3 core. We are also rapidly going through our stocks of 7029 3 core and earth and 1 5 3 core and earth. You will recall that we made a special offer of these cables at £9.50 + 76p and £5.50 + 44p. So if you haven't installed them yet, we advise that you do so now to be able to avoid disappointment. We have most other sizes of cable in stock but of course these are not so popular.

J. BULL (ELECTRICAL LTD.)

(Dept. W.W.), 103 TAMWORTH ROAD CROYDON CR9 1SG

# SINTEL for KITS - BOOKS - DISPLAYS - MPUs

Components from leading manufacturers only

A FREE CATALOGUE requested by post or phone, will be sent by return giving full details of our range of CASES • CHIPS • DISPLAYS • MPUs • MPU KITS • SWITCHES and other components not listed here, with same day despatch for goods in stock. All prices valid until 31st March, 1977.

## USEFUL PRINTED CIRCUIT BOARDS

| Order as | Description                              | Price |
|----------|--|-------|
| 610-950  | 6 digit Set. Size h 30mm w 173mm d 109mm | £5.50 |
| 246-950  | 4 digit Set. Size h 30mm w 126mm d 109mm | £3.95 |
| 915-950  | 2 digit Set. Size h 30mm w 80mm d 109mm  | £2.30 |

| Order as | Description                                     | Price |
|----------|---|-------|
| 876-001  | 6 digit counter format for FND500/TIL321/TIL322 | £0.75 |
| 875-001  | 4 digit counter format for FND500/TIL321/TIL322 | £0.55 |
| 472-001  | 2 digit counter format for FND500/TIL321/TIL322 | £0.29 |
| D500-6   | 6 digit clock format for FND500/TIL321/TIL322   | £1.35 |
| D652-6   | 6 digit clock format for XAN652/XAN654          | £1.35 |
| D500-4   | 4 digit clock format for FND500/TIL321/TIL322   | £0.90 |
| D500-8   | 8 digit counter format for FND500/TIL321/TIL322 | £1.35 |

| Order as | Description   | Price |
|----------|---|-------|
| 142-269  | COUNTER KIT<br>A complete kit for building a 2 digit, single PCB CMOS Counter Module with Latch Includes PCB 912-950, 2 x TIL322 or FND500, 2 x 4511, 1 x 4518, R's, socket pins, etc. Size h 116mm w 71mm d 18mm | £8.60 |
| 912-950  | Single PCB only as used in 142-269 COUNTER KIT above  | £1.05 |

## MEMORIES

| Order as                   | Description   | Price  |
|----------------------------|---|--------|
| NEW 9131                   | 4K STATIC RAM<br>1024 x 4 bit • 500nsec Access time • Single 5v supply • 120mA max current consumption • 22 pin DIL package<br>When wiring up a 1024 x 8 bit memory board using 9131s reduces the number of wires between memory ICs from about 100 to about 18 | £19.50 |
| TTL COMPATIBLE STATIC RAMS |   |        |
| 2102A-6                    | 1024 x 4 bit  | £3.61  |
| 2112A-4                    | 256 x 4 bit   | £4.76  |
| 6508                       | CMOS 1024 x 1 bit   | £8.05  |
|                            | 600nsec TTL Compatible  |        |

Our offices are at Link Property, 209 Cowley Road, Oxford, but please do not use this as a postal address.  
**ORDERS** Add VAT at 8% + 25p p&p. Phone orders see FAST SERVICE. Export orders welcome. No VAT but add 10% (Europe), 15% (Overseas) for Air Mail p&p. For export postage rates on heavy items - contact us first.

SEND YOUR ORDER TO  
**SINTEL**  
 PO BOX 75C, OXFORD  
 Tel. 0865 49791



**SINTEL**

## CMOS AND OTHER COMPONENTS

| Send for Catalogue |              |
|--------------------|--------------|
| CD4000 0.17        | CD4036 3.65  |
| CD4001 0.18        | CD4037 1.09  |
| CD4002 0.17        | CD4038 1.24  |
| CD4006 1.35        | CD4039 3.55  |
| CD4007 0.18        | CD4040 1.23  |
| CD4008 1.11        | CD4041 0.96  |
| CD4009 0.64        | CD4042 0.96  |
| CD4010 0.64        | CD4043 1.16  |
| CD4011 0.20        | CD4044 1.07  |
| CD4012 0.19        | CD4045 1.61  |
| CD4013 0.64        | CD4046 1.53  |
| CD4014 1.16        | CD4047 1.04  |
| CD4015 1.16        | CD4048 0.64  |
| CD4016 0.64        | CD4049 0.64  |
| CD4017 1.16        | CD4050 0.64  |
| CD4018 1.16        | CD4051 1.07  |
| CD4019 0.64        | CD4052 1.07  |
| CD4020 1.28        | CD4053 1.07  |
| CD4021 1.16        | CD4054 1.33  |
| CD4022 1.11        | CD4055 1.51  |
| CD4023 0.24        | CD4056 1.51  |
| CD4024 0.89        | CD4059 5.48  |
| CD4025 0.24        | CD4060 1.28  |
| CD4026 1.98        | CD4063 2.26  |
| CD4027 0.64        | CD4066 0.71  |
| CD4028 1.03        | CD4067 4.28  |
| CD4029 1.31        | CD4068 0.24  |
| CD4030 0.64        | CD4069 0.24  |
| CD4031 2.55        | CD4070 0.67  |
| CD4032 1.23        | CD4071 0.24  |
| CD4033 1.60        | CD4072 0.24  |
| CD4034 2.19        | CD4073 0.24  |
| CD4035 1.35        | CD4075 0.24  |
| CD4076 1.61        | CD4077 0.60  |
| CD4078 0.24        | CD4081 0.24  |
| CD4082 0.24        | CD4085 0.82  |
| CD4086 0.82        | CD4088 1.78  |
| CD4089 1.78        | CD4093 0.92  |
| CD4094 2.15        | CD4095 1.20  |
| CD4096 1.20        | CD4097 4.28  |
| CD4098 1.26        | CD4099 2.11  |
| CD4102 1.43        | CD4510 1.57  |
| CD4511 1.80        | CD4512 1.65  |
| CD4513 1.30        | CD4514 1.25  |
| CD4515 1.57        | CD4516 1.56  |
| CD4517 1.80        | CD4518 1.25  |
| CD4519 1.57        | CD4520 1.43  |
| CD4521 1.80        | CD4522 1.65  |
| CD4523 1.65        | CD4555 1.04  |
| CD4556 1.04        | MC14528 1.22 |
| MC14528 1.22       | MC14553 4.68 |
| MC14553 4.68       | IM6508 8.05  |

| Send for Catalogue  |                  |
|---|------------------|
| CLOCK CHIPS   | MPUs             |
| AY51202 2.89  | IM6100CCDL 45.36 |
| AY51224 3.50  | 8080 (2.5) 32.25 |
| MKS50253 5.60   | MC6800 33.87     |
| FLAT CABLE  | SC/MP            |
| 20w 1m 1.00   | ISPA 500 18.75   |
| 10m for 8.00  | MCS 60 £27.50    |
| VEROCASES   | MPU KITS         |
| 751410J 3.36  | MEK6800DI 137.00 |
| 751411D 3.77  | INTR0 KIT        |
| 751237J 2.15  | ISP8K/200E 93.55 |
| 751238D 3.00  | MCS 60 176.65    |
| 751239K 3.58  | TRANSFORMERS     |
| DISPLAYS  | FND500 1.02      |
| TIL321 1.30   | TIL322 1.20      |
| TIL322 1.20   | XAN652 2.45      |
| XAN654 2.45   | 5LT01 5.80       |
| SOLDERCON   | SUNDRIES         |
| IC PINS   | CA3130 1.14      |
| 1000 0.50   | -A741 0.35       |
| 1000 4.00   | (RCA 8 DIL)      |
| 10 000 34.00  | 78L12WC 0.77     |
| NEW DATA FROM SINTEL                                      |                  |
| Motorola CMOS Databook (Vol 5 Series B)                   | 3.50             |
| TMS 8080 Microprocessor Datasheet                         | 0.75             |
| TMS5501 (MultiFunction I/O Controller for 8080) Datasheet | 0.75             |

### HIGH QUALITY KITS

**CRYSTAL CONTROLLED 6 DIGIT CAR CLOCK WITH INDEPENDENT JOURNEY-TIMER.** Shows time or elapsed time in hrs mins secs • Runs off car 12v supply • Nine push buttons for Start/Stop/Reset selecting display to show time or elapsed time • All controls functional irrespective of display mode • Kit complete with case. Order as CCK. **£38.00**

**ACK (ALARM).** Orders as ACK + BBK + XTK Without crystal control and battery backup (Can be added) **£33.58**

**GCK CLOCK KIT.** Order as GCK + GBBK + XTK Without crystal control and battery backup **£19.65**

**Order as GCK** **£14.40**

**THE SINTEL CAR CLOCK KIT** Order as AUT-CCK Without case **£17.85**

**Order as AUT-MODULE KIT** **£16.45**

**50Hz CRYSTAL TIMEBASE KIT** Order as XTK **£6.28**

**FAST SERVICE.** We guarantee that Telephone Orders for goods in stock, received by 4.15 p.m. (Mon-Fri.) will be despatched on the same day by 1st Class Post (some heavy items by parcel post) and our stocking is good. Private customers should telephone and pay by giving their Access or Barclaycard number, with a minimum order value of £5. Official orders, no minimum.

# Strobes, Tachos, Meters, Generators and Telecommunications Test Equipment

E.B. import and distribute high-grade products from World-renowned British & Overseas Manufacturers.

## NEW FUNCTION GENERATORS!



G430 provides Sine-wave (0-10Vrms) and Square-wave (0-20V p-p) from 600Ω, continuously variable, via 4-position 0-60dB, push-button operated step attenuator. Frequency range 1Hz to MHz.

**£95** Send for details of our complete range



## NEW PULSE GENERATOR Model 70 (illustrated above)

Compact, low-cost pulse and square-wave generator, featuring

- P.R.F. 4Hz to 400kHz, gated or free-running.
- O/P 10v peak from 50Ω, also synch. O/P.
- Pulse width 1μSec to 100mSec.
- Delay 1μSec to 100mSec.
- Pulse mark / space inversion.
- TTL/CMOS HI LO gating facility.

**£89**

## NEW WIDE-RANGE MULTIMETER UM-11

Features 38-colour-coded ranges with high input impedance.

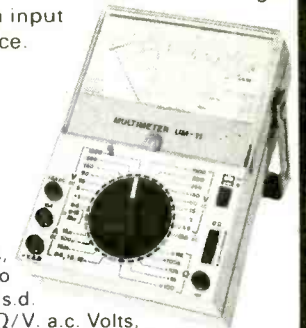

d.c. Volts, 150mV to 1500V f.s.d. at 100kΩ/V. a.c. Volts, 1.5V to 1500V f.s.d. at 31.6kΩ/v. d.c. Current, 10μA to 15A. a.c. Current, 15A.

Other star features include mirror-scale, rugged taut band suspension, dB scale, diode and fuse protection.

Supplied complete with test-leads and leather carrying case.

**£39.50**



See inside back cover for details of ICE Super range of multimeters!

Add 8% VAT to all prices shown. Carriage extra details on request.



**ELECTRONIC BROKERS LIMITED (New Products Division)**  
 49-53 Pancras Road, London NW1 2QB. Tel: 01-837 7781

Callers welcome—Monday to Friday 9 a.m. to 5 p.m.

| TTLs by TEXAS                        |            |               | C-MOS I.C.s                  |               |      | OP. AMPS                |               |              | TRANSISTORS   |  |  | DIODES     |  |  |
|--------------------------------------|------------|---------------|------------------------------|---------------|------|-------------------------|---------------|--------------|---|--|--|------------|--|--|
| 7400 16p                             | 74107 36p  | CD4000AE 20p  | 1458 Dual Op Amp Int Comp    | 8 pin DIL     | 70p  | AC125 25p               | BFY51 15p     | 2N3439 67p   | *SIGNAL   |  |  | RECTIFIER  |  |  |
| 74H00 28p                            | 74109 89p  | CD4001AE 20p  | 301A Ext Comp                | 8 pin DIL     | 36p  | AC126 20p               | BFY52 16p     | 2N3442 140p  | *O447 9p  |  |  | *B1100 25p |  |  |
| 74S00 63p                            | 74110 55p  | CD4002AE 20p  | 3130 COSMOS /Bi-Polar MosFet | 8 pin DIL     | 100p | AC127 16p               | BFY90 120p    | 2N3565 30p   | *O470 15p   |  |  | *B1126 12p |  |  |
| 74LS00 30p                           | 74111 90p  | CD4006AE 95p  | 3900 Quad Op Amp             | 14 pin DIL    | 70p  | AC128 16p               | BRV39 45p     | *2N3702 12p  | *O481 9p  |  |  | *B1127 10p |  |  |
| 7401 18p                             | 74112 96p  | CD4007AE 20p  | 5367 FET Op Amp              | TO-99         | 275p | AC141 20p               | BSX19 20p     | *2N3703 12p  | *O485 15p   |  |  | *B1128 10p |  |  |
| 7402 18p                             | 74118 84p  | CD4009AE 61p  | 709 Ext Comp                 | 8, 14 pin DIL | 30p  | AC142 20p               | BSX20 20p     | *2N3705 12p  | *O490 7p  |  |  | *B1129 10p |  |  |
| 7403 18p                             | 74120 120p | CD4011AE 20p  | 741 Int Comp                 | 8, 14 pin DIL | 30p  | AC176 20p               | *BU105 140p   | *2N3706 12p  | *O495 7p  |  |  | *B1130 10p |  |  |
| 7404 23p                             | 74121 32p  | CD4012AE 20p  | 747 Dual 741                 | 14 pin DIL    | 70p  | AC187 20p               | *BU108 250p   | *2N3707 12p  | *O499 7p  |  |  | *B1131 10p |  |  |
| 74H04 36p                            | 74122 54p  | CD4013AE 55p  | 748 Ext Comp                 | 8, 14 pin DIL | 36p  | AC188 25p               | *MJE2340 45p  | *2N3708 12p  | *O500 7p  |  |  | *B1132 10p |  |  |
| 7405 25p                             | 74123 76p  | CD4015AE 90p  | 776 Programmable Op Amp      | TO-5          | 140p | AC189 25p               | *MJE2955 120p | *2N3709 12p  | *O502 7p  |  |  | *B1133 10p |  |  |
| 7406 43p                             | 74125 73p  | CD4016AE 50p  |                              |               |      | AD149 49p               | *MJE3055 70p  | *2N3773 250p | *O505 7p  |  |  | *B1134 10p |  |  |
| 7407 43p                             | 74126 70p  | CD4017AE 100p |                              |               |      | AD161 36p               | *MPSA06 30p   | *2N3866 90p  | *O506 7p  |  |  | *B1135 10p |  |  |
| 7408 25p                             | 74128 75p  | CD4018AE 110p |                              |               |      | AD162 36p               | *MPSA12 50p   | *2N3903 18p  | *O507 7p  |  |  | *B1136 10p |  |  |
| 7409 43p                             | 74132 70p  | CD4019AE 52p  |                              |               |      | AF114 20p               | *MPSA56 32p   | *2N3904 18p  | *O508 7p  |  |  | *B1137 10p |  |  |
| 7410 18p                             | 74136 75p  | CD4020AE 120p |                              |               |      | AF115 20p               | *MPSU06 62p   | *2N3905 20p  | *O509 7p  |  |  | *B1138 10p |  |  |
| 74H10 28p                            | 74141 75p  | CD4022AE 100p |                              |               |      | AF117 20p               | *MPSU56 78p   | *2N3906 15p  | *O510 7p  |  |  | *B1139 10p |  |  |
| 7411 24p                             | 74142 320p | CD4023AE 22p  |                              |               |      | AF127 25p               | *OC35 75p     | *2N4058 15p  | *O511 7p  |  |  | *B1140 10p |  |  |
| 7412 25p                             | 74145 90p  | CD4024AE 80p  |                              |               |      | AF139 43p               | *OC36 75p     | *2N4060 13p  | *O512 7p  |  |  | *B1141 10p |  |  |
| 7413 36p                             | 74147 190p | CD4025AE 22p  |                              |               |      | AF239 48p               | *OC71 20p     | *2N4123 22p  | *O513 7p  |  |  | *B1142 10p |  |  |
| 7414 75p                             | 74148 190p | CD4026AE 170p |                              |               |      | BC107 B 9p              | *OC71 20p     | *2N4124 22p  | *O514 7p  |  |  | *B1143 10p |  |  |
| 7416 36p                             | 74150 140p | CD4027AE 65p  |                              |               |      | BC108 B 9p              | *OC71 20p     | *2N4125 22p  | *O515 7p  |  |  | *B1144 10p |  |  |
| 7417 36p                             | 74151 72p  | CD4028AE 98p  |                              |               |      | BC109 B 10p             | *OC71 20p     | *2N4126 22p  | *O516 7p  |  |  | *B1145 10p |  |  |
| 7420 18p                             | 74153 85p  | CD4029AE 120p |                              |               |      | BC109 C 10p             | *OC71 20p     | *2N4127 22p  | *O517 7p  |  |  | *B1146 10p |  |  |
| 7421 40p                             | 74154 150p | CD4030AE 55p  |                              |               |      | BC109 D 10p             | *OC71 20p     | *2N4128 22p  | *O518 7p  |  |  | *B1147 10p |  |  |
| 7422 22p                             | 74155 90p  | CD4040AE 120p |                              |               |      | BC109 E 10p             | *OC71 20p     | *2N4129 22p  | *O519 7p  |  |  | *B1148 10p |  |  |
| 7423 37p                             | 74156 90p  | CD4042AE 90p  |                              |               |      | BC109 F 10p             | *OC71 20p     | *2N4130 22p  | *O520 7p  |  |  | *B1149 10p |  |  |
| 7425 30p                             | 74157 90p  | CD4043AE 100p |                              |               |      | BC109 G 10p             | *OC71 20p     | *2N4131 22p  | *O521 7p  |  |  | *B1150 10p |  |  |
| 7427 37p                             | 74158 90p  | CD4046AE 140p |                              |               |      | BC109 H 10p             | *OC71 20p     | *2N4132 22p  | *O522 7p  |  |  | *B1151 10p |  |  |
| 7428 36p                             | 74159 190p | CD4047AE 100p |                              |               |      | BC109 J 10p             | *OC71 20p     | *2N4133 22p  | *O523 7p  |  |  | *B1152 10p |  |  |
| 7430 18p                             | 74160 120p | CD4049AE 63p  |                              |               |      | BC109 K 10p             | *OC71 20p     | *2N4134 22p  | *O524 7p  |  |  | *B1153 10p |  |  |
| 7432 36p                             | 74161 120p | CD4050AE 57p  |                              |               |      | BC109 L 10p             | *OC71 20p     | *2N4135 22p  | *O525 7p  |  |  | *B1154 10p |  |  |
| 7437 36p                             | 74162 120p | CD4054AE 120p |                              |               |      | BC109 M 10p             | *OC71 20p     | *2N4136 22p  | *O526 7p  |  |  | *B1155 10p |  |  |
| 7438 36p                             | 74163 120p | CD4055AE 140p |                              |               |      | BC109 N 10p             | *OC71 20p     | *2N4137 22p  | *O527 7p  |  |  | *B1156 10p |  |  |
| 7440 19p                             | 74164 120p | CD4056AE 135p |                              |               |      | BC109 O 10p             | *OC71 20p     | *2N4138 22p  | *O528 7p  |  |  | *B1157 10p |  |  |
| 7441 75p                             | 74165 220p | CD4060AE 130p |                              |               |      | BC109 P 10p             | *OC71 20p     | *2N4139 22p  | *O529 7p  |  |  | *B1158 10p |  |  |
| 7442 70p                             | 74166 160p | CD4069AE 130p |                              |               |      | BC109 Q 10p             | *OC71 20p     | *2N4140 22p  | *O530 7p  |  |  | *B1159 10p |  |  |
| 7443 140p                            | 74167 340p | CD4071AE 27p  |                              |               |      | BC109 R 10p             | *OC71 20p     | *2N4141 22p  | *O531 7p  |  |  | *B1160 10p |  |  |
| 7444 140p                            | 74170 250p | CD4072AE 27p  |                              |               |      | BC109 S 10p             | *OC71 20p     | *2N4142 22p  | *O532 7p  |  |  | *B1161 10p |  |  |
| 7445 120p                            | 74173 160p | CD4073AE 30p  |                              |               |      | BC109 T 10p             | *OC71 20p     | *2N4143 22p  | *O533 7p  |  |  | *B1162 10p |  |  |
| 7446 100p                            | 74174 120p | CD4081AE 21p  |                              |               |      | BC109 U 10p             | *OC71 20p     | *2N4144 22p  | *O534 7p  |  |  | *B1163 10p |  |  |
| 7447 85p                             | 74175 85p  | CD4082AE 27p  |                              |               |      | BC109 V 10p             | *OC71 20p     | *2N4145 22p  | *O535 7p  |  |  | *B1164 10p |  |  |
| 7448 80p                             | 74176 120p | CD4093AE 95p  |                              |               |      | BC109 W 10p             | *OC71 20p     | *2N4146 22p  | *O536 7p  |  |  | *B1165 10p |  |  |
| 7450 18p                             | 74177 100p | CD4510AE 130p |                              |               |      | BC109 X 10p             | *OC71 20p     | *2N4147 22p  | *O537 7p  |  |  | *B1166 10p |  |  |
| 7451 20p                             | 74179 160p | CD4511AE 160p |                              |               |      | BC109 Y 10p             | *OC71 20p     | *2N4148 22p  | *O538 7p  |  |  | *B1167 10p |  |  |
| 7453 20p                             | 74180 110p | CD4516AE 112p |                              |               |      | BC109 Z 10p             | *OC71 20p     | *2N4149 22p  | *O539 7p  |  |  | *B1168 10p |  |  |
| 7454 18p                             | 74181 298p | CD4518AE 130p |                              |               |      | BC109 AA 10p            | *OC71 20p     | *2N4150 22p  | *O540 7p  |  |  | *B1169 10p |  |  |
| 7460 18p                             | 74182 82p  | CD4528AE 120p |                              |               |      | BC109 AB 10p            | *OC71 20p     | *2N4151 22p  | *O541 7p  |  |  | *B1170 10p |  |  |
| 7470 36p                             | 74185 150p | MC14553 52p   |                              |               |      | BC109 AC 10p            | *OC71 20p     | *2N4152 22p  | *O542 7p  |  |  | *B1171 10p |  |  |
| 7472 30p                             | 74186 920p |               |                              |               |      | BC109 AD 10p            | *OC71 20p     | *2N4153 22p  | *O543 7p  |  |  | *B1172 10p |  |  |
| 7473 34p                             | 74190 160p |               |                              |               |      | BC109 AE 10p            | *OC71 20p     | *2N4154 22p  | *O544 7p  |  |  | *B1173 10p |  |  |
| 7474 34p                             | 74191 160p |               |                              |               |      | BC109 AF 10p            | *OC71 20p     | *2N4155 22p  | *O545 7p  |  |  | *B1174 10p |  |  |
| 7475 45p                             | 74192 120p |               |                              |               |      | BC109 AG 10p            | *OC71 20p     | *2N4156 22p  | *O546 7p  |  |  | *B1175 10p |  |  |
| 7476 36p                             | 74193 160p |               |                              |               |      | BC109 AH 10p            | *OC71 20p     | *2N4157 22p  | *O547 7p  |  |  | *B1176 10p |  |  |
| 7480 50p                             | 74194 120p |               |                              |               |      | BC109 AJ 10p            | *OC71 20p     | *2N4158 22p  | *O548 7p  |  |  | *B1177 10p |  |  |
| 7481 95p                             | 74195 95p  |               |                              |               |      | BC109 AK 10p            | *OC71 20p     | *2N4159 22p  | *O549 7p  |  |  | *B1178 10p |  |  |
| 7482 90p                             | 74196 120p |               |                              |               |      | BC109 AL 10p            | *OC71 20p     | *2N4160 22p  | *O550 7p  |  |  | *B1179 10p |  |  |
| 7483 90p                             | 74197 120p |               |                              |               |      | BC109 AM 10p            | *OC71 20p     | *2N4161 22p  | *O551 7p  |  |  | *B1180 10p |  |  |
| 7484 110p                            | 74198 250p |               |                              |               |      | BC109 AN 10p            | *OC71 20p     | *2N4162 22p  | *O552 7p  |  |  | *B1181 10p |  |  |
| 7485 120p                            | 74199 250p |               |                              |               |      | BC109 AO 10p            | *OC71 20p     | *2N4163 22p  | *O553 7p  |  |  | *B1182 10p |  |  |
| 7486 34p                             | 74221 160p |               |                              |               |      | BC109 AP 10p            | *OC71 20p     | *2N4164 22p  | *O554 7p  |  |  | *B1183 10p |  |  |
| 7489 320p                            | 74251 140p |               |                              |               |      | BC109 AQ 10p            | *OC71 20p     | *2N4165 22p  | *O555 7p  |  |  | *B1184 10p |  |  |
| 7490 40p                             | 74265 90p  |               |                              |               |      | BC109 AR 10p            | *OC71 20p     | *2N4166 22p  | *O556 7p  |  |  | *B1185 10p |  |  |
| 7491 85p                             | 74278 290p |               |                              |               |      | BC109 AS 10p            | *OC71 20p     | *2N4167 22p  | *O557 7p  |  |  | *B1186 10p |  |  |
| 7492 55p                             | 74279 140p |               |                              |               |      | BC109 AT 10p            | *OC71 20p     | *2N4168 22p  | *O558 7p  |  |  | *B1187 10p |  |  |
| 7493 40p                             | 74283 190p |               |                              |               |      | BC109 AU 10p            | *OC71 20p     | *2N4169 22p  | *O559 7p  |  |  | *B1188 10p |  |  |
| 7494 90p                             | 74290 150p |               |                              |               |      | BC109 AV 10p            | *OC71 20p     | *2N4170 22p  | *O560 7p  |  |  | *B1189 10p |  |  |
| 7495 70p                             | 74293 150p |               |                              |               |      | BC109 AW 10p            | *OC71 20p     | *2N4171 22p  | *O561 7p  |  |  | *B1190 10p |  |  |
| 7496 84p                             | 74298 200p |               |                              |               |      | BC109 AX 10p            | *OC71 20p     | *2N4172 22p  | *O562 7p  |  |  | *B1191 10p |  |  |
| 7497 340p                            | 74365 150p |               |                              |               |      | BC109 AY 10p            | *OC71 20p     | *2N4173 22p  | *O563 7p  |  |  | *B1192 10p |  |  |
| 74100 120p                           | 74366 150p |               |                              |               |      | BC109 AZ 10p            | *OC71 20p     | *2N4174 22p  | *O564 7p  |  |  | *B1193 10p |  |  |
| 74104 65p                            | 74390 200p |               |                              |               |      | BC109 BA 10p            | *OC71 20p     | *2N4175 22p  | *O565 7p  |  |  | *B1194 10p |  |  |
| 74105 65p                            | 74393 225p |               |                              |               |      | BC109 BB 10p            | *OC71 20p     | *2N4176 22p  | *O566 7p  |  |  | *B1195 10p |  |  |
| MEMORIES                             |            |               | TEXAS DTLs                   |               |      | SEVEN SEGMENT DISPLAYS  |               |              | NEW ADJUSTABLE VOLTAGE REGULATOR  |  |  | DIAC       |  |  |
| 2102 RAM 250p                        |            |               | 930 36p                      |               |      | 3015F 0.3" Red 160p     |               |              | 20220 3 pin Plastic Current in excess of 1 Amp Output voltage range 2V to 37V Requires only 2 R's to set the O/P voltage Line & Load regulation better than fixed regulators. Price £3.25. Data 0.20p + SAE |  |  | *B1196 10p |  |  |
| 2107 RAM 1000p                       |            |               | 936 40p                      |               |      | DL704 0.3" Red 140p     |               |              | 20220 3 pin Plastic Current in excess of 1 Amp Output voltage range 2V to 37V Requires only 2 R's to set the O/P voltage Line & Load regulation better than fixed regulators. Price £3.25. Data 0.20p + SAE |  |  | *B1197 10p |  |  |
| 2112 RAM 450p                        |            |               | 946 40p                      |               |      | DL707 0.3" Red 140p     |               |              | 20220 3 pin Plastic Current in excess of 1 Amp Output voltage range 2V to 37V Requires only 2 R's to set the O/P voltage Line & Load regulation better than fixed regulators. Price £3.25. Data 0.20p + SAE |  |  | *B1198 10p |  |  |
| 2513 ROM 850p                        |            |               | 955 60p                      |               |      | DL747 0.3" Red 225p     |               |              | 20220 3 pin Plastic Current in excess of 1 Amp Output voltage range 2V to 37V Requires only 2 R's to set the O/P voltage Line & Load regulation better than fixed regulators. Price £3.25. Data 0.20p + SAE |  |  | *B1199 10p |  |  |
| 2602 RAM 250p                        |            |               | 962 36p                      |               |      | Drivers: 75491 84p      |               |              | 20220 3 pin Plastic Current in excess of 1 Amp Output voltage range 2V to 37V Requires only 2 R's to set the O/P voltage Line & Load regulation better than fixed regulators. Price £3.25. Data 0.20p + SAE |  |  | *B1200 10p |  |  |
| X887 ROM 2200p                       |            |               | 963 40p                      |               |      | BT106 1A/700V Stud 110p |               |              | 20220 3 pin Plastic Current in excess of 1 Amp Output voltage range 2V to 37V Requires only 2 R's to set the O/P voltage Line & Load regulation better than fixed regulators. Price £3.25. Data 0.20p + SAE |  |  | *B1201 10p |  |  |
| VOLTAGE REGULATORS - FIXED - PLASTIC |            |               | MEMORIES                     |               |      | SCR-THYRISTORS          |               |              | NEW ADJUSTABLE VOLTAGE REGULATOR  |  |  | DIAC       |  |  |
| 1 Amp Positive 5V 7805 140p          |            |               | 2102 RAM 250p                |               |      | 1A 50V TO5 40p          |               |              | 20220 3 pin Plastic Current in excess of 1 Amp Output voltage range 2V to 37V Requires only 2 R's to set the O/P voltage Line & Load regulation better than fixed regulators. Price £3.25. Data 0.20p + SAE |  |  | *B1202 10p |  |  |
| 12V 7812 140p                        |            |               | 2107 RAM 1000p               |               |      | 1A100V TO5 42p          |               |              | 20220 3 pin Plastic Current in excess of 1 Amp Output voltage range 2V to 37V Requires only 2 R's to set the O/P voltage Line & Load regulation better than fixed regulators. Price £3.25. Data 0.20p + SAE |  |  | *B1203 10p |  |  |
| 15V 7815 140p                        |            |               | 2112 RAM 450p                |               |      | 1A400V TO5 45p          |               |              | 20220 3 pin Plastic Current in excess of 1 Amp Output voltage range 2V to 37V Requires only 2 R's to set the O/P voltage Line & Load regulation better than fixed regulators. Price £3.25. Data 0.2         |  |  |            |  |  |



# Two books from Wireless World

These books are of very special appeal to all concerned with designing, using and understanding electronic circuits. They comprise information previously included in Wireless World's highly successful

Circards – regularly published cards giving selected and tested circuits, descriptions of circuit operation, component values and ranges, circuit limitations, modifications, performance data and graphs. Each of these magazine-size hard cover books contains ten sets of Circards plus additional circuits and explanatory introduction.

## circuit designs

1

Collected Circards

PWilliams/JCarruthers/JHEvans/JKinsler

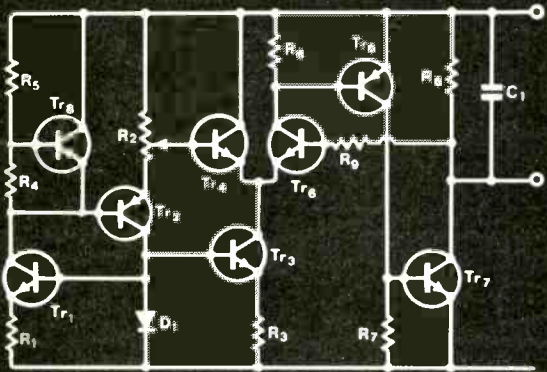

A WIRELESS WORLD PUBLICATION

### BOOK 1

|                      |                           |
|----------------------|---------------------------|
| Basic active filters | Constant-current circuits |
| Switching circuits   | Power amplifiers          |
| Waveform generators  | Astable circuits          |
| AC measurements      | Optoelectronics           |
| Audio circuits       | Micropower circuits       |

## circuit designs

2

Collected Circards

PWilliams/JCarruthers/JHEvans/JKinsler

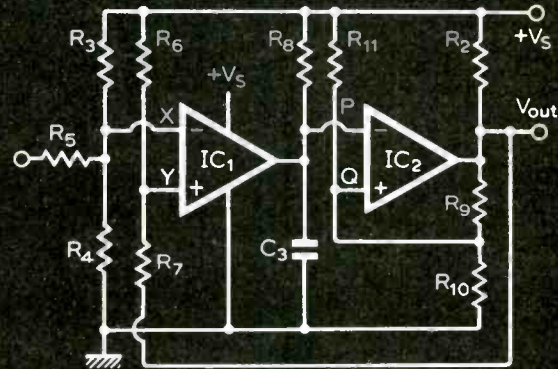

A WIRELESS WORLD PUBLICATION

### BOOK 2

|                     |                                    |
|---------------------|------------------------------------|
| Basic logic gates   | C d as – signal processing         |
| Wideband amplifiers | C d as – signal generation         |
| Alarm circuits      | C d as – measurement and detection |
| Digital counters    | Monostable circuits                |
| Pulse modulators    | Transistor pairs                   |

### ORDER FORM

To : General Sales Department,  
IPC Business Press Limited,  
Room 11, Dorset House,  
Stamford Street, London SE1 9LU.  
Please send me ..... copy/copies of  
Circuit Designs – Number 1 at £10.40   
Circuit Designs – Number 2 at £12.50   
each inclusive. I enclose remittance value £.....  
(cheques payable to IPC Business Press Ltd.)

Name (please print)

Address

Company registered in England and a subsidiary of Reed International Limited Registered No. 677128 Regd. office Dorset House, Stamford Street, London SE1 9LU.

# Stirling Sound

QV audio modules

## INTRODUCTORY MONEY-SAVING OFFER

**BUY THE SS.1100 100 W.R.M.S. POWER AMP WITH THE NEW SS.370 POWER SUPPLY AND SAVE £1.95**

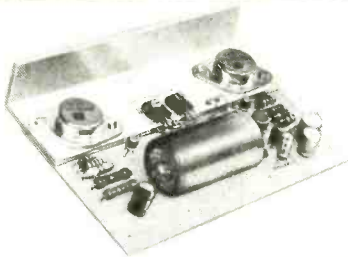

**SS.1100 POWER AMP £9.45\***  
 Large heat sink £1.00\*  
**SS.370 70V/2A POWER SUPPLY £12.50\***  
**£21.00\***  
 Ordered together with large heat sink (total normal cost £22.95)  
 POSTAGE — Add £1.00 for SS.370 alone or with SS.1100

Using a 70 volt supply, the SS 1100 delivers 100 watts R.M.S. into 4 ohms for an input sensitivity of 500 mV. Frequency response — 10Hz to 50 KHz  $\pm 1$  dB S/N ratio better than 75 dB, distortion typically 0.1% at half power. Size 5" x 3 1/2" x 1 1/4" including heatsink type mounting bracket. **NOW WE INTRODUCE SS.370, OUR NEW POWER SUPPLY — IDEAL FOR THE SS.1100.** The SS.370 includes low voltage take-off point for pre-amp, tuner, etc.

## STIRLING SOUND POWER AMPLIFIERS FROM 5 TO 40 WATTS

**SS.105**  
 5 watts R.M.S. into 4 ohms using 12V supply. Ideal for use in in-car entertainment. Size — 89 x 51 x 19mm. **£2.25**

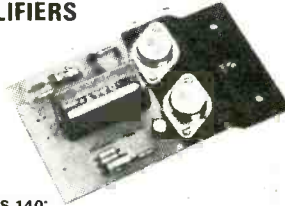

**S.110**  
 Similar in size and design to SS.105, this QV module delivers 10 watts R.M.S. into 4 ohms using a 24V supply, e.g. SS.324. Of great use in domestic applications. **£2.75**

**SS.120**  
 Using a 34 volt supply, such as SS.334, this amplifier will deliver 20 watts into a 4 ohm load. Same dimensions as above. **£3.25**

**SS.140\***  
 Mk. 3 version, complete with output capacitor and heatsink-type bracket. Delivers 40 watts R.M.S. into 4 ohms from a 45 volt supply such as the SS.345. Designed specially for long and heavy work. **£3.95\***

Power supplies ordered with above carry 12 1/2% VAT.

FOR POWER SUPPLY UNITS SEE BELOW

## STIRLING SOUND PRE-AMP/TONE CONTROL UNITS

**UNIT ONE**  
 Combined pre-amp with active tone-control circuits. 200mV output for 50 mV in. Runs on 10 to 16V supply. Treble — 15 dB at 10KHz. Bass — 15 dB at 30Hz. Stereo Balance, vol., treble and bass controls. **£7.80**

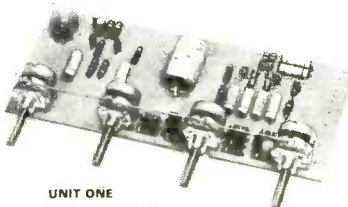

**SS.100**  
 Active tone control, bass and treble. **£1.60**

**SS.101**  
 Pre-amp for ceramic cartridges, etc. passive tone control circuit shown in data supplied. **£1.60**

**SS.102 STEREO PRE-AMP**  
 R.L.A.A. corrected for mag. plus tape, radio etc. **£2.65**

**UNIT ONE**  
 Pre-amp with active tone control circuits.

## STIRLING SOUND POWER SUPPLY UNITS

COMPLETE WITH TRANSFORMERS and 13-16V take-off points except SS.312. Add 50p p/p for any model except SS.370 — £1 ALL AT 8% VAT.  
**SS.312 12V/1A £3.75; SS.318 18V/1A £4.15; SS.324 24V/1A £4.60; SS.334 34/2A £5.20; SS.345 45V/2A £6.25; SS.350 50V/2A £6.75; SS.300. STABILISING UNIT 10-50V, adjustable for adding to unbalanced supplies. Short circuit proof (p/p 35p) £3.25; SS.310/50, STABILISED POWER SUPPLY, variable from 10 to 50V/2A with anti-short protection £11.95.**

THE BUILT-IN QV FACTOR is the symbol of Stirling Sound's guarantee of Quality and Value which gives you today's best buys all round. It is YOUR GUARANTEE OF SATISFACTION.

TO ORDER add 35p p/p for mail orders unless stated otherwise. VAT add 12% to total value of order unless shown when the rate is 8%. Every effort is made to ensure correctness of information at time of going to press. Prices subject to change without notice. E & O E

# Stirling Sound

A member of the BI-PRE-PAK GROUP OF COMPANIES  
 Dept. WW3, 220-224 WEST ROAD, WESTCLIFF-ON-SEA, ESSEX SS0 9DF  
 Phone: Southend (0702) 46344. PERSONAL CALLERS WELCOME

**NEW FROM STRUMECH**

Electric powered winch (110 volt, 5 amp). Bolts directly into existing towers without modification. Send for leaflet. Price £115 ex works.

**VERSATOWER**  
 Strumech Engineering Limited  
 Coppice Side, Brownhills, Walsall, West Midlands  
 Telephone: Brownhills 4321

WW-109 FOR FURTHER DETAILS

## STEREO DISC AMPLIFIER 2

Magnetic cartridge to balanced lines with the highest quality. Mains powered. Low distortion and continued attention to cartridge impedance interaction effects FOR BROADCASTING, DISC MONITORING AND TRANSFER.

The square wave distortion figure \* is a revealing guide to performance on asymmetrical signals and transient intermodulation distortion.

\* T. Holman "New Factors in Phonograph Pre-amplifier Design" JAES Vol. 24 No. 4, May, 1976. 1KHz @ 6mV set for 0dBV 7 output, loaded 600 ohms.

**Distortion**  
 Output 0dBV 7, 30Hz — 20KHz below noise  
 Output + 10dBV 7, 30Hz — 20KHz below noise  
 Output + 20dBV 7, 1KHz 88dB, 0.004% — 30Hz-20KHz 82dB, 0.008%  
**Intermodulation distortion** 50Hz + 7KHz 4:1  
 Output + 10dBV 7, 90dB, 0.003% limit of measurement  
**Square wave distortion**, Pre-emphasised 1KHz square wave input, 600mV pk-pk  
 Even harmonic generation — 70dB any harmonic.

**Cartridge impedance interaction on frequency response.**  
 High inductance cartridge Less than 0.2dB

**Low frequency response**  
 18dB/octave — 3dB, 24Hz  
 Group delay relative to 1KHz — 15ms @ 30Hz

**Noise**  
 Short circuit input — 70dBV 7 } 20Hz — 20KHz mean reading meter  
 Cartridge source, 100mH — 67dBV 7 }

## SURREY ELECTRONICS

The Forge, Luicks Green, Cranleigh, Surrey GU8 7BG (STD 04866) 5997

## TELERRADIO SPECIALISTS IN DESIGNS by John Linsley Hood

Example. VERY LOW DISTORTION AUDIO OSCILLATOR

An ideal instrument for checking Hi-Fi Amps

SINE AND SQUARE WAVE



REF A0113

Kit Price, £18 Made, £22. Tax 8%  
 Also available, THD Analyser, FM Sig. Gen, AC Millivoltmeter, P.S.U. Frequency Meter, etc. In addition we have amplifier designs by Blomley, Linsley Hood, Bailey, Mullard, etc.

Send S.A.E. (if scap) for comprehensive lists

## TELERRADIO ELECTRONICS

325 Fore Street, Edmonton, London, N9 0PE

Telephone: 01-807 3719

Closed Thursdays



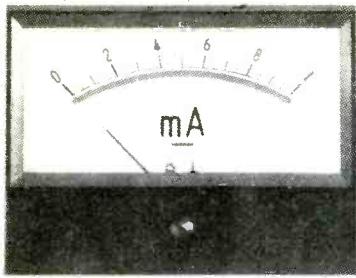

MODEL SU

**What more could you ask for?**

We are confident you can't do better than to incorporate ALPS Panel Meters in your next project whether it be Original Equipment Manufacture, Educational or the Replacement of an Existing Instrument.

- ★ SUPERB QUALITY AND SCALE PRODUCTION
- ★ ATTRACTIVE MODERN STYLING
- ★ EX STOCK DELIVERY FOR STANDARD RANGES
- ★ RAPID PROTOTYPE SERVICE
- ★ PRODUCTION FOR SPECIAL REQUIREMENTS
- ★ REASONABLE DELIVERY OF PRODUCTION QUANTITIES

available as: — True VU METERS  
DC MICROAMMETERS AC & DC VOLTMETERS  
AC & DC MILLIAMMETERS AC & DC AMMETERS

**SERVO AUTOTESTERS:**—A range of four types of instrument to measure auto/mobile currents and voltages dwell angle engine speed, etc. Details from:—



**SERVO AND ELECTRONIC SALES LTD.**  
Tel. LYDD 20252  
24 HIGH STREET, LYDD, KENT TN29 9AJ TLX 965265

WW 101—FOR FURTHER DETAILS

# New! from sanwa

**THE MULTIMETER TO MAKE YOUR TESTER OBSOLETE!**

The fabulous LCD900 incorporates a liquid crystal display only of the range to which the meter is switched.

- 7 DC voltage ranges  $\pm 1-1000V$  at  $50K \Omega/V$
- 5 AC voltage ranges  $10-1000V$  at  $10K \Omega/V$
- 4 DC current ranges  $\pm 0.3-300mA$
- 1 AC current range  $3A$
- 4 resistance ranges  $1K-1000K$
- Basic movement  $17.5 \mu A$



**PRICE £58.25 (+ £1 P&P) exc. VAT**

Also shortly available the **VS-100 ultra-safe industrial tester.**

For full details on these and 24 other standard instruments in the **sanwa** range contact.

**QUALITY ELECTRONICS LTD.**  
24 High Street, Lydd, Kent TN29 9AJ  
Tel. Lydd (0679) 20252, TLX 965265

WW 102—FOR FURTHER DETAILS

## The SECOND-USER Computer Specialists

# ELECTRONIC BROKERS

## Systems, Peripheral Equipment & Components for Data Processing

### Mini-Computer Exchange

**SAVE UP TO 60% ON LIST PRICES**

NOW IN STOCK! Fabulous PDP8M-ML 8K Processor. Brand new in original manufacturer's packing. Complete with all documentation.



- KK8E** — brand new PDP8E processor module set.
- ADD-ON MEMORY FOR PDP11/04 and PDP11/34:** 8K MOS Memory type MS11-IP (M7847)
- PDP11/20** Processor
- PDP8I 8K** Processor (Negative bus) with DW08 Bus Converter DF32 32K Disk Drive and Control (Slave drives type DS32 also available if required) 6801 Communications Data Lines
- PDP8 24K** Processor complete with KE09 Extended Arithmetic, TC02 DECtape controller + 2 TU55 drives, PC09 Paper Tape Reader and Punch, AF01B A/D Converter (8-channel), DA09B I/O Bus, LT19B Multi-tele-type station
- RPO2 30** Meg. Free-standing moving-head disk drive and control
- TU10** Magnetic Tape Units, 9-track 800 bpi, rack-mounted
- TU20** Magnetic Tape Unit, 9-track 45 ips TU55 DECtape drives
- DF32** Disk Drive and Control
- DS32** Slave Drives also available
- CENTRONICS 101** Line Printer and Control
- RK11/RK05** Disk Drive and Control
- TU60** Dual Cassette Drive and Control
- RT02** Alphanumeric Data Entry Display and Control
- DEC** Interface and Feature Boards, DC11-AC, DC11-DA, DL11C, DL11E, KDBE, KLBE, KE11F, KW11, KCBE, MCBEJ, MM11F, MR8E, M7239, G235, KE11, DB11, MB342, G1110, G231, H754
- DEC** Power Supplies H724, 728A, etc.
- 5ft. RACK CABINETS** with cooling fans, mounted on castors
- CALCOMP** drum plotters, models 563, 565, 663

**SPECIAL CLEARANCE OFFER — ICL 2802/2 8 MEG DISK DRIVES** (= Control Data 9450). £100.00 plus carriage and VAT!

#### TERMINALS — LARGE STOCKS AVAILABLE

- ASR33 Teletype from £465.00
- KSR33 Teletype from £295.00
- ASR35 Teletype from £750.00
- IBM731/0 Gollball Typewriter from £275.00

#### SPECIAL OFFER

Cossor DIDS 401 2A Visual Display Units 13 lines x 80 characters (8 1/2" x 4 1/2" screen) 64 character repertoire with detachable ASCII keyboard (Control device required) **Margin Price: £145.00**  
Also available Cossor DIDS 402 A as above but incorporating control logic. **Price £295.00.**

**FOR IBM 360 USERS** Sanders 72J Data Display System consisting of six VDUs, control unit and communications buffer. Complete with connecting cables and technical documentation. **Price £2,750.00.**

**MINIATURE MATRIX PROGRAMME BOARDS.** Brand new X.Y Matrix boards with 3mm grating, 12x10 positions (2 3/4" x 2 1/4") 18 00 3x10 positions (1 3/4" x 1 1/4") £4.00 P&P 40p

**MAGNETIC TAPES.** Manufacturers surplus stocks, brand new in original sealed packing. 1/2" x 2400, £4.00 per reel. P&P extra

### Keyboards

**FRESH STOCKS OF THE POPULAR CLARE-PENDAR**

**ASCII KEYBOARD TYPE KB6 NOW TO HAND**



ASCII Coded TTL-compatible 4-bank alphanumeric keyboards with ROM encoder chip, strobed output, two-key rollover and debounce. Standard 7-bit ASCII code (no parity). Supplied complete with circuit diagrams and code chart.

#### SPECIFICATIONS

Power Supply +5VDC  $\pm 5\%$  150mA -12VDC  $\pm 10\%$  10mA Output Logic Levels Data Bits 1 through 7 0V 0 45V 2.6V  $\pm 5.25V$  0V 0 48V Fan Out 10 standard TTL loads. Strobe signal delay 10 milliseconds nominal to allow data to stabilise  
**KB6:** 56 station standard Teletype layout. AS RECOMMENDED FOR PRACTICAL WIRELESS VIDEO-WRITER PROJECT **Price £39.50 + £1 P&P + 8% VAT** (send £43.74)

#### ALSO AVAILABLE — SPECIAL LOW-COST KEYBOARD

**KB5:** 3-bank alphanumeric keyboard coded, 16 station keyboard TTL compatible strobed output. **Price £20.00, plus £1 P&P + 8% VAT** (send £22.68)

#### NEW ARRIVALS

**FABULOUS NEW 96 STATION CRT DISPLAY KEYBOARDS** 8-bit ASCII code upper and lower case output PLUS separate numeric pad TTL logic. Delayed strobe signal and two-key rollover feature. Mounted in attractive box overall dimensions 20" x 7" x 3" x 1". **Price £65.00 + 13 carriage + 8% VAT** (Send £73.41)  
**BCD Coded 54 station keyboard** brand new upper and lower case outputs. Mounted on double PCB and set in attractive panel incorporating 5 indicator lamps and on/off switch. Dimensions 15 1/2" x 5 1/2" x 2 1/2". **Price £39.50 + £2 P&P + 8% VAT** (Send £44.82)  
Also available. A few only of the above model WITHOUT ENCODING OR PANEL. **Price £25.00 + £1.50 P&P + 8% VAT** (Send £28.62)  
**18-KEY CALCULATOR KEYBOARDS** (0-9 CK + X + =) Make/break switches mounted on PCB. Overall dimensions 150 x 110 x 40mm. **Price £4 plus 50p P&P + VAT** (Send £4.86p)

Add 8% VAT to all prices shown. Carriage extra details on request.



**ELECTRONIC BROKERS LIMITED (Computer Sales & Services Division)**  
49-53 Pancras Road, London NW1 2QB. Tel: 01-837 7781

Callers welcome Monday to Friday 9 a.m. to 5 p.m.

# THIS IS WHERE THE ACTION IS...

## Britain's biggest and best-known exhibition of home entertainment, audio and hi-fi.

● **UNIQUE** – for reputation and scope. This is our 23rd year, and no other fair offers such a comprehensive showcase for home electronic entertainment, plus the traditional appeal to audio and hi-fi specialists.

● **LONDON'S OLYMPIA** – the industry's favoured location, where the people and the money are . . . and the only venue with the size, scope and facilities for this great trade and public festival.

● **SEPTEMBER 12 to 18, 1977** – the preferred pre-Christmas selling-time period . . . and opening with a day and a half for the trade only.

● **BACKED** by major IPC specialist, trade and consumer publications, commanding a combined readership of 1,750,000.

● **ORGANISED** by the IPC Business Press specialist exhibition company, with a remarkable record and reputation for handling specialist fairs.





To: Audio Fair,  
Iliffe Promotions Ltd,  
Dorset House,  
Stamford Street,  
London SE1 9LU

YES, I MUST find out more  
about the 1977 International  
Audio Festival and Fair.  
Please send me an exhibitor's  
brochure right away.

Name .....

Position in firm .....

Address .....

Products we want to exhibit .....

**MARCONI NOISE GENERATOR TF987/1.**

4 Ranges 0.5; 0.10; 0.15; 0.30.  
Due to large purchases now priced at £15 ea.

**COMPRESSOR/VACUUM PUMP**

Twin Cylinder opposed with Integral 1/2 H.P. 220/110V 50HZ Single Phase Motor Tested & Checked. **£17.50 ea.**

110 Volts only **£15 ea.**  
1/2 H.P. Motor 240V **£12 ea.**  
1/2 H.P. Motor 110V **£10 ea.**

**MARCONI TF675F WIDE RANGE PULSE GENERATOR**

+/- variable outputs up to 50V. Optional delay. Small compact unit **£22.50 ea.**

**PRECISION EX-MINISTRY SIGNAL GENERATOR**

type 62 by DECCA 95 to 160 MHZ. Two front panel switches connected to a motor driven system for rapid frequency change due to dial length (can also be operated manually). Precision attenuator system. Internal / External AM Modulation. Carrier level meter & % Modulation meter. 1MHZ & 10MHZ Crystal Markers. Provision for external crystal as marker. This equipment was used for aligning service type Aircraft receivers etc. Complete with leads etc. Standard 240V **ONLY £15 ea.**

**WE ARE BREAKING COMPUTERS**

UNIVAC/HONEYWELL/ICL 1900 etc.  
Boards, Power Supplies, Core Stores are available  
**CALL AND SEE**

|   |      |                      |     |
|---|------|----------------------|-----|
| TALLY PUNCH                                       | £85  | CREED 8 Level READER | £35 |
| ASCII coded KEYBOARD with Punch and Reader        | £140 | CREED 8 Level PUNCH  | £45 |
| IBM coded Golfball in table with Punch and Reader | £200 | TALLY READER         | £95 |

Items constantly changing — Phone or call

**THE HONEYWELL KEYPAGE UNIT**

is a multi-channel Keyboard to Magnetic Tape System recording Keyboard entered data on 1/2" tape in 80 or 120 character records in a form easily usable as a computer input/output and verifier. 240 Volt operation.

From the simple to understand electro mechanical / vacuum system to the +15 — 15 +5 Power Supply and hinged wire wrapped card frame, the flexibility and reliability are outstanding, this coupled with the ease of interfacing to a VDU, Mini/Micro computer, etc. make all the Honeywell Keypages on offer very fine value.

Honeywell Keypage Unit, checked, tested with Manual. **£215 ea.**  
As above but less data boards. Tested forward / backward tape movement and control, etc. Data entry / exit via read / write boards. **£105 ea.**

Exactly as above but less keyboard and table. **£80 ea.**

All units carriage paid

KEYBOARDS also available at **£20 each**. Carr. £2.50

**SPOOLS OF 1/2" MAG TAPE**

**APPROX. 2000ft**  
50p ea. P&P £1 ea.

**AVO VALVE TESTER CT160 "THE SUITCASE"**

Size approx. 15" wide x 10" high x 11" deep.  
Limited quantity **£25 each.**

**TEKTRONIX OSCILLOSCOPE** Type 585A with type B2 plug-in. **£500.**  
**RHODE & SCHWARZ POLYSCOPE** SW081 **£425.**  
**RHODE & SCHWARZ GENERATOR** BN41022 300-1000MHZ **£185.**  
**R&S DIAGRAPH & GENERATOR** 3-300MHZ. Very nice condition **£475.**  
**RHODE & SCHWARZ ADMITTANCE METER** BN3511. As new **£65.**  
**POLARAD RECEIVER** Model FIM-82. Complete 1-10GHZ **£425.**  
**TELONIC SWEEPER** 2000-1 with LA-1M-20HZ-20KHZ **£120.** Other freq. available.  
**MARCONI OSCILLATOR** TF1101 20HZ-20KHZ. Nice condition. Special price **£50.**  
**MARCONI Wide Range Oscillator** TF1370. Freq. range 10HZ to 10MHZ. Sine Wave 10HZ to 100KHZ. Square Wave. High outputs up to 31.6V. Fantastic value at **£90 ea.**  
**MARCONI Generator** TF867. 15KHZ to 30MHZ **£60 ea.**  
**MARCONI ADAPTOR** TM6113 for TF2700, TF1313, TF688 **£20 ea.**  
**AIRMEC 4 trace scope** Type 279. Large screen **£120.**  
**COLLINS RECEIVER UNITS** with built-in Tube 90MHZ to 10GHZ. No power unit, no information — ex-Ministry. Type IPI0ULR **£35 ea.**  
**MARCONI TF142F DISTORTION FACTOR METER** giving percentage distortion on a directly calibrated dial and includes all spurious components up to 30KHZ **£32.50 ea.**  
**AVO TRANSISTOR ANALYSER** CT446 **£30 ea.**  
**MARCONI PORTABLE FREQUENCY METER** TF1026/11 100 to 160MHZ. Very fine condition. **£27.50 ea.**  
**DECCA NAVIGATOR DISPLAY UNIT.** Very impressive. **£12.50 ea.**  
**COURTENAY MAJOR Mk. 2.** 250 joules. 5 outputs. Can be combined — 1250 joules. No heads. **£40 ea.**  
**MARCONI SIGNAL GENERATORS.** TF801B from **£140;** TF801D from **£190.** Usually available ex stock.  
**MARCONI DEVIATION METER.** TF791D **£75 ea.**  
**RHODE & SCHWARZ POWER METER.** BNRD-BN2412/50 **£50.**  
**MARCONI RF POWER METER.** TF1020A/1.50 ohm **£65.**  
**HEWLETT PACKARD 11 Channel Numerical Printer** **£30.**  
**MARCONI 20MHZ SWEEP GENERATOR.** TF1099 **£45.**  
**MARCONI DOUBLE PULSE GENERATOR.** TF1400S with TM6600/S **£20.**  
**MARCONI TRAVELLING WAVE TUBE AMPLIFIER.** TF1278 **£15.**  
**RACAL Frequency Generator** MA 250. Any multiple of 100HZ from 1.6MHZ to 31.6MHZ 1V RMS. 50 ohm output impedance. **£120.**  
**MARCONI UNIVERSAL BRIDGE.** TF868 **£85 ea.**  
**AIRMEC Generator** type 304A. 50KHZ to 100MHZ. **£120.**  
**AIRMEC MODULATION METER** 210 **£130.**  
**SOLARTRON Oscillator** C0546. 25HZ to 500KHZ. Constant amplitude. Very reliable. Highly recommended. In good condition **£18 ea.**  
**PETROL GENERATOR.** 115/230V 60HZ. 10KWatt Standby rating. Fine condition **£350.**

**TELEQUIPMENT OSCILLOSCOPE.** Type S32. Very good condition. Small, compact, size 7 x 9 x 14in approx. Ideal for colour TV servicing. Superbly reliable. **FANTASTIC VALUE** at **£85 ea.**

**HILGER & WATTS SPECTROMETER** H1170. **£350.**

**OUR PRICES TOO HIGH? — THEN MAKE US AN OFFER WE CAN CONSIDER**

**MARCONI AM / FM SIGNAL GENERATOR** type TF995A/3S **£260.**  
**HEATHKIT CURVE TRACER** **£45.**  
**RHODE & SCHWARZ 10 KiloWatt Power Meter** **£120.**  
**RHODE & SCHWARZ Tunable Indicating Amplifier** UBM **£75.**  
**TEKTRONIX 180A Time Marker Generator** **£60.**  
**TEKTRONIX Oscilloscope** type 561 with plug-ins **£375.**  
**S.E. Labs Oscilloscope** type 102 **£220.**  
**MARCONI UHF-SHF Signal Generator** Type TF1058 **£80.**  
**TEKTRONIX 181 Time Marker Generator** **£40.**  
**TELONIC Sweeper** 0-200MHZ **£80.**  
**HEWLETT PACKARD Oscilloscope** type 175 DC-50MHZ Double Beam **£180** with delay amplifier **£220.**  
**GENERAL RADIO PULSE SWEEP & Time Delay Generator** type 13918 **£120.**  
**ROYAL INVERTORS** manufactured USA. 28V DC Input. Output 115V AC 400HZ up to 2KVA. Brand new. Crated **£12.50 ea.**

**EDWARD VACUUM PUMPS** type 1SC30A. Only **£80 each.**

**SOLARTRON CD1212 SB 40 meg** **£85.** DB24meg twice **£120.** Many other types available.  
 Ex-Ministry **OSCILLOSCOPE.** CT436 Double beam DC-6MHZ **£95 each.**  
 \***TELEPHONES.** Post Office style 746. Black or two-tone grey **£6.50 ea.** Modern style 706. Black or two-tone grey **£4.50 ea.** P&P 75p ea. Old black style **£1.50 ea.** P&P 75p.  
**TELEPHONE EXCHANGES.** eg 15-way automatic (exchange only) from **£95.**  
**MODERN FANS.** 4 3/4 x 4 3/4 x 1 1/2" 240 Volts. Superbly quiet. 6 Blades **£4.50 ea.** P&P 75p.  
**PAPST model** 240V available at **£7.50 ea.** P&P 75p.  
**PHOTOMULTIPLIER** Type 931A **£4 ea.** P&P 75p. Other types available.  
 \***POTENTIOMETERS** — All 5p ea. P&P extra. Metal bodied AB Linear. PCB Mount. Brand New. 10K, 100K ganged; 250K ganged; 100K ganged, concentric shafts.  
 \***BEEHIVE TRIMMERS** 3/30pf. Brand New. 10 off 40p P&P 15p. 100 off **£3.50** P&P 75p. 500 off **£15** P&P £1.25; 1,000 off **£25** P&P £1.50.  
**LARGE RANGE ELECTROSTATIC VOLTMETERS.** From 0-300V 2" **£3,** to 20KV Max. General guide 5KV 3 1/2" **£5.** Thereafter **£1** per KV. P&P 75p.  
**VARIACS** 240V input 0-240V output 8A **£18 ea.** 20A **£30 ea.** Carr. £2.50.  
**E.H.T. TRANSFORMERS** 20KV 2KVA **£70 ea.** Many other EHT transformers and EHT Capacitors available.  
**DON'T FORGET YOUR MANUALS.** S.A.E. with requirements  
**TUBE** type DB7/36 - Replacement for Telequipment S31 **£11 ea.** P&P £1.50.

**FOR THE VDU BUILDER.** New stock of Large Rectangular Screen 30 x 20cm tube. Type M38 at the ridiculous price of **£4 ea.** And also still available the CME1220. 24 x 15cm at **£9 ea.** Base connections for both tubes supplies

**SEMICONDUCTORS** — All at **8p ea.** \* P&P extra. Guaranteed all full spec. devices. Manufacturer's markings  
 BC147, BC158, 2N3707, BC107, BF197, BC327, 2N4403, BC172B, BC261B, BC251B, BC348B, BC171A/B, 2N3055RCA 50p ea. P&P 8p.  
 2N5879 with 2N5881 Motorola 150 Watt Comp pair **£2 pr.** P&P 15p.  
 \*Linear Amp 709 25p ea. P&P 8p.

**CREED 5-LEVEL COMBINED PRINTER AND PERFORATOR CRATED £35 each**

**CREED 5-LEVEL PAPER TAPE READER £25 each**

**CREED 7B TELEPRINTER CRATED £40 each**

**SPECIAL OFFER**  
**CREED 7B TELEPRINTER LATE MODEL WITH PERFORATOR, £60 ea.**  
**FREE WITH ALL PURCHASES PLESSEY READER**

Minimum Mail Order £2. Excess postage refunded. **Unless stated — please add £2.50 carriage to all units**  
**VALUE ADDED TAX not included in prices — Goods marked with \* 12 1/2 % VAT, otherwise 8 %**  
**Official Orders Welcomed. Gov./Educational Depts., Authorities, etc., otherwise Cash with Order**  
 Open 9 a.m. to 5.30 p.m. Mon. to Sat.



**CHILTMHEAD LTD**



7/9 ARTHUR ROAD, READING, BERKS. (rear Tech. College, King's Road). Tel. Reading 582605









### FROM E.S.E.

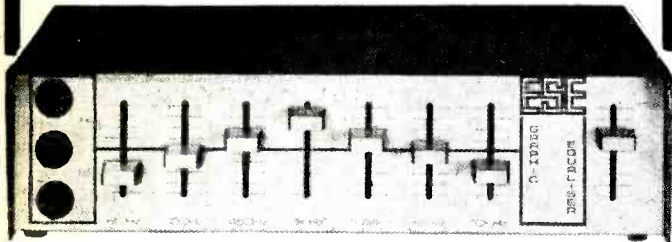

A full frequency range graphic equaliser **YOU** can afford !!

For **JUST £38.85 plus VAT** You can tune out all unwanted noises at **seven** different frequencies!

Bring all your recordings, P.A., discos, lead guitar, bass guitar, organ, **anything** amplified to life at the touch of a slider !!

No more annoying amplifier noises — just clear, true sound!

Frequencies from 60 Hz to 10 kHz! Cut or boost each frequency by maximum of 15 dB!

Hi and lo gain inputs.

Powered by just two PP3 batteries which last for ages. Or mains powered unit available. £49.95 plus VAT.

Try it and you'll buy it — it will change your concept of sound.

Trade enquiries welcomed.

**Condensed Technical Spec**

Max. output: terminated to 600Ω, -10 dB > 1.6 volts peak to peak, 2.5 volts R.M.S.

Signal to noise ratio: input terminated with 47K resistor. All filters at max. better than -70 dB.

Frequency response: All filters at central better than ± 2 dB.

Filter slope: Better than ± 13 dB per octave.

Filter ranges: Max. ± 15 dB at 60, 180, 480 Hz, 1, 2, 4, 5 and 10 kHz.

To: E.S. Electronics, 2 Upper Fant Road, Maidstone, Kent.

Please send me  1,  2,  3,  4,  5 of your Graphic Equalisers. I enclose cheque or postal order for £.....

having added £1.50 for p. & p. on each item ordered and V.A.T. I understand that two batteries are included.

Name .....

Address .....

.....

Tel. ....

WW—059 FOR FURTHER DETAILS

## HILOMAST SYSTEMS

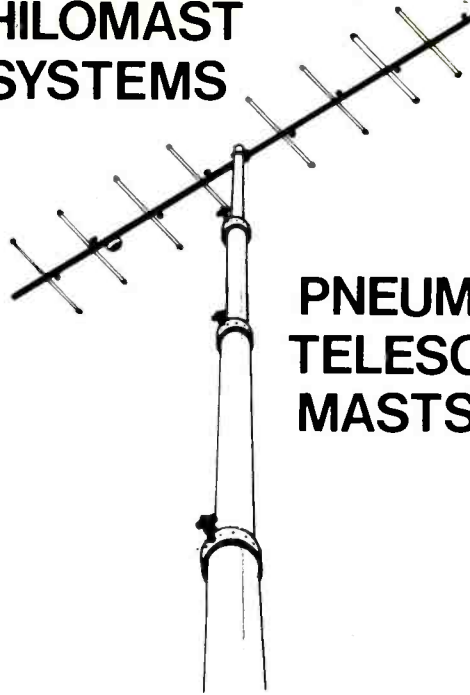

### PNEUMATIC TELESCOPIC MASTS

Specialists in design and manufacture of pneumatic and winch operated telescopic masts and towers. Vehicle, field and wall mountings available. Many standard models ex-stock.

## CLARBROOK Eng. Co. Ltd.

JUTSUMS LANE · ROMFORD · RM7 0ER · ENGLAND

Tel. Romford 65173

WW — 098 FOR FURTHER DETAILS

## PROXIMITY SENSOR

### TYPE EP45

#### ANIMAL VEGETABLE OR MINERAL

A new type of dielectric detector which is not limited to metals. Will detect movement of most materials at considerable distances. Variable sensitivity, will detect humans and animals easily up to six feet away and provides a T.T.L. compatible output pulse of adjustable width. Will count up to 5000 objects per minute.



Applications include security devices, process control and counting, automatic alarm and hazard warning systems, vehicle security, detection of humans and animals, etc. Power supply requirements 12-15 volts at 30mA.

### PHYSICAL & ELECTRONIC LABORATORIES LTD.

MANUFACTURERS OF PRECISION ELECTRONIC EQUIPMENT  
28 Athenaeum Road, Whetstone, London N20 9AE. Tel. 01-445 7683

### SCIENTIFIC CALCULATOR SALE!

**TEXAS SR52**—Magnetic card programmable calculator. 224 steps. 9 levels of brackets. Subroutine capabilities. indirect addressing. branching editing and debugging. pre-programmed IF. Statements decrement and skip on zero. user defined flags. 72 labels. 10 digit mantissa. 2 digit exponent. supplied with adaptor/charger, carry case and instruction manuals plus 20 blank magnetic cards @ £195 inc. VAT. Programme libraries: stats, maths, electrical engineering @ £28 inc. VAT.

**TEXAS SR56**, 10 digit mantissa. 2 digit exponent. 10 data memory register. 100 programme steps. 9 levels of brackets. 7 branching instructions. 2 loop control instructions. 4 subroutine levels. 5 programme levels. easy editing. 26 preprogrammed key functions @ £57.90 inc. VAT.

**TEXAS SR51-11**—New engineering notation displays scientific notation exponents as multiples of 3. Degrees. Radians. grads. a better independent linear regression line, a direct key to compute the correlation coefficient for analysis of two-dimensional stat data. 9 levels of brackets. 5 pending operations. 8 digit mantissa. 2 digit exponent @ £47.32.

T1 SR40 (successor to SR50A) @ £28.40.

T130 @ £15.95. T141 (financial) @ £28.45. 2550-11 @ £24.45; 1650 @ £16.45

**PC100 PRINTER FOR SR52/SR56**—Prints out entire programme, print calculate mode results, prints instructions or results without halting programme execution, trace programme execution step for error detection @ £175. 41-48 @ £26.95, 4190/5190R @ £36.88. CAS10 FX20(P-II) memories 127 steps (programmable) @ £49.95, 4

fraction calcs AL8 @ £13.95, AL10 @ £16.40, FX19 (6+2) @ £16.95, FX102 (8+2) @ £18.40.

HEWLETT PACKARD 21 @ £60. 22 @ £95. 25 @ £106. 25C @ £163. 27 @ £130. 67 @ £368. 91 @ £340. 97 @ £622. NOVUS 4520 @ £22.80. 4525 @ £34.90. 6030 @ £16.30. REALTIME SC6010-13 memories. 2 levels of brackets scientific. statistical rechargable @ £45. SC60 as SC6010 bit with 3 memories @ £34. ROCKWELL 6-4RD @ £22.42, 44RD @ £18.40.

**E4 UNIQUE STEREO CLOCK RADIO-AM/FM** stereo radio with an automatic alarm facility. clock display is a large green read out and can show minutes/seconds or hours/minutes intensity of the display can be adjusted from very bright down to dim glow @ £39.50 inc. VAT. P&P £1. S.A.E. for brochure.

All calculator prices inc. VAT + P&P. S.A.E. for Brochures and quantity prices. Export enquiries welcome. We accept company/hospital/University purchase orders. Mail Order Only.

C.W.O. to: **KRAMER & CO., 9 OCTOBER PLACE, HOLDERS HILL ROAD, LONDON NW4 1EJ. TEL. 01-203 2473. TELEX: 888941 ATTN. KRAMER**

servos  
synchronous  
steppers  
d.c. motors  
control systems  
gearboxes  
friction  
clutches  
instrument  
couplings

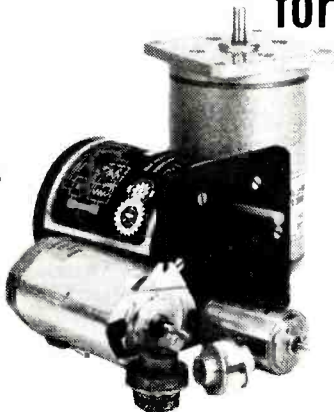

for a technical advisory service and off the shelf delivery, contact

**McLennan**  
telephone 03446 5757/8

MOTOR STOCKISTS FOR:  
IMPEX, PORTESCAP  
PRINTED MOTORS



**McLENNAN SERVO SUPPLIES LTD.**  
KINGS ROAD, CROWTHORNE, BERKS.

WW — 105 — FOR FURTHER DETAILS

# The Teletext decoder you don't have to modify your set for!



Your tv set needs no modification whatsoever! You just plug the decoder's output into your aerial socket. Our Teletext decoder has its own mains power supply, works with any 625-line receiver, monochrome or colour, and to make assembly particularly easy, the design uses four *p.c.b.s* which plug in to a main 'mother' board. Also, to simplify alignment, the very latest receiver techniques are used in the i.f. strip. All *p.c.b.s* will be made available through *Television* magazine's Reader's P.C.B. Service.

Part 1 of the Teletext decoder is in our March issue on sale now. It covers fundamentals and power supply details. Part 2 in the April issue begins the logic section.

Take up the March issue out now

# Television

April issue on sale Monday March 21

45p

## QUADRAPHONIC KIT MODULES

The following modules, currently being described in *Wireless World*, are offered. Each kit comprises of glass fibre PCBs and Components. Each module functions independently, but a universal system may be constructed by means of a master switch into which the boards may be plugged.

**CD-4 DEMODULATOR** £35 + VAT (£4.38)

CD-4 is a registered trade mark of the VICTOR COMPANY OF JAPAN LTD

**QS VARIOMATRIX DECODER SYNTHESIZER** £31 + VAT (£3.88)

QS, QS Variomatrix and QS Synthesizer are registered trade marks of SANSUI ELECTRIC COMPANY LIMITED OF JAPAN

**SQ DECODER** (Type L3A) £25.50 + VAT (£3.19)

(Variable Blend + Wave Matching Logic)  
SQ is the registered trade mark of CBS INC.

**MASTER SWITCH KIT** £8.50 + VAT (£1.06)

Add £1 postage packing and insurance per parcel. Overseas customers neglect VAT, but add £3.20 per kit to cover airmail postage

For enquiries please send S.A.E. to:

**COMPCOR ELECTRONICS LIMITED**  
9 DELL WAY, LONDON W13 8JH

or telephone 01-998 8221 on weekdays between 7.30 p.m. and 10 p.m. only



WW-106 FOR FURTHER DETAILS

## MAIL ORDER PROTECTION SCHEME (Limited Liability)

If you order goods from mail order advertisers in this magazine, except for classified advertisements, and pay by post in advance of delivery, *Wireless World* will consider you for compensation if the advertiser should become insolvent or bankrupt, provided:

1. You have not received the goods or had your money returned; and
2. You write to the publisher of *Wireless World* explaining the position not earlier than 28 days from the day you sent your order and not later than 2 months from that day.

Please do not wait until the last moment to inform us. When you write, we will tell you how to make your claim and what evidence of payment is required.

We guarantee to meet claims from readers made in accordance with the above procedure as soon as possible after the advertiser has been declared bankrupt or insolvent up to a limit of £3,550 per annum for any one advertiser so affected and up to £10,000 per annum in respect of all insolvent advertisers. Claims may be paid for higher amounts, or when the above procedure has not been complied with, at the discretion of *Wireless World*; but we do not guarantee to do so in view of the need to set some limit to this commitment and to learn quickly of readers' difficulties.

This guarantee covers only advance payments sent in direct response to an advertisement in this magazine (not, for example, payments made in response to catalogues, etc., received as a result of answering such advertisements). Personal advertisements are excluded.

# HIGH-SENSITIVITY INFORMATION PICK-UP

The Hi-Fi Year Book is more than just a handy reference. It is a sensitive instrument enabling you to pinpoint and track down the finest Hi-Fi items on the market. There are 500 pages of products, photos and expert articles to help you in your choice. Separate illustrated sections cover every major category of equipment—telling you what each item does, what it costs, who makes it and where to buy it. What's more, there are authoritative articles on the latest developments and how to apply them. Order your copy today, before it sells out... and you'll be tuned in to the finest in Hi-Fi all through 1977!

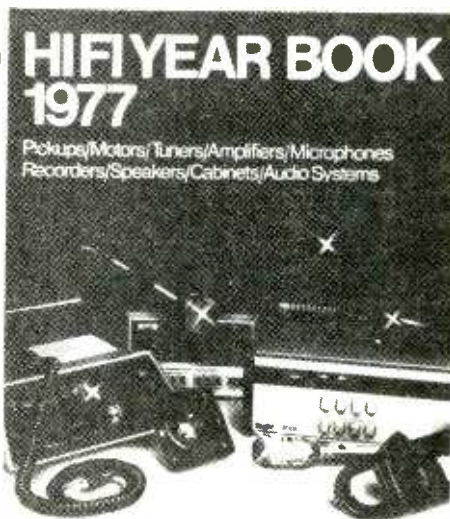

## HI FI YEAR BOOK 1977

Pickups/Motors/Tuners/Amplifiers/Microphones  
Recorders/Speakers/Cabinets/Audio Systems

Eagle.

Everything from a jack plug  
to a receiver.

## HI FI YEAR BOOK 1977

Available direct from the publishers @ £3.40 inclusive or from leading booksellers and newsagents price £3.00.

### ORDER FORM

To IPC Business Press Ltd., Room 11,  
Dorset House, Stamford Street,  
London SE1 9LU.

Please send me .....copy / copies of  
Hi-Fi Year Book 1977 @ £3.40 a copy  
inclusive, remittance enclosed.

Cheque P.O. should be made payable  
to IPC Business Press Ltd.

Name \_\_\_\_\_  
(please print)  
Address \_\_\_\_\_

Registered in England No 677128  
Regd Office Dorset House, Stamford  
Street, London SE1 9LU.



# Appointments

Advertisements accepted up to 12 noon Monday, February 28, for the April issue, subject to space being available.

**DISPLAYED APPOINTMENTS VACANT:** £6.50 per single col. centimetre (min. 3cm).  
**LINE advertisements (run on):** £1 per line, minimum three lines.  
**BOX NUMBERS:** 45p extra. (Replies should be addressed to the Box Number in the advertisement, c/o Wireless World, Dorset House, Stamford Street, London SE1 9LU.)  
**PHONE:** Owen Bailey on 01-261 8508  
*Classified Advertisement Rates are currently zero rated for the purpose of V.A.T.*

## ELECTRONICS + AIRCRAFT

= CHALLENGING WORK ON ADVANCED  
SYSTEMS

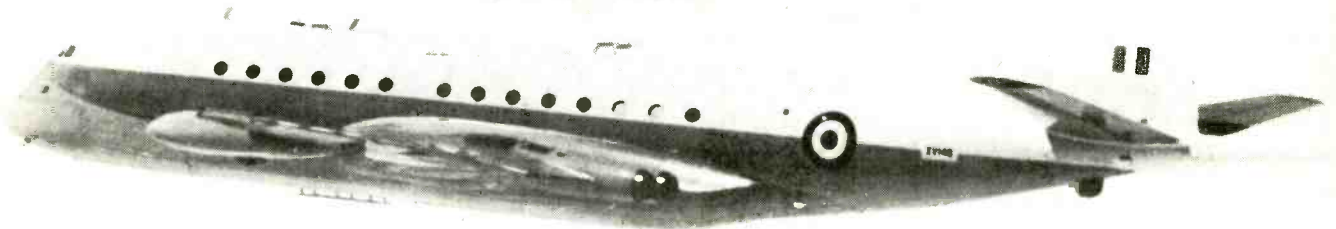

There are opportunities at our Aircraft Design, Development and Assembly Plant at Woodford, on the rural fringe of North Cheshire, to expand existing teams of men and women working on Avionics design and development on major aircraft programmes. A wide range of qualifications and experience can be integrated into our requirements, from recently qualified technicians and graduates to experienced engineers.

Digital computer systems experience, hardware and/or software would be particularly valuable but the extent of our interest in candidates with radio, radar, navigation flight control, acoustics, electrical systems, E.M.C. or mathematical modelling experience, illustrates the variety of opportunities available.

For further details and an application form, please write, giving brief personal and career information to:

J. Lewis,  
 Personnel & Industrial Relations Manager,  
 Hawker Siddeley Aviation Limited,  
 Woodford,  
 Stockport,  
 Cheshire SK7 1QR.

 **HAWKER SIDDELEY**

### The Polytechnic of North London

Department of Electronic  
and Communications Engineering

#### LABORATORY TECHNICIAN (Grade V)

Applications are invited for the appointment of a Laboratory Technician Grade V.

The work involves the operation and maintenance of High Grade test equipment in a Microwave and Radar Engineering Laboratory together with the general responsibility for the efficient running of the day-to-day requirements for students' experiments and project work, and includes participation in Research work.

Normal background experience required is at least 8 years.

Education to ONC or OND level in appropriate subjects.

Salary scale: £2,751-£3,207 plus £465 London Weighting and 5% earnings supplement.

Application form obtainable from the Establishment Officer, The Polytechnic of North London, Holloway Road, London, N7 8DB.  
 Telephone: 01-607 2789, extension 2019.

Further details from Mr. S. A. Elliott, extension 2176.

(7030)

### GRANADA TELEVISION LIMITED

#### ELECTRONIC ENGINEERS

We are looking for young experienced electronic engineers to fill a number of interesting jobs at our Manchester studios. The duties cover the operation and maintenance of the whole range of broadcast electronics, including television cameras, videotape recorders, telecine projectors and video switching, distribution and display equipment. The kind of people we need will probably have a formal qualification in electronics engineering but more important, will have an understanding of basic electronics and colour television principles arising from their genuine interest in the medium. They must be fit, with normal colour vision and prepared to work irregular hours including weekends.

Salary whilst training £3,310 increasing to £3,581 after one year and by annual increments to £4,669 after 5 years. Four weeks leave, pension and free life assurance.

Write with full details of education and experience to:



Robert Connell  
 GRANADA TELEVISION LIMITED  
 Quay Street  
 MANCHESTER M60 9EA

(7035)

## SENIOR SYSTEMS ENGINEERS & LOGIC DESIGNERS ELECTRONIC ENGINEERS INTERMEDIATE/JUNIOR LOGIC DESIGNERS

GEC Computers Ltd., Europe's largest and most experienced company specialising in real-time computer applications has vacancies for the above in their engineering hardware development department.

Applications for the senior systems engineer and logic designer vacancies must have a relevant degree or equivalent qualification and have had several years' experience in the computer field including complex digital equipment. They must have the ability to understand sophisticated central processor design under development and be able to play a significant and creative part in that design.

Electronic engineers are required for the design and development of computer memories, power supply units, displays, processors and peripheral equipment. Applicants must have a relevant degree or similar qualification e.g. HND, and a minimum of 1-2 years' practical experience.

Junior Logic designers are required to work on either the development of computers and associated equipment or the design and development of special purpose test equipment. Applicants must have a relevant degree or suitable qualification e.g. HNC ET5, etc., and have had some practical experience of digital design. Simple programming experience would also be an advantage although this is not essential.

Specialist training will be given for all of the above positions and there is a company training scheme for junior staff.

These positions attract competitive starting salaries and career progression is based on ability and performance. There is a contributory pension scheme and other fringe benefits normally associated with a large organisation.

Those interested should apply in writing or telephone to **Mr. D. F. Watts, Personnel Department, GEC Computers Ltd., Elstree Way, Borehamwood, Herts. Tel: 01-953 2030, ext. 3697.**

**GEC Computers Limited**



(7058)

## TEST GEAR MAINTENANCE ENGINEERS

The EMI M.O.D. Factory at Springfield Road has vacancies for Test Gear Maintenance Engineers who are required to carry out routine checks on standard and specialised equipment. The work also involves fault finding and repair of a wide variety of test equipment, and the construction of test equipment.

Applicants must have experience of servicing electronic equipment, e.g. radio and TV.

**Please write to or telephone Richard Black, EMI Limited, Springfield Road Works, Hayes, Middlesex. Telephone 01-573 2701.**

(7036)

University of Cambridge  
Scott Polar Research Institute

### TECHNICAL ASSISTANT

A vacancy exists in the S.P.R.I. for an experienced Technician to join an active research group engaged in studies of the Antarctic Ice Sheet using 10W frequency Radar backed up by specialist in house computer facilities. While the skills sought are primarily in Electronics, adaptability is important and knowledge of dark room work and machining would be an advantage. Field work is also involved and typically occupies two months a year. The appointment lasts until July 1979 and is at University grade R6 with a salary range of £2695-£3087 per annum. A shorter appointment without field work commitment may alternatively be available at the same salary level.

Applications enclosing curriculum vitae and names of two referees, should be sent to: The Director, Scott Polar Research Institute, Cambridge CB2 1ER.

(7057)

### BRISTOL POLYTECHNIC DEPARTMENT OF ENGINEERING

Applications invited for the following post for one year period commencing on 1 March 1977, or as soon as possible thereafter —

#### RESEARCH ASSISTANT

Graduate of equivalent required to assist with development work in the field of solid-state technology applied to the control of electrical machines. Some knowledge of electrical machine systems and digital techniques is required.

Suitably qualified applicants would be encouraged to register for a higher degree.

Salary £2469 p.a. plus £312 p.a. supplement.

Further details and application forms (to be returned by 25 February 1977) to from Personnel Office, Bristol Polytechnic, Coldharbour Lane, Frenchay, Bristol BS16 1QY. Please quote Post Reference Number **RS2/61/3** in all communications.

(7060)

### PIPCO (S & W SERVICES)

For Electronic Engineers, Technicians & TV Service Engineers.

**26a High Street  
Hounslow, Middx.  
Tel: 01-572 7363**

**Telex Pipco Hounslow 935413  
(6552)**



Cable and Wireless Limited, leaders in global telecommunications, are expanding their overseas interests, and are currently seeking the following staff for their Headquarters in Central London:

## WIDEBAND RADIO ASSISTANT PROJECT ENGINEER

To write specifications and tenders, evaluate and test UHF/SHF/Microwave/Tropospheric Scatter Systems and produce cost estimates and detailed engineering plans, including discussions with clients. Possession of HNC, C&G or higher qualification would be an advantage: age 25 plus.

## FREQUENCY PLANNING AND CO-ORDINATION ASSISTANT ENGINEER

To plan, obtain and ensure correct usage of frequency assignments for the Group's earth stations, HF narrow band VHF and UHF operations and consultancies in the Fixed and Mobile Services. This will include planning, and the maintenance of international records. Educated to a minimum of HNC standard: age 25 plus.

Excellent conditions of service are offered with commencing salaries between £4,206 and £5,000 per annum, depending on experience and qualifications, on progressive career scales rising to over £7,000 per annum.

Please write or telephone for an application form to:

**The Recruitment Manager, Ref. A490/628,  
Cable and Wireless Ltd.,  
Theobalds Road, London WC1X 8RX.  
Tel: 01-242 4433 ext. 211.**

# Cable & Wireless

## **ELECTRONIC DESIGN/ DEVELOPMENT ENGINEERS FERRANTI OFFERS YOU FREEDOM**

..... freedom to create. Over the years leading design and development engineers have been attracted to Ferranti by our reputation for truly innovative engineering and together they have formed specialised teams involved on a variety of sophisticated projects related to the Tornado, Sea Harrier, Jaguar, Nimrod 2 and other front line aircraft.

We now require additional engineers to join these teams engaged on the creative work of designing and developing airborne radar, laser and inertial navigation systems and their associated test equipment.

**Engineers are required in the following technical fields:-**  
**Digital and analogue electronic circuitry design.**  
**Design and application of small digital computers.**  
**Microwave and laser techniques.**  
**Advanced instrument design including gyroscopes of inertial quality.**  
**Design of small mechanical structures and analysis of stress.**

In addition to the above we have vacancies for production engineers with either electrical or mechanical backgrounds in these fields.

Applicants should have some design/development experience to offer in avionics and a desire to expand their experience to project leader level.

Edinburgh, with its outstanding facilities for education, housing, sport and entertainment, is one of the ideal cities in Europe in which to live, work and bring up a family. And to make moving here easier, we pay realistic relocation expenses. Salaries are negotiable and the Company operates a contributory pension and life assurance scheme.

Apply in writing, with full details of experience and qualifications to

**Staff Appointments Officer,  
Ferranti Limited,  
Ferry Road,  
EDINBURGH, EH5 2XS.**  
Please quote Ref. WW/1.

# **FERRANTI**

## Interested in computers?

### Lecture on Computer Servicing

## International Computers

think computers—think ICL

(7001)



We are looking for Lecturers to teach the practicalities of computer servicing.

You will be based at our Engineering Training Centre in Letchworth, Herts – the largest of its kind in Europe. Here you will be given a comprehensive grounding in computer technology in general and ICL equipment in particular.

You will be thoroughly prepared to train engineers to the point where they will be capable of maintaining computers at the optimum operational specification.

Ideally, you will have an HNC or Forces' training in a technical subject. Any experience of digital electronics, computers or instructing on these subjects, while not essential, will be useful. Fluency in written and spoken French or German would be a distinct advantage but is not essential.

We'll start you as an Assistant Lecturer on a salary of not less than £3800 a year. You'll be encouraged and expected to progress to the position of Senior Lecturer which carries a salary in excess of £5000.

Relocation expenses will be considered where appropriate

For an application form, phone David Reeves on 01-788 7272 extension 4150, or write to him at ICL, 85/91 Upper Richmond Road, Putney, London SW15 2TE. Please quote reference WW 1134

### UNIVERSITY OF SURREY DEPARTMENT OF ELECTRONIC AND ELECTRICAL ENGINEERING AN ELECTRONICS ENGINEER/TECHNICIAN

is required to join the Industrial Electronics Group working on a wide range of advanced electronic design and construction projects. The post entails working with the minimum of supervision on the construction and testing of high quality prototypes and presents an opportunity for career development in instrumentation, computers and communications.

A second post exists in the Department's Electronics Workshop where an ELECTRONICS ENGINEER is required to join a team designing, building and servicing a wide range of specialised electronic equipment. The successful candidate will be expected to work with a minimum of supervision and be capable of taking projects from outline design to final product.

The successful candidates will be appointed in one of the Technician Grades 2 to 5, depending on qualifications and experience. For the higher grades a minimum of 3 years' relevant experience and qualifications equivalent to ONC are expected. Opportunities are provided for further study leading to higher professional qualifications. There are promotion prospects to higher grades.

Salaries: Technician Grade

|    |               |   |               |
|----|---------------|---|---------------|
| 2A | £2152 – £2452 | 4 | £2689 – £3087 |
| 3  | £2455 – £2788 | 5 | £2889 – £3367 |
|    |               | 6 | £3314 – £3950 |

Application forms may be obtained from the Staff Officer, University of Surrey, Guildford, Surrey GU2 5XH, or Tel. Guildford 71281, Ext. 452, and should be returned as soon as possible.

(7056)

## SERVICE ENGINEER

L.K.B. Instruments require an additional engineer to service their range of clinical and nuclear products installed in customers' premises throughout the West Country and South Wales. The applicant should live or be prepared to move to this area.

Experience with nuclear counting equipment would be an advantage but a good general knowledge of digital electronics and a mechanical aptitude is considered essential.

The company offers a salary commensurate with experience, bonus scheme, company car, and assisted B.U.P.A. membership.

Please contact for application form –

The Service Manager  
L.K.B. Instruments Limited  
232 Addington Road  
South Croydon, Surrey  
Tel: 01-657 8822

(7059)

### UNIVERSITY OF MANCHESTER

Hester Adrian Research Centre,  
Anson House Pre-School Project for  
Mentally Handicapped Children

### A vacancy exists immediately for a TECHNICIAN (Grade 3)

in the above project. The successful applicant will work in the pre-school facility which is one mile from the University, but will have access to electronic and mechanical workshops in the University itself. A major requirement will be that the technician will be responsible for the operation of an extensive CCTV system and will undertake the editing of tapes. Experience with CCTV is therefore important. Subsidiary functions will involve some electronic and mechanical work. ONC is essential and HNC (Electronics or Physics) (or equivalent qualification) is desirable. Salary Scale £2325-£2655 p.a. plus earnings supplement of £130 p.a. Applications with full details of age, qualifications and previous experience should be addressed to Dr. J. Hogg, Hester Adrian Research Centre, The University, Manchester M13 9PL (7015)

## VIDEO & ELECTRONICS ENGINEER

required with experience of servicing and installation of Video and HiFi equipment for a responsible position in a new organisation in the centre of Bath. This is a challenging job for the right man, with excellent salary and promotion prospects.

Apply in writing to: Video South, 101 Eden Vale Road, Westbury, Wilts, or telephone Westbury (Wilts) 823140.

(7038)

## Aural and Visual Aids Technician

£3963-£4299 per annum

An experienced technician is required by the Croydon Education Service to maintain and repair a range of Audio and Video equipment including T.V. Receivers in schools.

Commencing salary in the scale will be according to qualification and experience.

In an appropriate case consideration will be given towards assistance with removal and lodging expenses.

## CROYDON

Apply in writing giving details of age, qualifications, present post and relevant work experience to The Superintendent, Education Service Centre, Princess Road, Croydon CRO 2QZ or telephone the Superintendent, Mr. A. Bevan (tel: 01-684 9393) for further details.

(7037)



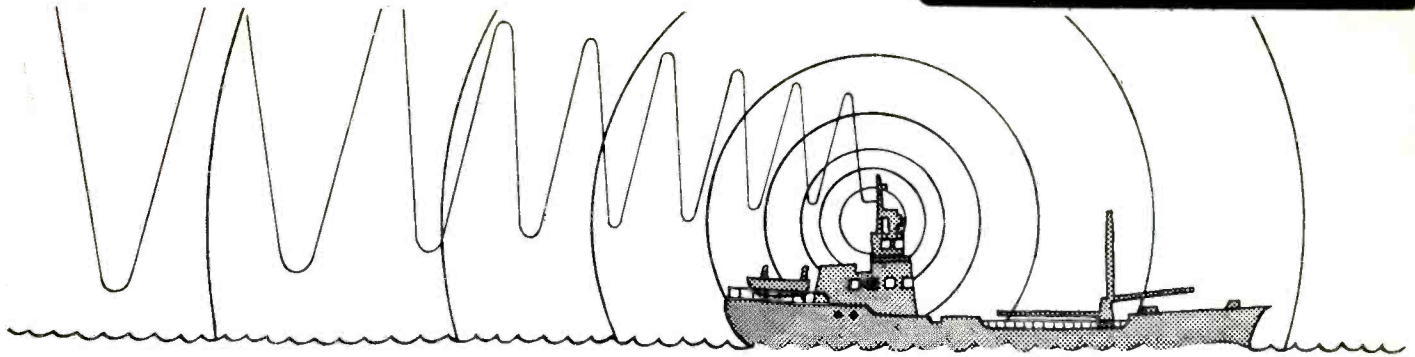

## Radio Officers—now you can enjoy the comforts of home.

Working for the Post Office Maritime Services really makes sense. You still do the work that interests you, but with all the advantages of a shore-based job: more time to enjoy home life, job security and good money. To qualify, you need a United Kingdom Maritime Radiocommunication Operator's General Certificate or First Class Certificate of competence in Radiotelegraphy, or an equivalent certificate issued by a Commonwealth Administration or the Irish Republic.

Starting salaries, at 25 or over, are £2905 rising to £3704 after three years service. Between 19 and 24, the starting salary varies from £2234 to £2627 according to age. In addition, a supplement of £312

p.a. is payable. You'll also receive an allowance for shift duties which at the maximum of the scale averages £900 a year and there are opportunities to earn overtime. There's a good pension scheme, sick pay benefits and prospects of promotion to senior management.

Right now we have a few vacancies at some of our coastal radio stations, so if you're 19 or over, preferably with sea-going experience, write to: ETE Maritime Radio Services Division (L690), ET 17.1.1.2., Room 643, Union House, St. Martins-le-Grand, London EC1A 1AR.

Post Office Telecommunications

## Senior Audio Visual Engineer

London Airport

C. £4,000 p.a.

An opportunity exists for an Audio Visual Engineer to fill a senior position in the Heathrow Conference Complex.

The successful applicant will have experience in the operation and maintenance of CCTV and colour studio equipment including broadcast cameras and 1" helical scan VTR and will also possess both the ability and the willingness to train less experienced engineers.

This is a small, highly skilled team whose responsibility it is to present the most sophisticated conferences in the United Kingdom.

Please apply with brief personal and career details to the Personnel Dept., The Heathrow Hotel, Bath Road, Heathrow, Hounslow, Middlesex, TW6 2AQ, or telephone 01-897 6363/2419 for an application form. (7002)



**The Heathrow Hotel**  
The only hotel on London Airport.

## RADIO TECHNICIANS

Government Communications Headquarters has vacancies for Radio Technicians. Applicants should be 19 or over.

**Standards** required call for a sound knowledge of the principles of electricity and radio, together with 2 years experience of using and maintaining radio and electronic test gear.

**Duties** cover highly skilled Telecommunications/electronic work, including the construction, installation, maintenance and testing of radio and radar telecommunications equipment and advanced computer analytic machinery.

**Qualifications:** Candidates must hold either the City and Guilds Telecommunications Part I (Intermediate) Certificate or equivalent HM Forces qualification.

**Salary** scale from £2,230 at 19 to £2,905 at 25 (highest pay on entry), rising to £3,385 with opportunity for advancement to higher grades up to £3,780 with a few posts carrying still higher salaries. Pay supplement of £313 20 per annum.

**Annual Leave** allowance is 4 weeks rising to 6 weeks after 27 years' service.

**Opportunities** for service overseas.

Candidates must be UK residents.

Further particulars and Application forms available from:

**Recruitment Officer**  
Government Communications Headquarters  
Oakley, Priors Road  
CHELTENHAM, Glos GL52 5AJ  
Tel. Cheltenham 21491 Ext. 2270  
(STD 0242-21401)

## SCOTTISH HOME AND HEALTH DEPARTMENT

# WIRELESS TECHNICIAN

Applications are invited for a post of Wireless Technician in Scottish Home and Health Department.

**Location:** Inverness.

**Qualifications:** Candidates must hold an Ordinary National Certificate in Electronic or Electrical Engineering or a City and Guilds of London Institute Certificate in an appropriate subject or a qualification of a higher or equivalent standard.

**Experience:** 3 years' appropriate experience.

**Starting Salary:** £2,010 (age 17) to £2,905 (age 25 or over), scale maximum £3,385

In addition a supplement of £313.20 per annum is payable for staff aged 18 or over (£261.00 per annum for staff aged 17). Applicants should have sound theoretical and practical knowledge of Radio Engineering and Radio Communications equipment in HF, VHF and UHF bands. The work involves installation and maintenance of equipment located at considerable distance from headquarters. A clean, current driving licence and ability to drive private and commercial vehicles are essential.

Appointment is unestablished initially but there is prospect of an established (ie permanent) appointment after 1 year's satisfactory service.

Application forms and further information are obtainable from Scottish Office Personnel Division, Room 105, 22/25 Queen Street, Edinburgh, EH2 1LY (quote ref: PM(PTS)2/1/77) (031-556 9222, Ext 727).

Closing date for receipt of completed application forms is 24 February 1977.

(7013)

# Electronic Engineer

Sonarmarine — a member of the BP Group — is a new survey company, situated near London Airport, whose business is surveying for the offshore oil industry.

The company is looking for an Electronic Engineer, qualified to HNC standard or equivalent, to be responsible to the Equipment Maintenance Supervisor for marine survey equipment.

Candidates must have considerable practical experience and the ability to work down to component level on a wide variety of digital and analogue equipment used in marine surveys.

Salary is dependent on experience and the company has a non-contributory pension scheme. Please write enclosing a c.v. to The Manager, Central Recruitment, Britannic House, Moor Lane, London, EC2Y 9BU.

(7012)

# SONARMARINE

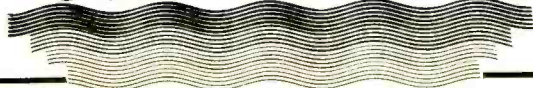

# ELECTRONICS OVERSEAS

## Airport Systems High tax-free salaries

International Aeradio Limited, a world leader in communications and aviation services, is offering immediate career opportunities overseas to experienced electronics engineers.

Vacancies exist in the following areas of operation:

### NAVAIDS

Including ILS, CADF, VOR, DME, NDB, Control Tower Installations.

### ATC RADAR

Approach and long range surveillance equipment plus SSR, HF, VHF and UHF radio equipments.

Applicants should be qualified to ONC or C&G (Telecomms) with a minimum of five years' maintenance experience either in a military or civil environment.

Excellent tax free salaries are offered and other benefits include: Free Housing · Married accompanied status · Child/Education allowances · Pension/sickness schemes.

Write or telephone for an application form to: John Callow, Senior Recruitment Engineer,

International Aeradio Limited, Aeradio House, Hayes Road, Southall, Middx. Tel: 01-571 1808.

# RADIO TECHNICIANS

The Home Office requires Radio Technicians in its Directorate of Radio Technology in Central London, Stanmore, Middlesex and Baldock, Hertfordshire. Radio Technicians in London and Baldock carry out installation, maintenance, modification and construction of complex specialised radio communications equipment and systems. The duties at Stanmore include work on radio interference measurement; constructing prototype models (including the mechanical construction) from engineering sketches and circuit diagrams. Applicants should be familiar with commonly used electronic and radio components and with test equipment such as oscilloscopes and signal generators.

### Qualifications and Experience

Candidates must possess either a City & Guilds Intermediate Telecommunications Technicians or Engineering Certificate, a relevant ONC or equivalent qualification. Candidates should also have had 1 year's practical workshop experience.

### Salary

is £2,010 a year at 17, £2,450 at 25 or over on entry, rising to a maximum of £3,385 plus a pay supplement of £313.20 and a London Weighting Allowance of £465 a year for those employed in Central London and £275 a year for those employed at Stanmore.

### A Secure Future

with a non-contributory pension scheme, prospects of promotion, generous leave allowance, further education facilities and a 5 day week of 41 hours.

### Interested?

Then write or telephone for application forms (for return by 16th March, 1977) and further details to: Mr J J Willis, Directorate of Radio Technology, Room 514, Waterloo Bridge House, Waterloo Road, London SE1 8UA. Telephone: 01-275 3006.

(7034)



Home Office

## mi

# Careers in Professional Electronics

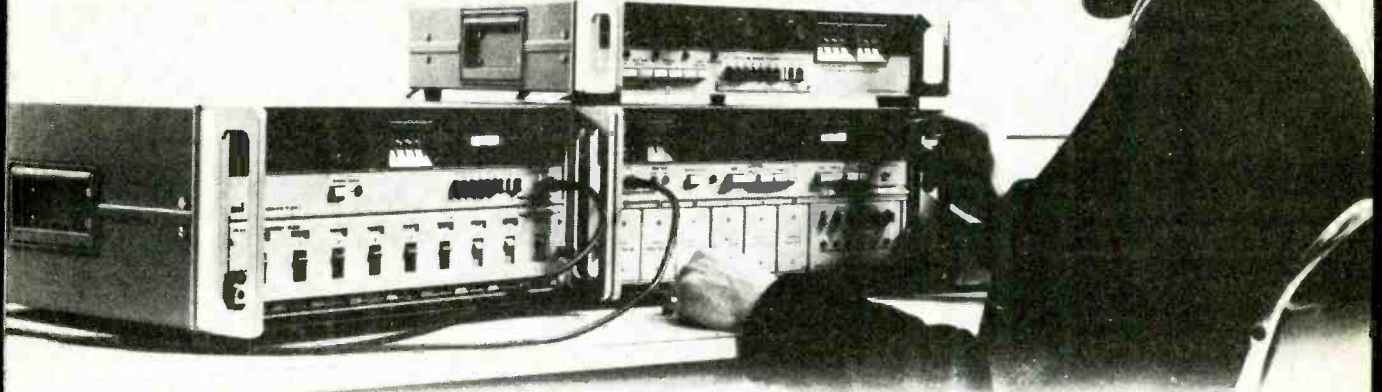

Your experience could open the door to a range of interesting and rewarding opportunities in the Design, Production or Service departments of a Company whose products complement the most advanced modern electronic techniques.

For more information apply in confidence to:— John Prodger,  
**MARCONI INSTRUMENTS LIMITED**  
 Longacres, St. Albans, Herts. Tel: St. Albans 59292

A GEC—Marconi Electronics Company

(7055)

UNIVERSITY OF THE WEST INDIES —  
 JAMAICA

### SENIOR LABORATORY TECHNOLOGIST

A vacancy exists for a Senior Laboratory Technologist at the Electronics Laboratory of the University of the West Indies, Mona

The successful applicant will be required to repair and maintain a variety of electro-mechanical and electro-optical instruments. He/she will also be required to provide technical support to two Electronic Engineers engaged in the maintenance and design of Electronic instrumentation.

**Qualifications:** Candidates must have a full Technological Certificate, (HNC City and Guilds or equivalent) and at least five years' experience in bench fitting and small instrument making.

**Salary Scale:** J\$6000-9372 per annum (£1 sterling = J. 1.53)

Benefits include generous Superannuation Scheme, subsidised medical attention and 10% Marriage allowance for male married employees.

Applications should be addressed to the Personnel Officer, Registry, University of the West Indies, Mona, Kingston 7, Jamaica, West Indies, giving details of present qualifications and experience together with the names of two referees acquainted with the candidates' technical competence. (7003)

Industrial Tape Applications require  
**ELECTRONIC**  
 and  
**ELECTRO MECHANICAL**  
**ENGINEER**

for design and development of equipment relating to the recording industry. An attractive salary is offered to the successful applicant who will be required to see projects right through to production.

Please phone  
 01-485 6162/7833

7007

## Loudspeaker Technician/ Engineer

Tannoy Products Limited, the international name in the field of audio electronics, are looking for an enthusiastic Technician / Engineer to join their Hi-Fi Laboratory at Tylers Green, High Wycombe, Bucks. The successful candidate will be responsible for the construction of experimental and prototype loudspeaker assemblies working with a dedicated design and development team under minimum supervision.

Candidates should have a self-motivated practical approach with attention to detail and possess some knowledge of modern materials, adhesives and current process technology. Experience with loudspeaker drivers and systems is desirable together with an understanding of their performance assessment.

Salary will be up to £4,000 per annum. Generous benefits include assistance with relocation expenses where appropriate, and 4 weeks' holiday. The company has recently moved its Design and Development Laboratories to a pleasant rural area and offers excellent conditions of employment.

For further details and application form, please contact the Personnel Manager, Mrs. D. Jennery, or the Chief Engineer, Alex Garner, at Tannoy Products Limited, St. John's Road, Tylers Green, High Wycombe, Bucks. Tel. Penn 5221.

(7023)

# TANNOY

**MEDIA ELECTRONIC  
 HOLDINGS LIMITED  
 MERCURY MOBILES**

### PROJECT ENGINEER

Mercury Mobiles require project engineers for their television systems group. The work involves TV system design, implementation and commissioning, possibly on customers premises, of broadcast OB vehicles and studios.

Prospective candidates should have a formal engineering qualification and experience of broadcast television engineering. Overseas travel, occasionally for extended periods, could be involved.

Replies in writing to:

**Mr. J. M. Gibson**  
**Engineering Manager**  
**Mercury Mobiles**  
**Woodland Ind. Estate**  
**Eden Vale Road**  
**Westbury, Wilts.**

(7047)

### TELEVISION

and Film Unit to be a member of a team operating and maintaining television equipment of professional standards. Experience of VTR and Teleciné work an advantage.

Salary scale £2889-£3367 Ref 65/C/

Application forms from

Assistant Secretary  
 Personnel Office  
 University of Birmingham  
 P. O. Box 363

Birmingham B.15 2TT 7018

**SWANSEA SOUND LTD.**

invite applications for

**AUDIO MAINTENANCE ENGINEER**

with a wide knowledge of professional broadcast and studio equipment.

Applications in writing to:

**Stan Horobin  
Chief Engineer  
Swan Sound Ltd.  
Victoria Road  
Gowerton  
Swansea**

(7051)



**ELECTRONICS TECHNICIAN**

KEF Electronics is an expanding company specialising in the manufacture of high quality loudspeakers.

An Electronics Technician is required to build and maintain sophisticated analogue and digital audio test equipment for use in both factory and laboratory.

We are looking for someone with considerable relevant experience and proven practical ability.

The salary will be negotiable.

Please write initially, giving personal details including age, qualifications and experience, to Dr. J. M. Berman, KEF Electronics Ltd., Tovil, Maidstone, Kent. (7040)



**CAPITAL APPOINTMENTS LTD.**

**FIELD SERVICE ENGINEERS (ELECTRONICS)**

If you're not earning, over **£3,500 p.a. plus a car** — then you had better contact us! (7042)

34 Percy Street, London, W.1  
01-636 9659 (day) or  
550 0836 (evening)

**SOUTH COAST**

Several of our clients require the following personnel urgently, offering excellent salaries and relocation expenses where necessary.

- PROJECT ENGINEERS
- ELECTRONIC ENGINEERS
- TEST ENGINEERS AND TECHNICIANS
- QUALITY ASSURANCE ENGINEERS
- TECHNICAL AUTHORS
- SYSTEMS PROGRAMMERS
- DRAUGHTSMEN/WOMEN, Electro-Mechanical and BUYERS

Please write or ring: **CBS APPOINTMENTS**  
224 Old Christchurch Rd., Bournemouth, Bournemouth  
29215S or Wimborne 4891 after 7 p.m. (7052)

**LABORATORY TECHNICIANS**

BBC Engineering, Designs Department, requires Technicians for Central London Laboratories.

Duties include assisting Engineers with the development, construction and testing of sound and television broadcasting equipment.

The successful candidates will probably be in their twenties and have a keen interest in, and at least two years practical experience of, electronics. They will have at least ONC or City and Guilds Part II or equivalent.

Salary according to qualifications and experience in the range £2784 - £3318 rising to a maximum of £3696 per annum (plus from £10.86 to £17.38 per month Pay Supplement according to earnings under current Incomes Policy).

Good opportunities for promotion.

Pensionable posts. Good restaurant and Club facilities.

Write for application form to **Engineering Recruitment Officer, BBC, Broadcasting House, London W1A 1AA**, quoting reference number

77.E.4005/WW and enclosing a self addressed envelope at least

9" x 4"



**ITN**

**VISION ENGINEER**

A vacancy exists in the Vision Maintenance Department of our West End Studios for an engineer to work on a wide range of broadcasting equipment including Vision Mixers, Computers, Digital Character Generators, as well as conventional Colour Coding, Decoding and Distribution systems.

We hope to recruit someone aged around 30 with wide relevant experience and qualifications to HNC level but, failing such an applicant, we are prepared to consider those with lesser qualifications for engagement at trainee level.

For further information, please apply to the Personnel Department of Independent Television News Ltd. on 01-637 3144. (7032)

**AUDIO ELECTRONICS ENGINEER**

A vacancy exists for a junior technician working with a young team in a London-based professional recording studio.

Duties will include assisting in the service and maintenance of complex audio equipment, and the design and construction of electronic devices.

The position includes possibility of European travel.

For further details and application form, please apply to **Peter Smith, LA MAISON ROUGE, 388 Oxford Street, London, W.1. Telephone: 01-408 2075.**

(7039)

**CHARING CROSS HOSPITAL MEDICAL SCHOOL**

(University of London)

**ELECTRONICS TECHNICIAN**

required in the Department of Physiology for the construction and maintenance of electronic equipment. The successful applicant will have the opportunity to assist in the neurophysiological research project.

Applicants should hold HNC or equivalent. Salary on scale £2,823-£4,050 plus £354 London Weighting Allowance. Further details and application forms obtainable from the Secretary, Charing Cross Hospital Medical School, The Reynolds Building, St. Dunstan's Road, London W6 8RP, quoting ref. 014. Closing date March 7th.

(7045)

**CAPITAL APPTS.**  
**FREE LISTS**  
101  
Design/Development and Test Jobs  
Permanent and Contract  
**To £6,000** (7043)  
34 Percy St. London, W.1  
**637 5551 day; 550 0836 eve.**

**SENIOR ENGINEER.** We specialise in marine electronics and need a skilful engineer with wide ranging practical electronic experience, to install and service SSB MF/HF and VHF R/T, Radar, Autopilots etc on yachts and commercial vessels. Proven ability to organise and work on own initiative is essential as work away from home is involved. The position is based in Central London. Salary negotiable. Company car. Telesonic Marine Limited 243 Euston Road, London NW1. 01-387 7467/8. (7017)

**MAINTENANCE ENGINEER** to work within West London film dubbing complex duties include construction and installation of all types of recording equipment. Box No. W/W 7014.

**SCANNING THE ADVERTS** to see what's going? If you are, we could be offering the best opportunity you've seen yet. We need a technically knowledgeable person who has a flair for writing, to train as assistant editor for one of our hi-fi magazines — and good assistant editors can progress rapidly to editors in our organisation. The post will probably most appeal to someone already in the trade/customer liaison department of a hi-fi orientated company but could be equally suitable to someone finishing a course or involved in retailing. — Write to Hugh Johnstone, Haymarket Publishing Ltd., 54-62 Regent Street, London W1. (7050)

# Iran Telecommunications

OSCO - The Oil Service Company of Iran, a Consortium of International Oil Companies engaged in the exploration and production of oil and gas for the National Iranian Oil Company have the following vacancies:

## Head Telecommunications Special Projects

(US \$30,000 per annum nett)

Responsible for the planning, co-ordinating and management of the telecommunication projects which include: microwave, UHF, VHF and HF radio systems, trunk line and cable carrier systems, telegraph networks, telephone exchanges and local telephone line distribution.

Candidates should be graduates in Electronics/ Telecommunications and have at least 10 to 12 years experience in telecommunication engineering and administration with at least 5 years at supervisory level.

## Head Telecommunications Services

(US \$25,000 per annum nett)

Responsible for all-over supervision and control of the drilling radio operation, maintenance of exchange and line, trunk telephone/telegraph network and all radio and electronic systems throughout the area of operations.

Candidates should be graduates in Electronics/ Telecommunications with at least 10 years experience in all telecommunication engineering aspects including administration with at least 5 years at supervisory level. Must additionally have experience relating to radio band/frequency and a good background of radio, exchange and line maintenance.

Both appointments will be located in Ahwaz in South-West Iran and the tour of duty will be for two years with a possibility of extension.

In addition to a generous salary free of local Income Tax, the following benefits will apply:

1. Married accommodation available after short initial period of single status.
2. Free medical attention in Iran for staff and families.
3. Home leave earned at the rate of 4 days per month of foreign service.
4. Primary schooling available locally.
5. Financial assistance towards boarding school costs.
6. Additional school children's passages for children at boarding school in the country of origin.
7. Substantial terminal bonus on satisfactory completion of contract.

Iranian applicants will be considered under the regulations existing for the employment of Iranian staff.

Please forward full details of experience and qualifications to Brian Doyle, Selection Consultant, Ref. 8381/WW, Whites Recruitment Limited, 72 Fleet Street, London EC4Y 1JS.

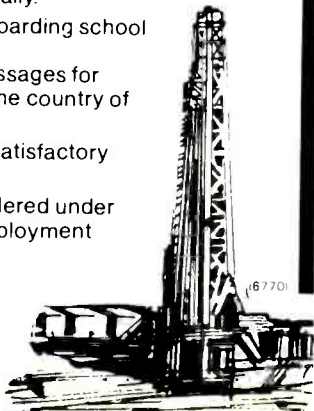

## THE FASTEST GROWING AIRLINE IN THE MIDDLE EAST

Saudia, the airline of the Kingdom of Saudi Arabia, is seeking, as part of a planned programme of expansion, two thoroughly experienced technicians, aged under 45, to sustain the existing level of operations and also to work on new communications equipment which is currently being installed.

### SENIOR TELEPRINTER TECHNICIAN

Starting salary c. £7,600 (income tax free)

Duties will include:

- routine and complex maintenance and repair of teleprinter equipment
- the installation of circuitry and teleprinter machines
- conducting periodic tests to check the quality of the teleprinter circuitry
- routine preventative maintenance on equipment and machinery
- the maintenance of service records for equipment in use
- maintenance and revision of technical manuals

Applicants should hold a certificate of training in the field of teleprinter/system maintenance and have 3-5 years practical experience. (Please quote reference A-503-762 when applying for this job).

### SENIOR RADIO TECHNICIAN

Starting salary c. £7,600 (income tax free)

Duties will include:

- routine maintenance and troubleshooting on radio equipment—eg. UHF/VHF/HF mobile communications equipment, public address systems, etc.
- work on communications system installations including antennas, feeder lines, power lines and cables
- the maintenance of technical journals
- keeping up-to-date regarding state of the art procedures in electronics maintenance
- field trips
- the maintenance of service records on equipment and logs of the utilisation of spare parts
- participation in on-job training of Saudi National employees

Applicants should have completed a trade school course or have equivalent experience. 3-5 years experience of electronics equipment servicing is essential. (Please quote reference A-504-762 when applying for this job).

These jobs, which are for a 2 year (renewable) contract period, are based in Jeddah. Saudia offer excellent (income tax free) salaries together with free unfurnished accommodation for you and your families, free and reduced air tickets, 40 days leave per annum and a re-location allowance.

Please write, with full personal and career details, or telephone for an application form, quoting the appropriate reference, to:

Miss Connie Mulshaw,  
Saudia's U.K. Personnel Representative,  
Saudi Arabian Airlines,  
Room 216, 93, Regent Street,  
London W.1. Tel: 01-439 1661.

Closing date for completed applications 24th January 1977.

**saudia**   
SAUDI ARABIAN AIRLINES





## COURSES

### Msc Course in Electrical Engineering

Specialisation in any one of the following

- Electrical Machines and Power Electronics
- Electrical Machines.
- Communications Systems.
- Electronic Instrumentation.
- Control Engineering & Digital Electronic Systems.
- Design of pulse and Digital Circuits and Systems.

The course, which commences in October 1977 may be taken on a Full-Time, Part-Time, Sandwich or Block Release basis, and is open to applicants who will have graduated in Science or Engineering, or will hold equivalent qualifications by that date. The Science Research Council have accepted the Course as suitable for the tenure of its Advanced Course Studentships. A Diploma Course, in some of the above topics or in Power Systems, is also open to applicants with the above, or slightly lower qualifications.

### Research in Electrical Engineering

Applications are also invited from similarly qualified persons who wish to pursue a course of research leading to the Degree of M.Phil. or Ph.D. in any of the above topics or in Electro heat.

Application forms and further particulars from the Head of the Department of Electrical Engineering (Ref. MSc), The University of Aston in Birmingham B4 7ET.

(7004)



THE UNIVERSITY OF ASTON IN BIRMINGHAM

## COURSES

**RADIO** and Radar M.P.T. and C.G.L.I. Courses. Write: Principal, Nautical College, Fleetwood, FY7 8JZ. (25)

## TAPE RECORDING ETC.

**YOUR TAPES TO DISC.** Mono or Stereo Cutting. Vinylite Pressings, Sleeves/Labels. Top professional quality. S.A.E. for photo leaflet. **DEROY** Records, "Eastwood," Cove Dunbartonshire, Scotland. (82)

## EQUIPMENT

# FOR EXCHANGE

Recent expansion of our telecine facilities has made available one Fernseh 35mm Colour Film Scanner Type FC35L 40 for 625 line 50Hz operation. The unit has been used for spot commercial transfer only, is in excellent condition, and includes selected optical and mechanical spare parts.

We are interested in exchanging for a good used Ampex or RCA VTR with colour replay accessories

For further information contact: The Chief Engineer  
VID-COM Limited  
P.O. Box 8859, Auckland, New Zealand

(7027)

## SERVICES

# The catalogue no professional can afford to be without

## Yours FREE from REW!



If you're setting up a mini recording studio, building a P.A. system, or even just looking for a microphone or a reel of tape, this catalogue is an absolute must! It contains the most comprehensive range of Microphones, Mixers, Multi-Channel Tape Recorders, Amplifiers, P.A. Speakers, Echo Units, Equalisers, Noise Reducers, etc.,

from leading manufacturers such as AKG, Amcron, Allen & Heath, Bose, Teac, JBL, HH, Quad, Revox, Tannoy, etc.

**OUR PROFESSIONAL TRADE PRICES ARE THE LOWEST IN THE UK**

Send large SAE for your free copy now to:  
Dept. WW, REW Professional Audio,  
10-12 High Street, Colliers Wood,  
London SW19.

West End Showrooms:  
146 Charing Cross Road,  
London WC2. Tel: 01-240 3064/5.

### SPEECH-PLUS RECORDINGS LTD

Specialists in Recording for Education, Commerce, Industry A/V Programmes / Pulsing for Training and Sales Cassette and Open-reel Duplicating

32 PAGES WALK, LONDON SE1

Telephone: 01-231 0961/2 (6250)

### EURO CIRCUITS

Printed Circuit Boards — Master layouts — Photography — Legend printing — Roller tinning — Gold plating — Flexible films — Conventional fibre glass — No order too large or too small — Fast turnaround on prototypes All or part service available NOW

**EURO CIRCUITS TD.**

Highfield House  
West Kingsdown  
Nr. Sevenoaks, Kent. WK2344

**LABELS, NAMEPLATES, FASCIAS** on aluminium or plastic. Speedy delivery **G.S.M. Graphic Arts Ltd.**, 1-5 Rectory Lane, Guisborough (02873-4443), Yorks, U.K. (13)

## BOOKS

"VINTAGE CRYSTAL SETS, 1922-1927". Just published by Wireless World, contains 128 pages. Chapters on the first days of broadcasting. The Crystal Set. Vintage Wireless Trademarks. Also catalogue sections listing and describing crystal sets together with their original prices in £:s:d. A book for the collector or those interested in nostalgia. Available from main bookshops or direct from us. Please send £2.80 inclusive to IPC Business Press Ltd., Room 11 Dorset House, Stamford Street, London, SE1 9LU. (6125)

## RECEIVERS AND AMPLIFIERS

**HRO** Rx58, etc., AR88, CR100, BRT400 G209, S640, etc., etc., in stock. **R. T. & I. Electronics, Ltd.**, Ashville Old Hall, Ashville Rd., London, E11. Ley 4986. (65)

**SIGNAL** Generators, Oscilloscopes, Output Meters, Wave Voltmeters, Frequency Meters, Multi-range Meters, etc., etc. in stock. **R. T. & I. Electronics, Ltd.**, Ashville Old Hall, Ashville Rd., London, E.11. Ley 4986. (64)



**CAPACITY AVAILABLE**

**ARTICLES WANTED**

**ENAMELLED COPPER WIRE**  
 swg 1 lb. 4oz 2oz  
 14-19 **2.40 .69 .50**  
 20-29 **2.45 .82 .59**  
 30-34 **2.60 .89 .64**  
 35-40 **2.85 1.04 .75**  
 inclusive of p&p and VAT  
 SAE brings Catalogue of copper and  
 resistance wires in all coverings  
**THE SCIENTIFIC WIRE COMPANY**  
 PO Box 30, London E4 9BW (6243)

**AIRTRONICS LTD.**, for Coil Wind-  
 ing — large or small production  
 runs. Also PC Boards Assemblies.  
 Suppliers to P.O., M.O.D., etc. Ex-  
 port enquiries welcomed. 3a  
 Waterland Road, London SE13 7PE.  
 Tel: 01-852 1706. (61)

**PRINTED Circuits.** Ultra fast turn-  
 around. Very competitive prices.  
 Also prototypes, artwork, photo  
 graphy, and drilling service. Kib-  
 more Circuits, 120 Garlands Road,  
 Redhill, Surrey. Phone 68850.  
 (6739)

**SMALL BATCH PRODUCTION**  
 wiring, assembly to sample or  
 drawings. Specialists in printed  
 circuit assembly. Rock Electronics;  
 41 Silver Street, Stansted, Essex.  
 Tel. Stansted (0279) 33018/814006.  
 (19)

**DESIGN AND DEVELOPMENT.** Our  
 Electronics Laboratory work in  
 most fields for customers through-  
 out the world. Including Telecom-  
 munications, RF, TV Links, TX  
 and RXs from 1 MHz to 1 GHz all  
 types of logic, digital and analogue  
 systems. counters microprocessors  
 R.P.Vs, control, telemetry and  
 D.F. Production facilities also  
 available. Write or phone Mr.  
 Falkner, R.C.S. Electronics, 6 Wol-  
 sey Road, Ashford, Middlesex.  
 Ashford 53661. (7021)

**P.C.B. ARTWORK DESIGN** — East  
 Anglia. Fast precise work at com-  
 petitive prices. Also instrument  
 panel designs, etc. Contact tangent  
 Electronics, 136 Whitehall Road,  
 Norwich, Norfolk. Tel (0603)  
 28015.

**PRINTED CIRCUIT BOARDS** —  
 Quick deliveries, competitive prices,  
 quotations on request, roller tin-  
 nings, drilling, etc., speciality small  
 batches, larger quantities available  
 Jamiesons Automatics Ltd, 1-5  
 Westgate, Bridlington, N. Humber-  
 side, for the attention of Mr J.  
 Harrison. Tel: (0262) 4738/77877. (18)

**BATCH Production Wiring and As-**  
 sembly to sample or drawings.  
 McDeane Electricals 19B Station  
 Parade, Ealing Common, London,  
 W.5. Tel: 01-992 8976.

**DESIGN, ARTWORK,** development,  
 test and production of electrical  
 equipment. Powerline Electronics  
 High Street Bognor Regis, Sussex  
 PO21 1EZ. Telephone B.R. 25689.  
 (7062)

**PRECISION TURNED PARTS** — spa-  
 cers, pillars, shafts, etc. Large/  
 small batches. Quotations by re-  
 turn. Send for plant/service ca-  
 pacity specials, no problem. Drury  
 Bros., Unit 6, Hedley Road, St  
 Albans, Herts. Phone: 65094.  
 (6548)

**BUSINESS OPPORTUNITIES**

**EXPORTER** requires high quality  
 turntables, pick-up arms, cart-  
 ridges and amplifiers for own  
 trademark, home and export dis-  
 tribution. Box No. W/W 6774.

★ **MINICOMPUTERS**  
 ★ **PERIPHERALS**  
 ★ **INSTRUMENTATION**

For fastest, best CASH offer, phone

**COMPUTER APPRECIATION**  
 Godstone (088 384) 3221

**WANTED: TEST AND  
 COMMUNICATION**



**EQUIPMENT**

single items or quan-  
 tities, also RF plugs,  
 sockets and connectors.

Call or phone

170 Goldhawj Road, London, W.12  
 01-743 0899 (7006)

**WANTED, all types of communi-  
 cations receivers and test equipment**  
 Details to R. T. & I. Electronics  
 Ltd., Ashville Old Hall, Ashville  
 Rd., London, E.11, Ley 4986. (63)

**SURPLUS COMPONENTS,** Equip-  
 ment and Computer panels wanted  
 for cash. Ring Southampton 772501.  
 (16)

**WE BUY** new valves, transistors  
 and clean new components, large  
 or small quantities, all details,  
 quotations by return. — Walton's,  
 55 Worcester St., Wolverhampton.  
 (62)

**R. F. INDUCTION HEATER** about  
 1.5KW. — Barrett, 1 Mayo Road,  
 Croydon, CRO 2QP. (6038)

**ALL SURPLUS** or used equipment  
 wanted. Radio telephones — com-  
 plete systems purchased. Ships  
 equipment and small boat radio's  
 — components, partly assembled  
 chassis etc., etc. Established 20  
 years. For prompt attention contact  
 Mr Grout at Worthing 34897. GWM  
 Radio Limited 40/42 Portland Road,  
 Worthing, Sussex. (6594)

**WANTED!**

all types of scrap and  
**REDUNDANT  
 ELECTRONIC &  
 COMPUTER  
 MATERIALS**  
 with precious metal content

**TRANSISTORS  
 & PRINTED  
 CIRCUIT BOARDS  
 TO COMPLETE  
 COMPUTERS**

**THE COMMERCIAL  
 SMELTING &  
 REFINING Co. Ltd.**  
 171 FARRINGTON ROAD  
 LONDON, EC1R 3AL  
 Tel: 01-837 1475  
 Cables: COMSMELT. EC1 (7005)  
 Works: FLECKNEY, Nr. LEICESTER

**ELECTRONIC INSTRUMENTATION.**  
 If you are interested in the buying  
 or selling of good quality used  
 electronic test instruments, ring  
 Reading 51074, Martin Associates  
 and converse with our Sheila  
 Hatch, who will deal promptly with  
 your enquiry. (6757)

**WILL BUY ANYTHING,** any quan-  
 tity if price is right ring Stan  
 Willets, West Bromwich, 021 553  
 0186. (6815)

**B-D ELECTRONICS** offer prompt  
 settlement for your surplus com-  
 ponents. Our main field of interest  
 is consumer electronics. Please  
 telephone our Miss Hughes, Peter-  
 borough (0733) 265219. (22)

**WESTREX 10A** pickup cartridge,  
 Goodmans Axion 80 speakers, PX-4,  
 PX-25, STC 4300B valves. Wanted  
 urgently. — Box WW7049.

**CLASSIFIED ADVERTISEMENTS**

**Use this Form for your Sales and Wants**

To "Wireless World" Classified Advertisement Dept., Dorset House, Stamford Street, London, SE1 9LU

PLEASE INSERT THE ADVERTISEMENT INDICATED ON FORM BELOW

- Rate 81p PER LINE Average seven words per line Minimum THREE lines
- Name and address to be included in charge if used in advertisement.
- Box No. Allow two words plus 45p
- Cheques, etc., payable to "Wireless World" and crossed "& Co."

NAME.....

ADDRESS .....

.....

.....

|  |  |  |  |
|--|--|--|--|
|  |  |  |  |
|  |  |  |  |
|  |  |  |  |

REMITTANCE VALUE..... ENCLOSED

PLEASE WRITE IN BLOCK LETTERS. CLASSIFICATION..... NUMBER OF INSERTIONS.....



Available from  
Selected Stockists.  
Write or phone  
for list.

## INCREDIBLE VALUE IN PRECISION TEST METERS

### MICROTEST 80 — I.C.E.

**20,000 OHMS/VOLT 40 RANGES**  
 20,000 ohms/Volt 1,000 ohms/Volt (AC) 2% accuracy  
 V DC 100mV to 1KV (6 Ranges) 1 DC 50 .A to 5A (6 Ranges)  
 V AC 1.5V to 1KV (5 Ranges) 1 AC 250 .A to 2.5A (5 Ranges)  
 Ohms Low ohms ohms  $\times$  1 ohms  $\times$  10 ohms  $\times$  100  
 Power Output Measurements 1.5V to 1000V (5 Ranges)  
 + 6dB to 62dB (5 Ranges)  
 Capacitance 25-F to 25,000 -F (4 Ranges)  
 1000 times overload protection (on OHM ranges)  
 Meter movement diode protection  
 Size (without case) 90  $\times$  70  $\times$  18 mm  
 Electronic zero non-parallel mirror scale. Unbreakable carrying case and probes supplied  
 Full After Sales Service available  
 Price **£14.50**. Post & Packing 60p VAT @ 8% £1.21 SEND TOTAL £16.31

### SUPERTESTER 680R — I.C.E.

**20,000 OHMS/VOLT 80 RANGES**  
 20,000 ohms/Volt 1% D.C. 2% A.C. V DC 100mV to 2KV (13 Ranges) V AC 2 to 2KV (11 Ranges) 1 DC 50 .A to 10A (12 Ranges) 1 AC 250 .A to 5A (10 Ranges) R  $\times$  100  $\times$  1000  $\times$  10,000 and Low ohms Detector Reactance  
 0.10 M ohms Freq. Measurement 0.5000 Hz (2 Ranges) Power Output 10.2000V (9 Ranges) Decibels -24 + 70 dB (10 Ranges) Capacitance 0.500 000 pF (2 Ranges using mains supply) 0.20.000 -F (4 Ranges using internal 3 Volt battery) 1000 times overload protection on ohms ranges, and meter movement diode protection. 10 Fields of Measurement and 80 ranges  
 Size 128  $\times$  95  $\times$  32 mm. Non parallel mirror scale. Unbreakable carrying case supplied which contains probes, mains lead crocodile clips and shorting link  
 Price **£22.50**  
 Post & Packing 85p  
 VAT @ 8% £1.87  
 SEND TOTAL £25.22

The I.C.E. Measurement Systems includes a comprehensive range of accessories: shunts, transformers, specialised probes, transistor tester, etc. Send for full details.  
 "Amperclamp" enables a multimeter to measure a.c. currents in 6 ranges, from 2.5A to 500A!  
 Ideal for use where breaking the circuit to insert an ammeter is impracticable, or where high initial currents are encountered. Versions available for use with other 50  $\mu$ A / 100mV multimeters  
 Price **£13.50**. P&P 60p. VAT £1.13. Total **£15.23**.

Price **£22.50**  
 Post & Packing 85p  
 VAT @ 8% £1.87  
 SEND TOTAL £25.22



Sole Importers  
and Distributors

**ELECTRONIC BROKERS LTD.** 49-53 Pancras Road, London NW1 2PB  
 Tel: 01-837 7781

WW — 114 FOR FURTHER DETAILS

## INDEX TO ADVERTISERS

Appointments Vacant Advertisements appear on pages 123-135

|                                     | PAGE                    |                                   | PAGE         |                                  | PAGE        |
|-------------------------------------|-------------------------|-----------------------------------|--------------|----------------------------------|-------------|
| Acoustical MFG Co. Ltd.             | 5                       | Hall Electronics Ltd.             | 30           | Radford Electronics Ltd.         | 18, 22      |
| AEL Crystals Ltd.                   | 22                      | Harmsworth Townley & Co. Ltd.     | 122          | Radio Component Specialists      | 113         |
| Amateur Components                  | 95                      | Harris Electronics (London) Ltd.  | 10, 14       | Rank Radio International         | 2           |
| Ambit International                 | 24                      | Hart Electronics                  | 117          | R.C.S. Electronics               | 12          |
| Aspen Electronics Ltd.              | 15                      | Hayden Laboratories Ltd.          | 3            | Rola Celestion Ltd.              | 97          |
| Audio Fair                          | 115                     |                                   |              | R.S.T. Valves Ltd.               | 98          |
| Audix Ltd.                          | 96                      |                                   |              | RTVC                             | 90          |
| Avo Ltd.                            | 6, 72                   |                                   |              |                                  |             |
|                                     |                         | Icon Designs                      | 4            | Salford Electrical Insts.        | 21          |
| Barr & Stroud Ltd.                  | 4, 11                   | ILP Electronics Ltd.              | 84           | Scopex Instruments Ltd.          | 96          |
| Barrie Electronics Ltd.             | 91                      | Industrial Tape Applications      | 20           | Service Trading Co.              | 106         |
| Bayliss, A. D. & Sons Ltd.          | 20                      | Integrex Ltd.                     | 92, 93       | Servo & Electronics Sales Ltd.   | 114         |
| Bentley Acoustic Corp. Ltd.         | 107                     |                                   |              | Shure Electronics Ltd.           | Cover iii   |
| Bi-Pak Semiconductors Ltd.          | 100, 101                | KEF Electronics Ltd.              | 83           | Sinclair Instruments Ltd.        | 27          |
| Boss Industrial Mouldings Ltd.      | 24                      | KGM Electronics Ltd.              | 12           | Sintel                           | 109         |
| Brenell Engineering                 | 8                       | Kramer & Co.                      | 120          | SME Ltd.                         | 71          |
| Bull, J.                            | 108                     |                                   |              | Special Products Ltd.            | 18          |
|                                     |                         | Ledon Instruments Ltd.            | 13           | Strumech Engineering Ltd.        | 112         |
| Cambridge Learning                  | 16                      | Levell Electronics Ltd.           | 1            | Stirling Sound (Bi-Pre-Pak Ltd.) | 112         |
| CEC Corporation                     | 21                      | Light Soldering Developments Ltd. | 10           | Sugden, J. E. & Co. Ltd.         | 22          |
| Chiltmead Ltd.                      | 116                     | Limrose Electronics Ltd.          | 11           | Surrey Electronics Ltd.          | 112         |
| Clarbrook Eng. Co. Ltd.             | 120                     | Linstead MFG Co. Ltd.             | 25           | Swanley Electronics Ltd.         | 87          |
| Click Shelving Ltd.                 | 91                      | Lloyd J. J. Instruments Ltd.      | 18           | Swift of Wilmslow                | 87          |
| Cliffpalm Ltd.                      | 15                      | Lyons Instruments                 | 19, 25       |                                  |             |
| Colomor (Electronics) Ltd.          | 102                     | Lynx (Electronics) London Ltd.    | 95           |                                  |             |
| Combined Precision Components Ltd.  | 88, 89                  |                                   |              | Tamba Electronics                | 88          |
| Compcoor Electronics                | 121                     | MacInnes Laboratories Ltd.        | 22           | Technomatic Ltd.                 | 110         |
| Crimson Elektrik                    | 25                      | Mayware Ltd.                      | 107          | Tektronix (Telequipment) Ltd.    | 28          |
| Crofton Electronics Ltd.            | 26                      | McLennan Servo Supplies Ltd.      | 120          | Teleprinter Equipment Ltd.       | 14          |
|                                     |                         | Maplin Electronic Supplies        | 17           | Teleradio Hi Fi                  | 112         |
| Danavox (Gt. Britain) Ltd.          | 7                       | Marconi Instruments Ltd.          | Cover ii     | Television                       | 121         |
| Datong Electronics Ltd.             | 98                      | Marshall, A. & Sons (London) Ltd. | 94           | Telford Communications           | 8           |
| Declon Ltd.                         | 85                      | Maughan, Thos & Associates Ltd.   | 91           | Tempus                           | 26          |
| Dema Electronics International      | 87                      | Multicore Solders Ltd.            | Cover iv     | The All Electric Show            | 25          |
|                                     |                         | Nombrex (1969) Ltd.               | 15           | Time Electronics                 | 107         |
| ECM (Europe) Ltd.                   | 88                      |                                   |              | Trampus Electronics              | 103         |
| Edicron Ltd.                        | 23                      | OMB Electronics                   | 23           | Trident Audio Developments Ltd.  | 86          |
| Electronic Brokers Ltd.             | 109, 114, 118, 119, 136 | Otari Corp.                       | 99           | Tweed Audio Electronics          | 22          |
| Electroplan Ltd.                    | 13                      |                                   |              |                                  |             |
| Electro-Tech Components Ltd.        | 117                     | PADS Electrical                   | 107          | Valradio Ltd.                    | 13          |
| Electrovalue Ltd.                   | 110                     | Patrick, J. B.                    | 122          |                                  |             |
| ES Electronics                      | 120                     | PB Electronics Scotland Ltd.      | 25           | West Hyde Developments Ltd.      | 94          |
|                                     |                         | Phonosonics                       | 86           | Whiteley Electrical Co. Ltd.     | 14          |
| Farnell Instruments Ltd.            | 85                      | Physical & Electronic Labs Ltd.   | 120          | Wilkinson L. (Croydon) Ltd.      | 91          |
| Fitch Tape Mechanisms Ltd.          | 24                      | Powertan Electronics              | 104, 105     | Wilmot Breeden Electronics Ltd.  | 9           |
| Forgestone Colour Developments Ltd. | 26                      | Precision Petite Ltd.             | 26           | Wilmslow Audio                   | 122         |
| Future Film Developments            | 26                      | Purnell                           | Loose insert |                                  |             |
| Fylde Electronic Comps. Ltd.        | 16                      |                                   |              |                                  |             |
|                                     |                         | Q. Max Electronics Ltd.           | 16           | Z. & I. Aero Services Ltd.       | 10, 24, 103 |
| Gardners Transformers               | 6                       | Quality Electronics               | 114          | Zettler (UK) Division            | 12          |
| Greenwood Electronics Ltd.          | 19                      |                                   |              |                                  |             |

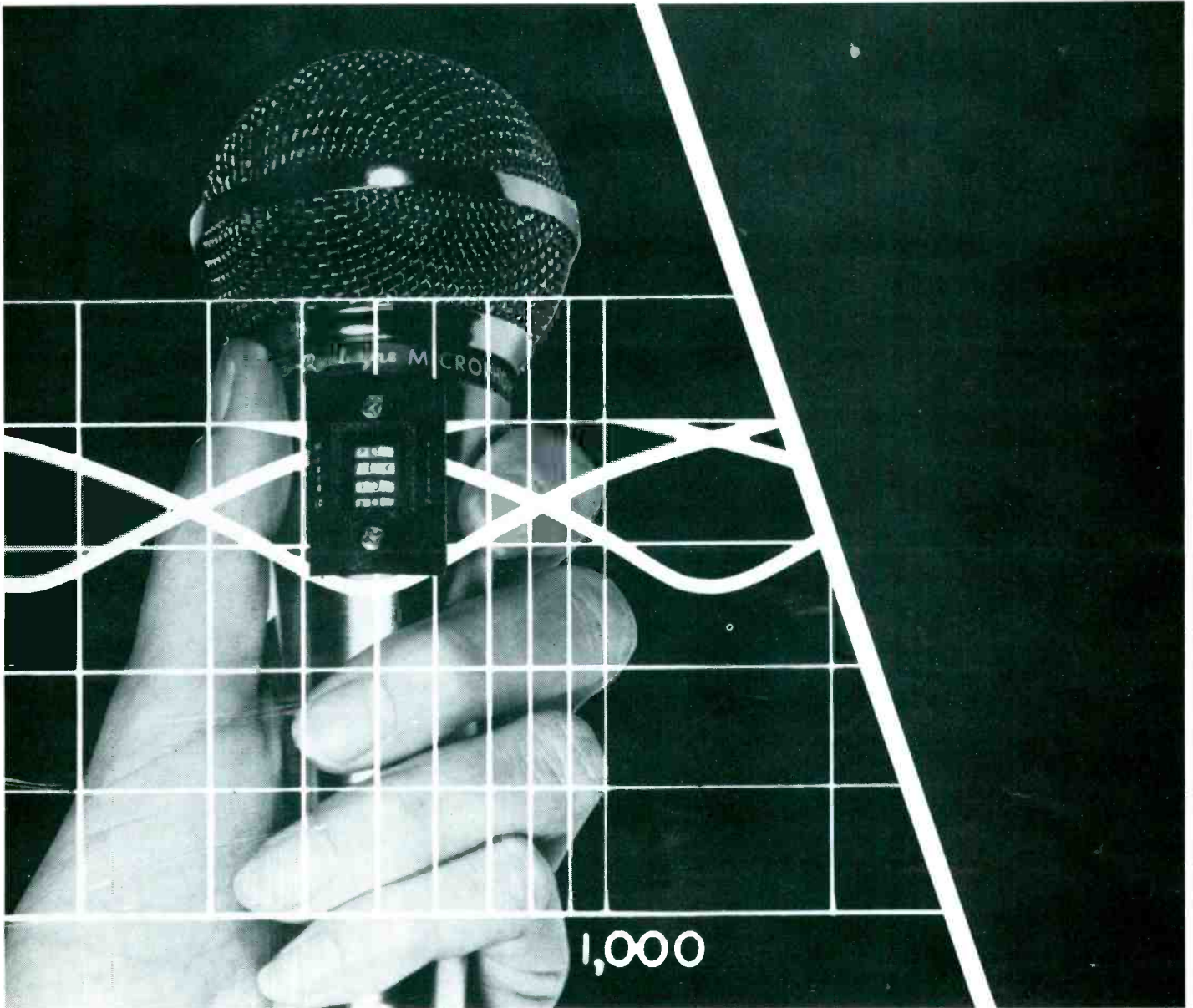

**New!**  
**Anti-Feedback & Equalization**  
**On the microphone!**



Never before has a microphone put such absolute sound control into the palm of your hand. With Shure's new revolutionary PE5EQ E-Qualidyne Microphone, you simply preset any of four frequency switches *on the microphone* to minimize your Number One enemy—feedback. You can also select —on the spot—any one of 16 frequency response variations to tailor your performance to ANY stage: Sweeten the strings . . . enhance the better qualities of your voice . . . or eliminate close-up “boominess.” Ideal where a single type of microphone will be used for different applications in the same act. Only the E-Qualidyne can offer such hand-held versatility. And only Shure has it!

Shure Electronics Limited  
Eccleston Road, Maidstone ME15 6AU  
Telephone: Maidstone (0622) 59881



# Multicore- the complete answer for printed circuit soldering.

Most printed circuit soldering problems can be avoided by using quality products and seeking quality advice. Naturally, we suggest ours. First, let's talk about quality products.

## Extrusol and Multipure.

EXTRUSOL Extruded Bars and MULTI-PURE Cast Bars are made from specially processed ultra high purity solder. EXTRUSOL bars and pellets are protected by plastic film from the moment they are made to the moment they are used. And MULTI-PURE bars are probably the smoothest and brightest solder bars you will ever see.



## Ersin Multicore Savbit.

This cored solder has countless uses. For instance, it avoids erosion of copper plating and wires as well as prolonging the life of soldering iron bits.

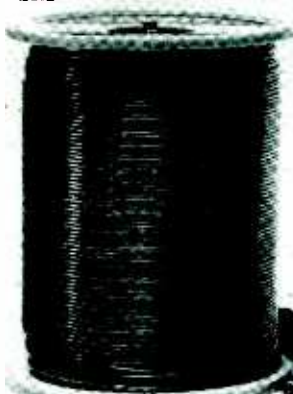

## Liquid Fluxes.

We have a whole family of them, so you're bound to find the right one for your job. One of our latest is PC 26, exceptionally fast but non-corrosive and non-conductive. Eliminates "icicles" and "bridging."

### ROSIN BASE

| ERSIN Flux No.   | Type  |
|------------------|---|
| 0360             | non-activated                                 |
| 5381             | mildly activated<br>Chloride and Bromide free |
| 304D }<br>304W } | mildly activated<br>Halide Free               |
| PC. 21A          | activated                                     |
| PC. 26           | activated (extra fast)                        |
| 366              | activated (extra fast)                        |
| 366A-25          | activated (extra fast)                        |

### ORGANIC ACID

|         |                           |
|---------|---------------------------|
| PC. 101 | water base                |
| PC. 112 | solvent base, fast drying |

### INORGANIC ACID

|      |                                |
|------|--------------------------------|
| ARAX | water base<br>extremely active |
|------|--------------------------------|

Right, those are the products. Now for the advice. And we can't really say any more than: if you've a soldering problem or question, call us. We really do have all the answers and the widest range of problem solving test equipment.

| Solids Content w/w | Specifications   |
|--------------------|--|
| 38%                | MIL-F-14256D Type R; DTD 599A<br>DIN 8527 F-SW 31  |
| 25%                | MIL-F-14256D Type RMA;<br>DTD 599A   |
| 10% }<br>25% }     | DIN 8527 Type F-SW 32<br>DTD 599A  |
| 38%                | DTD 599A; DIN 8527, F-SW 26  |
| 15%                | DTD 599A; DIN 8527, F-SW 26  |
| 38% }<br>25% }     | Meet DIN 8511 Type F-SW 26 and<br>pass DTD 599A Corrosion Test                               |
| 12% }<br>9.5% }    | Water soluble residues must<br>be removed after soldering.                                   |
| 40%                | Used with most "very difficult<br>to solder" metals. Not for<br>electronics assembly joints. |

## Solderability Test Instrument.

Already used by major electronic companies throughout the world, this novel instrument saves production costs by controlling solderability of component leads which, unlike a printed circuit, cannot be assessed by a simple "immersion and inspection" test.

## Multicore Soldering Chemicals.

We make a complete, compatible range to assist in soldering processes. They clean, protect and preserve.

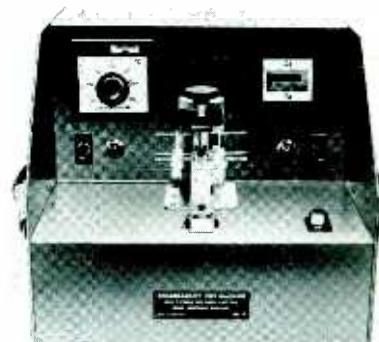

For full information on these or any other Multicore products, please write on your company's letterhead direct to:  
**Multicore Solders Limited**, Maylands Avenue, Hemel Hempstead, Hertfordshire HP2 7EP.  
Tel: Hemel Hempstead 3636. Telex: 82363.