

Wireless World

March 1972 20p

Cassette tape deck survey

Visualizing physical quantities

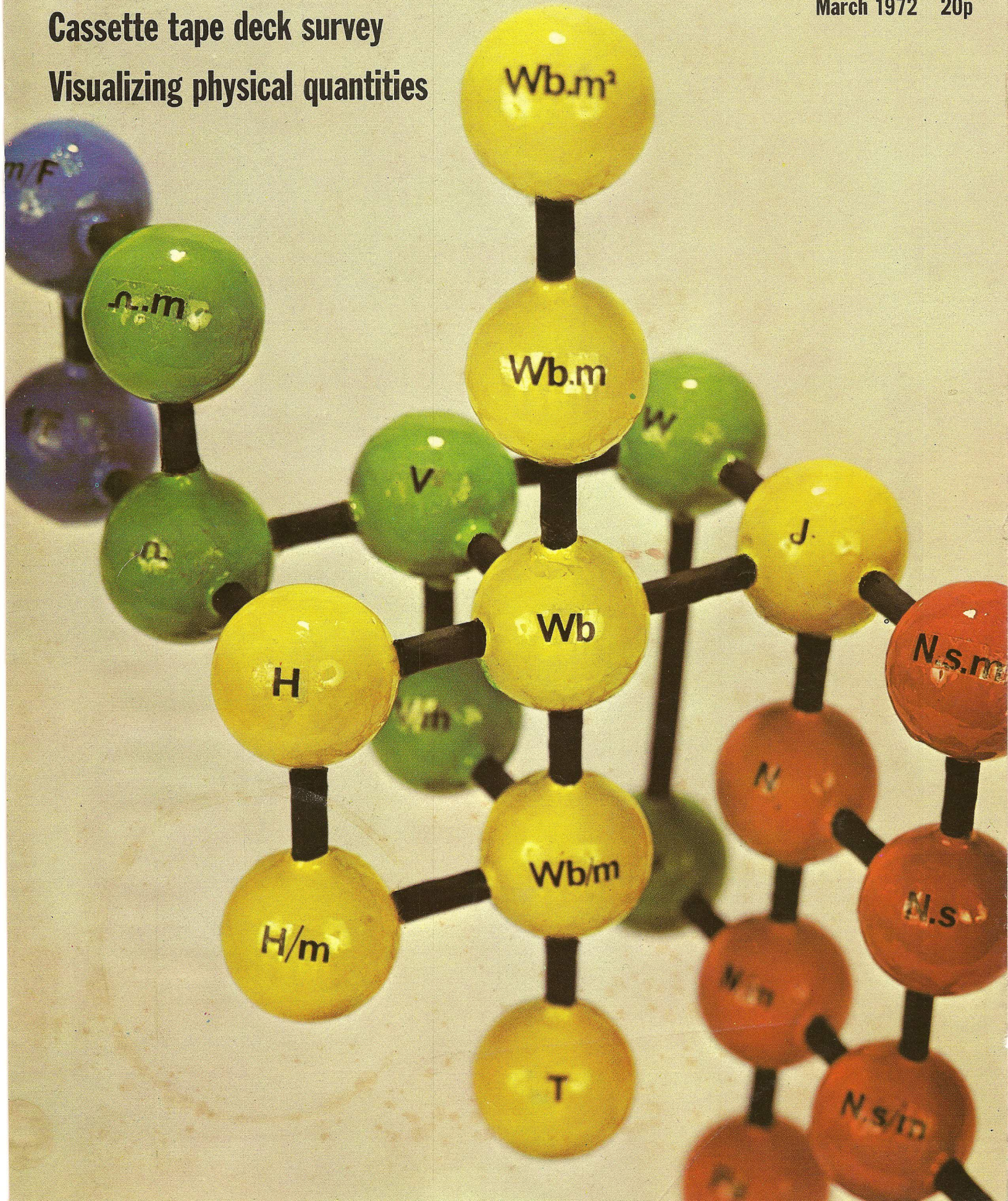

Wireless World

Is the manufacturer always right?

Editor:

H. W. BARNARD

Technical Editor:

T. E. IVALL, M.I.E.R.E.

Deputy Editor:

B. S. CRANK

Assistant Editors:

J. GREENBANK, B.A.

G. B. SHORTER, B.Sc.

Drawing Office:

L. DARRAH

Production:

D. R. BRAY

Advertisements:

G. BENTON ROWELL (*Manager*)

G. J. STICHBURY

A. PETERS (*Classified Advertisements*)

Telephone: 01-928 3333 Ext. 533

It is generally assumed that a company knows what it is doing commercially when it launches a new product. The launch is often accompanied by a blaze of publicity: potential customers are filled with wine and food and exposed to the new Excelsior, the press is alerted and glossy leaflets are spread far and wide. Such is the splendour of the occasion that nobody has the bad taste to ask whether the manufacturer has done his homework. In some cases this has been done, or equivalent results are achieved accidentally; in others the new Excelsior, which was to sweep the market and become an essential item of every lab., factory, home or office, as the case may be, becomes in twelve months' time inconspicuous by its presence in one or two dark corners (the darker the better).

The fact that some companies, including manufacturers of electronic instruments, do not in fact do their commercial homework is brought to light by a recent study by the Science Policy Research Unit of Sussex University, on what makes for commercial success or failure in industrial innovation*. 'Innovation' here does not mean just invention, but 'the total series of events leading from an idea or invention through the processes of research, development, design, production and marketing', to quote Andrew Robertson of the Research Unit.

An interesting feature of the study is that it applied a technique of 'pairing' successful and *unsuccessful* attempts at innovation which had been aimed at the same market. This technique, which involved some 200 'dimensions' relating to 29 pairs, was designed to create a complete 'profile' of an innovation, and to enable 'failure hallmarks' to be discerned in addition to the more commonly sought 'success hallmarks'.

What is surprising about the results, summarized in five statements, is their very obviousness and common sense. Successful innovators 'were seen to have a much better understanding of user needs'; they 'pay much more attention to marketing', do their development work 'more efficiently than failures, but not necessarily more quickly', '... make more effective use of outside technology and scientific advice'. Responsible people in the successful attempts 'are usually more senior and have greater authority than their counterparts who fail'.

If the stated results had been in some way unusual or unexpected it would *not* be surprising that some innovating companies had failed to foresee them. But it *is* surprising that responsible people should ignore, or elect not to be guided by, obvious and commonsensical ideas (even though there was no scientific evidence supporting these ideas). An explanation put forward by one member of the Research Unit is that some companies seem to be infected by an attitude of 'elitism' — we know best what the customer needs; this product must be right for the market just because we are the Big Bug Instrument Company and we are the experts in making Big Bugs. According to this member of the Unit, there are 'powerful forces' in these companies acting against the first three of the results — understanding of user needs, attention to marketing and efficient development. If this is true of certain electronic instrument manufacturers it might also be true of a proportion of manufacturers throughout the electronics industry.

*A short version of a full report on the study, 'Success and failure in industrial innovation', is published by the Centre for the Study of Industrial Innovation, 162 Regent Street, London W1R 6DD, price 75p. See also our leader of August 1971, 'Wasted R & D', which discussed a report 'On the Shelf' published by the Centre.

Tape Noise Reduction

An evaluation of noise problems in sound reproduction and suggested solutions for tape recording

by J. R. Stuart, B.Sc. (Eng), M.Sc., D.I.C.

Each advance in the technology of sound reproduction tends to make greater demands on the remaining components of the system. As microphone, disc-cutting, and amplifier design techniques improved it became clear that the dynamic range offered by a conventional tape recorder was simply not adequate. Any user will have noticed how objectionable tape noise can be on programme sources having large peak-to-mean ratios. On single instruments such as piano, guitar or flute such noise can seriously mar the musical impression.

This article explores the problem of improving the subjective noise performance of a tape recorder, and describes two approaches, one of the compandor type which is loosely related to pilot tone and Dolby systems, and the other a passive system.

Subjective sound quality

The evolution of a noise reduction method relies on an analysis which allows the subjective quality of a system to be predicted.

It is a sad truth that there is no direct way by which subjective quality can be predicted from objective measurement. The impression of quality is the result of an interaction of characteristics which can be individually measured as noise, bandwidth, and distortion.

The author suggests that the quality of sound reproduction can be depicted as a measure of unpleasantness, the measure being the weighted sum of critical parameters. It follows from this approach that for a given system, handling the music and speech waveforms, high quality does not necessarily correspond to a maximum or minimum of any one critical parameter.

Thus, in saying that the conventional tape recorder has gradually become unacceptable it is implied that tape noise has become more and more significant. The objective then is not so much to reduce background noise as to reduce the effect of such noise.

Tape recorder performance

Fig.1 is a conceptual description of the author's impression of the way in which the subjective quality of a recording of a piece of music varies with the mean

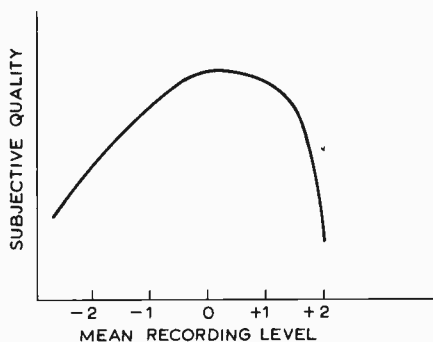

Fig.1. Subjective quality as a function of mean recording level.

recording level in a system of constant dynamic range. Distress is caused at low level by noise and at high levels by the progressive clipping and intermodulation distortion.

The dynamic range of the tape medium is determined by two factors — the maximum recording level set by the curvature of the B-H relationships for the head and tape, and the background noise generated by the random orientations of the granular oxide layer. A halving of

track width will result in at least a 3dB reduction in dynamic range, and for modern tapes and recorders there is a maximum realisable dynamic range which is determined by track width and (because of variations in replay characteristics) by speed.

A good quality half-track recorder can rarely exceed a dynamic range of 60dB at 15 or 7½ i.p.s. and this will reduce to 57dB at 3¾ i.p.s. A quarter track machine will offer 3-4dB less in each case.

In practice even these figures will rarely be achieved, for any residual magnetism in the tape guides and heads or an impure bias waveform will result in increased noise.

So much for conventional recording. †

Performance of the ear

Any process which accepts a recorder of fixed dynamic range and attempts to reduce the apparent noise must rely upon auditory masking phenomena, and this

† Theoretically, by operating at a high tape speed another form of coding could be used. Frequency modulation, for example, could offer improved dynamic range, but only if the wow and flutter were below 0.03%.

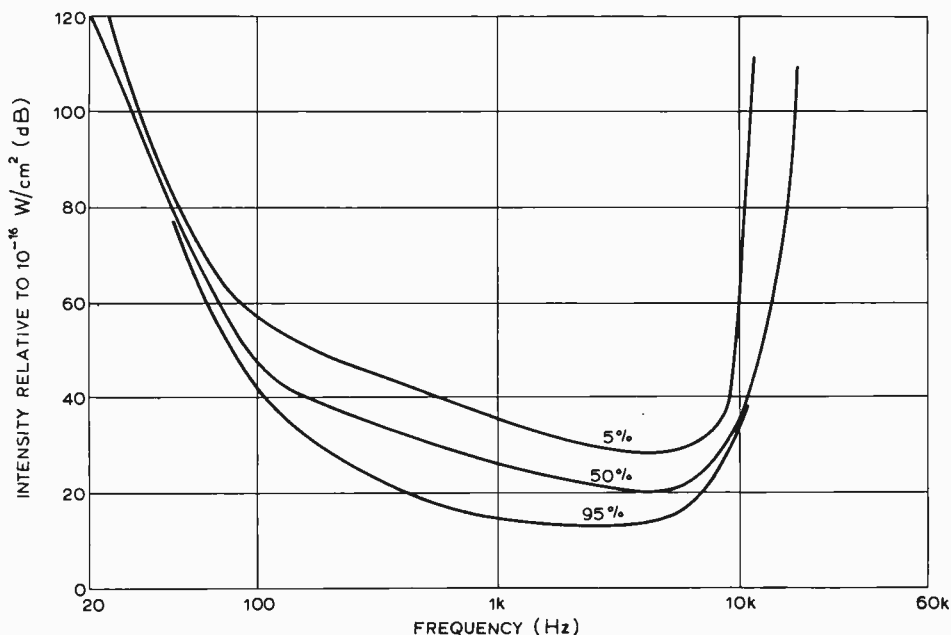

Fig.2. Threshold of hearing for pure tones in domestic surroundings.

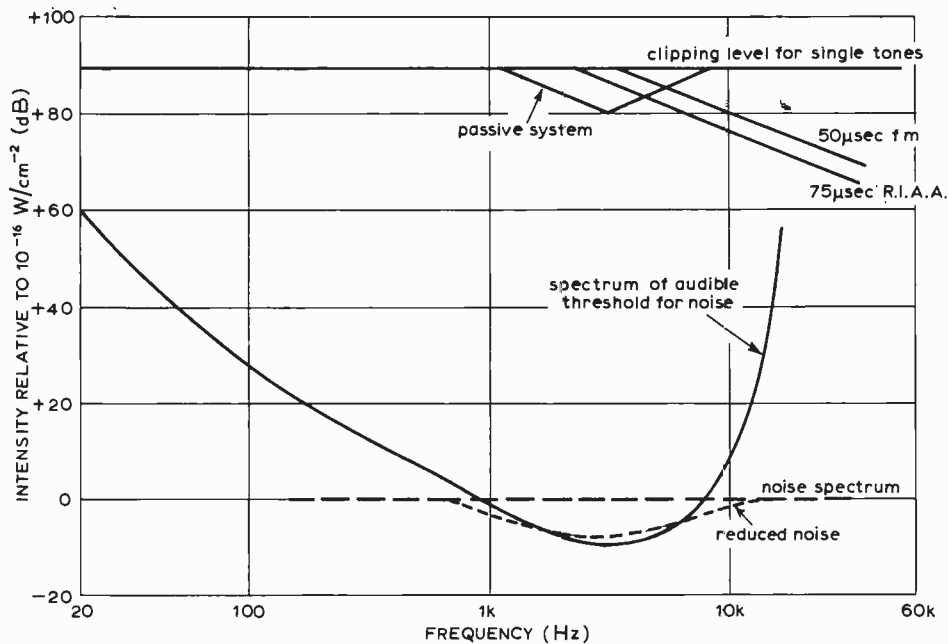

Fig.3. Threshold of hearing for noise in domestic surroundings.

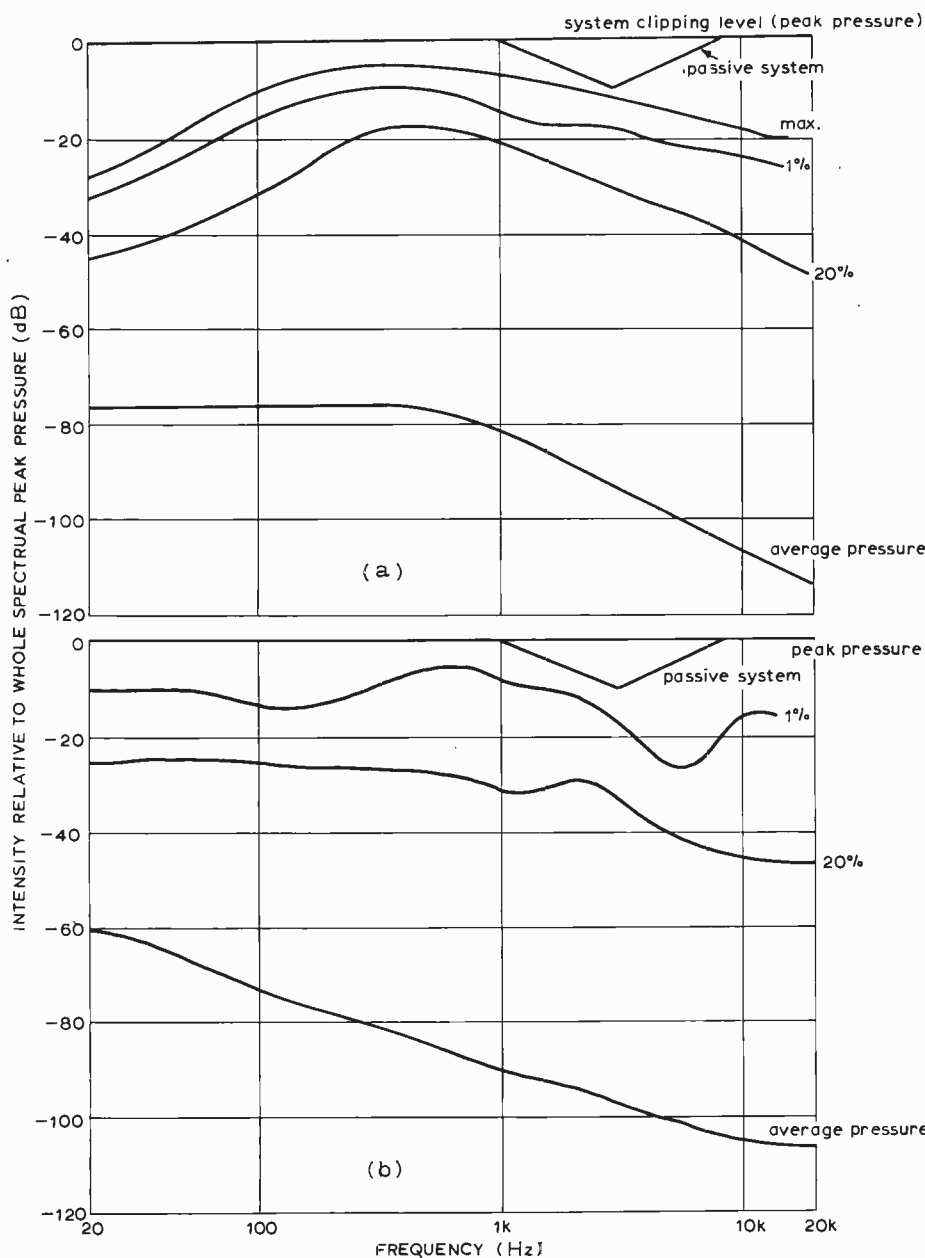

Fig.4. Energy distribution in two extended musical events.

masking can be steady state or of a transient nature.

In a steady-state condition the threshold of hearing is changed by the presence of a tone, the masker, and the threshold of hearing for a second tone of lower intensity is a function of the pitch of the masker and the pitch and loudness of the masker. This phenomenon is dealt with in detail elsewhere.^{1,2}

The presence of a noise distributed in frequency also raises the threshold of hearing for pure tones. For noise of uniform spectral density the threshold at 1kHz will be 20dB above the spectrum level. For example, a system of uniform dynamic range with a signal-to-noise ratio of 60dB and a bandwidth of 20kHz exhibits a noise spectrum 103dB below the clipping level in a 1Hz band. Therefore, although the aggregate noise level is -60dB the hearing threshold at 1 kHz is -80dB.

The distribution of hearing thresholds for sample groups have been examined and the results combined with measurements of room noise in domestic surroundings.¹ Fig. 2 shows the threshold of hearing for pure tones taking account of the masking of room noise giving the mean 5% and 95% "confidence" levels for combinations of rooms and ears. A tone below the lower curve cannot be heard by 95% of the population while only 5% cannot hear tones below the upper curve.

In designing systems for noise reduction the major problem is to decide the audibility of noise in such surroundings. The threshold of hearing for a noise in the presence of noise is taken to be that intensity at which, at any point, the masking levels of the two noises coincide; at this point, the noise will be heard in the frequency band of coincidence. By using the critical bandwidth correction,³ the spectral threshold of noise for acute ears can be calculated. This is shown in Fig. 3. The implication is that noise spectra below this curve are inaudible; below 200Hz and above 6kHz this is due to the hearing mechanism and between 200Hz and 6kHz due to room noise.

The musical signal

Fig. 4 shows the energy distribution of two musical sources.⁴ The average sound pressure is shown with the levels reached for certain percentages of time, and in each case the reference level is the whole spectrum peak pressure.

It will be seen that the energy content of the signal declines rapidly with increasing frequency above 800Hz.

Available data are combined in Fig. 5 to show the expected worst-case probability distribution of energy for a music signal.

Having digressed somewhat to sketch the background to noise reduction we can now return to the main argument.

Approaches to noise reduction

There are two fundamental approaches to signal processing to reduce the effect of noise on replay. These are:

- (1) a method which gives a probability

of lower noise and increased dynamic range, with little risk of overload; and (2) a method which gives a certainty of lower noise with a slightly increased risk of overload, and no change of dynamic range.

A system using compansion, i.e., compression of the dynamic range of the signal while recording accompanied by complementary expansion on replay, requires knowledge of the ear's response to a transient signal, and in particular the phenomena of forward and backward masking, whereby a transient sound obscures other sounds occurring before or just after it. A very important part of the characteristic of a compressor is its response to a sudden input. All compression systems are overloaded to some extent in this condition, and the problem is to minimize the overload-times-duration product while keeping serious intermodulation or clipping within 10ms. The ear has difficulty registering sounds of shorter duration than 5ms, and can tolerate severe interference of less than 1ms.

Type 1 includes companders or coders such as the Dolby⁵, Burwen⁶ and Philips⁷ systems, while type 2 includes those operating by pre-and de-emphasis.

For clarity the types are referred to as active and passive systems respectively, the important distinction being that an active system has characteristics which are controlled by the signal, whereas a passive method is determined and independent of the signal.

Two noise reduction methods are included here — an experimental active circuit and a description of a passive method that is suitable for construction.

Interpretation of active systems

Noise reduction methods which are active only on replay such as the Philips, or the Burwen in one mode, are not considered here, for inevitably they must cause some deterioration of quality.

The Dolby method is essentially a compander, but it operates in a differential mode which is quite new, and instead of reducing the compressor gain at high signal levels as is common, it is raised for low-level signals with certain practical advantages. This system offers up to 10dB reduction of noise and comes in two forms. Type A, for very high-quality recording, processes the whole audio spectrum in four bands and makes use of the masking phenomena described earlier. Type B processors are used in somewhat lower quality applications such as cassettes. Here only signals above 1kHz are compressed and use is made of the characteristics shown in Figs 2 and 3 where the signal above 1kHz contributes some 20% of the energy, yet encounters up to 80% of the mean-squared noise. The energy distribution of a musical signal ensures that when there is a large component above 1kHz, this and the low-frequency component will mask high-frequency noise where it is most audible.

The noise reduction method described

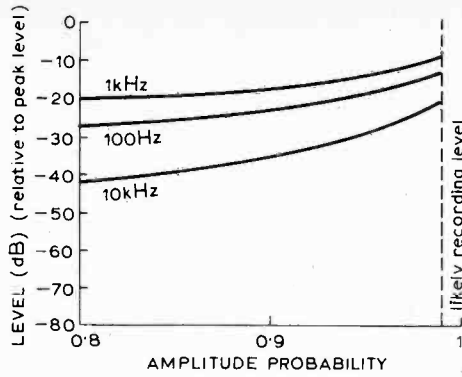

Fig.5. Probability distribution of energy in a musical signal.

here is of the companding type. It does not operate in the differential mode, but has two features which allow its transient performance to be far better than that normally obtained from companders. A major objection to compansion has always been that it suffers from signal and noise modulation or amplifier blocking effects on sudden transients.

A necessary requirement of a compander is that the expansion during replay is exactly complementary to the compression during recording at all levels. This requirement is critical, particularly in stereo where inter-channel inaccuracies of 1dB can cause disturbing movements of the sound field. One method of ensuring that the expander tracks accurately is illustrated in Fig. 6. The level of the pilot tone is either controlled manually, or by the signal. This tone sets the gain of the compressor, and expansion is performed by an identical compressor in the feedback loop of a high-gain amplifier. A pilot tone system of this type was described by Bedford⁸ in 1960, and, rather like f.m. multiplex, the pilot tone was included in the signal and involved a reduction of bandwidth. However, it would be well worth while using such a compressor on a four-track system with two tracks given up to the pilot tone; 20dB of compression would give an improvement in dynamic range of 17dB, over the equivalent half-track recording.

It was mentioned earlier that automatic compression can operate either by reducing the forward gain at high signal level, or by increasing the gain for low signals; the two characteristics are shown in Fig. 7.

Conceptually, there is no difference between the two compressors: in the

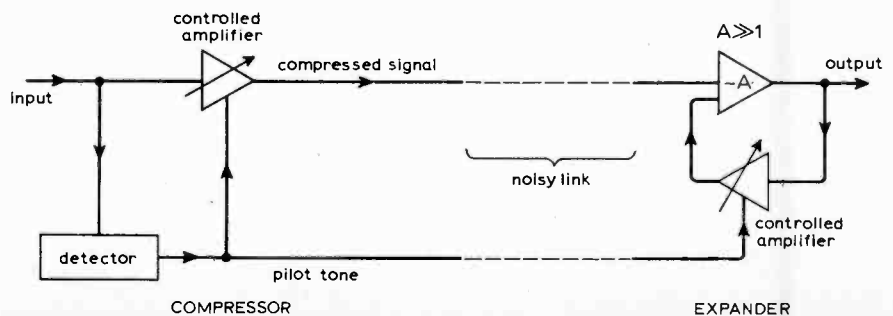

Fig.6. A pilot-tone compression system.

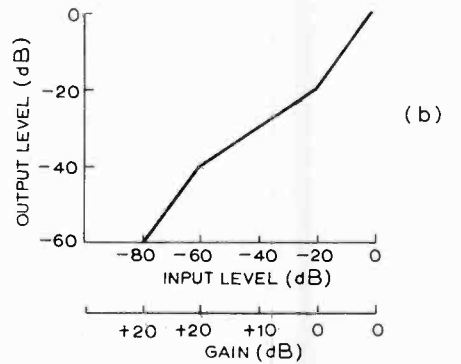
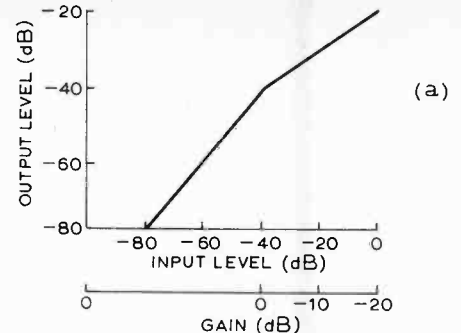

Fig.7. Characteristics of the two types of compressor.

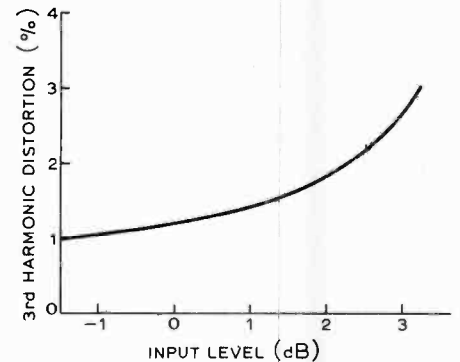

Fig.8. Recorder overload characteristics at 10kHz using BASF LR56 tape.

no-signal condition, both find themselves with values of gain too high to accommodate a sudden input at the maximum level, but in each case the requirement of the signal detector is different.

Consider the behaviour of a circuit described by curve (a) in Fig. 7, when no-signal is followed by a sudden input at the full level. To reduce the gain to

-20dB to accommodate the signal, the detector must recognize the full signal. Time delays are inevitable in this detection and overloading will occur unconditionally. In the circuit described by curve (b) in Fig. 7, however, the detector has only to recognize a signal at -20dB to get the gain to unity, and a well designed detector will achieve this before the maximum level is reached. The result will be a modified envelope attack which is not so readily audible.

Provided that such a compressor is designed with the data on masking described earlier in mind, it is fair to say that such a system will pass high-level signals unaltered in terms of audibility.

The compansion system developed by the author has a characteristic similar to Fig. 7(b) and careful attention to the signal detector has succeeded in eliminating many of the objectionable effects of signal modulation. In view of the experimental nature of the system and the calibration involved, it is recommended that it is undertaken only by experienced constructors with access to a good oscilloscope, voltmeter and signal generator.

An important advantage of a compandor noise-reduction system is that it demands no more of the tape recorder than the original signal in terms of levels and dynamic range, although correct operation is possible only if the frequency amplitude and phase responses of the recorder is correct within certain limits.

Interpretation of the passive system

In a 20kHz bandwidth, a noise of uniform one-sided spectral density P dynes/cm²/Hz exhibits a total noise pressure of P dynes/cm², where

$$p^2 = \int_0^{20,000} p^2 df \quad \text{i.e. } P = 100\sqrt{2} \cdot p$$

Thus the spectral pressure for a noise of uniform density is 43dB below the total noise pressure, and for a good tape recorder with a signal-to-noise ratio of 57dB the noise spectrum pressure will be 100dB below the clipping level.

In a life-like replay situation with sound pressures reaching a maximum of 85 phons in the band 300-800Hz the clipping level should be set to 90 phons in the whole band, and thus a uniform noise spectrum with a loudness of 33dB will have a density of -10dB/Hz where 0dB = 0 phons at 1kHz. This spectrum can be compared with the spectrum of audible

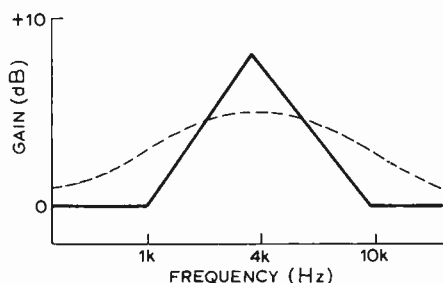

Fig.9. Asymptotes of the passive recording characteristic.

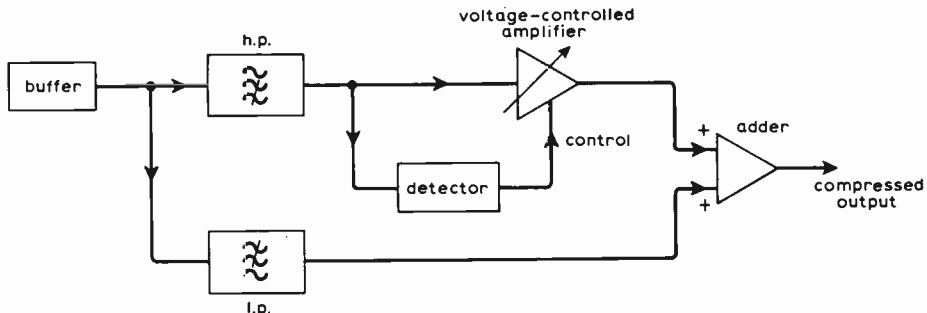

Fig.10. Block diagram of the compressor.

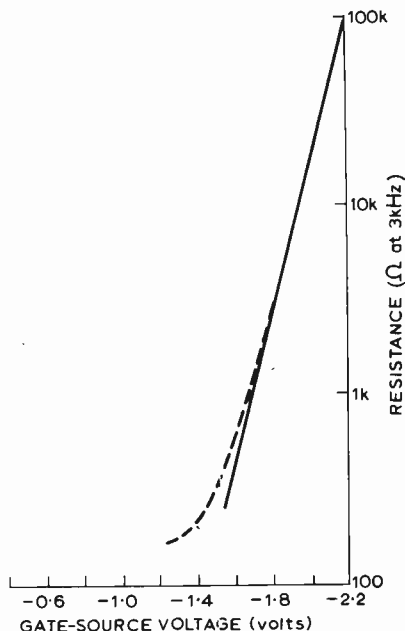

Fig.11. Measurements on a BF244B f.e.t.

noise shown in Fig. 3 by making a correction for the directional properties of a conventional stereo system.

The spectrum of acceptable noise is calculated on a monochotic basis. The effect of concentrating noise in a spatial sector is to emphasize its effect by a factor of about 10dB with the listener 6ft from each loudspeaker.

In terms of audibility, therefore, the uniform noise spectrum described above will compare with a noise spectral pressure 90dB below the whole spectrum peak pressure, that is, at a loudness level of 0 phons. Fig. 3 shows this spectrum.

It is immediately clear that noise between 1 and 8kHz only should be significantly audible. This corresponds well with experience. Tape exhibits a nearly uniform noise spectrum pressure; there is a slight rise at high and low frequencies but this rise does not approach the cut-off rate of audibility shown in Fig. 3. In the conditions described tape noise is familiar, predominantly as a high-frequency hiss with a staccato quality.

We have therefore established that in a tape recorder of reasonable quality the significantly audible tape noise is in the band 1 to 8kHz. It is highly objectionable around 4kHz.

Methods of pre- and de-emphasis have utilized the fact that the energy content of a musical signal declines rapidly above

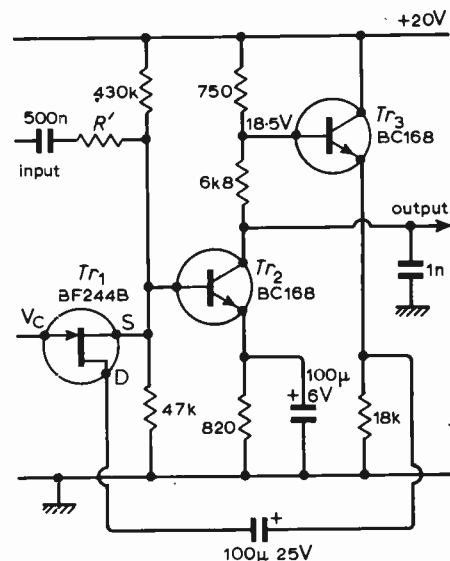

Fig.12. Gain-controlled amplifier. R' is set for unity gain ($\approx 120k\Omega$).

1kHz, and that in this band not only is the maximum noise energy contained, but also that which is most readily audible. There are in common use two methods of pre- and de-emphasis for noise reduction; these are the $50\mu s$ characteristic of f.m. and the $75\mu s$ section of the R.I.A.A. curve.

In each case pre-emphasis (above 2kHz and 1.5kHz respectively) before applying the signal to the medium allows de-emphasis on reproduction to reduce the system noise in the critical band while not exceeding the maximum input level of the medium at high frequencies. The two characteristics do not change the dynamic range of the medium, but simply move the absolute levels with respect to low frequencies. The input levels for these characteristics are shown in Fig. 3.

The rationality of tape noise reduction based on a pre- and de-emphasis is made clear by studying Fig. 4. The idea of setting a maximum recording level is to accept intuitively a probability of overload, which is low.

It would be expected from the notion of quality depicted in Fig. 1 that in a low distortion medium the recording quality would be maximized when the signal spectrum was adjusted to give equal amplitude probabilities at all frequencies, and this is the basis of the R.I.A.A. and f.m. systems.

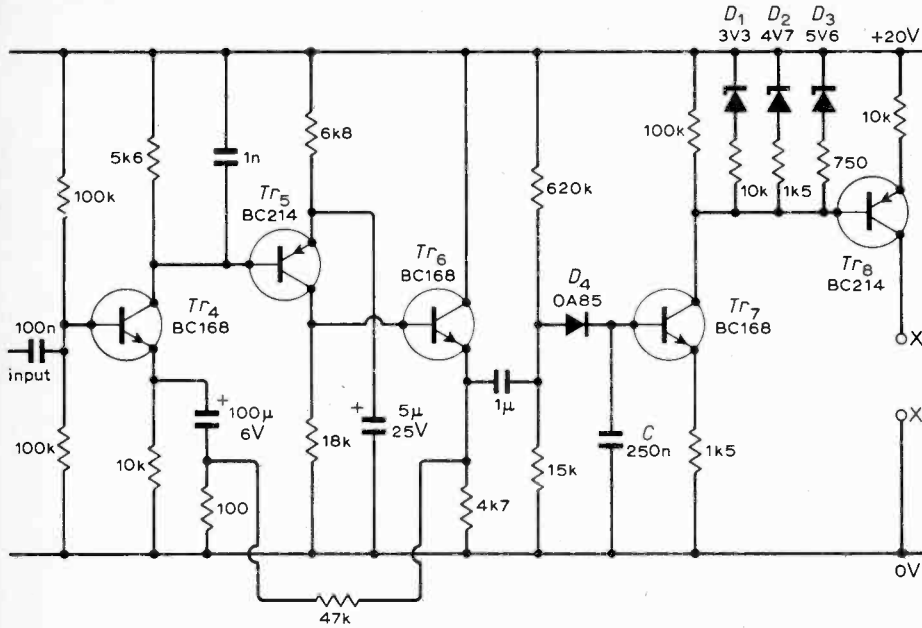

Fig.13. Circuit of logarithmic detector.

However, the tape recorder head/tape relationship shows rising harmonic distortion at high frequencies and the overload characteristics of the author's tape recorder⁹ are shown in Fig. 8. Additionally, in any recorder, intermodulation distortion at extreme frequencies can be quite objectionable towards the maximum level. In many cassette recorders this distortion can be objectionable well below this.

A noise reduction method was evolved, therefore, which used the data on critical noise, musical spectral energy and the model of quality, bearing in mind also the intermodulation distortion characteristics of tape recorders.

The recording characteristic is shown in Fig. 9. Noise is reduced only in the band 1-10kHz with a maximum reduction of 7dB around 4kHz. In this way the important noise is effectively removed from audibility, while not causing extra distress due to distortion. Signals above 10kHz and below 1kHz remain unchanged, and there is good argument for actually enhancing noise above 10kHz in some poorer recorders.[†]

Although this noise reduction method offers an absolute reduction of only 6dB the subjective improvement based on Fig. 3 is about 12dB.

An active noise reduction method

As an illustration of the general method of compansion an experimental system was built which operates by compressing the dynamic range of the signal above 1.7kHz on record. In fact to perform significantly better than the passive system it would be necessary to use three or four frequency-selective compressors rather like the Dolby A system.

[†]In the author's experience intermodulation distortion is a serious drawback of cassette recorders and such noise enhancement could improve the recorded quality while not detracting from the subjective noise performance.

A block diagram is shown in Fig. 10; signals below 1.7kHz pass unaltered in amplitude while the compression above this frequency is controlled by a detector and may be up to 20dB. The maximum reduction in noise is 10dB.

As the control elements in the compressor depend on the absolute signal level it is necessary to calibrate the recorder, tape and processing unit to ensure that the levels are matched. The circuits are described below.

Gain controlled amplifier. A method of speedy gain control will employ the variation of a device impedance with bias condition, and a diode or f.e.t. could be used as the control element.

This design employs an f.e.t. The Texas Instruments type BF244B was chosen for its narrow spread of characteristics and low pinch-off voltage, and Fig. 11 shows measurements made of dynamic impedance on a typical sample.

As an f.e.t. is a square-law device, any signal appearing across it is subjected to 2nd harmonic distortion and investigation showed that this distortion was 0.1% and

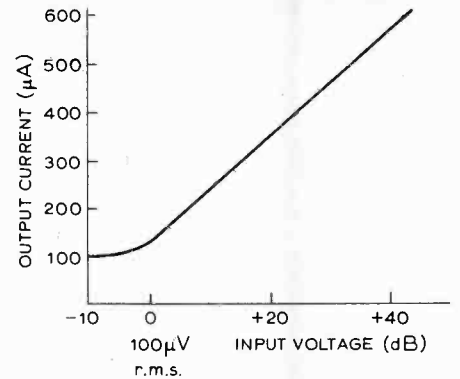

Fig.14. Response of the detector.

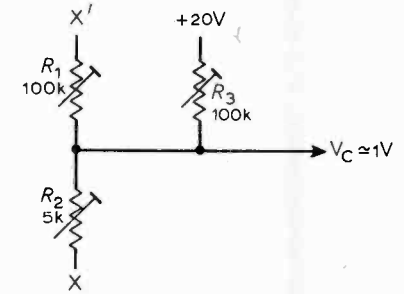

Fig.15. The derivation of V_c . R_1 ensures saturation of Tr_3 at -20 dB input. R_2 sets sensitivity, R_3 sets offset, and can be replaced by an adjustable current source. The f.e.t. g-s junction must be reverse biased.

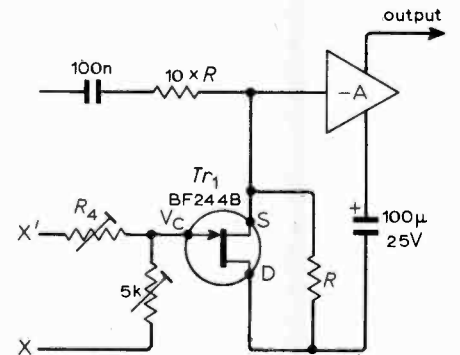

Fig.16. An alternative control arrangement. R_4 is adjusted to cause the f.e.t. g-s junction to be reverse biased by 100mV when Tr_3 saturates.

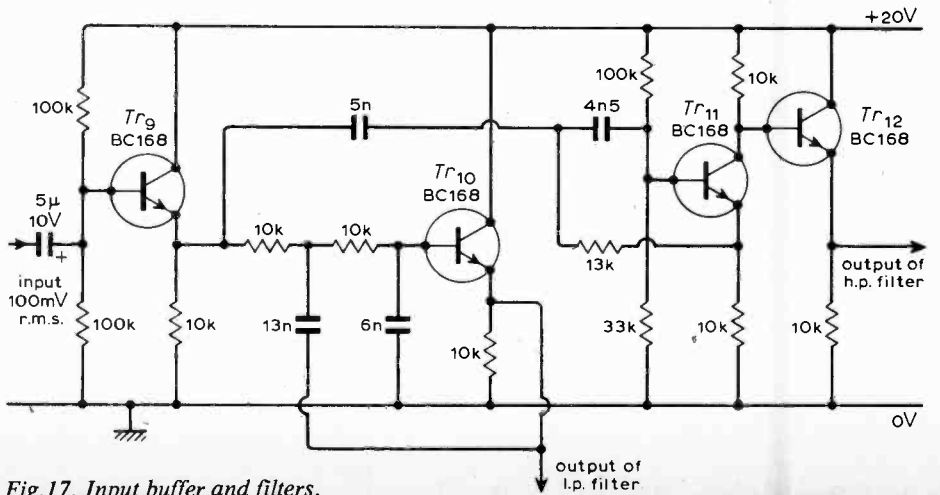

Fig.17. Input buffer and filters.

1% at 10mV and 25mV levels respectively. A 10mV level was chosen, particularly as the higher orders of harmonics were below 0.01%.

The circuit diagram of the gain-controlled amplifier is shown in Fig. 12. The amplifier handles a 0dB level of 100mV while the gain-control device operates at 10mV; this allows a better noise performance in the unit. The forward gain of the amplifier is high, so the signal appearing on the transistor source is very small, and the control voltage is not significantly modulated.

Logarithmic detector. It will be noted in Fig. 11 that over a large range the impedance of the f.e.t. is an exponential function of the control voltage, and therefore the detector should have a logarithmic response over the range -60dB to -20dB i.e. 100μV to 10mV input.

Such a detector is shown in Fig. 13; and the response in Fig. 14. The output shown is the collector current of Tr_8 .

In an ideal channel with linear frequency, phase, and amplitude responses the detector should respond to the signal envelope, or peak value. In a practical situation the tape recorder will have a less than ideal response, and phase variations can give an entirely different envelope on replay. For this reason the detector is often arranged to interpret a combination of both peak and r.m.s. values.

The signal envelope is measured on positive peaks. Its performance is satisfactory, although a more complex system along the lines indicated could give even better results with rather poor tape recorders.

This particular circuit configuration was chosen because its performance is predictable.

It was mentioned earlier that the temporal response of the detector was important if the action of the compressor was to be effectively masked. The circuit response time depends upon the difference between successive peaks — the larger the change in amplitude, the faster the response. The minimum rise time is determined by C , the output impedance of Tr_6 and the intrinsic resistance of D_4 . Decay is controlled by capacitor C and the input impedance of Tr_7 .

The values shown seem to be satisfactory, but there is plenty of room for experiment.

Having achieved a control current with the correct steady state and transient characteristics, the network of Fig. 15 is used to generate the control voltage, V_c . Potentiometers $R_{1,2}$ allow this voltage to be calibrated for any f.e.t. and R_2 ensures the required variation of V_c over the input range to reduce the gain to unity at a signal level of -20dB. So that the gain does not fall below unity at higher levels of input R_1 is arranged to saturate Tr_8 at an input of -20dB. In addition the detector driver amplifier clips symmetrically at an input of 10mV.

Standardization requires consistency

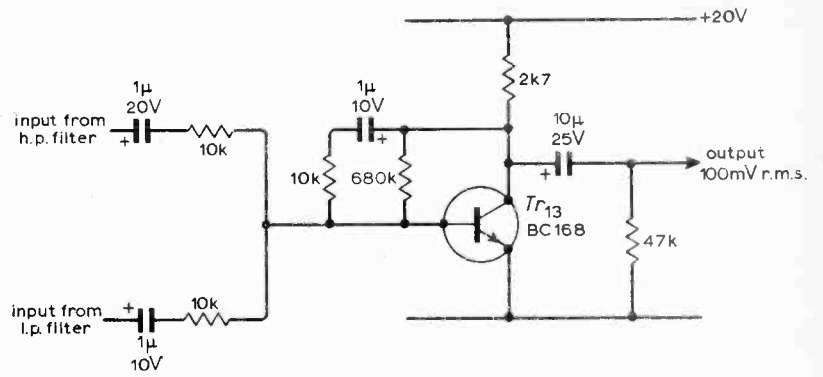

Fig. 18. Adding amplifier.

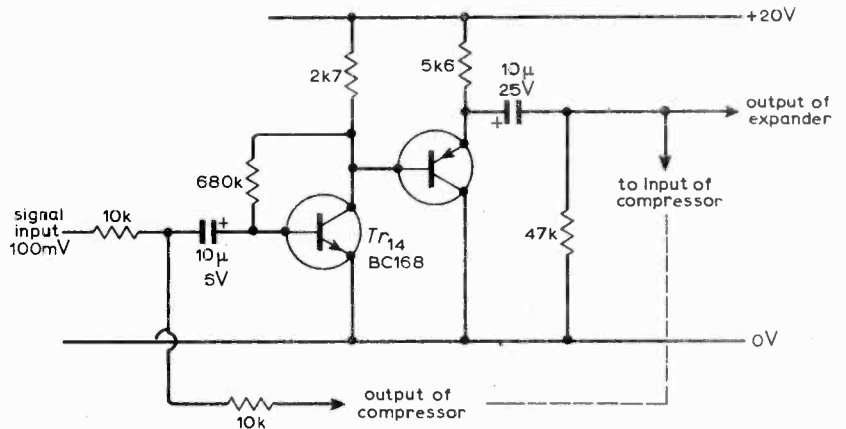

Fig. 19. Arrangement for expansion.

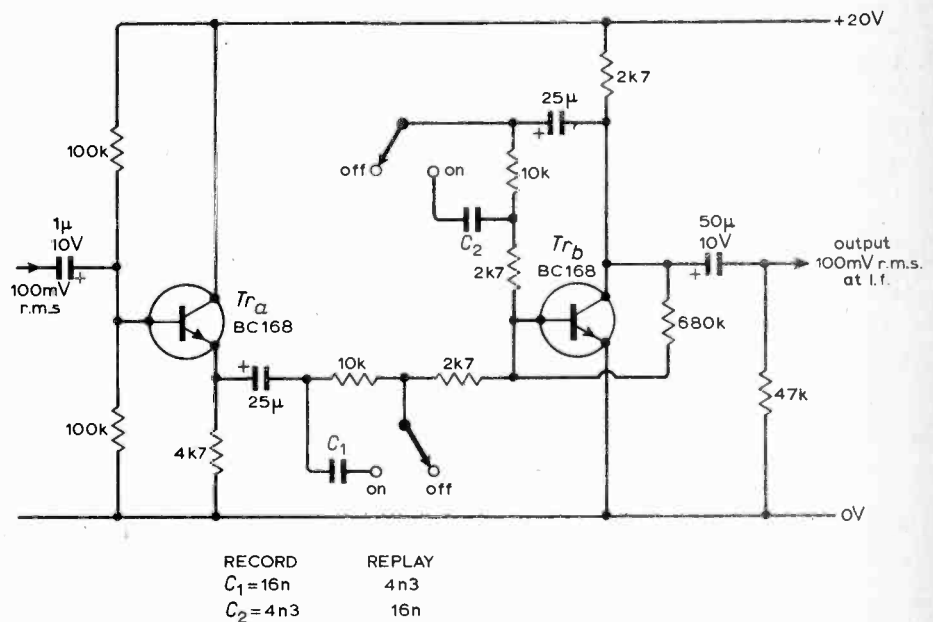

Fig. 20. Circuit for the passive system.

(if not linearity) of this gain although of course a linear gain/input function is an obvious choice. For correct operation, the actual law is unimportant so long as

$$\frac{\delta G}{\delta S} < \text{to avoid ambiguity.}$$

Here G is the controlled circuit gain and S the signal level measured in dB.

By accepting a non-linear control, calibration can be simplified as indicated in Fig. 16. The maximum value of gain is set by R which has a value of $10 \times$

R_{dss} this being chosen on calibration as a potentiometer would introduce too much noise.

Filters and summing. To complete the compressor, filters and a summing amplifier are needed. Fig. 17 shows active high- and low-pass filters with a -3dB point at 1.75kHz. The circuit of the adder is given in Fig. 18.

Expansion. On replay, expansion is achieved by using the compressor of Fig. 11 as the feedback element of a

high-gain amplifier. A suitable amplifier is shown in Fig. 19, and stability was not as serious a problem as was expected. To achieve the potential capability of a multi-band compandor, several filters with cut-off rates not less than 18dB/octave would be required.

A passive noise reduction system

Fig. 20 is the complete passive circuit. The emitter-follower stage (Tr_d) ensures that the equalizing amplifier (Tr_b) is fed from a low impedance source. If a signal is available at a low impedance level, this stage is unnecessary.

When used with the author's tape recorder the recording circuit of Fig. 20 is followed by the gain control with an input sensitivity of 100mV r.m.s.

Conclusions

In this study a new approach to the evaluation of audio equipment has been outlined and used. It should be appreciated that this simple description of the way in which system quality is determined has led directly to the passive circuit. Both circuits described are suitable for use with any good recorder, although the passive system may not be so useful in a low-quality recorder with a natural tendency to high-frequency overload. In particular, signals with large amplitude in the 4kHz region will be more likely to cause overload; for example a close recording of brass instruments could cause distortion. Nevertheless, on a good-quality machine third harmonic distortion should not exceed 10%, which compares very favourably with disc distortion under the same conditions.

In view of its extremely low cost the passive method is a very attractive approach to noise reduction. In use, the impression gained on a stereo system is that the 'hard' noise disappears from between the loudspeakers and one becomes conscious of a hint of much quieter low-frequency noise which appears to be more outside the sound field, and to blend with the ambient noise in the room.

References

1. 'Speech and hearing in communication', Harvey Fletcher, Van Nostrand 1953, Chapter 10.
2. 'High quality sound reproduction', James Moir, Chapman & Hall 1960, Chapter 2.
3. 'Transistor audio amplifiers' P. Tharma, Butterworth & Co. 1971, p173.
4. 'Absolute amplitudes and spectra of certain musical instruments and orchestras' Sixian, Dunn and White. *J.Acou. Soc. Amer.* Vol.2, No.1.
5. 'An audio noise reduction system', R. M. Dolby, *J.Audio Eng. Soc.*, Vol.15, p.383. 1967.
6. 'A dynamic noise filter', R. S. Burwen, *J. Audio Eng. Soc.* Vol.19, No.2, p.115 et seq.
7. 'London Audio Fair', *Wireless World*, Dec. 1971.
8. 'Improving the dynamic range of a tape recorder', L. H. Bedford, *Wireless World* March 1960, p.104 et seq.
9. 'High-quality tape recorder' J. R. Stuart, *Wireless World* Nov. and Dec. 1970, Jan. 1971.

Announcements

The Electronics Division of the I.E.E. is organizing a **vacation school** on lasers and optical electronics to be held at the University of Southampton from 10th-22nd September. Details are available from the Divisional Secretary, LS(S), Institution of Electrical Engineers, Savoy Place, London WC2R OBL.

A course of six lectures on **integrated circuit systems** will be held at Norwood Technical College each Tuesday evenings commencing 18th April. Details from the Senior Administrative Office, Norwood Technical College, Knight's Hill, London SE27 OTX. Fee £2.

The I.E.E.T.E. **residential study course** will take place at the University of Sheffield (26th-29th March) and is for those concerned with manpower recruitment and selection in all branches of engineering. Details are available from The Conference Secretary, I.E.E.T.E., 2 Savoy Hill, London WC2R OBS.

Grundig (Great Britain) Ltd has organized an **Amateur Tape Recording Contest** to be run until 31st March on eight B.B.C. Local Radio stations; Birmingham, Derby, Leeds, Leicester, Manchester, Medway, Oxford and Stoke-on-Trent from whom details are obtainable. The contest is being run in co-operation with the organizers of the British Amateur Tape Recording Contest.

The British Standards Institution is to hold a one-day crash **'Standards Course'** at Hampden House, 61 Green Street, London W1A 2BS, on 10th March, to give an insight into all B.S.I. activities.

A **synchronizer** has been produced by Marconi Instruments Ltd, as an accessory for the Marconi Instruments TF2002AS signal generator to obtain high frequency stability in two to three minutes.

Electronic Heat Co, 352 Lower Addiscombe Road, Shirley, Croydon CRO 7AF, offer a service for the **repair of high-power thermionic valves** used in communication and industrial applications.

Ministry approval. The HRO-600 v.l.f.-h.f. full-coverage receiver from the National Radio Company, has been given the approval of the U.K. Ministry of Post and Telecommunications as a "main and/or single sideband ships' receiver". The HRO-600 is said to be the first U.S. designed and manufactured equipment to be so qualified.

Plessey Avionics and Communications has been awarded a contract valued at over £1M by the Ministry of Defence for production quantities of u.h.f./v.h.f. shipborne **multi-channel communications equipment**.

The Marconi International Marine Co. Ltd, is to equip six new cargo ships with main **communications equipment** based on a 1.4kW Crusader s.s.b. transmitter and a Nebula single-sideband general purpose receiver.

A new £9M division, **EMI Sound & Vision Equipment**, has been formed by the EMI group to increase their share of the growing international market for sound and vision systems, and related products and services for industry, commerce, education, broadcasting and entertainment.

A comprehensive service is now provided by Coutant Electronics, 3 Trafford Road, Reading RG1 8JR, for the design, manufacture and encapsulation of custom-built **thick-film microcircuits**.

As from March 1st, two companies in the General Instrument U.K. group, **Hivac Ltd** and **Vitality Bulbs Ltd**, will be integrated to form one company called Vitality Ltd.

An agreement has just been signed under which Impectron Ltd, Impectron House, 23-31 King Street, London W.3, will market **Schrack products** in the U.K. The range of products includes general purpose, plug-in and very sensitive relays.

Allied International Co. Ltd, 59 Union Street, London SE1 1SQ, will market and service in the U.K. the entire range of **Esterline-Angus recorders** and other products due to a marketing tie-up with the Esterline Corporation of Indianapolis.

Cole Electronics Ltd, Lansdowne Rd, Croydon CR9 2HB, have been appointed agents for the range of tape cleaning equipment manufactured by **Virginia Panel Corporation**, of Waynesboro, Virginia.

Claude Lyons Ltd, Hoddesdon, Herts, have been appointed U.K. distributors for **Hutson Industries Inc**, of Dallas, Texas, manufacturers of Triacs and s.c.r.s.

Hellermann Electronic Components, East Grinstead, Sussex, have announced an agreement with **Kings Electronics Co. Inc.**, of Tuckahoe, New York, for the marketing of the American company's range of coaxial and filmware connectors, switches and tools.

Egen Electric Ltd, Charfleet Industrial Estate, Canvey Island, Essex, have been appointed sole U.K. agents for **Beyschlag GMBH**, of West Germany, manufacturers of carbon and metal film resistors.

Lyons Instruments Ltd, Hoddesdon, Herts, have been appointed U.K. representatives for **BAFCO Inc**, of Warminster, Pennsylvania, manufacturers of automatic Fourier analysis frequency response analysers.

Amalgamated Wireless (Australasia) Ltd, have appointed Marconi Instruments Ltd, as distributor in the U.K. for the sale and service of their telecommunications test instruments.

Computer Instrumentation Ltd, School Lane, Chandlers Ford, Eastleigh, Hants, can supply, in the U.K., the range of conversion and analogue modules manufactured by Zeltex Inc, of Concord, California.

Marconi Space and Defence Systems has reached agreement with **AMF Inc**, of America, to market their range of underwater acoustic systems in Britain.

Corrections

Current-limited power supply (February p.67). Several errors originating in the author's text and also typographical errors have come to light. (a) Pins 4 and 5 of IC_1 and IC_2 in Fig. 2 should be reversed. (b) Fig. 5 should have a hole for R_3 , 1.6cm from the left-hand side of the p.c. board on the conductor coming from pin 1 of the edge connector. (c) In Fig. 7 C_6 should be labelled C_5 and S_{2a} on the negative meter terminal should be labelled S_{3b} (d) In the component list C_4 should be $32\mu/10V$ and ' C_9 $64\mu/10V$ ' inserted. Also C_5 and R_{11} should be asterisked and for ' S_{3a} must ... C_7 ' read ' S_{3b} ... C_6 '.

In the article 'F.E.T. Tester' in the December 1971 issue the first line of the equations at the bottom of page 575 should read: Let $R_L < < R_G V_p$.

News of the Month

Propagation study for 10-100GHz

The Post Office research department and the Radio and Space Research Station are co-operating in the most comprehensive microwave propagation study yet mounted. Necessitated because existing Post Office links working at 2, 4 and 6GHz are approaching congestion, the study is aimed at relating weather effects on propagation between 10 and 100GHz to system economics. The main effect, signal attenuation due to water droplets, is worsened at these frequencies because droplet size is comparable with wavelength, resulting in greater loss of transmission through scattering and absorption. A secondary effect of precipitation is rotation of the plane of polarization — due to droplets being oblate spheroids — which is important as future relay systems may ultimately need orthogonal polarizations on the same frequency. Another effect, fading due to multipath propagation, occurs when refractive index varies rapidly with altitude. Such stratification can occur under stable weather conditions in clear air, especially at night. The study, therefore sets out to:—

- find the “diversity” spacing required in providing alternative transmission paths
- help decide the “hop” spacing by obtaining further data relating rainfall intensity with signal attenuation
- find effect of rainfall and refractive index variations on crossed-polarization performance
- investigate multipath transmission characteristics.

To provide statistical data for these experiments, tests are being carried out at frequencies of about 11, 20 and 37GHz on a rectangular network of paths in East Anglia. The network has been arranged to enable the effect of extending path lengths from 4 to 8 and 12km to be determined at the various frequencies and also the effect of increasing parallel spacing from 4 to 12km. As well, 40 telemetry-linked rain gauges are distributed at intervals of 400 and 800m over two of the paths. Weather radars, operating at 3 and 10GHz, will provide p.p.i. of the location and approximate intensity of rainfall in the area.

In parallel with this work in Suffolk, related studies are in progress at R.S.R.S.

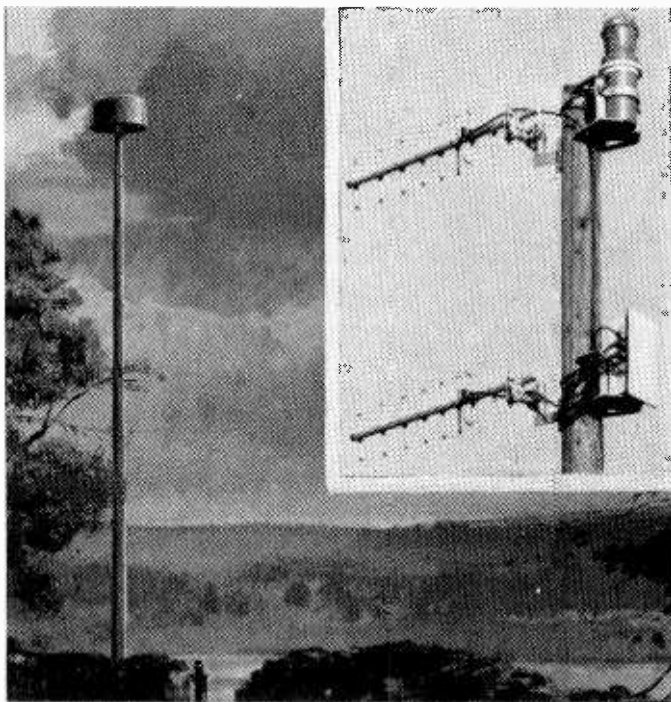

A microwave station of the future might look something like the illustration on the left. The masthead canopy (about 24m high) would contain all the electronic equipment and the two dish aerials and would be lowered to the ground for servicing using a winch. The inset shows a rainfall measuring apparatus and telemetry equipment which is being installed at 40 sites by the Post Office along the experimental microwave links.

A 36-GHz link 500-m long, using a smaller rain-gauge spacing than other workers, has provided good agreement between measured attenuation and that calculated from rainfall data, but further measurements are needed, both at 36GHz and at other frequencies. A 100-GHz link, set up in 1970 over the 2.7km between Windsor and R.S.R.S., has shown that even at 110GHz serious fading would probably be experienced for only a few tens of minutes per year.

Work so far has led to effort being concentrated on two specific systems for the immediate future. One is an 11-GHz digital (p.c.m.) system operating at 100Mbit/s and intended for 30km hops. The links will be suitable for use at existing stations in the U.K. (A similar, but analogue, link is in use between Plymouth and Caradon Hill television transmitter.) The other is a 20-GHz system with an information rate of up to 500Mbit/s on several carriers and suitable for hops of 5 to 10km. Low-power solid-state microwave equipment would be housed on roadside poles around 20-m high. For the more distant future, frequencies of 50 to 100GHz may be used for local distribution (up to 1km) covering, say, a residential area and providing communication facilities direct to customers' premises.

Record year for consumer electronics

Deliveries of television receivers to the U.K. retail market reached a total for 1971 of 2,685,000 (the highest annual total since 1959), a rise of 16% over 1970, according to the latest figures compiled by the British Radio Equipment Manufacturers' Association. Of this total, 917,000 were colour receivers, a rise of 82% compared with 1970 (504,000); the remaining 1,768,000 monochrome receivers represented a slight fall of 2% on 1970 (1,811,000). Altogether 4,899,000 radio sets were delivered in the year, a rise of 51% over 1970 (3,254,000). Also deliveries of radiograms increased to 232,000 (224,000) a rise of 4%. Record-player deliveries reached 585,000 for the year — the fall of 4% over 1970 (611,000) being attributable to the swing to audio separates.

Communications 72

The programme of papers (some 30 in all) has now been agreed for the conference to be held in Brighton during the Communications 72 exhibition from 13th — 15th June. The conference is being organized jointly by *Electronics Weekly* and *Wireless World*.

The three parallel conference sessions each day will be from 9.00 to 12.30. Each session will have a theme; e.g., mobile radio, data transmission, point-to-point, communications in transport, test equipment, military radio communications, and

new techniques. Fees for the conference will be £25 for three days, or £10 per day. Participants have to make their own arrangements for accommodation.

An announcement will be made as soon as programmes and registration forms are available.

Incremental computer

Cranfield Institute of Technology and Sussex University have received a grant of about £30,000 from the Science Research Council to study jointly the systems organization of incremental computers.

Cranfield has acquired experience of hybrid computers using two or more analogue and digital computers linked together. Because the machines represent numbers in different ways a large number of converters is required to transmit data back and forth between the machines. Other disadvantages are the drift and inaccuracy of the analogue sections, the low-bandwidth of the digital machines, the different methods which have to be used for programming the different sections and the inconvenience of the patch-board needed for the analogue computers.

The University of Sussex has developed high-speed digital integrators and have also been investigating electronic methods of interconnection.

The experience of the two organizations will be brought together for the project which will result in the design and construction of a 64-integrator digital differential analyser interfaced to M.15 and P905 digital computers. The resulting digital machine will have the advantages of a hybrid machine without the various disadvantages mentioned.

Mobile communications system

Bell Laboratories in America have planned a mobile communications system that is designed to operate in the 806 to 881MHz band and which can be modified to cater for more or fewer subscribers as required.

The system uses a honeycomb pattern

of small service areas and employs the same frequencies over and over again in any city. Bell Labs intend to start a development programme and it is expected that the first system might be ready in five years time.

Unlike air-to-ground or satellite communication, propagation in land-mobile systems is not line-of-sight but takes place by multi-path reflections. Propagation distances are relatively short, screening by buildings etc. is troublesome, and transmitter power available at a mobile unit is relatively low. The proposed small-cell design is said to make it possible to handle these difficulties in a mobile communications system.

With the small-cell pattern, the area to be served is divided into hexagonal cells which use channels from any one of seven different channel groups that subdivide the entire spectrum allocation. Three base transmitter/receivers, spaced at alternate corners of each cell, are used to communicate with mobile units within the cell.

Mobile switching offices (m.s.os) control switching for the proposed system. The m.s.o. is a stored-programme, electronic control central office handling such functions as paging, locating and assigning channels etc.

Before one can transmit to a mobile one must know where it is. Directional aerials located at each base station determine from which direction the mobile transmitted signal is received most strongly. The m.s.o. compares this directional information from several base stations and locates the mobile unit. When located within a cell, the mobile unit is assigned a voice channel by the m.s.o. and can proceed to originate or answer a call.

Paging is required for calls to a mobile unit. Channels for this purpose will transmit sequentially the identity numbers of mobile units which are being called. At each mobile unit, these numbers will be continuously compared to the unit's identity number and when a match is detected, the mobile unit will find a channel and transmit a signal from which its location can be determined. A voice channel will then be assigned by the m.s.o. and ringing at the mobile unit will take place.

Large-area diversity cell coverage using each cell's three base stations is used to minimize variations of the signal caused by major obstructions such as buildings or hills. In addition, there are two aerials for each mobile and base receiver and the receivers automatically choose the stronger signal. The m.s.o. assigns a channel to the mobile unit and selection of the particular cell from which to serve the mobile unit is based on continuous monitoring for the best received signal. Selection of this best-of-three coverage is updated continuously as relocation measurements are made. Shadows in the transmission are minimized by the multiple aerials in each cell.

Quadraphonic news

Since we went to press with our last article on multi-speaker sound reproduction (February issue), EMI have announced adoption of the CBS Laboratories SQ matrix system for coding stereophonic records. They plan to release SQ records around April (only discs are involved at this time), when it is presumed Sony will market decoders in the U.K. CBS Records have a stock of SQ discs held in the U.K. to be released when decoders become available. (Other, smaller, record companies are producing discs — even tape cassettes — coded to various methods in the U.S.A. and Japan, and RCA have expressed a preference for the JVC discrete (subcarrier) disc.)

The advantage of the CBS SQ matrix technique over others is its stereo compatibility in the sense that crosstalk between the two front channels is non-existent on the record, and so the "stage" width is retained in the ordinary two-speaker mode. Recorded back-channel information, however, appears at points between the two speakers. There are certain disadvantages, like centre back sounds being suppressed in mono, and sounds from the two centre side positions having a level differential of 7.7dB on mono (deducible from the table on page 56 February issue). The way round these and certain other drawbacks, of course, is acceptance of constraints during

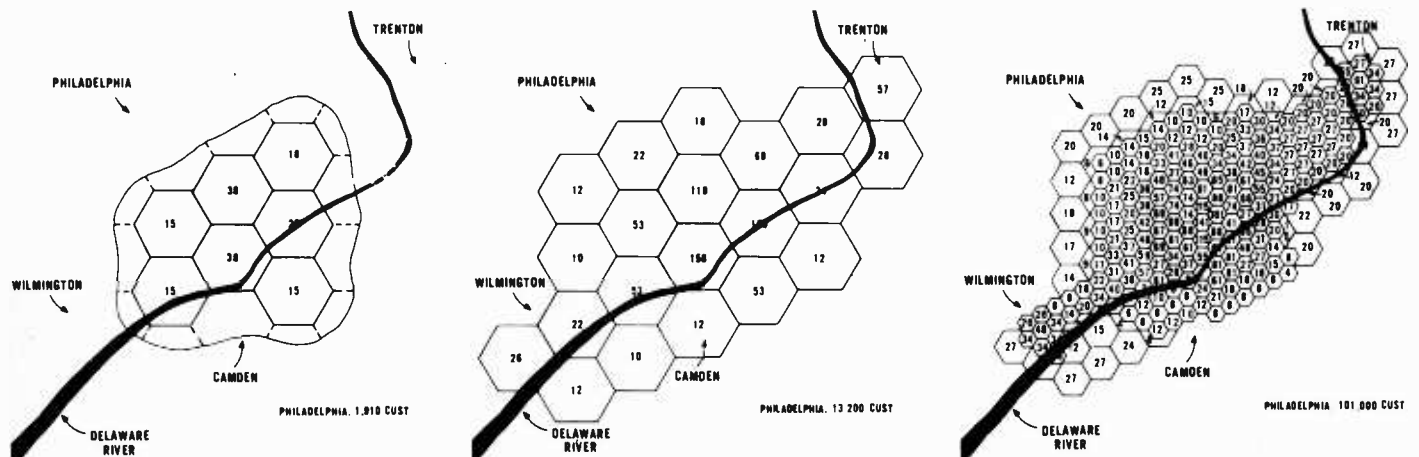

How the number of cells in the communications system proposed by Bell Labs can be adjusted to users' needs.

recording. Although other matrix systems may not impose such constraints there are still drawbacks, like limited listening area for proper effect or front crosstalk in the two-channel mode. A new **British-developed technique**, which claims advantages over others, has been proposed and is being put to selected record companies, but until detailed information is made available it's difficult to say for certain whether this suffers from the same kind of limitation.

Two Emma Tock ticks again

Fifty years ago, on February 14th 1922, a group of Marconi engineers began a series of experimental transmissions from a station with the call-sign 2MT at Writtle, Essex. The station was soon affectionately known by listeners as Two Emma Tock. Engineers associated with the project became household names in the broadcasting and radio world (P. P. Eckersley, Noel Ashbridge, R. T. B. Wynn and B. N. MacLarty).

The station's original purpose was to provide a source by which amateurs could calibrate their receivers but the broadcasts soon became regarded as a light entertainment programme.

To commemorate the start of regular transmissions from Two Emma Tock at Writtle, the Marconi Apprentices Amateur Radio Club will be operating a special amateur radio station, with the callsign GB2MT, from the original site. It is hoped to contact as many amateurs as possible, especially those who still recollect listening to the early transmissions of 2MT, and, later, 2LO. Every contact will be confirmed by a special QSL card, which will give details of the history and subsequent demise of 2MT. Transmissions began on 12th February, continuing through the actual anniversary until February 15th. Subsequent operation will be on the evenings of February 22nd, 29th and March 7th.

Transmission will be s.s.b. on 80, 20 and 15m using a K.W. Viceroy transmitter coupled to a Drake linear amplifier providing 400 p.e.p. A home-built 150W transmitter will be used on the 2m band. The receiver in use will be an Eddystone 880/2.

Tape noise reduction

In our report of the Berlin show ('Quadrphony and home video steal the Berlin show' pp.486-8 October 1971) we reported that National and Victor (Japan) had noise reduction systems like the Dolby system. Now, Dolby Laboratories announce they have licensed Matsushita of Japan to use the 'B' system in their audio products. Brand names covered by this agreement are National, Panasonic, Technics, Victor, and Nivico. This agreement follows recent licensing of Sony, Toshiba, Pioneer and General. There are about 70 licensees now of the Dolby 'B' system.

Calculated cut-down

Talks between the Japan Electronic Desk-top Calculators Council and the Japanese Ministry of International Trade and Industry have resulted in an agreement limiting the frequency with which new calculators may be introduced.

The 'interval agreement' provides that new electronic desk-top calculator models shall only be released twice a year (between April 15 and May 31, and September 15 to October 31).

The Japanese say that the agreement was reached following strong complaints by American and European manufacturers and dealers because the large share of the market occupied by the Japanese and the continual flood of new models and price reductions have led to a precarious market situation. The Japanese think that this is a negative attitude but have introduced the restrictions even though they say that the agreement will affect their competitiveness.

Farnborough show expands

For the first time in the fifty years the Society of British Aerospace Companies have been holding flying displays they are to allow equipment not manufactured in Britain to be shown at the 1972 Farnborough air show. About 400 European companies who are members of the Association Internationale des Constructeurs de Materiel Aerospatiale are being invited to participate. Altogether 1,000 companies are being invited to take part.

Sound '72

The annual exhibition of the Association of Public Address Engineers is being held at the Bloomsbury Centre Hotel London for the first time, from 14th to 16th March. The new location provides more space (8,000 sq.ft.) than previous venues (Kings Head, Harrow and Camden Town Hall)

and also a lower cost per unit area to exhibitors. During the exhibition there will be three lectures: 'Lighting and the p.a. engineer' by R. Benham (Rank Strand); 'Causes and cures of instability in transistor p.a. amplifiers' by J. Moir (consultant); and 'Marketing and costing in the p.a. industry' organized by E. Sawkins and the Institute of Marketing. Tickets for the exhibition are available free of charge from A.P.A.E., 394 Northolt Road, South Harrow, Middx HA2 8EY (telephone 01-864 3405). Exhibition times are 10.00 to 18.00 (16.00 on the final day).

Physics Exhibition

This year's Physics Exhibition (Alexandra Palace, London N.22, March 13th-16th) follows the general pattern of those of the past few years although there will be a reduction in the number of exhibits 'resulting from economic forces'. The exhibition, which will be open daily from 10.00 to 18.00 (17.00 on the last day), will be officially opened by the Secretary of State for Education and Science at 11.00 on the 13th. Admission will cost 25p.

The exhibition Handbook, which is a valuable reference book, is now available price £1.20, including postage, from the organizers — the Institute of Physics, 47 Belgrave Square, London SW1X 8QX.

As usual there will be a series of lectures during the exhibition. The lecture of particular interest to *W.W.* readers is that by Dr R. W. B. Stephens entitled 'High-intensity sound' on the opening day at 15.00. It will deal with high-intensity sound in the widest sense embracing both the audio and ultrasonic frequency range of mechanical vibrations. On the 15th at 14.30 there will be a discussion meeting on careers for the physicist.

Next year's exhibition is planned for April 9th-13th and it will be held in Earls Court. The Institute is to make 'an important statement concerning the future conduct of the exhibition' during this year's show.

High-voltage capacitor

Advance Filmcap Ltd, (Rhosymedre, Wrexham, Denbighshire, Wales) have produced a capacitor range which combines high working voltage and high capacity with small size. For instance an 8 μ F, 440V a.c. working (1kV d.c.) capacitor is housed in an aluminium cylinder only 80.2mm long by 82mm in diameter. The capacitors employ a polycarbonate dielectric and have a self time constant of > 10,000 seconds (M > F) and a dissipation factor of $\Omega\mu$ 0.2% at 50Hz.

The high performance is achieved by a novel construction which can be seen in the illustration. Two polycarbonate films have three metallizations. The dual metallization on one film extends to the edges and is connected to the lead out wires. The other film has a single

metallization which does not extend to the edges and is not connected to anything. When wound the metallizations form two capacitors in series doubling the maximum voltage that can be applied.

The normal range extends from 1 to 10 μ F in 1 μ F increments with working voltages of 360 or 440 a.c.; however, special values can be made to order.

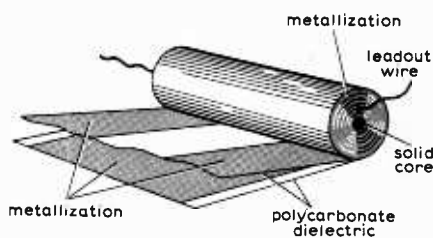

Letters to the Editor

The Editor does not necessarily endorse opinions expressed by his correspondents

Tape messages by post

I wonder how many readers know that the regulations for sending tape recordings through the post, as set out in the *Post Office Guide* (February 1971), are now out of date?

Formerly, 'Phonopost' packets weighing not over 2 oz — the Philips C30 Postal Pack for example — could be sent to Europe for 3p by surface mail or 6p by air mail, and for 14p by air mail to the U.S.A.

Since 1st July 1971, these concessions have been withdrawn, the term 'Phonopost' has been deleted and the current ruling* is that 'sound recordings . . . bearing current and personal messages must be sent as Letters'. Recordings of music, public speeches and so on may still be sent at a lower rate as Small Packets, with the Gilbertian proviso either that the size must be increased to $5\frac{1}{2} \times 3\frac{1}{2}$ in., or that a label not less than $4 \times 2\frac{3}{4}$ in. must be attached†.

I now have to pay 30p to send my monthly sound bulletin to relatives in America instead of the former 14p — an inflation of 107%!

F. L. Devereux,
Hindhead,
Surrey.

*Post Office Guide Special Supplement, Overseas Post, Revised Services and Charges, effective from 1st July 1971, p.106.

†Loc. cit., p.105.

Television sound quality

I have been following the correspondence on the poor sound quality of the average television receiver, culminating in John Gilbert's article in the January issue. His measurements seem to show that the output stages used leave something to be desired, which is rather foolish, considering how easy and cheap it is to do better.

My experience has been rather different. I have a Rank Bush Murphy 25in dual-standard colour set in which the sound quality was pretty average. I disconnected the 15-ohm 7×4 in elliptical speaker and substituted an Acoustical Corner Ribbon speaker which thought it had retired, but which, in the

pre-electrostatic days, was considered good. This sits beside the set, and without any other change the improvement was quite startling. The sound does not offend ears used to high-quality from electrostatic loudspeakers. The absence of stereo is a greater drawback than any deficiency in intrinsic sound quality.

The output stage consists of an AC176 and an AC128, with feedback to the driver and a 25-volt supply line, described whimsically in the service manual as '3 watts Music Power rating', whatever that may mean. If it overloads at normal listening levels, which is rarely, it seems to overload gracefully, and I seem to remember that the sensitivity of the Corner Ribbon is not unduly high by modern standards.

All this leads me to suspect that the main deficiency, and certainly the most difficult to rectify, is the loudspeaker, not the output stage, and anything worth listening to would add about £10 to the retail price of the set by the time it was housed properly. On the other hand, £10 is not much on the cost of a colour set, and one suspects there could be a market for reasonably good loudspeakers in cabinets designed so that the television set could be placed on top, with the legs, if any, removed. Such a unit could have provision for an optional plug-in amplifier fed from the set's supply line, to cater for those with hopeless output stages.

D. T. N. Williamson,
Edenbridge,
Kent.

The article 'Television Sound Adaptors' in the February issue reminds me that in 1967 I was working on this idea and produced a prototype which, via a tuned ferrite rod pick-up device, responded to the intercarrier signal at the output of the intercarrier sound channel.

My plan was to demodulate the sound information from the intercarrier signal, suitably process the signal and then apply it to frequency modulate a very low-level v.h.f. oscillator yielding a signal at a frequency corresponding to a quiet spot on Band II. My device consisted of a small plastics case with the battery-powered electronics contained therein and with no need whatever for any connection between

the television receiver and the f.m. tuner. The device (on which the only control was a battery on/off switch) was merely orientated on the top, side or rear of the receiver for optimum intercarrier pick-up (best S/N ratio) and the f.m. tuner adjusted to the frequency-modulated carrier from the low-level oscillator.

Before introducing the device to a manufacturer or launching it on the market I consulted the Radio Services Department of the Post Office with regard to the legality of re-radiating the television sound signal — albeit at very low level within the room — within Band II. Correspondence revealed the possibility of problems arising therefrom. It would have seemed possible, however, to transfer the f.m. television sound signal to the tuner via a coaxial link (not 'off air'), but, since a diplexer would have been needed to introduce also the normal f.m. aerial, it occurred to me that radiation problems might be even more severe working this way — the device signal to the aerial via the diplexer!

I considered translating the re-modulated TV sound signal to the intermediate frequency, but this destroyed the novelty of the device in that a connection would in fact have to be made to the electronics of the f.m. tuner.

One specific stipulation made by the Post Office was that 'neither the device nor the cable connection between it and the hi-fi equipment should radiate'.

Gordon J. King,
Brixham,
Devon.

Becker power supply

With reference to the article by R. B. H. Becker on High Power Audio Amplifier Design in the February issue I would like to point out some errors in his power supply.

First as the circuit is drawn (Fig. 12) it will not operate since Th_1 has not the stated effect on D_2 . Presumably there should be a connection between the junction of Th_1/R_{69} and the base of Tr_{35} . Under the section on setting up there is a reference to a potentiometer R_{67} , which should be R_{68} and the reference to R_{68} should be R_{69} .

When the power supply is tripped by Th_1 , the output voltage is reduced to approximately 5.6 volts because of the voltage across D_2 . It would seem better to reduce it to zero and this can be done by placing the zener diode D_2 between the junction of Th_1/R_{69} and the base of Tr_{35} .

Using the published circuit the reduction of the voltage across R_{68} from 50 to about 5.6 volts must produce an instantaneous voltage of about 45 volts between the base and the emitter of Tr_{32} in the reverse direction, this voltage being maintained by the large capacitor C_{16} . I cannot see why this does not result in the destruction of Tr_{32} .

It is a pity that the author does not explain how the trigger action of Tr_{33}

causes the output voltage to reduce to almost zero on overload. I wonder why two TIP3055 transistors are required and also why reference is made to a 150 watt transistor. The voltage across the regulator transistor on normal load is only a few volts (the *maximum* possible is $43\sqrt{2}-50 = 9$). Assuming that the power supply gives 4 to 5 amperes the power is only $9 \times 5 = 45$ watts and this is maximum and will be considerably less than this. Under fault or overload conditions the current is almost zero and hence the power very small.

G. N. Patchett,
Bradford.

* Apologies for the typographical errors. ED.

The author replies:

I would like to thank Dr. Patchett for correctly pointing out the non-correlation between circuit and text and the drawing error. The thermal trip clearly will not work with the mentioned connection missing.

Placing D_2 in the alternative position will reduce the reference to almost zero as suggested. However, the net effect will be the same because once the output of the supply has dropped so that there is a potential greater than about 35V across the regulator transistors, Tr_{33} will turn on, shutting down the supply with a self-regulative action. Whether the reference is at zero or a few volts above will be virtually immaterial though the published arrangement was regarded as slightly advantageous in that the current in the zener at the instant of trip-out will be of about two orders of magnitude greater and better defined.

Concerning the reverse bias on Tr_{32} while trip-out occurs, the base emitter junction will most probably undergo breakdown. Although this should be rendered non-destructive by the current limiting effect of R_{68} , it would seem wise to include a diode in the path from R_{66} to Tr_{32} .

The reason for the paralleled transistors in the regulator is not connected with the normal hazards of amplifier use. It was a precaution employed during development to safeguard the supply in the period just after removing the connections whilst the output is shorted, a time when shut-down is not complete and dissipation can rise above the 90W limit for a TIP3055. Transistor Tr_{29} and R_{81} could be omitted provided R_{80} is reduced in value to 0.1Ω .
R. B. H. Becker.

Turntable construction

During the assembly of the turntable described in the October 1971 issue, I found the alignment of the pulley to the turntable rather critical.

In order to make the system more stable an experimental pulley was made with a radiused or coned running surface, to utilize the tendency of the belt to ride to the highest point. A form tool was ground as shown, with a width slightly larger than the width of the belt and a shallow radius on the end. This system was found most

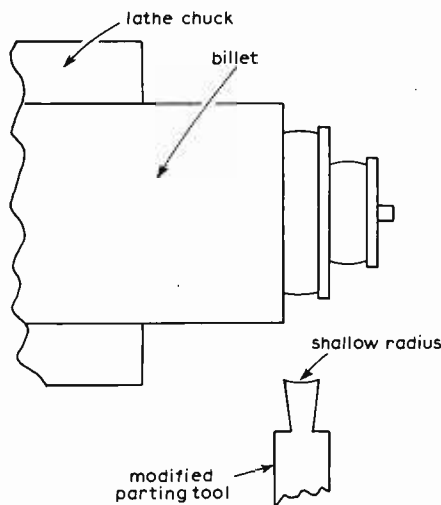

satisfactory, the belt almost automatically centring itself on the pulley.

It should be noted, however, that this method makes the active diameter of the pulley debatable. It was found, though, that if the maximum diameter of the pulley surface is made to the original dimensions and the core given only a very shallow radius then the effect may be discounted. The maximum diameter may be easily measured using vernier callipers.

R. G. Brown, G3CXV,
Nottingham.

The author replies:

I am most interested to learn of Mr Brown's work on a crowned pulley. This method of flexible belt stabilization appears to be more widely known than I imagined, judging by my correspondence. You have undoubtedly succeeded where in the first instance I failed, although to be fair to myself I did not persist beyond the realization that production of a crowned pulley would require the use of a specially ground form tool. I think you will agree with me when I say that working a centre lathe to the required accuracy of the project is one thing, but grinding a special form tool to a correct and accurate profile, most probably by hand, is another. It was for this reason I abandoned my work on the crowned pulley and concentrated on the form published. When the turntable is newly built I agree the belt can be difficult but after a few hours use the belt runs in, as it were. In fact the edge of the belt and the cheeks of the pulley became polished and the tendency to scuff and ride the pulley wall is much reduced.

However, since, as I mentioned above, others have raised the question of crowned pulleys, I cannot now ignore the subject and I shall try (with the Editor's permission, of course) to publish a suitable design in due course.
R. Ockleshaw.

The Liniac

Referring to the letter from P. W. van der Walt in the January issue (p.11), I suggest that the ASP, like its namesake, should be approached with caution. Anything heaved up by its bootstraps means that the heaver and the boots are heading in the same

direction; which is another way of saying positive feedback.

The circuit described is no exception to this. Taking average values for the transistor model and doing the computer analysis of the two circuits shown gives voltage gains of 89 for Fig. 1 and 47 for Fig.2 in Mr van der Walt's letter. If the collector load R_2 of Tr_1 is taken to the 10-V rail the corresponding gains are 9 and 7. In both cases the effect of the 22-ohm resistor is to reduce the gain by a factor of two or less. The computed results for the four cases, omitting reactance and phase are as follows:

Frequency	$R_{in} (\Omega)$	$R_{out} (\Omega)$	Gain
1 kHz	25k	230	89
100 kHz	23k	231	89
1 MHz	4.1k	228	86
10 MHz	816	242	21
1 kHz	47k	1.16k	47
100 kHz	46k	1.16k	47
1 MHz	14.4k	1.17k	47
10 MHz	875	11.2k	23
1 kHz	19.9k	37	9
100 kHz	19.9k	37	9
1 MHz	16.6k	38	8.9
10 MHz	23.3k	200	5.6
1 kHz	25.5k	187	7
100 kHz	25.5k	187	7
1 MHz	23.9k	186	6.9
10 MHz	4.7k	86.8	5.15

As a practical check the circuit was built with components and transistors straight out of the drawer and the gain measured roughly for the four cases — respectively, 100, 60, 20 and 15. Substituting a

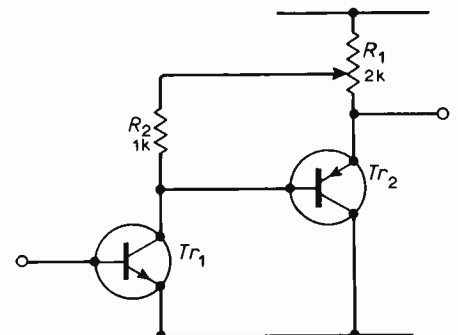

potentiometer for R_1 provided what was known in earlier days as a reaction control: the circuit oscillated just before R_2 reached the emitter of Tr_2 . Nevertheless this type of circuit, and its many variants and complications, is very interesting and justifies a great deal more work and analysis to establish what can be achieved with it but, as I said before, it should be treated with respect and caution.

H. Harper,
Fleet,
Hants.

Displaying frequency digitally

I read with interest the article by C. Attenborough on displaying frequency digitally in the December issue. If most experimenters are going to build a counter they will probably want it to be as flexible

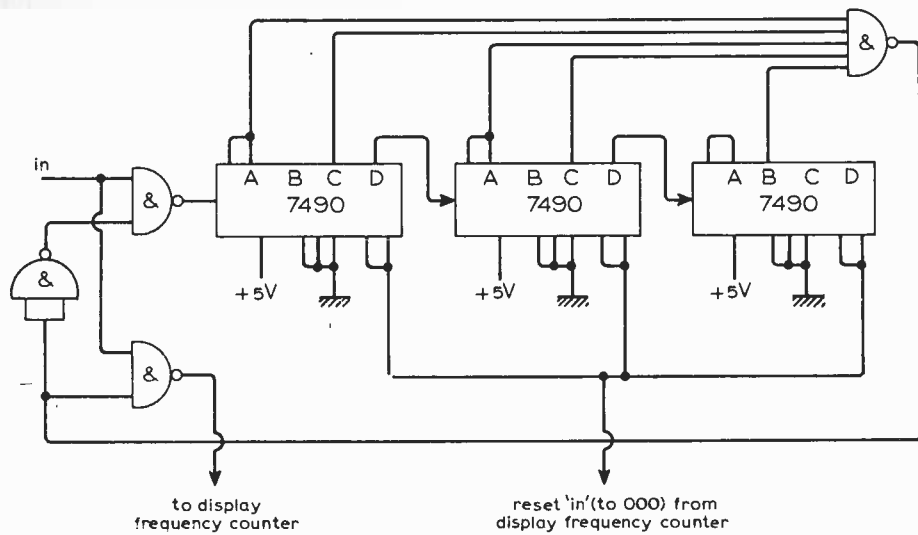

Circuit to subtract 455Hz from 'in' and gate remaining pulses to an external counter. To subtract 455kHz add preceding ÷ 1000 counter.

as possible for uses other than the direct readout of receiver frequency. Why not subtract the intermediate frequency of 455kHz first. This is easily done with regular SN7490 counters and a few gates. One does not need extra flip-flops to build complex resettable counters. After the counter has counted to 455kHz it then gates the remaining pulses to the frequency counter used to display the remaining pulses. The experimenter now has a direct frequency receiver and a frequency meter for other uses.

Jonathan A. Titus,
Blacksburg,
Va., U.S.A.

Corner horns

My letter in the February issue needs a correction. The area of hatching on the graph should come below the line of crosses (taking also the origin as one of the crosses) and not above; and, consequently, the reference at the top of the second column of text to the upper boundary of the hatching should be to the lower boundary. I am sorry if anyone has been puzzled by this mistake.

S. W. Gilbert,
Beckenham,
Kent.

Frequency response of discs

It had been a hard day's work but a good one; I was feeling quite pleased with the frequency response of the cutting system, within 1dB of the B.S.I. curve at 18kHz and only 0.5dB difference between channels; this including the tape playback machine.

So to a quiet perusal of the January *Wireless World* where I learnt to my surprise that 'the treble on commercial longplaying gramophone records is in any case severely limited . . .' this from the Cavendish Laboratory, no less (page 9).

Perhaps Mr Halliday considers 18kHz a 'severely limited' treble response, but I can assure him that any microphone he is likely to be using in his 'signals of better quality' is unlikely to have a better h.f. response than those used in good commercial recording concerns. Also, if the

test pressing does not match the master tape the recording engineer will be after the disc cutting engineer's blood!

It's there on the disc in the vast majority of cases, but is it coming off? I suggest a standard frequency test disc (e.g. Decca LXT5346) might show where the trouble lies in this case.

S. W. Davies,
London N.W.3.

T.T.L. trigger circuits

While agreeing in principle with the arrangement described by H. A. Cole in 'T.T.L. Trigger Circuits' I would like to point out that certain limitations exist in the performance of the circuit which were not mentioned. The problems with the circuit arise due to the slow level changes associated with the change and discharge of the capacitor.

Due to the slow level change at the input to the gate following the capacitor the gate

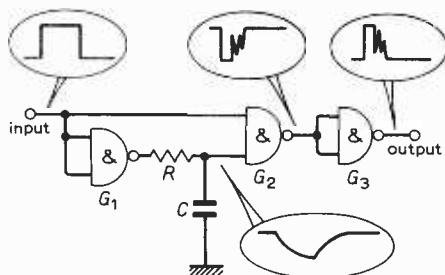

Fig. 1. Original circuit plus an inverting gate. Note the parasitic oscillation at the output.

could spend an appreciable time (e.g. greater than 50ns) biased into the linear region of the transfer characteristic giving undefined logic levels at the output. This condition of the slow pulse edges at the output can sometimes be tolerated and when used carefully can perform satisfactorily in a circuit with other logic.

However, if the output of the gate following the capacitor is fed into another gate as shown in Fig. 1 and both of them are in the same block, or on a p.c. layout with reason-

able capacitance between the input of G_1 and the output of G_2 , the slow level change at the input to G_1 will bias both gates into the linear region. Due to the gain of the gates operating as amplifiers and the presence of stray feedback capacitance the circuit will oscillate. For two gates in one package the frequency of oscillation is 3 to 10 MHz.

Hence, as the circuits stand they are unsuitable for driving edge triggered devices or counting circuits, since the counter can easily count the random oscillations on the edge of a pulse.

The solution to the problem lies in the use of a Schmitt trigger NAND gate (e.g. SN7413N) instead of a normal t.t.l. gate following the capacitor. The characteristics are shown in Fig. 2. This allows very slow level changes to take place across the capacitor without any adverse effect on the pulse shape or rise and fall times. Clean

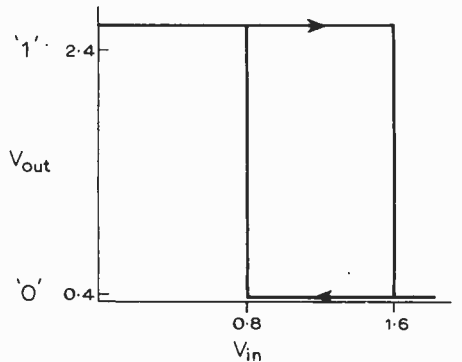

Fig. 2. Characteristics of Schmitt trigger NAND gate.

pulses are now obtainable even when long time constants are employed.

Due to the different levels at which the Schmitt trigger changes state, the pulse durations would appear to be different to those stated in H. A. Cole's article. However, calculations and practice show that Mr Cole's empirical expression $td = 1.3 CR$ is also valid when the Schmitt trigger is used.

M. F. Arnold,
Willenhall,
Staffs.

Hydrokinetic interference

Constant calls by the service engineer produced only temporary cures for the 'arcing' which assailed my television receiver. It was when the television-set was changed and the trouble still continued that my daughter casually remarked that it only happened after heavy rainfall. "It is as though rain gets into the set" she added.

Bearing in mind that the lead travelled upwards to the set, indoors, it seemed impossible, yet when I removed the plug from the coaxial cable it was indeed soaking wet.

Presumably water can be drawn into the interstices of the braiding by capillary action and by its own weight force the water upwards into the set and cause intermittent short-circuiting.

C. D. Newman,
Mawnan Smith,
Cornwall.

Unified Dimensional Display

Space-lattice presentation shows physical quantity relationships

by Rex N. Baldock,* B.Sc.

This novel visual aid allows 'dimensional' relationships between physical quantities to be clearly seen. The particular format described correlates mechanical, acoustical and electromagnetic quantities, and illustrates both fundamental and derived relationships in a simple and systematic way. Techniques are described for exploring the evolution of dimensional ratios and products, together with special applications of the complete display, with the aim of making the display a versatile educational aid. Because of the way dimensional relationships are presented, SI units of electric, magnetic, acoustical, mechanical and kinematic quantities are easily deduced.

It was not until late in the 17th century that a mathematical analysis of dynamical relationships was formulated by Sir Isaac Newton (1642–1727), based on the foundations laid by Nicolas Copernicus (1473–1543), Johann Kepler (1571–1630) and Galileo Galilei (1564–1642), and using the co-ordinate geometry devised by Rene Descartes (1596–1650). Only then were the physical phenomena connected with matter and energy comprehended, and several relationships evolved of far reaching importance. In particular, those concerned with the 'dimensions'† of quantities based on mass, length and time (M , L , T) were of fundamental interest.

Gravitational attraction was shown by Newton to be inversely proportional to the square of distance between mass centres, and he also found that force was dimensionally equal to mass multiplied by linear acceleration, so giving it the dimensional form ML/T^2 , or MLT^{-2} . From this it followed that force also equalled the rate of change of linear momentum, using the fluxional techniques of infinitesimal calculus invoked by Newton for his mathematical investigations, as linear momentum has the dimensions MLT^{-1} , and therefore force was given by $d(MLT^{-1})/dt$. (Time is here represented dimensionally by 'T' and generally by 't'). Because the relationships between physical quantities involved differentiations and integrations with respect to displacement and time, their dimensions

This kind of display—used for our cover picture—shows quantity relationships with SI unit symbols as the indicators (see also Fig. 9). Unit symbols in terms of SI base units (see table) are easily deduced from a different kind of model, shown on page 118.

took the form of products of integral powers of the base quantities, with, in some cases, a multiplying factor and possibly the addition of a constant of integration.

From these discoveries, it then became apparent that energy was dimensionally equal to the quantity force multiplied by displacement in its line of action, and also the quantity mass multiplied by the square of its linear velocity, both these providing the product ML^2T^{-2} . Power, or rate of working, then followed as ML^2T^{-3} , and from these the dimensions of other mechanical quantities were developed. Towards the end of the 19th century, Lord Rayleigh (1842–1919), ascribed appropriate descriptions to acoustical quantities, he being the originator of dimensional analysis of the form in use today.

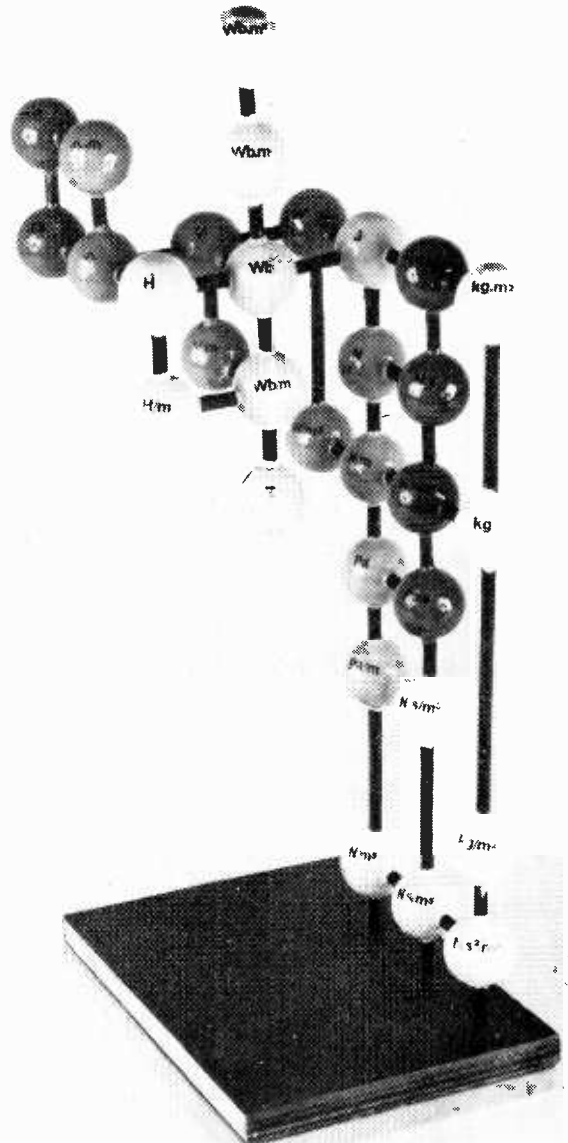

Meanwhile, heat, light, electric and magnetic phenomena were studied as separate sciences and their relationships with the mechanical quantities revealed, but the relationship between electricity and magnetism was not appreciated until André Ampère (1775–1836) described the magnetic field associated with the flow of an electric current. Michael Faraday (1791–1867) observed the inverse effect of electromagnetic induction (the induced current arising from a changing magnetic field) and finally James Maxwell (1831–1879) related electric and magnetic quantities by their wave propagation velocity, equal to that of electromagnetic radiation. Quantity relationships in these fields were completed by Albert Einstein (1879–1955) early in the 20th century, with his discovery of the

*Audio consultant.

†The term dimension in this context was first used in 1822 by Jean Fourier (1768–1830) in his book 'Théorie Analytique de la Chaleur' (Firmin Didot Père et Fils, Paris).

equivalence of rest mass and total static energy ($E = m_0c^2$), thereby relating mass, energy and electromagnetic phenomena directly (c being the velocity of electromagnetic waves in *vacuo*).

International units

Various systems of measuring the values of quantities developed over hundreds and even thousands of years in different countries, and consequently difficulties often arose when comparisons were made. To obviate this, a committee was set up in France in 1791 to make recommendations for a well defined and internationally acceptable system of units. They chose the metre-kilogram-second set, and, to abbreviate the story¹, this was finally adopted for international use in 1950, together with the ampere and suitable values of free space permeability and permittivity such as to give electromagnetic quantities of rationalized form.

By 1969, three other base quantities—thermodynamic temperature, luminous intensity and amount of substance, with base units, kelvin, candela and mole—were defined and accepted to describe quantities not directly covered by the electromechanical domain, the whole scheme being known as the International System of Units². This set is largely coherent, i.e. yields unit 'sizes' numerically related by a factor of unity, and is capable of dimensionally describing all normal physical quantities by suitable combinations of integral powers of the seven base units, together, where necessary, with quantities representing plane and solid angles.

Lists of physical quantities and their dimensions have been compiled and by appropriate multiplication and division quantity relationships can be investigated. However, while such lists may be sufficient for those skilled in the art, for students initially approaching the subject many important associations may not be appreciated because of the mental processes demanded for comparison. This is especially so where three quantities having very dissimilar dimensions are to be related and the connection may be obscure even when otherwise familiar with the field of interest. Generally, this difficulty arises because the majority of physical quantities embody three or four base quantities, sometimes raised to third, or even fourth powers.

It was while attempting to clarify the connections between the mechanical and acoustical quantities by drawing family trees involving multiplication and division by mass, time and displacement, that I originated the display system described (subject of a patent application). Detailed reference to the dimensional lists of mechanical and other quantities revealed—quite unexpectedly—that the dimension 'mass' only appears in the forms $(\text{mass})^1$, or $(\text{mass})^{-1}$, but those of time and length occur in powers up to the fourth. In fact, most familiar mechanical quantities include $(\text{mass})^1$ and belong to an 'impedance' cosmos, resisting change through such effects as momentum, stiffness or viscosity. This suggested that, for the majority of mechanical and acoustical quantities at least, only two inde-

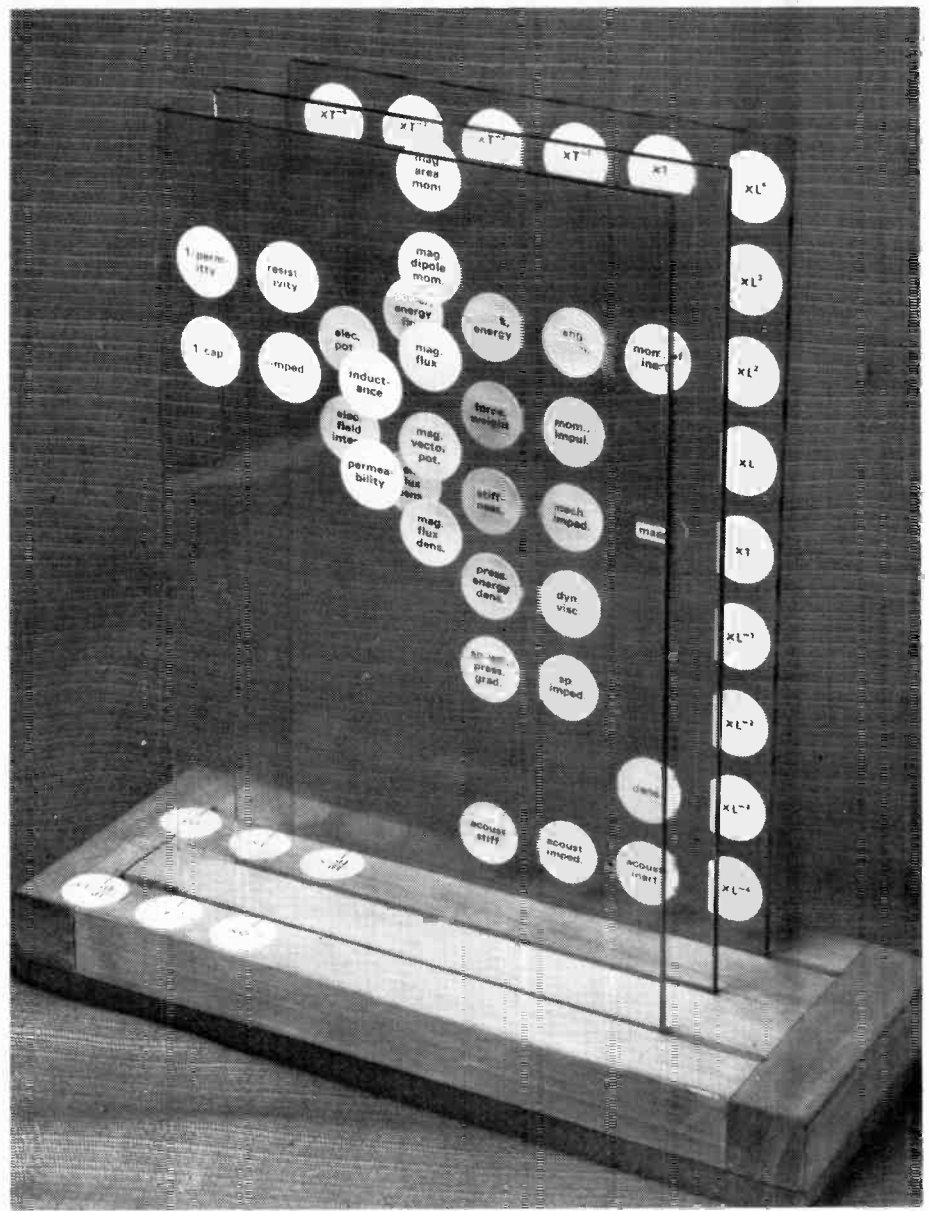

Prototype display system using quantity names suitably sited on transparent plates supported within slots. When aligned as shown, the normal linking factor between adjacent plates is electric current, but by shifting the front and rear plates by one basic division in opposite directions relative to the centre plate, the linking factor is transposed to either electric charge or the rate of change of electric current.

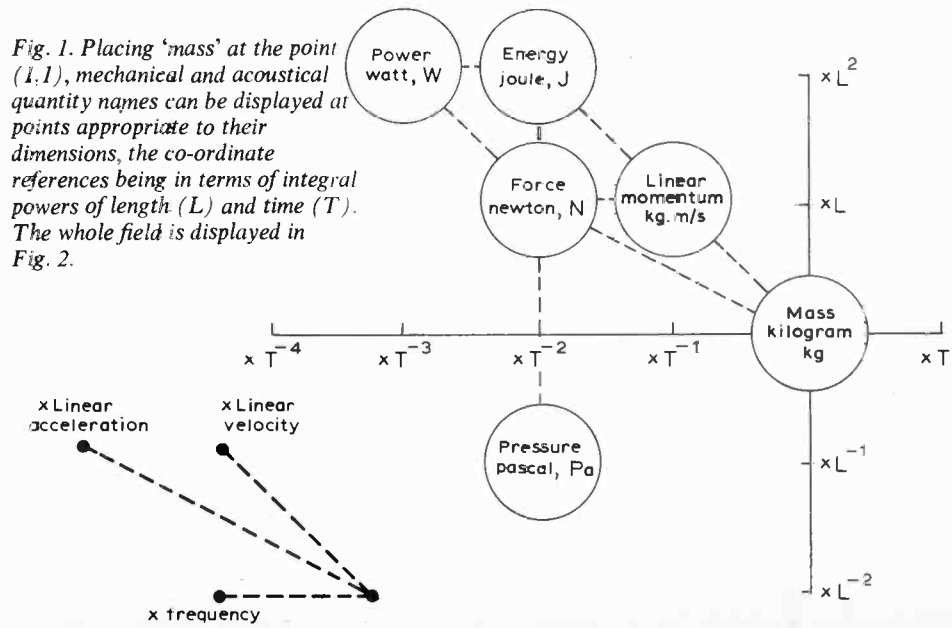

Fig. 1. Placing 'mass' at the point (1,1), mechanical and acoustical quantity names can be displayed at points appropriate to their dimensions, the co-ordinate references being in terms of integral powers of length (L) and time (T). The whole field is displayed in Fig. 2.

pendent dimensional descriptions were required, mass being a common factor. (In a display relating quantities with (mass)¹ as a common factor, quantities like area, acceleration and frequency only occur as 'multipliers'.†)

With only two dimensional descriptions remaining, it was clear that they could act as co-ordinate references. However, unlike most graphical displays in which equal increments along the axes represent linear or non-linear multiples of a parameter, here the most natural arrangement demanded sequential integral powers of the parameter, placed at equal intervals. This progression can also be regarded as a logarithmic function of the parameter, with the proviso that known quantities exist only at co-ordinate positions represented by the logarithm being an integer.

On investigation of the value of this form of display, it was immediately evident that consistent arrays were obtainable, in which all known physical quantities could be assigned co-ordinate references; not only did these reference positions show quantity dimensions at a glance, but also their relationships with others in a clear and systematic way. In view of the special interest attached to electro-mechanical phenomena, a complete array of mechanical and acoustical quantity indicators was first built up in one plane, following which further quantity indicators representing division by (electric current)¹ and (electric current)² were suitably sited on further transparent planes. These latter planes were related to the first plane by superposition at suitable distances. They were found to show the majority of important electromagnetic quantities, these again falling into an 'impedance' category.

As dimensions of quantities included on such a display are immediately apparent, it follows that their units, in terms of SI base quantities (see Table), can also be deduced. For example, in Fig. 1, which is part of a plane showing mechanical and acoustical quantities (Fig. 2), the dimensions of energy are clearly ML^2T^{-2} , starting with M as a common factor, multiplying by L^2 —indicated by moving two places up the display—and multiplying by T^{-2} —indicated by moving two places left along the display. The base SI units are evident by substituting kg for M , m for L and s for T .

Choice and use of display

Should it be desired to array quantities falling into an 'admittance' category directly (e.g. mechanical and acoustic compliance and electric capacitance), then it is merely necessary to invert the indicator (mass)¹ to (mass)⁻¹, together with the use of co-ordinates involving positive powers of time and electric current. However, only a few named quantities then appear, presumably because of the type of conditions under which the natural sciences have developed.

By placing (mass)⁰ = unity at the 'origin' of co-ordinates, a 'kinematic' display is obtained, in which quantities such as linear velocity and acceleration, 'specific energy and volume current' ('volume velocity') can be assigned co-ordinate positions. However,

†See Fig. 3.

Quantity	Usual symbol	SI unit		Basis of definition*
		Name	Abbrev.	
mass	m	kilogram	kg	equal to the international prototype of the kilogram.
length	l	metre	m	equal to 1,650,763.73 wavelengths in vacuum of radiation from a specified transition in the krypton-86 atom.
time	t	second	s	duration of 9,192,631,770 periods of radiation from a specified transition in the caesium-133 atom.
electric current	I	ampere	A	constant current in two straight, parallel conductors of infinite length and 1 metre apart, giving force between them in vacuum of 2×10^{-7} newton per metre of length.
thermodynamic temperature	Φ	kelvin	K	1/273.16 of thermodynamic temperature of the triple point of water.
luminous intensity		candela	cd	luminous intensity in the perpendicular direction of a surface of 1/600,000m ² of a black body at the temperature of freezing platinum under a pressure of 101,325N/m ² .
amount of substance		mole	mol	amount of substance which contains as many elementary particles as there are atoms in 0.012kg of carbon 12.
SI supplementary quantities				
plane angle†	α	radian	rad	plane angle between two radii of circle which cut off on the circumference an arc equal in length to the radius.
solid angle†	ω	steradian	sr	solid angle which, having its vertex in the centre of a sphere, cuts off an area of the surface equal to that of a square with sides of length equal to the radius of the sphere.

†It is arbitrary whether these quantities are regarded as dimensionally independent physical quantities, or ratios, giving respectively base or derived units.

*According to BS3763:1970.

these displays are generally of less interest than the types described below, in which the kinematic quantities appear as displacements involving length and/or time.

A few important and familiar mechanical quantities are related in Fig. 1 to illustrate the presentation and use of the system. Taking mass at the origin of co-ordinates (the origin (1,1) with logarithmic axes), the position corresponding to force is defined by mass \times acceleration, or MLT^{-2} , the expression LT^{-2} indicating that it is placed one division vertically above mass and two to the left. (To maintain correspondence with well-established graphical conventions, including positive time display progressing horizontally to the right, positive powers of the co-ordinate quantities are shown increasing to the right and upward.)

Energy, given by force multiplied by displacement in its line of action (force being a vector quantity), is therefore situated one division vertically above force, as mentioned. Energy is also dimensionally equal to the product of mass and (velocity)², as shown by the diagonal link through linear momentum (MLT^{-1}). (In fact, energy is equal to $\frac{1}{2}$ mass \times (velocity)², the factor $\frac{1}{2}$ arising from integration and effectively due to taking an average velocity. Either way, energy dimensions are ML^2T^{-2} .) Power is defined as rate of working, or $d(\text{energy})/dt$, and so appears one division to the left of energy. One relationship immediately observed from this is that power is also the product of force and velocity. Finally, in this simplified picture, as pressure is force/area, it is placed two divisions below force.

The whole mechanical/acoustical field is shown in Fig. 2 from which it is easily seen that acoustical quantities are displaced from their mechanical counterparts by four orders of length or displacement. This arises because acoustical quantities are related to specific impedance ($ML^{-2}T^{-1}$) by *dividing* by area, whereas mechanical quantities are given by *multiplying* specific impedance by area (ignoring the presence of time orders), so introducing a factor overall of $(area)^2$ or L^4 .

Display relationships

Certain quantities are not indicated on the display, e.g. specific momentum (= specific impedance) linear density ($= ML^{-1}$) and surface density ($= ML^{-2}$), because they were not considered of sufficient interest in the context of this description. (The equality sign is taken as meaning dimensional equality). However, pressure and energy density have a one-to-one relationship of great significance, while the reciprocals of stiffness (compliance), mechanical impedance (mechanical admittance), specific impedance (specific admittance), density (specific volume), acoustic stiffness (acoustic compliance) and acoustic impedance (acoustic admittance), indicate the connections with an 'admittance' field.

In mechanical engineering and some acoustical investigations, it is often convenient to regard force rather than mass as a base quantity, giving it the symbol F . On this display, the relationships between force and the other quantities are clearly unaltered, as it is the *ratios* of their co-ordinate values that give the required connections, rather than their absolute values. Naturally, if force is taken as the co-ordinate origin, the 'absolute' dimensions of all displayed quantities have to be normalized by being multiplied by F/MLT^{-2} , or $FM^{-1}L^{-1}T^2$. Hence, mass then acquires the description $FL^{-1}T^2$ and power becomes FLT^{-1} , or force \times velocity as seen in Fig. 1. Again, if desired, mechanical impedance could be taken as the reference quantity, giving relationships such as [force] = [mechanical impedance] \times [velocity], where [] signifies 'the dimensions of'.

Returning to mass as the common base quantity, many useful relationships are displayed in Fig. 2, some familiar, some perhaps unfamiliar, even to those having an automatic knowledge of the more important cases. Bear in mind that the display shows dimensional equalities, but for the SI system, and within one type of scientific field (e.g. mechanical), a one-to-one unit relationship is mostly applicable, especially in directions parallel to the co-ordinate axes. Among those relations including velocity

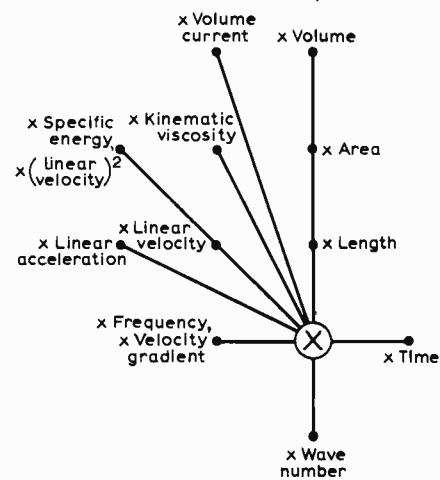

Fig. 3. This diagram illustrates the named quantities that link those displayed in Fig. 2 and also those of Figs. 4 and 5. Thus, multiplication of a quantity by 'volume current' involves a shift of three basic divisions upward and one to the left, so multiplying the chosen quantity by the factor L^3/T .

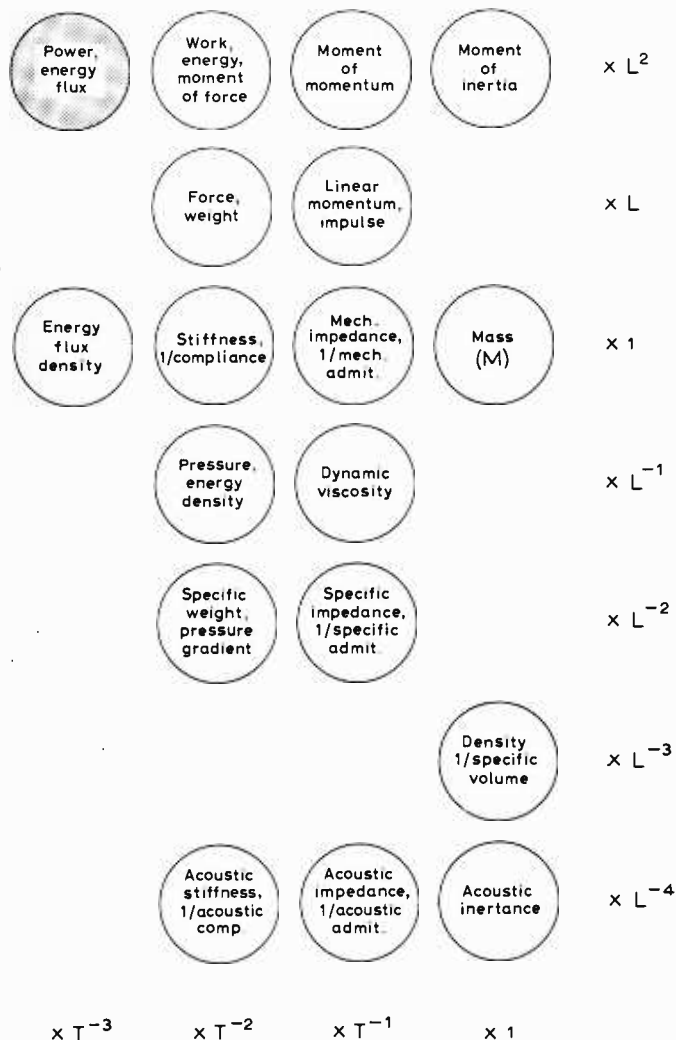

Fig. 2. Complete display of mechanical and acoustical quantities. This illustrates the dimensions of quantities directly in terms of mass, length and time, while the multiplier diagram allows inter-quantity relationships to be observed without division.

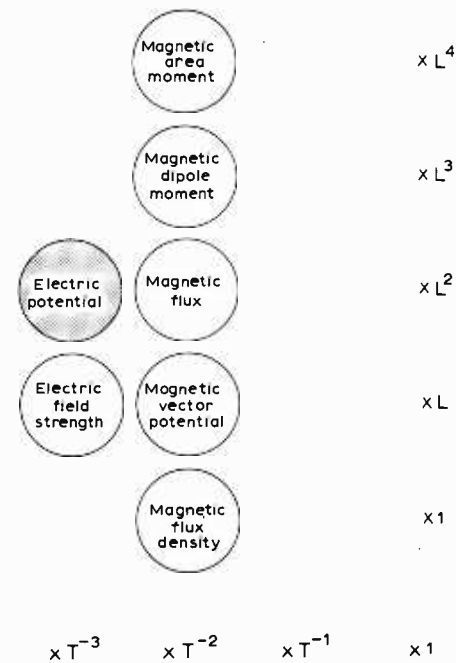

Fig. 4. Electric and magnetic quantities obtained by dividing those in Fig. 2 by electric current, the basic link being electric potential = power/electric current.

it may be mentioned that [energy flux density] or [power/unit area] = [pressure] \times [velocity], an expression used in acoustics in which the velocity is the r.m.s. particle velocity. Sound transmission velocity links density and specific impedance, i.e. $Z_0 = \rho c$. In the mechanical realm, power is given by the product of mechanical impedance—strictly the resistive component—and (velocity)², while dynamic viscosity is given by pressure multiplied by time, and measured in pascal seconds. Note that, alternatively, dynamic viscosity could be defined as mechanical impedance divided by displacement, specific impedance multiplied by displacement, stiffness divided by velocity,

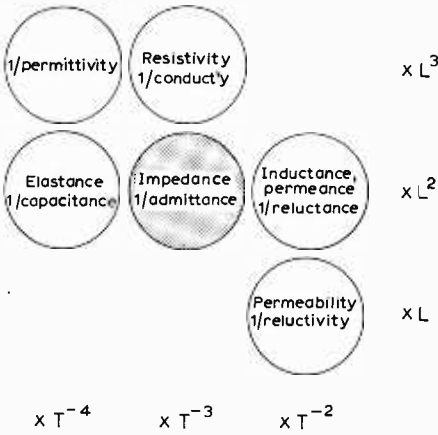

Fig. 5. Further electric and magnetic quantities are obtained from Fig. 4 on division by electric current, the definitive link being impedance = electric potential/electric current.

or, as defined by Newton, shear stress (= [pressure]) divided by velocity gradient.

Extension with electric current

The system can be extended using the remaining quadrature direction for the display of further quantity indicators related to it, either as described, or using, for example, force or energy as 'centres'. Displacements along this axis may take the form of representations of integral powers of thermodynamic temperature (allowing for instance, thermal conductivity and entropy to be assigned positions), luminous intensity or amount of substance, but in this present context the dimension represented by electric current is most appropriate. This is the base quantity used in the SI system for linking in electrical quantities to energy and power, the unit being the ampere.

The plane representing division of the mechanical/acoustical plane by (electric current)³, Fig. 4, the definitive link between them being the relation [electric potential] = [power]/[electric current], contains familiar electric and magnetic quantities set along vertical lines and related by the factor (time), magnetic flux being related to energy

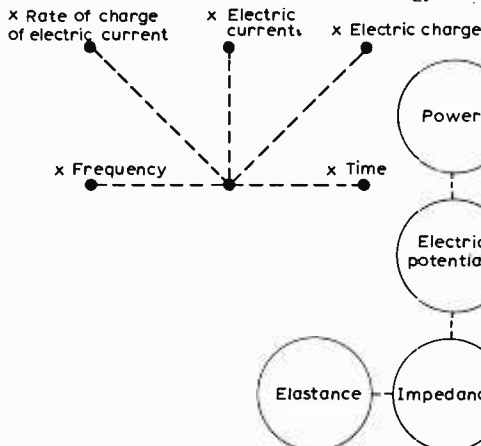

Fig. 6. A plane through the complete display showing relationships between mechanical and electromagnetic quantities. Among the relationships are electric potential = energy/electric charge, and also inductance x rate of change of electric current; magnetic flux = inductance x electric current.

by electric current. This immediately defines magnetic flux within the I⁻¹ plane as [electric potential] x [time] and obviously [magnetic flux density] = [magnetic flux]/[area]. A velocity link is revealed between flux density and electric field strength giving the clue to the standard relation, [electric potential] = [flux density] x [length of conductor] x [velocity], or V = Blv, one of the basic formulae of electromagnetic induction, for a conductor moving normally to a magnetic field.

Dividing the I⁻¹ plane itself by electric current, the I⁻² plane is obtained (Fig. 5), the basic link being [impedance] = [electric potential]/[electric current]. Within this plane, inductance appears as impedance x time, while impedance/time gives the quantity 'elastance', being the reciprocal of capacitance. From the expressions in Fig. 3, Z² = L x 1/C, or Z = (L/C)^{1/2}. Alternatively, 1/C x T² = L, from which T = (LC)^{1/2}, results basic in electronics.

Taking the dispositions of impedance, permeability and permittivity (shown as reciprocals)

$$Z = \mu \times \text{velocity}$$

$$Z = \frac{1}{\epsilon} \times \frac{1}{\text{velocity}}$$

and dividing one by the other gives 1 = μ x ε x (velocity)². Putting μ = μ₀ and ε = ε₀, the constants of free space, the well-known relationship 1/μ₀ε₀ = c² is obtained. The two equations together give Z² = μ₀/ε₀, or Z = (μ₀/ε₀)^{1/2}, and substituting the rationalized values for μ₀ and ε₀ (1.257 x 10⁻⁶ H/m and 8.849 x 10⁻¹² F/m), Z = 376.7 ohms, which is the intrinsic or wave impedance of free space. (This is an example in which the display is used in a non-coherent way, as otherwise the permeability unit would be one henry per metre and the reciprocal permittivity unit one metre per farad. But these are the conditions that would be operative in the unlikely medium having a relative permeability of nearly 800,000 and a relative permittivity of over 100,000 million in which the wave velocity would be down to 1 metre per second!)

Quantity products

A display based on logarithmically-related co-ordinates has other properties, illustrated in Fig. 8. The dimensions of any quantity,

Q₀, positioned on the lattice, are related to pairs of others disposed symmetrically about it, by relations such as Q₀² = Q₁.Q₂ and Q₃.Q₄, etc., from which cross-products involving four quantities can be studied. By equating 'dimensional moments' expressions such as Q₀³ = Q₃.Q₈.Q₁₀ and Q₈.Q₁₂.Q₁₅ can be evolved, and generally a quantity will be the geometric mean of n others

$$Q_0 = (Q_1 \cdot Q_2 \cdot Q_3 \cdot \dots \cdot Q_n)^{1/n}$$

provided

$$\sum_1^n Q_n \cdot x_n = 0 \quad \text{and} \quad \sum_1^n Q_n \cdot y_n = 0,$$

where x_n and y_n are 'dimensional displacements' in powers of the base quantity from Q₀. This may be restated that the algebraic sum of dimensional moments of Q₁-Q_n must be zero about Q₀.

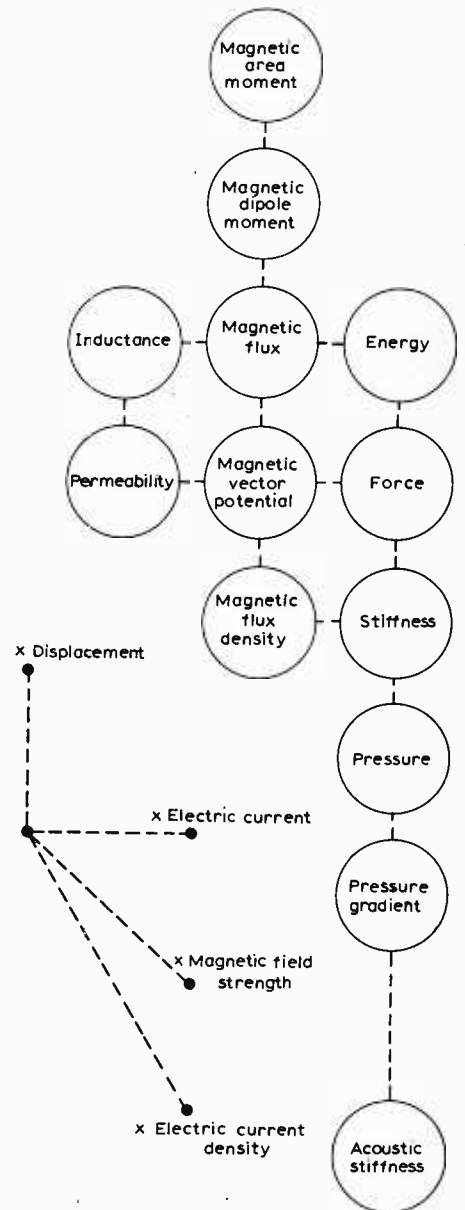

Fig. 7. Another plane through the display illustrating relationships between some of the mechanical and acoustical quantities and all the magnetic quantities. It illustrates, for example, the dimensional equality force = magnetic flux x magnetic field strength.

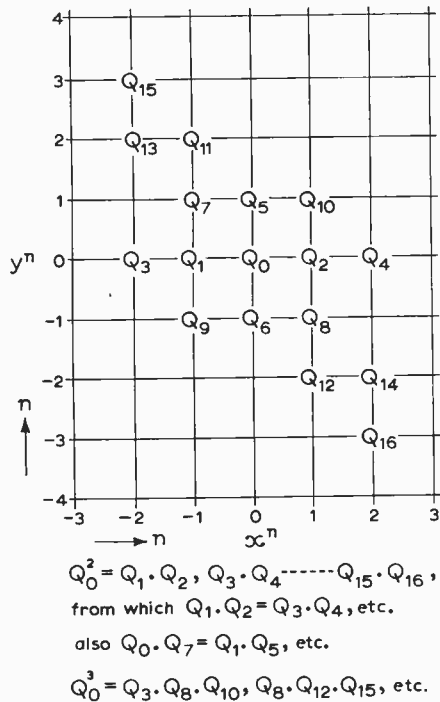

Fig. 8. In conjunction with Fig. 2, this diagram permits evolution of a relationship between three or more suitably disposed quantities. In addition to the types of relationship indicated, others arise if powers of x and/or y are used as multipliers. Thus $Q_0^2 = Q_1 \cdot Q_4/x,$ as $Q_2 = Q_4/x,$ etc.

Equations relating a quantity to three or more others are generally of less interest—for example, is the relation $[(\text{force})^3] = [\text{pressure}] \times [\text{power}] \times [\text{moment of momentum}]$ of special merit?—but those involving three quantities can be very useful, especially for relating quantities remotely disposed on the display. An example is $[(\text{pressure})^2] = [\text{acoustic impedance}] \times [\text{power}]$, or more familiarly, $[\text{power}] = [(\text{pressure})^2]/[\text{acoustic impedance}]$, a derivation of the acoustic Ohm's law, the ratios between quantities being $L^3 T^{-1}$ or 'volume current'. Relating acoustic impedance to energy flux density, it is seen that pressure gradient is at their 'centre of gravity', so that $[\text{pressure gradient}] = ([\text{energy flux density}] \times [\text{acoustic impedance}])^{1/2}$.

Yet another expression involving dynamic viscosity is also apparent from its symmetry with pressure gradient and mass, being $[\text{dynamic viscosity}] = ([\text{mass}] \times [\text{pressure gradient}])^{1/2}$.

Numerous other equalities lie within the mechanical/acoustical plane and you might find it instructive to unearth a selection though, as outlined earlier, it is unlikely to be rewarding if more than three quantities are involved!

Further viewpoints

By examining a horizontal section through energy (Fig. 6) some inter-plane links can be seen, such as electric charge and rate of change of electric current, appearing as diagonal multipliers. From these, such relations as $[\text{energy}] = [\text{electric potential}] \times [\text{electric charge}]$, ($E = QV$) and $[\text{electric potential}] = [\text{inductance}] \times [\text{rate of change}$

of electric current] ($V = L di/dt$), as well as the 'straight through' products, energy = $\frac{1}{2}$ inductance \times (electric current)², power = impedance (resistive) \times (electric current)² arise.

A vertical section taken through energy and magnetic flux (Fig. 7) gives a side-by-side view of magnetic and mechanical/acoustical quantities of the T^{-2} plane, the quadrature links being displacement (length) and electric current, with diagonal multipliers representing magnetic field strength and current density. Here a study of analogies can be undertaken, relating the stiffness and magnetic flux, force with mag-

netic vector potential and energy with magnetic flux, with extensions to permeability and inductance for the latter pairs.

Noteworthy relations in this diagram are $[\text{magnetic flux density}] = [\text{permeability}] \times [\text{magnetic field strength}]$, ($B = \mu \times H$) and that $[\text{force}] = [\text{magnetic flux density}] \times [\text{length of conductor}] \times [\text{electric current}]$ ($F = Bli$), between parallel conductors. Viewing the whole three-plane display from a convenient angle (Fig. 9 and photograph) products involving the diagonal multipliers illustrated in Fig. 10 can be appreciated. For instance, it can be shown that energy = $\iiint E di \cdot dt \cdot dl$ or $[\text{energy}] = [\text{electric field}$

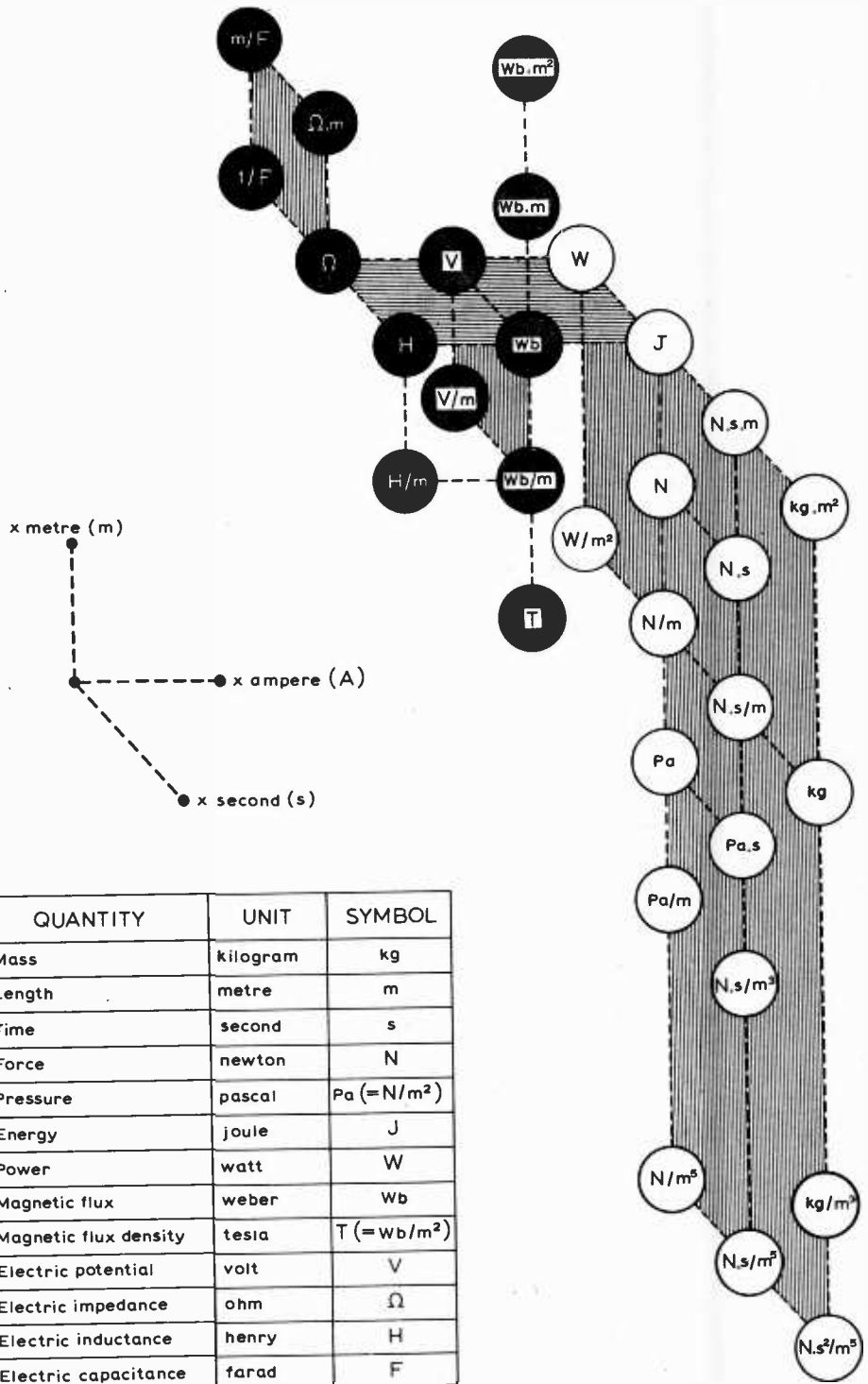

Fig. 9. Overall isometric view of all the displayed quantities, the indicators being their SI unit symbols. Emphasis is directed towards the unit of force, the newton (N), as it is usually preferred as a 'centre' in mechanical and acoustical investigations.

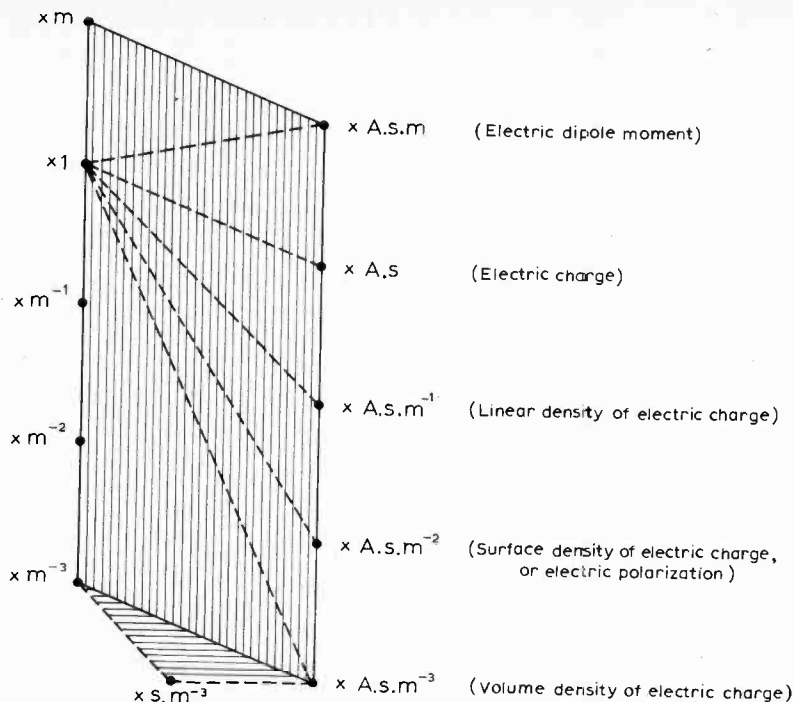

Fig. 10. These multipliers operate diagonally in conjunction with Fig. 9, to reveal relationships not easily appreciated from combinations of Figs 2, 4, 5, 6 and 7.

strength] \times [electric dipole moment], while reverting to a horizontal plane there is the important expression, electric field strength = force/unit charge.

Using all three planes diagonally, the force between electric charges is given by $(1/\text{permittivity}) \times (\text{electric charge})^2 / (\text{length})^2$ while the positioning of magnetic vector potential leads to the equality [magnetic vector potential] = [(mechanical impedance \times electrical impedance)^{1/2}]. A very large number of known relationships should be discovered using the three-dimensional properties suggested by Fig. 8, some well known, others of no direct interest, and others revealing and illuminating. If force is considered analogous to electric potential, then some thought may be provoked by the dimensional quotients [force/electric potential] = [electric potential/permittivity⁻¹] and the parallel set [stiffness/electric field strength] = [electric field strength/elasticity]. Taking velocity as analogous to current, it will be seen that power is similarly related to mechanical and electrical impedance.

The display need not be restricted to an 'in-line' format, although this is preferred to use the electric current link normally. However, some writers³ choose to retain electric charge as a fundamental link between mechanical and electromagnetic quantities; illustrated by shifting the I^{-1} plane one time division to the right and the I^{-2} plane similarly two divisions. All quantities are then related normally by (electric charge)¹ between adjacent planes in the direction towards the mechanical/acoustical plane (e.g. elastance, electric potential and energy). Alternatively, by shifting the I^{-1} and I^{-2} planes in a similar fashion to the left, the normal link becomes rate of change of electric current, di/dt , while lowering the I^{-1} and I^{-2} planes by one and two displacement divisions respectively would give a

normal link representing magnetic field strength (H). Some of these modifications might lead to more convenient exploration of relations and analogies, but experience with the display suggests that no difficulties arise using the electric current link provided the system can be observed from a selection of viewpoints.

Further discussion on other uses of the display, for example the derivation of dimensionless ratios such as the Reynolds and Mach numbers,⁴ and homogeneity checks on differential equations, is perhaps out of place here. But I hope that sufficient introduction to this new display has been given and that it will clarify quantity relationships for the student and also permit easier analysis in professional applications.⁵

Acknowledgement

Thanks to P. J. Baxandall and M. G. Scroggie for helpful criticisms and refinements regarding the display, and to R. C. Driscoll (Polytechnic of North London), for enlightening discussions on the mathematical implications of the system following its initial evolution.

To conclude, I present this integrated display of fundamental quantity relationships as a personal tribute to the giants of science, who have progressively resolved the mechanisms of the physical Universe.

References

1. Baldock, R. N., 'Audio units', Audio Annual 1969 (Link House).
2. British Standard 3763:1970, 'The international system of units'.
3. Carter, G. W., 'The Electromagnetic field in its engineering aspects', 1967 (Longmans).
4. Walshaw, A. C. and Jobson, D. A., 'Mechanics of fluids', 1962 (Longmans).
5. Kapp, R. O., 'Differences of opinion about dimension', *Proc. I.E.E.*, May 1957.

Conferences and Exhibitions

Further details are obtainable from the addresses in parentheses

LONDON

Mar. 14-16 Alexandra Palace
Physics Exhibition
(Inst. Physics, 47 Belgrave Sq, London SW1X 8QX)

Mar. 14-16 Bloomsbury Centre Hotel
Sound '72
(Association of Public Address Engineers, 394 Northolt Rd, South Harrow, Middx. HA2 8EY)

Mar. 22-26 Skyways Hotel
SONEX Audio Exhibition
(Federation of British Audio, 31 Soho Sq, London W1V 5DG)

Mar. 22-29 Earls Court
Electrex '72
(Electrical Engineers (ASEE) Exhibition Ltd, Wix Hill House, West Horsley, Surrey)

Mar. 27-29 Grosvenor House
Coilwinding Convention and Exhibition
(Electromation Exhibitions, 344a Holdenhurst Rd, Bournemouth, Hants.)

BRIGHTON

Mar. 20-24 Exhibition Halls
Oceanology International
(Oceanology International, 6 London St, London W2)

CARDIFF

Mar. 20 & 21 University College
Semiconductor Injection Laser and their Applications
(Inst. Physics, 47 Belgrave Sq, London SW1X 8QX)

CRANFIELD

Mar. 20-23 Cranfield Institute of Technology
Aerospace Instrumentation Symposium
(N. O. Matthews, Dept of Flight, Cranfield Institute of Technology, Cranfield, Bedford)

EDINBURGH

Mar. 27-29 The University
Ferroelectrics and their Applications
(Inst. Physics, 47 Belgrave Sq, London SW1X 8QX)

OVERSEAS

Mar. 9-14 Paris
Festival du Son
(Société pour la Diffusion des Sciences et des Arts, 14 rue de Presles, 75 — Paris XV)

Mar. 12-21 Leipzig
Spring Fair
(Leipzig Fair, DDR-701 Leipzig, Messehaus am Markt)

Mar. 14-18 Hanover
DIDACTA — Educational Materials
(Deutsche Messe- und Ausstellungs-AG, D-3000 Hannover-Messegeleande)

Mar. 15-17 Zurich
Speech, Video & Data Communications Seminar
(Fed. Inst. of Technology, Gloriastrasse 35, Zurich)

Mar. 20-23 New York
IEEE Intercon
(I.E.E.E., 345 East 47th St, New York, N.Y. 10017)

Battery Saving Circuit for Portable Communication Receivers

Switching receiver supply rail with 10% duty cycle from squelch circuit

by D. A. Tong, B.Sc., Ph.D. (G8ENN)

This article is about the technique of switching a receiver on and off rapidly so that anything appearing on a monitored channel would not be missed even though the receiver is off more than it is on, thereby reducing the average power consumption. A saving of at least 90 per cent in power drain can easily be obtained provided the receiver spends most of its time receiving only background noise. For example a receiver can fairly easily be made to be fully sensitive within say 50ms after switch-on so that if the receiver on-period is 300ms, a 10% duty cycle will still allow sampling at intervals as close as three seconds.

In principle the technique has great advantages with miniature battery-operated equipment where battery life is a limiting factor. For example it would allow RAENET* members to be continuously on call from a pocket receiver. For such a technique to be useful, however, a number of problems have to be solved, not least of which is how the device should be

presented to the operator? My answer to this question is summed up in the following specification which refers to the way in which the technique has been incorporated in my portable two-metre transceiver.¹

- In normal operation the receiver should behave as an ordinary receiver so far as the operator is concerned.
- When the squelch threshold control is turned up, so that the receiver is not muted, the receiver should operate continuously.
- For approximately 30s after the squelch circuit mutes the receiver, the latter stays on. If no further signal is received in that time the receiver automatically begins to switch itself off and on for periods of 3s and 0.3s respectively.
- If a signal is received during the on-period, the squelch circuit operates and activates the audio system, at the same time disabling the sampling process.

● The 30s recovery cycle should be initiated also after every release of the microphone switch, and also when the transceiver is switched on by its main switch.

● No audible sign that the sampling is taking place should be present.

As may be appreciated the successful achievement of this specification is an interesting design exercise, especially when the additional constraint is imposed that the power consumption during the receiver off-period should be negligible. Of course, for the system to be of any use the performance of the receiver must not drift in frequency either in the long term or during the first 50ms after switch-on.

The figure shows a circuit which performs the sampling function in my transceiver. It is designed to work with a squelch circuit which gives a sharply defined output transition when a signal is received; in particular, one in which the output is 'high' (i.e., near the supply potential) when a signal is present, and 'low' (i.e., close

*Radio Amateur Emergency Network.

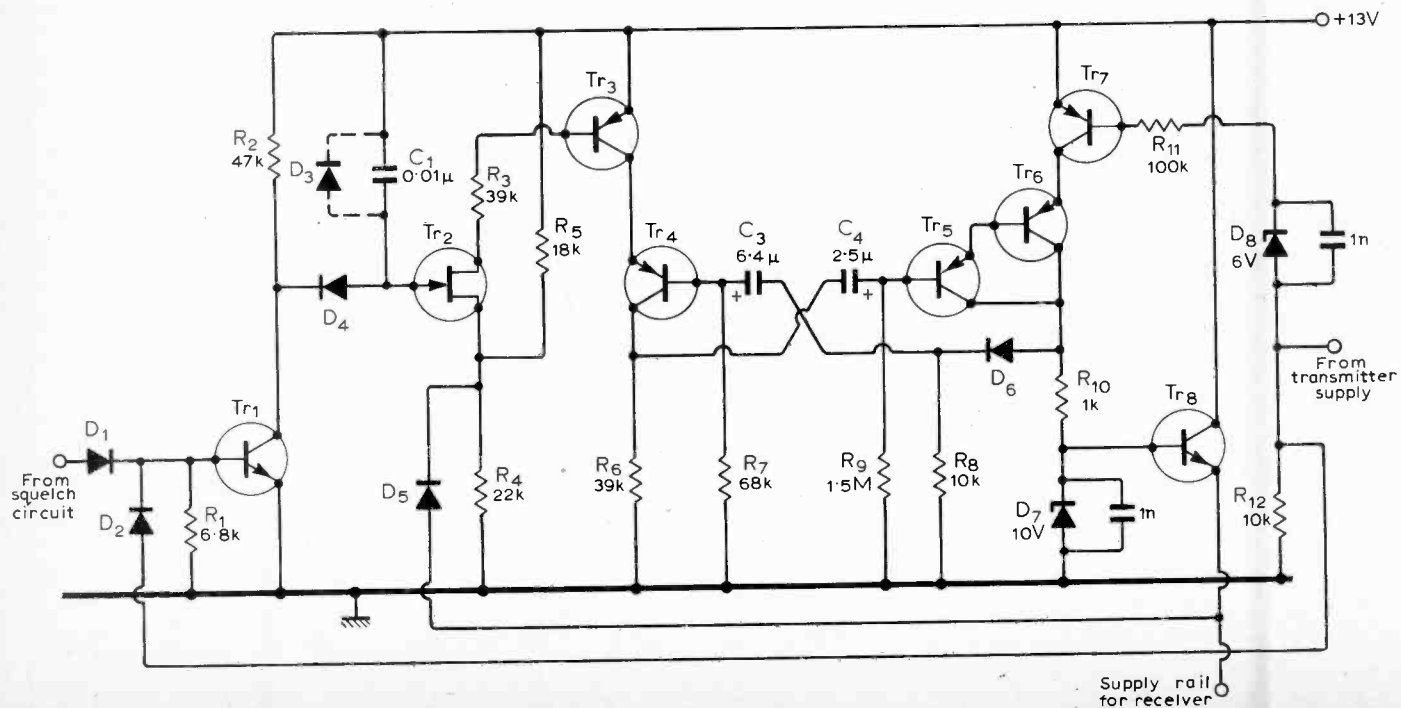

to earth potential) in the absence of a signal. There are two inputs to the unit: the squelch signal and the switched supply rail which operates the transmitter. The only output is a 10-V stabilized supply to the receiver circuitry to be switched on and off. In general this includes all except the pair of complementary output transistors. (The latter will normally pass little or no current if the supply to their driver stage is removed and anyway switching the supply of a class B output stage is complicated by problems with the common impedance of the switch.)

Circuit description

The heart of the circuit is a conventional astable multivibrator comprising Tr_4 , Tr_5 and Tr_6 . Transistors Tr_3 and Tr_7 will for the moment be assumed to be switched fully on. When Tr_5 and Tr_6 conduct, current is supplied to the zener diode D_7 , and Tr_8 acts as a series voltage stabilizer to the receiver supply. The voltage stabilization is a bonus; D_7 may of course be omitted if stabilization is not required. With the component values quoted Tr_6 conducts for about 0.3s and Tr_4 for about 3s. The function of D_6 is to reduce the fall time of the switched supply to the receiver.

If we assume now that the squelch system is producing a 'high' voltage level at the anode of D_1 (i.e. squelch threshold advanced or a signal received), Tr_1 will conduct and capacitor C_1 will be charged to the full supply voltage. The gate-to-source potential of Tr_2 will be $-10V$ because of the connection of its source via D_5 to the receiver supply, and therefore Tr_2 will be off and so will Tr_3 . Under these conditions only the right-hand side of the multivibrator can conduct and therefore the receiver is on continuously. When for any reason the squelch output signifies that the receiver is muted, Tr_1 ceases to conduct, R_2 is isolated from C_1 by D_4 , which is reverse biased, and the multivibrator action remains inhibited — but only for as long as it takes the charge on C_1 to decay enough to allow Tr_3 to conduct again. When Tr_3 begins to conduct slightly the effect is communicated rapidly through to Tr_8 and the receiver supply begins to drop. As it does so, however, the source voltage of Tr_2 also drops and this leads to increased conduction in Tr_3 . The feedback is positive and the effect is to produce a very rapid transition of the receiver supply from on to off. Diode D_5 ensures that no current can flow to the receiver through R_5 .

The time taken for C_1 to discharge is limited only by the value of C_1 and the reverse leakage resistance of D_4 . As very high-value resistors are cumbersome, even if obtainable, further reverse-biased diodes (such as D_3) may be used to modify the discharge time constant.

The full cycle of operation has now been described for the receiver alone. The effect of energizing the transmitter is similar in that Tr_1 is switched on via D_2 and therefore C_1 is charged ready to provide a delay before sampling after the

transmission ceases. In addition however Tr_7 is gated off and therefore the receiver is disabled during transmission. Zener diode D_8 ensures that Tr_7 goes off even though the transmitter supply might be less than $+13V$; i.e. with a 6-V diode the supply will be able to switch off Tr_7 provided it rises to $+7V$ or greater. If R_{12} and R_1 were not present, the current needed to keep Tr_7 conducting during non-transmitting periods would flow out of Tr_7 base and into that of Tr_1 . Thus Tr_1 could never turn off. The values of R_{11} , R_{12} and R_1 (and of course the presence of D_2 and D_8) ensure that this does not happen.

During the receiver off periods the only current-consuming parts of the circuit are the paths through R_3 and R_6 , thus the current wasted is only approximately $500\mu A$. Far lower consumption and smaller size could be achieved using complementary m.o.s. integrated circuits but these are not yet available at suitably low prices. Although the system described is really a collection of logic elements it seems that no other integrated logic families can offer low enough power consumption and high enough impedances to be appropriate to this application.

In using this type of system with a receiver the following points are worth bearing in mind.

- Large time constants must not be used in the receiver, e.g. in the supply decoupling circuits.
- The squelch circuit should not give a transient output when the supply is suddenly applied to the receiver. A suitable circuit has been described previously² and uses a Schmitt trigger circuit to gate an f.e.t. in series with the audio output of the receiver. The output of the trigger circuit is ideal for use with the present device.
- To avoid slight clicks in the loudspeaker of the receiver during sampling transitions the loudspeaker gate previously described³ can be used as the squelch gate either in addition to, or instead of, the f.e.t. in ref. 2.
- No type numbers are given for the bipolar transistors in the diagram but they should be silicon planar types. All diodes are silicon switching types except for the two zener diodes. Otherwise the actual types are unimportant. Similarly any n-channel junction-gate f.e.t. should suffice for Tr_2 . A 2N3819 was used in my circuit.
- Transistors Tr_5 and Tr_6 can be replaced by a p-channel f.e.t. such as the 2N3820. If in addition the f.e.t. has a low I_{DSS} (say 5mA) R_{10} can be eliminated and D_7 will in effect be supplied from a constant-current source and improved voltage stabilization for the receiver will be obtained.

References

1. (to be published shortly in *Wireless World*).
2. D. A. Tong, "Squelch acts faster with f.e.t. gate", *Electronics*, vol. 42 1969 p.96.
3. D. A. Tong, "Loudspeaker transmit/receive switch", *Wireless World*, vol. 76 1970 p.476.

H.F. Predictions March

The Solar Index value used by Cable & Wireless for the preparation of the charts is 48, which is one-third of the range from sunspot minimum to maximum. Despite this low value the recently introduced HPF (highest probable frequency) curves show that there will be days when the ten-metre amateur band will produce excellent contacts with South Africa and South America.

Operating below FOT (optimum traffic frequency) ensures immunity from day-to-day variations and seasonal trends in the ionosphere during the month, but moderate to high power is required to keep LUF (lowest usable frequency) well below FOT.

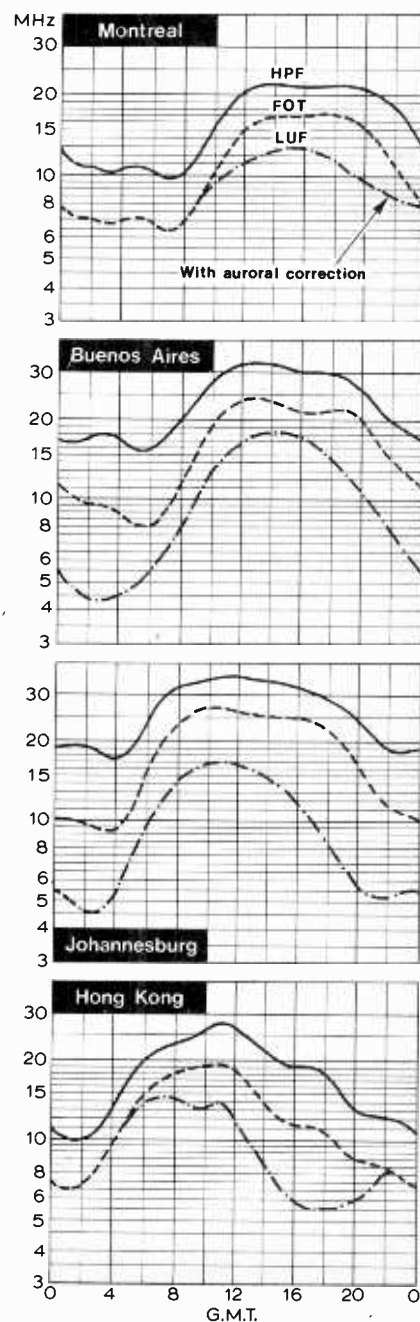

Electronic Building Bricks

21. Units and dimensions

by James Franklin

Originally man encountered natural phenomena as direct sense experience, such as heat, and from such percepts he formed concepts of magnitude, such as temperature, and then found numerical methods of measuring them. Measurement, of course, is a matter of assigning numbers to phenomena by using standard units established for the purpose. Thus a length may be measured as the number of times a standard metre goes into it. The simplest, primary, measurements are made by direct reference to such standards, but there are also secondary measurements, consisting of products or quotients of primary measurements, such as speed = distance ÷ time.

In this series the units we have used for electrical and other physical quantities are SI (Système International) units.* These comprise a small number of 'base' units—actually seven, for length, mass, time, electric current, temperature, light intensity and amount of substance—and other 'derived' units which are formed from these by simple multiplication and/or division. The definitions* of the base units provide the necessary unit standards for primary measurements, while the derived units are for secondary measurements. In the table are most of the quantities we have met so far, plus a few others necessary to explain the relationship of units in the SI system.

In the right-hand column are symbols called the 'dimensions' of the quantities. These can be thought of as roughly analogous to the familiar spatial dimensions of objects, but in fact are not confined to space. Each dimension is shown as a letter, signifying a generalized quantity (e.g. M means mass), with an index number attached.† By means of dimensions any physical quantity, such as power, can be analysed into terms of certain other quantities which have been defined as fundamental, such as (in the case of power) length, mass and time. This can be useful in checking the validity of equations in engineering design.

What do the index numbers mean? Let us consider area, which in SI is measured by the unit the square metre (m^2). This unit is derived from the unit of length, the metre

(m), by multiplying a length by a length; for example $2m \times 3m = 6m^2$. Correspondingly, the dimensions of area are length multiplied by length, $LL = L^2$. Similarly the dimensions of volume are $LLL = L^3$. Thus the index number shows the number of times a dimension is multiplied by itself in a dimensional formula. Where the index number has a negative sign this means, as in algebra, the reciprocal of ... or divide by For example, velocity, as we know, is measured as a length (distance travelled) divided by a time (taken to travel that distance) and dimensionally this is L/T or LT^{-1} .

In the table the derivations and dimensions of some quantities are simple but others depend on knowing the definitions of the units concerned. For example, with electric charge, the coulomb (C) is defined as the quantity of electricity transported in a time of 1 second by a current of 1 ampere, i.e. a coulomb is an ampere second (As), and dimensionally this is current multiplied by time, IT . The unit of force, the newton, is derived from Newton's second law of motion, briefly stated as force = mass × acceleration. Thus the newton is derived from the unit of mass, kg, multiplied by the unit of acceleration, metre per second squared, m/s^2 , and dimensionally mass × acceleration is ML/T^2 or MLT^{-2} . The joule, the unit of energy or work, is defined as the amount of work done when the point of application of a force of one newton is displaced through a distance (length) of one metre—in fact it is a newton metre (Nm). Multiplying the dimensions for force and length, we get $MLT^{-2} \times L = ML^2T^{-2}$.

We can now move into further electrical

units because energy is a quantity common to both electrical and mechanical phenomena. Thus power, the rate of doing work, is measured in joules per second (J/s) which are called watts (W). Dimensionally this calls for dividing by T , which gives for power the dimensions ML^2T^{-3} . The volt, mentioned only qualitatively in Part 5, is defined as the potential difference between two points on a conductor carrying a current of 1 ampere when the power dissipated between them is 1 watt; that is, the volt is the watt per ampere (W/A) under these conditions. The dimensions of voltage (e.m.f. or p.d.) follow from this. Most readers will be familiar with the formula for power in watts as volts × amperes (VA). If the dimensions for p.d. and current are multiplied together the same dimensional formula will be obtained as for J/s.

Finally, the unit of resistance to electron flow (Part 7), called the ohm,‡ is defined as the resistance between two points on a conductor when a p.d. of 1 volt applied to them produces a current of 1 ampere in the conductor; in fact the ohm is the name for the volt per ampere (V/A). Dimensionally this means dividing the dimensions of p.d. by the dimension of current, I , giving $ML^2T^{-3}I^{-2}$.

Note that some measurements, such as amplification (Part 9), are just numbers, ratios or factors, and have no units or dimensions.

‡ After the German physicist Georg Simon Ohm (1787–1854).

(Editor's note. A more extensive treatment of dimensions appears in the article 'Unified Dimensional Display' by R. N. Baldock in this issue.)

Quantity	Unit	Symbol	Derivation	Dimensions
time	second	s	(base unit)	T
current	ampere	A	(base unit)	I
charge	coulomb	C	As	IT
length	metre	m	(base unit)	L
mass	kilogram	kg	(base unit)	M
velocity	metre per second	m/s	m/s	LT^{-1}
force	newton	N	kg m/s ²	MLT^{-2}
energy, work	joule	J	Nm	ML^2T^{-2}
power	watt	W	J/s	ML^2T^{-3}
e.m.f., p.d.	volt	V	W/A	$ML^2T^{-3}I^{-1}$
resistance	ohm	Ω	V/A	$ML^2T^{-3}I^{-2}$

*See British Standard 3763:1970, 'The International System of Units (SI)'.

† Absence of an index number is shorthand for index 1, e.g. $T = T^1$.

White-noise Generator

An inexpensive, digital noise generator having a gaussian amplitude probability distribution

by H. R. Beastall*

One well-known method of measuring the noise performance of an amplifier is shown in Fig. 1. With the noise generator output set to zero, noise generated within the amplifier can then be read. The noise generator output is then increased until the amplifier output power is doubled. The amplifier's internally generated noise is then equal to the externally applied noise, both being referred to the input of the amplifier. While true r.m.s. reading voltmeters are available, they are not found in many laboratories. Rectified average reading meters which are calibrated in r.m.s. quantities for sinusoidal signals are generally available and these read 1.05dB low on noise signals, provided the noise has a gaussian amplitude probability distribution. The noise generated within the amplifier will certainly have this distribution so that, in order to use a rectified average reading meter, the signal from the noise generator should also have a gaussian form.

The author experienced considerable difficulty in using a commercial noise generator for measuring the noise figure of an a.f. amplifier. This was due to the considerable amount of mains frequency power in the (nominally) white noise output. It was therefore decided to design a battery-operated, audio-frequency white-noise generator to produce noise having a gaussian amplitude probability distribution. The cost of the components used was about £20—about one tenth of the cost of a comparable commercial instrument.

There has been considerable interest in recent years in digital methods of generating noise-like signals. A noise waveform can be

TABLE 1

A	B	C	D
1	1	1	1
0	1	1	1
0	0	1	1
0	0	0	1
1	0	0	0
0	1	0	0
0	0	1	0
1	0	0	1
1	1	0	0
0	1	1	0
1	0	1	1
0	1	0	1
1	0	1	0
1	1	0	1
1	1	1	0
1	1	1	1

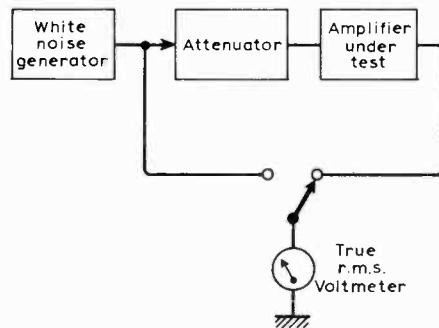

Fig. 1. Measuring amplifier noise.

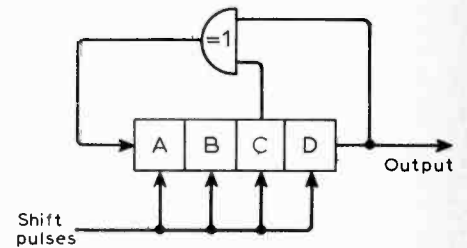
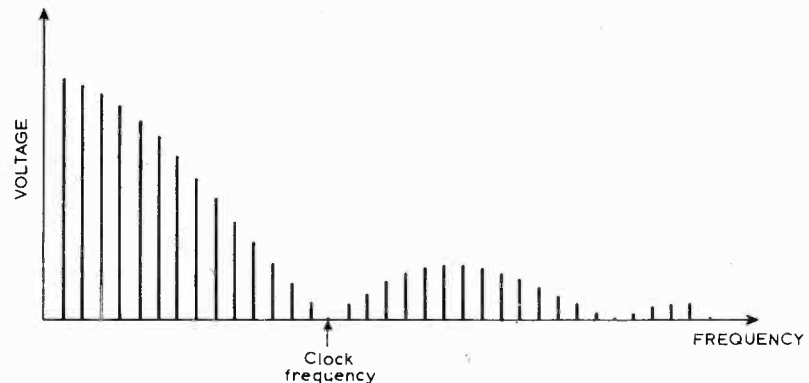

Fig. 2. Four stage maximal-length generator.

Fig. 3. Amplitude (voltage) spectrum of rectangular waveform of binary sequence generated by the system shown in Fig. 2.



considered as a sequence of randomly chosen values, hence a sequence taken from a table of random numbers can be considered as digital noise. These numbers can be expressed in binary form and it is in this form that digital noise generators usually produce their outputs. Many digital noise signals are based on maximal-length sequences, which are generated using feedback shift registers. Consider a 4-stage shift register connected as in Fig. 2, so that its input is obtained from an exclusive-OR gate driven from the two final stages. Table 1 shows the list of states, starting from 1111, as the register is clocked. Note that after 15 clock pulses the sequence repeats. Column D gives the output sequence. Since it repeats, it has a line spectrum with a line spacing of one fifteenth of the

clock frequency. The spectrum is shown in Fig. 3.

The noise generator uses a similar combination of shift register and exclusive-OR gate to generate a binary noise signal but, in this case, the register is 31 stages long and the exclusive-OR gate is driven from stages 3 and 31. The sequence produced by this arrangement is 2,147,483,647 clock periods long and, even with the 900kHz clock frequency used, the sequence does not repeat for almost 40 minutes. Thus, although this signal also has a line spectrum, the line spacing is now 1 cycle per 40 minutes or about 7×10^{-6} Hz. This is so small that most systems see the signal as having a continuous spectrum.

So that the binary noise shall be converted to a signal having a gaussian amplitude probability distribution, it must be

*Derby and District College of Technology.

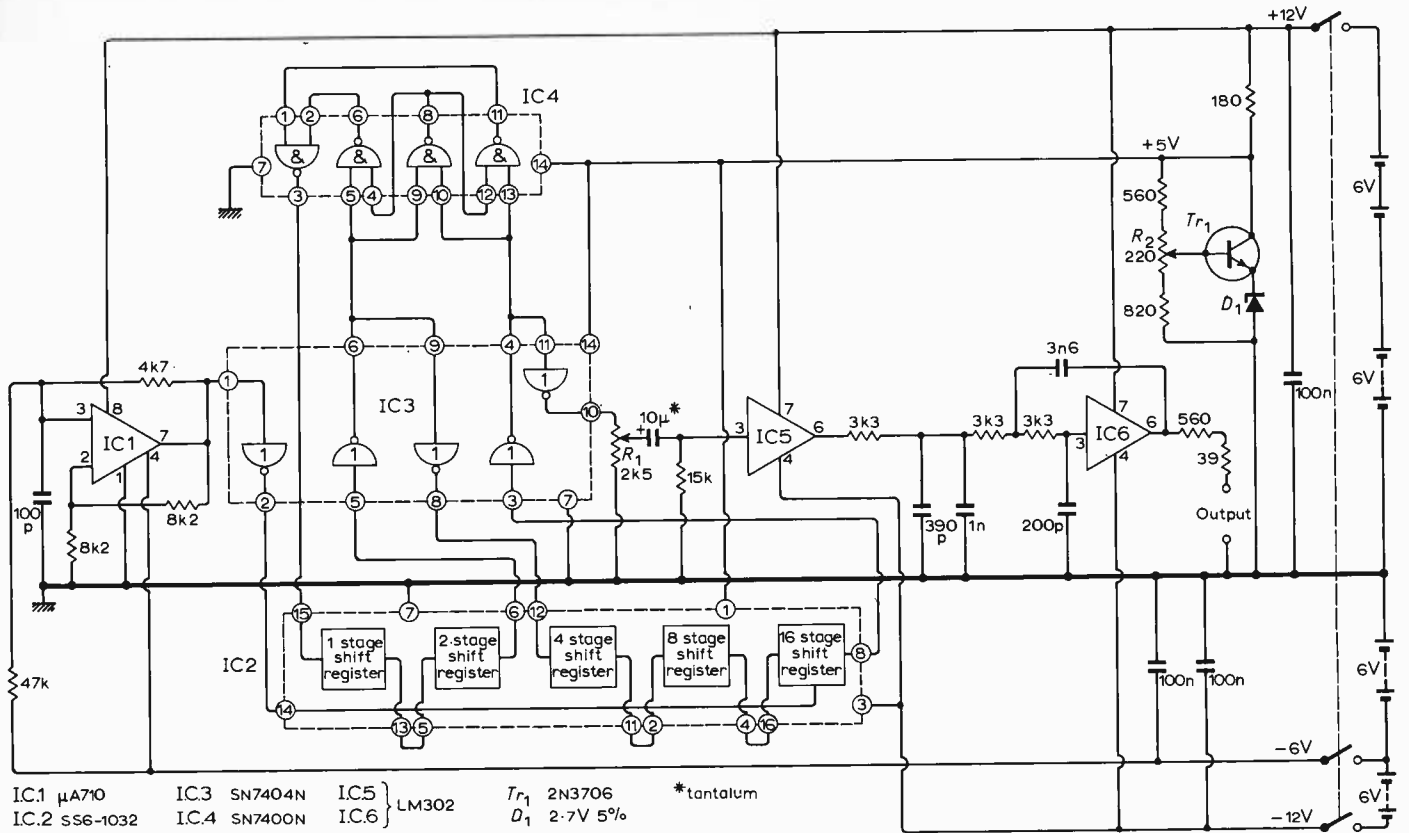

Fig. 4. Circuit diagram of the noise generator. All resistors are 2% metal oxide. All capacitors (with the exception of the 100nF decoupling capacitors) are 1% silver mica, unless shown.

filtered. It can be shown that a gaussian signal can be produced by adding together a large number of statistically independent binary signals. It can also be shown that the signals existing in the register at any one time are statistically independent. Thus, in order that the filter shall produce a gaussian signal, its impulse response should be negligible for times greater than the total delay time of the register. A suitable filter has a third order maximally flat (Butterworth) response with a cut-off frequency of approximately 50kHz so that the filtered signal can be considered as white noise to 50kHz with an 18dB/octave roll off above this frequency.

Circuit details

A circuit diagram of the noise generator is shown in Fig. 4. Integrated circuit IC₁ is a 710 comparator used as a 900 kHz square-wave oscillator. This provides the clock pulses to the shift register, IC₂. This integrated circuit consists of six shift registers in one package. There are two single stage registers and one each of lengths 2, 4, 8 and 16 stages. They share common clock signals and supply lines. One of the single-stage registers is not used in this instrument. The remaining five registers are connected as a three-stage register and a 28-stage register in cascade.

Integrated circuits IC₃ and IC₄ are standard t.t.l. integrated circuits used for buffering and for the exclusive-OR gate. The binary noise signal is developed across the output level control, R₁, from which it passes to a voltage follower buffer amplifier, IC₅. This amplifier is necessary to provide a

low impedance feed to the active filter built around another voltage follower, IC₆. The output impedance is padded to 600 ohms by the output resistor. The t.t.l. and m.o.s. integrated circuits require a 5-V supply and this is obtained from a regulator transistor Tr₁, and its associated components. Potentiometer R₂ is adjusted so that the collector voltage of Tr₁ is 5V. Four 6-V batteries supply the power.

Construction is not critical and the prototype was made on Veroboard. The interconnection of the shift register stages is rather complicated and it was found better to cut away the Veroboard completely from this region and make the connections from pin to pin, using tinned copper wire, which should be fairly stiff.

The LM 302 voltage follower integrated circuits are rather expensive and 741 operational amplifiers connected as voltage followers could be used in their place. Incidentally, 709 operational amplifiers are not suitable as they have a tendency to 'latch-up' if they are used in the voltage follower mode.

Appendix

Measurement of Amplifier Noise Figure

One definition of noise figure is:

$$F = \frac{\text{signal-to-noise power ratio of ideal system}}{\text{signal-to-noise power ratio of actual system}}$$

The noise from the noise generator can be

regarded as a signal applied to the amplifier. Hence, when the noise generator doubles the amplifier output power, the signal-to-noise power ratio is unity. Thus, the noise figure is given by:

$$F = \text{signal-to-noise power ratio of ideal system.}$$

In an ideal system the only source of noise is the input resistor, R_s. If the noise at the amplifier input due to the noise generator is e_s millivolts, then

$$F = \frac{e_s^2}{4kTR_s\Delta f}$$

In this case R_s = 600 ohms and Δf, the noise bandwidth, is 50kHz. Hence:

$$F = \frac{e_s^2}{0.48 \times 10^{-6}}$$

F is often expressed in decibels:

$$F = 20 \log_{10} e_s + 63.2 \text{ dB.}$$

In practice it is difficult to measure e_s because of its very low level. The noise at the input to the attenuator will usually be measured (Fig. 1). If this voltage is e_s' and the attenuation is KdB then

$$F = 20 \log_{10} e_s' + 63.2 - K \text{ dB.}$$

The first term in this expression is the voltmeter reading in dB relative to 1mV in 600 ohms. Many millivoltmeters have such a scale. If a rectified average reading meter is used, the noise figure is increased by 1.05dB over that calculated by the above formula.

A Survey of Stereo Cassette Tape Recorder Decks

Part one of a two part article commenting on three different sorts of tape, two noise reduction systems and some high-quality cassette tape decks

by Brian Crank*

We have broken with recent practice in presenting this set of test reports which review some of the best cassette tape decks that are, or soon will be, available on the British market. (There is one exception to this, an American machine which is not yet imported although we understand that there are plans to produce a 250V, 50Hz, version.) Our object is to help the reader decide if a cassette recorder is likely to provide the standard of performance he or she requires. It would be totally unfair to condemn a machine on the results of our measurements because we have tested only one sample of each model. If we had tested several samples, and had obtained consistent results, we would then be able to say which was the best and which was the worst; this we have not done.

We have tried to be constructive rather than destructive. We have included a section on using a cassette recorder with the object of helping the reader to obtain consistently good results from a machine. Different sorts of tape give very different results and to illustrate this measurements have been made using standard ferrous oxide tape and the new chromium dioxide and cobalt tapes. Other measurements on the compatibility and performance of the Doby-B noise reduction system and the National NED system are included.

Throughout our tests we have had a chance of comparing, side by side, a wide variety of different machines. It soon became obvious that certain basic features should be included in every machine and that some models had controls which made handling difficult. We have made some suggestions on these points.

Finally we feel that the standard of performance which will be obtained by the individual user will depend on his ability to use the machine. If the user is non-technical this ability will depend entirely on the guidance given in the instruction manual. We have therefore extended brief criticism to these manuals.

High-quality cassette tape decks

Manufacturers of the cassette tape decks we have tested are to be congratulated on two counts. First, for obtaining the quality of reproduction they have from a tape one-eighth of an inch wide with four tracks on it and travelling at only one and seven-eighth inches per second (housed in a cassette which cannot be called a precision item by any stretch of the imagination). And secondly, for maintaining high engineering standards; some of the machines were very well constructed (examples are given in Figs 1, 2 and 3).

When it is considered that a cassette tape deck may contain up to 50 transistors and a good many diodes with all the associated components, a precision tape transport mechanism and may require more than 20 electrical adjustments alone we do not think that they are generally over priced. Indeed it is difficult to see how the machines can be mass produced.

Most of the machines we tested when properly maintained and used with first quality cassettes will provide a sound quality which will satisfy the majority of people if not the extreme audio purists. The emphasis, however, is on proper maintenance and a section will be included giving advice on how to obtain consistently good results.

You will be able to decide from our report which machine offers

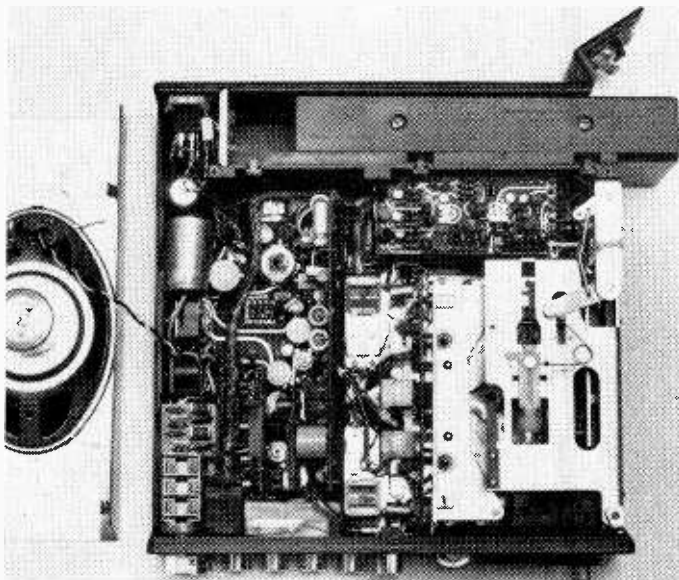

Fig. 1. Uher have achieved a very high packing density with their model 124 which is the only machine we tested with an internal loudspeaker and a.f. power amplifier. The battery compartment at the rear can house a variety of power sources.

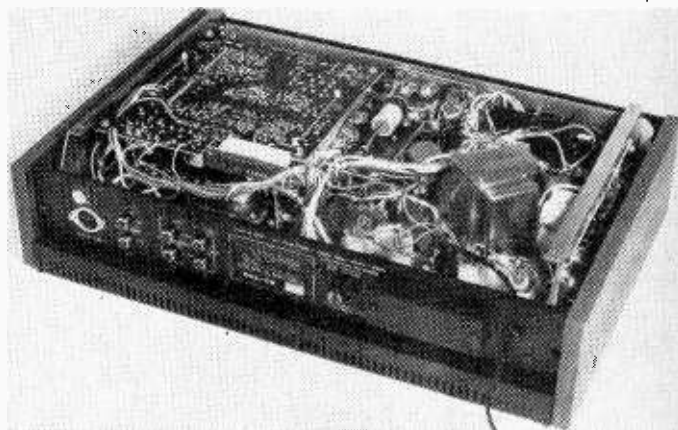
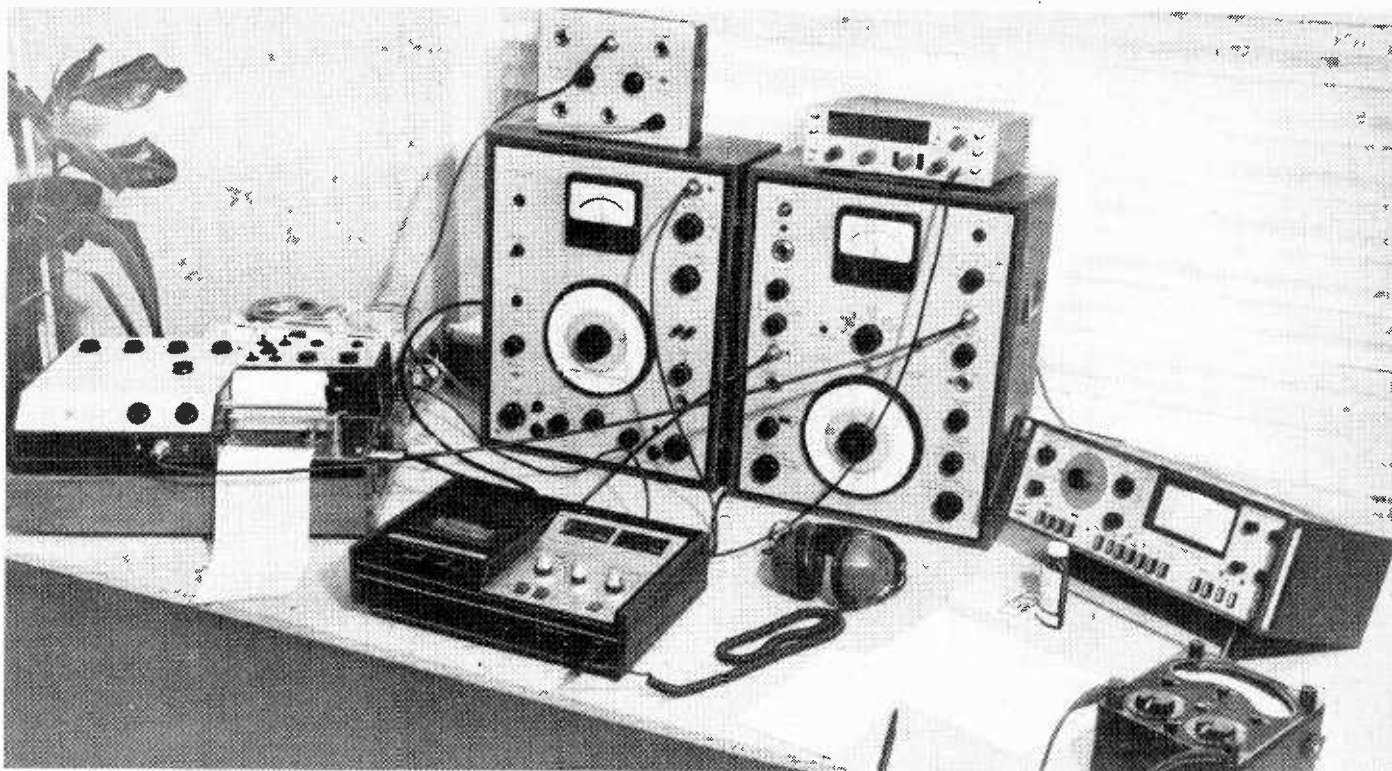

Fig. 2. Sansui SC700. The large printed circuit on the left together with the tape transport mechanism, which is mounted underneath, and the Dolby circuit card, which can just be seen mounted vertically on the right-hand side of the mechanism underneath the main circuit board, is the Nakamichi assembly common to four of the machines we tested. The board on the right (not common to other Nakamichi machines) contains two a.f. amplifiers which are intended to drive headphones and a circuit which disconnects the drive mechanism should the drive motor stall.



The test set-up we used. The two small units at the top are the B & K 4409 automatic start unit (left) and the Marconi Instruments TF2411 counter/timer (right) which are standing on the B & K b.f.o. type 1022 (left) and the B & K spectrum analyser type 2107 (right). The B & K 2305 chart recorder is on the left and behind it is a fairly old Stella tape recorder which was sometimes used as an amplifier to drive the 4409. On the right is the Ferrograph tape recorder test set type RTS1 and a model 8 AVO. The recorder being tested is the Sansui SC700.

the facilities you require. The tests we have carried out will give you the performance of the single sample we tested. We also carried out a listening test to try to find out how a representative cassette recorder matched a similarly priced reel-to-reel machine as far as sound quality goes. It was impracticable for us to carry out comparative listening tests on all the machines.

Ferrous oxide, chromium dioxide and cobalt tapes

These are the three main types of tape that are available (or soon will be). Ferrous oxide tape has been with us for a long time now and is well known. Throughout this report it is referred to as standard tape.

Chromium dioxide tape gives an improved high-frequency response and lower noise when used on a machine equipped with the proper equalization. Readers may be interested to learn of the effect of recording on chrome tape when using standard (iron) tape equalization. Using the Bell and Howell recorder we recorded two frequency sweeps (using a B & K Laboratories b.f.o. and chart recorder) on chrome tape; one using the correct equalization and another with standard tape equalization. The result can be seen in the upper two curves of Fig. 4; the unequalized response rises sharply above 1.5kHz.

We played the unequalized tape back through a tuner/amplifier (Bang & Olufsen 3000) and tried to equalize the response using the amplifier's tone controls; the lower two curves show that we were fairly successful ($\pm 2\text{dB}$). It would seem that the use of chromium dioxide tape even on recorders equipped for only standard tape has advantages as far as high-frequency response and lower noise are concerned if treble cut is used on playback.

The new cobalt (high-energy) tape is interesting in that it is the only cassette tape, as far as we know, which has a coating on the back. This coating is electrically conductive and prevents a build-up of static charges which normally tend to make the layers of tape adhere to one another, contributing to wow and flutter. The coating also has a lubricating effect on fast wind and lessens the chance of damage to the back of the tape. The magnetic coating on the front of the tape is made up of iron oxide and cobalt. We have not been able to find out from 3M if there are two separate layers or a single layer of a cobalt/iron mixture.

We recorded a steady 1kHz tone on five cassettes (BASF chrome, BASF standard LH, Scotch cobalt, Scotch standard Dynarange, and EMI standard). We played these cassettes back via a chart recorder to see the level fluctuations caused by the tape. The Scotch products did not come out as well as the others in this test. We returned the cobalt cassette to 3M for examination and they said that the cassette we had used was faulty.

We tried the cobalt tape on three machines to measure the frequency response; you can see the results of two of these tests in Figs. 5 and 6. In Fig. 5, on the Bell and Howell, the output is seen to fall below standard tape at the higher frequencies but on the Uher a higher output is maintained throughout the spectrum. We have been told that a cobalt demonstration cassette sounded very good on a Philips machine but very poor on a Wharfedale. We listened to the same cassette on a Bell and Howell and the results were again poor. The difference could be a question of head alignment as an error of three to four minutes of arc can destroy the high-frequency performance.

We carried out listening tests, mainly intended to compare a cassette recorder with a similarly priced reel-to-reel machine. We also recorded a short piece of music on each of the three types of cassette tape and these were listened to in turn. We will publish full details of how the tests were carried out in the second part of this article. Suffice it to say here that we had two listening panels, one expert and the other made up from people with no special knowledge of good-quality audio equipment. The experts were asked to assess the performance of each cassette and place it in one of the following categories: excellent, good, fairly good, rather poor, poor, very poor.

When analysing the results we scored zero for each person's lowest choice, the other tapes being allocated one point for each category they were above this lowest choice. For instance, if tape A was rated as poor, tape B as good and tape C as fairly good, A scored 0, B scored 3 and C scored 2. There was no measure of agreement as the results given in Fig. 7(a) show. If the scores are added up cobalt tape comes out best with standard and chrome tapes coming a fairly close second.

Our 'novice' panel was asked to list the tapes in order of preference. (Fig. 7(b) shows that again cobalt tape was preferred.)

The two tests were carried out separately and the listeners did not know what type of tape they were hearing.

Noise reduction systems

The majority of the cassette tape decks tested employ the Dolby-B noise reduction system which operates by raising the level of quiet high-frequency signals on record and attenuating them, and the noise, on playback. The effect of the Dolby system is illustrated in Fig. 8. The curves were obtained by playing back noise from a blank tape on a typical machine through a spectrum analyzer and recording the result on a chart recorder. The upper curve was made with the Dolby system switched out and the lower one with it switched in. The improvement ranges from almost zero at 630Hz, 7dB at 2kHz, to 10dB at 10kHz.

One of the basic ideas behind the cassette is uniformity in that a tape recorded on one machine can be played back on any other. A tape recorded on a machine with the Dolby system switched in strictly has to be played back on another machine which is also equipped with the Dolby system so the uniformity of the cassette system is destroyed.

To illustrate this we recorded five frequency sweeps on the

Harman Kardon, reducing the input by 10dB in between each sweep. The Dolby system was switched in. We played back the sweeps with the Dolby switch in, Fig. 9(a), and with it out, Fig. 9(b). Clearly the Dolby system is not compatible. To say it is would be to negate the efforts of cassette recorder manufacturers to produce machines with flat frequency responses whatever the subjective effect. It is important to note that the system is not compatible because Fig. 9(a) differs considerably from Fig. 9(b).

Other methods of noise reduction have been proposed which operate on playback only. One machine we tested, the National, was fitted with such a system, called NFD (noise free device).

To test this system we recorded four frequency sweeps reducing the level by 10dB between each sweep and played them back with the NFD switched out, Fig. 10(a), and with it in, Fig. 10(b). Because these two graphs differ it must be concluded that the NFD system is *not* compatible either. At least one can achieve noise reduction with the Dolby system and still leave the original signal more-or-less the same as it was.

The Dolby system is incompatible because it is not a standard although most of the new generation of machines have the Dolby system fitted. It would appear that now would be a good

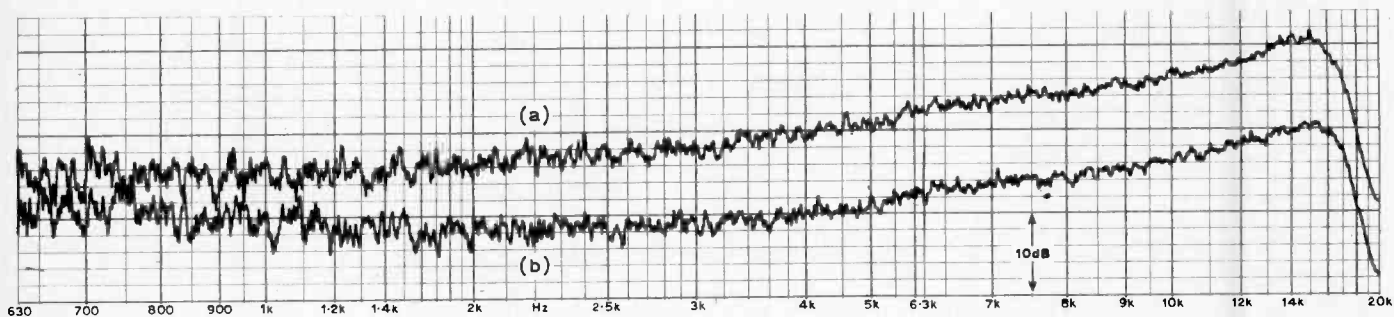

Fig. 8. Tape noise played back via a spectrum analyzer and chart recorder with (a) the Dolby system out, and (b) with it in.

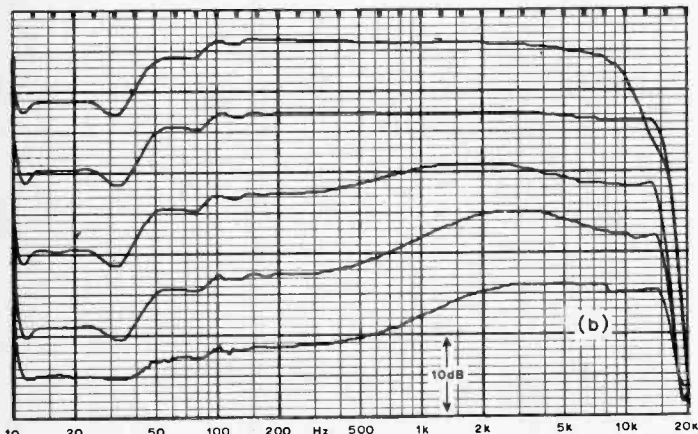

Fig. 9. Frequency sweeps recorded in 10dB steps with the Dolby noise reduction system switched in and played back with it in (a), and with it out (b).

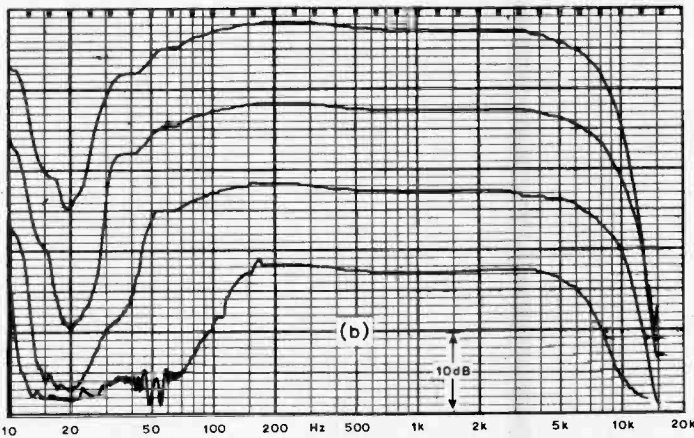
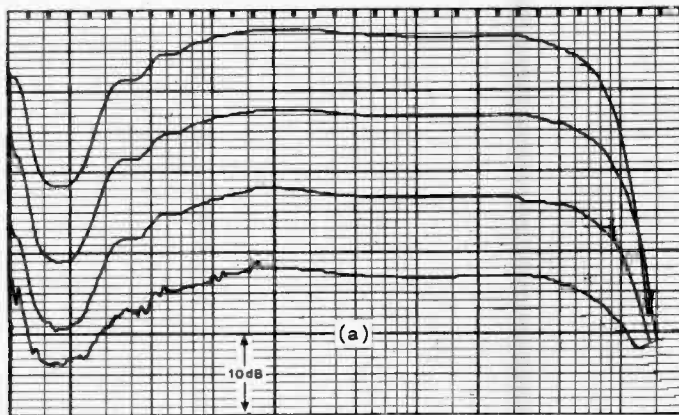

Fig. 10. Frequency sweeps recorded in 10dB steps and played back in (a) with the National NFD system out and (b) with it in.

time to establish the Dolby system as a cassette standard. Older machines, with their poorer high frequency performance, would probably benefit from the extra top lift on Dolby cassettes.

Acknowledgement

This survey was made possible by B & K Laboratories, Ferrograph and Marconi Instruments who lent us test equipment. We would also like to extend our thanks to BASF (U.K.) and the 3M Company who supplied cassettes; to Highgate Acoustics; Hart, Browne and Curtis; Rank Wharfedale; Unamec; Uher and Vernitron who supplied the recorders to be tested; to Shure and Tandberg who supplied equipment for the listening tests and to Dolby Laboratories for the assistance they gave us.

Test procedure

Every recorder was subjected to the same test sequence under identical conditions. In every case BASF LH tape was used for the standard tape measurements (all the cassettes were supplied by BASF from the same production batch) and BASF chrome dioxide tape for the chrome tape measurements. A photograph of the test set-up is shown on page 131.

The test sequence was as follows:

Amplitude/frequency curves: Two frequency sweeps, one in each channel, were recorded at -10VU from a B & K Laboratories b.f.o. type 1022 driven by a B & K 2305 chart recorder. The tapes were played back via an amplifier (B & K 2107 spectrum analyzer switched for linear operation) which drove the chart recorder to produce two curves which show frequency/amplitude response and channel balance.

Crosstalk and 0VU response: Using the same equipment as above a sweep of 0VU was recorded in the left channel and was followed by a 0VU sweep recorded in the right channel. The left channel was then played back to produce a curve corresponding to the 0VU frequency/amplitude response and played back again to produce a curve corresponding to the left channel output when a frequency sweep at full recording level is recorded in the right channel. During the recording of the last sweep the left hand record-level control was turned down.

All four of the above curves were produced on the same chart. If the recorder was equalized for standard as well as chrome tape the procedure was repeated for each tape type and a separate chart produced.

To interpret the frequency amplitude response curves remember that the top curve is an 0VU signal in the left channel, the next two curves are the left and right channel at -10VU and the bottom curve is crosstalk relative to the top 0VU curve.

Recorded signal at 3kHz: A 3kHz signal from the b.f.o. type 1022 was recorded on the tape and played back through a B & K 2107 spectrum analyzer and the 2305 chart recorder. The major peak on the charts (obtained for both chrome and standard tape for every recorder) is, of course, the 3kHz fundamental. A small peak sometimes can be seen at 6kHz but this is usually masked by the skirt of the 3kHz peak. The major harmonic distortion is seen to occur at the third harmonic (9kHz). The gap in the curves occurs as the spectrum analyzer changes ranges at 6.3Hz. In the test reports these curves are mounted below the frequency/amplitude response curves.

Total harmonic distortion: Measured using the Ferrograph tape recorder test set type RTS 1. A 1kHz signal was recorded. On playback the RTS 1 filters out the fundamental and measures what remains (hum, noise, harmonic distortion etc.) and displays it as a percentage of the filtered out fundamental.

Signal-to-noise ratio: A 1kHz signal was recorded on the tape at 0VU for a short period then the signal was removed and the recording level controls turned down with the machine still in the recording mode. On playback the noise was measured with reference to the 0VU 1kHz signal. The RTS 1 was used for this measurement.

Wow and flutter: Measured with the RTS 1, the figure quoted is a peak value weighted according to the DIN standard 45507.

Bias oscillator frequency: Measured using a miniature Marconi Instruments counter/timer type TF2411.

CrO₂ Erase: Measured as for signal-to-noise ratio using chrome tape after an 0VU 1kHz signal had previously been recorded on the tape.

Input for 0VU: With the machine in the record mode and the recording level control at maximum the r.m.s. input voltage (at 1kHz) which was needed to bring the recording level meter to 0VU was measured.

Output: A tape was recorded on the machine at 0VU (1kHz) and played back. The voltage available from each output was measured with the output level control (if fitted) at maximum.

Rewind time: Time taken to rewind a BASF LH cassette, size C90.

Test reports: In the reports which follow all the figures given are as measured by us.

Advent 201

Total harmonic distortion, 1.6%: Signal-to-noise ratio, Dolby out 46dB, Dolby in 50dB: Wow and flutter 0.17%: Bias oscillator frequency 104.6kHz: CrO₂ erase 50dB: Input for 0VU, phono L-36mV R-36mV: Output L-400mV R-410mV: Rewind 1m 5s: Dimensions 351 × 236 × 120mm: This recorder is not available in the U.K., American price \$280.

The Advent 201 is built round the American Wollensak (3M) tape transport mechanism which has controls differing somewhat from the other machines tested. Forward and reverse fast wind is controlled by a lever which is moved sideways in the direction it is wished to move the tape. It is necessary to hold this lever in position during winding operations as it does not lock; this is inconvenient. The play, record and stop buttons are heavy in operation and have a 'loose before becoming stiff' feel. The three lever switches Dolby on/off, chrome/standard tape and meter switching also have a heavy feel. Three record level controls, a mono/stereo rocker switch, a rather stiff pause control, and a power on/off switch, complete the controls provided on top of the machine. The single large (64mm) VU meter is controlled by a three position lever switch which is labelled channel A, channel B and higher of A or B. There is one rotary recording level control for each channel and another rotary level control which affects both channels at the same time. This system allows balance to be accurately set and also makes for easy fading.

A recess at the left hand side of the machine houses an output level control, input/output phono sockets, a +18V supply socket intended for an external microphone pre-amplifier (an extra), and a

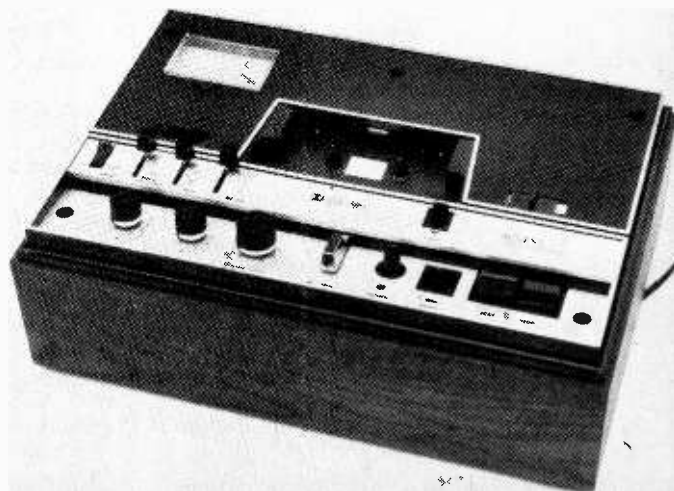

Advent 201

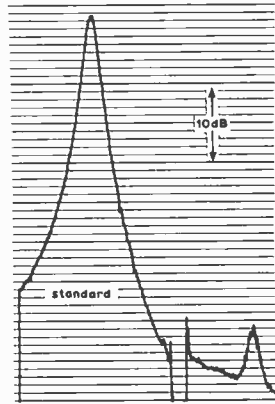
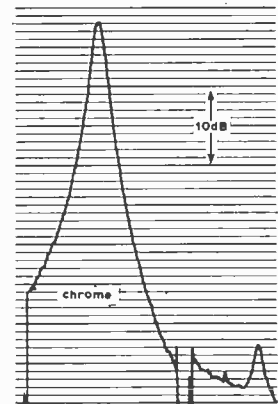
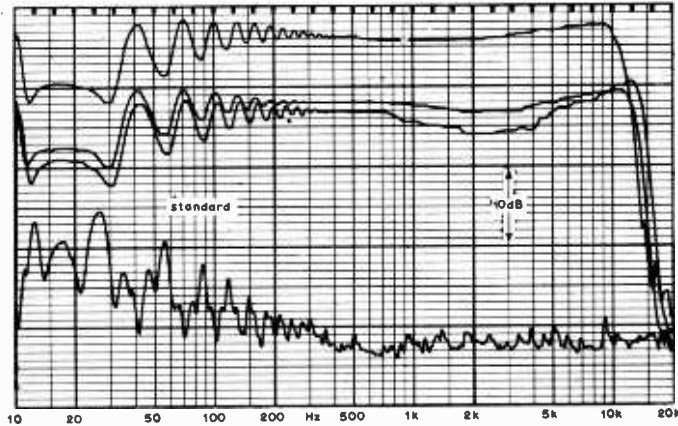
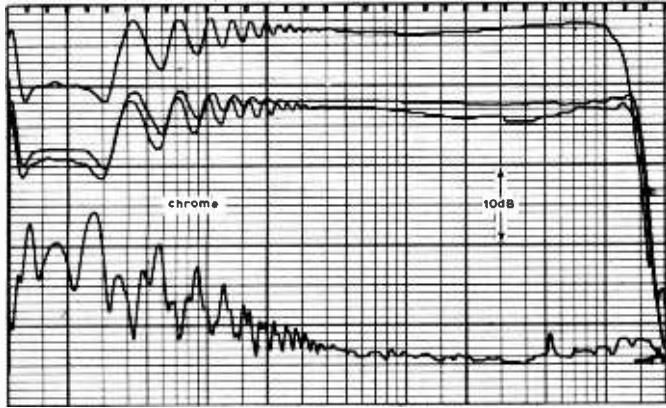

push button which controls an internal oscillator for calibrating the Dolby system. Another recess at the rear of the machine gives access to the Dolby record calibration presets while the playback presets are on the underside.

The machine has a good high-frequency performance, as can be seen from the frequency/amplitude curves, although the bass response is a little peculiar, the undulations being due to the geometry of the record/playback head. The channel balance when using standard tape could be a little better. All other aspects of the machine's performance are good and the mechanical parts seem to be very robust.

More attention should have been paid to the appearance of the machine as the various shaped knobs and switches give it an extremely untidy appearance. An internal microphone pre-amp should have been provided. A DIN input/output socket would have been useful and a cover should have been provided for the cassette compartment to prevent ingress of dust. The instruction manual is good and gives some useful recording hints. Part of the final production testing is to record, direct from a mastertape, a chrome cassette. This recorded cassette is supplied with the machine and shows the owner what can be achieved with his machine and sets a target for his own recording efforts. This is an excellent idea. The machine also comes complete with a head-cleaning cassette.

Akai GXC-40D

Total harmonic distortion 1.7%: Signal-to-noise ratio 43dB: Wow and flutter 0.18%: Bias oscillator frequency 59.6kHz: CrO₂ erase 40dB: Input for 0VU, phono L-52mV R-52mV, DIN L-5.2mV R-5.2mV, microphone L-0.2mV R-0.2mV: Output, phono L-0.95V R-0.99V, DIN L-270mV R-295mV: Rewind 1m 22s: Dimensions 412 × 222 × 122mm: Price £87.50.

A good machine which is spoiled by the low signal-to-noise ratio; some of this noise is made up of hum which could no doubt be eliminated. Continuing to look on the debit side the capacity to erase chrome tape is not high enough and the erase oscillator frequency is on the low side. Also, why include a gimmick like the 'over level suppressor' (o.l.s.) switch when the money could have been spent on a stereo/mono switch which the machine lacks? The o.l.s. is a compressor circuit that limits accidental high-level input signals to prevent over modulation of the tape.

Looking on the credit side the machine has a good tape transport mechanism with light controls that have a pleasant 'silky' feel. The motor is an outer rotor synchronous type. Wow and flutter figures compare fairly favourably with the other machines tested. A new type of head is employed, constructed of glass and ferrite, that gives an extremely good frequency response and is claimed to have over one hundred times the life of conventional heads. The tape transport mechanism is controlled by five keys (record, rewind, stop, play and forward wind) and two circular push buttons (pause and eject). One can go straight from,

Akai GXC-40D

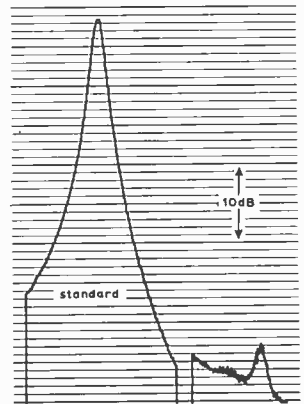
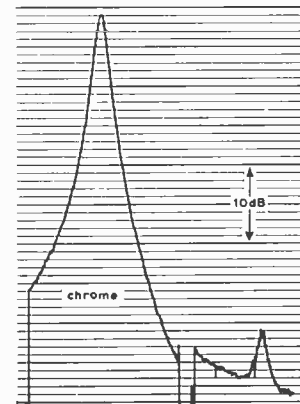
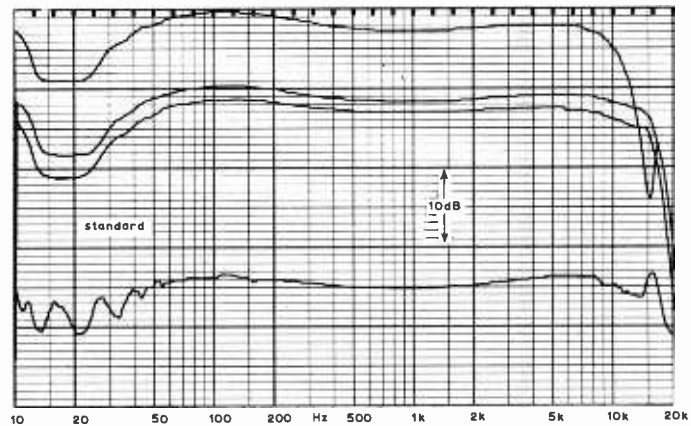
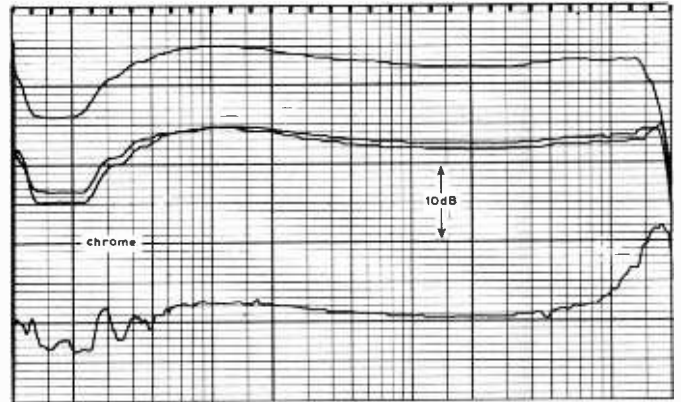



say, 'record' to 'rewind' without having first pressed the stop button.

Other controls and indicators on top of the machine include a standard/chrome tape equalization switch, the o.l.s. switch, two smooth, long, slider recording level controls, twin VU meters, a tape position counter, the power switch and a record warning light. On the front are two jack sockets for microphones and a monitor output socket for headphones (a good point). At the rear of the machine one finds the phono and DIN input/output sockets, a fuse, and a mains voltage selector which allows the machine to be used on any of six voltages from 100 to 240V, 50 or 60Hz. A control to vary the output level on the rear of the machine would have been a useful addition.

The instruction book is very explicit and is well illustrated. The machine comes complete with a circuit diagram; a practice which other manufacturers of domestic electronic equipment should follow.

If the various small points we have mentioned were rectified and if something is done about the signal-to-noise ratio this would be a good machine, particularly when one considers the price.

Bell and Howell DES 1700

Total harmonic distortion 4.4%: Signal-to-noise ratio, Dolby out 47dB, Dolby in 52dB: Wow and flutter 0.13%: Bias oscillator frequency 104kHz: CrO₂ erase 44dB: Input for 0VU, DIN L-29mV R-29mV microphone (DIN) L-0.2mV R-0.2mV: Output L-1.1V R-1.1V: Rewind 2m 10s: Dimensions 372 x 221 x 110mm: Price £109.75.

The Bell and Howell DES 1700 is manufactured in Japan by Nakamichi Research Incorporated and incorporates the Nakamichi tape transport mechanism and electronics. The tape deck, record-playback amplifiers, line amplifiers and some other circuitry are manufactured as a single unit. This unit is fitted to a number of the machines tested (these can be easily recognized merely by looking at the characteristic frequency response),



Bell & Howell DES 1700

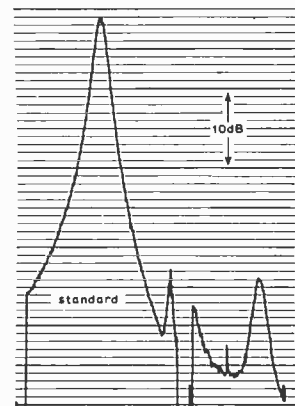
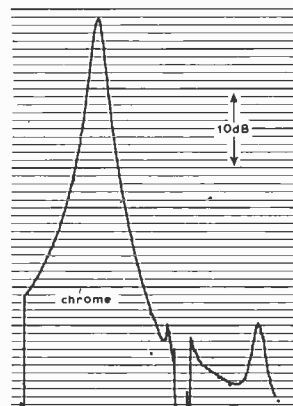
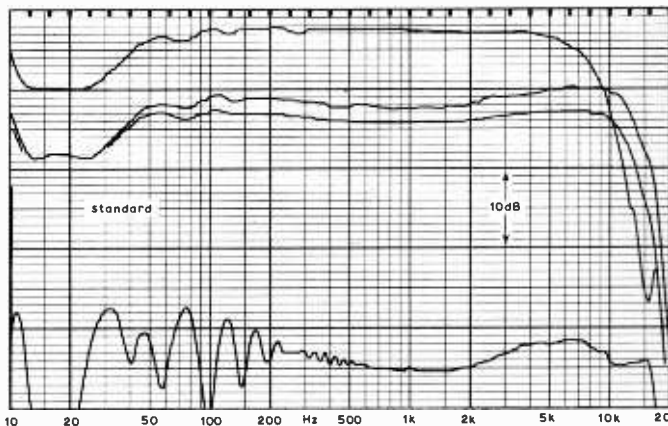
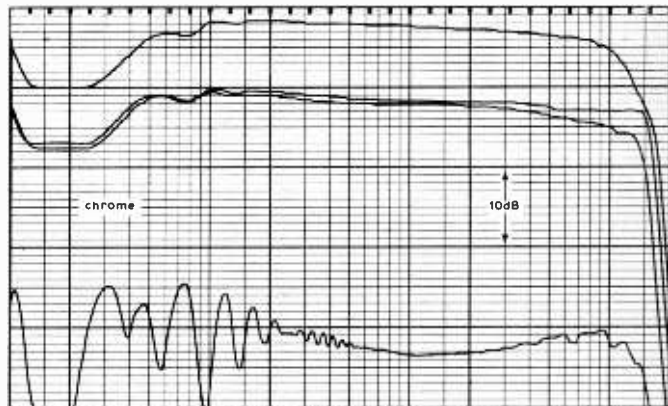

therefore, comments made on the Bell and Howell tape transport apply equally to all of the other machines incorporating the Nakamichi deck.

The deck is easy to use and all the controls are fairly smooth in operation. The exception is the record lever, which, after reading all the warnings about how easy it is to damage the delicate mechanism, is so stiff on first pressing it one expects something to break; one soon gets used to this. The deck performs well and the wow and flutter figure is very good. This machine is the only one which was not lent specially for the tests (it belongs to a member of the staff) and it is interesting to note that the wow and flutter figure has improved with use (from about 0.16%). This improvement with running-in could well apply to the other machines tested. The CrO₂ erase figure is not good enough and the harmonic distortion is too high (could be due to wrongly set bias or a too narrow head gap). Frequency response is good although the channel balance could be better for standard tape.

All the controls on the Bell and Howell are mounted on the vertical front panel. Four push-button switches select power on/off, Dolby in/out, stereo/mono and chrome or standard equalization. It is sometimes difficult to see exactly what is selected (although little green indicator lamps help for the Dolby and power switches); rocker or toggle switches would have made things clearer. Another warning light shows when the machine is in the record mode. The vertically mounted, rather short track,

slider recording level controls make it rather difficult to make a smooth fade. The two VU meters are not illuminated (a bad point) and cannot be read from any distance at all. A DIN microphone socket (jacks are more convenient and almost standard) complete the front panel equipment.

On the rear of the machine there is the DIN input/output socket (the addition of phono sockets would have made the machine more versatile), an output level control, and access to the Dolby record and playback preset potentiometers. We note that there is a blank space on one of the printed circuit boards marked 400Hz oscillator. The printed wiring is there but no components. The oscillator would be used for calibrating the Dolby circuits. Perhaps Bell and Howell, Dolby Laboratories or Nakamichi might supply a circuit and connection details so that Bell and Howell owners with the necessary knowledge could add a Dolby test facility to their machines? There is plenty of space on the rear panel for the switch.

The Bell and Howell instruction manual is the worst we came across. It adequately covers the operation of the machine and describes the Dolby system but omits to mention vital things like input voltage range, output voltage range and the sensitivity or impedance of the microphone socket. Faced with these omissions the owner would not know what kind of microphone to buy. We have already given the voltage information, the impedances are as follows: Microphone 600Ω, DIN input 100kΩ, DIN output 5kΩ.

This is a good machine but like the rest could have been improved at negligible extra cost if more attention had been given to detail. The machine is very good value for money and can be highly recommended.

Harman Kardon CAD-5

Total harmonic distortion 1.6%: Signal-to-noise ratio, Dolby up 50dB, Dolby in 53dB: Wow and flutter 0.13%: Bias oscillator frequency 103.6kHz: CrO₂ erase 46dB: Input for 0VU, phono low L-195mV R-195mV, phono high L-600mV R-610mV, microphone L-0.2mV R-0.2mV: Output L-1.1V R-0.96V: Rewind 2m 5s: Dimensions 320 × 227 × 84mm. Price £145.

This is another machine produced by Nakamichi Research containing basically the same transport mechanism and electronics as the Bell and Howell with a few additions. Most of the comments made on the performance of the Bell and Howell apply to the Harman Kardon. If you look at the frequency response curves you can see the resemblance.

The sloping front panel of the Harman Kardon makes for easy handling. There are three unambiguous rocker switches for power on/off, Dolby in/out, and mono/stereo. The recording level controls are of the slider type and operate in conjunction with the twin VU meters. Four warning lights are incorporated — record (indicates when the tape is running), overload (lights when overload occurs), Dolby on indicator, and power indicator. Two microphone jacks are fitted to the front of the machine. At the rear there are six phono sockets, one pair each for high- and low-level input signals and another pair for the output. There is no output level control and it is probable that some amplifiers might

Harmon Kardon CAD-5

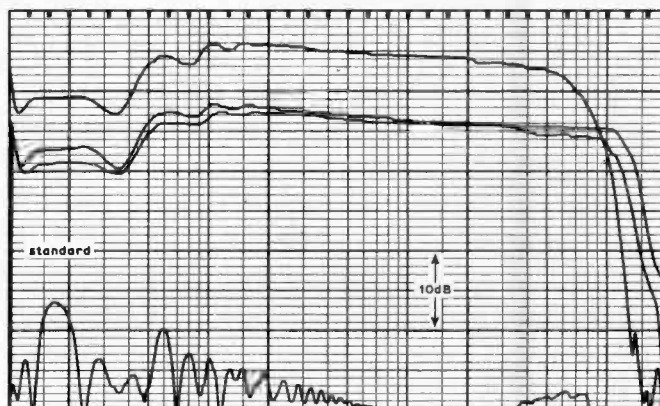
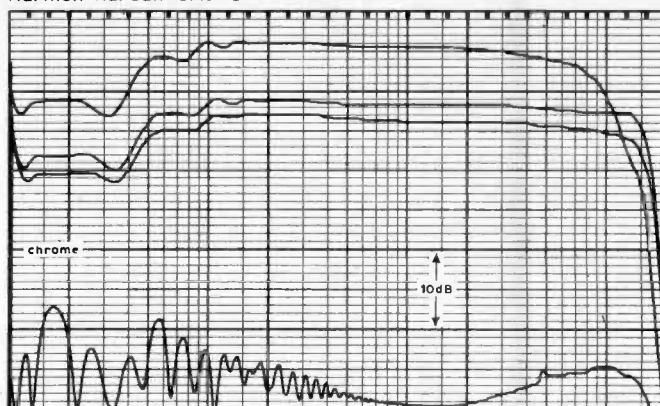

10 20 50 100 200 Hz 500 1k 2k 5k 10k 20k

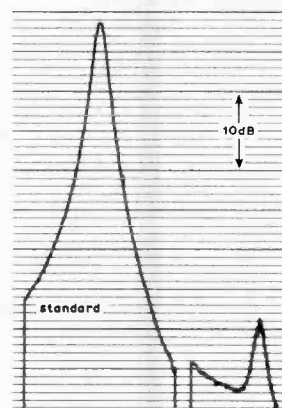
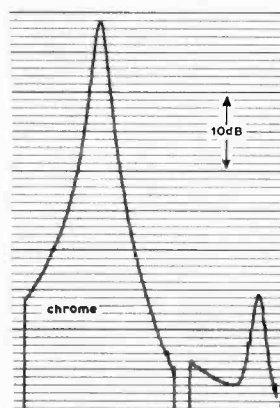

be overloaded with the volt or so that is available at the output. After using rocker switches on the front panel Harman Kardon lower their standards and use a push-button switch for chrome/standard tape equalization selection situated, unusually, at the rear of the machine. Until one becomes familiar with the machine it is impossible to tell quickly which standard is selected. Another push-button on the rear of the machine switches on an internal oscillator for calibrating the Dolby system when changing between different types of tape.

The instruction book is comprehensive and contains some very useful recording and cassette handling tips.

In summing up the same comment that was made for the Bell and Howell regarding details applies. In particular it would have been an advantage to replace the rather superfluous overload indicator with a preset, adjustable, output level control and we would also like to have seen a DIN output/input socket included.

The concluding part of this article will contain test reports on the National R-275-U, Sansui SC-700, Teac A-350, Uher 124 and Wharfedale DC9. We will also be giving advice on getting the best performance from a machine and the results of a listening test which compared cassette and reel-to-reel recorders.

Variable Pulse-rate Generator

A simple circuit to give a p.r.f. approximately proportional to V/RC

by D. T. Smith*

The circuit was developed for an application where a series of pulses was required whose mean frequency could be set manually over the a.f. band, and the frequency then modulated by an applied voltage. The circuit is simple and economical, and as it uses only one RC time constant the switching needed for wideband use is simple. It is potentially useful for a variety of applications where a variable pulse rate is required at a low or medium frequency. The circuit may be modified to provide a linear ramp.

Principle of operation

The basic circuit is shown in Fig. 1. Suppose initially point A has a negative bias, then Tr_1 and hence Tr_2 and Tr_3 will be cut off. Current fed from V_{in} via R_7 , R_{11} and R_4 will discharge C so that the point A bias will gradually rise towards V_{in} . As A passes $+V_{be}$ (the bias needed to make Tr_1 conduct) Tr_1 will start conducting and feed current to the base of Tr_2 , so that Tr_2 will conduct and feed current via R_3 and C back to the base of Tr_1 . The regenerative feedback loop switches Tr_1 and Tr_2 hard on, and Tr_2 switches Tr_3 hard on and shorts out the source of current from V_{in} . The transistors stay on while C can supply enough base current to keep Tr_1 conducting. When C has charged, Tr_1 is left without a source of base current and Tr_1 and hence Tr_2 and Tr_3 are turned off. At the end of the conduction period A is held near zero and point B

is held near +5 V. Just after the conduction period R_5 and R_6 will pull B to near zero, so A falls to nearly -5 V. Current is again fed from V_{in} and the cycle repeats. Fig. 2 shows an oscilloscope display of the waveforms at A and B.

Frequency of operation

The periodic time is made up of two components—the main part τ_1 while C is discharging towards V_{in} and a short fixed circuit recovery time τ_2 while C recharges and the transistors are on.

The discharge (shown in Fig. 3) is an exponential decay with time constant $R'C$ where $R' = R_4 + R_{11} + R_7$.

$$\begin{aligned} \tau_1 &= R'C \log_e \left(\frac{V_{in} - v_s}{V_{in} - v_{be}} \right) \\ &= R'C \log_e \left(1 + \frac{v_b}{v_a} \right) \end{aligned}$$

where v_b is fixed by the supply voltage and transistor characteristics, and v_a varies with V_{in} . When

$$V_{in} \gg v_s, \frac{v_b}{v_a} \ll 1 \text{ and } \log_e \left(1 + \frac{v_b}{v_a} \right) \approx \frac{v_b}{v_a}$$

$$\text{so } \frac{1}{\tau_1} \approx \frac{1}{R'C} \cdot \frac{v_a}{v_b} \approx \frac{1}{R'C} \cdot \frac{V_{in}}{v_b}$$

Fig. 4 shows a graph of $\frac{v_a}{v_b}$ plotted against

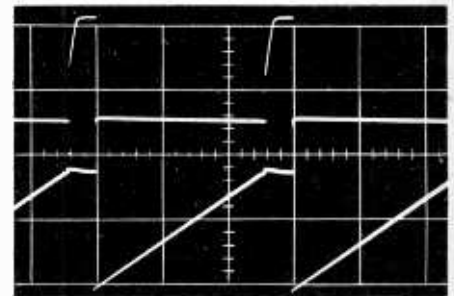

Fig. 2. Waveforms at A (lower) and B (upper), at 2 V/cm and 2 ms/cm.

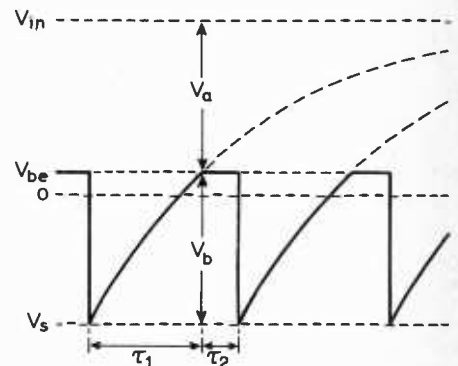

Fig. 3. Waveform at A.

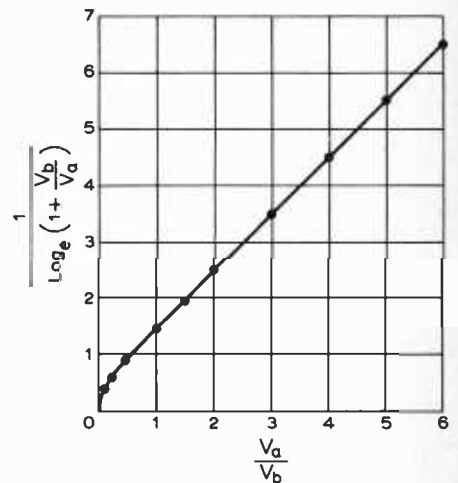

Fig. 4. Variation of $\frac{v_a}{v_b}$ against $\frac{1}{\log_e \left(1 + \frac{v_b}{v_a} \right)}$

Note the linear relationship over most of the range.

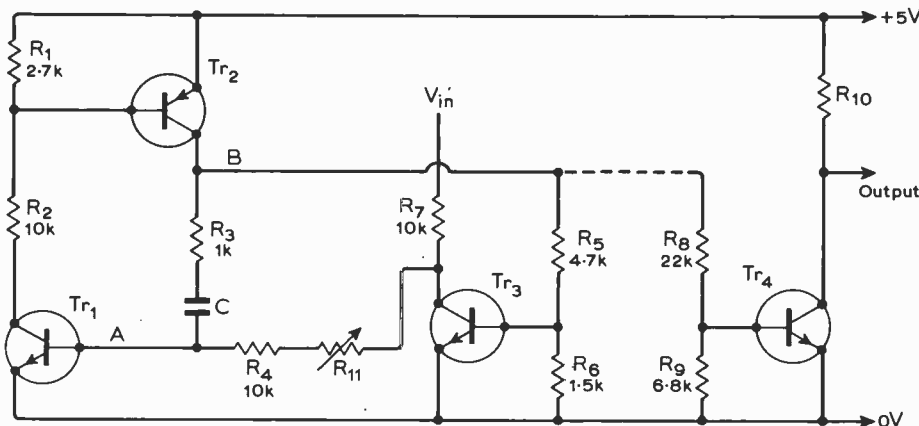

Fig. 1. Basic circuit— Tr_4 is an optional output stage. Tr_1, Tr_3, Tr_4 any low power n-p-n silicon planar transistor. Tr_2 any low power p-n-p silicon planar transistor.

* Clarendon Laboratory, Oxford

$$\frac{1}{\log_e \left(1 + \frac{v_b}{v_a} \right)}$$

showing that over a good range there should be an approximately linear variation of $1/\tau_1$ with V_{in} .

The circuit recovery time τ_2 depends on the time constant R_3C , and also on the transistor characteristics, so that $\tau_2 \approx 7R_3C$

$$f = \frac{1}{\tau_1 + \tau_2}, \text{ so if } \tau_1 \gg \tau_2$$

$$f \approx \frac{1}{\tau_1}$$

so that
$$f \approx \frac{1}{R'C} \cdot \frac{V_{in}}{V_b}$$

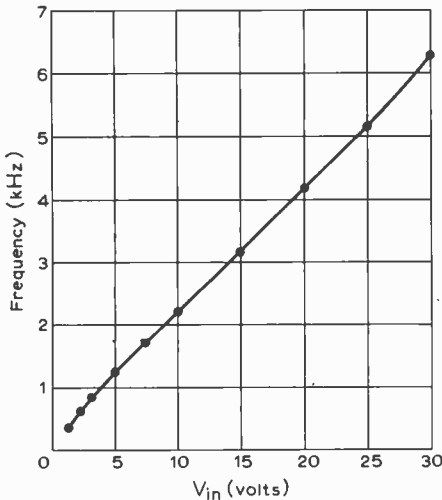

Fig. 5. Variation of frequency with V_{in} ($C = 0.01 \mu F$, $R' = 100 \text{ k}\Omega$).

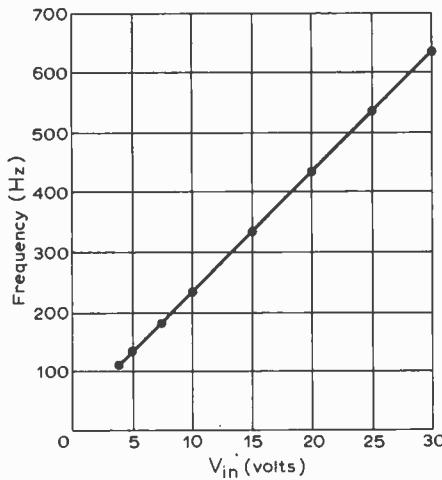

Fig. 6. Variation of frequency with V_{in} ($C = 0.01 \mu F$, $R' = 1 \text{ M}\Omega$).

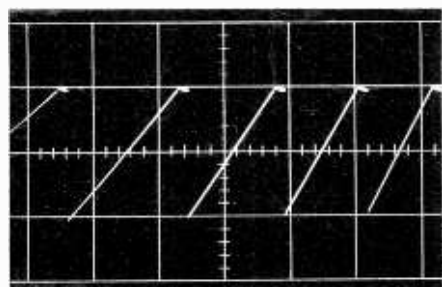

Fig. 7. Waveform at A when V_{in} is a l.f. linear ramp.

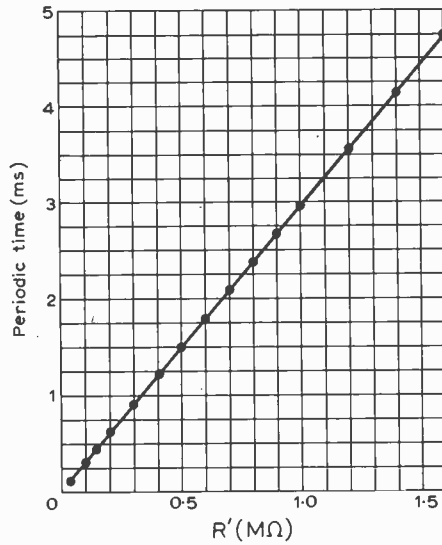

Fig. 8. Variation of periodic time with R' ($C = 0.01 \mu F$, $V_{in} = 15 \text{ V}$).

Performance

Figs. 5 and 6 show the measured variation of frequency with V_{in} at two values of R' . These show a reasonably linear variation in good agreement with theory. Fig. 7 shows an oscilloscope display of the waveform at A when V_{in} is being swept linearly to produce a frequency modulated output.

Fig. 8 shows the measured variation of periodic time with R' , which is linear in agreement with theory.

The frequency range can be extended up to about 100 kHz by reducing C but as the transistors are driven into saturation, hole storage limits the minimum circuit recovery time τ_2 and sets a useful upper limit to the frequency. The frequency range can be extended downwards *ad lib* by increasing C , which should have a low leakage; this makes most electrolytics unsuitable.

The optional output stage Tr_4 may be used as a buffer and will give a clean negative-going output pulse of duration τ_2 .

Modification for linear ramp

If a linear ramp is required, the circuit may be modified as shown in Fig. 9. A constant

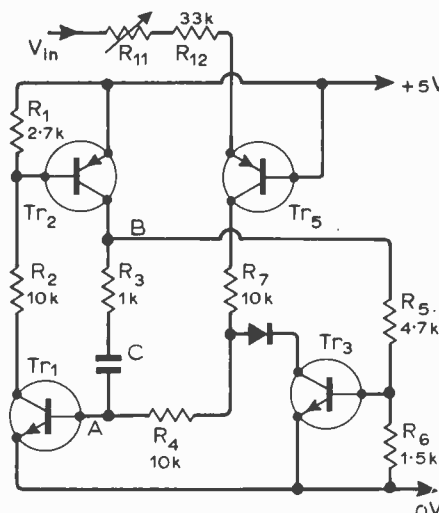

Fig. 9.

current generator Tr_5 replaces the simple resistive feed to C so that the discharge is changed from exponential to linear.

$$\text{The current feed } I = \frac{V_{in} - v_c}{R''}$$

where $R'' = R_{11} + R_{12}$

and $v_c = 5V + v_{be}(Tr_5) \approx 5.6 \text{ V}$.

$$\text{so } \tau_1 = v_b \cdot \frac{C}{I} = R''C \frac{v_b}{(V_{in} - v_c)}$$

$$\text{giving } f \approx \frac{1}{R''C} \left(\frac{V_{in} - v_c}{v_b} \right) \text{ provided}$$

$\tau_1 \gg \tau_2$.

Nearer the Tubeless TV Camera

The latest advance in RCA Laboratories' long programme of work to develop a solid-state television camera* is an experimental integrated-circuit sensor using m.o.s. techniques. Constructed by a research team led by Paul K. Weimer, it has 1,408 photo-sensitive elements laid out like a ladder with 32 rungs of 44 elements each. Light focused through a camera lens onto this structure produces at each element a positive electric charge whose magnitude varies in direct proportion to the intensity of the light.

The ability of the device to store and move the charges in sequence at television scanning rates is due to a technique of charge transfer first reported in 1969. It was found then that a row of transistors, each associated with a passive component, could be made to pass discrete amounts of electric charge along from transistor to transistor like water along a 'bucket brigade'.† Since m.o.s. transistors are produced in silicon, and since silicon is known to be photosensitive, it was decided to investigate whether an m.o.s. integrated 'bucket-brigade' array could be used.

The experimental device contains a shift register which selects the 'rungs' of the ladder to be read out in sequence, one line at a time, to form the television video signal. The 'bucket-brigade' process is effected by clock pulses that raise the potential of each photo-sensitive element in proper sequence so that the charge flows, or 'falls', into the next element, which is at a lower potential. The device is said to be more sensitive and to produce a more uniform picture than earlier solid-state image sensors because the charges from each element pass through a single output terminal whose capacitance is no more than that of each elemental capacitor. RCA claim that it is capable of taking recognizable pictures, 'especially of alphanumeric characters'. To reach broadcast picture standards an array containing about 500,000 photo-sensitive points is needed.

* See *Wireless World*, January 1967, p.12

† See *Wireless World*, May 1970, p.242

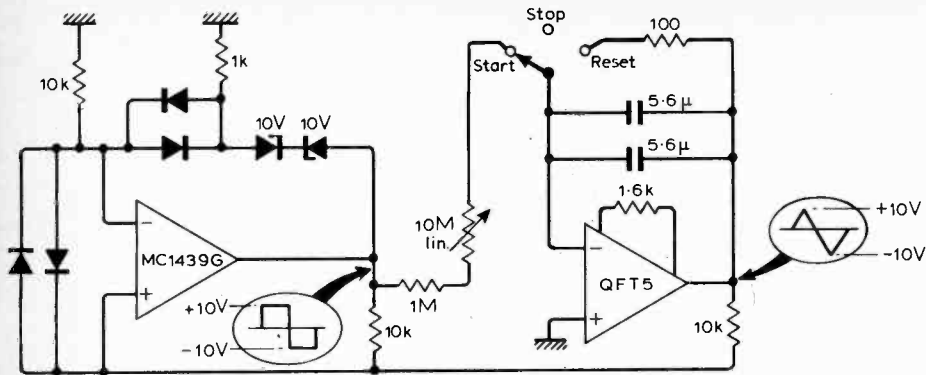

circuit can also be stopped at any point along the slope, positive or negative, of the triangular wave, then either continued from this point or reset. A Philbrick/Nexus QFT-5 was used as the second amplifier because of its high impedance f.e.t. input, necessary for good linearity.

N. S. Nicola,
Geneva,
Switzerland.

High impedance input protection at microvolt level

A very low level of voltage limiting is provided by the circuit shown — several tens of microvolts at an input resistance of the protected input of over 100kΩ and an internal resistance of the signal source less than 100MΩ. When the input voltage, V_1 , is low, it is amplified insufficiently by the differential stage (Tr_3 , Tr_4 and CA3015) to switch Tr_5 and Tr_6 on according to the polarity of the input. Transistor Tr_8 is then off and Tr_9 saturated. The controlling voltage fed to Tr_1 is

$$V_1 = \frac{V_{off}}{A} \left(1 + \frac{R_3}{R_4} \right)$$

negative and sufficiently high to saturate it, while the voltage fed to Tr_2 is slightly positive so that Tr_2 is cut off. The saturated transistor Tr_1 has a resistance of 1kΩ and Tr_2 , which is off, has a resistance of about 10GΩ. If the input resistance, R_{in} , of the protected circuit is above 100kΩ, the series connected resistance r_{on} of Tr_1 will cause an error smaller than 1%, which will decrease with a further increase of R_{in} . The shunting resistance r_{off} of Tr_2 also gives an error less than 1% provided the internal resistance of the signal source does not exceed 100MΩ.

When the input voltage exceeds the value at which one of the transistors Tr_5 or Tr_6 is made to conduct Tr_5 is saturated and Tr_9 turns off. The controlling voltages now have such values that Tr_1 is cut off and Tr_2 is saturated. The value of the voltage V_1 or V_2 at which limiting begins (V_l) is determined by the amplification, A , from Tr_3 , Tr_4 and CA3015 and the cut-off voltage of Tr_5 and Tr_6 (V_{off})

For the component values shown in the circuit, V_l is about 200μV. The transistors Tr_1 to Tr_4 are p-channel, enhancement mode m.o.s.f.e.t.s.

A. Ivanov,
Sofia,
Bulgaria.

Scratch filter

This continuously variable scratch filter was designed to overcome the need for four or six ganged potentiometers commonly

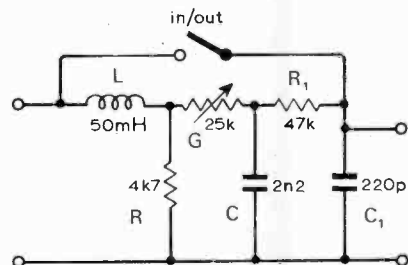

used for stereo amplifiers. The cut-off frequency (3dB) is given by:

$$\omega \sqrt{LC \left(\frac{R+G}{R} \right)} = 1$$

when $2\pi f_c L = R$ and $2\pi f_c C_1 R_1 = 1/f_c$ being the highest cut-off frequency. The roll-off is 18dB/octave, and the 'knee', sharply defined at the highest frequency, becomes progressively less well defined at lower frequencies, thus overcoming any unpleasant transient effects. The values given are for cut-off frequencies between 6 and 15kHz. The filter should be followed by a high-impedance (500kΩ) circuit.

A. E. Prinn,
Hoylake,
Cheshire.

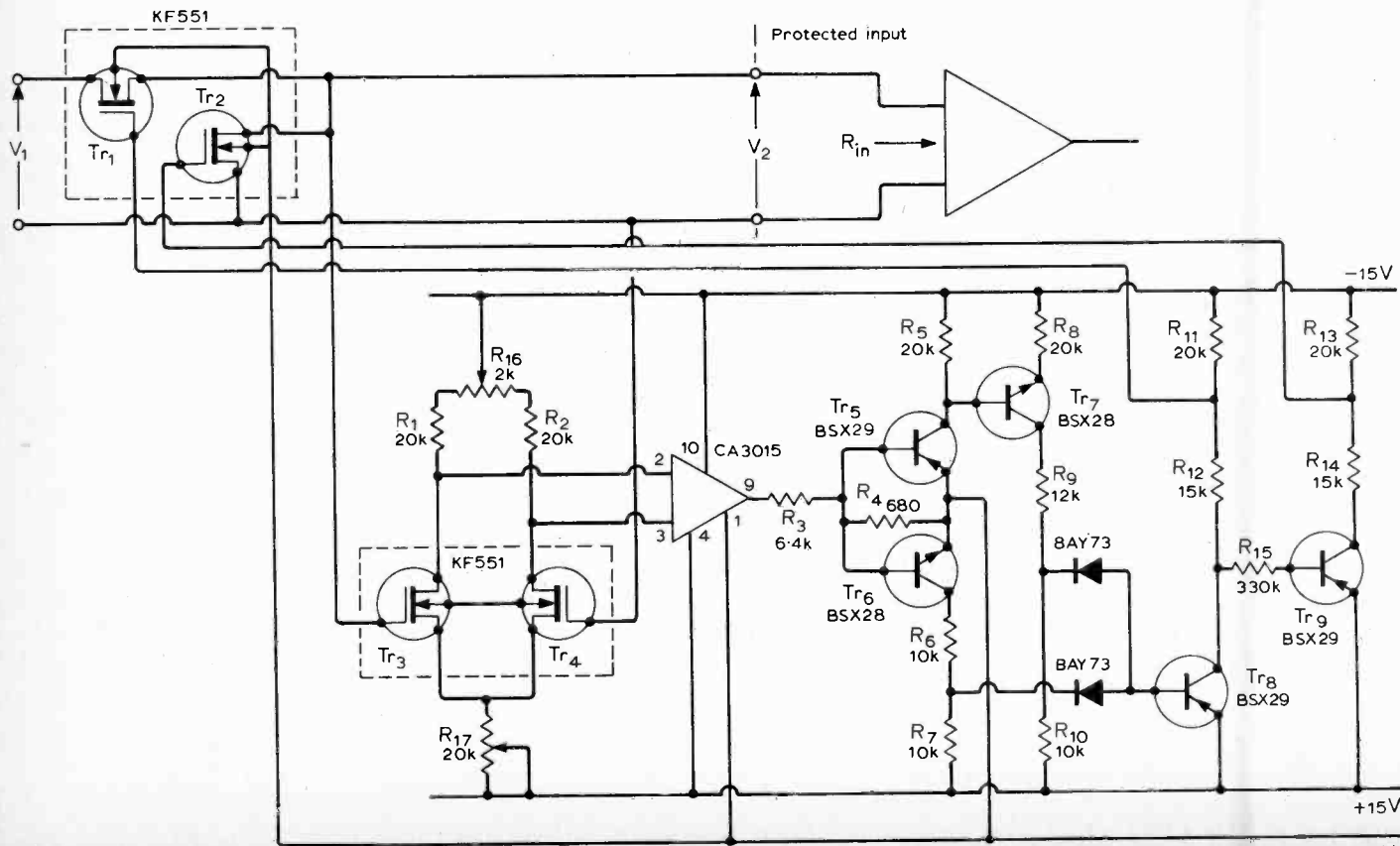

Hybrid H.F. Aerial

Better ground wave coverage than from a simple whip type

by T. A. Lindsey*

It is often desirable to use wideband aerials to eliminate or simplify tuning devices. Usually in the h.f. band this results in bulky and complex designs. The aerial described here is the result of a requirement for a simple light-weight radiator giving greater ground wave coverage over the frequency range 1.5 — 30 MHz than that obtainable from a 12ft whip aerial mounted on a vehicle. A compromise design was arrived at giving some broad banding over the upper part of the h.f. band, the lower part of the band being tuned.

The aerial consists of a vertical section 9m high of Uniradio 67 coaxial cable (total length 10m) feeding a frequency-independent skeleton biconical aerial (Fig. 1). The biconical part covers the range 20 — 30 MHz and also acts as top loading for the vertical radiator, which is tuned to resonance with an aerial tuning unit between 1.5 and 20 MHz.

The design gives greater ground wave coverage than the simple 10-metre whip because of the extra capacitance afforded by the biconical upper elements, especially at the lower h.f. frequencies. In addition, in the 20 to 30 MHz region the biconical portion acts as a wideband elevated half-wave dipole, whereas a 10-metre whip when tuned would be electrically over the half-wave length and ground wave radiation would be reduced at the expense of sky wave radiation.

The biconical portion of the aerial comprises six thin 2.44m (8ft) fibre glass covered whip aerials for the upper portion of the cone and six 2.44m plastic covered flexible wire braid elements for the lower portion. Nylon guys are fixed to the bottom of the lower cone elements to stretch them out. All the elements are fixed to a light-weight polypropylene head and equi-spaced around its top and bottom. The total included angle between upper and lower elements is approximately 110°. The upper whip elements have coarse screw threads so that they can be rapidly assembled.

Inside the polypropylene head a short-circuited coaxial stub, connected across the feed terminals of the biconical aerial, improves its v.s.w.r. over its

operational band (20 — 30 MHz). The stub is made a quarter wavelength long at the centre frequency, i.e. 25 MHz, and the stub impedance required for correct matching is approximately 25 ohms. This can be achieved by paralleling two quarter-wave lengths of 50-ohm coaxial cable. The stub so formed is wound in a spiral fashion within a sleeve portion of the biconical head.

In practice the biconical is assembled and fitted, ideally, on top of a telescopic mast, and the coaxial feeder cable is connected to it. The mast is then raised to a height of 9 metres and the lower elements 'pegged out'.

When operation over the 1.5 — 20 MHz band is required, the 'outer' of the coaxial cable is energized, and the aerial is fed against earth and tuned. For this reason, if a metal mast is used the lower portion must be insulated from earth. Where ground conductivity is poor a simple counterpoise system of six 10-m wires arranged radially will greatly improve radiation.

For operation over 20 to 30 MHz the biconical is fed coaxially from the lower end of the feeder and no tuning is necessary if the small mismatch can be tolerated.

All the parts of the aerial are made to

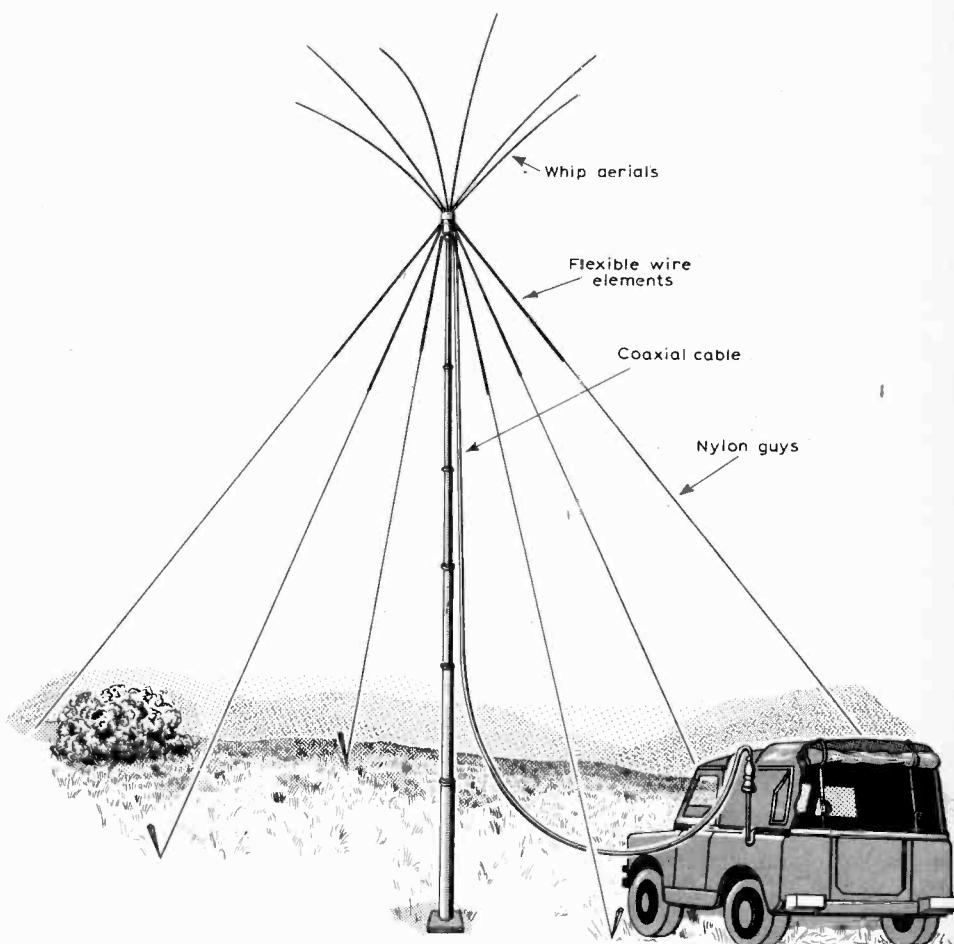

Fig. 1. The aerial consists of a 9m high length of coaxial cable feeding a skeleton biconical section made up of whip and flexible wire elements.

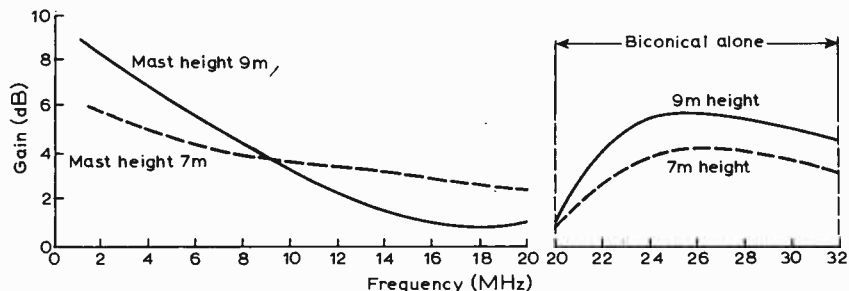

Fig. 2. Gain of the hybrid ground wave aerial compared to that of a 12ft vehicle whip aerial.

pack into a light-weight bag approximately 4ft 6in long. Each biconical whip element is made in two equal parts which fit together, and all the lower elements of the biconical, being flexible, can be wound up with the nylon guys around the picket used for pegging out. The complete kit of aerial parts including 10 metres of Uniradio 67 coaxial cable, pickets and hammer weighs only about 12 lb.

Electrical performance

The gain of the system referred to here is the gain relative to that of a tuned 12ft whip aerial mounted on a medium sized vehicle, e.g. a Land-Rover. Here some averaging out of the signal from the Land-Rover was required since polar plots of a vehicle's aerial are not entirely circular.

Fig. 2 shows that the gain at the low-frequency end is high, and gradually drops to 1 or 2 dB as frequencies of 12 — 13 MHz are reached. The drop in gain over the region 15 — 20 MHz is due to two factors. In the first place the 12ft whip aerial is becoming quarter wave resonant and highly efficient, very little of the transmitted power being wasted in its aerial tuning system. Secondly, with the biconical mounted with its centre at a height of 9m the total height of the ground wave aerial is of the order of 10.5m, and at frequencies greater than about 17 MHz this means that the effective height is greater than $\frac{1}{4}$ of a wavelength (the height for maximum ground wave radiation). Above about 17 MHz, therefore, the angle of the ground wave lobe rises and there is a drop in signal along the ground.

A simple and effective way to improve the gain from 15 to 20MHz, therefore, is to lower the mast height by about 2 metres.

Height gain is also the main factor in the improvement in signal over the 20 — 30 MHz band, using the biconical alone. Here we are bordering on the v.h.f. band. Space, ground and some sky wave are all radiated. The graph shows the improvement in gain due to the greater effective height at the higher frequencies.

Matching of the biconical alone, mounted at 9 m and compared to 50 Ω , is approximately 2 : 1 over the band 20 — 30 MHz. Power loss in the matching stub due to this amount of mismatch is small. The aerial is rated at 300 watts continuous, using a coaxial cable matching stub with a p.t.f.e. dielectric.

For practical use certain modification to the shape of the biconical can be made with very little deterioration of performance. If not convenient, for reasons of location, for example, it is not essential to equi-space the lower flexible elements. Even an arrangement in a semi-circle is possible (max. s.w.r. 3:1). The aerial will give good ground wave coverage with heights of approximately 6 to 9 metres.

Finally, although the horizontal polar diagram of the aerial is circular over the whole band, directivity can readily be achieved in the 20 — 30 MHz part by the usual technique of feeding two biconicals in end fire or broadside.

Work on the aerial was performed under a contract from the Ministry of Defence (Aviation Supply) and the author wishes to thank them and the M.E.L. Equipment Company for permission to publish this article.

Sixty Years Ago

March 1912. The leader in this issue of the *Marconigraph* attacked the critics of wireless and it quotes an early magazine article (1909) written by someone whose 'only wisdom was in withholding his name from the article'. The anonymous writer had said 'The great problem with the early inventors of the telegraph was how to tie the current to a wire but the problem with the wireless people was how to let it loose so that it may career over the face of the globe for anyone to catch hold of'. The object of the statement was to show how insecure wireless messages were. The editor retorts that the reason every navy worthy of the name fits wireless equipment, is, perhaps, the desire to cultivate espionage in a new form. (Looked at in the light of the events of recent years and ignoring the fact that the remark was not meant to be serious it was indeed an accurate prediction.)

A short note reports on an article, which appeared in the *Pall Mall Gazette*, lamenting the fact that the onrush of wireless meant that a pigeon post, which was used to get race results to evening newspaper offices in France, was to be closed down.

Books Received

Acoustics of Studios and Auditoria by V. S. Mankovsky deals with effects produced in enclosed spaces by sound, with the physical laws that give rise to these effects and with methods used to analyse them. It also considers questions of the influence of these effects on the quality of sound transmission, how to determine criteria for the evaluation of acoustics within enclosed spaces, and means by which good acoustic conditions can be achieved. These questions are discussed in the light of existing theory and with the help of experimental data which has greatly increased in the last ten or twelve years. The book includes some data on acoustic conditions for stereophonic reproduction. Pp.395. Price £5.00. Focal Press Ltd, 31 Fitzroy Square, London W.1.

Power Supplies for Electronic Equipment by J. R. Nowicki is a two volume series. The first volume deals with rectification, inverters and converters using silicon diodes, transistors and a number of other devices which may be required for particular networks. Volume 2 gives an account of stabilizing circuits, overload protection circuits, constant-current supplies and high-stability reference sources. Also included is an introduction to thyristor inverters and static sine-wave inverters. Both volumes contain many well-tries circuits contributed by various manufacturers of semiconductor devices and by writers in technical journals. Pp. 321 (Vol. 1), 244 (Vol. 2). Prices £6.50 (Vol. 1), £5.80 (Vol. 2). Leonard Hill Books, 158 Buckingham Palace Road, London S.W.1.

Solid-State Devices and Applications by R. Lewis. The first section of the book deals with the fundamental principles of semiconductors—diodes, bipolar and unipolar transistors and integrated circuits. The second part describes the applications of these devices, for example in amplifiers, oscillators, mixers, power supply circuits etc., and the last section contains a treatment of equivalent circuits, an introduction to Boolean algebra and finally the derivation and minimization of logic-system equations. Students in the later stages of the City and Guilds Course 57 and those studying for the H.N.C. in electronics will find this book particularly useful. P.p.258. Price £3.00. The Butterworth Group, 88 Kingsway, London WC2B 6AB.

Electron Physics by O. Klemperer is an introduction to the physics of the free electron and to the experimental procedures on which this knowledge is based. After a short historical introduction, Part 1 deals with the motion of electrons in electric and magnetic fields, electron optics, the effects of high space-charge density and a survey of methods of detection. Part 2 is concerned with the more fundamental properties of the electron and also deals with relativistic behaviour, the wave-like properties and the spin and magnetic moment of the electron. Each chapter ends with problems, mostly qualitative, and these, combined with lists of references and seven appendices, complete the book. Pp. 263. Price £4.90. The Butterworth Group, 88 Kingsway, London WC2B 6AB.

Sonex 72

Third audio equipment exhibition at London Airport

Many brand names will be included in the Sonex hi-fi show for the first time, which will again be held at the Skyway Hotel, Bath Road, Hayes, Middlesex (near London Airport), from Wednesday 22nd March to Sunday 26th March. The first two days will be for trade only and this year include a "late night opening".

Times are Wednesday 11.00 – 18.00 (trade), Thursday (trade), Friday and Saturday 11.00 – 21.00, Sunday 11.00 – 18.00. Free tickets for the show can be obtained from Sonex 72, 8 Hill Street, London W1, or individual exhibitors.

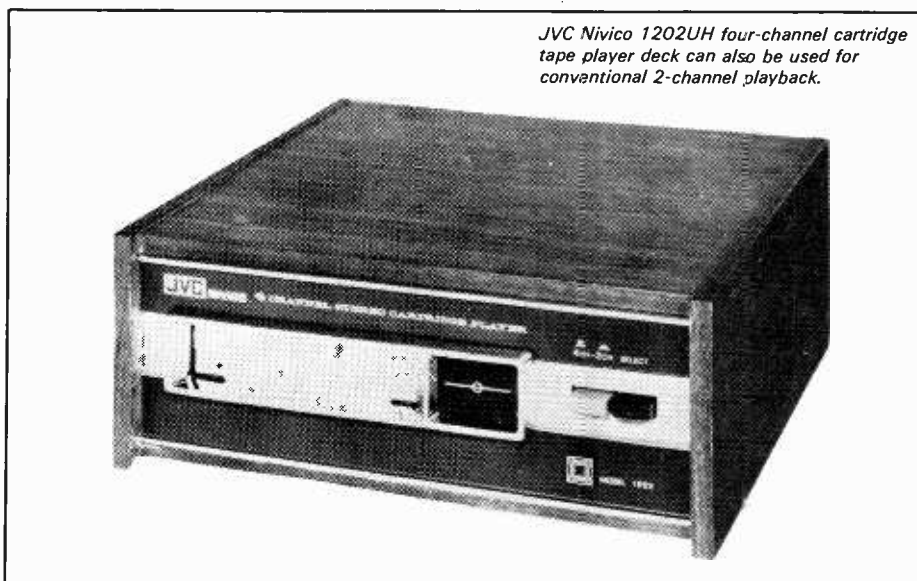

JVC Nivico 1202UH four-channel cartridge tape player deck can also be used for conventional 2-channel playback.

Exhibition briefs

Amstrad Electronics will be demonstrating their IC 2000 stereo amplifier, which is designed around integrated circuits. A new receiver on show, the TR-200 from Tandberg, has an output power of 10W r.m.s. per channel, with pre-tuning and press-button f.m. station selection and a muting button for noise-free tuning.

'The London' is a new cartridge Decca will be demonstrating, featuring a low mass and improved hum rejection.

No doubt, there will be plenty of surround-sound demonstrations using ordinary two-channel sources and some matrixed demonstrations (see page 112 for latest news). Among the surround-sound 2-2-4 equipment will be the Onkyo Y-2 turntable, tuner-amplifier and speakers. Costing £265, it includes four

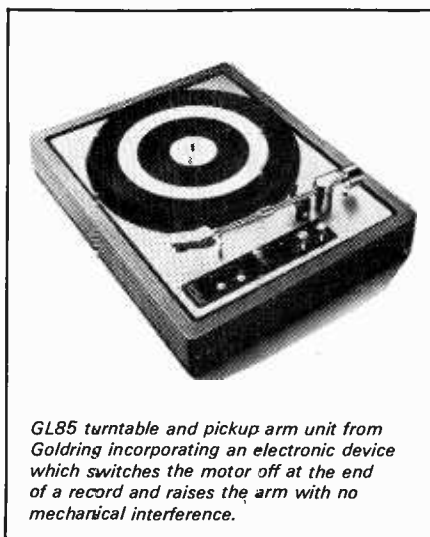

GL85 turntable and pickup arm unit from Goldring incorporating an electronic device which switches the motor off at the end of a record and raises the arm with no mechanical interference.

Brand names at the Show

A.K.G.	Klinger
Acoustic Research	Luxor
Alpha	McIntosh
Amstrad	Marantz
Audio Packs	Metrosound
B.A.S.F.	Mordaunt-Short
B.S.R. McDonald	Musitapes
B. & W. Electronics	Ortofon
Bang and Olufsen	Peerless
Bib	Philips
Bigston	Pickering
Binatone	Quad
Bush Arena	Revox
Cambridge Audio	Richard Allan
Canterbury Audio	Rogers
Celestion	Sansui
Connoisseur	Scan-Dyna
Decca	Sennheiser
Gabraphone	Shure
Garrard	Sinclair
Goldring	Sonab
Grampian Reproducers	Sonotone
Harman Kardon	Spendor
Heco	Stanton
Helme	Stax
I.M.F.	Sugden, J. E.
J.V.C. Nivico	Tandberg
Jordan-Watts	Teleton
Keith Monks	Thorens

amplifiers (for playing discrete 4-channel tape recordings) and four loudspeakers. An unusual feature is a variable mono-stereo-surround control. Speakers for rear placement are intended for wall hanging.

Rogers Developments' new studio monitor loudspeaker, which is now in full production, can be seen at the show. Based on a design of the B.B.C.'s research department, the most significant aspect of the design is the main drive unit, which employs a special plastic cone.

World of Amateur Radio

More bands on h.f.?

Since 1945, only two all-embracing I.T.U. frequency allocation conferences — Atlantic City 1947 and Geneva 1959 — have been held. Indeed there is a strong belief that many administrations, worried at the problems that have arisen at these specialized international conferences, are far from anxious to tackle an early revision of the entire frequency table. But sooner or later — and 1977 is one of the dates being mentioned — a re-allocation of the h.f. spectrum is bound to be attempted. Will this be an opportunity for amateurs? Or is it something to be feared?

With the exception of the 21-MHz band (gained at Atlantic City), amateurs have usually lost rather than gained frequencies at these international conferences, and tend to be very much on the defensive. But suddenly, in the United States, a wave of optimism seems to be spreading — and reading between the lines seems to have been actively encouraged by A. Prose Walker, W4BW chief of the F.C.C. Amateur and Citizens Division. It is being pointed out that with the transfer of so much commercial and defence long-distance communications to satellite, cable, microwave and tropo-scatter systems, there should be much reduced pressure on the h.f. spectrum. Amateurs may, therefore, be able to pick-up some more frequencies to alleviate congestion in the present bands. One very attractive idea suggested by A.R.R.L. would be to seek additional bands around 10, 18 and 24MHz. But this can happen only if the amateurs prepare their case well, and avoid practices which could bring discredit on their use of existing allocations. Mr Prose Walker has, for example, recently strongly condemned the 'DX pile-ups' during certain amateur 'DX-peditions' and threatened American amateurs that should such obviously illegal and disgusting practices become prevalent, they could form the basis for measures to require automatic identification of amateur transmitters, over and above those now contained in F.C.C. rules.

British amateurs will also feel that while pressure in the 10 to 30MHz range may well already be decreasing, there is no sign of this happening below 10MHz. Professional short haul and mobile

communications seem to be exerting tremendous pressure, evidenced by the number of non-amateur stations working in the 1.8 and 3.5 MHz shared bands and in the 'exclusive' 7 MHz band.

Death of a Hero

There can be few British amateurs who have worked at all regularly on 14 MHz c.w. during the past 25 years who have not had one or more contacts with RAEM — the callsign of the Russian ship s.s. *Chelusking* which was smashed by ice in the Arctic in 1934. This anomaly — surely the only instance of a ship's call being given officially for use as an amateur call — arose from the famous exploits of Ernst Krenkel, chief radioman in a series of Russian polar expeditions both by ship and airship in the thirties, as a result of which he was made a 'Hero of the Soviet Union' and given the call RAEM for his personal use. He became president of the Radio Sport Federation of the U.S.S.R., the Russian national society. Now RAEM is off the air. Ernst Krenkel died in December. A very famous key is silent.

Variable crystal oscillators

For many years, amateurs have sought means of readily shifting the frequency of crystal-controlled oscillators: the old Goyder lock (an early example of locking a master oscillator from a low-power c.o.); the painting of crystals with Indian ink or pencil; the variable air-gap crystal holder — all have enjoyed periods of popularity. But since 1963, attention has been firmly on the 'variable crystal oscillator' (v.x.o.) using variable series or parallel reactance loading of the crystals, based on a technique patented as long ago as 1940 and 'rediscovered' several times since. The degree by which the frequency of a crystal can be shifted without seriously degrading the stability depends on a number of factors and tends to vary from crystal to crystal but is usually from about 0.1 to 1% of nominal frequency.

Today, the v.x.o. is one of a number of variable frequency techniques being used increasingly on 144MHz, and also sometimes on h.f. The v.x.o. has recently received official recognition in the United

States, in an F.C.C. decision to permit Novice-class amateurs (previously forbidden to use variable-frequency systems) to use a v.x.o. But in doing so, F.C.C. has introduced a hotly disputed provision. This is that the v.x.o. must be factory-built and carry a warning against unauthorized interference with the unit. Amateurs point out that this smacks of 'type approval' regulations.

Space activities

Amsat-Oscar-B, an active amateur satellite with a planned lifetime of one year, is expected to be launched during 1972. Work on the prototypes and flight units was largely completed during 1971. The project has been organized by the Radio Amateur Satellite Corporation in the United States, but it is planned to carry equipment made in Europe and Australia as well as in America. The equipment will include a 432 to 146 MHz ten-watt linear translator and a 144 to 28 MHz linear translator to permit long-distances to be covered by amateurs working on v.h.f. and u.h.f. bands. There is a chance that it may be launched as a 'piggyback' package to an ITOS meteorological satellite intended to be put into a 1500-km polar orbit.

When the French 'Sonde 4' balloon was flown last Autumn, carrying a 432 to 144 MHz translator with 4-watts p.e.p. output, many amateur contacts were made. The longest distance covered is believed to have been between the British station G3LQR (S. J. W. Freeman) and the Austrian station OE20ML.

In brief

The de-restriction of TV broadcasting hours could reduce British amateur activity — not because amateurs want to watch the 'box' for longer periods, but because significant numbers give up the struggle against TV interference complaints (many of which result from receiver susceptibility to high r.f. fields rather than transmitter faults) and have been in the habit of limiting their operating, at least on some bands, to non-TV hours. . . . An R.S.G.B. lecture at the I.E.E., Savoy Place, London, W.C.2, on February 22 at 18.30 will be by B. O. Cooke, chief engineer of Eddystone Radio, on 'Modern techniques in high-stability receivers'. . . . The 1971 British North-west Amateur Radio Convention is planned for September 23-24 at the new University of Lancaster buildings. . . . Considerable numbers of 1.8 MHz contacts with North America and a few with Australia (including the Victoria, VK3 area as well as the more consistent VK6 stations in West Australia) have been reported this season. . . . The next Radio Amateurs Examination is being held on May 9 at local examination centres in the U.K. . . . The GB3GI v.h.f. beacon station, mentioned last month, is not yet operational as a licence has not been issued.

Pat Hawker, G3VA

New Products

Transmitter triodes

Metal-ceramic triodes, series YD1300 and YD1330, from Mullard are claimed to have high reliability. Triodes in the YD1300 series have outputs ranging from 25 to 50W, and are designed for use in bands IV and V combined vision and sound transposer transmitters. Linearity is very good and intermodulation distortion is less than 52dB in a three-tone test. The YD1330 series contains triodes with power outputs of 100 to 200W. Linearity standards are similar to those of the YD1300 triodes. Mullard Ltd, Mullard House, Torrington Place, London WC1E 7HD.

WW332 for further details

R.F. spectrum analyser

The Texscan AL-60 solid-state wideband r.f. spectrum analyser is capable of giving a 70dB minimal-distortion display with dispersion variable from 1kHz to 100MHz/division on a 10-division graticule. The maximum dispersion is 1.000MHz. The frequency range is 1MHz to 3.000MHz. A 'birdy-by-pass' marker system is incorporated for 0.005% frequency identification accuracy. I.F. bandwidths of 500Hz, 10kHz or 200kHz can be selected manually or automatically for best resolution, while bandwidth sensitivity is 60dB/3dB — a ratio of 20:1. The amplitude measurement range is -110dBm to +30dBm with accuracy

$\pm 3\%$ of full scale for linear and $\pm 5\%$ of full scale for square display modes. Residual responses are less than -90dBm referred to the signal input and spurious responses more than 60dB below the input level for a -30dBm signal input to mixer. Texscan Instruments Ltd, 102 High Street, Northchurch, Berkhamsted, Herts.

WW328 for further details

Digital multimeter

Multimeter type 196 from Bradley has five d.c. ranges, from 100mV to 1kV, each with an accuracy of 0.01% of reading ± 1 digit. Input impedance is 10M Ω on the 1000V and 100V ranges and not less than 1000M Ω on the lower ranges. Four a.c. ranges cover 20Hz to 100kHz, with four voltage ranges from 1V to 1kV. Measurements can be made down to 100 μ V with an accuracy over the frequency range 40Hz to 5kHz of 0.1% of reading ± 1 digit. Resistance measurements from 100m Ω to 10M Ω are possible. There are six ranges each with a resolution of 10m Ω and an accuracy of 0.1% of reading ± 1 digit. The display consists of four decade tubes and a polarity display tube. The decade tubes each contain a decimal point electrode. Over-range digit indication is included in the polarity tube. Display storage is used to eliminate readout flicker. Polarity, voltage display, and decimal point information are available in 1-2-4-8

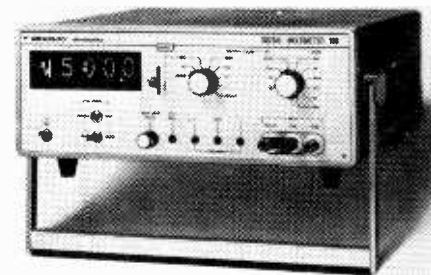

b.c.d. code at a socket on the rear of the unit. Also provided are display synchronization and printout command signals. The outputs are all available in d.t.l./t.t.l. compatible form, fully isolated from the unit. Fully guarded inputs are used, giving common mode rejection on d.c. ranges >140dB at 50/60Hz and d.c. Common mode rejection on a.c. ranges >60dB up to 100Hz. Series mode rejection on d.c. ranges >60dB at a line frequency of 50/60Hz $\pm 1\%$. G. & E. Bradley Ltd, Electral House, Neasden Lane, London N.W.10.

WW327 for further details

Push-button switch

A push-button switch type T115 from ITT provides independent or mutual release, and may be assembled into groups with impulse and clearing keys. It is intended for direct mounting on to p.c. boards. Four or six changeover contacts can be supplied for each key unit and the maximum number of keys that can be

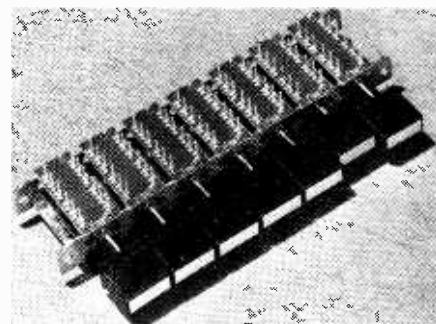

specified for each switch unit is fourteen. Switching voltage is 200V a.c., switching current is 2A and the switches are rated at 20VA. The mounting depth is 39mm maximum. ITT Components Group Europe, Electromechanical Product Division, West Road, Harlow, Essex.

WW331 for further details

Scaler timer

Model 402-ST scaler timer from Panax has a fast (1 μ s) pre-scaler with two-digit read-out of counts which drives a six-digit mechanical register with a 40ms resolving time, so giving eight-digit counting capacity. The maximum recommended input count-rates are 2,500/s and 2,000/s for regular and random pulses respectively, because of the limitation imposed by the register. A single button

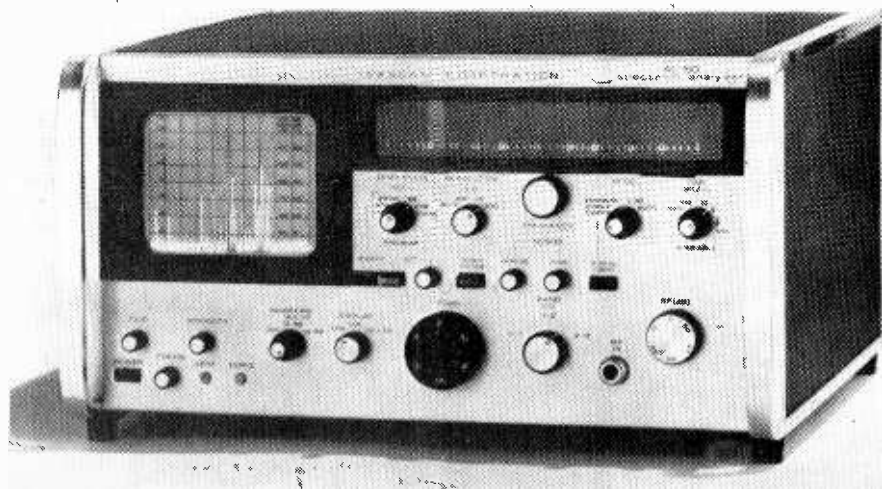



resets both the pre-scaler and the register simultaneously. A built-in 250-500V e.h.t. supply is suitable for operating most types of Geiger-Muller tube used in schools and colleges and is adjustable by a single-turn potentiometer with a graduated dial. As a timer, the instrument employs its own integral 1kHz oscillator. It also has a built-in bistable gating unit, to enable the timing interval to be started and stopped by external electronic pulses on separate lines, as well as by simple switch- or contact-closure. Panax Equipment Ltd, Holmethorpe Industrial Estate, Redhill, Surrey.

WW330 for further details.

Solder feed for iron

For use with most hand-held electric soldering irons, the Mark 2 Anextra solder feed incorporates two 'V' notches and two adjustable nylon straps to allow firm fixing

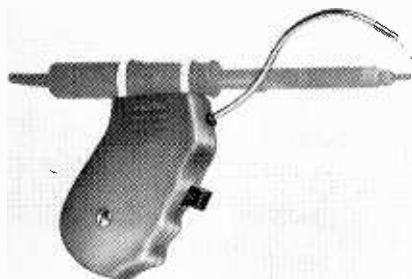

to the iron. The movement of solder is controlled by a button. The unit costs £3.75 direct from the makers. Anextra Ltd, Chiltern Works, Rear of 77/78 Chiltern View Road, Uxbridge, Middx.

WW329 for further details.

A/D converter using ramp and comparator

An analogue-to-digital converter, model ADC-8S from Analog Devices provides 8-bit resolution, $\pm \frac{1}{2}$ l.s.b. (least significant bit) and a temperature coefficient of 60 p.p.m./°C. Conversion time is one millisecond. The package measures $51 \times 76 \times 10$ mm (approx.) and employs the ramp and comparator principle. Other characteristics include $100M\Omega$ input impedance, t.t.l. and d.t.l. compatibility and the ability to provide binary, offset-binary, 2's complement or b.c.d. output codes. Four input ranges are available — 0 to 5V, 0 to 10V, ± 5 V, and ± 10 V. Power supply requirements are

± 15 V at 28mA and 5V at 120mA. The price is £28 each for 100 up. Analog Devices Ltd, 59 Eden Street, Kingston, Surrey.

WW333 for further details

Low-noise light detector

The IPL 16 analogue light detector manufactured by Integrated Photomatrix and distributed by GDS (Sales) is the combination in a single TO-5 can of an integrated circuit containing both a silicon planar photo-diode and an m.o.s. operational amplifier together with a thick-film resistor (used to provide shunt feedback around the operational amplifier). The small size of the amplifier input node and the screening effect of the

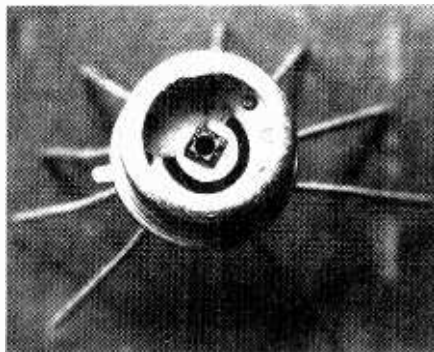

TO-5 case result in low sensitivity to interference and mains pick-up. Three versions of the IPL 16 are available. The options, obtained by varying the feedback values, give different speed/sensitivity ratios. The fastest (IPL 16C) has a 400kHz bandwidth while the most sensitive (IPL 16A) has a noise equivalent power of only 2×10^{-13} W.Hz⁻¹ and a responsivity in the order of 35V/ μ W. GDS (Sales) Ltd, Michaelmas House, Salt Hill, Bath Road, Slough, Bucks.

WW334 for further details

Voltage reference sources

Two millivolt sources, offering 0.02% accuracy and stability of 0.0025%, are available from Sintrom. Model E-10-D provides an output between zero and ± 11 V d.c. in steps of either 10 p.p.m. or 100μ V (whichever is larger). Output current is 50mA and is protected in case of

short-circuit. Model E-100 D provides two output voltage ranges ± 10 V and ± 100 V plus 10% over range in both cases. Resolution on the 10V scale is 10 p.p.m. or 100μ V; 1μ V steps on the 100mV range. Output current is 50mA at 10V with an output impedance of $50m\Omega$. Both models weigh just over 3.5kg. The E-10-D is priced at £270, model E-100-D at £315. Sintrom Electronics Ltd, 2 Arkwright Road, Reading, Berks. RG2 OLS.

WW325 for further details

Radar for small boats

The Decca 050 is a two-unit radar system with slotted waveguide scanner, transceiver, and power supply housed in a waterproof glass-fibre radome weighing about 25kg. The display, connected to the aerial unit by a single plug-in cable, can be table-top, bulkhead or deckhead mounted. There are seven controls. Range is from under 25 yards to 12 nautical miles with three range scales available: 0.5, 3 and 12n miles. Thermionic devices used are the magnetron and cathode-ray tube. Total power consumption is 75W. Price is from £695. Decca Radar Ltd, Decca House, Albert Embankment, London S.E.1.

WW321 for further details

Versatile electronic calculator

A pocket-size electronic calculator from Hewlett-Packard can handle all trigonometric and logarithmic functions, powers with fractional exponents, and square roots, as well as addition, subtraction, multiplication, division, and several other mathematical operations. There are four operational registers, plus a data storage register for constants. The four-register operational stack holds intermediate answers and, at the appropriate time, automatically brings them back for further use. Answers appear automatically on a display of light-emitting diodes. The display can show numbers having up to 10 digits plus two-digit exponents and appropriate signs. It is accurate to 10 significant digits and can handle numbers down to 1×10^{-99} and up to $9.99999999 \times 10^{99}$. The calculator is powered by a rechargeable

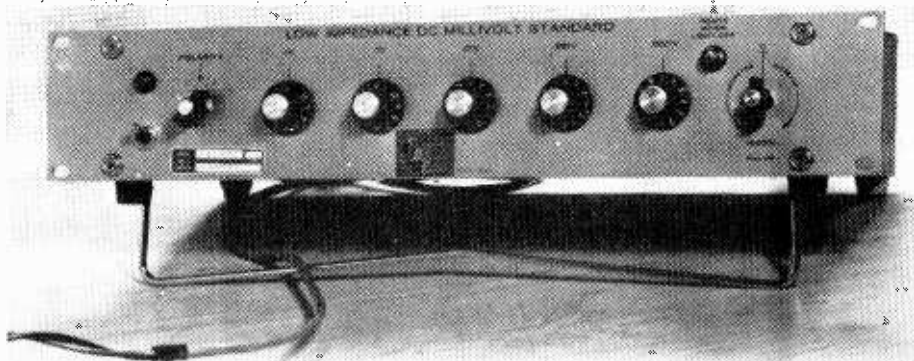

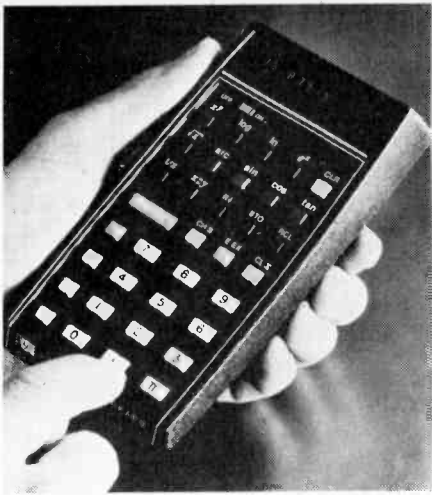

battery. A battery recharger and an a.c. adaptor are supplied with the unit together with various accessories. The price is £199. Hewlett-Packard Ltd, 224 Bath Road, Slough, Bucks SL1 4DS.
WW318 for further details

24-way d.i.l. socket

The Jermyn A23-2043 socket accommodates i.c.s and other devices in 24 lead \times 0.6in packages. The socket has gold-plated phosphor bronze contacts fitted into a glass-loaded nylon body. Contacts can be replaced in service without removing the

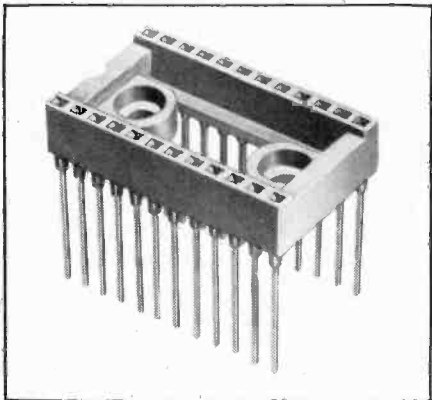

socket from the board. Terminal posts are 0.025in square and extensions moulded in the body give extra rigidity. Overall dimensions are less than 1.20 \times 0.7in allowing the sockets to be closely packed on 0.1in matrix. Jermyn Industries, Vestry Estate, Sevenoaks, Kent.
WW319 for further details

Monochrome monitor

The 'L' range of video monitors from Cotron Electronics consists of the L28 (11 inch), the L38 (15 inch), and the L50 (20 inch). The cathode-ray tubes fitted are illuminant 'D' phosphor types, and remote control of brightness, contrast, selection of dual video input and cue-lamp are available via a connector on the back panel.

The final anode supply voltage for the c.r.t. is regulated, and for reliability a fully encapsulated Cockcroft-Walton multiplier using silicon diodes and plastic-film capacitors potted with the feedback resistor network is used. This supply is automatically switched should either scanning system fail. Delay circuits provide displacement of line and frame scans (pulse-cross) so that information inserted in the blanking intervals can be viewed conveniently. Grid modulation of the c.r.t. is used. Flyback blanking is inserted on the cathode enabling the black-level clamp to bias the c.r.t. grid directly. A 75 Ω colour subcarrier notch filter is selectable for 4.43MHz PAL systems. A version of the L38 unit will be made specially for fitting in 19in racks and designated the L38R. Circuitry is built entirely on two pluggable printed boards with individual connectors, and the front panel controls are all built onto a



panel as a separate module. Prices are £295 for the L28 and L38, and £310 for the L50. Cotron Electronics Ltd, Eden Street, Coventry CV6 5HE.
WW301 for further details

Instrumentation tape recorder

The CPR 4010 tape recorder from Bell & Howell can record and reproduce up to seven channels of information on

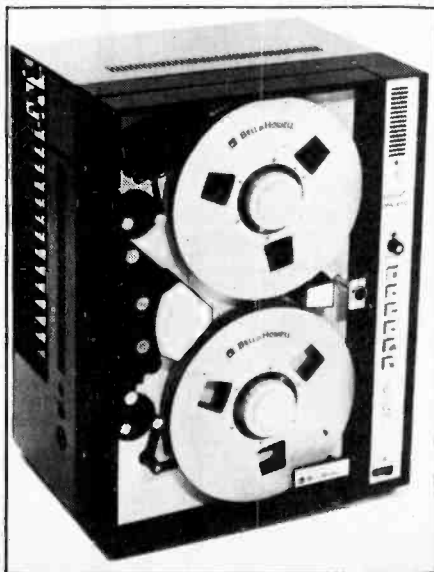

half-inch-wide tape, or 14 channels on inch-wide tape. It accepts up to 10 $\frac{1}{2}$ -inch diameter reels and has seven speeds ranging from 15/16 i.p.s. to 60 i.p.s. A dual capstan servo system offers tape speed accuracy of \pm 0.1% in tachometer mode, or \pm 0.05% in tape mode. The direct system bandwidth is 300kHz at 60 i.p.s. and the f.m. system offers a choice between I.R.I.G. intermediate band and wideband Group I responses of 20kHz and 40kHz respectively, at 60 i.p.s. An 'autoload' accessory allows fast tape threading. An edge track for voice annotation is included as standard. Bell & Howell Ltd, Lennox Road, Basingstoke, Hants.

WW326 for further details

Floating-input amplifier

A new solid-state twin floating-input amplifier type 15A-7d from Ancom is available as a mains-powered or fully portable battery-operated unit, and provides transformer isolation between inputs and output up to 2kV. Input current is less than 1pA and input noise levels, typically 5 μ V p-p. Output is \pm 10V at \pm 5mA and linearity is stated to be better than 0.1% with gain adjustable by means of fixed resistors from 40 to 1000 over a bandwidth of 300kHz (direct output) or 1kHz (filtered output). The amplifier is available either as a separate, metal-cased, encapsulated module measuring 60 \times 38 \times 19mm or assembled on a printed-circuit board, ready wired with the necessary ancillary circuit components for gain setting and bias current, and power supply or mercury battery unit. Typical unit prices are: circuit board (mains powered) £60; circuit board (battery powered) £54; and single module £45. Ancom Ltd, Denmark House, Devonshire Street, Cheltenham, Glos.

WW303 for further details

Self-adjusting wire strippers

A range of wire strippers from Thomas & Betts is designed to strip stranded or solid aluminium or copper wire in many sizes. Either individual or multiple wires can be handled without adjusting the tool. The wire is inserted in the jaws of the tool to the length which is required to be stripped. A wire stop can be fitted to determine a precise stripping length. The same tool will strip off outer and inner insulation without adjustment. Designed primarily for removing vinyl and polyethylene insulation material, the two hand-operated models



are suitable for stripping insulation diameters from 0.01 to 0.10in (0.254 to 2.54mm) and 0.08 to 0.20in (2.0mm to 5.0mm). A third model for bench production-line use will take diameters from 0.06 to 0.30in (1.5 to 7.6mm). The hand models are priced £9.25 and £12.50. The bench model costs £125.00. Thomas & Betts Ltd, 90-93 Cowcross Street, London EC1M 6JR.

WW302 for further details

Oscillators for telephone testing

Two hand-held oscillators, covering the range 30Hz to 300kHz with output levels of +10 to -70dBm have been introduced by STC. They are designed to feed into 75Ω, 150Ω (GTA-29A) or 140Ω (GTA-29B) and 600Ω circuits. A resistance-capacitance circuit is used to provide four decades and the scale is graduated from 30 to 300 on the edge of a drum. The output meter also provides a battery voltage check. Operation is from two standard 9V batteries. A leather

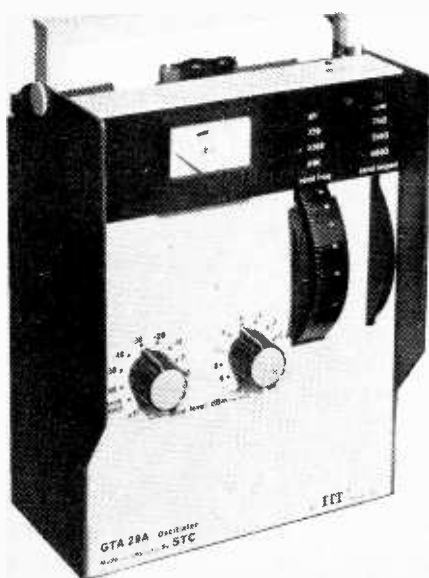

carrying case with shoulder strap is available as an optional item and the oscillators can be operated without it being removed. Standard Telephones and Cables Ltd, Corporation Road, Newport, Mon. NPT OWS.

WW322 for further details

High-speed photoconductive cell

A cadmium selenide photoconductive cell from Photain Controls has the following characteristics:

dark resistance	100M Ω
10 lux resistance	3.2k Ω
100 lux resistance	0.7k Ω
rise time	2ms
decay time	2ms
maximum voltage	200V
power dissipation	0.05W
spectral response peak	700μm

Overall size of the metal/glass case is 9.3 × 3.5mm. Price 55 to 75p each according to quantity. Photain Controls Ltd, Randalls Road, Leatherhead, Surrey.

WW320 for further details

Miniature power supply

Compact power supply module type M157, from Startronic, is designed for use with t.t.l. and other logic circuits requiring

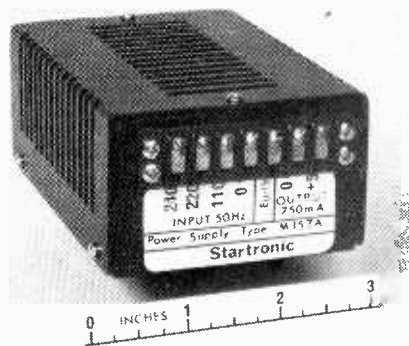

a low impedance stable 5V supply. Overload and short-circuit protection is provided by re-entrant current clamping circuits. Output is 5V, 0 to 750mA, and either side may be grounded. Ripple is less than 1mV p-p. The output changes less than 0.1% for ±10% input change. The size is 102 × 70 × 44.5mm. Prices: M157 £16.90; M157A (incorporating crowbar overvoltage protection) £19.50. Startronic Ltd, Beeching Road North, Bexhill-on-Sea, Sussex.

WW317 for further details

Studio reverberation unit

The main feature of a new studio reverberation unit by AKG is its portability. Model BX20 uses torsional vibrations transmitted along a specially treated spring, allowing a much smaller unit than with existing reverberation

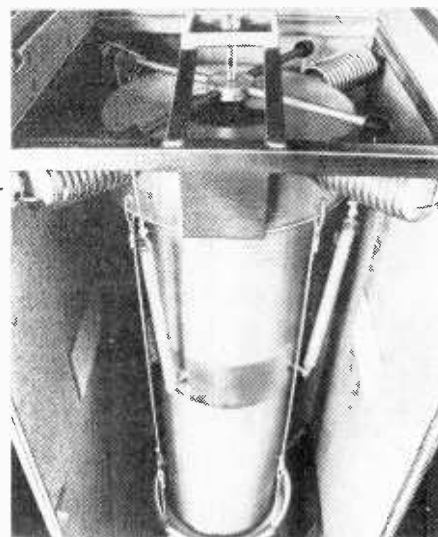

plates. Electronic damping through motional feedback permits variation in reverberation time from 2 to 4.5s (500Hz). The spring is treated to improve its transmission properties at high frequencies by etching and at low frequencies by deforming turns. Mechanical damping is applied to reduce reverberation at low frequencies. Springs and circuitry are duplicated for stereo use. The unit costs £975. AKG Equipment Ltd, 182 Campden Hill Road, London W8.

WW324 for further details

Digital dial potentiometer

Model 3610 potentiometer from Bourns includes readout in a single integral assembly with a guaranteed accuracy. No phasing is required. The unit is factory-phased to an accuracy of ±0.5% between electrical output and dial reading. Diameter is $\frac{3}{8}$ in, and rear panel extension is less than $\frac{7}{8}$ in including terminals. Resistance tolerance is ±5%, absolute minimum resistance 1Ω or 0.1%. Power rating is 1.5W. Bourns (Trimpot) Ltd, Hodford House, 17/27 High-Street, Hounslow, Middx.

WW310 for further details

Panel meter

The type E31G "Europa" panel meter produced by British Physical Laboratories has been designed to meet the requirements of the European market, in particular the relevant German specifications for physical size and electrical accuracy. The meter has a centre-pole

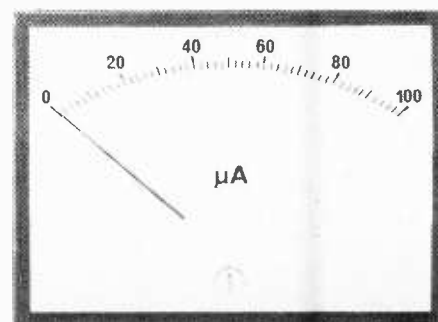

moving coil which is unaffected by external magnetic fields and the scale length is 90mm (expanded arc). The case is in ABS plastic and incorporates a small barrel diameter and is suitable for either sub-panel or front panel mounting. The meter is available in a wide range of sensitivities and is supplied to 1.5% accuracy. British Physical Laboratories, Radlett, Herts.

WW323 for further details

D.C. millivolt source

Voltage supply type 2301 from Comark provides an accurately defined output potential which is continuously variable from 0 to 100mV. A ten-turn helical potentiometer provides resolution of better than 1 part in 1000. Output impedance is 0.1 Ω /mV. The accuracy is $\pm 0.1\%$ at 100mV output, while regulation is better

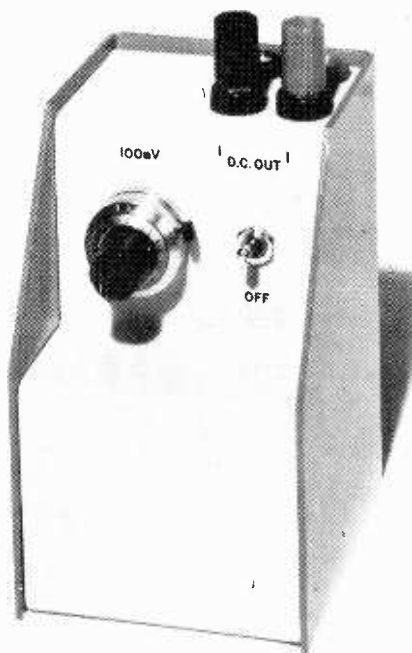

than 1000:1 for battery voltage variations from +10V to +7V. The output will work into any load, with a short-circuit current of 13mA. Comark Electronics Ltd, Brookside Avenue, Rustington, Littlehampton, Sussex.

WW306 for further details

U.H.F. meter

Model 9024 frequency-period meter from Racal has a direct-reading frequency range from 10Hz to over 600MHz. Sensitivity is better than 10mV up to 500MHz. The instrument has an eight-digit latched in-line display with overflow indication. Single and multiple period measurements from 10Hz to 3MHz can be made accurately — frequency ratio measurements have upper limits of 600MHz and 15MHz respectively. The two noise tolerant input channels are designed to operate correctly with high amounts of distortion, sub-harmonic



content and even amplitude modulation. Channel A has 50 Ω input impedance and operates to 600MHz while Channel B has high-input impedance and a frequency range to 60MHz. Racal Instruments Ltd, Duke Street, Windsor, Berks. SL4 1SB.

WW305 for further details

Frequency synthesizer

A solid-state frequency synthesizer that provides continuous coverage in the 1 to 18GHz range has been developed by Watkins-Johnson. The WJ-1154-5 synthesizer provides frequency steps of 100kHz (smaller steps available), frequency stability of 1 part in 10⁹/day and +10mW power output across the entire band. It can be swept or frequency modulated and it features local and remote digital programming (b.c.d.) to simplify operation. Watkins-Johnson Company, Shirley Avenue, Windsor, Berks.

WW312 for further details

Klystrons for 50 to 80GHz operation

A series of tunable extended interaction klystron oscillators is available from EMI-Varian, each tube delivering a c.w. output of at least 5W over a 4GHz tuning range selected between 50 and 80GHz. An integral 12V d.c. motor is used for remote

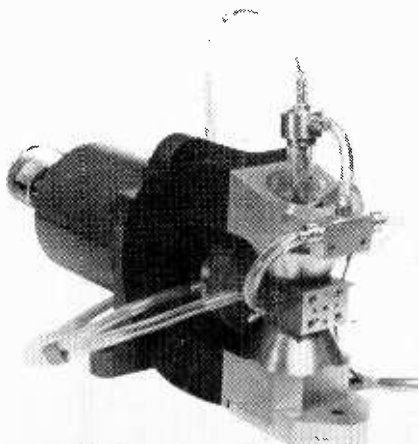

tuning. Mechanical tuning range is ± 2 GHz min. and electronic tuning range 150MHz. Beam voltage is 6kV d.c. and weight, approx. 6.5kg. EMI-Varian Ltd, Hayes, Middx.

WW309 for further details

C.R.T. for airborne radar

A 14cm diagonal rectangular-face airborne radar cathode-ray tube has been introduced by The M-O Valve Co. Type 1400E, this tube has a 23mm neck and is of compact design with an encapsulated



h.t. lead for high altitude use. It uses a low-drive cathode-modulated gun. Heater supply is 19V, final anode 17.5kV. Deflection angle is 44°. The M-O Valve Co. Ltd, Brook Green Works, London W.6.

WW304 for further details

Miniature logic power supply

Davis Electronics have released a new miniature logic power supply capable of supplying 5V output at 1.25A with a ripple of only 150 μ V typical and regulation of 0.01%. The unit makes use of a fully-screened and fused toroidal transformer considerably reducing overall size (particularly height) and gives the user the option of a mains input voltage of 110V. An over-voltage crowbar circuit operates at 6.8V and there is foldback current limiting. Units may be paralleled and include remote programming facilities. Terminations available are either 0.1in pitch edge connector or tag block. Athena Semiconductor Marketing Co. Ltd, 140 High Street, Egham, Surrey.

WW307 for further details

About People

The first Fellowship awards of the Royal Television Society for seven years have been made to six members. They are:

Sir Geoffrey Cox, C.B.E., deputy chairman of Yorkshire Television since he joined the company in June 1968 from ITN.

Tom Mayer, B.Sc.(Eng.), managing director of Marconi Communication Systems since 1969. He joined the Marconi Company as a graduate apprentice in 1948 after studying at the Regent Street Polytechnic, London.

Howard Steele, A.C.G.I., B.Sc.(Eng.), F.I.E.E., director of engineering, I.T.A. After graduating at the Imperial College of Science & Technology, London University, in 1952 he served an apprenticeship with the Marconi Company. He became chief engineer of ABC Television at Teddington in 1960. He joined the I.T.A. in 1966.

Leslie W. Turner, F.I.E.E., after service as a seagoing radio officer with the International Marine Radio Company, joined the B.B.C. in 1936 as a maintenance engineer and became head of the Engineering Information Department in 1952. He retired from the B.B.C. last December but is continuing as a part-time consultant.

John Ware, F.R.I.B.A., M.I.E.R.E., perhaps best known for his work as an architect and founder of his practice, the Ware Macgregor Partnership which has principally served the electronics and television industries, is also a keen television amateur. He was for some years chairman of the British Amateur Television Club.

E. L. C. White, Ph.D., M.A., F.I.E.E., who graduated at Sidney Sussex College, Cambridge, and did three years academic research at the Cavendish Laboratory. He joined EMI in 1933 in their research department and is now the company's director of systems research.

J. Frank P. Thomas, B.Sc., who joined the Post Office Research

Department in 1937, has been appointed director of network planning in the Corporation. Mr. Thomas, who is 51, was mainly concerned in the Research Department with the design of repeater components, power feeding equipment and fault location equipment for undersea cable systems, including transatlantic telephone cables. In 1963 he moved from research to the headquarters of the telecommunications service, working on trunk network matters. He has been deputy director of network planning since last October.

Professor Colin Cherry, D.Sc. (Eng.), M.I.E.E., is to give the second S.T.C. Communication Lecture in London on April 11th. The title is 'World communication — threat or promise?'. Dr. Cherry, who is 58, is professor of telecommunication in the Department of Electrical Engineering at the Imperial College of Science and Technology, London. He joined the staff at Imperial College in 1947 from the College of Technology in Manchester and was appointed to the Henry Mark Pease Chair in Telecommunications — which is endowed by S.T.C. — in 1958. Professor Cherry's early researches were on the theory of linear and non-linear circuits, modulation problems etc, but latterly he has been concerned with new forms of experimentation into human speech.

Each year the Telecommunication Engineering and Manufacturing Association awards prizes to several candidates from member

companies who submit an essay on some aspect of their work. This year a first (£50) and second (£20) prize was awarded in each of the two classes — technologist and technician. This year's winners, who received their awards at the T.E.M.A. dinner on February 1st, are **Robert N. Price** (GEC-AEI Telecommunications) and **Joy A. Orrell-Wighton** (Standard Telephones and Cables) respectively first and second in the technologist class, and in the technician class **Kenneth G. Brown** (S.T.C.) and **Barry R. Jones** (Plessey Telecommunications) respectively first and second.

Dr. Peter C. Goldmark, who developed electronic video recording at CBS Laboratories, has been appointed consultant and technical advisor to the London-based EVR Partnership. Dr. Goldmark, who retired as president and director of research at CBS Laboratories on 31st December, has taken the same title at Goldmark Communications Corporation, Norwalk, Connecticut.

The Marconi International Marine Company has appointed **G. R. C. MacDonald**, manager of its Lowestoft depot. Educated at Inverness Royal Academy, he joined the Royal Navy Communications branch in 1942. On leaving the Royal Navy in 1946 he attended the Edinburgh Wireless College where he obtained his P.M.G. certificate and joined Marconi Marine in 1948 as a seagoing radio officer. He has held various shore appointments and since 1967 has been service superintendent.

David Elsbury has been appointed deputy managing director of Rascal-Mobilcal Ltd of which he was previously director and general manager. Mr. Elsbury, who is 36, has been with Rascal since leaving the R.A.F. in 1956. Starting as a junior tester, he went through production, inspection and quality assurance departments in Rascal Communications before joining Rascal-Mobilcal in 1970.

The new position of marketing manager for EMI Electronics' Systems & Weapons Division is to be filled by **David Lane, B.Sc., A.R.C.S.** Mr. Lane, who is 46, was previously manager of EMI's

electro-optics and proximity systems department at Feltham. He joined EMI as a junior engineer in 1946 from the Ministry of Aircraft Production. He has spent most of his career with EMI in research and development associated with military systems, particularly guided weapons. In 1961 he became deputy chief engineer of the guided weapon division's research and advanced development department.

The M.E.L. Equipment Company has created a new position, that of chief commercial engineer of its Defence Systems Division, which is being filled by **S. J. Robinson**. He has joined M.E.L. from the Mullard Research Laboratories where he had been for 17 years, latterly as scientific adviser and deputy to the head of the Systems Division. At the Laboratories Mr. Robinson, who is 40, has been mainly concerned with microwave systems, including MADGE, the approach and landing system.

J. P. Andrews, M.Sc., has joined Multitone Electric Co. Ltd as an export sales executive. Apprenticed to the Ministry of Aviation, Mr. Andrews studied at the Royal Radar Establishment, Malvern, and took his degree in microwave physics at the University of Surrey. He then spent five years with Marconi Communications Systems Ltd.

OBITUARY

Edward Victor D. Glazier, C.B., Ph.D., B.Sc., F.I.E.E., director of the Royal Radar Establishment, Malvern, since 1967, died on 6th January aged 59. Dr. Glazier entered the Scientific Civil Service in 1935 as an executive engineer in the Post Office. In 1942 he transferred to the Signals Research and Development Establishment where in 1950 he took charge of the research division. He was director of scientific research (electronics and guided weapons) in the Ministry of Aviation for two years prior to 1959 when he went to R. R. E. as head of the ground radar department and was later head of the physics and electronics department.

Sidney A. Brown, managing director of Vortexion Ltd, died on 19th January. He founded the company in 1932 and has been responsible for the technical design of the wide range of mixers, amplifiers, and tape recorders.

Christopher E. G. Bailey, M.A., F.I.E.E., who died on January 4th aged 65, graduated at Balliol College, Oxford before entering the radio industry in 1930. Initially he was with Plessey as head of the radio laboratory until 1935 when he joined the Philips-Mullard Group. He was appointed technical director of Solartron Electronic Business Machines in 1955 and since 1962 has been a consultant. The development of the slot aerial is attributed to him.



Donald Aldous (left), 'hi-fi journal-ist of the year', receiving his award, which included £100, from **Gerry Adler**, managing director of *Eagle International*, the sponsors.

March Meetings

Tickets are required for some meetings: readers are advised, therefore, to communicate with the society concerned

LONDON

1st. IERE — "Power transistors" by A. Lear at 18.00 at the Engineering Lecture Theatre, University College, Torrington Pl., W.C.1.

2nd. IEE — "The future for the British electrical and electronics industries inside the E.E.C." by Dr. F. E. Jones at 17.30 at Savoy Pl., W.C.2.

2nd. RTS — "The technical future of television" by J. S. Sansom at 19.00 at the I.T.A., 70 Brompton Rd., S.W.3.

7th. IEE — "Control from within: how brains do it" by Prof. R. L. Gregory at 17.30 at Savoy Pl., W.C.2.

8th. IEE — Discussion on "New integrated circuits for TV receivers" at 17.30 at Savoy Pl., W.C.2.

8th. IERE/IEE — "A sub-miniature physiological data logging system and its transducers" by J. N. B. Beatty at 18.00 at the Engineering Lecture Theatre, University College, Torrington Pl., W.C.1.

14th. AES — "Alternatives to frequency and time in audio system design and analysis" by Dr. D. M. Leakey at 19.15 at the Mechanical Engineering Dept., Imperial College, Exhibition Rd., S.W.7.

15th. I.Phys. — "Filamentary conduction in solids" at 10.25 at Imperial College, Exhibition Rd., S.W.7.

15th. IEE — "Video recording and reproduction for educational and home use" by W. Kemp at 17.30 at Savoy Pl., W.C.2.

15th. IERE — "Innovation in the commercial environment" by Prof. C. Freeman at 18.00 at the Engineering Lecture Theatre, University College, Torrington Pl., W.C.1.

15th. IEE Grads — "Fibre optic waveguides and optical integrated circuits" by J. O'Reilly at 18.30 at Savoy Pl., W.C.2.

16th. RTS — "Integrated circuits in TV receivers" by S. N. Doherty, M. C. Gander and R. Saxby at 19.00 at the I.T.A., 70 Brompton Rd., S.W.3.

20th. IEE/IERE/I.Phys. — Colloquium on "Link scheme for the electronics industry" at 10.30 at the City University, St. John St., E.C.1.

22nd. IERE — Colloquium on "Characterization of components and circuits for c.a.d." at 14.30 at the Eng. Lecture Theatre, University College, Torrington Pl., W.C.1.

22nd. IEE — "Visual aspects of flight simulation" by Dr. A. M. Spooner at 17.30 at Savoy Pl., W.C.2.

23rd. IEE/I.Mech.E./I.Meas. Control — Colloquium on "University/Industry co-operation in control and automation" at 10.00 at Savoy Pl., W.C.2.

23rd. IERE — "Satellite attitude control using pulsed gas jets" by R. L. Davey at 18.00 at the Engineering Lecture Theatre, University College, Torrington Pl., W.C.1.

24th. IEE — Discussion on "electro-optic properties of liquid crystals" at 14.30 at Savoy Pl., W.C.2.

27th. IEE — Discussion on "Conferences, vacation schools and meetings — have they a future?" at 17.30 at Savoy Pl., W.C.2.

28th. I.Phys/IEE — "Fibre optical communications" at 10.00 at Imperial College, Exhibition Rd., S.W.7.

29th. IEE — Discussion on "Integrated circuit design using analogue and digital device models" at 14.00 at Savoy Pl., W.C.2.

29th. IERE — "Radio communications in mines and tunnels" by D. J. R. Martin at 18.00 at the Engineering Lecture Theatre, University College, Torrington Pl., W.C.1.

ABERDEEN

8th. IEE — "Thoughts on the future of world communications" by Prof. E. C. Cherry at 19.30 at Robert Gordon's Institute of Technology, Schoolhill.

AYLESBURY

16th. R.Ae.S/IEE — "Recent developments in aircraft approach and landing systems" by J. M. Jones at 19.30 at Lecture Hall A, Kermod Hall, No. 1 School of Technical Training, R.A.F., Halton.

BASILDON

22nd. IEE — "Developments in data communications" by N. B. Williams at 18.30 at the Bull's Eye.

BATH

1st. IEE/IERE — "Sound in synes" by Dr. C. G. Dalton at 19.00 at Bath University, Bldg. 2.

BIRMINGHAM

6th. IEE — "The Open University" by Prof. J. J. Sparkes at 18.30 at the MEB Offices, Summer Lane.

BOLTON

13th. IEE — "The use of visual aids in the teaching of technical engineering subjects" by E. J. Griffiths at 18.15 at Bolton Technical College, Chadwell St.

BOURNEMOUTH

8th. IEETE — "Aircraft crash recorders" by R. Pearce at 20.00 at Highcliffe Hotel, West Cliff.

BRIGHTON

21st. IEE — "Audio systems for the average home" by H. Mayo at 18.30 at Brighton Polytechnic.

BRISTOL

9th. IEE — "Microwave communication in the Post Office" by R. Hopton at 19.30 at Electricity House.

CAMBRIDGE

9th. IEE — "Optical communications" by F. F. Roberts at 18.30 at the University Engineering Dept., Trumpington St.

CHATHAM

23rd. IERE — "Advanced automatic test equipment" by A. J. Hill at 19.00 at the Medway College of Technology.

CHELMSFORD

8th. IERE — "Use of waveguides in long-distance communication" by R. W. White at 19.30 at the Hoffman Lecture Theatre.

CHELTENHAM

7th. IEE/IERE — "Navigation and communications with special reference to QE2" at 19.00 at Oakley G.C.H.Q.

COLCHESTER

22nd. IEE — "Microelectronics" by D. G. Dewdney at 18.30 at Essex University.

CROYDON

1st. IEE Grads — "Satellite communications — today and tomorrow" by J. K. S. Jowett at 18.30 at Croydon Technical College, Fairfield.

DUBLIN

23rd. IEE — "Colour television" by R. M. F. Barry and D. Ryle at 17.30 at the Physical Lab., Trinity College.

DUNDEE

9th. IEE — "Thoughts on the future of world communications" by Prof. E. C. Cherry at 19.00 at Ewing Bldg., Dundee University.

EDINBURGH

7th. IEE — "Trends in telecommunications" by R. Coakley at 18.00 at the SSEB Offices, George St.

8th. IEE/IERE — "Large scale integration" by A. F. Beer at 19.00 at Napier College, Colinton Rd.

ENFIELD

9th. IEE Grads — "Concorde electronics" by H. Hill at 18.30 at Enfield College of Technology, Queensway.

FARNBOROUGH, Hants

1st. IEETE — "Engineers' Registration Board and composite register" by A. C. Gingell, at 19.30 at the Technical College, Boundary Rd.

GLASGOW

9th. IEE/IERE — "Large scale integration" by A. F. Beer at 19.00 at Rankine House, Bath St.

HULL

30th. IEE/IERE — "Electronics in ocean technology" by V. G. Welsby at 18.30 at the YEB Offices.

HURSLEY

15th. IEE — "Semiconductor storage systems" by G. T. Dove and J. Gionis at 18.30 at IBM.

LIVERPOOL

28th. IEE — Colloquium, "New materials, new devices, new techniques" at 09.15 at the University.

MANCHESTER

14th. S.Relay Eng. — "The British Relay multi-channel colour television relay system" by K. A. Russell, A. Burke and B. Bashford at 15.00 at the Excelsior Hotel, Manchester Airport.

16th. IEE/IERE — "Television broadcast receivers" by B. A. Horlock at 18.15 at Renold Bldg., UMIST.

MOLD, Flint

2nd. BCS — "Artificial intelligence" by A. E. Sale at 19.30 at Lwynegryn Hall, Shire Hall.

NEWCASTLE-UPON-TYNE

6th. IEE — "Electronics in cars" by E. T. Emms at 18.30 at the Polytechnic.

14th. IEE Grads — "Thin films" by R. Chapman at 18.30 at the University, Merz Court.

NORTHAMPTON

15th. IEE — "Quality control in small electrical and electronic components" by P. Fox at 18.30 at EMEB, Angel St.

OXFORD

14th. BCS — "Developments in telecommunications" at 20.15 at The Mathematical Inst., 24 St. Giles.

POOLE

7th. IEE Grads — "Marine electronics for the yachtsman" at 19.30 at the Dolphin Hotel.

READING

15th. IERE — "Developments in the field of digital communications" by R. F. Purton and H. Mumford at 19.30 at the J.J. Thomson Laboratory, University of Reading, Whiteknights Park.

RYDE, I.o.W.

31st. IEE — "Semiconductors" by I. Nicholson at 18.30 at SEB Offices, Union St.

SALISBURY

13th. IEE — "The electronic performance testing of motor vehicles" by D. C. Freeman at 18.30 at Salisbury College of F.E., Southampton Rd.

WORCESTER

13th. IEE Grads. — "Space technology and the future" by G. K. C. Pardoe at 19.30 at Hillard Hall, Worcester Royal Grammar School, Upper Tything.

Literature Received

For further information on any item include the WW number on the reader reply card

ACTIVE DEVICES

From Texas Instruments Ltd, Manton Lane, Bedford, a price list of all their available discrete devices and integrated circuitsWW401

We have been sent preliminary specifications for the GWN105 integrated circuit m.o.s. dynamic shift register which is designed to control d.t.l. and t.t.l. units. MCP Electronics Ltd, Alperton, Wembley, Middlesex, HAO 4PEWW402

In "Semiconductors", a publication from Motorola Semiconductors Ltd, York House, Empire Way, Wembley, Middlesex, articles include "The Future of Electronics in the Car"WW403

We have been sent data sheets covering the range of integrated circuits (silicon networks) produced by Ferranti Ltd, Gem Mill, Chadderton, Oldham, LancsWW404

PASSIVE COMPONENTS

The most recent edition of Cambion's 'Product News Bulletin' presents detailed information on their range of standard miniature connectors with application examples. Cambion Electronic Products Ltd, Sales Department C-01, Cambion Works, Castleton, Nr. Sheffield S30 2WRWW405

Types LPS and LPD low-profile, reed relays are a new range of relays described in a data sheet. Osrom Ltd, 540 Purley Way, Croydon, SurreyWW406

A data sheet from Beckman Instruments International SA, Rue des Pierres-du-Niton 17, 1207 Geneva, Switzerland, describes a 10 resistor d.i.p. gain setting network from Helipot, which is suitable for operational, differential and potentiometric amplifier applicationsWW407

A list of standard capacitance and voltage ratings and performance characteristics of Dearborn Type LS88 metallized polystyrene capacitors is given in Engineering Bulletin No. 406. Dearborn Technical Information, c/o Sprague Electric Co., Marshall St, North Adams, Mass. 01247, U.S.A.WW409

Latest information on the Erie Redcap series of monolithic capacitors, is contained in a new brochure. Data sheet PFC/10 is also included detailing metallized paper capacitor type 50201 (W197). Erie Electronics Ltd, South Denes, Great Yarmouth, NorfolkWW410

APPLICATION NOTES

Feedback loop and servomechanism measurements using HP Fourier analysers is the subject of application note 140-2 from Hewlett Packard Ltd, 224 Bath Road, Slough, Bucks. SL1 4DSWW411

We have received a manual from USCC/CENTRALAB, 2151 N. Lincoln St, Burbank, California 91504, on selecting and using monolithic chip capacitorsWW412

A book giving full information on Bruel and Kjaer instruments contains specifications and examples of application. B & K Laboratories Ltd, Cross Lances Rd, Hounslow, MiddxWW413

EQUIPMENT

ARP electronic music synthesizers are described in a leaflet from F. W. O. Bauch Ltd, 49 Theobald St, Boreham Wood, HertsWW414

Data sheets from Fenlow Electronics Ltd, Whittet's Eyot, Jessamy Rd, Weybridge, Surrey, describe programmable voltage current source PS4, 'P' range power supply modules and automatic Nyquist plotter NP201WW415

Leaflets and price lists of equipment from Bryan Amplifiers Ltd, 18 Greenacres Rd, Oldham, Lancs., are now obtainableWW416

The 773A is the latest counter-timer (indication up to 80MHz) from Venner, a division of AMF, Kingston By-Pass, New Malden, Surrey. and a data sheet gives full technical detailsWW417

A booklet from Flann Microwave Instruments, Dunmere Rd, Bodmin, Cornwall, outlines the salient features of each instrument manufacturedWW418

'Synchro and Resolver Bridges', Bulletin 4-20B, describes the Theta line of instruments, which are used to measure the precise angular position of any system containing synchros or resolvers. Theta Instrument Corporation, Fairfield, New Jersey 07006WW419

Aveley Electric Ltd, Arisdale Ave, South Ockendon, Essex RM15 5SR, have sent us the Rohde and Schwarz TV test equipment catalogueWW420

Information on the Mini-UBIQ spectrum analyser and systems built around it is contained in several leaflets, from Federal Scientific Corporation, 615 West 131st St, New York, N.Y. 10027WW421

The 1972 catalogue of tubes and accessories from English Electric Valve Co. Ltd, Chelmsford, Essex, is called 'Electron Tubes Abridged Data' and lists almost 650 typesWW422

Wavecom Inc, 9036 Winnetka Ave, Northridge, California 91324, have sent us a news sheet, containing information on Model P-102 temperature compensated cavity filters for 40MHz communication systemsWW423

Op-amp testers 5104 and 5107 are described in a pamphlet from Teledyne Philbrick Nexus, St. Peter's House, Chichester, SussexWW424

RTV-51 radiotelephone systems is the subject of a booklet, offered by The Hallicrafters Co, 600 Hicks Rd, Rolling Meadows, Illinois 60008WW425

We have been sent a leaflet describing a 16-bit 'minicomputer' the Alpha 16. Also described is the Naked Mini 16, which is the Alpha 16 less its power supply, control console and metal chassis. CAI Ltd, 95a High St, Rickmansworth, Herts.WW426

A printer terminal from Tally Corporation, 8301 South 180th St, Kent, Washington 98031, is featured in a pamphlet received. The printer features 100-line per minute print-out in either 80 or 132 column formatWW427

Information on a 1300MHz r.f. sweeper, a 'total solution' computing counter system and digital oscilloscopes is contained in a news sheet entitled 'Measurement News' from Hewlett Packard Ltd, 224 Bath Rd, Slough, Bucks, SL1 4DSWW428

We have received information and a price list of electronic measuring equipment, including response test unit, level recorder and audio frequency analyser, from B & K Laboratories Ltd, Cross Lances Rd, Hounslow, MiddlesexWW429

GENERAL INFORMATION

Details of an electronic equipment repair and calibration service are given in a leaflet from ADL Technicare Ltd, 3C The Industrial Estate, Cores End Rd, Bourne End, Bucks.WW430

'Catalist' is the name of a booklet from GDS (Sales) Ltd, Michaelmas House, Salt Hill, Bath Rd, Slough, Bucks. It contains information on standard ohmic values, spindle variants for potentiometers, dimensions of diecast boxes, brief descriptions of many products and pricing informationWW431

A wall chart called the top 50 (new edition) from Firth Cleveland Fastenings Ltd, Treforest, Glamorgan, lists the most popular self-locking nuts, proprietary spring-steel fasteners, etc, made by Firth ClevelandWW432

A leaflet which describes and illustrates the products of Berg Electronics NV, Helftheuvelweg 1, P.O. Box 2069, 's-Hertogenbosch, Holland, has just been released. Berg products include connectors, terminals, wrapping posts, assembly machines, p.c. boards solder aids etcWW433

Also from Berg a bulletin entitled 'The advantages of dual-metal components in a miniature interconnection system' contrasting single-alloy with dual-metal constructionWW434

We have been sent a leaflet No. SD-143 on a line of Vaco-Matic magnetic screwdrivers. Special Products Distributors Ltd, 81 Piccadilly, London W1V 0HLWW435

The advantages of three-electrode arresters over single gap devices in the protection of telephone lines against atmospheric discharges or power line induction are discussed in a new booklet 'High-speed protection by 3-electrode arresters'. M-O Valve Co. Ltd, Brook Green Works, London W6WW436

Details and application forms for part-time research opportunities at Portsmouth Polytechnic, Department of Electrical and Electronic Engineering, Anglesea Rd, Portsmouth PO1 3DJ, are given in a booklet. Work can lead to an M.Phil or Ph.D award.

'The Journal of Teflon' covers applications and methods of application of Teflon. DuPont de Nemours International S.A., Public Relations Dept, P.O. Box, CH-1211 Geneva 24WW438

We have received four publications from the British Standards Institution, 2 Park St, London W1A 2BS.

Amendment No. 3 to Publication 122-1 (First edition-1962) 'Quartz crystal units for oscillators' Section one: Standard values and conditions Section two: Test conditionsPrice 55p Publication 117-14 'recommended graphical symbols Part 14: 'Telecommunication lines and accessories'Price 40p Publication 130-11 'Connectors for frequencies below 3MHz: Part II: Edge-socket connectors with closed ends and having a contact spacing of 2.54mm (0.1in) mating'Price £2-75p Publication 374 (1971) 'Guide for choosing modular dimensions for waveguide components'Price 90p

A brochure contains details of 26 sub-miniature coaxial connectors ('100 series') for operation within the 5kV working range. EMI Electronics and Industrial Operations, Blyth Rd, Hayes, MiddlesexWW439

The latest 'newsletter' from the British Amateur Radio Teleprinter Group, 51, Norman Rd, Swindon, Wiltshire gives details of the group's recent activities