

STEREO RECEPTION

SEPTEMBER 1966
Three Shillings

Wireless World

ELECTRONICS • TELEVISION • RADIO • AUDIO

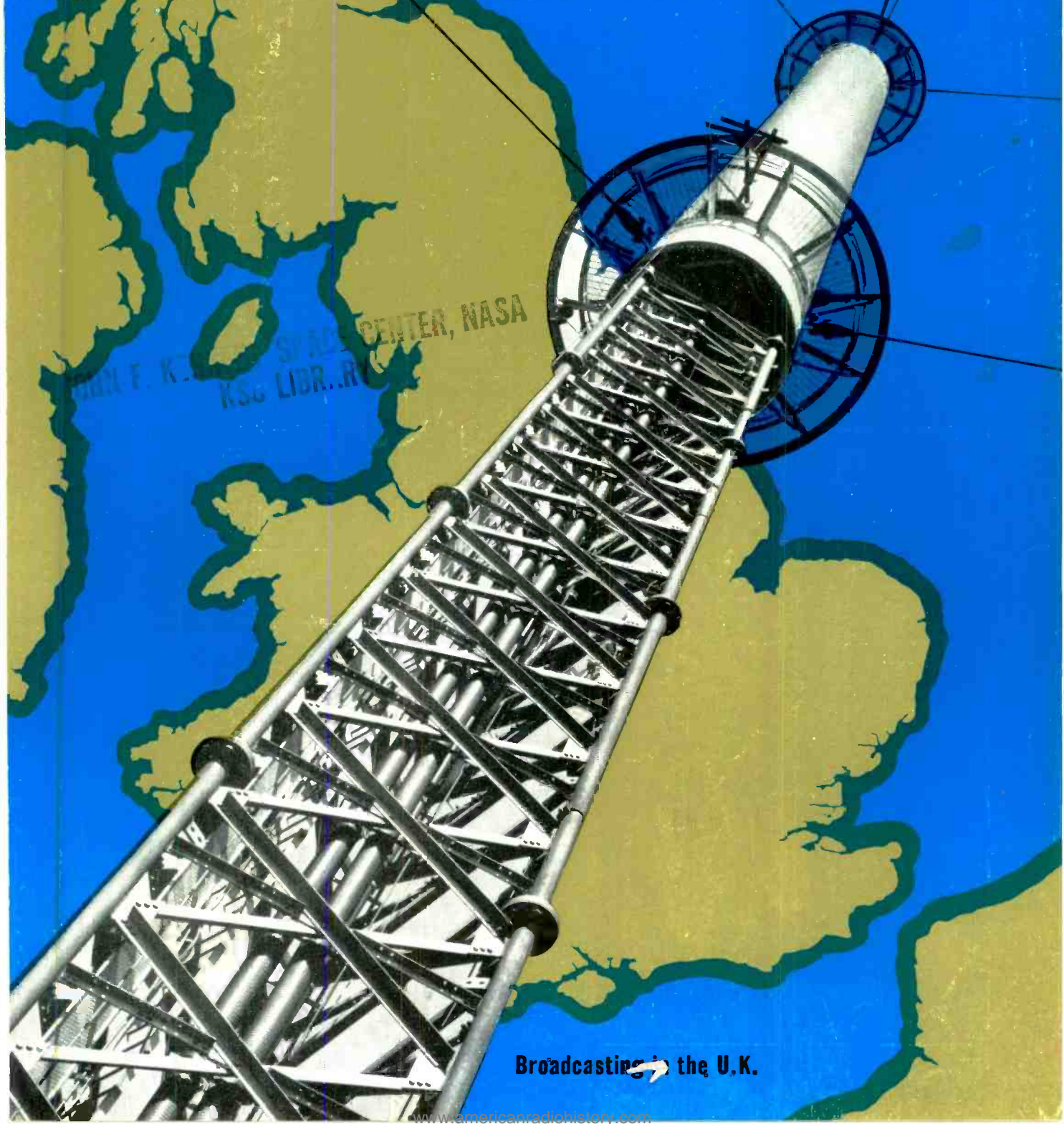

JOHN F. KE... SPACE CENTER, NASA
KSO LIBR. R...

Broadcasting to the U.K.

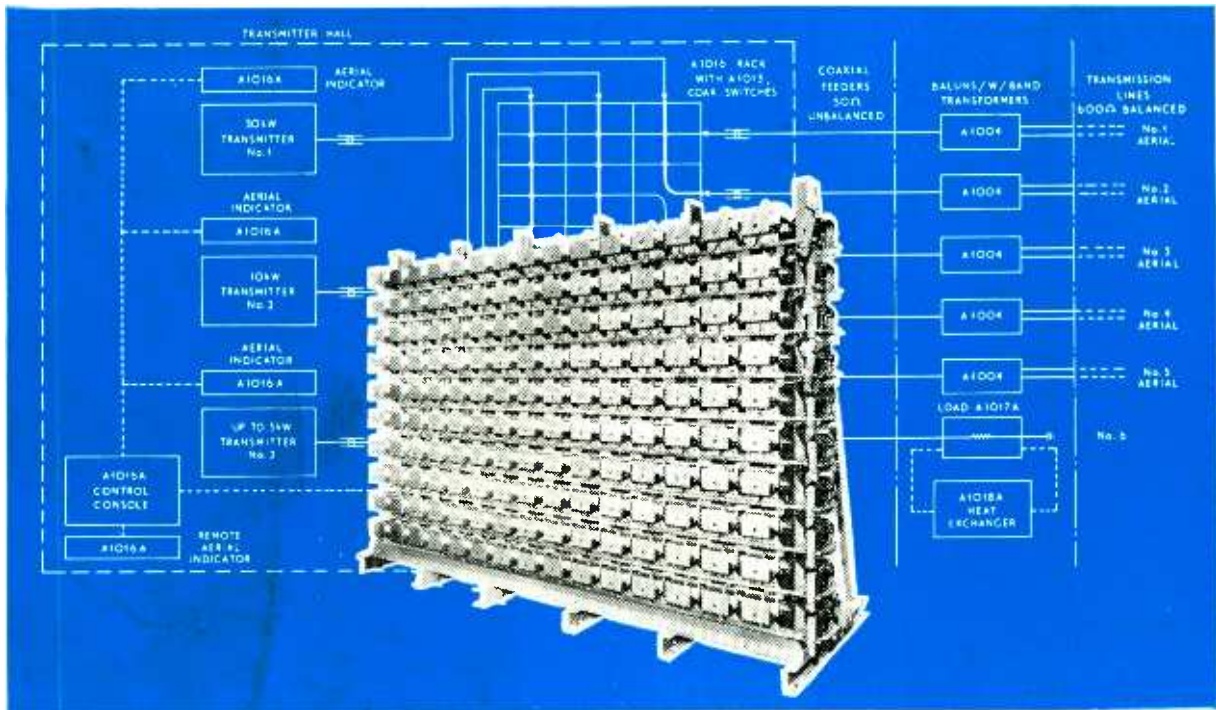

Aerial ancillaries

Automatic tuning and supervisory techniques enable the modern transmitting station to be operated with the minimum of attendance. The aerial systems for use with these stations must, of necessity, embody components designed specifically for this form of operation. STC can supply a complete range of aerial ancillaries for this purpose:

- 5kW Wideband Aerial Matching Transformer A.1003
- 10kW Wideband Aerial Matching Transformer A.1012
- 20/30kW Baluns A.1004
- Coaxial Crossbar Switch A.1013
- 2-Way Coaxial Switch A.1014-A
- 4-Way Coaxial Switch A.1015-A
- Crossbar Aerial Exchange A.1016-A comprising Switching Rack, Crossbar Switches, Control Console and Lamp Indicators.

For further details write, phone or telex Standard Telephones and Cables Limited, Radio Division, Oakleigh Road, New Southgate, London N.11. Telephone: ENTEnterprise 1234. Telex: 261912

world-wide telecommunications and electronics

STC

"Wireless World"
Iliffe Electrical Publications Ltd.,
Dorset House, Stamford Street,
London, S.E.1

Managing Director:
W. E. MILLER, M.A., M.I.E.R.E.

Editor-in-chief:
W. T. COCKING, M.I.E.E.

Editor:
H. W. BARNARD

Technical Editor:
T. E. IVALL

Editorial:
F. MILLS
G. B. SHORTER, B.Sc.

Drawing Office:
H. J. COOKE

Production:
D. R. BRAY

Advertisements:
G. BENTON ROWELL
(Manager)
J. R. EYTON-JONES

© Iliffe Electrical Publications Ltd., 1966. Permission in writing from the Editor must first be obtained before letterpress or illustrations are reproduced from this journal. Brief extracts or comments are allowed provided acknowledgement to the journal is given.

VOLUME 72 No. 9
PRICE: 3s.

FIFTY-SIXTH YEAR
OF PUBLICATION

Wireless World

ELECTRONICS TELEVISION, RADIO, AUDIO

SEPTEMBER 1966

- 431 Political Hues!
432 Audio Applications of Integrated Circuits *by R. Hirst*
438 Broadcasting Developments in the U.K.
440 London's International TV and Radio Show
445 Receiving Stereo Broadcasts
449 Scan Linearity Measurements without Tears *by A. J. Henk*
462 A Simple Sine-square Converter and Sync Amplifier *by T. E. EStaugh*
465 Multivibrator Design Difficulties *by J. R. Chew*
468 R.F. Diode Changeover Gates *by P. A. Schafle*
471 Is there a Shoenberg in the House?
473 Stabilization Using the Root-locus *by W. Tusting*

SHORT ITEMS

- 443 Citizen's Band Radio
443 Line Standards and Colour—B.R.E.M.A. Statement
454 Further Education
464 The Apollo Project

REGULAR FEATURES

- | | |
|---------------------------|---|
| 431 Editorial Comment | 461 September Conferences and Exhibitions |
| 437 Books Received | 467 H.F. Predictions—September |
| 443 World of Wireless | 476 New Products |
| 455 Letters to the Editor | 482 Real and Imaginary <i>by "Vector"</i> |
| 459 News from Industry | |
| 460 Personalities | |

PUBLISHED MONTHLY (3rd Monday of preceding month). Telephone: Waterloo 3333 (70 lines). Telegrams/Telex: Wiworld Iliffepres 25137 London. Cables: "Ethaworld, London, S.E.1." Annual Subscriptions: Home £2 6s 0d. Overseas: £2 15s 0d. Canada and U.S.A. \$8.00. Second-class mail privileges authorised at New York N.Y. BRANCH OFFICES: BIRMINGHAM: 401, Lynton House, Walsall Road, 22b. Telephone: Birchfield 4838. BRISTOL: 11, Marsh Street, 1. Telephone: Bristol 21491/2. COVENTRY: 8-10 Corporation Street. Telephone: Coventry 25210. GLASGOW: 123, Hope Street, C.2. Telephone: Central 1265-6. MANCHESTER: 260, Deansgate, 3. Telephone: Blackfriars 4412. NEW YORK OFFICE U.S.A. 300 East 42nd Street, New York 10017. Telephone: 867-3900.

silicon planar

**for audio, radio and hybrid
television applications**

Mullard now offer a comprehensive range of Silicon Planar Transistors for all new design requirements. These devices are outstanding in performance and are available at competitive prices.

Complete information is available to Design Engineers from:—

Mullard Limited • Entertainment Markets Division
Mullard House • Torrington Place • London • W.C.1
Tel: LANgham 6633 • Telex 22281

BC107

Low-frequency high-gain driver.

BC108

Low-frequency high-gain amplifier.

BC109

Low-noise high-gain A.F. amplifier.

BF115

V.H.F. mixer and oscillator for television.

BF167

'Integrated Screen' transistor for television I.F. amplifiers (A.G.C.)

BF173

'Integrated Screen' transistor for uncontrolled television I.F. amplifier stages.

BF180

Low-noise R.F. amplifier for U.H.F. and integrated tuners.

BF181

High-gain mixer and mixer/osc. for U.H.F. and integrated tuners.

BF184

High-gain I.F. amplifier for A.M., F.M. and television sound.

BF185

R.F. and I.F. amplifier for portable radios.

Mullard **Si** *planar*

See us on Stand Number 46 at The Television & Radio Show

WW—091 FOR FURTHER DETAILS.

Wireless World

ELECTRONICS, TELEVISION, RADIO, AUDIO

Political Hues!

ALTHOUGH many hundreds of documents were considered by the fourteen Study Groups of the C.C.I.R. at the recent month-long Oslo conference those concerned with colour television have received the widest publicity, because, of course, the subject is of wide public interest.

The U.K. delegation, numbering 38 and led by H. Stanesby (G.P.O.), were briefed to opt for PAL in view of the P.M.G.'s recent pronouncement, and it was hoped some measure of unanimity on a system might have emerged as a result of the Oslo deliberations. The results of a questionnaire, however, showed that nine countries opted for N.T.S.C., 17 for PAL and 35 (including a number of ex-French colonies, some of which have not even a monochrome service) for SECAM III.

In an attempt to secure some measure of unanimity, for which everybody hoped, the Danish delegation submitted a document pointing out that the PAL system, "may be regarded as much a development of the SECAM system as of the N.T.S.C." and is, therefore, "a truly international system." This is, of course, true to the extent that, like SECAM, it involves a line-by-line switching process and a delay-line store in the receiver, and is a QUAM (quadrature amplitude modulated) system—a fundamental feature of N.T.S.C. The Danes therefore suggested that PAL should be renamed SEQUAM (Sequential European Quadrature Amplitude Memory method).

It was pointed out that PAL in its present form has been modified very considerably since the original German conception as a result of contributions from other countries. For instance the modulation axes have been changed from I and Q to (R-Y) and (B-Y) as used in SECAM, and the swinging burst method of colour synchronization has been introduced.

The Danish proposal had the support of many delegations including the German, but despite this effort by the Danes "to stop the drift towards two different systems with all the serious consequences that this would involve" the Franco-Russian bloc, which appeared to be dominated by politicians rather than engineers, was unmoved.

The French delegation then offered to change from SECAM III to SECAM IV (N.I.I.R.) if the PAL bloc would do likewise and delay the introduction of colour television in all countries for a further year, at the end of which if agreement could not be reached countries would then be free to "go it alone." It was also suggested that in every country the development of colour receivers should be stopped so that no one country would be in a position of advantage!

It was then formally proposed by the retiring director of C.C.I.R. (Mr. L. W. Hayes) supported by the E.B.U. technical director (Mr. G. Hansen) that the SECAM IV (or N.I.I.R.) system should be adopted. Eventually, this attempt to secure a snap decision on a system still in the development stage was withdrawn as no documentation on it had been laid before the committee by the specified date.

It remains, therefore, that after innumerable tests, demonstrations and modifications followed by proposals and counter proposals at meetings in almost every capital on the Continent we are not to have a unified European colour system.

Should we feel despair that engineering decisions are so frequently being bent by political expediency? Or is it just a lesson to be learnt that engineering must always ultimately serve the interests of the community (however incorrect they may be from an engineering point of view)?

However deplorable may be the outcome of Oslo at least it provides one more job to keep the systems engineers busy—to find a satisfactory method of standards conversion for the exchange of programmes.

VOL 72 NO 9
SEPTEMBER 1966

AUDIO APPLICATIONS OF INTEGRATED CIRCUITS

By
ROBERT HIRST

USER EVALUATION OF TWO OFF-THE-SHELF PACKAGES : VARIOUS A.F. FUNCTIONS OBTAINED BY MAKING DIFFERENT EXTERNAL CONNECTIONS

DURING the introductory period of pre-packaged circuitry, there were many objections about the inadequacy of, say, an audio package in coping with the multitude of functions that could be anticipated. This factor alone was probably responsible for the stagnation of consumer demand once the initial interest had been satisfied. The static "requirement" may well have been caused unwittingly by the manufacturers themselves, as a result of sales techniques advocating inclusion of the modules into existing systems. Under

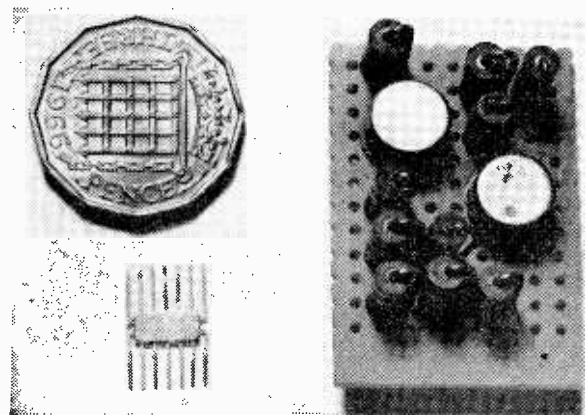

Fig. 1. The Texas Instruments 14-lead flat-package integrated circuit (bottom left) compared in size with an equivalent discrete-component unit and a three-penny bit.

these circumstances, it certainly would have been difficult to provide the customer with identical replacements as an off-the-shelf service. Had these units been presented to the customer as "components" which they virtually are, they could well have been included in future systems.

Monolithic circuits, enclosed as single capsules, tend naturally to be accepted as components by virtue of their physical appearance. Some of the larger manufacturers have recently introduced integrated linear amplifiers with up to seven circuit elements enclosed in a volume of approximately 3mm × 6mm × 2mm. The small size of this type of unit, compared with an equivalent unit of conventional construction, can be seen in Fig. 1. The integrated circuit shown is actually one marketed by Texas Instruments Ltd. This unit, Type SN2610 (price £5 for one-off), comprises a d.c. coupled pair, a configuration well known for its excellent temperature stability, and the circuit is shown in Fig. 2. The principal resistive paths have been terminated externally, enabling the user to devise a multitude of possible applications.

The unit was initially intended for high frequency applications and has substantial gain at 15 Mc/s, but in order to show what may be achieved in the lower frequency spectrum, the package has been connected in a few useful a.f. combinations.

Fig. 3(a) shows the unit connected in the simplest and most straightforward form without resort to external alteration of the d.c. working points. In this configuration we have a medium-gain amplifier, with a relatively low input impedance of the order of 300 Ω, which may be used as a microphone pre-amplifier. One can see from Fig. 3(a) that the only additional components are the capacitors C₁ and C₂. Some deviation from the intended circuitry has been made by moving the +ve supply voltage from Pin 1 to Pin 11. This places a further 2k Ω resistor in the collector of Tr1 thus taking advantage of the extra voltage gain that may be obtained in this way. The collector of Tr1 was set at 2V and the emitter of Tr2 at 1.5V in order to keep the feedback resistor supplying the bias to the base of Tr1 within the confines of the internal values available. The unit, under these conditions has an input impedance of 300 Ω when measured from a 600-Ω source, and for an input signal of 10 mV (measured under open-circuit conditions) has an output, taken across the 1k Ω collector load of Tr2, of 400 mV.

Curve A in Fig. 3(b) represents the maximum overall frequency response of the package and Curve B the response that results from connecting C₂ across the collector load of Tr2, turning the amplifier over in the region of 17 kc/s. This capacitor was included to minimize the risk of the circuit becoming unstable when positive capacitive feedback may be caused by haphazard layout in a system. The "roll-off" of the upper frequency response also

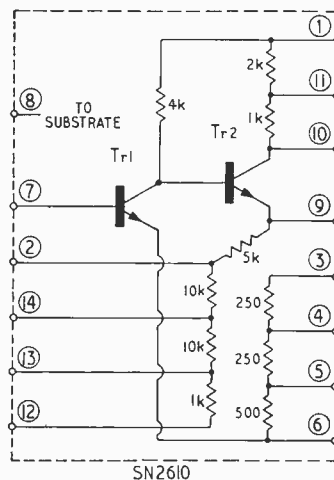

Fig. 2. Internal circuit and pin numbering of Texas SN2610 package. In all applications the semiconductor substrate (Pin 8) has to be connected externally to the most negative point in the overall circuit.

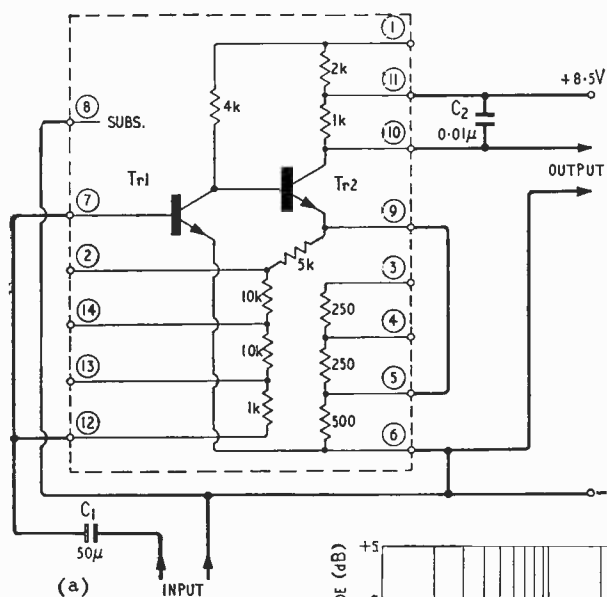
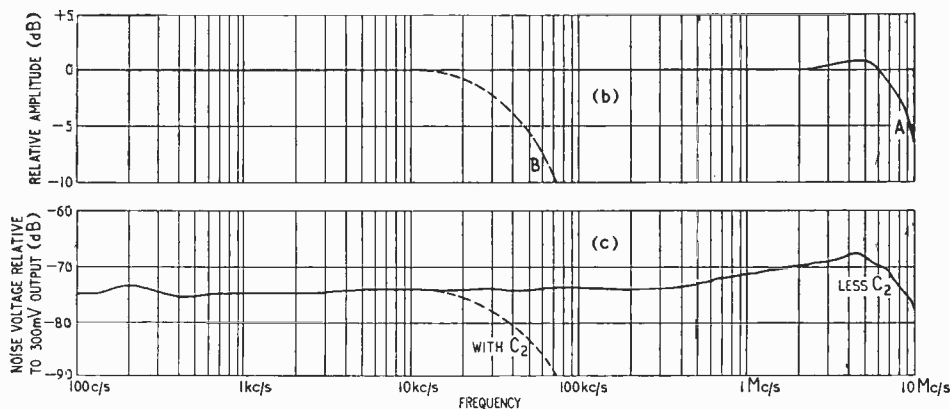

Fig. 3. (a) Circuit of microphone pre-amplifier using the SN2610 package. (b) Frequency response of microphone pre-amplifier in (a); curve A without C_2 , curve B with C_2 . (c) Noise voltage from microphone pre-amplifier relative to an output of 300mV r.m.s.



facilitated measurement of the S/N ratio in the frequency range applicable to a microphone pre-amplifier. The unit has in fact a good noise performance, the noise voltage being at worst more than 70 dB below the 400 mV maximum output. The noise was analysed at spot frequencies from 40 kc/s on a Brüel and Kjaer Frequency Analyser Type 2107, and the results are shown in Fig. 3(c). If C_2 were omitted the amplifier frequency response would of course be greatly extended, as indicated by Curve A in Fig. 3(b), but, on the other hand, the S/N ratio would suffer, being about 65 dB down at 1 Mc/s. When the package was used in a wide-band system, it was found necessary to decouple Pin 11 to Pin 6 by a 0.01- μ F capacitor to ensure stability at the higher frequencies.

Having established the d.c. working points of Fig. 3 one can make further use of the circuit as a record/replay amplifier for magnetic recording. With the addition of two more capacitors the unit becomes eminently suited to the replay characteristics of a high impedance tape head, Fig. 4(a).

It has been general practice to adjust replay amplifier frequency response to make it a mirror image of the open-circuit output voltage/frequency curve of the tape head (see, for example, Fig. 4(b)). This has necessitated an amplifier input impedance high enough to have negligible loading on the head output voltage. With transistors, however, this is not a very adequate solution, and advantage has been taken of the constant-current output

that may be obtained by feeding the tape-head output into a very low impedance. This constant input current will have deteriorated by 3 dB when $X_L = R_L + r_{in}$ (where R_L = d.c. resistance of the head and r_{in} = amplifier input resistance). Therefore we clearly have to make the amplifier input resistance as low as possible and use a high impedance tape head with as little d.c. component as possible. This is not as difficult to achieve as may be thought, as it is possible to obtain tape heads with an inductance of 1 H or more with a d.c. resistance as low as 80 Ω . If we apply the simple formula, taking the 3-dB point at 50 c/s, then the input resistance of the amplifier will have to be about 200 Ω to obtain the output response required. Owing to 26 dB of shunt feedback introduced by the external capacitor C_3 , the pre-amplifier input resistance is reduced to about 80 Ω , well below the desired figure.

It is worth noting that as the impedance of the tape head decreases towards the bass frequencies, then some of the feedback is shunted by this decreasing impedance of the

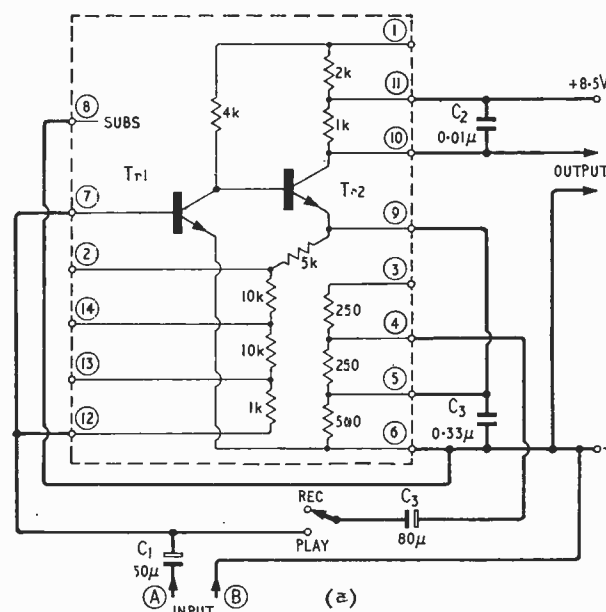

Fig. 4. (a) Circuit of tape pre-amplifier using SN2610 package.

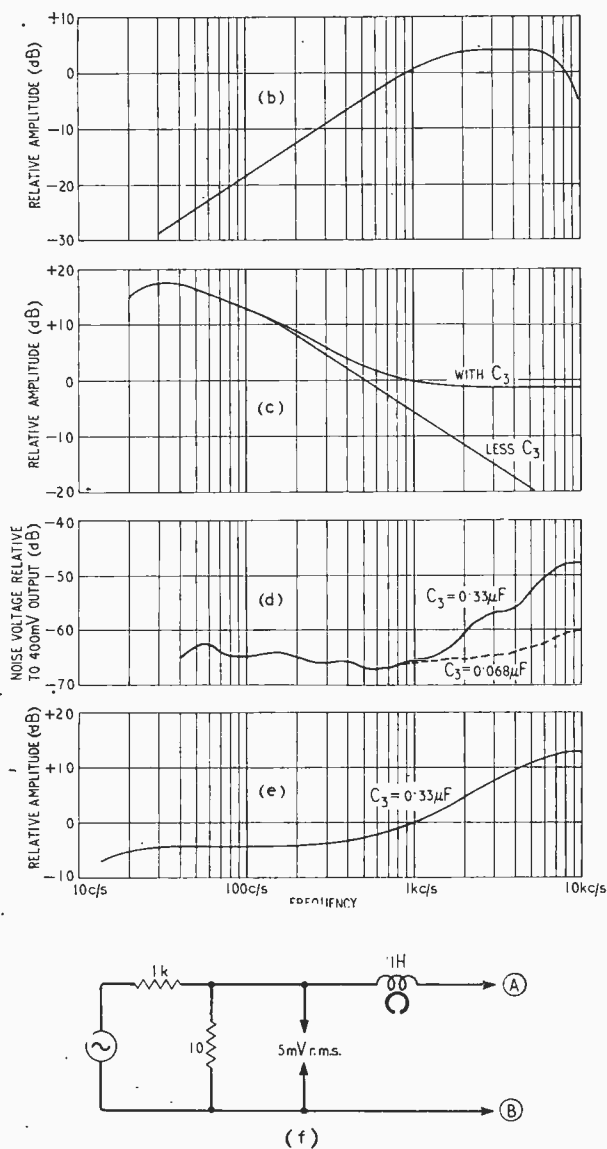

Fig. 4. (b) Open-circuit output voltage from tape head at $3\frac{3}{4}$ i.p.s. tape speed. (c) Replay curves of tape-head pre-amplifier, with and without C_3 in circuit. (d) Noise output of tape pre-amplifier. (e) Recording curve of tape pre-amplifier. (f) Replay test signal source.

head, in turn increasing the input resistance of the pre-amplifier and resulting in a deterioration of the lower frequency response. It is just as well to make the input resistance of the pre-amplifier as low as possible to counteract this shunting effect and maintain a constant current input.

In order to simulate the output that would normally be derived from the head the signal source shown in Fig. 4(f) has been used. The graph in Fig. 4(c) gives a good indication of the compensation that can be achieved in this configuration below 500 c/s. However, to produce a mirror image of the curve in Fig. 4(b) it is necessary to start to lift the upper response, and for $3\frac{3}{4}$ i.p.s. the 3dB point has to be at about 1150 c/s to correspond to the DIN and C.C.I.R. requirements. This can be

arranged simply by decoupling the emitter of Tr2 with a capacitor, the value of which may be calculated as:

$$C(\mu\text{F}) = \frac{10^6}{2\pi f_0 R}$$

where f_0 is the 3-dB point and R is the emitter resistance of Tr2. So in the present case C_3 is $0.33\mu\text{F}$. We can practically ascertain this point by referring to Fig. 4(c). This upper frequency response starts to fall again in the region of 17 kc/s as a result of the inclusion of C_2 , this once more ensuring high frequency stability.

Possibly the point of most interest is the excellence of the noise performance, the noise voltage being more than 60 dB below full output at frequencies lower than 2kc/s. It has always been difficult to approach this type of figure with thermionic valve amplifiers because of flicker noise, which is accentuated by the considerable amount of bass lift that has to be given under high impedance conditions. From Fig. 4(d) it will be noted that the overall noise voltage relative to full output in the range 40 c/s to 10 kc/s is better than -48 dB, and this is more than adequate for any purpose requiring a tape speed of $3\frac{3}{4}$ i.p.s. At 15 i.p.s., however, the noise voltage improves a great deal and is of the order of 60 dB below full output. This results from the reduction of C_3 by virtue of the fact that the 3-dB point at 15 i.p.s. is 4500 c/s, and C_2 , to the nearest preferred value, will be $0.068\mu\text{F}$. This is well up to the required standard for even professional recording.

By a simple switching arrangement (as shown in Fig. 4(a)), the pre-amplifier, when fed from a constant-voltage source, provides an output with the necessary treble lift to offset de-magnetization and other losses at the upper end of the register. The output response of Fig. 4(e) shows this in more detail, and the treble lift of 17 dB or so at 10 kc/s should compensate the recording losses so that the overall record/replay response is relatively flat. The pre-amplifier will provide an output of 400 mV at 1 kc/s for an open-circuit input voltage of 5 mV—this being what one might expect from a moving-coil microphone. Obviously the amount of upper frequency lift applied during the recording process depends on a number of factors, the main ones being the type of magnetic tape in use, the amount of bias current flowing through the recording head and the mechanics of the seating of the tape on the head. So it is necessary to take all these factors into account before deciding the value of C_3 .

With disc record players, as most of the pickup cartridges available are crystal or ceramic types which normally have to be fed into impedances of not less than 500 kΩ, the amplifier circuit in Fig. 5(a) should prove adequate. With a crystal cartridge with a capacitive output of 2000 pF, the lower frequency response will be 3 dB down when $X_c = r_{in}$, that is at 166 c/s when the cartridge is fed into a load of 500 kΩ. This is not as poor a low-frequency response as may be thought because the majority of small commercial loud-speakers have a bass resonance that is not substantially better than this figure, and in certain cases it could well be an advantage to curtail the lower frequency end of the response.

As a high impedance pre-amplifier the unit departs only a little from the original concept in so far as the biasing arrangement has reverted to a more standard pattern. The signal input point, on the other hand, is somewhat out of the ordinary, being introduced as a feedback path between the first base and the second emitter. The input impedance at this point is about 220 kΩ, and permits inclusion of a further series resistor to bring the total impedance to about 500 kΩ. Had this high-value series

resistor been included in a conventional pre-amplifier with an impedance of 1 kΩ or so, the attenuation rate and hence the excessive noise content would have proved undesirable. From Fig. 5(b) one can ascertain that the frequency response of the unit will prove tolerable for the intended application.

Because of the floating emitter of the second stage, it is possible to vary the circuit configuration more than would be feasible in a conventional circuit built for a specific function. By virtue of this, one can make use of part of the bias chain as an emitter load. By shorting Pins 9 to 13, 12 to 6 and 11 to 1, the circuit in Fig. 6 is obtained. This is a conventional phase splitter, and for an input signal of 10 mV from a 600-Ω source we have two similar, out-of-phase outputs of 1 volt r.m.s. In this circuit we have had to add only one external component to provide the correct working point for the d.c. coupled pair.

This apparently non-applicable package was deliberately chosen to emphasize what may be achieved with a unit intended for an entirely difference sphere. Even though this unit was primarily designed for high frequency applications its worth as an audio package can be measured in the terms of the five different configurations presented in this article.

At the other end of the scale, however, is a much simpler unit that is designed to perform a particular function—that of a hearing aid amplifier. There are only four external connections: input, output, positive supply, and a common signal/supply lead. The unit has recently been introduced by Mullard Ltd. under the type number 263 TAA (the price being £2 10s for one-off).

From Fig. 7 it can be seen that the unit comprises three

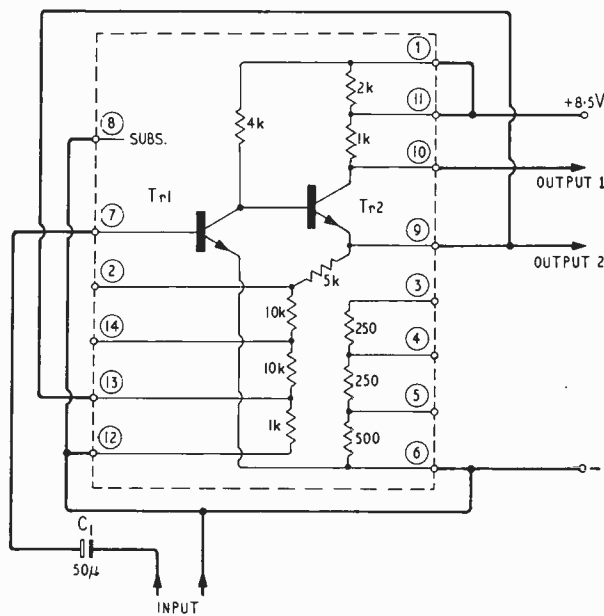

Fig. 6. Phase splitter using SN2610 package.

transistors and two resistors. It is housed in a TO 72 can which may be enclosed in a heat sink should an output power in excess of 10 mW be required. The package has an overall power gain of not less than 75 dB, giving an input sensitivity of the order of 10 mV r.m.s. for full output, without external feedback.

In the circuit of Fig. 8 the unit was required to drive a headset of 150 Ω impedance to a maximum output of 10 mW, being fed from a ceramic transducer with a capacitance of 2000 pF. The open-circuit output from the cartridge was 1V at 1 kc/s. In order to preserve the economy offered by this very simple device, the gain control VR₁ was utilized as the bottom end of the bias chain, and the high value of the series resistor R₁ made it possible to dispense with an input capacitor as the current flowing through the source would be low enough to be disregarded for all practical purposes. It was also possible to connect the headset load directly in the collector circuit of the final transistor, again avoiding the need for a coupling capacitor and, more important, allowing the load to take advantage of the full power output.

Some difficulty was experienced in maintaining sta-

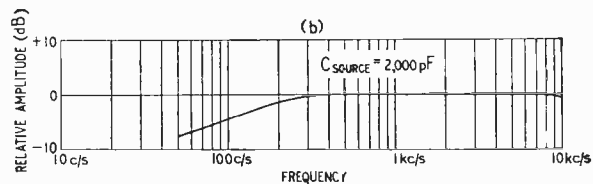
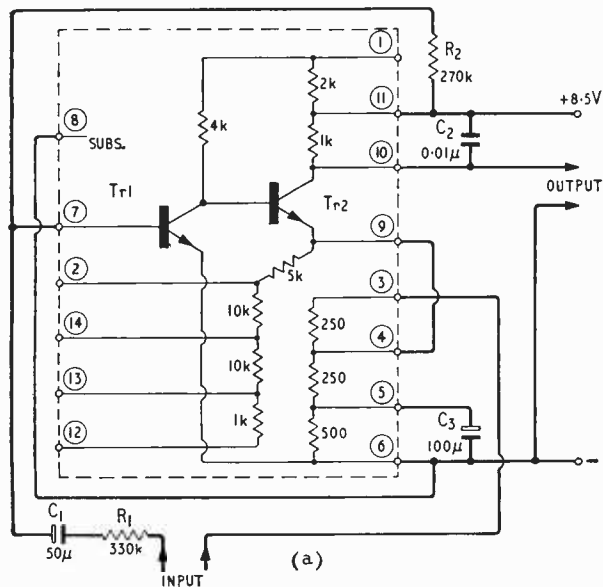

Fig. 5. (a) High impedance pre-amplifier using SN2610 package. (b) Frequency response of pre-amplifier.

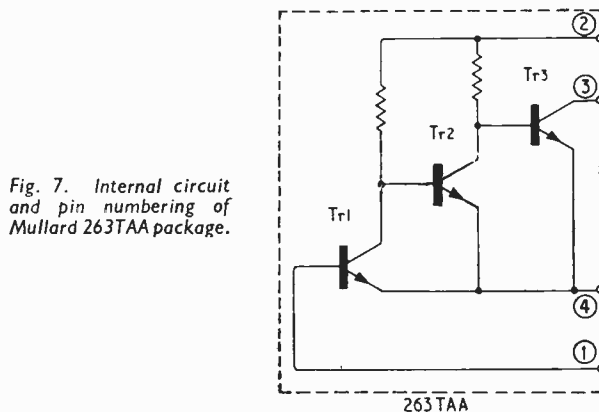

Fig. 7. Internal circuit and pin numbering of Mullard 263TAA package.

bility at the upper and lower ends of the frequency range, and in one application it was necessary to decouple the supply, Pin 2 to Pin 4, with a capacitor of about $100\mu\text{F}$ at the pins themselves. Also, the device had a dislike of being presented directly with a capacitive input, and this was another reason for placing the gain control in the base of the first transistor, presenting the unit with a virtual resistive element. Distortion at an output of 10 mW was lower than at first expected as there was no feedback because of the amount of gain required. Total harmonic distortion for this output was only 9%—adequate for intelligibility in speech communication.

As can be seen from Fig. 8(b) the frequency response was also adequate for communication systems, and capacitor C_1 was introduced in order to roll off the upper response at about 6 kc/s. This capacitor also maintained amplifier stability at the upper frequencies. However, it proved very necessary to keep the input and output leads as short as possible and well clear of each other.

It was found possible to drive the units to a power output of the order of 50 mW, but care had to be taken to ensure that the maximum current of 20 mA was not exceeded. In the units tested the input resistance was found to deviate, varying between 800Ω and $4k\Omega$, this being the only factor that marred the otherwise excellent interchangeability of the packages.

The gain achieved in the Fig. 8 circuit was apparently the maximum that that could be attained with such a package volume, because of in-phase internal feedback that could not be eliminated by external means, giving rise to instability. The relatively large V_{be} characteristics of silicon devices assisted this particular design, in that the emitter resistors of three directly coupled stages could be dispensed with; but this is about as far as one can advance in this direction without moving into the overload region of one of the stages.

It was with some little apprehension that the Fig. 9 circuit was "lashed up" because of the common input and output path that was inevitable in this kind of arrangement. Also, quite inadvertently, decoupling between the front and the rear end of the amplifier was

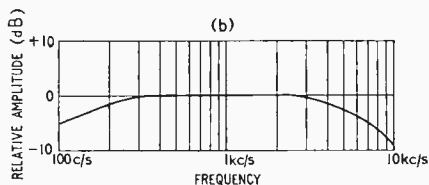
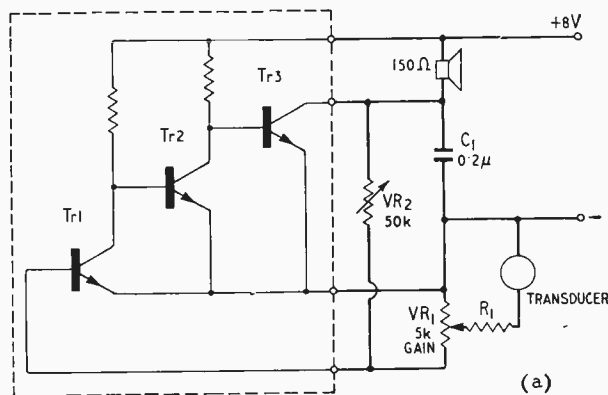

Fig. 8. (a) Headset amplifier using 263TAA package. (b) Frequency response of headset amplifier.

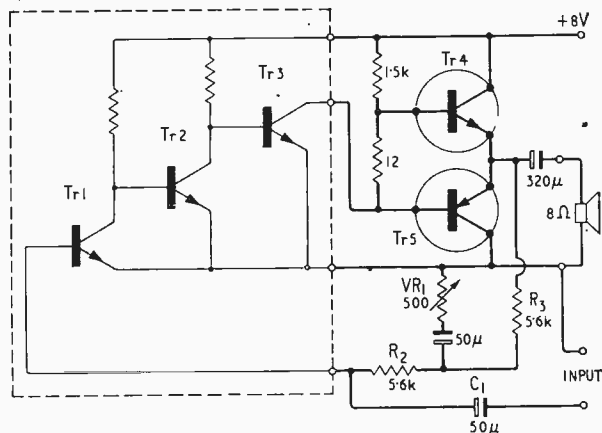

Fig. 9. 200mW amplifier based on 263TAA package.

omitted, so the excellent working characteristics of the arrangement came as something of a surprise.

The circuit was entirely directly coupled and the operating point was determined by the external resistors R_2 and R_3 feeding back a temperature compensating bias for the first stage. The good temperature stability factor was obviously in the main due to the fact that devices of a low order of leakage current were being run at substantial collector currents; therefore the subsequent change in leakage current and hence operating voltages produced only a minor variation in the operating points throughout. The feedback resistor was deliberately split into two parts to enable functions under various conditions of feedback to be plotted more easily. With VR_1 reduced to minimum resistance, the amplifier gave the full output of 200 mW into 8Ω for an input of only $30\mu\text{V}$; the only instability was in the upper frequency region and this was removed by a capacitor joining Pins 3 and 2. The instability persisted when this capacitor was first introduced and it had to be positioned as close as possible to the output terminal of the package, Pin 3, to produce the required effect—actually within $1/8$ in of the can.

With VR_1 set so that the input needed to give 200 mW output was about $100\mu\text{V}$, the noise voltage was better than 66 dB below full output in the frequency range, 20 c/s to 10 kc/s. The output pair were matched in current gain to within 10% at 50 mA d.c. and the resultant distortion was better than 3% for an output of 200 mW, a creditable performance indeed. The unit continued to perform well even though the temperature was raised to 50°C and showed no signs of thermal runaway. Some evidence of crossover distortion was noticed when the temperature was reduced to 10°C but this may be easily overcome by taking the usual compensating action of introducing a thermistor or the like into the V_{BE} characteristic of the output pair.

Such was the performance of this configuration that serious thought was given to including it at a late stage in a project in place of an equivalent unit manufactured from discrete components. It is plainly evident that simplicity such as this lends itself admirably to mass production techniques.

One notable point was the good power output capacity of the device as a single unit, suggesting the possibility that the unit is of the "stitch-bonded" variety in which some of the internal elements are discrete components. This surmise was based on the inability of some

(Continued on page 437)

of the smaller, one-chip units previously examined to handle currents of the order of 20mA.

After the technical design aspects, it is, of course, necessary to evaluate the production economics of manufacturing equipment with integrated circuits. In the more specialized field of industrial equipment, reliability and performance tend to be the prime consideration, and the components are "totted up" and then coupled with a labour content to produce a marketing price for the completed product. Unfortunately this is not the happy state of affairs in manufacturing for the domestic field. One is more often than not bound to a specific price set by competition long before costing has taken place. Then it becomes a matter of adjusting one's design and one's production techniques so that the final article is not only technically satisfactory but economically suited to the price structure of the particular market. In an instance such as this price becomes the major consideration. This does not mean that the manufacturer is prepared to impair his reputation to meet this end, but that he will go to a great deal of trouble to find the cheapest component in a specific range. However this market does at least help the component or integrated-circuit manufacturer to reduce prices, as consumption may be of a very high order.

It is not so very long ago that the cheapest silicon discrete transistor even in quantity commanded a price of about 12s 6d. Today one may purchase a device of extremely good quality for as little as 2s 6d and the price is still going down. The same applies to monolithic circuits in the U.S.A. where recently RCA have included a complete i.f. strip and audio pre-amplifier, comprising 12 transistors, 12 diodes, 24 resistors and a few capacitors, in a domestic television receiver. The cost of this TO-5 package is claimed to be about 17s. Quite obviously a manufacturing technique using discrete components would cost several times this figure. We have not yet reached this state of competitiveness in the U.K., but the

indications are that very soon linear circuits will be available at prices close to those of their discrete-component counterparts.

At present the 263 TAA package in Fig. 7 costs £2 10s for a one-off sample, as already mentioned, but Mullard have clearly indicated that the one-off price is to be reduced to £1 10s in the near future. On this basis it is reasonable to suppose that a large-quantity price could be somewhere of the order of 15s per unit. While this price does not compete with that of a discrete-component equivalent, it makes some effort to meet the problem half-way.

The price of the Texas package SN2610 is, as mentioned above, £5 for a one-off sample. For 100-off the price is £4 and for larger quantities it is fixed by negotiation. This unit is not intended primarily for the price-conscious consumer but invites attention from small equipment manufacturers, laboratories, concerns engaged in small-run prototype development programmes and perhaps educational establishments. All these potential customers are interested in a versatile unit which lends itself to a high degree of external manipulation of the internal parameters. In industrial applications this package could be found attractive because of the equipment-to-equipment variations demanded by users. Packages such as these will certainly coax the more sceptical equipment makers, by virtue of the external control that may be exercised, into the use of completely enclosed monolithic units.

Once we have reached the stage of economic compatibility there will be no good reason for rejecting this type of unit, other than to satisfy our egos by retaining the right to design circuitry rather than pass on this dubious pleasure to the device manufacturers. Monolithic circuits will not cure all ills but will certainly help to abolish the tedium of repetitive circuit design, leaving the skilled engineer employed by equipment makers more time to do what really is his job—the design of systems.

BOOKS RECEIVED

Reliability of Electronic Components, by C. E. Jowett. A presentation of all the relevant facts concerning the properties and stabilities of various classes of components and materials used in electronics. The introductory chapter deals with the effect of environment and atmosphere on equipment. This is followed by a chapter giving an analysis of faults (together with methods of avoidance) which can occur during soldering and crimping. Succeeding chapters are devoted to resistors, capacitors, thermionic valves, transistors and diodes, metal rectifiers, transformers and inductors, relays, r.f. cables, electrical contacts, printed circuits and wiring. The final chapter describes techniques for potting components, including a discussion on the relative merits and demerits of the potting resins used. Encapsulation using polysulphide rubbers is discussed in detail. Pp. 165; Figs. 28. Price 42s. Iliffe Books Ltd., Dorset House, Stamford Street, London, S.E.1.

Everyday Electronics, by Thomas Røddam. Starting from basic concepts, the text is developed in a logical manner to present an easy-to-understand account of the various aspects of radio and television (including colour). This then leads to a discussion of special electronic devices including lasers, magnetrons and the principles of computers. Mathematics is kept to a minimum and is introduced only where necessary during the examination of the electrical circuits. Pp. 245; Figs. 178. Price 22s 6d. George G. Harrap & Co. Ltd., 182 High Holborn, London, W.C.1.

Microwave Valves, by C. H. Dix and W. H. Aldous. This book is intended to provide engineers of graduate or H.N.C. level with a readily absorbed account of the basic physics and operation of microwave valves, and includes only mathematics essential to the subject. In the opening chapters, a fundamental approach is made to the subject, starting with a description of the motion of electrons in electric and magnetic fields together with the characteristics of the various types of r.f. circuits and transmission lines that are used in the devices. Further chapters cover the formation and focusing of electron beams, and the construction and application of microwave devices and their noise properties. References are given at the end of each chapter to sources of additional information. Pp. 296; Figs. 193. Price 55s. Iliffe Books Ltd., Dorset House, Stamford Street, London, S.E.1.

Higher Mathematics Examples for Electrical Engineering Students, by D. G. S. Bedding & D. W. Porter. A collection of more than a thousand problems in mathematics suitable for students studying for H.N.C., H.N.D., and parts of the examination of the I.E.E. Twenty chapters cover the many different aspects of the subject, including numerical analysis, vector analysis, statistics, matrices and Laplace transforms. Each chapter contains introductory worked examples followed by exercises for development of techniques which in turn are followed by examples taken mainly from past H.N.C. and H.N.D. papers. Pp. 300; Figs. about 120. Price 25s. Macmillan & Co. Ltd., 4 Little Essex St., London, W.C.2.

Broadcasting Developments in the U.K.

PLANS FOR THE SOUND AND TELEVISION SERVICES

SOUND broadcasting in this country has seen few changes over the past few decades but recent Parliamentary announcements and the issuing of the Bill to suppress unauthorized offshore broadcasting stations point to a wind of change. First, the "pirate" stations.

In fulfilment of the Government's undertaking as a signatory 18 months ago to the Strasbourg agreement to introduce legislation which would ban "pirate" stations a Bill has been laid before Parliament which, if it becomes law, will make it illegal to operate offshore broadcasting stations whether in ships, aircraft or on a structure on the high seas. The "Marine, etc. Broadcasting (Offences) Bill," as it is officially named, is intended to starve out the pirates for it makes it an offence to supply goods and equipment or "otherwise assist in their physical maintenance." Moreover persons who participate in the operation of a station or "a person who procures a broadcast to be made" is guilty of an offence the penalties for which are imprisonment for up to two years or a fine or both.

Although, as a journal, we are opposed to any action which jeopardizes law and order and therefore we deprecate the piratical action of offshore broadcasters, whatever their label, it has been obvious that the "pop" stations around our shores have provided a service of continuous music which has been welcomed by a large section of the populace (by no means entirely teenagers). It is to be hoped therefore that having decided to stop offshore broadcasting the Government will lose no time in making alternative arrangements for the provision of a continuous music programme. To broadcast such a programme, however, recourse must be had to records and this is where the "pirates" have been able to score over the B.B.C. which is strictly limited by its agreements with the Musicians' Union in the "needle time" permitted—about 30 hours per week for all three sound services.

A recently introduced Private Member's Bill in the House of Commons proposes the setting up of a separate authority financed by advertising revenue to broadcast a National Popular Radio Programme. But to establish the necessary chain of stations to give national coverage would almost certainly necessitate a reallocation of frequencies in this country.

F.M. broadcasting

V.H.F. sound broadcasting has not found the favour in this country that it has done elsewhere, in W. Germany for instance. This is obvious from the comparatively few British made receivers which cover the v.h.f. band. Now, however, v.h.f. broadcasting is to have a further boost; stereo transmissions using the pilot-tone system are being radiated from July 30th for three or four hours each day from the Wrotham, Kent, station and later also from transmitters in the Midlands and North of England. Elsewhere in this issue we discuss both the system and the equipment at present available on the British market.

It is several years since experimental stereo transmissions were started by the B.B.C. Initially the left- and right-hand channels were radiated by separate stations but subsequently multiplexed transmissions using the Zenith-GE system (later re-named pilot-tone) were radiated by the Wrotham station. This system is one of the two approved by the C.C.I.R. (the other being what is known as the polar modulation system) and was recommended by the B.B.C. after exhaustive laboratory and studio tests of the half-dozen or so systems which had been proposed.

Television topics

Television has been, and still is, very much in the news because of the protracted discussions on the colour system to be adopted. However, the Postmaster General's decision, in the light of the Television Advisory Committee's recommendation, to adopt PAL remains unchanged after the heated arguments at the recent Oslo meeting of the C.C.I.R. Unless the country's economic position should dictate otherwise the plan is for colour to be introduced on BBC-2, 625 lines, in October next year. This raises the controversial question of the use of colour by the I.T.A. Much has been said, and doubtless remains to be said, on this subject, suffice it to be said here that it is hoped that each service will be permitted to introduce colour at the earliest possible moment.

Technically, a much bigger question is the propagation problems inherent in u.h.f. operation. If, as it would appear, there will be a very large number of pockets of poor reception within the service area of each main station necessitating many more fill-in stations than was at first envisaged, should not other means of filling the gaps be considered? One figure mentioned for the number of fill-in stations was 1,200. Would it not be more economic and certainly more efficient to serve the inhabitants in these "pockets" by cable? Viewers would not be subjected to the vagaries of u.h.f. propagation and would almost certainly have a better picture when colour is introduced.

Although not truly broadcasting, because the signal is conveyed by cable, subscription television must be mentioned in this review. It will be recalled that the P.M.G. invited several companies to participate in a three-year experiment to provide a pay-as-you-view service in various parts of the country. Only one company, Pay-TV, eventually accepted the invitation, and for some months has been providing a service to subscribers in London. The decision regarding the introduction of a permanent service will depend upon the analysis of results based on the economic and social factors involved, but from first impressions the Pay-TV service appears to be meeting a need.

It may well be, of course, that the whole structure of this country's sound and television service will be recast when the long-awaited White Paper setting out the Government's plan for broadcasting is published.



The present distribution of sound and television broadcasting stations in the U.K. Fill-in stations for BBC-2 are omitted.

London's International TELEVISION AND RADIO SHOW

AFTER last year's abortive attempt to stage an international television and radio show in London, the organizers are to be congratulated on making yet another attempt. This time it has the support of all but one of the major U.K. receiver manufacturing groups as well as a number of Continental and Far Eastern receiver manufacturers.

Unlike previous London Radio Shows this one, which opens at Earls Court on August 22nd for five days, will be international in content but admission will be restricted to the trade.

As will be seen from the list of exhibitors there are very many fewer than at shows of yesteryear despite the fact that about one third of the 65 stands have been taken by overseas companies or their U.K. agents. It must not be forgotten, however, that the five major British set manufacturing groups who are participating (Philips, Pye, Rank-Bush-Murphy, S.T.C. and Thorn) between them market receivers under 20 or more brand names* each of which in years past would have occupied a separate stand. There is, of course, a growing tendency to standardize receivers within each group, often the only differences being in appearance—technically they are the same.

It will be particularly refreshing to have the opportunity of comparing overseas receivers with their U.K. counterparts. Countries represented will include Denmark (Arena, Bang & Olufsen), Germany (Blue Spot, Korting, Loewe-Opta, Kuba, Saba, Telefunken, Uher),

* Philips, Cossor, Stella; Pye, Ekco, Ferranti, Invicta, Pam, Dynatron; Bush, Murphy; K.B., Regentone, R.G.D., Argosy, Ace; Ferguson, H.M.V., Marconiphone, Ultra.

Place: Earls Court, London.
Dates: August 22—26
Times: 1000—2100 (1800 on last day)
Admission: Trade only, by invitation
Organizers: Industrial & Trade Fairs, supported by the Radio & Television Retailers' Association.

Italy (composite show by the Associazione Nazionale Industrie Elettrotecniche ed Elettroniche), Poland (Daltrade) and Japan (National, Sony, Trio and the Japanese Electrical and Radio Association).

The Federation Nationale des Industries Electroniques was to have staged a French industry display at the Show but in view of this country's decision to adopt the PAL colour television system they have withdrawn their support.

We have for a long time advocated an "international" show in London and we hope that it may give a "shot in the arm" rather than a shot in the heart for the British radio industry. Elsewhere in this issue we review the field of stereo reception which has opened up with the introduction of several periods of stereo transmission each day by the B.B.C. from its Wrotham station. It will be seen from the list of equipment available that despite the fact that the B.B.C. has been radiating experimental transmissions for well over a year, the British domestic set making industry in general does not seem

LIST OF EXHIBITORS

AEG (GB), 27 Chancery Lane, London, W.C.2
 A. M. Displays, 191/5 Shenley Rd., Borehamwood, Herts.
 Acme Electric Co., 74 Great Eastern St., London, E.C.2
 B. Adler & Sons, 32a Coptic St., London, W.C.1
 Aerialite, Castle Works, Stalybridge, Cheshire
 Akai Tape Recorders (Pullin), 11 Aintree Rd., Perivale, Middx.
 Alba (Radio & Television), 52/8 Tabernacle St., London, E.C.2
 Antiference, Bicester Rd., Aylesbury, Bucks.
 B.B.C. Broadcasting House, London, W.1
 B.M.B. (Sales), Fleming Way, Crawley, Sussex
 Bang & Olufsen U.K. Sales Division, Mercia Rd., Gloucester
 Barclays Bank
 Belling & Lee, Gt. Cambridge Rd., Enfield, Middx.
 Bolton Turntable Co., Emblem Works, Bolton, Lancs.
 Bosch, 20 Carlisle Rd., London, N.W.9
 Crown Radio Corp., c/o Ataka Co., Roman House, Wood St., E.C.2
 Daltrade, 110 Cannon St., London, E.C.4
 Dansette Products, Honeygot Lane, Stanmore, Middx.
 Derritron, 24 Upper Brook St., London, W.1
 EMI Tape, Blyth Rd., Hayes, Middx.
 Econsign, 19/21 Palace St., London, S.W.1
 Electrical & Electronic Trader, Dorset House, Stamford St., London, S.E.1
 Electrical & Radio Trading, 33/39 Bowling Green Lane, London, E.C.1

Europa Electronics, Howard Place, Shalton, Stoke-on-Trent
 Ever Ready Co., High Rd., Whetstone, N.20
 Fidelity Radio, 6 Olaf St., London, W.11
 G.P.O., London Telecommunications Region, 87/90 Albert Embankment, London, S.E.1
 Grundig (GB), Newlands Park, Sydenham, London, S.E.26
 Hacker Radio, Norreys Drive, Cox Green, Maidenhead, Berks.
 Highgate Acoustics Mfg. Co., 73 Gt. Portland St., London, W.1.
 Jalmic, 140 Park Lane, London, W.1.
 J. Beam Aerials, Rothersthorpe Crescent, Northampton
 J.E.R.A., 173/5 Cleveland St., London, W.1
 Lee Products, 10/18 Clifton St., London, E.C.2
 Levene, William, 30a Sackville St., London, W.1
 Lloyds Bank
 Midland Bank
 Monogram Electric, 296/302 High Holborn, London, W.C.1.
 Mullard, Torrington Place, London, W.C.1
 National Provincial Bank
 Pandon, D., 244 Edgware Rd., London, W.1
 Parker, J. & Co., 1 Paul St., London, E.C.1
 Philips Electrical, Century House, Shaftesbury Av., London, W.C.2
 Pye, Radio Works, Cambridge.
 Radio & Electrical Retailing, 46/7 Chancery Lane, London, W.C.2
 Rank-Bush-Murphy, Bessemer Rd., Welwyn Garden City, Herts.

Rippen Piano-Fabriek N.V., Reehorsterweg 50, Ede, Holland
 R.T.R.A., 19/21 Conway St., Fitzroy Sq., London, W.1
 Roberts Radio Co., Molesey Avenue, West Molesey, Surrey
 Sanyo Sales & Service, 23 Savage Gardens, Trinity Square, London, E.C.3
 Sharps Sales & Service, 16/18 Worsley Rd., Swinton, Manchester
 Sinclair Radionics, 22 Newmarket Rd., Cambridge
 Slingsby, H. C., 89/95 Kingsway, London, W.C.2
 Sony U.K. Sales Division, Mercia Rd., Gloucester
 Standard Radio Corp., Toyokawa Bldg. 4, 8 Tokyo, Japan
 Standard Telephones & Cables, Consumer Products Div., Footscray, Sidcup, Kent
 John Street (Manufacturers), Falcon Works, Barmeston Rd., London, S.E.6
 Television Recordings, 9 Windmill St., London, S.W.1
 Thorn Electrical Industries, 284 Southbury Rd., Enfield, Middx.
 United Africa Mechanical & Electrical, United Africa House, Blackfriars Rd., London, S.E.1
 Van der Molen, 42 Mawney Rd., Romford, Essex
 Veritone, 3/5 Eden Grove, London, N.7
 Westminster Bank
 Winter Trading Co., 95/99 Ladbrooke Grove, London, W.11
 Wireless World, Dorset House, Stamford St., London, S.E.1

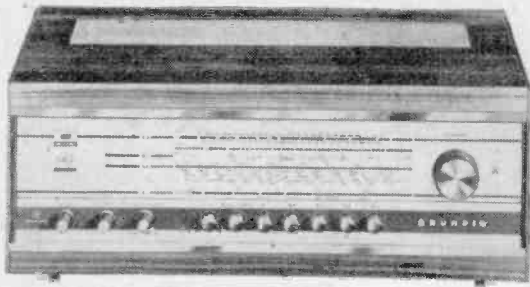

Grundig ST300 a.m./f.m. tuner, pre-amplifier and amplifier giving a push-pull output of 7 W per channel. Loudspeakers are separate.

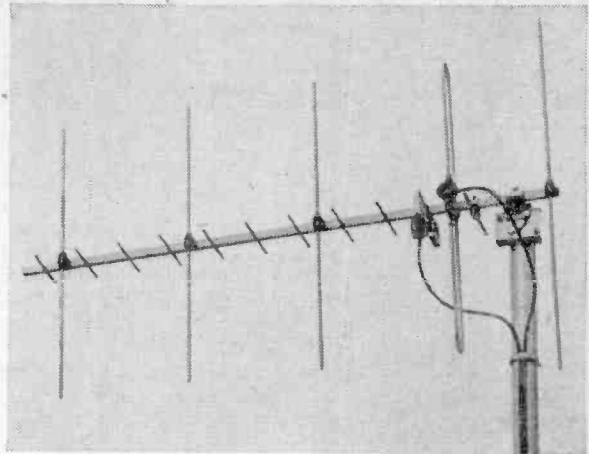

Aerialite multi-band television array (345/5/11) for Bands I, III, IV and V.



Bolero Studio 1Q1, one of four new Telefunken radiogramophones, all of which incorporate stereo decoders.

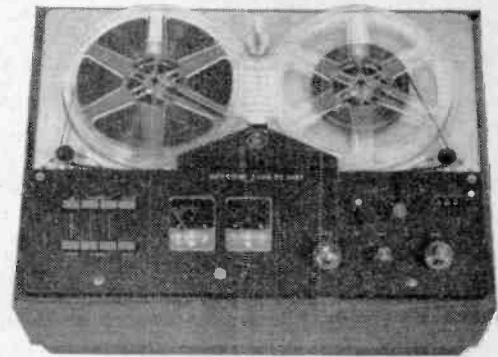

Bang & Olufsen Beocord 1500 tape recorder providing two-track record/playback and four-track playback facilities.

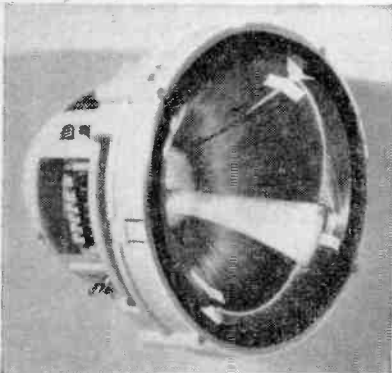

Convergence unit (above) and deflection coil (left) for the Mullard 90° colour television tube.



Alba R19 two-track two-speed mains/battery transistor portable tape recorder weighing 6 lb.



Left: This Murphy B837 portable, with a pivoted base, covers the v.h.f. band as well as l.w. and m.w.



Modular construction, comprising five match-box size units, is adopted in the Danish Arena T1200 four-band receiver being shown by Highgate Acoustics.

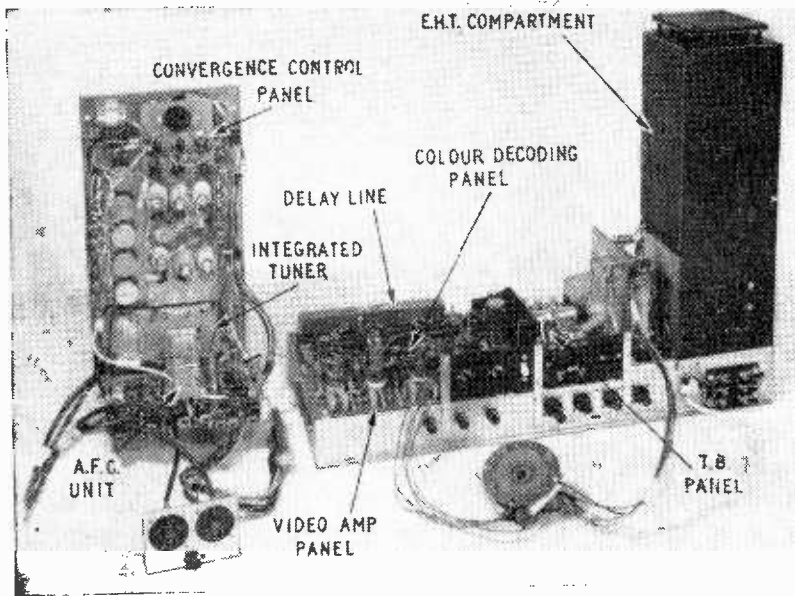

Left: Annotated chassis of the Pye 25 inch colour television receiver, brief details of which are given below.



The Hacker "Autocrat" home/car portable covering the l.w. and m.w. bands.

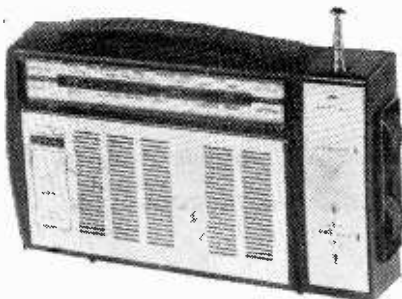

Fidelity's Zodiac l.w. and m.w. portable.

Roberts a.m./f.m. transistor portable model R700 incorporates a.f.c. on v.h.f.

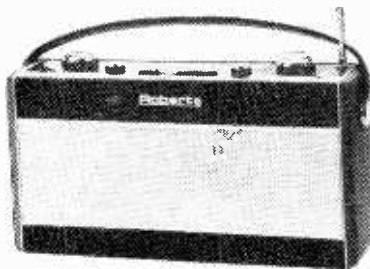

All Bush television receivers are now being built on the replaceable unit-plan-chassis system to facilitate servicing. The TV148U is shown.

to have had the initiative to prepare equipment in readiness for the potential market which the overseas manufacturers will not be slow to seize upon.

Although we see the justification for an exclusively trade show where manufacturers can discuss terms with the dealers who sell their products, we feel a good case could have been made for opening the Show to the public on, perhaps, the last day or alternatively for one or two evenings. In view of the fact, therefore, that a very large proportion of our readers will not have the opportunity of seeing the Show we will be devoting a number of pages in our next issue to a review of the trends in television and sound receiver circuitry as seen by members of our staff.

In view of the Government's decision for colour television to start in this country in the autumn of next year the organizers decided that the Show would provide an opportunity for dealers to see prototype colour receivers. They are therefore providing to selected stands a PAL colour signal. When there is no B.B.C. colour transmission for piping to the stands a video-tape programme will be provided.

Colour receivers will be shown by a number of manufacturers. One of them, Pye, has already demonstrated a production set in advance of the Show, and a picture on this page gives some idea of the chassis construction.

The receiver is a 25-inch compatible dual-standard one, capable of receiving the present 405-line and 625-line monochrome transmissions as well as the future 625-line colour transmissions. In addition to the usual viewer's controls as found on monochrome sets there is only one extra knob for dealing with the chrominance information—a saturation control. The set is for "de luxe" PAL reception, and uses a delay line made by Telefunken. The shadow-mask c.r.t. is a Philips rectangular type, and this determines the depth of the console cabinet, which is 22 inches.

Circuitry is hybrid; transistors are used for all signal circuits up to the chrominance amplifiers and in the timebase circuits up to the output and e.h.t. stages, while valves (9 in all) are used for the high-power circuits. One of the largest valves is the shunt stabilizer for the 25-kV tube e.h.t., and this and the other e.h.t. components are housed in a special compartment which is screened to prevent radiation. The integrated tuner is standard except for the addition of an a.f.c. unit operating on u.h.f. Construction is modular, with removable printed-circuit panels (e.g. one panel for the colour decoding circuits), and the main chassis is notably compact for a colour receiver, measuring only 21in x 8in. If the colour decoder panel has to be removed for servicing the set will continue to work on monochrome.

WORLD OF WIRELESS

Citizen's Band Radio

RUMOURS that the British Post Office is considering granting licences for the use of "citizen's radio" transmitter/receivers are strengthened by the fact that B.R.E.M.A. has undertaken a survey of the "C.B." services in other countries. According to this survey there are five countries in Europe plus the U.S.A., Canada and Japan which permit the operation of "C.B." equipment. It is apparently standard practice to use 10 kc/s channels within the range 26.965 to 27.275 Mc/s, and, except in Germany, equipment with an input power to the last stage of not more than 0.1 W is exempt from licensing. The maximum power is in general 5 W for a fixed station and 0.5 W for mobile equipment.

Japan, which had about 75,000 "C.B." licences in force at the beginning of this year, is probably the biggest exporter of equipment. It is reported that there are 36 manufacturers of "C.B." equipment in the country.

By far the largest number of receivers are in the U.S.A.—800,000 in March. Canada has 47,000. European countries with a "C.B." service, together with the approximate number of licences where known, are: Austria, Finland (4,000), W. Germany, Holland and Sweden (6,000).

In this country, of course, the "citizen's band" is used for the radio control of models and on 12 channels between 26.978 and 27.262 Mc/s tone (but not speech) modulation is permitted for free-radiation paging systems.

Until such times as the Post Office grants permission for "C.B." operation they will continue to prosecute known instances of operation irrespective of whether or not interference with other services is being caused. However, despite the illegality of operation one can walk into dozens of shops in central London and buy a pair of "C.B." transmitter/receivers.

Line Standards and Colour—B.R.E.M.A. Statement

MANY of the points made by Mr. Doo, of B.R.E.M.A., in his letter published in our past issue (p. 414) are incorporated in an industry policy statement on the planning of future television broadcasting in the U.K., particularly in relation to colour television. This has been sent to the P.M.G., the Minister of Technology, the Television Advisory Committee and the Electronics "Little Neddy."

The statement re-iterates the unanimous opposition of the industry, "comprising manufacturers of sets, components and valves, and capital equipment," to the introduction of colour on the "outmoded 405-line services." Among the reasons given is that a set capable of receiving 405/625-line colour and monochrome on v.h.f. and u.h.f. would "greatly increase design complexity and therefore adversely affect performance reliability and maintenance costs; and add about 10% to the initial cost of the receiver." It is also suggested that colour on 405 lines "would delay indefinitely the change-over to the 625-line standard and perpetuate dual-standard transmissions."

The 1000-word statement also summarizes many of the recommendations of the Television Advisory Committee

and the Pilkington Committee. It urges the Government to reach an early decision on the future development of the country's television service to provide the maximum number of programmes and puts forward three possible courses. These are:—

(1) Independent Television should be given a second programme to include colour using v.h.f. 625-line channels. This could be done by utilizing the existing and planned v.h.f. sites (and aerial masts) for the additional transmitters.

(2) The I.T.A. should be authorized to duplicate its present service by transmitting programme material originated on 625 lines v.h.f. (with some programmes in colour) and converting to 405 lines for v.h.f. monochrome transmission.

(3) As a short-term measure to secure maximum viewing for colour, pending the allocation of 625-line facilities to Independent Television, the I.T.A. and B.B.C. should share the BBC-2 channels on, say, an alternate day basis. As in (2) above, the I.T.A. could originate their programmes (including colour) on 625 lines and convert to 405 lines for v.h.f. monochrome transmission or have alternative programmes if desired.

Post-graduate Degrees Introduced by the C.N.A.A.

SET up in September 1964 by Royal Charter, the Council for National Academic Awards, an autonomous body, awards degrees and other academic distinctions to students completing approved courses in establishments which have not the power to award their own degrees. At present over 4,600 students are attending 143 courses in a variety of disciplines at 36 colleges in preparation for the Council's B.Sc. or B.A. degrees.

The Council has now issued details of its higher degrees, M.A. and M.Sc. The post-graduate degree courses, which may be full-time, sandwich, block release or part-time, will be more specialized than the first degree courses and the Council hopes that many of them will be planned with the help of industry. The first M.Sc. course to be approved by the Council is one in applied solid state physics at the Brighton College of Technology.

The Council has also established two research degrees—Master of Philosophy (M.Phil.) and Doctor of Philosophy (Ph.D.)—which will be awarded for original work. This may take the form of pure research or be "an investigation into a development, production or marketing topic in industry."

A booklet, "Conditions for the award of higher degrees," outlining the new scheme is obtainable from the C.N.A.A., 24 Park Crescent, London, W.1.

The eighth annual series of **Granada Lectures** on problems of communication in the modern world, arranged by the British Association for the Advancement of Science in conjunction with Granada Television Ltd., will be held in the Guildhall, London, in October. The subjects are:—"Telecommunications in the next few years" (17th) by F. C. McLean, B.B.C. director of engineering; "From the few to the many" (24th) by Sir Kenneth Clark; and "Technology and power" (31st) by Sebastian de Ferranti. Admission is free and tickets are obtainable from Granada Television Ltd., P.O. Box 494, 36 Golden Square, London, W.1.

"The development of the loudspeaker" is the title of the lecture by Ralph West at the September 23rd meeting of the Society of Electronic and Radio Technicians at 7.0 at the I.E.E., Savoy Place, London, W.C.2.

The biennial convention of the **British Amateur Television Club** will be held on Saturday, October 8th in the Conference Suite of the I.T.A., 70 Brompton Road, London, S.W.3, from 10 a.m. It will include an exhibition of equipment built by members and a short symposium of papers of general television interest. Admission will be free and further details concerning the Convention and the work of the Club can be had from M. Cox, 135 Lower Mortlake Road, Richmond, Surrey.

East Africa's only radio & electronics show is being organized by the Electronics Group of the East African Institute of Engineers and will be held in Nairobi from November 16th-19th. Manufacturers interested in exhibiting should communicate with the organizer D. J. Hart, P.O. Box 14285, Nairobi.

A conference entitled "**Solid State Devices**" to be held during September, 1967, is being arranged by the Institute of Physics & Physical Society jointly with the I.E.E. in collaboration with the I.E.R.E. and the I.E.E.E. Further details are available from the Institute, 47 Belgrave Square, London, S.W.1.

The **International Radio Communications Exhibition**, sponsored by the Radio Society of Great Britain, is to be held this year from October 26th to 29th, inclusive, at Seymour Hall, Seymour Place, London, W.1. Admission will be 3s.

Tests on the new **I.T.A. 1,265ft mast** at Emley Moor were recently completed and full-power trade test transmissions (channel 10, sound 196.25 Mc/s, vision 199.75 Mc/s) have begun. Programme transmissions will continue from the old aerial until the changeover date which has yet to be announced. The new aerial is mounted 800 ft higher than the old one.

Five weather data receiving stations for use with American weather satellites, are to be constructed by Hawker Siddeley Dynamics Ltd. and Dynatel Ltd. as the result of a contract awarded by the Meteorological Office. These companies will build the ground read-out stations for cloud cover photograph production at Meteorological Offices all over the world. These stations constructed as light, transportable buildings, enclosing receivers and recorders for read-out, are surmounted by a tracking aerial, controlled from within the building.

Broadcast Receiving Licences.—During the first six months of this year the number of combined television and sound receiving licences in the U.K. increased by 125,080 bringing the total to 13,641,064. Sound only licences fell by 85,093 to 2,593,062; this figure includes 677,534 for receivers in cars which represents an increase of 19,334.

British Amateur Electronics Club.—This club, originally known as the St. Cyres Electronics Group, will be holding its first meeting of the winter session on September 15th at the Penarth Secondary School, St. Cyres Rd., Penarth, Glam. Full details of the activities of the club are available from the chairman, at 26 Forrest Rd., Penarth, Glam.

The **Radio Trades Examination Board** has announced the results of the four **servicing examinations** for 1965. The bracketed figures against each pass number indicate the number of certificates awarded since the inception of the various examinations.

Radio and Television Servicing		
Intermediate	1,203	(9,902)
Final	556	(3,089)
Electronic Servicing		
Intermediate	263	(547)
Final	58	(79)

OUR NEXT ISSUE will include a survey of the trends in domestic receiving equipment as seen by members of the staff of *Wireless World* at the Earls Court Show. Among the other articles in the issue will be one on the subject of superconducting devices and another on calculating aerial gain. The issue will also include the normal quota of features and news.

A discussion on "Should Britain have a single- or double-standard colour television service?" has been arranged by the Television Society for August 25th at 7.0 p.m. at the I.T.A., 70 Brompton Road, London, S.W.7.

P.A. Exhibition and Symposium.—The Association of Public Address Engineers is holding an exhibition and symposium at the Woodlands Hotel, Timperley, Manchester, on Sunday, September 25th.

City and Guilds Courses.—The syllabuses for courses and the question papers set at the examinations of the City & Guilds of London Institute during the past three years are available from the Institute price 1s. 6d. (syllabuses) and 2s. per year's set of question papers. A list of the Institute's publications and question papers can be obtained from the headquarters, 76 Portland Place, London, W.1.

Stereo in Germany.—According to figures published in the *European Broadcasting Union Review* some 7.25 M stereophonic receivers were manufactured during the past two years in West Germany. About 1 M were sold in Germany and the rest exported. Eight of the West German broadcasting organizations now radiate stereo programmes and together provide about 70 hours stereo a week.

A new four-year **special degree course in electronic engineering** has been planned by the University of Hull which recently announced the inauguration of a Department of Electronic Engineering. One of the objects of this B.Sc. special degree course is to combine fundamental physics with the system-design aspect of electronic engineering and most of the first and second years will be occupied with physics, mathematics and subsidiary studies. The electronic engineering part of the course will cover electronic devices, circuits and systems. The course is to start in October and further details can be obtained from the Head of Department, Professor D. A. Bell.

The **Association of Civil Aviation Technical Staff** has been formed by the radio technicians and telecommunications officers of the Aeronautical Radionavigation Service. Formation of the Association provides an organization by which the members can be represented in a manner similar to the Guild of Air Pilots and Air Navigators and the Guild of Air Traffic Control Officers. Further details are available from A.C.A.T.S. P.O. Box No. 2, Cheadle Hulme, Cheadle, Cheshire.

A one-day course, "**Counter Design with Silicon Integrated Circuits**," is to be held on October 31st at the John Dalton College of Technology, Chester St., Manchester 1. Further details are available from Dr. D. N. Hall at the College.

WHAT THEY SAY

Maintainability.—Announcing the publication of the fifth of its "maintainability bulletins" the American Electronic Industries Association says "The bulletin . . . discusses the derivation of quantitative maintainability requirements to achieve a set of space-oriented operation objectives. With operational readiness probabilities and failure rates specified, a probabilistic operational figure of merit can be developed for any period in the countdown sequence based upon failure rates and maintenance task times for single or multiple failures." The announcement says "the approach is unique"!

Receiving Stereo Broadcasts

OUTLINE OF PILOT-TONE SYSTEM AND CIRCUIT TECHNIQUES IN RECEIVING EQUIPMENT

EXPERIMENTAL broadcasts of stereo programmes and test material have taken place for some considerable time now both in this country and on the Continent. The B.B.C. initially used two transmitters for the left and right channels (1958-1962)¹, but in 1962 tests commenced using only one transmitter (multiplex system).

On July 30th the B.B.C. announced a substantial increase in stereo transmissions. These take place on the Third Network in the v.h.f. band and two or three programmes are being broadcast each day. The programmes are initially being radiated from the Wrotham and Dover transmitters, but the Sutton Coldfield transmitter will also be used in the summer of 1967 and Holme Moss from the autumn of 1967. Further extensions (coverage and programmes) will be considered at a later stage.

The pilot-tone system

The pilot-tone system has been dealt with previously in these pages², but a brief outline is not out of place at this time. The system is a compatible one, i.e. mono receivers function normally and do not respond to the stereo information. The system used in Europe differs from that in the U.S.A. in that a 50 μ s time constant is used for pre-emphasis instead of 75 μ s, and the "storecasting" f.m. subcarrier of 67 kc/s is not used.

The f.m. transmitter is modulated by a composite signal consisting of three parts (Fig. 1): a monophonic signal, which is the sum of the left and right channels ($L+R$), this being the compatible part of the signal, extending up to 15 kc/s; a difference signal ($L-R$), amplitude modulating a 38 kc/s subcarrier (carrier suppressed to at least 1%) and producing sidebands from 23 kc/s to 53 kc/s (38 ± 15 kc/s); and a pilot carrier at 19 kc/s suppressed to $9 \pm 1\%$, which is used for 38 kc/s carrier reinjection at the receiver. Suppression of the 38 kc/s subcarrier to at least 1% results in a greater deviation being available for the $L+R$ signal. Examination of the first two terms in the expression for the composite signal (below) shows that the $L-R$ or stereo information may be included in the transmitted signal without having to impose a limit on the $L+R$ signal. The expression is:—

$$0.9 \left(\frac{L+R}{2} + \frac{L-R}{2} \cos \omega_s t \right) + 0.09 \cos \frac{1}{2} \omega_s t$$

where the first term is the main or mono channel, the second term is the suppressed-carrier subchannel, and the third is the pilot tone. The first two terms are limited to 90%³ of the available deviation (75 kc/s), and the third to 9%. A receiver making use of only the main channel signal will consequently be supplied with only 90% of the modulation, this resulting in a slightly reduced signal-to-noise ratio (about 4 dB). For stereo reception the signal-to-noise ratio is worsened by about 22 dB compared

¹ Tests were in fact carried out as early as 1926 using two medium wave transmitters.

² "The Zenith-GE Stereophonic Broadcasting System," G. J. Phillips and J. G. Spencer, *Wireless World*, January 1963, p. 39.

³ In the U.S.A. where an f.m. "storecasting" subcarrier is often transmitted this figure would be 80%.

to normal reception—this, of course, being the price paid for transmitting the additional stereo information.

Fig. 2 has been included to illustrate step by step the formation of the complex composite signal. The waveforms are explained in the caption. It can be seen that a method of producing the composite signal would be to modulate a 38 kc/s carrier with the $L-R$ signal, suppress the carrier and then add the $L+R$ signal and the 19 kc/s pilot tone. Alternatively, waveforms *i* and *l* can be considered as a kind of time-division multiplex signal, in which the L and R channels are sampled at the rate of 38 kc/s, but instead of using a rectangular waveform to switch from one channel to the other, a sinusoidal waveform is used.

Stereo receivers

There are a number of factors which require consideration in order to receive stereo broadcasts. It should be borne in mind at the outset that the results obtained are a function of the transmission path, the receiving aerial, the receiver, the decoder, and so on. If any one of the many links has deficiencies this will show in the end product. Elaborate decoder circuitry, for example, cannot give good results if the tuner is badly designed or misaligned.

The constraints placed on tuner design are greater for stereo tuners and generally only tuners which have been designed with stereo in mind should be used. Perhaps the most obvious requirement to be met is receiver bandwidth. For mono systems, the maximum modulating frequency is 15 kc/s, requiring a bandwidth of 240 kc/s for good quality reception. This, of course, is an extreme case and bandwidths ranging from 150 kc/s to 240 kc/s are used in practice. For stereo reception, where the maximum possible modulating frequency is 53 kc/s, the bandwidth requirement is increased and figures from 200 kc/s to 300 kc/s are found. The bandwidth figures apply to the i.f. stages—generally the front end and discriminator bandwidths are much greater. If the maximum modulating frequencies (i.e. $L-R$ information) are attenuated in the receiver crosstalk between the L and R channels occurs, resulting in reduced separation. (It should be clear that the de-emphasis filter must be removed from the tuner output.) The phase-frequency response must be linear and any deviation from this

Fig. 1. Spectrum of modulation fed to transmitter, and as it should appear at receiver discriminator.

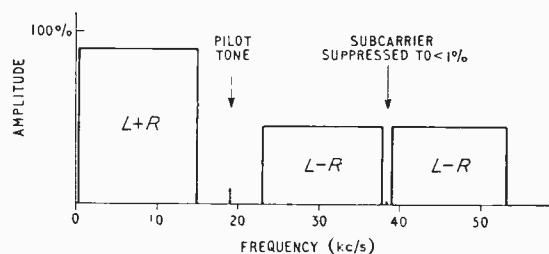

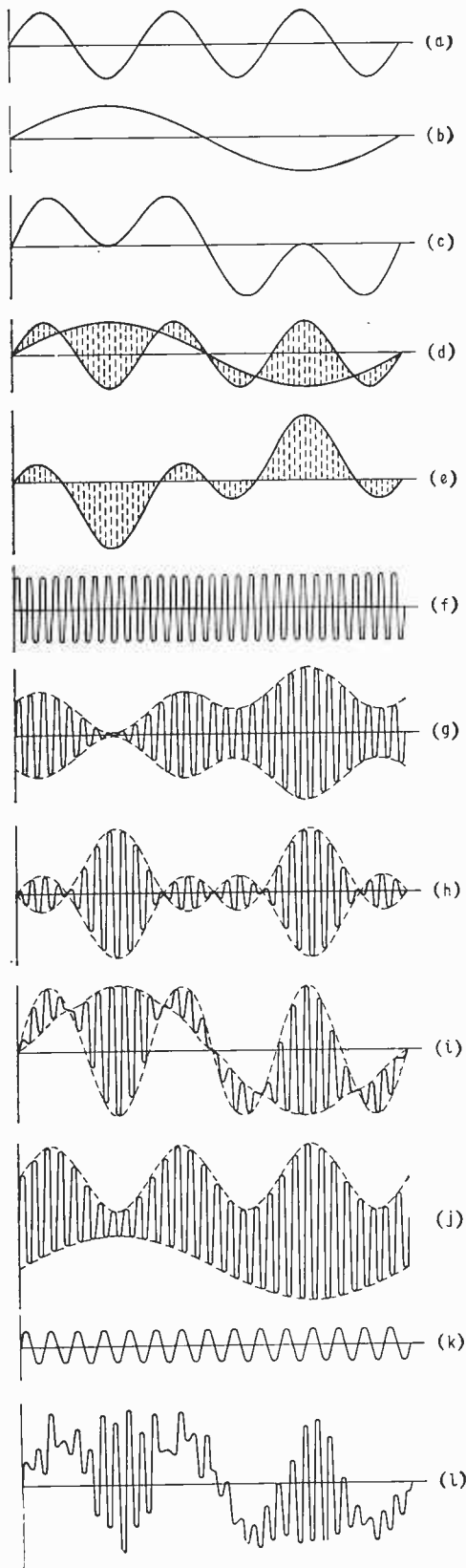

Left:— Fig. 2. Showing composition of multiplex signal. Vertical axes are not to scale. (a) Left-hand channel a.f. signal L (3.8 kc/s). (b) Right-hand channel R (1.27 kc/s). (c) Sum signal $L+R$ derived from matrix. (d) L and R signals superimposed to show how (e) is derived graphically. The vertical lines represent difference amplitudes. (e) Difference signal $L-R$ derived from matrix. (f) 38 kc/s sub-carrier ($\cos \omega t$). (g) 38 kc/s sub-carrier amplitude modulated with the $L-R$ waveform at (e) ($(L-R) \cos \omega t$). (h) Waveform at (g) with $L+R$ signal added. This is almost the complete multiplex signal ($L+R+(L-R) \cos \omega t$). (i) Result of reinserting sub-carrier in waveform at (i). The L and R envelopes are separated by the reinserted 38 kc/s sub-carrier frequency. (k) 19 kc/s pilot frequency ($0.1 \cos \frac{1}{2} \omega t$). (l) Composite signal. The effect of adding the 19 kc/s pilot is to raise and lower the peaks in waveform at (i).

Below:— Fig. 3. Block diagrams representing various methods of decoding the composite signal.

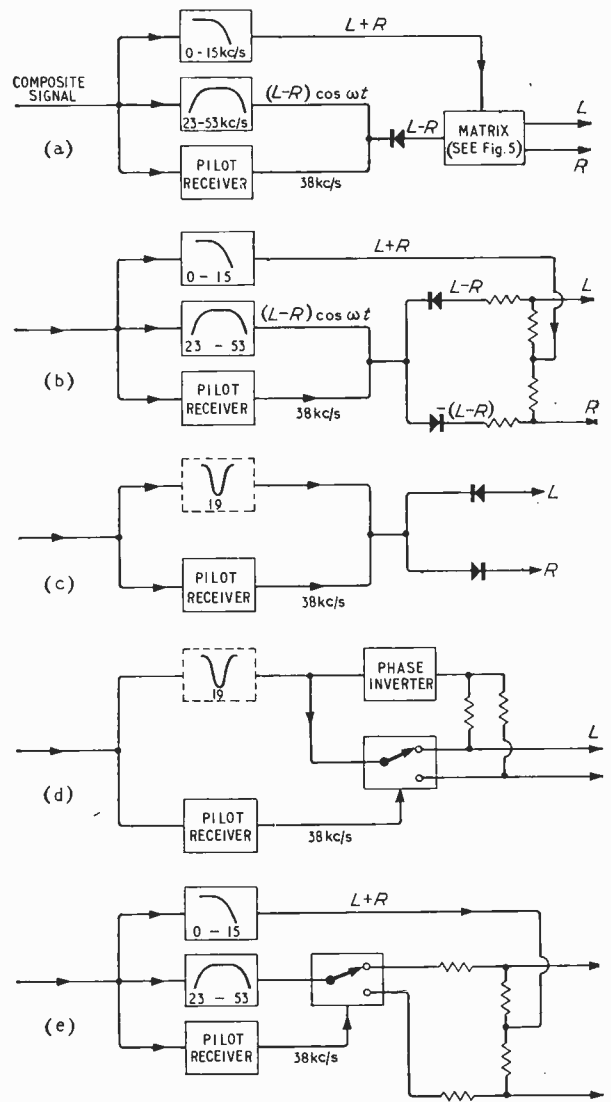

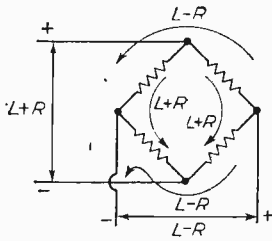

Fig. 4. Resistive matrix (equal value resistors) in which L and R signals are obtained from $L+R$ and $L-R$. Similarly for $L+R$ and $L-R$ from L and R .

will also reduce separation. Small deficiencies, however, in amplitude and phase responses can often be corrected in the decoder.

The a.m. limiter must be more effective where multipath reception takes place, as the effect on stereo will be more serious since the decoder is sensitive to disturbing frequencies up to 53 kc/s. In this connection a better aerial would offer an improvement. A better aerial will be required anyway owing to the signal-to-noise ratio degradation, particularly in fringe areas, and it is suggested that in all cases where it is intended to listen stereophonically the aerial be improved.

Stereo decoders

The function of the decoder is to extract the L and R signals from the composite multiplex signal and this can be done in a number of ways. Reference to the development of the composite waveform (Fig. 2) shows that one way would be to reverse the processing suggested by Fig. 2. The 19 kc/s pilot frequency must first be extracted from the composite signal and is then used to generate a 38 kc/s re-insertion carrier. The $L+R$ signal is filtered out and the $(L-R) \cos \omega t$ sub-channel signal added to the 38 kc/s carrier to provide an amplitude modulated signal which is then demodulated with a single diode in the normal way (Fig. 3 (a)). The resulting $L-R$ (a.f.) signal is then fed into a resistive matrix with the $L+R$ signal to give the L and R channels. Fig. 4 shows such a matrix and it can be seen that the $L+R$ and $L-R$ currents oppose in two of the resistors, giving $2R$, and add in the other two, giving $2L$. Alternatively, two diodes may be used in the demodulator, one giving $L-R$ and the other $-(L-R)$ or $R-L$, these signals then being added to the $L+R$, as shown in Fig. 3 (b). This method, which was frequently used in early decoders in the U.S.A., involves the use of awkward filters and is not used much in current designs.

The alternative approach to the subject, as mentioned already, is to view the composite signal as a time-division multiplex signal in which the composite waveform is equivalent to sampling the L and R information alternatively at the rate of 38 kc/s. Normally, of course, time division multiplex systems are switched with a rectangular waveform, but in this case the switching waveform is quasi-sinusoidal. This can be achieved by using a rectangular switching function and filtering out the harmonics. To regain the original L and R information the composite signal is applied to an electronic switch (typically diodes) operated at 38 kc/s as shown in Fig. 3 (d). However, this process of switching with a 1:1 mark-to-space ratio rectangular wave does not yield completely separated L and R signals and an attenuated and inverted $L+R$ signal is added to the resulting signals to achieve complete separation. Another method using this approach is to present the switch with only the difference information signal, and here again some correction is required for complete separation (Fig. 3 (e)).

A further approach is to insert the sub-carrier into the composite signal, giving the waveform shown in Fig. 2 (f). (The sub-carrier reinserted into the sub-channel signal only, gives Fig. 2 (g).) It is clear that simple diode detectors can be used to regain the upper and lower envelopes, corresponding to the left and right channels. This is illustrated in Fig. 3 (c).

Fig. 5 (a) shows a simple switching demodulator, the portion to the right of the broken line representing the correction referred to earlier. This may also take the form of an a.f. amplifier with partial common-mode suppression. Fig. 5 (b) shows a balanced ring demodulator in which the 38 kc/s signal is appreciably attenuated thus avoiding the necessity for twin-T filters. Here the diodes are often forward biased so that when a mono programme is transmitted, it can pass unaffected through the diodes.

The pilot tone receiver is an integral part of the decoder and three methods of regenerating the 38 kc/s signal are shown in Fig. 6. An advantage of the second two (b) and (c), is that the subcarrier amplitude is not as dependent on the signal strength as in case (a). Hysteresis in the pilot circuitry is often used so that the subcarrier will have a constant amplitude until the signal falls below a certain level.

A typical three transistor decoder circuit is shown in Fig. 7. The decoder uses three tuned circuits which is the minimum number in present designs for acceptable results. The first stage is a bootstrap amplifier giving a high input impedance and consequent minimum loading of the discriminator. The 19 kc/s signal is amplified in the second stage and doubled in the third. The doubler can also be a class A, AB, or C stage instead of the full-wave double diode circuit shown, but the 19 kc/s component would not be attenuated as greatly. A rectified output is taken from the third transistor collector back to the second transistor base in order to control the gain and giving the desirable hysteresis characteristic. A stereo indicator is often included, being operated by the 19 or 38 kc/s signal.

The composite signal is fed from the first transistor emitter to a balanced demodulator. An attenuated

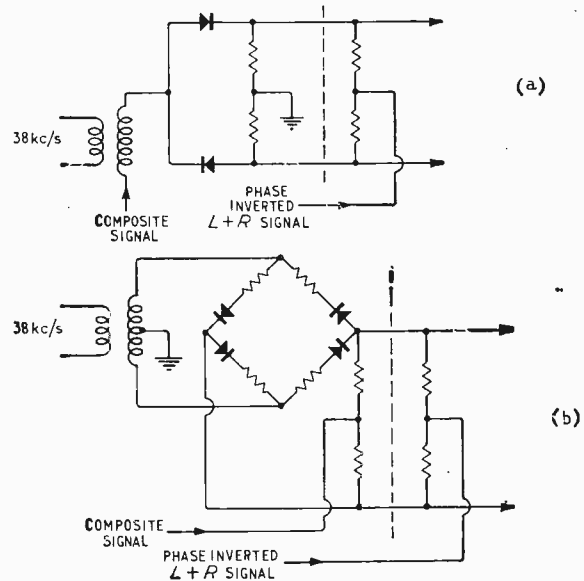

Fig. 5. Two of the many possible arrangements for "switching" demodulators; (b) is balanced, avoiding the necessity of filtering the 38 kc/s subcarrier by twin-T filters.

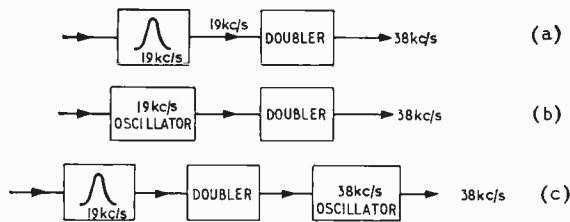

Fig. 6. Three possible arrangements for regenerating the 38 kc/s subcarrier or switching frequency. Another possible method would be to use an automatic phase control (a.p.c.) loop.

phase-inverted composite signal is fed from the first transistor collector circuit and added to the demodulator outputs. The capacitors in the diode ring merely prevent the forward d.c. bias, used for mono operation, from passing through the 38 kc/s transformer.

Equipment

It has been mentioned earlier that for serious stereo listening an improved aerial should be used mainly because of the reduced signal-to-noise ratio of stereo transmissions. Interference will be more evident and service areas (for stereo) will be reduced accordingly, so better aeriels are definitely the first requirement. These should be outdoor and preferably raised in height and directional. Directional aeriels will be a necessity in fringe areas. It has been estimated, incidentally, that with the use of directional aeriels in fringe areas, the population coverage will be reduced from 98% to 93%.

Domestic f.m. table receivers, as opposed to high-quality equipment, will not, in general, be suitable for stereo reception. It is anticipated, however, that some domestic radiograms suitable for stereo reception will be announced later this year.

Many better quality receivers in current use were designed without stereo in mind and for the most part

these will not give acceptable results. Should there be any doubt as to whether a receiver or tuner is suitable for addition of a stereo decoder, the manufacturer should be consulted. Decoders are available from a number of manufacturers and agents. Most of these manufacturers also provide complete stereo tuners with integral decoders. The following list includes decoder prices and availability.

- Acoustical Manufacturing Co. Ltd., (Quad) St. Peter's Road, Huntingdon. (£16.)
- Armstrong Audio Ltd., Warters Road, London N.7. (£4 10s.)¹
- Daystrom Ltd. (Heathkit), Bristol Road, Gloucester. (£8 10s kit, £12 5s assembled; £14 14s 6d U.S. decoder.)²
- Debenhams Elec. & Radio Distribution Co. Ltd. (B. & O.), Mercia Road, Gloucester. (£6 16s 6d.)
- Grundig (Great Britain) Ltd., Newlands Park, London S.E.26. (£12 15s 6d.)
- Highgate Acoustics (Arena & Loewe-Opta), 71 Great Portland Street, London W.1. (£7 7s and £9 9s respectively.)
- H. J. Leak & Co. Ltd., Brunel Road, London W.3. (£15.)³
- Lowther Manufacturing Co., St. Marks Road, Bromley, Kent. (About £15.)⁴
- Martin Electronics Ltd., 154 High Street, Brentford, Middx. (Available shortly.)
- Pye High Fidelity Division, St. Peters Road, Maidenhead, Berks. (Available shortly.)
- Radford Electronics Ltd., Ashton Vale Estate, Bristol 3. (About £15.)⁵
- Rogers Developments (Electronics) Ltd., 4 Barmeston Road, London S.E.6. (£15.)⁶
- Tripletone Mfg. Co. Ltd., 241a The Broadway, London S.W.19. (Available shortly.)
- Truvox Ltd., Neasden Lane, London N.W.10. (About £12, available shortly.)
- Winter Trading Co. Ltd. (Trio, Japan), 95 Ladbroke Grove, London W.1. (£19 19s.)

1. A conversion kit (3s) and instructions are also available for tuners ST3 Mk. 1 and 2; T4; Stereo 12 Mk. 1 and 2; and stereo 55 tuner-amplifiers.
2. Available November. American model 6 weeks delivery.
3. Cost of realignment and decoder for Trough-line II and III tuners.
4. For Mk. VI tuner. Mk. V tuner and previous models require realignment and a different tuner.
5. Available November. Suitable for all Radford tuners.
6. Without power unit. Available October. Self-powered decoder available December.

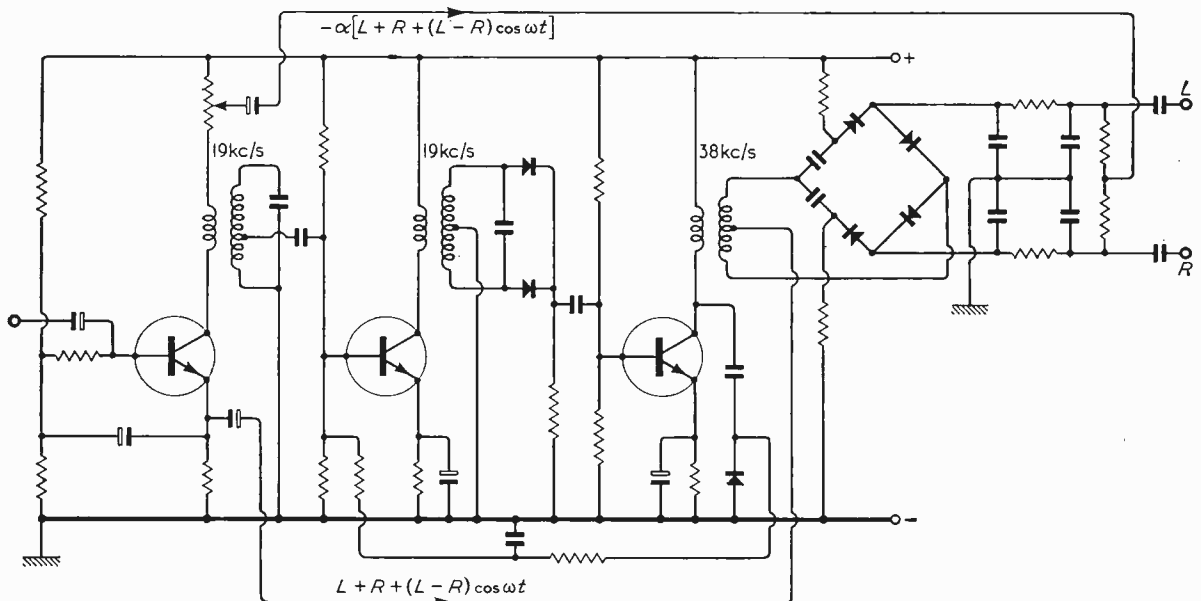

Fig. 7. Typical three transistor decoder circuit, for both mono and stereo operation. A stereo indicator, actuated by the 19 or 38 kc/s signal is often included.

Scan Linearity Measurements Without Tears

By A. J. HENK

QUICK, CONVENIENT TELEVISION TESTING METHOD USING OPTICAL INTERFERENCE PATTERNS FORMED BY VIDEO BAR GENERATOR AND CONVERGENT GRATING

OF the many performance parameters of a piece of television receiving equipment, whether a domestic receiver or a studio monitor, scanning linearity is without doubt one of the most tedious to measure. The usual method involves generating a pattern of small squares or rectangles for display on the screen and either carefully measuring them with a ruler or comparing the pattern with a reproduction printed on a transparent sheet and held in front of the cathode-ray tube face. In either case it is usual to find that either the picture size or the number of squares in the grating,

this by moving his head such that he is as near normal to the implosion screen as he can estimate with one eye closed—a difficult estimation which, if correct, would introduce another parallax error in the opposite direction. This type of error can hardly be ignored in large-screen displays where the specification claims a linearity performance in which any picture element is within 2% of the picture size of its correct position!

It is hardly surprising that many engineers blanch at the prospect of linearity measurements and tend to be satisfied by a quick look at a test card circle and a consolation that what distortion they can see contains a fair contribution from the camera or monoscope.

For linearity measurements to be made from the normal viewing distance a display is required which is large and easily read, easily set up and not critically dependent upon scanning amplitude. Other desirable features are that it be sufficiently simple to interpret to enable linearity controls to be "tweaked for optimum" without the need for measurement between settings and that errors occurring over a very small portion of the picture, whose assessment would be difficult using reference points spaced by $\frac{3}{8}$ - $\frac{1}{2}$ in, should be clearly visible. The method to be described is an attempt to provide an answer to the problem of linearity measurement in a manner satisfying these conditions.

The principle used is that of optical interference patterns, sometimes called Moiré patterns. An interference pattern is the visual effect produced when two regular fine structures are superimposed, for example, two pieces of thin silk held together. Both structures consist of alternate opaque and transparent areas, and when the opaque areas of one cover the transparent areas of the other there is little or no light transmission through the combination. When opaque areas cover opaque areas the transparent areas also correspond and the combination transmits light as though only one structure were present. One of the structures can take the form of a light pattern on a cathode-ray tube, while the other can be a transparency held against the implosion guard, as in Fig. 1, with a similar result.

A. J. Henk, who is 31, is a supervisory engineer in charge of the electronic maintenance and development section of Alpha Television Services (Birmingham) Ltd., operators of the Midlands Independent Television Studio Centre. After National Service, at what is now the Army's School of Electronics at Arborfield, Berks., he was with the B.B.C. in 1955/56. During his ten years with Alpha Mr. Henk has been concerned particularly with special effects projects and in our January 1962 issue he described an electronic "cuedot" generator.

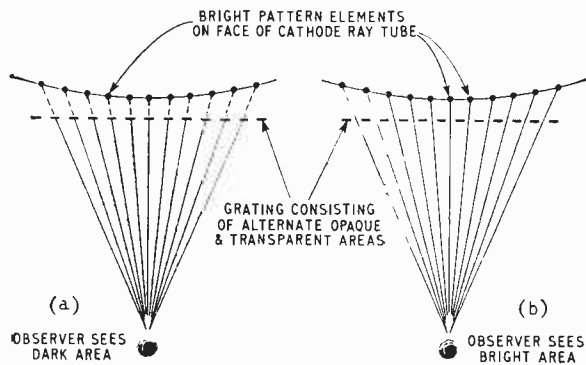

Fig. 1. Principle of formation of optical interference patterns. At (a) the bright pattern elements are obscured by the opaque parts of the transparency grating and the observer sees a dark area. At (b) the bright pattern elements are visible through the transparent parts of the grating and the observer sees a bright area.

or both, change as counting proceeds; not a condition conducive either to accuracy or ease of measurement. Even granted stable conditions this method is not usually capable of consistent or accurate results on account of the difficulty of holding a straight ruler or a flat transparency against a curved tube faceplate.

The parallax errors caused by a separation of an inch or more between the screen and a transparency at the screen edges are far from insignificant, except when the monitor is viewed squarely and at the normal viewing distance. This can be understood by imagining a curved c.r.t. face-plate, displaying pattern elements spaced such that an observer at the normal viewing distance will see a perfectly linear display, and a transparency in front of it in which the lines correspond exactly with the pattern elements. If the observer now moves close enough to count squares or measures distances there will be a parallax error. The observer tends to allow for

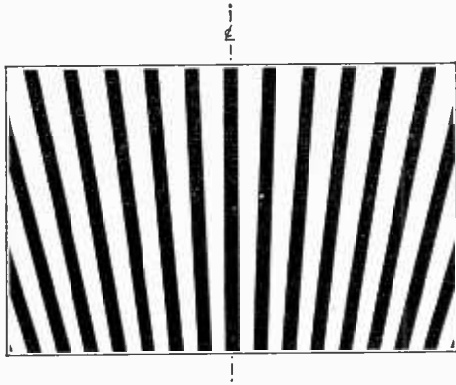

Fig. 2. Exaggerated sketch of a non-parallel grating.

The structure chosen for linearity measurements is a series of nearly parallel equally spaced opaque lines on a clear film base. The resulting transparency is trimmed to the size appropriate to the tube concerned, a different transparency being constructed for each tube size. This is simply affixed to the implosion shield by means of adhesive tape and the tube display is viewed through it. The light pattern displayed on the tube screen consists of equally spaced parallel lines derived from a suitable pattern generator.

From Fig. 1 it can be seen that a change in position of a light pattern element by half the pattern element spacing is sufficient to change its appearance to the observer from dark to full brightness. Also, if the pattern element spacing, as seen by the observer, is equal to the transparency line spacing, the area will appear either entirely dark or entirely white, depending upon the precise relation between pattern and transparency elements: either way the area will be uniform. Departure from exact correspondence will appear as non-uniformity in the viewed area. In practice, of course, the pattern seen is complex but the relationship holds:

continuous light areas represent regions of equal display and transparency pattern spacing.

We can now see how a parallel grating can tell us if a monitor or receiver is perfectly linear. However, we require rather more information than this and in order to extract this information it is necessary to use a transparency whose lines are not parallel, but slightly convergent, as in Fig. 2, which is an exaggerated illustration. With the centre line vertical as illustrated the line spacing increases linearly with distance up the picture. If a grating of this type is placed in front of a perfectly linear monitor displaying vertical bars whose spacing equals the line spacing at the centre of the grating, the resulting pattern will be a series of hyperbolae. Fig. 3 is a photograph of such a pattern. Across the middle is an area of light, indicated by the dotted line, in which every vertical line in the picture shows through a transparent part of the grating, the two spacings being precisely equal. The dotted line might be called an isophase. Were the spacing of the lines on the tube screen to vary, as is the case when non-linearity is present, this area of light would not centre on a straight isophase. Instead it would rise or fall in the frame in such a way that the picture tube line spacing and the grating line spacing would be equal along its length. Thus, where the picture elements were "crushed" closer together, the white area would move down the frame and when "stretched" farther apart the area would move above the middle following the change in spacing of the lines on the transparency.

In Fig. 4 a display obtained from a non-linear monitor is reproduced and an isophase (dotted line) has been drawn through the centre of the white area to illustrate the way in which this area is displaced from its "ideal" position in Fig. 3. The more non-linear the monitor, the greater the displacement.

Having now a means of detecting non-linearity, it is but a step to quantitative measurement. The spacing of the bars on the monitor screen is directly proportional to the horizontal velocity of the beam as it sweeps across the screen. Also, the spacing of the bars on the transparency is directly proportional to distance up the transparency. Along the dotted-line isophase drawn in

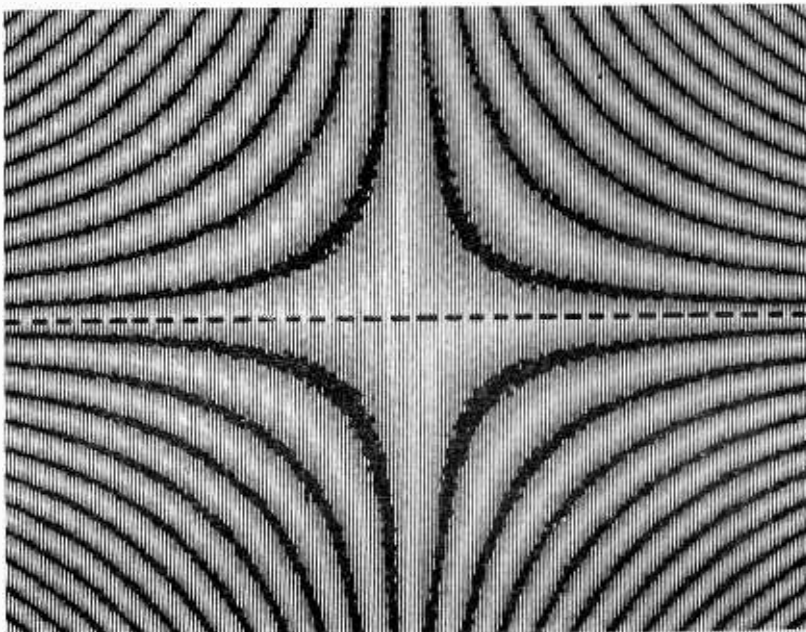

Fig. 3. Photograph of optical interference pattern produced by placing a convergent grating in front of a perfectly linear c.r.t. display of vertical bars. Note the hyperbolic fringes. The dotted line, an "isophase", joins all points where the spacings of the bars and the grating are exactly equal.

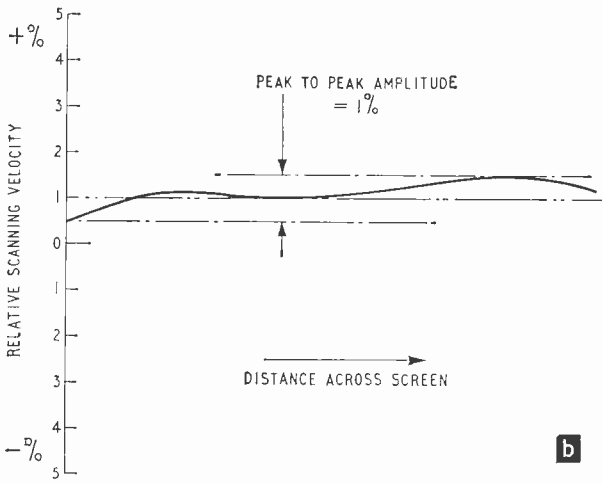
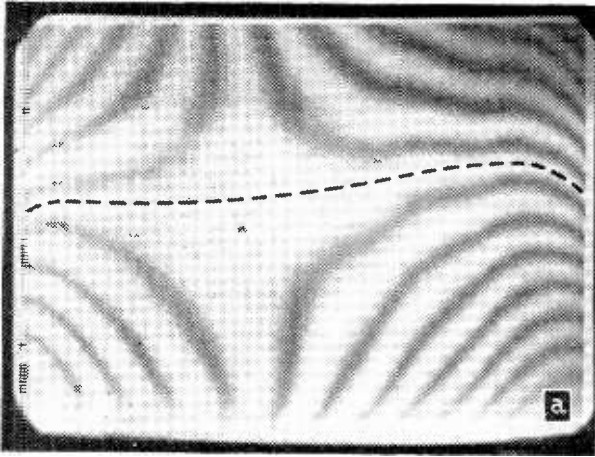

Fig. 4. Line linearity display on a good c.r.t. monitor; (a) interference pattern with isophase shown dotted; (b) interpretation of isophase as a scanning velocity/distance graph.

Fig. 4, since it is a continuous light area extending across the rulings, the spacing of the bars on the screen equals the spacing between rulings. It follows that, since the spacing of the rulings increases with upward displacement, the height of the dotted isophase is directly proportional to the spacing of the bars on the tube and hence to the scanning velocity. The isophase thus represents a graph of scanning velocity (plotted vertically) against distance across the picture (plotted horizontally), as it were, "real distance" units.

It is a simple matter, having dealt with horizontal scanning, to take a measurement of vertical linearity. We need hardly worry about generating bars on the screen: the line structure of the picture will serve admirably. It has been found desirable, however, to suppress the raster on alternate field scans, thus providing a 202½-line raster on the 405-line standard. If this is not done the structure of the transparency becomes unnecessarily fine, any interlace jitter is magnified greatly in the observed pattern and with small-screen units, where the spot size is not all it should be, definition problems arise. The same transparency can be used as in line scan observations: it is simply turned through 90°. The resulting pattern is, of course, seen to be on its side and must be interpreted accordingly.

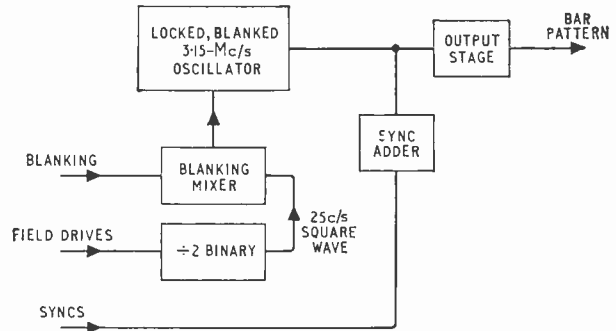

Fig. 5. Block diagram of video bar generator.

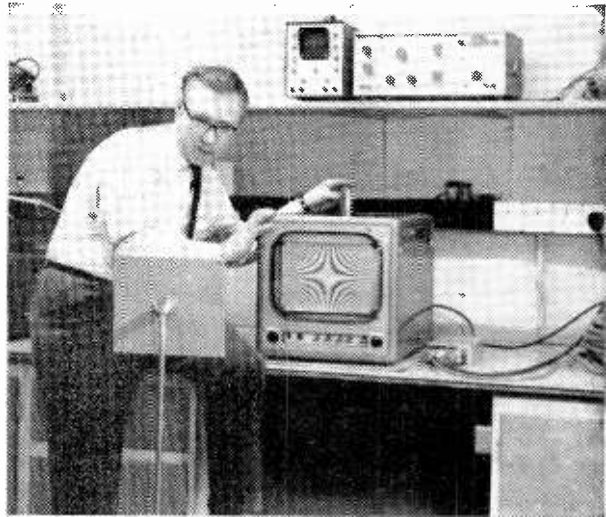

Fig. 6. Adjusting monitor linearity control with the aid of a mirror on a stand.

In the 405-line system there are 202½ lines displayed when alternate field scans are blanked out. Of these, 188 carry picture information, the remaining 14 being suppressed and of no interest for the purposes of linearity measurement. In order that the same transparency may be used for both horizontal and vertical measurements the spacing of the vertical bars must be equal to the spacing of our 188 displayed scanning lines. Since the aspect ratio is 4:3, the number of vertical bars is given by

$$n = \frac{4}{3} \times 188 \\ = 250$$

A generator is therefore required which will produce 250 bars during the active picture line time of 79.5 μsec, corresponding to a frequency of 3.15 Mc/s. The alternate field suppression can be applied to this oscillator. A block diagram of a suitable arrangement is shown in Fig. 5.

The dimensions of the transparency rulings are also easily determined. Across the centre of the transparency the number of lines will equal the number of bars on the tube screen, i.e. 250. If the system is required to measure linearity errors of ±5%, a useful range for studio work, the top edge of the transparency requires 5% fewer lines

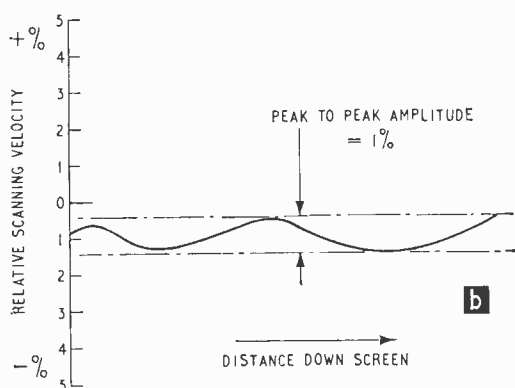
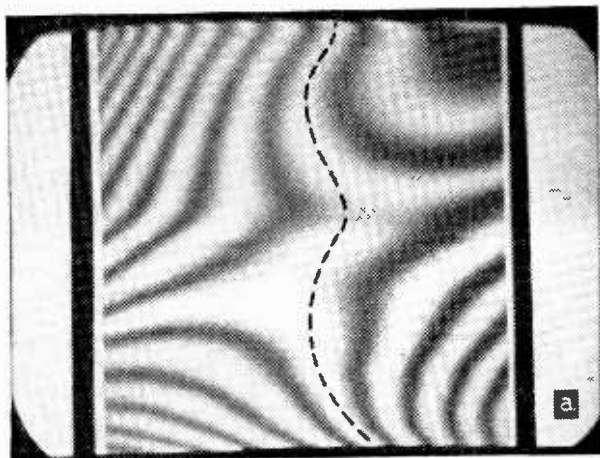

Fig. 7. Field linearity display on a good monitor: (a) interference pattern and isophase; (b) scanning velocity/distance graphical interpretation.

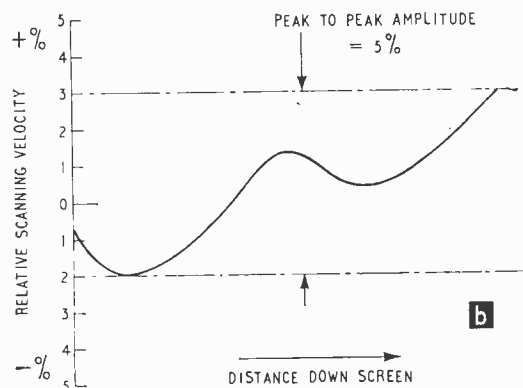
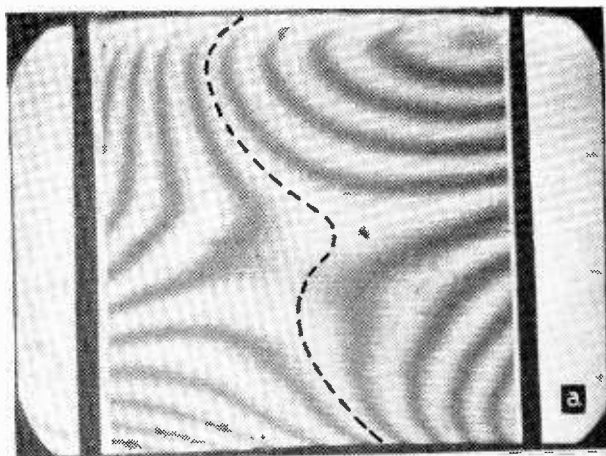

Fig. 8. Field linearity display on a poor monitor: (a) interference pattern; (b) graphical interpretation.

and the bottom edge 5% more than the middle. This results in 262 lines along the lower edge, diverging to 238 along the top.

As can be seen from the photographs of various displays (Figs. 7, 8 and 10), the shape of the pattern can easily be seen from normal viewing distances, obviating the need for the operator to be close to the screen when making observations and enabling the parallax errors mentioned above to be eliminated. For the most satisfactory results, especially the consistency of readings, the observer's viewpoint has to be constant throughout the period in which adjustments are being made and measurements are being taken. The observer also must be able to make adjustments to the linearity circuits while in this position. These conditions can be satisfied by placing a mirror, on a stand, about half the normal viewing distance from the screen, the centre of the mirror lying approximately on an extension of the tube's axis. The position of the mirror can be estimated quite accurately enough by eye. The observer can then work alongside the equipment, making adjustments as necessary and viewing the display as reflected in the mirror. If the mirror is no larger than necessary to enable the whole display to be seen (about half the picture size) the observer's viewpoint will always be effectively on the tube axis at twice the mirror's distance.

A complete working arrangement is shown in Fig. 6. The mirror can be seen in the foreground and the ease

with which the operator can make adjustments is clear from the photograph. The small unit to the right of the monitor is the pattern generator which produces the alternate field suppression and vertical lines on the screen.

Display Interpretation.—To the uninitiated the patterns produced by a non-linear monitor can be bewildering indeed. A series of photographs has been taken in order to illustrate the way in which various displays should be interpreted (Figs. 4, 7, 8 and 10), and it is hoped that by studying these and knowing what to look for, the reader will quickly be able to appreciate their underlying simplicity.

Although, so far, all patterns have been assumed to have an area of lightness centred on an isophase, a change in picture or transparency position by half a bar will result in this isophasic area being dark instead of bright. This will have the effect of, as it were, phase-inverting the display: all dark areas becoming bright and vice-versa. A small adjustment of the appropriate picture shift control will produce a display in whichever polarity the viewer pleases. Although for ease of illustration the bright central area display has been used in this article it is important to remember that the shape and therefore the interpretation of the pattern is precisely the same in either condition.

Setting Up.—The pattern generator is used to produce

bars on the monitor screen. The transparency is affixed to the implosion guard by means of adhesive tape, with the lines vertical if line linearity is to be measured; horizontal for field measurements. The mirror is placed in position and the display observed. Adjustment of scan amplitudes is now made until the characteristic pattern is seen. In the case of line measurements small alterations in picture width cause the pattern to move up or down in the frame; a setting is selected giving a more or less central position. If the setting is grossly incorrect the pattern will not appear; a set of divergent fringes will be seen which will move farther apart as the correct setting is approached.

Typical Patterns.—Fig. 4 shows a monitor with very good line linearity and an isophase has been drawn dotted through the centre of the continuous light central area of the pattern. The resemblance to Fig. 3 is quite clear. The departure from the centre line is small, the maximum deviation being roughly a tenth of the picture height. Since, as explained earlier, there are 10% fewer lines at the top of the transparency than at the bottom, the transparency line spacing changes by one tenth of this along the isophase. This corresponds to a scanning velocity change of $1/10 \times 10\%$, i.e., 1% peak to peak or $\pm 0.5\%$.

An example of a field linearity test is shown in Fig. 7. Since the transparency has been turned through 90° in order to obtain this display, the centre line now runs vertically and it is the departure of the isophase from the vertical which represents linearity error. It should be noted that the $\pm 5\%$ limits still correspond to the (now vertical) edges of the transparency and not to the edges of the monitor raster. The fact that the transparency is "overscanned" in the line direction is of no consequence to the field linearity measurement. Once again the linearity is very good; not much more than 1% peak-peak velocity error or $\pm 0.5\%$. The same monitor was deliberately degraded and the result is shown in Fig. 8.

In Fig. 9 a pattern from a monitor with poor line linearity is reproduced. A test chart was displayed on the same monitor and is reproduced in Fig. 10. The correspondence with Fig. 9 can be seen: crushing at both sides of the picture where scanning velocity is low, particularly on the right hand side where the accumulated positional error resulting from the increasing velocity error is very pronounced.

Making the grating.—The overall size of the grating is chosen to suit the size of the picture tube in the equipment under test; whatever size is chosen makes no difference to the number of lines in the transparency. Thus if a master grating of convenient size can be prepared it is a simple matter to produce a photographic reproduction of any convenient dimensions.

The technique employed by the writer to produce the master involved two stages, the first of which was to produce a parallel grating. A cylinder of 4in to 5in diameter was covered in malt-surfaced mylar film of the type used for drafting and the cylinder was mounted in a slow running lathe set for screw-cutting. A stylus-type drafting pen was fixed to the tool post of the lathe by a flat springy steel strip and a suitable bracket, such that the pen stylus was resting on the top of the cylinder with its axis vertical or perhaps trailing by a degree or two. By choosing a gear ratio such that the thickness of the trace drawn by the pen was equalled (roughly) by the spacing of adjacent lines and carefully keeping the pen topped up with black ink, a spiral was drawn along the cylinder. Great care was necessary to pro-

duce a satisfactory spiral, the slightest suspicion of oil or grease being sufficient to cause breaks in the trace. The cylinder had first to be thoroughly scrubbed with trichlorethylene while on the lathe and wiped with clean dry rag. Another rag moistened with the same solvent was pressed against the surface of the cylinder during tracing a few inches ahead of the pen. After a few attempts a satisfactory spiral was obtained and on removing the mylar film from the cylinder a parallel grating resulted.

The second stage combined drawing-board work with photography. The tracing was mounted with the lines vertical on the drawing board. A centre line was chosen somewhere in the middle of the usable area and identified by a mark at both ends. A pair of horizontal lines were drawn across the tracing, marking the upper and lower limits of the usable area. The final transparency required 262 lines along the bottom, so 131 lines were counted on both sides of the centre line out along the lower horizontal lines and lines Nos. +131 and -131 were marked (A, A' in Fig. 11). Similarly, in order to obtain 238 lines along the top, 119 lines were counted outwards along both sides of the centre line and the extremities marked (B and B' in Fig. 11). By joining

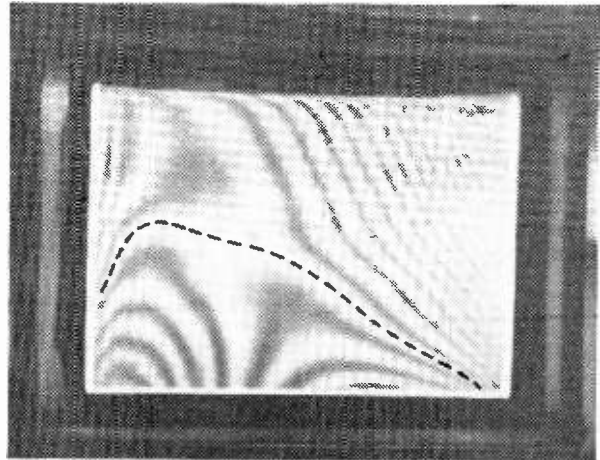

Fig. 9. Interference pattern showing poor horizontal linearity.

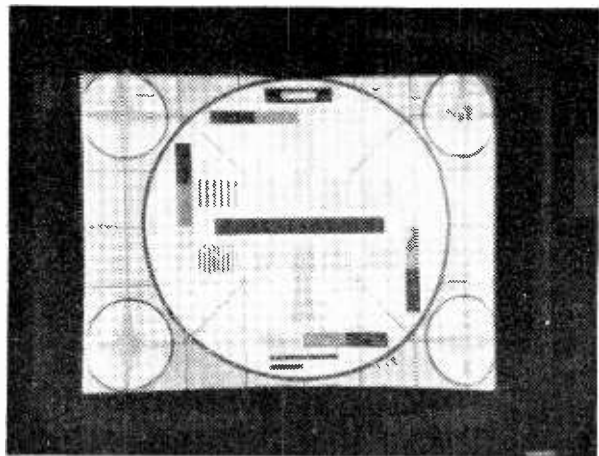

Fig. 10. Test card reproduced on monitor used in Fig. 9.

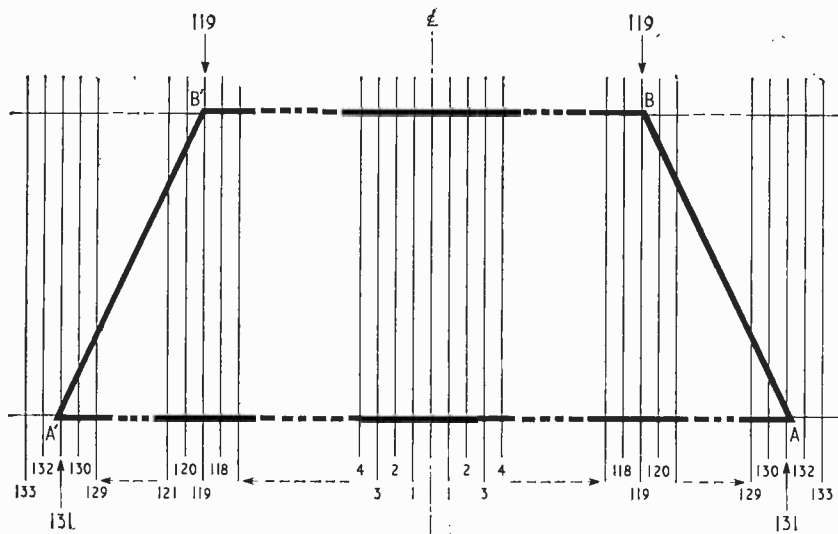

Fig. 11. Sketch showing how the master is marked out for the grating.

up the points a trapezium AA'BB' was marked out— heavy black charting tape was used for clarity—with the correct number of lines along the upper and lower edges. The rest was done by a photographer. The photographer was asked to mount the trapezium tracing on a flat easel which could be moved in all directions. He was also asked to mark out a rectangle on the camera's focusing screen having an aspect ratio of 4:3 and by judicious tilting and juggling of the easel to distort the trapezium as seen on the screen into a rectangle so that it lined up with the 4:3 rectangle. Perspective distortion made it possible to line these up quite accurately

and the resulting exposed plate formed the required master negative from which a number of copies were produced as needed.

Summing up

The convergent grating has, in numerous practical tests, shown itself to be a satisfactory means of assessing and measuring departures from perfect linearity in television picture monitors in terms of scanning velocity errors to a high degree of accuracy. The greatest advantages of the system are undoubtedly speed and convenience; the size of the raster, while it has to be approximately correct, is far from critical; small departures from the precisely correct setting resulting simply in a displacement of the pattern from a central position. Pattern interpretation can be a problem at first but familiarity comes very quickly, after which a quick glance is all that is necessary. Linearity controls can be set very quickly while the pattern is being observed and very small regions of non-linearity are as obvious as large areas. If a few simple precautions, such as careful mirror placing, are observed during setting-up, results are repeatable and consistent. Finally a simple box of circuitry and a photographically reproduced grating make for an economical kit which pays for itself very quickly in saving of time and frustration.

controls can be set very quickly while the pattern is being observed and very small regions of non-linearity are as obvious as large areas. If a few simple precautions, such as careful mirror placing, are observed during setting-up, results are repeatable and consistent. Finally a simple box of circuitry and a photographically reproduced grating make for an economical kit which pays for itself very quickly in saving of time and frustration.

Acknowledgement.—The author gratefully acknowledges the assistance of Alpha Television Services (Birmingham) Ltd. in the preparation of this article.

FURTHER EDUCATION

THE following courses to be held at various centres during the forthcoming academic year have been selected from information received as being of particular interest to *Wireless World* readers.

Leicester Regional College of Technology.—Commencing October 10th, a 30-week full-time course for the Electrical Technicians Final Certificate Course. Under the new H.N.C. rules it is possible for a student possessing the certificate to omit the O.N.C. course and enter the H.N.C. course directly.

Isleworth Polytechnic.—Full-time courses leading to the City and Guilds examinations in Radio and Television Servicing, Electronic Servicing and Telecommunications. This college is equipped with the Philco Electronics Trainer which is used extensively for these courses.

Croydon Technical College.—Commencing September 27th a 32-week course on non-destructive testing with special emphasis on ultrasonic, radiographic, magnetic and eddy current methods.

Norwood Technical College, London, S.E.27—Commencing September 20th, six evening lectures on colour television. Commencing January 10th, 1967, six evening lectures on Low Noise Amplifiers in Communication Systems, covering microwave masers, parametric amplifiers, tunnel diode amplifiers, varactor diodes. Commencing April 4th, six lectures, with particular reference to electronics, on Biological Engineering in the Medical Field.

Brentford (Middx) Centre for Adult Education.—Starting on September 27th, Radio and Television Servicing; on September 28th, High Fidelity and Tape Recording; on November 4th, Mathematics for Radio.

A 120-page booklet giving details of special advanced courses in higher technology, management studies and commerce being held in colleges in London and the Home Counties is issued by the Regional Advisory Council for Technological Education. Most of the courses are part-time (mainly evening) and cover a very wide variety of subjects. The bulletin costs 7s post free from the Regional Advisory Council, Tavistock House South, Tavistock Square, London, W.C.1.

Among the colleges and institutes providing evening courses of instruction for the Radio Amateurs' Examination, with commencing dates, where known, in parentheses, are: East Ham (London, E.6) Technical College (Sept. 19th). Hay Currie School, Byron St., London, E.14 (Sept. 29th). Basildon Evening Institute, Pattiswicke Sq., Basildon, Essex (Sept. 19th).

Brentford Centre for Adult Education, Clifden Rd., Brentford, Middx (Sept. 26th).

Beckenham Evening Education Centre, Beckenham Rd., Beckenham, Kent (Sept. 29th).

Bristol Technical College, Ashley Down, Bristol 7 (Sept. 12th).

Brighton Technical College, Richmond Ter., Brighton 1.

Riversdale Technical College, Aigburth, Liverpool.

LETTERS TO THE EDITOR

The Editor does not necessarily endorse opinions expressed by his correspondents

Electronic Organs

AS one who has made a modest contribution to the literature on this subject, I have no intention of commenting on the electrical design of Mr. Towers' organ; but I feel that he might have been a little more expansive on the constructional side. As president of the Electronic Organ Constructors' Society I have probably seen more of the difficulties confronting the amateur than most people, and I would draw attention to the need for ensuring that there is ample movement of the keytails to operate the signal contacts, since these must make firm contact with the busbar when off and move sufficiently to give some wiping action to the gold wires when on. Some keyboards may not have enough leverage so be careful when buying this item.

In the correspondence columns in the August issue Mr. Palmer mentions the possibility of using the expression "electro-phonetic"; this was in fact proposed by the council of the Royal Musical Association many years ago, but found no favour. Mr. Kirk mentions in the same issue the use of rotating Leslie speakers. This method is in wide use as a means of dispersing the sound which, in a pipe organ, comes from a multiplicity of point sources covering a large area. It was originated by the Allen Company and is used in Mr. Bourn's organs under the name Rotophon. And since Mr. Bourn mentions in his August letter tuning, and Mr. Towers considers it a relatively simple matter, I append a table which shows the way to set about it.

Starting with a tuning fork for C₂₅, this will give 261.62 c/s. Then proceed as follows, remembering that the

Hold notes	Musical interval	Approx. beats in 10 seconds	Remarks
C ₂₅ & G ₃₂	Fifth Up	9	Tune G to zero beat then flatten till correct
G ₃₂ & D ₃₇	Fourth down	13	Tune D to zero-beat then flatten
D ₃₇ & A ₃₄	Fifth up	10	A as above
A ₃₄ & E ₂₉	Fourth down	15	E as above
E ₂₉ & B ₃₆	Fifth up	11	B as above
B ₃₆ & F ₃₁	Fourth down	17	F# as above
F ₃₁ & C ₂₆	Fourth down	13	C# as above
C ₂₆ & G ₃₃	Fifth up	9	G# as above
G ₃₃ & D ₃₈	Fourth down	14	D# as above
D ₃₈ & A ₃₅	Fifth up	11	A# as above
A ₃₅ & F ₃₀	Fourth down	16	F as above

beats are all produced by *flattening* the note, not sharpening it. A little tedious, but well worth the trouble as I can testify that Mr. Towers' oscillators are very stable.

A quick check can be made on the above by holding C₂₅ and F₃₀; the C should be flat to the F by approximately 12 beats in 10 seconds. If it is too fast, the intervals have been tuned to too slow a beat.

The above bears out Mr. Bourn's statements about the necessary departure from perfect intervals and is a fact.

The maximum "out of tune" is required in a small organ having only one set of generators and only one waveform basically.

In conclusion, I would like to point out that the firm of Ernest Holt mentioned by Mr. Towers has been incorporated into that of Kimber-Allen Ltd., of London Road, Swanley, Kent, from whom all previous Holt supplies can be obtained.

Nottingham.

ALAN DOUGLAS

MR. BOURN suggests in his August letter that tempered scale distortion, consisting of the approximate equalizing of beat frequencies produced by fourths and fifths, make a distinctive key character when changing key (disregarding the actual change of pitch). I feel that there may be some confusion here between the somewhat bizarre effect experienced when changing key on a badly tuned key board instrument, and the phenomenon known as key colour or character.

The beats heard when sounding a perfect fourth must be quicker than those from a fifth otherwise the object of equal temperament would be lost. If the tuning process is not performed accurately the errors incurred are cumulative, and as such, a large error would be realized at the end of the tuning cycle. In other words, using middle C as a starting point with G above it forming the initial interval (a fifth) the tuner, proceeding through the scale finishes with C and F (a fourth). Obviously any errors "picked up" whilst "laying" the scale would result in a rather gruesome fourth, unless the tuning errors were self cancelling, in which case the scale would be internally distorted (which is equally objectionable). An organ tuner takes considerable care when fine tuning to "prove" each note of a stop by sounding alternately the fourth, fifth, and octave below the note. On a powerful stop the beats are very prominent and one can compare the beat frequency produced by the fourth with that produced by the fifth. The equally tempered scale must, therefore, be a geometric progression with a common ratio of $^{12}\sqrt{2}$, and to prove it multiply 261 c/s (middle C) by $(^{12}\sqrt{2})^9$ and we get 440 c/s (middle A)!

Axminster, Devon.

B. W. DANIELS

"The Engineer Shortage"

EVER since the shortage of candidates for the profession of engineering aroused comment—for example in the words of your August Editorial: "The root cause of the training problem is that engineering in general does not appear an attractive occupation to boys at school considering their future careers"*—I have been puzzling over it. For when I was a student, more than 40 years ago, the reverse was true. "Pure scientists" were regarded with something approaching pity or contempt, as concerned

* The motivations affecting choice between the "arts" side and the science and technology side in the schools are being studied by the Committee on Manpower Resources for Science and Technology (which includes several representatives of the electronics and electrical industries) and also by a Working Group of the Council for Scientific Policy. In the February 1966 interim report of the last-mentioned Group, "Enquiry into the Flow of Candidates in Science and Technology into Higher Education" (Cmd. 2893, H.M.S.O., 3s) there is an extensive bibliography and a list of research projects under the heading "Factors influencing choice" in the Appendices.—ED.

only with academic abstractions, whereas it was engineering that had the glamour, with its control of power, machines, and especially the mysteries of electricity—all the things to appeal to boys. What has happened to reverse this?

I confess I am not at all sure. One reason given is that schoolmasters—and, even more, schoolmistresses—are predominantly arts biased, and of those who teach science very few have much real knowledge or understanding of engineering. Do school leavers pay so much more regard for their teachers' advice nowadays than they used to? And are their outlooks more bounded by school? I should not have thought so. There are far more sources of information about engineering than there were in 1920.

Do school leavers know about the poor prospects in this country for engineers or even for pure scientists, and choose arts instead? Then surely, if they could so easily be deflected, they would never have made good engineers.

I agree that the introduction of "Chartered Engineer" cuts little ice; any corporate member of the I.E.E. has been entitled for many years past to call himself a Chartered Electrical Engineer if he wanted to.

There does seem to be a stronger case for supposing that there is general ignorance in this country of what engineering is; it seems to be almost a matter for pride among the classical scholars of the establishment. This would explain the attitude of business leaders you describe, and journalists and broadcasters habitually giving credit for engineering accomplishments to "scientists" rather than to engineers. The latter have thereby become associated in the public mind with strikes, wage claims and left-wing politics. This is presumably why, when someone wants to introduce me favourably he usually describes me as a scientist, using the word no doubt as a euphemism to spare me (wholly imaginary) embarrassment.

Is there a cure? No short cut, it would seem. But the process of enlightenment could be accelerated if influential engineers with some gift for modern means of education felt the need sufficiently to devote time and effort to it. The presentation of the case *must* be authentic in every detail, with no flavour of cheap publicity or "talking down." The I.E.E. film "The Inquiring Mind" was good. But there needs to be much more.

Bromley, Kent.

M. G. SCROGGIE

Constant Current Circuit

CONGRATULATIONS to Mr. G. Watson on an ingenious and useful constant current supply (August issue). There is a scarcity of published information on such circuits, the only one I can recall being by the same author in *Electronics*, July 6, 1962, p.50.

An alternative approach to the problem is to use

LOUDSPEAKER ENCLOSURES

Dr. A. R. Bailey is unable to supply any more long-fibre wool to readers building the loud-speaker enclosure he described in the October, 1965, issue. He says "bonded acetate fibre wadding or fibreglass seem to be the most readily available substitutes. One correspondent has tried wood-wool with success but I have not tried all the alternatives that have been suggested".

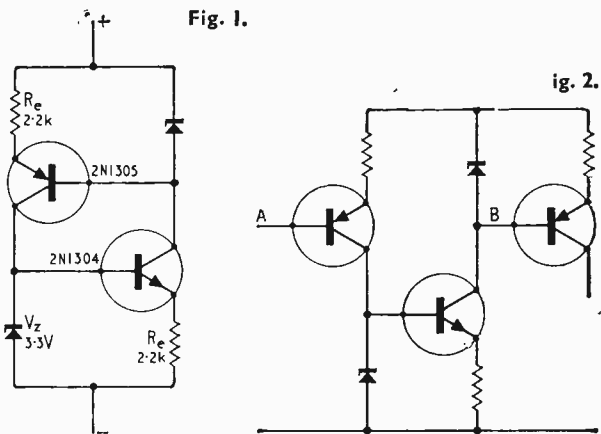

positive feedback in a complementary circuit (Fig. 1). It is fascinating to note the different ways in which circuit designers describe this arrangement when first encountering it. To a "digital" man it is a "complementary bistable with catching Zeners" while an "analogue" man will be more likely to see it simplified as in Fig. 2.

This is how I found the circuit when trying to produce a Zener reference of extreme stability. In an alternating series of constant current and constant voltage sources, each one biases the following so that each is working under conditions progressively approaching the ideal. Breaking at points A, B and joining these gives Fig. 1.

The total current for the symmetrical case is approximately

$$2 \frac{V_z - V_{be}}{R_e}$$

and temperature stability approaches the ideal when

$$\frac{dV_z}{dT} = \frac{dV_{be}}{dT}$$

As a bistable the circuit can rest in the offset though leakage currents normally ensure switch on. Alternatively a high resistance between the bases provides a starting current. Typical values for low currents are indicated on Fig. 1, but variations on this theme have provided the writer with currents from microamps to amps.

Paisley College of
Technology,
Renfrewshire.

PETER WILLIAMS

Colour Television

I FEEL I must answer the immoderately phrased and biased comment re BBC-2 from Mr. Cox in the July issue.

I am told by a large dealer that "at least" 5% have now got u.h.f. television receivers and that it is just a matter of waiting for receivers to wear out before the audience will "leap."

It has been quoted in the American press that the number of viewers of colour television "does not exceed 10%". Is 5% after a few months a flop, but 10% after 10-odd years a success?

Come now, Mr. Cox. Do you really imagine people are going to queue up for colour sets, even if it is sent out on all channels? Although I am a regular viewer of BBC-2, the prospect of being able to convert to colour at the price of a mini-car does not attract me!

Peacehaven, Sussex.

RONALD G. YOUNG

"The Diode-transistor Pump"

I WAS surprised to read in the article "The Diode-transistor Pump" by D. E. O'N. Waddington (*W.W.*, July, '66) that the simple pump frequency discriminator when applied to transistor circuits cannot give a sufficiently linear output and I wonder whether the reason for this pessimistic view might lie in the author's approach to the subject. Having first described the pump integrator, the author considers the case when a resistor is connected across the integrating capacitor (Fig. 1) and then quotes

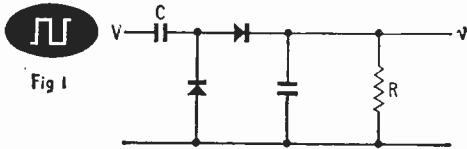

the characteristic of the frequency-to-voltage converter so formed:

$$v = \frac{VCR}{T \left[1 + \frac{CR}{T} \right]}$$

This expression shows that the output per volt of input step is very nearly equal to the fractional deviation from linearity and the designer must therefore trade one attribute for the other on these terms or resort to one of the additional linearizing devices described by Mr. Waddington. Incidentally, I was sorry to see the author drop the first of these devices, the emitter-follower bootstrap, in favour of the less elegant isolating amplifier. However, there is no real need to bootstrap or isolate the integrating capacitor since the need for this component does not arise.

Surely the best approach to design stems from the basic requirement to sense the mean level of a train of

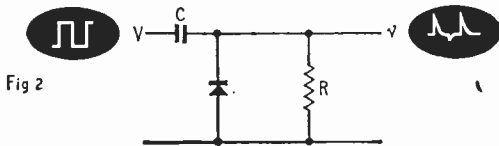

constant area pulses. A good starting point is the differentiator and clamp (Fig. 2). The mean output is:

$$v = \frac{VCR}{T} \left[1 - e^{-\frac{T}{2CR}} \right]$$

The second term in the bracket is the fractional deviation from linearity due to tail clipping and the ratio $\frac{T}{CR}$ must therefore be chosen to suit the application. Output has to be traded for linearity, as before, but a good compromise is now easier to achieve. Several published designs apply the basic principle.^{1,2,3}

Although the simple discriminator just described will give good linearity at an output adequate for most applications, a no-compromise solution can be achieved by generating a pulse whose area is absolutely independent of signal frequency. A trigger pulse derived from the limiter can be used to drive a waveform generator of the monostable class to give a train of rectangular pulses at the output. Such discriminators have been built^{2,4} but I would question whether the increased complexity is worth while.

A much simpler constant-area generator has been

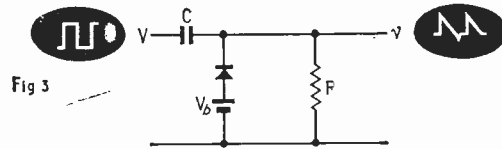

developed by returning the anode of the differentiator clamp to a positive bias V_b (Fig. 3). The exponential tail of the output pulse being caught at V_b is thereby terminated at a point in time independent of signal period. The mean output is:

$$v = \frac{VCR}{T} \left[1 - e^{-1} \left(1 + \frac{V_b}{V} \right) \right]$$

Putting $\frac{V_b}{V} = e^{-1}$, $\bar{v} \approx 0.42 \frac{VCR}{T}$ where the limiting value for $\frac{CR}{T}$ is 0.5 (assuming unity mark-space ratio). As V_b

is increased, the waveform approaches a linear sawtooth and the output at top frequency becomes $\bar{v} = 0.25V$ (very nearly). The technique has been applied to both f.m. receiver and frequency meter applications with perfectly satisfactory results.

I hope this brief account might help a little to restore the reputation of this thing they call a pump (but which neither integrates nor counts) and I wonder whether dropping the jargon might help the pulse-rate discriminator student even more.

Lee-on-the-Solent, Hants.

A. S. CHESTER

1. Scroggie, "Unconventional F.M. Receiver," *W.W.*, April and May, 1956.
2. Baxendall, correspondence, *W.W.*, September & November, 1964.
3. "Wireless World Audio Signal Generator," *W.W.*, November, 1963.
4. "Wireless World Transistor F.M. Tuner," *W.W.*, July, 1964.

HAVING read Mr. Waddington's article with great interest, I feel that I ought to make some comments on the subject, as I (independently) developed a similar circuit in 1965. The development resulted in the circuit in Fig. 1. The first attempt was to use it for adding successive amplitudes of a semi-periodic voltage (Fig. 2), but I also realized its usefulness as a staircase generator or a frequency divider (Fig. 3). In Fig. 1 the circuit is shown as a frequency divider with a unijunction transistor. As I worked with small pulses and a division by about 20, stabilization of the triggering of transistor Tr2 was found necessary. This is made with the capacitor C_1 , driving the first base of Tr2 opposite to its emitter voltage for

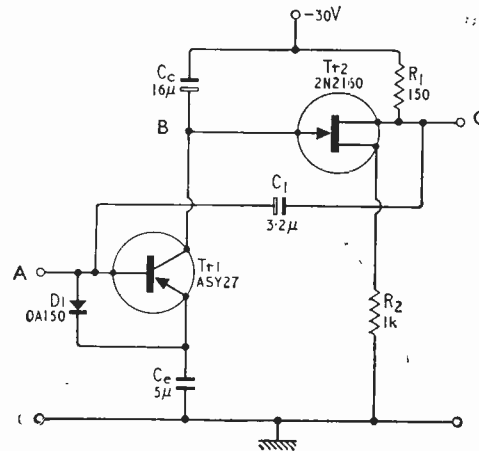

Fig. 1.

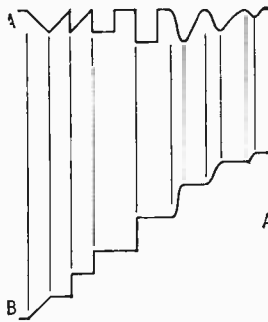

Fig. 2. Circuit adding successive amplitudes.

Fig. 3. Circuit used as staircase generator or frequency divider.

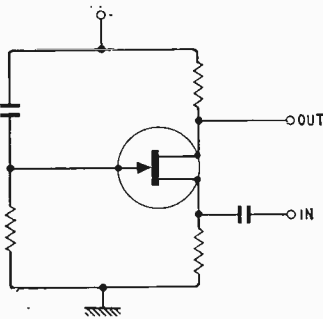
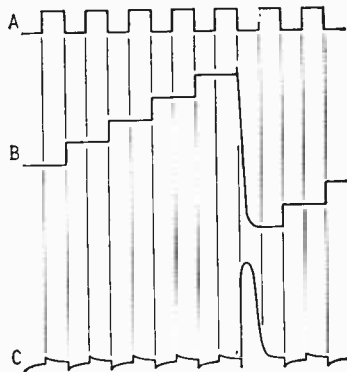

FIG. 4.

each input pulse. Careful design, increased swing in the voltage at point B (determined by the unijunction circuit) and some kind of temperature stabilization would probably allow a stable division by about 30. However, the unijunction transistor frequency divider in Fig. 4 shows, experimentally, a better stability.

JAN-ERIK SIGDELL

Division of Applied Electronics,
Chalmers University of Technology,
Gothenburg, Sweden.

MAY I make the following observations on the interesting article on diode pump circuits by Mr. D. E. O'N. Waddington in your July issue. Fig. 1 reproduces the simple diode pump circuit, which is the starting point of Mr. Waddington's article.

After every "switch on," the voltage step available to charge the capacitors is not V as stated by Mr. Waddington but $V - V_{D1} - V_{D2}$ where V_D is the forward voltage drop of the diodes. This is also true of the two modified circuits described by Mr. Waddington. In the circuit above capacitor C_2 charges asymptotically to $V - V_{D1} - V_{D2}$ and not to V . And since V_D changes with temperature, the operation of the circuit is somewhat temperature dependent unless V is much larger than $V_{D1} + V_{D2}$ (which is not always easy to achieve).

Fig. 2 shows a slightly modified circuit, which uses an additional supply rail but largely overcomes the temperature dependence of Fig. 1. The voltage step

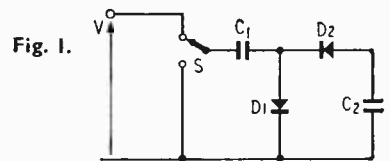

Fig. 1.

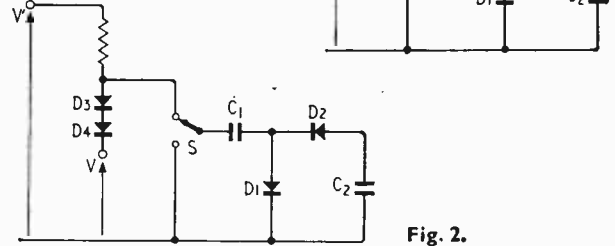

Fig. 2.

now available is $V - V_{D1} - V_{D2} + V_{D3} + V_{D4}$. Even if the actual forward drops of the diodes do not exactly cancel out, their variations due to temperature nearly do.

I have found in practice, using silicon planar diodes, that the forward voltage drops of D3 and D4 almost perfectly compensate for the forward drops of D1 and D2.

Basildon, Essex.

S. GHOSH

The author replies:—

I am sorry that my article caused Mr. Chester pain, particularly as the offending sentence contained a misprint. The second sentence originally read, "With thermionic valve circuits it has, generally speaking, proved adequate but with the lower supply voltages usual with transistor circuits, it no longer supplies a sufficient linear output." Thus, Mr. Chester is perfectly correct in his contention that the diode pump can provide a very linear output provided that the output is limited to less than 1/10th of the input pulse amplitude. However, with the diode-transistor pump described, the interdependence of the input and output amplitudes is no longer a restriction and it is possible, by suitable design, to obtain a greater output voltage than the input pulse amplitude and still to maintain linearity.

As Mr. Sigdell's letter is concerned mainly with an extension of the technique which I suggested using the unijunction transistor, no comment is necessary. However, the use of forward feed to make the trigger action more positive is interesting.

Regarding Mr. Ghosh's observations, in order to keep the analysis of the action of the circuit simple, I omitted the forward voltage drop of the diodes as, indeed, in Fig. 3 I omitted the effect of beta and in Fig. 4 the effect of alpha. In most applications the temperature dependence of the circuit is not important as the variation in diode voltage is only 2mV/°C. However, Mr. Ghosh's solution to the temperature problem is well worth remembering.

The input waveform in Fig. 8 was inadvertently shown as having half the correct frequency. It should be as shown below.

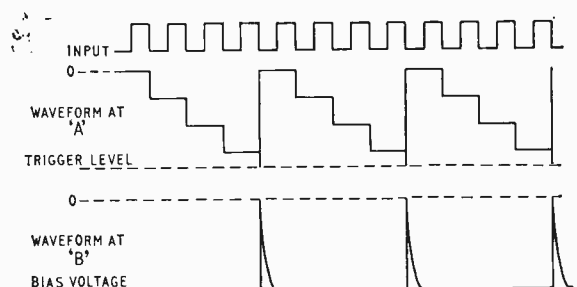

NEWS FROM INDUSTRY

EUROPEAN SATELLITE TEAM

A fresh European approach to space development has been initiated by **Elliott-Automation**. This company, which already has specialist experience in space technology, has organized a group of advanced and experienced European space research companies, into an association known as **European Satellite Team (EST)**. Elliott-Automation, the *Compagnie Francaise Thomson-Houston* in France, *Fokker* in the Netherlands, *Allmänna Svenska Elektriska AB* of Sweden, and the Italian company *Fabbrica Italiana Apparecchi Radio*, will form a consortium capable of designing and producing complete satellite systems, while the **General Electric Co. of U.S.A.** will act as the team's consultant. EST is to tender for the design and construction of the TD-1 and TD-2 pair of satellites which are to be launched from California in 1969 and 1970 for ESRO, by the National Aeronautics and Space Administration.

Should the tenders be accepted, Elliott-Automation will manage the overall project, and provide spacecraft attitude control. Fokker will be responsible for spacecraft structure and thermal control, C.F.T.H. will develop the telecommunication equipment, A.S.E.A. will provide ground support, and on-board logic equipment, and F.I.A.R. will produce the power supplies.

NEW OIL PORT PROJECT

Two British companies have been awarded contracts in connection with the Iranian Oil Companies' new project, which is concerned with the development, and re-equipping of Bandar Mah-Shahr, an oil port capable of accepting much larger tankers than Abadan can accommodate. **G.E.C. (Telecommunications) Ltd.** have received contracts worth over £216,000 for communications equipment. The main contract is for a microwave link between Abadan refinery and Bandar Mah-Shahr which will be constructed to augment the present 60 mile communications system. The 7,000 Mc/s radio and carrier equipment will have a capacity of 120 channels, and will handle teleprinter, telemetry alarm, and petroleum instrumentation signals. A repeater station will be established at Khor Dorag. They are also to supply and install telephone equipment. The second British company, **S.T.C. Ltd.**, have gained contracts worth £500,000 for control equipment. As the main contractors they will supply through their **Integrated Electronic Systems Division**, the **Selectronic** system. This will control the refined products pipe-line linking Bandar Mah-

Shahr with Abadan, the storage facilities and the tanker loading complex. **Selectronic** is a time-division multiplex control and indication system in which a control station will send out digital "messages" in a pre-set sequence, and any one of a number of out-stations that are in the system, will send back information requested if its "address" is included in the "message."

The information (or measurements in this case) are converted to digital form at the out-station, then decoded at the control station, and displayed in the form required on control panel instruments.

The **Plessey Company** are discontinuing the production of domestic receivers which for many years they have undertaken for a number of organizations primarily the **Co-operative Wholesale Society**. In future the Co-op range of Defiant television and sound radio receivers is being produced by **Rank-Bush-Murphy**. It is understood the Co-op still has a very close technical liaison with the Plessey organization.

Engineering Capacity Exchange is a central service for companies with spare production capacity for components or sub-assemblies. Location and reports on new sources of supply of components will also be provided on request. Data and information is stored in a punched card memory system operated by the Exchange at 31 Queen Anne's Gate, London, S.W.1.

Radford audio products are now available to the trade through **A. C. Farnell Ltd.**, 81, Kirkstall Road, Leeds, and **Lugton & Co. Ltd.**, P.O. Box 44, 209-211, Tottenham Court Road, London, W.1. Direct dealer sales have been discontinued.

High speed core stores tested with nanosecond pulses. A system designed by E. H. Research Laboratories, U.S.A., is shown being demonstrated at a recent seminar organized by Livingston Laboratories Ltd.

Western Union, of U.S.A., have agreed to purchase £260,000 worth of facsimile equipment from **Muirhead Instruments Inc.** (American subsidiary of **Muirhead & Co. Ltd.**, of Kent), and they will also act as marketing and service agent for Muirhead. United States police are testing Muirhead facsimile equipment for the transmission of fingerprints.

\$2 M worth of orders for public address systems, microphones, amplifiers, portable electronic organs and electric guitars have been obtained by **Jennings Musical Industries** at the American Music Trades Exhibition in Chicago. This equipment will be manufactured and distributed in the U.S.A. by the **Thomas Organ Company**, with whom Jennings have a reciprocal agency arrangement.

Pye Printed Motors Ltd., are to concentrate their manufacturing, sales, and development activities at the new address of Upper Street, Fleet, Hants. At the same time the company will operate under the new name of **Printed Motors Ltd.**

KPE Controls Ltd.—This is the new name for **Kent Precision Electronics Ltd.**, manufacturers of solid state industrial control instrumentation. As well as stating clearly the field of operations for this company, the new name is intended to eliminate any confusion that might arise in relation to the **George Kent Group**, with which there is no connection.

A. W. Hayden Company have appointed **Impez Electrical Ltd.**, Market Road, Richmond, Surrey, as sole U.K. agents for their products, which include precision timing motors, control devices and automatic test equipment, for military, aviation and specialist industrial applications.

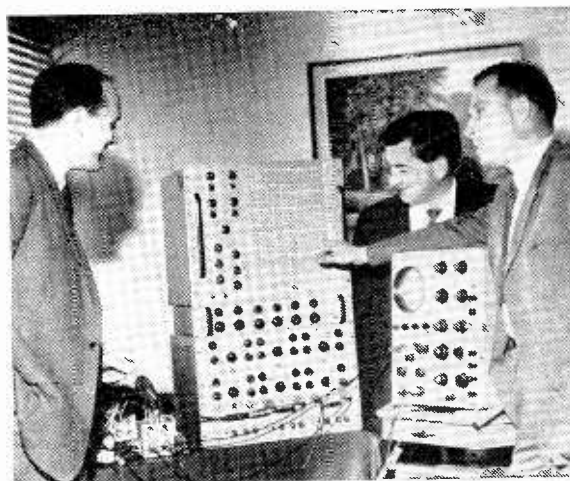

PERSONALITIES

J. N. Aldington, B.Sc., Ph.D., M.I.E.E., a vice-chairman of Associated Electrical Industries Ltd., has been elected president of the Telecommunication Engineering and Manufacturing Association in



Dr. J. N. Aldington

succession to **John Clarke**, of Plessey. Dr. Aldington joined Siemens Electric Lamps and Supplies Ltd. in 1923. He was appointed head of laboratories in 1935 and director of research in 1948. In 1955 he was appointed managing director of Siemens Bros. & Co. Ltd., and eight years later became managing director of A.E.I. the parent company. Among the companies of which Dr. Aldington is chairman is Seastation Telecommunications Ltd. set up to pioneer the establishment of floating radio communication stations.

A. C. Bentley, secretary of the British Radio & Electronic Component Manufacturers' Federation has been elected vice-president of the Committee of European Associations of Manufacturers of Passive Electronic Components (C.E.T.E.C.) from next January. This international organization, set up over 18 months ago, consists of representatives from industrial associations in Belgium, France, West Germany, Italy, the Netherlands and the U.K.

A. F. G. Sharples has been appointed general manager of Electroprints Ltd., and has relinquished his responsibilities for technical-commercial matters with the associated company Painton & Company Ltd. Electroprints Ltd. specialize in the development and manufacture of flexible printed wiring.

F. Walker, B.Sc., Ph.D., A.M.I.E.E., is to be professor of control engineering at the Bradford Institute of Technology which is to be given university status. Dr. Walker is at present a senior lecturer in the Electrical Engineering Department of the University of Manchester Institute of Science and Technology.

Since the death of Dr Ernst Metzler of Switzerland in 1963, the post of director of the International Radio Consultative Committee (C.C.I.R.) of the International Telecommunication Union has been filled *ad interim* by **Leslie W. Hayes** formerly vice-director. Mr. Hayes, formerly on the engineering staff of the B.B.C., is retiring having been with the C.C.I.R. secretariat for 17 years. The new director is to be **Jack W. Herbstreit**, deputy director of the U.S. Institute for Telecommunications, Sciences and Aeronomy. Born in Cincinnati, Ohio, in 1917, Mr. Herbstreit graduated with a professional electrical engineering degree at the University of Cincinnati in 1939. The following year he joined the Federal Communications Commission. In 1942 he joined the Operational Research Staff in the Office of the Chief Signal Officer, Department of the Army. While with this group, he made numerous operational radio systems studies, including measurements of atmospheric noise levels and the attenuation of radio signals by jungles and measurements and analyses of experimental low-frequency LORAN in the Western Hemisphere. In 1946, Mr. Herbstreit joined the Central Radio Propagation Laboratory of the National Bureau of Standards as a radio engineer. In 1963 he was appointed assistant chief of C.R.P.L. which became the Institute for Telecommunication Sciences and Aeronomy of which Mr. Herbstreit became deputy director.

T. C. B. Talbot, who recently joined Advance Controls Ltd., of Cheltenham, a subsidiary of Advance Electronics, as general manager, has been appointed to the board of the company. Mr. Talbot, who is 44, served as a Flight Lieutenant in the Technical (Signals Radar) Branch of the R.A.F. during the war. He subsequently joined Wayne Kerr and in 1951 went to Bush Radio (now Rank-Bush-Murphy). For three years before joining Advance Controls, he was product group manager with Rank Nucleonics and Controls.



T. C. B. Talbot

Several appointments are announced in the marketing department of Consolidated Electrodynamics Division of Bell & Howell Ltd. including **R. K. Nott**, a specialist sales engineer with the Company since early 1962, who is to fill the newly-created post of field sales manager. **P. J. Follett, Grad.I.Mech.E.**, who was a senior product engineer with Sperry Gyroscope Company joins the Company as applications engineer, transducer products. **B. Wright** has become specialist sales engineer for vacuum products and **R. A. Roberts** has been appointed specialist sales engineer for datatape products. Mr. Roberts was previously product sales manager with Epsylon Industries Ltd.

N. F. Durrant, B.Sc., until recently technical manager (silicon devices) of Semiconductors Ltd., has joined Hughes International (U.K.) Ltd. as technical



N. F. Durrant

manager of the Glenrothes, Fife, plant. Mr. Durrant was at one time a research physicist with the Plessey Company.

P. Scargill, A.M.I.E.R.E., has joined Union Carbide Ltd. as sales manager for capacitors and semiconductors. He has been in the electronics industry for seven years—latterly with Hughes International (U.K.) Ltd. **R. M. Kilvington** is appointed by Union Carbide sales manager for special products (which include laser equipment and crystals). Mr. Kilvington has been with the company for four years latterly as product manager (crystal products).

W. G. Patterson, M.B.E., divisional director and general manager of A.E.I. Telecommunications Division, has retired. He joined Siemens Brothers (now part of A.E.I.) in 1917 and became deputy general works manager in 1947. He was appointed to the board of A.E.I. in 1958 and was chairman of the Telecommunication Engineering and Manufacturing Association for 1962-3.

Lt.-Col. F. R. Hornby, O.B.E., who since retiring from Royal Signals has been technical director of the Government Communications Centre, Wolverton, Bucks, has retired on reaching the age of 60. Before the war Colonel Hornby was with the Philco organization.

W. L. Brown, who has been with the Derritron Group since 1961, has been appointed sales manager of the Domestic Divisions of the Group, covering products manufactured by Derritron Radio Ltd. and Reslosound Ltd.

E. H. Poulter has joined Van Der Molen Ltd., the Romford manufacturers of tape recording equipment, as chief engineer. He was previously with Elizabethan, Magnavox, Plessey and Philco.

Eric Marland, M.I.E.E., commercial director of the Telegraph Condenser Company since 1963, has joined A. H. Hunt (Capacitors) Ltd. as marketing director. After studying at Oldham Technical College, Mr. Marland, who is 44, received his technical training with the M-O Valve Company. From 1952 until he joined T.C.C. in 1962 he was divisional manager with the Plessey Company.

B. R. Sankey, A.M.I.E.E., managing director of the London-based International General Electric Company of New York Ltd. for the past 15 years, has retired. London born, he served his apprenticeship with B.T.H. in Rugby and went to South Africa where his father was chief engineer of the city of Johannesburg. Mr. Sankey joined the parent company, General Electric

Company of the U.S.A., in Schenectady in 1925. He returned to London in 1928, where except for two terms of duty in India and war service as a squadron leader in the Technical Branch of the R.A.F., he has served the company ever since.

Dr. E. T. Hall, director of the Research Laboratory for Archaeology and History of Art, Oxford, has received £5,200 from the Paul Instrument Fund of the Royal Society, for the construction of seaborne sonar position-fixing apparatus capable of fixing a boat's position relative to two anchored buoys to an accuracy of about two yards in a mile. Dr. Hall is also granted £1,220 for the construction of two instruments based on the detection of the eddy currents induced in a metal object when an applied magnetic field is sharply cut off.

SEPTEMBER CONFERENCES, SYMPOSIA AND EXHIBITIONS

Further details are available from addresses in parentheses

- LONDON**
Sept. 19-21 Chelsea Col. of Science
Instrumental Optics & Optical Design
(Inst. Phys. & Phys. Soc., 47 Belgrave Sq., London, S.W.1)
Sept. 26-28 I.E.E., Savoy Place
Advances in Electron Microscopy
(Inst. Phys. & Phys. Soc., 47 Belgrave Sq., London, S.W.1)
- BRIGHTON**
Sept. 8-10 The University
Examinations
(I.E.E., Savoy Pl., London, W.C.2)
Sept. 20-22 Hotel Metropole
Power Sources Symposium
(Symposium Committee, P.O. Box 136, Croydon, Surrey)
- CAMBRIDGE**
Sept. 12-16 The University
Microwave & Optical Generation & Amplification
(I.E.E., Savoy Pl., London, W.C.2)
- DURHAM**
Sept. 5-7 The University
Rare-Earths
(Inst. Phys. & Phys. Soc., 47 Belgrave Sq., London, S.W.1)
- FARNBOROUGH**
Sept. 5-11
S.B.A.C. Flying Display & Exhibition
(Society of British Aerospace Companies, 29 King St., St. James's, London, S.W.1)
- GLASGOW**
Sept. 21-23 The University
Nuclear and Particle Physics
(Inst. Phys. & Phys. Soc., 47 Belgrave Sq., London, S.W.1)
- HARWELL**
Sept. 28-30 A.E.R.E.
Isotopic Power Generators
(Postgraduate Education Centre, Building 455, A.E.R.E., Harwell, Didcot, Berks.)
- MANCHESTER**
Sept. 26-29 Col. of Science & Technology
Integrated Process Control Applications in Industry
(I.E.E., Savoy Pl., London, W.C.2)
Sept. 27-Oct. 1 Belle Vue
Electronics Exhibition and Convention
(Institution of Electronics, 78 Shaw Rd., Rochdale, Lancs.)
- NEWCASTLE-UPON-TYNE**
Sept. 13-15 The University
Electrical Networks
(Ministry of Technology, Wellbar House, Gallowgate, Newcastle-upon-Tyne 1)
- NOTTINGHAM**
Aug. 31-Sept. 7 The University
British Association Annual Meeting
(British Assoc. for the Advancement of Science, 3 Sanctuary Bldgs., Gt. Smith St., London, S.W.1)
- SOUTHAMPTON**
Sept. 12-15 The University
Electronic Engineering in Oceanography
(I.E.R.E., 8/9 Bedford Sq., London, W.C.1)
Sept. 19-22 The University
Electronic Engineering in Oceanography
(I.E.R.E., 8/9 Bedford Sq., London, W.C.1)
- SWANSEA**
Sept. 21-23 University College
Physics of Semiconducting Compounds
(Inst. Phys. & Phys. Soc., 47 Belgrave Sq., London, S.W.1)
- YORK**
Sept. 28-30 The University
Energy Beams and their Uses
(Inst. Phys. & Phys. Soc., 47 Belgrave Sq., London, S.W.1)
- ABROAD**
Sept. 16-18 Knokke
International Amateur Radio Conference
(Secretariat, 284 Lippenslaan, Knokke-Zoute, Belgium)
Sept. 20-22 New York City
Tube Techniques
(R. J. Bondley, General Electric Co., Schenectady, N.Y.)
Sept. 22-24 Washington
Broadcast Symposium
(I.E.E.E., 345 East 47th St., N.Y. 10017)
Sept. 23-24 Iowa
Communication Symposium
(I.E.E.E., 345 East 47th St., N.Y. 10017)

A Simple Sine-square Converter and Sync Amplifier

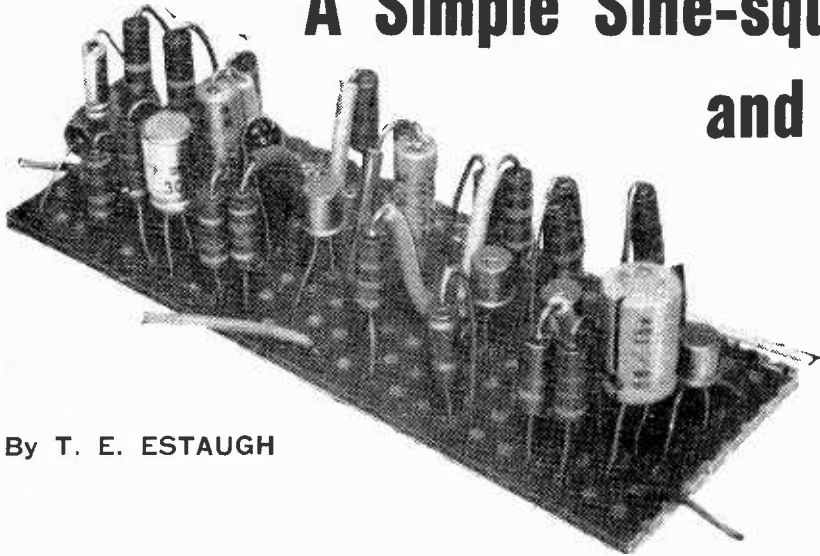

AN ADD-ON UNIT FOR
SINE WAVE GENERATORS
AND OSCILLOSCOPES

By T. E. ESTAUGH

FOR testing the performance of high quality audio and wide band amplifiers, a square wave generator can be considered as essential. Unfortunately, many audio generators in use by amateurs do not have provision for a square wave output, and the expense of an additional sine-square generator is not fully justified. This snag can be overcome by feeding the output of a conventional sine wave generator through a square wave converter, and the unit that forms the basis of this article is designed for this purpose.

The unit employs a total of five transistors, and gives a rectangular output with a very short rise time (about 300 ns) irrespective of the form of the input signal, and this facility makes the circuit suitable for use in many applications. Among these is that of a synchronisation amplifier for use with oscilloscopes, many of which suffer from very poor synchronisation when fed with a low frequency non-rectangular input. This snag can be overcome by converting the input signal to a rectangular form with a very short rise time, and feeding the resulting

signal to the external sync socket. In this case, of course, the sync converter should have a very high input impedance, so that it does not appreciably load the input signal, and this unit is ideal for this purpose, since it has an input impedance of approximately 800 k Ω .

Although a total of five transistors are used in the prototype, these can be reduced to three if the unit is to be used purely as a square wave converter in conjunction with a sine wave generator. The circuit is sufficiently versatile to be run from any supply voltage within the limits of 4.5-18V, without any changes in component values.

Circuit description

The full circuit diagram of the unit is shown in Fig. 1. In essence, the unit consists of four sections, the first of these being an impedance converter, Tr1, which gives a high input impedance. The output of this section is fed to an amplifier, Tr2, and on to the third stage, the

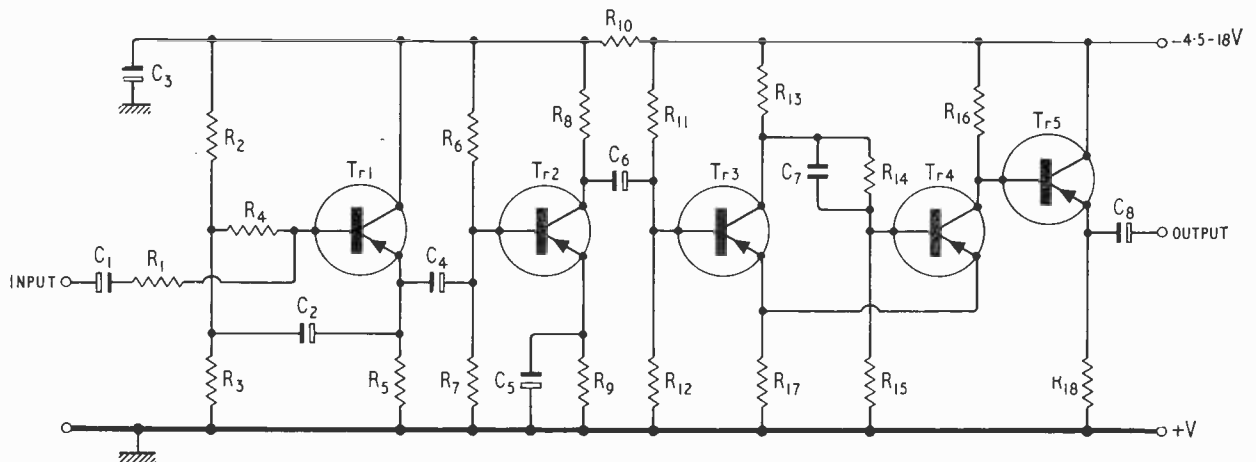

Fig. 1. Complete circuit of the sine to square wave converter and sync amplifier. For use as a square wave converter only, the circuitry around Tr1 and Tr2 may be omitted.

LIST OF COMPONENTS IN FIG. 1

Resistors		Capacitors	
R ₁	100 kΩ	C ₁	1μF 15V.
R ₂	47 kΩ	C ₂	16μF 15V.
R ₃	47 kΩ	C ₃	50μF 25V.
R ₄	100 kΩ	C ₄	16μF 15V.
R ₅	5.6 kΩ	C ₅	30μF 6V.
R ₆	33 kΩ	C ₆	16μF 15V.
R ₇	4.7 kΩ	C ₇	180pF silvered mica
R ₈	2.2 kΩ	C ₈	50μF 25V.
R ₉	470 Ω	All sub-miniature electrolytic types (except C ₇)	
R ₁₀	470 Ω	Transistors	
R ₁₁	47 kΩ	Tr1	2G414, 2G415, 2G416, 2G417
R ₁₂	5.6 kΩ	Tr2	
R ₁₃	5.6 kΩ	Tr3	NKT675, NKT676, NKT677, etc.
R ₁₄	27 kΩ	Tr4	
R ₁₅	10 kΩ	Tr5	
R ₁₆	5.6 kΩ		
R ₁₇	180 Ω		
R ₁₈	2.2 kΩ		

All 1/4W, 10% carbon.

squarer, which comprises Tr3 and Tr4. Finally, the rectangular waveform is fed to a second impedance converter, Tr5, which gives a low impedance output.

The input transistor, Tr1, is wired as an emitter follower, with "bootstrapping" applied. A conventional emitter follower, of course, would consist simply of the base-bias network R₂ and R₃ with the junction of these two components being taken to Tr1 base, and emitter load R₅, the resulting circuit giving unity voltage gain and zero phase shift between the input and output and the resulting circuit would give a high input impedance and low output impedance. The drawback with the conventional emitter follower, however, is that the input impedance is limited by the shunting effect of the two base-bias resistors, R₂ and R₃. In the circuit diagram this snag is overcome by interposing an isolating resistor, R₁, between the R₂-R₃ junction and the base of Tr1; the input signal is fed to Tr1 base, and part of the output, which is of the same form as the input, is taken from the emitter and fed, via C₂ to the R₂-R₃ junction, so that similar signals appear at both ends of R₁ and very little a.c. thus flows in this resistor, which therefore appears as a very high impedance to a.c. and effectively reduces the shunting effect of the two base-bias resistors. In the circuit, a limiting resistor, R₁, is in series with the input and prevents excessive input signals from damaging Tr1.

The output of Tr1 is fed to the base of Tr2, a conventional common emitter amplifier with collector load R₈, the amplified output from this stage being passed to the base of Tr3.

Tr3 and Tr4 are wired together as a Schmitt trigger, in which one transistor is biased hard on and the other is biased off, and the state of the circuit can be changed by applying a suitable trigger potential to the input.

Negative inputs do not affect the state of the circuit since Tr3 is hard on. A positive input causes the Schmitt circuit to change state rapidly until the input is reduced sufficiently. It should be noted that the circuit is triggered from one state to another by changes in input potential, and that the switching speeds are completely unaffected by the actual input frequency or waveform. The peak-to-peak amplitude of the rectangular output signal is nearly equal to the supply rail voltage.

C₇, wired across R₁₁, is a "speed-up" capacitor, and enables the circuit to switch from one state to another in the minimum possible time. On the prototype, the circuit is capable of operating at speeds in excess of 300 kc/s, and gives an output with a rise time of a fraction of 1μs.

The output of the Schmitt trigger, taken from Tr4 collector, is directly coupled to the base of Tr5, which is wired as an emitter follower, and the final output, at a low impedance level, is taken via C₈ from Tr5 emitter.

If preferred, C₈ can be emitted from the circuit, and the output can be taken directly from Tr5 emitter. This step would be advisable, for example, if the unit were to be used for testing d.c. amplifiers.

The decoupling network R₁₀-C₃ is inserted in the negative supply line between the Schmitt trigger and the preceding stages to prevent instability when no input signal is applied.

It may be noted that the circuit is so sensitive that, if a few feet of wire are freely connected to the input terminal, with the other end of the wire "floating" in space, the pick-up of signals radiated at mains frequency is sufficient to operate the circuit and give a square wave output at

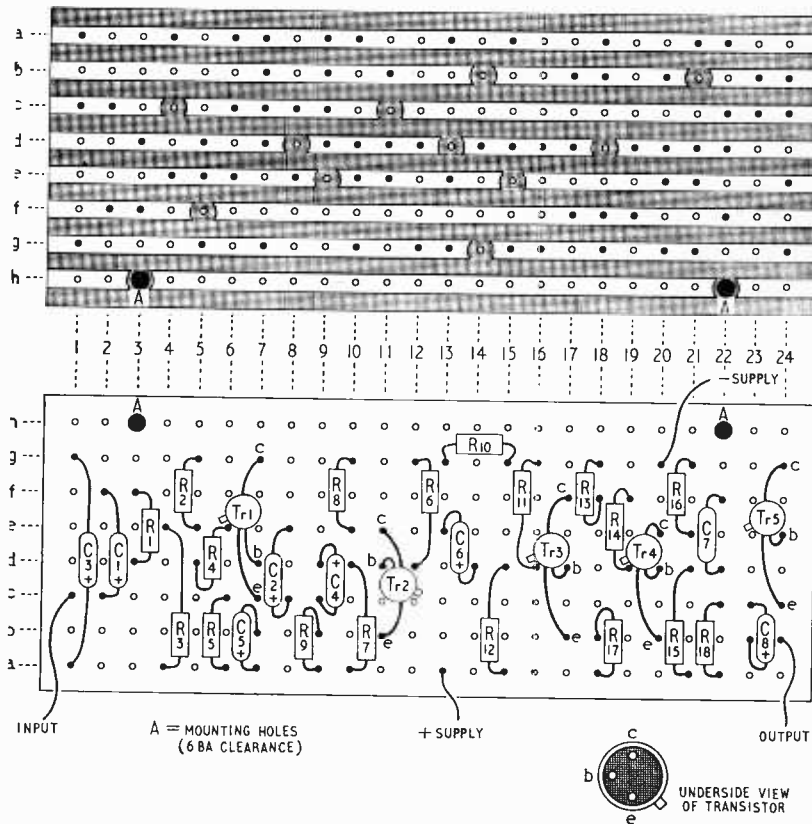

Fig. 2. Cutting details and wiring diagram of the circuit of Fig. 1.

50 c/s. In spite of this high sensitivity, however, the unit is perfectly stable.

Construction

The unit is wired up on a small piece of Veroboard, thus retaining all of the advantages of printed circuit construction while same time involving none of the difficulties of marking out and etching that are associated with normal printed circuit practice. Although the circuit is very compact, the layout is not unduly cramped, since all but one of the components are mounted vertically on the Veroboard panel.

The copper strips on the Veroboard panel should be cut with the aid of a small drill or the special cutting tool that is available, where indicated (Fig. 2). If the finished unit is to be mounted in a case (within a signal generator, for example) drill the two small mounting holes, to clear 6 BA screws, as shown.

The components can now be assembled on the Veroboard panel, as shown in Fig. 2. Construction can be carried out by starting at the left hand side of the panel by wiring in C_1 and C_3 , and then working progressively through the assembly to the right hand side of the panel, marking off each component in the circuit diagram as it is assembled. Note that all components other than C_3 are mounted vertically. Insulated sleeving should be used when there is any danger of components shorting. Note that all the transistors have short leads, and heat shunts must be used when soldering these in place.

When complete, the unit can be tested by connecting the circuit to a low voltage supply, about 4.5 V, providing

a sine wave input to the input terminals and checking that a square wave is available at the output. The input signal may be any frequency up to 300 kc/s with an amplitude between approximately 50 mV and 20 V. If operation is satisfactory, the unit can now be connected to the available voltage supply (up to 18 V).

Using the unit

In the form shown in Fig. 1, the unit has a very high input impedance and is sufficiently sensitive to operate from input signals of the order of tens of millivolts. The amplitude of the output signal is fixed, and corresponds approximately to the magnitude of the supply voltage. The circuit is thus particularly suitable for use as a sync amplifier for use with oscilloscopes, etc., but is in many ways more complex than is strictly necessary for converting the large amplitude output of a sine wave generator into a square wave.

If the unit is to be used purely as a square wave converter with an audio generator, the entire Tr1 and Tr2 sections of the unit can be omitted, and the remaining Tr3, Tr4, and Tr5 sections can be built into the signal generator, the sine wave signal being fed directly to the base of Tr3.

If a square wave output of variable amplitude is required, R_{18} , the emitter load of Tr5, can be replaced by a potentiometer, the output being taken from the slider. If the unit is required to operate at frequencies up to 300 kc/s, this potentiometer should be given a value of 2 k Ω . For operation up to frequencies of only 100 kc/s a 5 k Ω component may be used.

THE APOLLO PROJECT

LAST October Cable & Wireless placed a contract with the Marconi Company for a ground terminal station for installation on Ascension Island (*Wireless World* December 1965 p. 605). The schedule for the station, designed as part of the communications network for the American "man-on-the-moon-by-1970" Apollo project, has been so tight that the computer controlled PERT* system has been used. The equipment passed its proving tests at the Marconi site Rivenhall, Essex, early in July and was despatched on July 23rd on the *S.S. Flute* for delivery to Ascension Island.

The station will operate via the Intelsat II satellite, to be launched this October, and the Andover, Maine, station with the Goddard Space Flight centre in Maryland—the nerve centre of the Apollo project. Final tests were carried out in this country in modified form by tracking the Early Bird satellite: these tests were successfully completed in 40 minutes. It is expected that re-assembly of the station and handover to Cable & Wireless by the Marconi Company will be completed by September 21st.

Just before the station was dismantled, *Wireless World* was invited to the testing site; the station was not operating at the time but this provided an opportunity to examine the equipment and obtain some further details. A Cassegrain aerial system is used and incorporates a parabolic 42 ft diameter dish fitted with a Cassegrain 4 ft hyperbolic sub-reflector which rotates at approximately 1000 rev/min to produce a conical scan; the rotation of the sub-reflector can be varied as dictated by the spin rate of the satellite. A very narrow angle beam width of approximately 24 minutes (at the -3dB points) is obtained and the satellite has only to be 3 minutes of arc off the axis of the beam to cause the

directional system of the aerial to produce a "search" signal which directs the dish so that the axis of the beam is on the satellite. The gain of the polar diagram is 53 dB. Transmitter power is about 15 kW and its operating frequency range is 5.925 to 6.425 Gc/s. The power transmitted from the satellite is some 11 W at a nominal frequency of 4 Gc/s and the signal power received by the ground station is -133 dB relative to 1 W.

Four communication channels are handled by the earth station—two for communication, one for telemetry and "lock-on" facilities and one for interground station control. Each communication channel contains seven telephone channels with bandwidths of 0.3 to 3.1 kc/s. The telemetry facility is used for monitoring the conditions of the satellite and the "lock-on" facility provides directional information allowing the ground station to "follow" the satellite. The fourth channel is for interchange of operational information between the Andover and Ascension stations.

Movement of the aerial is controlled from a nearby "operations room" which is connected to the aerial structure by 150 cables. A 16-bit octal code is used during the organisation of control information for the aerial. This code is used to compress the conventional binary code to shorten the "information time." This digital information is processed by a digital to analogue converter which controls a servo-system for directing the aerial. The aerial, which weighs about 4.5 tons, can be positioned from digital indicators on a control console in the operations room to within ± 20 seconds of arc and can be moved at the rate of 5° per second in azimuth and between 2 to 7° in elevation.

Power supplies and all major elements of both the transmitting system and the receiving system are fully duplicated and changeover can be effected within 0.2s.

* Programme Evaluation and Review Technique.

Multivibrator Design Difficulties

By J. R. CHEW,
B.Sc., A.M.I.E.E.

WHY THE FREQUENCIES AND WAVEFORMS OF MULTIVIBRATORS
DO NOT ALWAYS CONFORM TO DESIGN CALCULATIONS

EVERY electronics student meets the multivibrator somewhere in his practical training and examines with interest the waveforms which it produces. The simple and satisfying explanation of its action usually given by his lecturers should complete the picture. Yet oddly enough, one finds him as a professional engineer, years later, looking puzzled when the frequency produced by a multivibrator turns out to be different from that calculated, and the waveforms not quite in accord with the classical theory.

In this article we shall outline the standard description of multivibrator action, look at some of the reasons for the discrepancies in the performance of the simple multivibrator, and suggest ways in which these discrepancies can be reduced, removed or allowed for. To limit the discussion, all the explanations and diagrams will be given in terms of n-p-n transistors. The corresponding results for p-n-p transistors, and valves where they apply, are self evident.

The basic multivibrator shown in Fig. 1 consists of two

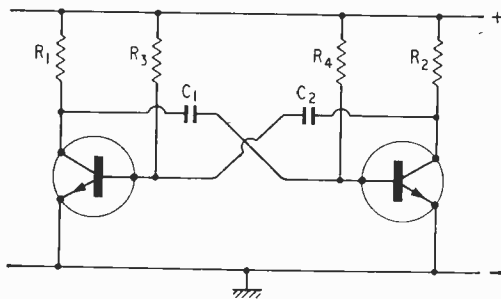

Fig. 1. Basic multivibrator.

common-emitter transistor amplifiers cross-coupled to each other by means of the capacitors C_1 and C_2 . The base return resistors are taken to the positive supply rail. The action of the circuit is, briefly, that instability caused by positive feedback round the closed loop drives each transistor in turn to saturation, simultaneously cutting off the other. The circuit thus has two quasi-stable states. Each quasi-stable state continues until the capacitor connected to the base of the cut-off transistor is discharged by the base return resistor. As the base voltage reaches the turn-on potential the loop gain returns and the feedback rapidly switches the circuit to the other state. The other coupling capacitor is then discharged and the circuit returns to the first state to complete the cycle.

To deal now with some of the less obvious effects, for example, the collector voltage waveform. The recovery of the collector voltage to the supply rail potential, during cut-off of either transistor is never as fast as the fall at the opposite edge of the voltage pulse when the

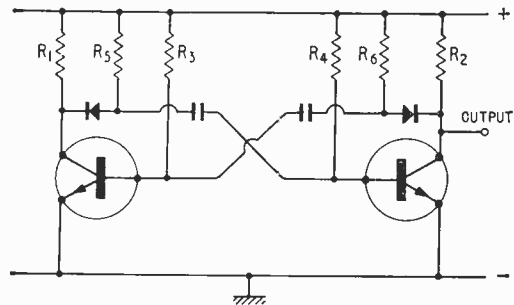

Fig. 2. Waveform correction (first method)

transistor is being bottomed. The slow recovery does not affect the calculated output frequency since the other transistor is switched on at the commencement of the recovery and the operation of the timing circuit triggered at this instant. However, from the point of view of obtaining an accurate rectangular output pulse, the slow return is decidedly embarrassing. The cause of the slow return is not far to seek. The low resistance of the base-emitter diode of the "on" transistor prevents the base voltage rising more than a fraction of a volt positive with respect to the negative rail potential. Thus, even though the other transistor is completely cut off, its collector volts can rise to the positive rail potential only at a rate determined by the time constant of the coupling condenser, and the collector resistor.

Correcting the waveform

Two schemes are in common use for improving the squareness of the collector voltage wave shape. Fig. 2 shows a method by which diodes are used to disconnect the collectors from the timing circuits during recovery so that a good square pulse can be taken from either collector. Fig. 3 shows the alternative method of using

J. R. Chew, who is 39, graduated in electrical engineering at Bristol University in 1948 and the same year joined the B.B.C. He was for a short time in the Designs Department but transferred to the Research Department where he has remained. He has worked mainly on electro-acoustics and the instrumentation associated with electro-acoustic measurement but from 1958 spent two years in the aerial section where he was also concerned with instrumentation.



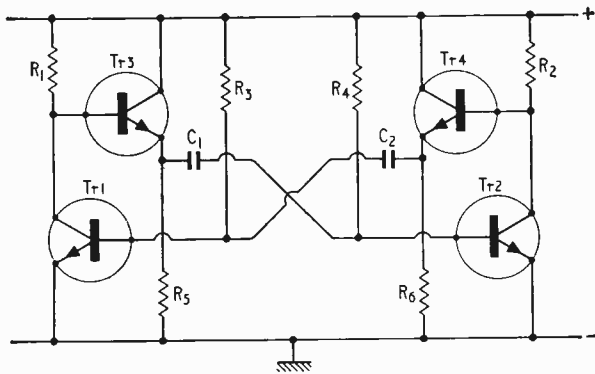

Fig. 3. Waveform correction (second method)

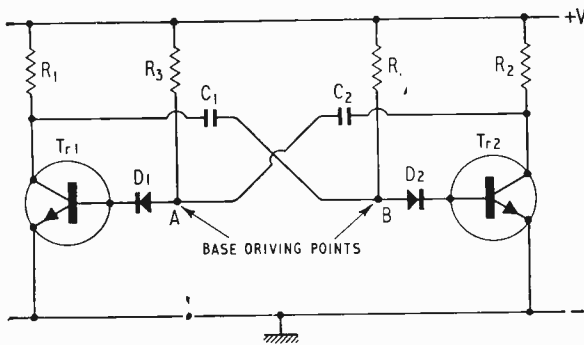

Fig. 4. Correction of frequency with the use of diodes.

emitter followers to charge the coupling capacitors rapidly from a low impedance. It should be noted that the current pulse applied to the timing capacitor in the latter arrangement, say by emitter follower Tr3, has to be accepted by the base of the bottomed transistor Tr2 without damage.

One further point of interest arises in the operation of the emitter follower assisted multivibrator shown in Fig. 3. As illustrated, emitter resistors R_5 and R_6 complete the emitter d.c. return path of Tr3 and Tr4. When Tr1 is bottomed, Tr3 will be cut off but its emitter voltage will not at once return to ground potential. Assuming the cut off to be instantaneous, the emitter voltage will drop to

$$\frac{2VR_5}{R_5 + R_4}$$

where V is the supply voltage

because the charge on C_1 cannot change instantaneously. R_1 and R_5 act as a potentiometer across the supply with the capacitor C_1 (charged initially to voltage V) in the middle, the polarity of the capacitor voltage aiding the supply voltage. The reduced voltage step at the emitter of Tr3 will, of course, be reproduced at the base of Tr2 and the frequency will be altered. The operating frequency will be substantially that of the unassisted multivibrator if R_5 is small compared with R_4 .

Now to turn to an effect which occurs only in transistor multivibrators.

The period of oscillation ' t ' of the simple multivibrator shown in Fig. 1 is, neglecting collector saturation and forward base-emitter voltages

$$t = 0.695 (C_1 R_4 + C_2 R_3)$$

The constant 0.695 results from the fact that each capacitor discharges to half its initial voltage.

$$\text{Hence, } f = \frac{1.44}{(C_1 R_4 + C_2 R_3)}$$

where f is the frequency

of oscillation.

Students' multivibrators constructed in laboratory training periods are often run on low voltage supplies of the order of six volts, and usually give operating frequencies quite close to the calculated values. If, however, a multivibrator such as is shown in Fig. 1 is run at say 40 volts, the operating frequency is usually very much higher than the expected value. This oddity of performance can be explained by considering the changes in various voltages at switch-over. The collector of the "off" transistor just previous to switch-over is at the supply rail voltage. The base of the "on" transistor is at the forward bias voltage of the base-emitter diode, i.e. near earth. The coupling capacitor is charged up to very nearly the full supply voltage. At switch-over the collector of the transistor switching on rapidly descends to earth potential, and because the charge on the coupling capacitor cannot change quickly, the base of the transistor being cut off tends to be driven to a negative potential equal to the positive supply voltage. So far all is in accordance with the simplest theory but here things go wrong. The reverse base voltage which a high voltage transistor will accept is very much less than the maximum collector voltage. The base-emitter diode will normally avalanche at reverse voltages of the order of six volts and clamp the base voltage at this level. At best the timing capacitor starts to discharge from a reverse base voltage of perhaps one sixth of the expected initial voltage. At worst the transistor can be destroyed by the pulse of energy put into the base.

Frequency correction

A simple way of overcoming the avalanche effect of the base-emitter diodes is to disconnect the bases by external diodes when the reverse voltage is applied, as shown in the circuit of Fig. 4. The base driving point voltage waveforms with and without the diodes are shown in Fig. 5.

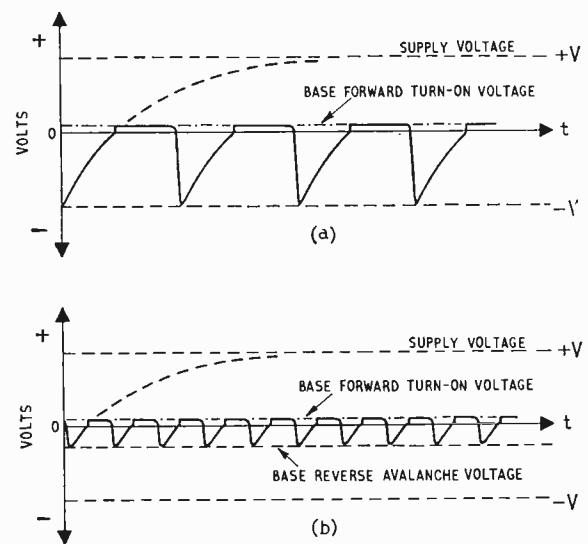

Fig. 5. Base driving point voltage waveforms: (a) with diodes; (b) without diodes.

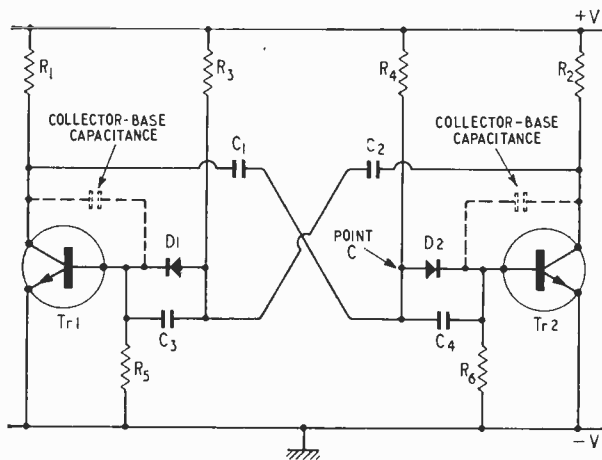

Fig. 6. Improved version of Fig. 4.

Provision of the diodes D_1 and D_2 cause the multivibrator to return to the calculated frequency. There is, however, a very marked slowing down of the rise of collector voltage on switch-off, caused by the transistor collector-to-base capacitance which provides forward current into the base during the rise of collector voltage. This base current prevents the rapid cessation of collector current at the moment when the external diodes go open circuit. The trouble can be remedied by providing in parallel with the external diodes a capacitance a little larger than the collector-base capacitance. The net effect is then to

maintain the base voltage negative with respect to the emitter during the period when the other transistor is switching on and prevent continuation of the collector current beyond the nominal instant of change-over.

Fig. 6 shows the circuit of a multivibrator (similar to that of Fig. 4), in which the capacitors C_3 and C_4 function as described above. The necessity for resistors R_5 and R_6 however, remains to be explained.

With reference to Tr2 in Fig. 6, switch-off occurs when the base driving point "C" suddenly goes to negative volts with respect to the negative rail. The collector voltage of Tr2 simultaneously rises to $+V$. If C_4 is sufficiently large, the capacitance potentiometer formed by C_4 and the collector-base capacitance will maintain the base negative as described above. However, this changeover accomplished, the point "C" then rises in voltage on an exponential curve aimed asymptotically at $+V$. The same capacitive potentiometer, however, with the collector potential fixed, now tends to drive the base of Tr2 positive and if the base were to reach the turn-on voltage, would cause premature switch-over to the Tr2 "on" condition. The presence of R_6 prevents this so long as the time constant of $C_4 R_6$ is sufficiently small with respect to the time constant $C_1 R_1$, to prevent the turn-on voltage of the base being reached.

Many circuits have been published for various configurations of multivibrators utilizing emitter coupling, complementary transistors and other features. In this article only the simple, one might say the original, form of the circuit has been discussed. Other configurations are no less worthy of close scrutiny for unexpected effects.

The author wishes to thank the Director of Engineering of the British Broadcasting Corporation for permission to publish this article.

H. F. PREDICTIONS — SEPTEMBER

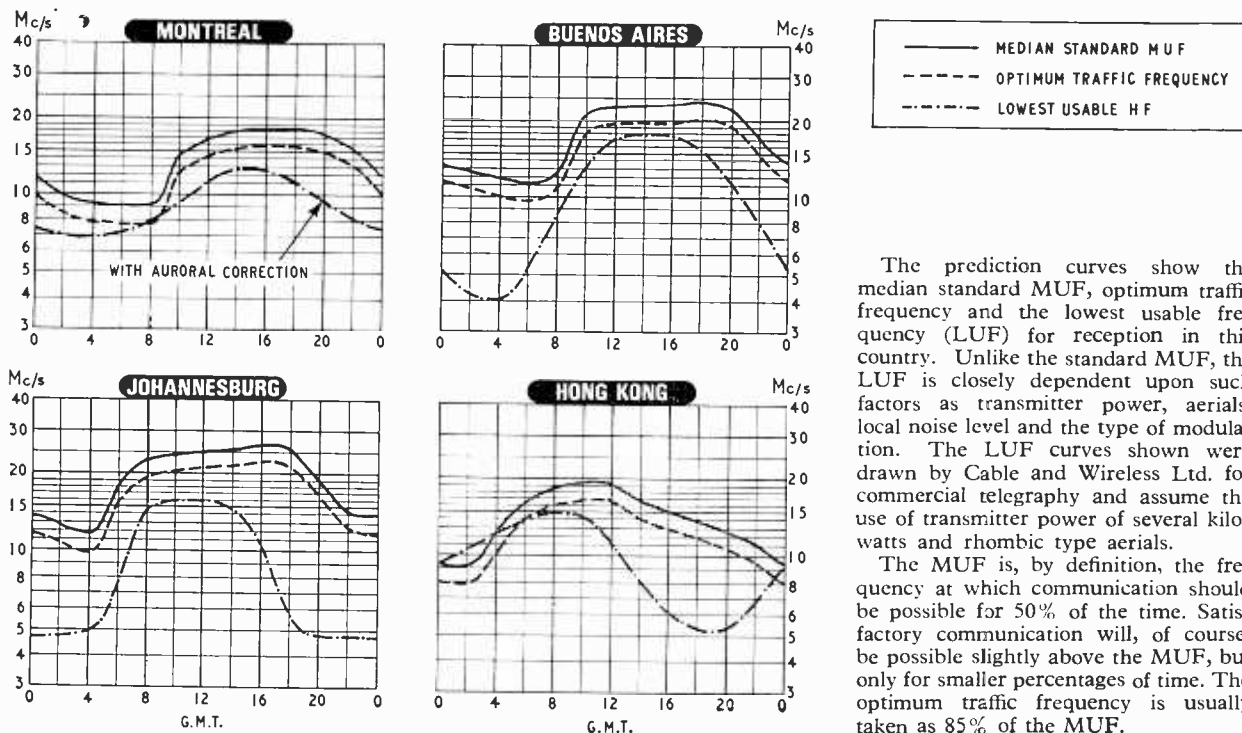

The prediction curves show the median standard MUF, optimum traffic frequency and the lowest usable frequency (LUF) for reception in this country. Unlike the standard MUF, the LUF is closely dependent upon such factors as transmitter power, aerials, local noise level and the type of modulation. The LUF curves shown were drawn by Cable and Wireless Ltd. for commercial telegraphy and assume the use of transmitter power of several kilowatts and rhombic type aerials.

The MUF is, by definition, the frequency at which communication should be possible for 50% of the time. Satisfactory communication will, of course, be possible slightly above the MUF, but only for smaller percentages of time. The optimum traffic frequency is usually taken as 85% of the MUF.

R.F. Diode Changeover Gates

By P. A. SCHAFLE,* Grad. I.E.R.E.

SWITCHING R.F. SIGNALS AT HIGH SPEED

THIS article describes a solid-state, electronically switched diode changeover gate. It was developed to enable 75 Mc/s i.f. signals to be switched in a radar test equipment, but can be used equally as well for any application which requires a low level r.f. signal to be switched at high speed, e.g. a square wave modulator giving no amplitude modulation conversion, an r.f. switch to switch received signals from two aerials to an r.f. amplifier, a low power co-axial relay, etc.

To meet the requirements of the test equipment the following specification was formulated:—

The gate was to be in the form of a single pole double throw switch, which was to have low insertion loss, high isolation between input and output when in the OFF state, a bandwidth of ± 10 Mc/s about a centre frequency of 75 Mc/s and a frequency response flat to within ± 0.1 dB over the stated band.

In *The Bell System Technical Journal*, November 1961, a "T" network diode gate is described. This configuration however has the disadvantage of not presenting a matched impedance in the OFF state. If the gates are to be used in the radar test equipment mentioned above, it is essential that they present a matched impedance in both ON and OFF states, otherwise a standing wave will be present with a resulting deterioration in isolation between input and output in the OFF state.

To meet the above requirements a circuit using a π attenuator network has been evolved. For minimum insertion loss in the attenuator a low value of resistance is required in the series arm.

If a diode is biased by a suitable d.c. voltage to work on a nearly linear portion of its forward characteristic, its a.c. slope resistance $\delta V/\delta I$ will be nearly constant and a small a.c. signal will pass through the diode un-

distorted. Therefore by using a suitably biased diode as the series arm, a low loss attenuator is obtained.

To enable the attenuator to act as a gate, two diodes are placed back to back in the series arm and a voltage is applied at the common point to either forward or reverse bias them. By knowing the combined a.c. slope resistance of the two diodes, it is possible to calculate the values of the two shunt arms to give the desired value of characteristic impedance. (75Ω in the gate described).

When considering the network so far described with the diodes in the reversed bias condition (i.e. with the gate switched OFF) it is seen that the input impedance is no longer matched to the r.f. signal source. By arranging for a third diode to effectively place a resistor in parallel with the input shunt resistor, a matched input condition is obtained.

A further condition to be met is one of high isolation in the OFF state. The circuit evolved so far takes the form of a simple potential divider when in the OFF state. To obtain the high isolation required another diode is connected between the junction of the two series diodes and the common rail. The effect of this can be seen later from Fig. 5b, 5c.

To meet the specification two diode gates (Fig. 1) are connected as shown in (Fig. 2). Therefore an r.f. diode changeover gate comprises two identical diode gates with a common output. This enables a single output shunt resistor to be used, common to both halves of the changeover gate.

* The Marconi Company Ltd., Research Division.

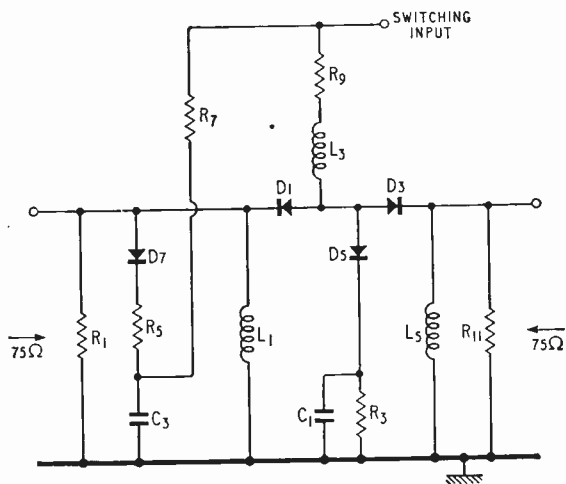
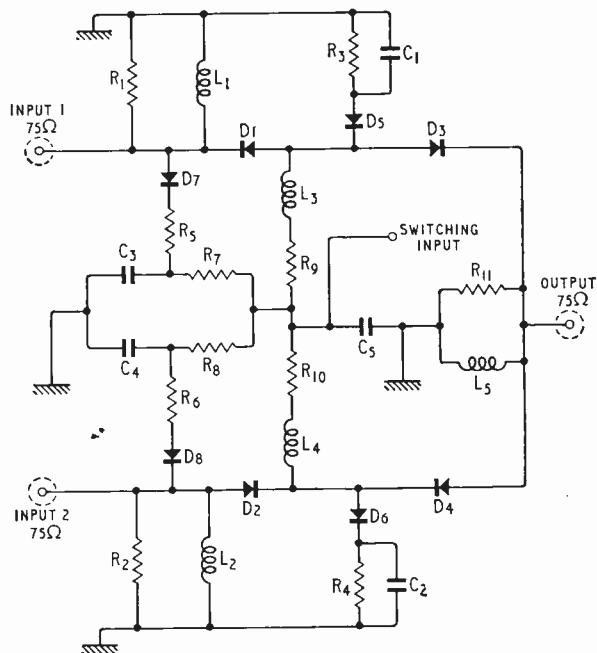

Fig. 1. Circuit of one of the diode gates.

Fig. 2. Complete circuit of the r.f. diode changeover gate.



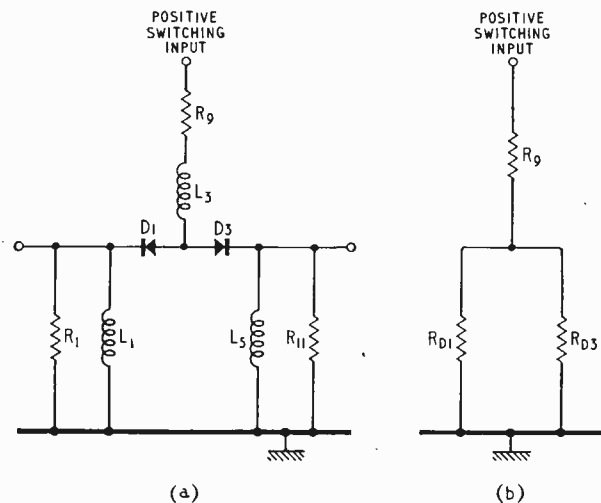

Fig. 3. (a) Modified version of the gate circuit shown in Fig. 1 when a positive switching signal is applied. (b) The circuit of Fig. (a) when the chokes L_1 , L_2 and L_3 are considered as short circuits.

Fig. 4. (a) Modified version of the gate circuit shown in Fig. 1 when a negative switching signal is applied. (b) The circuit of Fig. (a) when the chokes L_1 and L_3 are considered as short circuits.

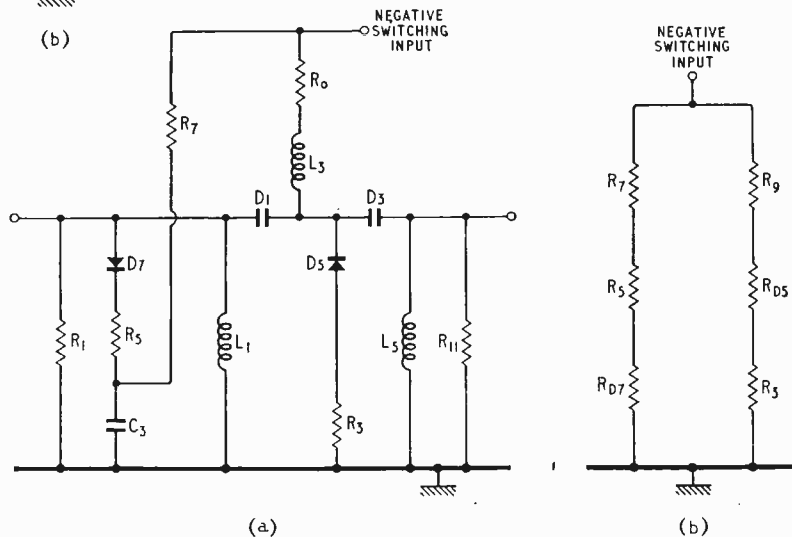
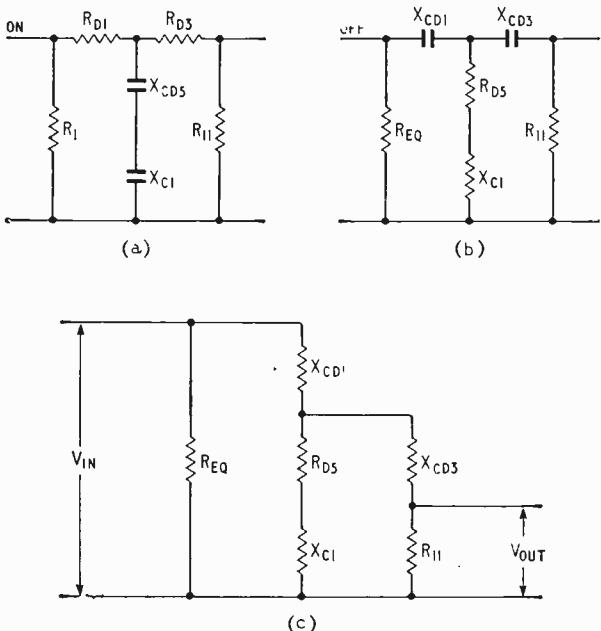

Fig. 5. (a) The π attenuator network formed by the diodes D_1 , D_3 , D_5 and D_7 . (b) The matched input impedance formed by the diodes D_1 , D_3 , D_5 and D_7 . (c) The potentiometer chain which determines the isolation of the input and output.



Operation

From the foregoing it will be appreciated that component values are obtained by considering the equivalent diode gate circuits for the conducting (forward biased) and non-conducting (reversed biased) states.

The operation of a gate can therefore be considered as follows: the d.c. requirement to (a) forward bias (b) reverse bias the diodes; also the a.c. equivalent circuits when the diode gates are (c) forward biased (d) reversed biased.

(a) It can be seen from Fig. 1 that the application of a positive-going switching signal will forward bias diodes D_1 , D_3 , and reverse bias diodes D_5 , D_7 . Fig. 1 can therefore be redrawn as shown in Fig. 3(a). As L_1 , L_3 , L_5 are short circuits to d.c. the circuit becomes that of Fig. 3(b) where R_{D1} and R_{D3} are the d.c. resistances of the diodes D_1 and D_3 at the predetermined current. The value of

this current is that which allows the a.c. signal to pass through the diode when the latter is working on the linear portion of its forward characteristic. The value of R_9 is obtained by knowing the amplitude of the switching signal and the required current to pass through the diodes.

(b) By referring to Fig. 4(a) it can be seen that the application of a negative going switching signal will forward bias diodes D_5 and D_7 and reverse bias diodes D_1 and D_3 and to indicate this condition in Fig. 4a both diodes have been shown as capacitors. As L_1 and L_3 are short circuits to d.c. the circuit can be redrawn as Fig. 4(b), where R_{D5} and R_{D7} are the d.c. resistances of the diodes and R_5 the parallel input matching resistor for R_1 in the OFF state (the latter when considered from the a.c. signal point of view). Resistor R_9 having been obtained from (a) the values of R_3 and R_7 can be calculated for the required current to pass through the diodes with given switching signal.

(c) When diodes D_1 and D_3 are forward biased and D_5 and D_7 are reverse biased by the d.c. switching signal, Fig. 5(a) (D_5 is shown as a capacitor to indicate the reverse biased condition), the r.f. signal will see a π attenuator network, the series arm formed by the sum of the a.c. slope resistances of the back-to-back diodes and the resistors R_1 and R_{11} , the two shunt arms. The value of R_1 and R_{11} depend on the a.c. slope resistance of the diodes (which should be as small as possible for mini-

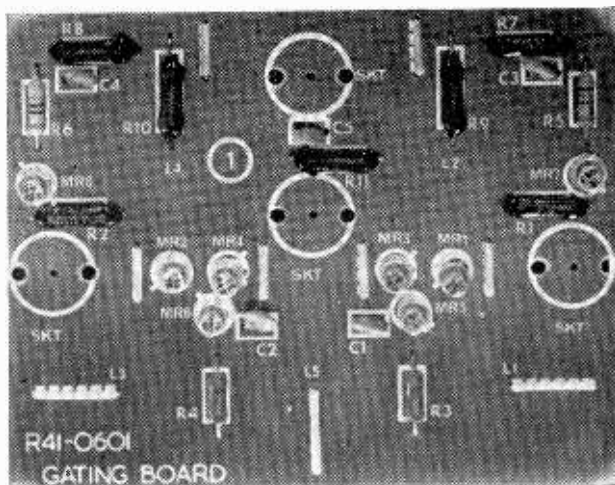
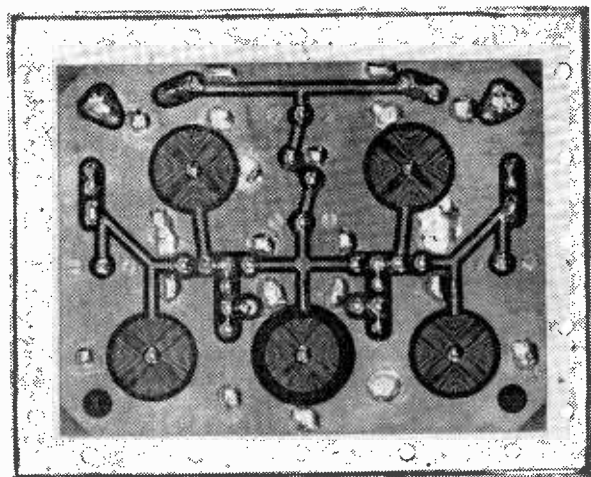

Fig. 6. (left) Underside of printed board showing inductors. (right) Top of board showing symmetrical layout of components.

imum insertion loss), to give the required input and output impedance, for the network. At r.f. the reactance of L_1, L_3, L_5 and D_5 are substantially higher than R_1 and R_{11} so therefore have no shunting effect.

(d) Referring to Fig. 1 and Fig. 5b, with D_1 and D_3 reverse biased and diodes D_5 and D_7 forward biased, the r.f. signal will see the matched input impedance presented by $(R_5 + R_{D7} + X_{C3})$ in parallel with R_1 (shown in Fig. 5b as R_{eq}), and the potentiometer chain formed by the capacitive reactances of D_1 and D_3 , the impedance $(R_{D5} + X_{C1})$ and R_{11} . It is this potentiometer chain, Fig. 5(c), that determines the isolation between input and output.

In the original application it was essential that each half of the gate should display the same frequency response, phase shift and insertion loss. To enable this to be achieved all diodes were selected to have similar forward characteristics at a given current with the aid of a transistor curve tracer. These a.c. and d.c. slope resistances enable the circuit component values to be calculated.

It will be appreciated that the quality of the gate depends on the diodes used. The Marconi "T" Gate Diodes Type F20-5101-02 which were developed especially for use in the gates exhibit the following characteristics: a small a.c. slope impedance, the reactive component of which is appreciably smaller than the resistive component, e.g. $8 + j2\Omega$ at 70 Mc/s.; low capacity in reverse biased condition, typically $< 1.0\text{PF.}$;

constant capacity with varying bias voltage; and linear forward characteristic having sharp forward knee. They are also individually mounted in TO-18 cans and therefore are ideal for use in printed circuit layouts, as can be seen from Fig. 6. One great advantage of being able to use printed circuit layouts is the repeatability of performance obtainable from gate to gate, mainly because the inductors and wiring layout are identical for all gates.

The forward characteristic of the diode is also important as the linearity of the gate is dependent on it.

The d.c. biasing should be such that with the maximum peak-to-peak input signal the latter remains on a linear portion of the diode forward characteristic.

By having R_{11} as a shunt arm common to both π networks, it is possible to feed in two separate signals and switch them alternately to a single output or have a single input and switch alternately between the two outputs. The maximum switching rate of the gate is of the order of 1 Mc/s.

From Fig. 5 it can be seen that the gate in the OFF state acts as a potential divider. The step-down ratio (isolation) between input and output depends on the capacitive reactance of the diodes, i.e. the smaller the capacity the larger the reactance—hence greater isolation between input and output.

The circuits given in Fig. 7 is a typical driver stage for the changeover gate and takes the form of a complementary emitter follower preceded by a current amplifier stage. This combination converts a single ended input to one symmetrical about earth with a low impedance source output. Performance figures for a small batch of diode gates have been obtained and some typical values are given below:—

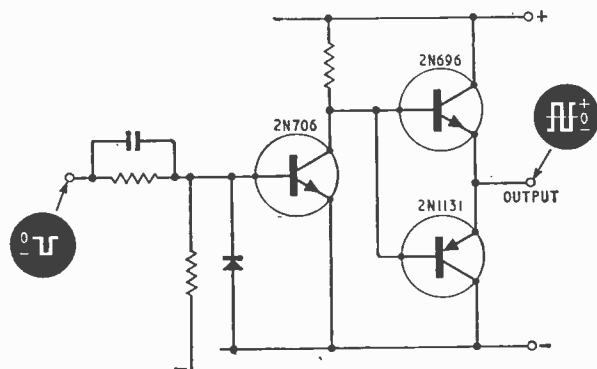

Fig. 7. Typical switching source for the changeover gate.

- | | |
|--|---------------------------------|
| Frequency response: 75 Mc/s \pm 5 Mc/s flat to \pm 0.1dB | Maximum input: 1 volt pk-pk |
| Insertion loss: 2.2dB | Maximum repetition rate: 1 Mc/s |
| Maximum repetition rate: 1 Mc/s | Switching time of gate: 200 ns |
| Isolation $<$ 50dB. | Phase shift: 30° |

This article describes work sponsored by the Ministry of Aviation. The author wishes to thank the Ministry and also the Director of Engineering, The Marconi Company Limited, for permission to publish it.

Is There a Shoenberg in the House?

By
"RADIOPHARE"

TELEVISION DEVELOPMENT HAS BEEN RESTRICTED TOO LONG BY
THE BROADCASTING STANDARDS ESTABLISHED THIRTY YEARS AGO

IN the 1920s and 30s, when the main stream of television engineering was committed to mechanical scanning devices, a few men, notably Zworykin in the U.S.A. and Shoenberg, Blumlein and others in Britain, were struggling across the current towards electronic scanning.

The outcome is history. In 1936, this country became the first in the world to provide a high-definition public television service, thanks to the engineering audacity of Shoenberg and his team at E.M.I. who in one jump bridged the gap between 30 lines, 12½ frames, and the then fantastic 405 lines, 25 frames interlaced. To the E.M.I. scanning system was added Marconi know-how in v.h.f. transmission. Thus in 1936 Britain led the world in television engineering. Today, thirty years on, our main television services still use the same old system, while our "new" system, born after incredible travail, is one which other countries have been using for the past fifteen or more years. Both systems are colour-blind, whereas colour has been in service for years elsewhere.

Currently fresh plans are afoot in the hope of stimulating domestic receiver sales, namely, the introduction of colour on the 625-line standard (and possibly on 405 lines) and a proposal to modify the 405-line, 50-field service to 525 lines, 60 fields. In the last-mentioned case we would be modifying our 30-year-old service to standards which are at least 25 years old themselves.

Clearly, somewhere along the road we have lost our engineering initiative. To account for our decline, two facile explanations are widely offered, the first of which is that "the war was to blame by putting a stop to British television for the duration"; the second is that "it is the price we have had to pay for pioneering." Both have some elements of truth in them, but is it not time we ceased to use these excuses?

Technical sloth

The truth, if we are honest enough to admit it, is that the real cause of our technical sloth is the complete absence over the past two decades of any long-term imaginative research. In 1945 we should have been planning for today. Instead, all our efforts have been directed toward the immediate future and as a result television development has been clamped firmly within the constraints of 405 and 625 lines.

A classic instance of this occurred in 1945, when the Hankey Committee issued its recommendations for the post-war resumption of television. At that time the whole future of television was in the balance, for the pre-war public had been slow to accept the new entertainment medium and a generous estimate of the number of receivers in the whole country put the figure at only 18,000—all at least six years old and virtually all in the London area where the only transmitter was situated.

The Hankey report recommended that the 405-line service should be restarted and that six provincial centres should be established as soon as possible. This was in due course done, but a further recommendation was completely ignored. *The Committee, after stating*

that it regarded the 405-line standard as unsuitable for picture sizes greater than 8in×10in (i.e. about 13in diagonal), suggested that an improved system of perhaps 1,000 lines should be introduced as soon as possible.

This suggestion cannot be dismissed as emanating from laymen with no knowledge of bandwidth problems, for the committee based its report on the opinions of expert witnesses from Marconi-E.M.I., Scophony, Standard Telephones and Cables, the B.B.C., the Radio Industry Council and others. It follows, therefore, that somewhere within that group some positive ideas must have been circulating.

But nothing was done about it and the country became irrevocably committed to 405 lines. In this connection it is interesting to recall that *Wireless World*, in its May 1945 issue, published an article by Major R. W. Hallows which applauded the 1,000-line project to the point of suggesting that no further 405-line stations should be built, and that the money thus saved should be devoted to the development of the 1,000-line system. Hallows, in deploring the proposed extensions to the 405-line system, wrote:—

"What will the rest of the world think of us if . . . we expend money, materials and technical ability in making nation-wide an admittedly inferior system? We should certainly have in being, not the best, but the worst television system of the great countries . . . by far the sounder course would be to regard our pre-war 405-line system as obsolescent if not, indeed, obsolete. . . ."

Prophetic words, indeed! Today we are still astride what Hallows, more than 20 years ago, described as the "almost dead horse of 405 lines." In the interim period, the industry gleefully cashed in on the immediate 405-line bonanza of the post-war boom, acquiring a gross over-capacity for receiver production in the process. Then when the pay-lode showed signs of deteriorating it frantically set about devising means of staying off the inevitable, for the most part by copying American trends. Thus, in spite of the Hankey Committee's screen limitation of 13in, we now have 23in displays which, in conjunction with the poor interlace of the average receiver and the restricted dimensions of the average living room, give the effect of viewing through a venetian blind. For the future, we have nothing more exciting than the prospect of the addition of colour to a 625-line system, or possibly to a 405-line system which may be patched to perform on 525 lines. And, in the process, the industry has saddled itself with the production of dual-standard receivers for the foreseeable future!

None of the foregoing is recrimination, for everyone in the television industry, from the greatest to the least, has contributed to the situation in degree. Rather, it is an attempt to face up to realities and to see whether even now it is not too late to regain something of our lost engineering reputation.

This can be done only by unshackling the fetters of the television research engineer, giving him long term freedom to work on some imaginative project.

Let us, as an example, consider an "impossible" project. Let us say a 2,000-line system (the round figure will suffice for the argument), setting our sights on five to ten years ahead.

First the question of bandwidth. Now, conventional transmission systems are extremely wasteful of bandwidth so there is plenty of scope for research here; for instance, it is highly probable that some really intensive work would crack the picture-redundancy nut, thereby transmitting information only about the changes in the picture. But this is by no means the only approach. Multiple interlace would be thoroughly investigated and digital transmission and scanning techniques other than the conventional raster explored (the picture of the future could well have a "dot" rather than a "line" structure).*

Even assuming that none of these bear fruit—an unduly pessimistic attitude, but just supposing—the battle is by no means lost. Using the worse-case equation as an approximation, the bandwidth requirement is:—

$$f_b = \frac{L^2 \times r \times F}{2,000,000}$$

where f_b = bandwidth in Mc/s (one sideband), L = number of lines per frame, r = aspect ratio, and F = number of frames per second.

Substituting numerical values we obtain:—

$$f_b = \frac{4,000,000}{1} \times \frac{4}{3} \times \frac{25}{1} \times \frac{1}{2,000,000} = 66.6 \text{ Mc/s}$$

So for a 2000-line, 50-fields system we need approximately 70 Mc/s video bandwidth—greater than the whole of Band III. This is precisely the situation which confronted Shoenberg and company in the 1930s when the 5 Mc/s demanded for 405 lines was more than the total available on the l.f. and m.f. bands. We might therefore take a leaf out of their book and ourselves go to much higher frequencies, say 1000 Gc/s or as near the infra-red as it is possible to get without suffering significant attenuation effects from the atmosphere. Here research is needed for more efficient modulation, transmission and receiving methods, but there is nothing inherently impossible in the situation.

Wideband distribution

At this point we have to abandon our old concept of broadcasting over a given area from a central point, because of the quasi-optical nature of the carrier wave. But it must not be forgotten that we now have—or can have in a few years' time—a proven ally in the synchronous satellite, which could take the signals from a ground station and re-transmit them in any of several possible ways. They could, for instance, be re-radiated by directional aerials to receiving points in various parts of the country for local distribution (of which more anon). Alternatively the time is not far distant when such satellites will be able to carry transmitters sufficiently powerful to cone the country with signal strengths great enough to permit direct reception into the home. Power supplies are at present the main obstacle here, but fuel cells or nuclear-powered sources hold considerable promise.

Nor is the situation lost even without satellites, for other signal distribution means are well into the realms

of possibility. Although there are no coaxial cables which will carry 70 Mc/s of video, some quite spectacular advances may be expected over the next five years or so. Piped (waveguide) transmission using optical maser frequencies offers considerable possibilities although it would probably be extremely expensive.

The direct-transmission satellite would seem to be the most elegant solution, for any form of overland distribution to main centres would bring local distribution problems in its train. These are by no means insoluble, however, and would not necessarily involve conventional broadcasting techniques. Possibly a grid of low-power millimetric transmitters—quite small and unattended—could cover large areas of population by corridor radiation.

So far, nothing has been said about colour because there is nothing inherently new to add to the proposed system in providing this facility. We might, however, find it possible to be sufficiently prodigal with frequencies as to dispense with band-saving techniques and thus give full colour information. We might even be able to introduce super hi-fi on a seven-colour basis; stereoscopic, of course!

To return to the general scene, we have a choice of directions. We can go muddling on with our present systems, patching here, improving there and spending a mint of money in the process, except on long-term research.

The alternative is for us to call a halt to the 625-line engineering programme in general; and for the industry or the broadcasting authorities to initiate long-term research to extend the "television horizon." It may be argued that in its present precarious state the radio industry could not finance such long-term research. This excuse cannot be put forward on behalf of the B.B.C., for if it lacks the necessary financial resources it could, I am sure, seek the backing of the National Research Development Corporation, one of the functions of which is to foster "where the public interest so requires, the development or exploitation of inventions resulting from public research." Britain could then offer to the world an incomparable new system, taking the technical lead once more. For the immediate future we could put colour on 405 lines and make do for a few years longer.

By so doing we should, as a by-product, inject new life into the television research effort which for years has been stultified by the limitations of a 5-6 Mc/s bandwidth. This would be particularly the case in such areas of investigation as:—

1. The design of transmitters and receivers for quasi-optical frequencies.
2. The evolution of efficient wideband modulation methods.
3. More efficient methods of packing information into the sideband.
4. The investigation of multiple interlace and other possible means of bandwidth reduction.
5. The design of simple high-stability oscillators.
6. The investigation of means of local distribution of the wideband video.
7. Improved resolution in camera pick-up tubes.
8. Improved c.r.t.s (spot diameter, etc.).
9. Investigation of alternative forms of display

and may other aspects. Several of these, when solved, would be of value to other areas of the industry.

Is there another Shoenberg in the house? Or a Blumlein, or an Anglicised Zworykin?

* As an example of advanced thinking see "The Improved Gray Scale and the Coarse-Fine PCM Systems, Two New Digital TV Bandwidth Reduction Techniques," by W. T. Bisignani, G. P. Richards and J. W. Whelan. *Proc. I.E.E.E.*, Vol. 54, No. 3, March 1966.

4-Stabilization Using the Root-locus

(Concluding the series)

By W. TUSTING

The use of a step-circuit to increase the stable gain of a three-stage RC amplifier is discussed in this final part of the series. Determination of the proper values of the stabilizing components involves trial and error but the root-locus method enables this to be done fairly easily.

IN Part 2 we considered as an example the high-frequency conditions of a three-stage RC amplifier with time constants of 1, 2.5 and 10 μ sec. We found that the critical gain at which instability just occurs is 19.5 and the corresponding value of ω is 0.735 (117.5 kc/s).

Let us now suppose that it is a design requirement to have a stable open-circuit loop gain of 20 times. Allowing the usual 6-dB factor of safety, this means that a critical gain of 40 must be secured. The design problem is to find out how the amplifier must be modified to permit this.

The root-locus diagram, Fig. 4 of Part 2, is reproduced here as Fig. 1 for ease of reference. If the circuit itself is unaltered, the only possible change is to the values of the time constants. In a practical case, it is usually difficult or impossible to reduce a time constant very much. One can always increase a time constant by adding capacitance, but other performance requirements may prohibit this. Nevertheless, in a three-stage amplifier it is usually beneficial to have two time constants the same and the third as different as other conditions will allow.

In Fig. 1 the problem is not just to secure the maximum value for the product of the lines from the critical point to the poles. This product has to be multiplied by $1/K (= T_1 T_2 T_3)$ to give the gain. Moving poles not only alters the lengths of the lines, but also alters K .

We shall not pursue this aspect further, partly because of this complication, but chiefly because it is rarely possible in practice to stabilize a three-stage amplifier merely by juggling with

the time constants. Instead, we shall assume that our time constants are fixed and seek stability by altering the circuit.

It is then necessary to add a compensating network to modify the performance without changing the main circuit elements. A favourite way of doing this is to add the series combination of capacitance and resistance as a shunt to one of the basic time constant elements. This is shown in Fig. 2, where (a) is the original coupling and (b) is this same coupling with the addition of C' and R' as stabilizing elements. This is commonly called a step circuit because of the form of the frequency-response curve obtainable under some conditions.

A very little algebra shows that the original response

$$F(p) = \frac{1}{1 + pT} = \frac{1}{T} \cdot \frac{1}{p + 1/T}$$

is altered to

$$F'(p) = \frac{1 + pTa}{1 + pT(1 + a + ab) + p^2 T^2 a}$$

$$= \frac{1}{T} \cdot \frac{p + 1/Ta}{p^2 + (1 + b + \frac{1}{a}) \frac{1}{T} + \frac{1}{T^2 a}}$$

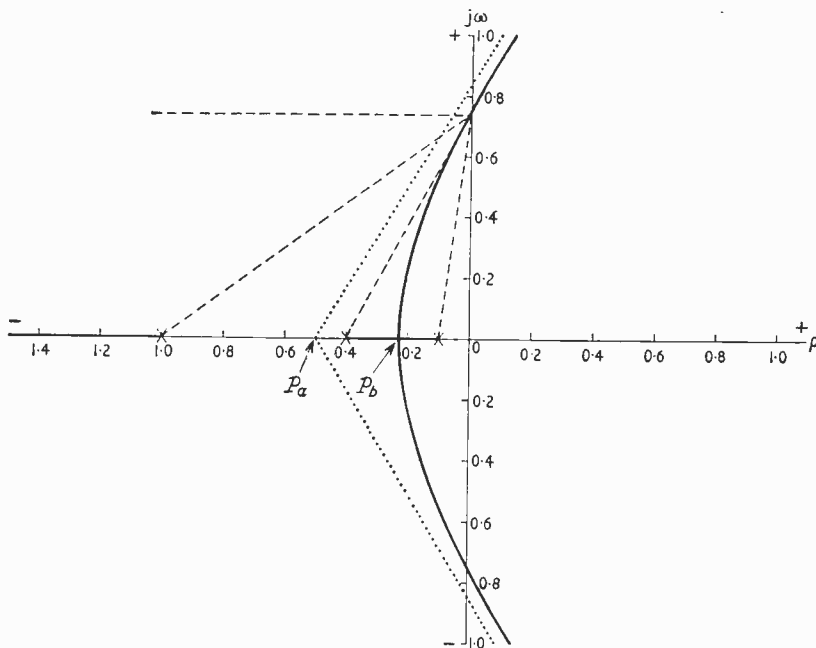

Fig. 1. This diagram shows the root-locus of a three-stage RC amplifier and is repeated from Part 2 for easy reference.

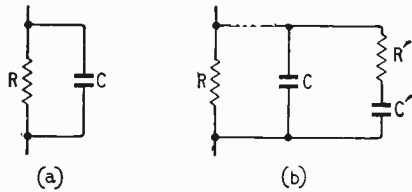

Fig. 2. An ordinary interstage coupling is shown at (a) and one with stabilizing components added at (b). This is the so called step-circuit.

where $T = CR$, $a = C'R'/CR$, $b = R/R'$

Factorizing the denominator we have

$$F'(p) = \frac{1}{T} \cdot \frac{p + 1/Ta}{(p + 1/Tx)(p + 1/Ty)}$$

$$\text{when } \begin{matrix} x \\ y \end{matrix} = \frac{1 + a + ab \pm \sqrt{(1 + a + ab)^2 - 4a}}{2}$$

In utilizing this circuit we can choose to which of the three circuits T_1 , T_2 or T_3 we add $C'R'$; we also have a choice of the values of a and b . It is particularly to be noticed that the value of $K = 1/T_1T_2T_3$ is unaltered by the addition of $C'R'$. In the expression for gain, one of the three terms like $F(p)$ above is replaced by $F'(p)$, but the multiplier $1/T$ which forms part of K is unaltered by this.

In root-locus terms, adding $C'R'$ to a circuit removes the original pole completely and replaces it by two poles and a zero. The complete system, instead of having three poles and no zero, will have four poles and one zero. The difference between the number of poles and the number of zeros is still unchanged at three, however. The asymptotes will thus still be at 180° , and $\pm 60^\circ$.

The problem thus resolves itself into choosing the positions of these poles and zeros to the best effect. We shall then end up with values of x and y and have to determine a and b from them. This is easily done for

$$a = xy$$

$$b = \frac{1}{x} + \frac{1}{y} - 1 - \frac{1}{xy}$$

Now we have no completely free choice of the two new poles and the zero, for the poles are governed by x and y whereas the zero depends on the product xy (since $a = xy$). We can choose two only out of the three. It follows, too, that one pole must be greater than the zero and the other smaller.

If we fit $C'R'$ to T_1 , we have

$$p_a = \frac{-(1 + b) - 0.4 - 0.1}{3} = -0.5 - \frac{1}{3}b$$

Ignoring for the moment the position of the zero, what we want to do is to separate the poles as much as we can. It is fairly obvious that one way of doing this is to put one of the new poles at -0.1 (if it is permissible to have two effective time constants of $10 \mu\text{sec}$ each) and the other well to the left of -1 . If the circuit is fitted to T_1 , this pole at -1 will disappear and a zero will come between the two new poles. If we can arrange for this to coincide with the pole at -0.4 , this pole and zero will cancel each other and we shall be left simply with a pair of poles at -0.1 and a pole at some value beyond -10 .

If we do this we have $1/Tx = 0.1$ and since $T = 1 \mu\text{sec}$, $x = 10$. The zero is at $1/Ta = 1/Txy = 0.4 = 1/10y$, so $y = 1/4 = 0.25$. Hence, the third pole is at $1/Ty = 1/0.25 = 4$. The pole-zero plot is shown in Fig. 3.

The scale is now changed compared with that of the

previous diagrams because we have to accommodate a pole which is numerically four times as great. Further, we now show little of the positive half-plane, the region of instability, and we do not show the negative imaginary part because it is the mirror image of the top half. We thus show little more than the top left quadrant.

There are a zero and a pole both at -0.4 so we indicate their position by a cross and a circle. There are two poles at -0.1 so we place a pair of crosses to indicate this. We apply Step 1 of Part 2 and draw in the root-locus on the real axis. It exists to the left of -4 only, because nowhere else is there a point with an odd number of zeros and poles to the right. If the two poles at -0.1 were slightly separated, it would exist between them. If the zero and pole at -0.4 were slightly separated it would exist between them.

As they are coincident, there is no locus at these places on the real axis. In effect, the coincident pole and zero cancel each other for all purposes and from now on we can ignore them. The breakaway point p_b lies between the two poles at -0.1 ; that is, it coincides with them. This is easily seen, for we need only imagine them to be slightly separated. There is then a real axis locus between them on which lies p_b . As they move together all three points coalesce. In effect, we have now nothing more difficult to deal with than a circuit of three poles, one at -4 and two at -0.1 .

We apply Step 2 and calculate

$$p_a = \frac{-4 - 2 \times 0.1 - 0.4 + 0.4}{4 - 1} = \frac{-4.2}{3} = -1.4$$

and draw in the asymptote at $\pm 60^\circ$

This crosses the $j\omega$ axis at 2.43 instead of at 0.85 as in the original circuit. However, p_b is now -0.1 instead of -0.235 .

We must now determine the point at which the locus crosses the $j\omega$ axis. Because p_b is rather close to this axis, the locus will cross it rather steeply and our first guess may not be very good. It looks as if it would be at about 1.5 . So we try this.

We draw the lines and measure the angles, not forgetting to count the angle at -0.1 twice, since there are two poles here. We get $20^\circ + 86^\circ + 86^\circ = 192^\circ$. The point is too high. Now lowering the point affects the angle at -4 much more than those at 0.1 , so we shall have to lower it quite a bit. Let us try 1.2 . This gives us $16^\circ + 85^\circ + 85^\circ = 186^\circ$. A point at 0.9 gives $12^\circ + 83^\circ + 83^\circ = 178^\circ$. This is near enough.

We now measure the distance to the poles from this point and find they are $4.1, 0.9, 0.9$. The product is 3.32 . Now $1/K$ is 25 , as before, so $G_0 = 3.32 \times 25 = 83$. This is about twice what we need.

Before we go further, let us work out component values to complete the job. We have $x = 10, y = 0.25, xy = a = 2.5 = C'R'/CR$

$$b = \frac{1}{10} + \frac{1}{0.25} - 1 - \frac{1}{2.5}$$

$$= 0.1 + 4 - 1 - 0.4$$

$$= 4.1 - 1.4 = 2.7 = R/R'$$

$$\therefore R' = R/2.7$$

$$C' = 2.5CR/R' = 2.5 \times 2.7C = 6.75C$$

With $T_1 = 1 \mu\text{sec}$, we might well have $C = 20 \text{ pF}$, $R = 50 \text{ k}\Omega$ and we should then have $C' = 135 \text{ pF}$, $R' = 18.5 \text{ k}\Omega$.

In this example we have overcompensated. Let us now try a pair of poles at -0.2 and -4 , with $C'R'$ still fitted to $T_1 = 1 \mu\text{sec}$. We have $1/T_1x = 0.2$ so $x = 5$; we have $1/T_1y = 4$, so $y = 0.25$; and we have $xy = 1.25$, so $1/T_1xy = 1/1.25 = 0.8$. We thus have poles at -0.1 ,

Fig. 3. The pole and zero plot for certain step-circuit values is shown here. The original pole at -1 has disappeared and the pole at -0.4 is cancelled by a zero of the same value. The result is a pair of poles at -0.1 and a third at -4 .

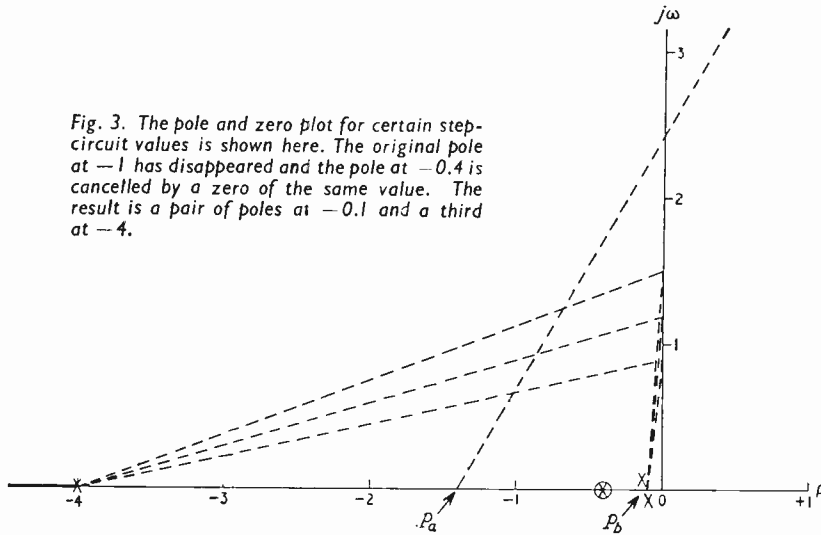
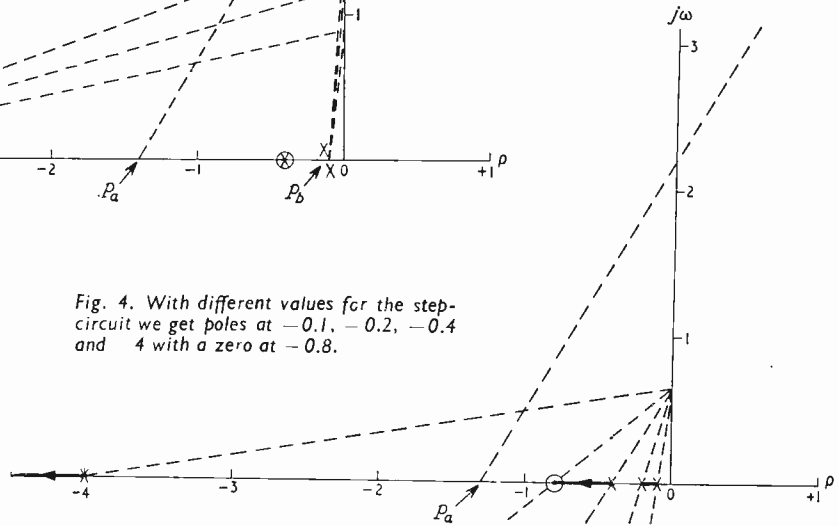

Fig. 4. With different values for the step-circuit we get poles at -0.1 , -0.2 , -0.4 and 4 with a zero at -0.8 .



-0.2 , -0.4 , -4 and a zero at -0.8 . The original pole at -1 disappears because $C'R'$ are fitted to this circuit.

The pole-zero plot is shown in Fig. 4. The locus exists on the real axis between the poles at -0.1 and -0.2 and between the pole at -0.4 and the zero at -0.8 and to the left of the pole at -4 . Since $P_n - Z_n = 3$ the angles of the asymptotes are as before, 180° and $\pm 60^\circ$. Now $\Sigma P = -4 - 0.4 - 0.2 - 0.1 = -4.7$ and $\Sigma Z = -0.8$. Therefore

$$p_u = \frac{\Sigma P - \Sigma Z}{P_n - Z_n} = \frac{-4.7 + 0.8}{3} = \frac{-3.9}{3} = -1.3$$

The breakaway point is between -0.1 and -0.2 and it is clearly not worth while to try to determine it accurately. All that we need do is to find the critical point on the $j\omega$ axis and we will start by trying $j\omega = 1$. As the table

$j\omega$	Angles to					Sum
	-4	-0.8	-0.4	-0.2	-0.1	
1	-13	52	-68.5	-79	-84	-192.5
0.9	-12.5	48.5	-66	-78	-84	-192
1.5	-21	62.5	-75.5	-82.5	-86.5	-203
0.6	8	37	-56	-71	-80	-178
0.7	-10	41.5	-61	-75	-82	-186.5
0.65	-9	39.5	-57.5	-73	-81	-181

shows, quite a few trials are needed to find $\omega = 0.65$ approx.

We now measure the length of the lines to the poles and zeros and we find they are 4.05, 1.04, 0.77, 0.67 and 0.66, so the gain is

$$25 \times \frac{4.05 \times 0.77 \times 0.67 \times 0.66}{1.04} = 33.2$$

This is not quite high enough.

By trying other values for the compensation circuit one can, of course, arrive at an arrangement which satisfies the requirements quite closely. In practice, however, one would probably first try out the initial values which permit a gain of twice the requirement. If this is satisfactory from other points of view, it gives an increased factor of safety against instability and this is always advantageous.

The main features of the root-locus technique have now been described. Appreciation of its advantages can come only when facility with its use has been achieved and for this much practice is necessary. The beginner must work slowly and carefully and refer continually to the steps given in Parts 2 and 3. With practice one can soon remember most, if not all, of these steps and with more practice one begins to see the general trend of the root-locus from a glance at the pole-zero pattern.

NEW PRODUCTS

equipment systems components

Selective Nanovoltmeter

TWO selective nanovoltmeters are offered by Unipan Scientific Instruments, a subsidiary of the Polish Academy of Science. Type 207 covers the range 1.5 c/s to 5 kc/s and type 208, 15 c/s to 50 kc/s. Both instruments are intended for selective measurements of very low a.c. voltages. They can be used for spectrum analysis of harmonic and noise signals, as sensitive balance indicators for a.c. bridge configurations, measurement of very small a.c. voltages of fixed frequency in the presence of heavy noise or interference background; for very sensitive photometric and spectrophotometric measurements when these are made with the appropriate photoelectric transducers and light beam choppers, and for basic research applications especially in solid state physics, nucleonics and physical chemistry, where it is required to measure very small, weak signals. Both the 207 and the 208 consist of two units, a high-impedance, broad band input or transformer input pre-amplifier, which are designed as separate units, permitting them to be placed as close to the signal source as possible and a main unit which includes two selective amplifiers I & II, that provide the selectivity of the amplifier, although amplifier II can operate as a selective or wide-band amplifier. High stability is obtained first by efficient regulation of all supplies, including the heater supply, and then by designing efficient negative feedback loops in the pre-amplifiers, in both amplifiers and in the a.c. valve voltmeter. In these instruments the selective amplifiers use "bridged T" resistance-capacitance filter networks so that efficient negative feedback applies to the resonant as well as the non-resonant frequencies. Both instruments can be tuned continuously by means of a set of four ganged wire-wound high precision potentiometers over seven frequency ranges. The scale law of the output valve voltmeter indicator is linear. Sensitivity ranges (f.s.d.) are (a) with type 203.50 pre-amplifiers (input impedance 20 M Ω /20 pF) 100 nV to

10 mV in eleven ranges, selected by means of a single rotary switch, (b) with various types of transformer input pre-amplifier (additional ranges) 1 nV to 30 nV, and (c) with type 203.50 pre-amplifier and a 203.1 or 203.2 voltage divider attached to the pre-amplifier input socket, seven additional ranges are obtained from 30 mV to 100 V. Output impedance is about 1 k Ω . Meter zero drift is stated to be nil. The output voltage is 1 V r.m.s. or 10 V r.m.s. Accuracy is better than $\pm 5\%$, and long term gain stability is below $\pm 2\%$. Power supply 90 to 130 V, and 200 to 240 V 50 to 60 c/s, and power consumption is about 170 VA. The main unit is 22 in \times 10 $\frac{1}{2}$ in \times 14 $\frac{1}{2}$ in, and weighs 51 lb. The sole exporter is Metronex, Warsaw, Poland.

WW 301 for further details

DIFFERENTIAL AMPLIFIER

THE Differential Amplifier 1-364 amplifies millivolt source signals to the level of 5 V output signals in order for them to be telemetered, taped, graphed, computed or used for control purposes. Manufactured by Consolidated Electro-dynamics, a division of Bell and Howell Ltd., this amplifier is a 1 in. cube weighing 1 $\frac{1}{2}$ oz and is designed for circuit-board mounting. Suitable signal sources for this unit are transducers of pressure, velocity, torque, temperature. The 1-364 possesses an input impedance of 1 M Ω and an output impedance of less than 250 Ω and a combined linearity and hysteresis of 0.1% maximum. Frequency bandwidth is from d.c. to 20 kc/s. Consolidated Electro-dynamics, 14 Commercial Road, Woking, Surrey.

WW 302 for further details

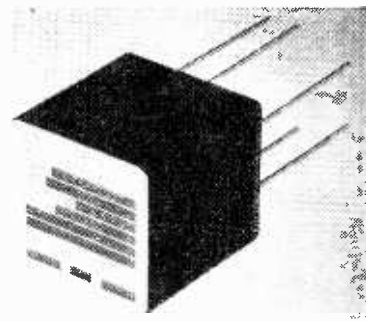

ANALOGUE COMPUTER

THE Heathkit Model EC-1U analogue computer is intended for use as a training computer in educational establishments and industry. Available in kit form or constructed and tested, this instrument possesses nine d.c. operational amplifiers, five coefficient potentiometers, a repetitive oscillator, a front panel three-range meter, and built-in power supplies including three initial-condition supplies. Problem solutions may be read out on the meter, or by external pen recorder or oscilloscope. There is also provision for amplifier balancing without removing a problem set-up. Also supplied are precision resistors, capacitors and test leads for

setting up and solving many of the problems given in the operational manual. Among the problems that can be solved with this computer are real roots of polynomials, simultaneous algebraic equations, single linear differential equations to 4th order, simultaneous differential linear equations up to four 2nd order or three 3rd order expressions. (A total of nine integrations can be performed and up to three initial conditions can be inserted.) Each of the nine d.c. operational amplifiers uses a high gain circuit with a pentode driving a cathode-follower output. The open loop gain is approximately 1,000, and the output can be any value between -60 V and +60 V with load current up to 0.7 mA. Short term drift is less than ± 5 mV referred to input. The computer cabinet is 19 $\frac{1}{8}$ in \times 11 $\frac{1}{2}$ in \times 15 in, and it weighs 36 lb. The power requirements are approximately 100 W at 110-120 V, 200-250 V, 50-60 c/s. Price, in kit form, £97 8s, or fully assembled and tested, £122. From Daystrom Ltd., Gloucester.

WW 303 for further details

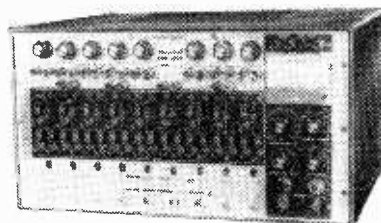

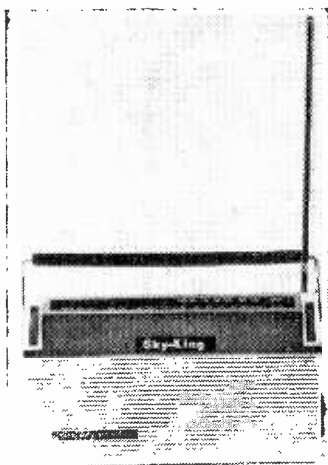

Civil Aviation Band Receiver

THE Civil Aviation band of frequencies is covered by the "Sky King" 15 semiconductor portable receiver marketed by Park Air Electronics, 22a High Street, Stamford, Lincolnshire. In addition to the v.h.f. band coverage of 108-136 Mc/s the long- and medium-wave broadcasting bands 150 to 370 kc/s and 540 to 1,600 kc/s are also covered. Two i.fs are used, 455 kc/s and 10.7 Mc/s. Sensitivity is 1.5 mV for 200 mW. Price of the "Sky King" is £21 5s.

WW 304 for further details

New Stand-off Terminal

ANNOUNCED by Selectro Ltd., Farington, Portsmouth, Hants, is the addition of the ST-SM-18-C2 terminal to the "Press-Fit" range. This new terminal has a major diameter of 0.15 in and is intended for use on electrical assemblies where high packaging densities are involved on a thin chassis. A centre-to-centre insertion hole spacing of 0.16 in is possible and the insulation bushing is p.t.f.e. A special tool type B-6-A-2 is required for mounting the terminal.

WW 305 for further details

Resistors Up-rated

INCREASE in the standard commercial power ratings of the Eric type 15 and 16 insulated carbon composition resistors has been announced. Type 15, previously rated at 0.1 W, is now 0.25 W at 70 °C ambient and the voltage rating is increased from 50 V to 150 V d.c. The Type 16 is rated at 0.5 W at the same ambient temperature and the voltage rating is 350 V d.c.

WW 306 for further details

Multiplex Stereo Encoder

DESIGNED to assist in the alignment and repair of stereo radio receivers or stereo decoders, is the transistor multiplex stereo coder Type 76 011. This instrument by Loewe Opta, Germany, is also intended for the development of such equipment and for demonstrating stereo sound, using local sources of stereophonic music such as record discs, or tapes. This instrument is designed to produce a complete multiplex stereo signal (using the pilot tone system), the level of which may be adjusted (at the multiplex output) from 0 to 10 V peak to peak. Separate input signal level controls are available for each stereo channel as well as a pre-emphasis circuit (50 μ s). Internal modulation facilities are provided by two built-in tone generators which supply audio frequencies of 1.3 kc/s and 5.2 kc/s. These are situated at the lower and upper limits of the frequency range which is important in obtaining the stereo effect, the upper limit being placed so that its

harmonics will not interfere with the 19 kc/s pilot tone. There is also an f.m. signal generator within the instrument which is frequency modulated by the multiplex signal. The frequency deviation may be adjusted from 0 to 100 kc/s. The deviation is shown on a moving-coil meter which simultaneously indicates the peak voltage at the multiplex output. It is claimed that this method of adjusting the amplitude of the signal for testing decoders (i.e. using a deviation meter) is more accurate than other methods. Input impedance is 1 M Ω and output impedance is 330 Ω . The pilot frequency is held to ± 2 c/s by crystal stabilization, with an output level of 3 V peak to peak and an output impedance of 600 Ω . The carrier frequency is 101 ± 1 Mc/s at an output level of 10 mV. The price is £86 from Highgate Acoustics, 71-73 Great Portland Street, London, W.1.

WW 307 for further details

Sub-miniature Battery Charger

DESIGNED for incorporation into equipment using rechargeable batteries or cells, a unit known as the MilliQ is available from Lexor Electronics Ltd., 25/31 Allesley Old Road, Coventry. Employing such a unit in a portable radio or tape recorder will permit the instrument to operate either from its own batteries or from the mains supply, in which case the batteries will automatically be recharged. Charging currents are constant for cells between 1.4 V and 25 V, and range from 8 mA at 110 V a.c. input to 18 mA at 240 V a.c. input. This unit is not damaged by short or prolonged overloads or short circuits. Housed in a sealed aluminium can $1\frac{1}{4}$ in \times $\frac{3}{4}$ in diameter, it is available either with flying leads for normal



mounting or with connections for direct application to a printed circuit.

WW 308 for further details

HELICAL POTENTIOMETER

THE 10 HP-10 ten-turn helical potentiometer by Sakae Tsushin Kogyo Co. Ltd.,

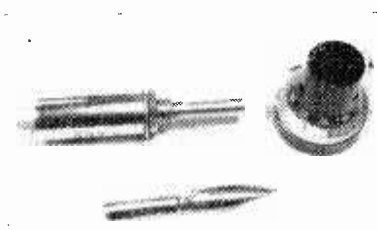

of Japan, has a diameter of 10 mm, allowing a very high stacking density, while the actual body length is 25.4 mm. Resistance values available as standard are from 500 Ω to 50 k Ω and 100 k Ω to special order. The power rating of this range is 1.5 W at 40 °C and resistance tolerance is $\pm 10\%$. Linearity below 5 k Ω is 0.5%, and above 5 k Ω it is 0.4%. These potentiometers are available from Electro Mechanisms Ltd., 218-221 Bedford Avenue, Slough, Bucks.

WW 325 for further details

Low-noise Amplifier

A NOISE figure of less than 2 dB with source impedances ranging from 800 Ω to 250 k Ω at frequencies above 500 c/s is a feature of the LA 350 low noise amplifier which covers a frequency range from 3 c/s to 300 kc/s. With such a low noise figure, the limiting factor in most measurements is the thermal noise of the source. Distributed feedback attenuators, operate over successive stages to prevent overloading of the amplifier and attenuate the noise by the same factor as the signal. These attenuators are adjusted by a single control which switches from 0 to 55 dB in 5 dB steps. Low frequency and high frequency filters each with a 6 dB/octave characteristic can be switched into circuit by two 10-position

switches. The low frequency switch selects from 3 c/s to 100 kc/s, and the high frequency switch selects from 10 c/s to 300 kc/s. Maximum gain is 100 dB and the output voltage which is indicated on a front-panel meter is 2 V r.m.s. maximum. Use of the meter enables the amplifier to be used as an a.c. voltmeter for mV measurement. Price is £130. (Brookdeal Electronics Ltd., Myron Place, Lewisham, London, S.E.13.)

WW 309 for further details

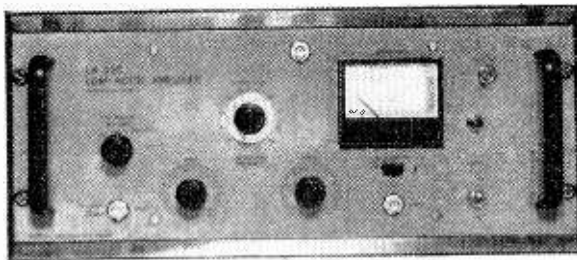

Mobile Aerial and Mike

INFORMATION has been received on an aerial and microphone for use primarily with the 12 V silicon transistor amateur mobile transmitter announced in last month's issue. The aerial (type 2 ATMA) is tuned by means of a ring which is rotated and is attached to a variable capacitor. The transmitter pin-network is tuned to give minimum indication on the p.a. meter and then the

aerial is tuned to give maximum indication. The aerial may be fitted in the front of the rear offside window—eliminating the necessity to drill a hole in the car body. From this position the aerial can easily be tuned from the driving position. The lip microphone (type MM2) is provided with a plastic coated aluminium headband so that the transmitter may be operated while driving. The headband may be adjusted to suit the wearer. The microphone is a balanced magnetic type with an impedance of around 300 Ω . Attenuation is provided below 300 c/s and above 3.5 kc/s. The retail price of the 2 ATMA aerial is £9 15s and the microphone costs about £2 17s 11d. Contactor Switchgear (Electronics) Ltd., Moorfield Road, Wolverhampton, Staffs.

WW 310 for further details

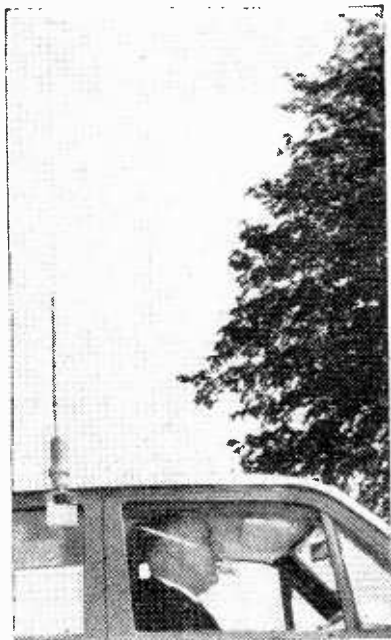

Miniature D.C. Solenoid

A MINIATURE solenoid with industrial control applications, the 60 Decco d.c. solenoid, is available from Expert Industrial Controls. Its base is 1.875 in square, height 2.7 $\frac{1}{16}$ in with a case diameter of 1 $\frac{1}{8}$ in. Coil voltages range from 6 to 240 V and the power rating is 13 W. The stroke is 4 mm, with 4 mm overtravel. Operating force is 1 kg at 4 mm. Expert Industrial Controls Ltd., Launt Works, Ashby-de-la-Zouch, Leics.

WW 311 for further details

Laser Diode

A TYPICAL power output of five watts at room temperature is produced by the pulsed gallium arsenide diode H1D1. It is stated that this low cost diode, from General Electric Co., U.S.A., has a peak wavelength around 9,000 \AA , thus enabling it to be used with standard silicon detectors. It has a room-temperature threshold current of 65A peak, and a maximum repetition rate of 500 c/s. It is housed in a hermetically sealed metal can, with a flat glass window. Available from International General Electric Co. of New York Ltd., 296, High Holborn, W.C.1.

WW 312 for further details

Combined TR Cell and Limiter

A CONVENTIONAL gas discharge TR cell and a varactor diode limiter have been combined in the Type B5808 TR limiter from the English Electric Valve Co. Ltd. The device, which has a very low leakage (maximum of 0.3 erg/pulse measured at 40 kW peak power, 1 μ s pulse duration occurring at 1,000 p.p.s.) is for use in X-band radar equipment where very sensitive crystal or tunnel diode amplifiers are used and has been designed so that, electrically and mechanically, it can be used as a direct replacement for conventional X-band TR cells. Frequency range is



9 to 10 Gc/s and the maximum transmitter peak power which the cell can handle is 200 kW. Primer supply voltage is -950 V (min) to -1,100 V (max) with corresponding primer currents of 90 and 150 mA; however, it should be noted that operation at power levels above 50 kW results in reduction of operating life and it is recommended that in such circumstances the cell be preceded by a pre-TR cell. Range of ambient operating temperature is -40° to +70°C. English Electric Valve Co. Ltd., Chelmsford, Essex.

WW 313 for further details

PYROMETER

WITH the increasing use in industry of soldering irons with bit temperatures related to particular applications, some form of accurate temperature measurement is required as an aid to instrument selection and to check consistency of performance. The Litesold Pyrometer is designed for such applications and

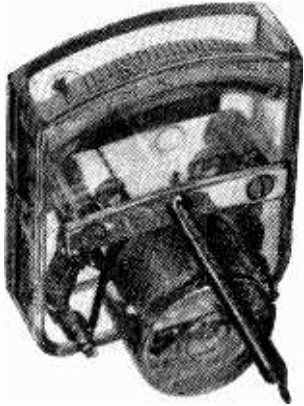

is based upon a moving-coil meter with edgewise indication. This instrument uses an iron/eureka thermocouple (24 s.w.g.) contained in a stainless steel probe whose diameter is 0.136 in. It is stated that the small probe mass of this instrument overcomes the chilling effect, which causes the erroneous readings experienced when a large probe of an orthodox thermocouple pyrometer is applied to the small bit mass of a modern lightweight soldering iron. This probe is in turn attached to the instrument case by a steel mounting plate. The meter is calibrated in 100 degree divisions (with 20 degree sub-divisions) up to 500 °C. The meter is 1½ in wide × 2 in high and the scale length is 1½ in. It weighs less than 1½ oz and is housed in a wooden instrument case. Price £7 7s. Light Soldering Developments Ltd., 28 Sydenham Road, Croydon, Surrey.

WW 314 for further details

Safety Solvent and Lubricant

A DUAL purpose cleaning fluid for delicate mechanisms, switches and relays is obtainable from Spectra Chemicals Ltd., High St., Caterham, Surrey. As well as cleaning and degreasing, SPRAYCLEN will also leave a thin film of refined oil for lubrication and the prevention of tarnish and corrosion. This non-flammable fluid is available with either switch or instrument lubricant in 12 oz aerosol containers, fitted with angled extension tubes. The price of the standard solvent is 7s 6d, and with either lubricant the price is 8s.

WW 315 for further details

ANALOGUE PROGRAMMER

SYSTEM variables such as position, velocity, temperature, voltage, current, pressure and level can be programmed by the Model 412 Analogue Programmer from Evans Associates, P.O. Box 5055, Berkeley, California 94705 U.S.A. The basic unit has one channel, but up to four additional channels of programme storage are available as modular supplements without duplication of controls. Features include automatic interpolation

and provision for computer control. Rates of change possible in the programming of variables range from 1 V/ms to 1 V/0.5 hr; this range can be extended by external timing control. The model 412 is priced at approximately £1,000.

WW 316 for further details

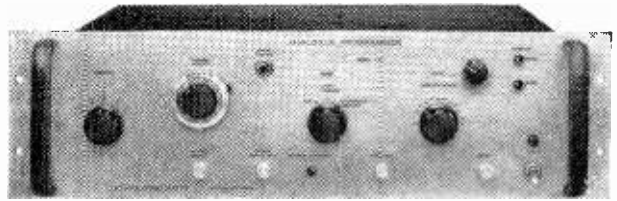

Hall-effect Gaussmeter

MODEL 750 Gaussmeter by Radio Frequency Laboratories Inc., U.S.A., is a sensitive wide range instrument capable of measuring magnetic flux density in the range 0.02 to 50,000 gauss in 24 overlapping ranges over the d.c. and a.c.

fields to 400 c/s, using Hall-effect probes. The use of solid state circuits obviates warm-up, and allows mains or optional battery operation. It possesses a 7 in scale and two balance controls. A read-out socket is provided at the rear

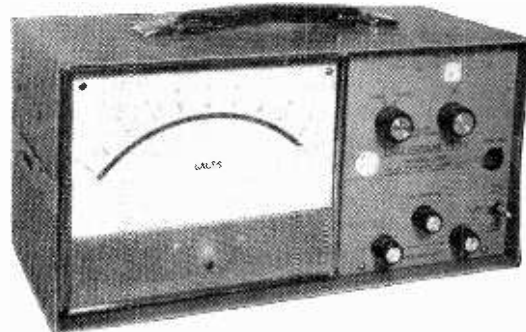

of the instrument for an oscilloscope, recorder, or digital voltmeter. A range of probes and reference magnets are available for measurements in transverse, axial and tangential fields. Taps are provided for matching any Hall-effect device with impedances from 2 to 50Ω. Sole U.K. representatives, Wessex Electronics Ltd., Royal London Buildings, Baldwin Street, Bristol 1.

WW 317 for further details

Piston Capacitor

CLAIMED to be a new approach in rotating piston trimmer capacitors, the RV-RB series by the Voltronics Corporation, U.S.A., utilizes the internal arms of the bushing for a smooth, sliding contact to the piston. This technique provides a low resistance, low inductance r.f. earth connection to the bushing as well as eliminating the screw as a path for current. End play is cancelled by the use of a plastic insert. The RB/RV4, which measures 0.844 in × 0.375 in, has a range of 0.4 to 4.5 pF. The RB/RV30 measures 2.844 in × 0.375 in and has a range of 1.0 to 30 pF. Both of these have a d.c.-working voltage rating of 1,000 V operating within a temperature range of -55°C to 125°C. The temperature co-efficients

of +50 p.p.m./°C and +300 to +500 p.p.m./°C are available. Voltronics Corporation 296 Route 10, Hanover, New Jersey, U.S.A.

WW 318 for further details

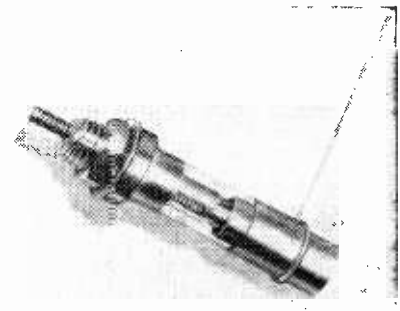

A.F. Wave Analyser

THE A. F. Wave Analyser Type 771 by Dymar Electronics Ltd., Rembrandt House, Whippendell Road, Watford, Herts., is intended for the analysis of complex waveforms, and the evaluation of distortion and intermodulation products of audio frequencies.

It employs the superheterodyne technique where the signal under test is

heterodyned to a high i.f. (100 kc/s), by means of a local oscillator which tunes from 100 kc/s to 150 kc/s, eliminating image response in the mixer, while a triple crystal filter centred at 100 kc/s ensures good selectivity. The frequency range is 20 c/s to 5 kc/s and 20 c/s to 50 kc/s, and selective voltage measurements range from 3 mV to

300 V f.s.d. in 15 ranges. Input impedance is $1 M\Omega$ on all ranges. The frequency accuracy is $\pm 2\%$ and the voltmeter accuracy is $\pm 5\%$, both these figures referring to after calibration. Residual noise is better than 80 dB, while intermodulation distortion is better than 70dB. Output impedance is $1 k\Omega$.

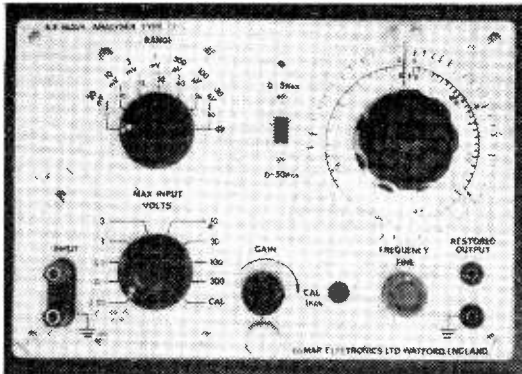

WW 319 for further details

MULTIPLE REED RELAY

UP to eight break before make contact groups enclosed in a single inert gas filled, hermetically sealed chamber constitute the Multireed relay by Thermosen Inc. U.S.A., which is now marketed

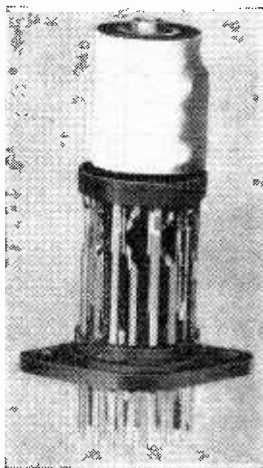

in this country by Livingston Components Ltd. It is intended for use as a multiple contact circuit control device for such applications as signal systems, machine tools, computers, aeronautical

and electronic systems. It is stated that contact life is estimated at 50 million operations at rated loads. The coil of this relay is outside the sealed chamber to prevent organic contamination. Each of the contact groups has its own reed armature moving between two fixed contacts, these armatures are cantilever type operating at low stress levels. The absence of hinges, pivots, or friction points minimizes wear and malfunctioning. Armature travel is sufficient to ensure positive transfer switching, and prevents bridging or false closure due to shock or vibration. The Multireed contacts are rated at 1 A maximum (resistive) 30 VA maximum d.c. 75 VA maximum a.c. Contact resistance is $50 m\Omega$ maximum. The rated coil voltages are 6, 12, 24, 48 V d.c. The operating time is 15 ms maximum and this includes approximately 2 ms bounce. Release time is 4 ms maximum including bounce. The Multireed relay has terminals designed for wire wrap techniques, and a solder lug or taper pin socket for plug-in applications will be available. Dimensions are $2\frac{3}{8}$ in high $\times 1\frac{1}{8}$ in diameter (excluding terminals). Terminals extend $\frac{1}{2}$ in below mounting surfaces. Weight 4 oz. From: —Livingston Components Ltd., Livingston House, Greycaines Road, North Watford, Herts.

WW 320 for further details



3-Range Process Timer

THE model 627 Timer, manufactured by Eberle & Co. of Nuremberg is now available from G. A. Stanley Palmer Ltd., Island Farm Avenue, West Molesey Trading Estate, Surrey. A timing ratio of 1:2,500 is represented by the three ranges 0.4 to 10s, 4 to 100s, 40 to 1,000s. Basically the timing sequence is controlled by a synchronous motor, a gear unit and a relay energized clutch which drives a camshaft. The timer incorporates two switching contact functions, instantaneous action contacts which operate immediately after the motor is energized, and delay action contacts which operate after the pre-selected time delay has elapsed. The rating of the delay-action contacts is 5 A at 220 V a.c. or 2 A at 380 V a.c., and the rating of the instantaneous action contacts is 2 A at 220 V a.c. or 1 A at 380 V a.c.

WW 321 for further details

HIGH FREQUENCY PRESSURE TRANSDUCER

WITH an output level of 0.5 V the P40 series of pressure transducers makes signal transmission easier over long and noisy lines, and permits the use of inexpensive and stable associate circuitry. Manufactured by the Valid Data Corporation, 24002 Long Valley Road, Calabasas, California, U.S.A., this transducer uses semi-conductor strain gauges and responds to static pressures, although it is also able to reproduce high frequency pressure variations. Pressure ranges from 100 p.s.i. to 10,000 p.s.i. full scale are available.

WW 322 for further details



WIRELESS WORLD, SEPTEMBER 1966

LOW NOISE MICROWAVE TRANSISTOR

INTRODUCED by Texas Instruments are two germanium-planar transistors Type TIXM103 and TIXM104 for low noise high gain performance in the frequency range 1 to 4 Gc/s. It is claimed that these devices offer substantial cost savings when used as solid-state replacements for travelling-wave tubes, tunnel-diode amplifiers and parametric amplifiers. Maximum noise factor for the TIXM103 is 4.5 dB at 1.56 Gc/s and 7 dB at 3 Gc/s; for the TIXM104 the figures are 5.5 dB at 1.5 Gc/s and 10 dB at 3 Gc/s. Both transistors have an unneutralized stable power gain of 9 dB per stage at 1.3 Gc/s. An insertion power gain of 5 dB into a 50Ω line is readily attainable. Texas Instruments Incorporated, 118 due Du Rhone, 12004 Geneva, Switzerland. WW 323 for further details

Solid State Frequency Multipliers

VARACTORS are being employed by Mirrowave Systems Ltd., in the construction of a series of solid state frequency multipliers. The varactors permit the multipliers to achieve harmonic generation, at power levels ranging from milliwatts to 5 watts in the 1.0 to 2.0 Gc/s range, and from milliwatts to approximately 1 W at C-band frequencies and up to 300 mW at X-band frequencies. From 300 to 2,000 Mc/s the power levels range from milliwatts to 1.0 W. All multipliers are of solid aluminium block construction or aluminium castings and are intended for aircraft and missile applications. Microwave Systems Ltd., Caltronics House, Hunting Gate, Hitchin, Herts. WW 324 for further details

INFORMATION SERVICE FOR PROFESSIONAL READERS

To expedite requests for further information on products appearing in the editorial and advertisement pages of *Wireless World* each month, a sheet of reader service cards is included in this issue. The cards will be found between advertisement pages 16 and 19.

We invite professional readers to make use of these cards for all inquiries dealing with specific products. Many editorial items and all advertisements are coded with a number, prefixed by WW, and it is then necessary only to enter the numbers on the card.

Postage is free in the U.K. but cards must be stamped if posted overseas. This service will enable professional readers to obtain the additional information they require quickly and easily.



**THE HOUSE OF BULGIN
AT YOUR SERVICE**

OUR LARGE & VARIED STOCK

Up to 5,000 of many of our Popular Products can often be despatched in 24 hours. Our reputation for quick delivery is second to none in the Component field.



Micro Switches

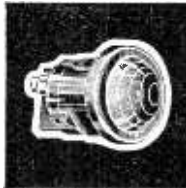

Neon Indicators



Message Indicators

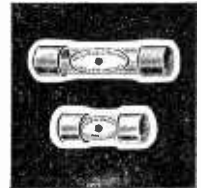

Fuses

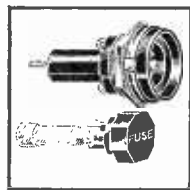

Fuseholders



Signal Lamps

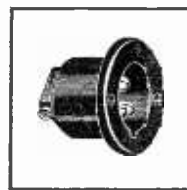

5 Amp. Plugs



5 Amp. Sockets



3-pin Plugs

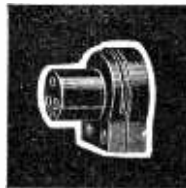

3-pin Sockets



M.E.S. Lampholders



Signal Lamps

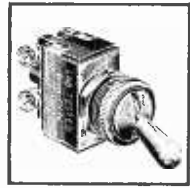

Moulded Switches

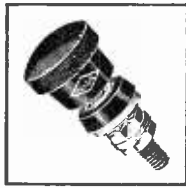

Terminals

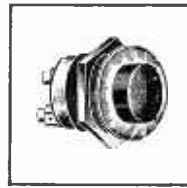

Meter Pushes

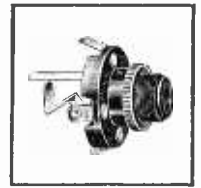

Jacks



Spring Shell Holders



Tag Strips

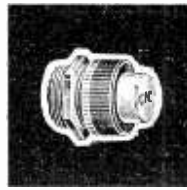

Legend Signal Lamps



Instrument Knobs

FOR FULL TECHNICAL DETAILS SEE CAT. 205

A. F. BULGIN & CO. LTD.,
Bye Pass Rd., Barking, Essex.
Tel: RIPpleway 5588 (12 lines)

MANUFACTURERS AND SUPPLIERS OF RADIO AND ELECTRONIC COMPONENTS TO

ADMIRALTY	MINISTRY OF WORKS	B.S.C.
WAR OFFICE	MINISTRY OF AVIATION	G.P.O.
AIR MINISTRY	MINISTRY OF SUPPLY	I.T.A.
HOME OFFICE	RESEARCH ESTABLISHMENTS	M.P.L.
CROWN AGENTS	U.K.A.E.A.	D.S.I.R.

WW-104 FOR FURTHER DETAILS.

The Anatomy of Meetings

COMMENTING in *Wireless World* several years ago on the report of the Pilkington Committee on Broadcasting the late P. P. Eckersley, the radio pioneer and first chief engineer of the B.B.C., wrote: "It has been said that a camel is a horse designed by a committee." No doubt he had had his share of committees in his distinguished life, as indeed we all have in degree, for the malady is peculiarly rife in the electronics industry. Why it should pick on us I don't now, except that the disease seems to be a function of company growth, and ours is a growth industry, whatever that might be.

What I mean is, that the virus rarely seems to attack the small back-room enterprise; it isn't until the business grows to at least warehouse dimensions that one must begin to keep a sharp look-out for the first symptoms. These are innocuous enough in themselves, being no more than a tendency for one or two of the chaps to wander down to the end of the building at tea break to talk shop.

That's all; but tall oaks from little acorns grow. The addiction spreads with the ease of You-Know-What margarine and when in due season the small works expands and needs a brand-new building, the architect finds himself lumbered with the provision of a suite of conference rooms in the design. "Lumbered" is *le mot juste* because he knows from bitter experience that no matter how many he provides, there will not be enough.

Long before this stage is reached, the informal natter-over-a-cuppa has been rationalized into a ritual meeting complete with internal memos, a chairman and (of course) a secretary to take notes. In fact the operation may now be defined as one in which minutes are kept and hours wasted. From this point the disease becomes rampant and various grades of meeting burgeon like daisies on a lawn.

There is, for example, the sort called by the chief of designs to settle the momentous issue of whether the control knobs on the new season's models shall be red or blue. The situation is truly critical because the advertising boys intend to describe the innovation as "a staggering technological break-through to ultimate realism" and as they've already written their copy they naturally want to know which colour they're talking about.

Now, a summons to attend this meeting does not mean that the chief of designs cannot make up his mind on the matter. He already has. The knobs are going to be red. No, what he is going to do is to spread the responsibility around a bit, just in case his decision is a flop and the sales graph takes a dive through the floor.

This is primarily why meetings were invented, the philosophy being that although the general manager may, in one of his choleric moods, present one man with his cards and no good wishes for the future, he cannot thus summarily dismiss twenty good men and true who, with due regard for the sanctity of their own cards, have voted the way they knew the designs chief wanted them to.

As most of the issues on any agenda are already settled before the meeting starts and the remainder after it has finished, the uninitiated may find it difficult to see how the interim hours are filled. It is really very simple. Providence, in her inscrutable wisdom, has decreed that whenever four or more people assemble for a meeting, there will always be at least one of the number who fervently believes that

his powers of oratory start where the late Mr. Mark Antony's left off. All that the chairman has to do therefore is to kick off with some question—it doesn't matter what—and the latter-day Mark Antony is on his hind legs in a flash. By comparison, Tennyson's celebrated brook is a non-starter.

And so, far into the day the rhetoric drones on. The chairman, his duty done, lapses into a blissful coma and the main body of the meeting feels itself free to doodle the circuit of a transistor automatic door-opener for the home garage, or to fill in its football coupons. The secretary, finding the flow of eloquence to be far beyond her statutory shorthand limit of ten words per minute, gives up the struggle and catches up on her manicure. So let no-one harbour the delusion that precious time is being squandered.

Ascending the social scale we come to the meetings at which section leaders tell the divisional manager just as much as they think he ought to know, and those at which the divisional managers perform the same office for the general manager. In due course the G.M. presents his own edited version to the Company chairman, who works the palatable bits off on the shareholders at that top-drawer function the Annual General Meeting. By reason of the multi-stage filtering which has gone on, any resemblance between his statement and the real situation is coincidental, but this doesn't matter as all shareholders exist in a state of torpor from which only the word "dividend" will arouse them.

Provided that the confirmed meeting-attender is sufficiently voluble and completely unintelligible he is certain to be delegated, sooner or later, to serve on an extra-mural committee, thereby qualifying for expense-account perks. Committees, unkindly described by some as bodies comprising twenty stomachs and no brain, exist for the purpose of going broody on clutches of technical eggs, mostly addled. The end product, achieved after a gestation period of three years, is a covey of singularly unpromising platitudes. (Australian committees hatch the duck-billed variety.)

Once a man has tasted the joys of serving on a committee he becomes the equivalent of a "mainliner." Soon he craves for a wider stage for his talents, and makes himself such a howling nuisance that his Company gives him one by packing him off to attend a symposium in Bartibog, N.B.

This is the penultimate phase of the rake's progress, as may be gathered from the dictionary definition which says: "Symposium; Ancient Greek after-dinner drinking party with music, dancers or conversation; any drinking party." I need stress the depths of depravity no further except perhaps to quote an extract from a form sent out to prospective participants. It reads as follows:

My wife will be with me } delete whichever inapplicable
My wife will not be with me }

I will share the room with

After only a short experience of this kind of bacchanalia the hapless victim is soon beyond all hope of redemption and winds up, a pitiful hunk of flotsam on the sea of life.

So with this horrible warning in front of us, let us erect in our mind's eye a statue to that unknown managing director of the future who will issue a decree that conference rooms are out, and that henceforth all meetings shall be held in a draughty, leaky Dutch barn. Preferably in mid-winter. That should separate the workers from the shirkers.

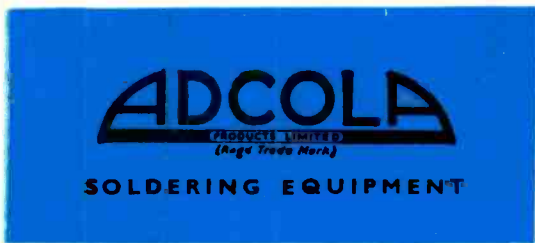

TOTAL PERFORMANCE

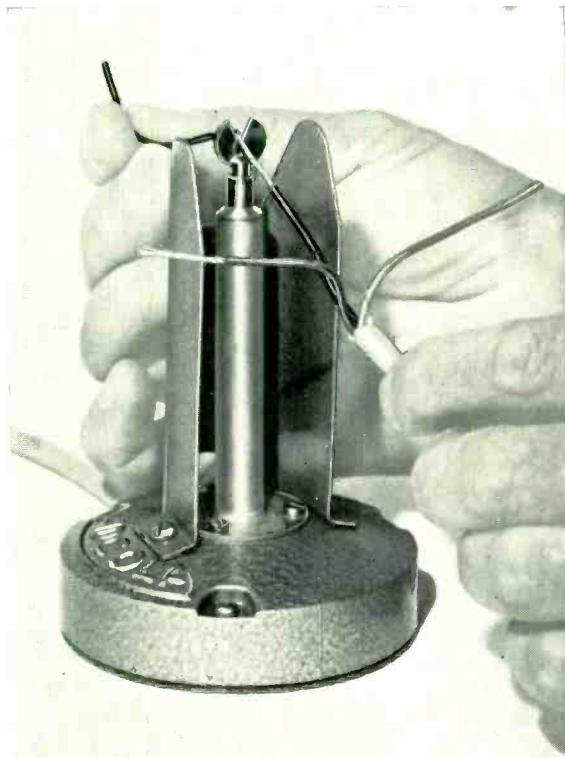

ILLUSTRATED
R300 BENCH STRIPPER



ILLUSTRATED
L64 IN PROTECTIVE SHIELD L700

*For full information
and sales apply direct to*

HEAD OFFICE SALES & SERVICE

ADCOLA PRODUCTS LTD
ADCOLA HOUSE, GAUDEN ROAD,
LONDON, S.W. 4.

Telephones: Macaulay 0291/3 Telegrams: SOLJOINT, LONDON, S.W.4

AUSTRALIAN ASSOCIATES: ADCOLA PRODUCTS PTY LTD., 673 WHITEHORSE ROAD, MONT ALBERT, MELBOURNE
AGENTS IN ALL LEADING COUNTRIES



Why do leading electronic manufacturers use Ersin Multicore Solder ?

Because they realise that their reputation can rest upon the quality of the solder they use. For utmost reliability they use Ersin Multicore, the *only* solder containing the purest tin and lead, plus 5 cores of extra-active, non-corrosive Ersin flux. Whatever the application – the speedy soldering of miniature components or the individual production of large units – there is an Ersin Multicore Solder which is exactly right for the job.

Standard Telephones & Cables Ltd. The manufacture of Automatic Telephone Exchange Equipment involves many million soldered joints. The accessibility of many of the wires is restricted after they have been terminated, and it is therefore essential that only solder of proved reliability be used. Consequently Ersin Multicore Solder, 60/40 alloy, has for many years been preferred by Telephone Manufacturers in Britain and overseas. It is approved by the British G.P.O. and many foreign Telephone Authorities, and is shown here being used by Standard Telephones and Cables Limited in the manufacture of a G.P.O. Line Finder Rack.

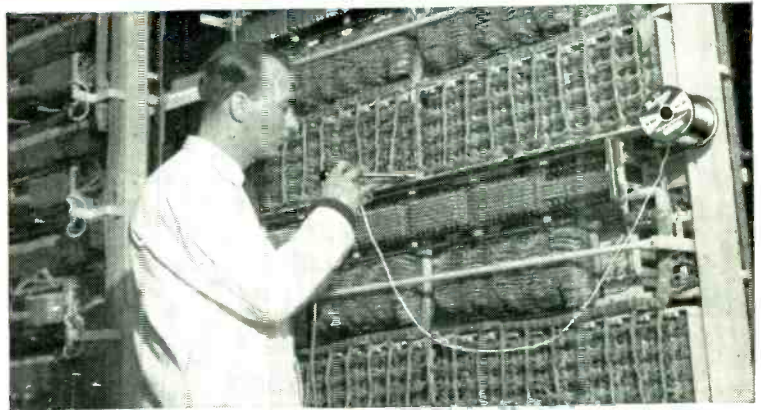

British Radio Corporation Ltd. The critical characteristics of U.H.F. tuners in television sets demand the highest quality of soldering. Ersin Multicore Savbit alloy containing five cores of extra fast Ersin 366 flux, is seen here being used by British Radio Corporation Ltd.

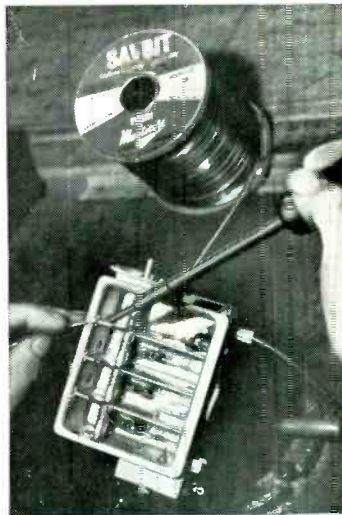

H. J. Leak & Co. Ltd. Ersin Multicore Savbit alloy is shown in use in the wiring construction of the Leak Integrated Stereo 30 Transistor Amplifier. In order to ensure the utmost reliability, the Leak High Fidelity equipment has been made with Ersin Multicore Solder for more than 20 years.

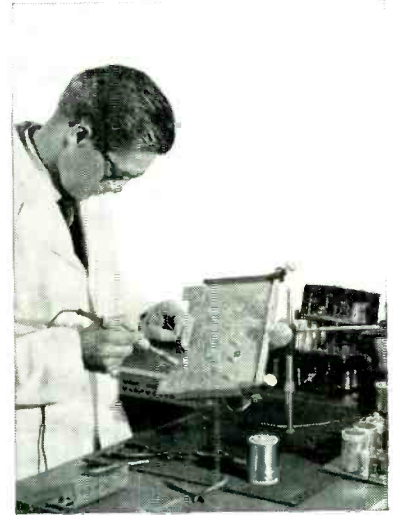

ERSIN

Multicore

5 CORE



SOLDER



reliability

Engineers and technicians are invited to write on their Company's letter heading for the booklet "MODERN SOLDERS" containing data on melting points, alloys, etc.

MULTICORE SOLDERS LIMITED, MAYLANDS AVENUE, HEMEL HEMPSTEAD, HERTS. TELEPHONE: HEMEL HEMPSTEAD 3636. TELEX: 82363 M.26