

LONDON COMPONENT SHOW PREVIEW

JUNE 1965
Three Shillings

Wireless World

ELECTRONICS • TELEVISION • RADIO • AUDIO

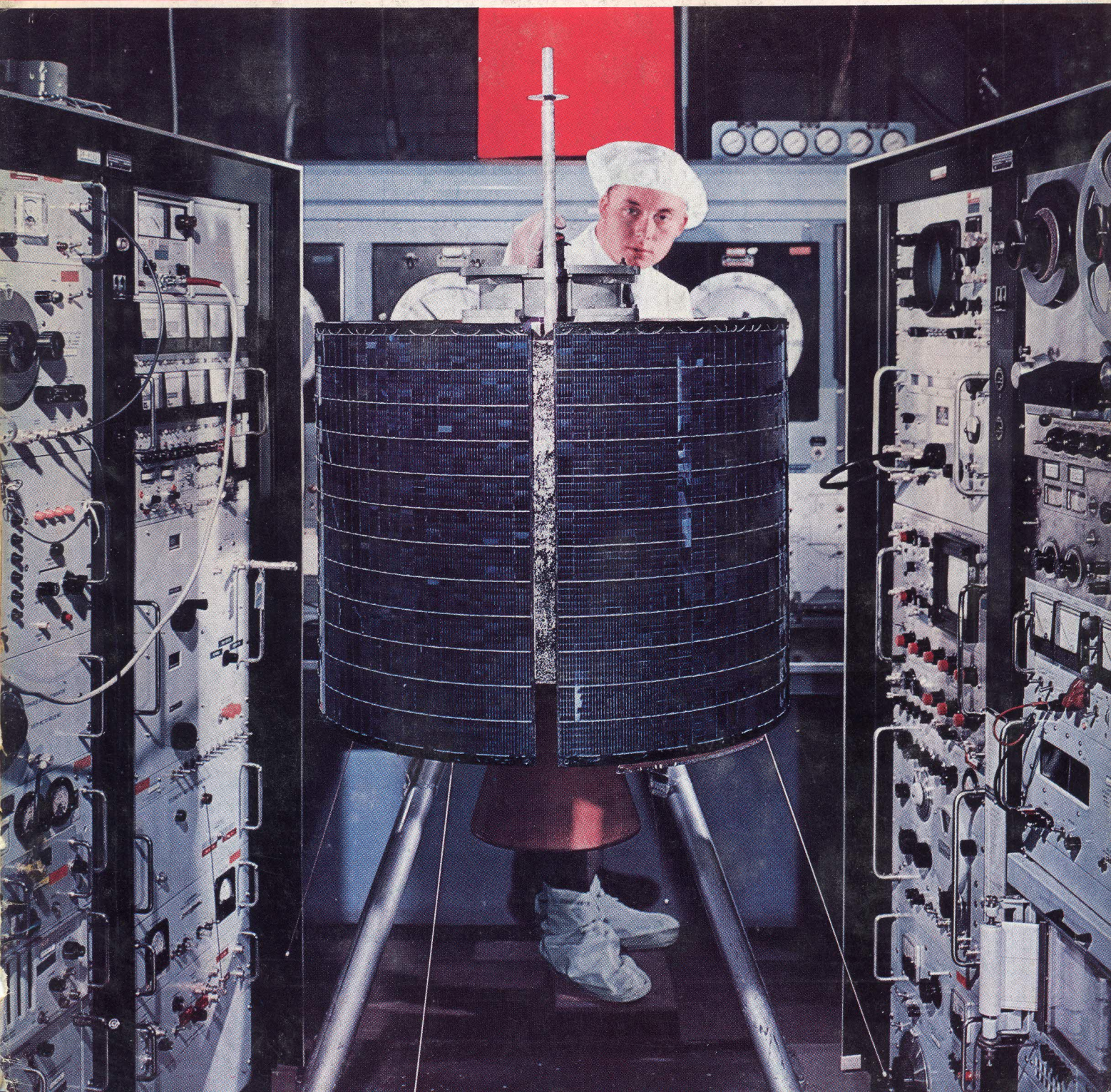

"Wireless World"
Iiffe Electrical Publications Ltd.,
Dorset House, Stamford Street,
London, S.E.1

Managing Director:

W. E. MILLER, M.A., M.I.E.R.E.

Editor-in-Chief:

W. T. COCKING, M.I.E.E.

Editor:

H. W. BARNARD

Technical Editor:

T. E. IVALL

Editorial:

D. C. ROLFE

G. B. SHORTER, B.Sc.

Drawing Office:

H. J. COOKE

Production:

D. R. BRAY

Advertisements:

G. BENTON-ROWELL
(Manager)

J. R. EYTON-JONES

© Iiffe Electrical Publications Ltd., 1965. Permission in writing from the Editor must first be obtained before letterpress or illustrations are reproduced from this journal. Brief extracts or comments are allowed provided acknowledgement to the journal is given.

VOLUME 71 No. 6

PRICE: 3s. 0d

FIFTY-FIFTH YEAR
OF PUBLICATION

Wireless World

ELECTRONICS, TELEVISION, RADIO, AUDIO

JUNE 1965

- 259 Editorial Comment
- 260 Field-effect Devices *By G. H. Olsen*
- 265 Information Theory and Pulse Communication *By D. N. Tilsley*
- 268 Recent Technical Developments
- 269 More about Early Bird
- 270 Radio & Electronic Components Show Preview
- 287 Letters to the Editor
- 291 International Audio Festival and Fair
- 294 World of Wireless
- 296 Personalities
- 297 News from Industry
- 298 Commercial Literature
- 299 Electronic Laboratory Instrument Practice—6 *By T. D. Towers*
- 305 SCR's for TV Line Scanning *By F. D. Bate*
- 311 Electronic Gaming Machines *By W. D. Gilmour*
- 316 H. F. Predictions—June
- 317 Manufacturers' Products
- 322 Real and Imaginary *By "Vector"*

PUBLISHED MONTHLY (4th Monday of preceding month). Telephone: Waterloo 3333 (70 lines). Telegrams/Telex: Wiworld Iiffepres 25137 London. Cables: "Ethaworld, London, S.E.1." Annual Subscriptions: Home £2 6s 0d. Overseas: £2 15s 0d. Canada and U.S.A. \$8.00. Second-class mail privileges authorised at New York N.Y. BRANCH OFFICES: BIRMINGHAM: King Edward House, New Street, 2. Telephone: Midland 7191. BRISTOL: 11, Marsh Street, 1. Telephone: Bristol 21491/2. COVENTRY: 8-10, Corporation Street. Telephone: Coventry 25210. GLASGOW: 123, Hope Street, C.2. Telephone: Central 1265-6. MANCHESTER: 620, Deansgate, 3. Telephone: Blackfriars 4412. NEW YORK OFFICE U.S.A.: 111 Broadway, 6. Telephone: Digby 9-1197.

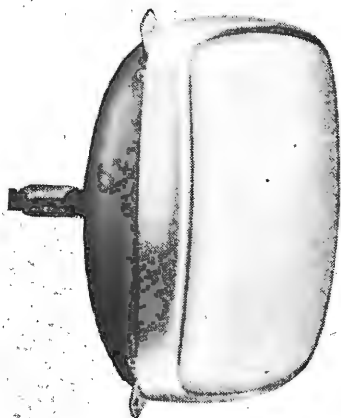

PANORAMA....

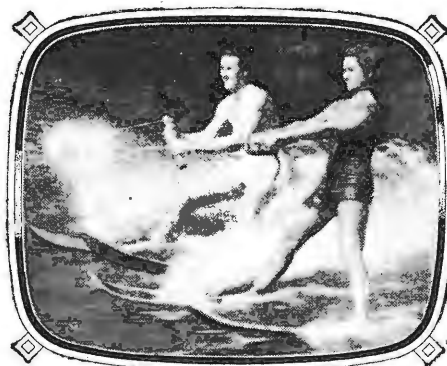

THE PICTURE WITH LIFE IN IT!

New PANORAMA tubes bring a fresh exciting sparkle to television. For the first time ever you're in touch with direct vision. There are no protective screens, no twin panels, no multiple reflections, no dust—nothing to spoil the clearest, truest-to-life reproduction ever seen.

And PANORAMA has long-life too. All the proven features of world-famous Mullard "Radiant Screen" tubes have been built into PANORAMA to make doubly certain that PANORAMA is the picture with life in it.

Mullard

Wireless World

ELECTRONICS, TELEVISION, RADIO, AUDIO

F. L. Devereux Retires

AFTER more than 40 years with *Wireless World*, including eight as Editor, F. L. Devereux has retired. A native of Birmingham, he became interested in wireless while at school in 1913 and had the (then) rare distinction of being given lines for drawing a circuit diagram in the flyleaf of his history book. He succeeded in building a crystal receiver, including headphones made from wooden pill boxes, with which he could receive (in Morse) the news bulletins from Eiffel Tower and recalls telling his parents that war had been declared hours before the special editions of newspapers were on the streets.

In 1917 he went to Parkeston Quay, Harwich, as a laboratory mechanic in the Board of Invention and Research engaged on anti-submarine methods, and in 1918 joined the Navy as a midshipman (Anti-submarine Division).

For a period immediately after demobilization in 1919 he joined his father in the family business as a manufacturing jeweller, but believing his potentialities to be scientific rather than artistic he was allowed to go to Birmingham University for three years where he took a degree in physics.

After toying with the idea of following his Professor's advice to go into teaching, he finally settled for what by now was clearly his abiding interest and in 1922 joined a Birmingham firm then in process of diversifying into the new field of sound broadcasting. He supplemented his meagre income by writing weekly features on the technical aspects of broadcasting for the *Birmingham Post*, which were subsequently produced in evidence when he was asked to show just cause why he should not accept a post on the editorial staff of *Wireless World* in 1923.

After a brief return to industry in 1924, during which time he continued to contribute regularly to *W.W.*, he rejoined the permanent staff and served for 30 years as an editorial assistant until he was appointed Assistant Editor in 1956 and Editor in 1957.

It is perhaps invidious to single out any one facet of his many contributions to the journal, the large majority of which have been unsigned, but mention must be made of the series of loudspeaker tests which he introduced in 1935 having built and calibrated an automatic loudspeaker frequency response curve tracer. It can now be said that more than one manufacturer submitted a prototype of a new loudspeaker for test before going into production!

G. A. Briggs in his "Audio Biographies," says: "Although I have known F.L.D. some twenty-five years, there has never been any 'scratch my back and I'll scratch yours' about the association. (You can't work that way with reputable journals or good audio writers.)"

We wish him a long, happy and healthy retirement during which he will have more time to enjoy his recreational interests, which include playing the viola, agriculture and horticulture.

Mr. Devereux is succeeded as Editor by H. W. Barnard, who has been 40 years with *Wireless World*, and Assistant Editor since 1959. T. E. Ivall, who recently returned to the editorial staff after a few years' absence, becomes Technical Editor. At the same time, W. T. Cocking, who has been associated with the journal for 35 years and has recently been Editor of *Industrial Electronics*, has been appointed Editor-in-Chief of both *Wireless World* and *Industrial Electronics*.

VOL 71 NO 6
JUNE 1965

Field-effect Devices

By G. H. OLSEN,* B.Sc., A.M.I.E.R.E.

ALTHOUGH it has been possible for more than thirty years to make field-effect devices in the laboratory, it is only recently that the significant advances made in semiconductor technology have enabled us to manufacture reliable units with useful characteristics. In an early form (O. Heil's patent—1935) the resistance of a semiconducting layer could be varied by the application of a varying voltage to an adjacent control electrode. The control electrode, although close to the semiconducting layer, was electrically insulated from it. In those days materials such as cuprous oxide and vanadium pentoxide were used, whereas to-day we employ p- and n-type silicon, cadmium sulphide, cadmium selenide and other semiconductors known to the manufacturers of solid-state devices. We have, in the field-effect transistor (f.e.t.), a device of outstanding importance; and it is not therefore surprising that in the last few years increasing emphasis has been placed on research into the physics and applications of such devices. It is, perhaps, not too

rash to predict the eclipse of the conventional transistor in several applications.

The trend in the last ten years towards transistorizing equipment has made us realize that the ordinary form of transistor suffers from several disadvantages, the most important being a low input-impedance. In conventional transistors noise is an inherent problem that results from the inevitable crossing of potential barriers by majority carriers and the recombinations that occur mainly in the base region. When using transistors in D.C. amplifiers for low-level work, in the medical or biological fields, for example, the off-set voltage is troublesome. Readers will recall that when we use ordinary transistors as choppers in d.c. amplifiers there is a small output from the chopper amplifier even when there is no input voltage. This output voltage, known as the off-set voltage, results from the difference between the unequal voltages that exist across the two p-n junctions within the transistor when the latter is in the "on" or conducting state. Unfortunately the offset voltage is a function of temperature so that variations of ambient temperature give rise to the introduction of a spurious "input" voltage.

Field-effect devices, as we shall see later, overcome these disadvantages. The reverse-biased diode type of f.e.t. has an input resistance of about 10^{10} ohms, whilst the insulated gate types now under development have input resistances approaching 10^{15} ohms with input capacitances of less than 5 pF. Herein lies the most important advantage of the field-effect transistor. Since, in the f.e.t., current is carried by only one type of charge carrier, and there are no potential barriers to cross, these new devices have a lower noise figure than ordinary transistors. In addition f.e.t.s. have no off-set voltage. This means that we can now combine the desirable features of the thermionic valve with those of a conventional transistor in a device that could be a superior substitute for both in many circuit applications.

Basically there are three types of field-effect transistor, namely, the reverse-biased p-n junction type, the insulated gate device based on a single crystal and the

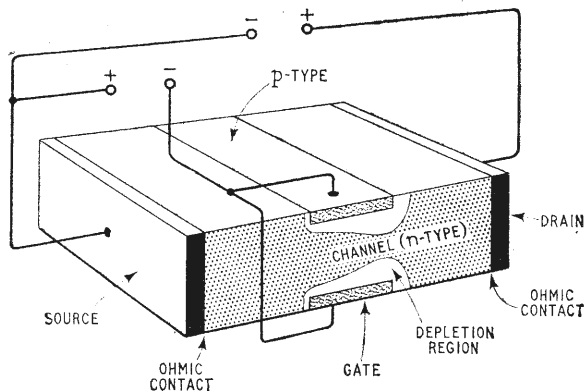

Above: Fig. 1. The Shockley-type device.

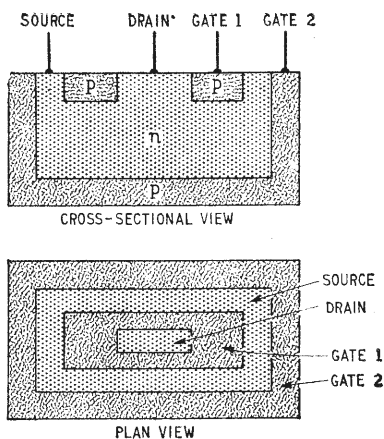

Right: Fig. 2. A Ferranti-type device. For many applications gate 1 and gate 2 are connected together in the external circuit.

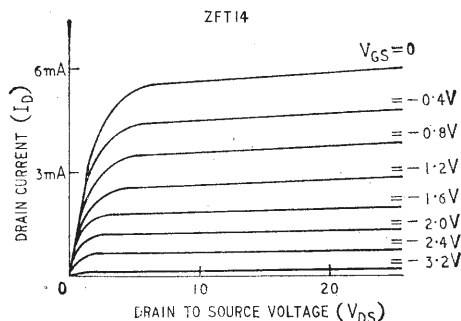

insulated gate version that uses a polycrystalline layer of semiconductor.

The Reverse-biased Diode F.E.T.

This type of device was first proposed by Shockley¹, who called it a unipolar field-effect transistor because only one type of charge carrier is used to carry the current. This is different from a conventional bipolar transistor in which both majority and minority charge carriers are involved.

Fig. 1 shows schematically the construction of such a device. A bar of n-type material has p-type impurities introduced into opposite sides. These p-type regions form the control electrode known as the gate. Between the gate electrodes there exists a channel of conducting material extending to ohmic contacts at the ends. One end is called the source and the other end the drain. Majority carriers (electrons in this case) may then flow along the channel from source to drain between the gate electrodes. The source-to-drain current, I_D , for a given source-to-drain voltage, V_{DS} , will depend on the total resistance between the drain and the source. The resistance is determined by the effective width of the channel between the gate electrodes. The gate-channel junctions are operated as reverse-biased p-n junctions. As the reverse voltage is increased, the depletion layer is extended into the body thus reducing the effective channel width and hence its conductance. It will be recalled that the depletion layer is an insulating layer since, as the term implies, this region is depleted of charge carriers. Thus, we can modulate the source-to-drain current by the application of varying gate voltages. Since the gate-channel junction is operated as a reverse-biased diode, the gate input resistance for silicon devices is extremely high. As will be seen from Fig. 1, depletion layer thickness is not constant in width along the channel. The region of the gate nearer the drain will have a greater reverse-bias voltage than elsewhere because of the voltage drop along the channel. The application of sufficient reverse voltage reduces the effective channel width to zero, and thus the current, I_D , is cut off. The channel is then said to be "pinched-off." The minimum voltage between the gate and source necessary to produce pinch-off conditions is termed the pinch-off voltage, V_p .

Although improvements in transistor technology have modified the physical arrangement used in the Shockley transistor, the principle of operation remains unaltered. The early Shockley types could not be made in commercial numbers with the techniques available in the mid-1950s. Now that the industry has mastered masking, diffusion and epitaxial techniques for silicon devices, we are able to manufacture f.e.t.s with a reasonable degree of reproducibility. Fig. 2 shows the physical form of a modern f.e.t. taken from a Ferranti report.² The drain characteristics for one of their commercially available devices are also given. At the time of writing (Feb., 1965), the cost of such devices is high (approaching £10 each for several manufacturers' products). However, such cost reflects the expensive research involved. Fundamentally, the devices are cheap to make; and with the fast-increasing use of large numbers of f.e.t.s it is expected that the cost will compare favourably with that of conventional transistors.

Fig. 3(a) shows a circuit designed by Ferranti Ltd. for the ZFT 12 field-effect transistor⁶. In order to test the claims made for the device the circuit was assembled on a piece of Veroboard* $2\frac{1}{2}$ in by 1 in. The gate electrode

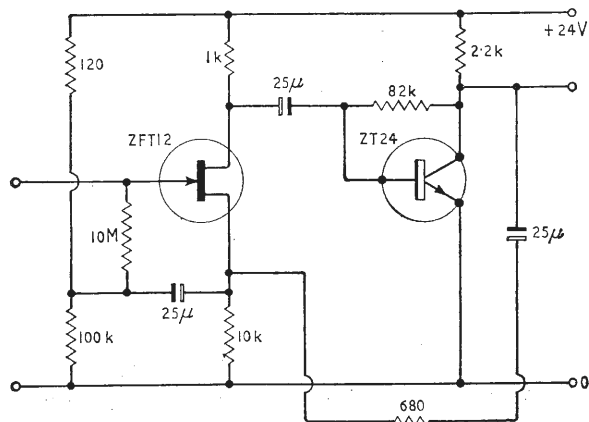

Fig. 3(a). High input impedance circuit (Ferranti Ltd.).

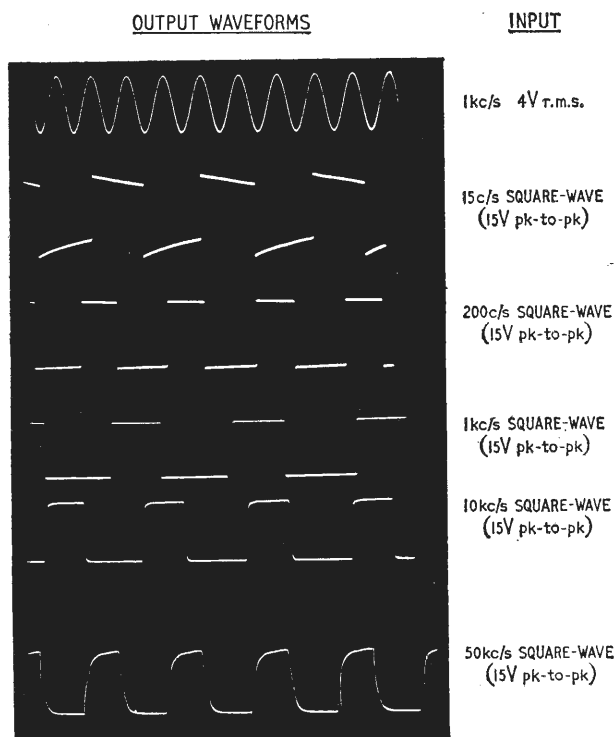

Fig. 3(b). Oscillograms showing the performance of the amplifier of Fig. 3(a) under the conditions described in the text.

was taken directly to a polythene-insulated terminal. The output of the f.e.t. is taken *via* a capacitor to the base of a silicon n-p-n bipolar transistor. Heavy negative feedback is used to increase the input impedance of the complete amplifier. Ferranti claim for their circuit an input resistance of 500 MΩ, an input capacitance of 4.5 pF and unity gain. The resistors in the test amplifier were ordinary 10% tolerance types. The amplifier was found to have an input resistance of 490 MΩ, an input capacitance of 10 pF (including the very short input lead) and a gain of 0.99. The distortion at 1 kc/s was too low to be measured on a Marconi distortion meter when the input voltage was 4 V r.m.s. Clipping of sine waves was not evident on the oscilloscope until the r.m.s. voltage

* Trade name of Vero Electronics Ltd.

reached 5.1 V. Fig. 3(b) shows the outward waveforms obtained with an input sinusoidal voltage of 4 V r.m.s. at 1 kc/s and square-wave inputs of 15 c/s, 200 c/s, 1 kc/s, 10 kc/s and 50 kc/s. The square waves had a pk-pk voltage of 15 V.

The Metal-oxide-semiconductor Transistor Insulated Gate F.E.T.

An attempt to increase further the input resistance of field-effect devices has resulted in a return to O. Heil's idea whereby the gate electrode is electrically insulated from the conducting channel. The construction and mode of operation is, therefore, significantly different from the Shockley reverse-biased diode type. Although only in the development stage at the moment, it seems that this latest device will give a much improved performance over the diode type.

There are several ways in which the insulated gate type of transistor may be constructed. Let us consider first a prototype model of the kind made by Hofstein and Heiman.³ Once this type has been understood, modifications can be easily appreciated. The main constructional features are shown in Fig. 4(a). A p-type silicon body is used as a substrate upon which are diffused two heavily doped n-regions in closely spaced parallel strips along the body. A layer of silicon dioxide some 1,000 Å thick is then thermally grown or evaporated on to the surface using a mask to leave the n-type regions uncovered. On the surface of the silicon dioxide insulating layer, and

between the n-type regions, an aluminium layer is deposited, which acts as the gate electrode. This method of insulating the gate is preferred to the use of a discreet wafer of insulating material partly because of the thinness that can be achieved, and also because a thermally grown silicon dioxide layer passivates the silicon surface (i.e. it reduces very considerably the density of surface traps). Ohmic contacts are made to the n-regions (one of which acts as the sink and the other the source) and also the gate. By making the gate positive with respect to the source, a positive bias exists between the gate and the p-type body in the region of the source. Positive charge carriers are repelled into the body and negative charge carriers are attracted to the surface. At the body-silicon dioxide interface there is thus induced an n-type layer of mobile charge carriers. This layer connects the drain and source resistively; it is often referred to as an inversion layer because, on increasing the gate voltage from zero, the channel, originally p-type, becomes intrinsic and then finally an n-type layer is formed. Further increases in gate voltage increase the number of electrons in the channel thus reducing the resistance between the source and drain. If a voltage is now applied between the source and drain, a drain current, I_D , will flow. The magnitude of the drain current can be varied by applying varying voltages to the gate. Although the gate is positive no current is taken by this electrode, since the silicon dioxide acts as an excellent dielectric.

Input resistances of the order of 10^{12} ohms have been achieved in available British units; whilst the Americans

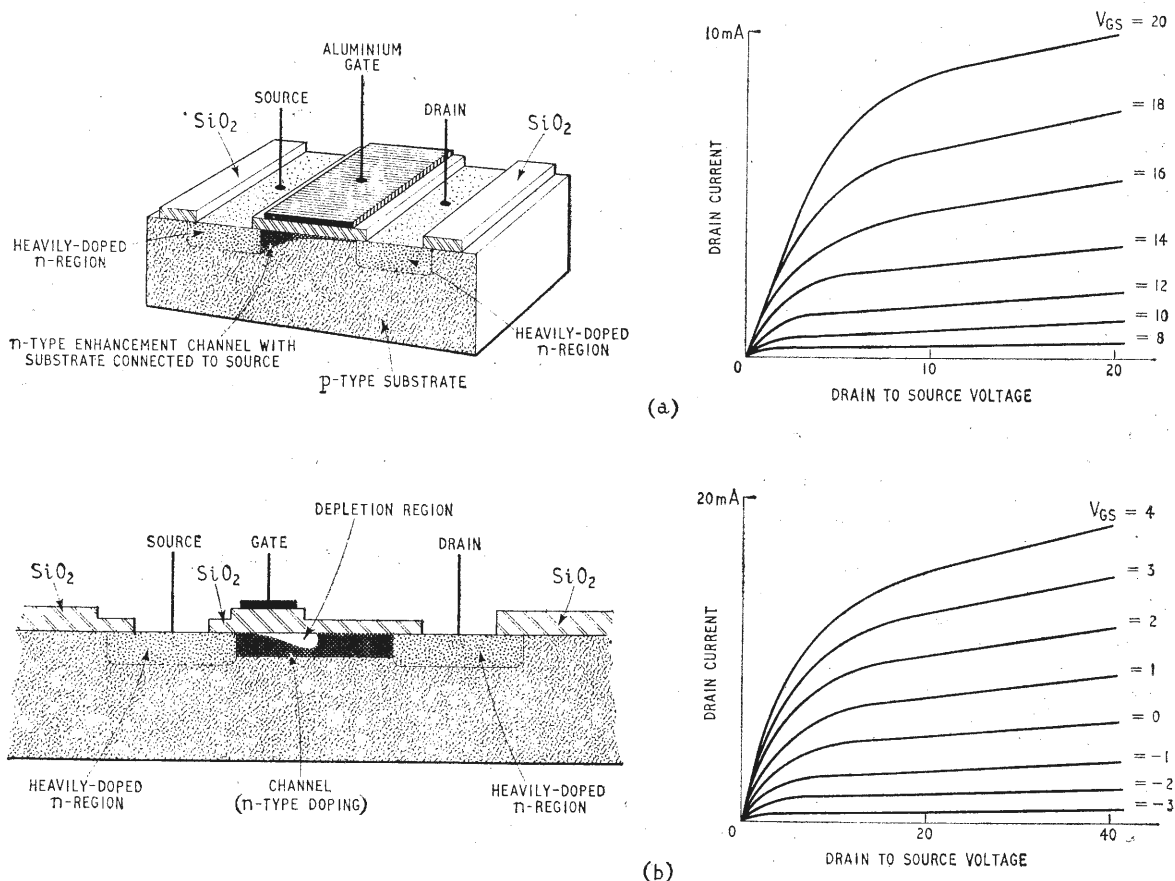

Fig. 4(a). An enhancement-type unit and typical characteristics; (b) A depletion-type device.

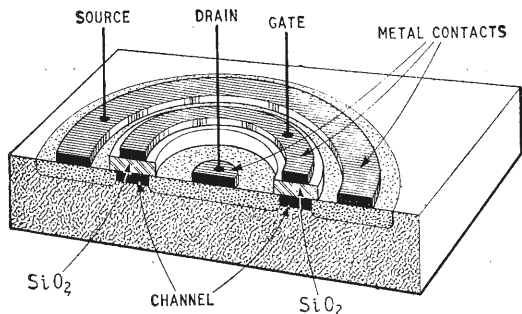

Fig. 5. Alternative geometry for an insulated-gate f.e.t. The heavily doped regions are shown dotted.

are claiming up to 10^{15} ohms for some of their transistors. We have therefore a solid-state device that is a close equivalent to a triode insofar as it is a voltage-operated device with a very large input impedance.

Insulated gate field-effect devices may be operated in one of two ways, namely, the enhancement mode or in the depletion mode, depending upon the form of construction used. In the enhancement mode we have an n-type channel between heavily doped n-type regions with the gate extending across the entire channel as in Fig. 4(a). The gate is forward-biased enhancing the number of electrons in the channel and reducing the source-to-drain resistance. At zero gate voltage the number of charge carriers in the channel is very low and so the drain current is effectively zero. One of the disadvantages of the enhancement type unit is the large capacitance associated with the gate electrode. To overcome this we may use an offset gate that does not cover the whole of the channel. Normally this would produce a very high resistance in the channel region not influenced by the gate. However, by suitable doping, a channel may be produced that has appreciable conductivity at zero gate voltage. Such a transistor would be a depletion type and have the drain, source and channel regions all of the same conductive-type material although the drain and source regions are still heavily doped. The gate voltage must then be driven to some negative value before the drain current is zero. Fig. 4(b) shows the cross-section of this type of unit together with typical characteristics. It will be seen therefore that the pinch-off voltage, V_p , for a given transistor may be positive, zero or negative depending upon the construction. In practice it is difficult to determine just when the drain current is zero so V_p is defined as that voltage that reduces the drain current to some specified low value (say 10 to $20 \mu A$).

Fig. 5 shows an alternative geometry. Some manufacturers (e.g. Ferranti and Mullard) make a fourth connection to the substrate creating a four-terminal device. Many workers are now exploiting f.e.t.s., and since several applications have been published, they will not be repeated here (see for example the article by F. Butler in the February 1965 issue of the *Wireless World*, correspondence in the following month's issue and also the Mullard booklet on their 95 BFY f.e.t.).

T(hin)-F(ilm) T(ransistors)

Conventional transistors, and those field-effect types so far described, depend for their successful action upon mechanisms within single crystals that have been suitably doped, polycrystalline material being clearly unsuitable.

However, a new type of amplifying device, that may loosely be called a transistor, has been described by Weimer.⁴ A microcrystalline layer of semiconductor has been used as a channel; and it is claimed that when low resistance contacts are made to the film, thus forming source and drain electrodes, a device is obtained that has a voltage amplification factor greater than 100, an input impedance of greater than 10^6 ohms shunted by 50 pf, gain-bandwidth products in excess of 10 mc/s and switching speeds of less than 0.1μ sec. So far as the writer is aware these units are not available from British manufacturers, but if the claims made for the device are realized in units that can be easily reproduced on a commercial scale, then a potentially cheap and popular transistor will be added to the range already available. Development is being pursued feverishly and already Weimer, Shallcross and Borkan,⁵ with an improved electrode arrangement, have raised the input resistance to 10^{10} ohms and extended the gain-bandwidth product to 25 mc/s.

Cadmium sulphide was chosen by these workers for the semiconducting film, presumably because a good deal is known about the solid-state physics of this material as well as the technology associated with its deposition in thin films. Fig. 6 shows diagrammatically the coplanar electrode form of a thin-film transistor (t.f.t.). A polycrystalline n-type CdS layer, a fraction of a micron thick, is deposited on an insulating substrate; and evaporated aluminium contacts are made to form the source and drain. The length of these electrodes is about 2 to 5 mm,

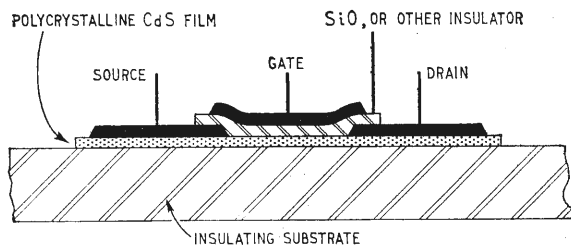

Fig. 6. A coplanar electrode arrangement of a thin-film transistor.

and they are spaced about 10 microns apart. An insulated gate is then formed in the usual way, the insulator being about 500 Å thick. Insulating materials found to be satisfactory are silicon monoxide and calcium fluoride. As in the f.e.t. described earlier, the presence of the insulating layer permits positive biasing of the gate without that electrode drawing current of any great magnitude. Typical drain characteristics exhibit the pentode-like characteristics of the f.e.t.

There are no prizes for guessing that the way in which this type of transistor works is more complex than those field-effect devices that rely on single crystals. In fact, the mechanism whereby the gate modulates the drain current is not yet fully understood. The picture is certainly complicated by the fact that the semiconducting layer consists of many small crystallites thus introducing the complications of grain boundaries and surface defects. The t.f.t. is a majority-carrier device in which the application of a voltage to the gate brings about the injection of majority carriers into the semiconductor *via* the source electrode. Many charge carriers are held by the surface traps and other immobile sites; and those that are not so held contribute to the density of mobile carriers. Increasing the gate voltage in an enhancement type unit

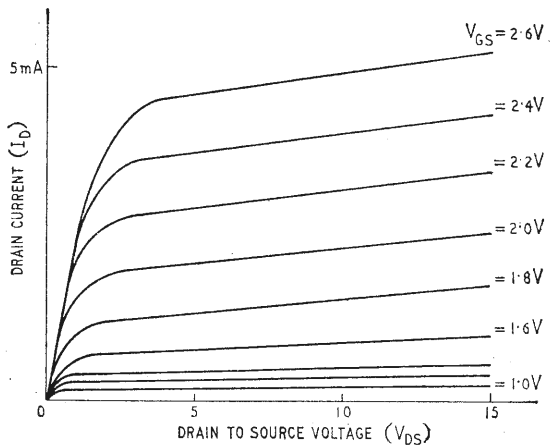

Fig. 7. Drain characteristics for a coplanar electrode f.e.t. of the enhancement type.

increases the density of carriers thus increasing the channel conductivity. The surface conductivity can alternatively be reduced by decreasing the gate voltage in which case the device is being operated in the depletion mode. In this latter case, reduction of the gate voltage from zero depletes the surface of mobile charge carriers.

For the types of construction that yield useful transistors, the field-effect is, of course, the dominant mechanism. Fig. 7 shows the characteristics that are obtained in one type of unit. The slow initial rise of drain current with gate voltage supports the theory that surface traps and states are being filled. As, however, the bias voltage is increased, the typical saturation and spacing characteristics of field-effect experiments are obtained. Such saturation effects are not always obtained in experimental units, however, owing to faulty construction and the effect of source-drain contacts. There is certainly still much to learn about the physics and technology of this device. In particular, we may note that cadmium sulphide is not the only semiconductor suitable for t.f.t.s. Although it is necessary to use a wide-gap semiconductor such as CdS in order that the resulting high resistivity avoids the shunting of the channel by the bulk of the material, other materials may prove to give an improved performance.

No one can doubt that these new field-effect transistors are very important additions to the range of solid-state electronic devices. Apart from the advantages already mentioned, we can easily see that the geometry of these new devices lends itself admirably to their incorporation in micromodule systems. With conventional bipolar transistors the current flow is perpendicular to the surfaces, whereas with the new active devices the electrodes can be brought out in a direction parallel to the substrate. Now that thin-film resistors, capacitors and inductors can be readily produced, it is particularly advantageous to have a thin-film transistor that can be fabricated by the same techniques. The advantages of thin-film circuits have not in fact been fully realized to date largely because of the lack of an active device such as the thin-film transistor. We shall certainly in the future be hearing much more about the incorporation of f.e.t.s and t.f.t.s into solid-state circuitry, and in other circuits where the conventional transistor has not proved wholly satisfactory. Engineers brought up on thermionic valves will be particularly interested in having a solid-state voltage operated

device that permits operation at high input impedances with very low noise levels. Those concerned with the design of integrated circuits will welcome such features as the direct-coupling possible because the control electrode of an insulated-gate device can be operated with a positive bias; the relative immunity from radiation effects (because f.e.t.s operate with only one kind of charge carrier); and the elimination of temperature compensating circuitry due to the fact that these new devices are not very susceptible to changes in ambient temperature.

REFERENCES

- (1) Shockley, W. "A Unipolar Field-Effect Transistor," *Proc.I.R.E.*, Vol. 40, p. 1365, November 1952.
- (2) Application Note No. 22. "Field-Effect Transistors and Applications." Ferranti Ltd., Oldham, Lancs.
- (3) Hofstein, S. R. and Heiman, F.P. "The Silicon Insulated-Gate Field-Effect Transistor," *Proc.I.E.E.E.*, Vol. 51, p. 1190, September 1963.
- (4) Weimer, P. K. "The T.F.T.—A new Thin-Film Transistor," *Proc.I.R.E.*, Vol. 50, p. 1462, June 1962.
- (5) Weimer, P. K., Shallcross, F. V., and Borkan, H. "Coplanar-Electrode Insulated-Gate Thin-Film Transistors," *R.C.A. Review*, Vol. 26, No. 4, December 1963.
- (6) Down, B. "Using Feedback in F.E.T. Circuits to Reduce Input Capacitance," *Electronics*, Vol. 37, p. 63, December 14, 1964.

THIS MONTH'S CONFERENCES AND EXHIBITIONS

Further details are obtainable from the addresses in parentheses

LONDON

- June 15-19 Earls Court
Church and School Equipment Exhibition
 (Hilfe Exhibitions, Dorset House, Stamford St., S.E.1)
- June 15-19 Earls Court
Noise and Vibration Reduction Exhibition
 (NAVREX, Crown House, Morden, Surrey)
- June 16-26 Olympia
Interplas Plastics Exhibition
 (*British Plastics*, Dorset House, Stamford St., S.E.1)
- June 30-July 2 University College
Microwave Applications of Semiconductors
 (I.E.R.E., 8-9 Bedford Square, W.C.1)

EXETER

- June 12-17 The University
International Spectroscopy Colloquium
 (Inst. Phys. & Phys. Soc., 1 Lowther Gdns., London, S.W.7)

OVERSEAS

- June 7-9 Boulder
Global Communications Convention
 (W. F. Ulant, N.B.S., Boulder, Colo.)
- June 10-21 Le Bourget
Paris Air Show
 (U.S.I.A.S., rue Galilée, Paris 16)
- June 18-29 Rome
Electronics Congress & Exhibition
 (Rassegna Elettronica, via della Scrofa, 14, Rome)
- June 20-24 Houston
Aerospace Conference
 (T. B. Owen, 635 20th St., Santa Monica, Cal.)
- June 22-25 Troy, N.Y.
Joint Automatic Control Conference
 (Prof. J. W. Moore, University of Virginia, Charlottesville)
- June 27-July 3 Stockholm
Navigation Congress
 (British National Navigation Committee, c/o I.C.E., Gt. George St., London, S.W.1)
- June 28-29 San Juan, Puerto Rico
Physics of Quantum Electronics
 (P. L. Kelly, M.I.T. Lincoln Lab., Lexington, Mass.)
- June 28-30 New York
Electromagnetic Compatibility
 (I.E.E.E., Box A, Lenox Hill Station, New York 21, N.Y.)

Information Theory and Pulse Communication

By D. N. TILSLEY,* B.Sc., Grad.Inst.P., A.M.I.E.R.E.

INFORMATION Theory, or Communication Theory as it is sometimes called, can be applied to almost everything from music and poetry to the sense of smell. But it was developed by communications engineers and it is most relevant to us as communications engineers, since it enables us to take a very wide view of our subject. It was given its present elegant and comprehensive form by C. E. Shannon over fifteen years ago, but the basic ideas have evolved gradually over the last century. The full theory is difficult even for mathematicians, but the principles can be readily understood.

Information is transmitted by some quantity assuming different values in succession. Ordinary conversation is effected by our varying the air pressure in talking; some insects probably communicate by waving their antennae. But electrically, information is usually transmitted by a varying voltage or current. In all forms of communication something must change its value or level.

There are two very important and fundamental limits to the quantity of information which can be transmitted in a given time:

(1) There is a limit to the number of different levels which may be distinguished.

(2) A finite time is needed for the quantity to change from one level to another.

A wall chart could be made showing a column of the 26 letters of the alphabet, and words could be spelled out by a pointer indicating one letter at a time. Why could not this chart be printed with all the words of the dictionary, or even all the 10^n possible sentences? This surely would speed up communication.

Quite apart from the limit due to the size of the carbon particles in printer's ink, the end of the pointer would be subject to small erratic movements which would cause uncertainty as to which level was intended. In every system there are small unpredictable random variations which are called noise. Sound is transmitted by air pressure and ultimately this is due to the bombardment of the individual molecules of which the air is composed. Similarly an electric current is the flow of electrons, and they too are subject to random movements. In general it will be very difficult to distinguish between levels differing by less than this random noise level. (It is interesting to note that our senses can operate down almost to the body's noise level. If you shut your eyes in a dark room you can see countless minute pin points of faint light: listen intently and you can hear a faint rushing noise.)

Noise is responsible for our first limit: we cannot use too many levels. In telegraphy and data transmission frequently only two levels are used—on and off, and then transmission in the presence of noise is possible with very few errors, since the receiver has to distinguish only between "signal" and "no signal."

How much information can be transmitted by a single signal which may be at any one of N levels? The usual unit of information is the binary digit or "bit." A single answer which must be either "yes" or "no" provides one "bit" of information. (This is strictly true only if the answers "yes" and "no" are equally likely.)

If there are four possible levels, 0, 1, 2 and 3, then which level is intended could be fixed by the answers to two "yes or no" type questions, such as "Is it greater than 1?" "Yes." "Is it No. 2?" "No." Therefore the required level must be No. 3. Similarly, to fix which of 8 possible levels is intended requires 3 bits, 16 levels need 4 bits and 32 levels need 5 bits. Now $4=2^2$, $8=2^3$, $16=2^4$ and $32=2^5$. The number of bits of information contained in the knowledge that a signal is at a particular level, when it could equally likely be at any one of N possible levels, is $\log_2 N$ bits. To apply this to an electrical system, we will assume that the input signal power is P_s and that the input noise power is P_n so that the total input power is $P_s + P_n$. Voltage levels differing by less than the noise voltage cannot easily be distinguished and so, since voltage is proportional to the square root of power, the greatest number of distinguish-

able levels is $\sqrt{\frac{P_s + P_n}{P_n}}$. A single signal transmitted over a system in which the signal-to-noise power ratio is $\frac{P_s}{P_n}$

will therefore be capable of containing up to $\log_2 \sqrt{\frac{P_s + P_n}{P_n}}$
 $= \log_2 \left(1 + \frac{P_s}{P_n}\right)^{\frac{1}{2}} = \frac{1}{2} \log_2 \left(1 + \frac{P_s}{P_n}\right)$ bits of information.

The second fundamental limit would be attributed by a mechanical engineer to inertia: the pointer on our wall chart cannot jump instantaneously from one level to another. We electronics engineers think of rise and fall times as due to capacitive and inductive circuit elements. Circuits with a fast risetime will also respond to the fast variations of high frequency sinewaves, and really "risetime" and "bandwidth" are just two different ways of looking at the same thing.

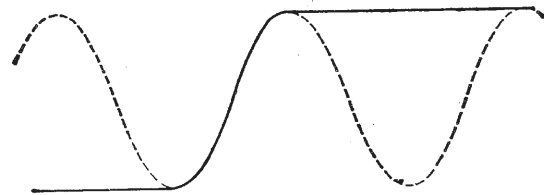
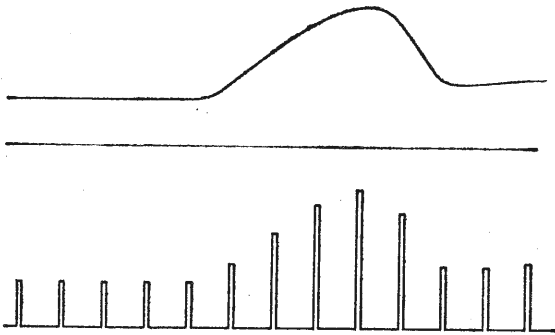

Fig. 1. Showing that risetime in a circuit is approximately half the period of the sinewave of the maximum frequency to which the circuit will respond.

* Borough Polytechnic, London, S.E.1.



Left: Fig. 2. Pulses of varying amplitude resulting from sampling a continuous a.f. waveform.

If a circuit can respond to all frequencies up to f , then the risetime will be approximately one half of the period of the sinewave of this frequency, that is, the risetime will be $1/(2f)$. Fig. 1 shows a dotted sinewave of the highest frequency to which the circuit responds, and the thick line shows that this is equivalent to a risetime of one half of the complete period.

Since the time required to change from one level to another is $1/(2f)$, we can have $2f$ changes in level effected in one second when the bandwidth is f c/s. This is not really a proof, and there are the difficulties of how we define risetime and bandwidth. However, the final result is true and is capable of rigorous proof: we have merely shown that the result is a very reasonable one.

Since each change of level can provide $\frac{1}{2} \log_2 \left(1 + \frac{P_s}{P_n} \right)$ bits, the theoretical maximum rate of transmission of information over a channel of power signal-to-noise ratio $\frac{P_s}{P_n}$ and bandwidth f cycles per second is:

$$2f \times \frac{1}{2} \log_2 \left(1 + \frac{P_s}{P_n} \right) = f \log_2 \left(1 + \frac{P_s}{P_n} \right) \text{ bits per second.}$$

Although it had been realized for a long time that a high rate of information requires a wide bandwidth and a good signal-to-noise ratio, this very important equation, due to Shannon, provides a quantitative relationship.

There is one more piece of theory to be glanced at before considering the application of all this to pulse communication. It is the Sampling Theorem and it is fundamental to all pulse communication systems, such as pulse amplitude modulation (p.a.m.), pulse width modulation (p.w.m.), pulse position modulation (p.p.m.) and pulse code modulation (p.c.m.).

The information to be transmitted is usually a continuously varying quantity, such as the output from a microphone, but pulses are discrete and separate. So in pulse communication systems the continuous a.f. output from the microphone (suitably amplified) is "sampled" as shown in Fig. 2. Pulses are thus obtained whose height or amplitude is equal to that of the a.f. waveform at the instant of sampling.

This sampling process is the first step in all pulse systems. One might think that it is bound to result in some loss of information, but this is not necessarily so, and the Sampling Theorem states that if the highest frequency present in the a.f. waveform is f , then no information need be lost if at least $2f$ samples are taken per second. To illustrate this let us imagine that a cine film is being made of a swinging pendulum. If one frame or "shot" were taken for each complete cycle, the resulting film would give the wrong impression and the pendulum would appear stationary. It would be essential to take at

Below: Fig. 3. (a), (b) and (c) show the a.f. waveforms from three channels A, B and C. They are sampled in turn and (d) shows them arranged for p.a.m., t.d.m. The pulses marked $A_1, A_2, A_3 \dots$ are the samples of waveform A, and those marked $B_1, B_2, B_3 \dots$ represent waveform B, sampled a microsecond or so later. (e) shows the pulses marked $A_1, A_2, A_3 \dots$ extracted, and the dotted line indicates the waveform which could be derived from these pulses, and which should be identical with that of (a). Similarly pulses B_1, B_2, \dots could be extracted and made to furnish the waveform of (b). Many channels may be multiplexed in this way, each set of pulses, A_n, B_n, C_n , being preceded by an easily recognized synchronizing pulse, probably of much longer duration. This simplifies the sorting out of the multiplexed pulses at the receiver: the first pulse after the sync pulse is an A, the second a B, and so on.

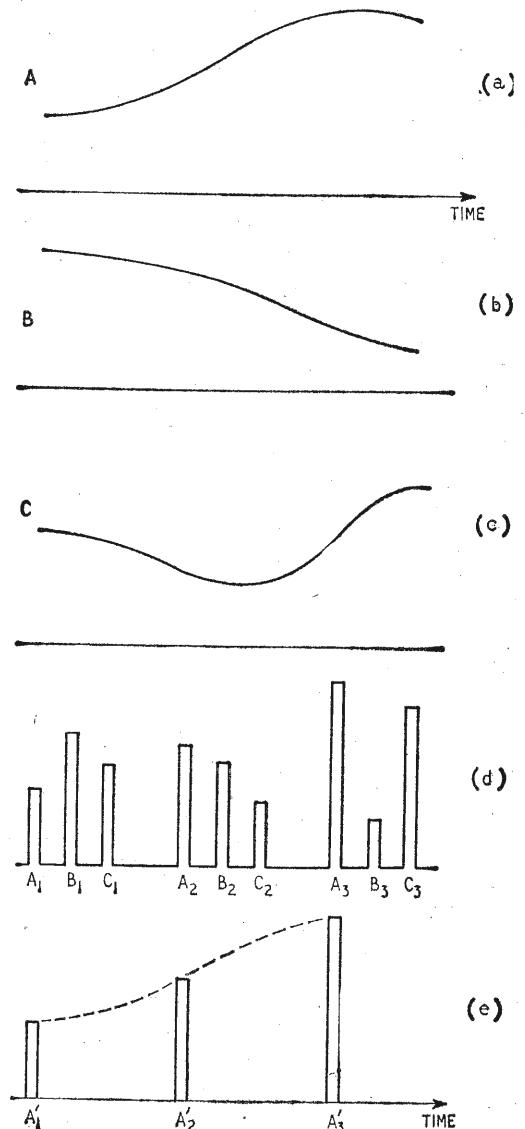

least two frames for each complete period of the pendulum.

Generally for a sine wave if we know the amplitude at two instants in the cycle, we can reconstitute the original waveform. The possible objection that we do not know its shape, and that there might be a "wobble" in it, is not a valid one, for this implies that there is some component of higher frequency present. (In a way the Sampling Theorem is the converse of the previous theorem that $2f$ changes in level can be transmitted in one second over a bandwidth of f c/s.)

This sampling rate of twice the highest frequency present is called the Nyquist Rate. The a.f. waveform is first passed through a low-pass filter with a sharp cut-off; for speech this might be designed to eliminate frequencies above 3.4 kc/s. This waveform could then be sampled at 8 kc/s or perhaps 10 kc/s. (6.8 kc/s would not be suitable, since no filter can have an infinitely sharp cut-off.)

The resulting samples might be transmitted along a line, in telephony, or used to modulate a radio frequency carrier, in radio transmission: this is pulse amplitude modulation. Usually several separate channels, each from a different telephone conversation, are "multiplexed" on a time basis and transmitted over a single line or radio link. This is called time division multiplex (t.d.m.) and is shown in Fig. 3 for p.a.m.; the other pulse systems which we will consider later are also usually multiplexed in this manner.

P.a.m. is a relatively simple system, but it gives no protection against noise. Any noise superimposed on these pulses during transmission will appear as noise on the reconstituted waveform in the receiver output. Pulse width modulation gives much better protection. In this system pulses are transmitted whose width is proportional to the amplitude of the samples. Fig. 4(a) shows a waveform as it would be transmitted by p.a.m., and (b) shows the corresponding p.w.m. waveform.

Suppose now that the received pulses have noise superimposed as shown in Fig. 5(a). The information is contained in the width of the pulse, and the noise sprouting on top of the waveform does not affect this. We may not know the true amplitude, but the width can be found exactly. If desired the noise can be eliminated by slicing off the top and the bottom of the waveform, and no noise would be detectable in the receiver output.

So it seems that we have beaten Shannon's formula, since it appears that we have eliminated noise. But we have considered an ideal pulse of zero rise and full times. If we draw an actual waveform such as in Fig. 5(b) it can be seen that the width of the pulse is slightly influenced by the presence of noise on the rising and falling sides of the pulses. The steeper their slopes the better protection against noise the system will give, but steep rise and falls necessitate a wide bandwidth for their transmission, and we are thus exchanging bandwidth for signal-to-noise ratio. In fact the rate of transmission is very much less than the theoretical maximum rate derived from Shannon's equation.

Really the only information in p.w.m. is contained in the starting and finishing times of the pulses and it is unnecessary to keep the transmitter radiating uselessly during the uninteresting flat top of the pulse. It need give out only a very short sharp pulse defining the beginning and another one defining the end of the width modulated pulse. The width modulated pulse could be made up at the receiver; for example the initial pulse could trigger a bistable circuit "on" and the final pulse could cause it to revert to its "off" condition.

In fact if the starting time of each width modulated pulse were known, by deciding, for example, that the pulses should start at $10\mu\text{s}$, $20\mu\text{s}$, $30\mu\text{s}$, etc. after a

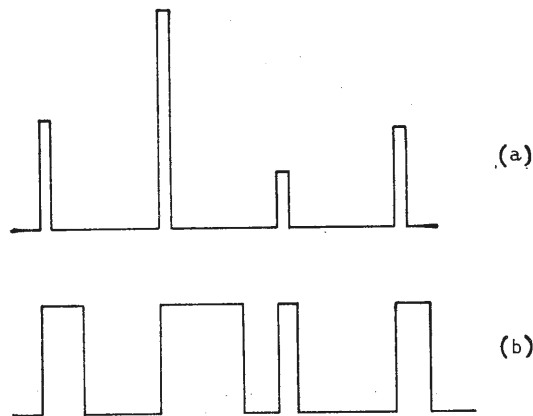

Fig. 4. (a) Transmission of a waveform by p.a.m.; (b) transmission of an identical waveform by p.w.m.

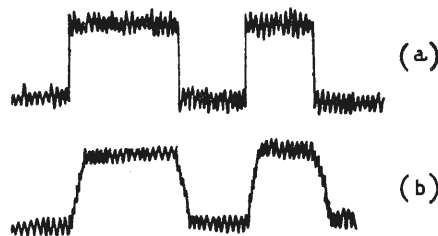

Fig. 5. Noise superimposed on (a) ideal pulse with zero rise and fall times; and on (b) actual pulses in a practical system.

synchronizing pulse, then all that need be sent for each width modulated pulse would be a very narrow pulse defining its back edge. Thus the transmitter would be off for most of the time and the mean power would be very low compared with the peak power radiated. This is pulse position modulation. To define the exact position of the back edge a pulse of very short risetime is required: if it is sloping then noise in the system will introduce uncertainty as to the intended position. P.p.m. is suitable for microwave transmission. Such transmitters can be pulsed in this way, and often the wide bandwidth necessary for the very fast risetime pulses can be tolerated at microwave frequencies.

Most advanced and efficient of the pulse communication systems is pulse code modulation. Here again the first step is sampling and obtaining amplitude modulated pulses as in p.a.m. But now the amplitude is measured and encoded. Suppose the amplitude of these pulses can be anything between 0 and 31 volts, and that at a particular sampled instant it is 25.29 V. This is next approximated to the nearest level and, assuming that we have 32 permitted levels, each one corresponding to a whole number of volts, this will give us 25 volts. The number 25 is expressed in binary form as 11001. A train of five pulses representing this number is radiated from the transmitter: amplitude modulation could be used, giving "on-on-off-off-on." (Actually the order of sending these digits is usually reversed, so that 10011 would be sent: the reason for this will be given later.)

The important idea is that, provided the receiver is able to distinguish between a 0 and a 1, no information is lost. The pulses received may be distorted and almost submerged in noise, but provided they are distinguishable

as intended pulses then the receiving apparatus can decode them as meaning 25 volts. The process of having a definite number of levels and then approximating the amplitude of the sampled pulse to the nearest level is called quantizing, and this introduces a small error which shows itself as quantizing noise. If the number of levels is large, such as 64 or 128 (needing a 6-digit and a 7-digit code respectively) then this quantizing noise is very small indeed. (There is no reason why the levels must be equally spaced, and a logarithmic spacing with more levels for the low voltages and fewer for the peaks may be preferable.)

Apart from the quantizing noise no noise is introduced during transmission. Provided that the signal received in the presence of noise is capable of being identified as either "pulse" or "no pulse," the pulses might be used to trigger a monostable flip-flop which could then furnish a neat and tidy waveform for retransmission. Repeater stations can thus transmit a regenerated pulse waveform on to succeeding repeater stations. Thus p.c.m. signals can be handled by a long chain of repeaters or links without any degradation of signal or introduction of noise.

You may think that this is very ingenious but feel that the decoding apparatus must be very complicated, requiring a computer to construct a pulse whose height is proportional to the number represented in binary form by the train of pulses. In fact the basis of the decoder is merely a capacitor and resistor in parallel, the time constant CR being such that the voltage across the capacitor decreases to one half of its initial value in the

time between successive pulses in the train. In twice this time the voltage across the capacitor will have fallen to one quarter, and in three times this interval of time to one-eighth. Considering our 32-level system which uses a 5 digit code, the voltage across the capacitor at the end of the train of 0 and 1 pulses will be $\frac{1}{16}$ th of the peak voltage of the first pulse + $\frac{1}{8}$ th of that of the second + $\frac{1}{4}$ th of the third, + $\frac{1}{2}$ th of the fourth + the voltage of the final pulse. The time constant provides just the correct weighting for the digits.

We considered level 25, which in binary form is 11001: it was mentioned that these digits are usually transmitted in the reverse order as 10011. Suppose these digits are received and amplified so that the 1s have an amplitude of 16 volts, then the final voltage across the capacitor will be

$$16 \left[\frac{1}{16} + \frac{0}{8} + \frac{0}{4} + \frac{1}{2} + 1 \right] = 16 \times \frac{25}{16} = 25 \text{ volts.}$$

Try it with 9 which is 01001 in binary form, or 28 which is 11100. These must be sent, of course, as 10010 and 00111 respectively. This delightfully elegant decoder is also due to Shannon.

Perhaps these pulse systems seem artificial. But while you have been reading this your brain has been receiving information from all your senses, and the method of transmission to the brain is by coded pulses. Pulse communication is the usual method in the nervous system, so that, far from being artificial, pulse systems are copying nature.

RECENT TECHNICAL DEVELOPMENTS

Semiconductor a.c. switching device

A DEVICE known as "Quantrol" in this country and "Ovonic" in the U.S.A. is under development in a number of countries to evaluate its potentiality as an a.c. circuit element in switching and in applications involving a voltage threshold. The bidirectional

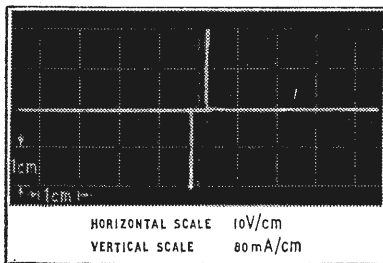

Fig. 1.

two-electrode device is made from a three-part semiconductor alloy and when a given threshold voltage is exceeded a filamentary breakdown occurs through the alloy.

On breakdown (which may be from 20 to 110 V) the devices change from a

highly resistive state (10 MΩ) to a very low resistive state (see Fig. 1) and in this state can pass up to 0.5 A. A typical device has a breakdown potential of 70 volts and when this is exceeded the voltage across the device is reduced to a few volts in approx. 10 nsec. On removing the voltage, the non-conducting state is returned. However, three-electrode devices have been developed in the U.S.A. which can be used as memory elements with two stable states.

"Ovonic" is under development by Energy Conversion Devices Inc. and in this country as "Quantrol" by Electronic Machine Control Ltd, Bromley, Kent.

Improving printed circuit soldering

Research is in progress at the International Tin Research Institute (Fraser Road, Greenford, Middlesex) into the improvement of the soldering process in connection with printed circuits. The object of the present investigations is to find coatings suitable for application to printed wiring boards to provide the highest level of solderability and protection of the copper conductors against

corrosion. Various metal coatings have been applied by electro-deposition, a fused 60/40 tin-lead alloy was applied by roller-coating and some coatings were applied by chemical replacement ("electroless" plating). Solderability was determined by a "wetting time" test and the "area of spread" test and also environmental and storage tests have been made. Some of the conclusions of the tests are contained in the 1964 Annual Report.

Tin coatings of pure and alloyed gold 0.25-0.5 microns thick did not improve the spread of solder, gave only a temporary protection and, as might be expected, caused the solder to become embrittled. Increasing the thickness to 2.5-5 microns showed little or no improvement. Rhodium and palladium coatings were inferior to gold. Poor area of spread and excessively long wetting times were obtained with tin chemical plating.

Electro-deposited tin and tin-lead alloy layers of 5 microns in thickness were wetted instantly, even after storage treatments, and the area of spread was fully adequate. However, if printed boards can withstand the temperature, hot-dipped tin coating is to be preferred.

More about Early Bird

COMMENTING on Arthur Clarke's famous predictions of synchronous communications satellites in 1945 in *Wireless World*,* Dr. F. P. Adler, a vice-president of Hughes Aircraft Company, U.S.A., remarked recently to a party of European journalists that this article had provoked much scepticism at the time but the feasibility and potential of communications satellites had now been clearly demonstrated. Our front cover, appearing 20 years after Clarke's article and showing final electronic checking of Hughes' Early Bird, the first operational communications satellite, symbolizes the beginning of this new era in communications. The event was certainly demonstrated in an impressive manner to the millions of viewers who watched the inaugural television programmes on 1st May. Pictures were of surprisingly good quality and it was difficult to believe that the signals had in fact travelled some 45,000 miles.

Apart from the public television programmes, the British Post Office tested the performance of the satellite system on colour television, by transmitting N.T.S.C. signals from the Goonhilly earth station to Early Bird and receiving them back at Goonhilly. The received picture, a colour test card, was reported to be of excellent quality.

About a fortnight after Early Bird was launched, another communications satellite was put into operation by the Russians. Called Molniya 1 (Lightning), this relay station does for the land mass of the U.S.S.R. what Early Bird does for the Atlantic. It travels in an elliptical orbit, however, inclined at 65° to the equatorial plane, with an apogee of about 24,833 miles in the northern hemisphere and a perigee of 341 miles in the southern hemisphere. Shortly after launching, the period of revolution was reported to be 12 hours. This orbit has been chosen because it gives optimum communication conditions for the U.S.S.R. The satellite has been used for transmitting television pictures between Vladivostok and Moscow, and in fact television relaying is stated to be one of its main functions.

Essential details of the radio equipment in Early Bird were given last month (May 1965 issue, p. 249). The picture on this page shows the internal construction of the satellite, with the outer cylinder of solar cells removed. The craft spins on its own axis at 140 r.p.m. (thereby avoiding the need for gyros for attitude stabilization), and the spin rate and attitude are detected by the sun sensors (13) shown in the picture. The attitude is such that the aerial beam, emerging at right angles from the communications array (2), irradiates a region of the Earth centred on the North Atlantic. The coaxial slot transmitting aerial, which has a gain of 9dB, has a beam width of 12°, while the receiving aerial, a co-linear array with a gain of 4dB, has a beam width of 50°.

Navigational control of the satellite, including attitude control, longitude positioning and adjustment of orbital plane inclination, is performed by two radial and two axial hydrogen peroxide jets (6), (14), remotely controlled from the American earth station at Andover, Maine. Frequency modulated command signals are transmitted in the 6Gc/s band and received by one of the two transponders in the satellite (7). They are then extracted from the transponder's i.f. section through a 1-Mc/s bandpass filter and detected in two separate command receivers. Each receiver output feeds one of two decoders, and either receiver-decoder combination can control the craft.

The life of the control system, which is determined by the continuance of the hydrogen peroxide fuel supply (5), is expected to be about two or three years. Thereafter the uncontrolled craft will drift westwards, but since the electronic equipment is expected to continue operating for 5 to 15 years, the satellite will still be usable for communications. The power output of the solar cell generator is expected to

fall to 80% of its present value (45 watts) in about 10 years, while the nickel cadmium rechargeable batteries—two groups of ten cells and two of twelve cells (8)—should last 3 to 5 years. These batteries provide a power reserve and also allow the electronic equipment to continue operating during 70-minute eclipses (of the sun) which occur at local midnight during two periods each year.

Information on conditions in the satellite—attitude, temperature, battery voltage, hydrogen peroxide tank pressure—is transmitted to Andover by a 10-channel time-division multiplex telemetry system. There are two telemetry encoders operating simultaneously, and during the launching and orbit adjustment phase they modulated two v.h.f. transmitters feeding whip aerials (10). Now they are modulating the two 4-Gc/s microwave beacons.

Early Bird is the first practical project of the U.S. Communications Satellite Corporation, which operates the space sector of satellite communications for an international interim committee representing all interested countries. The terminal stations and other ground installations are owned and operated by the telecommunications authorities of the countries concerned. Later this year a choice will probably be made of a satellite system for global communications. The choice will be between: a system of 3 to 6 stationary satellites; a medium-altitude random system of 18-24 satellites; and a medium altitude controlled system of less than 18 satellites.

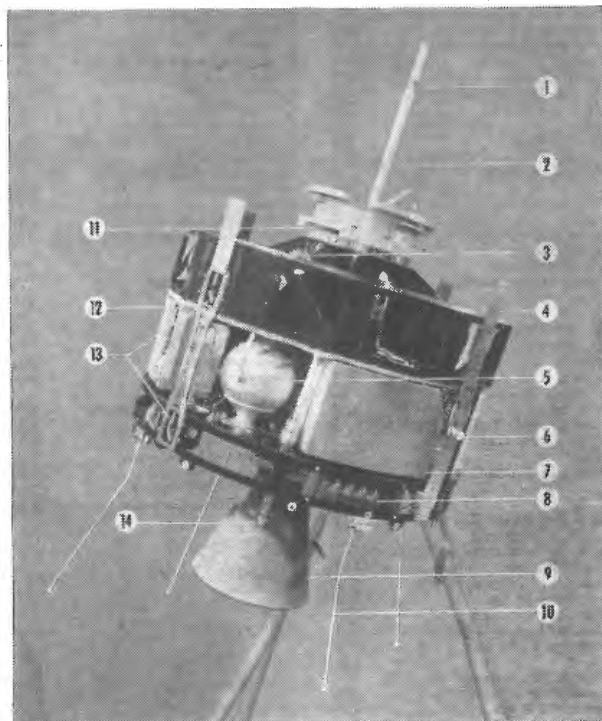

Early Bird with the solar-cell panels removed: (1) aerial reflector; (2) communications aeriels; (3) t.w.t. ferrite switch; (4) thermal shields; (5) hydrogen peroxide tank; (6) radial control jet; (7) transponder receiver; (8) rechargeable batteries; (9) motor nozzle; (10) telemetry aeriels; (11) separation interface for rocket; (12) encoder-decoder; (13) sun sensors; (14) axial control jet.

*"Extra-Terrestrial Relays", October, 1945, issue.

RADIO & ELECTRONIC COMPONENTS:

WHAT is a component? This question might well be asked by a visitor to the Radio & Electronic Component Show which opens at Olympia on May 18th for four days. As will be seen from the following preview of some of the main items to be seen on the 240 stands, exhibits range from discrete components, through integrated circuits, to complete pieces of equipment. The fact is that the line of demarcation between a component and a complete unit has almost disappeared. Be that as it may, the visitor will find that this nineteenth exhibition in the series sponsored by the Radio and Electronic Component Manufacturers' Federation, offers as wide a variety of "bits and pieces" as ever.

The information given in the following pages has been

extracted from material supplied by manufacturers. Some exhibitors, however, did not respond to our invitation to send details. All exhibitors are named in the following alphabetical list. Where a number of associated firms are sharing a stand the name of the one with which the note is headed in the preview is given in brackets. Similarly, if a stand is reviewed under a trade name then this is given in brackets, in the list.

For the convenience of professional readers unable to attend the show a number is appended to each report so that those wanting fuller information can readily obtain it by inserting the appropriate number on a reader service card.

LIST OF EXHIBITORS AND PLAN OF THE EXHIBITION

Stand No.	Exhibitor	Stand No.	Exhibitor	Stand No.	Exhibitor	Stand No.	Exhibitor
A.B. Metal Products	319	Dial Engineering Co.	107	Haddon & Stokes (see G.K.N.)	219	Levell Electronics	454
A.E.I.	302	Diamond H Controls	213	Hallam, Sleigh & Cheston	205	Lewis Spring Co.	110
A.K. Fans	207	Digital Measurements	495	Harwin Engineers	488	Linton & Hirst	275
Air Control Installations	106	Digitizer Techniques (see Twickenham Automation)	103	Hatfield Instruments	469	Livingston Laboratories	369
Aircraft-Marine Products(A.M.P.)	313	Dubilier	273	Hawker Siddeley Dynamics	51	Londex (see Elliott Automation)	160
Aladdin Radio Industries	57	Duratube & Wire (see Tygadure)	220	Hendrey Relays	503	London Electric Wire (Lewcos)	268
Alberice Meters	111	East Grinstead Electronic Components (Radiohm)	400	Highland Electronics	497	London Electrical Manfg. (Lemco)	262
Alden Metal Products	452	Eddystone	201	Hinchley Engineering Co.	280	Lucas	315
Allen Components	234	Egen Electric	258	Heywood & Co.	463	Lustraphone	209
Alma Components	150	Elcom	483	Hivac (see Plessey)	159	M.B. Metals	113A
Alston Capacitors (see Alma)	150	Electrical Apparatus Co.	408	Hughes International	324	M.C.P. Electronics	475
Amphenol-Borg (Electronics)	277	Electrical Research Assoc. (E.R.A.)	360	Hunt, A. H.	303	M.E.C.	300
Ancillary Developments	476	Electro Acoustic Indust. (Elac)	255	ICI Plastics Division	477	M-O Valve Co.	312
Anderson & Son (see Aladdin)	57	Electro Mechanisms	54	Iliffe Electrical Publications	456	McMurdo Instrument	218
Anglo-American Vulcanized Fibre	407	Electrolube	211	Imhof, Alfred	304	Magnetic Devices	314
Antiference	214	Electronic Machine Co. (E.M.C.)	169	Industrial Electronics	456	Magnetic & Electrical Alloys (see Telcon)	356
Applied Developments	323	Electroprints	409	Insulating Components & Materials	460		
Ariel Pressings	323	Electrosil	487	Insuloid Manufacturing Co.	278		
Arrell Electrical (see Permanoid)	206	Electrothermal Engineering	221	International Electronics	276		
Arrow Electric Switches	490	Elliott-Automation Group	160	International Nickel	116		
Ashburton Resistance Co.	60	Enalon Plastics	404	J.D. Electronics	473		
Astralux Dynamics	453	Enfield Phelps Dodge	486	Jackson Bros.	267		
Avel Products	105	Engineering Enterprises	359	Jermyn Industries	468		
Aviation, Ministry of	114	English Electric Valve Co. (E.E.V.)	164	K.G.M. Electronics	232		
Avo (see Taylor)	152	Enghoven Solders	217	Ketay (see Plessey)	159		
B. & R. Relays	170	Erg Industrial Corporation	269	Keyswitch Relays	450		
B.I.C.C.	161	Erie Resistor	228				
B.P.L. Instruments	250	Ether	364				
BSR	166	Ever Ready Co.	256				
B.T.R. Industries	500	Evershed & Vignoles	411				
Bakelite	485	Fane Acoustics	351				
Balfour & Darwins	279	Fenbridge Products	112				
Barclays Bank	496	Ferranti	311				
Barlow-Whitney	115	Filhol, J. P.	52				
Beckman Instruments	266	Fine Wires	502				
Bedco	484	Firth Cleveland	216				
Belclere	466	Flight Refuelling	492				
Belling & Lee	308	Formica	167				
Bird, Sydney S., (Cyldon)	200	G.K.N. Screws & Fasteners	219				
Bonnella, D. H., & Son	455	Gardners Transformers	478				
Bradley, G. & E. (see Lucas)	315	Garrard Engineering	402				
Brandauer & Co.	56	Girdlestone Electronics	363				
Brayhead	227	Goodmans Industries	270				
British Electric Resistance (Berco)	366	Greenpar Engineering	50				
Brush Cleveite Co.	479	Gresham Transformers	480				
Bulgin	155						
Burgess Products Co.	305						
C.C.L.	457						
C.G.S. Resistance Co.	352						
C. & N. (Electrical)	318						
Cambion Electronic Products	362						
Cannon Electric	233						
Carder, R. E. (see K.G.M.)	232						
Carr Fastener Co.	263						
Cathodeon Crystals	225						
Celestion (see Rola Celestion)	223						
Chromeplas (see Creators)	372						
Ciba	203						
Circetch (see Livingston)	369						
Clare-Elliott (see Elliott)	160						
Clarke, H., & Co.	254						
Claude Lyons	371						
Colvern	253						
Concordia Electric Wire	104						
Connollys	368						
Cosmocord	204						
Creators	372						
Davu Wire & Cables (see Day)	168						
Day, J., & Co.	108						
Derritron Group	493						

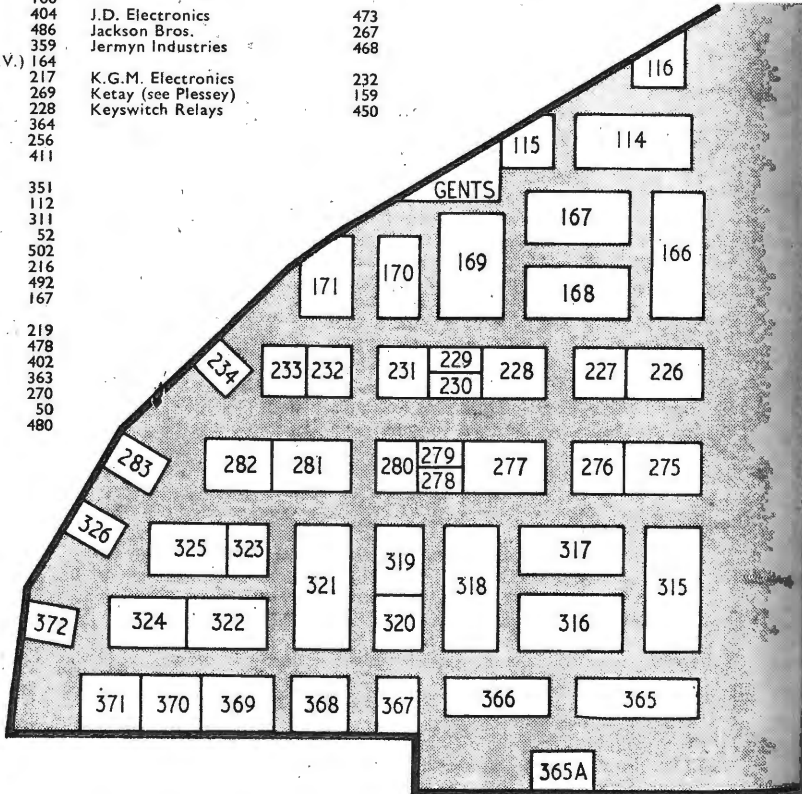

Preview of the London Show

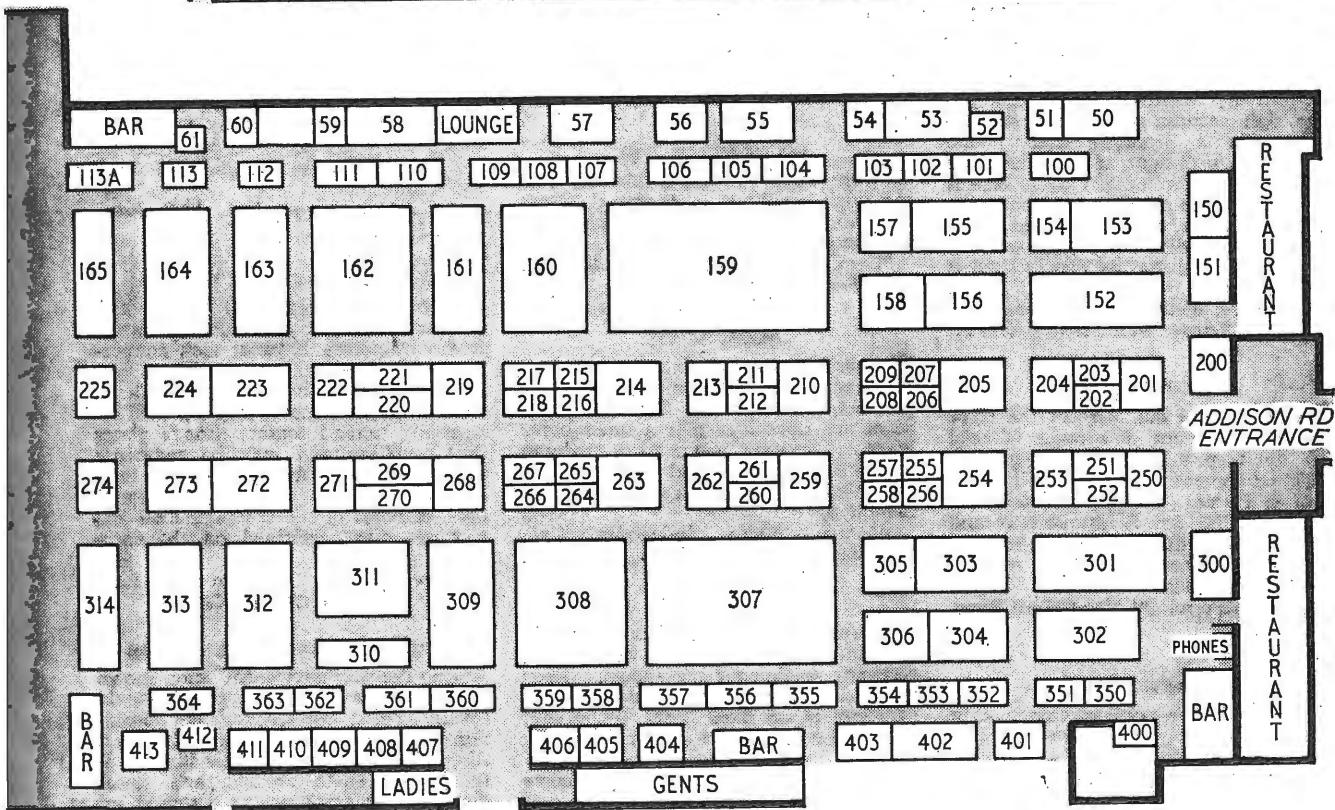
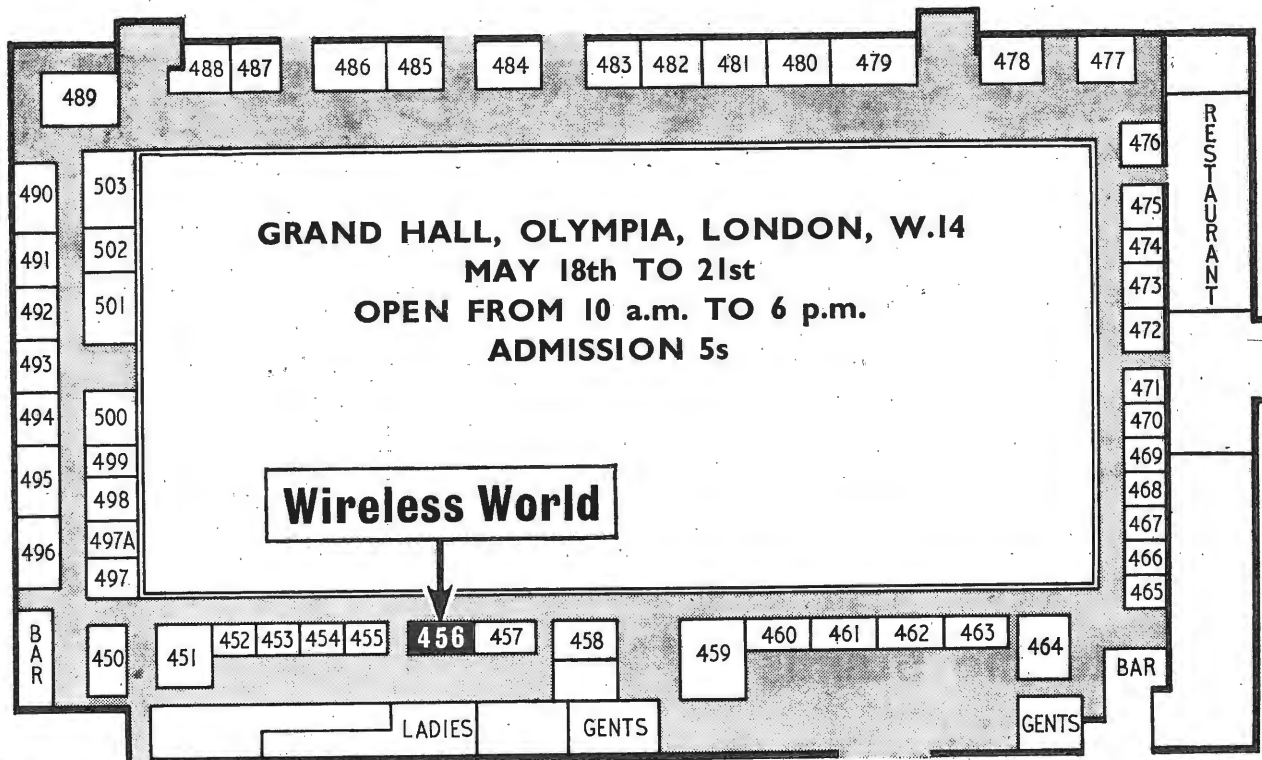

LIST OF EXHIBITORS (Continued)

	Stand No.		Stand No.		Stand No.		Stand No.
Mallory Batteries	100	Plannai	451	Sellotape Products	367	Tilson Metal Fabrications (see	
Mansol	274	Plessey Group	159	Semiconductors (see Plessey)	159	Twickenham Automation)	103
Marconi Co.	226	Plex (Engineering)	497A	Shaw Publishing Co.	354	Tucker Eyelet Co.	212
Markovits, I.	61	Precious Metal Depositors		Sifam	461	20th Century Electronics	467
Marrison & Catherall	472	(see P.M.D.)	282	Sintered Glass-to-Metal Seal		Twickenham Automation	103
Mec-Test (see M.E.C.)	300	Precision Electronic Terminations		(see Mansol)	274	Tygadure	220
Metway Electrical Industries	471	(see Vidor)	361	Slee Semiconductor Equipment	320		
Microwave Associates	498	Pressac	357	Smart & Brown (see A.B. Metal)	319	Ultra Electronics	310
Microwave Electronics Systems	491	Printed Circuits		Smith, S., & Sons	458	Union Carbide	401
Midland Bank	489	(see Lewcos)	268	Smith Hobson (see Zenith)	55	United Trade Press	465
Milton Ross Co.	365A	Pye Switches	215	Solartron Electronic Group	321		
Mining & Chemical Products				South London Electrical (Slee)	320		
(see M.C.P.)	475	Rank Organisation	171	Spears Engineering Co.	264	Vacwell Engineering Co. (see	
3 M	165	Rathdown Industries	462	Stability Capacitors	252	Electronic Machine Co.)	169
Morganite Resistors	301	Reliance Controls	151	Standard Insulator Co.	229	Valradio	113
Muirhead & Co.	410	Rendar Instruments	350	Steatite & Porcelain (see		Venner Electronics	406
Mullard	307	Reproducers & Amplifiers (R & A)	260	Morganite)	301	Vero Electronics	154
Multicore Solders	168	Resolound (see Derritron)	493	Stratton (Eddystone)	201	Vidor	361
Murex	257	Richard Allan Radio	355	Sufflex	210	Vision Engineering	470
		Rivlin Instruments	403	Surrey Steel Components	353		
NSF	222	Rola Celestion	223			Wego Condenser Co.	208
Neill, James, & Co.	261	Ross & Co. (see Marrison		T.C.C.	272	Welded Modules	412
Newmarket Transistors	281	& Catherall)	472	Taylor Electrical Instruments	152	Welwyn Electric	306
Newport Instruments	109	Ross, Courtney & Co.	482	Technical Encapsulations (see		Westinghouse Brake & Signal	317
		Rotax (see Lucas)	315	Twickenham Automation)	103	Westminster Bank	459
Oliver Pell Control	481	Royal Worcester Ceramics	358	Technograph & Telegraph	464	Weyrad (Electronics)	251
		Royston Industries (see Vidor)	361	Tectonic Industrial Printers	230	Whiteley Electrical Radio Co.	163
P.M.D. Group	282			Tektronix U.K.	365	Wingrove & Rogers	202
Painton & Co.	224	SASCO	494	Teleton-Metals	156	Winston Electronics	474
Palmer Aero Prods. (see B.T.R.)	500	SGS—Fairchild	322	Telephone Manufacturing		Wire Products & Machine	
Parmeko	158	S.T.C.	162	(T.M.C.)	153	Design	356
Partridge Transformers	259	Salford (see M-O Valve)	312	Tequipment	231	Wireless World	456
Percomponents	326	Salterfix	405	Temco (see Telcon)	156	Woden Transformer Co.	271
Pergamon Press	413	Saunders-Roe & Nuclear		Texas Instruments	53	Wolsey Electronics	101
Permanoid	206	Enterprises	59	Thorn-AEI Radio Valves &		Work Study Equipment	499
Permark Service	265	Scott, G. L., & Co.	370	Tubes	325		
Planer, G. V.	102	Sealctro	157	Thorn Electrical Industries	309	Zenith Electric Co.	55

Guide to the Stands

A.E.I. ELECTRONICS (320)

The range of thyristor firing circuits has been extended by the addition of a uni-junction device, and the new circuit is intended for situations where the load is essentially resistive. Ion pumps and ultra-high vacuum gauges are demonstrated on a working high-vacuum system. A technique of Araldite resin moulding used for military equipment is now being made available commercially, and a selection of encapsulated components and dissipative wedges for waveguides produced by this method is being shown. [301]

Associated Electrical Industries Ltd., Electronics Group, New Parks, Leicester.

A.K. FANS (207)

A miniature 3in dia. Airmax fan (type H4—Y3347) is one of a range of axial flow fans to provide air cooling in electronic equipment. The fan will move up to 45 ft³/min at 50 c/s and consumes 10 watts. The fan is tropicalized and uses self-lubricating sleeve bearings requiring no maintenance. The rotating parts are dynamically balanced. [302]

A. K. Fans Ltd., 20 Upper Park Road, London, N.W.3.

A.M.P. (313)

A breakthrough in point-to-point wiring is claimed by Aircraft-Marine Products with their "Termi-Point" connector wiring system, which uses the "Termi-Point" x-y co-ordinate programming

machine. This employs standard eight-track tape and drives the wiring machine. Working demonstrations are being given.

[303]
Aircraft-Marine Products (G.B.) Ltd., Terminal House, Stanmore, Middlesex.

AIR CONTROL (106)

A wide range of small blowers and miniature air filters is displayed. Both axial and centrifugal fans with impellers for from 1½in to 8in are shown. [304]

Air Control Installations Ltd., Victoria Road, Ruislip, Middlesex.

ALADDIN (57)

The well-known coil formers are seen together with Feradin ferrite components. The 3 mm Feradin screw cores are slotted to take a screwdriver blade, as opposed to the more common centre hole. Tools and dies used for moulding the plastic components are exhibited. [305]

Aladdin Radio Industries Ltd., Aladdin Building, Greenford, Middlesex.

ALBERICE (111)

Coin-operated time switches for use in the rental or hire-purchase of domestic receiving equipment are shown. They are available both with a variable tariff (Varimeter) or fixed tariff (Economy) and with or without a coin register. [306]

Alberice Meters Ltd., 87-89 Stierte Avenue, Poole, Dorset.

ALMA (150)

Reed relays and metal film resistors are the main items. The relays include two of the smallest types available in Europe, DR1 form A and DR2C form C. Development type reed relay uni-selector illustrates the specialized work which Alma are prepared to undertake.

Alston capacitors are also shown on the stand. [307]
Alma Components Ltd., Park Road, Diss, Norfolk.

AMPHENOL-BORG (277)

New products designed to meet British defence specifications include the 62 Series miniature bayonet lock connectors and a range of r.f. coaxial connectors. For flat ribbon cable, the Flex-1 connector uses a novel jointing method. Specially formed contact prongs pierce the insulation and may be resistance welded to the cable by a simple head assembly. There are also demonstrations of some of the environmental and proving tests performed on the company's products. [308]

Amphenol-Borg (Electronics) Ltd., Thanet Way, Whitstable, Kent.

ANCILLARY DEVELOPMENTS (476)

Among the new equipment being shown is a flux-sensitive encoder, its main features being low-torque, high resolution and the provision of a multi-track. Also of interest are the new flux-sensitive heads (with angular and linear displacement transducers) designed for

use in machine and process control systems. [309]

Ancillary Developments Ltd., Blackwater Station Estate, Blackwater, Camberley, Surrey.

ANGLO-AMERICAN FIBRE (407)

A wide range of electrical insulating materials and components are shown by the company under the trade name "Delanco." Products include sleeveings, adhesive tapes, ebonite sheet and rod, mica, laminated board, pressboard, laminated Bakelite sheet, etc. [461]

Anglo-American Vulcanised Fibre Co. Ltd., Bishops House, High Holborn, London, W.C.1.

ANTIFERRENCE (214)

The full range of u.h.f./v.h.f. television aerials are being shown including the Uniray series they have developed for the reception of Bands I, III, IV and V. The two latest additions to this range incorporate a "semi-broadband" Band III section and have a choice of 9 or 15 elements for the u.h.f. channels. [310]

Antiferrence Ltd., Bicester Road, Aylesbury, Bucks.

ARROW SWITCHES (490)

Subminiature toggle switches with two or three-lever positions are displayed with rotary switches, push-button switches and relays. A small new "stack" type of relay with a contact current rating of 5 A at 250 volts alternating is displayed for the first time. [311]

Arrow Electric Switches Ltd., Brent Road, Southall, Middlesex.

ASHBURTON RESISTANCE (60)

Prototypes of a sub-miniature precision wire-wound resistor for printed circuit board applications and also for applications calling for conventional wiring techniques are shown. The wattage rating is 0.1 W. Fixed and semi-adjustable wire-wound resistors are also being shown with the company's full range of precision wire-wound resistors. [312]

Ashburton Resistance Company Ltd., 72 Brewery Road, London N.7.

ASTRALUX DYNAMICS (453)

Voltage stabilising transformers are the main feature of this stand. There are nine basic models with several thousand variants. Output voltage is maintained to within $\pm 0.5\%$ for input voltage variation between $+10\%$ and -20% . [313]

Astralux Dynamics Ltd., Brightlingsea, Colchester, Essex.

AVEL (105)

Specialists in toroidally wound components, Avel Products will be showing inductors, transformers, d.c. converters and decade inductive voltage dividers. A Gorman toroidal winding machine, capable of winding coils with an internal

diameter of 0.055 in, will be demonstrating the manufacture toroidal coils. [314]

Avel Products Ltd., South Ockenden, Essex.

B. & R. RELAYS (170)

Loads up to 100 amps can be switched silently by the Q60 single-pole contactor, which has been designed primarily for controlling storage heaters from a timer. The contactor is fitted with a neutral link and has a fuse in its control circuit. Relays on view will include miniature and changeover plug-in types; and coaxial, mercury switch, dry reed, latching, interlocking, and delay relays. [315]

B. & R. Relays Ltd., Temple Fields, Harlow, Essex.

B.I.C.C. (161)

A substantial proportion of the display is devoted to B.I.C.C.-Burndy connectors and accessories. The range of miniature rectangular connectors has been increased by the introduction of the MS-M Hyfen, which is available with 14, 20, 26, 34, 42, 50, 75 and 152 contact positions. These connectors have approximately 40 through connections per square inch. A new type of flexible multiway cable, called Biccastrip, is shown. The flat rectangular conductors, which can be supplied with preformed terminations to mate with printed circuit connectors, are embedded in plastic. [316]

British Insulated Callender's Cables Ltd., 21 Bloomsbury Street, London, W.C.1.

B.P.L. (250)

A capacitance bridge capable of measuring values lower than 10 pF with an accuracy of $\pm 0.1\%$ is shown. It will also measure power factor accurately. Exhibited for the first time is a multi-channel component grader, enabling an operator to sort resistors, capacitors or inductors into one of three tolerances in a single operation. The grader can be operated at up to 6,000 tests per hour. Pointer meters manufactured to the BS 3693:1964 recommendations on scale design are displayed. [317]

B.P.L. (Instruments) Ltd., Radlett, Herts.

BSR (166)

The latest record changer (UA40) is shown for the first time and incorporates an 11 in turntable, a fixed stylus cleaning brush and pressure adjusters. A muting switch is provided and operates when changing records.

The recent range of ceramic pickup cartridges is shown and includes the following types: the high quality C1 with a compliance of 5.2×10^{-6} cm/dyne, an output of 110 mV at 1 cm/sec, and a recommended stylus pressure of 2-6 gm; the X1M and SX1M, mono and stereo cartridges with outputs of a few hundred millivolts, a response extending to 10 kc/s at 3 dB down, and with a stereo separation of 20 dB (higher output ver-

sions are available, at the expense of compliance and high-frequency response); and the high output types X2HE and SX2H. [318]

BSR Ltd., Monarch Works, Old Hill, Staffordshire.

B.T.R. INDUSTRIES (500)

Examples of the printed circuit boards made by Microcell Ltd., a subsidiary, are being shown. In addition to the conventional boards, several plated-through, flexible and flush-bonded circuits are on view, the latter being particularly suited to switching applications. [319]

B.T.R. Industries Ltd., Herga House, Vincent Square, London, S.W.1.

BAKELITE (485)

For printed wiring, a flexible copper-clad laminate based on polyethylene terephthalate film is introduced. The material can be folded or coiled to follow any contours required. Also shown is a composite laminate from which printed resistors can be manufactured. It consists of a thin resistive metal foil bonded to a layer of epoxide resin-treated glass fabric, which in turn is bonded to a sheet of aluminium. The foil can also be bonded to paper or woven glass fabric. [320]

Bakelite Ltd., 12-18 Grosvenor Gardens, London, S.W.1.

BARLOW-WHITNEY (115)

The principal item on show is an epoxy resin vacuum encapsulating and impregnating plant for electronic components. Also of interest are items of environmental test gear, in particular a humidity test chamber with refrigeration. [321]

Barlow-Whitney Ltd., Coombe Road, Neasden, London, N.W.10.

BECKMAN (266)

Examples from the current range of Helipot precision potentiometers and Duodial counting dials are on show. This includes single-turn and multi-turn potentiometers ranging from 3- to 40-turns, the latter having a resolution of 0.0007%. [322]

Beckman Instruments Ltd., Glenrothes, Fife.

BELLING & LEE (308)

One of the large range of products shown is the double coaxial connector. The connectors house two concentric screens but they are compatible with the Pattern 15 B.N.C. connectors. Their primary use is in connections to circuits requiring a very low shunt capacitance and this is achieved by the use of a feedback technique*. Also they can be used in circuits which require an earth return separately from the screen. [323]

Belling & Lee Ltd., Great Cambridge Road, Enfield, Middlesex.

*See, for example, *Wireless World*, November 1961, page 598.

BERCO (366)

Developed to enable lecturers in technical colleges to teach the principles of

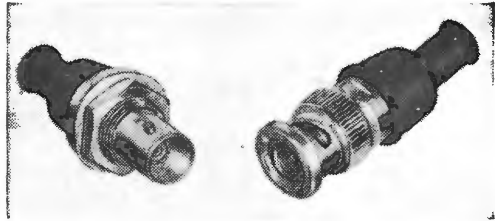

Belling & Lee double-screen coaxial connectors.

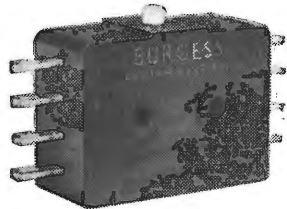

Burgess double-pole, four-way changeover micro-switch rated at 15 A at 250 V a.c.



B.S.R. UA40 automatic turntable and arm.

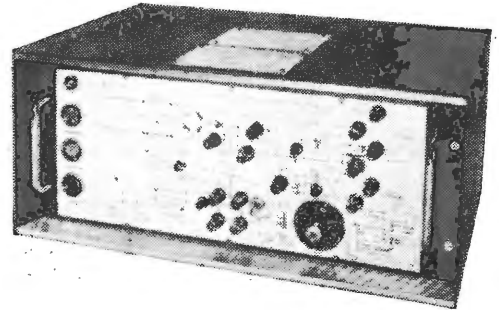

Bercotrol Model 3E teaching unit from the British Electric Resistance Company.

smooth variation of power, current and voltage by phase angle control of thyristors is the Bercotrol teaching unit which is being demonstrated. Pick-up points are provided so that motors, oscilloscopes and additional components may be connected to show the wave forms of the various parts of the trigger circuits, and the effects of altering time constants on closed-loop circuits. [324]

The British Electric Resistance Co. Ltd., Queensway, Enfield, Middx.

BONELLA (455)

The display of switches includes Bonella/Cherry micro-switches, which have a rock-wipe contact action, an interlocking case design and built-in actuators. Miniature moulded-body toggle switches include insulated versions rated at $\frac{1}{2}$ A, 250 V, with a variety of metal or moulded levers and slider or push-button actuators. A range suitable for switching electronic equipment is rated at 0.1 A, 250 V and has wiping contacts and trigger, push-button or other types of actuators. [325]

D. H. Bonella & Son Ltd., West Hill, Hoddesdon, Herts.

BRANDAUER (56)

Small precision pressings in a variety of metals are produced by this company. Their display includes a range of transistor eyelets for types TO5, TO18, TO46 and SO33, and pressings for inclusion in micro switches and miniature relays. [326]

C. Brandauer Ltd., New John Street West, Birmingham 19.

BRAYHEAD (227)

Examples from the wide range of i.f., i.f. and r.f. iron cored coils and transformers

they make for the industry are shown along with circuit modules they can provide as standard items for audio, i.f., and i.f./r.f. applications. [327]

Brayhead Electronics Ltd., Green Lane, Dronfield, Nr. Sheffield, Yorks.

BRUSH CLEVITE (479)

Piezoelectric ceramics (based on lead zirconate titanate), filters employing these P.Z.T. ceramics, Rochelle salt elements for use in pickups, microphones and headphones, and quartz crystal units are being shown. Brush offers three basic types of P.Z.T. ceramic filter—"transfilters" designed for use in transistor i.f. circuits replacing conventional i.f. transformers; multiple-section ladder filters; and "transfilter" combinations, comprising filters in cascade. [328]

Brush Clevite Co. Ltd., Hythe, Southampton.

BULGIN (155)

Large neon legend indicators incorporating moulded insulation switches have recently been announced. Front message plates may work up to 100 ° C and provide brilliant silhouetted messages. The individual messages are engraved and can be filled with any colour or messages may be invisible until illuminated. [329]

A. F. Bulgin Ltd., By Pass Road, Barking, Essex.

BURGESS (305)

A new double-pole microswitch shown by Burgess is rated at 15 A at 250 V a.c. It is suitable to control up to four circuits (eight terminals provided) and its features include high changeover speed, good repeat characteristics and compact size. The built-in actuator is made of

nylon and may be depressed in over-travel, without damage, until it is flush with the switch case. Lever and roller-lever auxiliary actuators are available for this switch which, incidentally can be supplied for manual operation. [330]

Burgess Products Company Ltd., Micro Switch Division, Dukas Way, Team Valley, Gateshead, 11.

C.C.L. (457)

This company specializes in the manufacture of aluminium foil electrolytic capacitors. Sizes range from $\frac{1}{8}$ in diameter, in a plastic-case type, to 2 $\frac{1}{2}$ in diameter in a metal-case type, with working voltages from 6 V to 500 V d.c. Specially featured are capacitors with low a.c. working voltages and a range with improved low temperature characteristics. [331]

C.C.L. Ltd., Hanworth Lane, Chertsey, Surrey.

C. & N. (318)

Prominence will be given to the Uniframe modular rack system, which is receiving its first public showing. The Uniframe system is available in nine basic kits, giving three different heights and widths, with standard G.P.O. rack spacing and 19 in panel widths. A wide range of accessories is available, for instance vertical extension kits, handles, louvered panels, blower unit and ducting. The side panels are available in a range of colours since they are made of Stelvetite, p.v.c. bonded on to sheet steel. [332]

C. & N. (Electrical) Ltd., The Green, Gosport, Hampshire.

CANNON (233)

Two new types of products marketed by this company are thermal shrink tubing and a wire designed for extreme abrasion resistance and operation at 200 ° C or 260 ° C. Inexpensive plugs and sockets on show include the R.C. Ribbon type, the JAE Series, the Royal D subminiature type with rear release crimp contacts, and the XL audio range. Introduced at this exhibition are Micro-K and Centi-K miniature circular connectors with contacts on 0.05 in and 0.1 in centres respectively. [333]

Cannon Electric (G.B.) Ltd., 25-27 Bickerton Road, Upper Holloway, London, N.19.

(Continued on page 275)

CARR FASTENER (263)

New components include a range of Permacon moulded edge connectors for 0.15 and 0.1 in contact pitch, with a varied selection of numbers of ways, terminations and mounting facilities. Working voltages are 500 for the 0.1 in pitch and 350 for the 0.15 in, each with a maximum current carrying capacity of 5 A per contact. A comprehensive selection of the company's Cinch and Dot components is also shown. [462]

Carr Fastener Co. Ltd., Stapleford, Nottingham.

CATHODEON (225)

A new crystal oven for proportional control is displayed in operation. The stability of this oven is $\pm 0.1^\circ\text{C}$ (over 24 hours) and $\pm 0.01^\circ\text{C}$ (over 1 hour), for a fixed ambient temperature, and over a range of ambient temperatures it is $\pm 0.2^\circ\text{C}$. The temperature may be set between 50°C and 80°C with a tolerance of $\pm 1^\circ\text{C}$. The oven will reach within 0.5°C of its operating temperature in 40 minutes at the lowest permissible ambient temperature of -20°C . Power supply requirements are 24 volts alternating at 1.8 A maximum, the oven consuming an average of 1 watt (13 watts during warm-up). [334]

Cathodeon Crystals Ltd., Linton, Cambridge.

CIBA (203)

Exhibits illustrating the uses of epoxy resins for encapsulation, casting, sealing and bonding applications in the electronics industry are on show. These include examples of their Araldite E-Pack system for high speed encapsulation using pre-formed pellets of Araldite appropriate in shape and size to the component to be protected. [335]

CIBA (A.R.L.) Ltd., Duxford, Cambridge.

CLAUDE LYONS (371)

Insensitive to frequency, extremely low distortion characteristics, unaffected by load changes, and an accuracy of 0.3% (filtered types 0.2%) are features of the Series BTR a.c. automatic voltage stabilizers. These units, which have load ratings from 400 VA to 10 kVA, are being shown with the Series TS and VB a.c. stabilizers and Series PST and PSS d.c. stabilizers. The latter cover the voltage range 6 to 50 volts with outputs from 200 W to 10 kW. [336]

Claude Lyons Ltd., 76 Old Hall Street, Liverpool, 3.

COLVERN (253)

Wirewound potentiometers and variable resistors are, of course, the speciality of this company. The display includes seven types of multi-turn potentiometers, from a small preset/manual control component to a precision 40-turn model which incorporates the new "Dialpot" with integral watch-type dial. [337]

Colvern Ltd., Spring Gardens, Romford, Essex.

CONNOLLYS (368)

Samples from the comprehensive range of insulated winding wires and strips, including self-soldering wire as fine as 0.0006 in, are shown. Non-magnetic quality copper can, if required, be used as the base material for the fine self-soldering enamelled wire. A wide selection of paper and plastic cables is also being shown. [338]

Connollys (Blackley) Ltd., Kirkby Industrial Estate, Liverpool.

COSMOCORD (204)

Among instruments produced by the Acos Instrument Division are acceleration measuring equipment comprising ceramic piezoelectric accelerometers (ranges up to 0-1000 g) and self-contained transistorized indicating units with moving-coil meters calibrated in peak g. Other instruments are a battery powered a.c. millivoltmeter (30 mV to 1,000 V; 10 c/s to 50 kc/s), a miniature oscilloscope (30 mm screen), and a battery powered instrument for measuring vibration in machine bearings. [339]

Cosmocord Ltd., Eleanor Cross Road, Waltham Cross, Herts.

CREATORS (372)

Cable trunking, cable sleeves, stripping pliers, cable markers and clips are the main products shown by this group. One of the subsidiaries, Chromeplas Ltd., is showing a representative range of printed circuitry and electroplated parts. [340]

Creators Ltd., Sheerwater, Woking, Surrey.

CYLDON (200)

A v.h.f./u.h.f. integrated tuner (IT100) for television sets is demonstrated. The

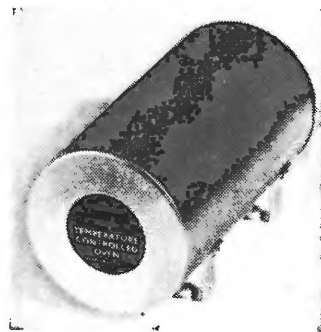

Above: Cathodeon crystal oven with 24-hour stability of $\pm 0.1^\circ\text{C}$.

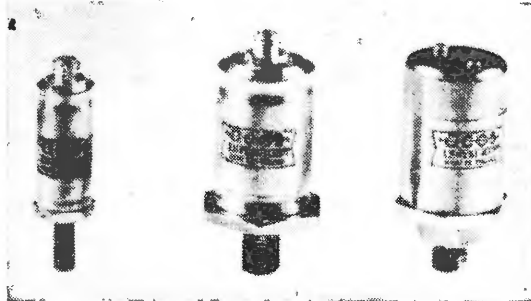

Acos ceramic piezoelectric accelerometers shown by Cosmocord.

provisional specification offers six station-selection push buttons, and provision is made for linking with the receiver channel selector. Operation of any of the six buttons will switch on the receiver whilst a seventh acts as a selector release and power-off switch. An export model is available which meets C.C.I.R. requirements. [341]

Sydney S. Bird & Sons Ltd., Cyldon Works, Fleets Lane, Poole, Dorset.

DAY (108)

The company's Davu range of wires, cables and cords is displayed. They are featuring their service to industry under which they supply leads cut to length and ready for assembly. [342]

J. Day & Co. (Derby Works) Ltd., Harrow Manorway, Abbey Wood, London, S.E.2.

DERRITRON (493)

A portable transistor oscilloscope is shown by the Telecommunications company of the group. Other exhibits include a new transistor echosounder, pH meters, a 12-channel radio control transmitter and receiver, and a handheld transceiver for emergency marine use. [343]

Derritron Ltd., 24 Upper Brook Street, London, W.1.

DIAL ENGINEERING (107)

A composite range of pressings for standard laminations for transformers and chokes, including "C" and "E" cores, and other ranges to Ministry specification are shown. [463]

Dial Engineering Company Ltd., Kingston Street, Chestergate, Stockport, Cheshire.

DIAMOND H (213)

This company features their Moduline scheme for making up rotary switches in the factory to customers' specifications. Their aim is to assemble and despatch switches within seven days of receipt of customers' orders. A wide variety of sizes and switching configurations is available, and the contacts (silver-plated brass or silver alloy) will break 1 A at 28 V d.c., 0.5 A at 110 V a.c., 0.25 A at 220 V a.c., or carry 5 amps. [344]

Diamond H Controls Ltd., Vulcan Road North, Norwich, Norfolk.

DIGITAL MEASUREMENTS (495)

An addition to the company's wide range of measuring instruments using digital presentation is the DM 2003 a.c./d.c. digital voltmeter. It measures d.c. from 1mV to 1kV, with an accuracy of 0.05% f.s.d. \pm 0.1% of reading, and a.c. from 2-700 V r.m.s., with an accuracy of 0.25% f.s.d. \pm 0.25% of reading over the frequency range 50c/s to 5kc/s. It can be operated for auto follow, manual trip or to hold the reading. Other equipment on show includes a multi-channel digital data logging system. [345]

Digital Measurements Ltd., Salisbury Grove, Mytchett, Aldershot, Hants.

DUBILIER (273)

The use of a mixed dielectric (a polyester film plus paper) is claimed to result in a good reduction in weight and size and an increase in temperature range (up to 125°C). The element is of extended foil electrode construction with a mixed dielectric of polyethyleneterephthalate film and paper dielectric tissue impregnated in a solid synthetic resin. The unit is moulded in polypropylene and the capacitors show greatly improved humidity resistance and shelf life. [346]

Dubilier Condenser Co. Ltd., Ducon Works, Victoria Road, North Acton, London W.3.

E.E.V. (164)

Three and four-and-half-inch image orthicons incorporating the new stick-free, long life Elcon targets are on show with the high-sensitivity E.E.V. vidicons with separate mesh construction. Many examples of the specialist valves they manufacture for industry and communications are also on show and include natural, forced-air, vapour and water-cooled power triodes with output powers up to 250kW. [347]

English Electric Valve Company Ltd., Chelmsford, Essex.

E.M.C. (169)

A range of inductive sensors that supplement E.M.C.'s existing range of industrial photo-electric, capacitive and ultrasonic sensors, is being shown. These offer a simple, low-cost means of detecting any metallic objects and can be mounted up to 50 ft away from the associated electronic switching relay. Another interesting item to be shown is the latest version of the Vacwell thermal compression bonder. It incorporates a 20-way rotary indexing table, which, with a trained operator, has an output of 250 complete transistor headers per hour. Nail-head, stitch and scissor bonding are all within the scope of this instrument. [348]

Electronic Machine Company, Sherman Road, Bromley, Kent.

E.R.A. (360)

Examples of the work the Electrical Research Association has recently carried out on electronic components—with

special emphasis to long term stability of capacitors and resistors—is on view. Another of their investigations is on the properties of thin vacuum deposited dielectric films for micro-electronic applications. [464]

Electrical Research Association, Cleeve Road, Leatherhead, Surrey.

EDDYSTONE (201)

A transistor dip oscillator, called the Edometer, which also can be used as an absorption or heterodyne wavemeter, signal generator, modulation monitor or audio oscillator, has been introduced by Stratton—now a subsidiary of Marconi's. The latest addition to the Eddystone range of receivers is the 990S transistor communications set which covers the 250-870 Mc/s band in two ranges. [349]

Stratton & Co. Ltd., Eddystone Works, Alvechurch Road, Birmingham 31.

EGEN (258)

The prototype of a new volume control designed specifically for high-gain transistor circuits is shown. A demonstration of the application of the firm's components is provided by a working "skeleton" model of an advanced type of electronic organ. A variety of custom-built sub-assemblies illustrates the scope of the light electrical manufacturing service offered by the company. [350]

Egen Electric Ltd., Charfleet Industrial Estate, Canvey Island, Essex.

ELAC (255)

Latest product from this firm is the Type 12/01 general-purpose 12-inch loudspeaker. It will handle a power of 15 watts (peak) and has an impedance of 15Ω. The frequency response is 30 c/s to 6kc/s, with a fundamental resonance at 55 c/s. Total flux of the 20-oz ceramic magnet is 136,000 maxwells. [351]

Electro Acoustic Industries Ltd., Stamford Works, Broad Lane, Tottenham, London, N.15.

ELCOM (483)

The company's printed-circuit edge switch is now available in a banked version with panel mounting controls having either 10, 13 or 15 positions. There is provision for resistor networks to be inserted on the printed circuit card. The current carrying capacity is 1 amp. Also on show are printed circuit connectors, switches, plugs and sockets, attenuators, and a wide range of modules such as microphone amplifiers, line amplifiers, faders, etc. [352]

Elcom (Northampton) Ltd., Weedon Road Industrial Estate, Northampton.

ELECTRICAL APPARATUS (408)

Moving-iron and moving-coil ammeters and voltmeters are shown in various types of case. "Solicon" transistor logic units intended for industrial con-

trol applications are featured. These units operate from 12 V and have a speed of 2 m/s. [353]

Electrical Apparatus Co. Ltd., St. Albans, Hertfordshire.

ELECTRO MECHANISMS (54)

Solid state load cells, manufactured by Kulite Bytrex Corporation, are available from the range of transducers. These JP Series cells use a semiconductor strain gauge as the active element arranged in a bridge circuit, permitting d.c. or a.c. of almost any frequency to be used. The units are suitable for tension or compression force measurement, covering from 25 to 10,000 lb. The bridge resistance is 120Ω (nominal) at 70°F (change with temperature is 0.07%/°F) and linearity is 0.1% of full scale. [354]

Electro Mechanisms Ltd., 218-221 Bedford Avenue, Slough, Bucks.

ELECTROLUBE (211)

A new aerosol lubricant (2A-X) has been introduced which is harmless to plastics, such as polystyrene and p.v.c., and to natural and synthetic rubbers. [355]

Electrolube Ltd., Oxford Avenue, Slough, Bucks.

ELECTROSIL (487)

The Electrosil VP3 and VP6 resistors on display for the first time are similar to the metal-oxide film type P but intended to meet the specification DEF 5115-2 which allows a maximum surface temperature of 235°C and a load life stability of \pm 2% max change with a temperature coefficient of \pm 250 parts in a million. The triple-rating (TR) range of metal-oxide resistors permits the same resistor to be used at three ratings—semi-precision, high stability and general purpose—without reducing reliability. [356]

Electrosil Ltd., Pallion, Sunderland, Co. Durham.

ELECTROTHERMAL (221)

A range of temperature-controlled chambers for environmental testing are being displayed. A bench model, with an internal volume of 6 in³, maintains temperatures of up to 150°C to within \pm 0.3°C. Twelve-way connection can be made to the item under test for monitoring circuits. [357]

Electrothermal Engineering Ltd., 270 Neville Road, London, E.7.

ELLIOTT-AUTOMATION (160)

Single-turn, wire-wound potentiometers for use in precision servo systems, made and marketed under licence from the Fairchild Controls Corporation, are being exhibited by Elliott Brothers (London) Ltd. These are available with linear or non-linear functions in equivalent synchro sizes 08, 11, 18 and 20, and also with sine-cosine functions in sizes 09 and 20. The non-linear functions include trigonometric, logarithmic and empirical.

Also exhibited is the Londex TOP



Digital voltmeter, type DM2003, introduced by Digital Measurements.

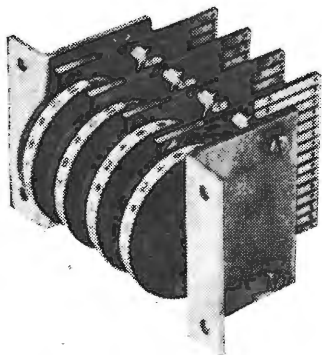

Left: Printed-circuit edge switch from Elcom is now available in a banked version.

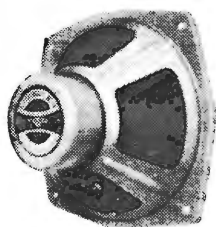

Elac 12-inch general-purpose loudspeaker.

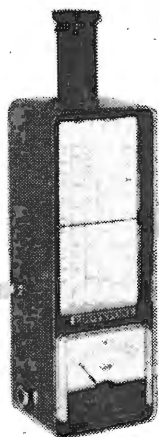

Eddystone Edo-meter transistor dip oscillator (Stratton & Co.).

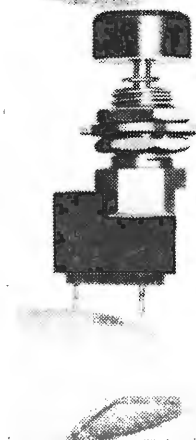

One of the series of miniature switching modules produced by ERG.

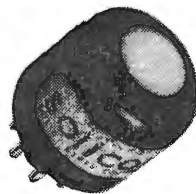

"Solicon" NOR unit by Electrical Apparatus Co.

ENFIELD PHELPS DODGE (486)

This company, formed jointly two years ago by Enfield Rolling Mills and Phelps Dodge of America, specializes in coated copper winding wires. Of particular interest to users of high-temperature enamelled wires is their Poly-Thermaleze 200 which has two coatings of polyester. It was developed in the U.S.A. and is now manufactured in this country by Enfield Phelps Dodge. [360] *Enfield Phelps Dodge Ltd., Lockfield Avenue, Enfield, Middlesex.*

ENGINEERING ENTERPRISES (359)

Latest designs of hinges, handles and catches applicable to the electronics industry are being shown. The company offer an "off the shelf" service for all sizes of continuous hinge. [361] *Engineering Enterprises (London) Ltd., 144 Shoreditch High Street, London, E.1.*

ENTHOVEN (217)

Conventional solders can produce small thermo-electric currents in copper wired

circuits under certain temperature-gradient conditions, and these can cause inaccuracies in low current applications. A new product, called Thermal-Free Solder, has been introduced to overcome this effect. The advantages of soldering by use of solder preforms and a hot plate are demonstrated. Also on show is the firm's full range of resin-covered solders, liquid fluxes, solder paints and preforms, stick solders and soldering irons. [362]

Enthoven Solders Ltd., Upper Ordnance Wharf, Rotherhithe Street, London, S.E.16.

ERG (269)

Miniature switching modules, with gold-plated beryllium copper contacts, which are electrostatically screened, providing freedom from noise and thermal bias in operation, are being demonstrated. These switches, which are for operation at 28 V direct at 0.25 amp, are available in three styles—for push-button operation and cam operation (fixed and adjustable). A new range of miniature reed relays, series M10, for printed circuit mounting is shown. These have operational speeds of less than 1 msec. [363]

Erg Industrial Corporation Ltd., Luton Road Works, Dunstable, Beds.

ERIE (228)

Thin-film sub-miniature RC modules are introduced by Erie. The temperature coefficient of the resistive elements is $\pm 0.05\%$ per $^{\circ}\text{C}$ and the shelf-life variation in resistor value is not greater than $\pm 0.5\%$. Module sizes are $\frac{1}{2}\text{in} \times \frac{1}{4}\text{in}$, $\frac{3}{4}\text{in} \times \frac{1}{4}\text{in}$ and $1\text{in} \times \frac{1}{4}\text{in}$, with four, six and eight terminals respectively. The modules are designated by a logical code, the first, second and third digits representing number of terminals, resistors and capacitors respectively. Examples are module 430-1, which has four terminals, three $150\text{m}\Omega \pm 5\%$ resistors, and 640-1, which has six terminals four $2\text{k} \pm 5\%$ resistors rated at 125mW . [364] *Erie Resistors Ltd., Great Yarmouth, Norfolk.*

ETHER (364)

Several power supplies are being shown, including one with two outputs (one fixed at 24 volts and another variable from 5 to 30 volts) to drive solid-state switching circuits. Also shown is a film-strip termination which provides a pin type of connector that can be crimped into the barrel of their Type MRAC removable crimped contacts. [365]

Ether Ltd., Caxton Way, Stevenage, Herts.

EVERSHED (411)

The display consists mainly of f.h.p. motors and servo amplifiers. The newest product is the Steromotor which is an a.c. induction motor but has no bearings, commutator or brushes. It is of French origin, invented by Rosain and Stcherbatcheff, and is available with speeds of from 2 to 200 r.p.m. for asynchronous

range of relays which is on show for the first time. Two- and three-pole changeover types are available, either enclosed in a transparent plastic dust cover or in an open form. Coil voltages are up to 240 V a.c. and 500 V d.c. and contacts are rated at 6 A at 240 V a.c.

Relays from Clare-Elliott Ltd. are also being shown and include several types using modular construction techniques. [358]

Elliott-Automation Ltd., 34 Portland Place, London, W.1.

ENALON (404)

Special stampings in laminated materials for push-button and slider switches, tuner units, e.h.t. transformers and i.f. coil sets are displayed; also injection moulded parts for switches, knobs and other receiver mechanisms. In addition, coil formers (phenolic impregnated tubes) for tuner units and transformers are shown. [359]

Enalon Plastics Ltd., South Premier Works, Drayton Road, Tonbridge, Kent.

types and of 20, 30 or 60 r.p.m. for synchronous. [366]
Evershed & Vignoles Ltd., Acton Lane, Chiswick, London, W.1.

FANE (351)

The Ionofane high-frequency loudspeaker (the recently introduced British version of the Ionophone) covering about 3 kc/s-30 kc/s is displayed. The device uses a modulated r.f. oscillator to provide energy to a quartz discharge tube which propagates the acoustic energy via an exponential horn. The loudspeaker is available with mid- and low-frequency units to form a complete high-quality system. [465]
Fane Acoustics Ltd., Hicks Lane, Batley, Yorkshire.

FERRANTI (311)

Linear circuit units combining silicon integrated circuits with thin film techniques are shown, under the name Multilin. For logic applications, Micronor units are a companion range of solid-state circuits. A semiconductor light source is provided by a gallium phosphide diode, giving electro-luminescent radiation at 7,000Å. Four types of parametric amplifier with constant gain-bandwidth product are shown, for the frequency range 390 Mc/s to 4,000 Mc/s. A new size of optical shaft encoder (size 23) has been developed. [367]
Ferranti Ltd., Hollinwood, Lancs.

FINE WIRES (502)

The normal range of textile-covered wires is augmented with "tinselated" wire. This has a core of terylene lapped with cadmium-copper, and is used for telephone connecting cable when covered with p.v.c. [466]
Fine Wires Ltd., P.O. Box 78, Grove Road, Nottingham.

FIRTH CLEVELAND (216)

The Spire range of fasteners and the Nyloc and Clevelec ranges of self-locking nuts are being shown. Other exhibits include a range of Spire plastic fasteners, a novel type of cable clip, a snap-in type of rivet and a self-retaining captive nut. [467]
Firth Cleveland Fastenings Ltd., Treforest, Pontypridd, Glamorgan.

FLIGHT REFUELLING (492)

Logic elements based on reed switches are shown for the first time. Called Relog modules, they provide multiple inputs and outputs and isolation of inputs. OR and NOR elements are currently available, and each element can drive up to 25 other logic elements. Compatible with the Relog system is a switching module with reed inserts from which uniselectors can be assembled for data scanning. Demonstrations are given of a programmed crane application and a strain-gauge scanning system. [368]
Flight Refuelling Ltd., Wimborne, Dorset.

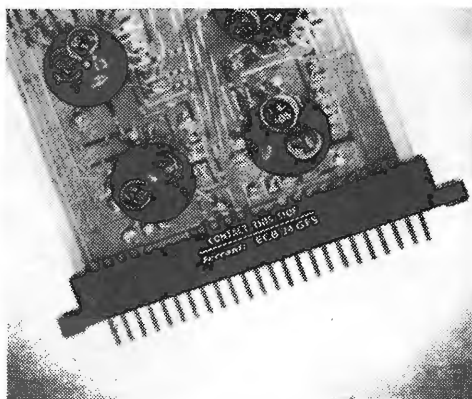

Ferranti edge connector for printed circuit boards.



Six-inch inverted loudspeaker from Goodmans.

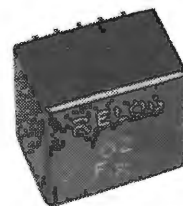

Relog logic module shown by Flight Refuelling.

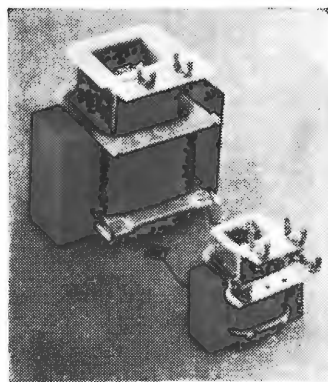

Double bobbin technique of transformer construction (Hinchley).

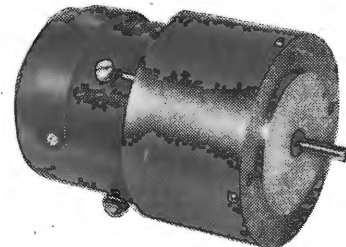

Evershed's Steromotor; a high-torque, low-speed motor particularly suitable for servo control.

FORMICA (167)

Among laminates being shown for the first time are a new grade copper-clad glass-epoxy (CGE 80) flexible for wrap-round circuits and an experimental nickel-clad laminate for micro-welding. A new copper-clad p.t.f.e. glass laminate for use, for instance, for printed waveguides is also shown. [369]
Formica Ltd., De La Rue House, 84-86 Regent Street, London, W.1.

GARDNERS (478)

In addition to a wide range of transformers, a pressure transducer system for communication with the totally deaf and blind which was developed in conjunction with the Royal National Institute for the Blind is on show. Several delay lines and filter networks—a field the company has recently entered and now offers full design and development facilities—are also on show. [370]
Gardners Transformers Ltd., Somersford, Christchurch, Hants.

GOODMANS (270)

High-quality, p.a. and general purpose loudspeakers are being shown with two inverted loudspeakers for "entertain-

ment" use. The new 6in inverted loudspeaker has a ceramic magnet and is useful for domestic equipment where size and weight limitations are important. [371]
Goodmans Industries Ltd., Axion Works, Lancelot Road, Wembley, Middlesex.

GRESHAM (480)

A multiple recording head providing 33 tracks within 1 inch is shown by Gresham Lion Electronics. Output is 1.5mV peak-to-peak at 300 bits/inch at 15 in/sec. Also displayed is a 16-track double-gap read/write head for use on 1-inch tape. Output is 33mV p-p at 300 bits/inch at a tape speed of 120 in/sec. The small Transformers Division are showing a range of hermetically-sealed oil filled transformers with a three-part case construction which simplifies terminal mounting and allows short leads. [372]
Gresham Transformers Ltd., Lion Works, Hanworth Trading Estate, Feltham, Middx.

HALLAM, SLEIGH & CHESTON (205)

The Widney Dorlec range of constructional units for building instrument con-

soles, racks, etc., has been extended by the addition of the 20/30 series which permits a wider variety of styling. Also shown is a range of cases and chassis, and telescopic slides for equipment drawers. [373]

Hallam, Sleigh & Cheston Ltd., 237 South Road, Handsworth, Birmingham 19.

HARWIN ENGINEERS (488)

The edge-lit, 12 character digital read-out indicators for flush or plug-and-socket mounting may be fitted with 6, 12 or 28 V lamps. The smaller types, with an overall length of about 2 in and an aperture of $\frac{1}{2}$ in² are provided with 12 V lamps. The strip digital readouts may be vertically or horizontally arranged and measure $\frac{1}{2} \times 5$ in. [468]

Harwin Engineers Ltd., Fitzherbert Road, Farlington, Portsmouth, Hampshire.

HATFIELD (469)

Covering the frequency ranges 40 to 230 Mc/s and 470 to 860 Mc/s the new transistor field-strength meter Type 6T4G on Hatfield Instruments stand should be of interest to the radio and television installation engineer. Sensitivity is displayed by meter—two scales calibrated to 1 mV and 50 mV f.s.d.—and provision is made for connection of phones for monitoring received signals. [374]

Hatfield Instruments Ltd., Burrington Way, Plymouth, Devon.

HINCHLEY (280)

Transformers for most applications are exhibited. The range includes constant voltage, high temperature, toroidal and short-circuit proof transformers. D.c. power supply units and the double bobbin method of transformer construction are also illustrated. [375]

Hinchley Engineering Co. Ltd., Pans Lane, Devizes, Wiltshire.

HUGHES (324)

A twelve-minute colour film is being used by Hughes International to highlight the advances made in microelectronics and includes information on the manufacture of silicon planar components, such as the diffusion photo resist and plating techniques involved in the production of planar epitaxial diodes. A wide range of semiconductors are on show and include an epitaxial switching diode with a 4 nsec recovery time and ratings of 50 volts and 100 mA. [376]

Hughes International (U.K.) Ltd., Glenrothes, Fife, and Heathrow House, Bath Road, Cranford, Hounslow, Middx.

HUNT (303)

A low-cost range of capacitors, with values from 1,000 pF to 0.0047 μ F, has been made possible by utilizing the characteristics of metallized film to permit a minimum of protective housing. Small dimensions and high insulation resistance are combined with ability to

recover from arduous humidity conditions. Another low-cost range is the type AW electrolytics. The low voltage tubular types in this range have welded axial connections suitable for printed circuits. [377]

A. H. Hunt (Capacitors) Ltd., Bendon Valley, Garratt Lane, Wandsworth, London, S.W.18.

I.C.I. (477)

Plastics materials of particular application in the radio and electronics industry are on show. These include "Fluon" p.t.f.e., which has a very low permittivity and power factor at frequencies at the upper end of the radio spectrum; "Melinex" polyester film; "Propathene" polypropylene; and the glass-filled nylons of the "Maranyl" range which are dimensionally stable at high temperatures. [378]

Imperial Chemical Industries Ltd., Imperial Chemical House, Millbank, London S.W.1.

IMHOF (304)

The modular chassis system, chiefly for printed circuit housing, is augmented with the type C and D frames, thus enabling the majority of wiring connectors to be accommodated. Almost any shape of instrument housing can be built with the Imlok series 901 construction system, examples of which are on show. [379]

Alfred Imhof Ltd., Ashley Works, Cowley Mill Road, Uxbridge, Middlesex.

INTERNATIONAL NICKEL (116)

Nickel-cadmium sealed cells, which can be recharged time after time, and nickel-alloy permanent magnets are the main features on this stand. Examples of the uses of the compact rechargeable batteries are also given. [469]

International Nickel Limited, 20 Albert Embankment, London, S.E.1.

J. D. ELECTRONICS (473)

Wound components of all types can be made to customer specifications and typical transformers and inductors, etc., are illustrated. Custom-built equipment, inverters, transducers and wire-wound resistors are also seen on this stand. [380]

J. D. Electronics (Birmingham) Ltd., Leafield, Corsham, Wiltshire.

JACKSON BROS. (267)

Three new trimmers using p.t.f.e. as the dielectric are on show. The capacitance range of the Style 518 is from 0.8 to 18 pF, the Style 330 from 2 to 30 pF and the Style 408L from 0.25 to 8 pF. A locking device is provided on the 408L, which is 1 in long by 0.2 in in diameter, to protect it from mechanical shock and normal vibration. [381]

Jackson Brothers (London) Ltd., Kingsway, Waddon, Croydon, Surrey.

JERMYN (468)

A new device, called a heat sink adaptor, allows direct attachment of transistors in TO-5 and TO-18 cans to a chassis, thereby avoiding the need for heat sinks. Insulated versions are exhibited. Also on show are a range of milliwatt heat sinks for TO-5 and TO-18 transistors, and transistor mounting pads for micrologic applications. [382]

Jermyn Industries, Vestry Estate, Vestry Road, Sevenoaks, Kent.

K.G.M. (232)

K.G.M. Electronics and its associated companies (Automatic Information Data Service, Integrated Data Processing and R. E. Carder) are featuring visual display equipment including the range of in-line multi indicators used in decade counters, digital clocks, etc. A compact variable speed control unit for f.h.p. motors giving precise and instant control, both forward and reverse, is being shown, together with examples of test and measuring equipment. [470]

K.G.M. Electronics Ltd., Bardolph Road, Richmond, Surrey.

KEYSWITCH (450)

Improved solid-state relay units, to which has been added a range of plug-in timers, are on view with the full range of subminiature relays. The recent 304 plug-in component module (see *Wireless World*, April) with transparent cover has a component mounting space of about $3\frac{1}{2} \times 2\frac{1}{4} \times 12$ in and uses a pierced board backed with copper strips. A new range of microswitch relays based on the standard B.P.O. 3000 and 600 types is introduced. [471]

Keyswitch Relays Ltd., 120-132 Cricklewood Lane, London, N.W.2.

LEMCO (262)

New capacitors exhibited by this company include barrier layer ceramic discs with values up to 0.2 μ F at 12 V; ceramic types using thin-film high-permittivity material with capacitances up to 50,000 pF at 30 V; and ceramic lead-through types, tinned and fluxed for installation. Other introductions are a range of polystyrene capacitors providing up to 20,000 pF at 30 V and moulded types meeting the B.S.I. humidity classification H2. [383]

London Electrical Manufacturing Co. Ltd., Bridge Place, Parsons Green Lane, London S.W.6.

LEVELL (454)

Two separate negative feedback amplifiers are incorporated in the new Type TM3A transistor a.c. microvoltmeter which can also be used as an amplifier. Full scale voltmeter ranges are from 15 μ V to 500 V with an accuracy of $\pm 1.5\%$ $\pm 1.5 \mu$ V; frequency response extends from 1 c/s to 3 Mc/s. Decibel ranges are also provided from -100 dB to +50 dB in 10 dB steps with a separate

scale from -20 dB to +6 dB relative to 1 mW into 600Ω. [384]

Levell Electronics Ltd., Park Road, High Barnet, Herts.

LEWCOS (268)

The London Electric Wire Company are showing samples from their comprehensive range of Lewcos insulated wires and strips including Lewmex general purpose enamelled wires, Lewsosol solderable enamelled wires, and Lewkanex high-temperature winding wires. A wide selection of Plasmet—single and double sided, flexible and rigid—copper etched wiring circuits are being shown by their subsidiary Printed Circuits Ltd. This display also includes samples of their recently developed printed potentiometers and resistance units. [385]

The London Electric Wire Company and Smiths Ltd., Church Road, Leyton, London, E.10.

LEWIS SPRING (110)

A double transistor clip allows the mounting of two OC72 transistors in parallel. Also shown is a range of stainless steel "Wavey" washers, for applications where the electrical properties of the firm's beryllium copper "Wavey" washers are not required. [386]

Lewis Spring Co. Ltd., Studley Road, Redditch, Worcs.

LINTON & HIRST (275)

The display consists of a comprehensive range of transformers and choke laminations in all grades of silicon iron, grain oriented and nickel iron alloys. The company's range of "C," cruciform and toroidal cores and transistor heat sinks is also being shown. [472]

Linton & Hirst Ltd., Parsonage Road, Stratton-St. Margaret, Swindon, Wilts.

LIVINGSTON (369)

Roband oscilloscopes, pulse generators, printed circuits and solid state control modules are displayed. These latter modular units are manufactured by a group member—Livingston Control—and are intended to be used in place of electro-mechanical switches. Their photo-electric and inductive modular switches have applications in industrial counting, sorting and routing, etc. [387]

Livingston Laboratories Ltd., 31 Camden Road, London N.W.1.

LUCAS (315)

Laser units on show from G. & E. Bradley, a subsidiary, include single- and multi-cavity heads with water cooling of both flash tubes and ruby. These units are available with outputs ranging from 1 to 250 joules. Bradley are showing for the first time solid-state frequency multiplier modules for use at frequencies up to 76 Gc/s, together with their ranges of solid-state parametric amplifier units and coaxial components

(including fixed and variable attenuators). [388]

Joseph Lucas (Sales & Service) Ltd., Dordrecht Road, Acton Vale, London, W.3.

LUSTRAPHONE (209)

To enable people to talk who have undergone surgical operations resulting in the loss of speech, Lustraphone have produced a small electro-magnetic contact transducer that can be worn in the neckband of a shirt or blouse. This unit, which measures $1\frac{1}{8} \times \frac{3}{4} \times \frac{5}{16}$ in, is being shown along with the new "Speech-Aid" transistor amplifier that has an adjustable output of up to 330 mW to an internal speaker. The size of this unit is $4\frac{7}{8} \times 3\frac{1}{4} \times 1\frac{1}{8}$ in. [389]

Lustraphone Ltd., St. George's Works, Regents Park Road, London, N.W.1.

M-O VALVE (312)

Additions to the M-O Valve range of cathode-ray tubes include the LD700 rectangular (12×9 cm) flat face dual trace oscilloscope tube with mesh p.d.a., making possible 10 kV operation. Also new is the X-band solid-state source type SSX1 employing a varactor diode multiplier. The centre frequency is adjustable between 7 and 12.4 Gc/s and the power output over this range varies from 30 mW at the lower frequencies to 10 mW. New gas-filled valves include the E2816, a metal-bodied deuterium-filled grid-controlled rectifier with an anode voltage of 40 kV and the E2830 pulse modulator thyratron with a 20 kV peak anode voltage.

Salford Electrical Instruments, an associated company, are showing quartz crystals (the full range covers frequencies from 200 c/s to 200 Mc/s), o.c. filters for 12.5, 25 and 50 kc/s separation in h.f. and u.h.f. communication equipment, and quartz crystal controlled transistor oscillators, among a wide variety of components, materials and instruments. [390]

The M-O Valve Co. Ltd., Brook Green Works, London, W.6.

McMURDO (218)

Additions to the range of plugs and sockets exhibited include a miniature version of the Red range giving the same amount of connector ways but occupying a quarter of the area. Specialized valve and relay holders and panel mounted moving coil meters with an accuracy commensurate with BS89/1954 are featured, together with a new hundred-way zero insertion force connector, known as Rotalok. [391]

McMurdo Instrument Co. Ltd., Rodney Road, Portsmouth, Hampshire.

MAGNETIC DEVICES (314)

Included in the wide range of relays on show are the new Series 120 and 130 small plug-in relays, the Series 140EP enclosed heavy-duty relays and a heavy-duty version on the Post Office 3000

relay. Also exhibited is a selection of Varicon standard connectors and printed circuit connectors and the Termiweld method of terminating flexible tape to a connector. [473]

Magnetic Devices Ltd., Exning Road, Newmarket, Suffolk.

MALLORY (100)

An improved version of their 1.5 V manganese alkaline dry cell system is a feature of this company's display. The anode and electrolyte construction have been modified to give better internal contact, resulting in lower internal impedance, higher flash currents and better stability with large circuit drains. The cells, produced in five standard sizes, are therefore now suitable for a wider range of heavy duty applications. [392]

Mallory Batteries Ltd., Crawley, Sussex.

MARCONI (226)

The rapidly expanding Specialized Components Division introduces one of the most accurate frequency standards available in this country. Three simultaneous frequencies of 100 kc/s, 1 Mc/s and 2.5 Mc/s are provided with a short-term stability of better than 3 parts in 10^{10} and a monthly stability of 1 part in 10^9 . In the event of mains failure, the complete unit will operate from batteries with the same stability. The recently formed Microelectronics Division display a frequency divider which will divide the frequency of an input signal by any whole number between 1 and 1,000 and uses the pulse counting technique with three decade division circuits. [393]

Marconi Company Ltd., Chelmsford, Essex.

MARKOVITS (81)

Examples of the nameplates the company makes for the radio and electrical trades are being shown. These are available in die-cast metal with various electro-plated finishes, metal and plastic. Other exhibits include self-adhesive labels, badges and advertising novelties. [394]

I. Markovits Ltd., 34 Stronsa Road, London, W.12.

MARRISON & CATHERALL (472)

Recently developed permanent magnets on show include types for use with mass spectrometers, getter ion pumps and reed switches. In transformer cores the firm is displaying toroids with epoxy resin covering, allowing the application of windings without further insulation; also a new form of screwed bonding clamp and C-core frame assemblies. [395]

Marrison & Catherall Ltd., Forge Lane, Killamarsh, Sheffield, Yorks.

METWAY (471)

Two recently introduced lines to the company's range of connectors and wiring accessories are the "Studway" cable strapping and "Keyway" interlocking

terminal blocks. The latter, rated from 5 to 100 amps, can be built into any number of ways, either in size or rating.

[396]
Metway Electrical Industries Ltd., Metway Works, Canning Street, Brighton, 7.

MICROWAVE ASSOCIATES (498)

A 1-watt solid state u.h.f. transmitter suitable for pulse modulation in telemetry links is shown. The transmitter operates at a fixed frequency and stability is 1 part in 10^6 over the temperature range -15°C to 65°C . The transmitter operates from a d.c. power supply of 24 V.

[397]
Microwave Associates Ltd., Cradock Road, Luton, Bedfordshire.

MICROWAVE ELECTRONICS (491)

A range of microwave swept signal sources is shown and includes a complete X Band swept oscillator and reflectometer system that employs the M.E.S.L. highly directive directional couplers for sampling. Also shown is an internally swept C Band oscillator that has a ten-watt travelling-wave tube amplifier and levelling network. Another interesting exhibit is a range of octave bandwidth p-i-n switches which includes the recently developed unit covering 500 Mc/s to 13 Gc/s.

[474]
Microwave Electronics Systems Ltd., Old Liston Industrial Estate, Newbridge, Midlothian.

MORGANITE (301)

Their new resin-coated metal film resistors are being shown by Morganite. The two versions available are the LFM02 (0.25 W) and LFM03 (0.5 W), which are additions to the "Filmet" range. The load stability is stated to be better than 0.5% in 2,000 hours and ageing change less than 0.1% in a year. They are also showing carbon composition and ceramic bonded resistors, and "Termilode" silicon carbide waveguide terminations.

The associated company, Steatite & Porcelain Products, are showing pressings, extrusions and precision ground products in three alumina ceramics. They are alumina 972 (97%), a refractory non-porous composition with an insula-

tion of 0.01% at 1 Mc/s; alumina 961 (96%) for the bulk production of component pieces where low loss (power factor 0.4% at 1 Mc/s) together with high mechanical strength are important, and a 75% alumina material.

[398]
Morganite Resistors Ltd., Bede Training Estate, Jarrow, Co. Durham.

MUIRHEAD (410)

Accurate voltage measurement requires temperature controlled reference voltages and one of the new Muirhead instruments uses a modified standard cell in a housing kept at 37.5°C to give a stability of $\pm 5\mu\text{V}$. An accuracy of $20\mu\text{V}$ is obtainable over the temperature range 12°C - 35°C . The voltage standard requires a supply of 100mA at 11-15 V, and measures $6\frac{1}{2}\text{in} \times 4\frac{1}{8}\text{in}$.

[399]
Muirhead & Co. Ltd., Beckenham, Kent.

MULLARD (307)

A 25-in rectangular 90° colour television tube, that does not require an external implosion shield and is currently being supplied to British manufacturers for use in experimental receivers, is shown. The rectangular screen ($50.4 \times 39.4\text{ cm}$) gives a useful picture area of approximately 1,800 sq in. Among the other exhibits is a comprehensive range of valves for colour television receivers that has been designed specifically to meet the exacting conditions encountered in time base and e.h.t. circuits. All have a "magnoval" (B9D) base which reduces

the seated height and also simplifies screening.

Many professional components are also shown and include some very small computer storage cores, which the makers claim are the smallest in the world; the diameter is 0.014in. Switching time is less than 150 nsec. Complete storage systems are also shown.

[400]
Mullard Ltd., Mullard House, Torrington Place, London, W.C.1.

MULTICORE (168)

Daily demonstrations are being given of a solderability test machine developed by the Electronic Engineering Association and the International Electro-technical Commission for testing the solderability of round-wire and round-wire-ended components. A new version of the Bib wire stripper, Model 8, has a gauge-setting device which automatically adjusts the stripping jaws to the required diameter of conductor. Examples of more than 400 specifications of solders are shown.

[401]
Multicore Solders Ltd., Maylands Avenue, Hemel Hempstead, Herts.

MUREX (257)

The company has die facilities for the production of over 500 different types of magnet from various metals and alloys. Among those shown are the new high coercive isotropic alloy, the extra-high coercive anisotropic alloy and sintered permanent magnets.

[402]
Murex Ltd., Rainham, Essex.

N.S.F. (222)

A heavy-duty rotary wafer switch, known as the model SD, is introduced and replaces the former Palec switch, model PL. The new switch is claimed to have a longer life at maximum rating than its predecessor. Up to 5 A can be switched at 250 V (alternating) and 10 A at 30 V (direct). The silver-plated copper contacts give a contact resistance of less than $5\text{ m}\Omega$ and are arranged to make before break.

[403]
N.S.F. Ltd., 31-32 Alfred Place, London W.C.1.

NEWMARKET (281)

Additions to the range of packaged circuits include a single-stage transistor amplifier designed to match high-impedance transducers to the low-input impedance of the firm's standard packaged amplifiers. The other additions are three mains power packs for the packaged circuits, giving respectively 12 V at 150 mA, 21 V at 330 mA and 12 V at 500 mA. Servikit transistors, shown for the first time, are groups of general-purpose, close-tolerance units allowing circuit design with a small standard set of transistors.

[404]
Newmarket Transistors Ltd., Exning Road, Newmarket, Cambs.

OLIVER PELL (481)

The Varley VP series of miniature plug-in relays have been extended to include types VP2/4 HD/5A, with 2 or 4

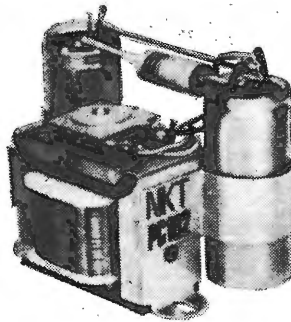

Newmarket Transistors mains power pack for packaged circuits.

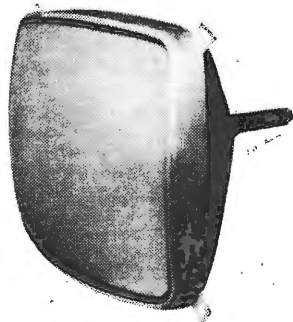

Mullard 25-in rectangular picture tube for colour receivers.

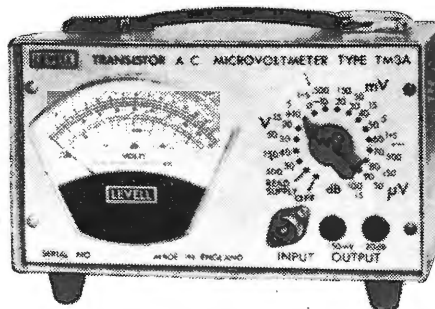

A.C. microvoltmeter Type TM3A from Levell Electronics Ltd.

change over silver contacts (5 A, 220 V, 100 W); VP 2/4/6 TC with either silver, gold alloy, palladium or platinum contacts (1 A, 100 V, 30 W); plus a number of others, one of which is for direct insertion into printed circuits. The Mark III sockets are improved and fitted with gold inserts to improve shelf life. These sockets are moulded in glass-filled nylon and are almost unbreakable. [405]

Oliver Pell Control Ltd., Cambridge Row, Burrage Road, London S.E.18.

P.M.D. GROUP (282)

The main theme of the exhibit is on the complete service provided by Precious Metal Depositors Ltd. in machining and plating of contacts for a wide range of plugs and sockets; a variety of these are being shown. A new neutral gold solution, known as PMD Transtherm H.R., which can produce a pure 24-carat gold deposit of low porosity, is being shown by P.M.D. Chemicals Ltd. [406]

Precious Metal Depositors Ltd., Broad Lane, Coventry.

PAINTON (224)

New products include a range of connectors primarily designed for the latest signal transmission equipment and approved by the Post Office. Features include easily removable plug blades and sockets, permitting use of contacts only in the position where they are required. Blades and sockets are positioned to a 0.1-in module and are gold-plated. The range comprises a 40-way plug and socket, and composite audio and coaxial units with provision for 2, 4 or 6 coaxial connectors. [407]

Painton & Co. Ltd., Kingsthorpe, Northampton.

PARMEKO (158)

Miniature sealed relays and a range of solenoids with encapsulated coils are added to the Parmeko range of components which range from circuit modules and s.c.r. trigger units to d.c. amplifiers, stabilized power units and voltage regulators. [408]

Parmeko Ltd., Percy Road, Aylestone Park, Leicester.

PARTRIDGE (259)

A range of high-voltage power transformers, hermetically sealed and oil filled, is displayed. Also shown are resin-cast h.t. 400-c/s transformers for the aircraft industry; e.h.t. transformers for operation up to 40 kV; and high power, low-frequency output transformers as used in environmental testing. The complete range of the company's products is represented, including output and power transformers with C-core and E-core construction. [409]

Partridge Transformers Ltd., Roebuck Road, Chessington, Surrey.

PERMANOID (206)

A full range of p.t.f.e. thin-wall sleeveings with thirty bore sizes from 0.013 to 0.336in is featured. Other exhibits include p.v.c. and glass-fibre sleeving, equipment wires, mains cables and coaxial cables. Television aerials, accessories and communal television equipment made by Arrell Electrical Accessories Ltd. is also being shown. [410]

Permanoid Ltd., New Islington, Manchester, 4.

PLANER (102)

Several new pieces of equipment for micro-circuit production are being shown, including an electron-beam power supply unit with a water-cooled electron-beam evaporation source for the deposition of thin films. A feature of the Planer-Unvala source is the facility for adjusting the focus of the beam from a small spot to a diffused zone upon the evaporant. Planer are also showing a new thermo compression machine for bonding leads to thin-film micro-circuits and semiconductor elements, and a surface profile monitor for the measurement of thin films within the range 0-50,000 Å. [411]

G. V. Planer Ltd., Windmill Road, Sunbury-on-Thames, Middlesex.

PLESSEY (159)

A comprehensive selection of components is being shown by Plessey, including a very small relay encased in a TO-5 transistor can. Although prim-

arily designed for missile use, this Type CJ relay should be of interest to those working with printed circuits. For the computer engineer, Plessey have on show a memory array featuring a 1,000,000-core frame. Also on display are 1 µsec read/write cycle cores, with an outside diameter of only 0.020 in, which are in production for up to 6,000-word stores.

In collaboration with Harowe Servo Controls Inc., Ketay Ltd.—a Plessey subsidiary—are showing a range of brushless synchros. These use a rotary injection transformer in place of the conventional brush gear, which obviates all physical contact of parts for rotor coupling. Accuracies of ±7 minutes of arc are quoted over the temperature range -65° to +125°C. [412]

Plessey-UK Ltd., Vicarage Lane, Ilford, Essex.

PRESSAC (357)

A solderless connector system introduced by this firm employs small metal receptacles into which wire ends are inserted and secured by a pneumatic press. The receptacles are available in strip form, wound on reels, and there are various designs to fit pins, blades and contact "nails" in common use. Various multi-way connector mouldings are available, housing ready-wired receptacles (colour coded if required) on staggered spacings. The pneumatic press can be hired from Pressac. [413]

Pressac Ltd., Long Eaton, Nottingham.

PYE (215)

Pye Switches Ltd. are exhibiting their full range of micro and limit switches, their heavy duty miniature toggle switches, camera controls and miniature joy-stick controllers. [414]

Pye Switches Ltd., Otehall Works, Burgess Hill, Sussex.

R. & A. (260)

The usual range of loudspeakers, normally available to industry, is augmented with 8, 10 and 12 in units intended for high-quality domestic installations. A

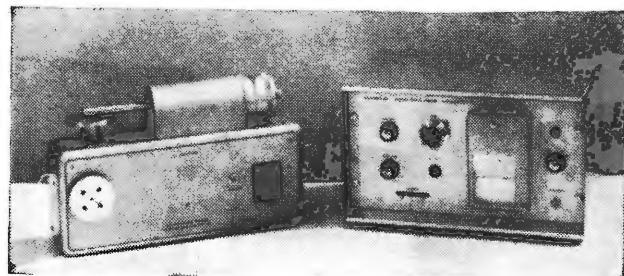
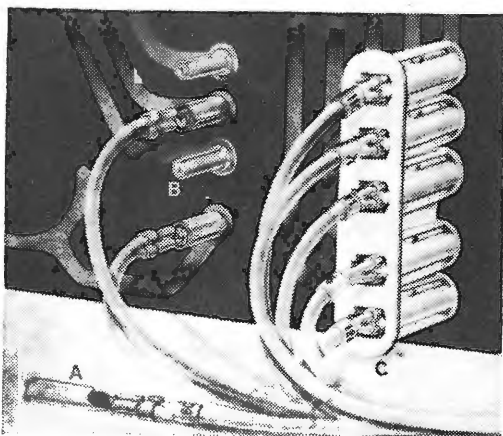

Surface profile monitor for measuring the thickness of thin films (Planer).

Pressac solderless connectors: A, receptacle with wire; B, used on printed circuit; C, multi-way connector.

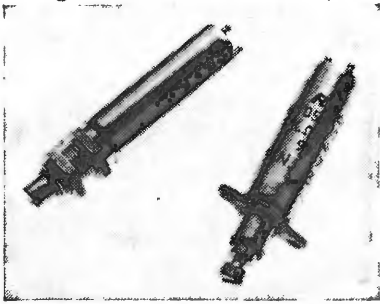

Reliance 10-turn helical potentiometer.

double cone technique is used which is claimed to reduce the inherent loudspeaker distortion. A feature on all loudspeakers is that the voice coil lead-out connections are in the form of phosphor-bronze tape sandwiched between a two-ply impregnated centring disc, which eliminates the more usual flying leads and cone anchor points. [415]

Reproducers & Amplifiers Ltd., Frederick Street, Wolverhampton.

RADIOHM (400)

Miniature and sub-miniature variable resistors and potentiometers, that feature a newly developed carbon track which gives a noise level reading of between 15 and 22 mV, are being shown. These units are available with or without switches and employ plastic spindles. [416]

East Grinstead Electronic Components Ltd., Imberhorne Industrial Estate, East Grinstead, Sussex.

RELIANCE (151)

Introduced this year is a ten-turn helical potentiometer of $\frac{1}{2}$ in diameter, available in ranges from 0-10 Ω to 0-100 k Ω . Linearities are from $\pm 1\%$ to $\pm 0.1\%$ and power rating is 1.5 W at 40 $^{\circ}$ C. Temperature range is -55 $^{\circ}$ C to +100 $^{\circ}$ C. Also new is a multi-turn trimmer potentiometer, rated 1 W at 20 $^{\circ}$ C, available with resistance ranges from 0-10 Ω to 0-50 k Ω . Temperature: -40 $^{\circ}$ C to +85 $^{\circ}$ C. [417]

Reliance Controls Ltd., Sutherland Road, London E.17.

RIVLIN (403)

Precision wire wound resistors are available with values from 1 Ω to 10 M Ω and tolerances down to $\pm 0.01\%$. Four-terminal types are supplied, in the range 0.001 Ω to 100 Ω , for applications where terminal resistance becomes significant. Temperature-sensitive types have temperature coefficients from +0.35 %/ $^{\circ}$ C to +55 %/ $^{\circ}$ C. Also shown are miniature pre-set potentiometers of wire-wound construction, with worm driven sliders and clutch mechanisms to prevent over-winding. [418]

Rivlin Instruments Ltd., Doman Road, Camberley, Surrey.

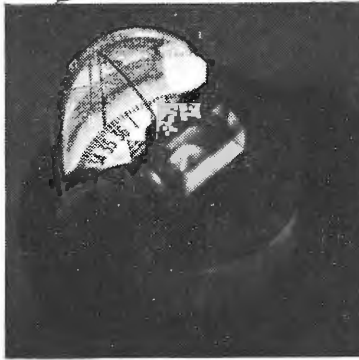

Illuminating this compass is a self-powered Betalight (Saunders-Roe & Nuclear Enterprises).

ROLA CELESTION (223)

Among the new loudspeakers being shown by Rola Celestion is a non-corrosive re-entrant unit for marine use. It has a fibre-glass flare, reflector, and diaphragm assembly. Also on display is the Ditton 10 high-fidelity 10-watt speaker which measures $12\frac{3}{4} \times 6\frac{3}{4} \times 8\frac{1}{4}$ in and has a frequency response of 30-15,000 c/s. They are also showing their range of round and elliptical loudspeakers for the domestic receiver manufacturer. The sizes range from 3 to 10 in diameter and, for elliptical models, 5 x 3 in to 10 x 6 in. [419]

Rola Celestion Ltd., Ferry Works, Thames Ditton, Surrey, England.

ROSS, COURTNEY (482)

Terminals are the main feature of this display and the range includes wire-end types, solder types, crimping terminals, coaxial cable sheath connectors, strip and pillar terminals. Cable straps, Oddie fasteners, various clips and cable connectors are also on view. [420]

Ross, Courtney & Co. Ltd., Terminal House, Elthorne Road, Upper Holloway, London, N.19.

ROYAL WORCESTER (358)

The full range of ElectroX high-alumina ceramic/metal terminals are exhibited. Also shown is a range of sealed bushings and stand-off insulators together with a selection of special designs in ceramics manufactured to customers' requirements. [421]

Royal Worcester Industrial Ceramics Ltd., Tonyrefail, Glamorgan.

S.G.S-FAIRCHILD (322)

Two new silicon planar epitaxial transistors, the P346 and V405, are included in the display of industrial types. The P346 is an n-p-n high-frequency switch (saturation from 1 mA to 50 mA with a 7 nsec storage time). The V405 is a p-n-p type with a low noise figure (3dB at 1mA). New among the company's consumer transistors are the BC114, with a noise figure of 1.5dB; the BC125 and BC126 n-p-n and p-n-p complementary

drivers capable of powers up to 1W; and the BC119 output transistor, a pair of which can deliver up to 7W of audio power.

New transistors in the professional range include the BSX12 thin film memory driver with 15 nsec turn off time at 1 amp; the BSX27 n-p-n ultra fast computer switch and the BSX35, the p-n-p complement to the BSX27. [422]

S.G.S-Fairchild Ltd., 23 Stonefield Way, Ruislip, Middlesex.

S.T.C. (162)

The range of potentiometers from S.T.C. Electro-Mechanical Division is augmented by the recently acquired firms of P.X.Fox and General Controls. A working demonstration will show a low torque potentiometer (type SB with a linearity of 0.35 %) being turned by wind-driven propellers. The latest S.T.C. miniature helical potentiometer with nylon bearings is also seen. [423]

Standard Telephones & Cables Ltd., Connaught House, 63 Aldwych, London, W.C.2.

SALTERFIX (405)

This new company, a subsidiary of George Salter & Co., are suppliers to industry of a variety of clips. Truarc retaining rings, various spring steel clips and moulded plastic clips are shown. [424]

Salterfix Ltd., Vestry Estate, Otford Road, Sevenoaks, Kent.

SAUNDERS-ROE (89)

A ready means of illuminating meter scales, markers, signs and dials, etc., is provided by the range of Betalights being shown by Saunders-Roe & Nuclear Enterprises Ltd. These light sources are self-powered and comprise a sealed glass tube internally coated with a phosphor and filled with tritium gas. There is a variety of sizes, shapes and colours and they have an almost unlimited range of applications throughout the electronics industry. A useful life of twenty years is quoted for these devices which have a much higher light output than luminous strip or paint. [425]

Saunders-Roe & Nuclear Enterprises Ltd., North Hyde Road, Hayes, Middx.

SCOTT (370)

Epoxy resin insulated toroidal cores with smooth corners, on which windings can be applied directly, are shown for the first time. The coating has a thickness of 10-15 mil and a voltage resistivity of 600 Ω /mil. Examples of laminations for transformers, chokes, motors and other devices typify the company's products, the emphasis being on cold-rolled materials. [426]

Geo. L. Scott & Co. Ltd., Cromwell Road, Ellesmere Port, Cheshire.

SEAELECTRO (157)

Among the new items added to the wide range of components shown by Seaelectro is a jack for use with RG-188/U

subminiature coaxial cable. This connector is a non-panel mounting adaptation of the standard panel-mounting Conhex cable jack. An addition to their line of "Press-Fit" terminals is one with a unique inserted spring connection for the above-chassis contact.

[427]
Sealectro Limited, Hersham Trading Estate, Walton-on-Thames, Surrey.

SELLOTAPE (367)

Two new insulating tapes are shown and a wrapping machine for small cylindrical items. A purified creped paper, impregnated to bond together the paper fibres, is the basis of one of the new tapes. The tape is coated with a thermosetting adhesive and the result is a tape with high insulation, moisture resistance and tear resistance and suitable for a wide range of applications. It can be used in normal impregnation processes associated with transformers, relays, motors, etc., and will withstand temperatures of 105° C (continuous) and 180° C for short periods. Total thickness is 0.009 in and breakdown voltage is 1300 V.

[428]
Sellotape Products Ltd., Sellotape House, 54/58 High Street, Edgware, Middlesex.

SIFAM (461)

A wide variety of electrical measuring instruments in many different types of case are being shown together with a range of pyrometer indicators and thermocouples, and the "Pyromaxim" phototransistor-operated controller now available in seven types.

[429]
Sifam Electrical Instrument Company Ltd., Woodland Road, Torquay, Devon.

SLEE (320)

A recently announced spark erosion machine, the Arcotron, is intended for application in miniature electronics. Slots can be cut to an accuracy of ± 0.0001 in and it is possible for the slot to be as small as 0.0004 in. The depth of cut depends on electrode size, for example, for widths of 0.0004 in and 0.0016 in, depths of 0.005 in and 0.0625 in, respectively, can be achieved. The maximum feed rate is 0.004 in/min.

[430]
South London Electrical Equipment Co. Ltd., Lanier Works, Hither Green Lane, London S.E.13.

SOLARTRON (321)

Solartron have introduced at the Show their range of operational digital modules. These solid-state 1 Mc/s units, although designed to perform specific operations, are engineered to give the widest possible application in computing equipment. The Group will also be showing digital voltmeters, data logging equipment, analogue computers and transducers.

[475]
Solartron Electronic Group Ltd., Victoria Road, Farnborough, Hants.

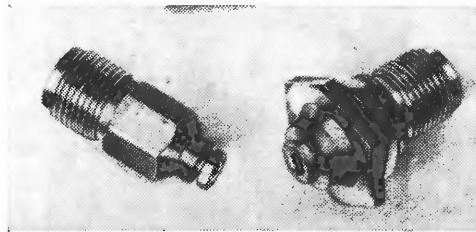

Left: Sealectro Conhex sub-miniature cable jacks for panel and non-panel mounting.

Below: Valve tester, type 45D, introduced by Taylor Electrical.

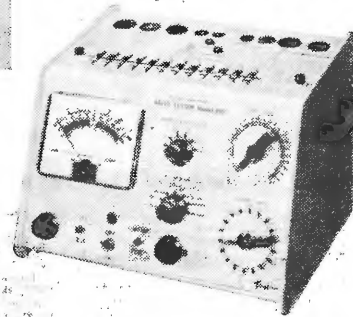

SPEAR ENGINEERING (264)

The Spearette range of tools and aids for manufacturers and service engineers are on show. Among the new items is a range of power transistor sockets designed to shorten the time taken to change transistors.

[431]
Spear Engineering Company Ltd., Titan Works, Limpsfield Road, Warlingham, Surrey.

STABILITY CAPACITORS (252)

Continuous operation with pulses up to 2 kV is possible with the new version of the firm's cement-insulated silvered mica capacitor, which is particularly suitable for television timebase circuitry. The range of polyester capacitors has been widened and, for use in transistor circuits, miniature ceramic disc types offering low capacitance values and close tolerances have been introduced.

[432]
Stability Capacitors Ltd., Cranes Farm Road, Basildon, Essex.

SUFLEX (210)

Polystyrene capacitors with voltage ratings of 2.5 kV and 5 kV, that considerably extend the previous ranges are being shown along with a new series of polyester/foil components (Polycaps) that have smaller dimensions than their predecessors in the 0.001 μ F to 0.01 μ F range. Ranges of metallized polyester and metallized polycarbonate capacitors are being introduced at the exhibition.

[433]
Suflex Ltd., Bilton House, 54-58 Uxbridge Road, Ealing, London, W.5.

T.C.C. (272)

Extended temperature range electrolytic capacitors are shown for use over the range -55° C to 125° C. These capacitors are made from very high purity aluminium foil and have low leakage currents: 0.005 μ A/ μ F/V at 20° C and 0.03 μ A/ μ F/V at 125° C, after a 5 min application of the working voltage. The maximum capacitance change with temperature is not greater than 30% compared with that at 20° C, and for the higher voltage capacitors it is considerably less. The performance is claimed to approach that of tantalum foil capacitors and they are only a third of the weight.

[434]
Telegraph Condenser Co. Ltd., North Acton, London, W.3.

T.M.C. (153)

A transistor speech scrambler suitable for use on public telephone lines is

being shown. The system known as "Secraphone" is housed in a container that measures $3\frac{1}{2} \times 6\frac{1}{2} \times 10\frac{1}{2}$ in and can easily be connected to a standard telephone instrument after the G.P.O. have made provisions for the extra connections. A unit is required, of course, at both ends of the line.

[435]
Telephone Manufacturing Company Ltd., Martell Road, West Dulwich, London, S.E.21.

TAYLOR (152)

Several new test and measuring instruments are on show. Among them is the 45D valve tester which is capable of testing every known type of valve with up to 12 pins and to a power dissipation of 25 watts. Taylors are also showing their "mini-edgewise" meters which occupy a minimum of panel area.

Avo, also a member of the M.I. Group, are showing the recently introduced Multimeter type HI.108 for measurement of alternating and direct voltage and current, resistance and decibels, with a maximum input impedance of 30 M Ω . It also has provision for the use of an external probe for the measurement of r.f. voltage up to 10 V at 250 Mc/s. Another new instrument is the in-circuit transistor tester (Type T/T 162).

[436]
Taylor Electrical Instruments, Montrose Avenue, Slough, Buckinghamshire.

TECHNOGRAPH (464)

This company is a subsidiary of Technograph Printed Circuits and is engaged in developing multi-layer etched circuits. Soldered connections, notably unreliable in certain applications, can be eliminated in many cases; for instance in double-sided printed boards. Holes, linking the circuit parts to be connected, are internally plated and destructive tests have demonstrated that component wires and base materials become damaged before failure of the plated hole.

[437]
Technograph and Telegraph Co. Ltd., Fleet, Aldershot, Hampshire.

(Continued on page 285)

TECTONIC (230)

This printed circuit company are now offering an accurate micro photography service for use in the manufacture of thin film and solid state circuitry. In addition to making complete units, this company will also undertake to produce etched masks for sub-miniature depositions. [438]

Tectonic Industrial Printers Ltd., Cirtec Works, Oxford Road, Wokingham, Berks.

TEKTRONIX (365)

An internal graticule, permitting parallax-free viewing, and uniform focus over a 6x10 cm display area are features of the 545B oscilloscope, which is shown with the 1A2 plug-in unit (successors to the 545A and CA combination). The hybrid amplifier and delay cable have a passband of 0-33 Mc/s. Type 547 oscilloscope, with 0-50 Mc/s response and automatic display switching, is being demonstrated, together with the 1A1 dual-trace plug-in unit giving effective double-beam operation. [439]

Tektronix U.K. Ltd., Beaverton House, Station Approach, Harpenden, Herts.

TELCON (156)

There is a combined display of four companies in the Group—Telcon Metals, Telcon-Magnetic Cores, Temco and Magnetic & Electrical Alloys. The range of high permeability nickel-iron and cobalt-iron-vanadium magnetic alloys include Mumetal, Supermumetal, H.C.R. alloy, Radiometal, Super Radiometal, Permendur and Supermendur.

Laminations in all grades of silicon steel and high permeability nickel-iron alloys for transformers, transducers, chokes and f.h.p. motors are also displayed. [440]

Telcon Metals Ltd., Manor Royal, Crawley, Sussex.

TELEQUIPMENT (231)

Highlight of the stand is the small, low-priced Serviscope Minor oscilloscope which weighs only 5lb and costs £23 10s. (see May issue, p. 240, for details). Also shown is a basic laboratory system comprising the D43 double-beam and S43 single-beam oscilloscopes with a range of five plug-in amplifiers. [441]

Tequipment Ltd., Chase Road, Southgate, London N.14.

TEXAS (53)

Of particular interest in the transistor field is the 2N2904 series of high performance p-n-p silicon epitaxial planar devices. These feature voltage ratings up to 60 V, current ratings up to 600 mA and a minimum cut-off frequency of 200 Mc/s. Applications include core driving, high-speed high-current switching, medium power amplification over a wide frequency range, and many other requirements previously met only by

n-p-n transistors. This high performance is made possible by the field relief electrode technique, which eliminates surface reversion of the collector-base junction, a phenomenon which has been previously a bar to the manufacturer of high-voltage p-n-p transistors. [476]

Texas Instruments Ltd., Manton Lane, Bedford.

THORN-AEI (325)

Two pairs of complementary output transistors for class B audio stages are introduced. The AC128 (p-n-p), AC176 (n-p-n), AD161 (n-p-n) and AD162 (p-n-p). Brimar show the EL506 for the first time. This is an output pentode with an anode dissipation of 19 W and a Magnoval (B9D) base. Two valves in class AB1 push-pull can deliver 20 W (music) at 0.1% harmonic distortion. [442]

Thorn-AEI Radio Valves & Tubes Ltd., 155 Charing Cross Road, London W.C.2.

THORN ELECTRICAL (309)

A small digital indicator offering the characters 0 to 9, a decimal point and a minus sign in a window space of 0.5 in sq is featured. The characters are engraved on slim acrylic sheets and edge-lit by "Wheatear" lamps, which are mounted on printed circuit boards and are claimed to have exceptionally long life. The overall length of these indicators, including the printed circuit board edge connectors is only 1½ in. [443]

Thorn Electrical Industries Ltd., Thorn House, Upper Saint Martin's Lane, London, W.C.2.

TUCKER EYELET (212)

Eyelets and soldering tags for a wide range of requirements are displayed, together with aluminium cans for sub-miniature capacitors, Pop and Imex rivets and a variety of metal pressings including fuse and valve caps. [444]

Geo. Tucker Eyelet Co. Ltd., 62 Horn Lane, Acton, London, W.3.

20TH CENTURY (467)

Ultra-high vacuum pumps and gauges have been introduced into the company's range of products. They are exhibiting a new series of Centronic mass spectrometer leak detectors. Among the electron tubes on show is the new three-stage image intensifier developed for application in astronomy and particle physics. The tube is based on the principle of electron multiplication by close optical coupling of a photocathode with a phosphor deposited on both sides of a mica film 4 µm thick. [445]

20th Century Electronics Ltd., King Henry's Drive, New Addington, Croydon, Surrey.

TWICKENHAM AUTOMATION GROUP (103)

A member of the group, Digitizer Techniques, are showing fibre-optic photo-

electric sensors, manufactured by Donner Electronics Inc. The flexible optical fibre bundles enable the light source and photoelectric detector to be operated remotely from objects requiring detection or counting. The aperture at the end of the light pipe may be as small as 0.020 in, permitting precise operation in confined spaces. Multiple sensors with a common detector unit can be used and allow logical control of machine functions. [446]

Twickenham Automation Group 301 Richmond Road, Twickenham, Middlesex.

ULTRA (310)

New products on show include two wire-wrap edge connectors designed for stacking purposes; a complete range of 0.05 in pitch printed wiring connectors incorporating Bellows contacts; and a 7-way hermetically sealed plug and socket. Also shown are rotary stud switches, precision wire-wound resistors and professional type attenuators. [447]

Ultra Electronics (Components) Ltd., Industrial Estate, Long Drive, Greenford, Middx.

VALRADIO (113)

Transistor and valve, voltage and frequency converters are shown. In particular a range of transistor units is available operating from 12 V or 24 V batteries and providing outputs from 60 W to 750 W at 230 volts direct or alternating with frequencies of 50 c/s, 60 c/s or 400 c/s. The output waveform is rectangular, but sinusoidal filters are available if necessary. A frequency adjustment and reed type frequency meters can be provided on some models. Operating range is from -20 °C to 40 °C and overload protection is incorporated. [448]

Valradio Ltd., Browells Lane, Feltham, Middlesex.

VENNER (406)

Among the instruments shown for research and production use is the Model TSA 628 transistor sliding pulse generator. It covers the frequency range 2.5 c/s to 2 Mc/s (extended to 2.5 Mc/s in the single pulse mode) and has a fast rise time; 10 nsec leading edge and 15 nsec trailing edge. Output is adjustable from 0.2 V to 20 V. [449]

Venner Electronics Ltd., Kingston Bypass, New Malden, Surrey.

VERO (154)

Veroboard printed wiring board is now available in fibreglass as well as in the existing range of synthetic resin bonded paper laminates. Another addition is roller tinned Veroboard, designed to facilitate soldering and reduce oxidation. A 5½ in modular rack needs only a screwdriver for assembly, and a rack handle with locking screws is now available. A new Veroboard with 0.05 in pitch, intended for use with integrated circuits, has been developed. [450]

Vero Electronics Ltd., South Mill Road, Regents Park, Southampton.

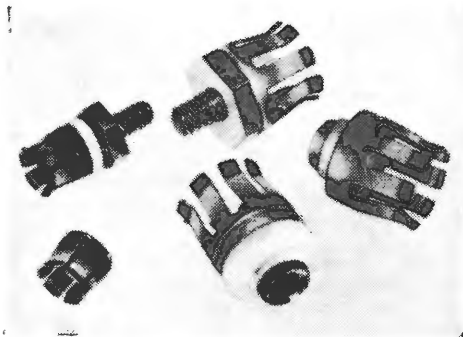

I.E.R.C. transistor heat dissipators (Winston).

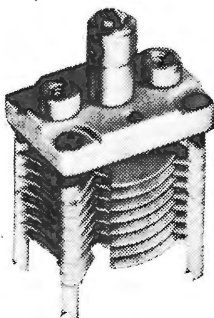

One of several new trimmers, the C952, introduced by Wingrove & Rogers.

VISION ENGINEERING (470)

As a result of two years' design and development work, the type 100 Universal Inspectascope is due to be introduced in June. The instrument is intended for internal inspection of bores as small as $\frac{3}{32}$ in and uses interchangeable probes. Photographic and measurement facilities are included and interchangeable eye-pieces give a choice of three magnification factors. [451]

Vision Engineering Ltd., Send Road, Send, Woking, Surrey.

WEGO (208)

Using a new principle, the Wego Condenser Company are now making a range of high-voltage pulse generators with fast rise times—tens of nanoseconds at outputs up to 250 kV. One of the units on show provides an output of 150 kV—with a rise time of 100 nsec. It requires an input voltage of 5.5 kV and this is provided from a power supply (the input capacity is 0.4 μ F). Spiral generators, that are self-contained and work off either the mains or internal 6 to 12 volt batteries, are also available. [452]

Wego Condenser Co. Ltd., Bideford Avenue, Perivale, Greenford, Middx.

WESTINGHOUSE (317)

Integrated circuits are shown for both digital and analogue use. The digital types are mostly in diode transistor



150 kV spiral generator from Wego Condenser Company.

logic (DTL) and include the usual range of NAND gates, binary counters, etc. A DCTL NOR gate is available. Among the analogue units are a Schmitt trigger circuit with a backlash of 100 mV (reducible with the aid of a Zener diode), a pulse video amplifier and differential amplifiers, one with a drift of 0.05 mV/°C. DTL blocks with a 10 nsec speed and TTL units are also shown. [453]

Westinghouse Brake & Signal Co. Ltd., 82 York Way, King's Cross, London, N.1.

WHITELEY (163)

Components encapsulated in epoxy resin include transducers based on the Hall effect and an e.h.t. transformer giving 18 kV and designed to operate in conjunction with transistor circuits. The company's range of cable identification and location equipment has been extended by the addition of a 0.5 W battery-operated portable oscillator and a 5 W battery/mains oscillator. Public address equipment on show includes the complete range of Whiteley loudspeakers. [454]

Whiteley Electrical Radio Co., Ltd., Victoria Street, Mansfield, Notts.

WINGROVE & ROGERS (202)

A new, small, split stator, butterfly vane, air dielectric trimmer with a capacity swing of 12.8 pF each side and a minimum capacity of 2.9 pF each side is introduced by Wingrove & Rogers. It is adjustable by means of a screw driver slot in the spindle. The length of this model C952 is 0.874 in from the mounting bushes on the ceramic base. A new variable capacitor (3CG87302) designed for a.m. and f.m. tuning is also shown.

Capacities are 392 pF in the a.m. sections and 15 pF in the f.m. [455]

Wingrove and Rogers Ltd., Paramount House, 75, Uxbridge Road, Ealing, London, W.5.

WINSTON (474)

Heat dissipators for T05 and T018 transistor cases will be shown by the I.E.R.C. Division. The Thermo-link series are made from beryllium-copper, cadmium plated and with a 500 V insulation finish. Up to 30% reduction in junction temperature can be obtained and the dissipators can be solder, screw or stud mounted. Beryllium oxide washers can be used for low capacity insulation. [456]

Winston Electronics Ltd., I.E.R.C. Division, Govett Avenue, Shepperton, Middlesex.

WIRE PRODUCTS (356)

This company, normally associated with precision cut wires, pins and special rivets, also produce glass-to-metal hermetic seals for electronic components. Among the products shown are relay bases, capacitor and resistor end caps, T05 and T018 cases for transistors, and low capacity chassis feed-throughs. [457]

Wire Products and Machine Designs Ltd., Kingsbury Works, Bridge Road, Hayward's Heath, Sussex.

WODEN (271)

A stepping drum programmer for electrically initiating events in an ordered sequence in production processes is one of the main exhibits. Also shown are a range of torque motors for actuating flow valves and other devices; an electro-hydraulic servo valve; and patchboards and card readers for programming purposes. [458]

Woden Transformer Co. Ltd., Bilston, Staffs.

WOLSEY (101)

Television aerials for the v.h.f. and u.h.f. bands, and aerial accessories from the wide range made by Wolsey are on show. Among the accessories are two u.h.f. mast-head amplifiers. The single-stage transistor amplifier has a gain of 14 dB and the two-stage 23 dB. Both are available for either battery or mains operation. [459]

Wolsey Electronics Limited, Dinas, Rhondda, Glam.

WORK STUDY EQUIPMENT (499)

An automatic winding machine for chokes and resistors is displayed. The machine is an adaptation of the Rota-winder turret coil winder and waxer. The modification consists of a device for holding the choke at both ends during winding, which is replaced by a hinged finger on the turret during indexing. Winding from the component body and wire leads is achieved by strips attached to a transverse bar. [460]

Work Study Equipment Ltd., 34 Uphall Road, Ilford, Essex.

LETTERS TO THE EDITOR

The Editor does not necessarily endorse opinions expressed by his correspondents

Pulse Width Modulated Audio Amplifiers

IT has been claimed by Turnbull and Townsend (*Wireless World*, April 1965), that a pulse width modulated audio amplifier is efficient. This claim needs justification.

The circuit can only be efficient when the load resistance has a comparatively large inductance in series with it and then only in certain circumstances. It is important that these circumstances should be clearly stated.

Dealing first with the pure resistance load shown by the authors in their Fig. 14 and used in Appendix 2 to calculate efficiency. The switching frequency square wave is across the

load resistance at all times and there is a current of $\frac{V}{R}$ amps giving a power dissipation of 4 watts at 100 kc/s for the figures given. The claimed audio power output is 2 watts giving an efficiency of 50% not 80% or 90% as claimed. This is similar to a class A amplifier as pointed out by Birt (*Wireless World*, February, 1963, page 80, modes of operation).

In this particular amplifier there are two reasons why the efficiency is probably lower than 50%. The first is that the power output is probably less than 2 watts. The published oscilloscope pictures (Fig. 7 and Fig. 11) appear to show a maximum peak-to-peak audio output voltage of 11 volts not 16 as assumed in Appendix 2. This gives an output of one watt. This agrees roughly with my own measurements on a similar amplifier. I found that the transistors would not bottom on modulation peaks, due I believe to the fact that the bootstrap coupling of $4 \mu\text{F}$ and 47 ohms will pass only the switching frequency and not the lower audio frequencies. This also increases the transistor dissipation and I burnt out the transistors in this experiment.

The second reason for low efficiency is that the switching voltage is also across the 47-ohm resistance which is only three times the load. There will be a further 1.3 watts dissipated in this resistance. The battery is supplying more than 5 watts for a power output of 2 watts or less.

Dealing now with the inductive load. It is stated by

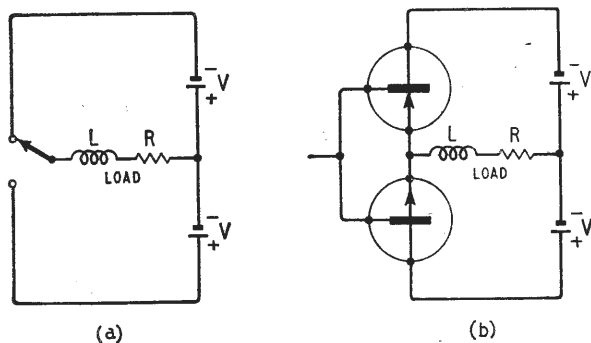

Fig. 1.

Turnbull and Townsend that the transistor switch in Fig. 1 is the practical implementation of the mechanical switch.

This may be true but it will probably be untrue. The difference is due to the fact that the mechanical switch conducts in either direction whereas a transistor usually conducts in one direction only.

Fig. 2 shows the waveforms for the circuits in Fig. 1. With a unity mark/space ratio the mean load current will be zero and the currents through the two switch contacts will be as shown in (c). The current through the load cannot

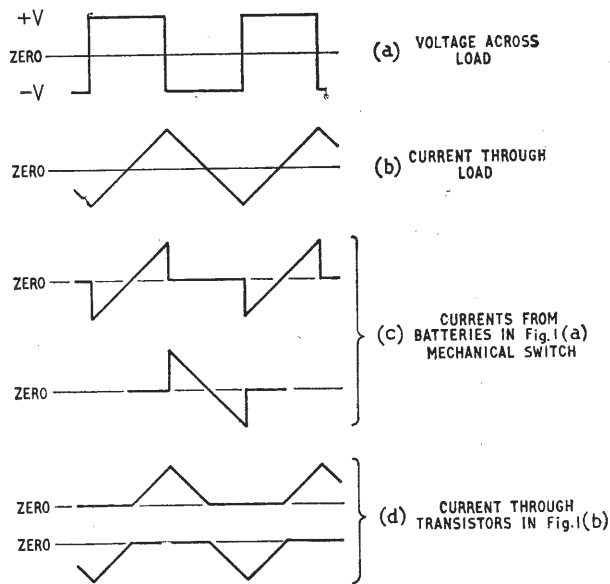

Fig. 2.

change instantaneously and it continues to flow after switching in the same direction as before. If the load is a pure inductance it returns to one battery the energy it has just taken from the other and there is no loss.

Unfortunately a transistor switch does not work in this simple way when the bases are driven by a square wave of pk-pk amplitude of $2 \times V$. When the bases are switched the reduction in current through the inductance produces a voltage across it. This voltage is applied to the emitters in a direction, such that it drives into conduction the transistor which is supposedly cut off and biases off the transistor which is supposedly conducting. The current continues to flow into the same transistor as it did before switching. Unfortunately this transistor now has the full load current through it as well as the full supply voltage across it. The energy stored in the

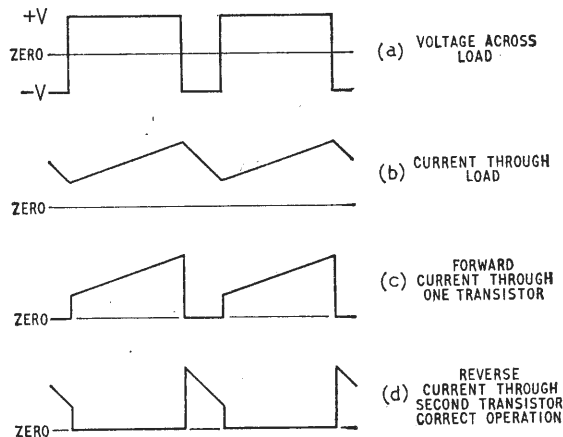

Fig. 3.

inductance is not returned to the battery but is dissipated as heat in the transistor, the very thing the circuit is intended to avoid. Compare Fig. 2 (c) and (d).

When the mark/space ratio is changed as in Fig. 3 the current is always in one direction and the entire load current is carried by one transistor, which also has the full supply voltage across it during part of the cycle. With this mark/space ratio the other transistor can be removed from the circuit without in any way affecting its operation.

Fig. 3 (c) and (d) show the waveforms which the transistor currents must have if the circuit is to work efficiently. Note that one transistor is conducting in the reverse direction as in the case of the mechanical switch. Energy is then returned to the supply instead of being dissipated in the transistor.

I have produced these waveforms experimentally. There are two ways of doing this, one is to put diodes across the transistors to carry the reverse current (K. C. Johnson, *Wireless World*, March, 1963) and the other is to drive the transistor so hard that the collector-base junction conducts and the emitter functions as the collector. Both methods can be made to work but only if the other transistor has sufficient reverse bias to cut it off. This means, that the drive must be large enough. The pk-pk value of the drive voltage must be several volts greater than the supply voltage.

Turnbull and Townsend state in their conclusions that four transistors in a bridge circuit will give four times the power output for a given supply. This is not true in the case of their amplifier since they are already outside the OC140 makers' ratings for current and power. It would not be safe to double the current again.

To sum up, with a resistive load the p.w.m. amplifier is not more than 50% efficient. With an inductive load the amplifier may be efficient but only if correctly designed. My measurements indicate that the latest one is not.

It would be interesting if Townsend and Turnbull would publish some measured figures for power output and efficiency at low audio frequencies.

Salford.

M. D. SALMAIN,
Royal College of Advanced Technology.

The Authors reply:

Our main purposes in writing the article "A feedback pulse-width modulated audio amplifier" were:—

(a) To show how feedback can be applied to very good effect in this type of amplifier;

(b) to show how, in fact, low-frequency equivalent circuits can be derived for amplifiers of this sort in order to evaluate such things as distortion, effect of power supply ripple, etc., using conventional techniques; and

(c) to present a simple circuit using a minimum of compon-

ents at a low cost in order that readers might experiment for themselves.

We have in fact been using similar techniques for several years in various servo amplifiers (particularly in the field of temperature controllers) and, judging by some of the correspondence we have received, we are certainly not alone. In other words, application to audio amplifiers is just one of many.

As to the actual circuit, we do not pretend that the design is optimum and, judging by Mr. Samain's letter, it would appear that we are possibly guilty of creating a few false impressions. First, with regard to efficiency (η), we were concerned in the appendix with the power dissipated in the transistors (i.e. according to the definition

$$\eta = \frac{P_{out}}{P_{out} + P}$$

where P_{out} is the maximum available audio power and P is the power in the output transistors), and the appendix was really included as a guide to evaluating transistor dissipation. In practice, the speaker is likely to be largely inductive at around 100 kc/s, and our tests were done, as stated, with a simulated load of 5 mH plus 15 Ω . With this inductance, and without the 47 Ω resistor, large reverse currents are demanded and, in fact, the transistors can conduct for long periods with full volts across them. The provision of OA47 diodes across the transistors is no use at all without extra series diodes in the emitter leads to make sure the volts across the parallel diodes are sufficient to obtain conduction. Even then, they are not fully effective since the driver transistor tends to come off bottoming under extreme conditions, thus cutting off the appropriate diode.

It was felt that overall efficiency,

$$\eta_o = P_{out}/P_{d.c.}$$

was not of prime importance in our mains operated circuit since we already had around 4 watts of dissipation from the power supply transformer. For this reason, we used the 47 Ω as a means of preventing reverse current flow being demanded (except on extreme swings at low frequencies) at the expense of the extra dissipation in this resistor. We worked out that the coupling condensers should be effective at the lowest oscillation frequency and should not pass the lower audio frequencies. In this way reverse current is not demanded until much later in the cycle of audio swing and, furthermore, on large swings the power in the 47 Ω actually decreases.

We calculate that if full swing were possible at low frequencies the 47 Ω resistor would have to be reduced to about 30 Ω to avoid reverse conduction and this would mean that the power rating for the transistors would only have to be 25% higher than in a design where the 47 Ω is replaced by the

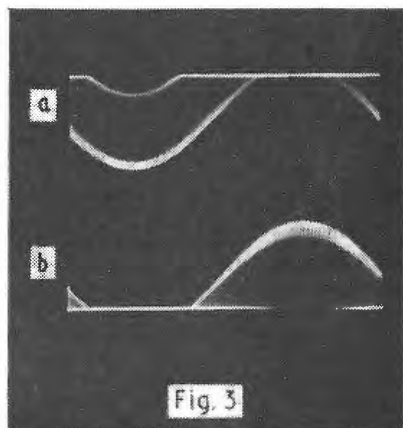
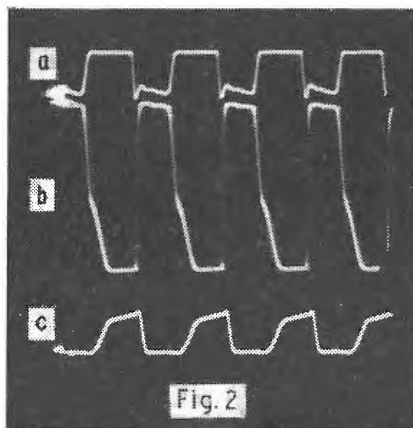
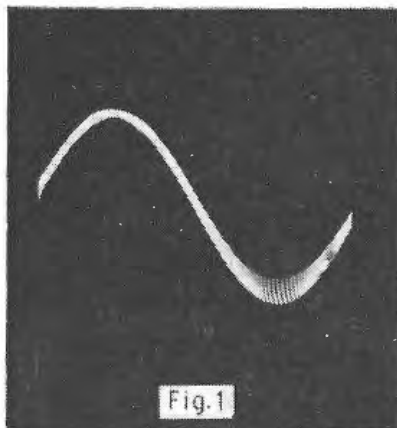

Fig. 1. Voltage across 1 Ω in series with speaker for maximum power. (200mV/cm).

Fig. 2. Condition of zero load power. (a) Current in the OC140 output transistor (volts across 1 Ω —200mV/cm); (b) Amplifier output voltage (5V/cm); (c) Current in the OC84 output transistor (volts across 1 Ω —200mV/cm).

Fig. 3. (a) Volts across 1 Ω in series with the collector of the OC140 output transistor at maximum power (200mV/cm); (b) Volts across 1 Ω in series with the collector of the OC84 output transistor at maximum power (200mV/cm).

speaker and the transistors are driven so that they reverse conduct.

In theory, with a 100 kc/s switching frequency a swing corresponding to $e_o/h=0.9$ (i.e. $\lambda/\lambda_o=0.2$ and maximum power $=0.81 P_{max}$) is the best that can be achieved since the oscillation frequency on extreme swings is within the audio band. In practice, especially using transistors with barely adequate switching times, the maximum power will be lower than this.

Since the article was written we have performed quantitative tests on an actual speaker. This was a Goodmans Axiette, which at frequencies around the switching frequencies looked like 15Ω in series with 0.42 mH. In series we placed a 0.5 mH non-saturating choke, for the reasons suggested by Mr. Johnson in the May issue, and a 1Ω resistance in order to look at the current in the speaker. In addition we replaced the 2G387 and the ASY26 (which can give trouble with its base-connected can) by OC84s—more readily available to non-professionals—and used an oscillation frequency of 65 kc/s. We drove the speaker sinusoidally at 150 c/s, at which frequency the loudspeaker was purely resistive. The waveforms (Figs. 1, 2, 3) shown were obtainable at peak drive (above which squeaks can be heard as the oscillation frequency enters the audio band).

Points to note are:—

(a) The oscillation frequency does not come down symmetrically on positive and negative swings, due to imperfections in the circuit (Fig. 1).

(b) With no drive, no reverse conduction is required and correct operation is maintained except for the rather slow turn-on of the OC84 (Fig. 2).

(c) Reverse current is asked for on peak swings, and actually flows in the OC40 but not in the OC84: this is due to the single-ended drive stage. (This gives a square-wave drive to the bases slightly greater than the h.t. lines.) In order to prevent this entirely, without extra complexity, the standing power must be increased. This is hardly worth while as the conditions shown can be maintained indefinitely without any danger of excessive heating of the transistors. Large increases in the bootstrapping capacitors worsens these conditions.

The power obtained was nearly 900 mW (a small fraction being consumed by the 1Ω resistor and the choke resistance). This corresponds to $e_o/h=.66$. This power can be increased to above 1 W by raising the h.t. voltage (which must not exceed 20 V when the OC40 current will be at its permitted maximum, being 300 mA under the conditions shown and maximum voltage).

We apologize for not going into detail on the power considerations—this would have made the article far too long—and for any confusion we may have caused on this score. Furthermore, we did not mean to imply that the present transistors can be used in a higher wattage version using a bridge (with which it is difficult to implement a feedback scheme anyway).

Finally, we were gratified to receive so much correspondence and hope that our article has stimulated further experimentation into class D amplifiers, leading to rather faster progress in evaluating design criteria and applications for this type of amplifier in audio engineering and in other fields. Up-rating and improvements in design are obviously possible, but achieving these without excessively increasing complexity and cost is the problem in hand.

G. F. TURNBULL and S. M. TOWNSEND.

Manchester University.

FROM the article in the April issue and the letters in the May issue of *Wireless World* it would seem that some controversy is arising as to whether the open-loop or closed-loop system is best for a p.w.m. amplifier. We recently announced a 20-watt amplifier, the X-20, using the former system and the reasons for our choice may be of interest.

The most serious disadvantage of the closed-loop system from our point of view is that loud beats occur when two such amplifiers are used in a stereo installation. This happens because the pulse repetition frequencies of the two amplifiers, being variable, cannot be locked together as they can in the X-20. The closed-loop system has the virtue of

simplicity, and is excellent for mono amplifiers but even here the open-loop mode has advantages. The additional components needed are inexpensive and I believe that, even for mono applications, the slight additional cost is usually justified.

As Mr. Johnson pointed out in the May issue, the closed-loop system distorts severely when the modulation index is large and he suggests that the same limitation applies to our system because of the finite and variable switching period of the output transistors. In the X-20, however, the switching times of the output transistors are only $0.15\mu\text{sec}$ for a cycle length of $14\mu\text{sec}$. Furthermore the variation in switching time with modulation is not more than 10% or $0.015\mu\text{sec}$. Thus this can contribute not more than 0.02% distortion. To this must be added the variation in "on" voltage of the transistors, but here again the change has been made sufficiently slight to contribute only 0.02%. Phase shift between the driver and output stages has also been made insignificant.

Thus the open-loop system can be used to effectively 100% modulation without significant distortion. This is important if one wishes to obtain the maximum possible power from the output transistors.

As regards the production of unwanted sidebands in the audio range, these can, in practice, be avoided in both systems if the design is correct.

On the subject of the design of open-loop systems, Turnbull and Townsend apply the audio to the base of the integrator transistor. This saves one transistor but the saving is small and leads to a loss of high-frequency performance and possibly to the introduction of some distortion.

Mr. Birt's plea in May for suitable output transistors, which was mine also not long ago, has been answered, at least partially, by some of the new silicon epitaxial planar transistors as used in the X-20. These have current ratings of around 2 amps and collector-emitter breakdown voltages in the region of 60 volts. Care must be taken when selecting an output transistor for a high-power output stage, however, because the avalanche conditions are very important and many manufacturers fail to specify these.

C. M. SINCLAIR,
Sinclair Radionics Ltd.

London, N.1.

IN an interesting article in your April 1965 issue, Turnbull and Townsend describe a high efficiency audio amplifier using supersonic pulse duration modulated switching. Perhaps your readers would be interested in an alternative compact modulator/oscillator which has much in common with the closed-loop system described.

Instead of a modulated rectangular wave of current giving rise to a sawtooth wave of voltage across a capacitor, here a modulated voltage wave applied to an inductor gives rise to a sawtooth flux wave. Hulme* has shown that when transistors are used to switch d.c. supplies of more than a few volts across windings on cores of high permeability, sharply saturable magnetic material, the linearity of the flux growth can rival that given by a Miller integrator (i.e. a large value for T in the expressions on p. 165). Furthermore, the material inherently provides the required hysteresis.

First it is necessary to provide the magnetizing current of either polarity from a low impedance source, and in the figure this duty is performed by the emitter follower pair Vt1 and 2. This feeds, via large capacitor C, one end of winding 1 of saturable transformer, T, the other end connecting to the emitters of complementary switching transistors Vt3 and 4. Their strapped bases as well as emitters ensure that conduction of Vt3 or 4 is mutually exclusive.

Winding 2 provides positive feedback which maintains Vt3 (say) bottomed so long as the core permeability is high (i.e. during the periods of flux growth). Once saturation flux density is reached, the magnetizing current rises substantially, bringing Vt3 out of current saturation and therefore increasing its volt drop. The accompanying fall in voltage across windings 1 and 2 reduces the base current and also the

* Hulme, V. B., "Some Switching Circuit Applications of Transistors and Saturable Magnetic Cores," (Appendix) *Proc.I.E.E.*, Vol. 106, Part B Suppl. No. 18, May 1959.

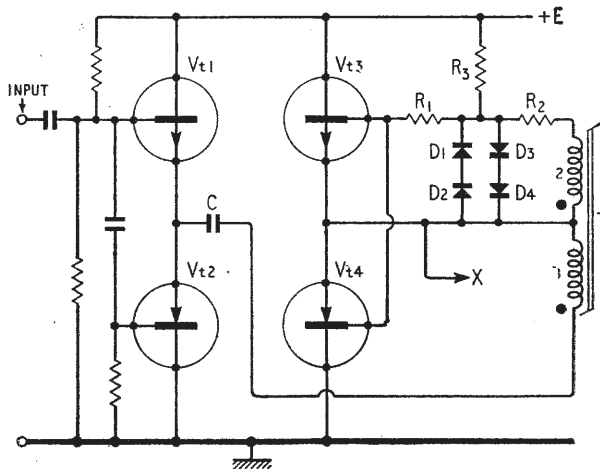

conduction of Vt3 cumulatively, leading to the rapid transfer of the supply to T from Vt3 to Vt4. The flux in T now commences to trace out the other flank of its sawtooth which continues until saturation of the opposite polarity causes the switches to revert to their previous condition.

When the voltage to C is zero, the circuit quickly settles to equal and opposite slopes of the sawtooth (and hence 50% duty ratio) with a mean voltage at X of $E/2$. An input voltage, v , then results in the imposition upon winding 1 of successively $(E/2 - v)$ and $-(E/2 + v)$, so giving the required control of the slopes of the sawtooth flanks and a mean voltage at X equal to the input, v . The input swing is best restricted to $\pm 0.25E$ or $0.3E$, corresponding to a range in duty ratio of 25% to 75% or 20% to 80% respectively.

The difference in voltage across windings on T between one phase of a cycle and the other could lead to a large range in the base currents sustained by winding 2. Limiting is therefore introduced by way of resistors R_1 , R_2 and diodes D1 to 4. The base-emitter diode of Vt3 is protected in respect of reverse voltage by the forward conduction of Vt4, and *vice versa*. Resistor R_3 provides a small "priming" current to ensure sufficient gain, once the supply is connected, for switch action to occur.

An output may be taken from X direct to a load or to control higher power switches. At somewhat reduced efficiency, an output at a higher voltage could also be taken from another secondary winding on L or, at a lower voltage, between X and a tap on winding 1. All loads must, of course, include a small amount of series inductance if heavy current surges at the instants of switching are not to lead to serious power loss in the switches.

The following transformer details would be appropriate to $E=12$ volts and germanium Vt3 and 4:—

Strip-wound "Nilomag" 800 core on G. L. Scott ceramic bobbin No. 1 (2mm I/Dia \times 4.5mm O/Dia \times 5mm long approx.).

Toroidal winding 1; about 45 turns of 38 s.w.g. wire.

Toroidal winding 2; about 25 turns of 42 s.w.g. wire.

D. P. FRANKLIN

Wells, Somerset.

E.M.I. Electronics Ltd.

Matrix Algebra

IN the first of the articles on matrix algebra by G. H. Olsen in the March issue, an example of a four-section, R-C phase shift network was considered (Fig. 6). The four-section network is not often considered in publications dealing with ladder phase shift oscillators and it may be of interest to note that in the same network as in Fig. 6 with R and C interchanged, $7\omega^2 C^2 R^2 = 10$ giving an upper bound of frequency but with a value of a_{11} unchanged at -18.39 .

For five sections the minimum value a_{11} can have lies between -15 and -16 . In the limit where the network

is replaced by a distributed R-C line the minimum value of a_{11} comes out at $-\cosh \pi$. The principal conclusion to be drawn from this last result is that the current or voltage gain in the R-C phase shift oscillators using these networks would appear to be no less than 11.5 (which is the value of $\cosh \pi$ for the circuit to oscillate).

M. F. MCKENNA

Automatic Telephone & Electric Co. Ltd.

School of Electronics.

Liverpool.

Klystron Action

I MUST thank Mr. E. H. Jones (May issue, p. 247) for his interest and comments. I must agree that my description of reflex klystron action in last October's issue was somewhat less than accurate for the modern klystron and arose from a confusion in my notes with an earlier experimental type of klystron.

Whilst I do not feel that the confusion of the basic qualitative understanding of klystron action caused by this error is great, I should like to clarify this action in a manner compatible with the introductory form of the article.

The cavity of a modern reflex klystron has the gap spaced quite close together, as shown in the accompanying diagram, to avoid transit time problems. The beam produced by the cathode and focusing anode will accelerate toward the resonator. The resonator, excited by random fluctuations

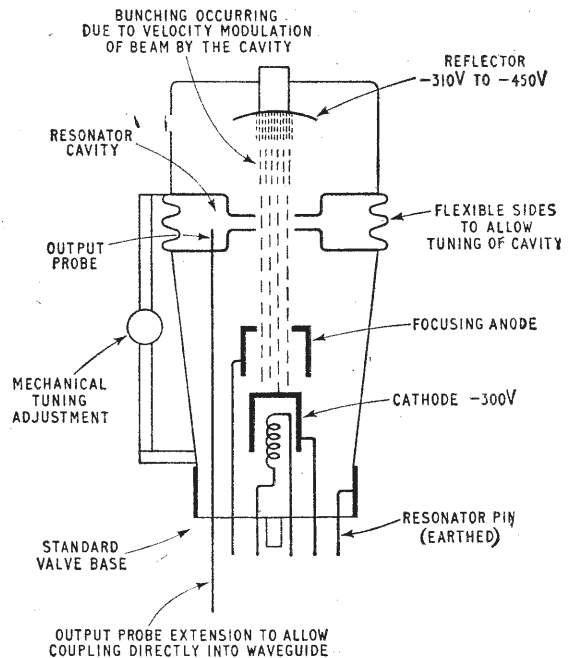

in the resonator voltage and beam current, will resonate at a microwave frequency determined by its physical size and shape, producing a minute voltage at the gap. This voltage will vary in the velocity of the beam passing through the gap. As the beam passes through the drift space between resonator and reflector those electrons that have passed through the gap at such a phase as to be increased in velocity will catch up with those with decreased velocity causing the bunching explained in the article. With the exception of the bunching taking place in the drift space, due to velocity modulation of the beam by the resonator, rather than in the resonator itself, the action is as previously given in the article.

Full mathematical analysis of klystron action may be obtained from J. C. Slater, "Microwave Electronics," D. Van Nostrand Inc, or several others of references mentioned in the final article. (December 1964 issue.)

Roxboro, P.Q.,
Canada.

K. E. HANCOCK

we can now report new and interesting information in the field of tape recording. An intensive research and development programme over the last eighteen months has been devoted to the improvement of record, playback and erase heads.

The tendency towards transistor portable tape recorders has received our special attention as the necessity for improvements in heads for this application has been an obvious requirement.

COMBINED ERASE HEAD AND OSCILLATOR COIL

“A most amazing component!” is the reaction of most people who test these, for in a space of only $\frac{3}{8}$ in. diameter by $\frac{5}{8}$ in. long, is contained a complete oscillator coil and erase head.

A simple oscillator circuit operates with a single OC81, or similar type of transistor, and requires only 20mA at 9V from the battery. As well as acting as an erase head, this component also provides the required bias supply to the recording head and (if required) HT for a recording level indicator of the DM70, or similar type. Although DC flows within the oscillator coil inside the head there is no DC flux whatsoever produced in the erase section.

Where an indicator of the DM70 type is used the heater may be seriesed with the circuit, as shown below. This offers a further economy of power, and in this case a total of 25mA at 9V, therefore, supplies indicator heater, indicator HT, 30 kc bias supply and erase power.

A further trend of transistor tape recorders may be to combine a radio tuner input—the erase head/oscillator coil would enable such a recorder to record with a transformerless loudspeaker output stage in operation.

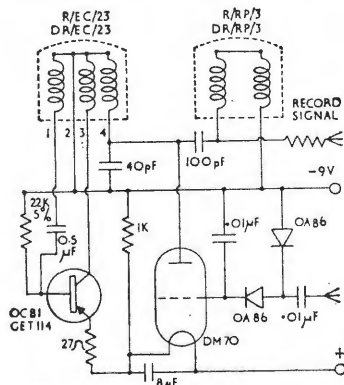

CLOSE TOLERANCE ON RECORD AND REPLAY HEADS X SERIES



As the tape recording art has developed, so manufacturers have quite rightly asked for closer tolerances and higher performances in heads. How can you produce an extremely high quality range of record and playback heads offering the maximum in performance, having far closer tolerances in all mechanical and electrical characteristics than hitherto envisaged and at the same time offer these at a reasonable price? That was the development and production problem we set ourselves eighteen months ago.

Some 75 heads from manufacturers throughout the world were examined and tested. Performance features were co-related to design factors applicable and so a design took shape based upon the rejection of all known bad features and the incorporation of good. Our design and production experience of over 3½ million heads over fourteen years, including heads for practically every special purpose, enabled us to maintain a realistic approach to the problem. We purchased superb new machinery and produced many special purpose machines ourselves, numerous items of special electronic test gear were developed to provide as comprehensive a system of quality control as could be envisaged, and last but not least, we engaged many highly skilled personnel.

The result fully measured up to our expectation and many hundreds of thousands of these heads are in use throughout the world—in fact the only limiting factor to their sale has been our production capacity which, we are now pleased to state, has now been considerably increased since we opened a new factory at Falmouth, in Cornwall.

A complete range of record, playback and erase heads (‘X’ series) is available with these qualities for providing all the requirements of heads for $\frac{1}{2}$ in. tape. Full track, $\frac{1}{2}$ track, 4 track stereo and 2 track stereo are all available and most of these in various impedances. A special feature of the erase heads is their extremely low power requirement, and that they can be operated at 100 kcs without appreciable heating.

‘R’ AND ‘DR’ RANGE OF $\frac{1}{2}$ TRACK HEADS has been re-designed and now give our output with the maximum in top response and with greatly improved shielding. Over 3½ MILLION ‘R’ and ‘DR’ heads are in use throughout the world!

Self-oscillatory erase head circuit with Marriott ‘X’-type erase and record/replay heads. Diagram reproduced by courtesy of Mullard Ltd.

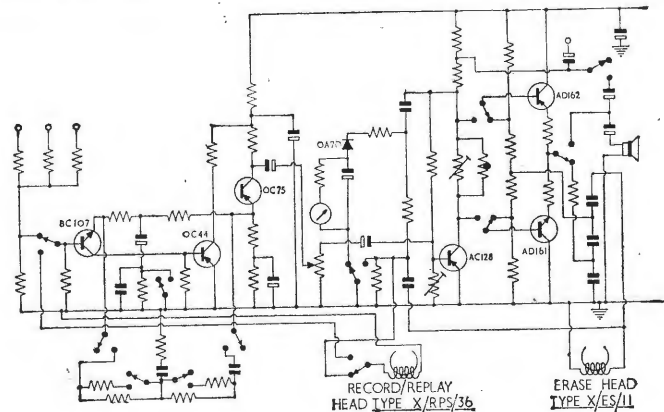

Details of all the above types of heads are available from:

MARRIOTT MAGNETICS LTD.
284a WATER ROAD, BRIDGE WORKS, WEMBLEY, MIDDX.

Tel. No. WEMbley 7493
ALPerion 2020
ALPerion 2029

Marconi self-tuning H.F system—
the first in the world to be station
planned from input to output.



breakthrough

MST 30kW transmitter type H1200

An h.f linear amplifier transmitter for high-grade telecommunications.
Frequency range: 4-27.5 Mc/s.
Output power: 30 kW p.e.p, 20 kW c.w.
Meets all CCIR Recommendations.

saves 80% floor space

Transmitters can be mounted side by side and back to back or against a wall. Floor-ducts are eliminated and all power supply components are built-in. These features lead to smaller, simpler, cheaper buildings or more services in existing buildings.

rugged reliability

R.F circuits have been simplified and the number of mechanical parts reduced to a minimum. Highest engineering standards are applied to the design of these parts: stainless steel shafts in ball-bearings in heavy, rigid, machined castings; stainless steel spur gears meshing with silicon bronze; heavy r.f coil contacts with high contact pressure. Specified performance is maintained with ample margins.

simplicity

MST reliability allows continuous unattended operation with extended or remote control, saving maintenance and operating staff. Any fault in the servo control circuits can quickly be located with simple test routines. Transistors and printed wiring give these circuits maximum reliability.

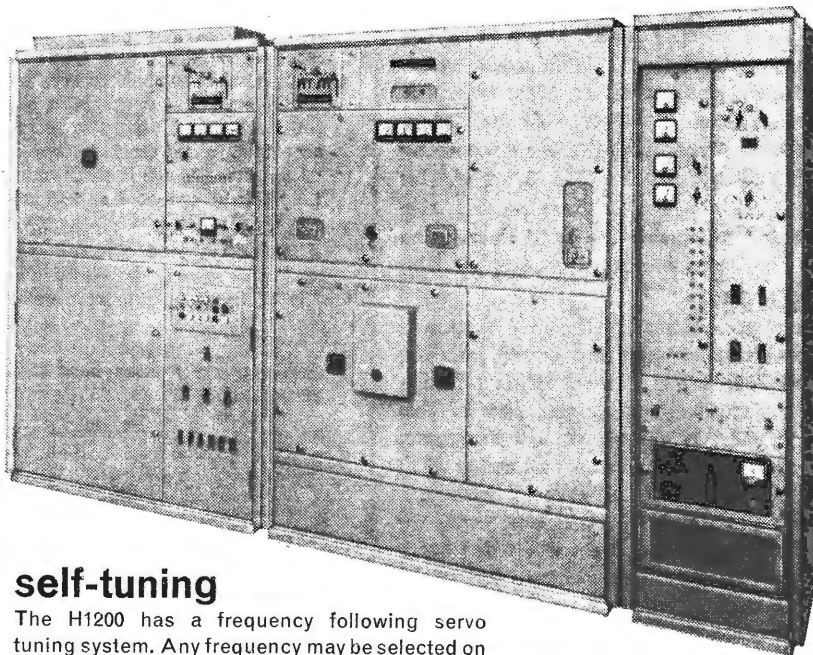

self-tuning

The H1200 has a frequency following servo tuning system. Any frequency may be selected on the synthesizer decade dials in the associated MST drive equipment; the unattended transmitter automatically tunes itself in an average time of twenty seconds. Final stage tuning and loading servos continuously ensure automatic compensation for changes in aerial feeder impedance caused by weather conditions. Self-tuning gives *one-man* control of an entire transmitting station.

Marconi telecommunications systems

The Marconi Company Limited, Communications Division, Chelmsford, Essex, England
6WW-116 FOR FURTHER DETAILS.

LTD/HM

International Audio Festival and Fair

HOTEL RUSSELL, LONDON, APRIL 22-25

FOUR whole days of bliss and blisters sums up the Fair for the majority of audio fans. To do the exhibition and oneself justice four days would be a minimum for the 70-odd demonstration rooms (on four floors) and nearly 90 stands. But, we imagine, few had the stamina to fight their way through all the demonstration rooms. One pronounced trend was that the audio equipment was perhaps more eye-catching than it had been in the past (the music provided in the demonstration rooms was certainly ear-catching), but that which looked good did, in the majority of cases, sound good and indeed one was embarrassed by the richness of the fair.

New developments (often new applications of old ideas) were evident and although switching amplifiers using pulse-duration modulation may not be ready for the hi-fi market, a British version of the Ionophone—a loudspeaker with no mechanical moving parts—has been developed and was introduced to the public at the Fair. Loudspeaker designers are producing more compact enclosures and smaller driver units with aluminium cones and voice coils, ceramic magnets and improved suspension. In the field of tape recording, cross-field heads are currently being talked about and tape/source comparison is provided on many machines by the use of separate record and playback heads and amplifiers. Recorders designed for vertical operation are becoming more popular and the Sony TC600 incorporates equalisation for magnetic pickups for direct recording of discs.

More automatic devices, which seem to be slow in catching on in Britain, could be seen here and there. For instance, an automatic tape changing recorder; automatic recording level control and automatic stereo/mono switching on a multiplex decoder. More f.m. tuners now use interstation noise suppressors and one is provided with a tuning check by applying a 50 c/s amplitude modulated signal so that accurate tuning is achieved by adjusting for minimum hum (Lowther). A comprehensive remote control unit (tuning, volume, wavechange, etc.) for a receiver provided endless entertainment in one of the demonstration rooms. Intercommunication between receiver and extension loudspeakers is provided on the Tandberg Huldra sets and it is surprising that this is not more common since the extra cost is not great. Another automatic feature that we think could be more widely used is optional automatic switch-off of complete equipment after a tape or disc has been played through, and at least one manufacturer has incorporated this into a tape recorder. On one single-disc player an unusual facility was an automatic pick-up arm return. Amplifier muting during record changing may become a popular feature of automatic turntables. Neon lamps are

included in a number of turntables to enable stroboscopic marking to be viewed more easily, particularly in daylight, and it would appear that variable speed turntables are slowly increasing in popularity. The ceramic cartridge, which is gaining a strong foothold in the market, offers the enthusiast of moderate means a good alternative to the crystal types, which are notably temperature and humidity dependent, and of course, require less extensive amplifiers than magnetic types. (Incidentally, work on semiconductor transducers brings to mind the possibility of semiconductor acoustic amplifiers—instead of electric amplifiers. Even if this can only be achieved at radio or microwave frequencies, perhaps audio modulation of a semiconductor r.f. or microwave generator and subsequent demodulation after ultrasonic amplification may form the basis of a system.)

In the stereo field the novelty of vertically directed sound appeared on a tape recorder. An amplifier had a facility for connecting a centre channel loudspeaker. Another amplifier incorporated a very useful test oscillator which produced single tones for phasing the loudspeaker and achieving correct centring. Loudness controls were evident on a number of amplifiers—in one case a loudness/volume switch gave a 10 dB accen-

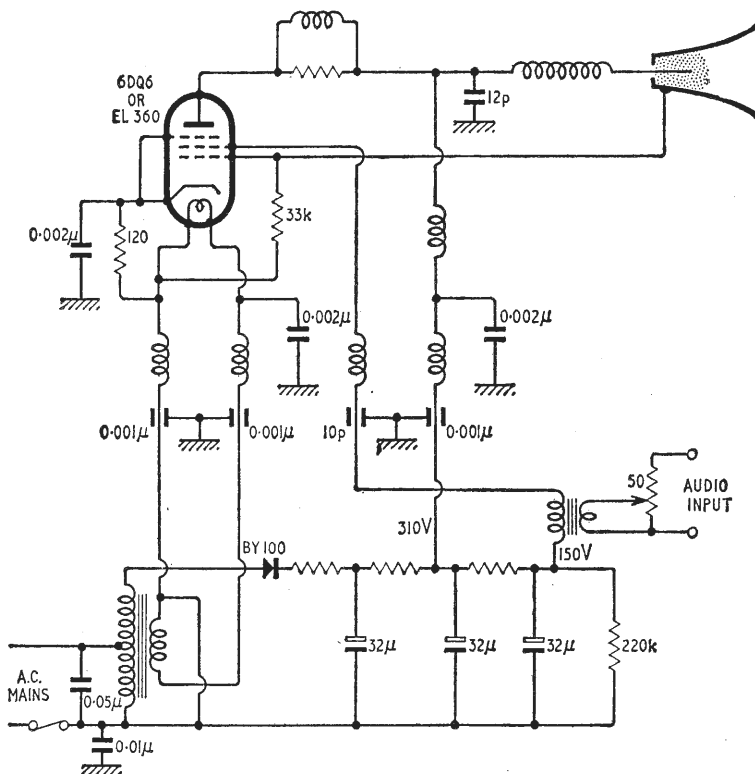

Circuit of the Ionophone loudspeaker.

tuation at 70 c/s and 5 dB at 14 kc/s in the loudness position.

Loudspeakers

The ionic loudspeaker referred to earlier is produced in this country by Fane Acoustics. (It is known as the Ionophone in France, the Ionovac in the U.S.A. and the Ionofane in Britain.) The principle, of course, has been known for some time. One contribution on the subject appeared some 13 years ago* but a resumé is not out of place. The idea originates from the phenomenon of the singing arc from which acoustic energy can be obtained from an r.f. or d.c. discharge modulated with audio information. Originally, the source of positive ions was a heated emitter, but Klein modified the arrangement so that the active material was maintained at 1000°C by ion bombardment in a 400 kc/s field with a potential of around 10 kV. The Fane model oscillates at 27 Mc/s and uses a 6DQ6 or EL360 with an anode dissipation of 15 W. The circuit shows that screen modulation (as in the original) is used, the input transformer providing about 33 V r.m.s. modulation from a 15 Ω input of 1 V r.m.s. The response of the unit is intended to be from about 3 kc/s to 30 kc/s but with a larger experimental horn frequencies down to 700 c/s can be reproduced, the limiting factor being the change from isothermal to adiabatic conditions. The upper frequency limit is probably in the region of 50-100 kc/s. The unit gives an extremely good transient response due to the negligible inertia of the gas molecules compared with a diaphragm.

The Jordon-Watts modular loudspeaker units and enclosures, shown last year, attracted a great deal of attention, particularly the application of a horizontal "line-source" to stereo reproduction. The loudspeakers have a number of desirable features: an aluminium cone to avoid the humidity and temperature dependence of paper cones; beryllium-copper suspension cantilevers which allow large cone displacements (incidentally, two are used to carry the voice coil current); rigid chassis; and ceramic magnet. Eight units were used in a horizontal array connected with phase delaying LC networks so that a wavefront was at an angle to the line of units. Stereo information was fed in at each end and the net effect was a much broader stereo listening region. The loud-

speakers were vertically directed, apart from the outer two which were used in conjunction with reflectors.

The new Celestion enclosure—the Ditton 10—uses a 5 in bass unit with ceramic magnet, and the construction permits excursions of up to ½ in. The 1½ in moving coil h.f. pressure unit has a response extending up to 15 kc/s. The bass loudspeaker response is 90 c/s-3.5 kc/s ± 2 dB and falls at a rate of 12 dB per octave below 80 c/s. The Radford Bookshelf loudspeaker contained a Celestion HF 1300 and a K.E.F. B139 bass unit and were selected after hundreds of drive units had been tested. The response quoted was 80 c/s-14 kc/s ± 2 dB and the enclosure measured 20 × 11½ × 7½ in, handling up to 25 watts r.m.s.

Tape Recorders

Pullin Photographic, now part of the Rank Organisation, market AKAI (Japan) tape recorders and they demonstrated, amongst others, the X-4 and M-8 models which use "cross-field" heads. The term derives from the fact that two magnetic fields are crossed. There appear to be two types of cross-field head: those in which both bias and signal are applied to two head windings* (due to M. Camras) and those in which bias and signal are supplied separately to two heads. The AKAI machines use the latter type and an improvement in high frequency response at the lower tape speeds is claimed. For the X-4 the response is given as 30 c/s-11 kc/s ± 3dB at 1½ in/sec and 30 c/s-5.5 kc/s ± 3dB at ½ in/sec. This portable stereo model has rechargeable Ni-Cd batteries and offers four tape speeds. The stereo/mono M-8 provides four speeds, four tracks, two VU meters and vertically directed loudspeakers.

Truvox have transistorized their tape recorders and produced two and four track mono recorders (R102 and R104) and two stereo tape units (PD102 and PD104) with emitter-follower output stages giving an output of up to 1 volt. Separate record and playback heads and amplifiers allow the original signal to be compared with the recorded signal, and the demonstration proved that it was difficult to distinguish between the two at 3½ in/sec. Other features are twin VU meters (PD102 and PD104), vertical operation (R102 and R104) and speed change without stopping.

The Ferrograph and Brenell tape recorders have undergone minor improvements and Telefunken demon-

*Wireless World, January 1952, p.2.

*Wireless World, March 1965, p.129.

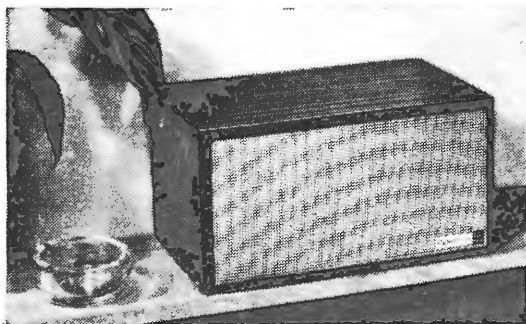

Ditton 10 loudspeaker system measuring 12¾ × 6¾ × 8½ in. (Celestion).

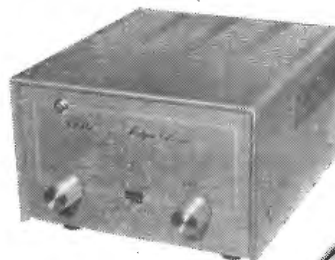

AD-5U stereo multiplex adaptor by Trio (Japan).

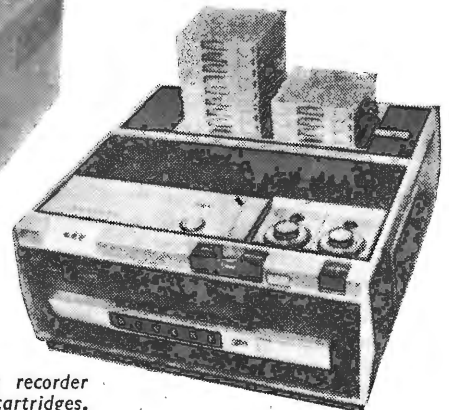

3M automatic tape changing recorder which accepts up to twenty cartridges.

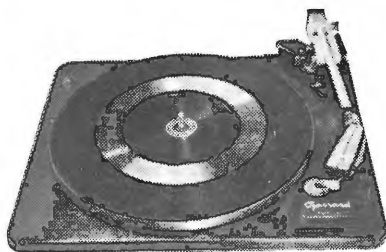

Garrard SP25 single disc player with automatic arm return.

Remote control unit used in conjunction with the Freiburg Studio stereo receiver from Saba (Germany).

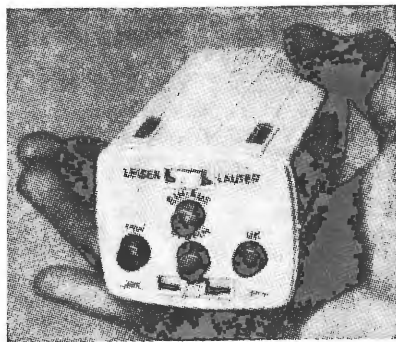

strated their Magnetophon Automatic II. The last-mentioned machine has an automatic volume level control and automatic input selection, and the equipment is switched off by switching foil at the end of the tape. An automatic/manual switch is also included. (A Philips recorder—EL 3552—also incorporates an automatic level control circuit.) Two more interesting items were the Philips video recorder (shown by Peto Scott) and the 3M tape-changing recorder (see picture). This latter machine however, is still under development. The tapes automatically thread themselves and twenty tapes can be loaded, giving 15 hours playing time. Mullard Ltd. featured a number of audio circuits including an experimental transistor tape recorder circuit, using the recently announced BC107, AC128, AD161 and AD162 transistors. The oscillator circuit, designed around the output transistors, economically uses the inductance of the erase head to determine the oscillator frequency.

Turtable Decks

The Connoisseur Classic turntable and pickup arm suggests that we may see more of the kind of transparent dust covers used on this model (also available for the Dual 1009). The Classic has a two-speed turntable and incidentally, uses two separate motors with rubber drive wheels which are disengaged when not in use. The pickup, mounted on gimbal bearings, uses a ceramic cartridge with an output of 100 mV into a 2MΩ load or about 25 mV into a 50kΩ load. (The latter, of course, requires equalisation.) The Dual 1009 turntable weighs 7½ lb, contributing to the low wow and flutter figure of less than 0.1%. A variable speed control is fitted and the model is a further illustration of the trend to automatic turntables in better quality equipment. The arm will track under the most adverse conditions, including a tilt of 45°! The Thorens turntables, although shown before, deserve mention; the TD124 has a turntable weight of 11½ lb! The TD 224 is automatic and plays discs taken from a stack alongside the turntable and returns them after playing. Both units have built-in stroboscopes.

Garrard now have a very wide range of turntable decks. The Lab 80 and 401 transcription turntables were new to the Fair but already have an outstanding reputation. (The 401 incorporates a neon lamp for viewing the stroboscopic markings in daylight.) The range now includes the A70 (a development of the Type A), AT60 (developed from the AT6), SP25 (illustrated), Models 50, 1000, 2000 and 3000. All but the 401 and SP25 are automatic record changers. The SP25 includes a number of worthy features: large non-magnetic turntable, a magnetic motor-shield, fine stylus pressure adjustment, bias compensator, pickup lowering device and automatic arm return.

Amplifiers

Amplifiers were represented by the well-known names of Quad, Leak, Armstrong, Radford, Rogers, Lowther, and many others; and, of course, integrated amplifiers were prevalent. A newcomer to the Fair was H. H. Scott (U.S.A., represented by A. C. Farnell). The three models (200, 260 and 299) are all integrated stereo amplifiers having loudness/volume switches. The 200 and 299 are both valve amplifiers; the former gives an output of 12 watts r.m.s. per channel at 0.8 % harmonic distortion with a response of 30 c/s–20 kc/s ± 1dB and the latter has a similar specification with an output of 32 watts r.m.s. The 260 transistor amplifier uses silicon output transistors and Baxandall tone control circuits. All three amplifiers have a facility for connecting a centre channel loudspeaker, whose output is derived from both left- and right-hand channels. The Lowther amplifier incorporates an oscillator for checking phase and balance at frequencies of 100 c/s, 1 kc/s, 5 kc/s and 8 kc/s.

Miscellany

A joint effort by four manufacturers (K.E.F., Armstrong, Goldring and Record Housing) is known as Group 4. The intention is to provide a ready-built high-quality sound system in a domestically acceptable cabinet. However, Group 4 will not manufacture these systems and retailers will assemble the items from the normal sources. The equipment consists of the specially designed Record Housing G.4 cabinet, the Armstrong 227 tuner-amplifier (10 watts), the Goldring GL58 deck fitted with CS90 stereo cartridge and K.E.F. G.4 loudspeakers. Provision is made for addition of the Armstrong multiplex decoder.

A novel item shown by Saba was the Freiburg Studio Automatic stereo receiver. This receiver has a remote control unit (see picture) which operates a motor-driven volume control, a music-speech tone control, f.m.-a.m. wavechange and a tuning control. The tuning control takes the form of a two-speed motor drive, which at the lower speed locks onto strong signals. The station search function can also be initiated from the receiver controls, and fine tuning is achieved with motorized a.f.c.

The Mellotron keyboard musical instrument, which uses pre-recorded tapes, has been modified for B.B.C. sound effects use, and 18 different effects are available at each of the 70 keys. The 70 three-channel tapes are arranged so that on playback a spring is put under tension and release of the key allows the spring to retract the tape almost immediately. A useful accessory from Grampian is the parabolic reflector for directional microphones. For the range 500 c/s to 5 kc/s and a distance of 100 ft, the increase in sensitivity is claimed to be 14 dB. The reflector has a diameter of 24 in and weighs nearly 5 lb.

WORLD OF WIRELESS

Subscription Television

LAST year the Postmaster-General announced the names of five organizations he had invited to take part in a three-year experiment in subscription television. The experiments were to be conducted in eight areas chosen to cover as wide a cross-section of the community as possible.

The companies offered licences and the suggested areas of operation are: Choiceview (Rank-Rediffusion), Leicester and possibly London; Pay-TV (British Relay), Sheffield and London; Telemeter, London and Billingham; Tolvision, Luton and Bedford; and Caledonian Television, Edinburgh area. The companies accepted the invitation and received licences which stipulated that the service had to begin within a year.

The Telemeter organization has now announced that having "re-assessed its position in the light of recent developments" it has informed the P.M.G. that "it does not intend to proceed with pay television trials . . . under the present unfavourable conditions." Choiceview has also pulled out of the scheme. Pay-TV, however, is going ahead with its plans to start a service in the autumn in the Westminster area. No announcement has been made by the remaining two potential operators.

Mobile Radio-Telephone Operation

IN view of the forthcoming introduction of a public radio-telephone service in the Greater London area the Minister of Transport proposes introducing legislation which will make it an offence to use a hand held telephone in a moving motor vehicle. The reason being that its use could be a

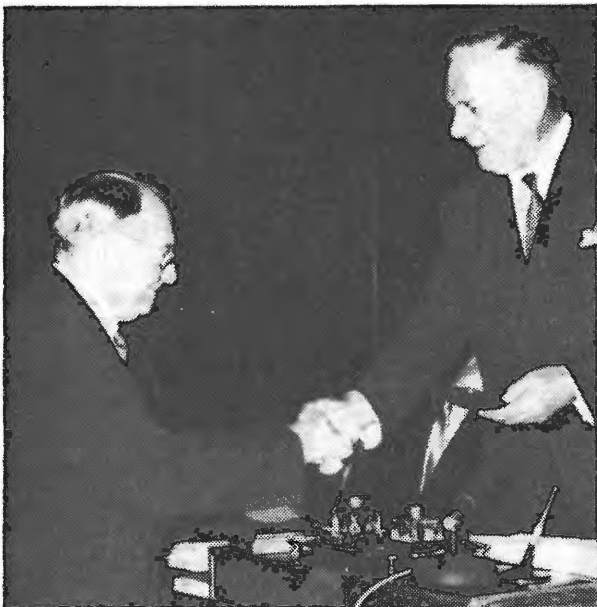

Dr. V. K. Zworykin (left), honorary vice-president of the Radio Corporation of America, receiving the Faraday Medal of the Institution of Electrical Engineers from the president, O. W. Humphreys, on April 29th. The citation read "for his notable scientific and industrial achievements, including the invention of the iconoscope and for his important role in medical electronics".

"traffic hazard." A limited public radio-telephone service has been in operation in a part of Lancashire for some time and the proposed regulations would apply to the whole country.

In the Minister's proposals, which have been circulated to "interested organizations," taxi drivers who use a fixed microphone will not be affected, neither will fire, ambulance or police operators who must of necessity use their equipment when in motion. Mobile radio amateurs, however, are not mentioned although it is to be hoped that they will continue to be able to operate "mobile."

Astronomers and Television Stations Share Frequencies

BECAUSE some of the frequencies in Channel 6 at the bottom of the television Band III are being used by radio astronomers, new B.B.C. and I.T.A. stations using this channel will have to share transmission time with them.

For many years the Mullard Radio Astronomy Observatory at Cambridge has been making observations using frequencies in this channel. This has been possible because of the absence of British broadcasting stations in this channel. One series of observations has been concerned with a sky survey of radio stars in the Northern Hemisphere which started in 1958 and will not be completed until 1966. This sky survey is said to be of fundamental importance to radio astronomers.

Frequencies in Channel 6 are also used for continuing series of shorter term observations such as measurements of the brightness and polarization of the radiation from the galaxy and observation of the interplanetary medium using the brighter radio sources. Unlike the sky survey these observations can be transferred to other frequencies which will be available for use by radio astronomers by the end of 1966 at the latest.

Scientific & Technical Information

THE Secretary of State for Education and Science (Mr. Crosland) announced in the House that the Government has set up a new organization to be known as the Office of Scientific and Technical Information. Its main function will be to promote more efficient handling and availability of scientific and technical information. It will also be responsible for the National Lending Library for Science and Technology at Boston Spa, Yorks, which previously came under the wing of the D.S.I.R.

The Minister has also set up an Advisory Committee for Scientific and Technical Information under the chairmanship of Sir James Cook, vice-chancellor of Exeter University.

Television Society Premiums.—On the occasion of the Fleming Memorial Lecture of the Television Society, given by Dr. R. D. A. Maurice on April 29th, the Society's premiums for papers read during 1963/4 were presented. The Mullard premium was awarded to K. Bernath (Swiss P.T.T.) for "The propagation of colour television signals at u.h.f."; the *Wireless World* premium to B. W. Osborne, A. M. Peverett and D. A. R. Wallace (Rediffusion) for "The K-rating of television equipment and networks"; the T.C.C. premium to P. Mothersole (Mullard) for "Television receiver design trends"; the E.M.I. premium to F. H. Wise (I.T.A.) for "The influence of propagation factors on u.h.f. television broadcasting"; the Pye premium to F. H. Steele (A.B.C. Television) for "Television studio planning"; and the *Electronic Engineering* premium to D. Maguire (Ferguson) for "The testing of mass-produced television receivers."

A space communications record has been set up by the U.S. Mars-bound spacecraft Mariner IV. On April 29th, its 152nd day in flight, it reached a distance from the earth of 66 million miles. At that distance transmissions take nearly six minutes to reach the earth. Soviet scientists lost radio contact with their Mars I spacecraft (in March 1963) at some 65 million miles after 149 days' flight. Mariner IV has been transmitting data 24 hours a day since its launch on November 28th.

During the first quarter of the year the number of combined television and sound receiving licences in the U.K. increased by 98,363, making the total 13,253,045. Sound-only licences totalled 2,793,558 (a decrease of 62,275) including 624,417 for sets fitted in cars.

The Electronics Group of the Institute of Physics and Physical Society is arranging a one-day meeting on "Semiconductor Junctions" to be held at the Royal Aeronautical Society, London, on December 7th. The morning session will be devoted to semiconductor particle detectors and the afternoon session to recent advances in heterojunctions.

The second "Ultrasonics in Industry" conference and exhibition is to be held on October 5th and 6th at St. Ermin's Hotel, St. James's, London, S.W.1. Details are obtainable from our associated journal *Ultrasonics*, Dorset House, Stamford Street, London, S.E.1.

I.E.C. Tokyo Meeting.—The next general meeting of the International Electrotechnical Commission will be held in Tokyo from October 10th-23rd.

A year's evening course on non-destructive testing starts at the Croydon Technical College, Croydon, Surrey, in September. The course is intended for students of H.N.C. level and will include practical work.

Network Theory.—A five-day residential symposium on electrical network theory is to be held at the College of Aeronautics, Cranfield, Bedford, from September 20th. Details are obtainable from S. R. Deards at the College.

Matrix Algebra, Part 1.—At the top of page 121 of the March issue the relation for the transfer function should read $v_2/v_1 = 1/a_{11}$ and not $v_2 v_1 = 1/a_{11}$.

Decca "Transar" Radar

A NEW generation of transistor radar equipment giving a choice of 21 types covering all requirements from short-range river radar to coastal and ocean-going vessels is announced by Decca Radar Ltd. The circuitry is based on the experience gained in the D202 model introduced two years ago, but with an important difference. From the design stage, through component selection, sub-assembly and final inspection and testing the principles laid down in the United States Advisory Group on the Reliability of Electronic Equipment (AGREE) have been followed. To this end the company has equipped an environmental testing establishment with the latest methods of simulating extreme conditions of heat, cold, humidity, corrosion, immersion, shock, vibration, wind loading, etc., at a cost of approximately £100,000. This has been used for development and will continue to be used for batch testing of sets during production for periods of not less than 500 hours on a 24-hour extreme temperature and humidity cycle.

The new series, with prices from £950 to £3,500, covers displays from 6in to 12in diameter, aerials from 4ft to 9ft, ranges from $\frac{1}{2}$ to 48 nautical miles, powers from 3kW to 25kW and with or without off-centring and true-motion facilities.

AGREE testing of a production sample of "Transar" marine radar.

"La Mot Juste".—The French Académie des Sciences has announced that the word "automatisation" will in future be used instead of "automation." This was, in fact, recommended by Norbert Wiener, the proponent of cybernetics.

A bibliography on medical electronics has been produced by Pye Laboratories, Ltd., Cambridge, and is available free to engineers in this field. It lists over 800 references to published material.

The next City & Guilds Radio Amateurs' Examination will be held on December 9th at local examination centres. Entries for the exam. must be received by November 8th.

Membership of the Society of Environmental Engineers rose during the past year by 125, bringing the total to 793.

Books Received

Square-Loop Ferrite Core Switching, by P. A. Neeteson. Written to enable engineers using switched ferrite cores to calculate in advance the behaviour of networks with reasonable accuracy. Dr. Neeteson derives a fundamental relation which describes the physical mechanism of switching and provides a basis for design calculations. Pp. 185. Philips Technical Library. Distributed in U.K. and Eire by Macmillan & Co. Ltd., 10-15 Martin's Street, London, W.C.2. Price £2 7s 6d.

Radio Wave Propagation, V.H.F. and Above, by P. A. Matthews, B.Sc.(Eng.), Ph.D., A.M.I.E.E. Up-to-date survey of the knowledge accumulated on the effects of the atmosphere and the ionosphere on radio propagation at frequencies above 30 Mc/s. Exploitation of various effects, including scatter, in long distance communication are discussed and the basic equations given. Pp. 155. Chapman and Hall Ltd., 11, New Fetter Lane, London, E.C.4. Price 28s.

British Special Quality Valves and Electron Tube Devices Data Manual 1964-65. Edited by G. W. A. Dummer and J. Mackenzie Robertson. Known formerly as the British Miniature and Subminiature Valves Data Annual, this revised version contains data also on small c.r. tubes, photocells, counters, electroluminescent panels, klystrons, etc. Pp. 1,391. Pergamon Press Ltd., Headington Hill Hall, Oxford. Price £10.

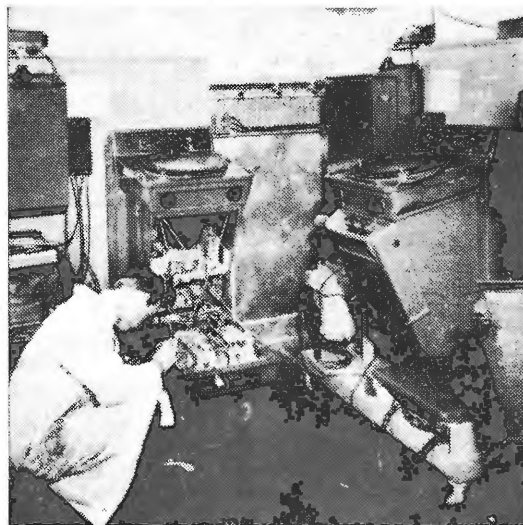

PERSONALITIES

Professor Martin Ryle, F.R.S., director of the Mullard Radio Astronomy Observatory at Cambridge has been awarded the Henry Draper Medal of the United States National Academy of Sciences for outstanding achievement in astronomical physics. The award was made on April 26th in Washington, D.C., during the 102nd annual meeting of the Academy. He has been Professor of Radio Astronomy at Cambridge since the chair was established in 1959. Prof. Ryle left Oxford University in 1939 with an M.A. degree and went to the Telecommunications Research Establishment (now R.R.E.) where he worked on radar development throughout the war. He then went to the Cavendish Laboratory at Cambridge as lecturer in physics until transferring to the Mullard Radio Astronomy Observatory in 1957. He operates an amateur station under the call G3CY.

Eric Eastwood, C.B.E., Ph.D., M.Sc., who, as announced on page 297, has been appointed chairman of English Electric Automation, formed to coordinate the automation activities within the English Electric Group, has joined the board of English Electric-Leo-Marconi Computers. Dr. Eastwood, who is 55, joined the Group in 1946. Two years later he was appointed deputy chief of research at the Marconi Company and subsequently director of research. He became a director of Marconi in 1963.

D. G. Hucker, until recently works manager of W. H. Sanders, has joined Microwave Associates at Luton where he will be responsible for all aspects of the Company's production. He joined W. H. Sanders from the Services Electronics Research Laboratory at Baldock in 1947.

David Balfour, M.A.(Cantab), A.M.I.E.R.E., has been appointed head of engineering by Brush Clevite Company, of Hythe, Southampton. Mr. Balfour, who is 31 and a graduate of Gonville and Caius College, Cambridge, was previously with Decca Radar and Plessey.

R. Loudon, B.A., D.Phil., on the research staff at the Royal Radar Establishment, Malvern, has been appointed reader in physics at the University of Essex. He is a senior scientific officer in the Ministry of Aviation.

D. Hunter, B.Sc., A.M.I.E.E., formerly a director and joint general manager of E-A Data Processing Ltd., has been appointed joint managing director of Elliott Space and Weapon Automation Ltd.

Sir Harold Bishop, formerly Director of Engineering of the B.B.C., has been appointed a member of the boards of the Central Research and Engineering Division and the Telephone Cables Division of B.I. Callender's Cables. Sir Harold will continue as a consultant of the B.I.C.C. Group.

W. Maurice Lloyd, who joined Bush Radio in 1946, has been appointed general manager of the Rank-Bush Murphy television receiver factory at Ernesettle, Plymouth. This is a new post and Mr. Lloyd is responsible for all the Rank-Bush Murphy activities at Plymouth and also at the company's "feeder" factory at Redruth, Cornwall. Mr. Lloyd, who is 39, took a degree in special physics at Imperial College, London, in 1944, and subsequently spent two years at the Telecommunications Research Establishment, Malvern. He has been at Plymouth since 1952 where he set up a research and development department, for which he has been responsible until his new appointment.

J. H. R. Manners, B.Sc., has been appointed chief engineer of H. C. D. Research Ltd., and its subsidiary Semikron

Rectifiers & Electronics Ltd., of Croydon, Surrey. He was formerly in the Research Group of the Westinghouse Brake & Signal Co., Ltd. where he was concerned with the application of Thyristors. Mr. Manners was at one time deputy head of the Brimar valve applications department of Standard Telephones & Cables, and later chief development engineer with Masteradio.

W. D. Gilmour, B.A., A.M.I.E.E., contributor of the article on electronic gaming machines in this issue, has been with E.M.I. Electronics on radar and general electronic design work since 1954. He is a graduate of St. John's College, Oxford, and served in R.E.M.E. from 1942 to 1946. For two years he was in the research department of St. Dunstan's working on devices to aid the blind after which he spent two years with Westinghouse and three with Marconi Marine before joining E.M.I.

Recent promotions on the staff of the University of Southampton to senior lecturships included those of **K. G. Nichols, M.Sc., A.Inst.P., A.M.I.E.R.E.** (electronics) and **G. Gladwell, B.Sc., Ph.D.** (sound and vibration research).

OBITUARY

Sir Edward Appleton, G.B.E., K.C.B., F.R.S., who died on April 21st at the age of 72, was one of our foremost radio physicists and was a pioneer in the field of ionospheric research. It was he and his co-workers, using the Bournemouth medium-wave transmitter of the B.B.C., who proved in 1924 the theories of Heaviside & Kennelly that there was an ionized conducting layer in the upper atmosphere. Sir Edward, who was knighted in 1941, received many scientific honours for his ionospheric research including the Nobel Prize for Physics in 1947. He was the first radio physicist since the days of Marconi to receive the award, the citation for which read "for his work on atmospheric physics, and especially for his discovery of the Appleton layer." He was also given the U.S. Medal of Merit for his contributions leading to the development of radar and to Anglo-American scientific collaboration during the war.

After teaching physics at Cambridge (1919-24) he was for 12 years Wheatstone Professor of Experimental Physics at King's College, London. Then followed three years as Jacksonian Professor of Natural Philosophy at Cambridge before he became secretary (administrative head) of the D.S.I.R. in 1939. Ten years later he returned to the academic



world as principal and vice-chancellor of Edinburgh University, a position he still held at his death.

Dr. R. L. Smith-Rose, writing in *The Times*, said, "In all this work, Appleton was not only an outstanding research scientist: he was also an inspiration, guide and wise counsellor to all the many younger physicists who were encouraged by his example to follow a career in radio research. His many students who graduated under him and continued to do research work stimulated by him are to be found today in all parts of the world; and he is acknowledged by them all to be the greatest pioneer of international scientific radio research."

NEWS FROM INDUSTRY



An in-the-ear hearing aid that weighs 6.2 grams is announced by the Zenith Hearing Aid Sales Corporation, of Chicago, Ill. A solid state circuit containing six transistors for this aid is so tiny that it can pass through the eye of a needle. An on-off switch and volume control are incorporated in this aid, designated Solitaire, which will retail in the United States at about \$325.

English Electric Automation Ltd.—This new company that will be responsible for the co-ordination of all of the automation activities of the English Electric Group—which includes the Marconi companies and English Electric-Leo-Marconi Computers—has been formed. Under the chairmanship of Dr. E. Eastwood, who is director of research for the E. E. Group, the board comprises: J. M. Ferguson, the chief engineer of English Electric's Stafford Works; H. S. Brown, manager of E. E.'s Industrial Applications & Automation Group; R. P. Shipway, manager of Marconi's Data Handling Project Group; J. McG. Sowerby, technical director of English Electric-Leo-Marconi Computers; and Sir Gordon Radley, who is a director of the English Electric Company and will be the new company's link with the main board.

The Kelvin Electronics Company has been formed by S. Smith & Sons (England) Ltd. to handle some of the products previously marketed by the Smiths Industrial Division which will, however, continue as a separate division. The main products to be transferred are: ultrasonic and other non-destructive test apparatus; recording and laboratory test equipment; boilerhouse instrumentation and controls; and process control and data handling equipment. Research, engineering and manufacture will be concentrated at Hillington, Scotland, with administrative and sales headquarters at Kelvin House, Wembley Park Drive, Wembley, Middx. (Tel.: WEMbley 8888.)

Message Switching System.—The first industrial computer-controlled message switching system is to be installed at Manchester to handle all the telegraph messages and data transmission within the I.C.I. organization which has some 90 establishments in the United Kingdom. This is the first of its type to be manufactured by a British company and is to be made and installed by the Automatic Telephone and Electric Company at a cost of nearly £500,000. The system, which will also provide communication between I.C.I.'s computers, is scheduled to be operational in the Autumn of next year. Data speeds of from 10 to 2,000 characters per second will be accommodated.

Group pre-tax profits of **Racal Electronics Ltd.** for the year ended 31st January, 1965, amounted to £611,000 compared with £451,000 for the previous year. Taxation took £314,000 as against £207,000 in 1963-64, leaving a net profit of £297,000 (£244,000).

Mitchel Enterprises Ltd., has been formed by the High Fidelity Centre, of 61 West Street, Dorking, Surrey (which will continue to function as a retail outlet), for the purpose of being sole U.K. agents and representatives for the Elac range of products made by Electro-acoustic G.m.b.H.

The Marconi Company have received an order from the Home Office for fifty sets of **radar speed measuring equipment**. As with the thirty-three sets already purchased, the extra sets of measuring equipment (called PETA-Portable Electronic Traffic Analyser) will be used by police authorities throughout the country. The equipment, which was designed in collaboration with the police authorities, works on the same principle as an aircraft Doppler Navigator. The basic accuracy is claimed to be better than 2 m.p.h. over the entire operating range, and the equipment has been designed so that any fault which might occur in the system will always produce a low reading of speed or no reading at all.

Gold Medal for Solartron.—The Solartron Electronic Group were awarded a gold medal for the technical standard of their Type LY 1471 compact logger and Type LM 1420 integrating digital voltmeter at the recent Leipzig Spring Fair.

R. H. Cole Ltd. have recently established a new subsidiary, **C. A. Cook Ltd.**, to concentrate on the design and manufacture of all types of filters, delay lines and related components. The new subsidiary will operate from 1 Heron Trading Estate, Wickford, Essex.

Agencies and agreements

Wessex Electronics Ltd. have moved to new offices at Royal London Buildings, Baldwin Street, Bristol 1. (Tel.: Bristol 26952.) Already agents for several American and European manufacturers, they have recently been appointed sole U.K. agents for Aeroflex Laboratories, of New York, and their subsidiaries Newtek and Transmetrics.

Electrautom Ltd. has been formed to act as importers for a number of overseas companies and also to act as an export facility for British manufacturers. The American companies represented include Duncan Electronics Inc., of California, who manufacture linear and

non-linear potentiometers; the Electronic Development Corp., of Boston, makers of precision voltage sources; and Abrams Instrument Inc., of Michigan, makers of digital motors. European companies represented include B. Précis S.A., of Paris, who make a wide range of capacitors; Marchetti, of Vienna, who are digital instrument manufacturers; and Papst Motorenwerke G.m.b.H., of West Germany, who make small a.c. motors. The managing director of the company, which operates from 408 Finchley Road, London, N.W.2 (Tel.: HAMpstead 8468), is T. Bunzl, B.Sc.

FXR Microwave Instruments, microwave instrument and test gear manufacturers of New York, have re-appointed Elliott Brothers Sales Agencies Ltd., of Wigton Gardens, Stanmore, Middx. (Tel.: DRYden 0971), sole U.K. agents.

Non-Linear Systems Incorporated, of California, have appointed Claude Lyons Ltd., 76 Old Hall Street, Liverpool, 3 as U.K. representatives. N.L.S. manufacture a wide range of digital voltmeters.

The Technical Devices Company, of California, who manufacture wire cutting and stripping machines, have appointed Technical Representation Ltd., 43 Clifford Road, Poynton, Stockport, exclusive U.K. agents.

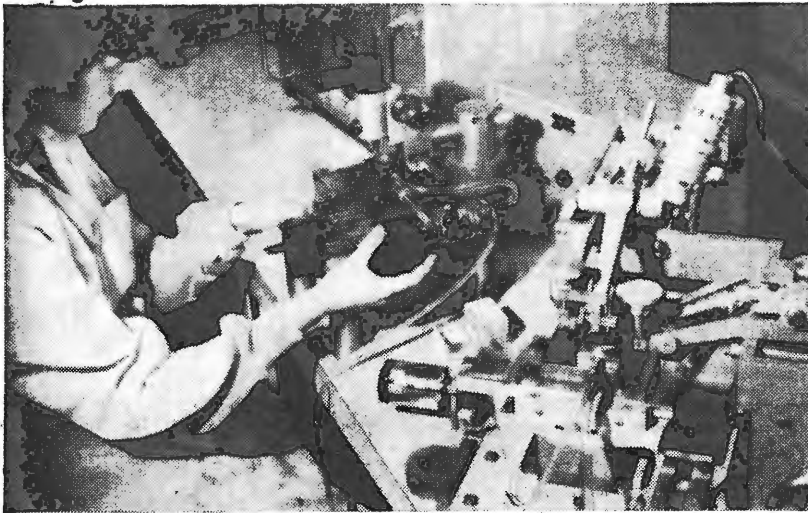

Segregation and Integration—From one slice of silicon, several hundred integrated solid circuits are separated into individual chips by the machine on the right, which is fully automatic and replaces the manual unit being operated. This is one of the many activities that come within the new components group of the Plessey Company Ltd., which takes in 22 existing companies and divisions.

From Overseas

Argentina

The Marconi Company have received an order for studio and transmitting equipment, valued at over £110,000, for a new television station at Santa Fé, Argentina. A 5-kW Band III vision transmitter and a 1-kW frequency modulated sound transmitter are to be supplied under the contract.

Denmark

The Posts and Telegraphs Administration of Denmark have asked Submarine Cables Ltd. to lay, in the Baltic, an underwater telephone cable providing 480 circuits between Nykobing (Falster) and Ronne on the island of Bornholm. The contract, worth nearly £500,000, will include approximately 105 nautical miles of underwater coaxial telephone cable and 13 submerged transistor repeaters, together with terminal-station equipment manufactured by the telecommunications division of Associated Electrical Industries Ltd.; one of Submarine Cables parent companies.

Germany

A West German manufacturer has placed an order with Thorn-AEI Radio Valves and Tubes Ltd., for £250,000-worth of television picture tubes.

New Zealand

The fleet of DC8 jet airliners in New Zealand's international airline TEAL is to be fitted with Marconi AD560 Doppler navigational equipment. In these installations, a Marconi track-guide navigation computer will work in asso-

ciation with the Doppler velocity sensor to show how far the aircraft has to go to reach the next reporting point, or destination, and will also tell the pilot whether he is maintaining the planned course. Information from this Doppler navigational equipment can also be fed into the flight system and to the automatic pilot.

The New Zealand Broadcasting Corporation has placed an order with EMI Electronics Ltd. for £40,000-worth of fixed microwave link and associated tower equipment. This equipment, which will be installed in the Christchurch and Wellington regions, operates in the 7 to 7.3 Gc/s band and will be used to carry both vision and sound circuits.

Pakistan

Eleven lattice steel towers, with heights varying from 75 to 265 ft, are being supplied by British Insulated Callender's Construction Company for a microwave system in West Pakistan. The order, worth approximately £70,000, was placed by the Marconi Company.

Zambia

A contract valued at over £350,000 for a 2 Gc/s semiconductor radio system in Zambia has been awarded to G.E.C. (Telecommunications) Ltd. Three two-way broadband frequency channels will be provided between the capital city of Lusaka, Broken Hill, Ndola and Kitwe, a distance of about 200 miles, via five repeater stations. One channel will be used to carry a 625-line television programme, a second will carry 960 telephone circuits and the third will act as a stand-by channel which will automatically replace either of the working channels in the event of a fault.

Commercial Literature

"Noise Reduction by Digital Signal Averaging" is the title of Technical Note 64-1 produced by Northern Scientific/Inc. This 8-page publication discusses the advantages and disadvantages of averaging and non-averaging measuring techniques in part one, then gives information on digital averaging instruments, including fast-record, slow playback devices. Copies are available from High Volt Linear Ltd., of 1 Cardiff Road, Luton, Beds.

6WW 477 for further details

Imhofs, of 112-116 New Oxford Street, London, W.C.1, have published a 56-page manual on their Series 901 Imlok construction system, which is an improved version of the system previously marketed under the name Miniature Imlok. Many new parts have been introduced and enable much larger and stronger units to be made although there is no loss of the facilities previously offered and units down to 4½ in cube can still be made. All the necessary information on the system whether one makes up the units or has them made to order, is contained in this publication.

6WW 478 for further details

The 1965 edition of Siemens semiconductor catalogue is now obtainable from the U.K. agents R. H. Cole Electronics Ltd., 7-15 Lansdowne Road, Croydon, Surrey. Maximum ratings and other characteristics are provided for their standard and industrial transistors, diodes and thermistors. A number of Hall effect devices are also included in this 24-page catalogue.

6WW 479 for further details

An application guide for "RCA Memory Products" has been forwarded to us by the Radio Corporation of America, of 415 S. Fifth Street, Harrison, New Jersey 07029, U.S.A. The guide presents information on RCA ferrite magnetic devices for memory cores, switching cores, transfluxors, etc., and also on complete memory systems. A brief review of basic magnetic theory applicable to ferrite magnetic memory cores is included in this 23-page publication.

6WW 480 for further details

"This year of hi-fi 1965" is the title of another Imhof publication recently released. It gives, in 52 pages, details of hi-fi units from various manufacturers including motors, amplifiers, pickups, speakers, tuners, cabinets, etc. A separate section of the catalogue deals with complete equipment such as tape recorders, radiograms and record players.

6WW 481 for further details

A leaflet describing a 0-150°C thermocouple thermometer has been sent to us by Somerset Electronics Ltd., of Pyramids, Crocombe, Wells, Somerset.

6WW 482 for further details

ELECTRONIC LABORATORY INSTRUMENT PRACTICE

By T. D. TOWERS,* M.B.E., A.M.I.E.E., A.M.I.E.R.E.

6.—MEASUREMENT OF IMPEDANCE, CAPACITANCE AND INDUCTANCE

LAST month we considered the measurement of the d.c. characteristics of circuit components in the form of their resistance (R). Now we turn to a.c. characteristics, i.e. inductance (L), capacitance (C), and the combination of these with resistance in the form of impedance (Z).

Impedance measurements

Often in the electronic laboratory you are interested in the magnitude only of an impedance, $|Z|$, without regard to its individual resistive and reactive components. Measurements of this type may arise with loudspeakers, filter circuits, chokes, transformers, tuned circuits, etc. With quite simple apparatus normally at hand, you can measure impedance over the range of 20c/s to 20Mc/s with some of the circuits described below. Above about 20Mc/s special methods and precautions are usually required. The circuits can be used as temporary "lab. lash-ups," although some of them form the basis of commercial impedance meters.

The low frequency "bridge-type" impedance measuring circuit given in Fig. 37(a) can be quickly set up. The unknown impedance, Z_x , is connected in series with a calibrated variable resistance, R, across an a.f. sinewave voltage source. A valve voltmeter is switched alternately across Z_x and R, while R is adjusted until the same reading is obtained in both positions. The reading in ohms of the calibrated resistor is then the magnitude of the unknown impedance Z_x at the test frequency. The source a.c. voltage can be supplied from an a.f. signal generator or from the 50c/s mains. In either case an isolating transformer (often an in-built feature of a good audio signal generator) should be used to avoid difficulty with the earthing of the valve voltmeter, and to enable the voltage applied to the components under test to be kept within their ratings. The circuit gives reasonably accurate results up to about 10kc/s before circuit strays become critical. Impedances from 1Ω to $1M\Omega$ can be measured with ease. The accuracy depends primarily on the accuracy of the calibrated comparison resistance, R, but you should not forget that departure from a pure sinewave driving voltage can lead to errors. The a.c. mains supply often contains quite a proportion of second harmonic distortion, and, if the test voltage is from this source, you may find errors up to several percent arising.

Another approach to l.f. impedance is the "audio volt-ammeter" method of Fig. 37(b). Here a voltage from an a.c. source is applied to an unknown impedance Z_x . The r.m.s. current, I_x , into Z_x is measured in the appropriate a.c. range of a multimeter, while the r.m.s. voltage, V_x , across it is measured on a valve voltmeter. By Ohm's law, the impedance is given by $|Z_x| = V_x/I_x$. The volt-ammeter method can give reasonable accuracy

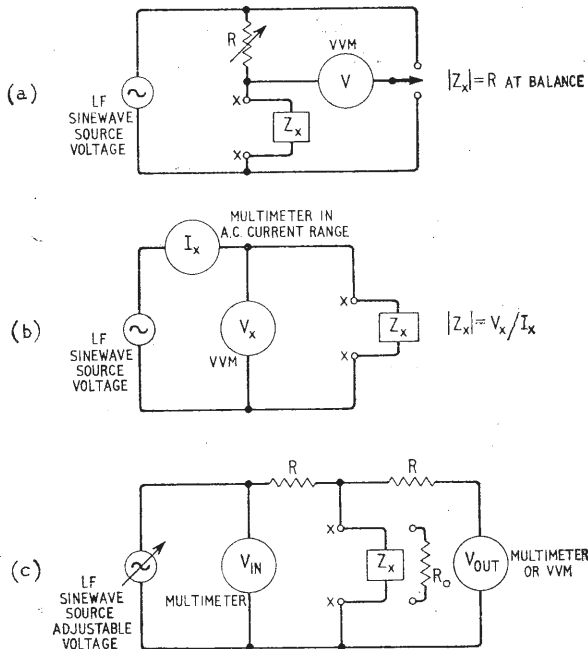

Fig. 37. Some simple basic l.f. impedance test circuits: (a) "bridge-type"; (b) volt-ammeter (c) T-network;

up to the highest frequency at which the multimeter can be used (5-10kc/s), and so long as $|Z_x|$ is small compared with the input impedance of the valve voltmeter.

A third simple way of measuring impedance in the low frequency range is the audio "T-network" method illustrated in Fig. 37(c). Here a known reference resistor, R_0 , is connected across the test terminals X-X, and the amplitude from the a.f. sinewave input is adjusted on the input multimeter to V_0 for a suitable reading V_{out} on the a.c. output meter. The reference resistor is then replaced by the unknown impedance Z_x , and the input voltage adjusted to V_x to give the same output voltage V_{out} . Then the value of the unknown impedance is given by $|Z_x| = (V_0/V_x)R_0$. This method is particularly easy where you have a signal generator displaying its output voltage directly on a meter, since you can then dispense with the separate meter for the input voltage to the T-network. The major precaution to be taken is to ensure that R is large compared with the

*Newmarket Transistors Ltd.

generator output impedance and small compared with the impedance of the meter at the circuit output.

The impedance measuring circuits of Fig. 37 are restricted to low audio frequencies. One of them, the T-network, can, however, be adapted for r.f. use as shown in Fig. 38(a), where the audio signal generator has been replaced by an r.f. signal generator with a calibrated output attenuator reading directly in microvolts and terminated in the correct resistance R_g (usually 50 or 75 Ω). Also the voltage across the unknown impedance is now monitored by a radio receiver fitted with an internal "S" meter or external output meter. The test procedure is to connect a non-inductive reference resistor, R_o (preferably a hi-stab cracked-carbon type), across the test terminals X-X, and tune the receiver to the signal generator frequency for maximum output. If the receiver has an internal S meter, the signal can be unmodulated, but if an external output meter is used,

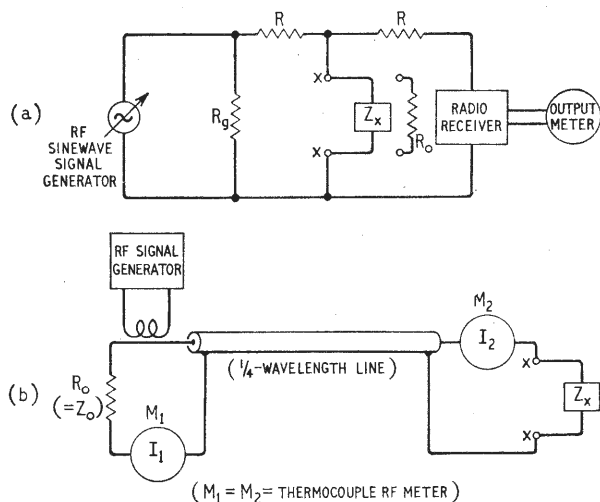

Fig. 38. Some simple basic r.f. impedance test circuits: (a) T-network (below 30 Mc/s); (b) use of coaxial cable to measure unknown Z (above 30 Mc/s).

the signal should be modulated. Receiver a.g.c. should be disconnected or the receiver operated at a low level (<50mW output) where the a.g.c. will not be operative. For a specified receiver output the signal generator output, V_o , is noted on its calibrated output attenuator. The reference resistor is now replaced by the unknown impedance, Z_x , across X-X, and the signal generator output adjusted to V_x for the same receiver output as before. Then the impedance of Z_x at the measurement frequency is given by $|Z_x| = (V_o/V_x)R_o$. For accuracy you must first ensure that R is high compared with the signal generator output impedance R_g , the reference resistance R_o , and the impedance Z_x ; a typical practical value of R is 1000 ohms. You must also take care that the T-network from the signal generator to the radio receiver is adequately r.f.-screened. The method can be used up to about 30Mc/s with care. As it happens, 30Mc/s is the upper frequency limit of run-of-the-mill communications short-wave receivers.

Above 30Mc/s, it is still possible to arrange conventional test equipment on a bench to measure impedances up to about 150Mc/s. Fig. 38(b) illustrates the use of a quarter-wavelength section of coaxial cable for this. Across the input (left-hand) end is connected a non-inductive resistance R_o equal to the characteristic

impedance, Z_o , of the coaxial cable (usually 50 or 75 Ω) in series with a thermocouple milliammeter, M_1 , which measures the r.f. current I_1 , in the screen of the coaxial cable at the line end. An r.f. signal generator is loosely coupled by a single-turn loop to the centre conductor at the same end. At the other end of the line another thermocouple milliammeter, M_2 , is connected across the line end in series with the unknown impedance connected between test points X-X. M_2 measures the r.f. current I_2 , in the centre conductor where it emerges from the cable screening. The coaxial cable length is made equal to a quarter wavelength of the frequency from the r.f. generator. When the unknown impedance is connected across X-X, then it can be shown that $|Z_x| = (I_1/I_2)R_o$. All connecting leads should be kept as short as possible and the output end of the cable kept as far as possible from the input. With care the method is usable from 30Mc/s (line length approx. 9ft) to 150Mc/s (length approx. 18in).

I have described some bench methods of measuring impedance magnitude (without phase consideration) because in the "ordinary" a.f. and r.f. frequency spectrum handled in the electronic laboratory, there are virtually no commercial test sets available which meet this simple requirement on its own. For the most part, if you use a commercial "impedance meter," you generally get your results in the form of a pair of values for resistance and reactance. You then have to combine these by the usual square root of the sum of squares to get the modulus or magnitude of the impedance.

There are, however, commercial instruments known as "Vector-Impedance," "Polar-Impedance" or "Z-Angle" meters available which do measure the impedance magnitude directly (as well as the phase angle). Typical of these is the Hewlett-Packard (Boonton Division) Vector Impedance Meter 4800A which displays on two meters the magnitude and phase angle of an unknown impedance, connected across its test terminals at any selected frequency from 5c/s to 500kc/s. An instrument of British make operating on the same principle is the Muirhead Type D728B, Impedance and Angle Meter.

The "Vector-Impedance" meter is only one of a large selection of instruments of various types commercially available for measuring both the resistive and reactive components of an unknown impedance. We have already mentioned some of these in the last article, where we referred to d.c. resistance tests commonly being made on low frequency a.c. bridges. In ordinary lab. practice, however, the problem that the engineer usually meets with is "What is the capacitance (or inductance) of this component?" rather than "What is the impedance?" We will therefore go on now to consider the measurement of capacitance and inductance rather than of reactance proper.

Capacitance measurements

To make a quick practical test of a suspected capacitor, engineers often take an ohmmeter or a multimeter in a resistance range (usually ohms \times 100), and place the capacitor across the meter terminals. After a bit of experience, you can tell the approximate capacitance value from the resultant "kick" of the meter pointer and the approximate leakage from the resistance reading to which it finally settled. This ohmmeter test method is limited because it doesn't give significant kick deflection for low value capacitances and tells only the low voltage leakage. Still it is a useful first test that quickly sorts out short or open circuits at least. (When testing electrolytics this way, see that the positive terminal of

the multimeter goes to the negative of the electrolytic. In most multimeters in an "ohms" range the d.c. test voltage at the +ve terminal of the meter is in fact negative.)

Another simple capacitance bench test that takes a little longer than the above ohmmeter "goodness" test, but can give quite accurate measurements, is the a.f. reactance method illustrated in Fig. 39(a) and (b).

The "reactance-current" method of measuring a capacitance shown in Fig. 39(a) arrives at the capacitance value of the unknown C_X connected across the test terminals X-X by measuring the r.m.s. current, I_X , driven through it by an applied audio r.m.s. voltage V_o of a known frequency f_o from a low impedance source. The capacitance value is given by $C_X = I_X / (2\pi f_o V_o)$. The source can be a signal generator, but to save setting it up, engineers often use the 50c/s mains either directly on 240V for high voltage capacitors or dropped to about 6.3V through a heater transformer for low rated units. The ubiquitous multimeter can be used to read the a.c. current, and you have a simple set-up for quick measurement. The method can easily be made to give $\pm 10\%$ accuracy for capacitors from 100pF to $1\mu\text{F}$ and $\pm 20\%$ down to 10pF.

Fig. 39(b) shows the basic circuit of the alternative "reactance-voltage" method of measuring an unknown capacitance. In this a voltage source of frequency f_o supplies (via an isolating transformer T_1) a test voltage to the series arrangement of a known standard non-inductive resistor, R_o , and the unknown capacitance C_X . A valve voltmeter is used to measure the r.m.s. voltage V_R across the resistance and V_{C_X} across the capacitance. The capacitance is then given by

$$C_X = V_R / (2\pi f_o R_o V_{C_X})$$

A simple variant of these two reactance methods of

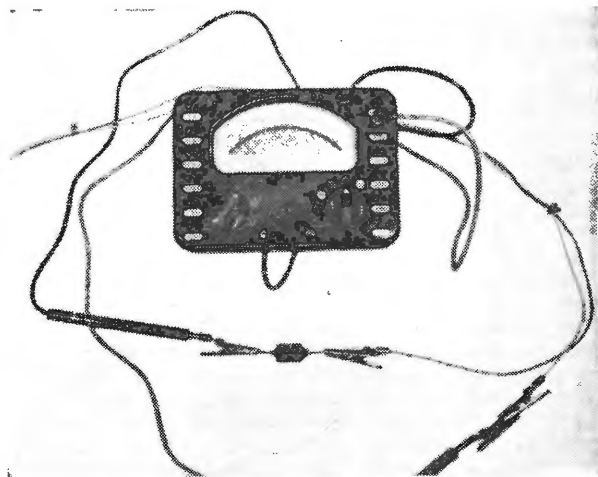

Fig. 40. Typical multimeter (Metrix Type 462) measuring 68pF capacitor by connecting capacitor and meter (switched to 300V a.c. range) in series across a.c. mains supply.

measuring C is illustrated in action in Fig. 40. Here a multimeter switched to an a.c. voltage range is connected in series with the unknown capacitor across a sine wave voltage source of known frequency and amplitude. In the illustration a Metrix Type 462 multimeter in its 300V a.c. range is being used to measure a 68pF mica capacitor with a test voltage derived directly from the mains. It will be seen that even 68pF gives a usable large deflection, but it should be emphasized that this particular meter has an unusual sensitivity of 20,000 ohms/volt in its a.c. ranges, and more normal multimeters could not easily be used to measure capacitances as low as 68pF. (A note of warning should be sounded here. When you use the mains as a source of test voltage, remember it can be dangerous. I was reminded of this when I set up the equipment of Fig. 40. Two of the crocodile clips with mains across them accidentally touched and left a black flash mark on my bench and vaporized a 13A fuse!) Whatever multimeter you use, you can take a series of known capacitors and calibrate an a.c. voltage range directly in capacitance, but be careful that you select a voltage source within the rating of the capacitors to be tested.

A square wave generator can be used to make up a capacitance test set as shown in Fig. 39(c). If a fixed-frequency square wave from a voltage source is applied through the unknown capacitor C_X to the half-wave rectifier circuit formed by the diode across the d.c. meter, the meter deflection is proportional to the capacitance C_X . The meter can therefore be calibrated to read capacitance directly. The square wave generator can be a commercial unit, but if you do not have one available you can make up your own astable multivibrator along the lines of the circuit in Fig. 39(c). The circuit values shown were chosen to give a pulse repetition rate of about 50 kc/s, suitable for measuring capacitances in the range 0-250pF. The meter reads linearly with capacitance, and the 10k Ω preset resistor enables it to be set for 250pF full scale deflection against a standard 250pF capacitor.

The methods so far discussed for measuring C can be vitiated if substantial leakage exists in the capacitor. So, for really accurate measurements, you must turn to methods which give readings of both the resistive and reactive parts of the capacitor impedance.

Most commercial capacitance measurement sets use

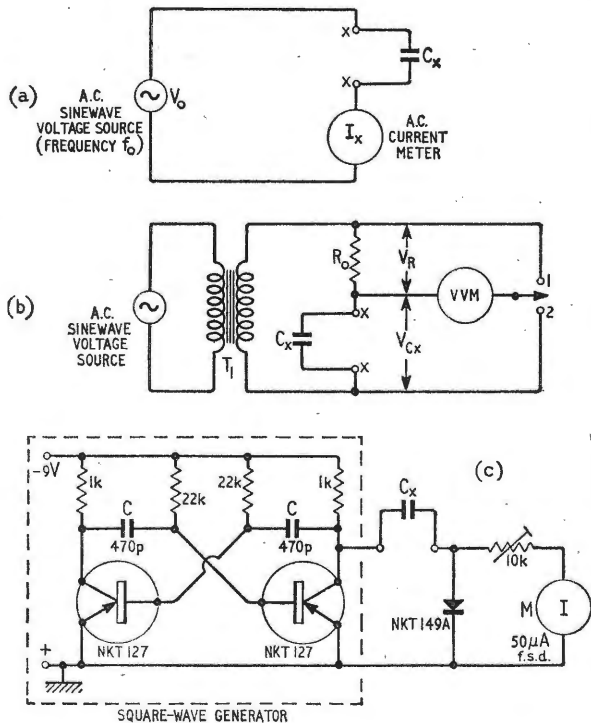

Fig. 39. Some simple basic capacitance measurement circuits: (a) reactance current method; (b) reactance voltage method; (c) square-wave method.

some form of bridge arrangement in which the resistance and reactance of the device under test are balanced against calibrated internal or external standards. For capacitance measurement, the simplest bridge circuit is an a.c. Wheatstone such as Fig. 41(a) where C_X , R_{CX} form the equivalent circuit of the capacitance to be measured. R_1 and R_2 are the ratio arms, and R_S , C_S the series arm. The values of R_S , C_S and R_2 are adjusted until the a.c. null detector M indicates a balance. Then it can be shown that $C_X = C_S(R_2/R_1)$ and $R_X = R_S(R_2/R_1)$. For non-electrolytic capacitors, the dotted components at the bottom are not used. For electrolytics a polarizing d.c. voltage is applied from a battery as shown dotted, and the battery decoupled by a large value capacitor, C_B .

A number of commercial RC bridges derived from the basic circuit of Fig. 41(a) are on the market. Typical of these is KLB's M300 Component Bridge shown in Fig. 42, with four capacitance ranges 10-5000pF, 0.001-0.5 μ F, 0.5-50.0 μ F and 20-1000 μ F. This bridge can be used also to measure resistance in four ranges 0.5-500 ohms, 50-50,000 ohms, 0.005-5 megohm and 2-100 megohm. A number of other companies market RC bridges in the United Kingdom, such as Cossor, Daystrom (Heathkit), and Metrix. Particularly notable are the Sullivan special direct-reading capacitance bridges of extremely high accuracy (in some cases 0.01%), and such new-generation instruments as the Wayne-Kerr B201 RC bridge capable of measuring from 0.0001pF to 0.1 μ F with a general accuracy of 0.1%. Besides general purpose capacitance bridges, there are available special-purpose units such as B.P.L.'s range of electrolytic capacitance bridges.

Where accurate measurements of capacitance have to be made it is advisable to keep standards, either singly or in decade boxes, for calibration purposes. Standard capacitors are available from such companies as B.P.L.,

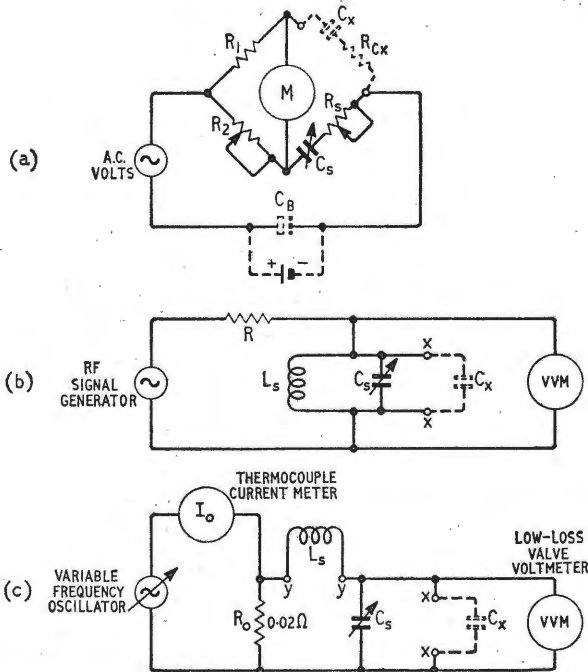

Fig. 41. More refined basic capacitance measurement circuits: (a) a.c. bridge; (b) resonant circuit substitution, parallel driven; (c) resonant circuit substitution, series driven.

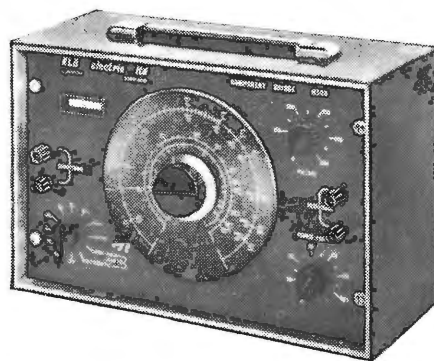

Fig. 42. Typical commercial "RC-meter": K.L.B. M300 Component Bridge.

Cambridge Instruments, Daystrom, Philips and Sullivan.

Although bridge methods of capacitance measurement are very powerful, many engineers prefer, for low values of capacitance, to use one or other of the resonant-circuit methods illustrated in basic form in Fig. 41(b) and (c).

Fig. 41(b) illustrates the use of a parallel-fed resonant circuit to measure a small unknown capacitance. The unmodulated output from an r.f. signal generator is fed through a buffer resistance R to the top end of a tuned tank circuit comprising a fixed inductance L_S and a calibrated variable capacitor C_S . With nothing connected to the test terminals $X-X$, C_S is adjusted for maximum reading on the valve voltmeter, indicating resonance in the tank circuit, and the value C_{S1} noted. Next C_X , the unknown, is connected to $X-X$, and C_S readjusted for a maximum on the valve voltmeter and the new value of C_{S2} noted. Then $C_X = C_{S1} - C_{S2}$. Quite frequently this sort of circuit is used in a bench set-up in a laboratory, because it uses standard instruments readily available, but it does not appear widely in commercial equipment.

A derived form of the circuit of Fig. 41(b) is, however, used in the widely known Tektronix Type 130 LC meter illustrated in Fig. 43. In this instrument, the capacitance to be measured is placed in parallel across the tuned circuit but, instead of the circuit being re-tuned to resonance by a calibrated variable capacitor, the frequency deviation caused is used to indicate the unknown capacitance. Before the unknown capacitor is connected to the test terminals, the LC oscillator is trimmed to zero beat with a stable internal 140kc/s crystal oscillator. When the LC circuit is thrown off tune by connecting the capacitance under test across it, the beat frequency is used to provide a meter deflection proportional to this capacitance. The Type 130 LC meter has five capacitance ranges of 3, 10, 30, 100, 300pF full scale deflection, and has an accuracy of 3% of full scale deflection. A guard-voltage circuit is provided for eliminating errors due to stray capacitances.

Fig. 41(c) illustrates the second approach to resonant circuit measurement of capacitance in the form of a tuned circuit L_S , C_S series fed with a constant input voltage across the series resistance drive resistor R_0 . With a specified test frequency and a selected fixed inductance L_S , the resonant circuit is tuned by means of the calibrated variable capacitor C_S until the valve voltmeter across it reads a maximum. The unknown capacitor C_X is then connected across $X-X$ and the amount by which C_S is reduced to bring the tuned circuit again into resonance

(Continued on page 303)



Fig. 43. Beat-frequency capacitance (and inductance) test set: Tektronix Type 130 LC meter.

is equal to the value of C_x . Many will, of course, recognize this as the basic circuit of the "Q-meter" discussed more fully below under inductance measurement.

Inductance measurements

While there are simple, rapid and convenient ways of measuring resistance and capacitance not requiring complicated bridges or resonant circuit instruments, simple testers for inductance are not common. As a result engineers tend to avoid testing inductance if they can.

Special bridges are available commercially for accurate measurement of inductance. These are usually Maxwell (for low Q inductances) or Hay (for high Q) types. An example of this type is the Furzehill B810B Inductance Bridge with a range from 5mH to 500H at low audio frequencies and with a 2% accuracy. H. W. Sullivan Ltd. specialize in high-accuracy direct-reading precision inductance bridges such as their AC1100 capable of measuring from $1\mu\text{H}$ to 100H, with an accuracy of $\pm 0.1\%$. The Wayne-Kerr B321 Inductance Bridge ($0.002\mu\text{H}$ -111mH, $\pm 0.25\%$) is another good example of such specialized bridges.

The Tektronix LC Meter Type 130, mentioned earlier

and illustrated in Fig. 43 in connection with capacitance measurements, can also (as its name implies) be used for direct-reading inductance measurements to a $\pm 3\%$ accuracy over the limits of its five inductance ranges of 3, 10, 30, 100 and $300\mu\text{H}$ full scale deflection.

The other instrument widely used in practice for inductance measurement is the Q-meter, the principle of which has already been described at the end of the section on capacitance measurement above. In the circuit of Fig. 41(c), if the oscillator frequency is adjusted to a known preset frequency f_0 , then L_s , C_s and f_0 are related by the formula $4\pi^2 f_0^2 L_s C_s = 1$. The variable capacitor can thus be calibrated in terms of the L_s necessary to tune to resonance. If then an unknown inductance, L_x , is connected across the terminals Y-Y, and C_s adjusted to resonance (as indicated by a maximum valve-voltmeter reading), the value of L_x can be read off on the calibration of the variable capacitor.

Q-meters have, however, much wider capabilities than the simple measurement of C or L indicated so far. The name "Q-meter" itself points to their major use in measuring the goodness factor, Q, of a circuit or component having reactance. In Fig. 41(c) the Q of the resonant circuit is the ratio of the resonant voltage across the capacitor C_s (measured by the valve voltmeter) to the input voltage $I_0 R_0$ (across R_0). Those interested in refinements in the use of Q-meters should obtain a copy of the Marconi publication "Impedance Measurements With a Q-meter". Fig. 44 is an illustration of the Marconi TF1245 Q-meter with its related TF1246 source oscillator for the range 40kc/s to 50Mc/s. For higher frequencies another oscillator TF1247 is available for 20-300Mc/s. Any standard audio signal generator can also be used to extend the lower frequency limit down to 1kc/s. Thus the Marconi TF1245 Q-meter can effectually cover measurements in the overall range from 1kc/s to 300Mc/s. Advance Electronics is another British firm whose Q-meters will be widely met with. Their well-known Model T2 is a relatively inexpensive instrument which yet covers the useful range from 100kc/s to 100Mc/s, while their model CM1 with the same frequency spread affords a wider range of measurement values.

With the spread of American instruments onto the British market, the Boonton (Hewlett-Packard) Q-meters type 260AP (50kc/s-50Mc/s), type 190AP

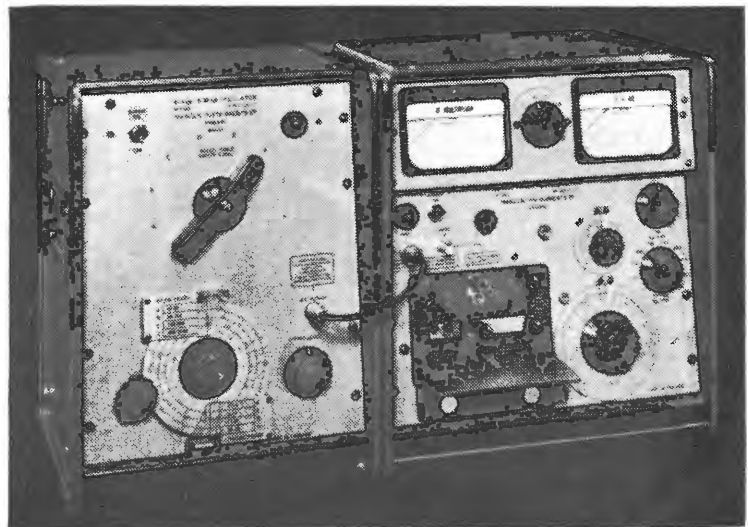

Fig. 44. Example of commercial "Q-meter": Marconi TF1245 Q-meter with TF1246 source oscillator.

(20Mc/s-260Mc/s) and type 280AP (210Mc/s-610Mc/s) may also be met with.

Universal bridges

In considering impedance, capacitance and inductance measurements, we have discussed a number of special-purpose bridges, designed to measure only one or two of these parameters. But special-purpose bridges are tending to disappear from lab. benches because efficient "universal" bridges are becoming freely available, capable of accurately measuring resistance, capacitance or inductance, all on one instrument. These universal bridges are also known as "LCR" bridges and fall into three main categories (a) low-frequency (b) high-frequency (or "wide-range") and (c) v.h.f./u.h.f.

Most universal bridges are low frequency with a drive oscillator frequency in the range of 50c/s-2kc/s. Typically these are of 1% accuracy, although examples like the Cambridge Instrument Co's Universal Bridge have a general 0.2% accuracy or better. Other low frequency bridges that will be seen in common use are the Avo Universal Measuring Bridge No. 1; General Radio GR1650A; Marconi TF868B, TF1313 (1%), TF2700 (transistorized) and TF2701 (in-situ); Metrix 620B and 626B; Philips PM6301; and Wayne-Kerr B221 (0.1%), and B521.

Year by year, frequencies being handled in laboratories are moving higher and higher. Nowadays most laboratories need equipment to measure impedance, capacitance or inductance in the r.f. field. This has given rise

to a group of r.f. bridges, of which the General Radio 1606A (400kc/s-60Mc/s), Hatfield LE300A (1.592Mc/s) and LE308 (1kc/s-3Mc/s), and Wayne-Kerr B601 (15kc/s-5Mc/s) are well-known examples. These r.f. bridges are usually of 1% accuracy and in general it is becoming common to find a single general-purpose wide-range r.f. bridge used in the lab. in preference to the l.f. types.

Bridges of even higher operational frequency are becoming widely used in ordinary laboratories. The choice of such v.h.f./u.h.f. bridges is still somewhat restricted. The principal instruments likely to be met with are the well-known Boonton RX meter Type 250A (0.5-250Mc/s), General Radio GR1607A (25-1500Mc/s) and Wayne-Kerr B801B (1-100Mc/s) and B901 (50-250Mc/s). V.h.f./u.h.f. bridges are in general of 2% accuracy, and nowadays have adapters or "jigs" available for accurately measuring the parameters of transistors at v.h.f./u.h.f. Fig. 45 illustrates the Wayne-Kerr B801B, set up with its related source, detector, and transistor adapter.

When you handle commercial bridges you will find that some measure "series" impedance, i.e. resistance and reactance (the latter usually expressed in capacitance or inductance). Other bridges measure "parallel" impedance in the inverse form of admittance, i.e. conductance and susceptance (the latter again expressed often in capacitance or inductance). What you usually find is that low frequency and some high frequency bridges tend to measure impedances, while v.h.f./u.h.f. and other high frequency bridges tend to measure admittances. This is why you find most v.h.f./u.h.f. bridges described as "admittance" bridges. Mathematical formulae are available for conversion from impedances to admittances, however, so that the distinction is a practical convenience rather than a theoretical difference.

Final words of advice

I have covered the more common methods used in a laboratory to measure impedance and its resistance, capacitance, and inductance components. The methods range from simple "order of magnitude" practical bench tests (whose accuracy may not be better generally than 25%) up to Q-meter and bridge measurements (with accuracies up to some 0.1%). For flexibility of measurement, it pays the average laboratory to keep two basic instruments—an economical, robust, easy-to-operate low frequency RC bridge and an accurate universal bridge, preferably a wide range r.f. one.

Whatever instruments a laboratory may use for impedance measurements, there should always be to hand a standard set of at least resistances and capacitances so that calibrations can be constantly checked. Inductance standards too are desirable, but in normal laboratories much less essential.

In using impedance measuring equipment, remember that the measurement frequency has a big bearing on the results. At frequencies below 1kc/s, strays have little effect, but some l.f. bridges can become inaccurate at high audio frequencies. In using r.f. (and even more v.h.f./u.h.f.) bridges, observe all the normal precautions in handling r.f. signals to avoid spurious results. Always be actively conscious of your bridge frequency when making measurements.

And a final adjuration—when you have made an impedance measurement, think "Is it sensible?" and look around for some independent check (even if only a rough one).

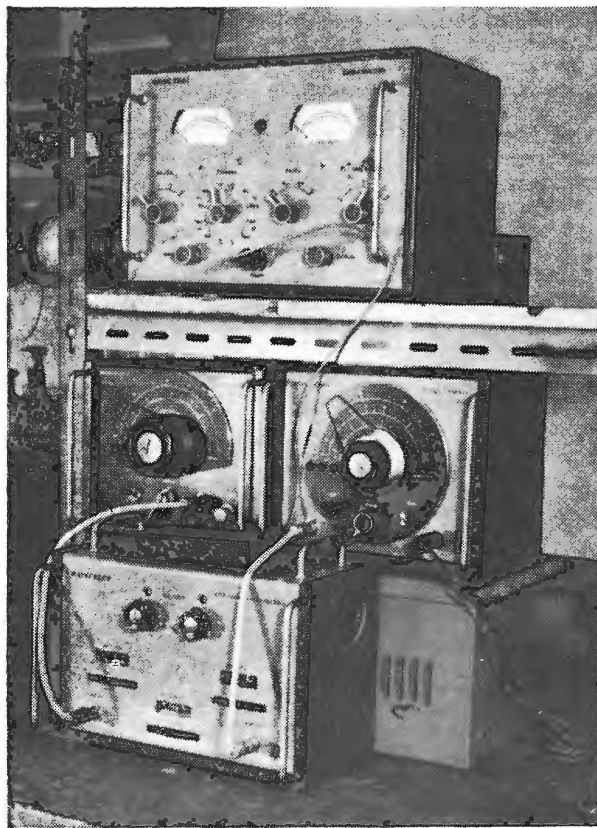

Fig. 45. Commercial v.h.f. "impedance" bridge: Wayne-Kerr B801B Admittance Bridge (1-100Mc/s) with related source oscillator, detector and transistor adapter.

S.C.R.s for TV Line Scanning

ALTERNATIVE TO TRANSISTOR/DIODE COMBINATIONS

By F. D. BATE,* B.Sc.(Hons.), A.M.I.E.E.

RECENT work in Japan and the U.S.A. has shown that silicon controlled rectifiers (s.c.r.) can be used for line scanning in a television receiver. The method of scanning, however, differs from a normal transistor scanning circuit, because once the s.c.r. is triggered into conduction, the trigger electrode has no further control and cannot be used to switch the s.c.r. off.

Before describing the circuit using an s.c.r. consider the basic transistor/efficiency diode circuit shown in Fig. 1(a) with the appropriate current and voltage waveforms. This circuit consists of a scanning coil L , a capacitor C_1 , a transistor and a diode. The transformer which would normally supply the e.h.t. and remove the d.c. from the scanning coil has been omitted since it is not essential to the basic circuit.

The current flowing in the scanning coil is perhaps best considered starting from halfway through the forward scan when the transistor just starts to conduct. At this point the current is increasing linearly in the coil L until the transistor is switched off by a square-wave pulse applied to the transistor base. Approximately half a sine wave of oscillation then takes place between the

inductance L and capacitor C_1 , during which time the current in the yoke reverses. At the instant the current has reversed and is at approximately its peak value the voltage across the coil is just starting to go slightly positive, and would continue to do so if it were not for the presence of the diode which clamps the current at this peak value. The diode thus conducts for the first half of the forward scan until the current has collapsed to zero, at which point the transistor comes into conduction and the whole process repeats itself. Thus the current flowing in the coil flows in the diode for the first half of the scan, the transistor in the second half of the scan and in the capacitor during the flyback period.

The Silicon Controlled Rectifier

Briefly an s.c.r. is a three-electrode solid state device having an anode, cathode and control electrode. Current flows from the anode to cathode when the anode is positive and a positive pulse is applied to the control electrode, once in conduction, the control or trigger electrode has no further control over the current flow.

The magnitude of the current flowing is limited by the external circuit and characteristic of the s.c.r. In order to switch off the s.c.r. the anode current flow must fall below a certain minimum value, called the holding current (usually a few mA) and be held at this value for a short interval of time, called the turn off time, which can be anything up to $100\mu\text{sec}$. The voltage across the s.c.r. is about 1-2 volts (depending on the s.c.r. and current) during conduction.

Before describing a scanning circuit using an s.c.r. consider Fig. 2(a) because this is the basic on/off switching circuit. In Fig. 2(a) the capacitor C is charged up through the inductance L , and then at a given instant a positive pulse is applied to the trigger electrode of the s.c.r. The capacitor then discharges through the small inductance L_1 and the s.c.r. If the small inductance L_1 were not present then the current would be limited only by the resistance in the circuit and the s.c.r. and when the capacitor had been discharged the s.c.r. would continue in conduction, there being no mechanism for switching it off. The presence of the small inductance L_1 , which can be less than $1\mu\text{H}$, and little more than a few turns of wire, completely alters the picture. The discharge current can now be oscillatory provided the values L , C and r are correct and the waveforms of the current and voltages present are as shown in Fig. 2. The discharge current through the s.c.r. is thus a damped half sine wave and after half a complete oscillation the voltage across the capacitor has changed its sign and become negative. The voltage across the s.c.r. during this period is reasonably constant at 1-2 volts. For oscillations to continue the current must now flow in the opposite direction in the s.c.r. and, apart from the small reverse current due to the stored charge in the s.c.r., this is not possible. The voltage across the inductance L , thus collapses to

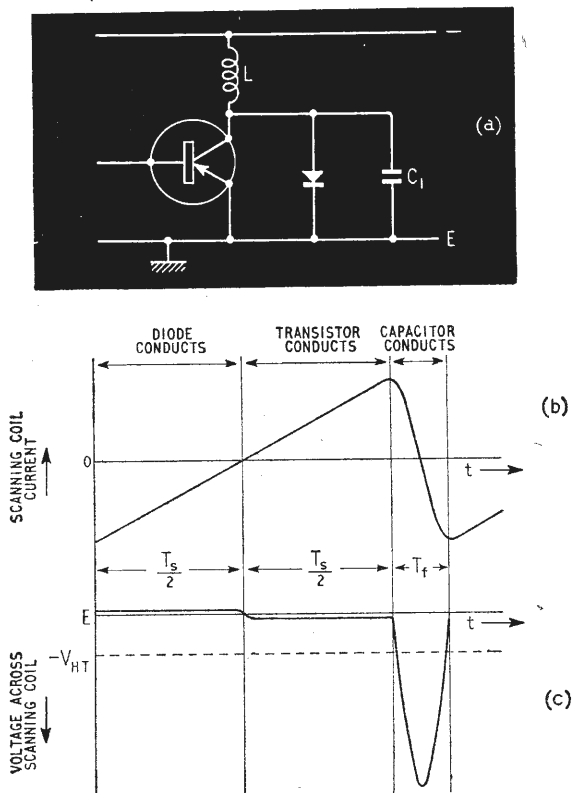

Fig. 1. (a) Basic transistor diode line scanning circuit. (b) Scanning coil current. (c) Scanning coil voltage.

*Thorn-AEI Radio Valves and Tubes, Ltd.

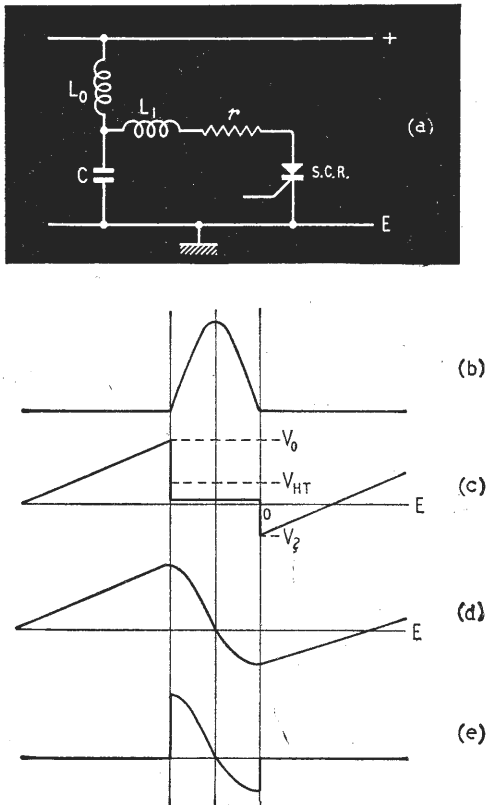

Fig. 2. (a) Basic on/off switching circuit. (b) Current in s.c.r. (c) Voltage across s.c.r. (d) Voltage across C. (e) Voltage across L_1 .

zero and produces a negative voltage on the anode of the s.c.r. equal to the collapse of voltage across L_1 (see Fig. 2(c)). The voltage across the s.c.r. is thus negative for the initial part of the charging of the capacitor and this provides time for the charge carriers in the s.c.r. to recombine and for the s.c.r. to revert to its non-conducting state. The s.c.r. will now not conduct until a positive pulse is applied to the trigger electrode. Appendix I gives a fuller treatment of the magnitude of the negative voltage appearing on the s.c.r. anode in terms of the Q of the circuit during the discharge period.

This switching off of the s.c.r. is one of the problems encountered in a scanning circuit using such a device which is not present in a normal scanning circuit. It does require an s.c.r. having a very fast switch-off time, otherwise any slight upset in the scanning conditions may make the s.c.r. permanently conducting and when this happens all one can do is to switch off the h.t. line.

Line Scanning Circuit Using an S.C.R.

The basic line scanning circuit using an s.c.r. is shown in Fig. 3 with the appropriate wave forms. L represents the scanning coil and L_1 is usually the leakage inductance of the transformer. Provided a single h.t. line is used, a transformer is essential, so that an s.c.r. scanning circuit requires an extra inductance L_0 and transformer when compared to a basic ordinary transistor scanning circuit. The e.h.t. can be obtained from extra windings on the transformer.

The scanning process using the s.c.r. constitutes what

is known as a "retrace driven circuit" and such a scanning circuit using a transistor was described as long ago as 1957 by W. Guggi. Referring to Fig. 3 the capacitor C is charged up through L_0 and the s.c.r. brought into conduction by a positive pulse on the control electrode. The capacitor C is discharged through L_1 and the reflected coil inductance L in parallel with the transformer primary winding. This continues as in the previous circuit, Fig. 2, until one quarter of an oscillation has taken place. At this instant the voltage across the coil in the secondary circuit has reached zero (if the transformer is connected the correct way round), and is about to reverse its sign and go positive. However, the presence of the diode prevents this, and thus clamps the current when it is at its maximum value. The primary of the transformer which is in the anode of the s.c.r. now only sees the small leakage inductance L_1 of the transformer, the transformer itself being effectively short-circuited by the clamping action of the diode. The second quarter of the oscillation is now determined by C and the small leakage inductance L_1 and is very rapid when compared with the first quarter oscillation. It is this small value of L_1 that gives the anode of the s.c.r. a sufficiently negative value for a sufficient length of time to allow the s.c.r. to revert to its non-conducting state. A comparison of the wave-

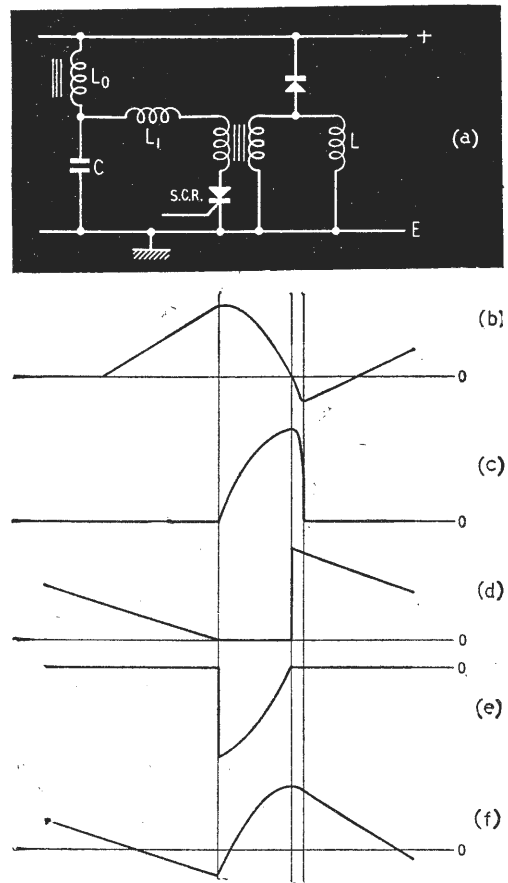

Fig. 3. (a) Basic s.c.r. line scanning circuit. (b) Voltage across C. (c) Current in s.c.r. (d) Current in diode. (e) Voltage across scanning coil L. (f) Current in scanning coil (voltages and currents not to scale).

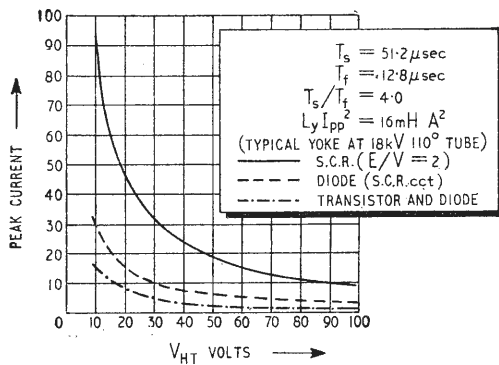

Fig. 4. Variation of peak currents of alternative devices with h.t. line volts.

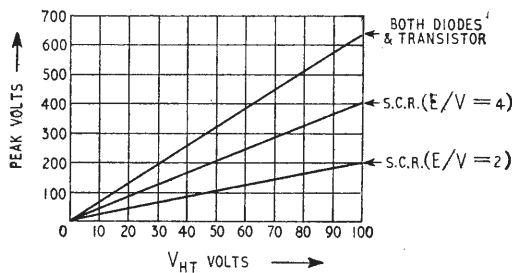

Fig. 5. Variation of peak voltages across the devices with h.t. line volts.

forms present in the s.c.r. circuit Fig. 3 and the normal transistor scanning Fig. 1 shows the main differences between the two modes of operation. In the s.c.r. circuit the diode is conducting for the whole of the scan time and the s.c.r. is conducting for the whole of the flyback or retrace time. In the normal transistor circuit the diode and transistor each conducts for about half the scan time and neither conduct during the flyback period.

In Appendix II a simple treatment gives the necessary equations which determine the value of C , transformer turns ratio n , and coil inductance L for a given h.t. line. The results of an estimation of the s.c.r. diode and transistor/diode circuits is also given in the accompanying table as well as a comparison of the peak current and voltage required by the devices as a function of h.t. line for a typical yoke at 18kV and a 110° scanning angle see Figs 4 and 5.

Comparison of an S.C.R. and Transistor Circuit (Same H.T. Line)

The accompanying table gives a comparison of the s.c.r. diode and the normal transistor/diode circuits. The differences can best be appreciated by considering each row of the table separately, and are as follows:—

1. The peak current of the s.c.r. diode has to be twice that of the transistor diode for the same scanning coil and h.t. line. Taking $n=5$ as typical for a transformer turns ratio the peak current of the s.c.r. must be ten times that of the transistor.
2. The conduction time of the s.c.r. diode is twice that of the transistor diode.
3. The peak volts on the transistor and both diodes are the same, the peak volts on the s.c.r. being equal to twice the h.t. line.

4. If the flyback time is the same then the capacitor C in the s.c.r. circuit is related to the capacitor C_1 in the transistor circuit by $C=C_1(2n)^2$ and if $n=5$, $C=100C_1$, thus a very much larger capacitor is required with the s.c.r. circuit which will be considerably more expensive.

5. The peak volt-amps required both by the s.c.r. and its diode are twice those of the transistor and its diode. The peak volt-amps is the product of the peak voltage which is present at some time during the cycle and the peak current which is required. These requirements do not occur at the same instant of time. For instance, in the case of the transistor, the peak current occurs at the end of scan and the peak voltage half-way through the flyback period.

6. The power in the diode in the s.c.r. circuit is at least four times that of the diode in the transistor circuit in the forward direction. The power in the s.c.r. is considerably more than four times that of the transistor in the forward direction because the forward voltage drop in the s.c.r. is 1 to 2 volts compared with approximately 0.3 volts in the transistor case.

7. During the switch off, power is dissipated in the transistor and this can be quite considerable unless a "fast" transistor is used. Little power is dissipated in the s.c.r. after it is switched off because the voltage across it in this time interval is very small. The power dissipated in the diode in the s.c.r. circuit can be very considerable when it is switched off because of the stored charge which is present in solid state diodes. The removal of this charge, after the forward current has fallen to zero, shows itself as a current in the opposite direction and occurs during the time of the large inverse voltage, this results in the dissipation of a considerable amount of power. The diode used in the transistor scanning circuit will not dissipate any power when the inverse voltage appears because the stored charge has had about half the scan time in which to be removed before the large inverse voltage begins. These con-

ESTIMATION OF THE REQUIREMENTS OF AN S.C.R./DIODE AND TRANSISTOR/DIODE CIRCUIT

	Transistor/Diode		S.C.R./Diode	
	Transistor	Diode	S.C.R.	Diode
Peak current	$\frac{I}{2}$	I	nI	I
Conduction time	$\frac{T_s}{2}$	T_s	T_f	T_s
Peak volts H.T. volts	$\frac{\pi T_s}{2 T_f}$ (approx.)	$\frac{\pi T_s}{2 T_f}$	E $V \approx 2$	$\frac{\pi T_s}{2 T_f}$
Flyback time, T_f	$\pi \sqrt{LC_1}$		$\frac{\pi}{2n} \sqrt{LC}$	
Peak volt-amps	$\frac{\pi T_s}{4 T_f} IV$	$\frac{\pi T_s}{4 T_f} IV$	$\frac{\pi T_s}{2 T_f} IV$	$\frac{\pi T_s}{2 T_f} IV$
Power in device (forward direction)	$\frac{1}{8} IV_T \frac{T_s}{T}$	$\frac{1}{8} IV_D \frac{T_s}{T}$	$\frac{1}{2} IV_{SCR} \frac{T_s}{T}$	$\frac{1}{2} IV_D \frac{T_s}{T}$
Power in device (Switch off)	Can be considerable. Fast switch-off transistor required	Negligible	Negligible	Can be very considerable. Fast switch-off diode required
Power in capacitor in circuit (if same power factor)	P_{C1}		$P_C \approx 4P_{C1}$	

siderations mean that a very fast diode is required in the s.c.r. circuit, that is, one with very low stored charge. 8. The s.c.r. circuit also requires an additional inductance over the transistor circuit which must result in more wastage of power as well as the cost of an extra component.

It would thus appear that if the same h.t. line is used the s.c.r. has no advantages over the normal transistor scanning circuit and has many disadvantages. It requires a very expensive diode, which must not only be very fast, but must withstand twice the peak volt-amps of the transistor circuit diode. The s.c.r. must also be very fast so that there is little chance of it not switching off should some adverse conditions arise in the circuit. An extra inductance is required and the capacitor must be considerably larger (by about 100 times) than the capacitor in the normal scanning circuit and also must have a very low power factor. The efficiency of the s.c.r. circuit must also be considerably below that of the transistor case. What advantage, if any, does an s.c.r. circuit have over an ordinary scanning circuit? The main advantage lies in the relative simplicity of the circuit preceding the s.c.r. All that is required is a blocking oscillator giving a positive pulse every 15 kc/s which drives an emitter follower, though more sensitive s.c.r.'s could probably dispense with this. The transistor scanning circuit requires a square-wave drive voltage, usually from a blocking oscillator with a buffer or driver stage extra. Thus the s.c.r. control circuit is very much simpler and cheaper than the transistor control circuit. Finally, if the s.c.r./diode circuit can be made to work at a considerably higher voltage than the transistor/diode circuit then the circuit efficiency will be increased. The power in the devices will fall off as the h.t. line increases.

Experimental S.C.R. Circuit

In Fig. 6 an experimental s.c.r. circuit is shown along with the drive circuit. Two n-p-n transistors are used working from a 9 volt h.t. line, one as a blocking oscillator and the other as an emitter follower. This enables the s.c.r. to be driven from a low source impedance. The driving pulse is about 8 volts and 5 μ sec duration. The output circuit is supplied by a 60 volt h.t. line and 250 mA giving approximately 6 mJ of energy per line

at 15 kc/s which is more than is required to scan a small sized television tube. The inductance L_0 is 5 mH and wound on a Ferroxcube core. The transformer is also wound on Ferroxcube and has a turns ratio of 5:1. It is wound for low leakage inductance by winding half the secondary, then the primary, followed by the other half of the secondary. The leads on the primary of the transformer leading to the capacitor and the s.c.r. are kept as short as possible otherwise severe ringing will occur when the diode clamps the circuit. The diode itself consists of three silicon diodes in parallel with small equalizing resistors in series, and were experimental types having low stored charge, this gave a noticeable improvement in the efficiency of the circuit over typical silicon diodes of the type BY105. It is essential that the capacitor C has a low power factor at 15 kc/s, less than 0.01 if the power dissipated is to be kept below 1 watt. A comparison of the power dissipated in the capacitors in each circuit is given in Appendix III.

Gate Control Switch

Recently a solid state device, called the gate control switch (g.c.s.) has been developed. This is similar to the s.c.r. except that the control electrode can be used to switch the device off as well as on. It is probably the first truly solid state switch and is exactly analogous to the ordinary mechanical single-pole single-throw switch which is used for switching the light on and off in the home. The control or gate electrode has a much larger active area in the g.c.s. than the s.c.r. and it is this change which enables it to switch the current off as well as on.

The g.c.s. is used as in a normal scanning circuit, that is, it is forward driven. It required two pulses, one to switch the current on and one to switch it off. In practice it can be driven with a square wave pulse of larger voltage amplitude than for a transistor but requiring considerably less power. Samples available at the moment have higher inverse voltage ratings (400 volts) than the transistor (300 volts), and since its construction is not unlike the s.c.r. higher inverse voltage ratings can be expected. The switch off of the current is about as fast as recent transistors and little power is dissipated.

The g.c.s. has the disadvantage that in the forward direction the voltage drop is about 1.5 volts compared

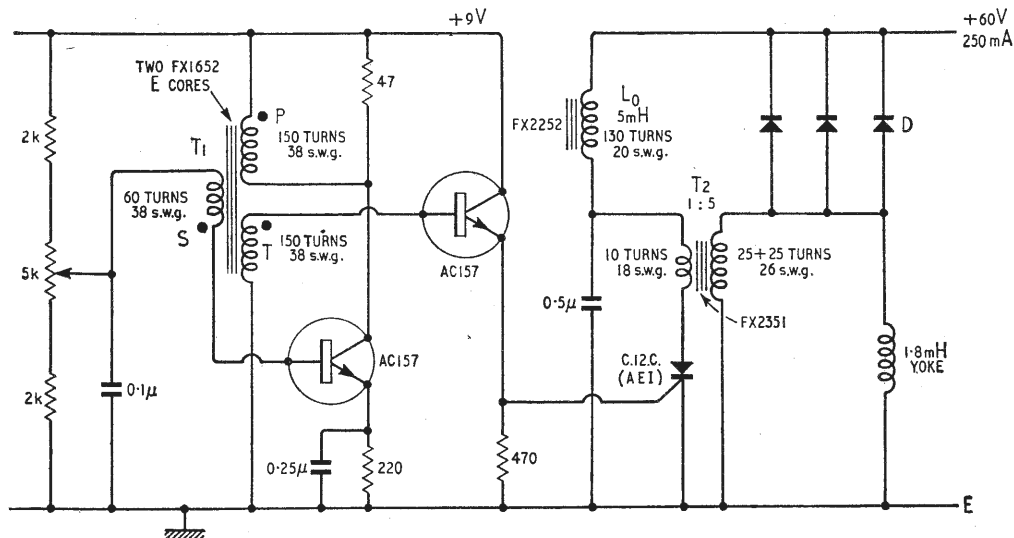

Fig. 6. Experimental s.c.r. scanning circuit. The diodes D are special development types with low charge storage. Inductances wound with Lewmex F wire.

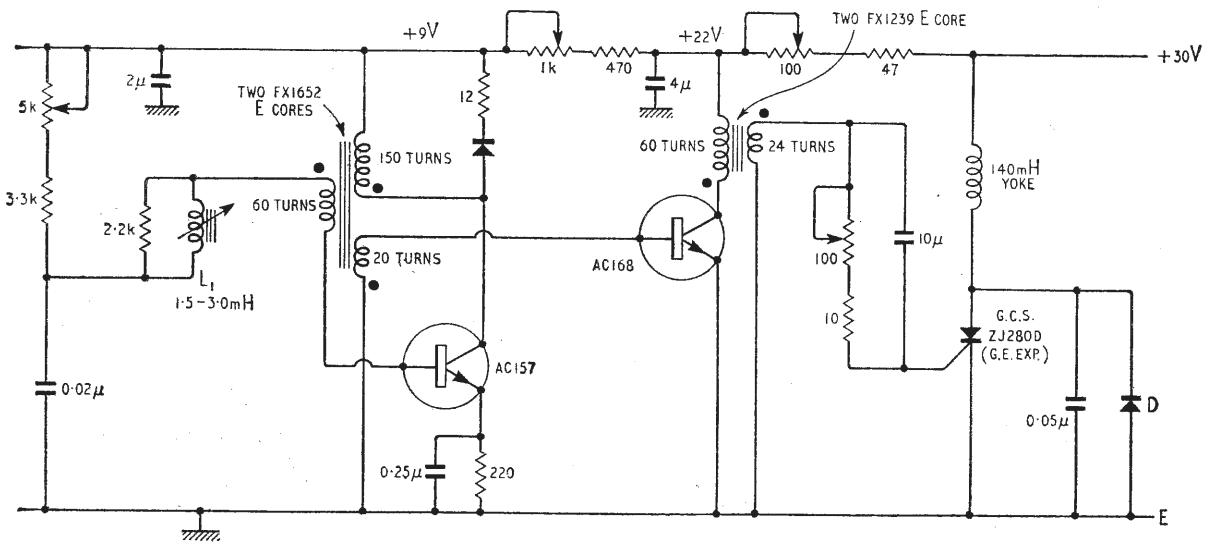

Fig. 7. Experimental g.c.s. scanning circuit. The gate control switch is a G.E. experimental type. D is an experimental silicon diode.

with 0.3 volts with a transistor. Not only is this a waste of power, it also results in a worsening in the linearity of the scan in that the effective h.t. line to the coils is about 2 volts less during the conduction of the g.c.s. than the conduction of the diode. This, compared with about 0.6 volt with a transistor and germanium efficiency diode. To get the same linearity, then, a higher h.t. line would seem to be necessary. A small voltage and current pulse is required to switch the g.c.s. into conduction and is of the order of a few volts and tenths of an amp. In order to switch the g.c.s. off a certain amount of charge must be pumped into the control electrode. Thus, for a fixed current to be switched off, the shorter the pulse the larger must be the peak current. For pulses of the order of 10 μsec. the control current gain is about 10 so that in order to switch off 1 amp a 100mA current pulse would be required. For fast switching, short pulses of high peak current are required.

One further characteristic of importance is that for any g.c.s. there is a maximum value of conduction current that can be switched off. Should the current ever rise to above this value the gate electrode loses all control and the device remains permanently conducting. This, then, is the second disadvantage of the g.c.s., in that transient conditions may upset the working so that larger than normal currents build up which cannot be switched off.

An experimental circuit is shown in Fig. 7. The output stage takes 500mA from a 30 volt h.t. line and delivers 14 mJ of scanning energy, this compared favourably with a transistor scanning circuit.

Conclusion

It is possible for both silicon controlled rectifiers and gate control switches to be used for the output stage of a line scanning stage. However, if the s.c.r. is used from the same h.t. line as a transistor circuit, it is fundamentally more inefficient and requires more expensive components as well as an additional inductance. The only advantage it appears to offer is a more simple control circuit. The use of a much higher h.t. line could improve the efficiency, although it is difficult to see how it could equal that of a transistor using present-day devices.

The gate control switch gives a performance comparable with the transistor although the forward voltage drop during conduction is much larger than a transistor. This makes linearizing rather more difficult as well as decreasing the efficiency. On the other hand, present day g.c.s.'s can work from about a 50 % higher h.t. line than the transistor, which partly overcomes this disadvantage. The problem of both of these devices not switching off under adverse conditions might mean additional components and expense, and could be a determining factor in their future use in a line scanning stage.

The position at the moment is that both transistors and g.c.s.'s are close rivals, both have been used in commercial receivers, in limited quantities. They are being constantly improved technically, as well as becoming cheaper, but they are still more expensive than the valve. The transistor still has the edge on the g.c.s. although only the future will decide which, if any, will dominate the field.

Acknowledgement:—The author wishes to thank the management of the Thorn-AEI Laboratories for permission to publish the article.

REFERENCES

1. "New Deflection Circuit Uses S.C.R., Saves Power," Tadaaki Tarin, *Electronics* August 9th, 1963.
2. "An S.C.R. Horizontal Deflection and High Voltage Circuit," *I.E.E.E. Transactions* (B.T.R.) November 1963.
3. "Silicon Controlled Rectifiers," T. Roddam, *Wireless World* September 1963.
4. "C.R.T. Deflection Circuit has High Efficiency," W. Guggi, *Electronics* April 1st, 1957.
5. "Transistor Line Deflection Circuits for Television," P. B. Helsdon, *Marconi Review* 1959, First Quarter.
6. "Now the gate turn off switch speeds up D-C switching," D. R. Grafham, *Electronics* March 23rd, 1964.

APPENDIX I

CONDITION AFTER SWITCH-ON OF AN S.C.R.

Referring to Fig. 2 we have that if V_0 is the initial voltage across the capacitor C then V_2 the negative value of the

voltage in terms of the Q of the circuit is given by:

$$V_2 = -V_0 e^{-\frac{\pi}{2Q}} = \alpha V_0 \quad \dots \quad (1)$$

where $\alpha = e^{-\frac{\pi}{2Q}}$

If we assume the inductance L_0 to have negligible resistance then the mean value of the voltage across C must equal V the h.t. line, and if, further, the capacitor C is assumed to charge linearly then from Fig. 2(c):—

$$V_0 - V = V - V_2 \quad \dots \quad (2)$$

combining equations (1) and (2) gives

$$\left. \begin{aligned} V_0 &= \frac{2V}{1-\alpha} \\ V_2 &= \frac{-2\alpha}{1-\alpha} V \end{aligned} \right\} \dots \quad (3)$$

The following short table gives the values of α , V_0 and V_2 for different values of Q.

Q	α	$\frac{V_0}{V}$	$\frac{V_2}{V}$	$\frac{V_0 - V_2}{V}$
1	0.2	2.6	-0.5	3.0
2	0.45	3.6	-1.6	5.2
5	0.75	7.4	-5.4	12.8

Thus even a circuit with a Q of 1 will give a voltage swing on the capacitor C of three times the h.t. line.

APPENDIX II

BASIC EQUATIONS OF THE S.C.R. LINE SCANNING CIRCUIT

The flyback time T_f is one quarter of a cycle and is given by:—

$$T_f = \frac{\pi}{2} \sqrt{L \frac{C}{n^2}} \quad \dots \quad (4)$$

where n is the transformer turns ratio. If \hat{V} is the voltage on the capacitor C at the end of the scan, the basic energy equation gives:—

$$I = \hat{V} \sqrt{\frac{C}{L}} \quad \dots \quad (5)$$

where I is the peak to peak scanning coil current, the effect of the transformer inductance being neglected for simplicity. Finally if V is the h.t. line the equation giving the collapse of the peak current to zero is given by:—

$$V = \frac{LI}{T_s} \quad \dots \quad (6)$$

where T_s is the time of scan.

Using these equations gives that

$$n = \frac{\pi}{2} \left(\frac{V}{\hat{V}} \right) \left(\frac{T_s}{T_f} \right) \quad \dots \quad (7)$$

$$\text{and } C = \left(\frac{V}{\hat{V}} \right)^2 \frac{T_s^2}{L} \quad \dots \quad (8)$$

The value of \hat{V} is approximately 2V, because if C is charged linearly from the h.t. line and L_0 is resistance-less then the mean value of the voltage across C must be equal to the h.t. voltage. The effect of the slight negative voltage on the capacitor C is to make $\hat{V} > 2V$ whereas the effect of the resistance of L_0 is to make $\hat{V} < 2V$, as these are both small and tend to cancel one another one can state without much loss of accuracy that $\hat{V} \approx 2V$. Equations (7) and (8) thus become:—

$$\left. \begin{aligned} n &= \frac{\pi}{4} \frac{T_s}{T_f} \\ C &= \frac{1}{4} \frac{T_s^2}{L} \end{aligned} \right\} \dots \quad (9)$$

APPENDIX III

COMPARISON OF THE POWER DISSIPATED IN THE CAPACITOR OF THE TRANSISTOR AND S.C.R. CIRCUIT IN TERMS OF THE POWER FACTOR OF THE CAPACITOR.

The power dissipated in the resistive part of a capacitor is given by $\frac{V^2}{R}$ where R is the effective value of the resistor across the capacitor and $V_{r.m.s.}$ the r.m.s. value of the a.c. voltage applied.

Transistor Circuit

Assuming half a sine wave of voltage is present during the flyback period T_f , the power dissipated in the resistor is given approximately by

$$P_{C1} \approx \frac{\hat{V}^2 T_f}{2R T} = \frac{\pi \hat{V}^2 C_1}{T} \cdot \frac{T_f}{T} \cos \phi \quad \dots \quad (10)$$

where $\cos \phi$ is the power factor = $\frac{1}{\omega CR}$, \hat{V} is the peak voltage and T the total time period.

Now by energy considerations:—

$$C_1 \hat{V}^2 = L \left(\frac{I}{2} \right)^2 = \frac{K}{4} \quad \dots \quad (11)$$

where I is the peak to peak current in the coil and $K = LI^2$ which is a constant for a given coil design, c.r.t. and e.h.t.

Using equation (11), equation (10) becomes:—

$$P_{C1} \approx \frac{\pi K}{4T} \cdot \frac{T_f}{T} \cdot \cos \phi \quad \dots \quad (12)$$

Taking $\frac{T_f}{T} = \frac{1}{6}$, $T = 64 \mu\text{sec}$ and $K = 16\text{mH A}^2$ for a 110° tube at 16kV:—

$$P_{C1} \approx 33 \cos \phi \quad \dots \quad (13)$$

S.C.R. Circuit

A linear sawtooth voltage is across the capacitor during the scan time, and a quarter of a sine-wave voltage, during the flyback time, but if, for simplicity, we assume a sawtooth voltage to exist for the whole time, we shall not introduce a very large error in estimating the watts dissipated in the resistive part of the capacitor. The watts then become:—

$$P_C \approx \frac{\hat{V}^2}{12R} = \frac{\hat{V}^2 \pi C}{6T} \cdot \cos \phi \quad \dots \quad (14)$$

Using the energy equation (5)

$$\hat{V}^2 C = LI^2 = K \quad \dots \quad (15)$$

which gives:—

$$P_C \approx \frac{\pi K}{6T} \cdot \cos \phi \quad \dots \quad (16)$$

using the same values as previously gives:—

$$P_C \approx 132 \cos \phi \quad \dots \quad (17)$$

Thus the power dissipated in the capacitor in the s.c.r. circuit is four times the power in the normal transistor scanning circuit. For instance, if the power factor of the capacitor is 0.01, the transistor capacitor would dissipate 0.33 watts and the s.c.r. capacitor 1.32 watts. The s.c.r. capacitor should thus have a power factor less than 0.01 in order to keep the dissipation as low as possible, this, together with the fact that it is approximately 100 times as large as the capacitor in the transistor circuit can make it a very expensive component.

ELECTRONIC GAMING MACHINES

CIRCUITS SIMULATING THE FRUIT MACHINE AND THE PIN-TABLE MACHINE

By W. D. GILMOUR,* B.A., A.M.I.E.E

Electronic fruit machine, EDGE. The characteristic flashy appearance of mechanical gaming machines has to be preserved in electronic versions.

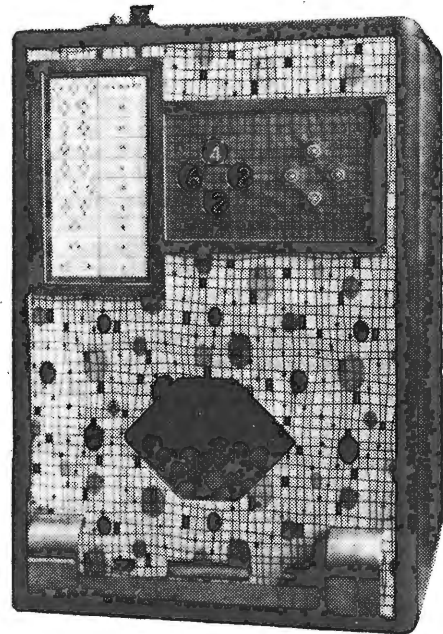

EXISTING gaming machines are fundamentally of two types: (a) *Roulette machines*, in which one or more numbers are selected, nominally at random, by the machine and winnings are paid on certain numbers or combinations of numbers. Unlike true roulette, the gamester has no choice of targets, which are programmed into the machine. (b) *Pin-table machines*, in which a ball or balls are propelled with a velocity at least nominally under the control of the gamester, who endeavours to hit defined targets or cause the ball to roll into certain defined holes. In some respects pin-table gaming resembles roulette played in Cartesian coordinates, but there is the major difference that in pin-table machines the intermediate path of the ball may be as important as its final position, and there may also be some degree of skill involved.

In addition there are hybrid devices called bingo machines. These resemble roulette machines in that the final position of the ball alone counts, and require certain combinations of targets to be selected, but also resemble pin-tables in that balls are propelled by the gamester.

All these types of machine lend themselves to electronic simulation.

Mechanized gaming equipment has a typically flashy appearance which it would be important to maintain in any redesigned equipment, for the average persistent gamester might not wish to play on unfamiliar looking devices. This preference for the showy is unfortunate, for electronic apparatus, containing no moving parts, is by nature superficially undemonstrative, and the addition of a mechanical display driven by the electronic control would add substantially to the cost. However, gas discharge devices can be spectacular, have long lives, and can be readily driven from electronic control signals, especially if cold-cathode valves are used for logical operations. So the electronic solution may lie along these lines. Alternatively, the existing mechanical field of play could be retained in a pin-table machine and electronic equipment employed to replace the rather bulky and

unreliable electromechanical scoring systems at present used.

The time taken to make one wager is important, for if the cycle is too short the gamester will feel that he has not had his money's worth, but if it is too long the taking capacity of the machine will be diminished. It is probable that pin-tables and roulette type machines attract different classes of customer. The average player on a pin-table is slower and more thoughtful, more intent on the game and perhaps less interested in his winnings than the gamester at roulette. Thus, a roulette machine could be set to have a playing cycle of about 6 seconds and a pin-table to have a cycle of about 30 seconds.

The question of reliability needs careful consideration. If the machine is to run continuously a failure rate of one fault per thousand hours is about the highest acceptable. If the machine is switched on for each game, switching surges may lead to additional breakdowns. Probably the best compromise solution is to use a time switch, so that the machine is energized only when customers are likely to be present, augmented by a second switch that turns off all of the machine except the display lighting when no game has been played for, say, ten minutes. Insertion of the next coin restores the machine to full operation.

An electronic fruit machine called EDGE (short for Electronic Digital Gaming Engine) and two electronic pin-tables will now be described.

Mechanical fruit machines usually employ three discs, each of which can stop independently in any of 20 positions, giving odds of $20^3:1$ on any given combination. Naturally the symbols representing the lower valued prizes will be repeated on the discs, thus allowing a graded system of prizes to be established. In EDGE the discs are simulated by electronic counters. It is inconvenient, however, to use scale-of-twenty circuits, so four scale-of-ten counters have been employed, giving maximum potential odds of $10^4:1$. In common with all fruit machines, the odds, although correctly graded, bear no absolute relation to the true odds—the overall odds being adjusted to allow the machine to retain 20% of the input money.

* EMI Electronics, Ltd.

We may consider that the gamester makes an n -way bet with his coin, where n is the number of winning combinations. Thus, for a small prize, which, in order to retain the gamester's interest, may be paid out on average in one game in three, the true odds will be, say, 3:1; but since it would be useless to pay back less than two units winnings, the game is very much in the gamester's favour. However, the largest prize (true odds, say 3000:1) is much smaller than it should in fairness be to compensate for the machine's generosity in small prizes. Table 1 shows the frequency of occurrence of symbols on each counter and Table 2 shows how the prizes have been divided.

In EDGE the counters are four Dekatrons directly coupled to cold-cathode numerical indicators. Each counter is separately driven by a neon relaxation oscillator, which, after an initial period of about two seconds to

secure randomization, may be stopped by the gamester to give him some control over the game. The effect of the slowing down of the discs in a mechanical machine is obtained by the charging up of a capacitor common to the power supplies of all four oscillators. If the gamester does not exercise his option to stop the counters they stop themselves after about six seconds' running time.

The logical diagram of EDGE is shown in Fig. 1. The sequence starts when a sixpence is inserted in a proprietary rejector mechanism, which rejects false money and excessively bent or battered coins. An accepted coin operates the microswitch S_{10} , which resets the control valves V_7, V_{11}, V_{15} and V_{19} and forces the discharge in the prize selector Dekatron, V_{29} , on to its rest cathode. The bistable $V_{30, 31}$ is also reset. The first sixpence inserted after a break in mains supply causes V_{22} to strike, and this remains burning thereafter. The relaxation oscillators

Fig. 1. Logical diagram of EDGE electronic fruit machine. Elements labelled Q are formed by transistor circuits and elements labelled V by cold-cathode tube circuits.

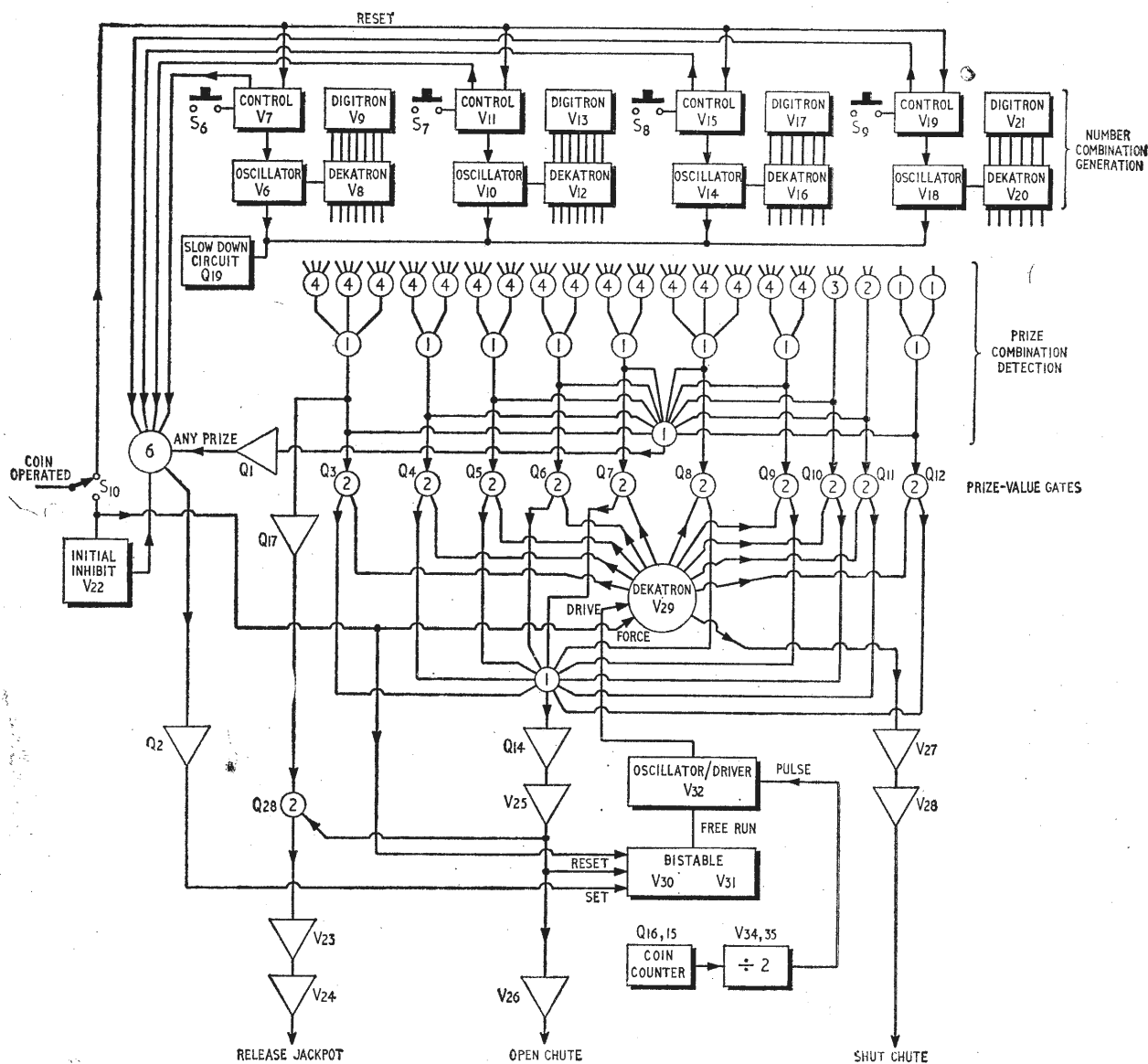

TABLE 1: FREQUENCY OF OCCURRENCE OF TARGETS ON SELECTORS

Symbol	Frequency of occurrence of symbol on selector			
	1	2	3	4
0	1	1	1	1
1	1	2	3	1
2	2	2	1	2
3	2	1	2	2
4	1	1	1	3
5	2	1	2	1
6	1	2	0	0

TABLE 2: WINNING COMBINATIONS AND THE ADJUSTMENT OF PRIZES

Winning combination (* = any)	No of wins per 10,000 games	Value paid per win	Value paid per 10,000 games
0 0 0 0	1	20+j.p.	20+j.p.
4 4 4 0	1	20+j.p.	20+j.p.
4 4 0 0	1	20+j.p.	20+j.p.
3 3 0 0	2	18	36
5 5 0 0	2	18	36
1 1 0 0	2	16	32
4 4 4 4	3	16	48
2 2 2 0	4	14	56
5 5 5 5	4	14	56
2 2 0 0	4	12	48
3 3 3 0	4	12	48
1 1 1 1	6	10	60
1 1 1 0	6	10	60
5 5 5 0	4	10	40
2 2 2 2	8	8	64
3 3 3 3	8	8	64
6 6 0 *	20	6	120
6 6 * *	200	4	800
6 * * *	1000	2	2000
* 6 * *	2000	2	4000
Totals per 10,000 games:	3280	—	7628+3j.p.

Note: One prize in 3.06 games. 20% profit for machine with a jackpot of 124 units.

then run, and may be stopped, as described above, by S_6 , S_7 , S_8 , and S_9 , or allowed to stop under the action of the timing circuits of the control valves.

Prize-winning combinations are detected in a matrix of AND gates driven from the prize selector tube cathodes. These AND gates drive OR gates for a prize of a given value, and these OR gates in turn drive a single OR gate, which operates if any prize has been won. The amplified output from this final OR gate is fed to a 6-input AND gate, together with a signal from each control valve indicating that it has stopped its associated oscillator, and one from V_{22} indicating that a coin has been inserted. The output from the 6-AND gate will therefore be present only if a winning combination is present when all oscillators have stopped. In any other case a losing combination has been selected and the next coin can be inserted, thus repeating this sequence.

If there is an output from the 6-AND gate it is amplified in Q_2 and triggers the bi-stable $V_{30, 31}$ into its "1" state, thus allowing V_{32} to oscillate and drive round the prize selector Dekatron, V_{29} , which has each of its cathodes connected to 2-input AND gates Q_3 - Q_{12} also fed by the appropriate value-of-prize line. Thus, if a prize of 10 units has been won, V_{29} will be driven round until the AND gate Q_8 is reached. The output from this gate passes through the OR gate Q_{13} , and after amplification in Q_{14} and V_{25} resets the bi-stable $V_{30, 31}$ to its "0" state, thereby cutting off drive pulses to V_{29} . At the same time, V_{25} fires the power trigger tube V_{26} , which opens the coin chute.

As coins leave the chute they are counted photo-electrically and the count is divided by two in a conventional binary divider $V_{34, 35}$, which drives on V_{29} by one cathode position for every two coins released. When

cathode "0" of V_{29} is reached, the coin chute is shut by V_{27} and V_{28} , thus stopping the paying-out process and concluding that game.

Should the jackpot be won, the appropriate output from the first-prize winning combination is amplified in Q_{17} , and gated in Q_{28} by the "open chute" command. Amplification in V_{23} and V_{24} operates the jackpot release solenoid. The bottom flap of the jackpot is held up by a mechanical catch until the additional prize of 20 units is paid out, when the catch is released and the jackpot base closes under the action of a spring. The same mechanical system holds up a supply of sixpences, trapped above the jackpot, and releases them into the now closed jackpot to provide some incentive until it fills up again. Sixpences entering the machine are first used to fill up a zig-zag ramp, with the coins stored on edge so that they roll down the ramp when paying-out occurs. When the ramp is full, coins are diverted into the jackpot, and when this and its reserve chute are full coins fall into the machine's profit bin.

The electronic circuits of EDGE may now be considered in more detail. The power supplies are conventional. A voltage-doubling circuit feeds a cold-cathode stabilizing chain to provide all voltages except for a +18V line, which is derived from a bridge rectifier, and a +10V line which is stabilized from the +18V line by a Zener diode. The +500V(NO) and (NC) line in Figs. 2 and 3 refer to the normally open and normally closed states of S_{10} , the coin operated microswitch in the rejector.

Fig. 2 shows the circuit of V_{22} , which is struck by a positive pulse from S_{10} on the first operation and remains burning thereafter until the mains supply is disconnected.

Fig. 3 shows one oscillator, V_6 , and its associated control valve, V_7 , and Dekatron, V_8 . Under quiescent conditions V_7 will be burning and there is insufficient voltage across V_6 for the last-mentioned to strike. Insertion of a coin momentarily opens the +500V(NC) line and extinguishes V_7 . The voltage across V_6 now increases as the 0.02- μ F capacitor charges up, and eventually V_6 breaks down, thereby discharging the capacitor and driving on V_8 by one step. The capacitor charges again, and thus V_6 oscillates at a frequency of a few tens of cycles per second. The cathodes of all four oscillators are strapped and the currents through the oscillators charge up the large capacitor in the common cathode circuit slowly, thereby reducing the voltage across all oscillators and reducing their frequency.

Meanwhile the trigger voltage of V_7 has been rising, as the capacitance in the associated RC network charges up. Until about 2 seconds have elapsed from the insertion of a coin, the voltage across the 0.5- μ F capacitor will be insufficient to fire V_7 when S_6 is closed, but thereafter V_7

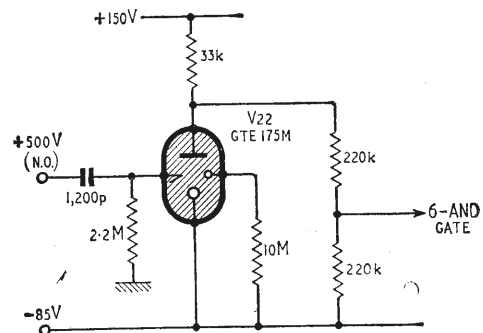

Fig. 2. Circuit of V_{22} , the "initial inhibit" element.

can be fired by closing this switch—a push-button on the front panel. If S_6 is not closed the 1- μ F capacitor will charge up in time, thus firing V_7 and restoring the quiescent condition to the oscillator. The resistive network between anode and cathode of V_7 feeds the 6-AND gate. The output will be positive with respect to earth when V_7 is off and negative when V_7 conducts.

The Dekatron, V_8 , has auxiliary anodes, which drive the numerical indicator V_9 directly. The cathodes of V_8 and the other target selector tubes are connected to a prize selection matrix, part of which is shown in Fig. 4. Normally the prize lines (running horizontally across Fig. 4) are earthy as the +10V applied through the 47-k Ω resistors is short-circuited through the diodes and the 3.3k Ω cathode loads of the Dekatrons. Should, however, all the cathodes connected to a given prize line be energized, that line will rise to about +5V, which passes through the OR gate for that value prize (vertical lines to right of figure) and also through the second OR gate (horizontal line at bottom of matrix) to the "any prize" OR gate, which allows Q_1 to conduct.

In Fig. 1 the 6-AND gate (a diode gate) drives the base of transistor Q_2 . Only when all the gate inputs are earthy (or slightly negative) will Q_2 be cut off and deliver a positive voltage at its collector. V_{30} and V_{31} are cold-cathode tubes forming a bi-stable pair. When either valve conducts the other is extinguished by capacitive coupling between the anodes. Normally V_{31} is conducting, but the output from Q_2 strikes V_{30} and the trigger potential of the oscillator/driver cold-cathode tube V_{32} goes very positive, well above its striking potential. V_{32} then acts as a relaxation oscillator, driving the discharge in Dekatron V_{29} round from cathode to cathode, applying positive voltages in turn to the collectors of the "prize value" transistor gates Q_3 - Q_{12} .

When the transistor in this group with a positive voltage from its prize line on its base is reached, it will conduct,

and a voltage will be developed across an emitter load common to all the transistors Q_{31-2} . As a result transistor Q_{14} is cut off and a +50V pulse is applied to the trigger of tube V_{25} , which strikes, thereby striking V_{27} , a power trigger tube, and opening the coin chute. V_{25} and V_{26} are capacitatively coupled and are thus self-extinguishing.

At the same time V_{31} in the bi-stable will be struck, thus cutting off V_{32} and allowing no further drive pulses to be fed to Dekatron V_{29} . Should the jackpot have been won, transistor Q_{17} will be conducting, and thus the base of Q_{28} , the succeeding transistor, will be earthy, and the output pulse from V_{25} will be applied to the trigger of tube V_{23} , which drives tube V_{24} , releasing the jackpot. If the jackpot has not been won, Q_{17} will be cut off and the output pulse from V_{25} will be shorted to ground in Q_{28} .

The coin chute is now open, and sixpences passing through will cut off illumination from a phototransistor, Q_{15} . The resulting positive pulses from the collector of an associated transistor amplifier Q_{16} will drive V_{34} and V_{35} , a simple divide-by-two circuit. The output from V_{35} drives V_{32} , which now has the normal bias voltage on its trigger and so operates conventionally, driving V_{29} one cathode forward for every two coins released. When cathode "0" of the Dekatron is reached, cold-cathode tube V_{27} is fired, thus firing tube V_{28} and closing the coin chute.

EDGE has now been running for over a year and has proved reliable in service, although it has not been made sufficiently rugged for completely unattended use. Its average rate of profit agrees well with the calculated 20%, and checks on the randomness of selection have shown that truly random operation has been achieved.

Pin-table Machines

Two pin-table machines have been designed, one operating on digital principles and the other on analogue

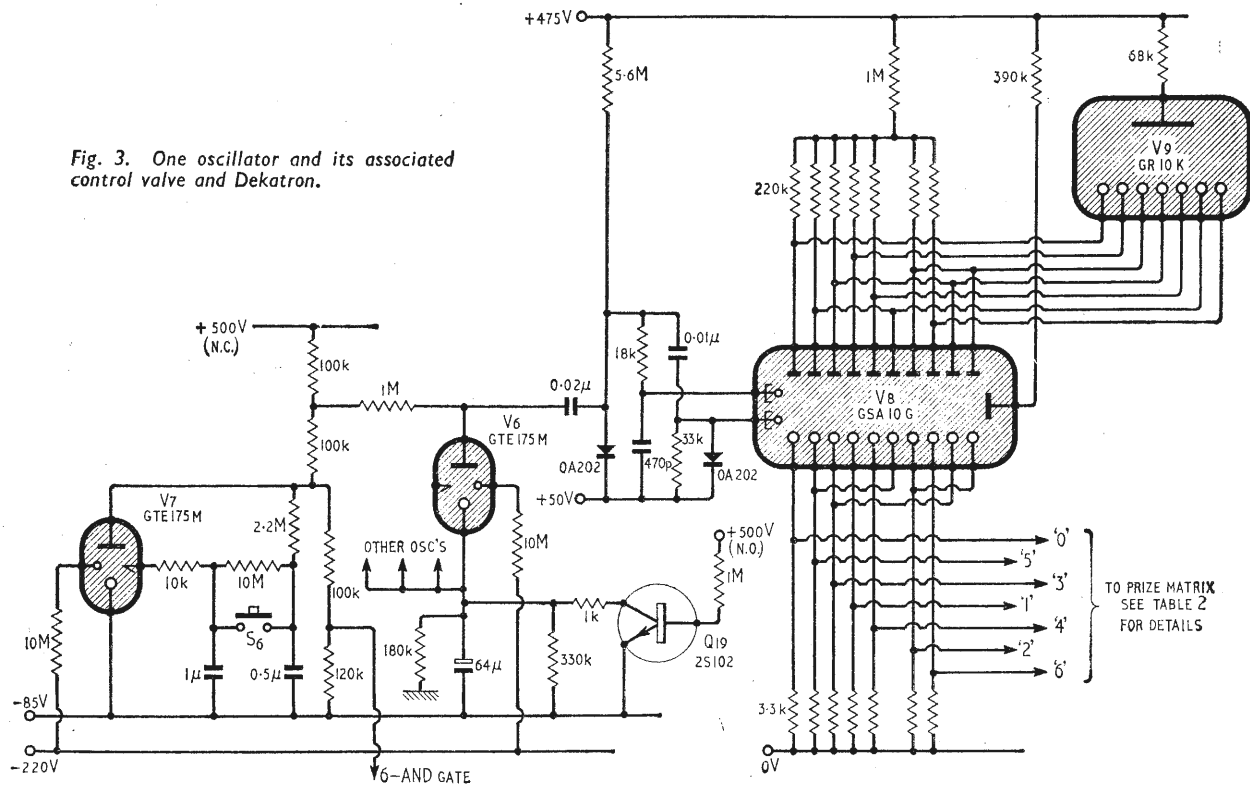
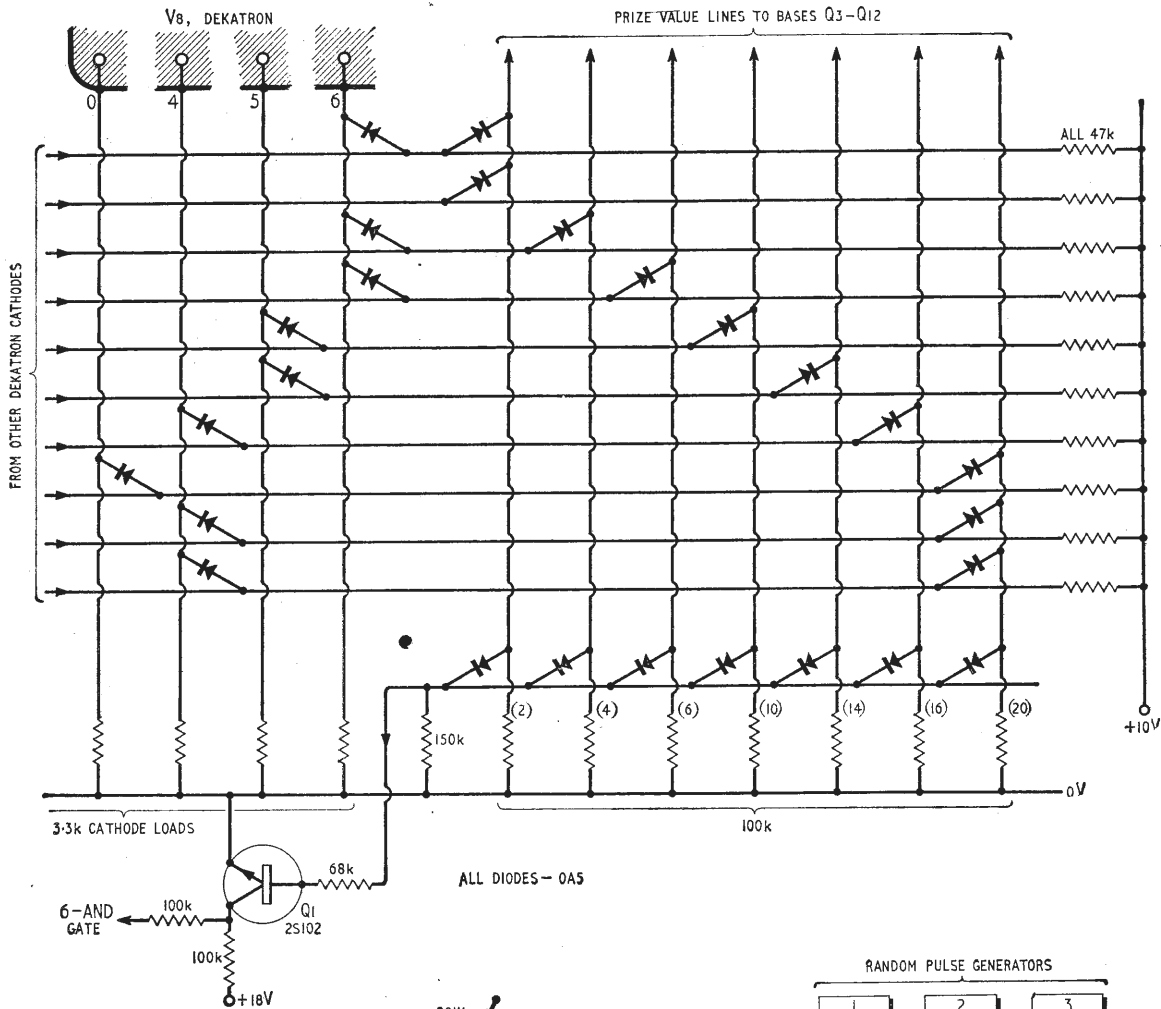

Fig. 3. One oscillator and its associated control valve and Dekatron.

principles. In the digital pin-table (Fig. 5), the display is provided by a matrix of neon lamps driven by two counters, one for the X-axis and one for the Y-axis. One lamp only is alight at any time, representing the intersection of the states of the two counters. One of the counters delivers a positive output and the other a negative output so that only the lamp at the intersection of the output from both counters will strike. Those lamps representing scoring positions are labelled on the display

and the low impedance existing between their trigger electrode and the other electrodes when they are struck is used to signal a hit. Both counters are cyclic, so that as the lit lamp moves off the left margin of the board it reappears on the right margin, and as it reaches the bottom of the board it reappears at the top, the last-mentioned condition also marking the start of the next "ball."

The counts, and hence the position of the lit lamp, are



Above: Fig. 4: Part of the prize selection matrix of EDGE, showing connections to Dekatron V₈.

Right: Fig. 5. Schematic of digital pin-table machine. The ball position is represented by an illuminated neon lamp in a matrix of such lamps.

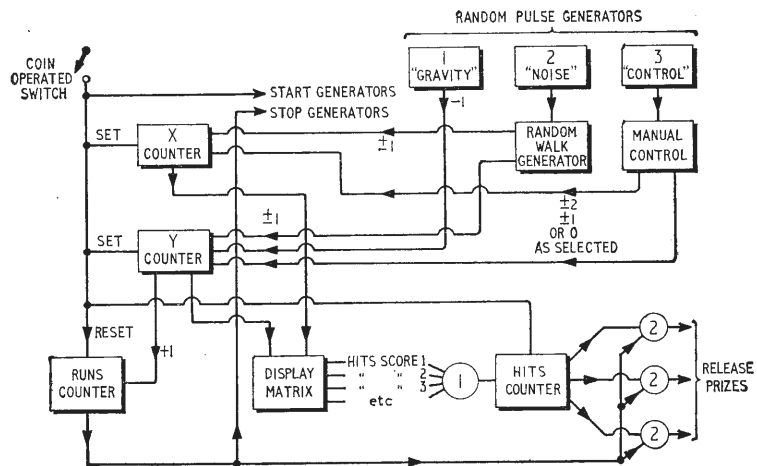

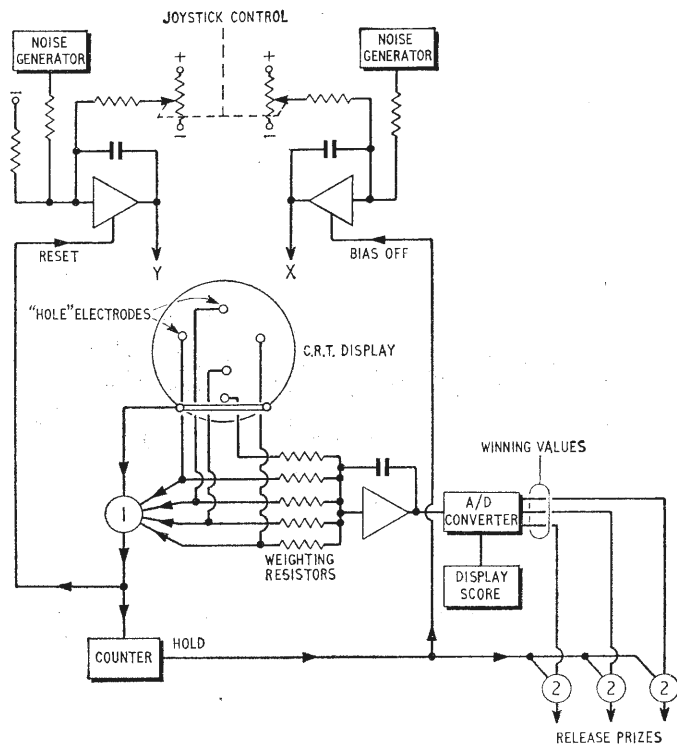

Fig. 6. Schematic of analogue pin-table machine, in which the ball is represented by a deflected spot visible on the c.r.t. screen.

altered by inputs from three generators of pulses occurring randomly in time at a mean rate of about 5 p.p.s. The first generator represents gravity and subtracts 1 from the Y counter; the second generates a random walk voltage and applies ± 1 to either or both of the counters;

and the third delivers a trigger pulse to a joystick-operated switch, which enables the gamester to apply ± 2 , ± 1 or 0 pulses to the X and Y counters as he sees fit.

The marked neons on the matrix score predetermined numbers of points when the discharge alights on them. These scoring points are summed and presented to the gamester, who has to score predetermined totals, which need not necessarily be very large. After a predetermined number of crossings of the vertical base line, the game ends, and if a winning score exists at this time a prize is awarded. The logic makes use of Dekatrons for the X and Y axis counters, giving a 12×12 matrix of 144 indicating neons. Dekatrons also keep the gamester's score and generate the appropriate counts for the various winning positions.

In the analogue pin-table (Fig. 6), the ball is represented by a spot of light on the face of a cathode-ray tube, normally deflected and focused. The holes on the pin-table are represented by areas of metallic foil on the inside of the tube face. When the beam strikes one of these electrodes the current flowing in the foil signifies a hit, causing the spot to disappear, another spot to start, and the appropriate score to be indicated. The c.r.t. faceplate can also have phosphors of several colours upon it and these can be excited by ultraviolet radiation as well as by the impact of the electron beam. At the bottom of the faceplate is a foil bar, of similar construction to the electrodes used to represent the holes. The beam, when it hits the bar, counts up another "ball."

The scheme uses normal analogue computer components. Integrating amplifiers receiving the same functional inputs as in the digital case control the position of the spot, and scoring is by another integrating amplifier feeding a simple analogue-to-digital converter.

In both analogue and digital pin-tables, rate laying is used, which adds considerably to the difficulty of the game.

H. F. PREDICTIONS—JUNE

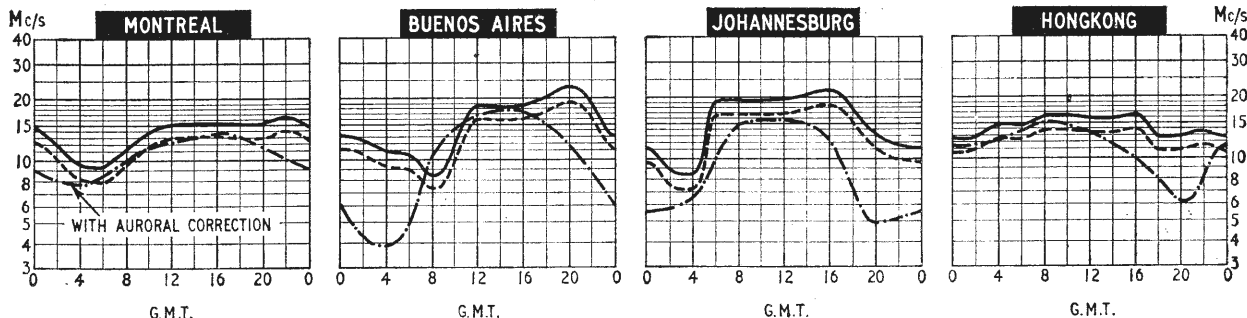

The prediction curves show the median standard MUF, optimum traffic frequency and the lowest usable frequency (LUF) for reception in this country. Unlike the standard MUF, the LUF is closely dependent upon such factors as transmitter power, aerials and the type of modulation. The LUF curves shown are those drawn by Cable and Wireless Ltd. for commercial telegraphy and assume the use of transmitter power of several kilowatts and rhombic type aerials.

Working should be possible throughout the 24 hours for the circuits shown with the exception of Buenos Aires from

0700-1100 GMT, when using the type of equipment specified in the first paragraph. For lower powers or lower aerial gains the LUF will rise by approximately 1.5 Mc/s for every 10dB reduction in e.r.p.

MANUFACTURERS' PRODUCTS

NEW ELECTRONIC EQUIPMENT AND ACCESSORIES

Digital Voltmeter

A SOLID-STATE digital voltmeter with an accuracy of $\pm 0.005\%$ is announced by Hewlett-Packard Ltd., of Dallas Road, Bedford. A five-digit display with a sixth digit for over-ranging is provided and the maximum resolution on the lowest range is $10 \mu\text{V}$. Input impedance is $10 \text{ M}\Omega$ on all ranges.

Unlike previous digital voltmeters, the Model 3460A is both integrating and potentiometric. The instrument takes the reading in two rapid, successive sampling periods. In the first, a floated and guarded voltage-to-frequency converter integrates the unknown to produce a series of pulses whose rate is proportional to the instantaneous input voltage. These pulses are counted and the most significant digits of the reading are actuated. The total count—stored in the counting units—is transferred to a digital-to-analogue converter, which generates an analogue signal exactly equal to the stored count (reading) and compares it with the unknown voltage. The difference is fed to the voltage-to-frequency converter and integrated into pulses which are counted in the second sampling period. These counts are entered into the fifth and sixth digits and the whole count is then transferred to the readout display. Full accuracy is maintained at the highest operating speed of fifteen readings per second.

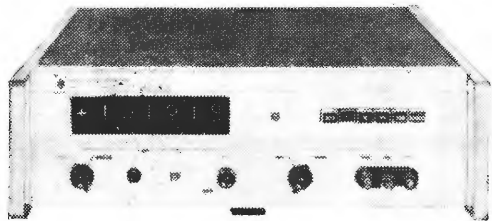

Hewlett-Packard solid-state digital voltmeter has an accuracy of 0.005% over the temperature range $+10^\circ$ to $+40^\circ \text{C}$.



Intersonde low-pressure transducer for 0-100 p.s.i. applications.

Due to the integration process, this potentiometric instrument is relatively immune from normal mode noise and with $1,000\Omega$ unbalance, the common mode rejection is 140 dB at all frequencies. Twenty per cent over-ranging is provided on all four ranges allowing the instrument to measure up to 1,200 volts d.c. Incidentally, reversible counters are used for integration of signals varying around zero potential.

Other features of this instrument include a binary coded digit printer output, facilities for remote programming of range and measurement, and accessories for making a.c. and resistance measurements. The price of the Model 3460A is £1,376.

6WW 501 for further details

Very Small Rectifiers

A NEW series of very small rectifiers has been introduced by Solitron Devices Incorporated, of New York. These devices have peak inverse voltage ratings from 50 to 2,800 V with current ratings from 500 mA to 125 mA respectively. Leakage current at the rated p.i.v. is only 100 nA.

Features of this MM series include extremely sharp breakdown characteristics, fast recovery time, high efficiency, and low capacitance. Applications for these devices include voltage multipliers,

infra-red image intensifiers, r.f. diodes and coaxial switches.

They are obtainable in this country through Auto-Electronics Ltd., of Peel Grove, London, E.2.

6WW 502 for further details

Low-pressure Transducers

DESIGNED for low-pressure applications is the new B.M. series of bonded strain gauge pressure transducers manufactured by Intersonde Ltd., of The Forum, High Street, Edgware, Middx. These transducers, which cover 0-100 to 0-750 p.s.i., are based on a pressure responsive element in the form of a closed-end beryllium copper tube to which four bonded strain gauges are attached and connected to a four-arm bridge configuration. Small pressures to the inside of the tube produce minute dimensional changes which are instantly converted into resistance changes by the two active arms in the bridge. The bridge unbalance signal is proportional to the applied pressure.

These transducers, which have an output resistance of 350Ω , will produce a 30 mV output at full rated pressure when excited with 20 volts. The combined non-linearity and hysteresis error is within 1.0% of full range and the operating temperature limits extend from -40° to $+120^\circ \text{C}$.

6WW 503 for further details

Frequency Meter Voltmeter

DESIGNED for measurement applications in the r.f. and v.h.f. ranges is the Type 2006 heterodyne voltmeter from the Danish manufacturers Brüel & Kjaer. Transistors are used throughout this instrument which covers the frequency range 40 kc/s to 260 Mc/s in six ranges and can be used to determine frequency (indicated on a meter), measure the amplitude of r.f. signals and also to determine the percentage modulation. A second meter is provided to indicate modulation level and r.f. voltage, and a loudspeaker is provided to give an audible check.

The frequency accuracy of the Type 2006 is 2% or $\pm 10 \text{ kc/s}$ and the voltage accuracy is within 0.5 dB from 40 kc/s to 170 Mc/s and within 1 dB from 170 Mc/s to 230 Mc/s. The voltage

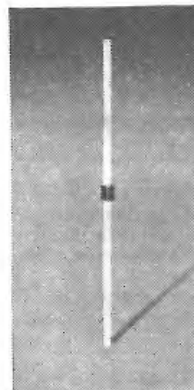

Very small rectifier from the Solitron MM series, which has p.i.v. ratings from 50 to 2,800 V.

range of the instrument (full scale) is from 50 μ V to 50 mV, although this can be extended to 50 V by means of an external attenuator. Access to an internal reference oscillator generating 2.5 mV at 30 Mc/s is provided on the front panel.

This instrument is handled in the United Kingdom by B. & K. Laboratories Ltd., of 4 Tilney Street, Park Lane, London, W.1.

6WW 504 for further details

Frequency Converters for Amateur Use

A SERIES of frequency converters that cover the 10 to 160 metre bands and produce outputs at either 550, 455 or 262 kc/s are being produced under the brand mark TRP by Herbert Salch & Co., of Woodsboro, Texas. These units are designed to feed directly into the i.f. stages of domestic receivers and operate from an internal 9 volt battery. Tuning is provided through a vernier drive with a six-to-one reduction to cover the range, which, for example, is 3.8 to 4 Mc/s on the 75 metre model.

Beat frequency oscillators can be fitted to these units which, in the United States, cost \$20 to \$35.

6WW 505 for further details

Ferrite Isolators

A NEW range of ferrite isolators covering the frequency bands 5925 to 6425 Mc/s, 5925 to 6175 Mc/s and 6175 to 6425 Mc/s has been introduced by the M-O Valve Company, of Brook Green Works, London, W.6. Included in the range is the CIC4, which is a field displacement isolator with a maximum forward loss of 0.35 dB and a minimum reverse loss of 35 dB; the v.s.w.r. is 1.02:1. The two resonance isolators in the range, CIC5 and CIC6, have forward and reverse losses of 0.5 dB and 25 dB maximum respectively, and a v.s.w.r. of 1.06:1.

These devices are particularly suitable for use in broadband radio communica-

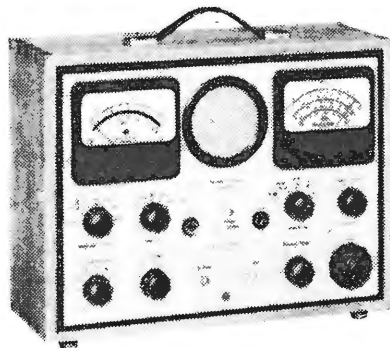

Brüel & Kjaer Type 2006 heterodyne voltmeter for r.f. and v.h.f. applications.

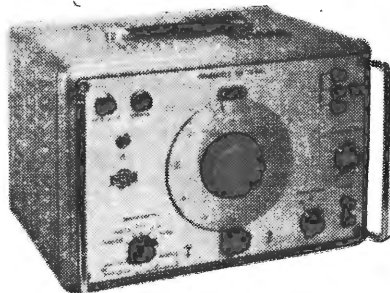

C.R.C. Type GB64 very low frequency generator covering 0.005 c/s to 500 c/s in ten ranges.

tion systems. The r.f. connections on all three devices are waveguide (number 14).

6WW 506 for further details

Very Low Frequency Generator

CALIBRATED in frequency and with indication of reciprocal periods on the range control is the C.R.C. Type GB64 v.l.f. generator, which covers the frequency range 0.005 c/s to 500 c/s. Sine, square and triangular waveforms are available from this instrument, which has a balanced output variable up to 40 volts 6-to-p into 10 k Ω —from an internal

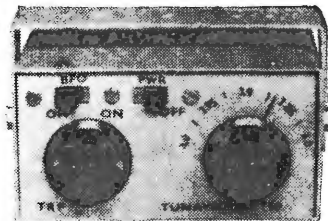

TRP frequency converter designed for use with domestic receivers for reception of the amateur bands.



Raytheon side-window digital indicator tube Type CK1084. It is a little under 2 1/4 in high.

impedance of 100 Ω . The sine wave output has a maximum distortion of 2 %, the triangular output a maximum slope error of 2 %, and the square wave output has a rise time of 25 μ sec. Maximum random noise level is 20 mV.

A 50 μ sec, 25 volt sync pulse is also provided for such purposes as oscilloscope triggering. It comprises alternative positive and negative pulses. The supplies of the Type GB64 are stabilized and for a 10 % variation in the mains supply, the frequency remains within 0.5 % and level within 0.2 dB.

This instrument, which is made by Constructions Radioélectriques at Électroniques du Centre, is available in the United Kingdom through Claude Lyons Ltd., of 76 Old Hall Street, Liverpool, 3 (Southern offices Hoddesdon, Herts.).

6WW 507 for further details

Digital Indicator Tube

A SIDE-WINDOW digital indicator tube for computer and instrument applications is announced by the Raytheon Company. Designated CK1084, the device is available with numerals 0 to 9 as standard, although special characters can be supplied to order. The digital tube is approximately 2 1/4 in high and 7/8 in

INFORMATION SERVICE FOR PROFESSIONAL READERS

To expedite requests for further information on products appearing in the editorial and advertisement pages of *Wireless World* each month, a sheet of reader service cards is included in this issue. The cards will be found between advertisement pages 16 and 19.

We invite readers to make use of these cards for all inquiries dealing with specific products. Many editorial items and all advertisements are coded with a number, prefixed by 6WW, and it is then necessary only to enter the number(s) on the card.

Readers will appreciate the advantage of being able to fold out the sheet of cards enabling them to make entries while studying the editorial and advertisement pages.

Postage is free in the U.K. but cards must be stamped if posted overseas. This service will enable professional readers to obtain the additional information they require quickly and easily.

in diameter and can be triggered from several sources, such as from transistor circuits, cold-cathode tubes, and electro-mechanical switches.

6WW 508 for further details

Waveform Generator

A VARIABLE phase attachment Type VP 142 for use with the recently introduced low-frequency waveform generator Type LF 141 is announced by Servomex Controls Ltd., of Crowborough, Sussex. This attachment uses the same circuit techniques as the variable phase unit for the de-luxe LF 51 generator, to provide variable phase waves of constant amplitude from a single-phase generator—for phase measurement using Lissajous figures on an oscilloscope. The amplitude of the variable phase output is adjustable, making the VP 142 suitable for measuring applications. The accuracy, of course, is dependent upon the associated oscilloscope amplifiers, as the method employed involves producing a Lissajous figure.

The LF 141 generator employs an integrator connected to a square wave generator in a feedback arrangement that is self-oscillating, to generate square waves and triangular waves at the same time. Features of this instrument, which covers the frequency band 0.002 to 2,000 c/s in six ranges, include facilities to run the generator for a single cycle or half cycle, and a "gate" terminal on the front panel. This allows the main generator to be keyed to produce bursts of pulses of any number from one upwards. In the half-cycle mode, the generator rests at the positive or negative limit of voltage. This allows the amplitude of the waveform prior to continuous operation, which is particularly useful in low frequency applications, such as servo testing.

6WW 509 for further details

Microvoltmeter

AN all-transistor microvoltmeter suitable for use over the frequency range 20 c/s to 10 Mc/s is announced by Laboratoire Electro-Acoustique, of 5, rue Jules Parent, Rueil Malmaison (S-&O), France. Audio and radio frequency probes are provided with this instrument, which is known as the E.V.T.1 and can measure voltages from 10 μ V to 100 V, and also provide a 300 mV output at 75 Ω . Stability is quoted to be within 0.2 dB for a 10% variation in mains voltage.

The E.V.T.1 has an input impedance of 100 k Ω and 10 pF; however, this changes, of course, when either of the

two probes are used: audio probe is 1 M Ω and 3.6 pF; r.f. probe is 30 k Ω and 2.7 pF. The frequency response of the audio probe is within 0.5 dB from 20 c/s to 100 kc/s and the r.f. probe within 0.5 dB from 20 c/s to 3 Mc/s and ± 1 dB at 10 Mc/s.

Applications for this instrument, which can also be used to measure decibels (from -100 to +42 dB), include low-voltage measurement, background noise measurement, zero detection and amplification. The unit measures 35 \times 19 \times 20 cm and weighs 8 kg.

6WW 510 for further details

Differential Voltmeter

SUITABLE for calibration of other voltmeters is the new Model 741A d.c. differential voltmeter/d.c. standard from Hewlett-Packard. An accuracy of 0.03% is quoted for d.c. measurement and of 0.1% of reading $\pm 0.01\%$ of full scale when the instrument is used as an a.c. differential voltmeter. Voltage range is from 1 to 1,000 V f.s.d.

This instrument, which can also be used directly as a d.c. voltmeter, has a

constant input impedance of greater than 1,000 M Ω , regardless of null condition. It can also be used to provide an accurate d.c. voltage source (0.03%) from zero to 1,000 volts; with regulated current to 20 mA. Selection of the required voltage is by four digital controls.

As an a.c. measuring instrument, the Model 741A introduces a shunt capacitance of less than 5 pF at the "touch and read" point in the circuit. The shunt resistance is 1 M Ω .

A recorder output is provided and is driven by a d.c. amplifier, which can be used externally. It has a maximum gain of 60 dB and an output of 1 volt into at least 2,000 Ω .

6WW 511 for further details

High-power Audio Oscillator

EXCELLENT frequency and amplitude stability are claimed for the new Type 440B audio oscillator from Dawe Instruments Ltd., of Western Avenue, Acton, London, W.3. Up to six watts output power is available from this instrument over the frequency range 20 c/s to 20 kc/s. The output transformer is

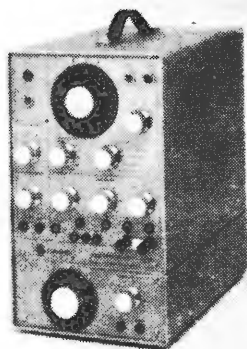

Waveform generator Type LF 141 with variable phase add-on unit Type VP 142 (Servomex Controls Ltd.). As can be seen the phase attachment plugs directly into the bottom of the waveform generator.

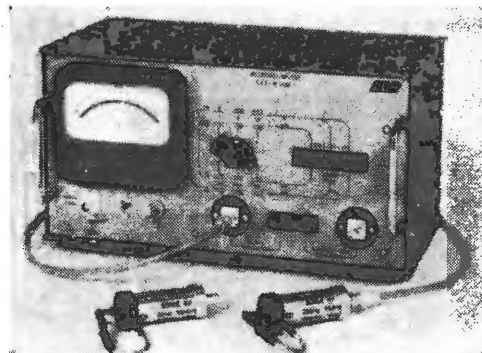

Type E.V.T.1 microvoltmeter from the French manufacturers L.E.A.

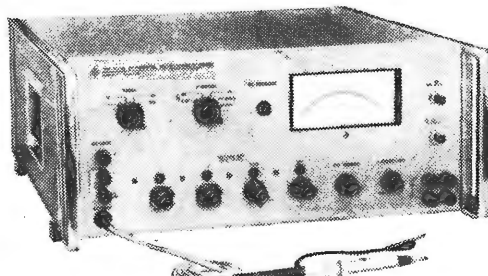

Hewlett-Packard Type 741A d.c. differential voltmeter/d.c. standard.

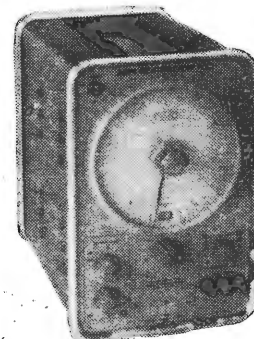

Dawe Type 440B high-power audio oscillator covers the frequency band 20 c/s to 20 kc/s in three ranges.

matched for loadings of 3.75, 15 or 600 ohms making the instrument suitable for many applications including vibration testing.

At three watts output, the amplitude is constant to within 0.5 dB over the whole frequency range. Typical harmonic content at 400 c/s is 0.02% second harmonic and 0.12% third harmonic, with less than 0.01% hum and spurious signal. Amplitude is stabilized to within 1% and frequency to within 0.05%; within 30 minutes of switching on.

The instrument measures $8\frac{1}{4} \times 13 \times 12\frac{1}{2}$ in and weighs 24lb. The price is £98. 6WW 512 for further details

Transistor Tester

ABLE to measure leakage currents down to 1 nA (100 nA f.s.d.) is the new Type 180 transistor tester from Comark Electronics Ltd., of Gloucester Road, Littlehampton, Sussex. This is the latest in their range of battery-operated instruments and is suitable for testing both p-n-p and n-p-n transistors. The collector test voltage is 4 V and collector current may be set to any value up to 30 mA. There are nine pre-set base currents providing direct-reading gain

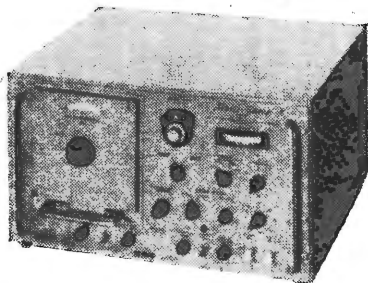

Kay Electric 500 kc/s to 1.3 Gc/s sweep and marker generator.



Close-up of the bit of the 60-watt low-voltage soldering iron made by the Weller Electric Corporation, which features a new type of temperature control.

scales of 0 to 30, 0 to 100 and 0 to 300.

This instrument may also be used externally as a nano-ammeter. Terminals are provided and an accuracy of 2% is quoted. The dimensions of the tester are $6\frac{1}{4} \times 5 \times 3\frac{1}{2}$ in.

6WW 513 for further details

V.H.F./U.H.F. Sweep Generator

COVERING the frequency range 500 kc/s to 1.3 Gc/s, with sweep widths adjustable from 5 kc/s to 500 Mc/s is the Model 121-C sweep and marker generator from the Kay Electric Company, of Maple Avenue, Pine Brook, Morris County, New Jersey.

Two head attachments are available for this instrument, the P-122A which covers the frequency range 900 Mc/s to 1.3 Gc/s with adjustable sweep widths from 50 kc/s to 500 Mc/s. The other unit, the Type P-123A covers the frequency range 100 Mc/s to 1 Gc/s with octave sweep widths (such as 100 to 200 Mc/s, 200 to 400 Mc/s, 300 to 600 Mc/s, etc.).

A direct-reading digital frequency dial is used for centre frequency adjustment and a meter is provided for indication of r.f. level, which is 0.5 volts r.m.s. (into 500Ω). A 0 to 60 dB attenu-

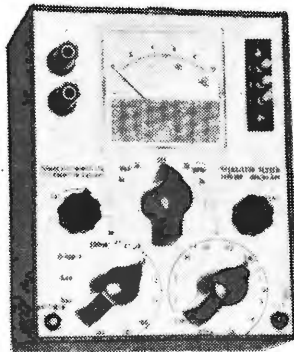

Transistor Tester, that can measure leakage currents down to 1 nA, from Comark Electronics Ltd.

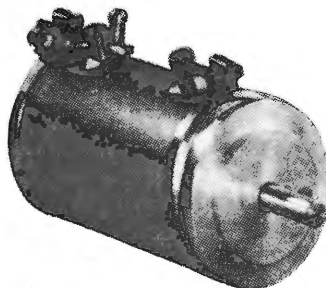

Type CP15 helical potentiometer from P.X. Fox/General Controls. Linearity is 0.5%.

ator (in 10 dB steps) is built into the Model 121-C and a fine 0 to 10 dB attenuator (in 1 dB steps) is available as an optional extra. Frequency response is within 0.25 dB to 800 Mc/s and within 0.5 dB to 1.3 Gc/s. Sweep rate is adjustable from 10 to 60 c/s internally or from zero frequency to 20 kc/s externally. Harmonic markers are generated at 1, 10 and 100 Mc/s internally, and circuits for an external variable marker are also provided.

6WW 514 for further details

Low-voltage Soldering Iron

AT the base of the new Weller low-voltage soldering iron is a disc of nickel-iron alloy. This is positioned next to a permanent magnet that is used to control the temperature of the bit. When cold, the magnet is pulled in contact with the disc, completing the heating element circuit. As the temperature of the bit increases, the magnetic properties of the disc decrease until the Curie point is reached where the disc becomes non-magnetic, disconnecting the supply. This change of characteristic of nickel-iron alloys at the Curie point occurs within a narrow temperature band and through different alloy compositions it is possible to maintain different temperatures within fine limits. Interchangeable bits having different alloy discs are available.

These units are made in the United States by the Weller Electric Corporation and are available in the United Kingdom through their subsidiary in Blatchford Close, Horsham, Sussex.

6WW 515 for further details

Small Helical Potentiometers

WHILE the electrical characteristics of a new range of miniature helical potentiometers from P.X. Fox/General Controls are the same as the original design, performance has been improved through the use of nylon bearings, which the manufacturers claim improves the life rating. Three-, five- and ten-turn models are available in this range with resistance ratings up to 120 kΩ; maximum dissipation is 2.5 watts at 40°C ambient. The external diameter of this CP 15 range is 0.875 in and standard units are provided with a $\frac{1}{4}$ in diameter shaft.

The address of P.X. Fox/General Controls, which is a subsidiary of S.T.C., is West Road, Harlow, Essex.

6WW 516 for further details

Microminiature Lamps

STANDARD dimensions of the new "flat-top" series of microminiature

lamps are 0.030 in in diameter by 0.080 in in length, although other shapes can be supplied by special order with diameters down to 0.010 in. Current consumption of these devices, which can be operated from voltages down to 1 volt, can be as low as 1 mA. This, of course, is dependent upon working voltage and resistivity of the element.

The light output of these Pinlite lamps extend into the infrared and

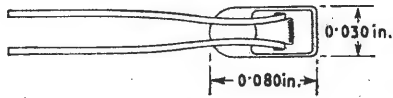

"Flat-top" Pinlite microminiature single-filament lamp from the Kay Electric Company.

ultraviolet regions of the spectrum making them suitable to operate as hot-wire noise sources right through the u.h.f. band. Another feature of these lamps is that they have low surface temperatures at relatively high light outputs.

These devices are manufactured by the Pinlite Division of the Kay Electric Company, whose address is 1275 Bloomfield Avenue, Fairfield, New Jersey 07007.

6WW 517 for further details

Miniature 28-volt Motor

A NEW precision-built permanent magnet d.c. motor is announced by Vactric Control Equipment Ltd., of Garth Road, Morden, Surrey. Known as the Type 09P, the diameter of the motor housing is only 0.880 in. Various shaft-ends are available for this motor which, with an input current of 250 mA, has a rated torque of 30 gm/cm at 6,000 r.p.m.

Two threaded holes are provided in the front of the face plate for mounting this motor, which weighs 45 gm



Miniature 28-volt d.c. motor with a balanced armature running on miniature stainless steel ball bearings to reduce vibration to a minimum. (Vactric Control Equipment Ltd.)

and is suitable for operation in the ambient temperature range -55° to $+85^{\circ}$ C. Under no load conditions, the current consumption is 100 mA; stall torque is 65 gm/cm. Provision has been made in the design for a double-ended shaft, if required.

6WW 518 for further details

WIRELESS WORLD, JUNE 1965

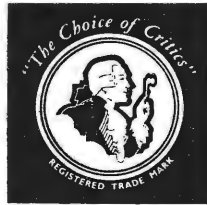

THE HOUSE OF BULGIN AT YOUR SERVICE

A SMALL SELECTION OF OUR NEW PRODUCTS

Always pioneering in the design and manufacture of New Components, the House of Bulgin introduce more additions to their already wide range of Precision made Products. Guaranteed to specification and most important quick delivery to customers at home and all over the world. Our Name is second to none in this respect, and has been built up over 40 years of close co-operation with our customers.

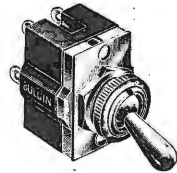

D.P.C.O. Moulded switch, pat. pend., high elec. spec., following five years research.

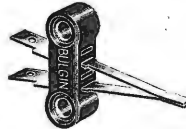

New cut-out, protects against damage through overheating or fire by interrupting circuit.



Cradle-type cell holders for portable equipment, three sizes for V.2, U.11 and U.7 cells.

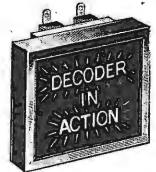

Message Signal Lamp, four L.E.S. bulbs, shake proof holders, one, two or four messages.



Knob and escutcheon indexed for standard 24 position rotary switches, white characters, black moulding.



Modern style knob pair, in black and 'silver' finish, grub screw to $\frac{1}{4}$ inch shafts.



Large lens Signal Lamp with minimum rear of panel projection takes L.E.S. bulbs.

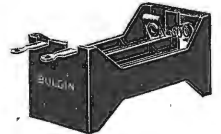

Four cell battery magazine U.7 size, in series to 6V or series/parallel to 3V.



Two sizes of modern knobs, with white index line and metal decor inserts.

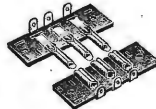

Strip connectors mate edge to edge, high rating, one to twelve poles.



Range of three, panel mounting, cell holders, accepting 1, 2 or 3 U.11 cells.



Mains rated, neon message indicators, double or single legends in red or green.



Contemporary self-fixing S.P.M.B. push switch, mains rating, tag or terminal connections.



Neon signal lamp for mains uses, push-fit to panel, AMP 250 series, tag connections.



Range of four knobs for concentric shafts, various decor inserts, many shaft sizes covered.

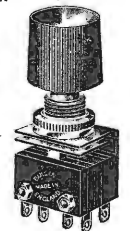

Push button operator for two S.800 micro-switches mounted side by side.

R.E.C.M.F. Exhibition, May 21st-24th

ON STAND 155

For full details send for brochures to:

A. F. BULGIN & CO. LTD.,

BYE PASS ROAD · BARKING · ESSEX · Telephone: RIPpleway 5588 (12 lines)

6WW-122 FOR FURTHER DETAILS.

Sweet are the Uses of Advertisement

AN electronics engineer, by definition, is a man who never knows whether he's on his a.c. or his d.c. And, when you stop to consider the multiple stresses and strains to which the poor chap is heir, it's not really surprising.

I was reminded of this when, on thumbing through a back issue of an American electronics journal, I was hit between the eyes by four pages of full colour, all dedicated to the proposition that any engineer who thinks that Paradise can only be gained in the fullness of time via the undertaker's box is simply not with it. One gathered that all the smart operator has to do is to hop on to the payroll of Slicktronics Inc. to gain the earthly equivalent of the Elysian Fields.

In short, a four-page colour ad. for electronic engineers. So, at last, it seems we have made it. We are in the big league. Doesn't this step up your ego-voltage? Doesn't it make you feel—well—kind of wanted? Oh, come now; let's not be bashful. You know it does!

I say "we" advisedly, for although it was admittedly an American magazine, this sceptred isle of ours is dutifully following the trail blazed by the transatlantic trend-setters, and although (so far as I know) none of our own journals has as yet splurged into colour to lure us to fresh woods and pastures new, this is perhaps because a committee is sitting to decide which colours to use. And we all know what that means in terms of dreaming the happy hours away. But any moment now we may find *The Daily Telegraph* burgeoning forth as a photogravure "SITS VAC" magazine with the news as a weekend black-and-white supplement.

Now that we are sitting so pretty it seems ungracious to quibble, but I do feel that, although the advertising boys are doing a perfectly splendid job in their traditional fields (and full marks in particular for those clever poaching ads in rival electronics companies' local papers) I must say that they don't seem to be showing much imagination in other directions.

Why, for instance, do they stick at paper seduction? What's the matter with television advertising? Wouldn't you be moved at the sight of a dusky maiden in a grass skirt and a smile, holding out her arms toward the taking lens and murmuring breathily, "You owe yourself nothing but the best. Come and join me at Gargantuan's wonderful laboratories on the palm-fringed shores of Wapping Old Stairs!"?

(Of course, there is always the possibility that the Little Woman may be moved simultaneously and the off-switch likewise, so the approach might have to be made more subtle; but we can safely leave the minutiae to the advertising boys.)

But enough of pipedreams. Let the pleasant present, with its thrusting newspaper appeals suffice. So, caps off, men, and pay tribute to the travail in which these messages of hope are born.

The uninitiated might consider that the compilation of a SITS VAC advertisement is a pretty short putt, and have been known to wonder why no ad. worthy of the name can be contained in less than half a page. But thinking men will have realized that it would never do to set out the vacancy baldly and bluntly, because from this we might easily get the idea that we are being asked to step into a sacked man's shoes, and you know how jolly sensitive we are.

So first of all, it is essential to project a chunk of Company Image to lay the bogy, and this is traditionally done in a preamble which incorporates nebulous references to "expansion" and "exciting new contracts" (and everybody knows how excited we get over new contracts).

Other old faithfuls, like "dynamic," "challenging" and "frontiers of science" are dragged in by the beards of their respective typefaces and, in fact, are currently so overworked that they get double time for every personal appearance. But "expansion" is the one which really works its fingers to the bone to bring us the image; unfortunately, the image I get

is that of a fly perched on a rapidly inflating balloon, in imminent prospect of severe mental stress when the darned thing bursts; but that no doubt means that I should visit a psychiatrist.

Next, the advertiser gets to work on the distaff side. Donning an estate agent's rose-coloured *pince-nez* he sketches in lyric prose the neo Deep South plantation-style residence awaiting you and yours. The climate, too, gets a big hand, to the point where no local inhabitant would recognize it. If perchance a school exists within ten miles of the factory, one is left wondering how Shakespeare, Clerk Maxwell and Einstein ever got by without attending it.

Finally, via the social life ("Little Bugsworthy is such a friendly place") we come to the real meat—which, by and large, is often not enough to raise the hackles of a vegetarian. While you get the general impression that the super-tax bracket is at last in the view-finder, this is not stated categorically; for the rest it seems that if you possess a degree, feel warm to the touch and breathe now and again, you are in. One of these days it may come as a fatal shock to an applicant to find that the word "laboratory" means "work place."

But who are we to cast stones from our glass palaces? After all, SITS VAC is our salvation in terms of keeping the wolf from shouldering open the door. After three years in a junior position at Company A, with no significant increase in the monthly total of grains of rice, we are lured to Company B by the promise of real money. We get it, but find that living expenses are much higher in the new area (it just so happens that the ad. we answered omitted to mention this). So after a few months we change to Company C, a smaller organization with a more senior post to offer. After a spell to learn the ropes, the time is now ripe to return to Company A in a still more senior post and at four times the salary we were getting there a year or so ago. So everything is now lovely, except for the awkward moments when we bump into former (and still junior), colleagues in the corridors. And so the merry-go-round goes round.

In fact the entire SITS VAC set-up is something of a merry-go-round, in that we who ride it may eventually find ourselves back at the starting point. Today we are in the four-page colour era, but time was—and not all that long ago either—when the SITS VAC section of a daily paper ran to but a single column, relegated to the most obscure corner of all and printed in the smallest type available. All this, of course, was with intent. It saved money and at the same time guaranteed that whoever got around to finding what he was looking for was possessed of better-than-average perseverance and moreover had excellent eyesight.

Very occasionally, sandwiched between "smart errand boy" and "temporary dustman" one might come across something like this:—

"Wtd. qual rad eng exp design all TXs shovel snow etc willing wk rd clock no o/time. Apply encl. SAE Anode and Bend Ltd. Limehouse."

Having replied (enclsg. SAE) the applicant, might, with luck, receive a curt command to attend the majesty of the Chief Engineer, Anode and Bend Ltd. at 8.30 a.m. on a given date (pay own expenses). At 10.45 a.m., just when our hero has reached the head of the queue, the office boy pokes his head around the door, yells "Job filled!" and that is that.

What I said about the set-up being a merry-go-round was triggered by something I mentioned earlier, namely that the four-page colour ad. was in a back number of the journal. The current issue reports an upsurge of unemployment in the American electronics industry. So perhaps, after all, *The Daily Telegraph* had better stick to its old format and it's as well if you got in some snow-shovelling practice, just in case. It's an invigorating pursuit, I'm told.