

Wireless World

ELECTRONICS, RADIO, TELEVISION

OCTOBER 1963

Editor:

F. L. DEVEREUX, B.Sc.

Assistant Editor:

H. W. BARNARD

Editorial:

P. R. DARRINGTON

D. C. ROLFE

D. R. WILLIAMS

Drawing Office:

H. J. COOKE

Production:

D. R. BRAY

Advertisement Manager:

G. BENTON ROWELL

- 471 Editorial Comment
472 The New Season's Sets
480 Controlled Rectifiers in Stabilized Power Supplies
By F. Butler
485 Books Received
486 Manufacturers' Products
492 Vision A.G.C. *By K. Cummins*
494 Electronic Standards Conversion
495 World of Wireless
497 Personalities
499 News from Industry
501 Letters to the Editor
503 German Radio Exhibition
507 Capacitive Transducers with Transistor Amplifiers
By A. R. Bailey
511 The Future of Projection Television *By V. Valchera*
515 Demonstrating A.C. Theory *By T. Palmer*
517 *Wireless World* "Stereo Balancer"
521 Electronics in Neurophysiology *By P. E. K. Donaldson*
524 H.F. Predictions—October
525 Syncom II
526 October Meetings
528 Unbiased *By "Free Grid"*

Managing Director: W. E. Miller, M.A., M.Brit.I.R.E.

Illife Electrical Publications Ltd., Dorset House, Stamford Street, London, S.E.1

VOLUME 69 No. 10

PRICE: 2s 6d.

FIFTY-THIRD YEAR
OF PUBLICATION

Please address to Editor, Advertisement Manager or Publisher as appropriate

©Illife Electrical Publications Ltd., 1963. Permission in writing from the Editor must first be obtained before letter-press or illustrations are reproduced from this journal. Brief abstracts or comments are allowed provided acknowledgement to the journal is given.

PUBLISHED MONTHLY (4th Monday of preceding month). *Telephone:* Waterloo 3333 (70 lines). *Telegrams:* "Ethaworld, London, Telex." *Cables:* "Ethaworld, London, S.E.1." *Annual Subscriptions:* Home £2 0s. 0d. Overseas £2 5s. 0d. Canada and U.S.A. \$6.50. Second-class mail privileges authorized at New York, N.Y. *BRANCH OFFICES:* BIRMINGHAM: King Edward House, New Street, 2. *Telephone:* Midland 7191. COVENTRY: 8-10, Corporation Street. *Telephone:* Coventry 25210. GLASGOW: 62, Buchanan Street, C.1. *Telephone:* Central 1265-6. MANCHESTER: 260, Deansgate, 3. *Telephone:* Blackfriars 4412. NEW YORK OFFICE: U.S.A.: 111, Broadway, 6. *Telephone:* Digby 9-1197.

PCF802 — NEW MULLARD TRIODE-PENTODE *for line oscillators*

MULLARD TRIODES FOR U.H.F. TUNERS — PC86 AND PC88

BBC2, the second BBC television programme scheduled for 1964, will be transmitted at ultra high frequencies. In readiness for this, many of the latest television sets are equipped to receive these new u.h.f. transmissions as well as the existing v.h.f. transmissions. In these sets will be encountered two high-frequency triodes — the PC86 and the PC88 — which have been developed by Mullard specifically for operation in Bands IV and V.

The PC88 is designed as a u.h.f. r.f. amplifier, and the PC86 as a self-oscillating mixer. Both valves use frame grids: the accuracy and rigidity of this construction enable a very small spacing to be used between the anode and grid, so that the necessary high value of mutual conductance is achieved. To reduce grid-lead inductance, the

WHAT'S NEW IN THE NEW SETS

These articles describe the latest Mullard developments for entertainment equipment

grid of the PC88 is specially connected to five base pins, and that of the PC86 to three. To improve the stability of the PC88 further, the valve capacitances are minimised by the use of a single-sided electrode structure in which the grid and anode are placed to one side of the cathode, instead of surrounding it.

WITH the coming of a negative-modulation 625-line television service in this country, receivers have been produced using line oscillators operating on the flywheel principle. In anticipation of this, Mullard have recently introduced the PCF802, a new triode-pentode which has been developed specifically for this application.

In a typical mode of operation, the pentode section of the PCF802 will be used as a sine-wave oscillator whose frequency is controlled by the triode section of the valve functioning as a reactance valve. The d.c. frequency-control signal at the triode grid is obtained in a phase-frequency detector comparing the incoming synchronising pulses with pulses taken from the line output stage.

An attractive feature of this circuit is that only one switch is needed to change the frequency of the oscillator from that required for the 405-line standard — 10.125kc/s — to that required for the 625-line standard — 15.625kc/s.

Special attention has been paid in the development of the new valve to minimising hum and microphonic interference, which can be troublesome in this type of line-oscillator circuit. Furthermore, the amplification factor of the triode section of the valve is high, thus making the section particularly suitable for operation as a reactance valve.

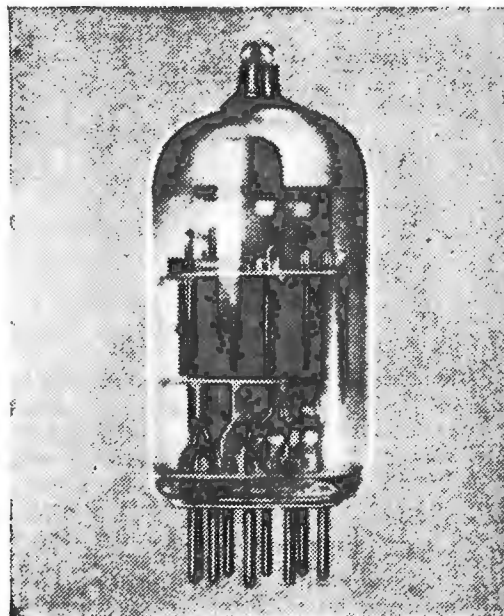

AA129 — BIAS STABILISING DIODE longer battery life in portable radios

The AA129 Mullard junction diode is now being used in the latest portable radios to provide compensation for changes in battery voltage and operating temperature.

In portable receivers, the performance will deteriorate with the fall in battery voltage with age, and to ensure good battery life, the sets should be designed to give acceptable performance when the battery voltage falls to about 50% of the nominal value. The effect of falling battery voltage is accentuated as the operating temperature falls, so that, to maintain good battery life, some form of compensation is desirable.

If the AA129 is incorporated in the base-bias network of the output stage, the necessary compensation can be achieved. With such an arrangement, the battery voltage can fall well below the 50% limit without the performance at low temperatures falling below an acceptable standard. Furthermore, the deterioration at higher temperatures is also much less. Use of the Mullard bias stabilising diode thus ensures less variation in performance with battery voltage decay at all normally encountered temperatures, and also considerably prolongs the useful life of the batteries in a portable radio.

MVE 1942

Under Way Again

WHEN the decision was taken to drop the National Radio Show this year, the consequences could hardly have been foreseen. Its place has been taken by an efflorescence of private shows which have vastly entertained the dealers, tested to the limit the stamina of peripatetic journalists and presented a pile of bills which are still being re-scrutinized by anxious accountants to see if the number of significant figures is really true. As more and more firms decided that they must have their own shows in London during the "exhibition" period, pressure on space in the many-starred hotels grew and the sphere of activity expanded to the whole of the Central London area. Pye, true to form, struck out in a different direction and invited their trade friends to Newmarket for a day's racing and, for those who were interested, a view of their new sets in a marquee reputed to be the largest so far erected in this country.

The function of these events was the same as that fulfilled by the demonstration rooms or the private areas of the stands at Earls Court, and although they were no doubt highly successful for all concerned they lacked the stimulating presence of the buying public, whose faces (grave, gay or just blank), are there to remind all who go to Earls Court why there is broadcasting and who ultimately pays the bills. True, many firms will be putting on the road their own travelling shows and in collaboration with local dealers will do their best to recreate Earls Court in miniature, but nothing can quite recapture the special flavour of the big national exhibition where those who originate the programmes, those who sell the means to receive them and those who enjoy them meet on equal terms.

Had there been a Show this year it is not hard to guess what the theme would have been—the event which is due to take place in April 1964, and which is likely to determine the fortunes of the industry in the immediate future.

There is no doubt that the general public is still a little vague as to what this event portends. Some people believe that 625 is the operative factor,

without which an extra television programme would not be possible. It is not always made clear that a much more important factor is the change to u.h.f. for which new aerials will be needed; that even then, there is no guarantee that everyone will get a satisfactory service because of the vagaries of u.h.f. propagation.

A National Radio Show with the presence of the B.B.C. to direct attention to the possibilities of an alternative programme would have been very welcome at this stage. Although primarily a technical journal we would be the first to admit that the immediate future rests primarily with BBC2 and the quality of the programmes which it emits. This must be forthcoming without prejudice to the existing service, as indeed sound broadcasting has been sustained by the B.B.C. in spite of the more clamorous demands of television. The problem of who pays for this is not easy to solve, but to try to do things on the cheap, particularly in the early stages would be disastrous.

Second in importance only to the programme producers, will be the retailers who carry a heavy responsibility in giving honest advice and competent service to customers attracted by the possibility of a third programme. Detailed surveying of sites for the best position and type of aerial will be the rule rather than the exception. The dealer who equips himself with a sensitive field strength meter (including display tube for ghosts) is going to have the edge on more empirical competitors, and we foresee the ultimate in "one-upmanship" taking the form of one of those articulated-arm trucks, used in some cities by window cleaners, for running over the profile of a building to find the best place for the aerial.

After a longish period of slack water the tide is on the turn for all concerned in any way with television. If we are to make the most of it there must be unanimity on the course to be steered. In our view this should be BBC2 which will give us the possibility of a continually changing horizon. "625" is not a course but a slightly better lens in the passenger's spectacles.

THE NEW SEASON'S SETS

TECHNICAL FEATURES SURVEYED BY "WIRELESS WORLD" STAFF

ALL the major domestic receiver manufacturers, covering some 20 trade names, and several of the smaller companies have held trade shows in London during the past few weeks. Having visited these and obtained information from some manufacturers not holding an exhibition, we have endeavoured to assess what, if any, are the significant trends in domestic receiver design. One interesting aspect of these private shows is that manufacturers have not been bound by the "British made" formula as they are at the National Radio Show. Philips, for instance, showed several models "made in Holland" and are using a Dutch chassis in some radiograms. There have, of course, also been a number of exhibitions staged by agents of overseas manufacturers. We are not, however, dealing with all of them in this survey as many of the sets will be seen at the various Continental shows which are being reviewed separately; the Berlin show in this issue and the Paris and Amsterdam shows in November.

TELEVISION

THE most active member of the television receiver design team this past year appears to have been the cabinet maker. Economic considerations decree that for mass production, standardization is essential, and electrically-speaking, receivers are rapidly approaching the economic ideal. The adoption of the u.h.f. 625-line system, and the period of transition from one standard to the other, brought many problems, but these have been overcome and an almost standard specification has been evolved. This is a very good thing from the point of view of production and economy of design effort, but it does materially reduce the number of interesting circuits one can describe.

Tube sizes remain at 19 and 23 inches, the introduction of the new standard favouring a swing towards the larger tube, which is probably about the maximum size for comfortable viewing.

The vexed question of how to get from one standard to the other seems to have been resolved in the logical way with maximum convenience to all concerned. "Convertible" sets—those which can be converted to 625 lines by replacing parts of the chassis and adding a tuner—have almost disappeared and most of the sets seen are of the dual-standard variety. In these receivers, every circuit is switched to operate on either system and the tuner is already provided. The controls are therefore laid out logically with no evidence of afterthoughts. These dual-standard receivers cost very little, if any, more than the old single-standard sets, which means that for the viewer who is not likely to be within the service area of a u.h.f. transmitter before his set is outdated, a dual-standard receiver minus its 7- or 8-guinea u.h.f. tuner is an economic proposition.

Experience has yet to show the effect of ignition noise on u.h.f. transmissions in all circumstances. Theoretically, it should not be too much of a problem in Bands IV and V, and possibly for this reason, flywheel-sync units are often provided as a plug-in or easily-fitted accessory.

Mean-level a.g.c. continues to reign supreme, unfortunately, although K.B.'s "Finlandia" uses the gated type. Alba were showing receivers (T890 and T895) using amplified mean-level a.g.c. and the Bush TV123 has adjustable, delayed control.

The potential quality of sound in television transmission is at last being realized, and several firms are making definite efforts to produce a rather better sound than has been usual. Decca, for instance, use a forward-facing 10×6in speaker in an enclosure.

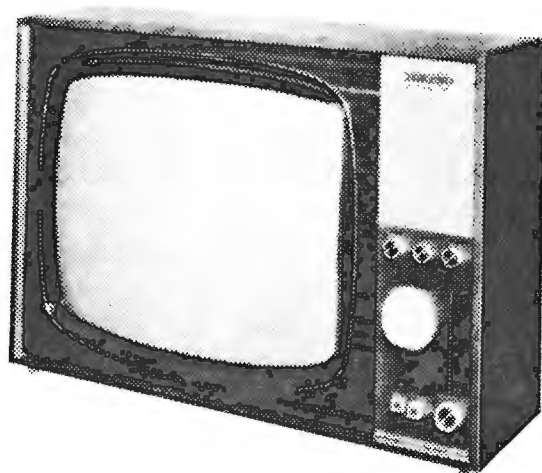
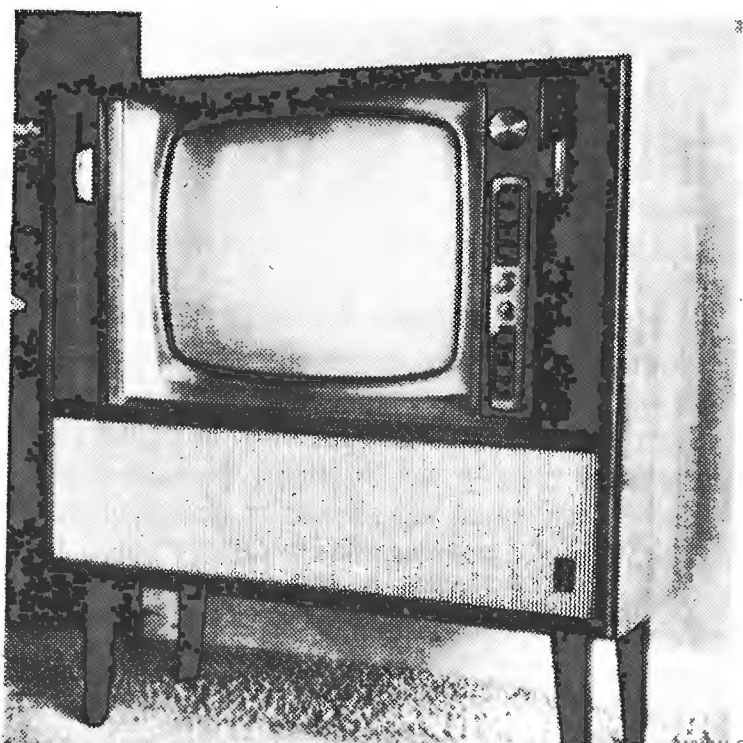

TV960 19-in. dual-standard receiver, first in the Peto-Scott range.

Murphy V873C, with flywheel sync.

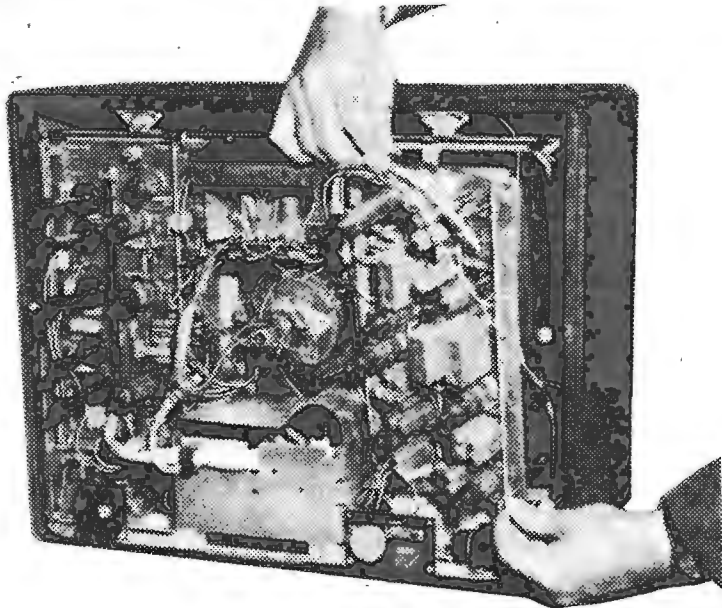

Philips 9152, with back removed. All parts are accessible for servicing.



Decca DR202 with doors closed. Lower part of cabinet houses 10 x 6 in loudspeaker.

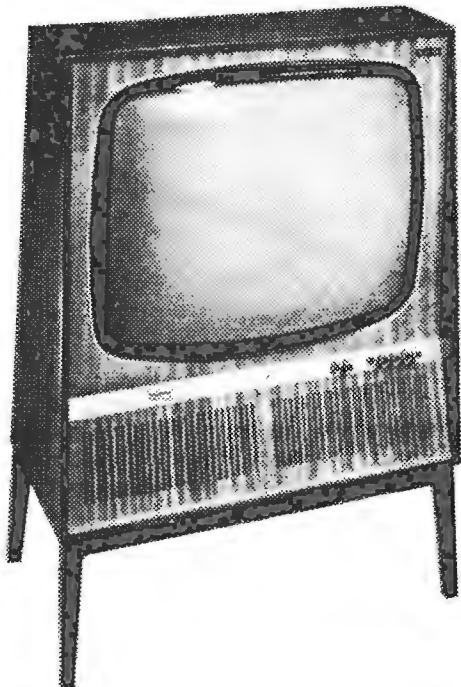

Defiant 3A54 23-in dual-standard set. Interlace is claimed to be exceptional.

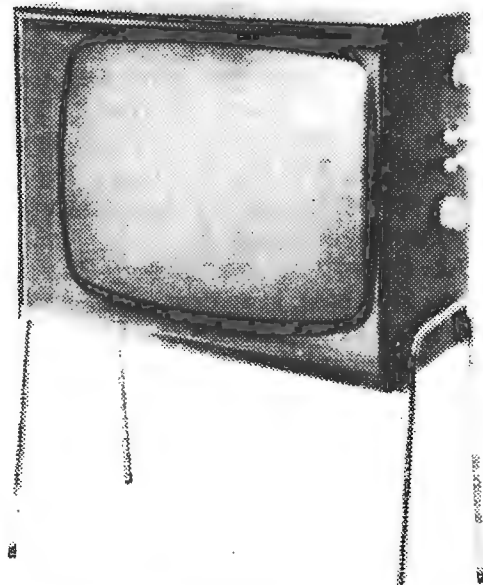

Ultra Bermuda. Available in both dual-standard and convertible forms.

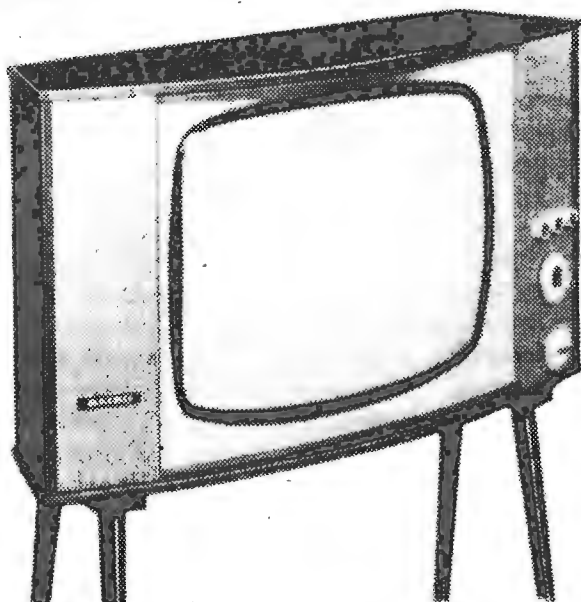

Baird 628, with fly-wheel sync, scan stabilization, and higher e.h.t. than usual for increased brightness and contrast.

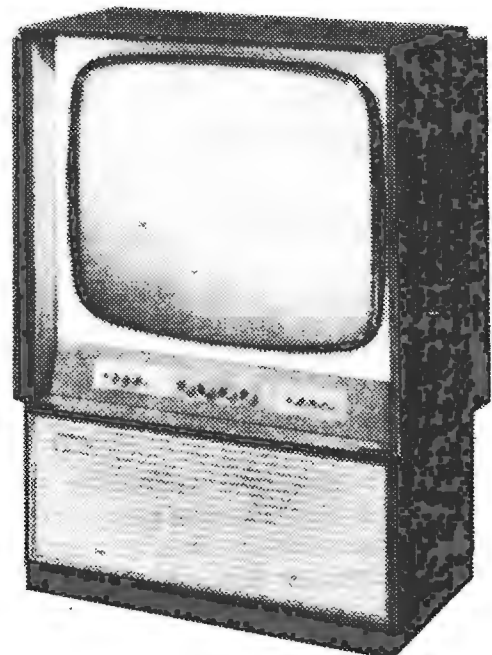

Ekco TC421 with u.h.f. push-button tuning and forward-facing speaker.

Bush and Alba also position their speakers at the front and have dispensed with insignificant little units that leave a double-bass player twanging away at -50dB or thereabouts. The use of f.m. sound on 625 renders a discriminator necessary, and the British Radio Corporation (H.M.V., Marconiphone, Ferguson) have taken advantage of this to provide for reception of v.h.f. broadcasts. As no one seems to remember why 10.7Mc/s was chosen for the f.m. intermediate frequency, B.R.C. were a little wary of using the 6Mc/s intercarrier i.f. of television, but no snags have been found.

Reception of 625-line programmes from the Continent may necessitate a field frequency which is not locked to the 50c/s mains. Normally, this would produce a broad moving hum bar across the picture, but several receivers are now being provided with sufficient h.t. smoothing to obviate this. Also slightly unusual in the power supply department are the G.E.C., Sobell and McMichael receivers, in that there is no thermistor in the heater chain. Sets of Mullard valves are used which warm up at the same rate and do not cause unequal heater loadings.

Taking account of conditions experienced last winter, when pictures shrank and went out of lock, most firms have introduced some measure of scan stabilization, both in regard to frequency and amplitude. Bush/Murphy, for instance, use separate multivibrators for both frame and line. The flyback pulse from the line output transformer is stabilized, and as this provides the boost voltage for the frame oscillator, the frame frequency is stabilized. Frame output is thermally controlled.

Mechanical design of many sets has improved enormously in the past few years, particularly from the point of view of accessibility. G.E.C. receivers, for instance, are completely accessible from the rear. The main printed panel lifts out and is propped in a convenient position for servicing while the set is still in operation. A hinged chassis is used in Pye models, which also work when opened out. Printed circuits, even after so many years, are still the subject of heated arguments. G.E.C., Sobell and McMichael use "plated" circuits with plated-through component holes and are proud of the fact. Decca, on the other hand, will not have them at any price, saying that they are prone to failure and are difficult to service.

No colour television was seen at the shows. Presumably this is due to the fact that no one yet knows which kind to make.

UHF AERIALS

THE imminence of the introduction in this country of a television service in Bands IV and V has placed the emphasis on u.h.f. aerials. It is extraordinary how the catch-phrase "625 lines" has even got into the jargon of aerial manufacturers for we now have 625-line aerials!

When the u.h.f. service opens, initially in London, next April, there will doubtless be many problems for aerial installers. Variations in field strength in built-up areas may be considerable. It will no longer be possible, in general, to say that in this or that area only an *n*-element array is needed. Whereas in one house a 3-element aerial (or even a set-top device) may suffice, in another a few streets away a multi-element array may be necessary. To facilitate the final

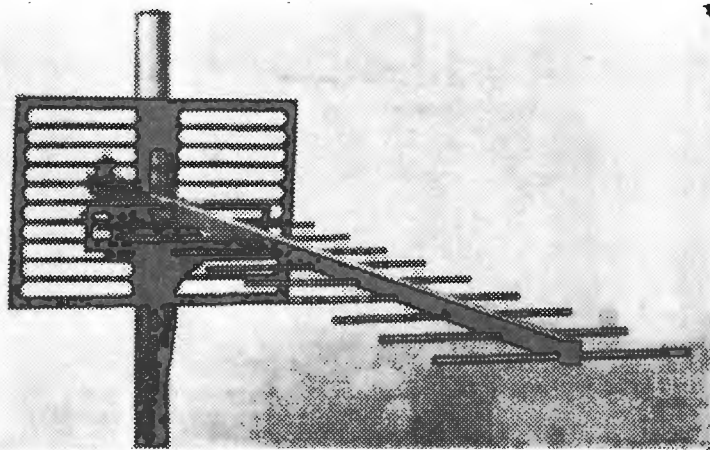

Aerialite employ a sheet metal mesh reflector for all their u.h.f. arrays.

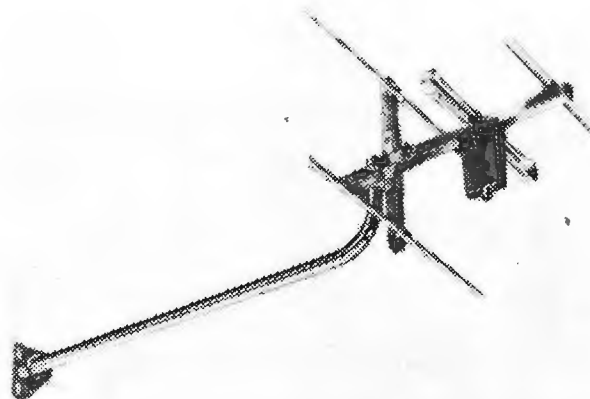

Particularly designed for flat dwellers the Anti-ferrence "winner" array is for window mounting. Note the combined balun-connector unit.

choice of the size of array required some manufacturers (including Aerialite and Belling-Lee) have introduced "add-on" booms enabling fitters to modify aerials on the site with a minimum of trouble.

Several manufacturers are following the Continental trend by using rectangular section booms which facilitate the addition of an extension. Some are also using curved section elements.

Various shapes have been adopted for the dipole. Aerialite are using what they call a "planar" folded dipole. It is pressed out of sheet metal, and the upper and lower edges angled for strength.

As there are a variety of shapes for dipoles so there are different types of reflector. Aerialite Tele-rection and Wolsey favour the mesh type. Aerialite's reflector, which is pressed out of sheet metal, is claimed to be equivalent to eleven rod reflectors. Telerection are using a wire mesh reflector and in one model have used a mesh corner reflector with a "bow-tie" pressed-steel dipole. Incidentally, Telerection are using steel cocooned in polythene for all their aerials. Antiferrence, Belling-Lee, Ben Nevis, and Labgear favour the multi-rod reflector.

One of the main bones of contention among aerial designers is whether or not it is necessary to fit a "balun"—a device enabling the connection of an unbalanced cable to the balanced dipole without interfering with the performance of the aerial.

Antiferrence, who fit baluns to all their u.h.f. aerials,

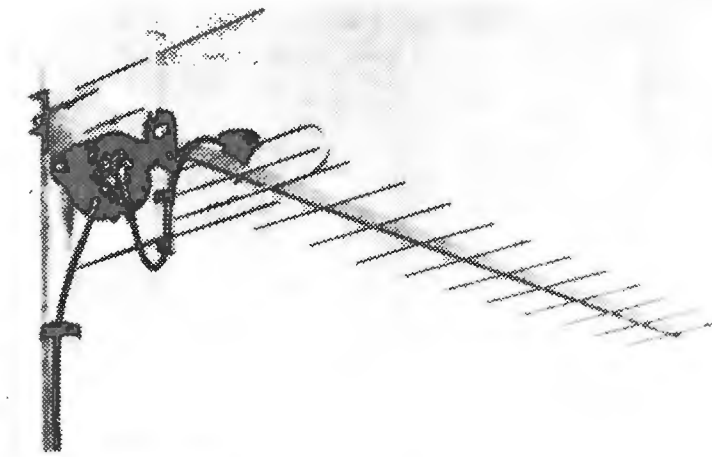

Labgear's 14-element u.h.f. aerial with low-noise transistor pre-amplifier from which the cover is removed. The amplifier, giving a 14 dB gain is powered through the download by a small unit attached to the receiver.

claim that this is essential if the laboratory performance of the aerial is to be repeated in general use. It is the last few inches of the cable run to the dipole which give rise to the field disturbance. These few inches may be insignificant when operating in Bands I and III but they are such a large fraction of a wavelength in Bands IV and V that Antiference claim a serious disturbance of the field around the dipole is created.

Another moot question is whether or not it is advisable to use a diplexer to enable a common downlead to be used from v.h.f. and u.h.f. aeriels. Some manufacturers and installers contend that it is preferable to run independent leads from each, especially as a common lead necessitates the use of a combining unit, or diplexer, on the mast and another at the set as all receivers have separate v.h.f. and u.h.f. inputs.

Notwithstanding what has been said about the problems of u.h.f. reception there will be many areas where the field strength will permit the use of a set-top aerial or similar device. Most manufacturers have therefore introduced various types including the "Discus" (a disc device from Belling-Lee of which no details are available) and the Telerection "Double Top," which is a rotatable "bow-tie" element with a "dartboard" grid reflector. Several manufacturers are also producing small arrays for window mounting.

SOUND RECEIVERS AND REPRODUCERS

DESPITE the cacophony emanating from once-favourite picnic spots and beaches, the "transistor portable" has not as yet totally distracted attention from the development of new table-model receivers. Many new table models made their appearance at the shows. Though proven circuit techniques were retained (this being true for most domestic categories) cabinet stylings were new. If a trend was indicated, this was the use of push buttons where possible in place of knobs. Almost all new table models seen, had v.h.f./f.m.—a testimonial to the now almost country-wide f.m. transmissions of the B.B.C.

Of particular interest in the f.m. field was the push-button tuning system employed on the Model U428 receiver manufactured by Ekco. Here, depression of the relevant button gives instant selection of

the transmission required. An a.f.c. system is not employed, since it is claimed that on Band II services in certain areas, a.f.c. can result in programmes being received indiscriminately from one of several transmitters. Also, brief interruption of the wanted carrier can result in the set tuning itself to another station. The system is based on the usual 2.2Mc/s spacings between programmes from the B.B.C. transmitters. The buttons are used in conjunction with a tuning pointer which is adjusted by the user to coincide with a pre-set red indicator. (This is pre-set to 95.7Mc/s if the set is being used in the Wrotham service area). After lining up the tuning pointer on the red indicator, if the "Home" button is depressed the frequencies of the local oscillator and the r.f. anode circuit are lowered by 2.2Mc/s. Similarly, the "Third" button lowers them by 4.4Mc/s and the "Light" by 6.6Mc/s. The stability of the system is such that retuning by the user should not be necessary. The 2.2Mc/s steps are achieved by switching in extra capacitors across the oscillator circuits. Frequency changes due to thermal drift are within 15kc/s on the f.m. tuning circuit. The repetition accuracy on the push-button selection system is within 5kc/s. A similar circuit is used by Ferranti on their Model 1103 receiver.

Whereas country-wide f.m. coverage has induced many manufacturers to incorporate v.h.f./f.m. tuners in their sets, the Hacker "Mayflower II," mains-operated, table receiver is f.m. only. A push-pull, 7W, ultra linear output stage feeds a 10×6in loudspeaker. An internal aerial is provided but so also is a socket for adoption of an external one. Other facilities include sockets for tape record and replay and gramophone pick-up. An external loudspeaker (15Ω) can be plugged into the radio.

Judging by the prominence and proliferation of the displays, the day of the "transistor portable" has

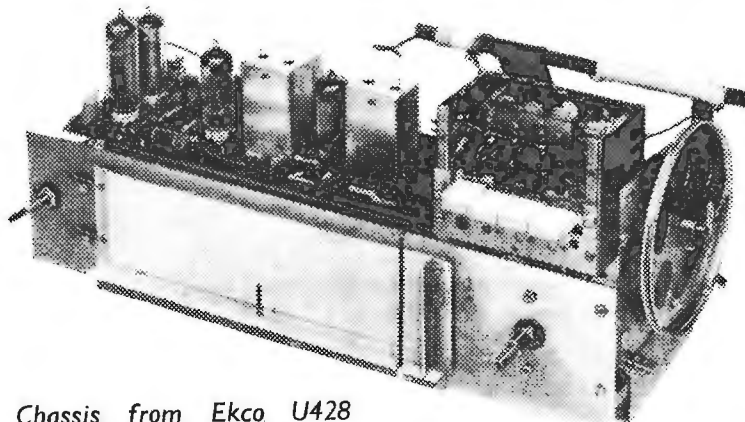

Chassis from Ekco U428 push-button tuned f.m. receiver. Medium and long wavebands are also provided.

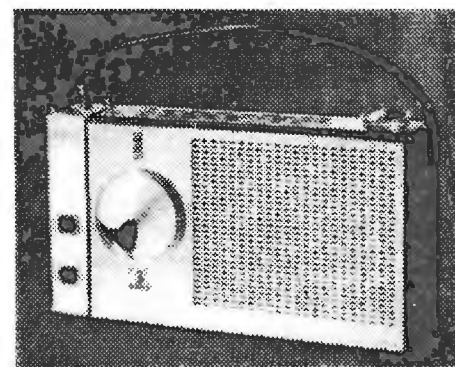

Sobell receiver employing thermistor temperature compensating circuit.

not reached its twilight. Many small and not so-small, but all portable, were exhibited. Some, could be quickly converted for car installation. V.h.f./f.m. tuners were incorporated on some new models.

The designer of the Perdio "Town and Country" model, has provided, in addition to the customary medium and long wavebands, a shipping band from 1.6 to 4.7Mc/s. The Dynatron "Jewel TP30," transistor radio featured a "4-position tonal colour switch." Operation of this switch changes tone-control networks to provide four listening conditions, namely speech, jazz, orchestra and mellow. A 6×4in elliptical loudspeaker is fed from a 1W, push-pull output circuit.

The linear tuning scale calibrated in frequency and wavelength is a feature of the Sobell 314 transistor portable. A temperature stabilizing circuit using two thermistors is incorporated. Frequency coverage is 150 to 265kc/s, 540 to 1,560kc/s and 5.7 to 16Mc/s.

For the man who likes to "roll his own," Heathkit's "Oxford" transistor portable provides 500 mW into a 7×4-in speaker, with push-buttons for wave-change and tone control, which consists of a capacitor across the emitter resistor of the voltage

amplifier. Provision is made for connection of a car aerial, and a tape-recording output is taken from the detector.

An electronic locking device, through the car's ignition system, has been included in the latest "car-portable" from Ever Ready. Called the Sky Tourer, it covers the l.w. and m.w. bands. A mounting tray and a separate 6×4in elliptical speaker unit are included in the price.

Best described as transportable rather than portable, the transistor Intercontinental 1125 manufactured by Decca Radio and Television Ltd., covers the frequency range 1.6 to 5Mc/s, 4.6 to 14.6Mc/s, 9.4 to 30Mc/s, 520kc/s to 1,650kc/s and 145 to 290kc/s. Both the main-tuning capacitor and band-spread capacitor are 3-gang types. Bandsread can be effected over any one of the bands without further adjustment of the main tuning control on that band. The receiver can be powered by a bank of internal U2 batteries or a PP10 (or equivalent).

Many new radiograms were introduced at the shows. With very few exceptions the design accent was centred on furniture styling, chassis being common to a number of *marques*. Also, and again with a few exceptions, v.h.f./f.m. tuners were incor-

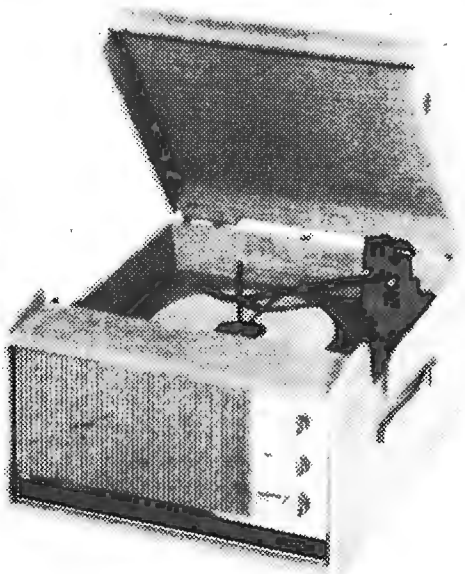

RP1106 record player manufactured by Ferranti has a 7W output.

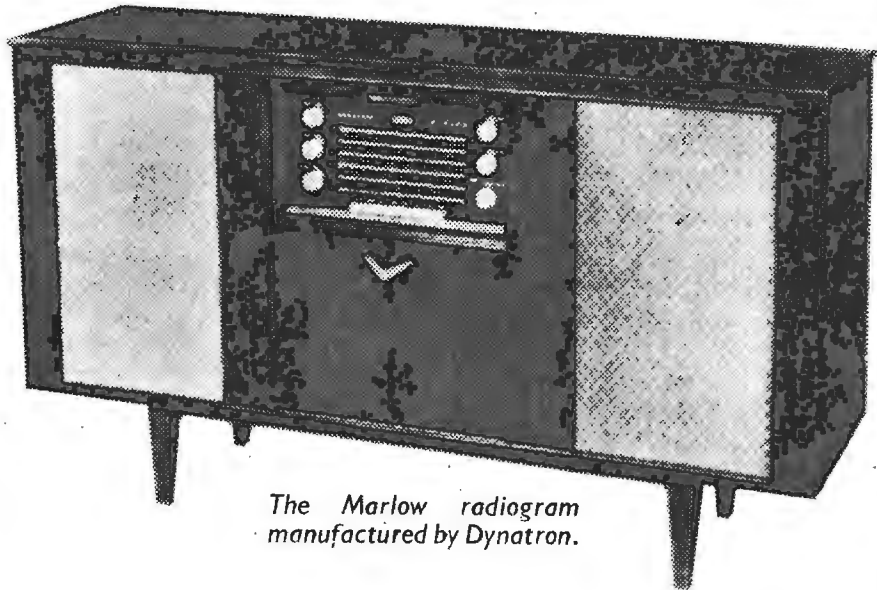

The Marlow radiogram manufactured by Dynatron.

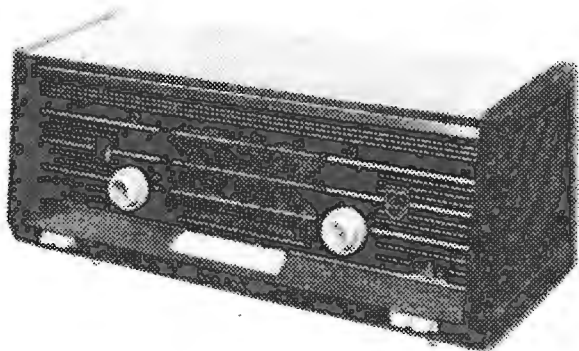

Model 4X23A radio receiver manufactured by Philips. Two 5-in speakers are employed.

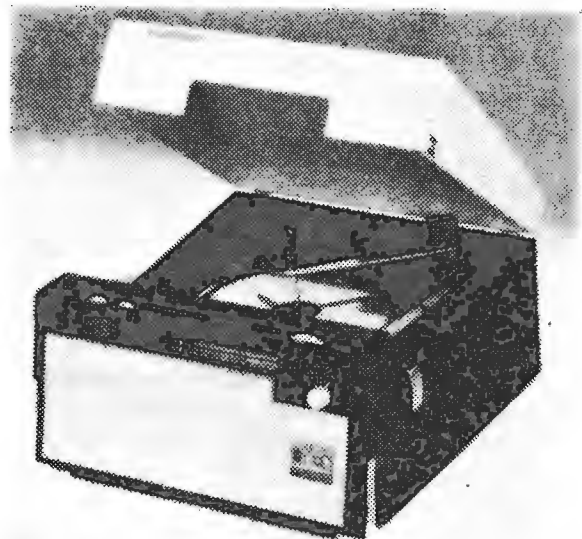

The "Perdiogram Auto" battery/mains powered record player.

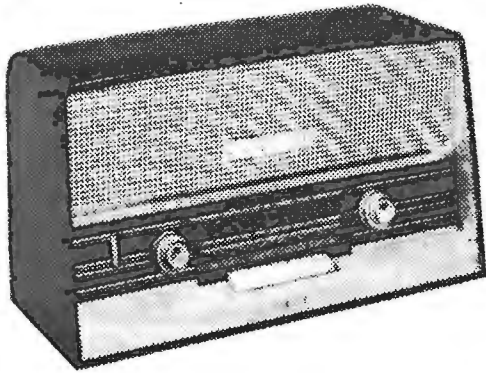

The Baird Model 270 transistor, table-top receiver uses a 7×4in. loudspeaker. Provision is made for the use of larger long-life batteries or the smaller types usually encountered in portable radios.

Four-waveband a.m./f.m. receiver made by Stella. Two 5-in. dual-cone loudspeakers are used. Tone adjustment is made by five push buttons.

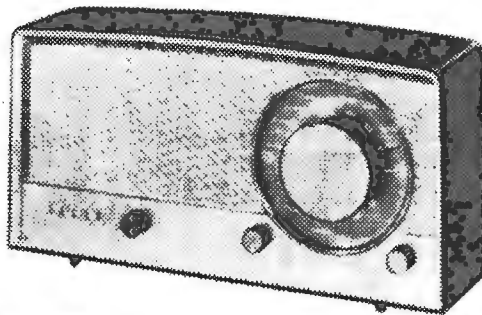

Roberts Radio R.200 transistor portable radio receiver. A hinged door at the back of the case and a rotating chassis facilitates servicing.

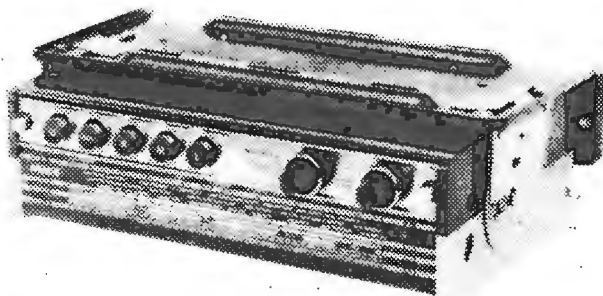

Car-fitting version of the Grundig Automatic Boy transistor portable receiver. The side panels can be removed to convert set to portable version.

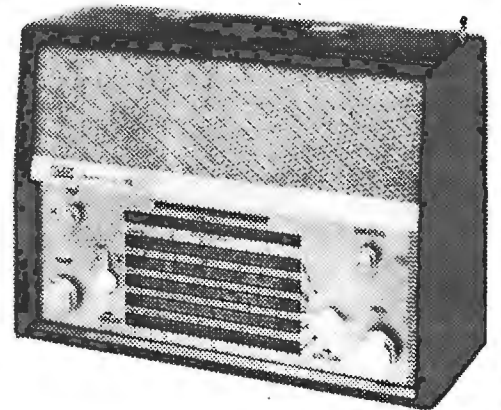

Decca Intercontinental 1125 transistor portable receiver, covering the short-wave bands with bandspread tuning.

porated. Many manufacturers left ample space and connection points in their cabinets for the addition of a tape recorder.

No one can accuse the B.B.C. of loudly proclaiming their stereo transmission intentions, but even so a number of radiograms were shown as being "readily adaptable to receive stereo broadcasts." In some instances the purchase of a decoder unit will be necessary; the Dynatron Marlow radiogram RG27, however, is sold complete for the reception of the Zenith-G.E. system of stereophonic broadcasts. Worthy of special mention was the demonstration of the Decca "Junior Separates", designed to meet the considerable demand for what might be termed "mid-fi" quality of reproduction. These consisted of a record player using the Deram arm and cartridges, and the "3+3" transistor stereo amplifier housed in a low-level cabinet. Space is also available for the addition of a tuner unit. Two separate loudspeakers 13×8in in cabinets completed the installation.

Departing the "house-furniture" radiogram field and entering the portable, Perdio introduced their first models. Both types were battery/mains powered and both had medium and long wavebands. One, the Perdiogram Solo, plays records singly, the other model had an autochanger unit.

Many of the record players introduced if not boasting stereophonic reproduction, claimed easy convertibility. A newcomer, the RP1106 manufactured by Ferranti with an output of 7W, can also

be used as an amplifier for radio, tape replay and baby alarm. A comparative newcomer to the domestic-radio ranks, Silvertone, featured record players (and other equipments) housed in thermo-plastic cabinets.

TAPE RECORDERS

THE only novelty in tape recorders this year is the announcement of a low-priced video recorder by the newly formed Nottingham concern Telcan. The machine, which is designed to record domestic TV programmes and is used in conjunction with a standard receiver, opens up new possibilities in the domestic entertainment market and the manufacturers have stated that they will be marketing them by the end of the year.

Standard $\frac{1}{4}$ in magnetic tape running at 120in/sec is used for recording TV programmes. The signal-to-noise ratio at this speed is about 28dB and the bandwidth is around 2 Mc/s. Obviously these standards are considerably lower than those associated with the professional video recorders, but so is the price at 59gns. compared with the professional instruments which are priced from £4,000.

Conventional recording techniques are used in this machine and the signals to be recorded are taken (and on playback reinstated) from the output of the receiver's detector stages. The maximum spool size is 11in and using triple-play tape it is possible to

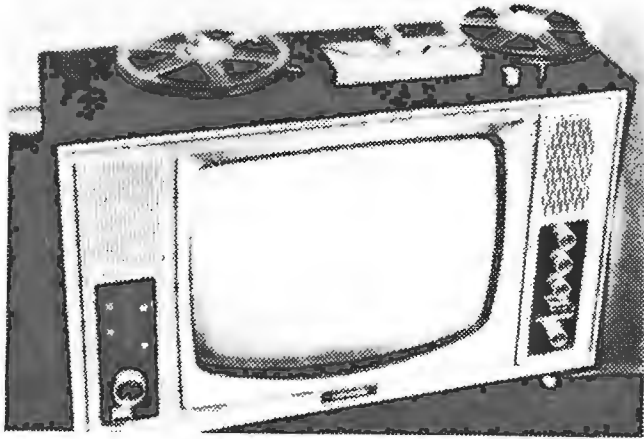

Telcan—the first domestic video recorder. It is shown here as an integral part of a television receiver.

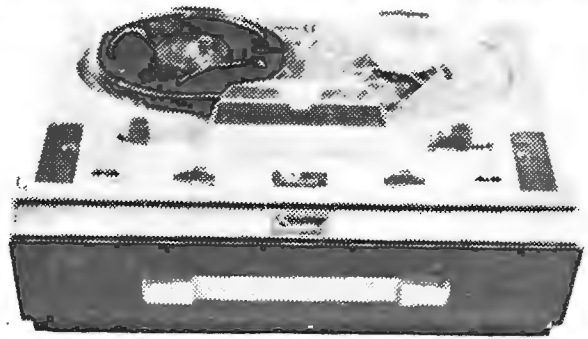

Fidelity's single-speed, four-track Playmaster.

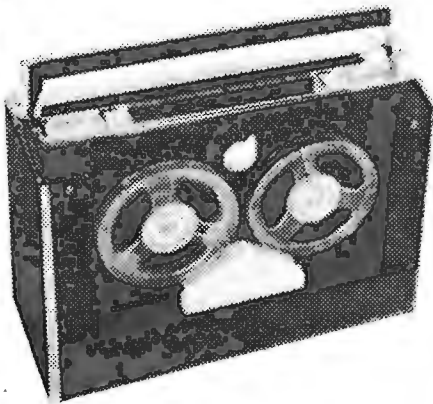

Grundig's latest mains/battery recorder, the TK6 with the spool cover removed.

Dynatron's latest recorder, the Specialist 1200, has a semi-professional specification which includes variable bias fade, echo effect and full superimposing facilities.

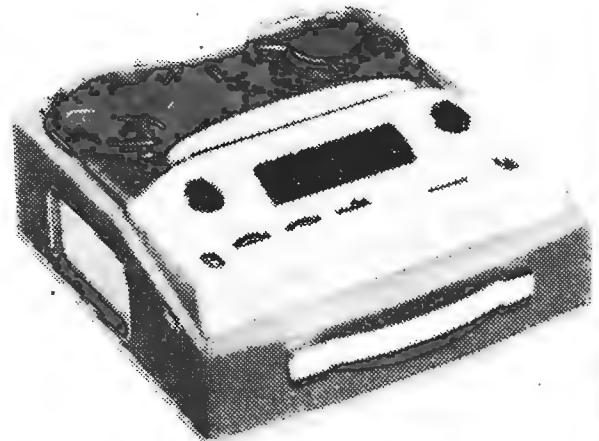

This three-speed twin-track machine is the latest model in Tape Recorders (Electronics) Riviera series.

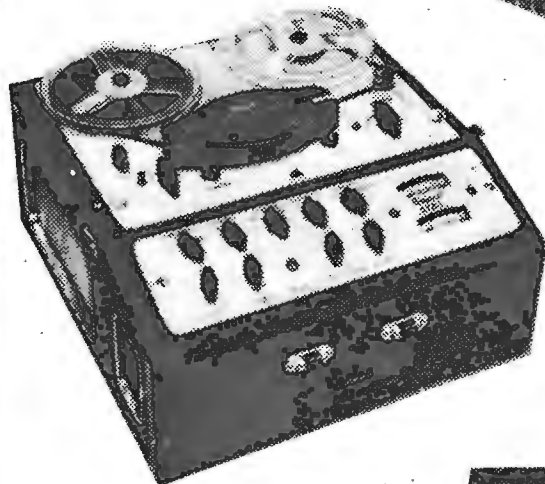
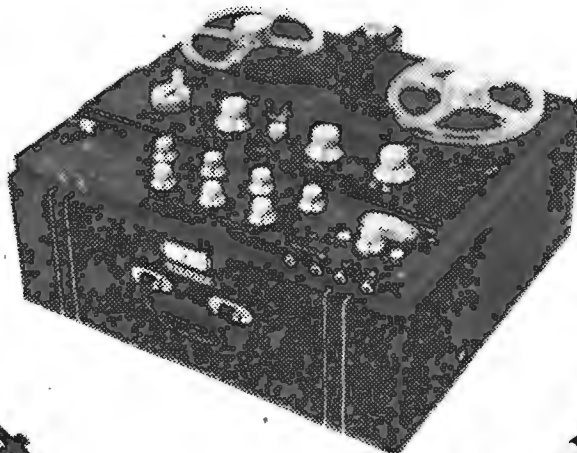

The Brenell STBI four-speed four-track recorder has full mono and stereo record and playback facilities. Features include monitoring from a separate head, variable bias, and track-to-track superimposition.

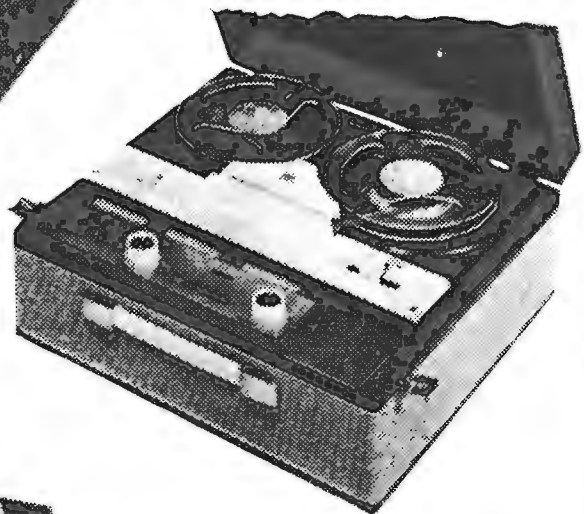

Two new models, the T14 (twin-track) and the T15 (four-track, shown here) have been added to the Defiant range of recorders this year.

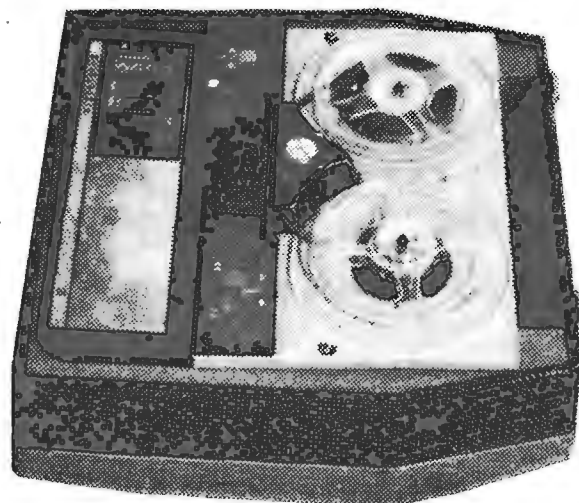

Masteradio's latest model, the D502, is a twin-track machine with a single speed of $3\frac{3}{4}$ in/sec and an output of $2\frac{1}{2}$ watts.

record a 30-minute programme. Incidentally, a $7\frac{1}{2}$ in/sec speed is provided for sound only recording.

With the exception of a high-frequency-controlled motor in the new Grundig TK6 portable (which is explained at the end of this section) there appear to be no major changes in the mechanical or electrical design of recorders this year. However, there have been many detail changes to simplify operation and provide some of the cheaper models with facilities which have previously been associated with the higher-priced models.

Among the lower-priced machines are two new recorders from Fidelity. Called twin-track and four-track Playmasters, these single-speed models are simple to use and have facilities for headphone monitoring. Tone controls and magic-eye level indicators are fitted to both models, whose outputs are rated at 3 watts, and a tape indicator is fitted to the four-track model which, incidentally, sells at 23 gns complete with microphone and tape. The latest model from Fidelity is the three-speed, four-track Playmaster Major, which uses the latest B.S.R. deck, the DT10, and incorporates a meter level indicator and full superimpose facilities.

Parallel track facilities have been incorporated, for simultaneous playback of two separately recorded tracks, in a new four-speed, four-track recorder by Cossor this year. Designated CR 1605, this machine has a fully transistorized amplifier and a new deck layout. There are also facilities for mixing microphone with radio or gramophone inputs, and for monitoring, through either headphones or the internal speaker whilst recording.

Separate level controls for microphone and radio inputs have been added to the only new model in the current range of Dansette recorders. Called the Empress, it uses the latest three-speed four-track B.S.R. deck and its features include a strip record level indicator and a 3-digit tape position indicator.

To facilitate playback of recorded tapes, which are becoming more popular, Tape Recorders (Electronics) have introduced a mains-operated add-on unit. Priced at 14 gns, this accessory enables all the current "pre-recorded" tapes to be played on their four-track Sound Riviera and Slimline machines.

Lee Products have introduced two new models this year, the Shaftesbury 802, a single-speed twin-track recorder and the 804, a twin-speed four-track machine.

Following the introduction of a recorder with the "magic ear", a voice-operated gain adjusting device, at the beginning of the year, Grundig's have introduced a special version, of the TK18 "magic ear" recorder, with all the controls marked in Braille relief. The price of this machine, which includes microphone and tape, is remaining at 39 gns.

Among the quality machines designed for use in large rooms or halls without additional amplifiers are two models from Clarke and Smith; the TR 634 and the TR 635. Both machines incorporate 10 watt transistorized amplifiers, the outputs of which may be developed across the internal 9×5 in speakers or externally connected to either 15Ω speakers or a 70 volt line. The major difference between the two machines is that, priced at 103 gns, the TR 634 uses a Mk V Wright and Weaire deck and the TR 635, which retails at 86 gns, uses a Mk II Truvox D82 deck.

Ferrograph have introduced two new series of recorders, the 5A and the 420. A modified capstan

flywheel assembly has been fitted to the first machine in the 5A series (5A/N) to improve wow and flutter characteristics and to extend the frequency response. Priced at 85 gns, the 5A/N is designed for standard mono recording and playback at $3\frac{3}{4}$ and $7\frac{1}{2}$ in/sec and has its own $2\frac{1}{2}$ watt power amplifier and speaker. The Ferrograph 420 series make use of the standard Ferrograph deck whose features include three independent motors and a gear-driven turns counter, but have no internal speakers or power amplifiers. Features of these 110-gn machines include facilities for track-to-track recording and stereo recording and playback with continuous monitoring on both channels.

The cabinet shape of Simon's semi-professional recorder, the SP5, is rather unusual but practical, as the rear compartment houses a 10×6 in speaker with a 4 in tweeter. Facilities of this two-speed, twin-track model include track-to-track re-recording, and simultaneous monitoring.

An unusual method of controlling motor speed in Grundig's latest portable recorder—the TK6—has been introduced to overcome pitting and burning of the make and break contacts in the centrifugal governors, which were previously in series with the d.c. motor's power supply. Two transistors are used—one as a switch and one as an oscillator—and a theoretical diagram showing the essential parts is given below.

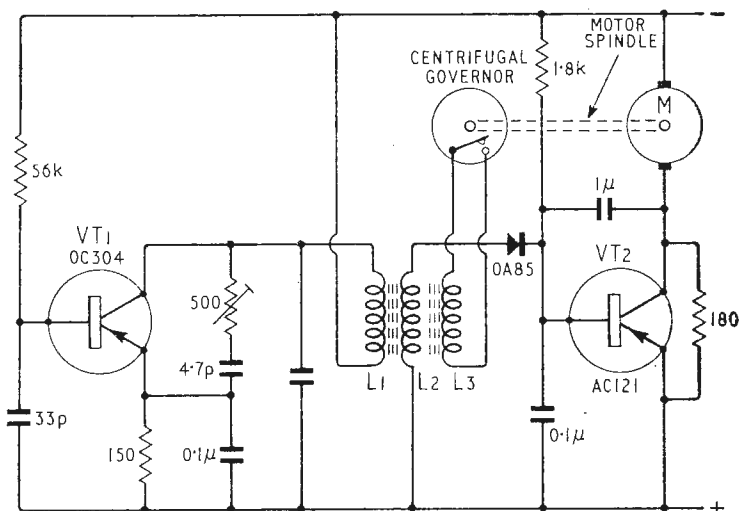

High-frequency motor control circuit for the Grundig TK6.

When power is connected to the control circuit, transistor VT1 starts to oscillate at about 70 kc/s. The output of this transistor is rectified and applied as a positive potential to the base of the switching transistor VT2. When this potential overcomes the existing base bias on VT2, the transistor conducts, and short circuits the 180Ω resistor in series with the motor's power supply.

The motor then starts to revolve and this condition remains until the speed of the motor is such that the contacts on the centrifugal governor close (through excessive speed) and short L3, a heavily damped (resistance) winding on the oscillator former. This causes the oscillations to cease which, through VT2, disconnect the supply to the motor.

Once the speed of the motor falls, the governor's contacts open and this restarts another cycle of operation—VT1 begins to oscillate and, through VT2, power is restored to the motor. The make and break frequency of the governor's contacts is the same as the conventional type of regulator systems, which are said to be supersonic.

Controlled Rectifiers in Stabilized Power Supplies

By F. BUTLER

FOR use in low power applications, voltage regulators using a transistor as a series or shunt regulating element have been developed to a stage which meets most practical requirements. The performance is particularly impressive as regards ripple voltage reduction, low output impedance, close regulation at any preset level, rapid response to load current or supply voltage changes, freedom from overshoot and absence of disturbing radiation or noise. The circuits tend to become rather complicated when it is required to control the output voltage over a very wide range and the electrical efficiency is poor if maximum current demand coincides with a low output voltage. If, for example, a particular unit is designed to give 2 to 28V output at 5A load current, it is reasonable to allow say 3V drop across the series regulating transistor at full output power. The transistor dissipation is then 15W and the requisite input voltage to the regulator is 31V. If the output is reduced to 2V at 5A the voltage drop across the transistor becomes 29V and the power dissipation rises to 145W. The situation could be improved by switching the power transformer secondary voltage in steps corresponding to the desired output voltage, but this raises other complications.

An alternative scheme is to switch the series regulator transistor on and off so that it is periodically cut-off and saturated. In both these conditions the energy dissipation is small and, provided the switching is abrupt, there is little energy loss during the transitions. The actual output voltage will then depend on the proportion of the total time during which the switch is closed. This economy measure has some unfortunate consequences. In the first place the output now requires to be filtered and smoothed. If a large capacitor is used alone the switching transistor will be called upon to pass current pulses of possibly damaging amplitude. To reduce these we may use a choke input filter, only to encounter another difficulty concerned with time constants. If the cut-off frequency of a low-pass filter is f its response time will be $1/f$ and this time-lag implies a corresponding time delay in the response of the regulator to load current changes. There are

attendant difficulties with stability in the control amplifier loop. Concepts like the output impedance of a switching-mode regulator need careful examination; the regulator transistor contributes nothing to the smoothing and the filter alone must serve this function. Clearly there are advantages in using a high switching frequency but the limit is set in practice by the cost and availability of power transistors with good switching characteristics.

Once the idea of a switching-type regulator is accepted it is possible to consider alternatives to the transistor as the series element. A transducer with a square-loop core material is one attractive possibility. Another is the silicon controlled rectifier. Both of these are most conveniently designed to switch synchronously at the power supply frequency whereas a synchronous switching of a transistor is made possible by using it as one element in a relaxation oscillator.

To sum up, the conventional series—transistor regulator gives an excellent performance in low-power circuits at the cost of efficiency. Moreover, the wasted energy is dissipated in the most inconvenient and expensive way. Switching-type regulators can give a very wide range of output control with high efficiency at any load. The performance is achieved with some sacrifice of response time, an increased output impedance, and less perfect smoothing. If an input choke filter is used there will be voltage overshoot when the load is reduced and undershoot if it is increased. This is due to energy storage ($\frac{1}{2} Li^2$) effects in the filter choke. If a large capacitor is used alone (without a surge-limiting resistance), high peak currents will call for de-rating of rectifiers and power transformers in the system. Protection by fuses will be made more difficult. High-speed switching transients are potentially damaging to vulnerable components like controlled rectifiers and they can also be a nuisance if the power supply feeds a receiver or high-gain amplifier. Nevertheless there are applications for which switching-mode regulators are well suited or at least acceptable and they make an ideal pre-regulator for use with the series-transistor type when the ultimate in performance is desired.

In the February issue of this journal the writer

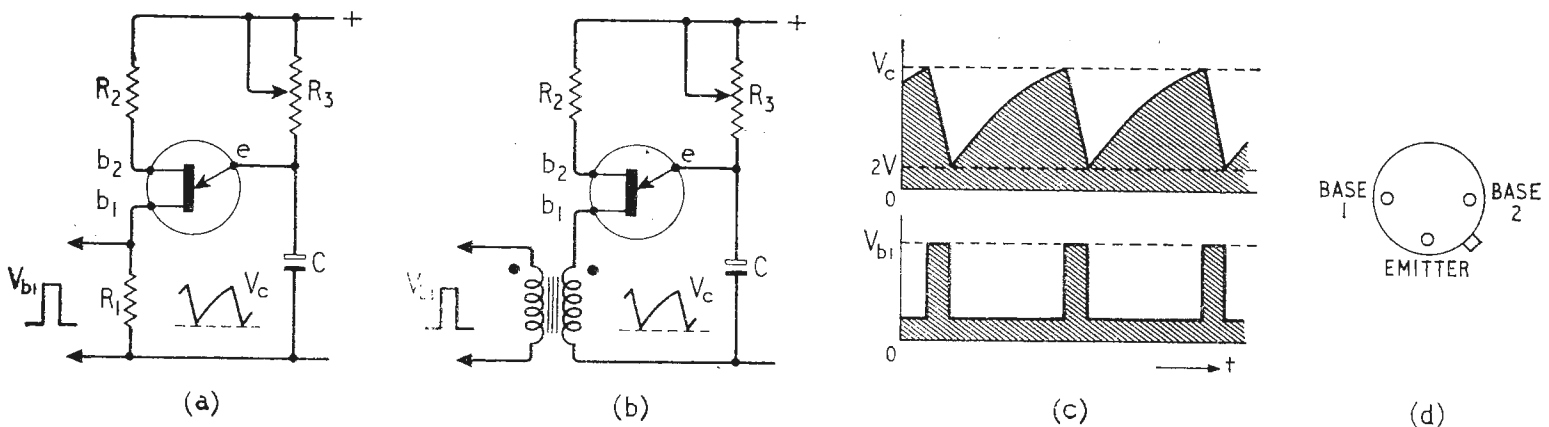

Fig. 1. Unijunction relaxation oscillators.

described a number of d.c. power supply units, employing controlled rectifiers, designed to give a variable output voltage while providing reasonably close voltage regulation at any chosen output level. The present paper is a sequel to this and is taken up with a discussion of two practical circuits giving a much improved performance at the expense of only moderate increases in cost and complexity. With no change in principle and with scarcely any modifications, other than obvious changes in transformer and rectifier ratings, the circuits may be used to give a closely regulated output at any level between a few watts and several kilowatts or even tens of kilowatts.

It is assumed that the reader is familiar with the basic principles of operation of controlled rectifiers and, if not, the elementary discussion given previously will provide sufficient background to understand the present work.

Pulse Firing Circuits

The ideal gate trigger signal to fire an s.c.r. is a rectangular pulse having a duration of a few tens of microseconds. Once fired, the s.c.r. will continue to conduct so long as its anode remains sensibly positive with respect to the cathode. A gate signal of long duration is objectionable since it merely increases the gate-circuit energy dissipation. If the gate-drive pulse can be delayed with respect to the time of application of positive anode voltage then firing will be correspondingly delayed and, with a fixed load, the circuit current will be reduced and so will the mean voltage developed across the load. Automatic control of the firing-pulse delay will serve to control or regulate the output voltage.

It is not particularly difficult to design a pulse generator in which the time of occurrence of a pulse is caused to vary in response to a control signal derived from an external source. The voltage-regulator problem is virtually solved if we can arrange that any small reduction in the output voltage, due to supply voltage or load current changes, is amplified and used to advance in time the firing point of a controlled rectifier used as a series regulator element.

One of the simplest pulse generators for this purpose makes use of a unijunction transistor. This is a three-terminal semiconductor device made from a small rectangular block of n-type silicon. Two ohmic contacts, base-1 and base-2 are formed at opposite ends of the bar and on the same side of it. A third (rectifying), contact known as the emitter is made on the opposite side of the bar, closer to b_2 than to b_1 . Normally b_1 is earthed and a positive supply voltage is connected, through a current-limiting resistance of a few hundred ohms, to b_2 . In the absence of emitter current the bar acts as a simple voltage divider having an interbase resistance of 5 to 10 k Ω . If the applied external emitter voltage is less than a certain critical fraction of the supply voltage the emitter is reverse biased and the emitter current is simply a small leakage current. When the emitter voltage is raised to the point at which forward conduction takes place, holes are injected into the silicon bar. They drift down towards b_1 and give rise to an increased electron density in this region. The net result is a decrease in the resistance between the emitter and b_1 which accounts for a further increase in emitter current. The path e- b_1 has a negative resistance characteristic and the device can be used as a type of relaxation oscillator.

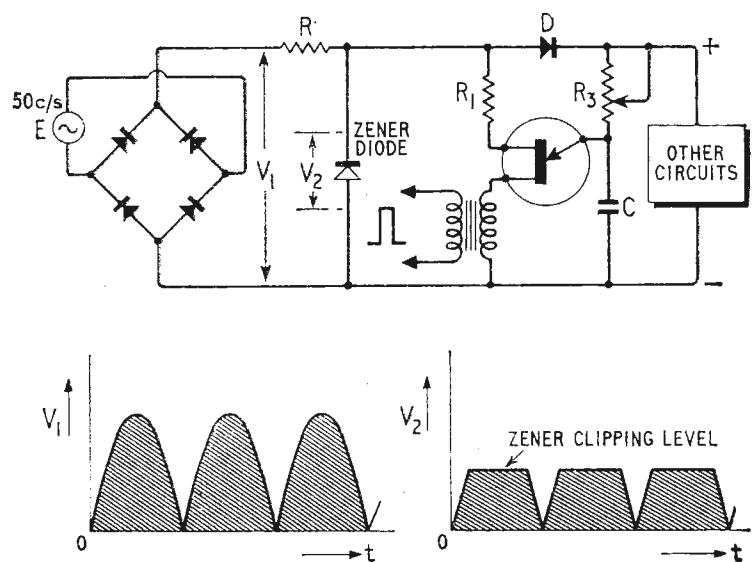

Fig. 2. S.c.r. trigger pulse generator synchronized with 50c/s supply.

The simplest possible circuit is that shown in Fig. 1 (a). In this, C charges almost linearly through R_3 until the emitter becomes forward biased. Any further rise in voltage causes a rapid increase of emitter current and a sharp fall in the e- b_1 resistance. C is then rapidly discharged and a rectangular voltage pulse is developed across the small resistance R_1 in series with b_1 . Another pulse, of opposite polarity, appears across R_2 . With a supply voltage around 15 to 20 V the b_1 pulse is sufficient in amplitude to give reliable firing of most s.c.r.s. The waveforms across C and across R_1 are shown in Fig. 1(c).

A pulse transformer may be substituted for the resistance R_1 as in Fig. 1(b). The base connections of a typical unijunction transistor are shown in Fig. 1(d). This is the (American) General Electric 2N1617A, a type well suited for triggering all except the very largest s.c.r.s at present on the market.

It has been stated that the reverse bias on the emitter is setled by the voltage-divider action of the silicon bar which forms the interbase resistance. It follows that a reduction of the supply voltage will automatically reduce the amount of reverse bias on the emitter. A sudden reduction of the supply voltage to a relaxation oscillator will thus cause a premature discharge of the capacitor C followed by the re-charge cycle which will begin as soon as the supply voltage is restored to the normal level. Fig. 2 shows a circuit developed by the General Electric Company in order to synchronize the relaxation oscillator to the frequency of the supply mains. It will be used to generate precisely timed firing pulses in the two regulator circuits with which we shall be concerned. A bridge rectifier is used to produce a full-wave rectified output waveform as shown in the lower part of the diagram. A resistance R, followed by the Zener diode, produces a flat-topped waveform by a clipping process. Since there is no smoothing capacitor, the waveform dips sharply to zero at a rate of 100 times per second. With a constant supply voltage the relaxation oscillator shown would generate pulses at a rate decided by the R_3C time constant, which need not necessarily be related to the supply frequency of the mains. The effect of the waveform notches is to discharge C at uniformly recurring intervals and re-charging of C starts from zero at the beginning of each cycle

of the trapezoidal waveform. If now a positive half sine wave voltage is applied to a controlled rectifier in series with a load resistance the s.c.r. could be fired by the pulse output from the unijunction oscillator. The time delay in triggering the s.c.r. is clearly the time which elapses between the start of the trapezoidal waveform and the production of the next pulse by the relaxation oscillator. For a fixed value of C , this time interval depends on R_3 . It is only the first pulse which is effective in firing the s.c.r. and after this it is quite immaterial how many more pulses are generated during the remainder of the conducting phase. At the next Zener waveform notch, C is discharged. The s.c.r. anode voltage is also zero so that conduction stops and does not start again until the anode is once more made positive and another firing pulse is generated.

Before leaving Fig. 2 it is necessary to explain the function of the diode D . In brief, it may be followed by a large filter capacitor so that a smoothed d.c. supply is available for other circuits which may be required to operate in conjunction with the relaxation oscillator. Without the diode, this large capacitor would smooth out the notches in the Zener output waveform and thus preclude the possibility of synchronizing the firing-pulse train to the frequency of the supply mains. The diode serves to isolate the filter capacitor from the relaxation oscillator.

Functional Diagram of a Voltage Regulator

The block diagram Fig. 3 shows the principle of a voltage regulator using s.c.r.s. The power transformer T supplies a conventional rectifier-filter unit.

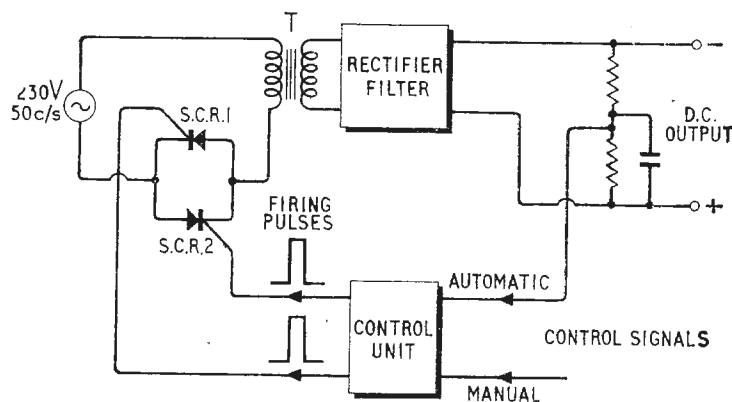

Fig. 3. Schematic diagram of voltage regulator.

Two controlled rectifiers SCR1 and SCR2 are connected in parallel-opposition in the primary circuit of T . They are fired alternately by pulses derived from the control unit which incorporates a relaxation oscillator of the type just described. One s.c.r. conducts during a portion of the first half-cycle of the input supply voltage while the other conducts in turn during the next half-cycle. The conduction angle has some value between 0 and 180° , the precise value being determined by the timing of the firing pulse-pairs. It is the function of the control unit to allow for manual adjustment of the output voltage to some chosen level. At the same time there must be some automatic means of holding this level constant in spite of load current or supply voltage changes. Manual

control calls for nothing more elaborate than a variation of the resistance R_3 in Fig. 2. Automatic control requires that some sort of error signal should be derived from a minute change in the output voltage. This error signal should cause the control unit to re-time the s.c.r. trigger pulses in such a way as to restore the output to normal. If R_3 in Fig. 2 is replaced by a transistor it is clear that the capacitor charging current and hence the firing-pulse timing could be controlled by varying the base bias of this transistor. In turn, this bias could be derived in part from the d.c. output of the power unit and we have a means of achieving the desired control.

Practical Voltage Regulator Circuits

Fig. 4 is the complete circuit diagram of a regulated power supply which stems directly from the block diagram in Fig. 3. The main power transformer $T1$ feeds the bridge rectifier $B1$ and delivers its output to the load through a choke-input filter LC_2 , designed on standard lines. A bleeder resistance R_B (1 to $2k\Omega$, 10W), provides a permanent load on the output and sets a limit to the requisite maximum inductance of the swinging choke L . The small transformer $T2$ feeds the unijunction pulse generator $Q1$ and a control amplifier consisting of the transistors $Q2$, $Q3$ and associated components. The pulse transformer $T3$ has three windings each of 250 turns of 30 s.w.g. enamelled wire wound on a nickel-iron core of E and I laminations (cross-section $\frac{1}{2}$ in \times $\frac{1}{2}$ in). The three windings must be extremely well insulated from each other since there are very high potential differences between them. Silicon diodes $D1$, $D2$ and $D3$ serve to suppress pulses of unwanted polarity. A rating of 0.25A and 50V peak inverse voltage is ample for this application.

The resistance R_1 and the 20V 1W Zener diode provide the trapezoidal waveform shown in Fig. 2 and, by means of the isolating diode $D4$ and the $50\mu F$ capacitor, also provide a smoothed and regulated supply to $Q2$ and $Q3$.

The control amplifier $Q3$ (n-p-n), picks off a fraction of the d.c. output voltage, determined by R_6 , R_7 , R_8 and R_9 . Of these, R_9 is manually variable to set the output voltage at any desired value. Any subsequent change in the output level affects the base bias of $Q3$ and causes changes in its collector current, further amplified by the complementary p-n-p transistor $Q2$. The collector current of $Q2$ constitutes the charging current for C_1 , associated with the pulse generator $Q1$. The resistance of the transformer primary winding limits the peak pulse current to a safe value while the resistances R_3 and R_4 ensure that $Q2$ is biased beyond cut-off in the absence of a control signal. The charging rate of C_1 and hence the delay in triggering $Q1$ to produce firing pulses for the s.c.r.s is thus made to depend on the level of the d.c. output and firing is advanced or retarded in order to hold a constant output in spite of changing load current or supply voltage.

Due to the long time-constant of the main LC filter, it will be evident that regulation can never be made instantaneous. Close voltage regulation calls for high gain in the d.c. amplifier $Q2$, $Q3$. Unfortunately the combination of high gain and filter time delay sets up the conditions for instability in the control loop and unless precautions are taken

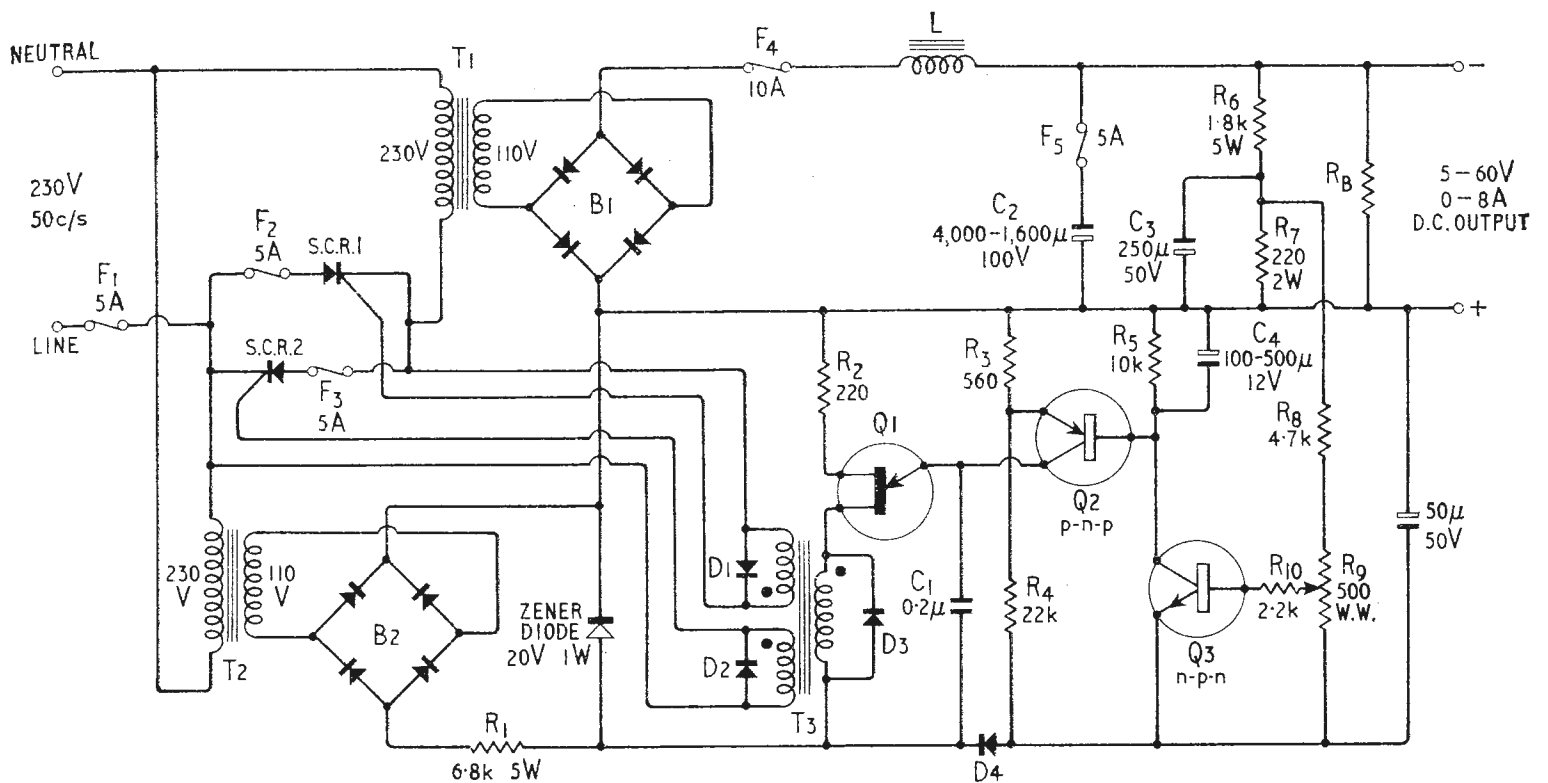

Fig. 4. Complete circuit diagram of voltage-regulated power supply using two s.c.r.s.

low frequency oscillations will be set up in the system. Suppression of these is extremely difficult and it has been found necessary to slow down the amplifier response to an impulse signal by shunting C_4 across the collector load of Q_3 . The minimum value of C_4 required to maintain stability depends on the filter constants, the load resistance and the gain of the control amplifier. Conditions are worst when there is no load on the power supply. If C_4 is chosen to ensure stability in this case the system will be quite stable under other conditions. In any case the capacitor should be no larger than the value necessary to maintain stability, otherwise the control action becomes very sluggish. The overall response time depends on the value of C_4 and on the charging current instead of being determined by the filter and load resistance.

The transistors Q_2 (p-n-p) and Q_3 (n-p-n) are low power types (preferably silicon), of moderate current gain and rated to work at 20V. The diodes in the bridge B_2 are 50mA types with a 200V peak inverse rating while D_4 is a single silicon diode of the same type. The 5A fuses in series with the s.c.r.s should be of the fast-clearing type. Some thought should be given to the layout of wiring. Fast switching of relatively large currents may conceivably inject undesirable transients into the control amplifier stages although the timing is such that the regulator action ought not to be affected.

Fig. 5 shows waveforms at various points in the circuit of Fig. 4.

The controlled rectifiers used in the regulator are rated to pass an average forward current of 5A at 65°C. Peak inverse and forward breakover voltage ratings are each 400V. These components are used at very nearly the maximum permissible voltage ratings and there is only a small safety margin against line voltage transients or switching surges. No trouble has actually been experienced but it might be a wise precaution to use some scheme, such as that shown in Fig. 7, to increase the allowable peak reverse voltage rating. The resistances R_1 (say 33k Ω), serve to share the steady reverse voltages

across the diode and the s.c.r. The components CR (0.1 μ F and 50 Ω) take care of transients and allow for differences of hole-storage times in the diode and s.c.r.

The voltage regulation of the complete system is between 1 and 5 per cent over the whole range of outputs, being better at high than at low output voltages. It holds good over the input range 180-260V.

Output voltage overshoot is troublesome if a heavy load is suddenly switched off and recovery is sluggish. The only obvious way of speeding up the response time is to leave out the main filter choke. This would allow C_4 to be reduced in value or eliminated. It might also be necessary to omit the 250 μ F capacitor shunting the 220 Ω arm of the output potential divider which feeds Q_3 . The filter inductor L is a large, heavy and expensive component and it is tempting to remove it. Unfortunately this will cause

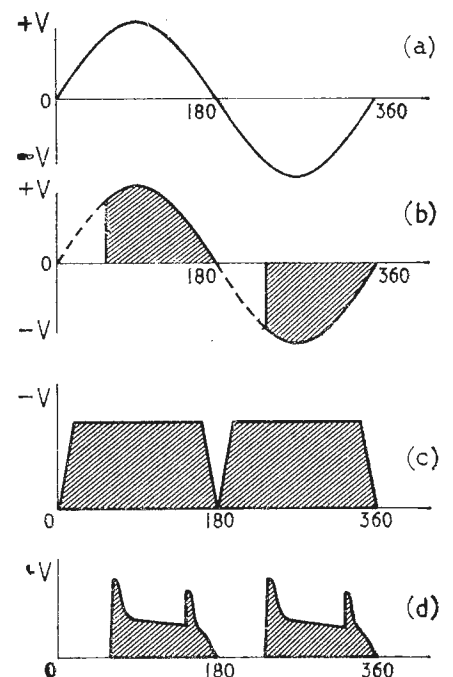

Fig. 5. Waveforms at various points in circuit of Fig. 4. (a) Supply voltage. (b) Power transformer primary voltage. (c) Zener voltage. (d) Gate pulse voltage.

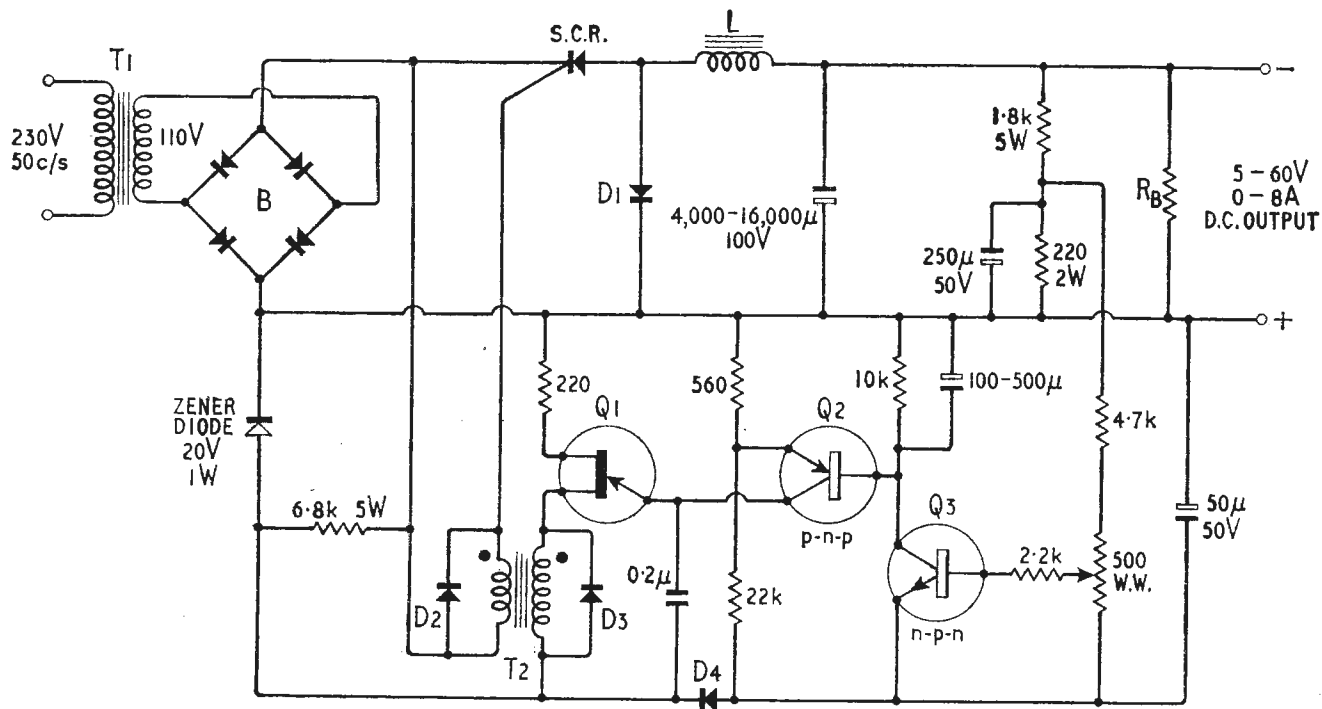

Fig. 6. Voltage-regulated power supply using a single s.c.r.

large increases in the peak currents to be handled by the controlled rectifiers and by the diodes in the bridge B1. The main power transformer must also be de-rated. A partial cure might be effected by using a low-value resistance instead of L but this tends to reduce the efficiency and impair the voltage regulation. In spite of its shortcomings and inherent defects, the regulator in Fig. 4 has been found useful and reliable. It is highly efficient, runs cool under all conditions and can be controlled over the range 5 to 60V with good regulation and from 0 to 60V if close regulation is not required.

Voltage Regulator Using a Single S.C.R.

The circuit of Fig. 6 is a simplified version of Fig. 4, using a single s.c.r. as a switched series-regulator element on the d.c. side of the main rectifier. In this position it is called upon to handle a train of full-wave rectifier sine waves. The s.c.r. rating is more economically exploited in this connection since it conducts twice per cycle of the input frequency and the r.m.s. and mean currents are more nearly equal than in Fig. 4 where each s.c.r. conducts only once per cycle. Because the main rectifier output voltage in Fig. 6 is constant, it can also be used to supply the pulse generator and control amplifier stages. The auxiliary supply in Fig. 4 is thus unnecessary. The design of the firing-pulse transformer is simplified because it only needs a single secondary winding.

The power diode D1 is an essential component in Fig. 6. It serves to maintain current conduction in L while the s.c.r. is blocked and non-conducting.

Because of the lower working voltages on the secondary side of the transformer, the s.c.r. voltage ratings can be lower than those required in Fig. 4 but the current to be controlled is proportionately larger. As regards performance, there is little to choose between the two circuits. Similar mechanisms are responsible for regulation and control and the same factors decide the response times to supply voltage and load current changes. The circuit of Fig. 4 has obvious advantages when a very high output voltage is required since the controlled

rectifiers are on the lower voltage side of the power transformer and, though the peak voltage problems are quite severe on the primary side of the 230V mains, they would be impossible at a secondary voltage of the order of kilovolts.

Full Wave A.C. Control by a Single S.C.R.

High voltage s.c.r.s are so expensive that it is worth considering ways in which a single unit may be made to do the work of a pair. Fig. 6 is of course one way of doing this. Instead of using one s.c.r. in the position shown, two of them could have been used as substitutes for two of the diodes in the bridge rectifier. In this particular case, other changes in the circuit would have been required as well. For example, an auxiliary power supply would have been necessary to supply the pulse generator.

Fig. 8 shows how one s.c.r. can be used to give full-wave a.c. control. It requires four extra diodes in a connection similar to that used in rectifier-type moving coil meters. Alternating line current causes unidirectional current flow in the s.c.r., assuming of course that this is suitably triggered into conduction. When the s.c.r. is blocked, the forward voltage is the same as that of the supply mains. Except under transient conditions, when hole storage times in the

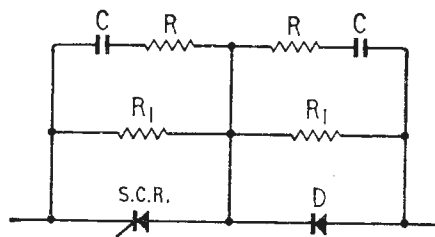
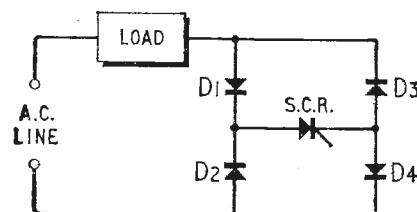

Fig. 7. Increasing the peak reverse blocking voltage of an s.c.r.

Fig. 8. Full-wave a.c. control by a single s.c.r.



diodes and the s.c.r. must be taken into account, there is a negligible inverse voltage on the s.c.r.

Under the d.c. conditions of operation of the s.c.r. in Figs. 6 and 8, it is relatively simple to provide protection against over-voltage. A polarized-type selenium surge-suppressor could be connected in parallel with the s.c.r. Recent types of power diode have a built-in avalanche characteristic. One of these, suitably rated, could give protection if used in shunt with the s.c.r.

The four diodes in Fig. 8 are much less expensive than a single high-power s.c.r. which they can replace, particularly when the relationship between r.m.s. and average values of the s.c.r. current is taken into account. There is no problem of matching or symmetrical firing as there is when two controlled rectifiers are used.

Conclusion

It is probably true to say that the ideal switching-type regulator has not yet been devised. The difficulties are fundamental and inherent and are basically due to the interposition of a filter between the switching element and the output from which the d.c. error signal is derived and applied to the control stages. In cases where high efficiency, high

output power and wide range of output control are required there are good arguments in favour of the use of controlled rectifiers as regulator elements. In respect of voltage regulation, ripple reduction, output impedance and speed of response the s.c.r. regulated supply is inferior to the conventional series transistor regulator. The circuits in Figs. 4 and 6 represent a reasonable compromise between cost, complexity and performance. At the time of writing, the arrangement in Fig. 4 has given trouble-free performance over a period of six months. Its only real defects are its slow response to load changes and the voltage overshoot caused by shedding a heavy load.

REFERENCES

1. (American) General Electric Publications:—
 - (i) "Transistor Manual" (including signal diodes),
 - (ii) "Silicon Controlled Rectifier Manual,"
 - (iii) "Semiconductor Rectifier Components Guide."
2. Texas Instruments Publications:—
 - (i) "Power Application Theory,"
 - (ii) "The How and Why of Unijunction Transistors,"
 - (iii) "Industrial Control and Power Applications, of Semiconductor Components,"
 - (iv) "Power Seminar Papers."

BOOKS RECEIVED

Aircraft Maintenance, by C. Van der Meulen. Although not implied in the title, the book is concerned with maintenance, in the broad sense, of the electrical equipment of aircraft. It does not set out to be a handbook or service manual, but treats the general approach to servicing, modification and methods. The broader aspects of maintenance policy and organization are discussed, and three sections are devoted to specialized equipment classed as electrical, instruments and radio. The book is designed to interest those who intend to make aeronautical maintenance a career, and sufficient description of the operation of equipment is given to enable non-specialists to understand the general discussion. Pp. 326. Heywood and Co. Ltd., Carlton House, Great Queen Street, London, W.C.2. Price £6.

Radio and Television by C. A. Quarrington, A.M.Brit.I.R.E. A broad survey in four volumes of the whole field of radio and television reception. Originally published in 1946 it has now been brought up to date and includes colour television and frequency modulation. The treatment is discursive but thorough and includes guidance on servicing as well as on basic principles. Pp. 1237, profusely illustrated. The Caxton Publishing Co. Ltd., 44 Hill Street, London, W.1. Price 10gns (which entitles the purchaser to a free information service).

The Synthesis of Relay Switching Circuits, by V. N. Roginskii. Relays of some type or another have been used in almost every field of engineering, but, the theory of relay-contact switching circuits based on Boolean algebra has been developed only over the last decade or so. The principles of this theory are outlined in this book, along with the methods of structural synthesis (as worked out in the Line Communication Laboratory of the U.S.S.R. Academy of Sciences). An extensive bibliography concludes the book. Pp. 184. D. Van Nostrand Company Ltd., 358 Kensington High Street, London, W.14. Price 50s.

Ionospheric Sporadic-E, edited by E. K. Smith, Ph.D., and S. Matsushita, Dr. Sc., is one of the International Series of Monographs on Electromagnetic Waves. The book is composed of recent articles and papers by workers in this specialized field. A large portion is devoted to accounts of observations made in different parts of the world during the International Geophysical Year, and analysis of the routine data, while a third section is devoted to theories of sporadic E formation and structure and their interrelation with ionospheric currents. Pp. 391, Pergamon Press Ltd., 4 and 5 Fitzroy Square, London, W.1. Price £5 5s.

Electronics in Industry, by J. S. Murphy reviews current trends and techniques. The earlier pages are devoted to thermionic valves and semiconductor devices. Thereafter their applications in the fields of servomechanisms, measuring devices, digital and analogue computers and control and automation are discussed. Pp. 216. Oxford University Press, Amen House, Warwick Square, London, E.C.4. Price 25s.

Telemetry, by R. E. Young, B.Sc. (Eng.), M.I.E.E., A.F.R.Ac.S., is one of the Temple Press monographs on rockets and missiles. The introductory chapters survey the role of telemetry in missile work, and subsequent sections give succinct and quantitative assessments of the communication system as a whole, of special r.f. techniques and of data handling at the sender and at the receiver. Pp. 78. Temple Press Books Ltd., 42 Russell Square, London, W.C.1. Price 17s 6d.

Handbuch des Rundfunk- und Fernseh-Grosshandels 1963/64, by the editorial staff of *Funk Technik*. Comprehensive guide to current German radio and television sets, record players, tape recorders, aerials, batteries and the prices of valves and semiconductors. Pp. 464; Figs. 1297. Verlag für Radio-Foto-Kinotechnik G.m.b.H., 1 Berlin 52, Eichborndamm 141-167. Price DM 7.50, postage 98pf.

MANUFACTURERS' PRODUCTS

NEW ELECTRONIC EQUIPMENT AND ACCESSORIES

Heavy-duty Push Switch

A PUSH-BUTTON switch suitable for use in instrumentation and heavy-duty industrial work has been introduced by A. F. Bulgin and Co. Ltd., Bye-Pass Road, Barking, Essex. Designated the Type M.P.10 the push button itself can be supplied in black, white or red. The switch body is constructed from a phenolic material and can be supplied in either black or white. The switches are rated from 1 to 28V a.c. and d.c. at 5A, 110V a.c. 3A and 250V a.c. 2A. Connections to the component are made to pillar terminals at the rear and these will accept conductors up to 3/0.029in or equivalents. The switch is mounted by spring-loaded clamps which tighten on to the front panel. The dimensions of the switch are 24.6mm from rear to the front of mounting panel, 5.5mm from panel to front of switch. The maximum diameter is 34.9mm. The mounting panel will require a hole of 26.2mm diameter and two keyways.

IWW 301 for further details.

Audio Generator

BOTH amateur and professional users will find the price and the specification of the Nombrex Model 63 audio generator worthy of note. The frequency extends from 10 to 100,000 c/s in four ranges. Sine or square wave outputs are available at a maximum of 1 V (peak). The amplitude is constant over the entire range to within 1dB. Less than 1% distortion is claimed for the sine-wave output and the rise time of the square wave is 0.3 μ S; the accuracy of the frequency calibration is within 5%. The output is available from a continuously variable but calibrated attenuator coupled with a three-position output multiplier. This latter control also functions as an on/off switch.

The instrument is powered by a 9 V dry battery, the total consumption being 18 mA. Frequency and output voltage accuracy is not affected until the battery voltage drops to 7 V. The equipment is housed in a mild-steel case with an enamel hammer finish. The front panel has a silver finish, the legends

being printed in black. A bakelite handle on top of the instrument allows easy transportation. The dimensions are 6 $\frac{3}{8}$ \times 4 $\frac{3}{8}$ \times 2 $\frac{1}{4}$ in (including projecting controls). The weight, with battery is 1lb 13oz. The price is £15 and the manufacturers are Nombrex Ltd., Estuary House, Camperdown Terrace, Exmouth, Devon.

IWW 302 for further details.

Piercing Nuts

SHEET metal assemblies often have to be provided with accurately positioned fixing facilities such as captive nuts. Insertion of such devices is generally achieved by drilling or punching holes and then fixing the component. "Piercenuts," introduced by Tolwood Multifasteners Ltd., Bush House, Sandhills, Headington, Oxford, are nuts which pierce their own mounting hole and lock in

position in one operation. At the same time, if required, the metal around the nut can be embossed. A power press using conventional press-tool methods and equipped with a "Piercehead" is used for the attachment of the nuts. The head receives the components from a feeding device, regulates their flow and positions them for piercing. At each press stroke a plunger drives a nut through the metal panel into which it is required to be inserted. Precautionary devices include prevention of premature release of the nut and a sensing device to ensure that in the event of a misfeed or interruption of nut flow the press does not operate. As the nut is driven through the panel, the metal is forced by the die button into preformed undercuts on the nut, fixing it securely to the sheet. "Piercenuts" are available in a range of thread sizes and nut sections for attaching to sheet-metal

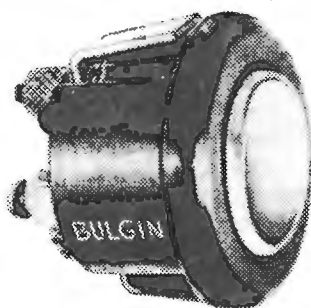

Bulgin Type M.P. 10 heavy-duty push switch.

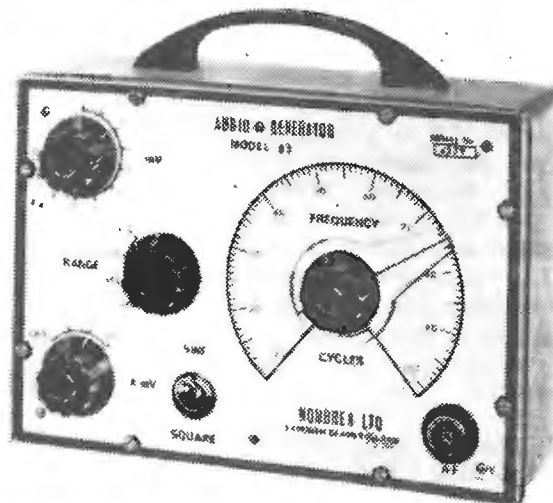

Nombrex audio generator Model 63.

Sheet metal with "Piercenut" inserted (panel can be embossed or remain flat).

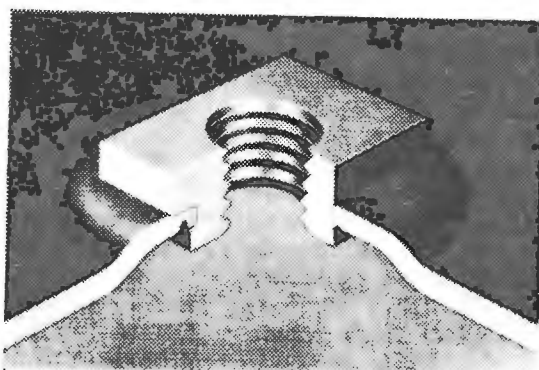

Hatfield Instruments low-loss insulator.

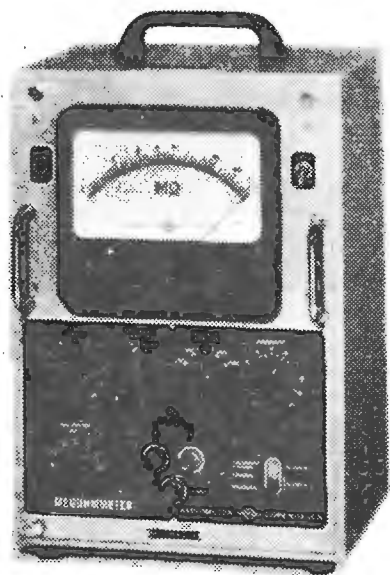

Megohmmeter Type 1M5 manufactured by Radiometer of Copenhagen.

steel between 0.025in and 0.120in thick. A number of variations on the basic apparatus are available.

IWW 303 for further details.

Low-loss Insulator

A LOW-LOSS, "Polypropylene" insulator has been developed by Hatfield Instruments Ltd., of Burrington Way, Plymouth, Devon. The terminal is keyed into the moulding, which is loaded with a filler which prevents deterioration due to ultraviolet light exposure. The insulator is claimed to be "virtually unbreakable" and costs 4s 6d.

IWW 304 for further details.

Megohmmeter

RESISTANCES from $1M\Omega$ to $100 \times 10^6 M\Omega$ are capable of being measured by the Type 1M5 Megohmmeter manufactured by Radiometer Company of 72 Emdrupvej, Copenhagen NV, Denmark. Five stabilized test voltages are available, namely 50, 100, 200, 500 and 1,000V d.v. A quick measurement of the insulation resistance of large capacitors is possible since the capacitor can be charged at a very low time constant. On completion of measurement the component is automatically discharged. Other features include an instantaneous indication of whether the insulation resistance of a capacitor is higher or lower than the acceptance value, direct measurement of the mutual leakage in three terminal capacitors or between two conductors of a multicore cable and with other equipment, the volume resistance of an insulating material can be determined.

IWW 305 for further details.

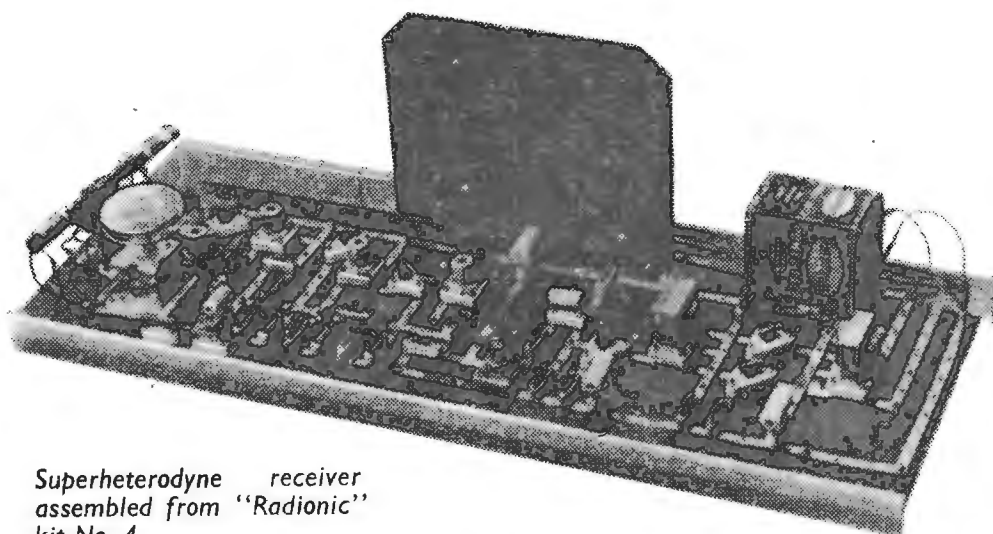

Superheterodyne receiver assembled from "Radionic" kit No. 4.

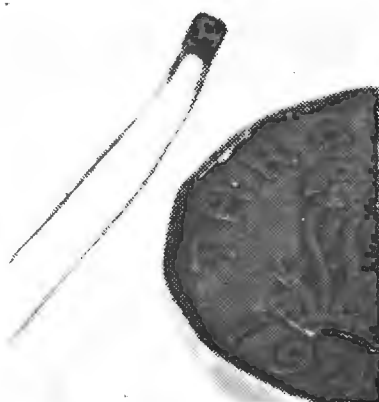

Gulton wafer thermistor Type TD25.

Educational Kits

A SERIES of constructional kits introduced by Radionic Products Ltd., Adastral House, Nutfield, Redhill, Surrey, should prove of value in educational establishments. Basically, a "Radionic" kit consists of a perforated transparent panel (allowing visual circuit checking), perforated brass connecting strip, "screw-up" connectors and components mounted on colour-coded bases that fit into the perforations of the transparent panel. Each kit has a number of circuit sheets indicating the equipments that may be built. These include audio amplifiers, wireless receivers, test equipment and multivibrator circuits, etc. No soldering is necessary, thereby allowing the equipment to be used many times without deterioration.

IWW 306 for further details.

Wafer Thermistor

THE TOLERANCE, over a broad temperature range, of a new wafer thermistor the Type TD25 designed for temperature measuring probes is such, that similar types can be inter-

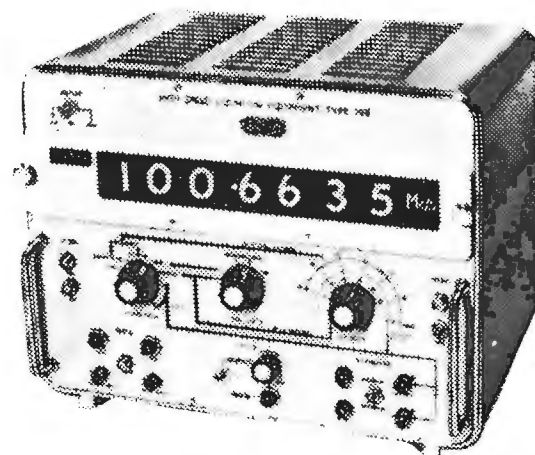

Airmec high-speed counting equipment Type 298.

changed without the need for recalibration of the equipment in which they are used. Thus, the need for padding resistors to adjust the resistance/temperature characteristic is eliminated. The components are manufactured by Gulton Industries (Britain) Ltd., 52 Regent Street, Brighton 1. They are epoxy coated and with maximum dimensions of $0.1 \times 0.1 \times 0.05$ in, the temperature response time is rapid. Nominal resistances available at present are 1, 2 and $5k\Omega$ (all at $25^\circ C$) and are within $\pm 0.84\%$. The maximum resistance deviation from the specified resistance temperature characteristic at temperatures between $-55^\circ C$ and $+150^\circ C$ is 3.3%.

IWW 307 for further details.

Transistor Counter

A DIGITAL counter using transistors throughout and capable of counting pulses or sine waves directly from z.f. to 100 Mc/s, is being manufactured by Airmec Ltd., of High Wycombe, Bucks. The input sensitivity from 100 c/s to 100 Mc/s is claimed to be better than 100mV. The principal functions of the instrument, selected by

a front panel switch, are frequency, period and time measurement. However, sinusoidal standard-frequency outputs at 1 and 10 Mc/s and a number of pulse outputs are available. The counter also has a self-check facility. The crystal oscillator, oven controlled, has a short-term stability of ± 5 parts in 10^8 . A 12-figure digital read-out is used. This consists of a large 7-figure, in-line, electronic read-out and a 5-digit electro-mechanical counter. The display time is variable from $\frac{1}{2}$ second to 10 seconds before being reset automatically. Alternatively, a manual reset facility can be engaged. The counter may be operated from a 50 or 60 c/s mains supply and the power consumption is approximately 100W. The weight is 43lbs and the dimensions are $16\frac{3}{4} \times 12\frac{1}{2} \times 12$ in approximately. IWW 308 for further details.

U.H.F. Voltmeter

VOLTAGE measurement problems associated with Bands IV and V television may be solved by the use of the Rohde and Schwartz Type USVF, selective u.h.f. voltmeter. This was designed specifically for v.h.f. television and it complies with the standard specifications (5/4) of the Association of Broadcasting Corporations in w. Germany. Applications of the instrument include measurement of the amplitude ratio of picture and sound carrier, point-by-point measurement of the energy distribution within the sidebands of the picture carrier, measurement of modulation depth and distortion, linearity measurements and measurement of interference from adjacent channels.

The voltmeter can be tuned up to ± 8 Mc/s from the picture carrier frequency in each channel of the range. The meter indication is relative, and the range is -20 to $+2$ dB.

The input impedance of the instrument is 50Ω for the /50 instru-

Rohde & Schwartz
u. h. f. selective
voltmeter.

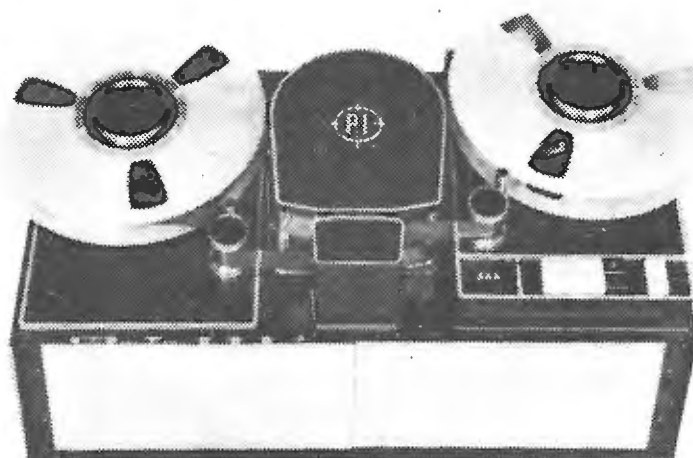
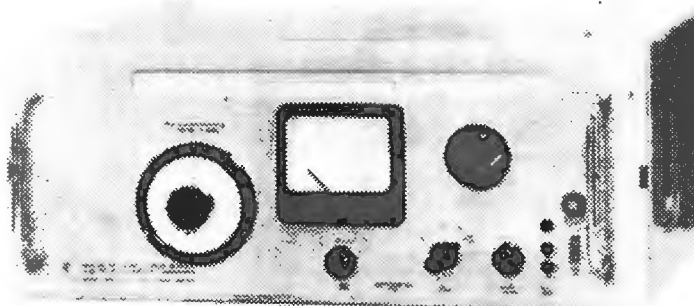

Precision Instrument
closed-circuit tele-
vision tape recorder
Type P1-3V.

ments of the series and 60Ω for the /60 types. The accuracy of the voltage indication is within $\pm 2\%$ of f.s.d. Suitable mains supplies are 115 to 125V and 220 to 235V, 47 to 62 c/s. The voltmeter can be supplied as a cabinet model or as a rack-mounting equipment and is distributed in the U.K. by Avey Electric Ltd., South Ockendon, Essex. IWW 309 for further details.

Closed Circuit Television Tape Recorder

A NEW television tape recorder designed for closed-circuit systems manufactured by Precision Instrument weighs 75 lbs and occupies only 2 cubic feet of space. Designated the Type P1-3V it is available for use on 405, 525, 625 or 819 line systems and is suitable for operation on 50 or 60 c/s mains frequencies—switch selected. One-inch width tape is used and reels up to $10\frac{1}{2}$ in can be accommodated.

The video input level required is 0.5 to 1.5V (75Ω termination). The output level is from 0.5 to 2.0V. The signal to noise ratio is quoted as less than 100mV p-p with respect to 1V video signal. The frequency response of the audio circuit is 60c/s to 10kc/s ± 3 dB. (S/N ratio 40dB or more).

Tape threading is a simple procedure as is also the operating procedure. After the correct levels have been established, push buttons have to be depressed for either "play" or "record" facilities. "Stop" and "rewind" switches are of the push-button variety also. The remaining operational controls are video and audio levels, phase and meter-selector switch. Distributors for the instrument in the U.K. are Carrion Television Systems Ltd., 15 Station Road, Reading, Berks. IWW 310 for further details.

Wideband Amplifier

AN AMPLIFIER Model 104, manufactured by Keithley Instruments and marketed in the U.K. by Livingston Laboratories Ltd., 31 Camden Road, London, N.W.1, has a bandwidth of 15 c/s to 180 Mc/s. From 25 c/s to 150 Mc/s the frequency response is flat to within ± 0.5 dB. It is claimed that the instrument is usable up to 300 Mc/s.

The equipment is designed as three separate amplifiers in one enclosure, which can be used individually or in combination. When used in this latter way, an overall gain of

INFORMATION SERVICE FOR PROFESSIONAL READERS

To expedite requests for further information on products appearing in the editorial and advertisement pages of *Wireless World* each month, a sheet of reader service cards is included in this issue. The cards will be found between advertisement pages 48 and 49.

Each editorial item dealing with a specific product, and each advertisement, is coded with a number, prefixed by IWW, and to obtain further information the appropriate numbers should be entered on a card.

Readers will appreciate the advantage of being able to fold out the sheet of cards, enabling them to make entries while studying the editorial and advertisement pages.

Postage is free in the U.K., but cards must be stamped if posted overseas. This service will enable professional readers to obtain the additional information they require quickly and easily.

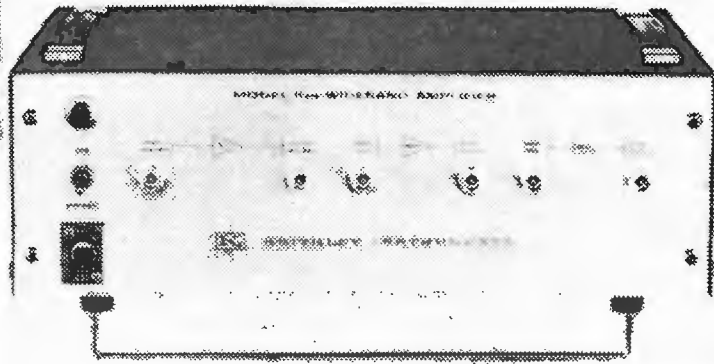

Keithley Instruments Model 104 wideband amplifier.

Spectro Avionics deci-microsecond Chronometer Type 222.

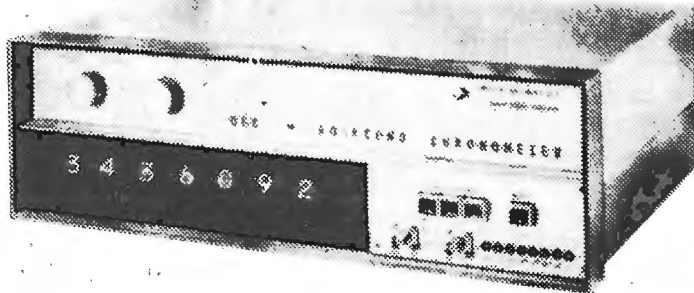

100 (40 dB) is achieved. Two of the amplifiers are identical, with gains of 10 and input and output impedances of 50 Ω . The remaining section has unity gain and is intended for impedance matching, with an input impedance of 1 M Ω , 10 pF and an output impedance of 50 Ω . The rise-time for any one stage is less than 3 nsec or less than 4 msec for all three sections in series. The delay time is less than 5 nsec per stage. Models may be cascaded to achieve gains of up to 10,000. The price of the Model 104 is £278 excluding duty.

IWW 311 for further details.

Low-pass Filters

A RANGE of coaxial low-pass microwave filters have been introduced by Decca Radar Ltd., Albert Embankment, London, S.E.1. Designed to have a Tchebyscheff response, they have 50-ohm impedance characteristics and can be assembled in different combinations to give varying degrees of attenuation. The filters can be supplied with both N type or Deccoax connectors. They can be added together to give any desired frequency response up to 7.5 Gc/s.

IWW 312 for further details.

Deci-microsecond Chronometer

THE deci-microsecond chronometer Type 222 introduced by Spectro Avionics Ltd., Feltham, Middlesex,

can be used for time measurement from 0.1 μ sec to 1sec in 0.1 μ sec steps, frequency measurement up to 12 Mc/s and delay measurements from 0.1 μ sec to 0.999999second. The internal crystal accuracy is within 2 parts in 10⁷ per week. The instrument uses transistors throughout and it may be operated over a temperature range of -20° to +40°C. The printed circuit boards used in the instrument can be purchased separately for use in other products.

IWW 313 for further details.

Printed Board Etching

FERRIC chloride or acid etching solutions can be used in the welded, reinforced, plastic tank of the Lee-Smith Rota-Etch machine for the etching of printed circuit boards. The temperature of the etching solution is thermostatically controlled. The solution is continuously circulated and can be maintained at any temperature within the range of 50° to 130°F. Processing periods up to 15 minutes can be selected.

The boards are fitted to a circular worktable mounted on the hinged lid of the tank. During the etching, the boards are rotated at 10 r.p.m. and a plastic impeller sprays the solution on the boards. The intensity of etching can be controlled by variation of impeller speed. When the lid is raised the electrical supply to the machine is disconnected. Machines are available for experimental boards—larger versions are available for production work. They can be obtained from

Lee-Smith Photomechanics Ltd., Lyon Way, Hatfield Road, St. Albans, Herts.

IWW 314 for further details.

Transistor Receiver

AS well as receiving in the medium and long wavebands, the Shorrock v.h.f. receiver can be used to receive transmissions in the aircraft band. Nine transistors are used in the set. Other features include a 5-in loud-speaker, push-button wave change, slow-motion tuning, 7-in ferrite aerial tape recording socket and a telescopic aerial. The manufacturers, Shorrock Developments Ltd., 51 Preston New Road, Blackburn, Lancs., suggest, that apart from family listening, the receiver can be used by students and pilots revising R/T techniques and to receive the half-hourly meteorological reports.

The full frequency coverage is 155 to 385 kc/s, 525 to 1,570 kc/s and 109 to 131 Mc/s. The total weight of the equipment, which is powered by a standard 9V transistor radio battery, is 5½lb. The overall dimensions are 10×7×4½in and the cost is £36.

IWW 315 for further details.

Tape Labelling

LABELLING of equipment in white letters embossed on a coloured tape with an adhesive backing is quickly achieved by the "Dymo" Type M-55 "Tapewriter" manufactured by Hellermann Equipment Ltd., Gatwick Road, Crawley, Sussex. The labels so made, are permanent, can be used indoors and out and are easy to read. The "Tapewriter" is

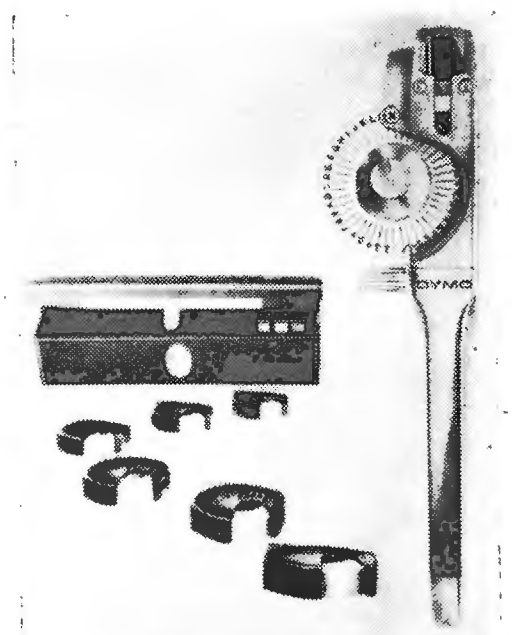

"Dymo Tapewriter" Type M-55 with carrying case and magazines.

hand-held and contains a rotating wheel which carries the letters, figures and symbols. Rotation of the dial to the letter required, followed by pressure on the handle embosses the tape which is also contained in the machine. The tape is available in 11 different colours. Since the letter selected shows up in a dial prior to embossing, the chances of errors are reduced. Embossing wheels can be interchanged without difficulty as, of course, can the reels of tape. The tool is sold complete with 9 different colour tape magazines in a leather carrying case.

IWW 316 for further details.

Silicon Planar Transistor

A SILICON planar transistor, suited for use in thin-film circuits, bonded to a molybdenum support approximately $0.05 \times 0.05 \times 0.01$ in and protectively coated, features a 360 Mc/s bandwidth, 12V collector-emitter rating and a typical h_{fe} of 80 at 10mA. Thus the C206, as it is designated, is eminently suitable for amplifier and switching applications. Each transistor is mounted on a card and covered with a plastic dome. One side of the package has labelled conductive strips to which the transistor leads are attached. This arrangement allows the component to be tested without removal from the card. They may be obtained from SGS-Fairchild Ltd., 23 Stonefield Way, Ruislip, Middlesex.

IWW 317 for further details.

Circuit Elements

THE range of circuit elements incorporating germanium transistors and manufactured by Ferranti Ltd., Ferry Road, Edinburgh 5, has been



An "element" from the Ferranti range of packaged circuitry.

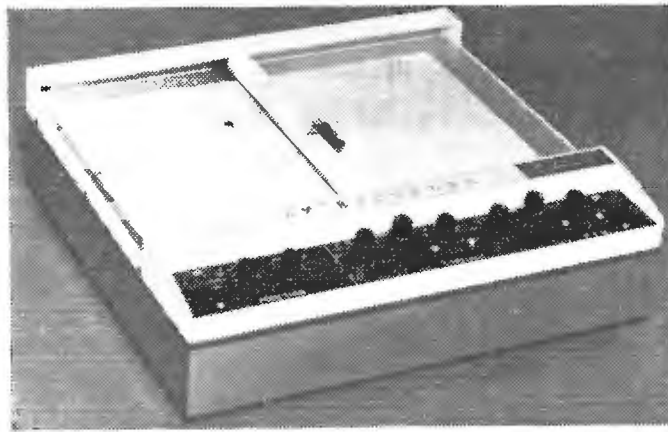

Electro Instruments Model 500 x-y recorder.

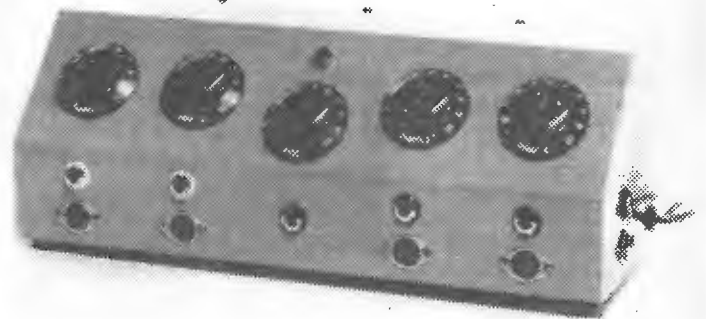

"Esimix" Major 4-channel electronic mixer.

extended. In addition, elements using silicon semiconductors have been introduced. Apart from voltage polarity, both types are compatible. They are designed to operate on supply voltages of 12V and 6V. Each range has been designed primarily to cover the majority of applications in the data-processing and control field. "Circuits" available include a trigger circuit/amplifier circuit, variable frequency multivibrator, variable-period monostable circuit, quadruple emitter follower unit and a dual inverter/amplifier.

IWW 318 for further details.

X-Y Recorder

DIRECT voltage information from two independent sources may be plotted on graph paper 11×17 in with the Electro Instruments Inc. Model 500 x-y recorder. A built-in time base enables data from a single source to be plotted as a function of time. The plotting accuracy is within $\pm 0.2\%$; the time base extends from 0.02 in/sec to 1.0 in/sec in six ranges. The maximum speed of the carriage is 25 in/sec and that of the pen 20 in/sec. The maximum input voltage on both axes is 500 V, but both inputs are stepped from 1 mV/in to 100 V/in with a vernier between ranges. On all ranges the input impedance is $1 M\Omega$.

Other facilities include a "vacuum hold down" for the paper, an internal Zener diode reference and the

ability to point-plot digital data in conjunction with a digital to analogue converter. Transistors are used throughout. The recorder costs £790 excluding duty and is available in the U.K. from Livingston Laboratories Ltd., 31 Camden Road, London, N.W.1.

IWW 319 for further details.

4-Channel Mixer

THE versatility of an audio amplifier or tape recorder may be increased by the use of a mixer unit. The "Esimix" Major 4-channel mixer is a self-powered equipment having two input facilities for each channel, namely a standard jack and DIN socket. A similar arrangement exists for the output. A monitoring socket and a master-fade control are provided. The output is via a cathode follower and has a nominal impedance of 600Ω at a maximum level of 200mV. The microphone inputs have a sensitivity of 2mV. There are two high-level inputs with a sensitivity of 100mV.

IWW 320 for further details.

Printed Board Manipulator

THE assembly or replacement of components on a printed board may be facilitated by a printed board manipulator developed by McKetrick-Agnew and Co. Ltd., Great North Road, Macmerry, East Lothian. The equipment is designed

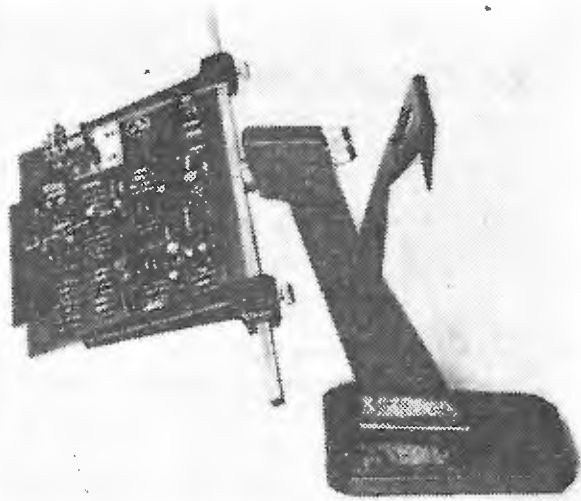

Printed board manipulator manufactured by McKettrick-Agnew & Co. Ltd.

to hold boards up to 10×10in in size and they can be held in any position through a 360° rotation. A spring arrangement on one of the two "holding" arms permits quick loading and unloading. The arms are designed to accept boards of $\frac{1}{16}$ in thickness but alternative arms can be supplied. A spring clip on the unit is useful for attaching a drawing or sample card. The manipulator is finished in stove enamel and costs £5 8s 6d.

IWW 321 for further details.

Microwave Amplifier System

A MICROWAVE amplifier system which will accept any type of small-signal travelling wave tube operating in the frequency range 500-26,000 Mc/s has been developed by Mullard Equipment Ltd., Mullard House, Torrington Place, London, W.C.1. The system consists of a control and power supply unit and a t.w.t. amplifier unit. Two versions of this latter unit are available; one for use with a permanent-magnet t.w.t., the other for electromagnetic types. A number of protection circuits are included in the control unit such as a delay before the e.h.t. is applied and an overload trip against excessive helix current. The equipment can be mounted in 19in racks or in cabinets.

The control and power supply unit designated XL620 is intended for operation from a 46-65 c/s, 110 to 250V mains supply. Its output voltages are a 60V, 1.2 kc/s square wave for heaters, a 130V d.c. and variable 0-130V d.c. supply for the grid, +700V anode voltage, +150V collector voltage and +50 to 175V supply for the helix, dependent on the type of t.w.t. used.

The amplifier units, Type XL622

and Type XL621 for permanent magnet t.w.t. and electromagnetic varieties respectively are basically similar, both having facilities for setting electrode and heater voltages for different types of tubes. The Type XL621 incorporates a solenoid current regulator.

IWW 322 for further details.

Audio Recording Tape

A GENERAL purpose recording tape is being manufactured by Kodak Ltd., Kingsway, London, W.C.2. Four varieties are available, these are Standard (T.100), Long-Play (V.150), Double-Play (P.200) and Triple-Play (P.300).

Standard tape can be obtained in 600ft and 1,200ft reels and has a 10 micron thick, oxide coating on a 37 micron triacetate base. The long-play tape has a p.v.c. base and 300ft, 900ft and 1,800ft reels are available. Double-play tape can be purchased in 400ft, 1,200ft and 2,400ft reels and like the triple play variety has a pre-stretched polyester base. The triple play tape can be obtained in 450ft, 600ft, 1,800ft and 3,600ft reels.

Each type has a different coloured label for rapid identification and each is packed in a polythene bag and box. The boxes have printed rulings on the back for indexing recordings.

IWW 323 for further details.

Miniature Meters

AUDIO levels, tuning and balance indication are among the applications envisaged for the new sub-miniature, edgewise, indication meters, manufactured by Measuring Instruments (Pullin) Ltd., of Acton. The meter movements are housed in plastic cases and have a total weight

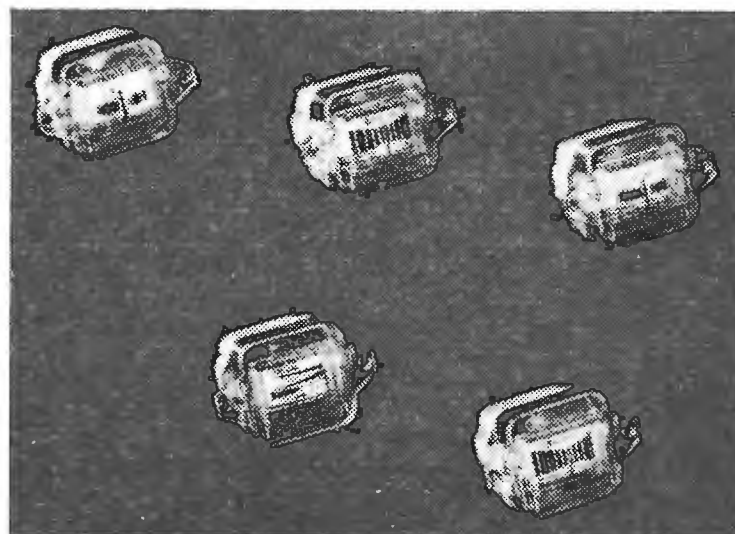

Series 1 meters from Measuring Instruments (Pullin) Ltd.

of 0.5 oz. The dimensions are 0.84 × 0.89 × 1 in approximately. Thus, where weight and space are limiting factors the instruments could be invaluable. Designated the "Series 1" products, the movements are moving coil (d.c.) with an accuracy of ±10% at 20°C. The basic ranges (f.s.d.) and coil resistances are 50 μA (1,200Ω), 100 μA (625Ω), 250 μA (190Ω), 500 μA (45Ω) and 1 mA (14Ω). The pointers are obtainable in either red or black and are supplied in standard, non-adjustable zero positions. Centre zero and right-hand zero types are available if the meters are required in large quantities.

IWW 324 for further details.

Gas Laser

A GAS laser suitable for both teaching and research purposes is available from Elliott-Automation Ltd., 34 Portland Place, London, W.1. The helium neon laser produces a narrow beam of coherent light, plane polarized, having a wavelength of 0.6328 microns.

The equipment incorporates a fused-silicon, high-voltage discharge tube approximately 70 cm long and 7 mm internal diameter. Tubes and mirrors are mounted on a conventional 1-metre optical bench and the whole assembly is enclosed in a dust-proof case. Protection for the r.f. tube connectors is provided by an inner transparent sheath so that the laser is ready for operation immediately the top cover is removed. Excitation of gas discharge is by means of a 100 W, 25 Mc/s oscillator. The power level may be adjusted. A number of accessories are available. The equipment costs £450.

IWW 325 for further details.

VISION A.G.C.

By K. CUMMINS *

GATED SYSTEM USING SYNC. PULSE

THE present-day necessity for domestic television receivers to employ vision automatic gain control has resulted in two basic approaches to the problem of providing an efficient and economical system.

For positive modulation, the first system, usually termed "mean level" a.g.c. employs the negative voltage developed at the grid of the sync. separator pentode. A portion of this potential is cancelled in a resistive network by a positive feed from the contrast control, the remainder being employed as a.g.c. bias for the controlled r.f. and i.f. stages. The bias developed by this means is dependent upon the overall brilliance of the displayed picture. As a consequence the black level is not constant, for the video signal is always maintained at its mean level. This system has been widely used owing to its simplicity and cheapness.

The type of receiver capable of maintaining correct black level in the reproduced picture must employ some form of gated vision a.g.c. The video signal is gated during a black period which is constant irrespective of picture information, and the amplitude of signal so observed used as an a.g.c. reference.

Suitable gating periods occur after the line and frame synchronizing pulses. Gating after the line pulses, i.e. during the line sync. pulse "back porch," provides a high sampling rate and consequent rapid a.g.c. action. The gating pulse can be derived from the line timebase. This method however presents problems.

(a) If the line timebase falls out of synchronism it is possible for the gating to occur during the incorrect parts of the video wave form. Where the picture has been predominately white this has been observed to result in a reduction of gain to such an extent that correct synchronism is no longer possible. Careful design will of course prevent this.

(b) As the line timebase efficiency diode is usually the last valve to heat, the vision receiver will be operating without a.g.c. until the line timebase provides the gating pulses.

(c) The phase of the line timebase will affect the coincidence of gating pulse and line sync. back porch. The adjustment of the line hold control can often affect the timebase phase sufficiently to produce gating difficulty, particularly if a flywheel timebase is employed.

It is possible to use delayed line sync. pulses to operate the video gate. These pulses always occur at the same point in time and when suitably delayed can be usefully employed in gating. The system to be described has been employed for a considerable time and found to be consistently reliable.

Fig. 1 shows the basic system. A triode V1 has negative-going video applied to its cathode from a low-impedance source. The triode is biased beyond

cut-off to a degree adjusted by VR₁, the contrast control. Positive gating pulses applied to V1 grid via a CR network drive it into conduction. The degree of conduction depends on

- (a) The cathode potential at the instant of gating.
- (b) The extent to which the grid is driven positive.

If the gating pulse is of constant amplitude, the degree of conduction depends upon the standing d.c. level as set by VR₁, and the cathode potential of V1. Negative pulses appearing at V1 anode are rectified by MR₁ to provide a.g.c. bias.

If the signal strength falls, as the video drive to V1 cathode is in a negative sense, its d.c. level at the instant of gating will rise. Consequently the conduction of V1 during gating is reduced and the negative anode pulses are diminished, resulting in an increase of receiver gain. The higher the gain of V1 the more efficient the a.g.c. action becomes.

V1 cathode is fed from a low-impedance source in order that its d.c. level will not be affected significantly by current flowing through the valve during the gating period.

Most sync. separators provide a negative output. The line pulses could be differentiated and the positive peaks used for gating but the writer has not tried this method. The prototype receiver employs a flywheel line timebase and a sync. phase splitter is incorporated to drive the discriminator. Consequently a positive-going sync. pulse is readily available.

Owing to the necessity for the gating pulse amplitude to be constant, the sync. separator is arranged to clip heavily by using a somewhat lower screen voltage than is usual.

The prototype circuit is shown in its environment in Fig. 2. V1 is the controlled i.f. stage, V2 the video amplifier, V3 the sync. separator and phase splitter

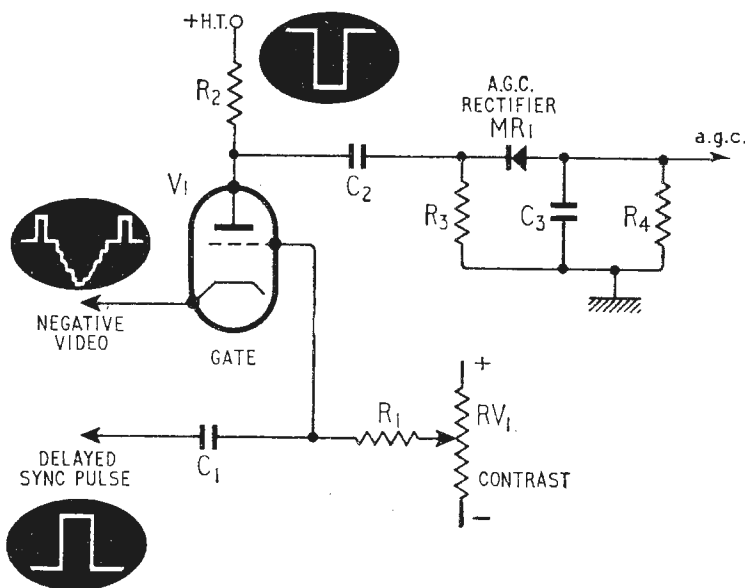

Fig. 1. Basic system for positive modulation.

* Decca Radar, Ltd.

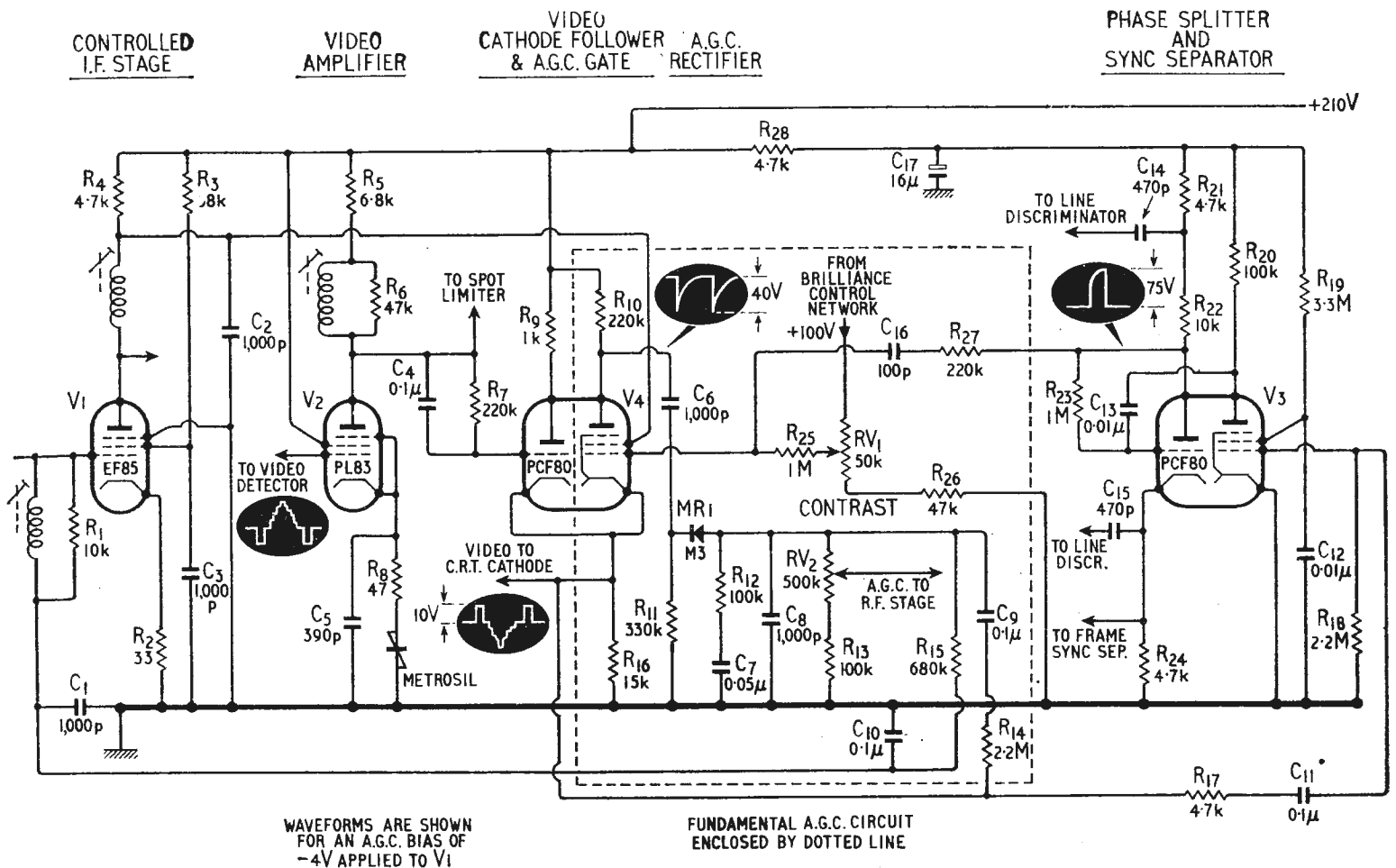

Fig. 2. Sync-pulse-gated vision a.g.c. system in prototype circuit.

and V4 the video cathode follower and gating valve.

The sync. pulse is delayed approximately $3\mu\text{S}$ by V3 the sync. separator and phase splitter. As only the tip of the gating pulse is used to drive V4 into conduction, the pulse rise time may be retarded by integration so that by the time the required amplitude has been reached a further $9\mu\text{S}$ delay is realised. The integration is provided by R_{27} and the input capacitance of V4.

It will be observed of course that the effective gating pulse width will vary depending upon the amplitude of positive drive required by differing signal conditions and also that the gating pulse is no longer rectangular. No detrimental effects have been observed to result from these factors.

In the prototype circuit the delay is precisely optimum and if any alteration is contemplated it is suggested that a double beam oscilloscope provides the simplest means of doing so. The video waveform may be displayed on one trace and the gating pulse on the other. The amplitude of the sync. gating pulse must be arranged to be greater than the maximum negative video drive representing peak white, so that the standing bias applied to V4 grid by the contrast control may be sufficient to cut the valve off under all conditions. MR_1 is the a.g.c. rectifier. A potentiometer is provided to adjust the degree of a.g.c. applied to the r.f. stage, although doubtless a circuit as proposed by R. H. Skinner (*W.W.*, Oct. 1958) would be more effective.

As it is possible for the video amplifier to saturate instantly on receipt of a large signal, no sync. pulse and hence no a.g.c. action is available under these conditions. The saturated state is then maintained indefinitely. As saturation of the video amplifier is characterised by a large drop in its anode potential, this drop may be differentiated by the network C_9, R_{14}

to provide a negative pulse on the a.g.c. line which instantly reduces the receiver gain.

The video amplifier consequently desaturates and normal a.g.c. takes place as the system recovers. The effect of these anti-saturation components is negligible when the system is operating normally. At this point it may be useful to mention components R_{12} and C_7 which are included to prevent the system hunting.

A refinement of the basic system is made possible by the use of a pentode as the gating valve. This involves the feeding of the screen grid from the anode circuit of the controlled i.f. stage. The i.f. stage acts as a d.c. amplifier and provides a varying potential at V4 screen in phase with the a.g.c. action. An increase in a.g.c. loop gain results.

One possible disadvantage of the system is that no a.g.c. action can take place unless the sync. waveform is available, i.e. the receiver can saturate with a c.w. input. One of the simplest forms of protection is a CR feed to the grid of the last i.f. stage enabling a heavy bias to be built up under such conditions which will protect the video section of the receiver. Of course such circuits must be used carefully if the noise immunity of the receiver is to remain unimpaired. The writer has found no need for any protection circuits of this type.

In conclusion it can be said that to employ this system in an existing receiver requires the possible addition of one valve and its associated components. The valve can be of the PCF80 type, the triode part being employed as a video cathode follower or sync. pulse inverter, the pentode as the gating valve. In some cases it may be possible to change two valves to double types and thereby avoid increasing the total number of valves used. The reader will doubtless have his own ideas of these matters.

ELECTRONIC STANDARDS CONVERSION

THE system of standards conversion proposed by R. Rainger in a paper at the I.E.E. International Television Conference last year has since been developed by the B.B.C. Engineering Designs Department to the point where it can be put into regular service as soon as a sufficient number of installations have been duplicated.

No camera or display tubes are used in the new system which depends on electronic analysis of the 625-line picture and its re-synthesis at 405-lines. Fig. 1 illustrates the principle involved. The video signal equivalent to each horizontal line is sampled at 600 regularly spaced intervals by a high speed transistor switching system operating at the 625-line scanning speed (Fig. 2(a)). A low-pass filter is allocated to each vertically aligned element of the lines and this performs two functions (1) to eliminate frequencies associated with switching transients and the line repetition frequency and (2) to "stretch" the response in time due to the delay in the filter. Each of these 600 filters may be regarded as being responsible for a vertical strip element of the picture and the potential at its output will be continually varying as shown by the smoothed core in Fig. 2 (c). The network has a sine-squared response with a half-amplitude duration equal to the line interval of the incoming signal.

The state of each filter-store is then sampled by a second switching system timed to cover the 600 filters in the longer scan period of the 405-line system. Thus a picture is reconstructed with exactly the same horizontal resolution but with fewer lines per field. There is no reason why the system should not be used in reverse though there is not likely to be any future need for this. Conversion between 50

and 60 fields per second is at present not feasible.

Although between 2,000 and 3,000 transistors are used, the cost of the equipment is actually less than that of the conventional optical converter and the running costs of display and camera tubes are, of course, eliminated. So is the need for constant supervision and manual control, necessary when the conversion is made off a displayed image.

At a normal viewing distance the original and converted pictures at the B.B.C.'s demonstration were indistinguishable and only by going up close to the screens could the difference even in number of horizontal lines be discerned. Because the conversion is made within the same field period, "smearing" on moving objects (frequently observed with earlier systems of conversion) is eliminated.

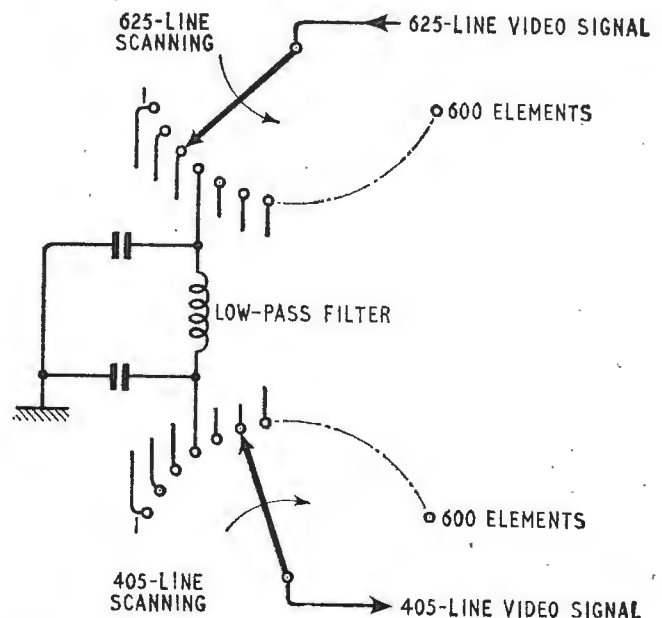

Fig. 1. Basic principle of 625/405-line standards converter.

Rear view of the B.B.C.'s electronic standards converter, showing input (625-line) switch at top, storage and interpolation units and at bottom output (405-line) switch

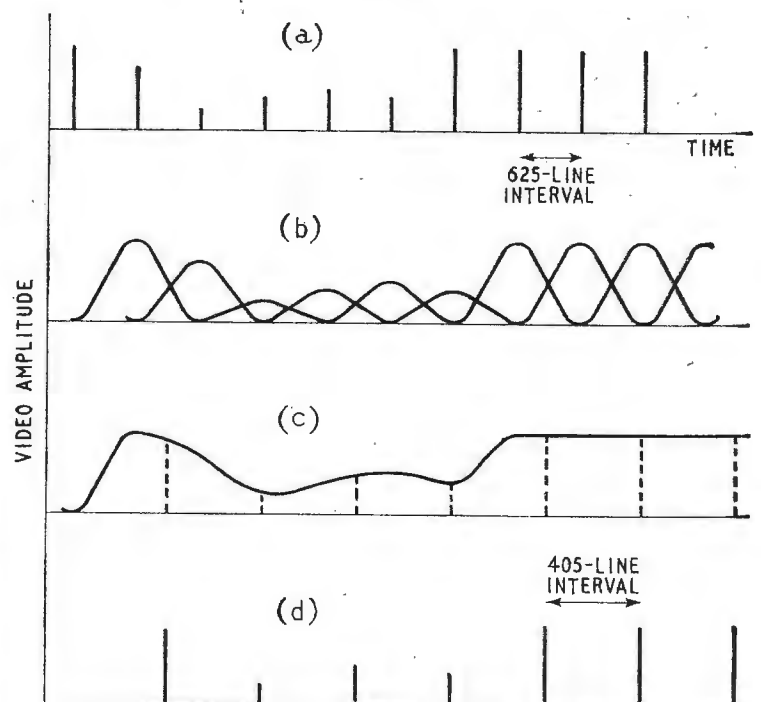
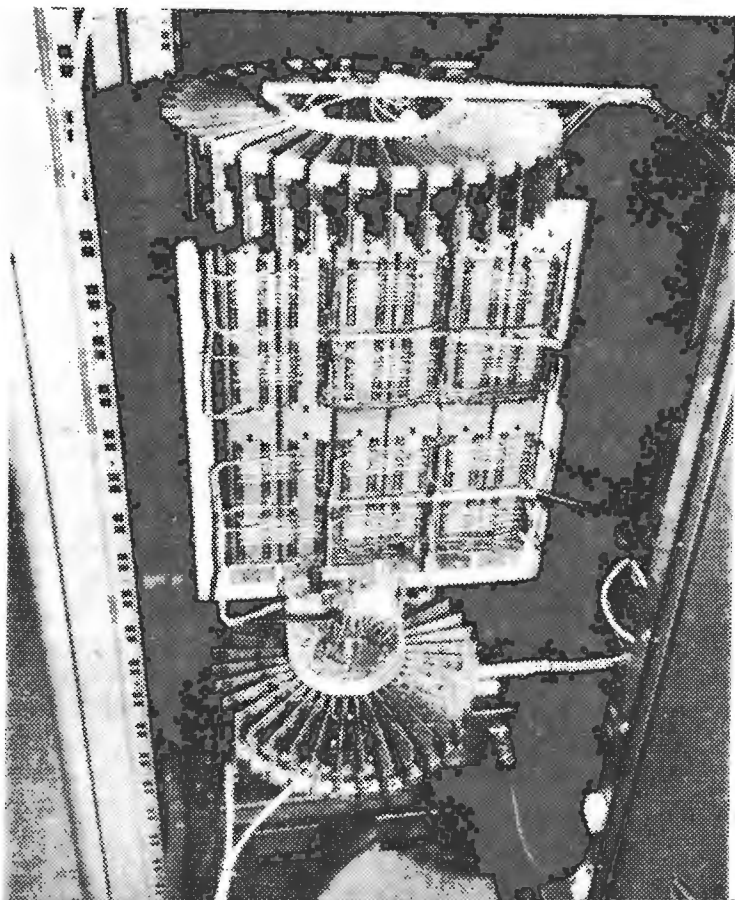

Fig. 2. (a) Sampling pulses at line frequency corresponding to a vertical strip of the picture applied (b) to one of the 600 filters, the smoothed output of which is shown at (c). This is then sampled (d) at 405-line frequency.

Band IV Tests Resumed

THE B.B.C. resumed its 625-line u.h.f. colour tests from the Crystal Palace station on 16th September, but these are now on Channel 33 (vision 567.25 Mc/s, sound 573.25 Mc/s) which will be used when B.B.C. 2 starts next April.

Transmissions are radiated each weekday (Mondays to Fridays) from 1000-1300 (N.T.S.C.) and 1400-1700 (PAL or SECAM) and every day (including Sundays) from 1930-2100 (N.T.S.C.) and 2100-2230 (PAL or SECAM). The German and French systems are being used alternatively for the second period of each session; SECAM being used today (23rd Sept.) and PAL on 24th.

Transmissions, which are asynchronous (that is the waveform generators are not locked to the mains), are horizontally polarized and have an e.r.p. of 160 kW.

Signal Coding in Colour TV

DURING a lecture on colour television to the British Association in Aberdeen on 2nd September, demonstrations of various properties of human sight and how these are exploited in modern coding systems were given.

A video tape recording, using the 625-line SECAM colour coding system, was played back and decoded to give the RGB primary signal voltages which were then recoded according to the N.T.S.C. system. Subsequent decoding produced again the three primary signals. Switching an RGB monitor from the decoded SECAM signal to the decoded N.T.S.C./SECAM signal showed no visible change in hue or saturation on the recorded colour bars and slides. There was, however, some increase in the level of spurious signals on colours of the highest saturations. Also, on parts of the other recorded film stock, certain errors in hue, scarcely discernible after the first decoding, were aggravated by the additional N.T.S.C. recoding and decoding.

This experiment during the lecture by I. Macwhirter, of Thorn-A.E.I. Applications Laboratory, demonstrated the practicability of transcoding from SECAM to the N.T.S.C. system.

The video tape recording was made especially for the occasion by A.B.C. Television Ltd., Teddington, on an R.C.A. TRT22 machine and was transmitted by line from the studios of Grampian Television Ltd., to the lecture room.

A world wide contest for amateur transmitters has been announced by the Central Radio Club of Czechoslovakia. Participants have to establish two-way telegraph or telephone contact, on any of the amateur bands, with fixed amateur stations in the 75 broadcasting zones listed in the Geneva Radio Regulations. Only contacts made on or after 1st January, 1960, are valid for the contest and three separate classes of awards are to be given, for contacts with 50, 60 and 70 different zones. The award is to be known as the "P75P" (*Pracoval se 75 Pasmy*; which means worked 75 zones). Further details can be obtained from the Central Radio Club, Box 69, Prague 1, Czechoslovakia.

The third **Interkama**—international congress and exhibition of measuring instruments and automation—is to be held in Düsseldorf, over the period 13th-19th October 1965. Further details are available from the organizers, Nordwestdeutsche Ausstellungs-und Messe, Düsseldorf, Postfach 10203.



Syncom, the "stationary" satellite, is featured on one of two new postage stamps issued by Nigeria. It also shows the U.S.N.S. Kingsport, the command ship in Lagos harbour. The other stamp shows the American Mercury capsule used for manned space flights and the Kano tracking station.

Space Communication.—Some forty member countries of the International Telecommunication Union will be participating in the International Space Radio-communication Conference which will open in Geneva on the 7th October for five weeks. It will be concerned mainly with the allocation of frequency bands for space communications and telemetry, and will also consider the question of frequencies for radio astronomy.

Communications Networks.—An international conference on transmission aspects of communications networks is being organized by the Institution of Electrical Engineers for 24th-28th February next year. It will cover cables, waveguides, radio links, multiplexing and modulation techniques and bandwidth compression. Electronic switching will not be included as this will be the subject of a later conference. An exhibition and programme of technical visits is also planned. Further particulars are obtainable from the I.E.E., Savoy Place, London, W.C.2.

At the annual general meeting of **The Institute of Physics and The Physical Society** the following elections were made:— Professor M. R. Gavin, vice-president; Dr. J. Taylor, treasurer; Dr. G. G. Wynne, secretary; and Dr. N. F. Astbury, Dr. J. V. Dunworth and F. Oldham, new ordinary members of the council. The membership of all grades at the end of the year was 9,591, a net increase of 472. With the support and encouragement of the council, the Australian branch became the independent Australian Institute of Physics during the year and at the request of a group of members in New Zealand, a branch was formed in that Dominion.

Radio Interference.—In the revised edition of B.S. 1597 "Radio-interference suppression on marine installations," the frequencies covered have been extended to include those within the range 15 kc/s to 300 Mc/s. Other alterations to B.S. 1597 include changes in the stipulated limits of interference-producing voltages at the terminals of the ship's aerials and in the general guidance on how to reduce radio interference.

The biannual Bulletin of the Regional Advisory Council for **Technological Education** lists special advanced courses being held in London and the Home Counties, most of them being part-time (usually evening) courses. Copies of the 136-page book are obtainable, price 4s, from the Regional Advisory Council, Tavistock House South, Tavistock Square, London, W.C.1.

I.E.E. Council.—The new president of the Institution of Electrical Engineers for 1963/64 is Sir Albert Mumford (see "Personalities") and the new vice-president is J. A. Ratcliffe, C.B.E., F.R.S., director of the D.S.I.R. Radio Research Station, Slough. The new members of the Council include J. H. H. Merriman, O.B.E., M.Sc., assistant engineer-in-chief of the Post Office, and M. J. L. Pulling, C.B.E., M.A., deputy director of engineering in the B.B.C.

The first annual volume of the Library Association's "**British Technology Index**," covering the fields of engineering, chemical and manufacturing technology, has been published. It covers the subject content of all the major articles in 400 British journals published during 1962 and includes some 28,000 subject entries with about 50,000 cross-references. This annual volume is part of a comprehensive service which includes monthly subject indices. Further information may be obtained from The Library Association, Chaucer House, Malet Place, London, W.C.1.

Electrical Engineering Education.—For the past five years the Electrical Engineering Department of the Faculty of Technology at Manchester University has issued every 6 months the *Bulletin of Electrical Engineering Education* to provide a medium for the interchange of ideas and information on electrical engineering and allied topics of interest to those engaged in the education of electrical engineers. In future it is to be published quarterly (the first issue appeared in June) as the *International Journal of Electrical Engineering Education* with Sir Willis Jackson, F.R.S., as chairman of the International Advisory Panel.

A new Ministry of Education booklet "**Further Education for School Leavers**," giving details of the many opportunities now available for further education in technical and commercial colleges is obtainable from the Ministry of Education, Further Education Branch (1) General, Curzon Street, London, W.1.

Scholarships.—The education committee of the British Electrical and Allied Manufacturers' Association has published a new edition of "Scholarships and Other Awards in Electrical and Allied Engineering." This booklet indicates the considerable help available through scholarships and grants to young students whose inclinations are towards a career in engineering. It costs 4s and is available from 36 Kingsway, London, W.C.2.

Servicing Certificates.—The City and Guilds of London Institute announce that 456 of the 853 candidates who took the Final Radio and Television Servicing Certificate written papers earlier this year passed. The successful candidates may now take the practical tests which will be organized by the Radio Trades Examination Board.

The Birmingham College of Advanced Technology is starting a fifteen-week evening course on **pulse and digital circuits** on the 29th October. Further details are available from the head of the electrical engineering department at the University, Gosta Green, Birmingham 4.

Among the special evening courses being conducted at the **Twickenham College of Technology** during the present session is one of 12 lectures on the fundamentals of semiconductor devices beginning on 30th September. A 20-lecture course on computer engineering begins on 3rd October and one of 11 lectures on transistor circuit design starts on 13th January.

"Receiving Secam."—M. Cox, of A.B.C. Television, asks us to point out an error in his article in the September issue. The last sentence of the first paragraph on p. 436 should read "On the next field, the identification signal will now be *negative* . . ."

Radio astronomy is the theme of this French stamp, issued in June, which depicts the "Radiotelescope de Nancy"



At the annual general meeting of the **British Industrial Measuring and Control Apparatus Manufacturer's Association** W.T. Marchment (Evershed & Vignoles) was elected president for the period 1963 to 1965. New members of the Council for the year 1963/4 are: G. C. Fairbanks (Elliott Bros.), K. West (Crosby Valve & Engineering Co.), W. J. A. Copeland (Ether Ltd.), J. Tham (George Kent Ltd.), H. Oughton (Foster Instrument Co.), J. C. Page (Teddington Autocontrols Ltd.), and G. R. Ranger (Bristol's Instrument Co.). H. J. Smith (Industrial Pyrometer Co.) as been elected chairman of the new Council.

New stations.—The B.B.C.'s television relay station at Skegness came into service in August, radiating in Channel 1 using horizontal polarization. The Corporation's v.h.f. sound transmitters at Tapton Hill, Sheffield, were brought into service early in September. The frequencies used are 94.3, 92.1 and 89.9 Mc/s, and transmissions are horizontally polarized.

Southern Television Ltd. are supplying about £10,000 worth of **closed-circuit television** equipment to the County Secondary School at Warblington, Hampshire. It is part of a three-year study to investigate the possibilities of using closed-circuit TV as an integral part of the work of the school. The Hampshire Education Committee are providing the school with a portable classroom for use as a studio.

Closed-circuit colour television is to be featured at the C.W.S. Centenary Exhibition, which opens in Belle Vue, Manchester, on the 5th October for three weeks.

An exhibition of **cabinet styling accessories** opens on 1st October at the Hotel Russell, Russell Square, London, W.C.1. The organizers are Radio Industry Exhibitions Ltd., 59 Russell Square, who are staging the exhibition on behalf of the British Radio Equipment Manufacturers' Association. Admission is by invitation.

Signal Processing Techniques.—A symposium on "Signal processing in radar and sonar directional systems" is to be held at Birmingham University from 6th to 9th July next year. It is being organized jointly by the British Institution of Radio Engineers and the electrical engineering department of Birmingham University.

Computer Conference.—The fourth international conference of L'Association Internationale pour le Calcul Analogique is to be held from 14th to 18th September next year, at the Brighton College of Technology, Lewes Road, Brighton. The conference is organized by the British Computer Society. Registration forms may be obtained from the B.C.S./A.I.C.A. Honorary Secretariat, Ferranti Ltd., Kern House, 36 Kingsway, London, W.C.2.

A conference on the "**Fundamental problems of low pressure measurements**" is to be held at the National Physical Laboratory, Teddington, from 23rd to 25th September next year; it is being organized jointly by the N.P.L. and the Institute of Physics and Physical Society.

PERSONALITIES

K. S. Davies, B.Sc., A.M.I.E.E., a director of Rank-Bush Murphy Ltd., has been appointed director in charge of the company's newly formed Electronics Division (see "News from Industry"). Mr. Davies joined Murphy's in 1933 from Cambridge University, and was primarily concerned with television receiver design before being appointed director of engineering, which position he held until the Bush-Murphy merger in 1962.

The appointment of three executive managers have been made following the formation of the Rank-Bush Murphy Electronics Division. These are: **T. A. McMullin**, M.I.E.E. (for communications, radar and industrial electronics); **G. W. Hart**, M.A.(Cantab), A.M.I.E.E. (for television and medical equipment); and **T. C. B. Talbot** (nucleonics and instrumentation). Mr. McMullin, who for a number of years was in charge of the radar laboratory, and became chief engineer of Murphy's electronics division in 1957, joined the company from school in the thirties. Mr. Hart, who was head of the radar division of E.M.I. Engineering Development Ltd. until 1949, joined Murphy in 1951 after spending two years as a development officer with the Council of Industrial Design. Mr. Talbot, who became general manager of the general radiological nuclear division at Welwyn in May this year, was for 11 years with Bush at Plymouth, where he was for some time assistant chief engineer.

S. S. Carlisle, M.Sc., M.I.E.E., has been appointed director of the British Scientific Instrument Research Association. Mr. Carlisle, who takes up his appointment on 1st November, is a vice-president of the Society of Instrument Technology and deputy chairman of the research and development panel of the British Conference on Automation and Computation.

Eric Eastwood, C.B.E., Ph.D., M.Sc., M.I.E.E., who joined the Marconi Company as deputy chief of research in 1948 and is now the director of engineering and research, has been elected to the Marconi board of directors. Dr. Eastwood was appointed director of research for the entire English Electric group in August of last year, and has been a director of Marconi Instruments since 1961. **Robert Telford**, B.A. (Cantab.), M.I.E.E., who has been the general manager of the Marconi Company since 1961, has also been elected to the Marconi board of directors. Mr. Telford joined Marconi's in 1937 as a management trainee and has held several managerial positions including that of managing director of Marconi Brasileira from 1946 to 1950.



Dr. E. Eastwood



R. Telford

Sir Albert Mumford, K.B.E., B.Sc.(Eng.), M.I.E.E., engineer-in-chief of the Post Office, has been elected president of the Institution of Electrical Engineers for the 1963/64 session. Sir Albert, who has been vice-president of the I.E.E. since 1958, joined the engineering department of the Post Office in 1924 as a probationary assistant engineer at the age of 21.



Sir Albert Mumford



Dr. R. C. G. Williams

R. C. G. Williams, Ph.D., B.Sc.(Eng.), D.I.C., A.C.G.I., M.I.E.E., chief engineer of Philips Electrical Industries, has been elected chairman of the Electronics Division of the Institution of Electrical Engineers for the year 1963/64. Dr. Williams, who has been with Philips since 1946, is a past chairman of what was the Electronics and Communications Section of the Institution. Prior to joining Philips, Dr. Williams had spent 15 years with Murphy Radio.

F. E. Terman, Sc.D., well-known author of the textbook "Radio Engineering," who is vice-president and provost of Stanford University, California, has been awarded the Western Electronic Medal of Achievement which is presented annually by the Western Electronics Manufacturers' Association in the U.S.A.

This year's David Sarnoff Gold Medal of the U.S. Society of Motion Picture and Television Engineers is being presented to **Dr. Henry N. Kozanowski**, R.C.A.'s manager of television advanced development, for his "sustained drive to improve the quality and practical operation of television studio and film camera equipment." Dr. Kozanowski, who took his bachelor's and master's degrees in physics at the University of Buffalo, in 1927 and 1928, received his doctorate in physics at the University of Michigan in 1930.

The premier award of the Brit.I.R.E., the Clerk Maxwell Premium of 30 gn for the year's most outstanding paper, has been awarded to **M. W. Gough**, M.A., of the Marconi Research Laboratories, for his paper, "Propagation Influences in Microwave Link Operation." The Associated Rediffusion Premium (£50) for the Institution's outstanding paper on advances in the technique of television broadcasting has been awarded to **I. J. P. James**, B.Sc., and **W. A. Karwowski**, B.A., of Electric and Musical Industries, for their paper, "A Constant Luminance Colour Television System."

The American Geophysical Union's twenty-fifth William Bowie Medal "for unselfish co-operation in research" has been awarded to **Dr. M. A. Tuve**, director of the Carnegie Institution of Washington's Department of Terrestrial Magnetism. Dr. Tuve, who is well known

for his early work on radar and his ionosphere research, has recently been concerned with planning a new radio telescope in the Andes. The Union's J. A. Fleming Award "for original research in geomagnetism and aeronomy" has been awarded to **Professor J. A. Van Allen** whose name has been given to the earth's radiation belts which he discovered. Prof. Van Allen is head of the Department of Physics and Astronomy of the State University of Iowa.

Mino Green, B.Sc., Ph.D., is to direct the research laboratory being set up in this country by the Zenith Radio Corporation, of Chicago. Dr. Green, who is 36, was born in America and graduated in this country at University College, Durham, where he also obtained his doctorate. Since graduating he has spent ten years in the United States, latterly as associate director of the Electrochemistry Laboratory at the University of Pennsylvania.

C. R. ("Corney") Webster, D.F.H., Grad.I.E.E., senior video engineer of Ampex Great Britain for the past three years, has joined Carrion Television Systems Ltd., of Reading, as technical director. Trained at Faraday House, London, Mr. Webster was with Southern Television immediately prior to joining Ampex and before that was with Television Wales and the West. Carrion Television Systems are marketing the PI3V closed-circuit television recorder manufactured by Precision Instruments, of California.



C. E. Eastty

Charles E. Eastty, A.M.Brit.I.R.E., has been appointed to the new post of Technical Head of the Mullard Service Department. He joined the Mullard organization at Mitcham in 1941, and has been in the Service Dept. for the past two years.

Donald S. Reid, M.A., has relinquished the honorary secretaryship of the British Amateur Television Club on being appointed chief engineer of Sierra Leone Television, Freetown. Mr. Reid had been on the

staff of the Rank Cintel Television Development Laboratory since 1960. Prior to this he served for two years in the electronics section of the Physics Research Laboratory of Ilford Limited. From 1954 to 1958 he was with Marconi's.

N. V. Gadadhar, who has held various technical-administrative posts in the Indian government since 1938, has been appointed senior counsellor of the International Radio Consultative Committee (C.C.I.R.). Mr. Gadadhar, who is 48, is vice-chairman of the C.C.I.R. Study Group XII which is concerned with tropical broadcasting. Among his recent appointments in India were those of wireless adviser to the government and chairman of the Radio and Cable Board.

Frank Poperwell, Assoc.Brit.I.R.E., who has been general manager of Reslosound Ltd. since 1961, has been elected to the board. Prior to joining Reslosound, one of the Derritron group of companies, in 1961, he had been with G.E.C. for 35 years. Mr. Poperwell is chairman of the Association of Public Address Engineers.

Dr. P. C. Bailey's new position in the English Electric Valve Company is assistant manager of camera tube research and not display and storage tubes as stated in our September issue (p. 439).

Philip G. Parker, A.M.I.E.E., who has been chief engineer of Radio Eireann for the past three years, has been appointed Director of Engineering. After spending 17 years with Electric and Musical Industries Ltd. as a research engineer, Mr. Parker spent two years as a television consultant to Plessey International Ltd. and a year as a planning and design engineer with Associated-Rediffusion before joining Radio Eireann.

OUR AUTHORS

P. E. K. Donaldson, M.A., A.M.I.E.E., contributor of the article on electronics in neurophysiology on page 521, has been in the Physiological Laboratory of Cambridge University since 1952 where he is concerned with the design and construction of apparatus for teaching and research into neurophysiology and allied subjects. For eight years, before going to Cambridge, he was in the Royal Navy after studying at the Royal Naval College, Dartmouth. Mr. Donaldson, who is 36, is editor of *Medical Electronics and Biological Engineering*.

T. Palmer, B.A., Grad.I.E.E., Assoc.Brit.I.R.E., author of the article on p. 518, was in the R.E.M.E. during the war and since 1948 has taught at the Acton Technical College. For a short time after the war he was a development engineer with E.M.I.

Keith Cummins, who writes in this issue on vision a.g.c., heads a small development section at Halpins of Hampshire Ltd. working on navigational and industrial devices. Prior to starting on development work he was, for five years, maintaining Decca radar and Navigator equipment for the same company.

OBITUARY

Charles John V. Lawson, O.B.E., M.I.E.E., engineer-in-chief of Cable & Wireless Ltd., died on 16th August at the age of 57. Charles Lawson was for many years manager of the cable station and head of the company's school of telecommunication engineering at Porthcurno, near Land's End. He was appointed the company's deputy e.-in-c. a few months prior to succeeding Mr. Smale as engineer-in-chief in 1957. He was appointed an O.B.E. in 1958 and had served as a member of the Radio Research Board of D.S.I.R. since 1960.

Percy W. Harris, who died on 31st August aged 74, was for 25 years in radio before he turned to photographic journalism and started what is now *Modern Camera Magazine*. He joined Marconi's in 1910 as a wireless operator and when he left in 1923 was an instructor. He then spent several years in radio journalism, first as editor of *Wireless Constructor* and later, after a few years in industry, as editor of *Wireless Magazine*. During his few years in industry he was associated with Dr. Robinson and was for a year president of the Stenode Corporation of America.

Leonard Hamlyn J. Phillips, B.Sc., A.M.I.E.E., assistant commercial manager of A.E.I., at Trafford Park, died on 5th September aged 58. He joined Metropolitan-Vickers as a college apprentice in 1927 and was in the Research Department until 1941 working on the development of radar. He then joined the staff of the R.A.E., Farnborough, where he became head of the Radio Department. In 1942 he transferred to the Ministry of Aircraft Production as Deputy Director of Communications Development and three years later returned to Metrovick which became part of A.E.I.

A. Godfrey Imhof, managing director of Alfred Imhof Ltd., died on the 27th August at the age of 52. When he was 26 he became a director and initiated the company's instrument case business. He succeeded his mother as managing director when she retired in 1951.

Anglo-American Agreement.—Advance Components Ltd., of Hainault, Essex, have signed a reciprocal manufacturing and marketing agreement with the Houston Instrument Corporation of Bellaire, Texas. Advance will, initially, manufacture and market the Houston range of X-Y and T-Y recorders, and log frequency and voltmeter converters, whilst Houston will produce and market the Advance H1, J1 and J2 audio-signal generators, the CG88 v.l.f. function generator, the PG5002C double-pulse generator, and the Advance VM77B voltmeter.

Consolidated trading profits of **The Rank Organisation** for the year ended 29th June, showed an increase of £3M on the previous year's results. Net profit after deductions, including £2,751,000 for taxation and £3,927,000 for depreciation, amounted to £3,557,000 and represents an increase of £1,201,000 on 1961/62.

The profit, before providing for taxation, of the **Dubilier Condenser Company** for the year ended 31st March amounted to £201,224, representing an increase of £34,713 on the previous year's results. After taxation of £106,789, the net profit this year was up by £3,816 and totalled £94,435.

Standard Telephones and Cables Ltd. has formed a new subsidiary called **Standard Telephones and Cables (Transistors)** with a capital of £50,000 to manufacture and market transistors and allied semi conductor devices. The South African S.T.C. subsidiary, Standard Telephones & Cables (Pty.) S.A. Ltd., of Johannesburg, is to start manufacturing silicon epitaxial planar transistors next year.

K.G.M. Electronics has acquired a 50% interest in Automatic Information and Data Services Ltd., of Richmond, who manufacture Vidiaid closed-circuit television equipment.

Associated Electrical Industries Ltd. have purchased a 26% interest in **Welwyn Electric**, a subsidiary of Royal Worcester, for £780,000 in cash.

Murphy's Electronics and General Radiological divisions at Welwyn have been amalgamated with the professional and industrial departments of Bush, which are located at Plymouth, to form a new division in The Rank Organisation. It is to be known as the **Rank-Bush Murphy Electronics Division** and will be responsible for a wide range of products, including communications equipment, closed-circuit television systems, navigational aids, and electro-medical equipment.

Honeywell Controls Ltd. have announced that their affiliate company **New Electronic Products Ltd.** is to be known as the Scientific and Medical Instruments Division of Honeywell Controls. New Electronic Products was founded in 1946 and acquired by Honeywell Controls in 1960. They will continue to manufacture their wide range of medical products which include miniature portable electrocardiographs and heart-lung machines.

Savage and Parsons Ltd. have recently announced that the new laboratories they have opened adjacent to their Watford factory are to be made available on a contract basis to other firms requiring fully equipped and staffed laboratory facilities for precision electro-mechanical and instrument research and development.

Keyswitch Relays Ltd. of 120-132 Cricklewood Lane, London, N.W.2, have informed us that they are able to produce a prototype relay to customers' requirements in twenty-four hours.

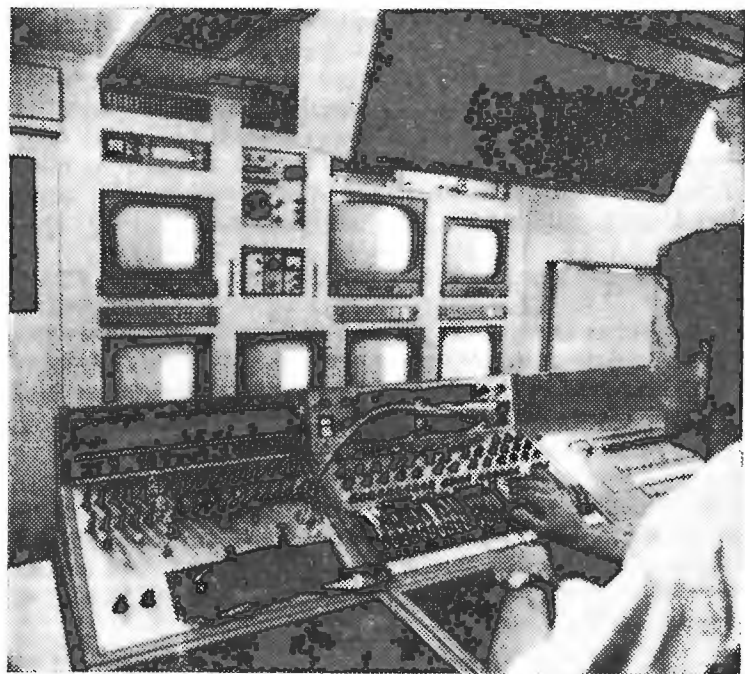

The interior of one of a fleet of ten television mobile control rooms for outside broadcasts supplied to the B.B.C. by Pye T.V.T. Ltd. Each vehicle has four camera channels and can be operated on 405-, 525- and 625-line standards.

The **International Rectifier Company** of Oxted, Surrey, announce that the parent company in California has perfected an epitaxial process for the manufacture of silicon controlled rectifiers with bulk avalanche characteristics extending up to 1,500V and with a typical leakage current of 500 μ A. The American company is already producing 70 A s.c.r.'s. using this process and these will be available later this year in the U.K. The Oxted plant will eventually manufacture these components.

Pay-TV Ltd. is the new title of Toll TV Ltd., which was registered by British Relay Wireless and Television Ltd. some time ago and was re-formed as a joint company by B.R.W. and British Home Entertainment Ltd. earlier this year to foster pay television.

Motorola Semiconductor Products Inc. of Arizona, U.S.A., have opened a London sales office at New Bond Street House, 1-5 New Bond Street, W.1. (Tel.: HYDe Park 3416.)

C.T. (London) Ltd. of 27 Ashley Place, Westminster, (TATe Gallery 8631) have been appointed sole agents in the U.K. for **De Mornay-Bonardi** of California, whose products include a wide range of microwave equipment.

Melabs, of California, manufacturers of microwave systems and components, have appointed Roberts Electronics Ltd., of Hitchin, as their U.K. agents.

E.M.I. Electronics Ltd. of Hayes, Middx. have been appointed sole U.K. agents for the **Voigtlander** range of motor-driven zoom lenses for use with closed-circuit television cameras.

Weather Radar.—Decca Radar Ltd. has received an order from the Ministry of Aviation, on behalf of the Meteorological Office, for a number of general purpose radars for deployment at various weather stations in the United Kingdom. One of these is to be installed in London's radio tower, now nearing completion, and will be remotely controlled from the London Weather

Centre in Holborn. The scanner for this equipment, which rotates at 10 r.p.m., is to surmount the 600ft tower. A "slave" display unit is to be installed in one of the public galleries.

The Zenith Radio Corporation of Chicago recently formed a British subsidiary—**Zenith Radio Research Corporation (U.K.) Ltd.**—to set up a research laboratory in Stanmore, Middx. The laboratory is expected to open within the next few weeks, with an initial staff of about thirty, and will be devoted to basic studies of various solid-state phenomena and will not be associated with engineering or manufacturing.

Six British commercial officers from America are to tour the U.K. from 21st October to 29th November to talk to firms individually about **selling in the American market.** Any company interested in seeing one of these officers should write to the Commercial Relations and Exports Dept., Board of Trade, Horse Guards Avenue, London, S.W.1.

A simultaneous four-channel interpretation system manufactured by **Trix Electronics Limited**, a subsidiary of Ultra Electronics Limited, has been installed in the new conference room of the National Coal Board at Hobart House, London.

The semiconductor division of **Electronic Machine Control Ltd.**, of Thornton Heath, Surrey, has received an order, valued at £266,000, for semiconductor manufacturing equipment from the Continent. The name of the purchaser is not disclosed.

Decca Radar Ltd. has received over 450 orders for its low-priced marine radar equipment Type D 202, which was introduced earlier this year. So far this year, Decca has received orders for well over 1,000 marine radars, 90% of which were from overseas countries. Incidentally, Decca, which has been in this field for 12½ years, received its 14,000th order for marine radar in August.

The Admiralty Research Laboratory has ordered a high-speed computer system from the recently formed **English Electric-Leo Computers Ltd.** The system will also be used by other Admiralty establishments and is to be installed in the autumn of next year at Teddington, Middlesex.

The Admiralty has placed an order with the **Marconi Company** for about 70 m.f.-h.f. independent sideband transmitters; Type NT 204. A previous order, which was placed about 18 months ago and was worth £900,000, called for a larger number of these 500-watt transmitters. An interesting feature of the transmitters is the inclusion of a frequency synthesizer which enables the transmitter to be tuned continuously in steps of 100 c/s through the band 240 kc/s to 24 Mc/s.

Manufacturers' radio, television and radiogram deliveries to the home market since 1955. This graph was prepared from quarterly figures issued by the British Radio Equipment Manufacturers' Association.

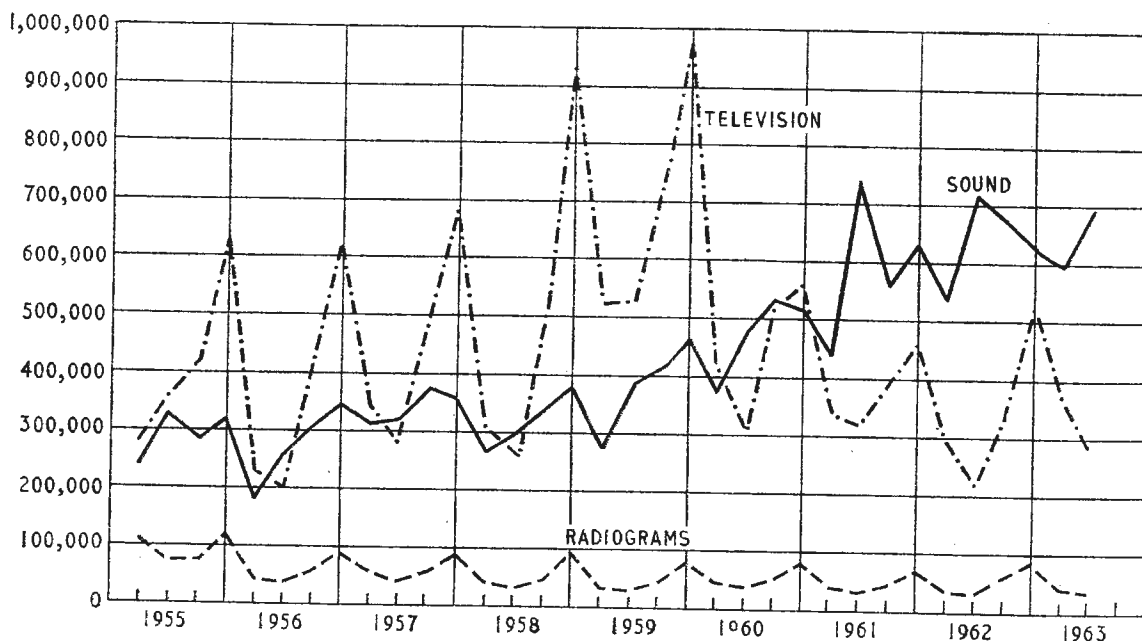

OVERSEAS TRADE

Australia.—Radio equipment to be displayed by the Council of Industrial Design during the series of British Weeks in Australian cities next year include a Ferrograph tape recorder, Grampian microphone, Leak loud-speaker and Ultra portable record player.

The **Australian Post Office** has given the General Electric Company an order to supply all the microwave equipment for four s.h.f. radio relay systems. The equipment will include 34 repeater stations, 10 television terminals and four telephone terminals.

Magyar Televizio, the Hungarian broadcasting authority, has ordered a third television outside broadcast unit from E.M.I. Electronics Ltd. The vehicle, which is identical with the previous two, will be equipped with four E.M.I. 4½in image orthicon cameras.

China.—The National Machinery Import and Export Corporation, of Shanghai, has ordered 15 delayed pulse and sweep generators from Rank Cintel. This order is valued at £4,500.

The **Department of Posts and Telegraphs in Ghana** has commissioned the Marconi Company to supply and install a 48-channel, twin-path, v.h.f. link between Ghana's new atomic research station at Kwabenyam and the capital, Accra. Marconi's are using their own multi-channel radio equipment and the Automatic Telephone and Electric Company are supplying the carrier and voice-frequency telegraph equipment.

The **East African Posts and Telecommunications Administration** has awarded the Marconi Company a contract totalling £80,000 for the modernization of the multichannel link between Nairobi, Mombasa, Tanga and Dar-es-Salaam installed by Marconi's ten years ago.

German Subsidiary.—Marconi Instruments Ltd. have formed a German sales and service company—**Marconi Messtechnik G.m.b.H.**—with headquarters in Munich. T. Broderick, who served as a radio officer with Marconi Marine before joining M.I. in 1955, has been appointed manager and will operate from Wolfratshausener Strasse 243, München-Solln.

Redifon Ltd. have opened an office in **Lagos, Nigeria**, to cover the west coast of Africa. C. K. Harrison who has been with Redifon for three years, is the area manager. He is an amateur transmitter and uses the calls G3OPJ and 5N2CKH.

LETTERS TO THE EDITOR

The Editor does not necessarily endorse opinions expressed by his correspondents

Non-linearity Distortion Measurement

(1) I AM sure that Mr. M. V. Callendar (p. 446, Sept. issue) will agree that in introducing a new idea it is justifiable to consider simple cases before frightening the reader with the full complexity of a rigorous treatment of class-B cross-over distortion. We limited the introduction to the first three terms mainly for this reason. It seems that our critics feel that the whole analysis is thus limited, which is by no means the case.

As will be seen by studying equation (2), from Brockbank and Wass, the noise power expression is given for all orders of distortion including the r th, which is surely high enough to cope with any type of characteristic, however kinky.

Again, we included 8th-order distortion powers in Table III, p. 164 of the April issue. Perhaps future critics may care to note while the first three terms were chosen to illustrate the analysis we have nowhere stated that under abnormal conditions high orders are unimportant.

(2). We are aware that high-order distortions produce fractional terms normally associated with the fundamentals and other low-order products, but this does not affect our argument.

(3) There is in our view absolutely no justification for comparing distortions at constant volume. This habit is a relic of a bygone age when M.V.C., "Cathode Ray" and this author were younger and when we were all trying to squeeze a few hundred milliwatts from a single P625 or LS5A at 10% distortion. In those days the "wick" was turned up until the distortion became intolerable. Since speaker efficiencies were also low the result was much as it is today—"the very large proportion of music heard" being intolerable and scarcely audible!

The better way to consider distortion, when it is tolerably low is to imagine a single instrument, such as a soloist with the backing of a full orchestra. Does anyone rush to the volume control to cut down the tutti to the same total power as the single oboe or violin or flute? Surely not. The efforts made to increase available dynamic range would be totally wasted. Today it is possible to produce sound levels in the home at least equal to those in the concert hall without overload for periods in excess of 1/10,000th part of the time by using amplifiers of adequate power (plus forty to plus forty-five dBm) and efficient speakers. In these circumstances the addition of equal tones is completely justified when comparing the relative powers in intermodulation and in harmonic distortion. Even if this were not true, it would still not affect our argument.

(4) Audibility of single tones, wanted or unwanted is not discussed in the article.

(5), (6). We have shown that in complex signals comprising many tones of random duration simultaneously, the distortion due to non-linearity of any order resembles a uniform band of noise added to the wanted signal. If this be true, and so far no one has queried this result, the annoyance must be the same as that of an equal instantaneous noise power added to the complex signal.

The demonstration with the square-law distorter was sufficient to show that the distortion did in fact sound exactly like white noise, when the number of tones was sufficiently great. Since the analysis shows that this type of noise power is produced by any order, we fail to see how the ear can distinguish between two equal powers of white noise and thus pretend to a preference for one originating cause rather than another.

When the level is changed, however, the noise power in high orders increases faster than in low orders.

The idea of weighing a given harmonic is irrelevant now that it has been shown that the intermodulation noise power is "astronomically" greater than the power in a single harmonic. Our demonstration showed practically that the intermod noise was unmusical, i.e., that the harmonics were inaudible below the intermodulation noise. It was to prove this audibly that we took so much trouble to derive the distortion from the only known method which completely eliminates the signal. We used a precise squarer which could be balanced to eliminate fundamental and third-order terms. This method does not restore the signal frequencies due to secondary effects. The importance of the test relies entirely on its success in this one point. Did it or did it not sound like noise? There were several hundred in the audience at the time but the test can always be repeated for anyone interested.

The relevance of this test is whether or not it confirms the analysis. We think it does.

(7). One does not need to have automatic audio level control to exclude overload. One can always build a big enough amplifier.

To conclude, we agree that harmonic measurements if carefully made and equally carefully interpreted may be used to derive a calculated value for the intermodulation power. The calculation is by no means simple, since it has to be carried out for a number of frequencies and for all orders of distortion. Nor is the interpretation easy when more than one distorting element is used in tandem.

It is for all cases, the simple and the increasingly difficult, that we put forward the slotted white noise method as giving the quickest, most reliable single figure numerical result including all orders of distortion simultaneously. It is the Noise Power Ratio that determines the quality of a system at any particular level. Measurements by this method would show that this ratio is poor at low levels in badly set up class B networks, a fact which is known to many besides our critics. Our method gives this result—directly and without calculation in a repeatable numerical form in about two minutes for each observation.

In final summary:—

We have shown that distortion gives rise to noise and that the "slotted white noise" method can measure this noise in the form of a power ratio. We think that all ambiguity in interpretation of harmonic percentages can be eliminated once and for all by the acceptance of the N.P.R. as a convenient and unambiguous figure of merit. The audio fraternity may be interested to learn that this kind of measurement was made on Telstar and is standard practice in the carrier telephone field where low distortion is really important.

J. SOMERSET MURRAY.

Tape Guides

MAY I suggest to Mr. R. E. Ross (p. 446, Sept. issue) that the excessive friction with p.t.f.e. sleeved tape guides may be due to electrostatic attraction? Presumably the greater conductivity of glass would allow the charge on the tape to leak away.

Also on a similar subject, I wonder if anyone else has noticed the effect of capacitive current near the 25kV electrified railway from Crewe to Manchester? I find that touching my wife's hand when standing near the edge of the platform produces the same tingling sensation as an imperfectly earthed piece of mains-

driven equipment. As a capacitance of 1pF would produce about $8\mu\text{A}$ a sensible current is quite feasible; indeed we suspect a farewell kiss would be very dramatic!

Cheadle.

B. PRIESTLEY.

MAY I add a few comments on the use of p.t.f.e. guides in tape recorders, as raised by your two correspondents in the August and September issues?

I have tried this material both as guides and as the contact surface of head pressure pads and in each case flutter was increased rather than diminished.

Although p.t.f.e. has a low coefficient of friction when applied to hard surfaces, I do not think this applies when it is in contact with a comparatively soft material such as magnetic tape.

I would suggest that Mr. Skinner's "flutter distortion" was caused by poor tape/head contact and was not flutter in the accepted sense. The p.t.f.e. in this case may have corrected the trouble.

On the other hand, Mr. Ross's experience was undoubtedly due to static build-up between the tape and the p.t.f.e. which caused the tape to adhere to the guides. Often a smell of ozone is detected or a corona discharge is visible during fast spooling under these conditions.

I have found only two materials satisfactory in contact with the back of the tape, these are hard chrome or highly-polished stainless steel. I think this is due to the fact that most tapes are slightly "tacky."

As far as pressure pads are concerned, my only advice would be to try not to use them. Tape fingers which slightly bend the tape round the face of the heads are a better solution.

On the other hand the oxide surface of the tape carries a certain amount of lubricant and I see no reason why glass guides should not be satisfactory here, especially as wear would be considerably reduced.

It has been suggested elsewhere that p.t.f.e. in continuous contact with the oxide would tend to reduce tape hiss on playback, but I have yet to prove this.

Witham, Essex.

G. R. LAWSON.

Flag Day

MAY I please be allowed to comment on Mr. George Stratton's letter (August issue) regarding suggestions for a suitable heraldic device for the patron saint of radio, St. Gabriel.

I feel sure that Mr. Stratton did not mean to be so cruel to the poor transistor, but meant to say "... a herculean figure destroying some of those more irresponsible users of pocket transistor radios".

The transistor radio has a very great part to play in the future of electronics and is certainly not worthy, or indeed deserving, of the fate he would, in his annoyance, inflict upon it.

Mr. Stratton would also be well advised to become cognizant of the laws of copyright in his hagiographic search as I would remind him that there is already in existence an emblem such as he suggests, with a herculean figure striking, not a transistor radio, but a gong, which has resounded and echoed over the greater part of the world.

Welwyn Garden City.

F. F. BIRMINGHAM,

Electronics Division, Rank-Bush Murphy Ltd.

PREPARATIONS FOR TAT-3

THE world's largest cable ship, *C.S. Long Lines*, which was commissioned earlier this year, has now completed loading 1,700 nautical miles of lightweight cable from the Southampton factory of Standard Telephones & Cables. This cable is to be used to complete TAT-3, the 3,600n.m. transatlantic link, which when complete will provide the first 128 direct telephone circuits between Britain and the U.S.A. The task of laying this cable, which costs about £25,000 per 20n.m., is being shared with *H.M.T.S. Alert*, the G.P.O.'s latest cable-laying ship. The *Alert* has now laid over 1,500n.m.

of cable from the American end—Tuckerton, New Jersey—and *Long Lines* is expected to complete TAT-3, which terminates at Widemouth in Cornwall, by the end of the year. The repeaters, which are spaced at 20n.m., were designed and manufactured by the Bell Telephone Laboratories in the U.S.A. Both Bell Telephones and the Transoceanic Cable Ship Company, which owns *Long Lines*, are subsidiaries of the Automatic Telephone & Telegraph Company.

C.S. Long Lines, which was built in Germany at a cost of \$19,000,000, is 511ft long, has a beam of 69ft and when fully loaded with 2,000n.m. of armourless deep-sea cable the displacement is 17,000 tons. A test room sited on the working deck of the ship houses specialized equipment for testing the cable and the repeaters. Using this equipment, the ship's technicians can check the transmission characteristics of individual repeaters, and also the whole cable system before and during the laying operations by passing high-frequency currents through the cable. The ship's radio-navigational aids include British Decca Radar, American and Japanese Loran and American communications equipment. She carries a crew of 90 officers and men.

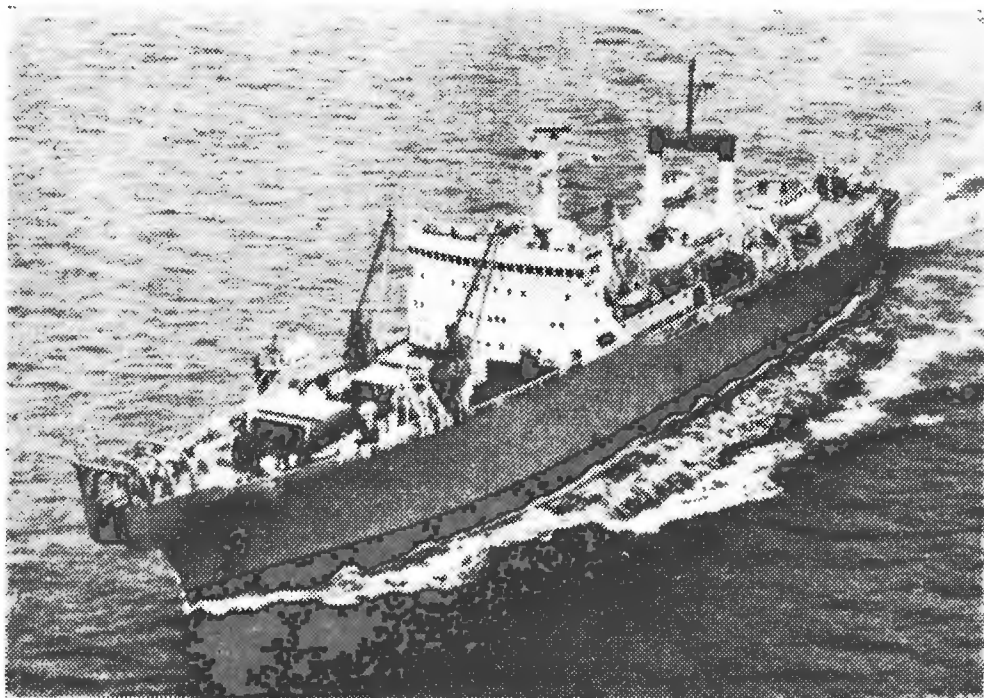

C. S. Long Lines cable-repeater handling system provides precise control of cable slack and permits uninterrupted laying. Cable is stored in three 32ft deep tanks.

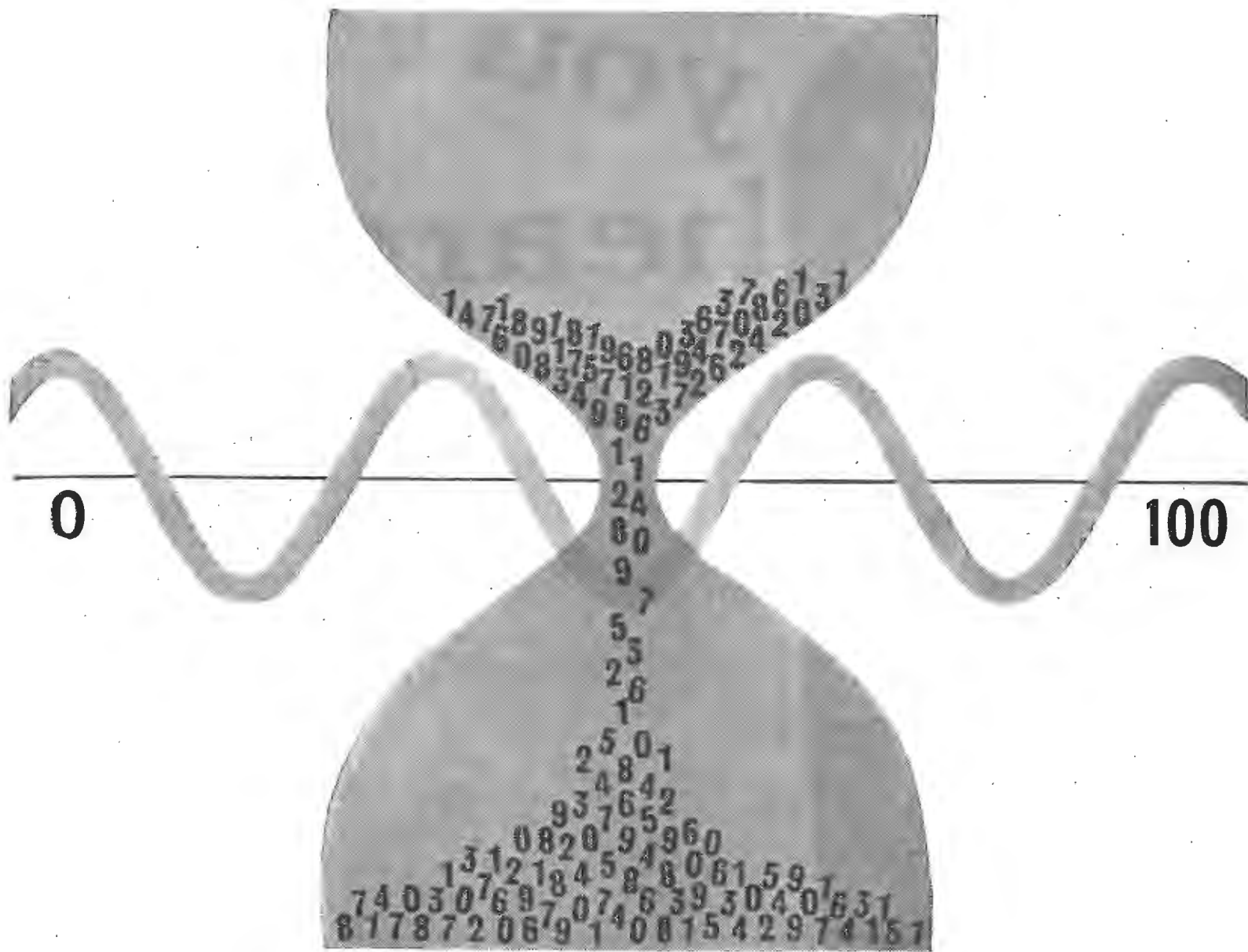

Frequency 0 to 100 Mc/s — Time or Period, 1 microsecond to over 3 years

The Airmec High Speed Counter Type 298 is a basically new, fully-transistorised instrument, covering the frequency range d.c. to over 100 Mc/s without the complication of additional plug-in units or external accessories. It offers in one compact unit a unique combination of facilities for time and period measurements, and for frequency measurement either by direct or inverse methods. The indicator is a large 8-figure in-line display unit showing both the units of measurement and the decimal point, combined with a 5-digit resettable electro-mechanical counter. For permanent records of readings, there are facilities for operating an Airmec Printer Type 316 from the Counter.

The High Speed Counter Type 298 is part of the comprehensive range of high quality electronic instruments produced by Airmec for use in laboratories and workshops.

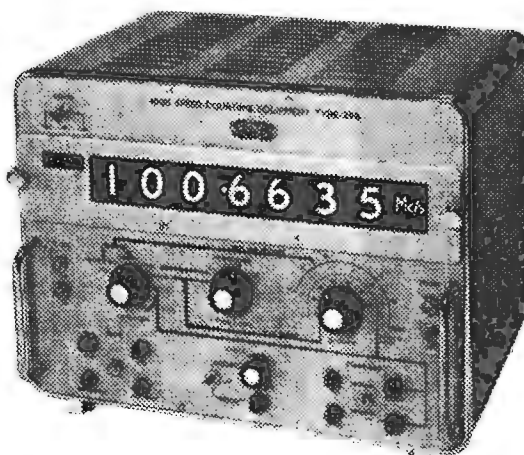

SPECIFICATION

D.C. to 100 Mc/s
12 figure digital read-out
Automatic indication of decimal point and units of measurement

MEASURES

Frequency, Time, Period

COUNTS

Pulse or Sinewave Inputs

PROVIDES

Standard Frequency Outputs at 1 and 10 Mc/s
Divider Facilities 10^{-1} to 10^{-8}
Connection for external frequency standard
Output to Airmec Printer Type 316 for digital print-out
Self-checking facilities
All these features are built-in, and are provided by the Counter without the need for external accessories.



Airmec for peak performance consistently

LABORATORY INSTRUMENTS DIVISION - High Speed Counters, Signal Generators, Oscilloscopes, Wave Analysers, Phase Meters, Ohmmeters, Valve Voltmeters, etc.

AIRMEC LIMITED HIGH WYCOMBE BUCKS ENGLAND
TELEPHONE HIGH WYCOMBE 2501 (10 LINES)

AP265A

1W W-114 FOR FURTHER DETAILS.

you heard me

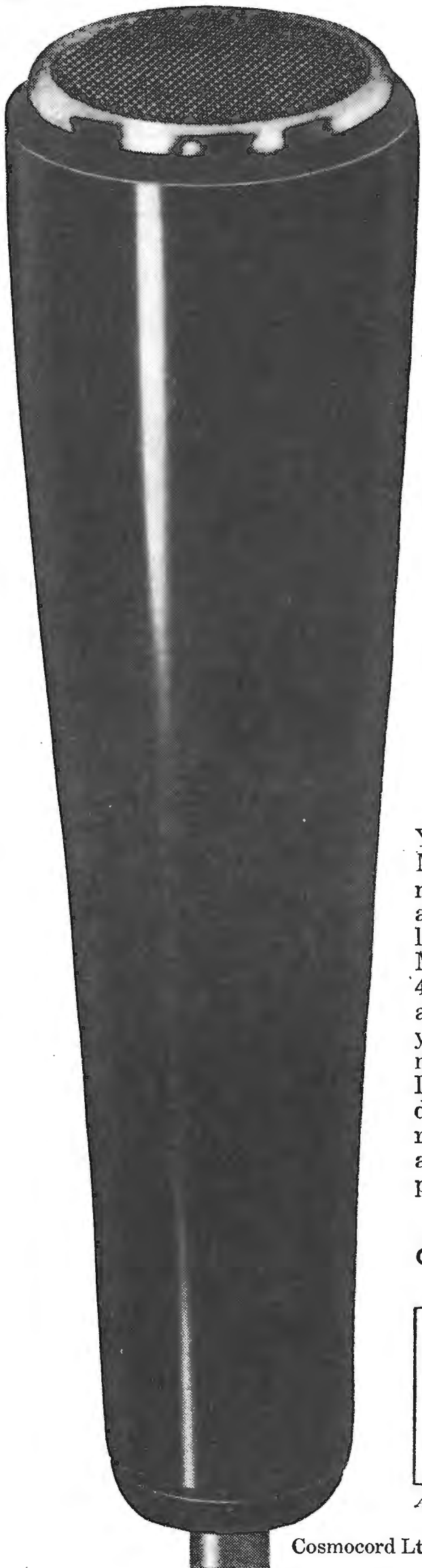

You heard my quality—I'm the dynamic Acos MIC 39 Magnetic. You know my famous brother, MIC 39 crystal microphone. We give you good sound, and good value, and we stick to a strict decibel diet to keep our slim, trim looks. We have well-known relatives: elusive cousin MIC 40 (she keeps on folding away), sensitive little MIC 45. Clever, omni-directional ACOStereo MIC 44, MIC 55 and 60, the newcomers. We're a *well-connected* family—you heard us in the majority of all British designed and made tape-recorders, and in many foreign ones as well. If you are a manufacturer, we help you to keep costs down, quality up. If you are a user, make sure you buy a recorder with an Acos microphone. (If you have a recorder already, consider fitting one of us as replacement to improve your sound.)

acos microphones

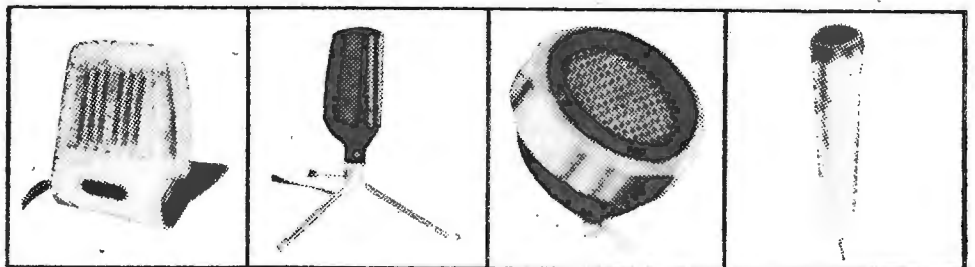

Acos MIC 40

ACOStereo MIC 44

Acos MIC 55

Acos MIC 60

Cosmocord Ltd, Eleanor Cross Road, Waltham Cross, Herts. Telephone: WS 27331

1W W-115 FOR FURTHER DETAILS.



GERMAN RADIO EXHIBITION

BERLIN 1963

A MORE relaxed atmosphere surrounded this year's Berlin exhibition than was evident in 1961, immediately after the division of the city, but in general character the exhibition was not much changed. Again the big names in the German radio industry had spent large sums in fitting out their individual *halls* (not stands), and the task of visiting them all was almost, though not quite, as searching a test of stamina as going the rounds of this year's London trade exhibitions.

The theme of the exhibition (it would seem a *Leitmotif* is essential to the Germans) was this year

Rundfunk-Stereofonie: Neue Technik—Neue Klang (Stereo Radio: A New Technique—A New Sound). To ensure that no visitor should miss the message, after passing the turnstiles all were plunged into darkness and harangued on the subject by a gentleman of compelling personality on a large-screen film projection, accompanied by proportionate sound.

Anniversaries are also an important feature of German life, and the fact that this is the 40th year of sound broadcasting in Berlin was not overlooked. All the famous household names in German radio proudly marked their early association with broadcasting by devoting some part of their stands to a display of equipment of historical interest.

The drive for stereo radio has come from the industry. Within a few weeks of the announcement by the F.C.C. in America of its acceptance of the Zenith/G.E. pilot-tone

system as a national standard the firm of Körting was in production and selling complete sets and decoders in the American market. Other firms have not been inactive and now every leading manufacturer is offering a similar service. Until a European standard is established the transmissions now taking place from *Sender Freies Berlin* on the American system must be regarded as experimental—as a means of demonstrating to buyers from the U.S. and as a possible stimulus to German listeners to demand a regular service of stereo in Germany. Berlin has maintained its traditional technical initiative in putting on these special broadcasts for the exhibition period, but when pressed to continue declines to do so on the grounds that sufficient funds may not be forthcoming from the other *Länder* broadcasting authorities, who in the present political situation must help to keep the Berlin service going. One gets the feeling that this hesitance owes its origin, in the minds of all German broadcasting authorities, to the belief that stereo radio is not really wanted by the listening public, and that the difficulty and expense of broadcasting in stereo should not be undertaken on a permanent basis until there is a clear demand. For years German listeners have been accustomed to the idea of *raum Klang* or three-dimensional sound, produced artificially by reverberation and diffusion principles, and unless stereo sounds very different from

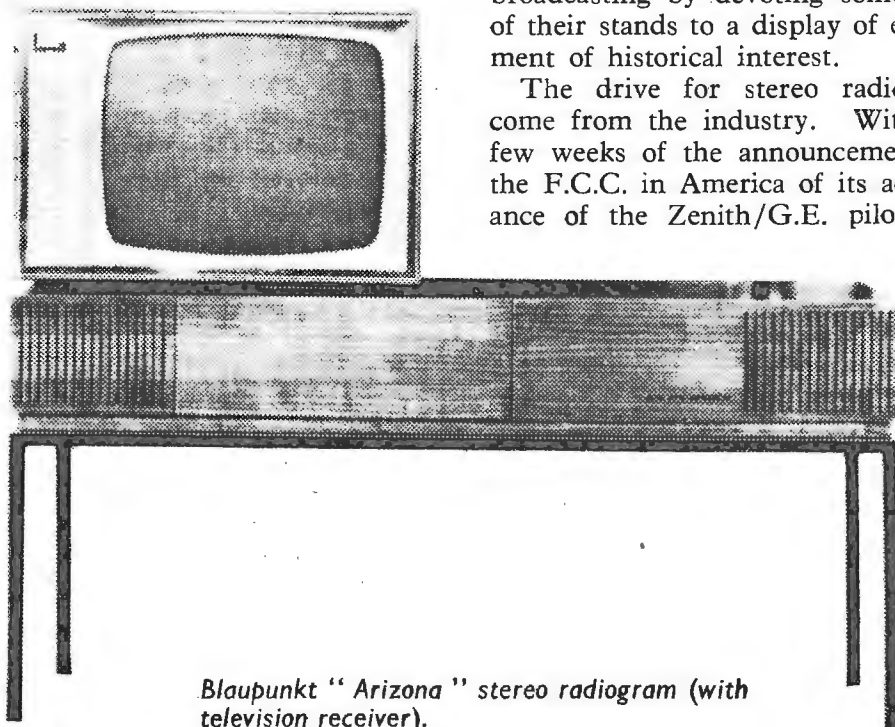

Blaupunkt "Arizona" stereo radiogram (with television receiver).

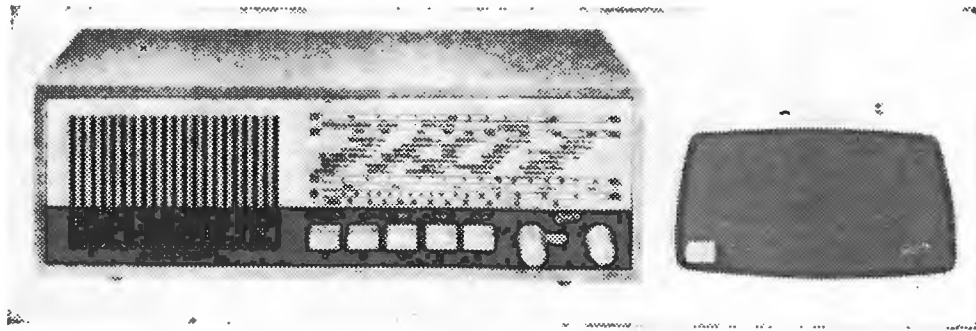

Graetz "Contact" transistor a.m./f.m. receiver and extension loudspeaker with built-in transistor a.f. amplifier permitting two-way speech contact. Loudspeakers are used as microphones when the changeover switches are operated. Power consumption is only 15 watts.

Telefunken "Opus" tuner and control unit, with loudspeaker units.

this, sales are unlikely to be stimulated. In the environment of the exhibition with all sets going full out the subtleties of stereo are somewhat swamped, but thanks to the forethought of the SFB station authorities, who had invited firms to bring their equipment into the central building, visiting journalists at least were given the opportunity of hearing representative sets working in separate rooms from a live transmission.

The more successful sets are those with widely spaced loudspeakers such as the Blaupunkt "Arizona" which is 4½ft long and incidentally is low built to serve as a table for the television set. Wider spacing and more freedom of choice is possible when the loudspeakers are mounted separately from the amplifiers and tuners and this system is much favoured by the German radio industry this year. It would seem that at last the Anglo-American cult of "hi-fi" has been accepted—even to the extent of proudly claiming that the *Steuergerät* (control unit) has the "technical appearance" which is valued by customers interested in hi-fi combinations. Loudspeakers (*Lautsprecherboxen*) are multi-unit, moving-coil affairs, one of the most impressive both in size and performance being the Grundig Type 100 with no fewer than nine units, one of which goes down to less than 20 c/s. Generally a long rectangular enclosure is favoured which can be mounted either horizontally or vertically, notable examples being those of Blaupunkt and Telefunken.

Most control units combine tuner, stereo decoder and the two amplifier channels in the same cabinet, but Grundig use a separate valve tuner unit and a transistor dual power amplifier rated at 25 watts in each channel. It was noted that much more heat was rising from the RT 50 tuner than from the SV50 power amplifiers! Automatic noise suppression between stations is a feature of this tuner and also automatic switching from mono to stereo (and vice versa) with pre-set sensitivity

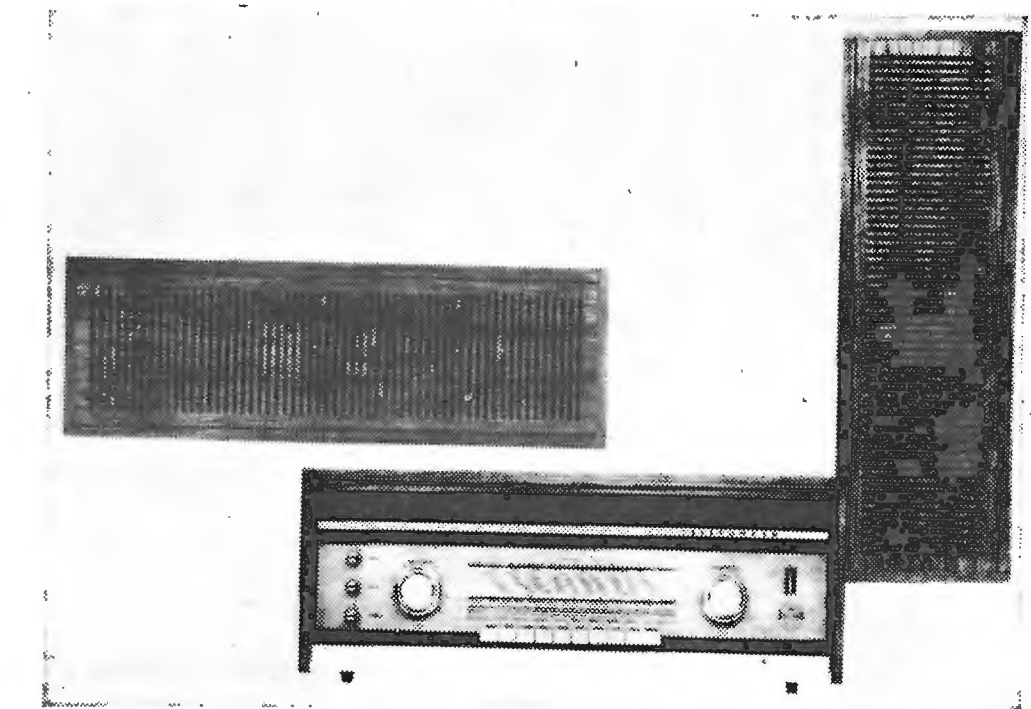

control and an indicator showing when the stereo circuits are in operation. In the latest "14" series of fully automatic receivers SABA have adopted electronic switching in preference to a relay for dividing or paralleling the two audio channels. Even when automatic switching is regarded as a luxury, indication of the nature of the modulation in a received signal is given by filtering the 19 kc/s pilot tone and applying the rectified voltage to a neon lamp. This is the principle used in the Telefunken "Opus" which, like most German v.h.f. receivers in the top class, is provided with automatic fine tuning as an alternative to manual control.

As in the U.K. a substantial part of the turnover of the German radio industry is accounted for by the sale of transistor portable radio sets. The dual-purpose portable/car-radio set is still popular and Graetz have provided an auxiliary 5-watt amplifier for use with their portable when it is installed in sports cars. They have also devised a special anti-vibration mounting for tractors so that the ploughman also can have "music while he works." The popular little Telefunken "Ticcolo" pocket receiver with alarm clock has also been

turned into a car radio through the medium of a Plexiglass container with three large suction caps for attachment to the windscreen. Further miniaturization of transistor portables is envisaged by Siemens who demonstrated "Microblock" circuit elements and showed how space could be saved in their "Klangmeister T" receiver.

What might be described as a "communications portable" (T1000) has been developed by Braun. It covers 13 wavebands: v.h.f. (1), short waves (8), medium waves (2) and long waves (2). Both a.m. and f.m. are covered and there is a b.f.o. for telegraphy. It uses semiconductors throughout and operates from internal dry cells, external accumulators or mains. Dimensions are 14×10×5¼in.

Television.—The design of television receivers in west Germany is now more or less stabilized. It is three years since the first u.h.f. tuners made their appearance and production has reached a level at which a substantial number are available for export, including many types using low-noise transistors.

The sets themselves have not changed much since last year. The

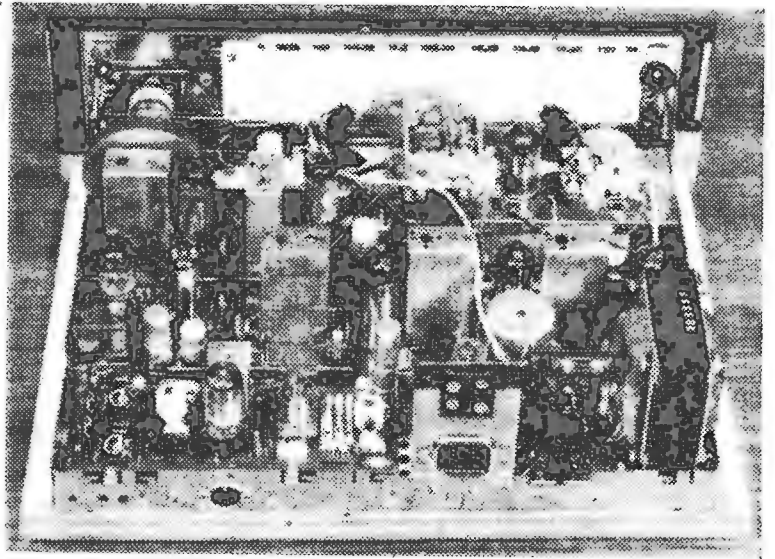
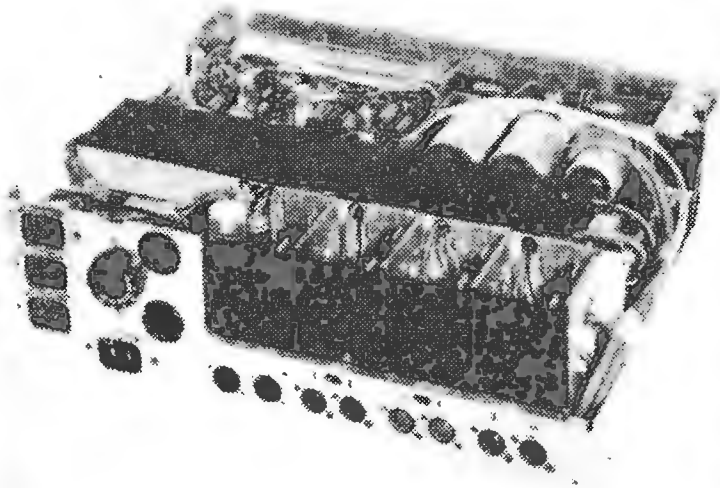

▲ Grundig SV50 transistor stereo amplifier and (right) RT50 valve stereo tuner unit.

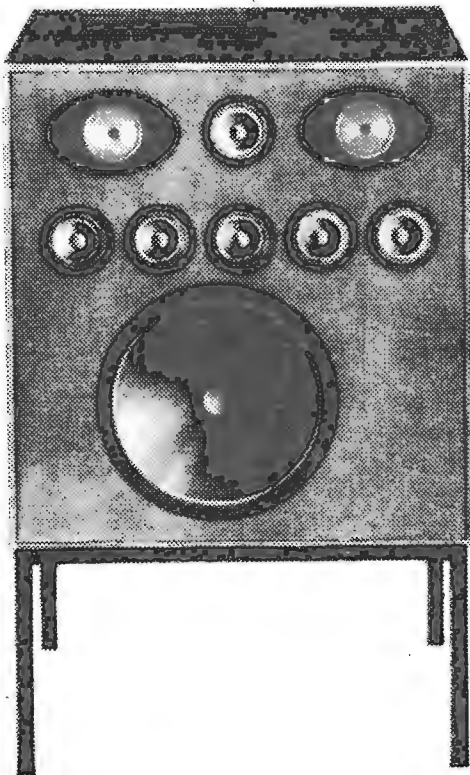

▲ Grundig Type 100 "hi-fi" loudspeaker.

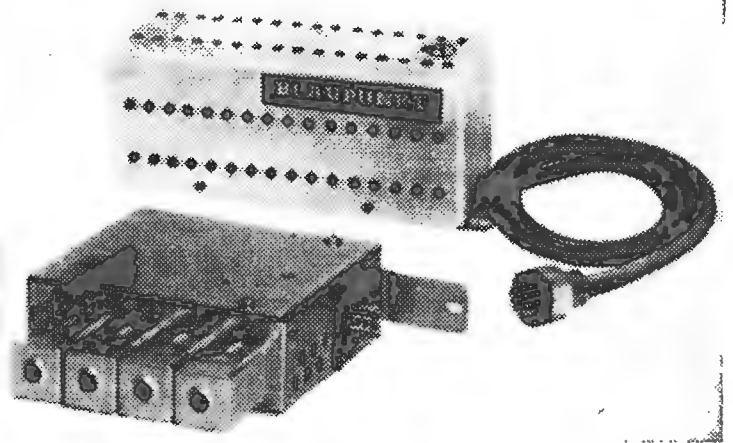

▲ Two typical stereo decoder units. The one in the foreground is by SABA and the other by Blaupunkt.

Automatic tuning mechanism in the Nordmende "Tippomatic" television receiver.

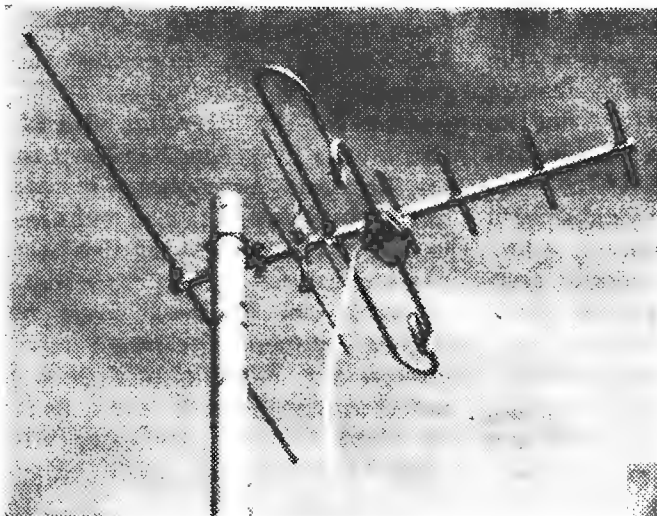

▲ Fuba combined v.h.f./u.h.f. aerial (FSA1U8).

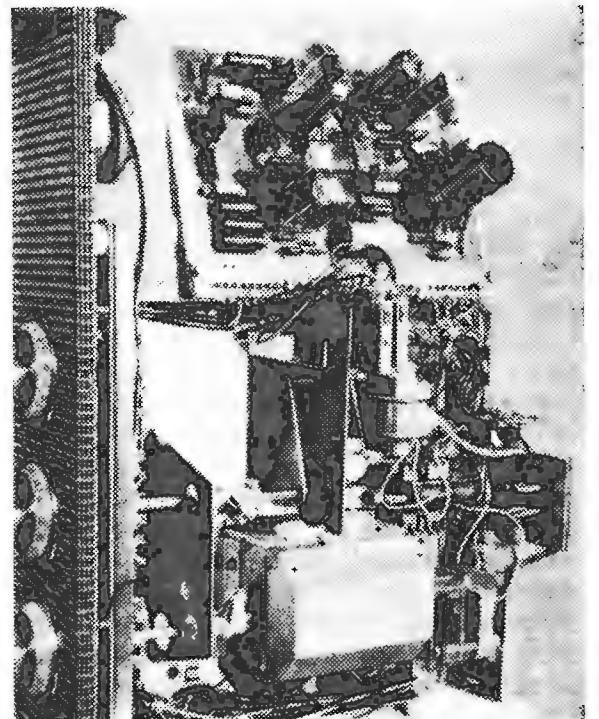

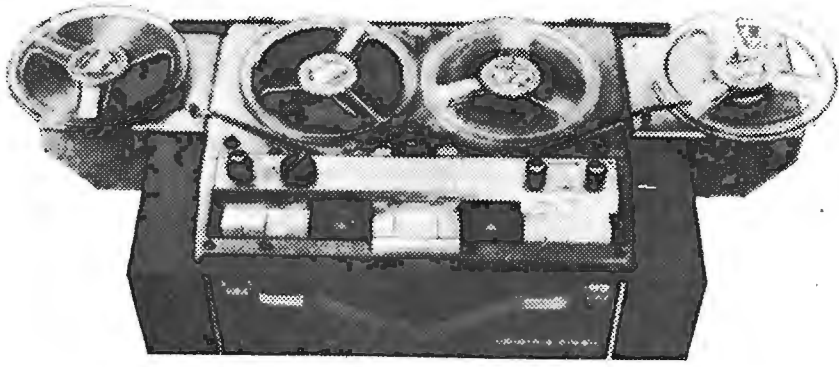

▲ Körting MT3624 tape recorder with duplicating attachment.

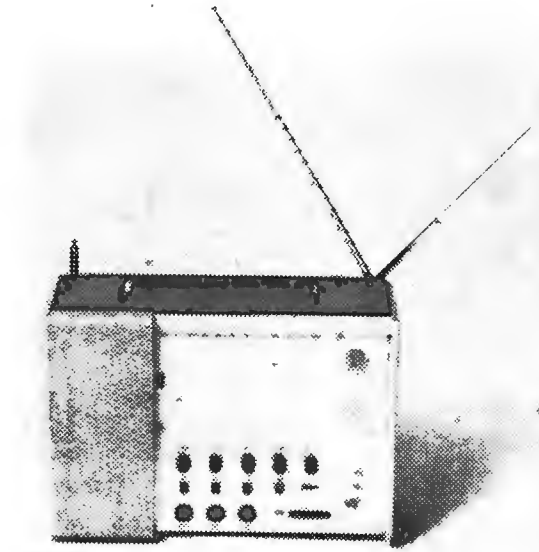

▲ Braun T1000 "all-wave" transistor portable.

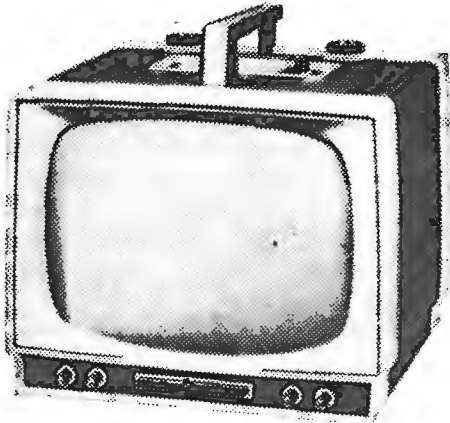

▲ Provision for v.h.f. sound broadcasting is a feature of the 10in Loewe Opta "Optaport" television receiver.

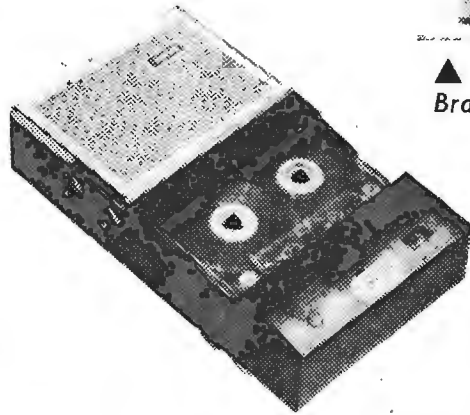

▲ Philips 3300 miniature ($7\frac{3}{4} \times 4\frac{1}{2} \times 2\frac{1}{4}$ in) tape recorder, giving one hour's playing time at $4\frac{3}{4}$ cm/sec.

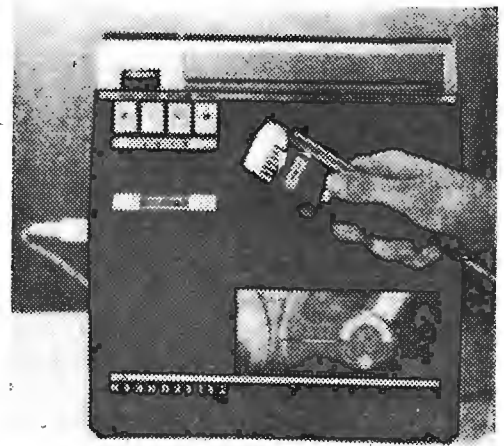

▲ Telefunken "Magnetophon 300" portable recorder with level indicator incorporated in the microphone.



▲ Chassis of the Nordmende "Transvisa" 10in portable.

popular tube size is 59cm (23in) but Grundig have brought out a 69cm (27in) model. The "luxury" set still finds a market here and the Nordmende "Tippomatic" must surely represent the ultimate in ease of control. Here even the effort of turning a knob or pushing a button is eliminated for to change a station the touch of a finger on the channel indicator dial is sufficient to set in motion the motor-driven station searching mechanism and automatic fine tuning control. The metal indicator dial is connected to the high resistance grid circuit of a triode which is normally negatively biased and has a control relay connected in its anode circuit.

Portable television sets are beginning to gain ground and fall into two categories: 19in sets like the Telefunken FE103P which are mains-operated and whose carrying handles are intended only for moving the set around the house, or the true portables with 10in screens and alternative mains or battery operation such as the Loewe Opta "Optaport" and the Nordmende "Transvisa," the former being adapted for v.h.f. sound as well as television reception.

Although many sets retain the Zeilenfrei (line eliminating) feature as a switchable alternative, not so much emphasis has been put on this refinement as in 1961. SABA who started the fashion with their optical diffusion screen have, however, pursued development to its logical conclusion and have developed what they term the V-tube, similar in construction to the twin-panel (anti-reflection) tube and using a soft p.v.c. covering grooved for line-free diffusion and bonded to the glass with an adhesive of the correct refractive index to avoid internal reflections. It is claimed that the new composite covering disperses

electrostatic surface charges as well as providing implosion protection.

Tape Recorders.—The new Philips miniature portable recorder Type 3300 which made its debut in Berlin measures only $7\frac{3}{4} \times 4\frac{1}{2} \times 2\frac{1}{4}$ in and uses 3.8mm twin track tape in a reversible cassette giving one hour's playing time at a tape speed of 4.75cm/sec. Although the output is rated at only 250 mW an efficient loudspeaker gives a very good sound from the claimed frequency range of 120-6000c/s. A somewhat larger portable, the Telefunken M300, is notable for the ingenious idea of incorporating the recording level meter on the hand microphone instead of on the instrument panel, and also for its use of contra-rotating flywheels to obviate inertial "wow" so that the recorder can be used while being carried. Among the larger tape recorders the Körting MT 3624 was noted as a high-grade stereo recorder to which a tape duplicator attachment (Type 14 901) could be added for making copies on the same machine. In effect there is a transposition of tracks (3 to 1 and 2 to 4, or vice versa).

Capacitive Transducers with Transistor Amplifiers

By A. R. BAILEY* M.Sc.(Eng.), A.M.I.E.E.

This article deals first with the obtaining of high input resistances with transistors. An alternative method of obtaining a sufficiently long input time constant is then examined and its relative noise performance is investigated. Finally a detailed circuit is given which will give good results with either capacitive or inductive transducers.

THERE is a widespread belief that capacitive devices, such as crystal microphones, crystal pickups, etc., cannot easily be used with transistors. The reasoning behind this view is presumably the difficulty in obtaining a very high input resistance in a transistor stage without excessive cost. Before an investigation is carried out into the development of suitable circuits, it will be as well to go over the reasons why crystal devices give difficulty.

The equivalent circuit of crystal devices can be represented by a constant voltage generator of e.m.f. V_s and an internal capacitive impedance of value X_c . The effective capacitance that causes the reactance is constant over the greater part of the frequency range and for our purposes will be assumed constant for the present. The total "equivalent" circuit of such a transducer with a resistive input circuit is shown in Fig. 1. At high frequencies virtually all the output voltage of the transducer will be developed across the input to the amplifier. As the frequency is reduced, however, there will come a time when the increasing reactance of the transducer will cause an increasing loss in the output. As it is a single RC section that is causing the loss in output, the -3dB point will be given where the reactance of the capacitor is equal to the input resistance. The ultimate rate of fall will be 6dB per octave. In the case of crystal microphones and pickups, the value of C will most likely lie between 500 and $5,000$ pF. For a 3dB loss at 50 c/s this gives limits to the input resistance of $6.36\text{M}\Omega$ and $636\text{k}\Omega$ respectively. For a response extending farther down into the low frequencies this would mean using still higher values.

Having seen what values of input resistance are necessary for an adequate bass response, it is now required to see what values of input resistance can be obtained with the use of transistors. Taking the case of a transistor run in the common-base connection¹, the input resistance is approximately $\frac{25\beta}{I_e}$, where β is the common-emitter current gain of the transistor and I_e is the emitter current of the transistor in milliamperes. This, however, is of little use unless we know the values to fit in the

equation. We have a starting point in that most transducers give only a small output. For a good signal-to-noise ratio it is therefore essential to use low-noise transistors. For low-noise transistors such as the AC107 the value of β is in the region of 100 , so all that is left is the value of I_e .

As will be seen from the equation above, the value of the transistor input impedance varies inversely as the value of the emitter current I_e . Hence it would appear that any value of input impedance could be obtained by a choice of a suitable emitter current. In fact, however, this state of affairs does not exist as the value of β falls off fairly rapidly below a certain range of current. Luckily the low-noise transistors maintain their current gain down to quite low values of current, and it is quite possible

Fig. 1. Equivalent circuit of capacitive transducer when driving into a resistive load.

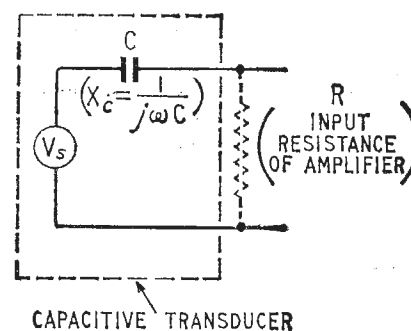

to run with emitter currents as low as $50 \mu\text{A}$ without much loss of current gain. Hence if we take the fairly optimistic case if I_e being $50 \mu\text{A}$ and β being 100 , the input impedance becomes $\frac{25 \times 100}{50 \times 10^{-3}} = 50\text{k}\Omega$.

This value of input impedance is obviously far too low for a crystal transducer as it stands. For a reasonable bass response the input impedance will need to be approximately 10 to 100 times greater. The first way of tackling the problem is to use the emitter-follower connection as shown in Fig. 2. With a current gain of 100 in the transistor the input impedance will be stepped up by a factor of many times, the exact amount depending on the value of the emitter resistor R_3 . If this resistor had a value of $50\text{k}\Omega$ it would reflect a value of 50β ($\text{k}\Omega$) across the input of the circuit. If β is 100

*Bradford Institute of Technology.

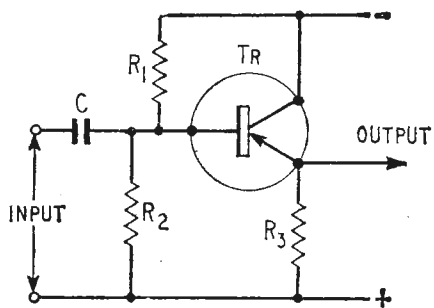

Fig. 2. Single emitter-follower circuit.

then this value is equal to $5.0 \text{ M}\Omega$. This would be very satisfactory but unfortunately there are more factors to be taken into account.

First, the input impedance of the transistor proper will only be stepped up by a factor of approximately β and this will give an additional $5.0 \text{ M}\Omega$ in parallel with the input using the values taken previously. In addition there is the base-to-collector resistance which is normally ignored. In this case, however, it cannot be ignored as the input impedance is so high. The value of this resistance is very variable and varies greatly with conditions but is unlikely to greatly exceed $2.5 \text{ M}\Omega$. These values when taken together give a total input impedance of $1.25 \text{ M}\Omega$ which would appear to be satisfactory. However there are further factors that cannot be ignored. The input impedance of the following stage must not be below about $50\text{k}\Omega$ or it will severely reduce the total input impedance. In addition the input potential divider for the base of the first transistor must have a high impedance if it is not to shunt the total impedance appreciably. This can be arranged, but the thermal stability of the circuit will then suffer and the transistor may "bottom" at even moderate temperatures.

One way out of these difficulties is to use a two-stage emitter-follower with the first collector bootstrapped to the output emitter. Such a circuit is shown in Fig. 3. The input impedance can be as large as $5 \text{ M}\Omega$ but of course there is no voltage gain overall. With the transducer connected the output impedance will be in the region of 1,000 ohms, this being very suitable for driving into a normal transistor input. It will be noted that the bias supply to the base as well as the collector of the first transistor is bootstrapped from the output. This is necessary as the d.c. base impedance must be low if thermal stability is to be adequate.

This circuit gives no voltage gain, but owing to the large impedance change there is a considerable power gain. Although the overall gain will only be about the same as that given by a single transistor and a step-down matching transformer, the frequency response will be far better. The transformer would need an enormous primary inductance to give a good bass response and the resulting interwinding capacitance would seriously degrade the signal-to-noise ratio. In addition, unavoidable resonances in the transformer would give a final performance far inferior to that obtainable by using the circuit just described.

The author was not satisfied that this was the best that could be done with the components in use. In particular it is necessary to use no fewer than three bootstrap capacitors for the best performance. If the original equivalent circuit given in Fig. 1 is re-examined, it will be seen that the time-constant can be made sufficiently long by increasing either C or R. Now there is little point in putting

a large capacitor directly in parallel with the transducer as the output voltage will be correspondingly reduced. It is, however, possible to produce large effective capacitances by negative feedback without degrading the noise performance. This is due to the negative feedback being applied to the noise as well as the signal. The virtual-earth type of circuit appeared to hold the most promise and it was this circuit that was finally decided on.

The block diagram of the proposed circuit is shown in Fig. 4. With infinite gain in the amplifier the output would be in anti-phase with the input and the magnitude scaled in the ratio of C_1 to C_2 . With a reasonable finite gain, of say -100 times, then providing that C_1 and C_2 are comparable, the magnitude error will be very small. The response will not extend down to zero frequency as it would in the case where the gain was infinite. It is, however, possible to determine the frequency-response from a knowledge of the input capacitance of the amplifier.

As the feedback of the amplifier is via a capacitor the effective input capacitance of the amplifier² will be $(m + 1) C_2$. If C_1 and C_2 have the same value this gives a total capacitance to earth of $(m + 2) C_2$. The input time-constant is therefore $(m + 2) C_2 R$. If m has a value of 100 this then gives an effective input time-constant of $102CR$. Hence, although the value of R may be only $50\text{k}\Omega$, the time-constant is such that the transducer appears to be running into a resistance of just over $5\text{M}\Omega$. In addition the effect of stray leakages across the input is minimized as the input resistance is only $50\text{k}\Omega$.

There remains, however, the problem of whether the signal-to-noise ratio of the circuit has been degraded as compared with the circuit originally described. The relative signal-to-noise ratios were therefore determined by the following method.

Provided that due care is taken in the design, the noise generated will be predominantly caused by the first transistor in the circuit. This will be treated as a noise voltage of value E_n , the two being connected between emitter and base of the transistor. To ease the analysis the gain measured from emitter/base at the input to the output will be assumed to be infinite. This may appear a rather violent assumption but as there is negative-feedback on both circuits it is not so bad as it might appear.

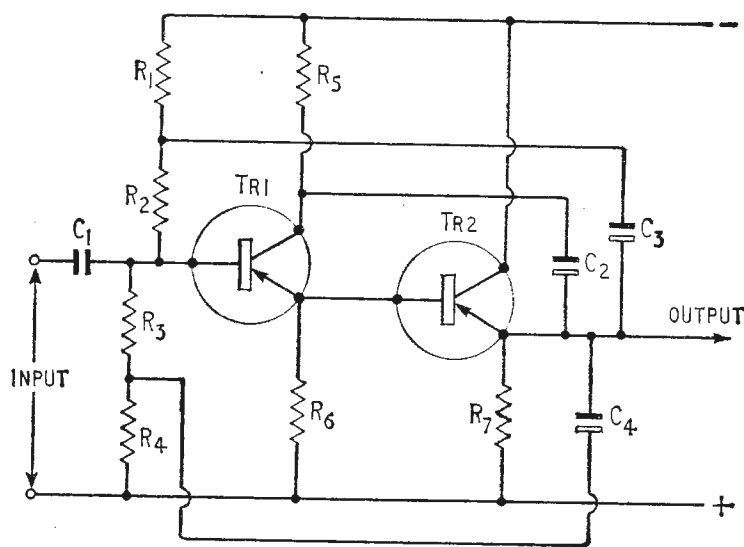

Fig. 3. Two-stage emitter-follower circuit giving a greater input impedance than that in Fig. 1.

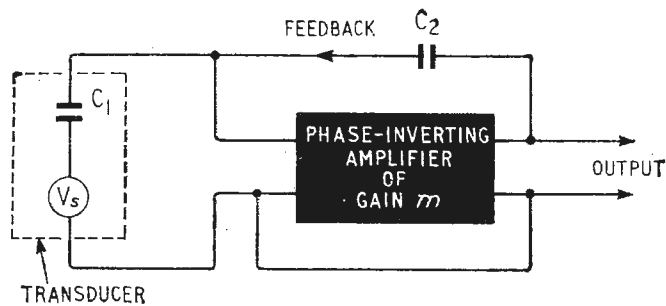

Fig. 4. Proposed amplifier system using "Miller" feedback.

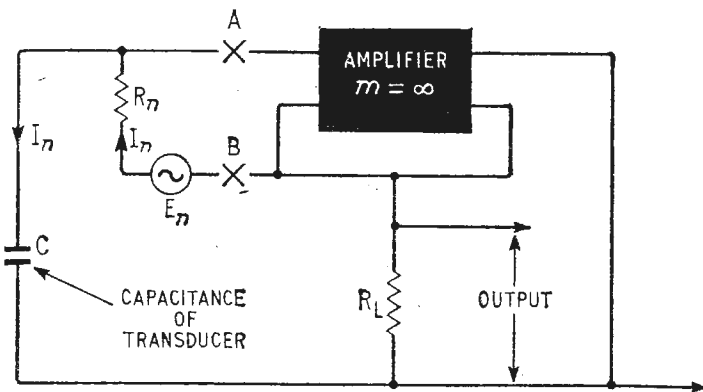

Fig. 5. Equivalent circuit for emitter-follower when considering the effective noise output.

In fact it is only the extreme bass noise that is affected by this assumption.

Taking the emitter-follower circuit first (Fig. 5) it will be seen that due to the infinite gain the voltage across points A and B will be zero for any finite output. Therefore all the noise current developed by E_n will flow into C. The voltage developed

across C is given by $\frac{1}{C} \int I_n dt$ and as there is no voltage across AB, all the noise e.m.f. is dropped across R_n . The noise current flowing into C is therefore equal to $\frac{E_n}{R_n}$ and the voltage across C (which is equal to the output voltage) is given by $\frac{1}{C} \int \frac{E_n}{R_n} dt$.

Similarly in the feedback circuit (Fig. 6) it will be seen that the net input voltage across the input to the amplifier is zero due to the infinite gain. This means that the noise current generated I_n (which will be equal to $\frac{E_n}{R_n}$) must all flow into the capacitor

C_2 . No current can flow into the transducer as there is no voltage across it.

The voltage developed on the capacitor is therefore $\frac{1}{C_2} \int \frac{E_n}{R_n} dt$ and as there is no net input voltage the output voltage must therefore be $-\frac{1}{C_2} \int \frac{E_n}{R_n} dt$.

If C_1 and C_2 are made equal so that the overall gain is unity, then the final noise output will be $-\frac{1}{C} \int \frac{E_n}{R_n} dt$

where C is the capacitance of both the transducer and the feedback capacitor.

Apart from the phase inversion in the second case it will be seen that the two equations are identical.

The overall voltage gain is unity for both cases so far as the signal is concerned and it is therefore apparent that the signal-to-noise ratio is identical for the two cases. As the noise output depends on the integral of the noise e.m.f. it will be apparent that the noise spectrum is of the "pink" kind. In other words the noise power per unit bandwidth will fall as the frequency is increased. It would be therefore expected that the audible quality of the noise would be less harsh than that caused by a magnetic transducer, and this has been shown to be so. The reduced noise at high frequencies therefore causes a better signal-to-noise ratio than would be expected at first sight. In practice the finite gain of the amplifier will prevent integration at the very low frequencies and the noise output at these frequencies will be therefore reduced. However under these conditions the useful output from the transducer will be reduced by a similar amount so the net effect on the signal-to-noise ratio will not be noticed.

It is therefore obvious that the dynamic performance of the Miller-feedback amplifier is as good, if not better than the double emitter-follower circuit. The cost of the Miller type of amplifier can be less than the emitter-follower type owing to the absence of bootstrap capacitors. For this reason alone it would appear preferable to use the second circuit, but there is another factor that may be very useful in some circumstances.

It will be noted that the only difference between a "straight" amplifier and the Miller-feedback amplifier is the addition of the feedback capacitor. If this capacitor is removed the amplifier will operate as a perfectly normal low input impedance amplifier. If this is done the amplifier will then be able to operate with magnetic transducers and at the same time give a useful voltage gain. Hence for a transistorized amplifier or recorder it is merely necessary to break the feedback lead when operation from non-capacitive sources is desired. By the use of a three-pin input plug this could be done automatically, capacitive devices having two of the pins shorted together.

The final circuit that has given excellent results is shown in Fig. 7. This has been used by the author in conjunction with an Acos Mic 39-1 to enable it to be run with long leads and also to feed into transistor amplifiers. The complete amplifier has been fitted into the die-cast housing immediately behind the microphone insert and the on/off switch and a three-cell mercury battery fitted into the bottom stem of the die casting. The results obtained compare very favourably with much more expensive moving-coil

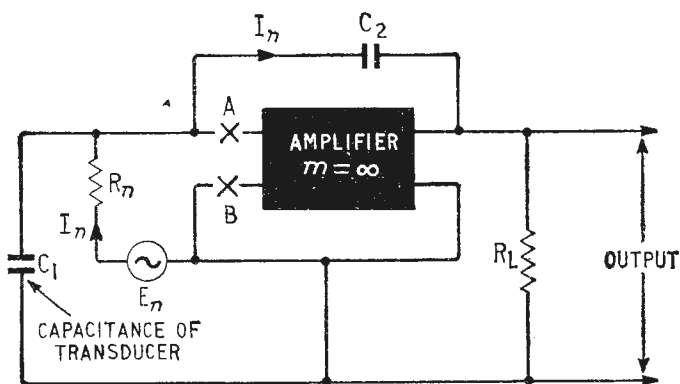

Fig. 6. Equivalent circuit of the capacitive feedback amplifier when considering the effective noise output.

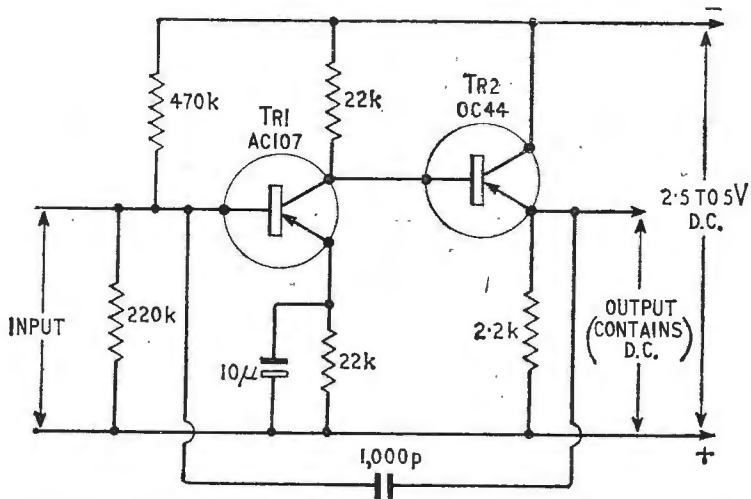

Fig. 7. Final circuit of a transistor amplifier suitable for use with capacitive transducers.

units. Microphony in the leads is not in evidence, this being so even with normal coaxial cable.

The circuit can, of course, be used with any capacitive device. It has not been tried with a condenser microphone, but with a different value of feedback capacitor and a polarizing supply, there seems little reason why good results should not be

obtained. Piezoelectric accelerometers and similar devices could well be used with the circuit and in this case a hybrid of the two circuits could well give operation down to very low frequencies.

It might be as well to insert a word of warning here about the use of unsuitable transistors. For low-noise operation it is necessary to use r.f. types and preferably those that have been selected for low-noise operation. The noise variations in "identical" general-purpose transistors can be phenomenal and in addition the current gain falls off very sharply at low current values. Provided that suitable transistors are used the circuit described will operate very satisfactorily and the hum and noise performance is considerably better than that normally obtainable when using valves. Due to the heavy negative feedback the distortion is extremely low unless the amplifier is driven to saturation output levels. When connected for non-capacitive inputs the voltage gain is approximately 100 times and the input impedance around 50 kilohms.

REFERENCES

1. R. A. Greiner "Semiconductor Devices and Applications," p. 109 (McGraw-Hill).
2. "Waveforms," Radiation Laboratory Series, No. 19, p. 31 (McGraw-Hill).

Commercial Literature

Mullards have just released a 31-page publication entitled "**Mullard Special Quality Valves**". It discusses some aspects of the design and manufacture of quality receiving valves, and also gives details of the methods of control adopted during manufacture. Copies of this illustrated booklet are available from the Government and Industrial Valve Division, Mullard House, Torrington Place, London, W.C.1. 1WW-326 for further details.

Belling-Lee have just released an illustrated catalogue describing their ranges of **domestic aerials and associated apparatus**. Some fifty aerials are illustrated in this publication together with numerous installation accessories ranging from brackets and masts to coaxial plugs and distribution amplifiers. Copies are available from Belling & Lee Ltd, Great Cambridge Road, Enfield, Middx. 1WW-327 for further details.

A lightweight transistorized **aircraft transmitter-receiver** is described in a leaflet available from the manufacturers, Shorrock Developments Ltd., 51 Preston New Road, Blackburn, Lancs. The transmitter is crystal controlled (12 channels) and covers the band 116-136 Mc/s. 1WW-328 for further details.

A leaflet describing the Model 448 variable frequency **audio oscillator** manufactured by the Holt Instrument Laboratories of America is now available from the U.K. representative A. Dunkley, 14 Wellington Road, Ashford, Middx. This oscillator is continuously adjustable from 1 c/s to 100 kc/s. Frequency selection is by means of three banks of decade push-buttons with a calibrated vernier control for fine adjustment. 1WW-329 for further details.

The Components Group of Standard Telephones and Cables Ltd. have recently issued a booklet giving "**a summary of industrial transistors**". It gives operating characteristics and physical dimensions of their silicon and germanium transistors and is available from the Components Group of S.T.C., Footscray, Sidcup, Kent. 1WW-330 for further details.

Audio, microphone, line-output, matching and modulation transformers are described in a brochure entitled "**Sound Reproduction**" now available from Gardners Transformers Ltd., Somerford, Christchurch, Hants. Technical details and dimensional data are included. 1WW-331 for further details.

E.M.I. Electronics Ltd. have produced a **booklet in Spanish** describing the broadcast equipment they manufacture. Copies of the booklet can be obtained from the broadcast and recording equipment division of E.M.I. Electronics Ltd., Hayes, Middx. 1WW-332 for further details.

A new 20-page illustrated brochure "**Sound and Vibration Measuring Equipment**" is now available from the General Radio Company, West Concord, Massachusetts, U.S.A. Among the new instruments described are two analysers and a microphone "reciprocity" calibrator. 1WW-333 for further details.

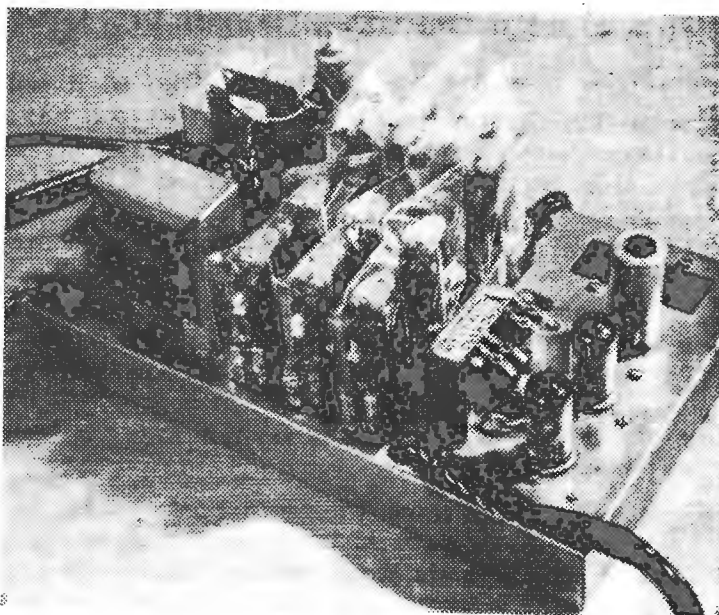

The photograph shows a bank of relays protected from dust and moisture by plastic bags made by Secol Ltd., 44a Station Road, North Harrow, Middx., from "Melinex", an I.C.I. polyester film. The apparatus is part of a Hartley Electromotives Tape-Riter dictating machine. 1WW-334 for further details.

REVOLUTIONARY NAVAL RADIO TRANSMITTING SYSTEMS

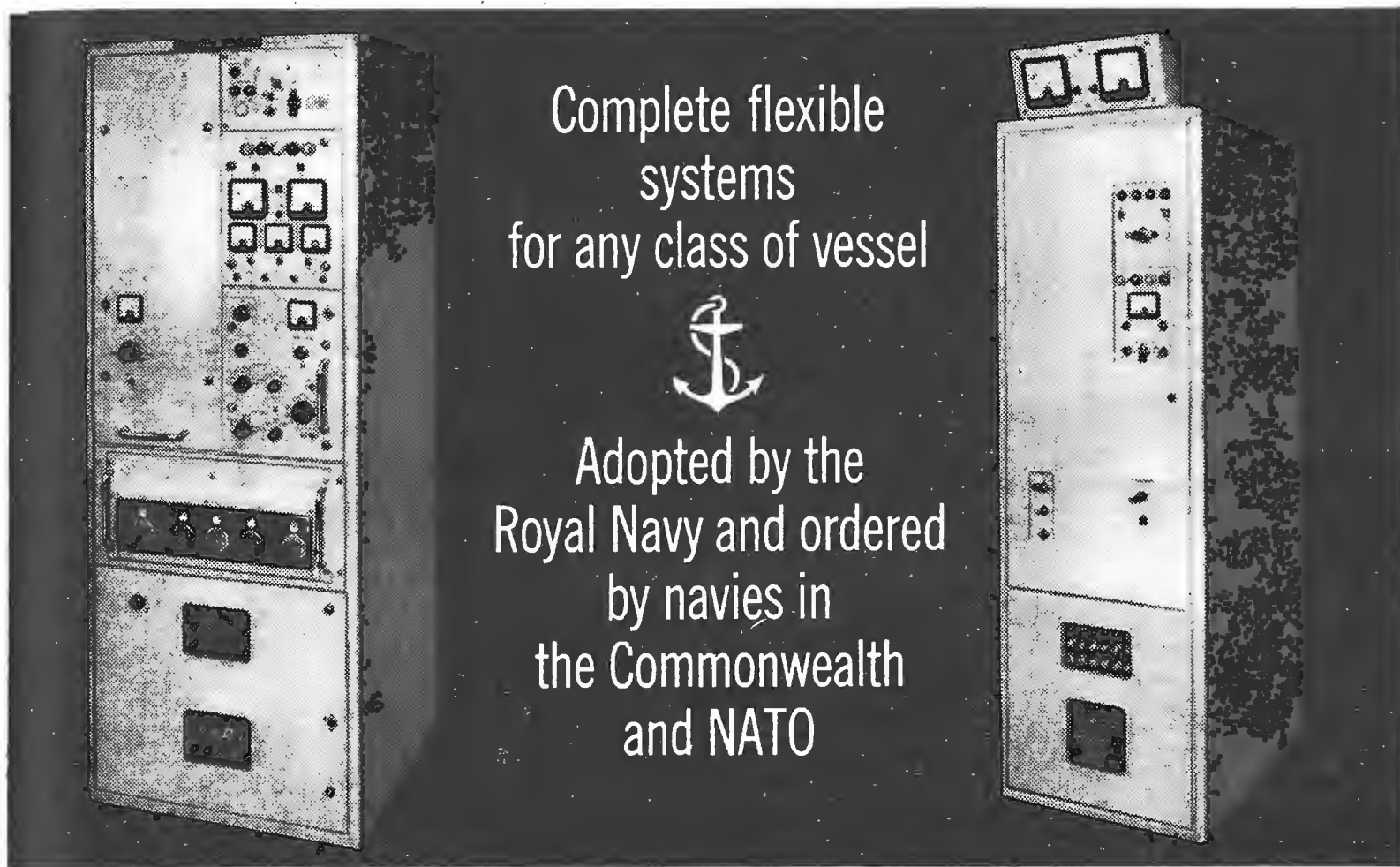

Complete flexible
systems
for any class of vessel



Adopted by the
Royal Navy and ordered
by navies in
the Commonwealth
and NATO

- Precise frequency setting and positive stability allows full advantage to be taken of SSB which provides the most reliable communications under difficult conditions of propagation or interference
- Continuous frequency coverage from 240 Kc/s to 24 Mc/s
- Covers all types of signalling
- Broadband amplifier and synthesizer system provides simplest operation and almost eliminates tuning
- Aerials can be sited for maximum radiating efficiency.

MARCONI NT 203/204 SYSTEMS



COMPLETE NAVAL RADIO AND RADAR SYSTEMS

THE MARCONI COMPANY LIMITED · CHELMSFORD ESSEX ENGLAND
1WW-116 FOR FURTHER DETAILS.

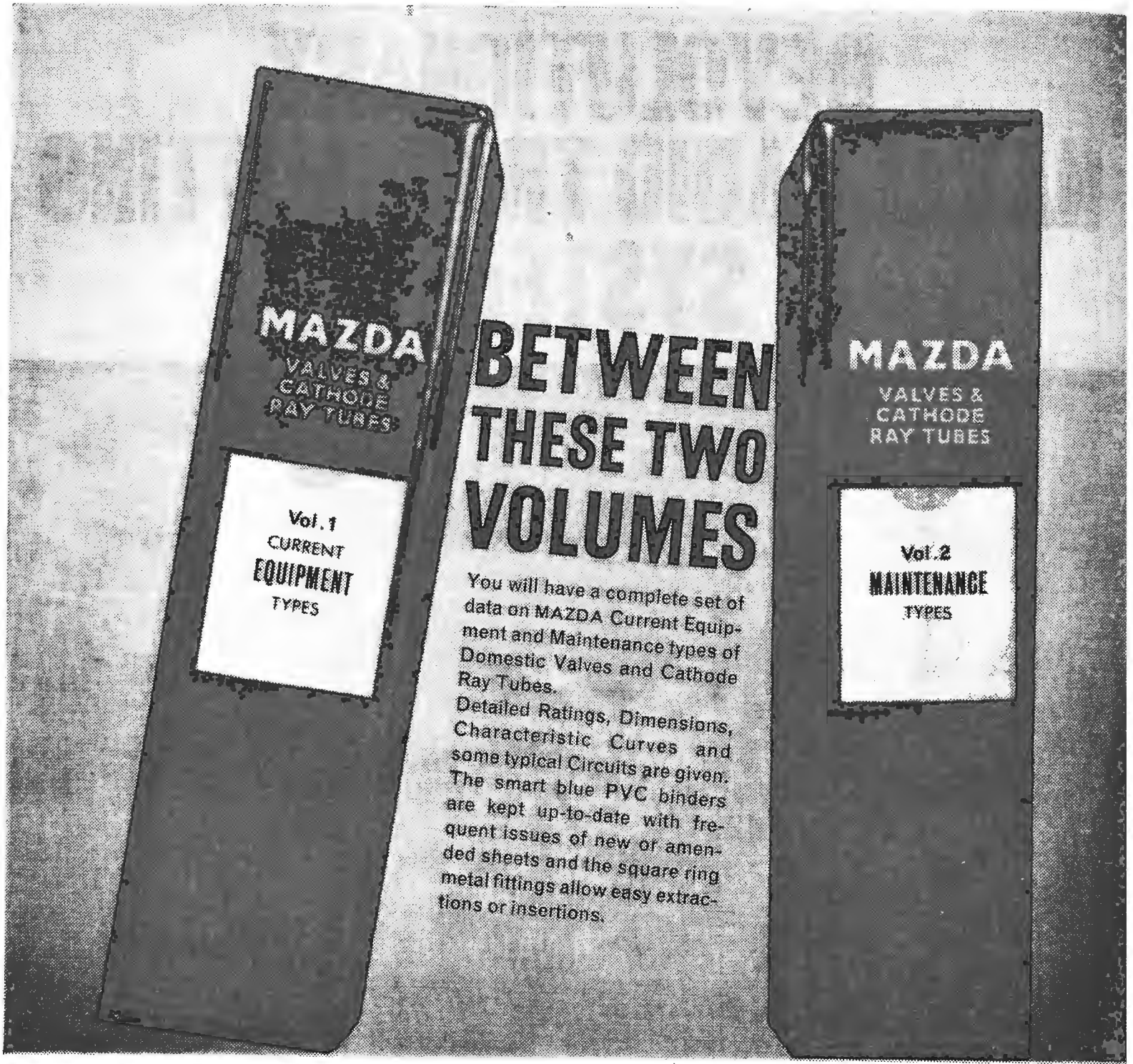

INITIAL CHARGE of £2 MAZDA DESIGN DATA SERVICE

provides new subscribers with both volumes completely up-to-date and includes packing and postage. It also entitles subscribers to "follow-up" data to 30th June following the date of joining.

An ANNUAL RENEWAL CHARGE of £1

covers subsequent amendments and new issues and is made every 12 months on 1st July.

SPECIAL OVERSEAS EDITION

covering components under the EDISWAN brand by our Export Division in which precedence is given to European type numbers is available. The price is the same as for U.K. publications.

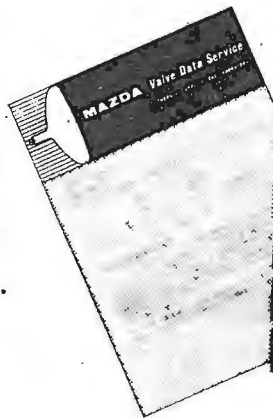

To: PUBLICITY DEPARTMENT,
THORN-AEI RADIO VALVES & TUBES LTD.,
155 Charing Cross Road, London W.C.2

Please send me..... sets of the new handbooks;
I enclose £2 in payment for each set.

MAZDA handbooks EDISWAN handbooks
(Please tick whichever edition you require)

NAME.....

FIRM.....

ADDRESS.....

SIGNED.....

BLOCK LETTERS PLEASE

MAZDA

Thorn-AEI Radio Valves & Tubes Ltd.

HEAD OFFICE: 155 CHARING CROSS ROAD · LONDON, W.C.2 · Telephone: GERrard 9797

EXPORT DIVISION: THORN HOUSE · UPPER ST. MARTIN'S LANE · LONDON, W.C.2

1WW-117 FOR FURTHER DETAILS.



THE FUTURE OF PROJECTION TELEVISION

By V. VALCHERA^{*}

A FRESH LOOK AT FORWARD PROJECTION

THE present form of television picture presentation by means of direct-viewing cathode ray tube has reached the limit of further development. One development which may come back in the very near future is the optical projection method of television, using a very small tube of 2½in to 5in diameter. This system can produce exceptionally large and clear pictures for viewing in the normal domestic environment.

Comparison with Direct Viewing

The reader may justifiably say that projection was tried some years ago and did not quite make the grade. Projection television came at a time when viewers were looking for something larger than the 9in and 12in sizes then available. Unfortunately, in order to quickly fulfill the demand, manufacturers adapted direct viewing receivers for this very exacting application with very unsatisfactory results. The early projection television receivers were invariably of the back projection type, of a physical construction not unlike a direct viewing receiver. The limitations imposed by this form of construction resulted in pictures suffering from light diffusion through the translucent plastic screen, giving a "woolly" appearance, poor definition, poor contrast and very low light intensity. Later developments rectified these shortcomings by the introduction of front projection.

Front projection has all the advantages of the cinema and home ciné, and like the cinema it is desirable that the screen be shaded from any direct light. A skeleton diagram of the Mullard optical system is shown in Fig. 1. Projection television offers two advantages over direct viewing; the complete absence of interlace flicker and the almost indiscernible line structure. The picture "lininess" is less discernible because the scan lines take up a greater proportion of the area, having the effect of closing the gaps between lines. This effect is achieved partly by the fact that the line is wider, and partly by the more pleasing effect reflected light has on the optic system. The differences could be

Fig. 1. Skeleton diagram of Mullard optical agency.

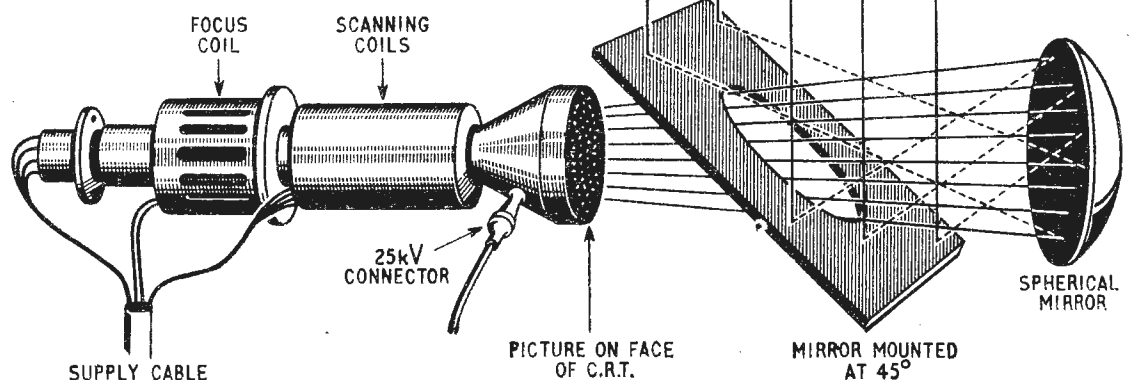

considered analogous to looking into the headlight of a car and looking at the area lit up by the lamp.

It is a fact that some people suffer from considerable eye strain after watching direct viewing television whereas they do not experience such discomfort when viewing front projection television.

Technical Differences

Having detailed some of the advantages of projection, we can now consider some of the technical differences between the two systems. The sound systems for both forms are virtually identical except that in the front projection system the loudspeaker is best placed facing the screen. This gives the realistic effect of the sound coming from the picture. A typical layout is shown in Fig. 2.

The "front end" of a projection receiver is identical to a direct viewing type, but we begin to notice essential differences in the vision i.f. stages. For the larger picture to be visually acceptable, the basic image on the face of the c.r.t. must have a much better definition than that normally acceptable with direct viewing. It is because of this that the vision bandwidth response must be much closer to the ideal. A practical r.f. and i.f. response curve found in a good projection television receiver is shown in Fig. 3. It will be noticed that in order to obtain

*Valradio Ltd

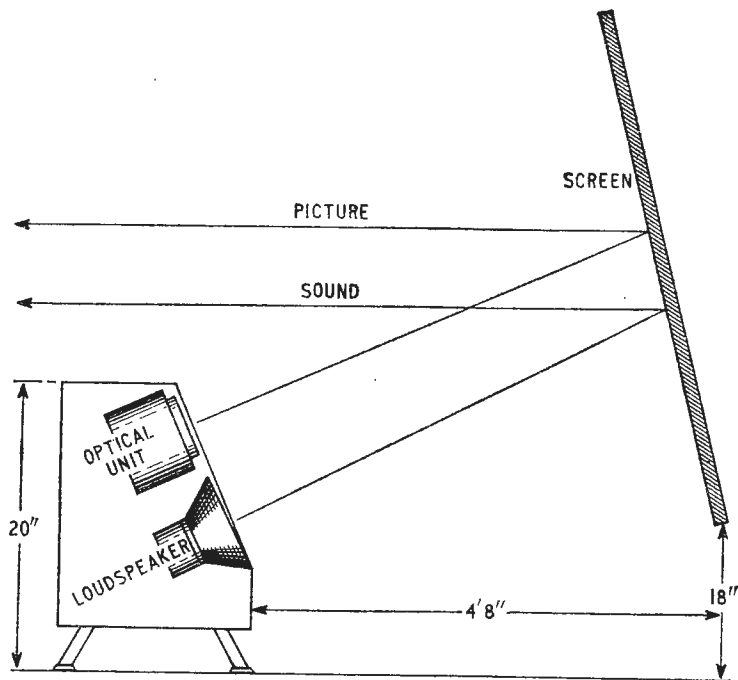

Fig. 2. Schematic diagram of television projection system for picture size of 34in.

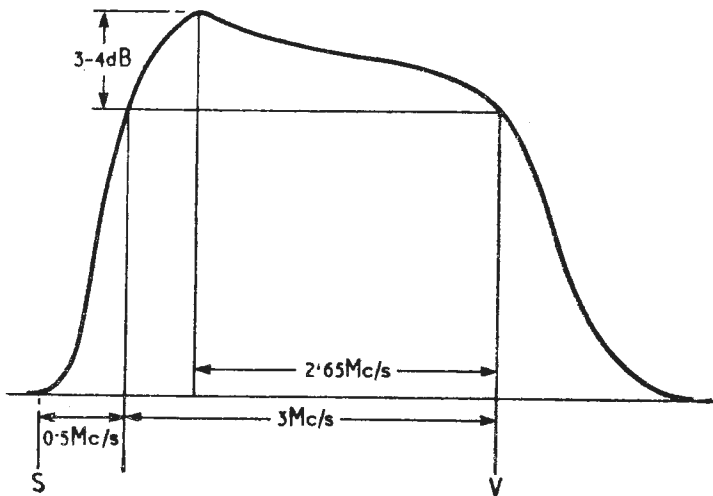

Fig. 3. I.f. response curve. Rising response towards three Mc/s tends to offset h.f. roll-off in video amplifier.

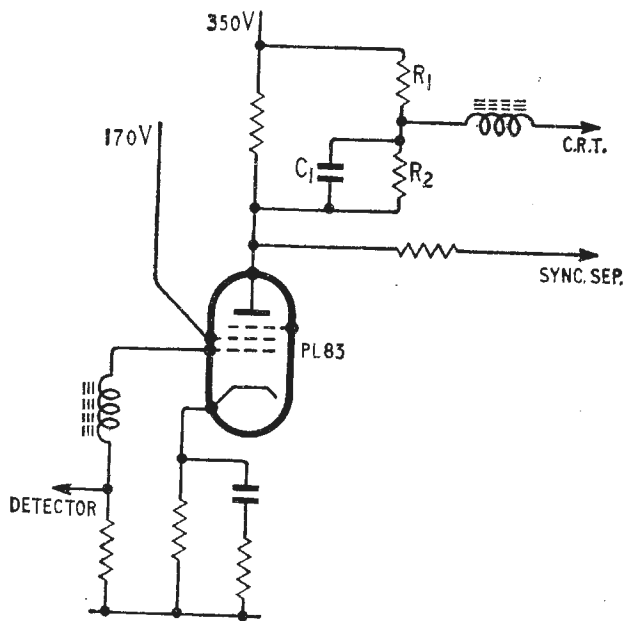

Fig. 4. Projection television video stage, showing black-level clamp.

the best possible definition, the i.f. response has a slightly rising characteristic which helps to offset the falling response at the higher frequency end of the following video amplifier. To avoid undesirable overshoots the frequency uplift is strictly limited and must as much as possible follow a linear rise. The response curve shown in Fig. 3. is achieved by over-coupled transformer and frequency-selective antiphase coupling.

The output from the final i.f. stage of a projection receiver must be between 15 and 20 volts for good picture contrast. The video amplifier of projection receivers must be capable of providing a peak to peak output of 130 V, including sync. pulses, to fully modulate a projection tube such as the Mullard MW6/2. The circuit of a video stage capable of this relatively high output is shown in Fig. 4.

As compared with direct viewing receiver circuit, the unusual features of the projection circuit are the addition of R_1 , R_2 and C_1 and the fact that the supply voltage is 350 V. In order to hold the c.r.t. cathode at black level, the travel is restricted by the potentiometer R_1 and R_2 , high frequencies being passed by C_1 . This process provides a simple form of black level clamp, while retaining the protection of the tube safety circuit which is intended to operate in the event of a timebase failure.

Because we have a very strong video signal, it is possible to introduce noise clipping in the sync. separator stage to reduce noise in the line sync.

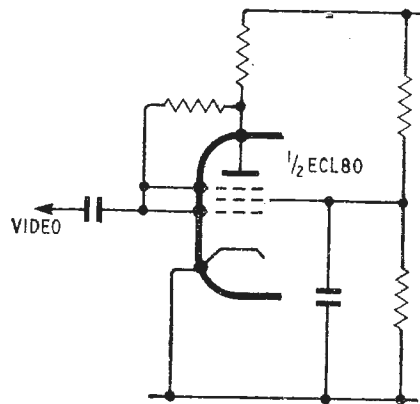
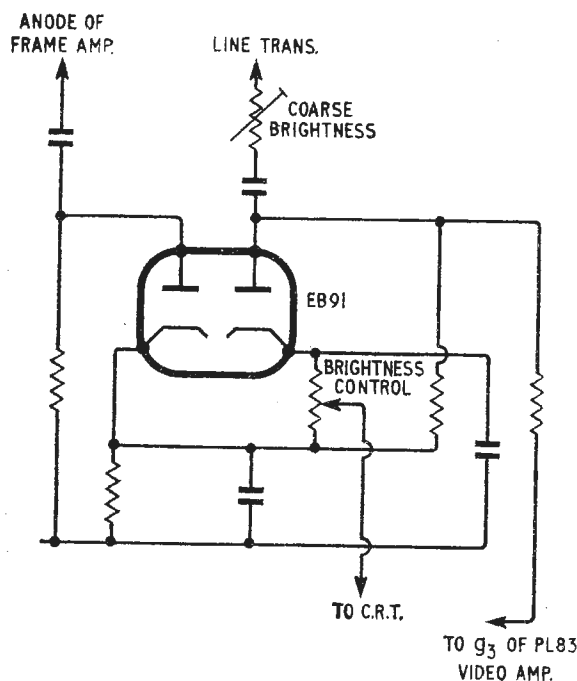

Fig. 5. Sync. separator stage.

Fig. 6. Cathode-ray tube safety circuit.



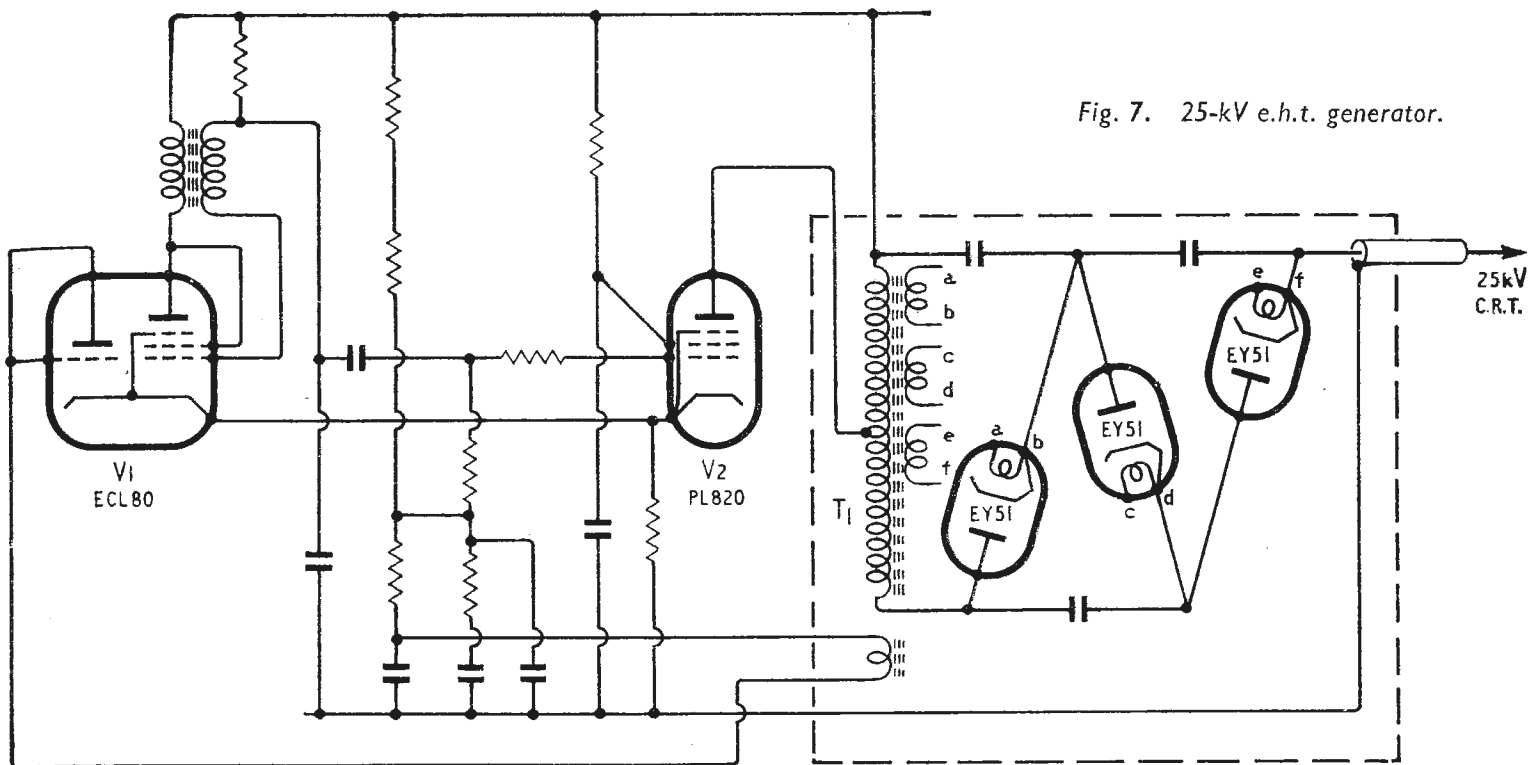

Fig. 7. 25-kV e.h.t. generator.

pulses and produce clean vertical edges to the picture. Fig. 5 shows the circuit, where it will be seen that the grid is returned to the anode *via* a high resistance; the positive bias so applied clips the top edge of the sync. pulse and eliminates any noise that may be present. To reduce the sync. separator valve grid base, the suppressor grid is taken to the control grid and biased negatively.

The timebase circuits of a projection receiver follow the usual practice with the exception that, because of the high beam intensity, it is necessary to cut off the beam current in the event of a frame or line timebase failure. This is achieved by rectifying part of the output of both timebases and applying the resultant voltage as positive bias to the c.r.t. grid.

In the event of a frame or line timebase fault, the positive voltage on the grid of the c.r.t. will fall, biasing the tube beyond beam cut off. Although in normal operation the grid of the c.r.t. is about 200 V positive, the cathode is about 250 V positive, maintaining the correct tube biasing conditions. The collapse of the 200 V positive grid voltage results in the tube grid being biased up to 250 V negative in respect to the cathode. In addition to biasing the c.r.t. to cut off, a frame failure would also bias the video amplifier to cut off so that even in the presence of a very strong video signal, the c.r.t. would remain cut off, thus preventing any damage to the fluorescent screen.

Unlike direct viewing receiver practice, the e.h.t. for projection receivers is not obtained from the line fly-back circuit, but from a separate very efficient e.h.t.

generator which provides a well-regulated output of just under 25,000 V at up to a peak of 400 microamps. This basic circuit is shown in Fig. 7. The circuit may appear to be more complicated than the corresponding direct-viewing e.h.t. supply, but in reality it is quite straightforward. V1 is a conventional blocking oscillator operating at a frequency of 1,000 c/s, the output of which is applied to V2, the e.h.t. generator, operating under Class "C" conditions. Its bias is obtained by rectifying part of its output. Any reduction of c.r.t. beam current will cause this bias to rise, resulting in a reduction of output. The circuit is made more effective by returning the control resistances to the positive h.t. line. The transformer T₁ is designed to resonate at about 20 k/s which, when excited from 1kc/s pulses, results in severe ringing of the transformer,

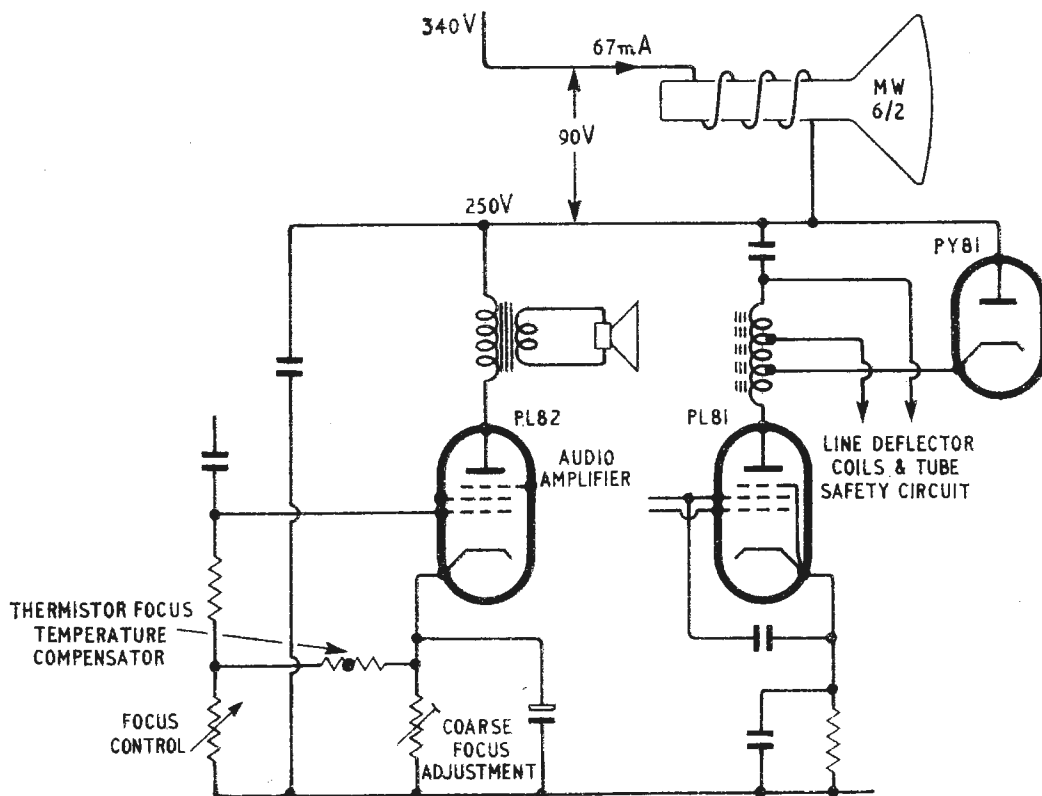

Fig. 8. Electromagnetic focus arrangement.

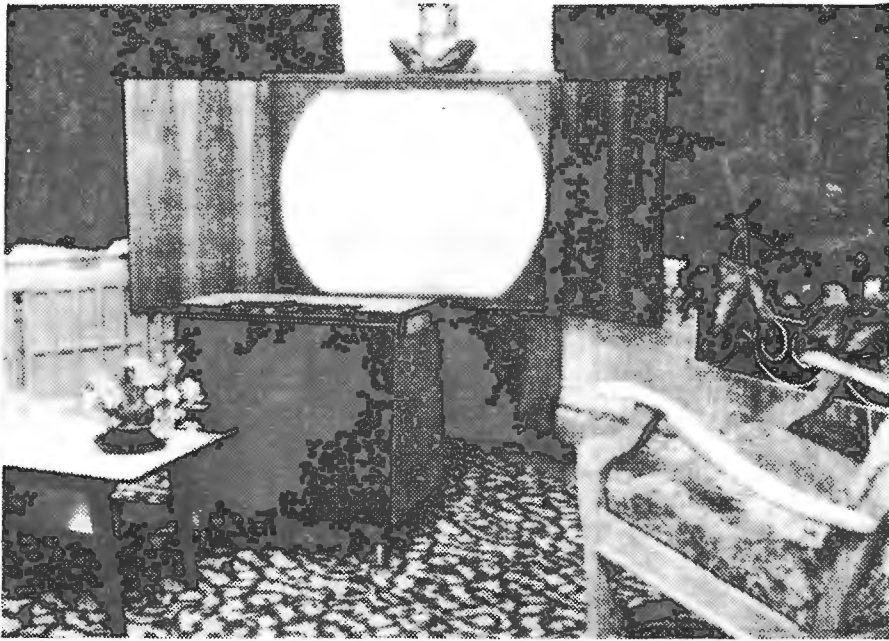
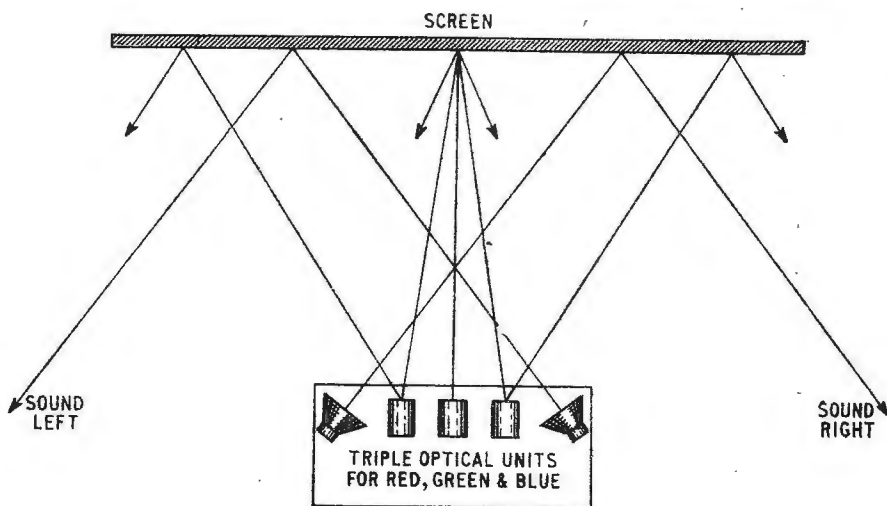

Fig. 9. 34-in projection receiver in domestic setting.

Fig. 10. Layout of projection colour television receiver and stereo sound.



which is coupled to a tripler rectifier circuit and produces a smoothed, regulated output of 25 kV. The transformer T_1 with its associated rectifiers and condensers is enclosed in an oil filled container.

Cathode ray tubes used in projection systems are usually electromagnetically focused, as the use of a permanent magnet would hold the beam in focus at the moment of switching off, resulting in possible damage to the fluorescent screen surface. Electromagnetic focusing provides the required protection at the moment of switching off as the beam will be defocused by the rapid collapse of the h.t. supply. Unfortunately, it was found in the early projection receivers that the electromagnet suffered from loss of magnetic flux as the coil assembly warmed up, resulting in a defocused picture. Various forms of temperature compensation have been used, but perhaps the most satisfactory is that shown in Fig. 8.

With the Mullard MW6/2 tube, a magnetizing coil, 90 V at 67 mA, is necessary to obtain correct focus. A convenient and practical way of energizing the focus coil is to use it in the anode supply feed circuit to the audio and line amplifier. The resistance of the coil will drop the 340 h.t. voltage to the operating voltage of 250 V. The anode current of the two valves having fairly constant

characteristics further stabilize the focus current. The cathode circuit of the sound output valve incorporates a temperature compensating resistor which causes the anode current to rise slightly as the focus coil warms up. By this method the picture is held in focus at all times.

Having considered the technical difficulties between direct viewing and projection, we can now consider some of the aspects of the physical layout of the latter system. To obtain the most realistic results from projection, it is best to have a separate screen conveniently positioned against a wall or in a corner. A typical domestic installation is shown in the photograph, Fig. 9, and the schematic layout, Fig. 1. A comfortable viewing distance for such an arrangement is about 6 feet.

So far we have only considered projection as a means of producing life-size black and white pictures, but projection is sufficiently flexible to be readily adapted for colour television and stereophonic sound reproduction. A diagram of such a comprehensive system is outlined in Fig. 10.

Conclusions—The Future

Judging by present-day developments it is difficult to foresee any further advancement in the direct-viewing form of television presentation, but with projection future developments look extremely promising. It is not difficult to foresee television adaptations of "Cinemascope", "Cinerama" and other forms of popular cinema presentation. It would not be unreasonable to predict that the television receiver of the future will be along the lines shown in Fig. 10.

Much of the development of the projection system described is due to Mullard Limited.

INFORMATION SERVICE FOR PROFESSIONAL READERS

To expedite requests for further information on products appearing in the editorial and advertisement pages of *Wireless World* each month, a sheet of reader service cards is included in this issue. The cards will be found between advertisement pages 48 and 49.

Each editorial item dealing with a specific product, and each advertisement, is coded with a number prefixed by IWW, and to obtain further information the appropriate numbers should be entered on a card.

Readers will appreciate the advantage of being able to fold out the sheet of cards, enabling them to make entries while studying the editorial and advertisement pages.

Postage is free in the U.K., but cards must be stamped if posted overseas. This service will enable professional readers to obtain the additional information they require quickly and easily.

new

transistorised, lightweight and compact

ac Millivoltmeter in the 10 c/s to 5 Mc/s range

Type PM 2453

battery operated

use it wherever you wish

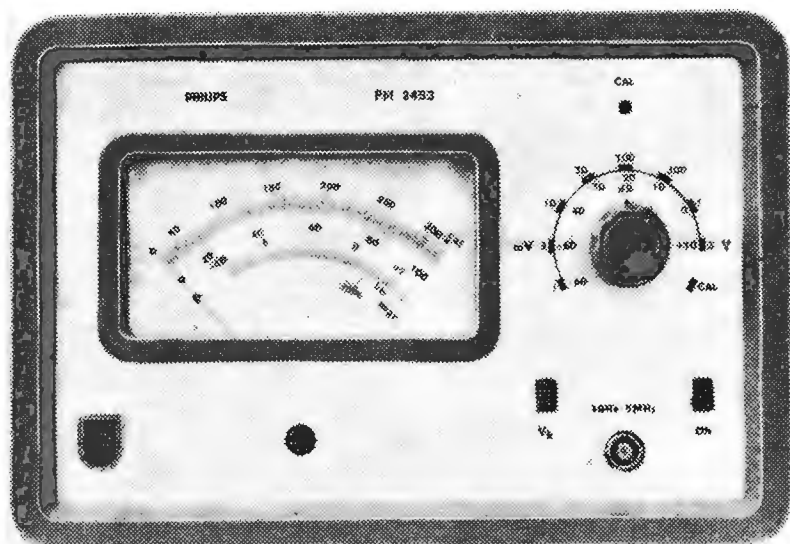

Voltage range: 1 mV (f.s.d.) to 3 V or, when using attenuator probe, 100 mV (f.s.d.) to 300 V

Accuracy better than 5% of full scale from 50 c/s to 1 Mc/s, better than 9% of full scale from 10 c/s to 50 c/s and 1 Mc/s to 5 Mc/s

Completely free of internal hum and isolated from the mains - ideal for measurements at power line frequency and measurements free from earth

Input impedance: $1\text{M}\Omega // 35\text{ pF}$ (direct), $1\text{M}\Omega // 15\text{ pF}$ (via attenuator probe)

Internal calibration voltage provided

Easily portable, weight only 2 kg (4.5 lbs)

Power supply: 5 rechargeable NiCd batteries (included); battery life 40 hours/rechargeable, up to 300 times

For easy recharging:
**Philips Battery Charger,
type PM 9000**

Suitable for charging batteries up to 12 V
Charging current 45 or 200 mA
Mains supply 110 or 220 V

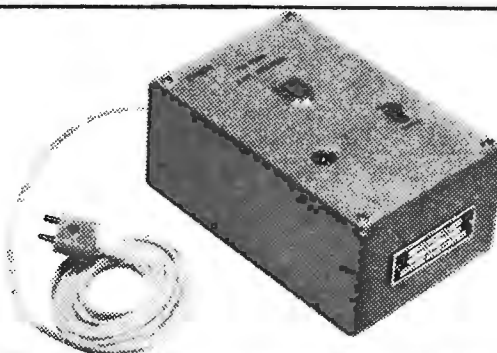

PHILIPS

electronic measuring instruments

Sales and Service all over the world

Sole distributor for the U.K.: **Research and Control Instruments Ltd.**, 207 Kings Cross Road, LONDON WC1

For the Republic of Ireland: **Philips Electrical (Ireland) Ltd.**, Newstead, Clonskeagh, DUBLIN

Overseas enquiries please, to the manufacturers, **Philips, Ema Department**, EINDHOVEN, Holland

1W W—118 FOR FURTHER DETAILS.

VALVE USERS WHATS WHAT

NOW IN TWO VOLUMES

These loose-leaf handbooks contain in two volumes comprehensive data on all new and maintenance types of Brimar domestic and industrial valves and picture tubes. Numerous characteristic curves and some typical circuits are given. The sheets are secured in smart blue PVC covers by square ring-binders for flat opening and easy insertion.

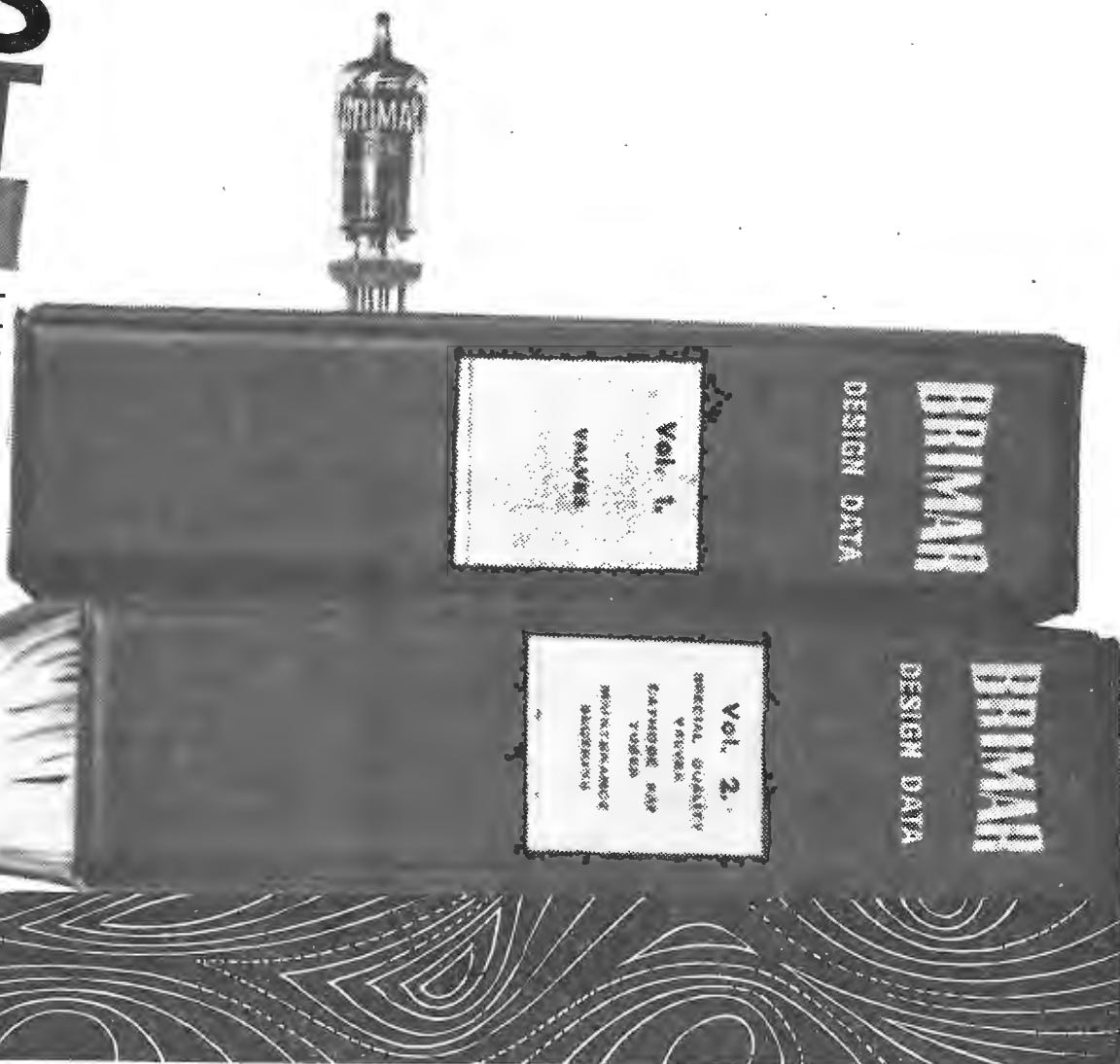

BRIMAR DESIGN DATA SERVICE

Initial Charge covering two volumes complete to date, packing and postage, and data service up to 30th June following the date of joining: £2. 0. 0. Subscribers are then invited to subscribe on 1st July each year to the follow-up data service. This brings parcels of data in two forms periodically: (a) Preliminary data on new development types. (b) Final data on established types.

Renewal Charge covering subsequent amendments and new issues: £1. 0. 0.

Special Overseas Edition is published at the same price covering domestic and industrial valves and picture tubes.

To: Publicity Department, Thorn-AEI Radio Valves and Tubes Ltd. 155 Charing Cross Road, London, W.C.2
Please send me.....copy(ies) of the handbook. I enclose £2 in payment for each Home or Export edition.

NAME

FIRM

ADDRESS

SIGNED.....BLOCK LETTERS, PLEASE



Thorn-AEI Radio Valves & Tubes Ltd.

HEAD OFFICE: 155 CHARING CROSS ROAD · LONDON, W.C.2 · Telephone: GERrard 9797

BRIMAR EXPORT DIVISION: THORN HOUSE · UPPER ST. MARTIN'S LANE · LONDON, W.C.2

1W W-119 FOR FURTHER DETAILS.

Demonstrating A.C. Theory

PHASE RELATIONSHIPS AT VERY LOW FREQUENCIES DISPLAYED ON METERS

By T. PALMER, B.A., Grad.I.E.E., Assoc.Brit.I.R.E.

IN "Principles of Electricity in M.K.S. Units" Dr. E. Hughes says that "one of the most puzzling things to a student commencing the study of alternating currents is the behaviour of a current in an inductive circuit. For instance, why should the current be at its maximum value when there is no applied voltage? Why should it be possible to have a voltage applied in one direction and a current flowing in the reverse direction (for part of the cycle)?" He gives a useful mechanical analogy. Elementary students may also be helped by seeing demonstrations: it is fairly easy to display on a double-beam oscilloscope sine wave patterns corresponding to the voltages across a coil and across a resistor connected in series, and some years ago (*Electronic Engineering*, July, 1951) the writer arranged a circuit to draw a vector diagram on a cathode ray tube. The snag is that elementary students tend to believe that any desired pattern can be displayed on a c.r.t. if the knobs are twiddled long enough.

On the other hand, students are familiar with moving-coil meters used in d.c. experiments, before they start a.c. theory. The purpose of this note is to describe demonstrations at frequencies of the order of 5 cycles per minute, in which centre-zero moving-coil meters are used to investigate phase relationships. The oscillator used by the writer gave an output of 1 volt r.m.s. and is based on the Wien bridge circuit in the "Mullard Reference Manual of Transistor Circuits" (Fig. 7, page 240), using 400 μF tantalum capacitors. Ordinary electrolytic capacitors in the bridge were expected to give a poor wave form, and did.

The experiments may conveniently be conducted in the following stages:—

1. The demonstration begins with resistors R_1 and R_2 connected to terminals T_1 and T_2 respectively, as in Fig. 1. The centre-zero meters, M_1 , M_2 and M_3 , require 25 μA to give full scale deflection on either side. Suitable values for R_1 and R_2 are in the range 100k Ω to 200k Ω . Students see that the pointers on M_1 and M_2 swing in step with one another; when one pointer reaches its maximum deflection to the right, so does the other. The pointer on M_3 is also in step, and its peak swing is equal to the sum of the peak swings on M_1 and M_2 . It is helpful at this stage to remind students of the necessity for a suitable convention; we could agree, for instance that the current in each branch is to be considered positive when flowing from A to B; the meters are connected according to a consistent pattern, so that when current is flowing from A to B the pointer is deflected to the right.

2. The resistor previously connected to terminals T_2 is now removed; a capacitor of the order of 15 μF is connected to T_2 . It is seen that the current through M_2 leads that in M_1 by 90°; when the pointers of M_1

and M_2 are swinging from left to right, that of M_2 reaches its peak deflection to the right at the instant when that of M_1 is passing through zero. If "leading" is interpreted in this way, the order of the runners is M_2 , M_3 , M_1 . The phase difference between M_3 and M_1 can be changed by varying the ratio of the peak swings of M_1 and M_2 . For this purpose, it is convenient to have R_1 variable. It can be seen that the peak swing of M_3 is less than the sum of the peak swings of M_1 and M_2 .

3. The leads from terminals T_2 are now removed from the capacitor and connected to something intended to represent a coil; for the moment it will be referred to as a black box; it will be described later. If it were possible to find a coil with sufficient reactance at 5 cycles per minute to be comparable with its resistance, we would use it. It is not claimed that the black box is equivalent to a coil in every respect; for instance, its reactance decreases with frequency.

The effect of connecting the black box to the T_2 terminals is to give a current through M_2 which lags that through M_1 by about 90°. The running order is now: M_1 , M_3 , M_2 . The box has a control which enables the current through M_2 to be varied and the phase angle between M_1 and M_3 varies correspondingly.

4. The resistor R_1 is now removed from the T_1 terminals, and the capacitor is connected to them (the black box remains connected to the T_2 terminals). It can now be seen that the currents in M_1 and M_2 are in anti-phase: when one pointer swings from left to right the other swings from right to left. The current I_3 through M_3 is in phase with whichever current has the greater amplitude, and the amplitude of I_3 is the difference between the amplitudes of I_1 and I_2 . By adjusting the control on the black box

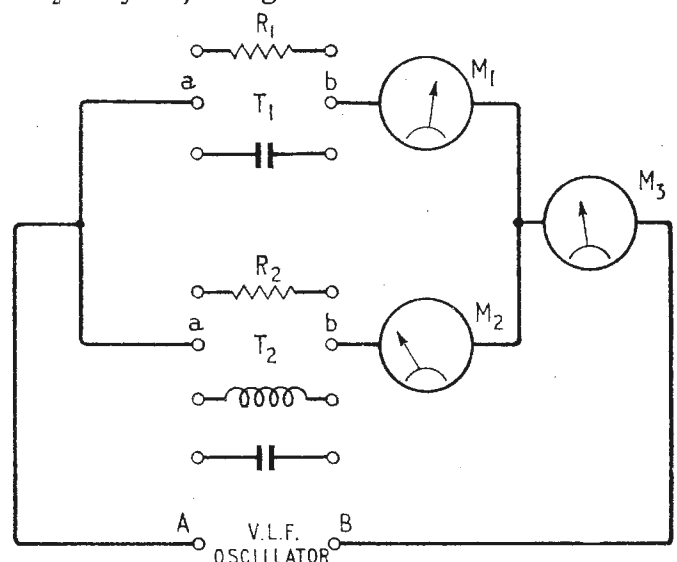

Fig. 1. Three centre-zero meters arranged to demonstrate a.c. phase relationships.

we can make the amplitude of I_1 equal to that of I_2 , in which case the current I_3 has almost zero amplitude. This of course corresponds to parallel resonance, and as far as I_3 has any visible amplitude, it is due to the phase angle between I_1 and I_2 being not quite 180° .

Simulated Inductance

A grounded-emitter transistor introduces a phase shift of 180° . A coupling capacitor in series with a resistor very much less than the reactance of the capacitor gives a current leading the collector-emitter voltage by almost 90° . The vector (or, if you prefer it, phasor) relationship is represented in Fig. 2. The net effect is that the capacitor current leads the applied voltage V_{A-B} by 270° , which is the same as lagging by 90° . This current flows through M_2 when the "black box" is connected to the T_2 terminals. The circuit of the black box is given in Fig. 3; it is based on the information given on page 130 of the Mullard Reference Manual, but no emitter bypass capacitor was used. VR_1 is the control which allows the current from the black box to be adjusted. The transistor, its associated resistors and capacitor C_1 and its 9V battery were fitted in a 2-oz tobacco tin. The positive terminal of the battery was connected to the tin case. Before the demonstration began, the case was connected to the B terminal of the supply. When it is time for the black box to be connected in series with M_2 , leads which previously went to the capacitor are taken to the input and output terminals of the amplifier. It is, of course, important to ensure that the lead from the A terminal of the oscillator goes to the input of the amplifier. When the lead is connected to the output of the amplifier, to protect the meter against the transient charging current, it is convenient to have a limiting resistor of the order of $150k\Omega$ in series with the meter. This can afterwards be short-circuited by a crocodile-clip lead. Incidentally, to protect the meter against excessive transient currents when the capacitor is being connected in place of the resistor (when changing from stage 1 to 2) it is desirable to reduce the output of the oscillator to zero.

5. The effect of rectifiers. Revert to stage 1 with R_1 and R_2 connected to M_1 and M_2 respectively. This time M_2 has a bridge rectifier associated with it, but M_1 is not modified. (The rectifier can be

improvised out of r.f. diodes). At 5 cycles/minute, the pointer of M_2 swings only on one side of zero; that of M_1 of course swings on both sides of zero. Increase the frequency of the oscillator gradually. When it reaches a certain value the inertia of the moving-coils prevents any swing on either meter; M_1 indicates zero; M_2 , the mean half-cycle value.

Practical Points

In the Mullard circuit for the Wien bridge oscillator is a capacitor which applies the output from Tr3 to the bridge. The value recommended is $1000\mu F$. I used an ordinary electrolytic with a value of $5000\mu F$ and a rated working voltage of 12V. The fact that it is not the more expensive tantalum type does not seem to affect the waveform very much. An S.T.C. thermistor type R53 is used in the circuit; I have no knowledge of its time-constant, and wondered whether it might be desirable to replace it by a pre-set variable resistor, when working at a frequency of 5 cycles/minute. This does not seem to be necessary. S.T.C. Stantelum capacitors, which are reasonable in price, work well in the Wien bridge.

Centre-zero meters were not available for the original demonstrations. Ordinary types, with full-scale deflection of $50\mu A$, were biased by sending $25\mu A$ through them; each meter had its own 1.5V cell and variable resistor. (A volume control incorporating an on-off switch was used, so that the battery could be disconnected when not in use). The meters were mounted on a peg-board inclined plane together with the terminals T_1 and T_2 . The meters were arranged in line, one above another, so that the eye could easily appreciate phase relationships. Meter M_2 had a 2-pole, 2-way switch so that it could be connected to its bridge rectifier.

Another oscillator which has been tried is the one given as Fig. 15 in the article by F. Butler in the December, 1962, issue of *Wireless World*. This works well, and when an attempt is made to apply slow motion to three-phase circuits, its CR ladder network should be very useful.

Student Reactions

When the difficulty of finding a coil of sufficient inductance (and low enough resistance) had been mentioned, and the necessity of the "black box"

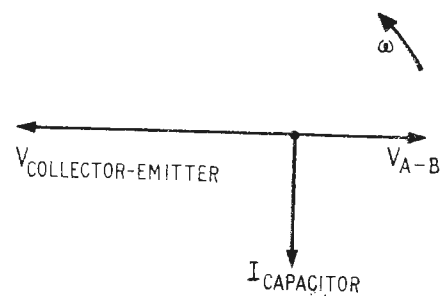
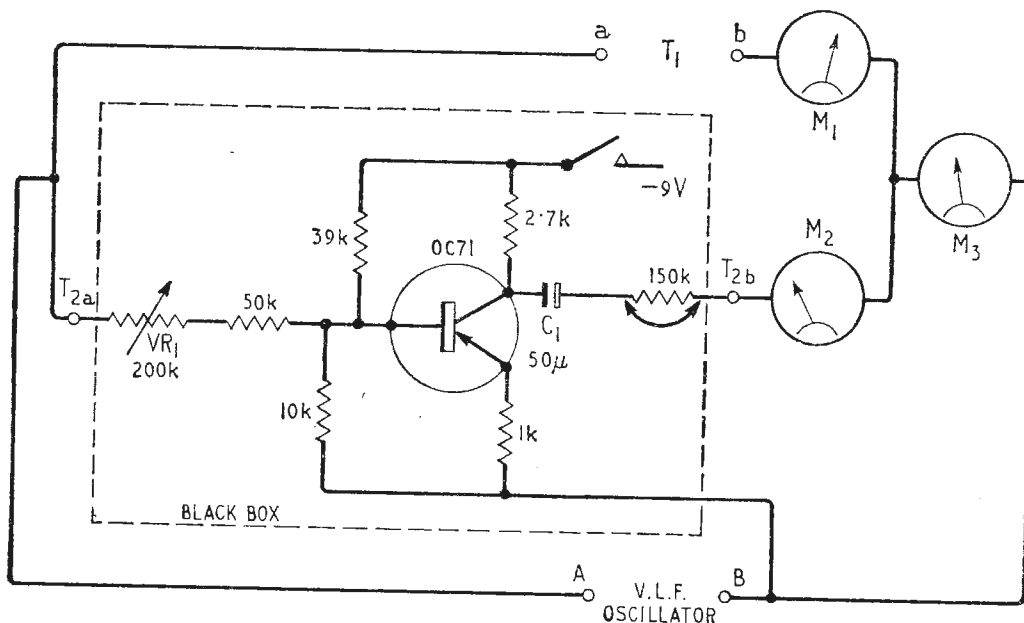

Above: Fig. 2. Derivation of 90° lag equivalent to a 270° lead.

Left: Fig. 3. Circuit diagram of "black box" which simulates a large inductance.

had been explained, one student asked why I did not use a capacitor and reverse the connections to the meter. If we were only using two meters M_1 and M_2 , this could certainly suggest that the M_2 current lagged the M_1 current by about 90° . Whether it would be very ethical, is rather a moot point, depending on what the students are told they are being shown. Of course when there is a meter in the M_3 position, this expedient is exposed as a fraud. (My trick is better because M_3 does not expose it.)

Before the demonstration was given, students were

brain-washed: sketches were made of the pointers at various points of the cycle and the phasor diagram was drawn in the appropriate position. One student said that this was more helpful to him in understanding phasor diagrams than the demonstration itself. This may mean that the demonstration is not very valuable; or that it is valuable because it brings my previously-too-abstract presentation down to earth.

One student liked the demonstration; he of course will pass.

TEST SET FOR BALANCING
STEREOPHONIC EQUIPMENT
TAKING INTO ACCOUNT
LOUDSPEAKER EFFICIENCIES

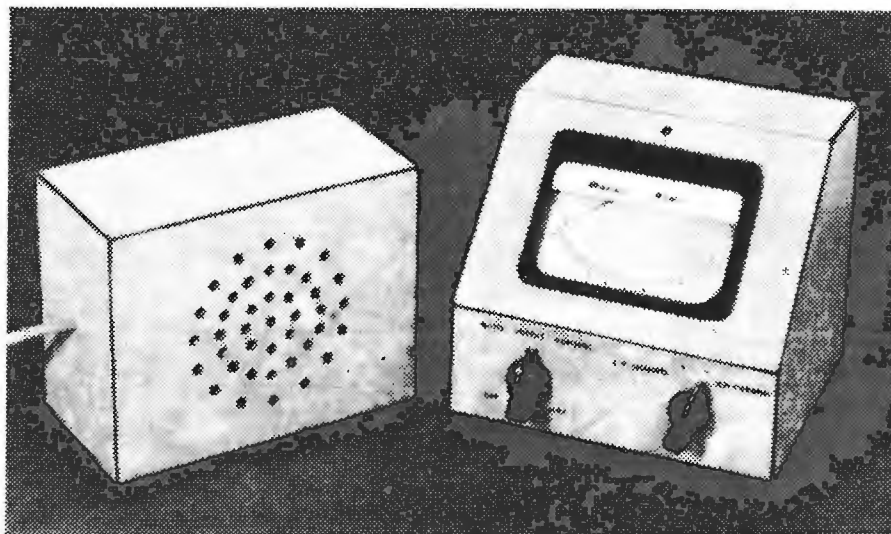

Wireless World

"STEREO BALANCER"

USUALLY, a stereophonic system is balanced by listening to a record of an orchestra, and it is often a matter of opinion whether balance is correct. It may be said that if it sounds right, then it is right, but the nagging doubt remains, and purists may tend to be uneasy.

Using the unit to be described, the system can be set up remotely from the listening position, that is, at the amplifier controls, and one can be sure that balance is perfect.

In the majority of stereophonic balance systems, the output of each amplifier is adjusted to deliver equal power to the speakers, and the efficiencies of the loudspeaker systems are not usually taken into consideration. In the unit to be described balance is achieved by feeding a "white noise" signal into each channel in turn; the signal transmitted by the loudspeakers is then picked up by an omnidirectional microphone placed in the normal listening position, its output being taken to an indicating device. Each channel is then adjusted to give the same reading on the indicator. By manipulation of the tone controls unequal frequency responses in the amplifiers will be shown up, and the relative efficiencies of the loudspeaker systems in the bass and treble frequency ranges can be compared.

Experiments carried out using a single frequency for the balancer gave completely misleading results due to standing-wave patterns set up in the room. Different balance settings were obtained whenever someone moved their position in the room, and even minute changes in the positioning of the pickup microphone produced reading changes. On a listening test, the apparent position of the sound source changed with the movement of one's head. Listening tests using a "white noise" signal, (a signal composed of audio frequency components varying in a random manner both in frequency and amplitude) gave encouraging results; the sound source could be heard to change from one loudspeaker, through the middle position, to the other loudspeaker, and indicator readings gave reliable balance conditions.

Various sources of white noise were tried and the best proved to be a low voltage neon of the Hivac 3L type which can be operated from a 90-V battery. The noise signal obtained from this neon contains frequency components extending from approximately 15c/s to well beyond the audio spectrum. The signal level is unfortunately rather low, being less than 1mV r.m.s. and considerable amplification is necessary to obtain a sufficiently large output. The 90-V supply for the neon is extremely useful in obtaining

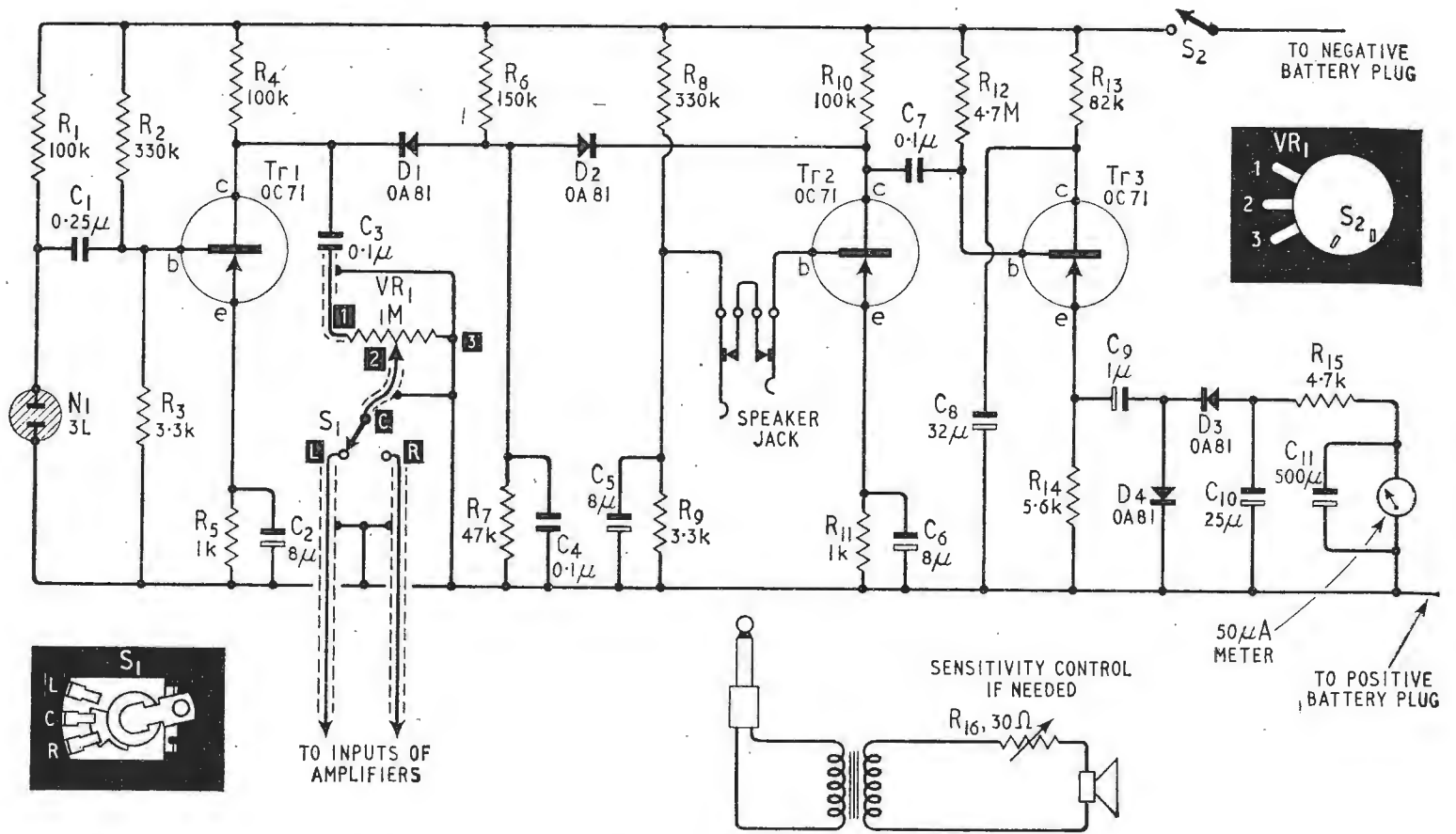

▲ Fig. 1. Circuit diagram of noise generator and indicator.

Fig. 2. Layout of tagboard, drawn full size. Turret tags in black protrude on facing side of board. ▼

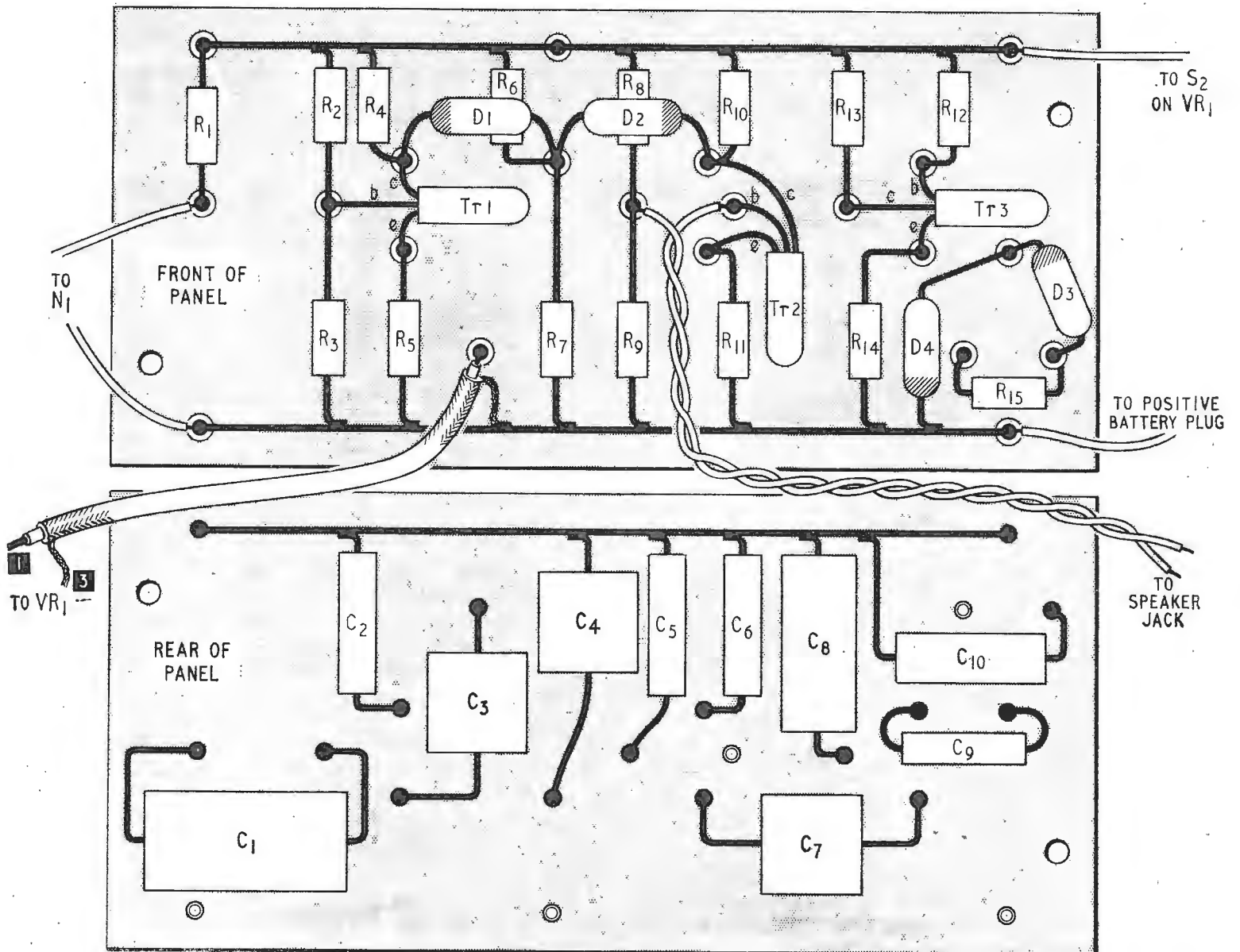
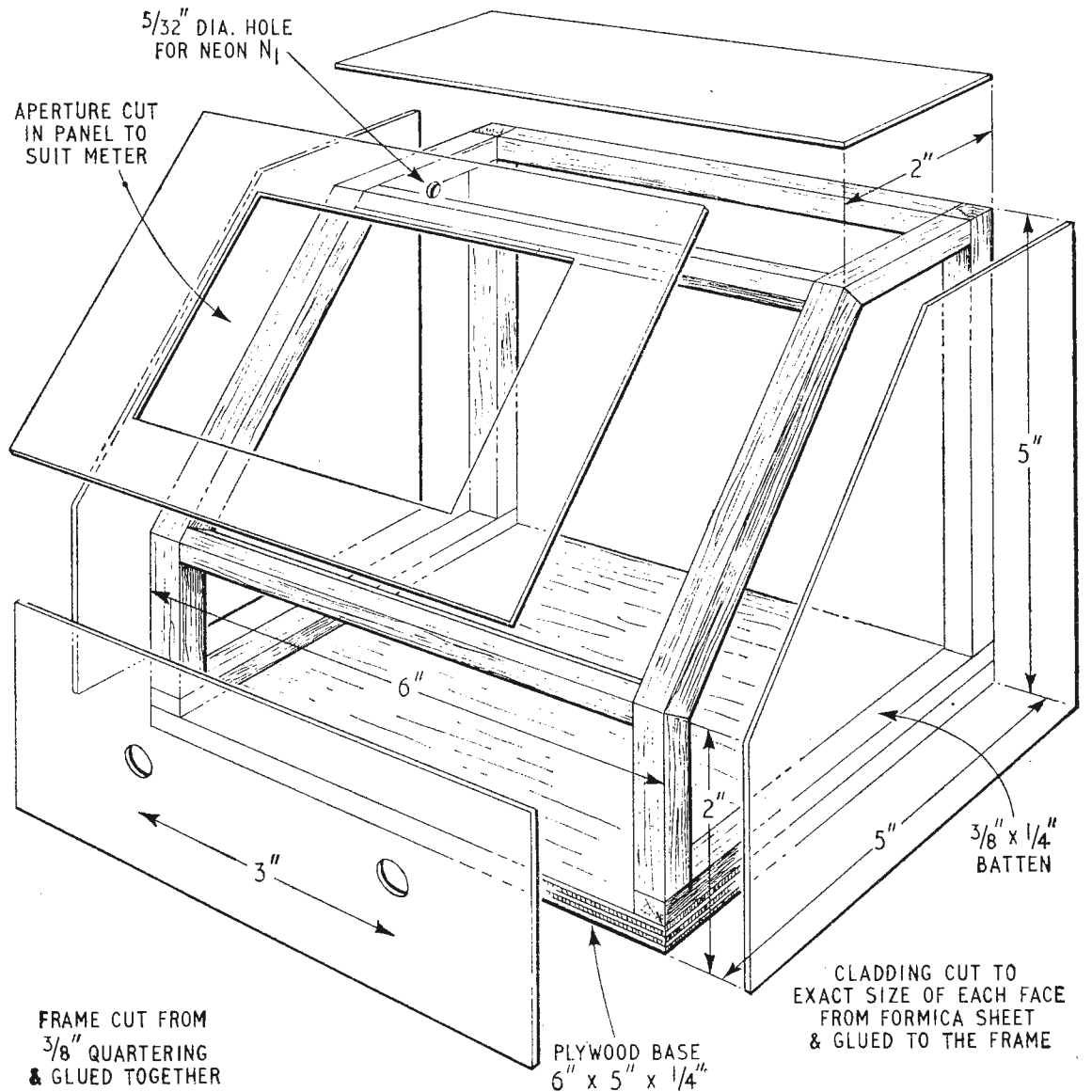

Fig. 3. Construction of case.



the required gain with economy of components, a single transistor stage with a high collector load being all that is required to give an output of about 50mV r.m.s.

The design of the amplifier is conventional with respect to the biasing arrangements, component values being chosen to give reasonable thermal stabilization ($K \approx 1/8$). Due to the use of a 90-V battery some extra precautions to protect the transistor must be employed. Apart from keeping the transistor within its maximum permissible dissipation, care must be taken that if the transistor is cut off at any time, the maximum collector-emitter voltage is not exceeded. The components D_1 , R_6 , R_7 , C_1 , form a clamp circuit. The voltage at the junction of R_6 , R_7 is slightly less than the maximum permitted collector-emitter voltage. If the collector voltage becomes more negative than this voltage, D_1 conducts and clamps the collector to the voltage at R_6 , R_7 junction. The amplifier output is capacitance-coupled to VR_1 , the output control, and then *via* a single-pole, two-way switch to the output leads.

An identical high-gain amplifier to that in the noise-generator stage is used in the indicator section, with the exception that the pickup device is transformer-coupled to the input. (A small speaker with the cone facing upwards, in an enclosed box has proved suitable for use as a microphone). The output of the amplifying stage cannot be used to drive a low-impedance meter directly, and so an emitter follower is included after the amplifying stage, its output being capacitance-coupled to a rectifying and smoothing circuit and thence to the meter.

The type of rectifier circuit chosen merits some explanation. The output of the indicator amplifier is sufficient to drive a $\frac{1}{2}$ -mA meter *via* a bridge rectifier, but due to the signal varying in frequency and amplitude in a random fashion the meter needle jitters sufficiently to make accurate balancing difficult. Further amplification and clipping of the signal was tried and although a steady reading was obtained when the clipped signal was fed directly into the indicator amplifier, jitter was still present when the clipped signal was obtained from the amplifier and microphone. This jitter was traced to the fact that not all the noise components were present in the microphone output in the same proportions as in the signal in the clipped output of the generator, due to peaks and dips in the frequency responses of the pickup microphone and loudspeaker systems producing corresponding peaks and dips whenever signal components at these frequencies were present. With the rectifier system shown, even with no clipping, and a long time-constant smoothing circuit, considerable reduction in jitter is obtained, although there is some loss in sensitivity and a more sensitive meter must be used.

The unit is constructed on a $\frac{1}{2}$ inch wooden frame with a plywood base, pinned together and then glued, the Formica panels being attached with "Evostik." The meter is mounted on the sloping panel with the neon above it used as an on/off indicator as well as a noise source. It is necessary to mount the neon in foam rubber as it is prone to microphony. The "electronics" are all wired on a single Paxolin panel with components mounted on "turret tags"; resistors

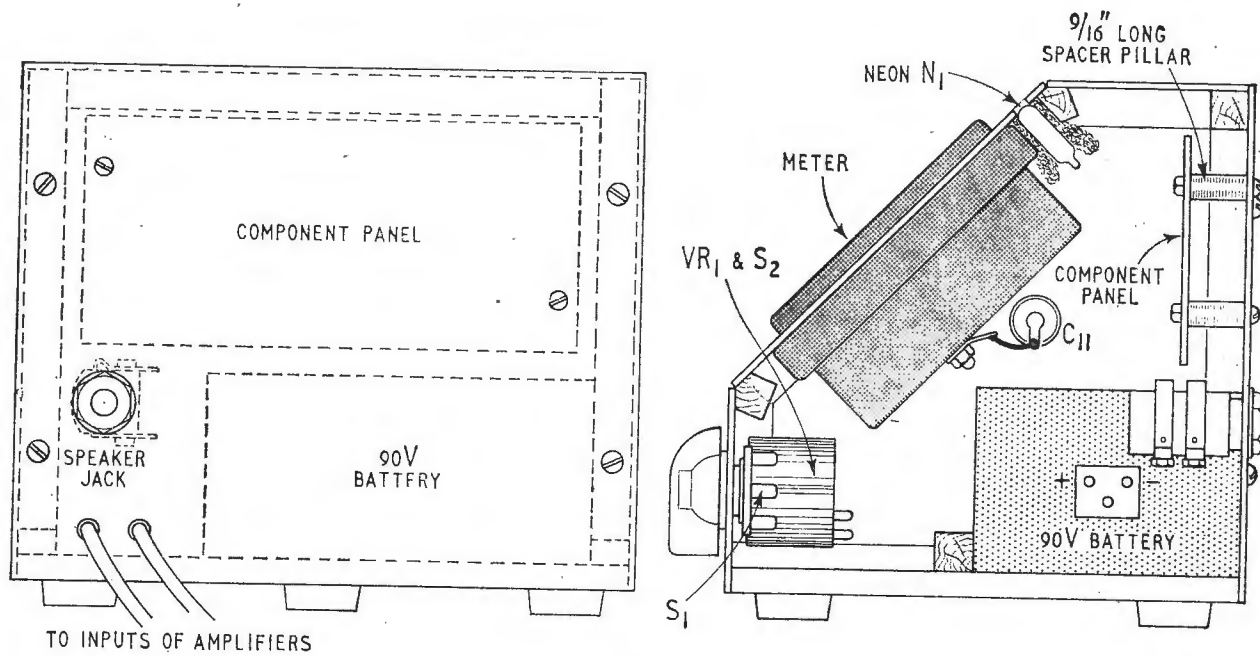

Fig. 4. Positioning of major components.

RESISTORS

| | | |
|-----------------|----------------------|----------|
| R ₁ | 100kΩ | ½W ± 10% |
| R ₂ | 330kΩ | ” ” |
| R ₃ | 3.3kΩ | ” ” |
| R ₄ | 100kΩ | ” ” |
| R ₅ | 1kΩ | ” ” |
| R ₆ | 150kΩ | ” ” |
| R ₇ | 47kΩ | ” ” |
| R ₈ | 330kΩ | ” ” |
| R ₉ | 3.3kΩ | ” ” |
| R ₁₀ | 100kΩ | ” ” |
| R ₁₁ | 1kΩ | ” ” |
| R ₁₂ | 4.7MΩ | ” ” |
| R ₁₃ | 82kΩ | ” ” |
| R ₁₄ | 5.6kΩ | ” ” |
| R ₁₅ | 4.7kΩ | ” ” |
| R ₁₆ | 30Ω variable | ” ” |
| VR1 | 1MΩ log. with switch | ” ” |

CAPACITORS

| | | |
|-----------------|--------|------|
| C ₁ | 0.25μF | 250V |
| C ₂ | 8μF | 15V |
| C ₃ | 0.1μF | 250V |
| C ₄ | 0.1μF | 250V |
| C ₅ | 8μF | 15V |
| C ₆ | 8μF | 15V |
| C ₇ | 0.1μF | 250V |
| C ₈ | 32μF | 15V |
| C ₉ | 1μF | 15V |
| C ₁₀ | 250μF | 15V |
| C ₁₁ | 500μF | 6V |

MISCELLANEOUS

- 3—OC71 transistors
- 4—OA81 germanium diodes
- 1—50μA meter
- 1—3L neon (Hivac)

- 1—1-pole changeover switch (Radiospares)
 - 1—shorting jack socket
 - 1—jack plug
 - ½ × ½ in. wood strip
 - Paxolin
 - 90-V battery (VIDOR L5512 or equivalent)
 - 3-pin plug for battery
 - 1 speaker and transformer
- (Turns ratio of transformer should be chosen to match speaker into 1.5kΩ. This is not critical and many small output transformers will suffice.)

and transistors are on one side and capacitors on the other. The total current consumption of the unit is approximately 4mA and should ensure a long battery life. If it is found that the voltages at the collectors of the two amplifying stages differ greatly from 9V (measured with a 20,000 Ω/V meter) due to variations in component tolerances, the values of R₃ and R₉ may have to be altered slightly to give the correct collector voltages. The speaker used as a microphone is mounted in a suitable box with its transformer, and its lead is terminated in a jack plug.

It is preferable to have sufficient output from the loudspeakers to give a good signal-to-background noise ratio, but if there is excessive background noise, a variable resistor in series with the speaker may be needed to eliminate this, although some loss in sensitivity will inevitably occur.

When balancing a stereophonic system, good results are obtained by introducing bass and treble cut and balancing for the middle range of frequencies. By adjustment of the bass and treble controls an indication of the relative efficiencies of the loudspeakers at those frequencies can be obtained, and if it is found that the readings for each channel differ noticeably, by exchanging the loudspeakers from one channel to another it can be ascertained whether the speakers or the frequency responses of the amplifiers are at fault.

The white noise source may be used without the indicator if desired. It is far easier to adjust for a central image using this type of signal than it is with a record. It will be necessary to feed the noise to both amplifiers of the stereo system and set the balance control so that the source appears to be central.

CLUB NEWS

Chelmsford.—“Radio Astronomy” is the title of the lecture to be given by F. Hyde at the meeting of the Chelmsford Amateur Radio Club to be held at 7.30 on 1st October at Marconi College, Arbour Lane.

Edinburgh.—At the Lothians Radio Society meeting on the 10th October L. F. Benzie (GM3DDE) and W. C. Bradford (GM3DIQ) will discuss “Early experiences on v.h.f.” Meetings are held on alternate Thursdays at 7.30 at the Y.M.C.A., 14 South St. Andrew Street.

Hampshire.—The month’s meetings of the Wessex Amateur Radio Group include visits to the I.T.A. Repeater Station, Stockland Hill, Honiton, Devon (6th) and to the Bournemouth Telephone Exchange (14th).

Melton Mowbray.—The tape-recorded lecture “Amateur Radio in the Antarctic” by Roth Jones will be given at the meeting of the Melton Mowbray Amateur Radio Society to be held at the St. John Ambulance Hall, Asfordby Hill at 7.30 on 17th October.

The Scout Jamboree on the Air will be held on October 19th and 20th. Further details are available from the Boy Scouts Association, Buckingham Palace Road, London, S.W.1.

Electronics in Neurophysiology

HISTORICAL REVIEW OF ELECTROPHYSIOLOGICAL TECHNIQUES

By P. E. K. DONALDSON,* M.A., A.M.I.E.E.

IN 1751, one Michel Adanson, whilst visiting West Africa, encountered *Malepturus electricus*, the electric catfish. He described the experience as "un tremblement très-douloureux", and went on "son effet ne m'a pas paru différer sensiblement de la commotion électrique de l'expérience de Leyde, que j'avois déjà éprouvée plusieurs fois." This is perhaps the first report in which animal electricity was recognized as such. The topic has been studied ever since, though nowadays under the more dignified name of electrophysiology. Electrophysiology is the study, in terms of their electrical properties, of the mechanism of the nervous systems of those living creatures sufficiently complex to need one. As such, it is one of the techniques of the neurophysiologist.

Although electronic equipment is inevitably part of the stock-in-trade of the modern electrophysiologists, it would be erroneous to suppose that electronic techniques have suddenly made electrophysiology possible; a great deal was known about the electrical properties of nerve and muscle before anyone had heard of electronics. Indeed, one can go so far as to say that physiologists were doing important work *before* electrotechnology could provide any apparatus to help them. Everyone has heard of Galvani, who at the close of the 18th century became intrigued by the twitching of a frog's leg; the leg was suspended from some iron railings by a copper hook. The sequel to these observations is perhaps less well known: Galvani thought that the energy which stimulated these contractions came from the frog's leg, whereas Volta held that the junction between the dissimilar metals was responsible. It turned out eventually that Volta was right; the piece of nerve attached to the muscle was sensitive to the feeble current set up by the metals, and in some way caused the muscle to shorten. The frog nerve-muscle preparation thus became used as a detector of feeble and transitory electric currents, which for many years greatly exceeded in sensitivity anything the embryo electrical instrument industry could provide. So much was this so, that although Helmholtz proposed the tangent galvanometer in 1849, we find his close friend du Bois-Reymond using the apparatus shown in Fig. 1 nearly 40 years later.² The electric catfish discharges in a train of shocks; du Bois wanted to measure the strength of one shock. He used one nerve-muscle preparation to ring a bell, signalling that the fish had discharged, and another to open the circuit connecting the catfish to a ballistic galvanometer; in this way, only the first shock of the train was measured.

In 1850, Helmholtz had measured the conduction

velocity of nerve, of the order of 100 metres per second. The announcement met a good deal of disbelief from the philosophers of the time, who felt that the Will and the Action must surely be simultaneous; it had been supposed that the conduction velocity would be infinite, or at least the speed of light. A more important difficulty, however, was that nobody knew what it was that the nerve conducted. It was suspected that some electrical change accompanied the contraction of muscle, if not the conduction by nerve, because in 1842 Matteucci had discovered "secondary contraction"; if the muscle of one nerve-muscle preparation is laid against the nerve of another and the first nerve stimulated, both muscles contract. It looked as if the second nerve were being stimulated by current from the first muscle. At last, two instruments appeared which were to shed some light on the matter. The capillary electrometer was invented by Lippmann in 1872 and used ten years later by the physiologist Burdon-

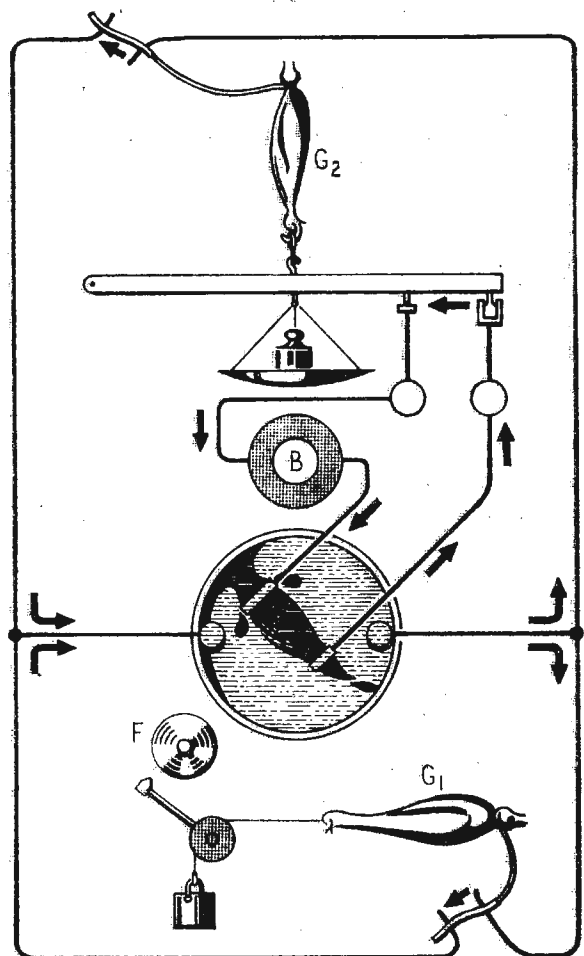

Fig. 1 Preparations of frog-leg nerve muscle used for investigating electrical pulses from cat fish. The first pulse of a train causes G_1 to shorten and ring the bell F . G_2 also contracts and opens the circuit to the galvanometer B .

*Physiological Laboratory, Cambridge.

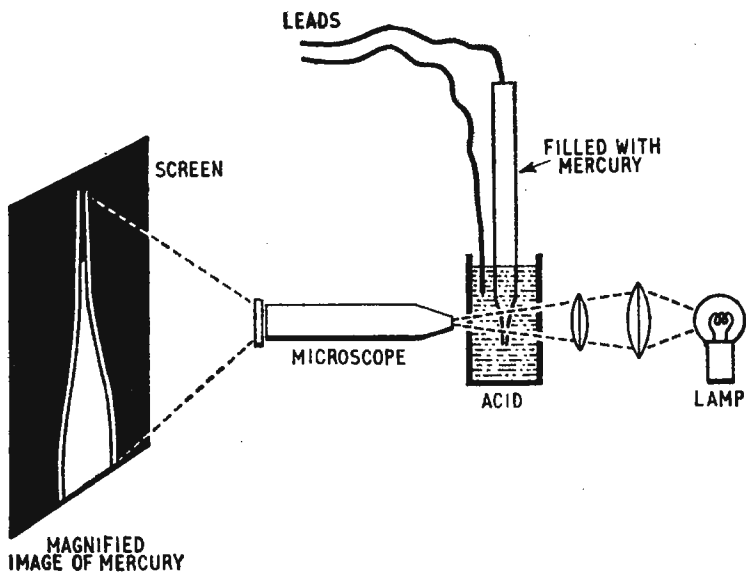

Fig. 2 Principle of capillary electrometer. Length of mercury column varies with applied potential.

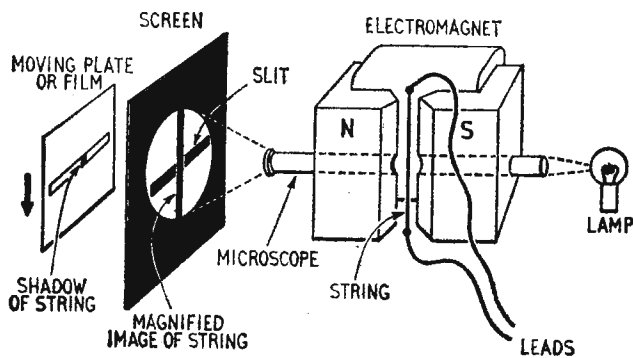

Fig. 3 String galvanometer.

Sanderson to record the output of the electric organ of the skate, brief discharges of a few volts. The instrument was improved until it became possible to see that contraction of muscle is indeed accompanied by an "action potential", a wave of negative potential of the order of 20 mV which sweeps over the surface of the muscle in a millisecond or two, and which may be detected by surface electrodes placed at two different points along its length. Capillary electrometers have a high input impedance, but the voltage sensitivity is limited and changes in indication are retarded by viscous damping of the mercury column (Fig. 2).

The other instrument was the string galvanometer, invented by Einthoven in 1901. With a strong magnet and a gold-plated quartz fibre for the string, the instrument could be made quick-acting and sensitive. The impedance was low, so it was better adapted to a low-resistance signal source. An entire human being is such a source, and the early electrocardiograms were taken with string galvanometers; an electrocardiogram is just a picture of the rather unusual action potential exhibited by cardiac muscle, which is itself a rather unusual muscle. It was possible to investigate the action potentials of other muscles, using the string galvanometer, and under very favourable conditions it became possible at last to detect that the disturbance that nerves conduct is accompanied by a feeble action potential also (Fig. 3).

Quantitative investigations into nerve action potentials had to await the coming of electronics. Braun had devised the cathode ray tube in 1890 and

de Forest the triode valve in 1906. By 1922 we find these devices much improved and the Americans Gasser and Erlanger using them in the first electrophysiological set-up of modern type, apart perhaps from the electromechanical time base or "spreading" these workers used. With such apparatus, Fig. 4, it is possible to stimulate either a whole nerve or—more important—a single constituent nerve fibre (cf. one core in a multi-core cable) at the electrodes T, launching an action potential which is propagated *without attenuation* along the nerve and which is recorded as it passes the electrodes E. In this way the true shape and amplitude of the nerve action potential can be demonstrated, with such other features as its all-or-none nature, and its maximum recurrence frequency—of the order of hundreds per second.

Cathode ray tubes did not at once become popular; the early models were expensive and short-lived, and produced only dim traces. Hence in 1925 we find Adrian—now Lord Adrian—using a three-valve amplifier but retaining the capillary electrometer as indicating device. In 1928 a special oscillograph for electrophysiologists' use, Fig. 5, was described by Matthews—now Sir Bryan Matthews, Professor of Physiology at Cambridge. This was a high speed moving-iron reflecting galvanometer; its response extended to 5000 c/s and it was intended to follow a five stage resistance-capacitance-coupled amplifier, whose output stage comprised four of the then available power triodes in parallel.

The stage was now set for the '30s. "Wireless" components were easily obtainable, and the way was open for any physiologist to research, not only into nerve and muscle, but also into the animal input transducers. Lights could be shone into eyes, clicks directed into ears, toes could be tweaked, and records taken of the accompanying neural signal in the visual, auditory and tactile nervous pathways. Alternatively, gross effects produced by such peripheral stimuli could be investigated in the central nervous system itself, recording from electrodes in or on the spinal cord or brain, or by attaching surface electrodes to the scalp (electroencephalography). The need to record microvolt signals necessitated during this period the adoption of new circuit techniques for achieving low noise and for suppressing interfering signals. By 1934 Matthews was using a push-pull input stage for his amplifier, later improved by the addition of a long tail.

In this kind of work, the system studied was patently complex, involving perhaps a transducer organ, some peripheral synapses (neural relays), appreciable lengths of nerve and possibly some central synapses as well. Whilst some physiologists were doing this, others were interested in an apparently simpler problem—just nerve, and how it worked. The theory current at the time had been proposed by Bernstein at the beginning of the century, and required that the core of a resting nerve fibre be polarized negatively with respect to its exterior. Such a polarization can easily be detected in a whole nerve (where a number of fibres act in parallel) by squashing part of the nerve and connecting a galvanometer between the squashed part and an intact part. The connection to the damaged portion of nerve is effectively in contact with the core material of each fibre, and a so-called "injury current" flows round the circuit. But the polarization

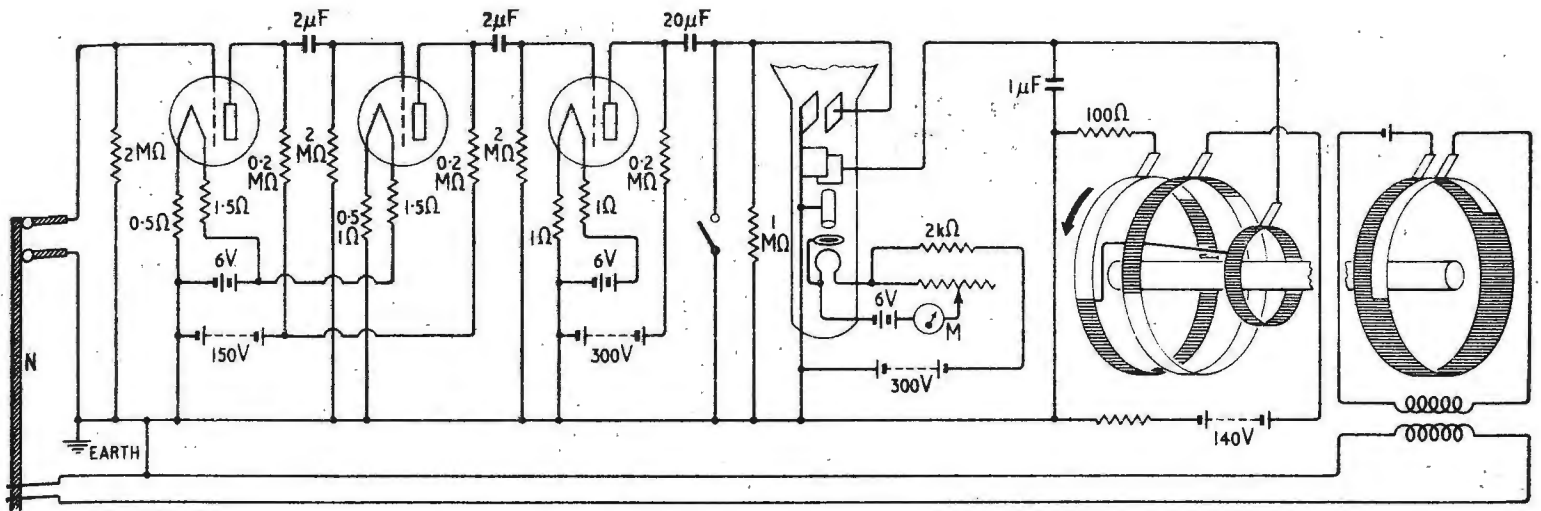

Fig. 4 Gasser and Erlanger's oscillograph.

could not be measured without getting some kind of electrode *inside* a nerve fibre without damaging the fibre. Since fibres commonly range in diameter from 1 to 100 microns, it is evident that a very delicate electrode indeed was needed (25 microns \approx 0.001 inch). All electrophysiological records taken hitherto had been *extracellular*, that is, both electrodes were outside the cell membrane—be it nerve fibre or muscle fibre or any other nervous tissue—and signals had been obtainable because, fortunately, the membrane of an active cell is not equipotential. The problem, then, was to find an intracellular microelectrode, and a solution was found in 1939. Curtis and Cole in America, and Hodgkin and Huxley in Plymouth, used a glass saline-filled capillary tube, 60 microns in diameter, pushed axially into a particularly large nerve, one which controls the jet-propulsion of a squid. Using differential direct-coupled amplifiers and a cathode-ray tube (by now a practical proposition) for indication it was confirmed that the interior is indeed negative, by about 60 mV; and further, that when an action potential comes along, this polarization not only disappears, as had been forecast, but it momentarily reverses, reaching some 40 mV the other way (Fig. 6).

By the end of the '40s, the American physiologists Ling and Gerard had evolved techniques for pulling capillary electrodes less than 1 micron in diameter.

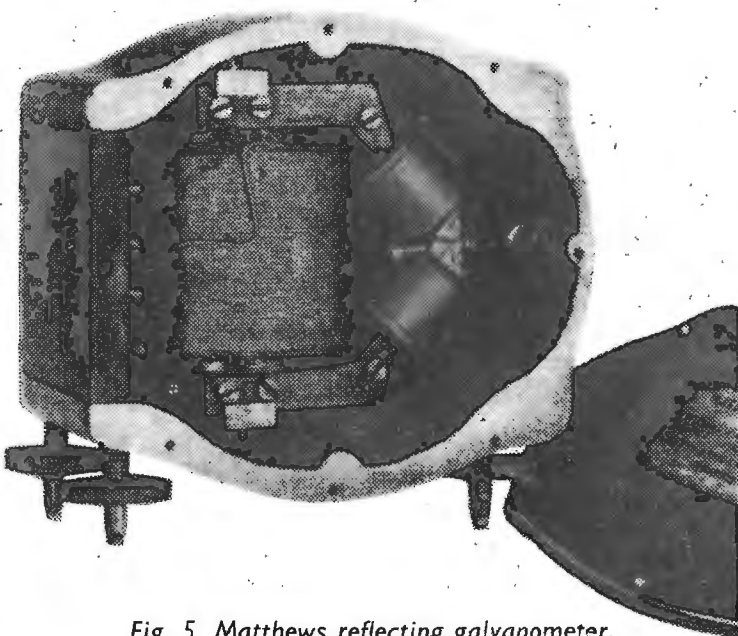

Fig. 5 Matthews reflecting galvanometer.

The tip of such an electrode is too small to see under an optical microscope, however high the magnification, because the dimensions are of the same order of magnitude as the wavelength of light. It can be seen under the electron microscope; fortunately it is not necessary to have an electron microscope to do intracellular recording, as there are cheaper ways of checking the electrodes. A 1-micron electrode will puncture the membrane of a nerve fibre or muscle fibre without tearing it. At last, the

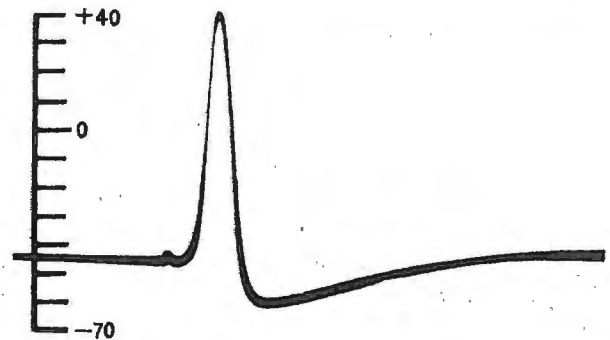

Fig. 6 Record of action potential between inner and outer of nerve.

activity of just one cell, whether nerve, or muscle, or one individual buried deep in the mass of cells of the brain and spinal cord, could be studied.

The resistance of such an electrode is high, of the order of 10 or 100 megohms, and in order to follow potential changes at the tip lasting less than 1msec, amplifiers of very low input conductance and capacitance are necessary. Hodgkin, using electronic techniques developed during the war, showed how these could be made.

One important innovation was the use of cathodal screening of the cathode-follower input stage, a procedure invented by Dr. (now Professor) M. Ryle. Hodgkin's input stage is shown in Fig. 7. The cathodal screen reduced the input capacitance to about $1\frac{1}{2}$ pF. To this must be added the distributed capacitance to earth of the microelectrode itself, radially through the shank, a few more pF, yielding an overall input circuit time constant of 70μ secs for a $22\text{ M}\Omega$ electrode. Selection of 6AK5 valves was necessary to obtain sufficiently low grid current (it is instructive to work out the current density when 1 microampere passes down a 1-micron microelectrode) and specimens were accepted having currents of less than 10^{-11} A.

More recently, other workers have reduced further

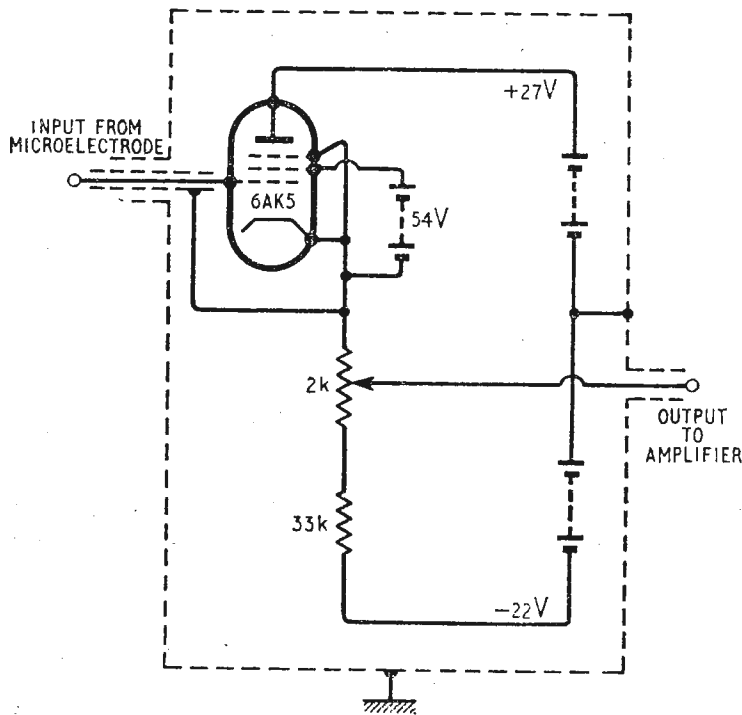

Fig. 7 Extremely high input-impedance stage for measurement of nerve-fibre potential.

the time constant of microelectrode recordings by the use of sufficient positive feedback to make the effective capacitance of the input stage zero. To do this requires care, and the method is fraught with traps for the unwary; many physiologists will have nothing to do with it.

The modern physiological laboratory abounds in electronic apparatus; pH meters, spectrophotometers, ionized particle counters, stimulators, even computers of various kinds. But these are all known in fields outside electrophysiology. ("Stimulator" is only the biologist's name for a pulse generator.)

The microcapillary electrode remains the latest major step forward in the study of animal electricity. With its help, we know there is a pattern in the way the transducer cells work: that the incident stimulus—in whatever form—causes a direct current to flow in the neighbourhood of the cell, which in turn launches an action potential in the attached nerve. With its help, we know so much about nerve that contemporary studies seem more biophysical than physiological. With its help, we hope to find out why muscles contract and perhaps, one day, to gain some understanding of the brain itself. All this, from a little piece of glass tube, drawn out in a flame until it is too thin to be seen, and then filled with salt water.

REFERENCES

1. Keynes, R. D. "The Generation of Electricity by Fishes", *Endeavour*, Vol. XV, No. 60, p. 215 (October, 1956).
2. "Biological Memoirs. Physiology of nerve, muscle and electric organ." Ed. Burdon-Sanderson. O.U.P. 1887.

ACKNOWLEDGEMENTS

- Fig. 1 is taken from reference 2 above.
 Figs. 2 and 3 are from "Electricity in our bodies", by B. H. C. Matthews. George Allen & Unwin, Ltd. 1931.
 Fig. 4 is from the *American Journal of Physiology*. H. S. Gasser and Joseph Erlanger. "A study of the action currents of nerve with the cathode ray oscillograph." Vol. LXII, p. 496. (1922) Baltimore, U.S.A.
 Fig. 6 is from the *Journal of Physiology*. Hodgkin, A. L., and Huxley, A. H. "Resting and action potentials in single nerve fibres." Vol. 104, p. 176 (1945-46). Cambridge University Press.
 Fig. 7 is redrawn from "Journal of Cellular and Comparative Physiology" (Wistar, Philadelphia, PA.). W. L. Nastuk and A. L. Hodgkin. Vol. 35, p. 39 (1950).

H. F. PREDICTIONS — OCTOBER

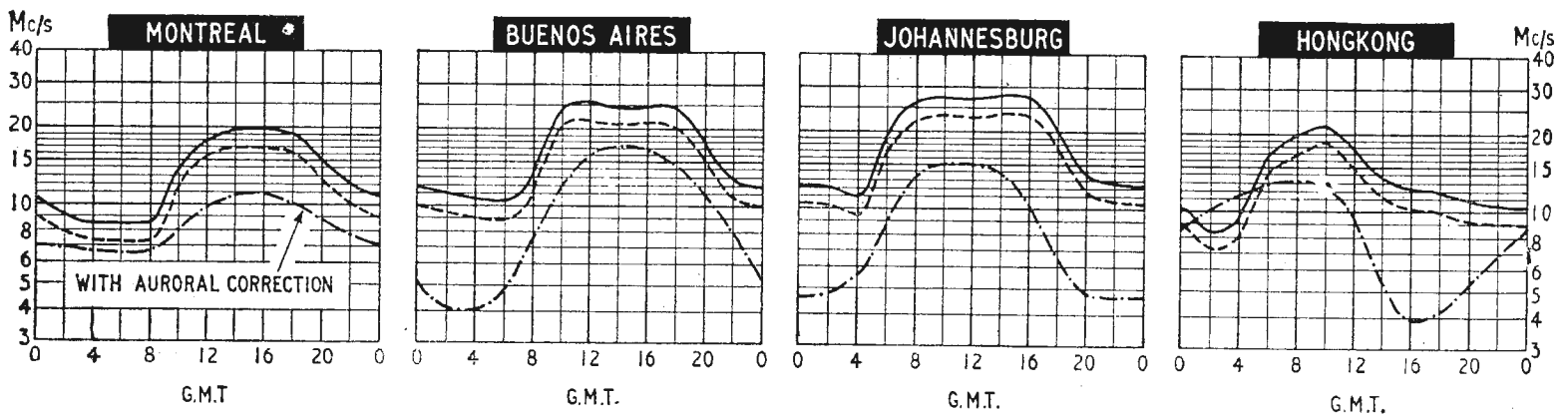

The high daytime MUFs, characteristic of winter conditions on routes largely in the northern hemisphere, are reappearing. It is interesting to note that on southerly circuits to Africa and South America the highest frequencies in the h.f. band will be of use again, even though the sunspot cycle is close to its minimum.

The prediction curves show the median standard MUF, optimum traffic frequency and the lowest usable high frequency (LUF) for reception in this country. Unlike the MUF, the LUF is closely dependent upon such factors as transmitter power, aerials, local noise

level and the type of modulation; it should generally be regarded with more diffidence than the MUF. The LUF curves shown are those drawn by Cable and Wireless, Ltd., for commercial telegraphy and they serve to give some idea of the period of the day for which communication can be expected.

SYNCOM II—SYNCHRONOUS—ORBIT COMMUNICATIONS SATELLITE

THE first successful synchronous-orbit artificial satellite—Syncom II—was launched from Cape Canaveral on July 26th. The 79-lb drum-shaped satellite, designed and built by Hughes Aircraft Company, measures 28in in diameter and is 15½in deep. A total of 3,840 silicon solar cells cover the cylindrical surface of the satellite. The power supply is designed to provide a minimum of 20 watts at 27.5 volts.

The communications system is a duplicated frequency-translation, active-repeater system. Incoming signals from ground stations at a frequency of approximately 7400Mc/s are fed to one of two receivers—the desired one being selected by command from the ground. The output of the receiver supplies the input to a signal hybrid network, the output of which is connected to one of the satellite's two travelling-wave tube transmitters. The output of each t.w.t. is at least 2W at a frequency of 1815Mc/s. The transmitters also provide a 100mW tracking signal at 1820Mc/s.

A coaxial slotted aerial for communications is mounted on one of the flat ends of the drum. There are four whips in a turnstile arrangement around the periphery of the other end for telemetry and command, and a dipole mounted on the vertical side for the communications receivers. The telemetering transmitter, operating around 136Mc/s, delivers 1.25W to the turnstile aerial. Functions telemetered include temperatures of the electronics unit; power supply voltages; transponder receiver and transmitter signal strength; solar sensor output pips, and the pressure of the nitrogen gas and hydrogen peroxide.

The two command receivers are identical, parallel units each with mixer, i.f. amplifier, and a.m. detector. Commands transmitted to the satellite from ground stations include the switching of communications systems and telemetry, apogee motor firing, and gas jet operation. The switching on or off of the radio equipment is done by 12 command signals and another 13 commands are used for controlling the satellite.

Syncom was launched by a three-stage Delta rocket and when at an altitude of about 22,300 miles and after separating from Delta its own propulsion system consisting of a solid-propellant rocket motor supplied the boost necessary to inject it into a nominally synchronous circular orbit at a speed of about 7,000 m.p.h.

Syncom does not in fact hover over one point on the earth but appears to describe a figure of eight. This is because its orbit is not truly equatorial. Having been launched from Cape Canaveral, which is 28.3° north of the equator, its orbit takes it back and forth across the equator twice a day, travelling 33° north and 33° south, hence the figure 8 pattern.

The satellite's attitude and location in orbit is controlled from a converted Liberty ship, the *U.S.N.S. Kingsport* anchored off Lagos, Nigeria. Communications via the satellite are conducted between the *Kingsport* and the Naval Air Station at Lakehurst, N.J.

Syncom is spin stabilized, that is it maintains the position of its axis just as a gyroscope does. The control system consists of four gas jets the control valves of which are the only moving parts in the satellite. Each of the control systems (for attitude and velocity) has two jets, one fires parallel to the spin axis of the satellite and the other perpendicular to the spin axis. The nitrogen system has a total correction capability of about 50 feet per second and the hydrogen peroxide system of about 300 feet per second.

The plane of the satellite is oriented so that the aerial pattern is continuously beamed on to the earth, the axis of the "drum" being parallel to the earth's axis.

Direction of the spin axis of the satellite is established by measuring the polarization of the aerial pattern via the ground communications system.

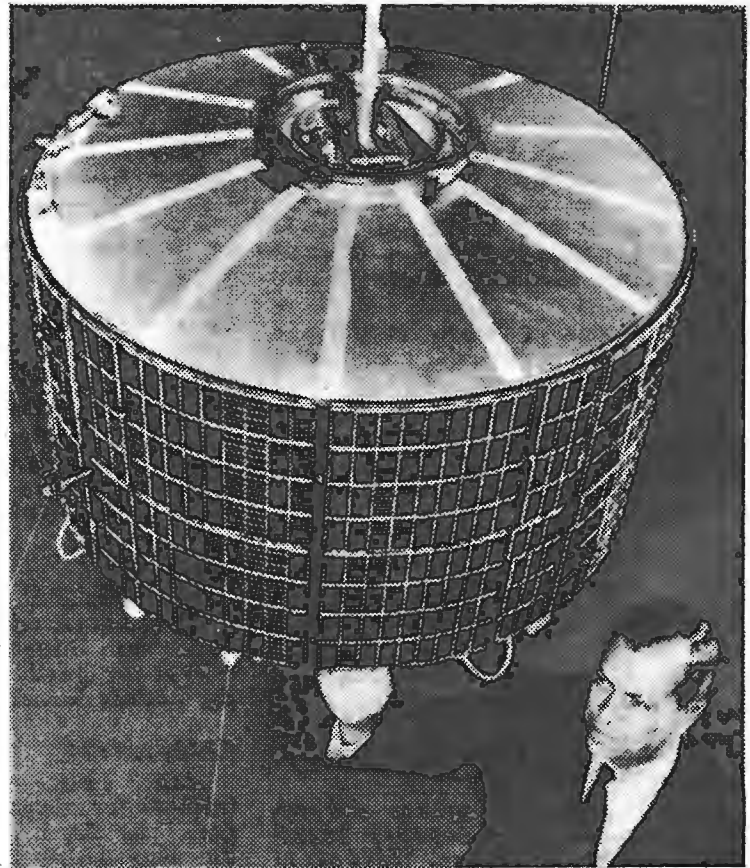

Dr. Allen Puckett, vice-president of Hughes Aircraft Company, inspecting the satellite before it was mounted on the rocket.



Syncom is composed of two concentric units; an outer ring, which supports the solar panels and contains the gas control systems and most of the electronics, and an inner cylinder which houses the remainder of the electronic equipment and the rocket motor. This motor added nearly 70lb to the satellite's weight.

OCTOBER MEETINGS

Tickets are required for some meetings; readers are advised, therefore, to communicate with the secretary of the society concerned.

LONDON

2nd. Brit.I.R.E. & I.E.E.—Discussion on "Electronic equipment for medical research—build or buy?" opened by W. J. Perkins and Dr. G. H. Byford at 6.0 at the London School of Hygiene and Tropical Medicine, Keppel Street, W.C.1.

8th. Society of Relay Engineers.—Symposium on pay-television at 2.30 at 21 Bloomsbury Street, W.C.1.

9th. British Conference on Automation and Computation.—"Computers and management" by Sir Edward Playfair at 5.30 at the I.E.E., Savoy Place, W.C.2.

9th. Brit.I.R.E.—"Novel types of magnetic recording heads" by Dr. J. C. Barton at 6.0 at the London School of Hygiene and Tropical Medicine, Keppel Street, W.C.1.

10th. Radar & Electronics Association.—"Optical masers, how they work and what they do" by Dr. G. W. Wilson at 7.0 at the Royal Society of Arts, John Adam Street, W.C.2.

15th. I.E.E.—"Computers and engineers" by Dr. J. R. Mortlock (chairman, Science and General Division) at 5.30 at Savoy Place, W.C.2.

22nd. I.E.E.—"Predictive control" by J. F. Coales, at 5.30 at Savoy Place, W.C.2.

23rd. I.E.E.—"Electronics—the expanding frontier" by Dr. R. C. G. Williams (chairman, Electronics Division) at 5.30 at Savoy Place, W.C.2.

23rd. Brit.I.R.E.—"Methods of distinguishing sea [radar] targets from clutter" by A. Harrison at 6.0 at the London School of Hygiene and Tropical Medicine, Keppel Street, W.C.1.

24th. Society of Instrument Technology.—The Thomson Lecture "Technology, life and leisure" by Prof. Dennis Gabor at 6.0 at The Royal Institution.

28th. I.E.E.—Discussion on "Solid-state nanosecond techniques" at 5.30 at Savoy Place, W.C.2.

28th. I.E.E.—"Self-checking in the SATCO air traffic control system" by Ir. R. A. Grijseels at 5.30 at Savoy Place, W.C.2.

29th. I.E.E. & Brit.I.R.E.—Discussion on "Fixed [computer] stores" at 6.0 at Savoy Place, W.C.2.

29th. Society of Instrument Technology.—"Solid-state telemetering and supervisory control systems" by A. J. Keeling and G. S. Kermack at 7.0 at Manson House, 26 Portland Place, W.1.

30th. Brit.I.R.E.—"Studio problems for colour television" by J. S. Samson at 6.0 at the London School of Hygiene and Tropical Medicine, Keppel Street, W.C.1.

30th. Television Society.—Symposium on "Multistandards studio planning" at 7.0 at the I.E.E., Savoy Place, W.C.2.

31st. Television Society.—Fleming Memorial Lecture "Television in space research" by Prof. J. D. McGee at 7.0 at the Royal Institution.

BIRMINGHAM

24th. Brit.I.R.E.—"Infra-red in medical research" by C. M. Cade at 6.15 at University of Birmingham.

25th. I.E.E.—"Teaching machines" by G. Pask at 6.15 at the College of Advanced Technology, Gosta Green.

28th. I.E.E.—"Stereophonic sound" by Prof. Colin Cherry at 6.0 at the James Watt Memorial Institute.

BOURNEMOUTH

9th. Brit.I.R.E.—"Laser communications" by M. Dore and G. S. Waters at 7.0 at Bournemouth Municipal College of Technology and Commerce.

BRISTOL

8th. Brit.I.R.E. & I.E.E.—"The field effect transistor and its applications" by C. S. den Brinker and D. Ellison at 6.30 at the Bristol University Engineering Lecture Rooms.

CAMBRIDGE

15th. I.E.E.—"Use of operational methods for analysis of non-linear functions" by Dr. J. K. Lubbock at 8.0 at the Engineering Laboratories, Trumpington Street.

31st. I.E.E.—"Some electronic techniques for radio telescopes" by Dr. D. M. A. Wilson at 8.0 at the Engineering Laboratories, Trumpington Street.

CARDIFF

2nd. Brit.I.R.E.—"Tunnel diode applications" by M. R. McCann at 6.30 at the Welsh College of Advanced Technology.

CATTERICK

15th. I.E.E.—"Pulse techniques in line communications" by R. O. Carter at 6.30 at the School of Signals, Catterick Camp.

CHRISTCHURCH

30th. I.E.E.—"Communication satellites" at 6.30 at the Kings Arms Hotel. (Joint meeting with the Royal Aeronautical Society).

FARNBOROUGH

31st. Brit.I.R.E.—"Laser communications" by M. Dore and G. S. Waters at 7.0 at Farnborough Technical College.

HUDDERSFIELD

22nd. I.E.E.—Discussion on "Television in the service of technical education" opened by J. Scupham at 6.30 at Huddersfield Training College for Technical Teachers.

ISLE OF WIGHT

25th. I.E.E.—"Some factors influencing the design of h.f. broadband mono-pole aerials" by H. P. Mason at 6.30 at the Isle of Wight Technical College, Hunnyhill.

LEEDS

2nd. Brit.I.R.E. — "Loudspeakers today" by K. R. Russell at 7.0 at Leeds University, Department of Electrical Engineering.

LEICESTER

8th. Television Society.—"The world-wide relaying of television by artificial earth satellites" by W. J. Bray at 7.30 in the Main Hall, Vaughan College, St. Nicolas Street.

"WIRELESS WORLD" PUBLICATIONS

| | Net Price | By Post |
|--|-----------|---------|
| PRINCIPLES OF SEMICONDUCTORS M. G. Scroggie, B.Sc., M.I.E.E. | 21/- | 21/11 |
| COLOUR TELEVISION: N.T.S.C. System, Principles and Practice. P. S. Carnit, B.Sc. (Eng.), A.C.G.I., A.M.I.E.E. and G. B. Townsend, B.Sc., F. Inst.P., M.I.E.E., A.K.C. | 85/- | 87/3 |
| RADIO VALVE DATA Compiled by the staff of "Wireless World." 7th Edition | 6/- | 6/10 |
| RADIO AND ELECTRONIC LABORATORY HANDBOOK M. G. Scroggie, B.Sc., M.I.E.E. 7th Edition | 55/- | 57/3 |
| PRINCIPLES OF TRANSISTOR CIRCUITS S. W. Amos, B.Sc.(Hons.), A.M.I.E.E. 2nd Edition | 21/- | 22/- |
| HIGH-QUALITY SOUND PRODUCTION AND REPRODUCTION. H. Burrell Hadden. | 42/- | 43/5 |
| SOUND AND TELEVISION BROADCASTING. General Principles. K. R. Sturley, Ph.D., B.Sc., M.I.E.E. | 45/- | 46/4 |
| GUIDE TO BROADCASTING STATIONS Compiled by "Wireless World." 13th Edition | 3/6 | 4/- |
| MICROWAVE DATA TABLES A. E. Booth, M.I.R.E., Graduate I.E.E. | 27/6 | 28/8 |
| WIRELESS SERVICING MANUAL 10th Edition W. T. Cocking | 25/- | 26/- |
| FOUNDATIONS OF WIRELESS 7th Edition M. G. Scroggie, B.Sc., M.I.E.E. | 16/- | 17/6 |

A complete list of books is available on application.

Obtainable from all leading booksellers or from

ILIFFE BOOKS LTD., Dorset House, Stamford Street, London, S.E.1.

16th. Brit.I.R.E.—“ Gallium arsenide devices and infra-red diodes ” by B. R. Holeman at 6.45 at Leicester University.

LOUGHBOROUGH

17th. Society of Instrument Technology.—“Space research by rocket and satellite” by Dr. P. C. Russell at 7.15 at the Loughborough College of Technology, Ashby Road.

MANCHESTER

3rd. Brit.I.R.E.—“Electronic equipment in modern liners” by P. A. Bendelow at 7.0 at Reynolds Hall, Manchester College of Science and Technology.

15th. I.E.E.—“The electrical measurement laboratory of the Manchester College of Science and Technology” by J. Rawcliffe at 6.15 at the College.

NEWCASTLE-UPON-TYNE

9th. Brit.I.R.E. — “High-quality transistor amplifiers” by J. K. Manners at 6.30 at the Institute of Mining and Mechanical Engineers, Westgate.

NEWPORT

30th. Society of Instrument Technology.—“Solid state instrumentation” by P. S. Boden at 6.45 at Newport and Monmouthshire College of Technology, Allt-yr-yn Avenue.

OXFORD

9th. I.E.E.—“Optical masers—how they work and what they do” by Dr. G. W. Wilson at 7.0 at the Demonstration Room, Southern Electricity Board, 37 George Street.

PETERBOROUGH

23rd. I.E.E.—“Steerable radio telescope” by Prof. H. A. Prime at 7.30 at the Angel Hotel.

PORTSMOUTH

16th. I.E.E.—“A magnetic logic airborne digital computer” by C. E. Tate and K. Firth at 6.30 at the College of Technology.

SHREWSBURY

16th. I.E.E.—“Post Office television networks—present and future” by J. B. Sewter and P. J. Edwards at 7.0 at the Music Hall, Shrewsbury. (Joint meeting with the Institution of Post Office Electrical Engineers.)

SURREY

2nd. I.E.E.—“Satellite communications” by J. H. H. Merriman at 7.30 at the Central Electricity Research Laboratories, Leatherhead.

WEYMOUTH

31st. I.E.E.—“Man and ideas in the development of electro-magnetism” by P. Hammond at 6.30 at the South Dorset Technical College.

WHITEHAVEN

17th. Society of Instrument Technology.—“Design problems of data processing systems” by J. K. Beadsmoore at 7.30 at the Lecture Theatre, Whitehaven College of Further Education.

WOLVERHAMPTON

9th. Brit.I.R.E.—“Telemetry and the civil user” by R. H. D. Hardy, G. S. Kermack and A. J. Keeling at 7.15 at Wolverhampton College of Technology.

MAINS CONNECTORS

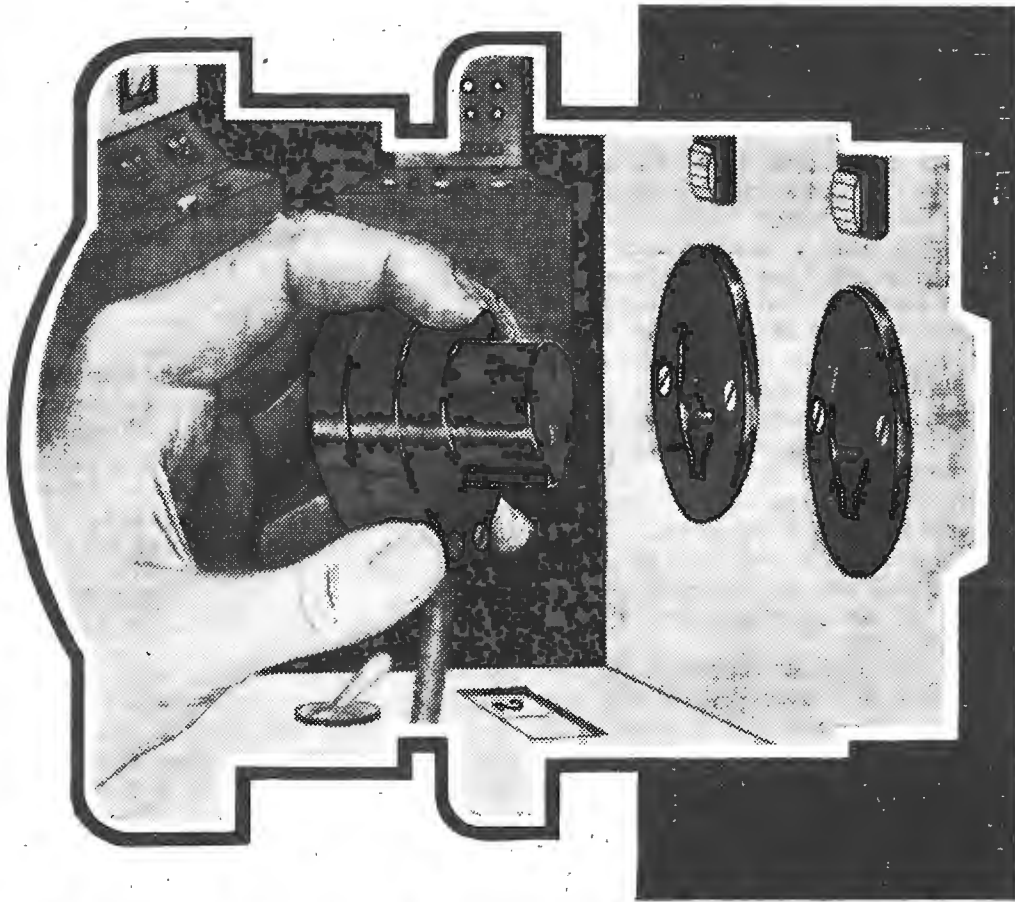

For reliable connection at all times, specify Bulgin Mains Connectors. The design and manufacture of these components, and the intensive research and testing ensures that every model leaving our factory will give perfect mating and electrical performance at all times.

We illustrate on the right two of our extensive range of over 400 varieties.

Our **P.360/SE**, 3 pin, one-hole-fixing model, non-reversible in mating and keyed to fit panels preventing rotation in use; Electrical rating: 1.5A. at 250V.~ and 3A. at 6V.~. Also our **P.74**, 2 pin, model with Electrical rating: 1A. at 500V.~; 5A. at 250V.~ and 7A. at 6V.~.

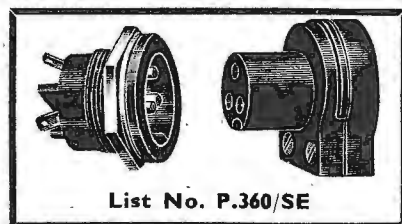

List No. P.360/SE



List No. P.74



Our 188 page technical catalogue, contains illustrations, full working details and dimensions of our entire range of over

10,000 ELECTRONIC COMPONENTS.

Send for your copy to-day quoting reference 203/C. Price 2/6d. post free, or free to trade letterhead or order.

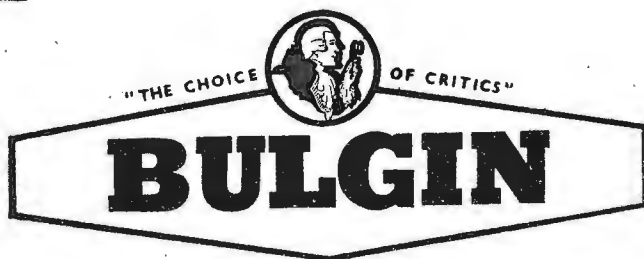

A. F. BULGIN & CO. LTD., BYE-PASS ROAD, BARKING, ESSEX

Telephone: RIPpleway 5588 (12 lines)
1W—122 FOR FURTHER DETAILS.



By "FREE GRID"

Radar & Echar

WE all know that bats use a very effective "acoustic radar" technique in order to avoid colliding with obstacles, and I was interested to notice recently that the reviewer of a new book entitled "The Senses of Animals" mentioned that whales and dolphins use similar principles for finding their way about.

The reviewer used the unqualified word "radar" when talking of the d.f. activities of bats, but later in his remarks he quoted the words of the two authors of the book, who use the term sonar which they define as "the giving out of very short, abrupt bursts of sound which can bounce back as echoes."

The tautologism embodied in this definition distressed me greatly, and I should like to be told in what guise other than that of an echo, a sound could do its bouncing back. After all, the term echo, which is one of the few Greek words which we have taken into our language without modification, means a reflected or bounced-back *sound*, and nothing else.

This makes nonsense of the phrase "radio echoes" sometimes used by people who ought to know better to describe the soundless and, therefore, non-echoic come-back of man-made electromagnetic waves.

The word sonar is an acronym like radar, its letters standing for "SOund Navigation And Ranging." It is used to designate any radar-like system which uses waves in media other than what we, in the days of our ignorance, used to call the ether. Such other media are water in the case of sounding the depths of the sea or locating submarines, etc., and air in the case of bats.

I have always thought that the word echar would have been preferable as its very sound instantly suggests the word echo, and therefore the *modus operandi* of the system. Furthermore the word echar is just as good an acronym as sonar, namely, "Echo-Controlled Homing And Ranging."

But, of course, the word sonar is now well established with the powers that be, and I fully realize that nothing I can say is likely to shift it.

Strictly speaking there is nothing in the word radar which rules out its use to describe the sound-wave technique of bats even though the first "r" in radar is the initial letter of radio. Words like radiate and radia-

tions are often found in the literature dealing with sound waves, and they have the same ancestry as radio.

The word radio is at least two-and-a-quarter centuries old; it was used in the compound word radiometer as early as 1727. This was the name of the instrument then used by surveyors for measuring the angular separation of radii, or in other words, angles. But we must bow to common usage by accepting the word radio as an American synonym for what we call wireless, just as we had to accept the American "radar" as a synonym for our own terms radiolocation and r.d.f.

Defoxing Fuchs' Formula

IN the August issue, I drew attention to a newspaper report from Lisbon which told how a schoolboy had been caught cribbing in an examination by means of a transistor transmitter-receiver. I also mentioned an earlier instance of wireless cribbing, using morse which had been discovered owing to the difficulty of transmitting in morse a long and complex equation which I reproduced in my note in the 28th April, 1938, issue. I expressed the opinion that it would be just as difficult to transmit by telephony as it had been by morse.

However, the Editor confounded me by turning the equation into "morsable" and "phonable" phonetics which he added as a footnote to what I had written in the August issue.

To his immense surprise, and mine also, a letter arrived from Dr. R. C. Chambers, of Bristol University, in which he said that he did not possess a copy of *W.W.* for 28th April 1938, but that from the Editor's phonetics, he had been able to identify the equation. He did indeed identify it accurately as coming from a paper by K. Fuchs entitled "The Conductivity of Thin Metallic Film According to the Electron Theory of Metals" published in Vol. 34, Part 2 (January 1938) of the *Proceedings of the Cambridge Philosophical Society*. I well recall sitting in the early part of 1938 with a file of the *Proceedings* in front of me. I was very struck with this particular equation, and I quoted it as it seemed in its complexity and magnitude to be on a par with the longest word in Welsh, which has 52 letters, and a similar monstrosity in Greek which is over three times as long, having no fewer than 169 letters.

In his letter to me, Dr. Chambers says the fact that I quoted Fuchs' formula "leads me to wonder again who you may be". To the implied question in his remark I can only answer by quoting Mr. Asquith's famous "Wait and See". Maybe he won't have to wait too long as I have been writing this feature in *W.W.* for over 33 years and the Editor has promised to publish all printable biographical details in my obituary notice.

Meanwhile I would point out that as Dr. Chambers has so unerringly defoxed (*le mot juste*) Fuchs' formula from the Editor's phonetics, he ought not to have great difficulty in elucidating my identity by studying the details of my life which were given in "Audio Biographies," by G. A. Briggs which was published in 1961. It is true that the details written there are in a rather esoteric form but should present no difficulty to the initiated, more especially as I gave the latitude and longitude of my dwelling which is still the same; "elementary my dear Watson".

A First-class Fiddle

DURING the latter days of August I managed to get into the British Musical Instruments Trade Fair at the Russell Hotel, London. Among the exhibits were such instruments as electric guitars and a transistor organ, but I was surprised that nobody had produced a special violin for street musicians, whose strident scrapings are often such an offence to the ear. Surely it would be possible to produce a violin with a cunningly concealed door in its belly, through which access could be gained to a miniature battery-driven tape recorder.

The street musician could then put on a tape record—I refuse to use the puerile pleonasm "prerecorded" tape—by Yehudi Menuhin, and then go through the usual motions with his bow over the strings, which would actually have to be made of string to ensure their silence. I feel sure that a street musician equipped with such a Stradivarius would soon have an admiring crowd around him, dropping money into his upturned hat.

Friends have often regarded me as a bit of a fiddler, and so when I retire I might try the idea myself. I shall look forward to seeing such an electronicized (ugh!) fiddle at the next British Musical Instruments Trade Fair.