

RADIO & ELECTRONIC COMPONENT SHOW GUIDE

# Wireless World

JUNE 1963 Price Two Shillings and Sixpence

ELECTRONICS  
RADIO  
TELEVISION

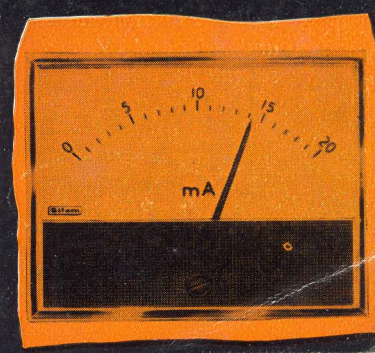
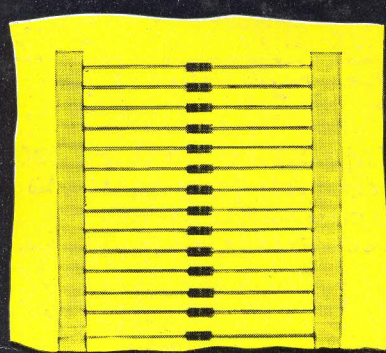
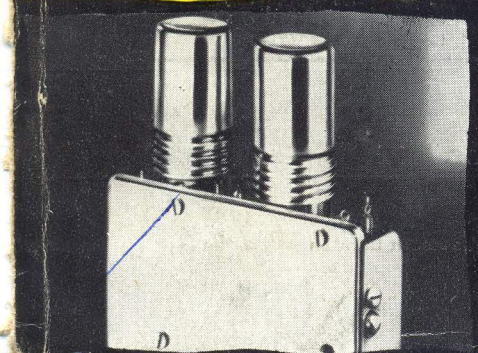
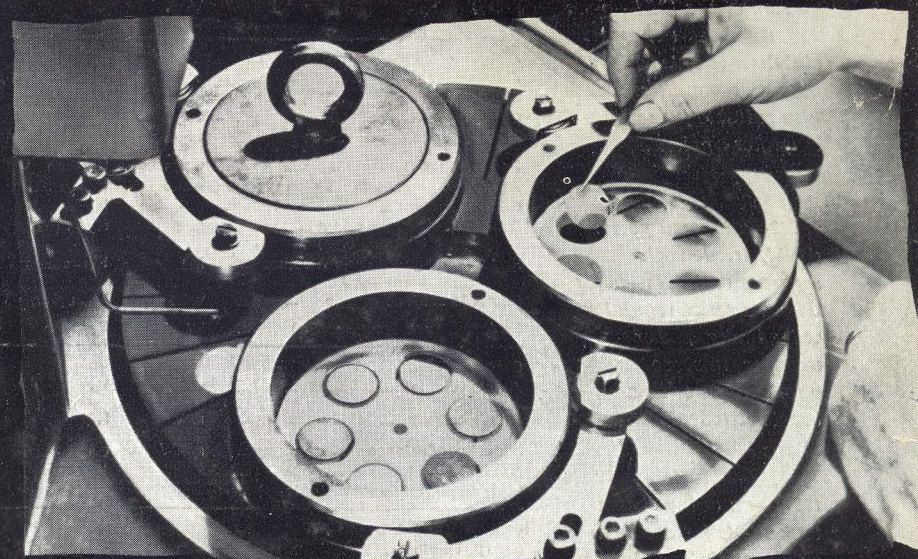
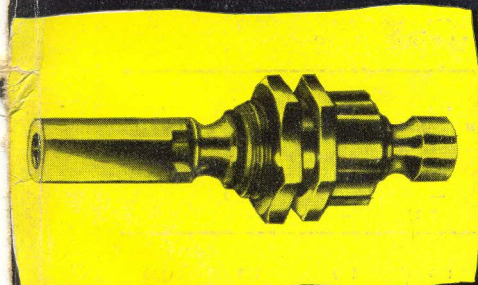
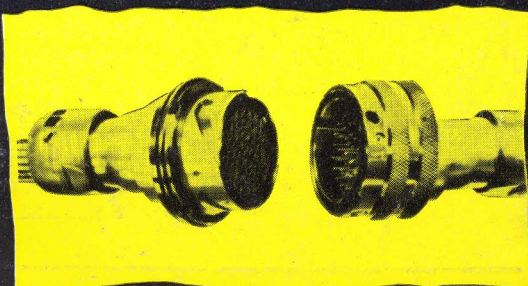
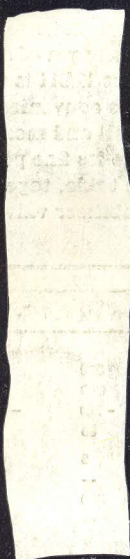
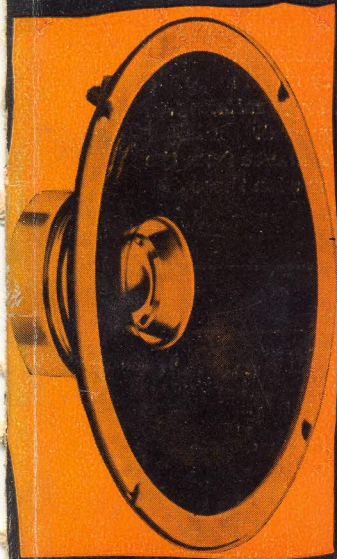
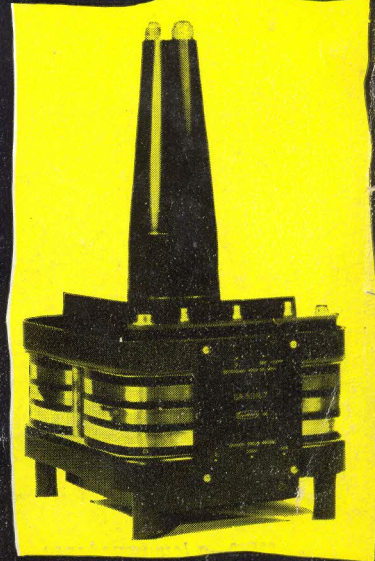
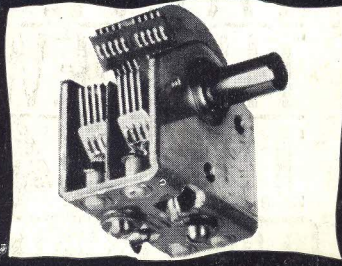
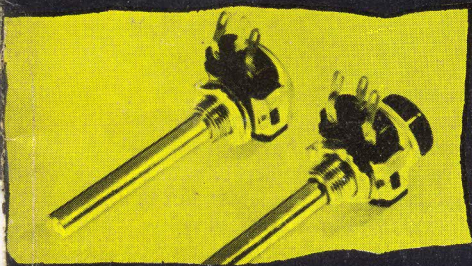

# Wireless World

ELECTRONICS, RADIO, TELEVISION

JUNE 1963

*Editor:*

F. L. DEVEREUX, B.Sc.

*Assistant Editor:*

H. W. BARNARD

*Editorial:*

P. R. DARRINGTON

D. C. ROLFE

D. R. WILLIAMS

*Drawing Office:*

H. J. COOKE

*Production:*

D. R. BRAY

*Advertisement Manager:*

G. BENTON ROWELL

- 255 Editorial Comment
- 256 *Wireless World* Oscilloscope—4
- 262 World of Wireless
- 264 R.E.C.M.F. Show Guide
- 284 News from Industry
- 286 Personalities
- 287 Letters to the Editor
- 292 Semiconductor Integrated Circuits *By G. Bradshaw and C. H. Taylor*
- 295 Some Thoughts on Impedance Functions *By B. J. Austin*
- 297 International Audio Festival 1963
- 300 Transistor High-quality Amplifiers—2 *By R. Osborne and P. Tharma*
- 304 H.F. Predictions—June
- 305 Non-linearity *By "Cathode Ray"*
- 309 Books Received
- 310 Transistor Amplifier Output Stages—6 *By O. Greiter*
- 314 Manufacturers' Products
- 316 Unbiased *By "Free Grid"*
- 318 Televised Carrier Landings

VOLUME 69 No. 6

PRICE: 2s 6d.

FIFTY-THIRD YEAR  
OF PUBLICATION

*Managing Director:* W. E. Miller, M.A., M.Brit.I.R.E.

Iiffe Electrical Publications Ltd., Dorset House, Stamford Street, London, S.E.1

*Please address to Editor, Advertisement Manager or Publisher as appropriate*

©Iiffe Electrical Publications Ltd., 1963. Permission in writing from the Editor must first be obtained before letter-press or illustrations are reproduced from this journal. Brief abstracts or comments are allowed provided acknowledgement to the journal is given.

*PUBLISHED MONTHLY* (4th Monday of preceding month). *Telephone:* Waterloo 3333 (70 lines). *Telegrams:* "Ethaworld, London, Telex." *Cables:* "Ethaworld, London, S.E.1." *Annual Subscriptions:* Home and Overseas, £2 0s. 0d. Canada and U.S.A. \$5.50. Second-class mail privileges authorized at New York, N.Y. *BRANCH OFFICES:* BIRMINGHAM: King Edward House, New Street, 2. *Telephone:* Midland 7191. COVENTRY: 8-10, Corporation Street. *Telephone:* Coventry 25210. GLASGOW: 62, Buchanan Street, C.1. *Telephone:* Central 1265-6. MANCHESTER: 260, Deansgate, 3. *Telephone:* Blackfriars 4412. NEW YORK OFFICE: U.S.A.: 111, Broadway, 6. *Telephone:* Digby 9-1197.

# TEMPERATURE COMPENSATION PROLONGS EFFECTIVE BATTERY LIFE

## *AA129 Bias Stabilising Diode*

**T**HE AA129 Mullard junction diode is now being used in the latest portable radio sets to provide compensation for changes in battery voltage and operating temperature.

In portable receivers, the voltage of the batteries used will decrease with life, and the performance of the sets will deteriorate with this fall in voltage because of an increase in crossover distortion. To ensure good battery life, it is desirable that the receivers should be designed to give acceptable performance when the battery falls to about 50% of the nominal value.

The effect of decreasing battery voltage is accentuated as the operating temperature falls. Acceptable performance at low battery voltages can be achieved directly with most types of audio transistor for temperatures down to about 15°C, but at lower temperatures crossover distortion will become excessive at much higher battery voltages. At 5°C, for instance, the lower limit of battery voltage for acceptable performance is usually about 80% of the nominal. Obviously, therefore,

to extend the battery life, temperature compensation of some form is desirable.

If the AA129 is incorporated in the base-bias network of the output stage of the receiver, the necessary compensation can be achieved. With such an arrangement, the battery voltage can fall well below the 50% limit without the performance of the receiver at extremely low temperatures falling below an acceptable standard. Furthermore, the deterioration at the higher temperatures is also much less. Use of the Mullard bias stabilising diode thus ensures less variation in performance with battery voltage decay at all normally encountered temperatures, and also considerably prolongs the useful life of the batteries in a portable radio.

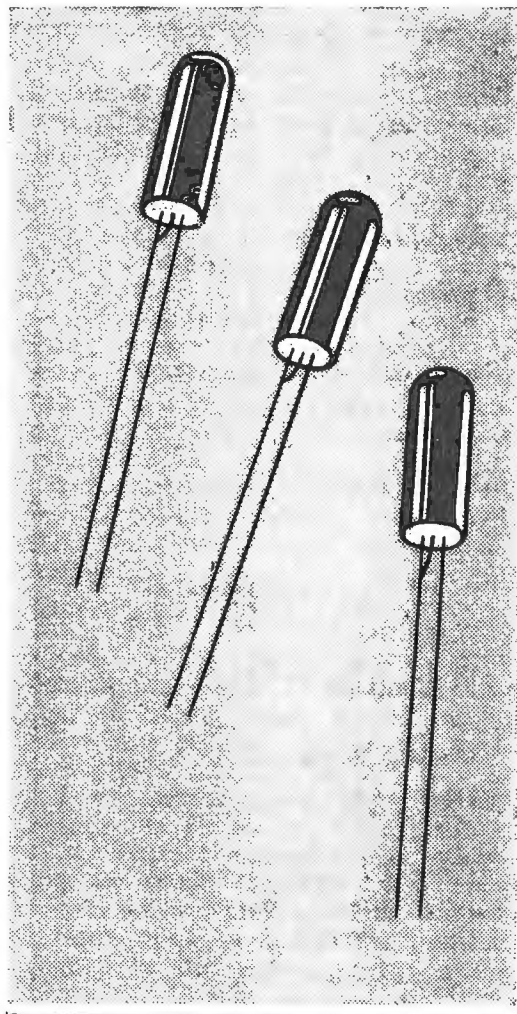

## WHAT'S NEW IN THE NEW SETS

These articles describe the latest Mullard developments for entertainment equipment

## MULLARD TRIODES FOR U.H.F. TUNERS

Mullard have recently introduced two important high-frequency triodes—the PC86 and the PC88—which have been developed specifically for operation in Bands IV and V. The PC88 is designed as a u.h.f. r.f. amplifier, and the PC86 as a self-oscillating mixer. Both valves use frame grids: the accuracy and rigidity of this construction enables a very small spacing to be used

between the anode and grid, so that the necessary high value of mutual conductance is achieved. To reduce grid-lead inductance, the grid of the PC88 is specially connected to five base pins, and that of the PC86 to three. To improve the stability of the PC88 further, the valve capacitances are minimised by the use of a single-sided electrode structure.

## E.H.T. RECTIFIER TYPE DY86

The Mullard DY86 will be encountered in many present-day television receivers. It is a new e.h.t. rectifier on a noval base. The heater voltage of the DY86 is 1.4V, which can be obtained from a single turn on the line output transformer. The new valve is capable of delivering a rectified current of 500 $\mu$ A, the peak cathode current being 40mA. This value of current is ample for modern picture tubes, and results in excellent brilliance and contrast, even in daylight.

The e.h.t. rectifier of a television receiver must be safeguarded from the effects of over-voltage in the e.h.t. winding of the line output transformer. The maximum peak inverse voltage of the DY86 is 22kV. An ample safety margin is thus provided for a design value of e.h.t. voltage of 18kV.

## A Council for Research

THE investigations of the Research Committee of Brit. I.R.E. initiated by Earl Mountbatten and directed to the expansion and better organization of radio and electronics research in Great Britain have now been completed. We have already commented (January 1962 and February 1963 issues) on the progress of this work which is now fully documented in the survey "Radio and Electronics Research in Great Britain," dated April 1963.

The survey reiterates the main conclusions of the interim report of last autumn, namely that the volume of research is gravely inadequate and that there is lack of facility for the exchange of ideas and the co-ordination of effort between the three main categories of research—educational, industrial and defence. Four possibilities for remedying the situation are reviewed in some detail, (1) a new co-operative research organization, (2) expansion of existing research associations, (3) co-ordination and expansion of university research and (4) entire dependence on Government-controlled research.

The time-lag inevitable in building adequate new laboratories and difficulties in raising the necessary capital are considered by the Committee to be factors militating against the first two proposals. The staffing of any large new laboratories would also intensify competition for the services of those grades of qualified scientists of which existing organizations are already in short supply. The Committee has found no desire, as a political issue, to control through Government machinery the co-ordination and application of research in radio and electronics, but it records the willingness of Government departments to undertake research which will be of benefit to industry as well as to those defence requirements which are governed by considerations of security. It endorses unequivocally the proposals for the expansion of university research and in particular any plans which will enable the Government to entrust a larger proportion of research projects to universities. This would provide much needed additional finance for the universities and a broader basis for post-graduate training.

But above all, the fundamental requirement is an agreed plan for the co-ordination of industrial efforts with those of Government so that expansion will be more effective. The Committee strongly recommends in the following terms the formation of:—

### "The Radio and Electronics Research Council

*Constitution.* The constitution of such a Council is of paramount importance if really worthwhile decisions are to be taken. The Council should comprise representatives of top level management in the manufacturing industry, Chief Scientists of Government departments controlling research establishments and of user Minis-

tries including the Defence Services, as well as representatives from the Universities.

*Rotation of Membership of Council.* Careful planning would be required to prevent such a Council becoming numerically unwieldy. Further, it would be essential to provide for appropriate rotation of membership if new thought is constantly to be introduced.

*Working Parties.* The Council would be dependent on Working Parties of experienced scientists and engineers charged to report on specific topics. Special arrangements for a Working Party dealing with security matters are proposed.

*The Scope of Council Activities.* The Council should be in a position not only to review the recommendations of the Working Parties but also to implement their recommendations, and to secure that these Working Parties are constituted of the *very best talent in the country.*

In order to consider the most immediate way of securing an expansion of radio and electronics research the Council will require close liaison with existing sponsoring bodies, namely the University Grants Committee, the Department of Scientific and Industrial Research, and the Ministry of Aviation.

In the opinion of the Brit. I.R.E. Research Committee, the first enquiry of the Council should commence with an examination of the immediate results to be obtained from better utilization of University facilities."

We hope and expect that this Council will be formed. It must not be allowed to degenerate into one of those committees of which it has been said that the members, though individually incapable of making any decision, are capable collectively of deciding that nothing can be done. First and foremost the success of the project will depend upon the quality of the Working Parties. If their output is comparable with that of, for example, the Working Parties within the European Broadcasting Union, the Council will be well served.

Of the proposed Council itself we have one comment to make. While acknowledging the virtue of flexibility in its constitution we question *rotation* as the best means of making changes. It would be disastrous if, after forming a Council of acknowledged authority and good judgment, it should be changed merely for the sake of giving equality of prestige to individual firms or departments. Equality of participation will be achieved and unwieldiness avoided if the members of the Council are selected by the votes of their compeers on the basis of their known ability (which will, of course, include a capacity for continuous new thought). New ideas—the results of inspiration or enthusiasm—will no doubt be supplied to them from all quarters in copious measure. The Council's contribution must be a unique and sound assessment of value, and the power to get things done.

# Wireless World

## OSCILLOSCOPE

WE are now at the stage where signals are provided for the deflection of the spot in both directions, but the horizontal signal needs amplification. As a matter of fact, the output of the "No. 1" timebase unit would normally be sufficient to drive the tube directly. Future timebase units, however, will produce a much smaller output and will need amplification; the output of the present unit is therefore attenuated to "fit" the amplifier.

The amplifier used is of the same type as the "No. 1" y amplifier—a long-tailed pair. Two EF184's are used to give sufficient gain at a wide bandwidth, and shift and gain controls are as before. A rather puzzling feature of the timebase circuit

shown last month can now be explained. The aimless-looking 100kΩ resistor connected from P8 to earth is now seen to be the "bottom" part of the x shift chain. In future timebase units this resistor will be replaced by a calibrated variable resistor to show time.

The long-tailed pair type of amplifier has one feature which has not yet been fully exploited, namely, that if the input is more than the amplifier can take, it overloads cleanly at each "end" and the part of the signal between the overload points is reproduced without distortion as in Fig. 1. This process is known as "windowing," and it enables us to make an expanded timebase without going to

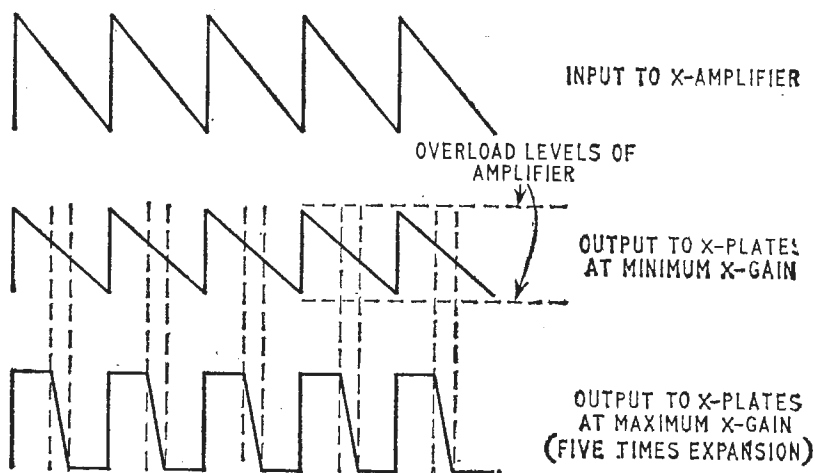

Fig. 1. Windowing in x amplifier provides expanded-trace working. Overloading at ends of trace are outside screen area and cause no trouble.

Fig. 2. Complete diagram of x amplifier. Crosses show lead-through insulators.

### X AMPLIFIER COMPONENT LIST

|                 |                    |                          |    |
|-----------------|--------------------|--------------------------|----|
| R <sub>1</sub>  | 10kΩ               | ±10%                     | 1W |
| R <sub>2</sub>  | 47Ω                | "                        | ½W |
| R <sub>3</sub>  | 15kΩ               | "                        | 3W |
| R <sub>4</sub>  | 6.8kΩ              | "                        | 3W |
| R <sub>5</sub>  | 15kΩ               | "                        | 2W |
| R <sub>6</sub>  | 47Ω                | "                        | ½W |
| R <sub>7</sub>  | 15kΩ               | "                        | 3W |
| R <sub>8</sub>  | 10kΩ               | "                        | 1W |
| R <sub>9</sub>  | 2.2MΩ              | "                        | ½W |
| R <sub>10</sub> | 2.2MΩ              | "                        | ½W |
| R <sub>11</sub> | (in Timebase Unit) |                          |    |
| VR <sub>1</sub> | 10kΩ               | linear (mounted on case) |    |
| VR <sub>2</sub> | 1MΩ                | linear (mounted on case) |    |
| C <sub>1</sub>  | 0.1μF              | 350V                     |    |
| C <sub>2</sub>  | 0.1μF              | 350V                     |    |
| C <sub>3</sub>  | 0.1μF              | 350V (mounted on case)   |    |
| V1              | EF 184             |                          |    |
| V2              | EF 184             |                          |    |

1 Miniature tagboard, 9-way (Radiospares)  
 1 Tag Strip, 28-way (Radiospares)  
 4 Type P491 Domina connectors (Bulgin)  
 Lead through insulators "Lektrokit"

All components specified should be obtained through retailers. It is inconvenient for manufacturers to supply single items.

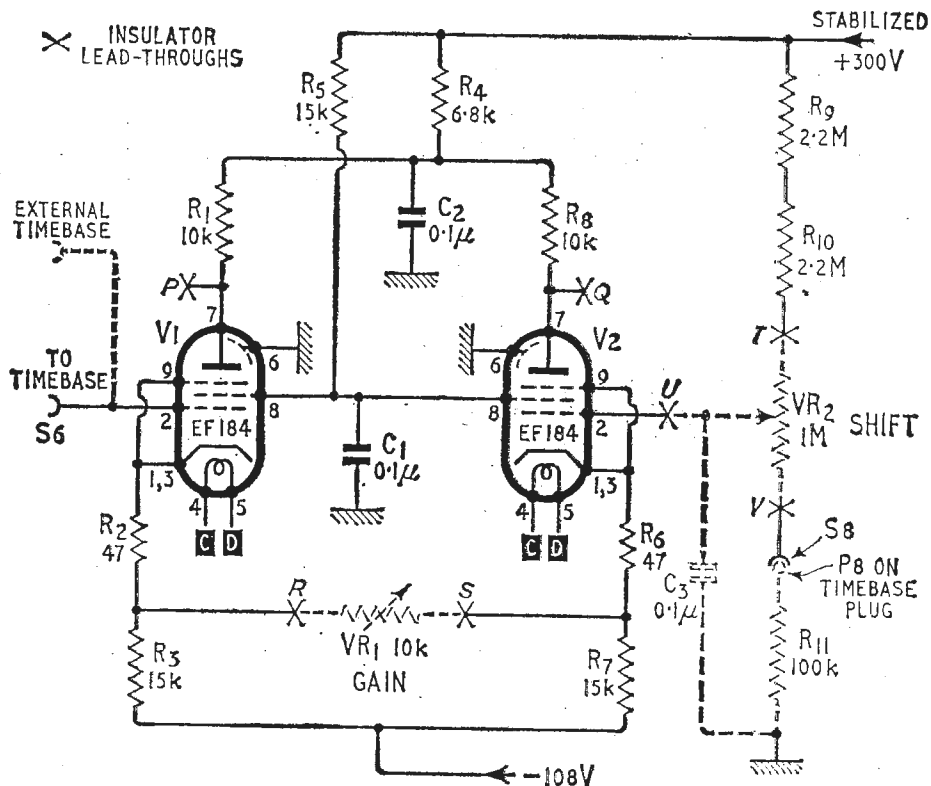

# 4.—X AMPLIFIER TRIGGER STAGE AND POWER SUPPLY

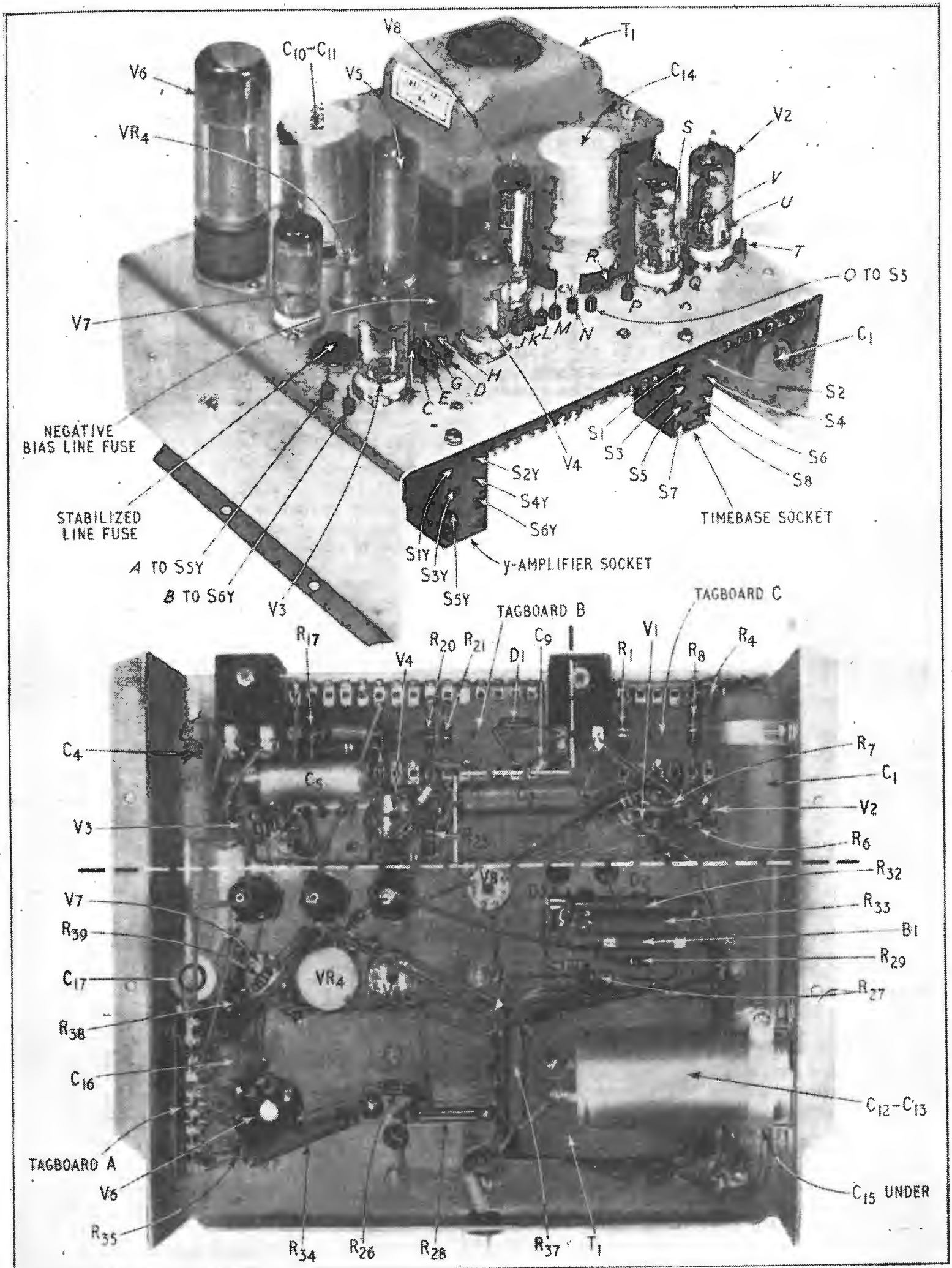

the trouble of kinking the sweep waveform or using a separate circuit. The expansion control is merely the counterpart of the  $y$  gain control and has no connection with the sweep generator. With the gain control at maximum, the timebase is expanded about five times.

Direct coupling is used, as slow sweeps of about 10 seconds are used in timebases to be described later. The input of the  $x$  amplifier is only slightly above earth potential, so that external inputs will not require a blocking capacitor. In an article to appear later, the use of the external  $x$  input for frequency measurement, etc., will be described.  $R_5$  and  $R_6$  in Fig. 2 are negative feedback resistors, inserted to allow the use of high value anode resistors, while still retaining a sufficiently wide bandwidth.

### Trigger Stage

To synchronize or trigger the timebase generator, it is necessary to inject a signal from the  $y$  amplifier, preferably at a selected level. This is easier and more definite in operation if, instead of relying on the  $y$  signal itself to synchronize the timebase, it is first converted into constant width, sharp pulses. In a triggered sweep, it is almost essential to do this to avoid small changes in the point of "firing," which result in successive traces not being exactly superimposed—i.e. jitter. The simplest way of arranging this is to use the ubiquitous Schmitt trigger circuit, fed with the amplified  $y$  signal. A general diagram is shown in Fig. 3. Starting conditions can be assumed as  $V1$  cut off and  $V2$  conducting fully.  $V1$  grid is now taken in a positive direction by the input and as it approaches the voltage on the common cathode,  $V1$  begins to conduct. Its anode voltage decreases and drives  $V2$  grid in a negative direction, cutting off  $V2$ . The common cathode voltage falls, driving  $V1$  further into conduction, and  $V2$  further into the negative grid region, and this trigger action ends with  $V1$  anode low,  $V2$  anode high. The circuit is bi-stable, which means that this state of affairs continues until the reverse situation is dictated by the input grid. Comparatively slow rises and falls of the input signal have now been converted into sudden steps, which are ideal for shaping into pulses.  $VR_1$  adjusts the level at which the trigger action takes place and is therefore called "TRIG. LEVEL."  $C_1$  is included to avoid attenuation of the high-frequencies contained in the step: it is almost always found in directly coupled toggles and flip-flops and is variously called a "speed-up" or "h.f. compensation" capacitor. Some rather vulgar people have been known to use the term "fiddle  $C_1$ ," because in high-frequency toggles (more than about 10Mc/s input) it is a trimmer capacitor.

Turning to the circuit diagram (Fig. 4) it is seen that two more stages are included.  $V3a$  is cathode follower, or to use Short's\* term, "bootstrap follower," which is solely a buffer stage to prevent feedback of switching transients from the trigger circuit to the  $y$  deflection plates. This valve being half a double triode, there is now a spare triode and  $V3b$  is used to give a little extra gain to the trigger input. The timebase will synchronize with a screen deflection of less than half one screen division.

Some explanation is required of the two switches  $S_{wb}$  and  $S_{wa}$  which are ganged and perform the

\* The "Bootstrap Follower" G. W. Short, January 1961.

function of trigger selector.  $S_{wb}$  selects the triggering source, while  $S_{wa}$  determines the polarity. To define this more clearly, consider Fig. 5, which is a drawing of the front panel control. In the position marked "HF," the  $y$  signal is taken straight from the anode of  $V_{3b}$  to the timebase, where synchronizing takes place. This is for use with signals of about 1.5Mc/s upwards, where control of triggering level is not required. (To make the Schmitt work faster than 1.5 Mc/s would entail greater expense, and it was decided not to try.) The next two positions are for use with external signals, so that the timebase is triggered by an outside source, and the last two positions are for normal use, that is, for signals derived from the  $y$  input up to about 1.5Mc/s. The output to the timebase generator is taken from either anode of the trigger stage,  $V_1$ , the appropriate one being selected by  $S_{wa}$ . After the rectangular waveform has been differentiated by  $C_6$  and  $R_{25}$ , the resulting spikes are decapitated by  $D_1$ , which lets only the negative-going spike through to the timebase generator.  $VR_3$  is the "Trig. level" control, and to avoid having long grid leads, it is inserted at the "bottom" end of the chain.

### Power Supply

The requirements of the main power supply are that it should provide stabilized and unstabilized h.t. for the other sections, a stabilized negative line and heater supplies. Extra-high tension for the cathode-ray tube is obtained from a stabilized oscillator which will be described in next month's final oscilloscope constructional article.

All supplies are derived from a single transformer. To take the negative line first, this is taken from one half of the centre-tapped h.t. secondary winding, half-wave rectified and RC-smoothed. The output is then held at  $-108V$  by the neon shunt stabilizer  $V8$  in Fig. 7. The Brimistor  $B_1$  is needed to limit the initial surge of current through  $V8$  when the instrument is first switched on. The positive lines are taken from a thermionic rectifier, which takes a

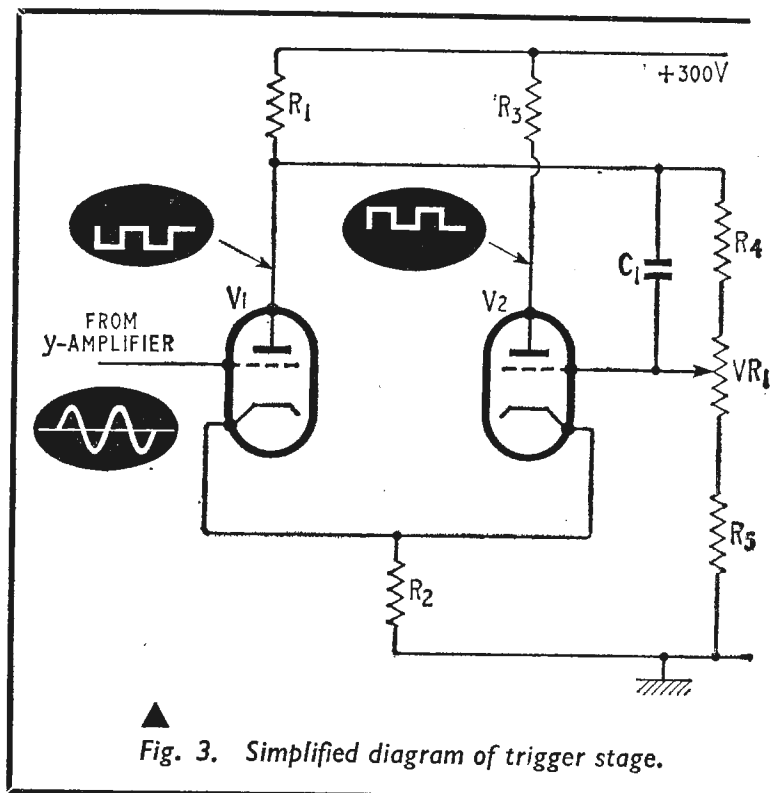

Fig. 3. Simplified diagram of trigger stage.

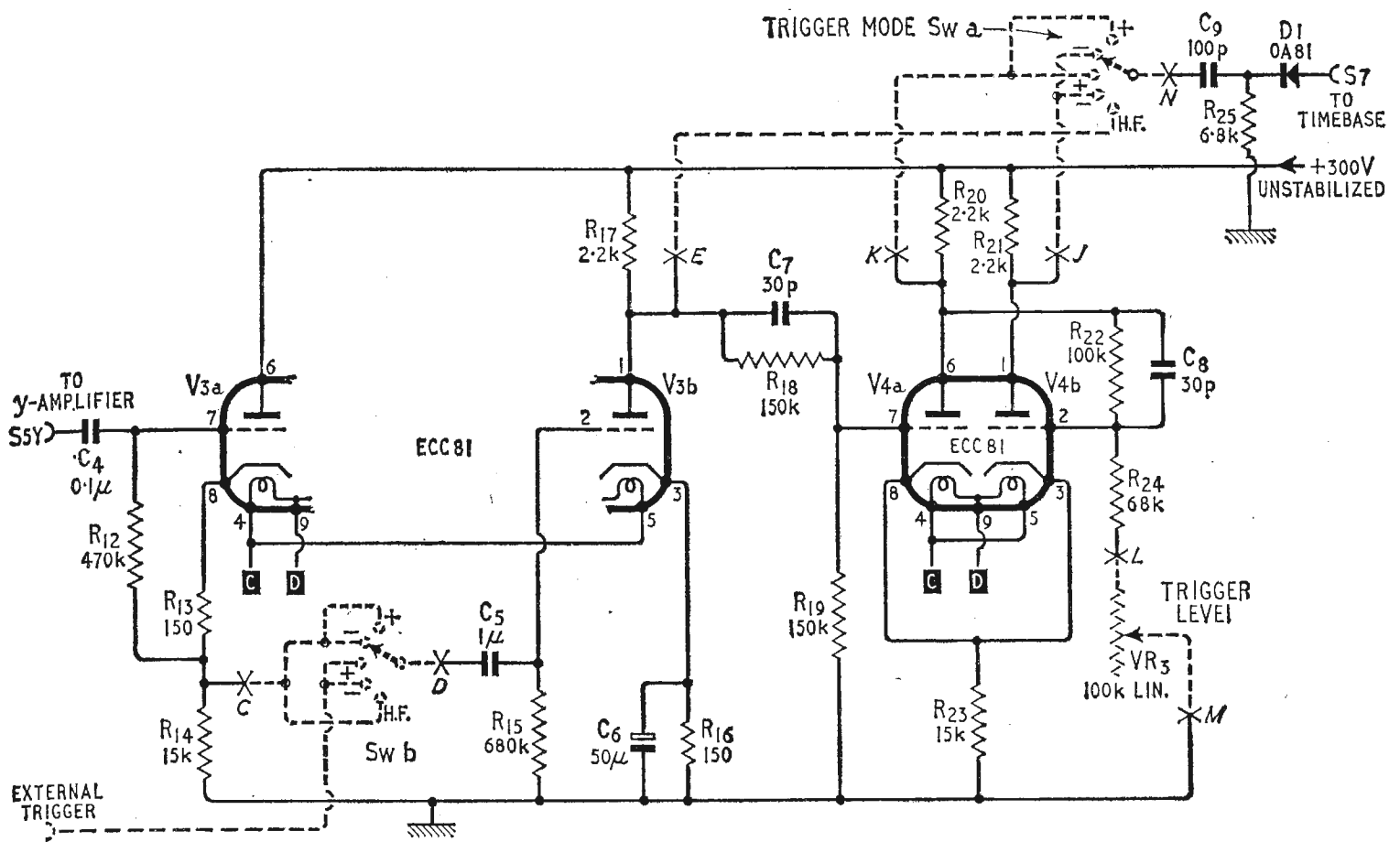

Fig. 4. Final circuit of trigger. Switches are mounted outside main chassis, and will be shown when main frame is described. Crosses indicate lead-throughs.

**TRIGGER STAGE COMPONENT LIST**

|                 |       |      |    |                 |                |                      |                   |   |
|-----------------|-------|------|----|-----------------|----------------|----------------------|-------------------|---|
| R <sub>12</sub> | 470k  | ±10% | ½W | R <sub>24</sub> | 68kΩ           | ±10%                 | ½W                | 4 Type P491 Domina connectors (Bulgin)<br>Miniature tag panel 18 way—(Radiospares)<br>2-pole, 5-way, "Maka-switch" (Radiospares) (mounted on case)<br>All components specified should be obtained through retailers. It is inconvenient for manufacturers to supply single items. |
| R <sub>13</sub> | 150Ω  | "    | ½W | R <sub>25</sub> | 6.8kΩ          | "                    | ½W                |   |
| R <sub>14</sub> | 15kΩ  | "    | 1W | VR <sub>3</sub> | 100kΩ          | linear               | (mounted on case) |   |
| R <sub>15</sub> | 680kΩ | "    | ½W | C <sub>4</sub>  | 0.1μF          | 350V                 |                   |   |
| R <sub>16</sub> | 150Ω  | "    | ½W | C <sub>5</sub>  | 1μF            | 250V                 |                   |   |
| R <sub>17</sub> | 2.2kΩ | "    | ½W | C <sub>6</sub>  | 50μF           | 25V                  |                   |   |
| R <sub>18</sub> | 150kΩ | "    | ½W | C <sub>7</sub>  | 30pF ±5%       | 350V Salford Type PF |                   |   |
| R <sub>19</sub> | 150kΩ | "    | ½W | C <sub>8</sub>  | 30pF ±5%       | 350V Salford Type PF |                   |   |
| R <sub>20</sub> | 2.2kΩ | "    | ½W | C <sub>9</sub>  | 100pF ±5%      | 350V Salford Type PF |                   |   |
| R <sub>21</sub> | 2.2kΩ | "    | ½W | D <sub>1</sub>  | OA81           |                      |                   |   |
| R <sub>22</sub> | 100kΩ | "    | ½W | V <sub>3</sub>  | ECC81 or 12AT7 |                      |                   |   |
| R <sub>23</sub> | 15kΩ  | "    | 1W | V <sub>4</sub>  | ECC81 or 12AT7 |                      |                   |   |

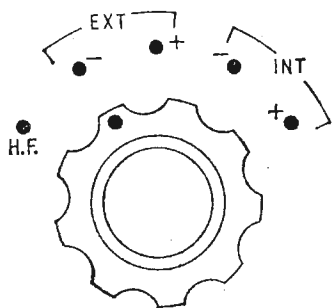

Fig. 5. View of trigger selector legend.

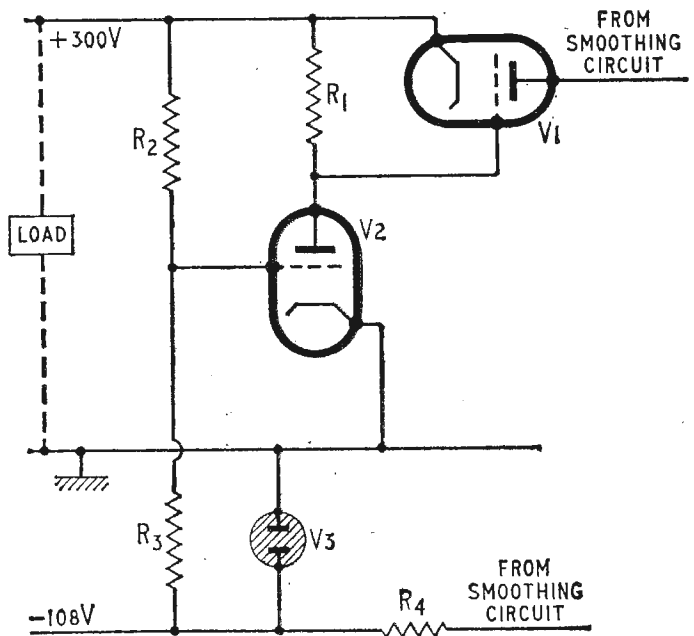

Fig. 6. Essentials of stabilizer.



little time to warm up, during which time the voltage across V8 is not dropped sufficiently by R32 and R33. As the valves begin to take current, B<sub>1</sub> heats up, its resistance decreases and V8 works normally.

The positive line at 300V is stabilized by the combination of V6 and V7, in Fig. 7. The circuit is shown diagrammatically in Fig. 6. The 300V h.t. supply is stabilized against both mains and load changes and the ripple voltage is extremely low. The operation is quite easy to follow, and neglecting side issues goes as follows. Imagine that the load demands more current. In the absence of a stabilizer, the increased current would drop more volts across the smoothing circuit, rectifier and transformer resistance and the output voltage would fall. What is needed is a variable resistor, in series with the output. A dedicated gremlin could then be trained to vary the resistance to exactly the right value to keep the output voltage constant in spite

of load variations. Gremlins being what they are, it has been found a little more reliable to use valves, and in the diagram V1 is the variable resistor, while the gremlin's function is taken over by V2. If the output tries to fall, this fall is fed, via the potentiometer R<sub>2</sub>, R<sub>3</sub> to V2 grid. The current through V2 decreases, the anode voltage increases, and so does the grid voltage of V1, which thereby decreases in resistance. The output voltage cannot be kept absolutely constant by this means, as there must be a slight variation to enable the amplifier V2 to work, but the variation can be such that if the whole stabilizer were replaced by a fixed resistor, the value would be only a fraction of an ohm. As regards mains input variation, it is usual to express the stability in terms of the ratio percentage mains variation/percentage output variation. Figures of several hundred to one are commonplace, and 1,000:1 is not extraordinary.

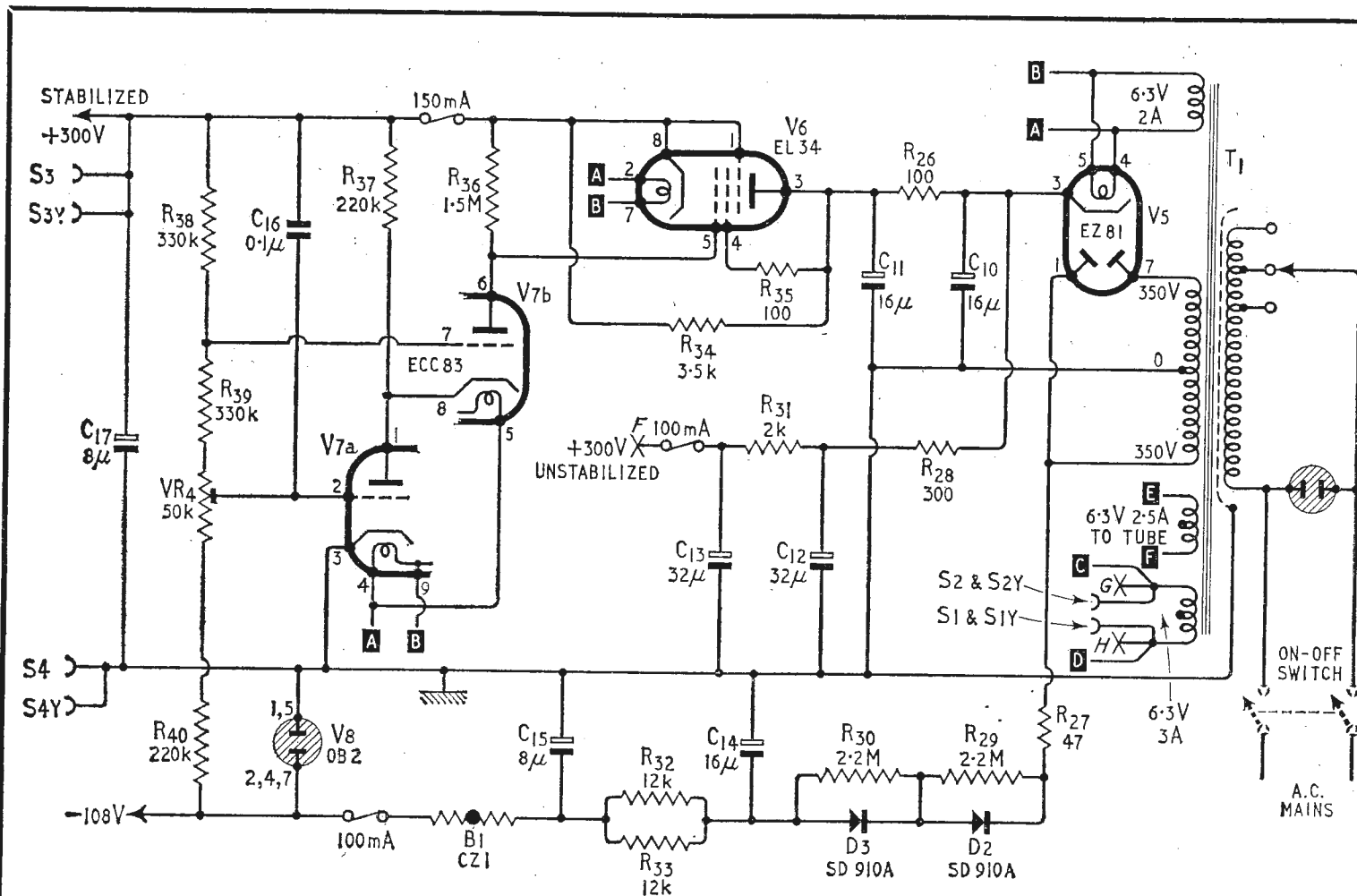

▲ Fig. 7. Power supply circuit diagram.

**POWER UNIT COMPONENT LIST**

|                 |       |      |     |                 |                |                           |    |   |   |
|-----------------|-------|------|-----|-----------------|----------------|---------------------------|----|---|---|
| R <sub>26</sub> | 100Ω  | ±10% | 2W  | R <sub>40</sub> | 220kΩ          | ±10%                      | ½W | D2  | SD910A (International Rectifier)  |
| R <sub>27</sub> | 47Ω   | "    | ½W  | VR <sub>4</sub> | 50kΩ           | linear                    |    | D3  | SD910A  |
| R <sub>28</sub> | 300Ω  | "    | 3W  | C <sub>10</sub> | 16+16µF        | 500V                      |    | "Heavy Duty Mains Transformer"—(Radiospares) or equivalent 350-0-350V at 150mA, 6.3V 2A, 6.3V 2.5A, 6.3V 3A. Panel Neon Indicator (Radiospares) |   |
| R <sub>29</sub> | 2.2MΩ | "    | ½W  | C <sub>11</sub> |                |                           |    |   | All components specified should be obtained through retailers. It is inconvenient for manufacturers to supply single items. |
| R <sub>30</sub> | 2.2MΩ | "    | ½W  | C <sub>12</sub> | 32+32µF        | 500V                      |    |   |   |
| R <sub>31</sub> | 2kΩ   | "    | 10W | C <sub>13</sub> |                |                           |    |   |   |
| R <sub>32</sub> | 12kΩ  | "    | 10W | C <sub>14</sub> | 16µF           | 500V (insulated mounting) |    |   |   |
| R <sub>33</sub> | 12kΩ  | "    | 10W | C <sub>15</sub> | 8µF            | 500V                      |    |   |   |
| R <sub>34</sub> | 3.5kΩ | "    | 5W  | C <sub>16</sub> | 0.1µF          | 350V                      |    |   |   |
| R <sub>35</sub> | 100Ω  | "    | 1W  | C <sub>17</sub> | 8µF            | 500V                      |    |   |   |
| R <sub>36</sub> | 1.5MΩ | "    | ½W  | V <sub>5</sub>  | EZ81           |                           |    |   |   |
| R <sub>37</sub> | 220kΩ | "    | ½W  | V <sub>6</sub>  | EL34           |                           |    |   |   |
| R <sub>38</sub> | 330kΩ | "    | ½W  | V <sub>7</sub>  | ECC83 or 12AX7 |                           |    |   |   |
| R <sub>39</sub> | 330kΩ | "    | ½W  | V <sub>8</sub>  | OB2            |                           |    |   |   |

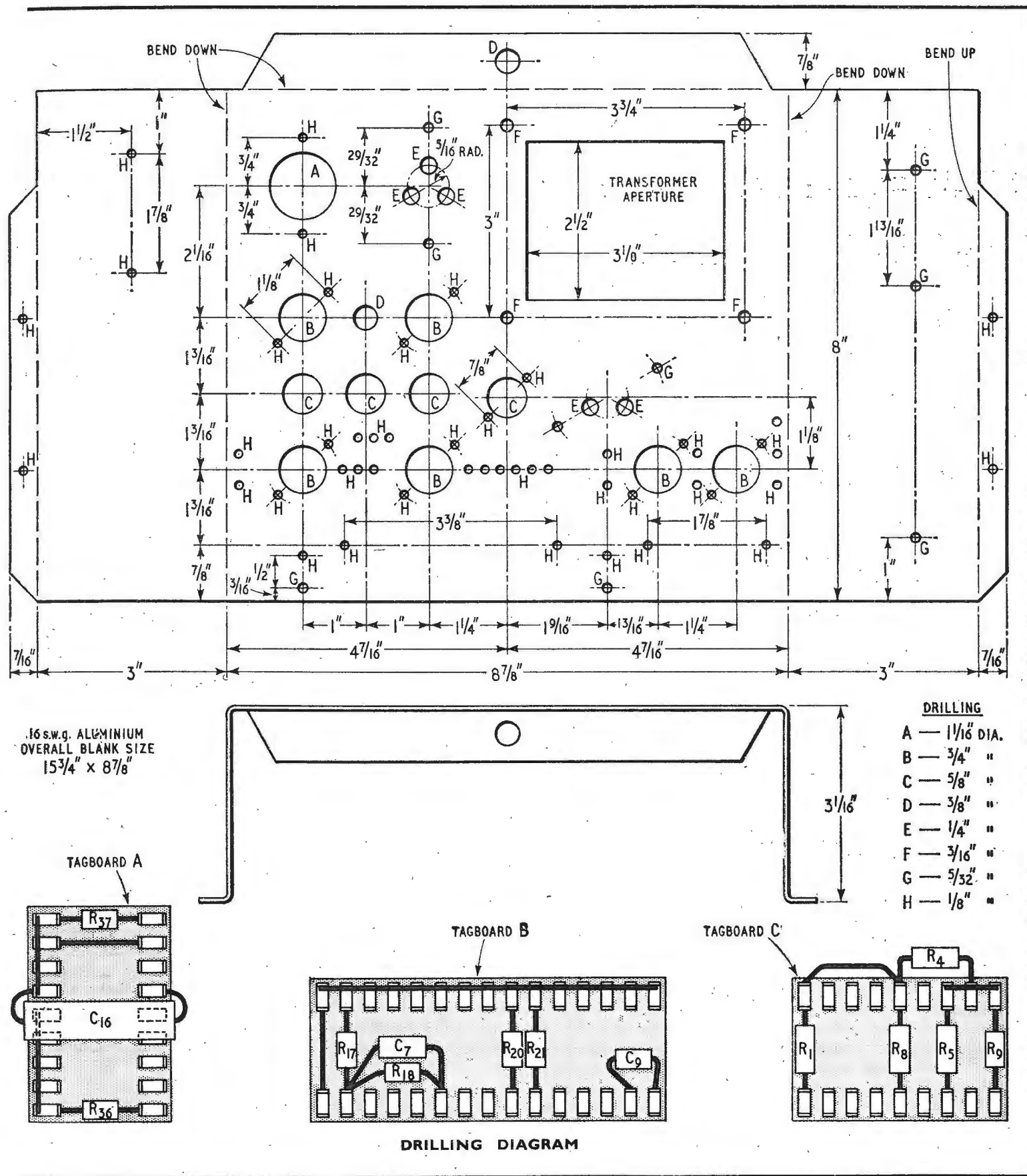

Turning now to the complete circuit diagram, Fig. 7, several variations need explanation. The shunt amplifier V7 is transformed into a cascode amplifier, which, while employing no more components, gives a much higher gain than the pentode which is normally used in this application. C<sub>16</sub> is connected across the "top" part of the potentiometer feed to V7 grid in order to provide a lower impedance path for rapid fluctuations of the output. The stabilizer then helps to remove ripple and noise from the output as well as slow variations. C<sub>17</sub> is additional smoothing which takes over where the stabilizer finishes at a few kilocycles. R<sub>34</sub> is a by-

pass resistor across the series valve V<sub>6</sub>, its function being to pass current in excess of the abilities of V<sub>6</sub>. The provision of this resistor means a slight reduction in regulation, but this is still adequate. A separate, unstabilized 300V supply is taken off before V<sub>6</sub> to feed the trigger stage and e.h.t. unit, neither of which requires stable supplies.

In all these circuits, the dotted leads are external to the unit, and will be shown fully in the final part.

In next month's article, we will deal with the design and construction of the e.h.t. and tube circuit, final assembly and calibration.

# WORLD OF WIRELESS

## Radio Show 1964

THE date of the thirtieth British National Radio and Television Exhibition has now been announced. It will be held at Earls Court, London, from August 26th to September 5th, 1964. The organizers, Radio Industry Exhibitions Ltd., also announce that it will again be an annual event and that they have reserved accommodation at Earls Court for several years. It will be noted that the exhibition still carries the title "national" despite the overtures both from manufacturers in this country and from the Continent for reciprocal "international" shows.

## Technician Engineers

THIS term has been used by the I.E.E. in a report of the Joint Committee on Practical Training in the Electrical Engineering Industry. The term has been accepted by the Conference of Engineering Societies of Western Europe & the U.S.A. and the Commonwealth Engineering Conference and is used in the report to describe those "skilled in the application of engineering techniques in a specific field" as opposed to the professional engineer who "applies the scientific method in a wider context." In other words the technician engineer comes between the craftsman and the professional engineer. The I.E.E. report, which costs 1s, is intended to serve as a guide to those who are concerned with the education and training of electrical technician engineers. At present there is no organization which caters specifically for the increasingly large number of men in this category and while the I.E.E. itself cannot take them under its wing it is apparently prepared to foster their recognition as engineers provided that the term is appropriately qualified.

## Naval Officer Entrants

AS a result of the growing complexity of apparatus, new entry regulations for electrical and electronic specialists are being introduced for qualified men between 21 and 39 years of age. Officer entrants will be given seniority "credits" on entry based on their previous experience in outside industry and additional seniority for their academic qualifications. As an example, a man who qualifies for no "credits" will enter as a Sub-Lieutenant and will remain so for 18 months. An officer who qualifies on entry for the maximum 8-years' "credits" will come into the Navy as a Lieutenant with 6½ years' seniority.

Under the new scheme for Electrical Specialization, candidates will be accepted provided that they have one of three basic qualifications; a degree or degree equivalent in electrical engineering—or in science with suitable engineering subjects; graduate membership of the I.E.E. or of the Brit.I.R.E.; or possession of a Higher National Diploma or equivalent in electrical subjects. Before joining the Fleet they will do up to a year's training at Naval Electrical Schools. Lieutenants will be eligible for promotion to Lieutenant Commander on gaining 8-12 years' seniority (for which the new "credit" system of outside experience will count). Further promotion will be by selection.

## Birmingham Radio Tower

A NEW 500ft radio tower is to be erected in Birmingham, to replace the 170ft lattice mast on the roof of Telephone House. It will be the focal point in Birmingham for microwave links carrying public telephone

Model of the new Birmingham 500ft radio tower. It is to be built in Lionel Street and forms part of Post Office development; bounded by Newhall Street, and Lionel Street. The design of the tower is the work of the Chief Architect's Division of the Ministry of Public Building and Works. Work is to begin this summer and it is expected to be completed by the end of 1965.

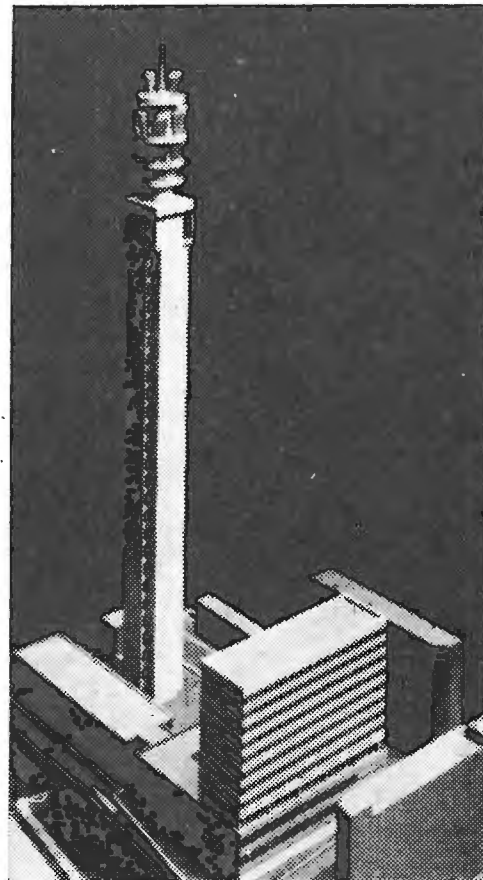

trunk circuits and television programmes, and will be able to handle about 150,000 simultaneous telephone conversations or 40 television channels. The tower will be used to relay programmes between the studios, control centres and transmitters in the Birmingham area and as an inter-city link.

Four circular galleries, of 40ft diameter, are sited at the top of the tower allowing aerials to be oriented in any direction. Vertical waveguides from the aerials are brought to a branching chamber, 40ft square, immediately below the galleries where they are distributed through ducts to the 24 equipment floors below. The tower, which has a total weight of 6,000 tons, is to be constructed in "L"-shaped reinforced concrete segments and is to rest on a truncated pyramidal base, some 90ft square. A model of the proposed tower is on display at the Royal Academy's Summer Exhibition.

## Mobile 625-line TV Test Station

TO give dealers and the general public in areas outside the range of present B.B.C. u.h.f. test transmissions an opportunity of satisfying themselves that the dual-standard receivers now on sale "will actually receive" 625-line pictures on u.h.f., Pye have equipped a mobile transmitter from which test transmissions of about a week's duration will be made (under G.P.O. licence) in a number of towns in the Midlands and the North. The u.h.f. (625-line signal) will be on Channel 39 (614-622 Mc/s) and will have a power of 100 watts. The articulated vehicle contains in addition to the transmitter a small studio from which live talks may be given, using a small industrial camera chain.

The next radio amateurs' examination has now been fixed for 13th December. Particulars may be obtained from the City and Guilds of London Institute, 76 Portland Place, London, W.1.

**EUROCAE.**—As a result of a meeting in Lucerne of some 30 European manufacturers of civil aviation electronic equipment an association, to be known as the European Organization for Civil Aviation Electronics, has been formed. Its aims include the study on an international level of "technical problems facing users and manufacturers of electronic equipment for civil aviation" and to "advise and assist . . . in the establishment of international standards. The work of the organization will be controlled by a steering committee on which there are three U.K. representatives—Dr. B. J. O'Kane (Marconi's), who is chairman, C. A. Bell (G.E.C.) and M. Settelen (S.T.C.). Ten of the 23 founder members are U.K. companies.

**I.E.E. Educational Standards.**—The Institutions of Electrical, Mechanical, Civil and Municipal Engineers have announced that the educational requirements for admission to student membership are to be raised. The new standard comes into effect on 1st September and in place of the four G.C.E. "O" levels, two "A" levels will be required, in physics and either pure or applied mathematics, plus three other subjects at "O" level, one of which must be English.

**Board of Trade.**—Japanese valves, including c.r. tubes, have now been freed from licensing restrictions when imported into the U.K. However, the import of semiconductors, transistor radio and television receiving apparatus and components is still controlled. Under the provisions of the Anglo-Japanese Commercial Treaty, which came into effect on 4th May, £200,000 of semiconductors, £500,000 of transistor radio reception apparatus (half of which will cover components and component parts), and £225,000 of transistor television receivers may be exported to the U.K. annually.

**B.R.E.M.A.**—Manufacturers' radio and television receiver despatches (including radiograms) during the first quarter of 1963 were up on the same period in the previous two years. These estimates, made by the British Radio Equipment Manufacturers' Association, show that the despatches to the home trade (with the 1962 figures in brackets) were 612,000 radio receivers (546,000), 45,000 radiograms (32,000) and 367,000 television receivers (297,000). These figures include those supplied to specialist rental and relay companies.

**The B.B.C. experimental 625-line,** Channel 44, transmissions are being relayed by Multisignals over their wide-band network at Luton. The signals are converted to a frequency of 61.75Mc/s for vision and 67.75Mc/s for sound; one of the Channels agreed with B.R.E.M.A. for 625-line relay. The aerial used is a nine-element Yagi mounted on a 95ft tower on Farley Hill, Luton.

**Battery Symposium.**—The fourth biennial symposium on batteries will be held in Brighton in October 1964. Again organized by the Inter-departmental Committee on Batteries (which co-ordinates research in Government establishments and in industry) it will last for three days but the actual dates have not yet been announced. Offers of papers are required by the secretary, D. H. Collins, Electrical Department, Admiralty Engineering Laboratory, West Drayton, Middlesex, by June 30th with a synopsis by the end of the year.

**Interplas,** the International Plastics Exhibition, where there will be some 350 exhibitors, opens at Olympia, London, on 12th June for 10 days. At the convention to be held on three days (17th-19th) during the exhibition, a wide range of subjects will be covered. Admission to both the exhibition and convention is by ticket obtainable free from the sponsors, *British Plastics*, Dorset House, Stamford Street, London, S.E.1.

**Broadcast Receiving Licences.**—There was an increase in combined television and sound licences of 211,819 in the first quarter of this year compared with the final quarter of 1962, bringing the figure up to 12,442,806. Sound only licences for the same quarter fell by 93,228 and they now total 3,256,185. This figure includes 528,644 licences for receivers fitted in cars—an increase of 2,095. At the end of the same quarter, 31st March, west Germany had 7,710,887 television sets registered; this figure includes west Berlin.

**Stereophonic broadcasting** is under discussion among the west German regional networks. At a recent meeting, executives of the organizations decided to try out stereo radio in some selected areas with high population density. A probable starting date for the experiments is August or September, this year, when west Germany will hold its National Radio Show (Funkausstellung) in Berlin. Experiments in stereo radio will not be co-ordinated but different regional networks will draw up their own plans.

**1962 Servicing Trades Examinations.**—Of the 2,118 who took the practical test for the intermediate Radio and Television Servicing Certificate 1,093 were successful. In the final R.T.S.C. practical test 314 of the 441 entrants passed. Twenty-one of the 42 candidates in the practical test for the intermediate Electronic Servicing Certificate were successful. In each case, successful candidates qualify for the award of the Certificate.

**Tic-Tac by Radio.**—Three men using Japanese "walkie-talkie" sets to send race results out of Hackney greyhound stadium were ordered to pay £80 in fines and 15gn costs at Old Street, London, on 19th April. Mr. R. C. Halse, prosecuting, said that the sets were not licensed by the Post Office and could not be because they operated outside the authorized frequency bands. The transmitters were confiscated.

A three-day exhibition and symposium entitled "**Electronics in action**" is to be held in the McLellan Galleries, Sauchiehall Street, Glasgow, commencing on the 20th June. It is being organized jointly by the I.E.E. and Brit.I.R.E. and will cover the uses of electronic instrumentation to improve productivity and also career possibilities in the field of electronics.

The Institute of Physics and the Physical Society are to hold a four-day residential conference on "**Plasma Physics**" at the Culham Laboratory of the U.K. Atomic Energy Authority, Abingdon, Berkshire, commencing 24th September. Further details can be obtained from the society, 47 Belgrave Square, London, S.W.1.

The seventh international trade show of **cabinet styling** accessories is to be held at the Hotel Russell, Russell Square, London, W.C.1. It will run for three days starting 1st October, and will be open between 2 and 6.30 p.m. daily.

At a recent meeting of the major organizations marketing **paging equipment** in the U.K., it was decided to form an association to be known as the Selective Paging Committee to agree technical details, formulate standards and represent members in discussions with the licensing authority.

**Intercom**—the international fair of sea, inland waterway and telecommunications, which was to have been held from 25th May, in Genova, has been postponed to 5th October. The exhibition will run for 15 days.

**Stereo Records.**—A total of 4,900,000 stereo records were sold in west Germany last year. This is an increase of 28.3% from the previous year.

# RADIO AND ELECTRONIC

**T**HE components section of an industry is probably the best thermometer from which to ascertain the temperature of the industry as a whole. From the profusion of components and accessories to be seen at the Components Show, which opens at Olympia on May 21st, and the recent report of the Radio and Electronic Component Manufacturers' Federation the radio and electronics industry is in a very good state of health. Component production for 1962 was valued at £137M, of which some 30% was for professional equipment, 20% for domestic equipment, 20% direct exports and the remainder for audio equipment, defence contracts, retail sales, etc.

This exhibition is the eighteenth in the series sponsored by the R.E.C.M.F. and is now held in alternate years. There are 220 stands on which the wares of the 270 exhibitors listed below are shown. In the following eighteen pages a summary is given of the equipment shown by each of the manufacturers. This is inevitably brief but we hope it will serve as a guide to the activities of individual firms as well as giving readers an overall picture of the diversity of equipment on show. It will be

seen that in addition to component manufacturers there are a number of exhibitors who provide equipment and materials for the production and testing of components, potted and printed circuits and sub-assemblies, etc. This "preview" is prepared from advance information obtained from manufacturers. In our next issue we shall give a detailed survey of some of the more notable items among the exhibits and of trends in the industry as exemplified at the show.

With the aid of the list of exhibitors and the plan of the stands it is hoped visitors will readily be able to locate particular manufacturers. For the convenience of readers unable to visit the show a number is appended to each report so that those wanting information available at the stands can readily obtain it by circling the appropriate number on one of the information service sheets at the back of this issue.

The show catalogue, which incorporates a directory section listing members of the Federation with their trade names and other information, is obtainable from the organizers, Industrial Exhibitions Ltd., 9 Argyle Street, London, W.1, price 5s.

## ALPHABETICAL LIST OF EXHIBITORS

| STAND NO.                            |     | STAND NO.                      |      | STAND NO.                                |      | STAND NO.                        |     |
|--------------------------------------|-----|--------------------------------|------|--|------|----------------------------------|-----|
| <b>A.B. Metal Products</b> .....     | 280 | <b>B.C.C.</b> .....            | 278  | Bulgin.....                              | 304  | Darwins .....                    | 226 |
| <b>A.E.I.</b> .....                  | 314 | <b>B.I.C.C.</b> .....          | 167  | Burgess Products .....                   | 457  | Datum .....                      | 273 |
| <b>A.K. Fans</b> .....               | 352 | <b>B.P.L.</b> .....            | 491  | Burndept-Vidor .....                     | 410  | Dave Instruments .....           | 256 |
| <b>A.M.F.</b> .....                  | 455 | <b>BSR.</b> .....              | 313  | <b>C.C.L.</b> .....                      | 456  | Day, J., & Co. ....              | 222 |
| <b>A-MP</b> .....                    | 165 | Bakelite .....                 | 450  | <b>CIBA (A.R.L.)</b> .....               | 253  | Dial Engineering .....           | 102 |
| <b>Aerialite</b> .....               | 367 | Barlow-Whitney .....           | 468  | <b>C. &amp; N.</b> .....                 | 406  | Diamond H Controls .....         | 254 |
| <b>Air Control</b> .....             | 113 | Beck, .....                    | 221  | <b>Cambion Electronic Products</b> ..... | 412  | Derritron Group .....            | 150 |
| <b>Alberice Meters</b> .....         | 363 | Beckman .....                  | 401  | <b>Cannon</b> .....                      | 403  | Dubilier .....                   | 274 |
| <b>Alma Components</b> .....         | 201 | Belclere .....                 | 469  | <b>Carr Fastener</b> .....               | 306  | Duratube & Wire .....            | 225 |
| <b>Alston Capacitors</b> .....       | 201 | Belling-Lee .....              | 310  | <b>Cathodeon</b> .....                   | 115  | <b>E.M.I.</b> .....              | 482 |
| <b>Amphenol-Borg</b> .....           | 320 | Beme (See Derritron) .....     | 150  | <b>Chance (See Pilkington)</b> .....     | 479  | <b>E.R.A.</b> .....              | 100 |
| <b>Ancillary Developments</b> .....  | 464 | Berco .....                    | 218  | <b>Clarke, H., &amp; Co.</b> .....       | 157  | Eclipse .....                    | 203 |
| <b>Antiference</b> .....             | 169 | Berec (see Ever Ready) .....   | 101  | <b>Colvern</b> .....                     | 213  | Eddystone .....                  | 151 |
| <b>Ardente</b> .....                 | 482 | Bird .....                     | 258  | <b>Concordia</b> .....                   | 175A | Egen .....                       | 259 |
| <b>Ariel Pressings</b> .....         | 229 | Board of Trade .....           | 481A | <b>Connollys</b> .....                   | 321  | Elac .....                       | 209 |
| <b>Arrell</b> .....                  | 207 | Bonnella.....                  | 454  | <b>Continental Connector</b> .....       | 54   | Elcom .....                      | 485 |
| <b>Arrow</b> .....                   | 281 | Bradley, G. & E. ....          | 483  | <b>Cosmocord</b> .....                   | 228  | Electro Methods .....            | 353 |
| <b>Arrow Electric Switches</b> ..... | 488 | Brayhead .....                 | 51   | <b>Currie &amp; Mill</b> .....           | 175  | Electrolube .....                | 111 |
| <b>Ashburton Resistance</b> .....    | 358 | Bribond Printed Circuits ..... | 496  | <b>Dagnall Electronics</b> .....         | 206  | Electronic Engineering .....     | 168 |
| <b>Avdel</b> .....                   | 407 | Britannia Tool .....           | 460  |  |      | Electronic Machine Control ..... | 460 |
| <b>Avo</b> .....                     | 158 | Brush .....                    | 164  |  |      |                                  |     |

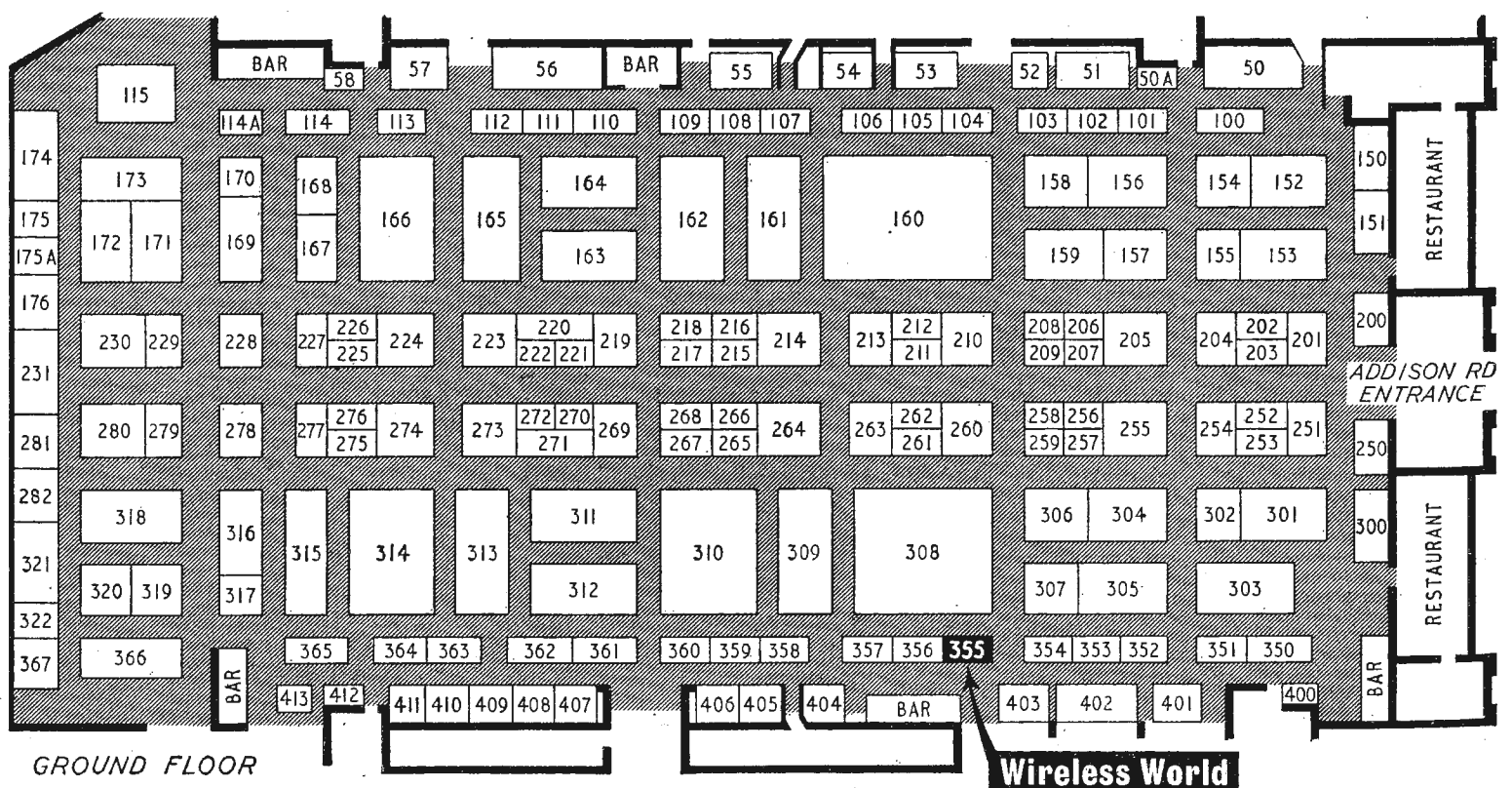

# COMPONENT EXHIBITION

|  |  |   |  |
|--|--|---|--|
| <b>Electrosil</b> ..... 275                          | <b>J. &amp; S. Engineers</b> ..... 461                         | <b>Oliver Pell Control</b> ..... 484                        | <b>South London Electrical Equipment</b> ..... 453 |
| <b>Electrothermal</b> ..... 204                      | <b>J.-Beam Aerials</b> ..... 174                               | <b>Painton</b> ..... 224                                    | <b>Spear Engineering</b> ..... 215                 |
| <b>Elliott-Automation</b> ..... 172                  | <b>K.G.M. Electronics</b> ..... 52                             | <b>Panax Equipment</b> ..... 460                            | <b>Stability Capacitors</b> ..... 257              |
| <b>Enalon</b> ..... 317                              | <b>LPS Electrical (see Day)</b> ... 222                        | <b>Parmeko</b> ..... 154                                    | <b>Standard Insulator</b> ..... 202                |
| <b>Engineering Enterprises</b> ..... 467             | <b>Labgear</b> ..... 115                                       | <b>Parrish Instruments</b> ..... 281                        | <b>Steatite &amp; Porcelain Products</b> ..... 155 |
| <b>English Electric Valve</b> ..... 311              | <b>Langham Thompson</b> ..... 108                              | <b>Partridge</b> ..... 277                                  | <b>Stevenage Relays (see Sanders)</b> ..... 281    |
| <b>Enthoven</b> ..... 267                            | <b>Lemco</b> ..... 219   | <b>Pergamon Press</b> ..... 50A                             | <b>Stocko</b> ..... 322                            |
| <b>Erg</b> ..... 262                                 | <b>Lewcos</b> ..... 214  | <b>Permanoid</b> ..... 207                                  | <b>Suflex</b> ..... 307                            |
| <b>Erie</b> ..... 205                                | <b>Lewis Springs</b> ..... 110                                 | <b>Permark</b> ..... 473                                    | <b>Surrey Steel Components</b> ... 105             |
| <b>Ever Ready</b> ..... 101                          | <b>Linton &amp; Hirst</b> ..... 492                            | <b>Pictorial Machinery</b> ..... 409                        | <b>Sylvania-Thorn</b> ..... 152                    |
| <b>Evershed &amp; Vignoles</b> ..... 107             | <b>Livingston Laboratories</b> ..... 315                       | <b>Pilkington &amp; Chance</b> ..... 479                    | <b>T.C.C.</b> ..... 264                            |
| <b>Fane</b> ..... 356                                | <b>Long &amp; Hambly</b> ..... 227                             | <b>Plannair</b> ..... 220                                   | <b>T.M.C.</b> ..... 56                             |
| <b>Ferranti</b> ..... 309                            | <b>Lucas (see Bradley)</b> ..... 483                           | <b>Platt Brothers (see Oliver Pell)</b> ..... 484           | <b>Tape Heads (see BSR)</b> ..... 313              |
| <b>Floform</b> ..... 260                             | <b>Lustraphone</b> ..... 266                                   | <b>Plessey</b> ..... 160                                    | <b>Taylor</b> ..... 170                            |
| <b>Formica</b> ..... 316                             | <b>M.C.P. Electronics</b> ..... 475                            | <b>Precision Electronic Terminations</b> ..... 410          | <b>Technograph</b> ..... 459                       |
| <b>Fortiphone</b> ..... 354                          | <b>M-O Valve</b> ..... 161                                     | <b>Pressac</b> ..... 350                                    | <b>Tectonic Industrial Printers</b> 362            |
| <b>Fox</b> ..... 315                                 | <b>McMurdo</b> ..... 217                                       | <b>Printed Circuits</b> ..... 214                           | <b>Telcon</b> ..... 159                            |
| <b>G.E.C.</b> ..... 161                              | <b>Magnesium Elektron</b> ..... 470                            | <b>Pullin (see Measuring Inst.)</b> 53                      | <b>Teledictor</b> ..... 357                        |
| <b>G.K.N.</b> ..... 260                              | <b>Magnetic &amp; Electrical Alloys (see Telcon)</b> ..... 159 | <b>Pye Switches</b> ..... 115                               | <b>Teleguide</b> ..... 471                         |
| <b>Gardners</b> ..... 472                            | <b>Magnetic Devices</b> ..... 366                              | <b>Radiohm</b> ..... 400                                    | <b>Telerection</b> ..... 271                       |
| <b>Garrard</b> ..... 50                              | <b>Mallory Batteries</b> ..... 361                             | <b>Rathdown Industries</b> ..... 106                        | <b>Temco (see Telcon)</b> ..... 159                |
| <b>General Controls</b> ..... 408                    | <b>Mansol</b> ..... 265  | <b>Redpoint (see Linton &amp; Hirst)</b> 492                | <b>Texas Instruments</b> ..... 303                 |
| <b>Goldring</b> ..... 221                            | <b>Marconi Instruments</b> ..... 166                           | <b>Rejafix</b> ..... 359                                    | <b>Thermionic Products</b> ..... 278               |
| <b>Goodman, George</b> ..... 260                     | <b>Marconi's W/T</b> ..... 495                                 | <b>Reliance Controls</b> ..... 55                           | <b>Thorn-A.E.I.</b> ..... 152                      |
| <b>Goodmans Industries</b> ..... 223                 | <b>Markovits</b> ..... 58                                      | <b>Rendar Instruments</b> ..... 270                         | <b>Thorn Electrical</b> ..... 171                  |
| <b>Greencoat</b> ..... 413                           | <b>Marriott, P. A. (see BSR)</b> 313                           | <b>Reproducers &amp; Amplifiers</b> ... 212                 | <b>Toolpro (see Telcon)</b> ..... 159              |
| <b>Greenpar Engineering</b> ..... 109                | <b>Marrison &amp; Catherall</b> ..... 474                      | <b>Reslosound</b> ..... 150                                 | <b>Truvox</b> ..... 278                            |
| <b>Gresham Transformers</b> ..... 462                | <b>Measuring Instruments (Pullin)</b> ..... 53                 | <b>Richard Allan Radio</b> ..... 200                        | <b>Tucker Eyelet</b> ..... 211                     |
| <b>Gulton Industries</b> ..... 411                   | <b>Metway</b> ..... 466  | <b>Rivlin Instruments</b> ..... 251                         | <b>20th Century Electronics</b> ... 112            |
| <b>Haddon &amp; Stokes (see G.K.N.)</b> ..... 260    | <b>Mica &amp; Micanite</b> ..... 272                           | <b>Rola Celestion</b> ..... 230                             | <b>Union Carbide</b> ..... 404                     |
| <b>Hallam, Sleigh &amp; Cheston</b> 231              | <b>Microponent Development</b> 114A                            | <b>Ross, Courtney</b> ..... 481                             | <b>United Trade Press</b> ..... 465                |
| <b>Harwin</b> ..... 300                              | <b>Midland Bank</b> ..... 458                                  | <b>Royal Worcester</b> ..... 104                            | <b>Vactite</b> ..... 214                           |
| <b>Hassett &amp; Harper</b> ..... 57                 | <b>Midland Silicones</b> ..... 312                             | <b>Rustrak Instruments</b> ..... 411                        | <b>Venner</b> ..... 476                            |
| <b>Hellermann</b> ..... 153                          | <b>Miniature Electronic Components</b> ..... 114               | <b>SGS-Fairchild</b> ..... 494                              | <b>Vero Electronics</b> ..... 364                  |
| <b>Hinchley</b> ..... 279                            | <b>Mining and Chemical Products</b> ..... 475                  | <b>S.T.C.</b> ..... 162                                     | <b>Vidor (see Burndept)</b> ..... 410              |
| <b>Hirst Electronic</b> ..... 477                    | <b>Ministry of Aviation</b> ..... 318                          | <b>Salford</b> ..... 161                                    | <b>Wandleside</b> ..... 176                        |
| <b>Hughes International</b> ..... 489                | <b>Minnesota</b> ..... 463                                     | <b>Salter</b> ..... 365                                     | <b>Wego Condenser</b> ..... 252                    |
| <b>Hunts</b> ..... 163                               | <b>Morganite</b> ..... 210                                     | <b>Sanders (Electronics)</b> ..... 281                      | <b>Welwyn</b> ..... 255                            |
| <b>I.C.I.</b> ..... 487                              | <b>Moulded Fasteners</b> ..... 365                             | <b>Scott &amp; Company</b> ..... 402                        | <b>Westinghouse</b> ..... 305                      |
| <b>Iliffe Electrical Publications</b> 355            | <b>Mullard</b> ..... 308                                       | <b>Sealctro</b> ..... 486                                   | <b>Westminster Bank</b> ..... 478                  |
| <b>Imhof</b> ..... 156                               | <b>Multicore</b> ..... 301                                     | <b>Sellotape</b> ..... 452                                  | <b>Weymouth Radio</b> ..... 261                    |
| <b>Industrial Electronics</b> ..... 355              | <b>Murex</b> ..... 208   | <b>Shaw Publishing Co.</b> ..... 480A                       | <b>Whiteley</b> ..... 173                          |
| <b>Instrument Review</b> ..... 168                   | <b>N.S.F.</b> ..... 269  | <b>Sheffield Steel Products (see Oliver Pell)</b> ..... 484 | <b>Wingrove &amp; Rogers</b> ..... 276             |
| <b>Insulating Components and Materials</b> ..... 493 | <b>National Trade Press</b> ..... 263                          | <b>Sifam</b> ..... 405                                      | <b>Wire Products</b> ..... 103                     |
| <b>Insuloid Manufacturing</b> ..... 451              | <b>Newmarket Transistors</b> ..... 115                         | <b>Sims, F.D.</b> ..... 490                                 | <b>Wireless World</b> ..... 355                    |
| <b>International Electronics</b> ..... 480           | <b>Newport Instruments</b> ..... 360                           | <b>Sintered Glass to Metal Seal (see Mansol)</b> ..... 265  | <b>Woden Transformer</b> ..... 302                 |
| <b>Ionic Plating (see G.K.N.)</b> ... 260            |  | <b>Smart &amp; Brown</b> ..... 280                          | <b>Wolsey Electronics</b> ..... 216                |
| <b>Irish Cables (see Wandleside)</b> 176             |  | <b>Smith, S., &amp; Sons</b> ..... 319                      | <b>Zenith Electric</b> ..... 282                   |
| <b>J.B.</b> ..... 268                                |  |   |  |

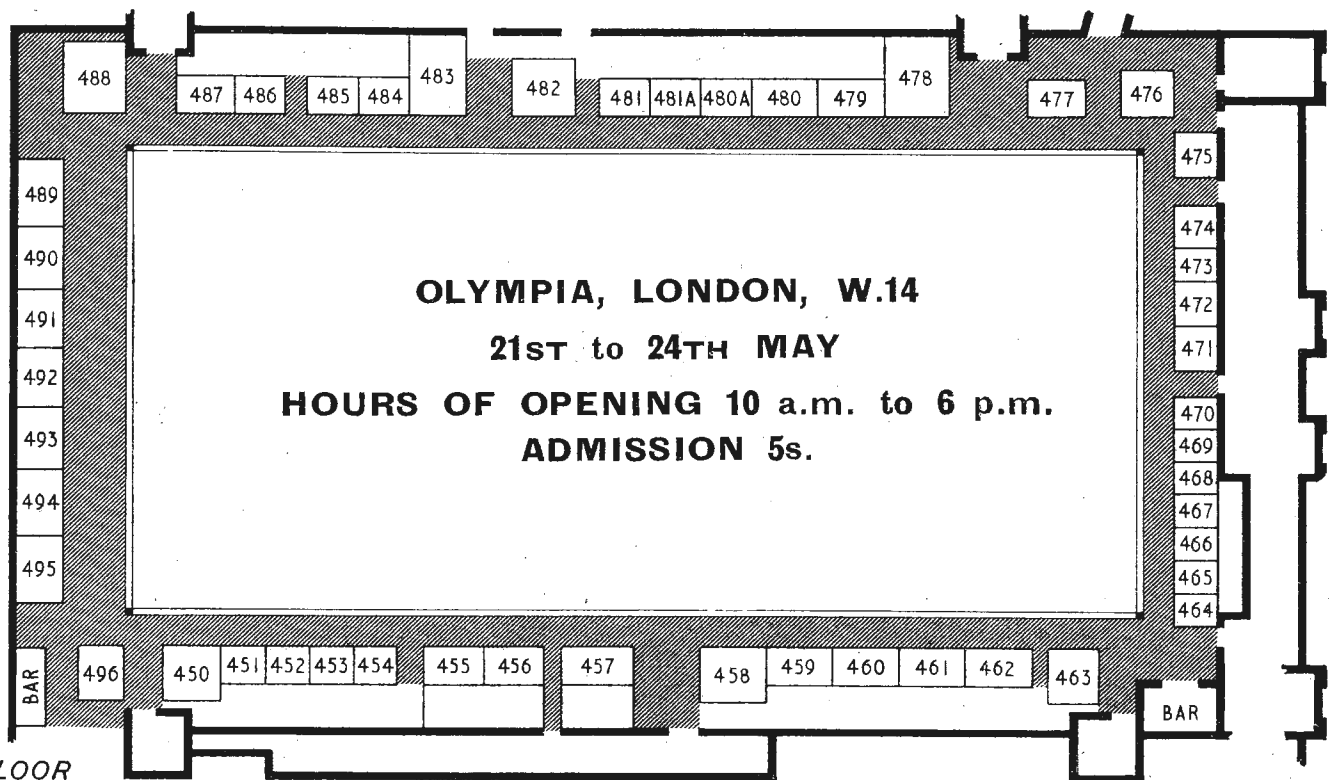

FIRST FLOOR

# RADIO AND ELECTRONIC COMPONENT EXHIBITION

## Guide to the Stands

### A. B. METAL PRODUCTS (280)

Among the turret tuners on show is one for the u.h.f. television bands. The design requirements for receivers for Bands IV and V have also been borne in mind in the new range of slider system switches. Also to be seen is the company's range of rotary push-button, and lever switches; Clarostat potentiometers; and composition and wirewound resistors. Smart & Brown connectors and a new version of the Trolex switch are also on show. [501]

*A.B. Metal Products Ltd., North West House, Marylebone Road, London, N.W.1.*

### A.E.I. (314)

The stand is shared by the Electronic Apparatus and the Telecommunications Divisions, who both exhibit a wide selection of equipment. Semiconductors on view include a complete range of silicon controlled rectifiers of from 4 to 100 amp rating, and what is claimed to be the first controlled avalanche rectifier. Representative of components are transistor stabilized power supplies, a sealed, low-current switching relay, and a new telephone handset. [502]

*Associated Electrical Industries Ltd., Crown House, Aldwych, W.C.2.*

### A.K. FANS (352)

A comprehensive range of "Airmax" miniature fans, from 1in diameter upwards, are on show. These are available for operation from 400c/s, 50c/s or d.c. supplies. New models include a 400c/s, 2in fan (only 1½in deep) and an inexpensive 50c/s model, with either a 4in or 6in diameter fan for use in commercial instruments. [503]

*A.K. Fans Ltd., 20 Upper Park Road, Hampstead, London, N.W.3.*

### A.M.F. (455)

They are exhibiting their "Potter & Brumfield" series of power, general purpose, and special purpose relays. [504]

*A.M.F. Ltd., 25-28 Old Burlington Street, London, W.1.*

### A-MP (165)

Three new products, together with a representative selection from their range of A-MP terminals and connectors, are on show. These are: A-MP Termashield ferrules, test probe receptacles—with two or three leg mountings—and miniature edge connectors for printed circuit boards.

They have also introduced a fine wire splicing device, capable of splicing wires as fine as 47 s.w.g. and up to 450 splices per hour. [505]

*Aircraft-Marine Products (Great Britain) Ltd., Amplo House, 87-89 Saffron Hill, London, E.C.1.*

### AERIALITE (367)

As well as the established range of Band I/III aerials, types designed for u.h.f./v.h.f. reception are shown. Accessories include coaxial plugs, sockets, diplexers, triplexers and matching units. Television signal distribution equipment suitable for most requirements may be examined. Among the coaxial cables displayed is one designed for u.h.f. transmissions. On the communication side, there is a display of cables for telephone and signal circuits. [506]

*Aerialite Ltd., Castle Works, Stalybridge, Cheshire.*

### AIR CONTROL (113)

A selection of their axial and centrifugal blowers with impeller diameters from 1½in to 8in and miniature filters, which have been specially designed for the electronics industry, are on show. [507]

*Air Control Installations Ltd., Victoria Road, Ruislip, Middx.*

### ALBERICE METERS (363)

Two Alberice television slotmeters are on show—the Varimeter and the Fixed Tariff Meter. The Varimeter is retained in an insulated plastic case and is adjustable from 5 minutes to 12 hours (72 settings). The fixed meter gives timing rates between 30 minutes and 2 hours; the

setting is effected by changing one of the timing gear wheels. [508]

*Alberice Meters Ltd., 87/89 Sterte Avenue, Poole, Dorset.*

### ALMA COMPONENTS (201)

Metal film resistors, with a long-term stability of  $\pm 0.1\%$  and a temperature coefficient of  $0.002\%$  per  $^{\circ}\text{C}$ , are being shown. This new Type M range is encapsulated in resin tubes. Another range (MB) has a t.c. of  $\pm 0.005\%$  per  $^{\circ}\text{C}$  and a stability of  $\pm 0.3\%$  for the first 1,000 hours' use. Alma are also showing a new range of subminiature wirewound resistors measuring  $\frac{1}{8}$ in in diameter and  $\frac{3}{8}$ in long and having two axial lead-outs at one end to facilitate printed circuit board mounting. [509]

*Alma Components Ltd., Park Road, Diss, Norfolk.*

### ALSTON CAPACITORS (201)

Silvered-mica capacitors are featured by this subsidiary of Alma Components. They are also showing development samples of subminiature ceramic capacitors. [510]

*Alston Capacitors Ltd., Park Road, Diss, Norfolk.*

### AMPHENOL-BORG (320)

A full range of connectors is on show, using identical contacts which are crimped to their leads before insertion into the sockets. Contact densities of 100-175 per square inch can be obtained. Other components shown include precision, miniature potentiometers and trimmer resistors, and coaxial switches. [511]

*Amphenol-Borg Ltd., Thanet Way, Whitstable, Kent.*

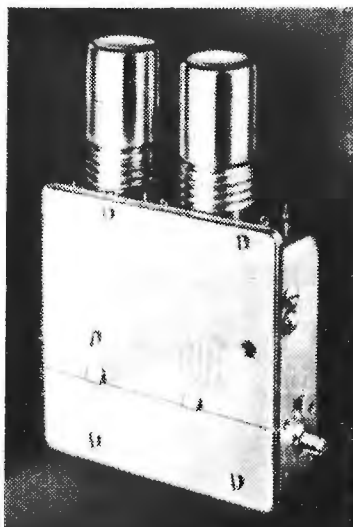

Turret tuner for the u.h.f. television bands (A.B. Metal Products).

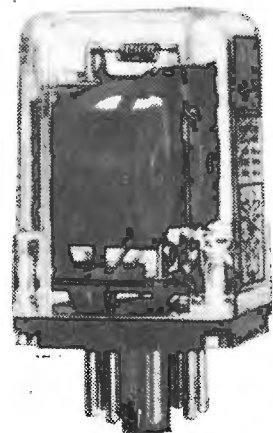

Plug-in relay by Arrow Electric Switches with an 8-pin international octal base.

#### ANCILLARY DEVELOPMENTS (464)

Precision potentiometers and trimmer resistors constitute the main part of the exhibit, a notable example of the range of potentiometers being the type with a torque of 1gm/cm and linearity of 0.1%. One of the smallest trimmer resistors in production is shown, which is fully sealed and is able to operate over the range  $-40^{\circ}\text{C}$  to  $150^{\circ}\text{C}$ . High stability over a wide range of temperatures, combined with high values of resistance is obtained by the use of metal oxide in another range of trimmers. [512  
*Ancillary Developments Ltd., Surrey Avenue, Camberley, Surrey.*

#### ANTIFERRENCE (169)

The advent of u.h.f. television transmissions has called for the introduction of a completely new range of aerials for reception of the B.B.C. Second Programme. Single and stacked arrays with a wide choice of mounting equipment are shown. Aerials and their associated accessories for use with Bands I, II and III transmissions are displayed together with car radio aerials. [513  
*Antiferrence Ltd., Bicester Road, Aylesbury, Bucks.*

#### ARDENTE (482)

Miniature multi-purpose rotary switches with Ministry qualification approval are on show together with their associated assembly kits. Other items of interest include miniature illuminated push-button switches (with up to 4-changeovers), a comprehensive range of miniature transformers, rotary edge-operated miniature potentiometers (with and without internal switches), transistor sub-assemblies and hearing aids. [514  
*Ardente Acoustic Laboratories Ltd., 8-12 Minerva Road, North Acton, London, N.W.10.*

#### ARIEL PRESSINGS (229)

Coaxial plugs, sockets and line couplers are on show together with their extensive range of components. New items this year include telescopic aerials, slider switches, moulded leads for coaxial and mains terminations, fully insulated coaxial sockets, and bulkhead line connectors. Other items on show include a new type of switch, with up to 100 positions, which will give multi-circuit selection in a single unit. [515  
*Ariel Pressings Ltd., Wollaton Road, Beeston, Nottingham.*

#### ARRELL (207)

Arrell Electrical are showing a simple transistor amplifier unit, built into the insulator of the driven element of an aerial. This amplifier has been produced to improve reception of television programmes in poor areas and has a gain of approximately 14dB. Arrell Electrical are also showing their full range of tele-

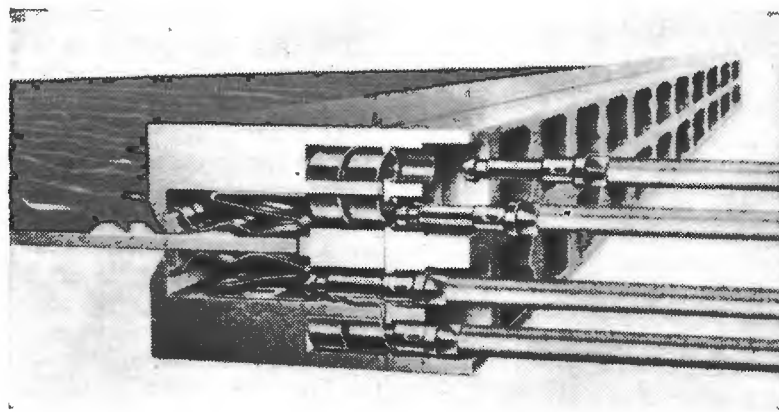

Strip connector for printed circuits by B.I.C.C.-Burndy. Crimped contacts are inserted separately.

vision aerials, component parts and communal television equipment. [516  
*Arrell Electrical Accessories Ltd., Brookfield Road, Cheadle, Cheshire.*

#### ARROW (281)

A selection of Post Office Type 3000 relays are on display together with the Arrow relay kit. Also shown is a selection of gear boxes and wheels for use in small mechanisms. [517  
*Arrow Ltd., Hideway, Welwyn Garden City, Herts.*

#### ARROW ELECTRIC SWITCHES (488)

A comprehensive selection of their wide range of control gear and switches is on show, with particular emphasis on a range of insulated toggle switches, plug-in relays, and rotary cubicle door isolators. [518  
*Arrow Electric Switches Ltd., Brent Road, Southall, Middx.*

#### ASHBURTON RESISTANCE (358)

Precision wirewound potentiometers, with ratings from 0.1 to 2 watts, are featured in their comprehensive ranges of wirewound resistors. Among other items on show there is a selection of fixed vitreous embedded resistors ranging from 6 to 180 watts, heavy-duty fixed and semi-adjustable resistors, and rotary rheostats and potentiometers ranging from 25 to 200 watts. [519  
*Ashburton Resistance Co. Ltd., 72 Brewery Road, London, N.7.*

#### AVDEL (407)

Component assembling equipment, including the Chobert and Avex riveters, are being demonstrated. The company also produces parts for use in the assembly of components. [520  
*Avdel Industrial Fasteners Ltd., Welwyn Garden City, Herts.*

#### AVO (158)

Avo are exhibiting a comprehensive range of electrical, electronic and nucleonic instruments including a number of new products shown for the first time at a national exhibition. Among the items on show there is a transistorized multimeter, a Douglas programmed multi-winder (a standard coil winding machine to which

an electronic programme unit has been added), a new Avo radiation monitor, an *in-situ* transistor tester and a Zener diode selector. [521  
*Avo Ltd., 92-96 Vauxhall Bridge Road, London, S.W.1.*

#### B.C.C. (278)

British Communications Corporation are exhibiting their new v.h.f. portable radiotelephone, the B.C.C. 40/45. This unit is fully transistorized, weighs  $4\frac{1}{2}$ lb and its dimensions are a mere  $8 \times 5 \times 2\frac{1}{2}$ in. Features of this set include the choice of either phase or amplitude modulated operation and provision for five or six channels within any of the v.h.f. bands. The radiated power of the transmitter is in the order of 350 to 400mW. [522  
*British Communications Corporation Ltd., Neasden Lane, London, N.W.10.*

#### B.I.C.C. (167)

Among a wide range of cables and connectors, several new developments are to be seen. B.I.C.C.-Burndy have their new connectors for r.f. and power applications which employ compression-jointing techniques, in particular the PC printed-circuit edge connector which has removable crimped contacts for high-speed assembly and easier quality control. Recently introduced are miniature coaxial cables with a p.t.f.e. extruded sheath which is impervious to liquids and gases. [523  
*British Insulated Callender's Cables Ltd., 21, Bloomsbury Street, London, W.C.1.*

#### B.P.L. (491)

In addition to the standard range of component testing equipment and moving-coil meters a number of new instruments can be seen. These include an electrolytic capacitance bridge, a breakdown and insulation tester and a digital voltmeter. The bridge has a capacitance measuring range from 0.2 to  $22,000\mu\text{F}$ . The polarizing voltage may be varied between 0 and 800V. The digital voltmeter is a two-digit (1%) d.c. voltmeter reading with multipliers from 0 to 1,000V in ten ranges. The input resistance is 100,000 ohms/volt.



Sullivan instruments are also shown on this stand. [524]

*British Physical Laboratories, Radlett, Herts.*

#### BSR (313)

Among the new items on show there is a three-speed tape deck— $1\frac{7}{8}$ ,  $3\frac{3}{4}$  and  $7\frac{1}{2}$  in/sec, a "Gardisk" retractable cradle, a ceramic stereo cartridge, and a 4-track combination head, which incorporates record/replay and erase facilities. P. A. Marriott and Tape Heads Ltd., makers of magnetic tape recording heads, are also represented on this stand. [525]

*BSR Ltd., Monarch Works, Old Hill, Staffs.*

#### BAKELITE (450)

Compression and injection moulding materials; laminated sheet, rod and tube; phenolic, polyester and epoxide resins and adhesives; p.v.c. extrusion materials; p.v.c. rigid and elastomeric sheet and polyethylene resins and compounds in a variety of applications are to be seen. Of special interest is an entirely new grade of Bakelite laminate surfaced with styrene/butadiene rubber, which is used for capacitor sealing discs. There is also a new low-loss glass fabric laminated material with a low temperature/permittivity coefficient. Copper-clad laminates based on phenolic or epoxide paper and epoxide glass are also featured. [526]

*Bakelite Ltd., 12-18 Grosvenor Gardens, London, S.W.1.*

#### BARLOW-WHITNEY (468)

Process heating equipment for use in the manufacture and testing of components is featured on this stand. Among the equipment shown is vacuum impregnation plant, a humidity test cabinet with refrigeration, furnaces and various types of oven including a vacuum oven for production and experimental process under vacua to 50 microns and temperatures to 300°C. [527]

*Barlow-Whitney Ltd., Coombe Road, Neasden, London, N.W.10.*

#### BECK (221)

A wide range of subminiature solid-dielectric variable capacitors, which can be fitted with a variety of types of drive, is being shown. [528]

*L. Beck (GB) Ltd., 414, Chiswick High Road, London, W.4.*

#### BECKMAN (401)

A complete range of Helipot wire-wound precision potentiometers and Duodial turns-counting dials, including a precision type, are on display. In addition to the standard range of potentiometers, many special versions are on show, including a concentric shaft potentiometer for use with coaxial dials. [529]

*Beckman Instruments Ltd., Glenrothes, Fife.*

#### BELCLERE (469)

They are showing their comprehensive ranges of subminiature and microminiature transformers and fine wire windings—up to 54 s.w.g. Other items on show include a complete range of Belclere hearing aids (including one which fits entirely inside the ear), Belclere audiometers, miniature plastic injection mouldings, and a range of resin-encapsulated circuits (delay lines, filters, etc.) and components. [530]

*The Belclere Co. Ltd., 171 Cowley Road, Oxford.*

#### BELLING-LEE (310)

In a range of well over 1,000 different components, Belling-Lee are showing several new items including a cable cover for miniature uniters, a plug-in version of the Securex miniature circuit breakers, a range of two-way unbreakable terminal blocks with captive screws, miniature coaxial bridging links, printed circuit components and terminals rated at 15A. Other items include a new range of components, conforming to the Continental standards. Belling-Lee are also displaying their "Prest-incer" kit, comprising bench press, tools and components. This kit is of particular interest as the rivets are self punching and are fixed in one operation without the preliminary piercing of the mount.

On the aerial side Belling-Lee are showing three u.h.f. aerials (3, 5 and 10 element) and also a u.h.f. signal strength meter which is of interest to those in the aerial erection field. They also have a broadside double 10-element u.h.f. aerial, which has a gain of the order of 10dB. Belling-Lee signal distribution equipment is also on show.

Another item of particular interest is a screened compartment of modular construction with a new type of door. Also on show is a weld tester, for use in testing r.f. continuity. [531]

*Belling & Lee Ltd., Great Cambridge Road, Enfield, Middx.*

#### BERCO (218)

The new Bercotrol universal power regulator, which gives regulated a.c. or d.c. outputs from the standard a.c. supply, is shown. In addition Berco are exhibiting examples of their wide range of resistors, potentiometers and stud switches, together with variable-ratio auto-transformers. [533]

*British Electric Resistance Co. Ltd., Queensway, Enfield, Middx.*

#### BIRD (258)

A combined v.h.f./u.h.f. tuner and selector mechanism is introduced. Both tuners are manipulated from a common pre-set control allowing selection of channels in Bands I, III, IV and V. A Cyldon u.h.f. tuner using two transistors, but mechanically similar to the valve version referred to above, is also on show.

The established range of Cyldon tuners, variable capacitors and telescopic aerials are included. [534]

*Sydney S. Bird & Sons Ltd., Palace Gardens, Enfield, Middx.*

#### BOARD OF TRADE (481A)

This stand is primarily an information bureau where literature is available on the services Government departments and British embassies and posts abroad can offer the U.K. exporter. [535]

*Board of Trade, Export Services Branch, Hillgate House, 35 Old Bailey, London, E.C.4.*

#### BONNELLA (454)

A wide range of switches is shown including micro-switches with the "rock-wipe" action and miniature types with lever, slide, trigger and push-button actuators. [536]

*D. H. Bonnella & Son Ltd., West Hill, Hoddesdon, Herts.*

#### BRADLEY, G. & E. (483)

A number of additions have been made to their range of precision laboratory instruments. These are being demonstrated and include a battery-driven solid-state electronic multimeter—Type CT471B—and a universal impedance bridge—Type 131. They are also showing a range of microwave and coaxial components together with a number of solid-state frequency multipliers. There is also a working demonstration of one of their ruby lasers, which are now commercially available.

Bradley's are responsible for the sales in the electronic industrial markets, of semiconductor devices manufactured by Joseph Lucas Ltd. They are showing Lucas controlled avalanche rectifiers, silicon rectifiers, high-voltage transistors, and voltage regulators. [537]

*G. & E. Bradley Ltd., Electral House, Neasden Lane, London, N.W.10.*

#### BRAYHEAD (51)

The electronics side of this organization's activities is conducted by Brayhead Electronic Components Ltd., of Derbyshire. They produce multi-channel d.c. amplifiers and power supply units under the trade name "Experitron." They also manufacture i.f. transformers and r.f. coils. The associated company, Brayhead (Ascot) Ltd., of Ascot, Berks., specialize in the production of mechanical assemblies, springs, extruded cans, valve holders and switches. [538]

*Brayhead Electronic Components Ltd., Green Lane, Dronfield, Derbyshire.*

#### BRIBOND PRINTED CIRCUITS (496)

The main feature is a cabinet with standard racking for modular chassis

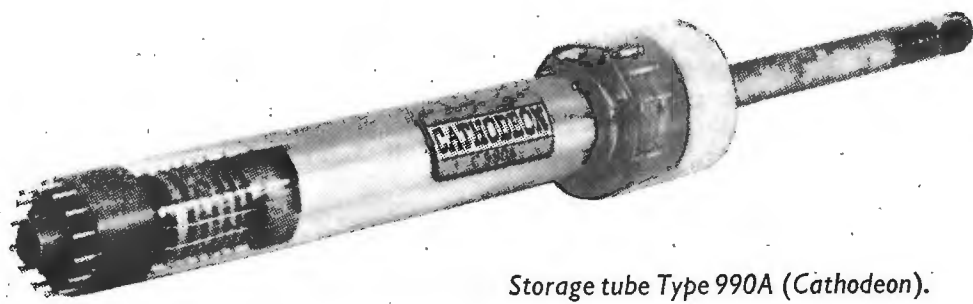

Storage tube Type 990A (Cathodeon).

and printed circuit boards. Also on show is the Elite roller tinning machine for printed circuit production. [539]

*Bribond Printed Circuits Ltd., Industrial Estate, Terminus Road, Chichester, Sussex.*

**BRITANNIA TOOL (460)**

This company is showing a selection of precision piece parts together with examples of prototypes and small batch precision parts, manufactured for use in the instrument and electronics fields. [540]

*Britannia Tool Company, Bodmin Road, Wyken, Coventry, Warwick.*

**BRUSH (164)**

The piezoelectric ceramic, acoustic element, quartz crystal and semiconductor divisions are represented on this stand. New products include a range of silicon transistors designed for chopping applications. These can be supplied in matched pairs or quadruples. Other semiconductor ranges include epitaxial planar transistors, Zener diodes and p-n-p-n four-layer diodes in a wide range of switching voltages. Three basic filter types based on lead zirconate/titanate ceramic material are demonstrated along with transfilters, requiring no initial or subsequent adjustment, for use in miniature i.f. circuits with transistors. [541]

*Brush Crystal Co. Ltd., Hythe, Southampton.*

**BULGIN (304)**

There are several new items at the show which have been added to the well-known Bulgin range which consists of over 10,000 electronic component varieties. Among the new items there are switches, actuators, flexible couplers, miniature tag strips, signal lamps, holders, battery connection blocks, and fuse holders. [543]

*A. F. Bulgin & Co. Ltd., Bye Pass Road, Barking, Essex.*

**BURGESS PRODUCTS (457)**

Manually actuated switches, both plain and illuminated push-button types, are featured among the several hundred Burgess micro switches on show. [544]

*Burgess Products Co. Ltd., Micro Switch Division, Dukes Way, Team Valley, Gateshead 11.*

**BURNDIPT-VIDOR (410)**

A new range of miniature sealed nickel-cadmium rechargeable accu-

mulators, with outputs ranging from 50mA-hr to 2.5A-hr are on show. They are also showing their complete range of cells and primary batteries. Other items on show include a power meter—having a frequency coverage of 1kc/s to 1,000Mc/s and capable of measuring up to 1.5 watts of power—an ultrasonic cleaner with a stainless steel half-gallon tank, and a range of plugs and sockets. [545]

*Burndipt Ltd., Riversite, High Street, Erith, Kent.*

*Vidor Ltd., West Street, Erith, Kent.*

**C.C.L. (456)**

The company specializes in the manufacture of electrolytic capacitors with aluminium electrodes. In addition to the range in aluminium containers, varying in size from  $\frac{1}{8}$ in to 2 $\frac{1}{2}$ in in diameter, they are also showing a range of plastic-cased capacitors. Working voltages range from 6 to 500V d.c. [546]

*C.C.L. Ltd., Hanworth Lane, Chertsey, Surrey.*

**CIBA (253)**

The main theme of the display is the use of epoxy resins for potting electronic components and sub-assemblies. The new Araldite E-Pak system consists of moulded cases and preformed pellets of epoxy resin which are not fully cured and which, under the influence of heat, fill the moulded housing containing the components.

One of the examples of potting is a cardiac "pacemaker" made by Devices Ltd. for St. George's Hospital, London, and is for implanting in the body. [547]

*CIBA (A.R.L.) Ltd., Duxford, Cambridge.*

**C. & N. (406)**

Based on designs produced by R.A.E., a wide range of aluminium alloy instrument cases are displayed, complete with matching front panels. Unit construction chassis to go with the cases are also shown, together with examples of the firm's electronic design and manufacturing processes. [548]

*C. & N. (Electrical) Ltd., The Green, Gosport, Hants.*

**CAMBION ELECTRONIC PRODUCTS (412)**

Exhibiting for the first time at an R.E.C.M.F. exhibition the display is mostly of a hardware nature. The products shown include a large



Cardiac "pacemaker," weighing only 100 grams and containing a transistor pulse generator powered by four Mallory cells. An example of Araldite potting.

variety of insulated terminals, handles, coil formers, collet knobs and terminal boards. Of the terminal boards available, one ceramic variety, is particularly adaptable to high temperature applications. [549]

*Cambion Electronic Products Ltd., Cambion Works, Castleton, Sheffield.*

**CANNON (403)**

Connectors for every conceivable purpose in the electrical and electronics field are on show. Of particular interest amongst the new products are the extensions to the Cannon "D" miniature range and the introduction of the fully environmental-tested "D" miniature connectors. [550]

*Cannon Electric (Great Britain) Ltd., 168/172 Old Street, London, E.C.1.*

**CARR FASTENER (306)**

The Cinch "Greenline" series of moulded edge connectors for printed circuit boards are on show. They are also displaying their comprehensive range of Cinch components, including plugs and sockets, micro switches, transistor clips and valveholders. Other items on show include their special fastening devices in metal and plastic. [551]

*Carr Fastener Co. Ltd., Pinfold Lane, Stapleford, Notts.*

**CATHODEON (115)**

Three types of storage tube, all employing the same storage structure, consisting of a fine metal mesh coated with a dielectric film on the side facing the writing gun are featured by Cathodeon. In the C990 (with magnetic writing and read-out guns) and C992 (electrostatic writing and magnetic read-out) tubes the read-out gun is based on a standard 3in image orthicon gun and operates in standard image orthicon coils, and the output signal can be taken from the electron multiplier as in an image orthicon. In the C991 both guns are high-resolution all electrostatic

and no electron multiplier is incorporated, and the output signal is taken from the collector mesh. [552]  
*Cathodeon Ltd., Church Street, Cambridge.*

**CLARKE, H., & CO. (157)**

Insulating materials in general, and "Pirtoid" laminated sheets, rods and tubes in particular are shown on this stand. Fabricated formers, plastic cable trunking and polyester and epoxy glass fabric mouldings are included in the wide range of products of this firm. [553]

*H. Clarke & Co. (Manchester) Ltd., Atlas Works, Patricroft, Nr. Manchester.*

**COLVERN (213)**

Colvern are exhibiting some 40 basic types of wirewound potentiometers this year. Their standard range includes 1 to 15-watt rated potentiometers. They also manufacture sealed units to the specification DEF 5121 and also a comprehensive range of multi-turn helical potentiometers. Items of particular interest include a miniature wirewound potentiometer (0.5in diameter) and a 10-turn helical potentiometer incorporating a watchface dial. [554]

*Colvern Ltd., Spring Gardens, Romford, Essex.*

**CONCORDIA (175A)**

Wires and cables of every description for the radio and electronics industry are shown by Concordia. Their range includes American (B. & S.) and metric sizes as well as British s.w.g. [555]

*Concordia Electric Wire & Cable Co. Ltd., Long Eaton, Nottingham.*

**CONNOLLYS (321)**

A comprehensive range of winding wires and strips are on show, and the Cable Division are displaying paper and plastic mains cables, numbered-core control cable, telephone and self-supporting aerial cables. Plastic slides containing information on winding wire will be supplied from the stand. [556]

*Connollys (Blackley) Ltd., Kirkby Industrial Estate, Liverpool.*

**CONTINENTAL CONNECTOR (54)**

This firm is exhibiting a comprehensive selection of precision-made connectors in three basic ranges—miniature, subminiature and microminiature. These connectors possess high dielectric and mechanical strength and have machined gold-plated floating pin and socket contacts. Other items on show include printed circuit connectors, high accuracy mouldings in Melamine, terminal blocks (up to 60-way), and test point connectors. [557]

*Continental Connector Ltd., Industrial Estate, Long Drive, Greenford, Middx.*

**COSMOCORD (228)**

Among the microphones and pick-up arms demonstrated by this company, two new microphones are introduced. The Mic 60 is a crystal hand microphone intended for use with high quality domestic recorders. The Mic 55 is a small lapel microphone of similar electrical specification to the type 60. [558]

*Cosmocord Ltd., Eleanor Cross Road, Waltham Cross, Herts.*

**CURRIE & MILL (175)**

The chemical etching of components on cupro-nickel, backed with a thin layer of fibre-glass on an aluminium base, and the production of printed circuits is the particular interest of this company. [559]

*Currie & Mill Ltd., Abbots Factory, Galashiels, Scotland.*

**DAGNALL ELECTRONICS (206)**

A feature of the display is a comprehensive range of transformers for use in transistor circuitry. Among the other items there are many examples of their wirewound components including mains and output transformers, solenoid coils, pulse transformers, radar e.h.t. units and television timebase components. [560]

*Dagnall Electronics (Cranfield) Ltd., Cranfield, Nr. Bletchley, Bucks.*

**DARWINS (226)**

Two additions have been made to Darwins range of ceramic permanent magnet materials. These are Feroba II, an anisotropic version of the well-known Feroba I, and Feroba C, a rigid plastic-bonded material in which magnets can be produced to close tolerances without machining. [561]

*Darwins Ltd., Fitzwilliam Works, Tinsley, Sheffield 9.*

**DATUM (273)**

An entirely new range of instrument racks is being shown on this stand. Known as the E-type, they are available in a choice of five heights and three depths and as single or multi-bay assemblies. [562]

*Datum Metal Products Ltd., Colne Way Trading Estate, Watford, Herts.*

**DAWE INSTRUMENTS (256)**

They are displaying a comprehensive range of test and measuring instruments. These include examples of their stroboscopes, sound level indicators, ultrasonic cleaning equipment and a storage oscilloscope. [563]

*Dawe Instruments Ltd., Western Avenue, London, W.3.*

**DAY, J. & CO.  
L.P.S. Electrical (222)**

Coaxial cable for use at 600Mc/s and microphone leads employing lap-screening are items of special interest

in the wide range of "Davu" wires and cables on this stand. [564]

*J. Day & Co. (Derby Works) Ltd., and L.P.S. Electrical Co. Ltd., Harrow Manorway, Abbey Wood, London, S.E.2.*

**DIAL ENGINEERING (102)**

Clamps, shrouds, end frames and allied transformer parts are on show. Of special interest is a range of miniature "C" core clamps. [565]

*Dial Engineering Co. Ltd., Kingston Street, Chestergate, Stockport.*

**DIAMOND H CONTROLS (254)**

Hermetically-sealed relays and time-delay units form the basis of this display. Typical examples of the relays are the Series BR and BS 4-pole change-over types, which are used for aircraft and guided-weapon applications. Time-delay units are available to cover the range 50msec to 15 minutes with various mountings. Toggle switches, neon indicators and a range of heavy-duty rotary switches are also exhibited. [566]

*Diamond H Controls Ltd., Gunnersbury Avenue, London, W.4.*

**DERRITRON GROUP (150)**

Products of six companies in the Derritron group are to be found on this stand. A complete range of electromagnetic vibrators is manufactured by Derritron Electronic Vibrators for vibration testing systems. The standard series of vibrators covers thrusts from 40lb to 3,000lb. The instruments shown by Derritron Instruments are all related to component testing. New items include a digital Wheatstone bridge (Model E3378) with an instant digital readout and a limit bridge (E3381) for resistor batch testing. High-power amplifiers for vibration testing systems are the main product of Derritron Ultrasonics. Derritron Transformers are showing examples of some special windings. The other two companies are Beme Telecommunications, which produces encapsulated components, and Reslosound whose exhibits are dealt with separately. [567]

*Derritron Group, 24 Upper Brook Street, London, W.1.*

**DUBILIER (274)**

Capacitors, fixed and variable resistors, suppressors and pulse-forming networks are displayed. The range of capacitors includes tantalum electrolytic, foil-paper and metallized-paper types, some of them intended for printed-circuit use. [568]

*Dubilier Condenser Co. (1925) Ltd., Victoria Road, London, W.3.*

**DURATUBE AND WIRE (225)**

A large range of Durawires and Duracables are shown, they include single and multicore, solid or flexible conductors. The insulations available include p.v.c., polythene and

*(Continued on page 271)*

p.t.f.e. In addition to wires and cables, p.t.f.e. insulating sleeving and p.t.f.e. coated glass fibre, lacing tapes and cords are exhibited. [569]

*Duratube and Wire Ltd., Central Way, Faggs Road, Feltham, Middx.*

#### E.M.I. (482)

Two electronic components which have only recently been made available to industry—a new type of push-button switch (with up to 12 change-over contacts per button and up to 14 buttons in a single frame) and a range of high-reliability capacitors—are on show for the first time. Other items on show include magnetic recording heads, various valves and tubes for industrial and scientific applications—including a new vidicon tube with a fibre optic faceplate—and a selection of “Creeth” case assemblies and stand-off insulators.

Emitape, a product of EMI Tape Ltd., is also on show. There are four grades and six spool sizes to suit the requirements of the tape recorder and tape record manufacturer, and also a grade for computer and instrumentation purposes (in two thicknesses and lengths up to 7,200ft). Other products of EMI Tape Ltd. include Emifilm (a sprocketed recording medium), Emitape for video recording, and Emidisc lacquer recording blanks. [570]

*E.M.I. Electronics Ltd., Hayes, Middx.*

#### E.R.A. (100)

The Association's research in fields affecting the radio and electronics industry is illustrated. The examples include the results of life tests on impregnated plastic film capacitors and performance data on fixed resistors. In the field of microelectronics the Association has outlined a programme aimed at providing basic background information for manufacturers for the production of components and thin film devices. [571]

*Electrical Research Association, Cleeve Road, Leatherhead, Surrey.*

#### ECLIPSE (203)

Permanent magnets for measuring instruments and waveguide isolators; magnetic strip and sheet, in plastics and rubber (bonded Ferroba); and loudspeaker and television magnets are displayed. The company is featuring magnets of standard tooled-up designs, which can be assembled with limitless pole-pieces. [572]

*James Neill & Co. (Sheffield) Ltd., Napier Street, Sheffield 11.*

#### EDDYSTONE (151)

Among the new items on the stand are two panoramic display units, types EP.14 and EP.15. The former is a general purpose mains operated display unit intended for use with the “770” range of communications receivers. However, it can be used

with any v.h.f./u.h.f. receiver having intermediate frequencies in the range 5-60Mc/s. The EP.15 is intended for receivers having intermediate frequencies of the order 100-800kc/s. In both units, provision is made for camera mounting and both are suitable for mounting in a standard 19-in rack. [573]

*Stratton and Co. Ltd., Eddystone Works, Alvechurch Road, Birmingham 31.*

#### EGEN (259)

A comprehensive range of components for domestic radio and television receivers, together with examples of custom-built electrical equipment and small repetition electro-mechanical assemblies, are on show. Their range of components includes carbon and wirewound potentiometers and mains switches.

They are also exhibiting a v.h.f./u.h.f. aerial isolation unit, which provides full aerial isolation for a.c./d.c. television receivers. [574]

*Egen Electric Ltd., Charfleet Industrial Estate, Canvey Island, Essex.*

#### ELAC (209)

Electro Acoustic Industries are showing their comprehensive range of loudspeakers and transformers to-

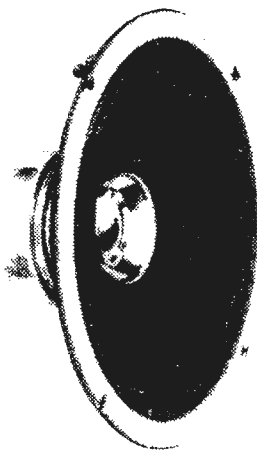

One of Elac's two new loudspeakers (8in) which has a ceramic magnet and a metallized plastic film tweeter cone.

gether with television receiver coil assemblies including line and frame output transformers. [574]

*Electro Acoustic Industries Ltd., Stamford Works, Broad Lane, Tottenham, London, N.15.*

#### ELCOM (485)

An electronic fader unit and complete mixer systems for broadcast and recording studios are the principal products of this firm. [576]

*Elcom (Northampton) Ltd., Weedon Road, Industrial Estate, Northampton.*

#### ELECTRO METHODS (353)

Printed circuit connectors and a wide range of miniature plugs, sockets and multi-way connectors constitute the main part of the exhibit. [577]

*Electro Methods Ltd., Electrical Connector Division, Hitchin Street, Biggleswade, Bedfordshire.*

#### ELECTROLUBE (111)

The standard range of Electrolube products, synthetic lubricants and grease, is on display. Technical data on an Aerosol grease which is to be introduced later in the year is available. [578]

*Electrolube Ltd., Oxford Avenue, Slough, Bucks.*

#### ELECTRONIC MACHINE CONTROL (460)

Samples of their new solid-state a.c. switching device Quantrol are being demonstrated. They are also showing a selection of industrial control equipment including high and low speed counters and batch counters in various forms. Other items on show include a Contimitor continuous level indicator, Proximitor capacitance operated relay, Pulsimitor electronic switch, Incrementor incremental capacity meter, Proxitran transistorized level control switch, and a Limitor transistorized proximity switch. [579]

*Electronic Machine Control Ltd., Mayday Road, Thornton Heath, Surrey.*

#### ELECTROSIL (275)

The Electrosil display is devoted to their range of metal oxide resistors, with the introduction of triple ratings being the main feature. The rating system allows the same resistor to be used either for semi-precision, high-stability or general-purpose applications, according to the rating applied. The ohmic range has been extended, by employing new spiralling techniques, and their range of NJ60  $\frac{1}{4}$ W and CJ20  $\frac{1}{2}$ W resistors has been increased to 10 $\Omega$ -470k $\Omega$  and their NJ60  $\frac{1}{4}$ W series has been extended to 1M $\Omega$ . Other items on show include insulated power resistors (up to 7 watts) and Multiform glass piece parts suitable for a variety of insulating roles where high voltages and temperatures are present. [580]

*Electrosil Ltd., Colnbrook By-Pass, Colnbrook, Slough, Bucks.*

#### ELECTROTHERMAL (204)

The company's new series (G101) all-moulded precision wirewound resistors, which have a stability of better than  $\pm 0.03\%$  and are available with either axial, radial or tag terminations have pride of place. They are also showing environmental test chambers as well as their range of component accessories. [581]

*Electrothermal Engineering Ltd., 270 Neville Road, London, E.7.*

#### ELLIOTT-AUTOMATION (172)

Three Elliott-Automation companies are jointly exhibiting on this stand: Elliott Bros. (London) Ltd.; C. P. Clare Ltd.; Elliott-Litton Ltd. Among the new items there are a range of Minilog logic elements (half the size of earlier elements and up

to five times faster), associated power supply units (capable of driving up to 18 Minilog logic elements), a direct-reading wavemeter covering the range 8.2Gc/s to 12.4Gc/s, a "Farite" conductive plastic track potentiometer, a magnetic-tape instrumentation system, and magnetic-tape loop mechanisms. [582]

*Elliott-Automation Ltd., 34 Portland Place, London, W.1.*

#### ENALON (317)

Small injection mouldings, machined and stamped parts and fibre-glass reinforced instrument cabinets are on show. [583]

*Enalon Plastics Ltd., South Premier Works, Drayton Road, Tonbridge, Kent.*

#### ENGINEERING ENTERPRISES (467)

New items this year include a range of "D-type" handles designed to meet the requirements of the electronic instrument industry. Engineering Enterprises are manufacturers and stockists of all types of metal, plastic and rubber components used in the TV, radio and audio fields. They also handle cabinet and case components, and continuous hinges (up to 72in long).

Their trim section includes several hundred patterns. [584]

*Engineering Enterprises (London) Ltd., 144-5 Shoreditch High Street, London, E.1.*

#### ENGLISH ELECTRIC VALVE (311)

Components for transmission rather than reception are produced by E.E.V. Of special interest is a new series of 40-ampere high-voltage vacuum variable capacitors with tunable capacitances within the range 5 to 750pF, together with other types having capacitances up to 2000pF. A new magnetron (M514) for marine radar equipment, having a peak output power of up to 20kW, is introduced at the show. High-power klystrons, and 25kW tubes specially developed for Bands IV and V, are featured with a range of associated accessories. Television camera tubes include the 4½-inch and 3-inch image orthicons and 1-inch vidicons. [585]

*English Electric Valve Co. Ltd., Chelmsford, Essex.*

#### ENTHOVEN (267)

A range of activated resin-cored solders in strip and wire form, fluxes and solder paints are to be seen. A demonstration is provided of the use of solid and flux-cored solder preforms designed for specific production requirements. A display panel shows the use of solder preforms as semiconductor heat sinks, and the new Thermacon strip for the fabrication of heat sink preforms. [586]

*Enthoven Solders Ltd., Dominion Buildings, South Place, London, E.C.2.*

#### ERG (262)

Among the newly introduced components is the AB1434 miniature reed relay. It is intended for applications where encapsulation is not used, for instance when the very high surface resistance of the glass must be realized.  $10^{15}\Omega$  open-circuit resistance can then be obtained. In the range of precision and power resistors are encapsulated precision wire resistors and subminiature types designed to NATO specifications. Transformers are well represented, and an engineer is available to answer questions. [587]

*ERG Industrial Corporation Ltd., Luton Road, Dunstable, Bedfordshire.*

#### ERIE (205)

A number of new components are included among the exhibits. "Micro-cap" ceramic capacitors available in four values, 1,000pF, 2,200pF, 4,700pF and 10,000pF with a working temperature range of  $-40^{\circ}\text{C}$  to  $+85^{\circ}\text{C}$  and a working voltage of 30 may be seen. Other new types include silvered-mica plate capacitors, subminiature axial-lead capacitors and "Transcap" capacitors. These latter types employ a barrier layer technique to achieve a high capacitance, small size and low working voltages required for transistor applications. Metal-oxide, high-stability resistors, developed to DEF5114 specification, form part of the display. [588]

*Erie Resistor Ltd., South Dene, Great Yarmouth, Norfolk.*

#### EVER READY (101)

They are showing their comprehensive range of batteries for use with all devices utilizing transistors. Berc International Ltd., who cover the export side, are represented on the stand. [589]

*Ever Ready Co. (G.B.) Ltd., Hercules Place, Holloway, London, N.7.*

#### EVERSHED & VIGNOLES (107)

Examples from some two thousand different types of servo motors, motor generators, generators and geared units are on display. Other examples on show include semiconductor amplifiers with outputs from 8 to 100 watts, valve amplifiers, power packs and the Evershed range of "Megger" test instruments. [590]

*Evershed and Vignoles Ltd., Devonshire Works, Dukes Avenue, London, W.4.*

#### FANE (356)

Ceramic-type magnets are employed in a new range of 12in, 15in and 18in heavy-duty loudspeakers introduced at the show. Also on show is the standard range of "domestic" speakers (from 2in to  $8 \times 5$ in) in which a new system of magnet construction is employed. [591]

*Fane Acoustics Ltd., Hick Lane, Batley, Yorks.*

#### FERRANTI (309)

Several complete integrated circuits are shown which consist of transistors and resistors contained in a shortened version of a normal TO-5 transistor package. Broadly, two types of circuit are available, linear amplifiers and logic circuitry. Field-effect transistors and silicon strain gauges can be seen, and a range of microwave components is displayed. [592]

*Ferranti Ltd., Hollinwood, Lancashire.*

#### FLOFORM (260)

Items of particular interest in the Floform range of brazed steel and copper assemblies supplied to the electronics industry at this year's show include rectifier studs made from zirconium o.f.h.c. copper and power transistor bases in oxygen-free high conductivity copper. [593]

*Floform Parts Ltd., Lion Works, Pool Road, Newtown, Mont.*

#### FORMICA (316)

A new Formica glass/epoxy copper-clad laminate, C.G.E.70, is on show for the first time. Features of this new material include greater retention of mechanical properties at very high temperature, high level of bond strength between foil and laminate after thermal shock, and its suitability for plating with the precious metals used in printed circuitry. Paper and glass based copper-clad laminates are also on display. [594]

*Formica Ltd., De La Rue House, 84/86 Regent Street, London, W.1.*

#### FORTIPHONE (354)

In addition to their range of type-approved miniature transformers and 2-pole and 4-pole relays, Fortiphone are exhibiting the bone conduction transducer which they are supplying to the Admiralty for a diver-to-diver communication system. [595]

*Fortiphone Ltd., 125-9 Middlesex Street, London, E.1.*

#### FOX (351)

Toroidal variable resistors on ceramic formers, in ratings from 10 to 1,000 watts, and a wide range of helical and precision potentiometers are displayed. [596]

*P. X. Fox Ltd., Hawksworth Road, Horsforth, Yorks.*

#### G.E.C. (161)

Examples of their wide range of electro-mechanical equipment is on show. Items of particular interest include a "Both-way Uniselect" (which will step in either direction by either self-cycling or impulse drive), a high-speed miniature Uniselect, and a comparatively small and inexpensive ratchet relay. [597]

*The General Electric Co. Ltd., Telephone Works, Coventry, Warwickshire.*

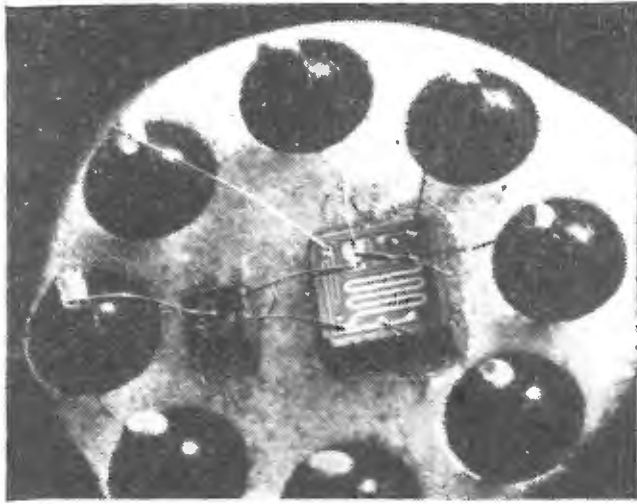

Interior of Ferranti "Micro-lin" silicon integrated linear amplifier, contained in shortened JEDEC TO5 can.

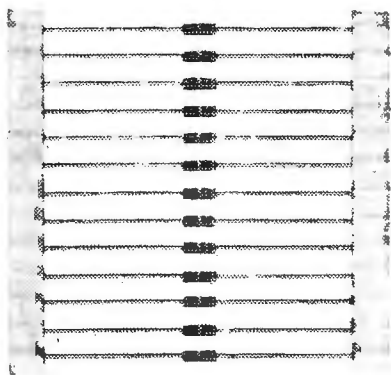

Resistors from the Erie range.

**G.K.N. (260)**

A representative selection of G.K.N. screws and fasteners are on show. Ionic Plating, a subsidiary company, are showing examples of plating. The company's service includes a specially equipped precious metal plating department able to handle the most delicate electronic components in gold, silver and rhodium. Another associated company, Haddon & Stokes, who specialize in the production of rolled head machine screws and cold-headed pattern parts, are also participating. [598]

G.K.N. Screws & Fasteners Ltd., P.O. Box 24, Heath Street, Birmingham 18.

**GARDNERS (472)**

A new range of resin-cast e.h.t. transformers, which are smaller than the conventional oil-filled type, have been introduced by Gardners. Known as the Forest series they are for working voltages of up to 50kV d.c. The company are also showing low-power (50W-1kW) controlling saturable reactors. The two standard ranges each incorporate series/parallel load coils.

Two versions of a new range of microphone and audio line-matching transformers are on show. One, the octal-based plug-in amplifier input and line matching transformer, is for professional recording and broadcasting equipment and the other, which

Below: Resin cast e.h.t. transformer measuring 8.5 x 7.5 x 12 in high for 40kV d.c. working (Gardners).

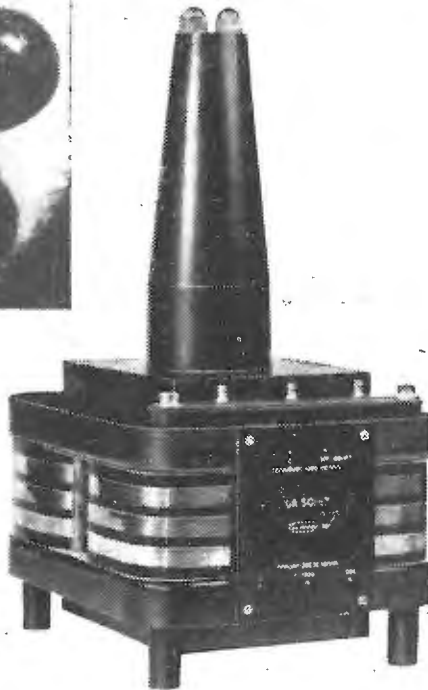

is available with a B7G base or B.S.F. fixing bush, is for non-professional audio equipment. [599]

Gardners' Transformers Ltd., Somerford, Christchurch, Hants.

**GARRARD (50)**

Record players and changers, pickups and fractional-horsepower motors are all shown, one of the most interesting exhibits being the AT.6 high-quality record changer. A heavy turntable and transcription-quality pickup is used, and the stylus pressure is adjusted so that there is no variation from first to last record. Various tape decks are on show, including an automatic deck for commentaries or telephone answering purposes. [600]

Garrard Engineering & Manufacturing Co. Ltd., Newcastle Street, Swindon, Wiltshire.

**GENERAL CONTROLS (408)**

Precision wirewound potentiometers, in a variety of types of winding, digital counters and miniature wirewound controls (with ratings of 2 and 3W although less than 1in in size) are among a wide range of components and parts. [601]

General Controls Ltd., 13/15 Bowlers Croft, Honywood Road, Basildon, Essex.

**GOLDRING (221)**

A stereo ceramic pickup cartridge (Model CS90), with a frequency response up to 20,000 c/s, has been added to Goldring's range of crystal, magnetic and ceramic cartridges for both mono and stereo. Replacement sapphire and diamond styli are also

produced for all known makes of pickup. [602]

Goldring Manufacturing Co. (Great Britain) Ltd., 486-488 High Road, London, E.11.

**GEORGE GOODMAN (260)**

They are exhibiting a comprehensive range of components moulded in all thermoplastic materials, including Delrin, nylon, polypropylene and polycarbonate. Also featured is a selection of miniature zinc alloy die-cast products and Insulgrip, a unique fastening device for use with the majority of commonly used sheet materials. [603]

George Goodman Ltd., Robbin Hood Lane, Hall Green, Birmingham 28.

**GOODMANS INDUSTRIES (223)**

A selection of vibration generators accompanied by the associated driving and monitoring equipment is demonstrated by the vibrator division. The VG.1K, Mark 1 has a maximum thrust of over 1,000 lb and an excursion of 0.5in. The loudspeaker division is showing a selection of units as used by the radio and television industry, public address reproducers and high-fidelity loudspeakers. [604]

Goodmans Industries Ltd., Axiom Works, Wembley, Middx.

**GREENCOAT (413)**

An extensive range of battery-operated record players and 3- and 6-pole d.c. motors are on show. New items include a three-speed record changer and a three-speed record player. [605]

Greencoat Industries Ltd., 118 Southwark Street, London, S.E.1.

**GREENPAR (109)**

Coaxial connectors are the speciality of this company and a wide variety of types and sizes is shown. [606]

Greenpar Engineering Ltd., Station Works, Cambridge Road, Harlow, Essex.

**GRESHAM TRANSFORMERS (462)**

In addition to a wide range of transformers up to 2kVA, examples of encapsulated resistor networks are shown. The company is also producing a range of multi-track magnetic recording heads to the specifications of the S.B.A.C. and I.R.I.G. (American Inter-Range Instruments Group). [607]

Gresham Transformers Ltd., Lion Works, Hanworth Trading Estate, Feltham, Middx.

**GULTON INDUSTRIES (411)**

The range of components is based on the application of extremely thin sheet ceramic materials. Components employing these materials include capacitors and ultrasonic transducers, one example of the latter being in the form of a one-piece five-inch sphere with one small access hole.

High-permittivity and temperature-compensating capacitors are shown, and a complete range of thermistors is displayed. Also on show are ranges of low-noise cables and connectors, and lightweight airborne vibration-analysis equipment. [608]

*Gulton Industries (Britain) Ltd., 52 Regent Street, Brighton, Sussex.*

**HALLAM, SLEIGH & CHESTON (231)**

Makers of the Widney Dorlec system of metal cabinet construction using standardized components, including a range of telescopic slides, from which equipment housing to any specification can be quickly assembled. [609]

*Hallam, Sleigh and Cheston Ltd., Widney Works, Bagot Street, Birmingham 4.*

**HARWIN (300)**

A new digital indicator is shown, which uses twelve optical display plates directly edge lit by J/S midget bulbs. Advantages claimed over indicators using bent plates are increases in brightness and sharpness of the display. [610]

*Harwin Engineers Ltd., Rodney Road, Portsmouth, Hants.*

**HASSETT & HARPER (57)**

Specialists in the design and manufacture of desks, cabinets and consoles in enamelled steel to customers' requirements. A standard range is also available. [611]

*Hassett & Harper Ltd., Regent Place, Birmingham 2.*

**HELLERMANN (153)**

The Hellermann group of companies are showing several new products and a number of these are demonstrated. Hellermann Electric Ltd. are exhibiting their range of sleeves and cable markers together with their new cable strapping "Helastrap" and new Sleevemaster and rotary wire stripper machines. Hellermann Terminals Ltd. are showing their extended range of terminals and hand, and bench mounted, compression tools together with their new Hellermann Malco wire wrap system for putting stand-off posts into printed circuit boards. They are also demonstrating, for the first time, their new portable electro-hydraulic crimping unit—the Auto Crimp. Hellermann Plastics Ltd. are displaying their range of cabinets and components together with a wide range of plastic extrusions and handles. Hellermann Equipment Ltd. are showing the latest model in their range of Dymo Tapewriters—the Dymo M55. Hellermann Deutsch Ltd., are exhibiting their comprehensive range of Bambi, H.A.N. and Deutsch standard, miniature and sub-miniature connectors. [612]

*Hellermann Ltd., Gatwick Road, Crawley, Sussex.*

*Helical u.h.f. serial by J-Beam. No insulators are used to support the radiating system and the whole aerial is at d.c. earth potential.*

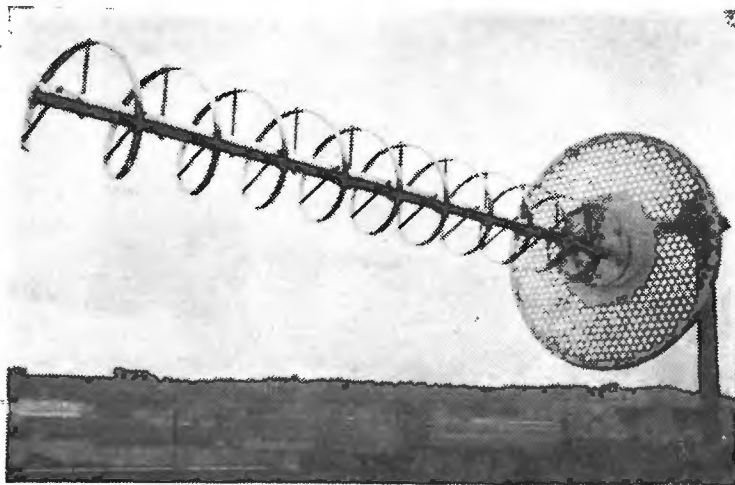

**HINCHLEY (279)**

Examples from their full range of commercial transformers for the electrical and electronics industries, including some with special mountings for printed circuit applications, are on show. Constant-voltage transformers and new types of portable isolating transformers in robust steel cases are also featured together with a number of small d.c. power units and battery chargers. [613]

*Hinchley Engineering Co. Ltd., Pans Lane, Devizes, Wiltshire.*

**HIRST ELECTRONIC (477)**

Hirst Electronic are showing their miniature and microminiature welding heads together with ancillary equipment including a battery-operated cycle counter, glove boxes, and a self-contained clean air box. Other items of interest include capacitor discharge magnetizing equipment, transistor d.c. power amplifiers rated at 20 and 100 watts, a surge suppression indicator (a test instrument to determine the optimum values of capacitance and resistance required to suppress switching transients in semiconductor circuits), and samples of resin casting and encapsulation of circuits and components. [614]

*Hirst Electronic Ltd., Gatwick Road, Crawley, Sussex.*

**HUGHES INTERNATIONAL (489)**

A wide range of planar devices, including their current series of diodes, p-n-p and n-p-n complementary transistors are on show together with working demonstrations of complementary transistors. Other exhibits include a display of gold-bonded and silicon computer diodes, examples of microelectronics (modules made using the Hughes welding system and standard miniature components) and several forms of thin film applications. They are also showing a new range of solid-state constant-current regulator devices, which have a current limiting action comparable to the voltage limiting action of Zener diodes. [615]

*Hughes International (U.K.) Ltd., Glenrothes, Fife.*

**HUNTS (163)**

Capacitors for most electronic applications are shown. As well as the more established electrolytics, tantalum types of foil and slug construction may be seen. The new developments include samples of the Hunt "Dipseal" range which are resin impregnated and resin cased, all with a 100°C rating. The metallized lacquer capacitors from 0.5 to 10 $\mu$ F represent, in the opinion of the manufacturers, the present optimum in miniaturization consistent with high performance. [616]

*A. H. Hunt (Capacitors) Ltd., Bendon Valley, Garratt Lane, Wandsworth, London, S.W.18.*

**I.C.I. (487)**

The Plastics Division of I.C.I. are displaying a wide range of their plastic materials for the radio and electronics industries. These include Perspex acrylic sheeting, Darvic rigid p.v.c. sheeting and Melinex polyethylene terephthalate film. [617]

*Imperial Chemical Industries Ltd., Plastics Division, Bessemer Road, Welwyn Garden City, Herts.*

**IMHOF (156)**

Prominent among the standard range of racks, consoles, cases and accessories, is the Imkit sectional chassis system—a completely new system offering versatility in chassis design and layout. [618]

*Alfred Imhof Ltd., Ashley Works, Cowley Mill Road, Uxbridge, Middx.*

**INSULATING COMPONENTS & MATERIALS (493)**

One of the new activities of this company is in the manufacture of polyester shrink sleeving (Synshrink). There is an extensive display of their industrial plastic components ranging from commercial paper base laminate stampings to high-temperature glass reinforced machinings and mouldings. [619]

*Insulating Components & Materials Ltd., 10-18 Sandgate Street, Peckham, London, S.E.15.*

**INSULOID (451)**

The firm's cradleclips and miniature cradleclips together with plastic and

nylon cable clips are shown. Other items on show include their adjustable saddles, Insulok cable ties, nylon ring lock bushes and Flexiguard cable protectors. [620]

*Insuloid Manufacturing Co. Ltd., Sharston Works, Leestone Road, Wythenshawe, Manchester.*

#### INTERNATIONAL ELECTRONICS (480)

Among the power units introduced at the show is the very high stability reference unit which has an output voltage in the region of 100V and is capable of supplying currents of the order of 100mA. This and the bench power supply unit, which has an output continuously variable from 0 to 50V at 0.5amp, are of modular construction. [621]

*International Electronics Ltd., 132-135 Sloane Street, London, S.W.1.*

#### J. B. (268)

The whole range of J.B. variable capacitors, drives, stand-off insulators and ceramic insulated terminal strips can be seen. New components are a dual-ratio ball drive, epicyclic cord drives and miniature air-dielectric trimmer capacitors on a  $\frac{3}{8}$ in square siliconed ceramic base. The dual-ratio ball drives were inspired by the need for small slow-motion drives for tuning u.h.f. television tuners. [623]

*Jackson Brothers (London) Ltd., Kingsway, Waddon, Surrey.*

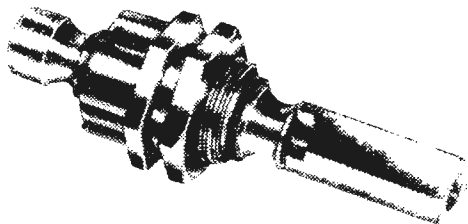

*J. B. epicyclic reduction drive.*

#### J. & S. ENGINEERS (461)

The exhibit is concerned with the fixing of terminals and components to chassis or laminates. Insulating bushes, solder-tags, components, etc., are punched directly into the base material, the components themselves acting as punches. The process is termed JASTAC, and is for the insertion of hard material into relatively soft sheet. A different process, JASFLO, is used when, for instance, a nylon bush is to be punched into a steel sheet. [624]

*J. & S. Engineers Ltd., 1A, London Road, Crayford, Kent.*

#### J-BEAM AERIALS (174)

A helical aerial, co-linear arrays and  $\frac{3}{8}$ th wave mobile-radio whip are the latest additions to the wide range of domestic and "professional" aerials produced by J-Beam. The helical aerial, which although designed for the transmission or reception of cir-

cularly polarized waves can be used for the reception of plane polarized signals, is most suitable for frequencies above 300 Mc/s, has a bandwidth of 1.4:1 and a front-to-back ratio of the order of 20dB. Designed to increase the service area of the base station in a mobile radio system the omni-directional co-linear array employs a number of radiating members in a vertical stack. The elements are supported in a synthetic resin bonded fibreglass sleeve and the connections to them are enclosed in polythene. [625]

*J-Beam Aerials Ltd., Westonia, Weston Favell, Northampton.*

#### K.G.M. ELECTRONICS (52)

Exhibits indicative of the firm's wide range of interests include mechanical and electronic counters, v.h.f./u.h.f. test equipment, a motor speed control unit and a wide range of illuminated indicator panels and mimic diagrams. [626]

*K.G.M. Electronics Ltd., Bardolph Road, Richmond, Surrey.*

#### LABGEAR (115)

Labgear are showing their range of wire wound resistors together with their wide range of aerials and associated equipment. Items of particular interest include a subminiature radio microphone complete with receiver attachment for a public address system, a transistorized 1c/s-1Mc/s double pulse generator, and a u.h.f. signal strength meter. [628]

*Labgear Ltd., Cromwell Road, Cambridge.*

#### LANGHAM THOMPSON (138)

The latest range of semiconductor strain gauges and a range of new transducers embodying these gauges for the measurement of pressure, load and tensile force are on show. They are also exhibiting transducers for the measurement of acceleration, vibration, pressure, force and displacement, together with assorted instrumentation, including amplifiers, a range of balance units, indicators and controllers. A new range of miniature power supply units, both pre-set and variable, are on show together with a range of transistor voltage regulators. [629]

*J. Langham Thompson Ltd., Park Avenue, Bushey, Herts.*

#### LEMCO (219)

In addition to the full range of their own capacitors, which includes silvered mica, silvered ceramic, mica, polyester, and polystyrene capacitors, Lemco are also showing a range of subminiature and miniature electrolytic capacitors from a subsidiary, the Universal Capacitor Company. [630]

*London Electrical Manufacturing Co. Ltd., Bridges Place, Parsons Green Lane, London, S.W.6.*

#### LEWCOS (214)

A comprehensive range of their insulated wires and strips, enamelled wires, high-temperature winding wires, and superfine self-fluxing wires are displayed. [631]

*The London Electric Wire Company & Smiths Ltd., Church Road, Leyton, London, E.10.*

#### LEWIS SPRINGS (110)

Exhibits include high-quality coil springs, flat metal pressings, clips, transistor mounting clips and heat sinks, electrical contacts and light metal assemblies. [632]

*Lewis Spring Co. Ltd., Redditch Worcs.*

#### LINTON & HIRST (492)

Transformer laminations in all grades of silicon iron, grain oriented material and nickel iron alloys are on show. The company is also exhibiting toroidal cores and "C" Cores. The associated company, Redpoint Ltd., is also represented. [633]

*Linton and Hirst Ltd., Parsonage Road, Stratton St. Margaret, Swindon, Wilts.*

#### LIVINGSTON LABORATORIES (315)

Equipment designed for electronic measurement and component testing manufactured by Tektronix, Hewlett Packard, HCD Research, Ampex, Avo, Levell Electronics, Roband Electronics, Servomex and Telequipment is demonstrated. Mullard "Combi" and "Norbit" elements are exhibited. Also on show is equipment manufactured by Livingston Control—a manufacturing division of Livingston Laboratories. [634]

*Livingston Laboratories Ltd., 31 Camden Road, London, N.W.1.*

#### LONG & HAMBLY (227)

Specialists in rubber, silicone and polyurethane mouldings for the radio and electronics industries. Products include special sulphur-free rubbers and also bonded rubber-to-metal work. [635]

*Long and Hambly Ltd., Slater Street, High Wycombe, Bucks.*

#### LUSTRAPHONE (266)

The new G.P.O. approved radio microphone with its associated equipment is exhibited. Other new products include a miniature cheek or throat electromagnetic microphone and a sub-miniature ribbon "Lavalier" microphone with adjustable neck halter for specialized applications in theatres, recording studios and lecture halls. [637]

*Lustraphone Ltd., St. George's Works, Regent's Park Road, London, N.W.1.*

#### M.C.P. ELECTRONICS (475)

They are exhibiting their range of diodes for computer applications, including their series of germanium



gold-bonded types. Other exhibits include demonstrations of their gallium arsenide infra-red emitting devices together with their indium antimonide and indium arsenide Hall effect devices. [638]

*M.C.P. Electronics Ltd., Station Wharf Works, Alperston, Middx.*

#### M-O VALVE (161)

Four new double-gun cathode-ray tubes, for high-grade oscilloscope work, and two mixed-gas half-wave rectifiers with a peak inverse voltage of 13kV are introduced at the Show. Among the very wide range of the company's products shown are a number of travelling-wave tubes, including the E3025 for use in 1800-channel 6,000-Mc/s communication systems. The Ophitron, an electrostatically focused backward-wave oscillator, is demonstrated. [639]

*M-O Valve Co. Ltd., Brook Green Works, London, W.6.*

#### McMURDO (217)

Numerous examples from their comprehensive range of plugs and sockets, valve holders, crystal sockets, transistor sockets, etc., are displayed. New items this year include several microconnectors and valveholders. [640]

*The McMurdo Instrument Co. Ltd., Rodney Road, Portsmouth, Hants.*

#### MAGNESIUM ELEKTRON (470)

The display illustrates the various methods of fabricating magnesium, including castings, press die-casting and wrought work. [641]

*Magnesium Elektron Ltd., Bridge-water House, St. James's, London, S.W.1.*

#### MAGNETIC DEVICES (366)

Electro-magnetic control equipment is the speciality of this company. Among the new items at the exhibition are sequence timers, Varicon printed circuit connectors, heavy duty relays and an "intrinsically safe" relay unit meeting Government specifications covering pentane, ethylene and hydrogen classes. [642]

*Magnetic Devices Ltd., Newmarket, Suffolk.*

#### MALLORY BATTERIES (361)

In addition to the range of mercury batteries, the smallest of which is about the size of an aspirin tablet, the exhibit contains examples of a new range, the manganese alkaline battery. These are made in five international 1.5V sizes, and are intended for heavy-current duties or applications where long periods of continuous use are required. [643]

*Mallory Batteries Ltd., Gatwick Road, Crawley, Sussex.*

#### MANSOL (265)

This company, and its associated Sintered Glass to Metal Seal Co., are showing sintered glass preforms for use with transistor headers, relay bases, etc. [644]

*Mansol (Great Britain) Ltd., Hollands Road, Haverhill, Suffolk.*

#### MARCONI INSTRUMENTS (166)

The accent on this stand is on the new series "2000" range of telecommunications measurement equipment. New instruments include oscillators and attenuators covering a.f. and m.f. ranges. These conform to a fixed shape and size enabling three units to be fitted side by side into a rack mounting case. All units can be used separately. Two new oscilloscopes, a television transmitter sideband analyser, two component bridges and a valve voltmeter complete the list of new instruments on show. [645]

*Marconi Instruments Ltd., St. Albans, Herts.*

#### MARCONI'S W/T (495)

Marconi's Wireless Telegraph are exhibiting a full selection from their range of components, including three new developments—a low-medium and a high power waveguide loads, and a water calorimeter. Among the exhibits is a comprehensive range of ferrite isolators, crystal filters, delay lines and crystal ovens. [646]

*Marconi's Wireless Telegraph Co. Ltd., Marconi House, Chelmsford.*

#### MARKOVITS (58)

Filigree cut-out nameplates finished in gilt or chromium plate are exhibited. New lines include two-tone

coloured injection-moulded high-impact plastic nameplates. [647]

*I. Markovits Ltd., 34, Stronsa Road, London, W.12.*

#### MARRISON & CATHERALL (474)

Examples from the wide range of permanent magnets made by this firm are shown. Also grain-oriented silicon-iron transformer cores of "E," "C" and toroidal types. [649]

*Marrison & Catherall Ltd., Forge Lane, Killamarsh, Sheffield.*

#### MEASURING INSTRUMENTS (PULLIN) (53)

Measuring Instruments' exhibit consists of a range of Cirscale meters up to 6in diameter, new edge-reading instruments, including one with a rotating dial, and a sub-miniature type with a  $\frac{5}{8}$ -in scale. R. B. Pullin are showing examples from their ranges of motors and transistor amplifiers. [650]

*Measuring Instruments (Pullin) Ltd., Electrin Works, Winchester Street, Acton, London, W.3.*

*R. B. Pullin & Co. Ltd., Phoenix Works, Great West Road, Brentford, Middlesex.*

#### METWAY (466)

Terminal block connectors in p.v.c., nylon, polythene, rubber, Bakelite and porcelain, rated from 5 to 100 amps, and in a variety of types of connections are shown. Blocks are available for up to 12 connections but several types can be built up into multi-way connectors. [651]

*Metway Electrical Industries Ltd., Canning Street, Brighton, 7.*

#### MICA & MICANITE (272)

Stamped, machined and fabricated parts in various resin-bonded laminates under the trade names "Ashlam" and "Lamalac," and mouldings in polyester resin fibreglass are displayed, together with laminates in sheets, rods, tubes, etc. [652]

*Mica & Micanite Supplies Ltd., Mica House, Barnsbury Square, London, N.1.*

#### MICROPONENT DEVELOPMENT (114A)

This recently formed company is specializing in the photo-etching of metals — "Etchengineering" — which can be used for the production of printed circuits or wiring. It is also applicable to the making of thin flat component parts in metal. [653]

*Microponent Development Limited, 55 Alcester Street, Birmingham 12.*

#### MIDLAND SILICONES (312)

New encapsulating materials exhibited include a flexible silicone resin, a self-healing dielectric gel which permits the insertion of test probes, and one-liquid cold-curing silicone rubber. Equipment used in

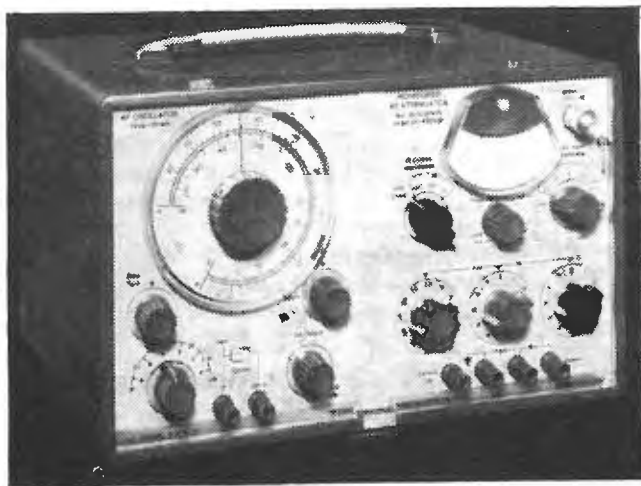

*Marconi Instruments of signal source Type TF 2000.*

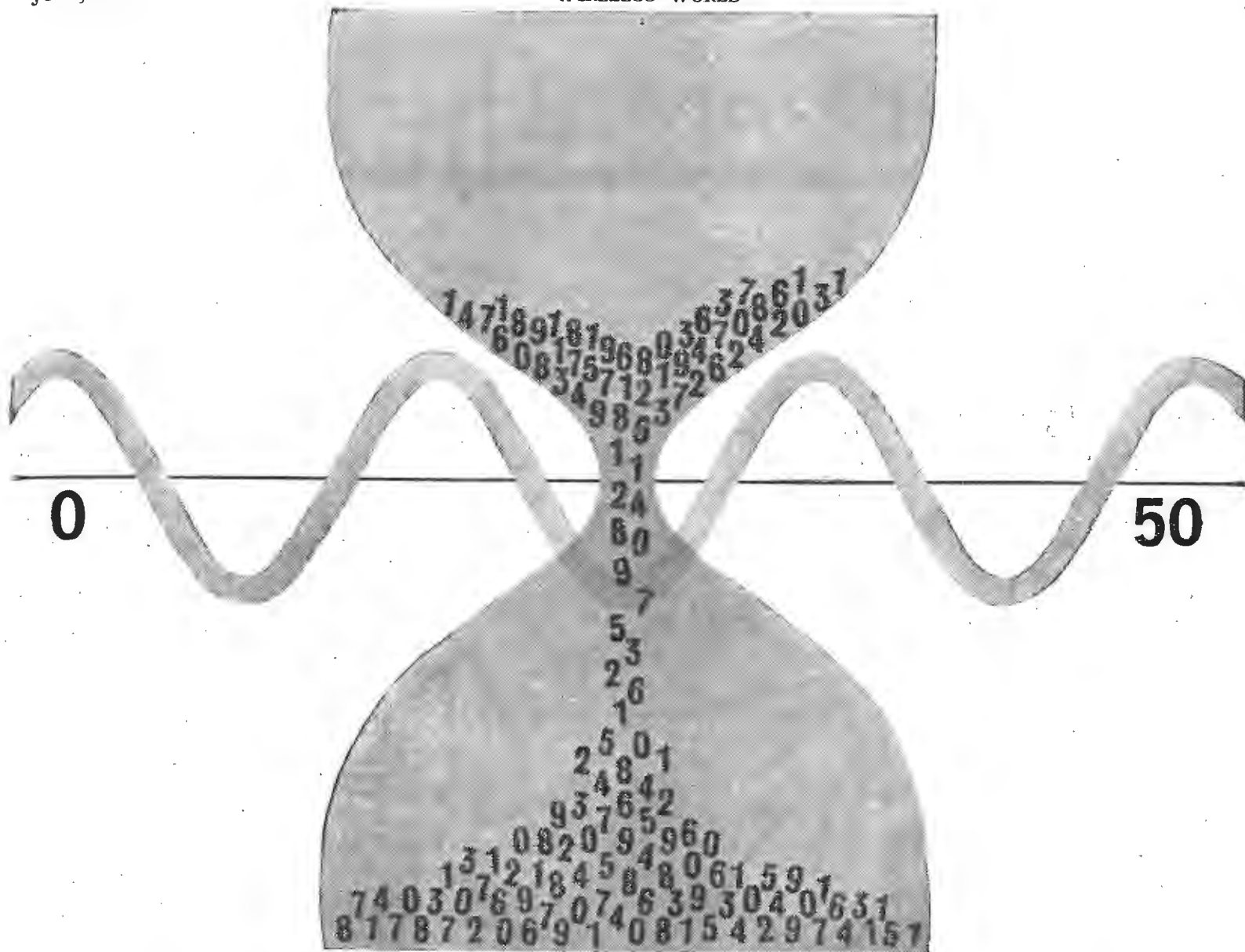

## Frequency 0 to 50Mc/s – Time or Period, 1 microsecond to over 3 years

The Airmec High Speed Counter Type 298 is a basically new, fully-transistorised instrument, covering the frequency range d.c. to over 50 Mc/s without the complication of additional plug-in units or external accessories. It offers in one compact unit a unique combination of facilities for time and period measurements, and for frequency measurement either by direct or inverse methods. The Indicator is a large 8-figure in-line display unit showing both the units of measurement and the decimal point, combined with a 5-digit resettable electro-mechanical counter. For permanent records of readings, there are facilities for operating an Airmec Printer Type 316 from the Counter.

The High Speed Counter Type 298 is part of the comprehensive range of high quality electronic instruments produced by Airmec for use in laboratories and workshops.

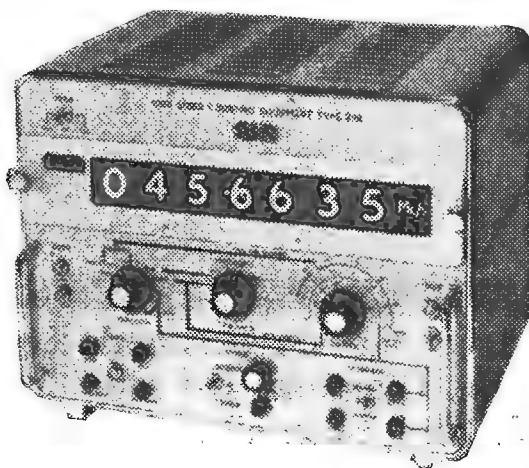

**SPECIFICATION**

D.C. to 50 Mc/s  
12 figure digital read-out  
Automatic indication of decimal point and units of measurement

**MEASURES**

Frequency, Time, Period

**COUNTS**

Pulse or Sinewave Inputs

**PROVIDES**

Standard Frequency Outputs at 1 and 10 Mc/s  
Divider Facilities  $10^{-1}$  to  $10^{-8}$   
Connection for external frequency standard  
Output to Airmec Printer Type 316 for digital print-out  
Self-checking facilities  
All these features are built-in, and are provided by the Counter without the need for external accessories.



# Airmec for peak performance consistently

LABORATORY INSTRUMENTS DIVISION - High Speed Counters, Signal Generators, Oscilloscopes, Wave Analysers, Phase Meters, Ohmmeters, Valve Voltmeters, etc.

AIRMEC LIMITED HIGH WYCOMBE BUCKS ENGLAND  
TELEPHONE HIGH WYCOMBE 2501 (10 LINES)

AP 265A

# ACOS ADVANCE | styli \*

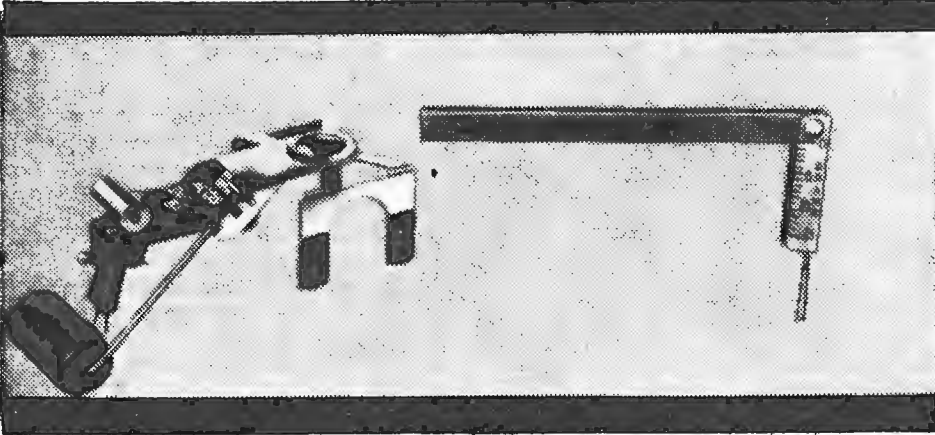
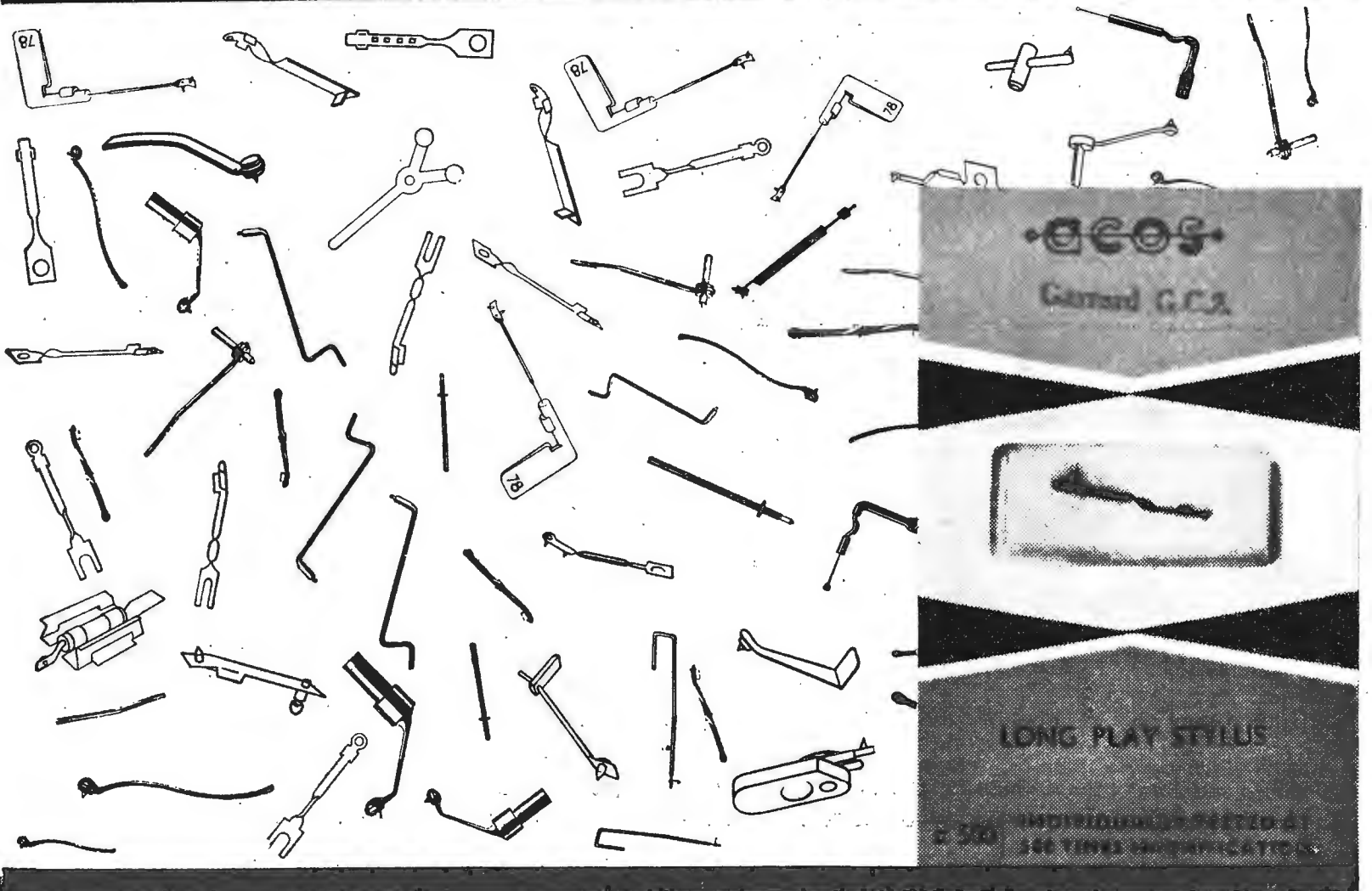

\* & changer dust bug  
& stylus pressure  
gauge

Acos continue to advance and be recognised. Recognised as the finest range of replacement styli now available. Diamond and sapphire, mono and stereo, there are now over 150 types of Acos x500 styli, to fit all makes of pick-ups and cartridges. There is one to fit *your* equipment. All Acos x500 styli are individually tested at 500-times magnification, yet they cost no more than other makes. Look for Acos styli in the characteristic pack. *Accessories after the fact:* Don't overlook the Acos Changer Dust Bug that sweeps all before it, and the Acos Stylus Pressure Gauge which stops pick-ups from throwing their weight about.

*Other Acos products: mono and stereo pick-ups, cartridges, microphones.*



**ARE DOING THINGS IN STYLI**

See us at the R.E.C.M.F. Exhibition, Stand No. 228

COSMOCORD LTD, WALTHAM CROSS, HERTS. TEL: WALTHAM CROSS 27331

aircraft and missiles demonstrate the range of application of the company's variety of new and established encapsulants. [654]

Midland Silicones Ltd., 68, Knightsbridge, London, S.W.1.

#### MINIATURE ELECTRONIC COMPONENTS (114)

Improved miniaturization is introduced by M.E.C. in their wirewound trimmer potentiometers with a saving of 40% of the volume. Types 031 and 015, available for from 10 ohms to 20k, measure  $\frac{3}{4}$ in long and have a max. power rating of 1.25W. Miniature single-pole changeover toggle switches with an overall diameter of  $\frac{1}{4}$ in and projecting only  $\frac{1}{4}$ in behind the panel are introduced. [655]

Miniature Electronic Components Ltd., St. Johns, Woking, Surrey.

#### MINING & CHEMICAL PRODUCTS (475)

Bismuth Telluride modules are on display together with a selection of their raw materials, which includes samples of vacuum baked indium, zone refined arsenic and antimony—with purities better than 99.999%. [656]

Mining & Chemical Products Ltd., 86 Strand, London, W.C.2.

#### MINISTRY OF AVIATION (318)

The theme of the exhibit is the design and production of electronic equipment capable of withstanding all extremes of use under the widely different conditions met in the field. Examples of tests on components by the manufacturers are demonstrated by members of the trade Associations (R.E.C.M.F., E.E.A. and V.A.S.C.A.). [657]

Ministry of Aviation, Strand, London, W.C.2.

#### MINNESOTA (463)

The "Scotch" range of insulating tapes, magnetic recording tapes and epoxy resins are displayed. The recording tapes include those for instrumentation, video and audio. The "Scotchcast 260" fast-curing epoxy resin for insulation and moisture proofing is being demonstrated. [658]

Minnesota Mining & Manufacturing Co. Ltd., 3M House, Wigmore Street, London, W.1.

#### MORGANITE (210)

Their full range of components including potentiometers, linear and non-linear resistors of different types, and high-stability resistors is displayed. Two new additions have been made to the range. These are "Filmet" metal-film resistors and new miniature carbon potentiometers. The high power absorbing material "Termilode" is also on show. [659]

Morganite Resistors Ltd., Bede Trading Estate, Jarrow, Co. Durham.

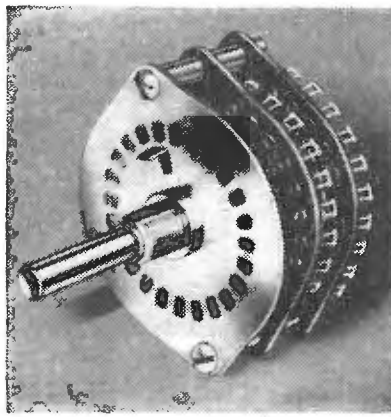

N.S.F. Oak switch from the "MF" range.

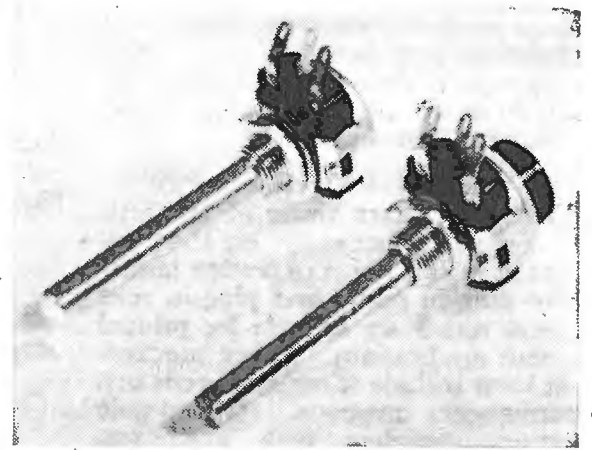

Two miniature carbon potentiometers from the Morganite range.

#### MOULDED FASTENERS (365)

In addition to the products implied by the firm's name a wide variety of small precision mouldings for use in micro switches, record players, cord drives, etc., are shown. [660]

Moulded Fasteners Ltd., 165-7 Beckenham Road, Beckenham, Kent.

#### MULLARD (308)

Mention can be made of but a few of the 40 or more new products and techniques covering valves, tubes, semiconductors and other components which are displayed. New valves include the low-noise triode, PC88, and complementary triode mixer, PC86, for u.h.f. receivers. A lightweight magnetron and a klystron for airborne X-band (7-11Gc/s) radar and a rugged miniature C-band (4-7Gc/s) magnetron for radar beacons are introduced.

In the semiconductor field there are new germanium and silicon power transistors (with operating voltages up to 100V and currents up to 30A), silicon planar transistors and diodes giving even lower leakage currents than previously found with silicon devices, and germanium and silicon S, X & Q-band mixers with improved noise factors. There is a new vidicon tube with  $\frac{1}{2}$ W cathode for transistor cameras, a cold-cathode counting tube for operation up to 50,000 p.p.s. and a 2.5A xenon thyatron for ignitron firing. [661]

Mullard Ltd., Mullard House, Torrington Place, London, W.C.1.

#### MULTICORE (301)

A new Ersin solder, containing less than half the usual percentage of flux and particularly suitable for the soldering of miniature components, is introduced at the Show. To promote the extra rapid spread of the smaller quantity of Type 362P flux and to deodorize the resin base an agent, "Pentacol," has been incorporated in the flux. Multicore are also showing a new automatic soldering machine for repetition work, which is primarily for single joints, but models can be supplied to make two solder joints per operation. [662]

Multicore Solders Ltd., Maylands Avenue, Hemel Hempstead, Herts.

#### MUREX (208)

Sintered permanent magnets and soft-iron pole pieces form the main part of the exhibit. Internal magnet assemblies are much improved by the use of the "Sincomax" technique, in which magnetic material and iron powder are pressed and sintered together to form magnet and pole-pieces in one mass. High-reluctance gaps are thereby avoided. A molybdenum furnace is shown, which employs tungsten elements, and is used for very high temperature vacuum work. [663]

Murex Ltd., Rainham, Essex.

#### N.S.F. (269)

A full range of the company's products is exhibited. This includes "Oak" and "Cutler-Hammer" switches, "Ledex" rotary solenoids and circuit selectors, "Union" miniature relays and "Centralab" carbon-track potentiometers. New products on show are a flexible 24-position rotary "Oak" switch, a 12-position ceramic section switch and a miniature rotary relay with 10-amp contact rating. [664]

N.S.F. Ltd., 31-32 Alfred Place, London, W.C.1.

#### NEWMARKET TRANSISTORS (115)

In addition to a comprehensive range of transistors, including n-p-n germanium alloy a.f. types, matching standard p-n-p types, this Pye company is showing a range of "packaged circuits." The range includes a general purpose 125mW audio amplifier (PC1), using complementary symmetry p-n-p/n-p-n circuits, and three others with outputs of 330mW. A semi-automatic tester for the production testing and grading of transistors is also on view. [665]

Newmarket Transistors Ltd., Exning Road, Newmarket.

#### NEWPORT INSTRUMENTS (360)

Samples of ferrite cores, chokes, pulse transformers, transfluxors and matrixes are on show. Other products of this company include specialist instruments for nuclear scientists,

electromagnetic clutches, brakes and reversing gear boxes. [666  
*Newport Instruments (Scientific & Mobile) Ltd., Crawley Road, Newport Pagnell, Bucks.*

**OLIVER PELL CONTROL (484)**

The Platt/Stearn range of magnetic brakes and clutches are on show together with a range of Varley miniature plug-in relays and plug-in reed relays which are suitable for printed circuit applications. Other products on show include wirewound resistors, permanent magnets, shaded-pole motors complete with gearboxes, solenoids and various coils. Both Platt Brothers and Sheffield Steel Products are represented on this stand. [667

*Oliver Pell Control Ltd., Cambridge Row, Burrage Road, Woolwich, London, S.E.18.*

*Platt Brothers & Co. Ltd., Hartford Works, Oldham, Lancs.*

*Sheffield Steel Products Ltd., Templebrough Works, Sheffield 9, Yorks.*

**PAINTON (224)**

A comprehensive selection of their products, which includes connectors, switches, faders and attenuators, are on show, together with a new range of edge connectors for printed circuit applications. Other exhibits include their range of Bourns Trimpot trimmer potentiometers. [668

*Painton and Co. Ltd., Bembridge Drive, Kingsthorpe, Northampton.*

**PANAX EQUIPMENT (460)**

An extensive range of nucleonic instruments and equipment is on show. Items included are a liquid phosphor scintillation counter, a very low background anti-coincidence counting assembly, and a liquid flow scintillation counter. There are also several new portable instruments of interest to those in the health physics and radiation monitoring fields. [669

*Panax Equipment Ltd., Holmehorpe Industrial Estate, Redhill, Surrey.*

**PARMEKO (154)**

A representative selection of Parmeko transformers and transducers are on display. New products on show for the first time include a series of constant-voltage transformers, a range of low-cost transformers and several examples of components and circuit encapsulation. Other items on show include a representative selection of Parmeko's activities in the electronics field, which covers circuit modules and silicon-controlled rectifier trigger units to d.c. amplifiers, automatic voltage regulators, stabilized a.c. and d.c. power units, etc. [670

*Parmeko Ltd., Percy Road, Aylestone Park, Leicester.*

**PARRISH INSTRUMENTS (281)**

They are displaying their "Digitiser," an electro-mechanical servo system used for producing digital informa-

Aluminium Mark 6 connector from Plessey

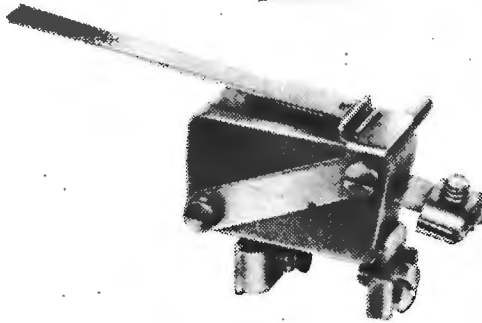
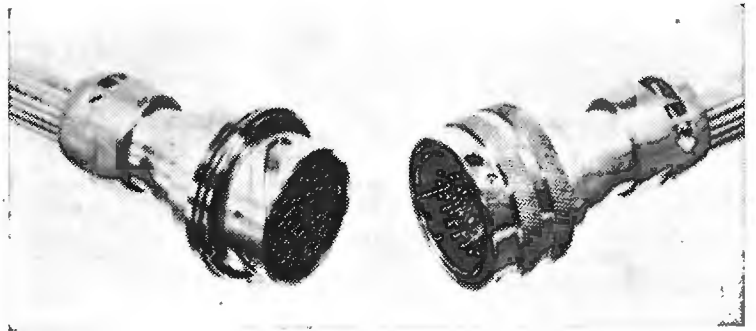

"Zero Plus" type micro switch (Pye Switches).

tion resulting from shaft rotation. Other new developments on show include a resolver and a step-by-step motor, both designed for use in remote indicating equipment. [671

*Parrish Instruments Ltd., 3 Friars Lane, Richmond, Surrey.*

**PARTRIDGE (277)**

A range of transformers, including high-quality audio types, power transformers with ratings up to 2kVA and miniature types for transistor circuit applications, is featured. Partridge are also displaying their saturable reactors, rectifier units, and invertors. [672

*Partridge Transformers Ltd., Roebuck Road, Chessington, Surrey.*

**PERMANOID (207)**

A new range of high-temperature p.v.c. insulated wires, flexibles and sleeveings, is on show. Other exhibits include television coaxial cables, high-frequency cables, and glass-fibre and p.v.c. sleeveings. [673

*Permanoid Ltd., New Islington, Manchester 4.*

**PERMARK (473)**

Identification sleeving in various materials (p.v.c., Neoprene, silicone rubber, etc.) and a wide range of sizes—from 0.5mm to 25mm internal diameter—are displayed. They are also showing the new portable "Permatik" identification sleeving unit which utilizes a pneumatically operated expanding tool. [674

*Permark Service Ltd., Cranleigh, Surrey.*

**PICTORIAL MACHINERY (409)**

The company, which is a subsidiary of the Monotype Corporation, is featuring a range of photo-mechanical equipment for the production of printed circuits. The two main items are the Lithoprintex junior "step-and-repeat" machine for the produc-



"Thimble" blower from the Plannair range of blowers designed for forced cooling electronic apparatus.

tion of multi-image negatives or positives on film or glass, and an exposure cabinet for the printing of negatives on to sensitized copper-clad laminates. [675

*Pictorial Machinery Ltd., Kelvin Way, Manor Royal, Crawley, Sussex.*

**PILKINGTON & CHANCE (479)**

The main emphasis of the display is upon television tube component parts. A new spherical implosion guard is on show, made in "Armourplate" glass. Float glass components for 19-in and 23-in tubes are displayed, as are several camera tube parts, notably image orthicon tubes 18in long. Chance Brothers have lead-glass transistor tubing in 1.4mm and 2.4mm o.d. sizes and show examples of finished transistor components. [676

*Pilkington Brothers Ltd., St. Helens, Lancashire.*

**PLANNAIR (220)**

A comprehensive range of temperature control equipment used in the electronics industry is on show together with two new products; the Thimble blower and a six-stage axial flow blower. The Thimble blower is only 1.6in long and 1.14in diameter, produces 4 cu ft per minute at a pressure of 0.1in/water and 1½ cu ft per minute at 1in. The six-stage blower only occupies about 150 cu in and has a capacity of 80 cu ft per minute at 2in. Plannair are also exhibiting a representative

selection from their standard range of blowers. [677]

*Plannair Ltd., Windfield House, Epsom Road, Leatherhead, Surrey.*

#### PLESSEY (160)

A novel space-saving technique has been introduced in Plessey's new range of air-dielectric variable capacitors, by inserting plastic pips in both the stator and rotor vanes. A new high-K ceramic solid-dielectric capacitor, having stator vanes metalized directly on the ceramic, is shown.

Two tuners are on show for the first time. One is a u.h.f. type, covering Bands IV & V and it uses the same push-button mechanism as in the recently introduced v.h.f. 5-button TV tuner. The other is an entirely new push-button car radio tuner.

Among the new components from the aircraft equipment group are a 1½ in axial blower for cooling miniature electronic equipment, a range of high-temperature magnetic drum indicators, and a new 50 c/s servo-amplifier incorporating silicon controlled rectifiers. Latest in the range of static inverters is a 700 VA unit.

Altogether several thousand different components are on display. Established Plessey ranges at the exhibition include i.f. transformers, filters, interference suppressors, loudspeakers, valveholders, memory cores and complete systems, TV scanning coils and line output transformers, rotary and slider switches, aerial rods and r.f. transformers, industrial paper capacitors, ferrite pot core assemblies, relays, synchros and resolvers. [678]

*The Plessey Company (U.K.) Ltd., Ilford, Essex.*

#### PRECISION ELECTRONIC TERMINATIONS (410)

A wide range of coaxial terminations for cables having 0.060 in to 4.5 in diameters are on show. They are displaying their r.f. and e.h.t. connectors having ratings up to 100kW and 100kV respectively. [679]

*Precision Electronic Terminations Ltd., Riversite Works, Erith, Kent.*

#### PRESSAC (350)

Recent examples of Pressac die-stamped printed circuits are on show together with other examples of their

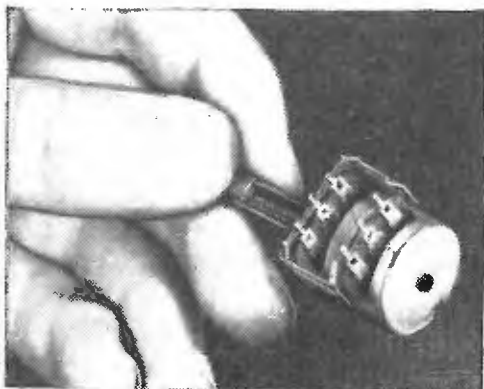

*Tab-fixing potentiometer from Radiohm.*

products, which include connectors, fuse and lamp holders, switches, mouldings and pressings. [680]

*Pressac Ltd., Leopold Street, Long Eaton, Nottingham.*

#### PRINTED CIRCUITS (214)

Flexible and rigid Plasmec copper-etched wiring circuits—both single and double sided—for both domestic and industrial applications—are on show. Strain gauges, cable forms, heating elements and code discs are also displayed. [681]

*Printed Circuits Ltd., Stirling Corner, Barnet By-Pass, Herts.*

#### PYE SWITCHES (115)

Their new range of large gap (up to 3mm) miniature "Zero Plus" micro switches, which comply with the specifications of the International Commission on Rules for the Approval of Electrical Equipment are on show. Two examples of the "joystick" controller for remote TV camera operation, developed in collaboration with the B.B.C., are shown and a new miniature "joystick" controller is introduced. [682]

*Pye Switches Ltd., Otehall Works, Burgess Hill, Sussex.*

#### RADIOHM (400)

Several variations on normal practice in the potentiometer field are exhibited. Tab-fixing types are produced, and for printed-board use, a bracket is shown which enables the potentiometer to be soldered in position. A non-conductive spindle can be obtained which is detachable, affording greater convenience during set manufacture. [683]

*East Grinstead Electronic Components Ltd., Imberhorne Industrial Estate, East Grinstead, Sussex.*

#### RATHDOWN INDUSTRIES (106)

They are showing examples of their torsion, tension and compression springs, which they manufacture to customers' requirements, together with a comprehensive range of tag panels, solder pins and aluminium screening cans. [684]

*Rathdown Industries Ltd., Goodwood Works, 17 London Road, Ascot, Berks.*

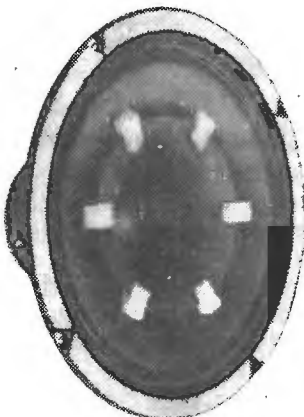

*Reproducers and Amplifiers wide range 8in dual cone speaker.*

#### REJAFIX (359)

Machines designed for the marking of electronic and radio components are exhibited. The five machines shown are designed for printing on cylindrical articles, transistors, flat capacitors, components with coaxial wire leads and the Model 555 rotary high-speed printing machine which can mark suitable components at a rate of 8,000 per hour. [685]

*Rejafix Ltd., Harlequin Avenue, Great West Road, Brentford, Middx.*

#### RELIANCE CONTROLS (55)

Emphasis is being given to the new SYN 11-00 series of multi-turn potentiometers especially applicable to servo equipment and control systems in general where very low inertia and quick response are essential. The element is wound from bare precious metal wire and is bonded into a rigid spiral. [686]

*Reliance Controls Ltd., Sutherland Road, London, E.17.*

#### RENDAR INSTRUMENTS (270)

Several new components are included in the display. Three push-button switches with various types of action are claimed to be among the smallest marketed. The body is 0.36 in in diameter and the switch is 1⅝ in from the push button to the pins. Other new products shown are the double-pole change-over switch for microphones with a contact resistance of about 6mΩ, and side-entry jack plugs, both screened and unscreened. [687]

*Rendar Instruments Ltd., Victoria Road, Burgess Hill, Sussex.*

#### REPRODUCERS AND AMPLIFIERS (212)

A number of completely new loudspeakers are introduced. These include a "compact" range with circular (3 in dia) and elliptical (6 in × 4 in) types. Standard voice-coil impedances in this range are 3, 15 and 25 ohms. Modifications to established types such as the fidelity dual cone units consist of treatment by plastic impregnation to the main cone surround and the provision of polyurethane foam pads to the edge of the supplementary cones. [688]

*Reproducers and Amplifiers Ltd., Frederick Street, Wolverhampton.*

#### RESLOSOUND (150)

New products of this Derritron company include the "Studio" ribbon microphone (SR1) and the extended frequency range ribbon-type VRT. Also shown are new versions of line source loudspeakers and examples from the company's wide range of domestic and "professional" equipment. [689]

*Reslosound Ltd., 24 Upper Brook Street, London, W.1.*

#### RICHARD ALLAN RADIO (200)

Their complete range of domestic and commercial loudspeakers is on

snow together with examples of their "packaged" hi-fi kits. Other items on show include new short-period process timers and a selection of audio and mains transformers. [690]  
*Richard Allan Radio Ltd., Taylor Street, Batley, Yorkshire.*

#### RIVLIN INSTRUMENTS (251)

Components shown include precision wirewound resistors, four-terminal resistors, temperature-sensitive resistors, miniature preset potentiometers and resistance standards. Of particular interest are the low-value resistors of the four-terminal type. This form of construction is used to reduce terminal resistance to maintain accuracy. The values manufactured range from 0.001Ω to 100Ω. [691]

*Rivlin Instruments Ltd., Doman Road, Camberley, Surrey.*

#### ROLA CELESTION (230)

A representative selection of their comprehensive ranges of domestic and commercial loudspeakers are on show. New models include speakers in the 3 to 4in range, specially designed to meet the requirements of the latest "handbag" transistor receivers, and at the other end of the scale 12in to 15in models, for electronic organ and guitar amplifier manufacturers. Features of the 15in model include a 2in diameter voice coil and a ceramic magnet. [692]

*Rola Celestion Ltd., Ferry Works, Thames Ditton, Surrey.*

#### ROSS, COURTNEY (481)

Wire end terminals and closing tools, solder tags, eyelets and crimping terminals which include their new range of "Sta-Kon" pressure terminals with hand and power operated installing tools are on show. Other items on show include pillar terminals, brass and copper cable sockets, steel cable clips, nylon cable straps and ties, and grounding sheath connectors. [693]

*Ross, Courtney and Co. Ltd., Ashbrook Road, London, N.19.*

#### ROYAL WORCESTER (104)

A comprehensive range of ceramic components manufactured from "Regalox" and "Electrox" alumina bodies are on display together with examples of the recently introduced pure alumina manufactured under the trade name of "Nobalox." [694]

*Royal Worcester Industrial Ceramics Ltd., Tonyrefail, Glam.*

#### RUSTRAK INSTRUMENTS (411)

They are exhibiting their range of miniaturized recording output meters. Eleven chart speeds ranging from ¼ to 60in per hour are available with their standard instruments and special instruments with speeds up to 450in per hour are also available. New instruments include a controller recorder, a two point recorder and a wattmeter recorder. [695]

*Rustrak Instruments, The Hyde, Brighton 7, Sussex.*

#### SGS-FAIRCHILD (494)

Five display sections covering micro-logic integrated circuits, planar transistors, diodes, special products (including multi-chip devices) and a full selection of literature are on show. [696]

*SGS-Fairchild Ltd., Stonefield Way, Victoria Road, South Ruislip, Middx.*

#### S.T.C. (162)

The six divisions of the components group of S.T.C. are showing a number of new products at this year's show, including the Ministac technique of assembling conventional and miniature components to give high packing density. New items in the semiconductor field include a range of Miniflake caseless planar epitaxial silicon transistors, germanium power transistors dissipating up to 40 watts, and silicon avalanche rectifiers. Other newly developed items include silicon solar cells and silicon controlled rectifiers, which are on show for the first time. S.T.C. are demonstrating a new light-emitting gallium arsenide diode and details of their laser experiments are available. Other items of interest include a range of thin film circuits, a new travelling-wave tube, a ceramic-enveloped hydrogen thyatron, a range of crystals, filters and frequency standards, and samples of their Permalloy and Stanferite magnetic materials and recording heads. [710]

*Standard Telephones & Cables Ltd., Connaught House, 63 Aldwych, London, W.C.2.*

#### SALFORD (161)

Included on the stand are quartz crystal units, ferrite components, miniature polystyrene capacitors and a number of thermoelectric components. In addition to components, a number of multirange test sets are exhibited. [697]

*Salford Electrical Instruments Ltd., Peel Works, Silk Street, Salford 3.*

#### SALTER (365)

Newly developed spring fasteners for use in radio and electronic equipment are shown *in situ* on parts loaned by other manufacturers. Examples of their range of retaining rings, including "E" and "Crescent" rings, are also shown. [698]

*Geo. Salter & Co. Ltd., West Bromwich, Staffs.*

#### SANDERS ELECTRONICS (281)

A cross-section of their wide range of microwave components, suitable for use in measuring systems, is on display. They have several items of equipment working, including their new sensitive microwave power meter, restyled Mk. III v.s.w.r. indicator and Mk. IV low-voltage klystron power unit. Among the industrial electronics exhibits, which include servo modules, magnetic proximity switches, magnetic to transistor logic converters, there is a

working demonstration of a low ripple constant voltage source using a S.C.R. power amplifier. The audio division of Sanders is showing the '62 battery-operated 33/45 r.p.m. record changer unit. Stevenage Relays Ltd. are represented on this stand. [699]

*W. H. Sanders (Electronics) Ltd., Gunnels Wood Road, Stevenage, Herts.*

#### SCOTT & CO. (402)

This company, which specializes in the production of laminations and cores, is offering three new grades of electrical steels for stampings—Stan-Dynis 32 and 27 and Extra 200. All are of low-carbon (non-silicon) grades. Stampings in the first two are recommended for fractional horsepower motors. Scotts now provide epoxy coated toroidal and bobbin cores. [700]

*Geo. L. Scott & Co. Ltd., Cromwell Road, Ellesmere Port, Cheshire.*

#### SEAELECTRO (486)

In addition to the range of Seaelectro connectors and terminals, the new "Cloverleaf" junction socket is demonstrated. This is part of the press-fit range, and is intended to enable dip-soldering to be carried out when metal chassis are used. The Seaelectroboard programme board is now developed into a system and is demonstrated. [701]

*Seaelectro Corporation, Hershams Factory Estate, Walton-on-Thames, Surrey.*

#### SELLOTAPE (452)

Sellotape Products are showing their current range of tapes. Items of particular interest include their copper-clad polyester film, new extra thin polyester tape (0.0005in) and new conductive aluminium foil tape. Other items on show include polythene electrical tapes and creped paper electrical tapes. [702]

*Sellotape Products Ltd., Sellotape House, 54-58 High Street, Edgware, Middx.*

#### SIFAM (405)

Electrical measuring instruments up to 4½in body diameter in round, square and rectangular cases are shown. These include volume level indicators, time meters, decibel meters and relay switchboard instruments. In the pyrometric field, panel-mounted indicators from 2in to 6in body diameters and differing scale sizes are exhibited. The new products are a 5in edgewise indicator, and ranges of electrical measuring instruments with new styling ("Harmony" and "Clarity"). [703]

*Sifam Electrical Instrument Co. Ltd., Woodland Road, Torquay, Devon.*

#### SIMS, F. D. (490)

Examples of Sims insulated high-conductivity copper wires and strips  
(Continued on page 281)

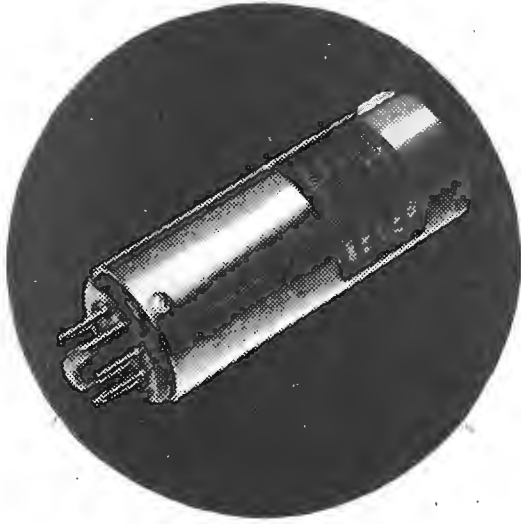

# QUARTZ STABILITY

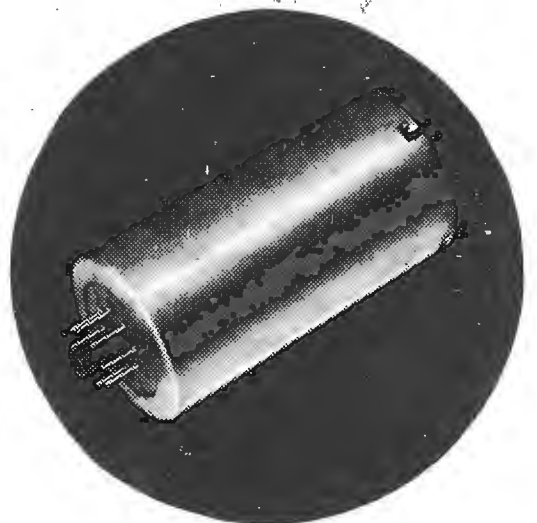
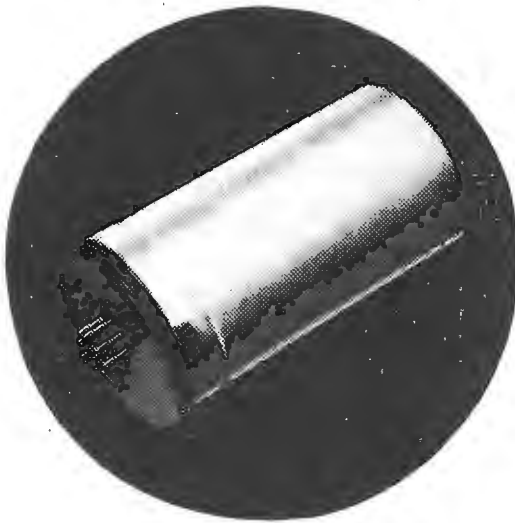
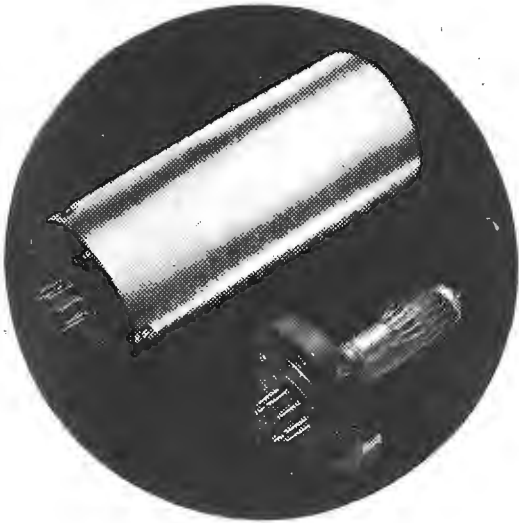

## CRYSTAL OVENS

The Marconi 'change of state' oven employs no thermometer switch and has a switching differential of 0.0014°C.

Orthodox crystal ovens, using thermostats or thermometer switches, are available where wider temperature variations are acceptable.

## CRYSTAL FILTERS

Standard crystal filters with SSB or bandpass characteristics are available for 100 kc/s operation, and I.F. filters for 455 kc/s. Many special filters are available for frequencies up to 20 Mc/s; and new designs can be produced to meet specific requirements.

*The Specialized Components Catalogue lists over 110 Marconi Components, the design and manufacture of which is undertaken only when no suitable alternative is available, and in almost every case Marconi components are designed for higher performance and are made to closer tolerance than any available alternative.*

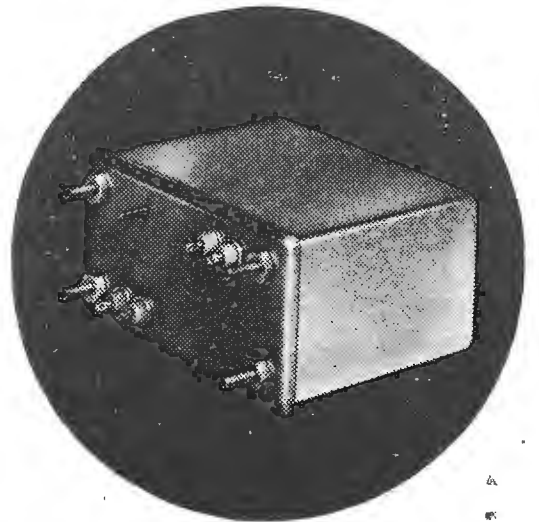
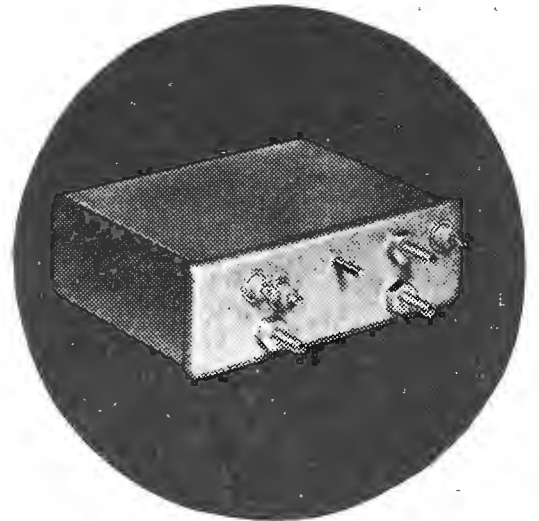

# MARCONI

**SPECIALIZED COMPONENTS**

Please address your enquiries to: **SPECIALIZED COMPONENTS DIVISION**  
**MARCONI'S WIRELESS TELEGRAPH COMPANY LIMITED, CHELMSFORD, ESSEX, ENGLAND**

W5C





# PANEL METERS

Take a compact panel meter design, easy readability and maximum performance—in short, take the new TAYLOR VISTA METERS to see just how clear precise panel reading can be. The Vista range incorporates all the features that have given Taylor Meters their high reputation for reliability and sensitivity: the large diameter pivots, the shock-proof sapphire bearings, the hair springs of incredible durability and, of course, the highly developed centre pole movements—factors that have enabled Taylor to produce some of the world's finest meters.

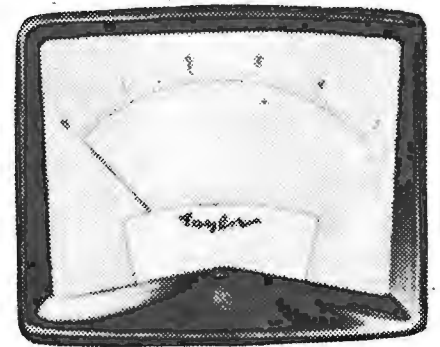

VISTA

TAYLOR MINI EDGEWISE meters specially designed for compact electronic equipment where every inch counts. These tiny meters fit into place as neatly as a half-crown slips into a cigarette machine. Yet these new Mini Meters have all the high performance features that make Taylor Instruments famous:—magnetically shielded centre pole movement: wide range of sensitivities from 50 microamps: maximum readability in minimum panel space. These Taylor Meters are masterpieces in miniature.

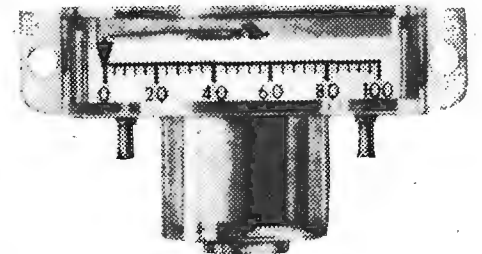

MINI—EDGEWISE



# INSTRUMENTS



127A



100A

The TAYLOR 127A., unequalled for high performance at a low price, is recognised throughout industry as the finest piece of equipment in its field. The instrument, weighing only 1 lb., has a sensitivity of 20,000 o.p.v. D.C. and resistance ranges up to 20 megohms—yet it slips into the pocket as easily as a wallet. The 127A., cased in shock-proof bakelite, can take overloads of up to 10,000%. This tough-as-they-come, 26 range meter with its own internal batteries is ideal for bench and field work (adopted by the G.P.O.).

Another unique TAYLOR achievement:—the MULTIMETER 100 A. with an ultra-high sensitivity of 100,000 o.p.v. D.C.—the most sensitive in the world. It has a self-contained resistance range of 200 megohms and its third remarkable feature is the newly patented mechanical overload protection device.

For full technical data, write for the Taylor catalogues—they're worth having as reference for all types of panel and multimeters.

And when you order from Taylor you can be sure of prompt delivery—their service is as good as their meters.

★ See the full range of Taylor panel meters and instruments on Stand No. 170 R.E.C.M.F. Show

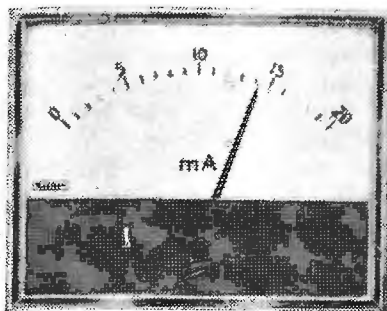

Sifam "Clarity" meter.

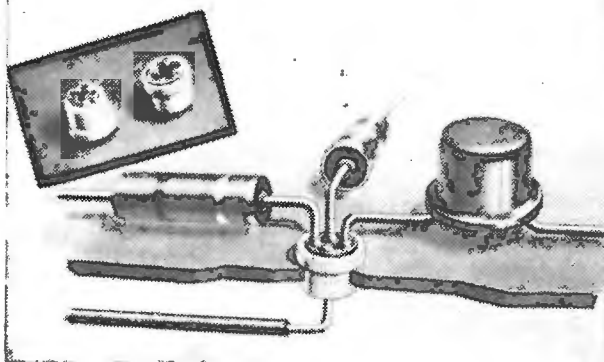

Press-fit junction by Sealectro, for dip-soldering.

are on show. The insulations available include several types of enamels, cotton, paper, glass, and combined coverings of enamel with either cotton or glass. Other products include insulated resistance wires and insulated aluminium wires. [704

F. D. Sims Ltd., Hazelhurst Works, Ramsbottom, Nr. Bury, Lancs.

#### SMART & BROWN (280)

Their new range of connectors Pattern 104, to specification DEF.5325, is on show together with their range of M4 connectors, to specification RCS.321; these are fully "intermateable." Other exhibits include their miniature American multipole connectors and coaxial connectors. [748

Smart & Brown (Connectors) Ltd., North-West House, 119-127 Marylebone Road, London, N.W.1.

#### SMITH, S., & SONS (319)

High-alumina ceramics are featured this year with a comprehensive range of K.L.G. plain and sealed terminals, bushings and stand-offs. They are also showing the applications of metallized Lodge Sintox valve envelopes, which provide quicker heat dissipation than the conventional glass envelopes. [705

S. Smith & Sons (England) Ltd., St. Peter's Road, Rugby, Warwickshire.

#### SOUTH LONDON ELECTRICAL EQUIPMENT (453)

Micro spot welding apparatus capable of welding wires down to 0.0005in diameter and sheet 0.0001in thickness is on show together with general-purpose welding equipment. Other equipment on show includes low-temperature refrigerator and climatic simulation cabinets, and high vacuum ovens. [706

South London Electrical Equipment Co. Ltd., Lanier Works, Hither Green Lane, London, S.E.13.

#### SPEAR ENGINEERING (215)

The company's complete range of manufacturing and servicing aids, including pin aligning tools, wiring jigs, thermal shunt clamps and trimming tools, is displayed, together with a variety of plugs and sockets. New

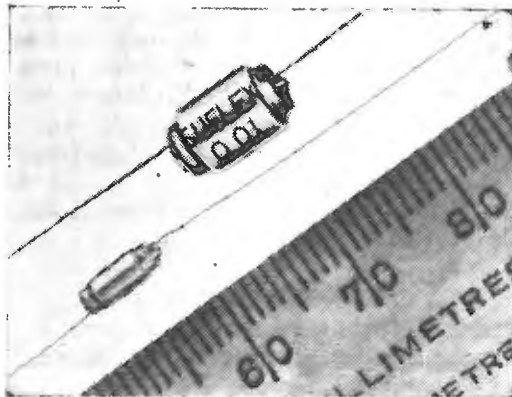

Suflex 30V plastic film capacitors.

items include printed circuit servicing racks. [707

Spear Engineering Co. Ltd., Limpsfield Rd., Warmingham, Surrey.

#### STABILITY CAPACITORS (257)

The main feature of the display is a range of components intended for u.h.f. television tuners. A notable example is a pi-section filter feed-through unit, which provides greater attenuation than a single feed-through capacitor over the whole u.h.f. band. The necessary inductance is achieved with the help of a ferrite bead. Ceramic, silvered-mica and polyester capacitors are shown, including a new 400V range. [708

Stability Capacitors Ltd., Cranes Farm Road, Basildon, Essex.

#### STANDARD INSULATOR (202)

Moulded rubber masks for c.r. tubes are specially featured. Other items shown include natural and synthetic moulded rubber grommets and industrial rubber mouldings, battery charging and test clips and moulded rubber insulating hoods. [709

The Standard Insulator Co. Ltd., Bridge Road, Camberley, Surrey.

#### STEATITE & PORCELAIN PRODUCTS (155)

Low-loss ceramic pressings, extrusions and precision ground products are shown. Among the new materials is Alumina 961, a 96% alumina ceramic. S. & P.P. are also showing a range of nickel-metallized terminal seals. [711

Steatite & Porcelain Products Limited, Bewdley Road, Stourport-on-Severn, Worcs.

#### STOCKO (322)

They are displaying their standard ranges of eyelets, tags and end caps. Other Stocko items on show include a representative selection of small steel precision pressings, including pressings in bandolier form. [712

Stocko (Metal Works) Ltd., Queensway, Ponders End, Enfield, Middx.

#### SUFLEX (307)

Items from the range of insulating sleeves, lacing cords and capacitors are displayed. Sleeving in glass, Terylene, rayon, etc., is provided with a variety of finishes, an example being "Periglas", which is a plastic coated glass braid. There is also a range of single and double-ended plastic film capacitors includes the new 30-V series of polystyrene capacitors with values up to 0.01 $\mu$ F. [713

Suflex Ltd., Bilton House, 54-58, Uxbridge Road, London, W.5.

#### SURREY STEEL COMPONENTS (105)

Sheet metal work for the electronics and radio industries includes chassis, metal cases and many types of press-work such as transformer clamps and shrouds. [714

Surrey Steel Components Ltd., Trinity Road, Richmond, Surrey.

#### SYLVANIA-THORN (152)

Sylvania-Thorn are sharing the Thorn-AEI stand, and are showing a selection from their range of high-sensitivity spiral post-deflection accelerator oscilloscope tubes. An interesting example is the 4-inch double-gun SE4/2B which, in addition to small spot size (0.4mm), provides for anode modulation or beam blanking at anode potential, and electrostatic beam alignment. [715

Sylvania-Thorn Colour Television Laboratories Ltd., Gt. Cambridge Road, Enfield, Middx.

#### T.C.C. (264)

A very wide range of capacitors of all types is exhibited. Electrolytics are represented by a new selection of tantalum capacitors, both polarized and non-polarized, some being suitable for operation at 125°C. A sub-miniature type of component for transistor use is also shown. High insulation resistance is afforded by the "Metamold" range of metallized-polyester dielectric capacitors, which are also notable for their small size. [716

Telegraph Condenser Co. Ltd., North Acton, London, W.3.

#### T.M.C. (56)

Of the various types of capacitor shown, with dielectrics of paper, film foil and metallized film foil, perhaps the most interesting are the paper power-factor correction types capable of working in the temperature range -25° to +80°C and the metallized polyethylene terephthalate models.

Solid state circuit elements—oscillator, modulator, amplifier and demodulator—are also being shown by T.M.C. [717]

*Telephone Manufacturing Co. Ltd., Martell Road, West Dulwich, London, S.E.21.*

#### TAYLOR (170)

Taylor are showing their ranges of test equipment and panel meters. Among the new items there is a rear mounting panel meter. This is known as the Model 55, has a 4in scale and is available with a 50 $\mu$ A movement. [719]

*Taylor Electrical Instruments Ltd., Montrose Avenue, Slough, Bucks.*

#### TECHNOGRAPH (459)

Included among the new developments are a printed circuit motor and multi-layer circuits. These latter items consist of alternate layers of insulated material and conductor patterns with inter-circuit connections made by holes plated through the circuit where required. Other printed and etched-foil exhibits include precision resistors, strain gauges, inductors, thermal de-icing elements, switches and temperature sensing elements. [720]

*Technograph Electronic Products Ltd., Fleet, Aldershot, Hants.*

#### TECTONIC INDUSTRIAL PRINTERS (362)

All the processes of printed circuit production, including protective treatments, are illustrated together with examples of the applications of flexible circuits. [721]

*Tectonic Industrial Printers Ltd., Cirtec Works, Oxford Road, Wokingham, Berks.*

#### TELCON (159)

The Telcon Metals group of companies are sharing this stand. Telcon Metals are showing examples of its range of high permeability magnetic alloys, thermostatic bi-metals and beryllium copper. Examples of ultra-thin foil (down to 0.00015in) in a variety of alloys is now available.

Magnetic and Electrical Alloys specialize in laminations and are displaying examples in various grades of cold reduced silicon steel (oriented and non-oriented) and high permeability nickel-iron alloys.

"Telmag" strip-wound cores, including "C" cores, in grain-oriented silicon iron are featured by Telcon-Magnetic Cores. Electrical resistance wires for all types of fixed and variable resistors are shown by Temco and examples of tools and machinery produced by Toolpro are illustrated. [722]

*Telcon Metals Ltd., Manor Royal, Crawley, Sussex.*

#### TELEDICTOR (357)

A representative selection of their transformers, chokes, solenoids, loudspeakers, photoelectric devices, etc.,

is on show. Teledictor are also demonstrating a new model of their portable electronic comparator and flaw detector. [723]

*Teledictor Ltd., Groveland Road, Tipton, Staffs.*

#### TELEQUIPMENT (471)

Continuing the trend towards replaceable units, a new oscilloscope, the D.43, is announced. A 4-in double-gun tube is used, operating at 4kV, and all the usual triggering and synchronizing modes are provided. Three amplifiers are available, for general and specialized duties. The Type A possesses a bandwidth of 15 Mc/s at 100mV/cm, while the Type B is a differential-input device with a common-mode rejection ratio of 80dB. Type C, intended for acoustic and recording work, provides a sensitivity of 100 $\mu$ V/cm from 3c/s to 75kc/s. [724]

*Telequipment Ltd., Chase Road, Southgate, London, N.14.*

#### TELERECTION (271)

Scaled-down versions of Telerection's aerial arrays for Bands I, II, III and IV, correct in every detail, are displayed. In the u.h.f. range they are showing a 12- and 24-element plane grid Yagi's and a corner reflector type with bow-tie dipoles. These three aeriels are shown in their polythene cocooning, which Telerection feel to be essential for maintaining efficient u.h.f. reception. Their new car aerial range is also on show. [725]

*Telerection Ltd., Antenna Works, Lynch Lane, Weymouth, Dorset.*

#### TEXAS INSTRUMENTS (303)

They are showing their ranges of transistors, diodes and rectifiers together with a selection of integrated circuits using planar multi-diodes and multi-transistors. Among the working exhibits there is a communications link using a Texas SNX100 gallium arsenide infra-red diode, a binary-to-decimal decoding matrix, a transistorized closed-circuit television network, and a television tuner using a Texas germanium mesa transistor. [726]

*Texas Instruments Ltd., Manton Lane, Bedford.*

#### THERMIONIC PRODUCTS (278)

The Thermionic TDR4 four-speed tape transport and Thermionic TLS2 loop store are on show. Other items of interest include a range of multi-track magnetic recording heads together with direct and f.m. carrier modules for instrumentation recorders. [727]

*Thermionic Products (Electronics) Ltd., Hythe, Southampton, Hants.*

#### THORN-A.E.I. (152)

Three valve and c.r.t. brand names—Brimar, Mazda, and Ediswan—are to be seen on this stand. Of special interest among the Brimar valves are

the ECC 807, a low-noise double-triode with "the highest mu in the world," and the E88CC, a "special quality" double triode with low cathode interface impedance. Mazda's new TV valve 30C18 (PCF805), which was introduced at this year's International Components Show in Paris, is a triode frame-grid variable-mu pentode for use mainly as a v.h.f. frequency changer, but it can serve a double purpose in a u.h.f. receiver as an extra i.f. stage when the u.h.f. tuner is in use. Mazda are also showing their 19- and 23-in all-glass twin-panel c.r. tubes. The Ediswan trade name is used solely overseas in place of Mazda. [728]

*Thorn A.E.I. Radio Valves & Tubes Ltd., 155 Charing Cross Road, London, W.C.2.*

#### THORN ELECTRICAL (171)

Examples of the use of electroluminescent materials for the lighting of instrument panels and for clock faces, telephone dials, switch surrounds, etc., are on show. Other items on display include a representative range of connectors, relays, tantalum capacitors, and indicator lamps. [729]

*Thorn Electrical Industries Ltd., Gt. Cambridge Road, Enfield, Middx.*

#### TRUVOX (278)

In addition to the "Series 80" tape decks and units, the new "Data Decks" are shown. All decks are push-button controlled and suitable for horizontal or vertical operation. Replay pre-amplifiers and record amplifiers with integral erase, bias and power supply are available for the "Series 80" decks. [730]

*Truvox Ltd., Neasden Lane, London, N.W.10.*

#### TUCKER EYELET (211)

A representative selection of the company's wide range of eyelets, solder tags, washers and other metal pressings is displayed. A new range of aluminium cans for subminiature electrolytic capacitors has been introduced. In addition to supplying machinery for the insertion of their own products in equipment the company has also developed machines for the insertion of components into printed wiring boards. [731]

*Geo. Tucker Eyelet Co. Ltd., Walsall Road, Birmingham, 22B.*

#### 20TH CENTURY ELECTRONICS (112)

Exhibits include an ultrasonic camera tube and solid state radiation detectors suitable for contamination monitoring, low background counting, alpha particle and proton spectroscopy, and charged particle mass identification. Vidicon camera tubes, storage tubes and a pulse height analyser Model 1363D (a 100-channel instrument) are also shown. [732]

*20th Century Electronics Ltd., Centronics Works, King Henry's Drive, New Addington, Surrey.*

#### UNION CARBIDE (404)

A comprehensive selection of solid tantalum polar and non-polar capacitors are on show. Other exhibits include their standard range of Varium getters. [733]

*Union Carbide Ltd., Kemet Division, 8 Grafton Street, London, W.1.*

#### VACTITE (214)

Nickel-chrome (Vacrom) and cupronickel (Eureka) resistance wires, strands and tapes are on show with the Vactite range of molybdenum rods, wires and tapes. [734]

*Vactite Wire Co. Ltd., Linacre Lane, Bootle 20, Lancs.*

#### VENNER (476)

A new all-transistor portable frequency meter with a range up to 1.1 Mc/s is displayed with their standard range of equipment, which includes frequency measuring equipment, printers, a digital voltmeter, digital clock, and a variable rise time pulse generator. [735]

*Venner Electronics Ltd., Kingston By-Pass, New Malden, Surrey.*

#### VERO ELECTRONICS (364)

The "Veroboard" system of circuit wiring is illustrated on this stand together with accessories such as assembly stands and pin-inserting tools. "Verorack" units for 19in cabinets, holding up to 28 cards are also shown. [736]

*Vero Electronics Ltd., South Mill Road, Regent's Park, Southampton, Hants.*

#### WANDLESIDE (176)

The three cable companies in the Wandleside Group are exhibiting jointly on this stand, and are displaying a comprehensive range of wires and cables, insulated in rubber, p.v.c., Hitem, and p.t.f.e. [737]

*Wandleside Cable Works Ltd., 106 Garratt Lane, London, S.W.18.*

#### WEGO CONDENSER (252)

Examples of their range of low-inductance capacitors, for rapid discharge applications, are on show with

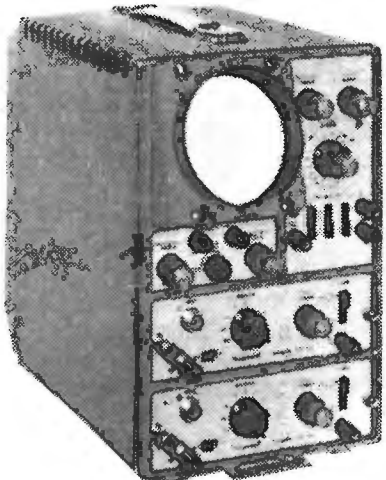

Double-gun Teleequipment oscilloscope Type D.43. Plug-in amplifiers are used.

a comprehensive selection of their ranges of mica, paper, and plastic film capacitors. [738]

*Wego Condenser Co. Ltd., Bideford Avenue, Perivale, Middx.*

#### WELWYN (255)

In addition to their well-known range of resistors and potentiometers Welwyn are showing metal film resistors and a range of integrated networks of components on ceramic substrates. Other additions to their normal ranges include a series of moulded insulated high-stability carbon resistors and a range of "Metox" power oxide resistors. [739]

*Welwyn Electric Ltd., Bedlington, Northumberland.*

#### WESTINGHOUSE (305)

The exhibit consists of examples from the range of semiconductors and selenium devices. An illuminated display panel is used to demonstrate the use of silicon controlled rectifiers, controllers and drivers in complete control systems. The display itself is SCR-controlled. Silicon diodes with peak inverse ratings of up to 1800 volts are to be seen, together with crystal-aligned selenium rectifiers for applications where high power/volume ratios, high current densities and high temperatures are needed. [740]

*Westinghouse Brake and Signal Co. Ltd., 82 York Way, London, N.1.*

#### WEYMOUTH RADIO (261)

In addition to the standard range of Weyrad components they have introduced at the show a series of 10.7 Mc/s i.f. transformers and a transistor i.f. strip incorporating these. A printed circuit transistor receiver chassis has been developed to facilitate the production of sets in overseas countries. [741]

*Weymouth Radio Mfg. Co. Ltd., Regent Factory, Weymouth, Dorset.*

#### WHITELEY (173)

Well known for their Stentorian loudspeakers and associated equipment, Whiteley are featuring epoxy-resin and polythene encapsulated components and sub-assemblies, including e.h.t. transformers, search

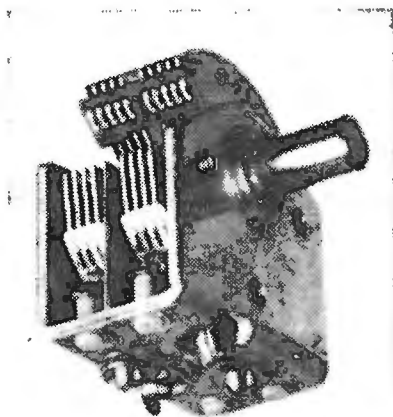

Wingrove and Rogers C7922 gang capacitor.

coils, scanning coils, oscillators and audio amplifiers. The company are also showing a wide variety of miscellaneous components, printed circuits and moulded parts and a selection of test and measuring equipment. [742]

*Whiteley Electrical Radio Co. Ltd., Victoria Street, Mansfield, Notts.*

#### WINGROVE AND ROGERS (276)

Polar gang capacitors are the main exhibit. Practically all the ganged varieties shown can be supplied with gear and pinion drive. A miniature air-dielectric variable capacitor less than 1in cube may be examined. This contrasts with the 7 gang types manufactured for communications equipment. Some new trimmers of the compression type are shown. These are designed for printed board mounting. Other exhibits include gear and pinion drives, epicyclic ball drives, terminal strips and stand-off insulators. [743]

*Wingrove and Rogers Ltd., Dornville Road, Mill Lane, Liverpool 13.*

#### WIRE PRODUCTS (103)

They are showing a comprehensive range of precision pins, cut wires and special rivets together with glass-to-metal hermetic seals. Wire Products also manufacture cap and lead assemblies for the resistor trade. [744]

*Wire Products and Machine Design Ltd., Kingsbury Works, Bridge Road, Haywards Heath, Sussex.*

#### WODEN (302)

Their comprehensive range of high quality transformers and chokes are on display. Features of the display include cast-resin and hermetically sealed components using "C" and toroidal cores. Other Woden products include precision relays and torque-motors. [745]

*Woden Transformer Co. Ltd., Oxford Street, Bilston, Staffs.*

#### WOLSEY ELECTRONICS (216)

Their new range of inductive outlet boxes, tee units and associated splitter units for sound and TV distribution systems are on show together with their range of resistive units. The Wolsey range of aerials for Bands I-V and distribution amplifiers for Bands I-III are also on show. [746]

*Wolsey Electronics Ltd., North West House, 119/127 Marylebone Road, London, N.W.1.*

#### ZENITH ELECTRIC (282)

Their range of Variac transformers, Ceramite wirewound vitreous embedded resistors are on show together with their new range of Zenohm rotary vitreous enamelled potentiometers. Other Zenith products include adjustable rheostats, insulation flash testing equipment and phase shifting transformers. [747]

*Zenith Electric Co. Ltd., Zenith Works, Villiers Road, Willesden Green, London, N.W.2.*

# News from Industry

**Anglo-American Loran Agreement.**—The Decca Navigator Company and the Norden Division of the United Aircraft Corporation of America, are to be associated in the development and manufacture of navigation equipment for military and commercial applications. Norden will manufacture and sell Loran "C" equipment developed by Decca, as their licensee in the United States. Decca will provide technical assistance to Norden in the design and manufacture of the equipment and the two companies will exchange information concerning future product and marketing development.

A new Anglo-American company, **EMIHUS Ltd.**, has been jointly formed by Electric & Musical Industries Ltd. and the Hughes Aircraft Company of California. The new company, which is equally owned, is to combine British and American "know-how" to develop and manufacture military equipment. Initially the types of equipment will cover digital computers, digital test equipment, airborne radar, airborne instrumentation, and airborne navigation and control systems. EMIHUS will be British based with offices situated in Blyth Road, Hayes, Middx., and equipment is to be manufactured in this country by E.M.I. Electronics Ltd.

**The Bell & Howell Company** of Chicago have regrouped their U.K. interests by the formation of a new British company, Bell & Howell Ltd. Consolidated Electrodynamics Corporation (U.K.) Ltd., which started business at 14 Commercial Road, Woking, in the Autumn of 1961, now becomes the Consolidated Electrodynamics Division of the new company and continues in its present factory at Mytchett, Hampshire.

**Racal Electronics Ltd.** group net profit (before taxation) for the year ending 31st January amounted to £309,000, compared with £231,000 for the previous year. The company became public in October 1961.

**BSR Limited** group net profit (before taxation) for 1962 was £2,170,724 (£1,815,421 previous year). BSR have formed a new subsidiary, Rapier Tools Ltd. to administer the sales of their engineers' cutting tools.

The whole of the issued share capital of **Park Wireless Ltd.** has been acquired, for a consideration of £750,000, by the Rank Organization. Park Wireless will continue to operate under the same name. It has five wholly owned subsidiaries trading from 31 retail outlets in the Manchester area, and the shops will form part of the Top Rank Home and Leisure Service Division of The Rank Organisation.

**Elliott-Automation** group profits (before deductions) in 1962 was £3,923,563; an increase of £975,000 over the previous year. After all deductions, including tax, there was a net profit of £1,513,780, against £1,159,793 in 1961.

**Relay Exchanges**, the television and radio relay and rental chain, group trading profit increased, from £4,155,346 in 1961 to £4,796,648 last year. The net profit for 1962 after all charges, including depreciation of £3.4M, was £1,183,115 (£951,646).

By special arrangement with the **American Heath Company**, Daystrom are now able to accept orders for any of the wide range of American Heathkit models for direct delivery to customers in the U.K. Copies of the latest available American catalogue (costing 1s) and full details of the scheme are available from Daystrom Ltd., Gloucester.

**S.T.C. is 80 Years Old.**—On May 2nd 1883, J. E. Kingsbury, a Londoner, opened an office in Moorgate, London, for the sale of telephone instruments made by the Western Electric Company of the U.S.A. and thus laid the foundations of the S.T.C. organization in Britain. With the rearrangement of Western Electric overseas interests in 1925 S.T.C. emerged as the British company within the International Telephone and Telegraph Corporation. S.T.C. now has 20 factories employing some 30,000.

**Thorn-A.E.I. Radio Valves & Tubes Ltd.** has acquired the industrial cathode ray tube business of Associated Electrical Industries (Woolwich) Ltd., and has taken over the responsibility for production and sales. All outstanding orders will be fulfilled and continuity of supplies assured. In August, 1961, it was announced that all A.E.I. interests in valves and c.r. tubes for the domestic market would be transferred to Thorn-A.E.I.

A new company, **Thorn Electronics Ltd.** has been formed by Thorn Electrical Industries to co-ordinate the electronics activities of the group. The new company is headed by A. Deutsch, G. J. Strowger and G. Gibson, and embraces Nash & Thompson, the Microwave Components Division, and the Industrial Control Systems Division.

**Mullard Ltd.** has formed a new division to handle its microwave tubes, transmitting valves, and vacuum devices. It is to be called the Transmitting and Microwave Division and will operate from their premises at Queensway, Waddon, Surrey.

**Advance Components Ltd.** have completed their 20,000 sq ft two-storey extension of their Hainault factory. The new extension is being fitted out to cater for the expansion of manufacturing capacity plus new test and inspection departments and additional office accommodation.

The new £250,000 research laboratories and factory of **Ferranti Ltd.**, at Dalkeith, Scotland, were recently opened by Lord Home, the Foreign Secretary. This is the first plant of its kind in Western Europe to be laid down specifically for the development and manufacture of numerical control equipment and has a floor area of 70,000 sq. ft.

**Associated Electrical Industries Ltd.** are to install three of their high resolution EM6 electron microscopes in the new £1.5M biology building at the University of Birmingham.

**Eastern European Production.**—According to east Berlin reports, Czechoslovakia, east Germany, Poland, Hungary, Bulgaria and the U.S.S.R. plan to co-ordinate their domestic radio receiver production in order to reduce costs and to integrate exports and imports. At present they are producing some 125 different models between them.

**R.C.A. Great Britain Ltd.** have asked us to point out that the "Student" twin-track tape recorder referred to on page 168 of our April issue forms part of the language laboratory equipment manufactured by Cedamel which they are marketing in this country.

Manufacturing rights of **WAL products** have been sold by the widow of Roy N. Wellington, founder of Wellington Acoustic Laboratories Ltd., of Farnham, Surrey, to A. C. Farnell Ltd., of Leeds.

As from May 1st, manufacture and distribution of the complete **Chapman** range of public address amplifiers, microphone mixers, loudspeakers and accessories, hitherto undertaken by Derritron Ultrasonics Ltd., will be transferred to Reslosound Ltd., their associated company in the Derritron Group. The Chapman range of hi-fi domestic amplifiers, together with a.m./f.m. radio tuners, will continue to be produced by Derritron Ultrasonics Ltd.

High fidelity components distributed under the H.M.V. trade mark will now carry the "**C.S.I. Sound**" emblem. The equipment, which had its first public showing with the new emblem at the Audio Fair, continues to be marketed by the Clarke and Smith Manufacturing Company of Wallington, Surrey.

The **Ministry of Aviation** has placed orders worth over £900,000 with the airborne radio and radar division of Elliott-Automation for sonobuoy anti-submarine detection equipment for R.A.F. Coastal Command. The contracts, which were the subject of competitive tenders by a number of firms, are the first to be placed with Elliott-Automation for this type of equipment. Deliveries are due to start next year.

An order for 30 "**Autoplex**" solid-state terminals (automatic error detecting and correcting telegraph equipment) has recently been received by Marconi's W/T Company from the British General Post Office. This order includes a full range of auxiliary items such as telex units, channel sub-dividers and start/stop converters, etc.

**Airtech Ltd.**, Haddenham, Bucks., have received a substantial order from the Ministry of Aviation for h.f. portable radio stations. These are built up from "manportable" modules, each contained in fibreglass protective cases.

**Hughes International (U.K.) Ltd.** have been appointed exclusive sales distributors for Fansteel tantalum capacitors in the U.K. and Eire. Enquiries should be addressed to Hughes International (U.K.) Ltd., Kershaw House, Great West Road, Hounslow, Middlesex.

**Sperry Microwave Electronics Ltd.**, of Florida, U.S.A., have appointed Roberts Electronics Ltd., of Hitchin, as their U.K. agents. Roberts have also been appointed agents for **P.R.D. Electronics Incorporated**, of New York.

**Racal**, of Bracknell, have obtained from Tracor Inc., of Austin, Texas, the sole marketing rights of their **Textran** equipment throughout the world except North America. One of the principal Textran equipments is the all-solid-state v.l.f. tracking receiver (599CS), which is in widespread use as an aircraft navigational aid and as a tracking receiver in space satellite research programmes.

**Sakae Tsushin Kogyo Co. Ltd.**, of Tokyo, have appointed Electro Mechanisms Ltd., of Slough, to market their range of precision wirewound potentiometers and multi-dials.

**Fisher Radio Corporation** of New York, manufacturers of high-quality audio equipment have appointed Imhof's of New Oxford Street, London, as their U.K. representatives.

**Direct TV** group of companies, which includes Beulah Electronics, have moved from Lewisham to 126 Hamilton Road, West Norwood, S.E.27 (Tel.: Gypsy Hill 6166).

**Henry's Radio Ltd.**, the well-known component suppliers, have moved from Harrow Road to 303 Edgware Road, London, W.2.

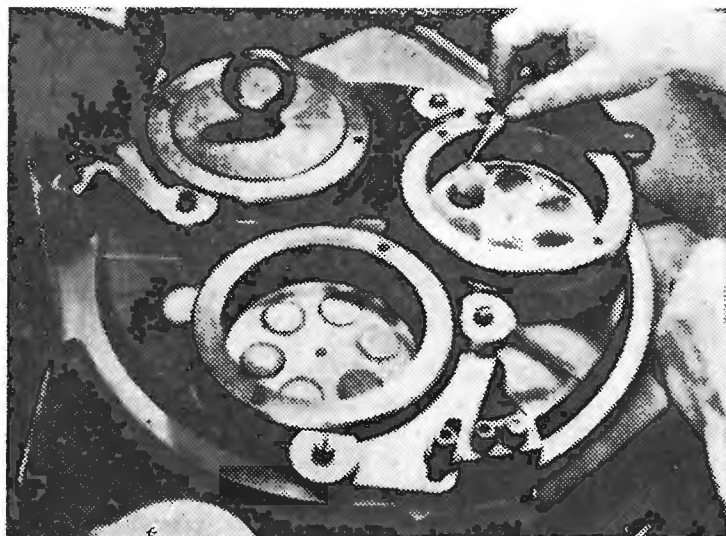

Slices of n-type doped silicon for the manufacture of silicon controlled rectifiers, being prepared for lapping in a Lapmaster machine (Payne Products International) at the Lincoln factory of A.E.I.

**A.T. & E. (Bridgnorth) Ltd.** have received an order for v.h.f. equipment for a 100-mile radio link between the Ministry of Aviation radio stations at Rhu Stafnish and Tiree in the Hebrides. A repeater station will be sited at Kilchiaran. The radio link will carry audio and switching signals for the modulation and control of the transmitters at Tiree, and for receivers in the return direction. In addition a two-way supervisory circuit is provided.

An agreement which will lead to the manufacture of **British-designed multiplexing equipment in the U.S.A.** is now in force between Automatic Telephone and Electric Company Ltd. and the Stromberg-Carlson Division of the General Dynamics Corporation. At present the arrangement is limited to the distribution of A.T. & E. equipment, but it is expected that production to A.T. & E. designs will soon begin.

## EXPORT NEWS

The **General Electric Company** has secured an order to supply all the multiplex equipment for a microwave link between Montreal and Vancouver. The system, which is being jointly constructed by Canadian National Telecommunications and Canadian Pacific Telecommunications, will have G.E.C. transistorized multiplex equipment installed at 32 terminal locations. Altogether the system will consist of 600 speech circuits and at the intermediate terminals extensive use will be made of supergroup derivation filters to avoid demodulating the supergroups directly connecting Montreal and Vancouver.

The electronic training equipment division of **Philco International Ltd.** have recently received, via a European associate company, an order to supply training equipment to a number of military establishments having N.A.T.O. commitments. This order includes equipment in the telecommunications, radar and automatic control fields.

The **Solartron Electronic Group** have been awarded a contract for £60,000 by V-O Mashpriborgintorg, the Soviet State purchasing organization, for digital voltmeters, oscilloscopes and general instrumentation equipment.

**A. N. Clark (Engineers) Ltd.**, of Binstead, Isle of Wight, have secured an order for 125 30-foot high portable aerial masts for the Danish Army through their agents, Claus Kettel of Copenhagen.

# Personalities

**Wing Commander K. B. Crosby**, of the R.A.F. Air Traffic Control Branch, who in his long association with A.T.C. has done considerable research into the subject particularly latterly at R.R.E., Malvern, has been elected Master of the Guild of Air Traffic Control Officers. The Guild was formed in 1951 to further the safety and progress of aviation through the working together of civil and military control office and officials of the aviation industry.

**Colonel F. R. Peathey-Johns**, M.B.E., B.Sc.(Eng.), M.I.E.E., M.Brit.I.R.E., until recently assistant director of Electrical and Mechanical Engineering (Electronics) at the War Office, has joined Gresham Lion Electronics Ltd., where he will be concerned with the development of electronic products, particularly those with Services applications. Colonel Peathey-Johns, who is 50, was commissioned in 1938 as an Ordnance Mechanical Engineer and transferred to R.E.M.E. on its formation in 1942. He later commanded the Electronics Base Workshop of the British Army at Old Dudley, Nr. Leicester, and since 1957 has been in the War Office.

**E. P. Stanton**, M.B.E., Ph.D., B.Sc.(Eng.), M.I.E.E., who has been appointed chief inspector of the Plessey Company (U.K.) Ltd., joined Plessey as deputy chief inspector in 1957. Dr. Stanton previously served for 18 years with the Royal Corps of Signals and the Ministry of Supply, before which he was for 12 years in the Engineering Department of the G.P.O. After the war he was appointed technical staff officer at the Signals Research and Development Establishment. When he left the Government service in 1957 he was assistant director (electronics) in the Engineering Inspection Directorate of the Ministry of Supply. Dr. Stanton is a council member of the Institution of Engineering Inspection.

**J. A. F. van Dijk**, M.Sc., who joined Mullard Blackburn Works in 1948 as chief valve engineer and has been manager of the valve division since 1953, has been appointed plant director. He will have overall responsibility for all four divisions of the Blackburn works—valves, components, glass and wire—and for its “feeder” units at Southport, Fleetwood, Lytham and Rawtenstall. Mr. van Dijk, who is 46, studied at the Technological University of Delft, Holland.

**Hector V. Slade**, M.B.E., T.D., has relinquished his appointment as managing director of the Garrard Engineering and Manufacturing Co. which he joined as an apprentice in 1935, but remains on the board. He is succeeded, as managing director, by **T. H. Pritchard**, who joined the Plessey Group, of which Garrard is a subsidiary, in 1951, and for the past year has been production director of Garrard. The company's technical director is **A. W. Say**.

**Leonard Stone**, who founded Electric Audio Reproducers Ltd. in 1953, has resigned from the managing directorship of the company which was recently acquired by Perdio Electronics Ltd.

**B. J. Austin**, who writes in this issue on impedance functions, is engaged in research in theoretical solid state physics at the Cavendish Laboratory, Cambridge, for his Ph.D. degree. He is a New Zealander and has come to this country under a fellowship of the University of New Zealand. He is a graduate of the University of Otago where he studied mathematics and physics.

**S. B. Marsh**, B.Sc.(Eng.), A.M.I.E.E., for the past few years a superintendent in the Guided Weapons Department of the Royal Radar Establishment, Malvern, has been promoted to deputy chief scientific officer and also head of the Airborne Radar Group. His career in the Civil Service began in the G.P.O. Research Station at Dollis Hill which he joined as a trainee in 1940. He gained an honours degree at the University of London in 1945 and in 1949 left the Post Office to join the Radar Research and Development Establishment, which in 1953 became part of R.R.E.

The council of the City and Guilds of London Institute confers each year the Insignia Award in Technology (C.G.I.A.) *honoris causa* on selected persons in each of several industries “who have achieved distinction in their chosen field.” This year's electrical industries award is conferred on **J. A. Lawrence**, T.D., M.I.E.E., staff engineer of the Telephone Electronic Exchange Systems Development Branch of the Post Office. Mr. Lawrence, who is 55, joined the Post Office as a youth-in-training in 1927. He is a member of the Joint Electronic Research Committee set up to co-ordinate the efforts of the Post Office and manufacturers in the field of electronic telephone exchanges.

**R. L. Beurle**, B.Sc.(Eng.), A.M.I.E.E., manager of the camera tube and image tube research department of the English Electric Valve Company since 1957, has been appointed to the new chair in electronic engineering established at Nottingham University. Before joining E.E.V. Mr. Beurle was a research fellow and lecturer in physics at Imperial College, London.

**P. J. B. Clarricoats**, B.Sc.(Eng.), Ph.D., A.C.G.I., is appointed professor of electronic engineering in the Department of Electrical Engineering at the University of Leeds and takes up his duties on July 1st. Dr. Clarricoats was engaged in microwave ferrite research with the General Electric Company until 1959, when he was appointed to a lectureship in light electrical engineering at Queen's University, Belfast.

**K. G. Smith**, deputy managing director of N.S.F. Ltd. and a director of several of the subsidiary companies (including Dawe, Cawkell and British Centralab) in the Simms Group, has been appointed to the board of the parent company, Simms Motor & Electronics Corporation. Born in Cape Town in 1908, he was for 14 years with the Kolster-Brandes division of S.T.C., of which he became chief engineer. He joined N.S.F. in 1940. Mr. Smith is a council member of the R.E.C.M.F. and is chairman of its technical committee.

**J. Hughes**, B.Sc., Ph.D., has joined Vactric Control Equipment Ltd. as chief scientist. After graduating in physics at the University of Liverpool in 1943 he joined D.S.I.R., and spent two years at the Los Alamos Laboratory, U.S.A. He returned to the University as research fellow and obtained his Ph.D. In 1953 Dr. Hughes was appointed lecturer in the Department of Natural Philosophy at the University of Edinburgh, and since 1956 has been with the Rank Organization, for the past two years as chief scientist to Rank Xerox Ltd.

**M. F. Osmaston**, M.A., recently joined Vactric Control Equipment Ltd. as a project engineer. After graduating from Oxford University with an engineering degree he furthered his studies at King's College, Newcastle, after which he took up an appointment with the Mullard Research Laboratories. In 1952 he joined Vickers-Armstrong (Aircraft) Ltd., where he was responsible for co-ordinating guided weapons systems.

**J. L. Woollett** has been appointed by Aerialite Ltd. general manager of its aerial and electronic division, Congleton Factory.

# LETTERS TO THE EDITOR

*The Editor does not necessarily endorse opinions expressed by his correspondents*

## Phase Splitters

I HAVE read with interest Mr. Bailey's reply, published in the March issue, to my letter which appeared in the January issue.

I do, of course, agree with Mr. Bailey that it is unrealistic to ignore completely the effects of overload, but provided these are comparatively mild compared with the "fit of hysterics lasting several seconds" to which he refers, I do not see that their exact nature is of any real importance in a loudspeaker amplifier, since such an amplifier, in a good system, has a sufficient output rating to avoid the occurrence of overloading completely. Even if the volume control were turned up a little beyond the point at which overloading commenced, the overloading which would occur with most types of programme material would be of such momentary duration that there would not be time for appreciable back biasing of the output valves to take place. Indeed, the B.B.C. allow such short-duration overloads to occur, and find the modulation depth of their transmitters can be usefully increased in this way without causing noticeable distortion. The 2.5 millisecond charging time-constant in their peak programme meters is intentionally chosen to allow short-duration overloads to occur without being registered on the meter.

However, Mr. Bailey's comments have caused me to investigate the overload behaviour of my 5-watt amplifier in a more quantitative way than I did at the time of the original design, and the results may be of interest.

The first test, done with a 15-ohm resistance load

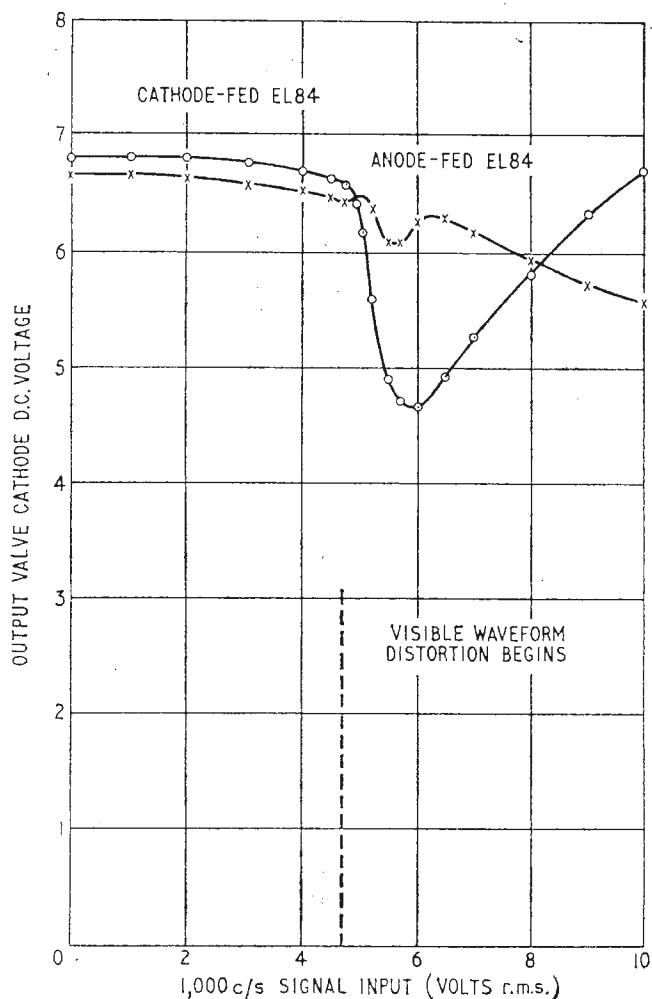

Fig. A

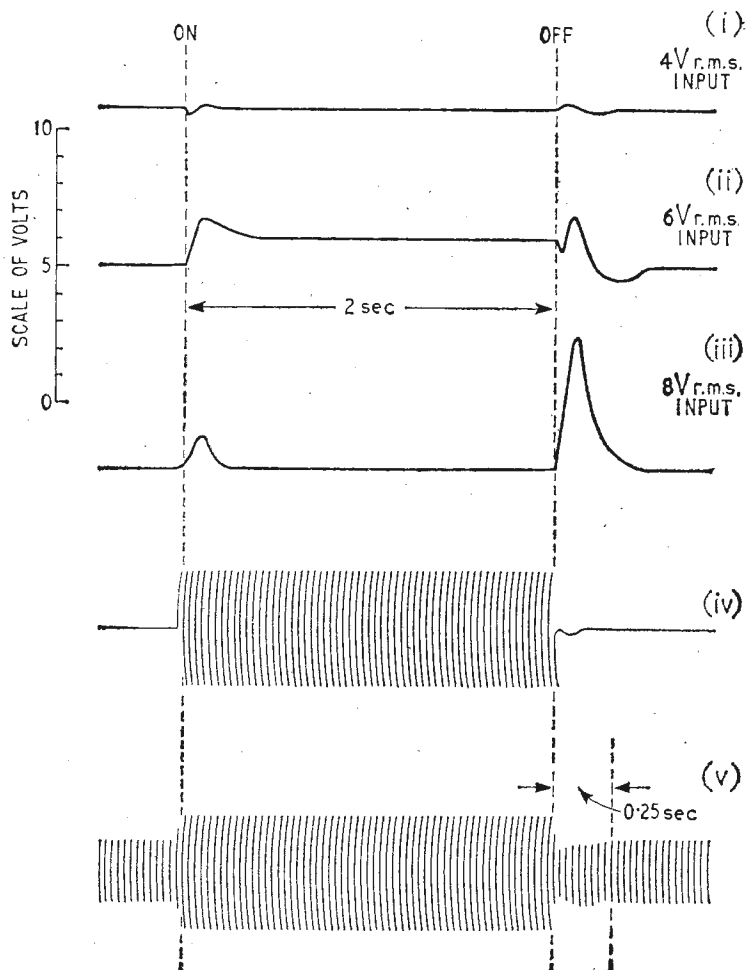

Fig. B.

connected to the amplifier output, was to measure the variation in the d.c. voltages between the output valve cathodes and earth as the sine-wave input to the amplifier was increased up to and well beyond overload. The results are given in Fig. A. It will be seen that the output valve fed from the cathode of the phase splitter is initially biased back more than the other one, just as predicted by Mr. Bailey, but that, at even greater overloads, the situation becomes more complicated. It should be pointed out that the maximum input used, 10V r.m.s., would produce, if overload did not occur, an output power of just over 30 watts. The amplifier appears to be none the worse for this treatment, I am glad to say!

Some further tests were done with the help of a d.c. amplifier feeding a moving-coil waveform recorder, whose frequency response extends up to about 60 c/s. This apparatus was initially arranged to record the variation in the d.c. voltage between the output valve cathodes in the 5-watt amplifier, as a 1,000 c/s sine-wave signal was switched on and off at 2-second intervals.

Fig. B(i) shows the voltage waveform between the cathodes for an input of 4V r.m.s., producing an output of 5 watts. (The actual voltage contains a large 1,000 c/s component, but this was filtered out by a simple C-R filter and, in any case, the recorder would not respond to it.) Figs. B(ii) and B(iii) are for inputs of 6V and 8V r.m.s. respectively.

At the level used for the Fig. B(iii) test, Fig. A shows that the cathode currents, on a sustained overload, recover approximate equality, but it is clear from Fig.



B(iii) that quite large transient disturbances nevertheless occur, particularly when the input signal is turned off.

For the remaining tests, the recording system was fed from the 15-ohm output terminals, the signal frequency being reduced to 60 c/s to allow the recorder to respond satisfactorily.

Fig. B(iv)\* shows the amplifier output when an 8V r.m.s. sine-wave input is switched on and off. It will be seen that a recovery transient is visible after the cessation of the input, but that, compared with Fig. B(iii), it is relatively inconspicuous, being severely attenuated by the output transformer.

Finally, in Fig. B(v)\* is shown the effect of increasing the amplifier input from 2.7V r.m.s., which is well below overload level, to 8V r.m.s., which produces violent overloading, and returning it again to 2.7V. Distortion of the actual signal waveform does not show up on this recording, because the harmonics are above the cut-off frequency of the recorder—the significant part of the recording is, rather, that showing the recovery of the amplifier after the input is switched from 8V to 2.7V. It is evident that the amplifier has substantially recovered its normal gain after less than a quarter of a second—no evidence of a fit of hysteresis lasting several seconds!

I come now to Mr. Bailey's comment that the concertina phase splitter gives a gain about 20 times less than the long-tailed pair. It is true, of course, that a single triode used as a concertina phase splitter gives a gain of only unity to each output, whereas a long-tailed pair, typically employing a double triode, may well give a gain of 20 to each output terminal. But it seems to me that a much more significant comparison to make is between an arrangement (such as in my amplifier) employing a double triode to provide a gain stage plus a concertina phase splitter, and a circuit using the same double triode as a long-tailed pair. The gain in the concertina arrangement is then over twice that given by the same double triode used as a long-tailed pair—over twice, because the first triode in the concertina system is operated with more voltage between h.t. positive and its cathode than is the long-tailed pair, and because a high value of anode load, d.c. coupled to the phase splitter, may be used, thus making available a gain approaching the amplification factor of the valve. In the long-tailed pair, on the other hand, it is less satisfactory to employ very high anode load values, because of the loss of gain then caused by the shunting effect of the output stage grid leaks, and by stray capacitances at high frequencies.

A further point about phase splitters, not so far mentioned as far as I am aware, is that it is possible, in some circuits, for trouble to arise owing to overloading of the phase splitter itself, as distinct from the output stage grid circuit.

The first example of such trouble involves a negative-feedback amplifier with an anode-follower, see-saw, or floating-paraphase phase splitter (Mr. Bailey's Fig. 2). If such an amplifier is violently overloaded, the paraphasing valve may get cut off on its grid. The signal input can then get transferred to the output via the two see-saw resistors in series, *without phase-inversion*. If one output valve—the one which is not fed from the paraphasing valve—is also temporarily cut off, an amplifier circuit is left which has overall *positive* feedback. The phase-splitter gain will, of course, be much less than it normally is but, in an amplifier having a large amount of overall feedback, the loop gain may, nevertheless, be greater than unity under these positive feedback conditions, and oscillation may then occur until the system recovers. My amplifier, published in *Wireless World*, January 1948 (push-pull 6L6's) exhibits this effect, and produces a momentary squeak if violently overloaded. This does not happen under any normal conditions of operation, and it does not imply that the stability margins, as usually understood, are inadequate

—they are, in fact, unusually wide. All the same, it may properly be regarded, I think, as a shortcoming of the type of phase splitter used.

The concertina phase splitter, using a valve, is quite free from the above trouble, but it is interesting to note that, when a transistor is used in it, the possibility of passing on the signal without phase inversion, under overload conditions, appears again. Thus, consider a concertina phase splitter using an n-p-n transistor. As the base is lifted more and more positive, the collector voltage falls to meet the base, until no voltage is left between them. The collector/base junction is no longer reverse biased, and if the base is lifted even more positive, the collector must move with it, the two electrodes being connected together, in effect, by a forward-biased junction diode. Thus all three transistor electrodes move together, and the collector output is no longer phase-inverted with respect to the base voltage.

In conclusion, while it is true, as stated in my January letter, that I have never heard of anyone having instability troubles with the 5-watt amplifier, i.e. troubles involving the stability of its negative-feedback loop, this would seem to be a good opportunity to mention that two or three readers have written, over the past few years, to say that they have experienced a tendency to motor boating when using the Inexpensive Pre-amplifier, described in the May 1957 issue, in conjunction with the 5-watt amplifier. The motor boating starts up when bass lift is in use and an accidental overload occurs. There is no trace of this trouble with the original prototype, and it happens only when an unfortunate, and apparently rare, combination of component tolerances results in the h.t. decoupling in the pre-amplifier being insufficient in relation to the available forward gain. I have investigated the effect carefully, and the best cure is to increase the h.t. decoupling capacitors in the pre-amplifier from 16+16 $\mu$ F to 32+32 $\mu$ F. An alternative cure is to reduce the value of the input stage grid leak in the 5-watt amplifier from 270k $\Omega$  to 150k $\Omega$ . This gives a bass loss of about 1 dB at 40 c/s, which is quite negligible aurally.

Great Malvern.

PETER J. BAXANDALL.

## “Non-linearity Distortion Measurement”

IN reply to Mr. Scroggie in your May issue:—

(1) We say that under “normal operation” the higher orders of distortion become increasingly less important. This does not exclude the testing of amplifiers in overload, and the method of test proposed in our paper would provide a fundamental measure of the audible effect of distortion even when very high orders of distortion are present. Nevertheless, amplifiers are normally operated where lower orders of distortion only are significant, for if high orders of distortion were significant a small increase in signal power would make them intolerable. For example, the analysis shows that a 1-dB increase in signal power will increase the tenth order distortion power by 10 dB.

(2) The purpose of quoting the astronomical ratio of the power in intermodulation noise to that in the harmonics of the same order was not to prove the advantages of two-tone testing over single-tone testing but to show that the effect of distortion on a complex signal was an increase in noise rather than the production of possibly pleasing harmonics.

At the B.S.R.A. lecture we gave a demonstration of this point. We played a record through a device which provided pure second order distortion without any trace of the original signal. Single instruments still had outputs with identifiable tones, but when all the orchestra was playing, the harmonics had completely disappeared beneath the flood of intermodulation products and no musical quality remained. The device used was a squaring circuit in which a pure sine wave was converted into d.c. and another pure sine wave of twice the fre-

(Continued on page 289)

\* These records were re-drawn as the originals on Teledeltos paper proved to be unsuitable for reproduction.—Ed.

# REVOLUTIONARY NAVAL RADIO TRANSMITTING SYSTEMS

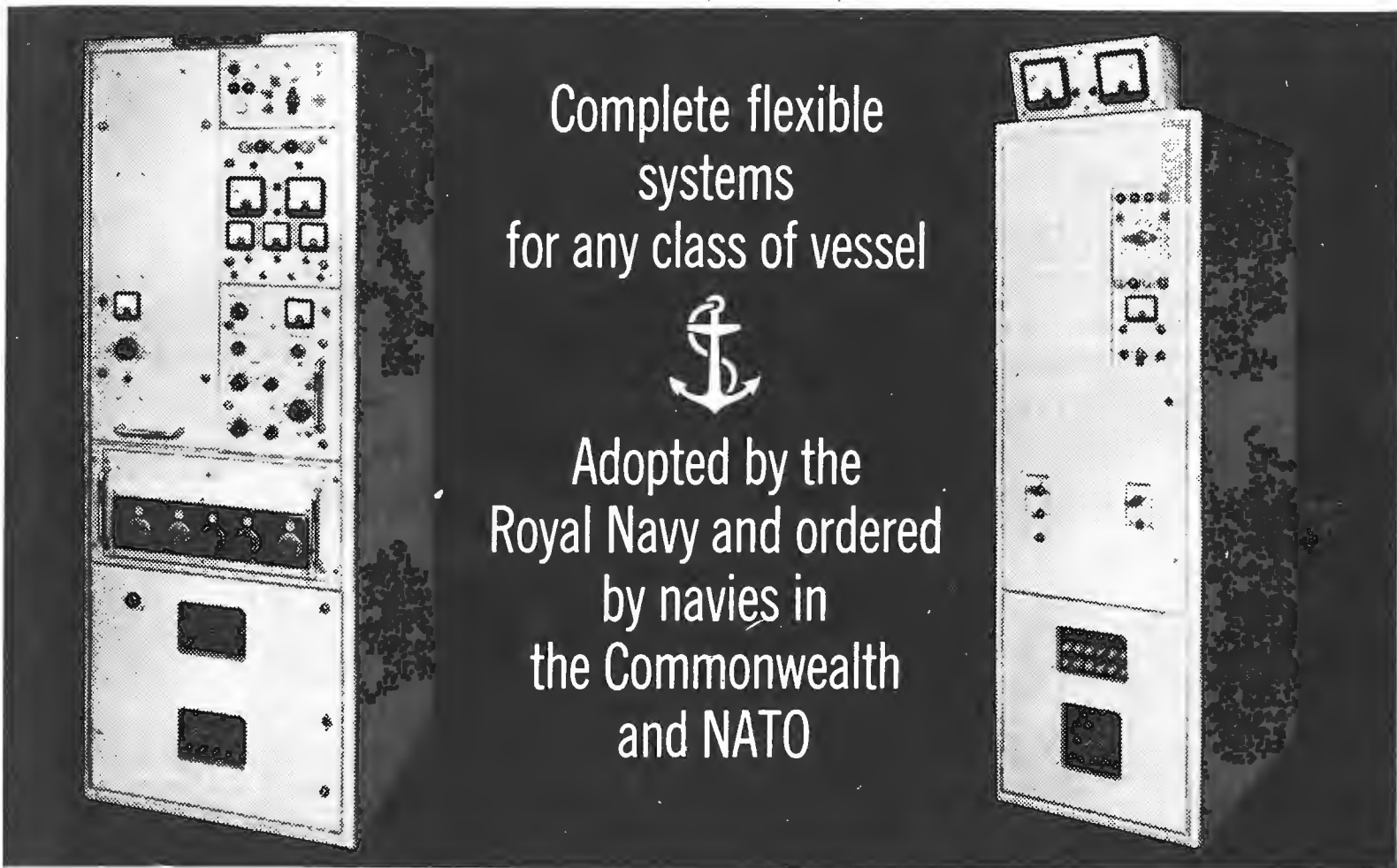

Complete flexible  
systems  
for any class of vessel



Adopted by the  
Royal Navy and ordered  
by navies in  
the Commonwealth  
and NATO

- Precise frequency setting and positive stability allows full advantage to be taken of SSB which provides the most reliable communications under difficult conditions of propagation or interference
- Continuous frequency coverage from 240 Kc/s to 24 Mc/s
- Covers all types of signalling
- Broadband amplifier and synthesizer system provides simplest operation and almost eliminates tuning
- Aerials can be sited for maximum radiating efficiency.

## MARCONI NT 203/204 SYSTEMS



**COMPLETE NAVAL RADIO AND RADAR SYSTEMS**

MARCONI'S WIRELESS TELEGRAPH COMPANY LIMITED • CHELMSFORD • ESSEX

Products of  
**N.S.F.**  
 THE SWITCH PEOPLE

**Oak** CIRCUIT AND BAND SELECTING,  
 TAPPING, ETC. **SWITCHES**

ROTARY multi-section switches from 1in. diameter and with 12 to 24 positions per section and numerous poles. Dual concentric shafts available certain models. Kits for prototype building. Ex stock—"JK" switches, 12 positions, 1, 2 or 3 sections. Complete with fixed, and adjustable stops.

PUSH-BUTTON switches with up to 16 buttons and up to 32 contacts per button.  
 SLIDE SWITCHES—2-12 pole changeover. With push-pull or rotary control.

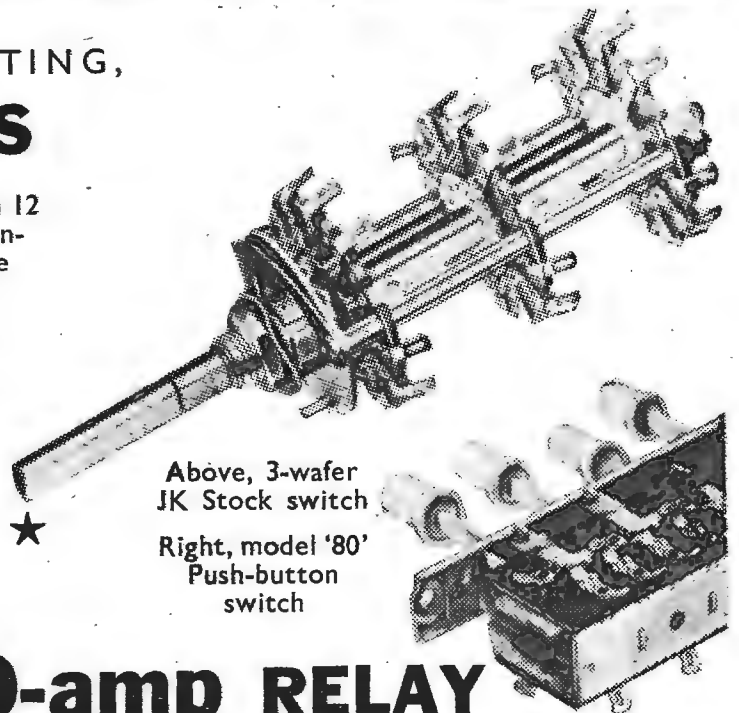

Above, 3-wafer JK Stock switch

Right, model '80' Push-button switch



MINIATURE

NSF/UNION **10-amp RELAY**

New "H" type, 4-pole changeover. Hermetically sealed case. Rugged and reliable. Contact rating, 10 amps at 26.5V. D.C. Operating coils for 16 to 200V. supplies. Flange mounting or plug-in. "M" 1 and 2-amp types also available.

Licenseses of Westinghouse Brake & Signal Co. London.

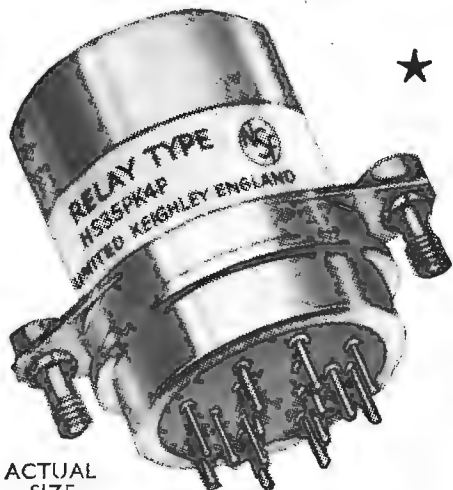

ACTUAL SIZE

**LEDEX** ROTARY SOLENOIDS

Small components for remote control and similar applications. Snap action high-torque-for-size rotary motion with substantially linear and level work-to-rotation curve. Ledex Circuit Selectors (as illustration)—rotary wafer switches with solenoid drive. Simplify complicated circuit switching.

Licenseses of Ledex Inc., Dayton, U.S.A.

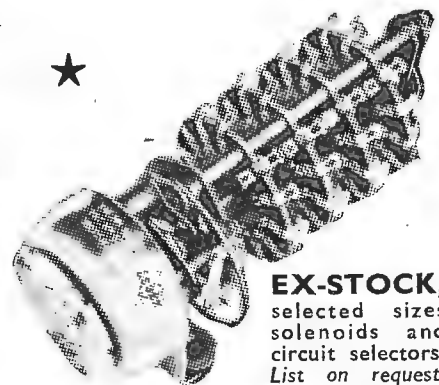

EX-STOCK, selected sizes solenoids and circuit selectors. List on request

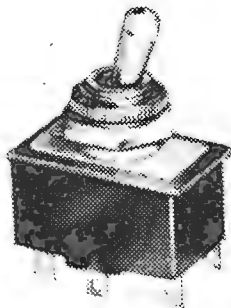

**Cutler-Hammer LEVER SWITCHES**

These well-known switches are available with 1-20 amp A.C./D.C. ratings and with various other operating mechanisms—push button, slide and trigger.

Licenseses of Cutler-Hammer Int., Milwaukee, U.S.A.

**R.E.C.M.F.**  
**Exhbn.**  
**STAND**  
**269**  
**GRAND HALL**

Information on request to

**N S F LTD.,** 31-32 ALFRED PLACE, LONDON, W.C.1

Telephone : LANgham 9561 Telegrams : Enesef Telex London Telex : 21907

WORKS: KEIGHLEY, YORKSHIRE

A MEMBER OF THE **Simms** GROUP OF COMPANIES



quency. (This demonstration could be repeated.) The reasons for using power rather than amplitude ratios are:—

- (a) Amplitude is ambiguous for a complex signal.
- (b) Powers of uncorrelated signals can be added, amplitudes must be root-mean-squared!
- (c) Ratios of powers in dB can be obtained by addition and subtraction.

We accept Mr. Scroggie's point that the reason we gave for stating that a two-tone test can measure lower levels of distortion than a single-tone test was not valid for second order distortion, but we do not accept that the conclusion was incorrect, or that the fair comparison between multi-tone and single-tone testing is on the basis of signals which can never exceed a specified maximum amplitude. This not only excludes white noise testing but also the playing of concerted music.

(3) The ramifications of frequency-dependent transfer characteristics are interesting and complex, but will not shake the conclusions of the paper that the dominant effect of distortion on a complex signal is to produce noise in the form of intermodulation products, and that the distortion of a system can effectively be measured by means of a slotted white noise signal.

Finally, we would like to refer to Mr. Scroggie's article in *Wireless World*, July 1953. This gives a detailed description of the methods of measurement for audio systems proposed at that time, and includes a plea for a better method involving "a physical measurement to which audible distortion is as nearly as possible proportional." This is what we believe we have described.

J. S. MURRAY.  
J. M. RICHARDS.

### Intuition and Instability

ENGINEERS should not let Mr. Donaldson make them forget that it is only a short step from the crystal balls of intuition to the golden balls of insolvency. In the first example intuition is said to work, but many of us find it difficult to accept *intuitivity* that with an open-loop gain of, say, 5 and an open-loop phase shift of  $170^\circ$  (or  $10^\circ$  if  $A$  is  $-5$ ), the system is stable. It was not until the work of Black and Nyquist became familiar that we began to think this was common sense. Readers may care to make themselves dizzy by considering the reasoning given by Mr. Donaldson for his Fig. 2 when applied to the accompanying Fig. A, which has an open-

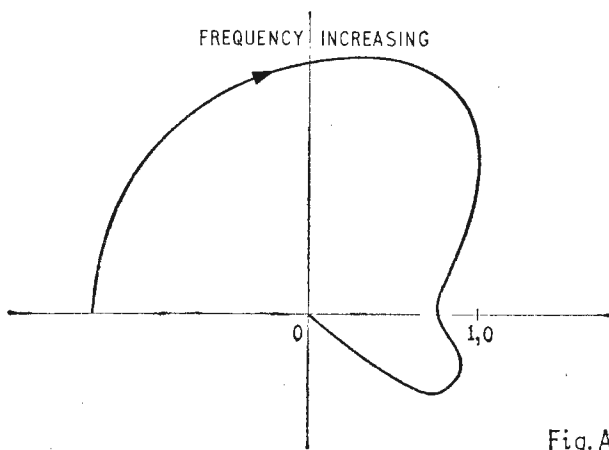

Fig. A

loop gain characteristic suitable for oscillator applications.

When we turn to the three integrators and the adder of Fig. 3 I cannot show easily by Nyquist criterion that the system is unstable if  $A < 1$ . Before my intuition is brought to bear on the problem I must sketch the open-loop characteristic given as Fig. 4. Finally my intuition begins to stick on the question of  $A=0$ , a value which is certainly  $< 1$ .

The three integrators offer a problem of very great interest, because they force us to examine rather closely

what we mean by zero frequency. Suppose that we wish to plot the open-loop behaviour. We measure the gain and phase at a set of points. To simplify matters we take these points at equal intervals in the scale of periodic times, so that  $f_n = 1/n\tau_0$ . Zero frequency becomes a point of accumulation. (Readers who wish to go further will find chapters I and IV of G. H. Hardy, "A Course of Pure Mathematics," C.U.P., very stimulating.) As  $n \rightarrow \infty$  we have  $f_n \rightarrow 0$ , but we also have the problem that our integrators will have been integrating from time immemorial. On this rock intuition is wrecked.

To draw the Nyquist diagram let us make our integrators imperfect, so that we use elements giving  $1/(p + \delta)$ . we then draw Fig. B. Part of the characteristic is shown

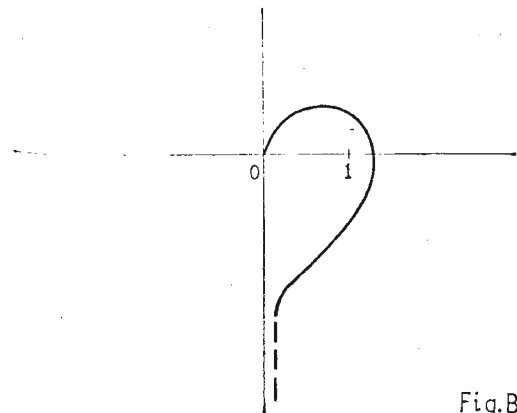

Fig. B

as broken lines, and this is the part in which  $|p|$  and  $\delta$  are of the same order. As  $\delta \rightarrow 0$  this part is traversed in the infinity of very small frequencies at the point of accumulation.

Now we see that we are dealing only with a special case of conditional stability. It is essentially the same as the plot of Fig. C, except that the point B has vanished

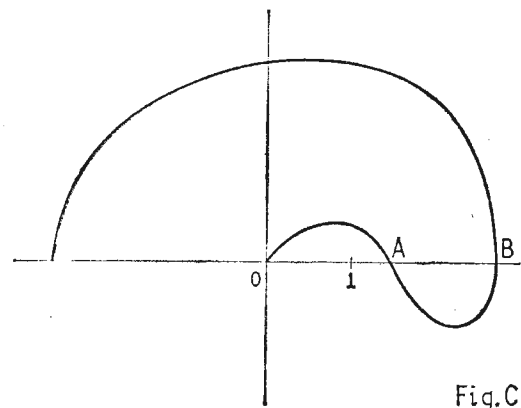

Fig. C

up Mr. Donaldson's sleeve. All we really need is a physical argument to explain conditional stability. Probably we might say that growing oscillations at frequency B imply a sideband term at A which then grows to give a cancelling sideband at B. I prefer to accept contour integration.

The trouble with intuition is that it often gives us a result which is not not closed but chopped off before the right answer is reached. Intuitively the system of Fig. D is surely stable, for any amplifier output at frequency

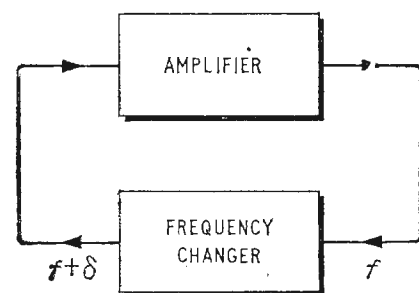

Fig. D

$f$  produces only an input at another  $f+\delta$ . Such a system would have great advantages in four-wire, two-wire connections but, alas, intuition plays us false.

G. EDWIN.

## "Transistors as Switches"

MR. D. A. Smith's comprehensive article in the April issue leaves us all without any excuse for blowing up switching transistors, or even contacts.

But some electromechanical devices resent the mechanical damping implicit in electrical damping. It can upset the timing in such things as teleprinters and high-speed relays; and in developing a motor system using a modified M-motor with switched coils and a permanent magnet rotor† (with Dr. U. W. Arndt and Mr. A. R. Long at the Davy Faraday Research Laboratory of the Royal Institution) we found that plain suppression diodes, as in Mr. Smith's Fig. 6, cut our off-load stalling speed in a particular case from 12,000 to 6,000 r.p.m. The way round this is to use a transistor capable of withstanding large voltage surges. This may ultimately be as cheap as it is simple.

Newcastle-upon-Tyne.

F. B. JONES.

International Research & Development Co. Ltd.

† Patent applied for by N.R.D.C.

MR. Smith's interesting circuits (April issue, p. 183), unfortunately, have a weakness of a rather subtle nature. Due to the collector current of the p-n-p being the same as the base current of the n-p-n transistor it is of necessity (a) low and (b) variable. The effect on the p-n-p  $\beta$  is (a) to very much reduce it and (b) to impose on its own production variability a further variation due to the production variability of the n-p-n  $\beta$ .

In addition, as a practical point, most transistors are not controlled for currents of  $100\mu\text{A}$  or less.

Similar arguments apply as regards the frequency determining parameter  $f_T$ .

The simple solution is one extra resistor and supply

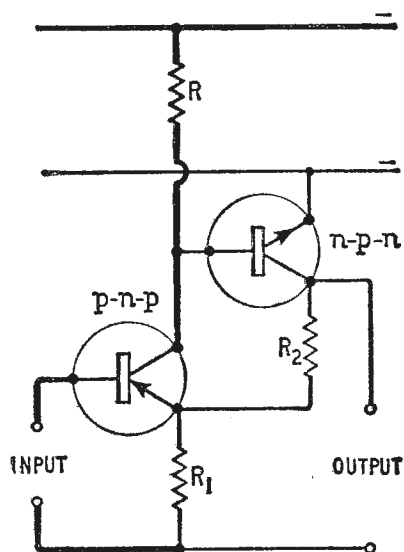

as indicated in the accompanying diagram, and the circuits are then suitable for production when, from experience of similar configurations, they are to be commended.

Harlow.

A. SANDMAN.

## 625/525 TV Standard

WITH reference to the editorial in your April issue, it is perhaps worth pointing out that the Television Group Committee of the British Institution of Radio Engineers, in their report to the Pilkington Committee published in May 1961 (Section 5), recommended that: "If a change were made to the 625-line standard in this country very little technical difficulty would be experienced in broadcasting and receiving on the same system,

recordings which have originated in the countries using the 525-line standard. . . ." The report went on to point out that the proposals would necessitate precautions being taken in the design of receivers, i.e., better smoothing, etc., for asynchronous operation and that further field tests were necessary to establish the practicability of the proposal.

Apart from a switch between the line and field repetition rates, in such a system the other parameters of the 625 system would be retained, i.e., vision-sound carrier spacing, etc. It would appear that 625/525 colour would be impracticable, however!

D. W. HEIGHTMAN.

(Member of Brit.I.R.E. Television Group Committee.)

## Asynchronous Working

I NOTE with interest that in your May issue you state that the B.B.C. has adopted asynchronous operation for television trade test transmissions from March 25th.

I would like to point out that due to the fact that the Northern Ireland electricity grid is not locked to the British mainland grid, whenever we here in Ulster radiate network programmes we are invariably working asynchronously, and we have been doing this since our first "on air" date almost four years ago, and I might add that we have received very few complaints because of this from any of our viewers.

Belfast.

F. A. BRADY.

Technical Controller, Ulster Television Ltd.

## Blind Landing Systems

In your description of the Miles blind landing system, you refer to this as being a new approach. This most certainly is not so, for during the last year of World War II I worked out and submitted to the then head of Radio R.A.E. Farnborough, a scheme exactly as described in your write-up. I still hold the original papers together with Dr. Gates' polite letter of thanks and rejection of the scheme.

While it may well be that the limited sophistication of servo-mechanism and computers in that day would not have allowed for easy development I still hold the opinion that it was a practical scheme. Additionally I had considered to what extent a servo-controlled variable focal length might be employed to ease perspective difficulties. That part of the device which comprised the camera and airfield model I dubbed "Scannerdrome." In discussion (this is not in the papers I hold) I had gone over the value of using a form of coded secondary radar for securing a really exclusive lock-on in the face of high target density and interference.

While I am nowadays only concerned with how people can be given telephone service and have no direct interest in blind landing systems, I wish Messrs. Miles every success in their endeavours and hope they will lead to safer air travel.

CHRISTOPHER SEARCH.

Hurstpierpoint, Sussex.

## Citizens' Radio

MR. Conhaim's article in your March issue on the history and present state of Citizens Band Radio in the U.S.A. is a valuable comment on the debatable value of introducing a service of this kind in Britain. In reviewing this service it should be borne in mind that the situation in this country in regard to such a service would not be the same as in the U.S.A.

First, the allocations of frequencies to the professional mobile services is much more generous in the U.S.A. Almost the entire band 25-50 Mc/s (or 1,250 20-kc/s single frequency channels) is available for such services which, unlike the Citizens Band, are of unquestionable value to the community. Frequencies in this band have always been precluded from mobile allocation for reasons that have never been very satisfying. It is, therefore,

surely in the national interest that the allocation of frequencies below 40 Mc/s in the U.K. be reviewed in favour of mobile services in general before any decision on a Citizens Band Radio is made.

The demand for mobile radio services is potentially far greater than is generally realized in this country. Although our development level, corresponding to 0.5 per cent of all vehicles is high on the list of national comparisons, it is well below the U.S.A. (2 per cent) and New Zealand (3 per cent) where mobile services are still growing vigorously.

Recently the German Federal Republic has added 10 Mc/s between 145-155 Mc/s for mobile services. Based on 20 kc/s channelling this represents 500 channels and will make a very substantial increase in the efficiency of distribution services in that country. Transport in this country must surely be given comparable communication facilities.

A second point to be borne in mind about the Citizens Band is that nearly 25 per cent of our population lives in the Greater London conurbation where propagation would be very poor and interference chaotic. In provincial and rural areas Citizens Band operation might, however, be useful, particularly in emergencies.

Cambridge.

J. R. BRINKLEY.

Pye Telecommunications Ltd.

### "Stylus Mass and Distortion"

I WISH to point out to your readers that I omitted to have published the fact that the above article (*Wireless World*, April 1963) was based upon work which was first reported in a paper to the 1962 October Convention of the Audio Engineering Society of America.

London, N.W.6.

J. WALTON.

### The Indusistor

IN a letter published in the January 1963 issue of *Wireless World*, Mr. S. C. Dutta Roy is of opinion that with a distributed RC network it is not possible to compensate the barrier capacitance of the collector junction (circuit repeated in Fig. 1) because the effect of the shunt arm in the equivalent  $\pi$  circuit of the distributed RC network had not been considered. A demonstration is given in his letter that between the points A and B the distributed RC network is never inductive.

It is true that in my letter of June 1962 I overlooked the shunt arm of the equivalent  $\pi$  circuit of the distributed RC network. This is taken into account in the complete theory of the device. It may be shown using even the

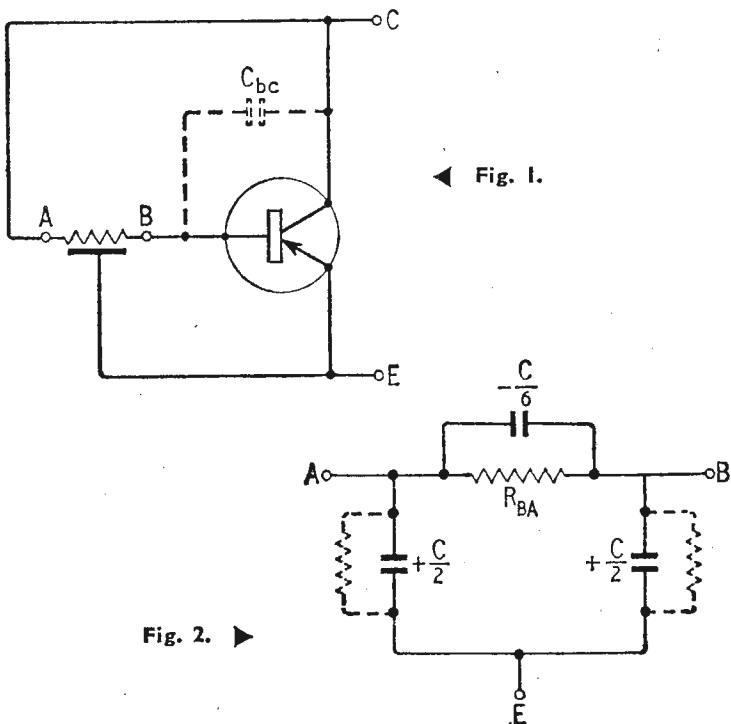
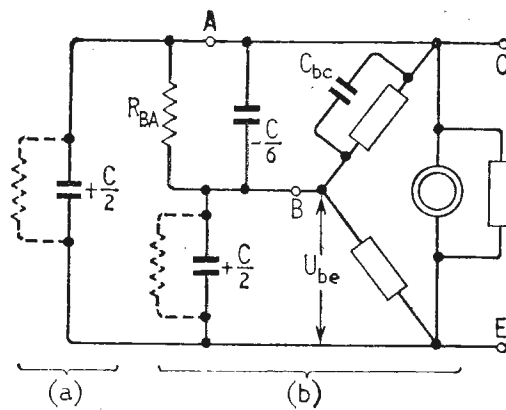

Fig. 2. ▶



◀ Fig. 3.

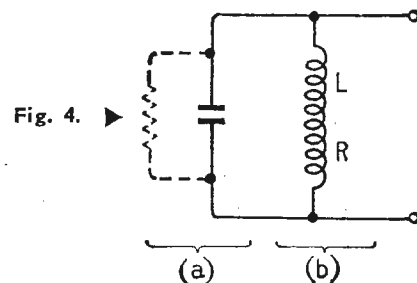

Fig. 4. ▶

formulae given by Mr. Dutta Roy in his letter that for relatively low frequencies the equivalent circuit of the distributed RC network is that of Fig. 2, where C is the total (electrostatic) capacitance of the network. The complete equivalent circuit of the indusistor is shown in Fig. 3, from which it may be clearly seen that the negative capacitance  $-\frac{C}{6}$  may really compensate  $C_{bc} > 0$ . Therefore the part (b) of the scheme of Fig. 3 has the properties examined in my letter of June 1962 and has an inductive behaviour (Fig. 4).

The question is now if the part (a) of the scheme may not destroy the inductive effect of the part (b). With respect to this question the remark of Mr. Dutta Roy is justified, but the theoretical analysis has shown that there is a large domain of frequency where the overall inductive behaviour remains.

With respect to the demonstration of Mr. Dutta Roy that between the points A and B of Fig. 1 the distributed RC network is never inductive, this is true in the conditions demonstrated in his letter of January 1963, but one of these conditions (the B end of the network is considered short-circuited) does not apply to the device of Fig. 1 as may be seen from the equivalent scheme of Fig. 3. Also from Fig. 2 it may be seen that if the arm BE is short-circuited then the capacitance presented between the points A and B will be  $\frac{C}{2} - \frac{C}{6} > 0$ , therefore always positive. But this is not the case for the device of Fig. 1. Rumania.

M. DRAGANESCU.

Department of Electronics,  
Polytechnic Institute of Bucharest.

### INFORMATION SERVICE FOR PROFESSIONAL READERS

The reply-paid forms have proved to be very helpful to professional readers, judging by the number of forms returned to us. This *Wireless World* service is therefore being continued.

The forms are on the last two pages of the issue, inside the back cover, and are designed so that information about advertised products can be readily obtained merely by ringing the appropriate advertisement code numbers. Code numbers are also provided for requesting more particulars about products mentioned editorially on pages 264-283 (inclusive), and pages 304, 314 and 315.

# Semiconductor Integrated Circuits

FABRICATION BY PLANAR CONSTRUCTIONAL TECHNIQUES

By G. BRADSHAW,\* B.Sc., A.M.I.E.E., and C. H. TAYLOR,\* A.M.I.E.E.

**S**ILICON, the second most common element of earth's crust (26% by weight), is used as the basic material for most integrated circuits because of its electrical properties and fabrication advantages. Silicon crystal can have either a predominance of p type (positively charged) carriers, or n type (negatively charged) carriers by the introduction of suitable impurities. Controlled amounts of impurity may be introduced into the melt when the ingot is grown, or later into the crystal by diffusion or alloying. The type of a region of crystal can be changed by "over-doping" with an opposite type impurity, and a p-n junction is formed where the two types of impurities are equal in concentration. This is illustrated in Fig. 1.

Impurity concentration gradients and geometry of

restricted by the difficulties of providing adequate heat dissipation, and obtaining high-frequency operation. There is also a limitation on the values of the diffused resistors and capacitors. (Maximum practical values are about  $100k\Omega$  and  $0.1\mu F/cm^2$ .)

The practical design of an integrated circuit must take into account the opportunities and limitations presented by the fabrication techniques, in addition to electrical, mechanical and other considerations. Principal factors to which attention must be given are choice of resistivity and type of starting material, geometry and diffusion parameters of the device regions, junction biasing conditions, inter-capacitance of components, and prevention of current saturation. Inductive and transforming effects are achieved by circuit means.

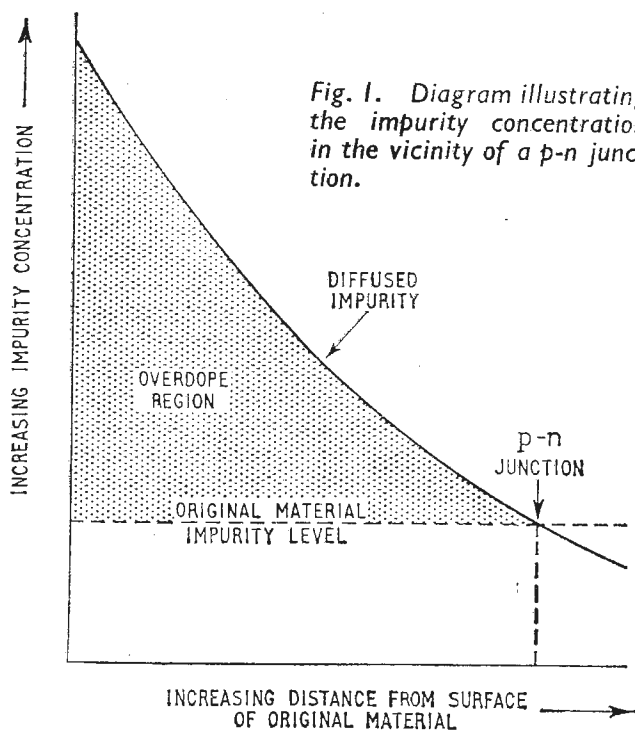

Fig. 1. Diagram illustrating the impurity concentration in the vicinity of a p-n junction.

## Fabrication

Diffusion of suitable impurities into selected regions of a silicon crystal slice to form combinations of n-n+, p-p+ or p-n junctions produces diodes, resistors, capacitors or transistors. Suitable interconnection of these regions in the bulk material or by evaporated aluminium tracks on the surface results in completed circuits or circuit functions. Alloy, diffused-mesa or planar fabrication techniques can be used, but the latter, having the advantages of oxide surface passivation, control of circuit geometry and top contact availability is now almost universally employed, and is described here.

An oxide, to be used as a diffusion masking medium, is thermally grown on the polished surface of a silicon slice and selectively removed by photolithography. This produces an exposed silicon pattern corresponding to the plan shape of the components, and through which the impurity is diffused to a controlled depth and concentration. Combinations of components can be produced simultaneously in a single piece of silicon and are then suitably interconnected to form a circuit. Up to three sequential diffusions may be required to give the necessary junction structures. Each silicon slice produces an array of similar circuits. These are then cut from the slice (diced) and mounted individually.

The above processes are usually done in special rooms or areas where control of atmospheric cleanliness, temperature and humidity is maintained. Great care is taken to avoid contamination of slices during and between process stages. Inter-stage cleaning is done with vapour degreasers, ultrasonic baths of de-ionized water or de-ionized water recirculators.

diffused regions determine, to a large extent, the electrical characteristics of semiconductor devices and integrated circuits. This article describes the technology used during their fabrication.

A semiconductor integrated circuit is one in which the "individual" components have been fabricated and suitably interconnected in one piece of single-crystal semiconductor. (There are other allied forms of microminiature circuit construction which include fabrication of the circuit in two or more pieces of silicon—"multi-chip" circuits—and hybrid circuits with evaporated or sputtered components).

Types of electronic circuits which may be made at present in semiconductor integrated form are mainly

## Planar Technique Processes

Fig. 2 shows the main processes required to produce the type of structure shown in Fig. 3. This particu-

\*Royal Radar Establishment, Malvern.

lar configuration may not form a practical circuit, but has the merit of simplicity. Fig. 4 illustrates the various stages in the fabrication of part of a planar circuit. A single-junction device is used for simplicity.

**Silicon Crystal Growth:**—Silicon for semiconductor device applications is usually obtained by chemical reduction of its halides or hydrides. This form of silicon is, however, polycrystalline and contains unacceptably high levels of unwanted impurities.

A single-crystal silicon ingot is generally grown on a seed crystal either by pulling it from a crucible of molten silicon, or by causing a molten zone to pass along a polycrystalline silicon rod which is seeded at one end. An r.f. heater, concentric with the rod, is used for this purpose. During these processes, unwanted impurities are removed and those required introduced. Ingots of monocrystalline silicon of p and n type are produced in a wide range of resistivity.

**Slice Preparation:**—Silicon ingots of 0.5in-2.0in diameter are sliced, usually by diamond wheel, to about 0.010in-0.020in thickness. These slices are then lapped smooth with an extra-fine grain alumina abrasive to prepare for polishing. The slices are finally etch-polished using a 95% HNO<sub>3</sub>/5% HF etchant which produces a fine mirror finish. Slice thickness is then about 0.006in. Mechanical methods can also be used for the polishing stage.

**Oxide Growth:**—Surface oxidation of the polished slice (Fig. 4 (b)) produces a masking medium which, when selectively removed by photolithography, enables impurity diffusion to take place in a predetermined pattern into the silicon. Oxide growing is generally carried out in an open-tube furnace having a recrystallized alumina or quartz liner. The slices are placed in an oxidizing atmosphere (steam, oxygen or wet nitrogen) at temperatures usually between 1000°C and 1250°C for times up to two or three hours, depending on the required oxide thickness, temperature and atmosphere. Oxide thicknesses in the region of 0.5 micron are usually needed and these films produce the brilliant interference colours characteristic of planar semiconductor devices.

**Photolithography:**— Diffusion masking patterns are produced in oxide on a silicon slice by photolithography. A particular device or circuit may require up to six interrelated patterns. The process of photolithography may be divided into three stages.

#### Photo-Mask Production

Original device patterns up to 100 times full size are photographically reduced and stepped-and-repeated to form multi-patterned, exact-sized negatives of the devices.

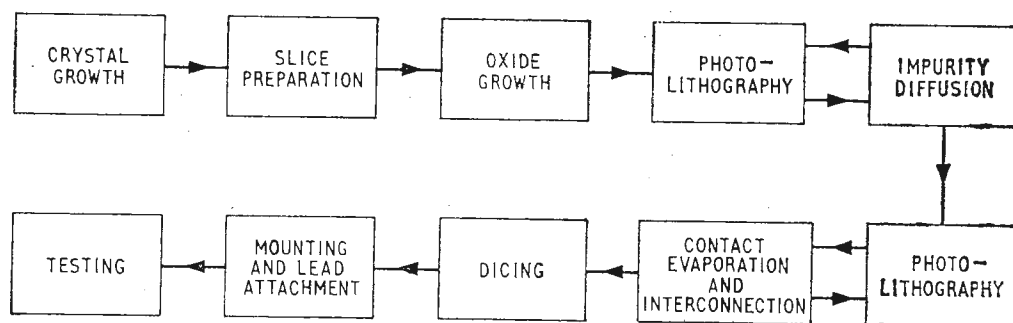

Fig. 2. Simplified process chart for planar semiconductor devices.

There may be up to several thousand on a slice having widths down to 0.001in.

#### Etch-resistant Masking

A thin layer of photo-sensitive emulsion is spun onto the oxide-coated slice (Fig. 4(c)). The photo-sensitized slice is then mounted on an alignment rig and exposed to ultra-violet light through the photomask (Fig. 4(d)). Development of the exposed emulsion removes the soft areas which were under the black portions of the photomask (Fig. 4(e)). The emulsion pattern remaining is then baked, after which it is etch-resistant and has good adhesion to the silicon oxide.

#### Oxide Etching

The unprotected oxide is etched away with a hydrofluoric acid etchant, and finally the etch-resistant emulsion is removed with methylene chloride (Fig. 4(f)).

**Impurity Diffusion:**—Impurity diffusion is usually done in a similar furnace to that used for oxide growing, and at the same temperature range. Vacuum and closed-box furnaces are also sometimes used. In the furnace tube the impurity source is vaporized and passed over the slice by a carrier gas. Boron (p-type) and phosphorous (n-type) in the forms of B<sub>2</sub>O<sub>3</sub> and P<sub>2</sub>O<sub>5</sub> are commonly used impurity sources. Accurate control of atmospheres, temperatures and carrier-gas flow rates is necessary for quality and repeatability of diffusion runs. The impurity concentration and junction depth in a slice are determined by the impurity source, slice temperature, and the method and duration of the diffusion,

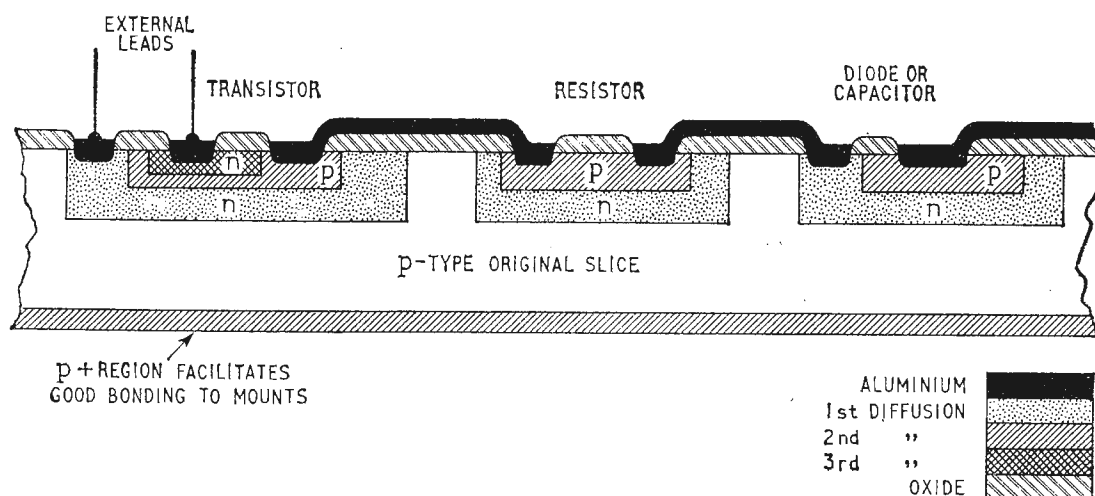

Fig. 3. Integrated semiconductor components. Note that the first diffusion forms isolating pockets for each component.



which can vary from 10 minutes to many hours but is usually less than two hours.

Photolithographic and diffusion stages are repeated where successive junction formation is required, as in the structure Fig. 3. During each diffusion run oxide is regrown over the diffused areas ready for the next photolithographic stage (Fig. 4(g)).

**Interconnection and Contact Evaporation:**—A further photolithographic stage removes oxide from contact areas on the slice. The slice is then placed in a vacuum evaporator at a pressure of about  $10^{-5}$  mm Hg and a film of aluminium about 0.5 micron in thickness is evaporated onto the slice, completely covering the oxide and exposed contact areas. A final photolithographic stage selectively etches the aluminium to form the required interconnection pattern. The slice is then heated in vacuum to about  $600^{\circ}\text{C}$ . causing the aluminium on the contact areas to alloy into the silicon and the remainder to bond to the oxide. The oxide provides electrical isolation, where necessary, for the interconnections. A gold film about 0.25 micron is sometimes deposited onto the underside of the slice to facilitate mounting the devices.

**Dicing, Mounting and Lead Attachment:**—The processed slice is cut into individual circuits by ultrasonic cutter, wire saw, or diamond stylus scribe-and-break methods. These individual dice, or "chips," are usually gold-bonded to multi-pin transistor headers and fine gold wire (0.0005in-0.002in diameter) connections made to the header pins from the contact areas on the dice. Thermo-compression bonding machines are employed for this form of mounting and lead attachment.

**Testing:**—Prior to final testing of the mounted circuits, electrical and microscopic examination is done between fabrication stages. Electrical properties of junctions are observed by making contact to the slices with probes mounted on micro-manipulators. Quality of polishing, oxides and photolithography are assessed using metallurgical microscopes of magnifications up to 1500. Rejection of unsatisfactory slices can thus be made at any stage.

## Present and Future Developments

Equipments produced using integrated circuits have maximum component packing densities of about 1200/cu. in. Because of their small size, weight and power requirements, the incorporation in equipments of redundant parts (or circuits) to increase reliability is an attractive proposition. Basic reliability of individual circuits promises to be very high compared with conventional methods of construction, because of the reduced number and method of interconnections, simplicity of construction, purity of materials used, tight process control and oxide passivation of junction surfaces. In addition, because of their small mass, their ability to withstand mechanical shock and vibration is enhanced.

At present integrated circuits are normally operated in the temperature range of  $-55^{\circ}\text{C}$  to  $+125^{\circ}\text{C}$  and are rated in frequency up to 5 Mc/s, but as techniques improve this limit should be exceeded. Resort is made to the multi-chip method of fabrication to overcome this frequency restriction, and

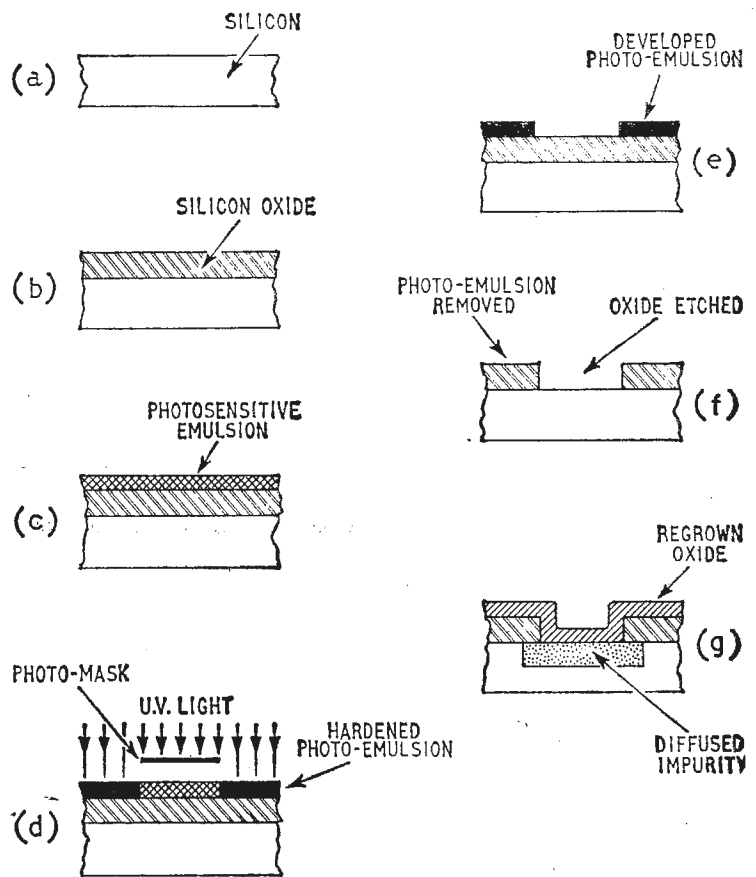

Fig. 4. Cross-sections (not to scale) illustrating stages in the fabrication of a semiconductor planar single-junction device.

circuits capable of 100 Mc/s operation are obtainable by this means, but at the expense of additional bonded wire connections.

Semiconductor planar circuits which are now available in this country include both digital and linear types. Circuits involving integrated distributed R-C networks, field-effect devices, solar batteries and other novel elements are under consideration in research laboratories.

The cost of circuits is relatively high at present, and as production increases this should be considerably reduced, but "simple" circuits such as three diodes in one dice of silicon, if bought in quantity, can now be obtained more cheaply than the separately encapsulated components.

Increasing demands for reliable equipments of extremely small size and weight, mainly for military and space applications, have stimulated the development of microminiature techniques. The planar fabrication method is probably the most important of these techniques, and during the next few years should have a large influence on the development of electronics in general.

## REFERENCES

- "Solid-Circuit Microminiature Oscillator". G. Bradshaw and C. H. Taylor, *Wireless World*, Oct. 1961.
- "The Principles of Integrated Single Crystal Circuit Design". J. M. Allen, B. L. H. Wilson and D. H. Roberts, *Electronics Reliability and Microminiaturization*, Vol. 1, April-June 1962.
- "Molecular Electronics and Microsystems". J. P. Stelmak, *Electronics Reliability and Microminiaturization*, Vol. 1, July-Sept. 1962.
- "Designing Molecular Circuits for use in Complex Systems". H. W. Henkels, *Electronics*, Sept. 21st 1962.
- "Latest Design Techniques for Linear Microcircuits". L. Pollock and R. Gutteridge, *Electronics*, Oct. 12th 1962.

# SOME THOUGHTS ON IMPEDANCE FUNCTIONS

By B. J. AUSTIN\*

**P**ROVIDING us with food for thought is our old friend, the two-terminal black box (Fig. 1(a)). The box is passive, i.e., it may contain any (linear) circuit elements (e.g., R's, L's, C's) but no sources of energy. This article sets out to examine some of the simpler properties that must be possessed by the impedance of such a network. For all but the most trivial cases we will have to write the impedance as  $Z(s)$ , i.e., as a function of complex frequency  $s = \alpha + j\omega$ .

Regular *Wireless World* readers, and especially

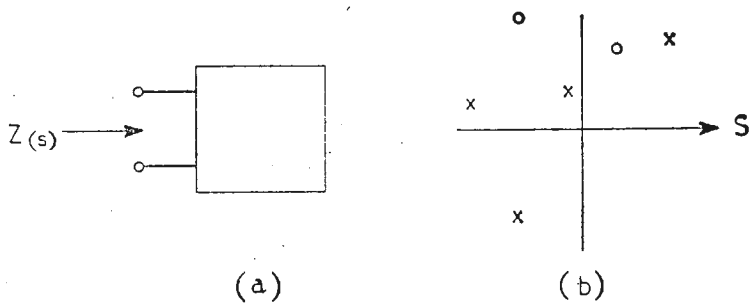

Fig. 1 (a) A passive "black box" and (b) its pole-zero diagram.

"Cathode Ray" fans, will know that we can characterize an impedance function, apart from a multiplying constant, by giving the positions of all its poles and zeros. We will keep this correspondence between  $Z(s)$  and its pole-zero diagram well to the fore, and in particular we will try to find what arrangements of noughts and crosses are allowed. Our first thoughts would lean towards the view that practically any function  $Z(s)$  is possible, if networks of sufficient complication can be manufactured. Hence Fig. 1(b) might well be a valid pole-zero plot.

Second thoughts counsel caution. For instance a negative resistance is not a *passive* impedance. We see then, that restrictions on the form of  $Z(s)$  must exist and we can reasonably expect to see something of these restrictions reflected in the pole-zero diagram.

First, let us use a rather insignificant scrap of information—viz., a real voltage must always produce a real current—to show that  $Z(s)$  has a certain kind of symmetry. Of course, you protest, the current always turns out to be real because we take only the real part when we have finished all that  $e^{st}$  business. This is true enough but it obscures the underlying reasoning. A voltage  $Ve^{st}$  is not real (i.e., physical and to get a physical voltage we have to add the complex conjugate  $\bar{V}e^{\bar{s}t}$ . Using the Superposition Theorem, we find the total current to be

$$Ve^{st}/Z(s) + \bar{V}e^{\bar{s}t}/\bar{Z}(\bar{s}).$$

If this is real for *all values of t* the second term must be the complex conjugate of the first.

$$\therefore Z(s) = \bar{Z}(\bar{s}) \quad \dots \quad (1)$$

Hence, if  $Z$  has a pole at  $s$ , it has a pole at  $\bar{s}$ , and similarly for zeros. We can say that the bottom

half of the pole-zero diagram must be the mirror image of the top half in the real axis (Fig. 2). (N.B.  $\bar{s}$  is obtained from  $s$  by reflection in the real axis.)

If  $s = j\omega$  (ordinary frequencies) we get two further equations by splitting (1) into real and imaginary parts.

$$\left. \begin{aligned} R(j\omega) &= R(-j\omega) \\ X(j\omega) &= -X(-j\omega) \end{aligned} \right\} \dots \dots \dots (2)$$

These equations are summarized by saying that  $R$  is an even and  $X$  an odd function of  $j\omega$ . These names arise because an even function, if it is a polynomial, will contain only even powers of the argument ( $j\omega$ ). In general,  $R(j\omega)$  is the ratio of two even polynomials while  $X(j\omega)$  is the ratio of an even polynomial and an odd one. Most functions, however, cannot be classified as either even or odd, just as most complex numbers are neither purely real nor purely imaginary. But we can always split  $Z(s)$  into two parts, of which one is even and the other odd. We define

$$Ev[Z(s)] = \frac{1}{2}[Z(s) + Z(-s)]$$

$$Od[Z(s)] = \frac{1}{2}[Z(s) - Z(-s)]$$

These are obviously even and odd respectively, and their sum is  $Z(s)$ . (The process is very similar to that for separating a complex number into real and imaginary parts.)

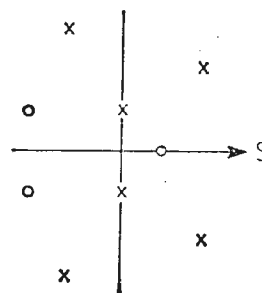
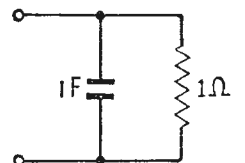

Fig. 2 The lower half is the reflection of the upper half.

Fig. 3 A simple circuit.



Let us now consider the simple, if impractical, circuit of Fig. 3. The impedance is given by:—

$$Z(s) = 1/(1 + s) \quad \dots \quad (3)$$

$$\therefore \left. \begin{aligned} Ev[Z(s)] &= 1/(1-s^2) \\ Od[Z(s)] &= -s/(1-s^2) \end{aligned} \right\} \dots \quad (4)$$

For comparison, the real and imaginary parts are:

$$\left. \begin{aligned} Re[Z(s)] &= \frac{1 + \alpha}{(1 + \alpha)^2 + \omega^2} \\ jIm[Z(s)] &= \frac{-j\omega}{(1 + \alpha)^2 + \omega^2} \end{aligned} \right\} \dots \quad (5)$$

A number of remarks can be made about these equations. First, equations (4) are somewhat simpler than equation (5). Secondly, for real frequencies ( $\alpha = 0, s = j\omega$ ) the two pairs are identical.

\* Cavendish Laboratory, Cambridge.

$$\left. \begin{aligned} R(j\omega) &= \text{Re}[Z(j\omega)] = \text{Ev}[Z(j\omega)] \\ jX(j\omega) &= j\text{Im}[Z(j\omega)] = \text{Od}[Z(j\omega)] \end{aligned} \right\} \dots (6)$$

Put in another way,  $\text{Ev}[Z]$  at all frequencies can be obtained from the resistance at real frequencies merely by substituting  $s/j$  for  $\omega$ . A similar remark obviously holds for  $\text{Od}[Z]$ . One should avoid the trap of identifying  $\text{Re}[Z]$  as the resistance and  $\text{Im}[Z]$  as the reactance when  $\alpha \neq 0$ . For instance, when  $s$  is pure real, so is  $Z$  (see eqn. (1)), even for a network containing no resistances!

Returning to our main theme, we now make a very important deduction from the fact that our black box is *passive*. We know already that poles in the impedance function give rise to terms in the free response of the network. In other words, if we apply some sort of impulse to the circuit, the response will contain terms like  $e^{s_p t}$ , where  $s_p$  is the position of the poles. If  $s_p$  lies to the left of the imaginary axis, this is a sinusoid of decreasing amplitude, but, if  $s_p$  lies to the right, the amplitude increases with time. This second state of affairs cannot possibly occur with a passive network, which by definition contains no sources of energy.

But worse is to come. If we do the maths correctly we find that the response after the impulse contains terms from the left half plane, and, before the impulse as applied, the response is not zero, but consists of terms arising from the poles in the right half plane. These terms are exponentially increasing, but this doesn't really count as they get off to a very modest start at  $t = -\alpha$ . What irks us is that the network has responded at all before the impulse was applied to it. Such a system would be "non-causal."

If we restrict ourselves to causal networks we must exclude the possibility of poles in  $Z(s)$  to the right of the imaginary axis. In the left half plane we can have any array of poles (subject to the  $s \rightarrow \bar{s}$

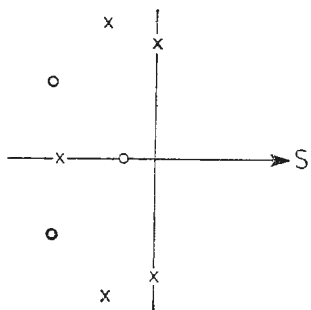

Fig. 4 The final result—poles and zeros of a causal network.

symmetry). Just what happens on the imaginary axis is not so obvious. A little mathematics, which we will have to dodge, shows that passive networks may have only simple poles on the  $j\omega$  axis (e.g. an undamped LC circuit).

We can quickly see that exactly the same restrictions apply to the zeros of  $Z(s)$ . Just as we cannot decide whether the chicken or the egg came first, so we cannot be sure whether the voltage is the excitation and the current the response, or vice versa. This means that all the arguments put forward for  $Z(s)$  apply equally to  $Y(s) = 1/Z(s)$ . Since a pole in  $Y(s)$  corresponds to a zero in  $Z(s)$ , neither poles nor zeros in  $Z(s)$  are permitted in the right half plane ( $\alpha > 0$ ), and poles and zeros on the  $j\omega$  axis must be simple (see Fig. 4). This is quite a remarkable conclusion to draw merely from passivity.

(A careful reader will note that we have really used the fact that the network is causal, not the slightly stronger condition of passivity. The require-

ment imposed on  $Z(s)$  by the latter condition is  $\text{Re}[Z] > 0$  for  $\alpha > 0$ . However, a passive network must be causal and so all our conclusions apply to passive networks.)

A number of other theorems about  $Z(s)$  can also be proved (using passivity) but, lacking a good deal of mathematics, we will have to be content with one further example. It turns out, not surprisingly, that  $\text{Ev}[Z]$  and  $\text{Od}[Z]$  are curiously interconnected. Thinking of real frequencies for the moment, this means that  $R(j\omega)$  and  $X(j\omega)$  are not independent functions. We find that a constant resistance can be added to  $R(j\omega)$  without affecting  $X(j\omega)$ , but not an arbitrary resistance function. Similarly, the only change that can be made to  $X(j\omega)$  without upsetting  $R(j\omega)$  is the addition of a lossless network in series (this introduces poles and zeros into  $Z$  down the  $j\omega$  axis). Thus, our freedom of choice has been drastically curtailed.

To illustrate this, let us suppose we have been given only the first of equations (5) (and only for  $s = j\omega$ ) and let us try to find an odd function  $X(j\omega)$  so that  $Z(j\omega) = R(j\omega) + jX(j\omega)$  is the impedance of a passive network. (We have really set ourselves the problem of finding  $\text{Od}[Z]$  given  $\text{Ev}[Z]$ .)

As a first (and rather stupid) attempt take  $\text{Od}[Z] = 0$ . Then  $Z(s) = 1/(1-s^2)$ , which has poles at  $s = \pm 1$ . From our discussion above, we conclude that this is not acceptable, because of the pole at  $s = +1$ . We now see, however, that  $\text{Od}[Z]$  must be chosen so as to cancel out this pole. We can rewrite  $\text{Ev}[Z]$  as

$$\text{Ev}[Z(s)] = \frac{1}{2} \left( \frac{1}{1-s} + \frac{1}{1+s} \right)$$

in a form which gives a separate term from each pole.

Then  $\text{Od}[Z]$ , when written similarly, must have a term  $-\frac{1}{2} \frac{1}{1-s}$ . To make  $\text{Od}[Z]$  an odd function,

this must be paired with  $+\frac{1}{2} \frac{1}{1+s}$ , and any further

terms must also be in pairs, corresponding to poles at  $\pm s_i$ , say. One pole of each such pair must be in the right half plane, and cannot be accepted, unless  $s_i$  is pure imaginary. Such poles arise from networks without resistances. Thus, we conclude that, apart from the addition of a lossless network in series

$$\text{Od}[Z(s)] = \frac{1}{2} \left( -\frac{1}{1-s} + \frac{1}{1+s} \right) = \frac{-s}{1-s^2}$$

Thus we arrive at the second of equations (4) merely by demanding that  $Z(s)$  has no pole with  $\alpha > 0$ . We could carry out much the same procedure in reverse to find  $\text{Ev}[Z]$  given  $\text{Od}[Z]$  (or  $jX(j\omega)$ ). We would see that  $\text{Ev}[Z]$  is fixed uniquely, apart from a *positive* constant.

Complex variable theory can be used to get a pair of equations connecting  $R(j\omega)$  and  $X(j\omega)$ . These are called dispersion relations (because of their use in other branches of science) and give  $R(j\omega)$  as an infinite integral involving  $X(j\omega)$  and vice versa. A detailed discussion is out of place here. It is more important to notice how, in requiring that our black box be passive, we have surrendered some (about half) of our control over its characteristics. We can specify  $Z(s)$  to some extent, but all the rest is done for us by passivity. Whether this should be taken as a comfort or as a warning is left to the discretion of the reader.

# International Audio Festival 1963

LONDON, MAY 18-21

**J**UDGING by the new equipments shown and demonstrated at the 1963 festival, it seems clear that pre-amplifiers and power amplifiers, using thermionic valves, can be considered to have reached their zenith. Apart from modifications to established types there was very little new in this field. The response to the challenge of transistors is so far not very evident; only two manufacturers, Pye and Radford, were showing integrated transistor amplifiers as finished products. The picture presented by the input and output transducers was, however, very much different. Many new microphones were introduced, and at the output end there was a trend to what is somewhat contradictorily called "silent listening." This, apparently, is the use of headphones, in place of loudspeakers for private listening. This development will, no doubt, bring joy to the "non-hi-fi" community in densely populated areas.

There were more exhibitors from overseas this year. Particularly noticeable was the styling of the Japanese Trio and American Sherwood and Scott equipments.

## Microphones

The recently G.P.O.-approved radio microphone manufactured by Lustraphone was demonstrated. The "Radiomic" system consists of a transistor crystal-controlled f.m. transmitter measuring slightly less than  $3\frac{1}{2} \times 2\frac{1}{2} \times 1$  in and weighing only 6oz complete with battery, a crystal-controlled transistor receiver and a microphone with adjustable neck halter (commonly called a "lavalier" microphone from the French *lavallière*, a loose neck-tie).

Of the new units introduced by S.T.C. the Type 4114 moving coil microphone should appeal to amateur sound recordists. Very reasonably priced, it has a nominal impedance of  $200\Omega$ , thus dispensing with the need for an input transformer when feeding transistor input stages. The shape of the case is suitable for holding in the hand or standing on a table. Also, a threaded insert in the base enables the microphone to be fitted to a standard camera tripod stand.

Shure Electronics took advantage of the Show to introduce four new microphones. Of these, the slim appearance of Models 576 and 578 caught the eye. These were only  $\frac{3}{4}$  in in diameter.

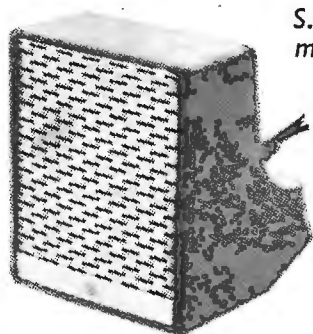

S.T.C. Type 4114 microphone.

Audio Pioneer SH100 pickup arm and headset.

Cosmocord demonstrated their new MIC55. This is a small lapel microphone incorporating a crystal insert.

## Headphone Listening

A number of manufacturers, including A.K.G. and S.T.C., exhibited headphones suitable for high-quality two-channel listening.

Unusual, but pleasantly surprising, is probably the best description of the Audio Pioneer exhibit. This consisted of a turntable to which was fitted the Audio Pioneer pickup arm. There is no electrical amplification and the stylus drives two sound boxes which are arranged to separate the two channels of a stereo record. Two lengths of tubing (1 metre length recommended) convey the sound to a stethoscope-type headset. The claim that frequencies from 100c/s to 10kc/s may be heard seemed well founded.

## Amplifiers

As previously mentioned, two commercially produced transistor amplifiers were shown. In the Mullard demonstration room, however, three transistor amplifiers were compared with each other and with the now famous "5-10" valve amplifier. The semiconductor amplifiers with Class A (5W + 5W), Class

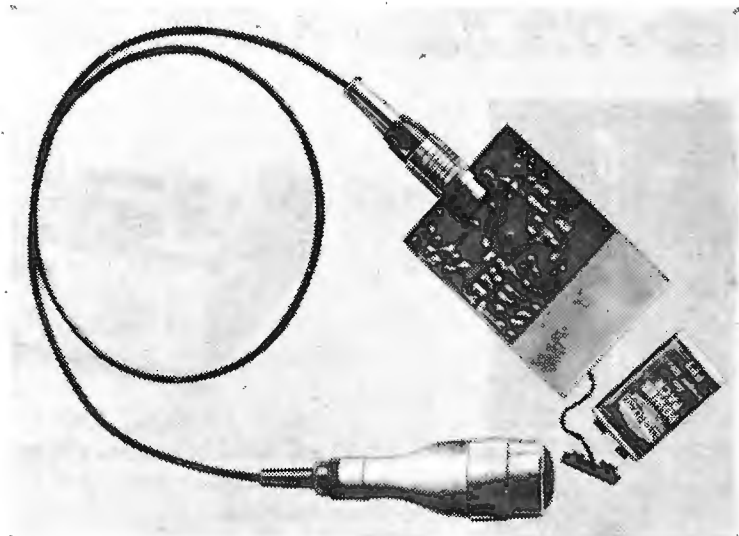

F.m. transmitter and microphone of Lustraphone "Radiomic."

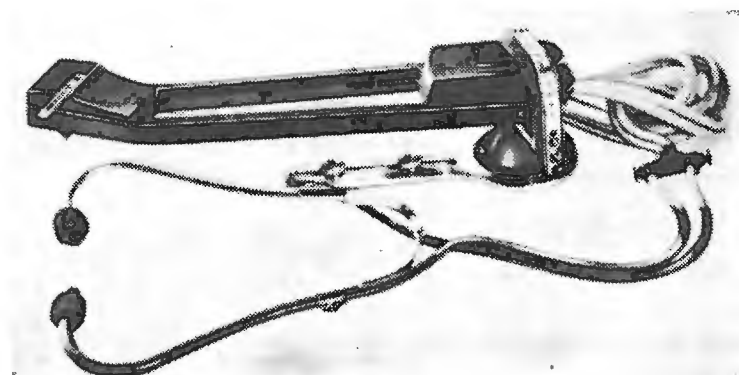

AB (10W + 10W) and Class B (10W + 10W) output stages, with their low-distortion, noise-free outputs and correspondingly smaller sizes should stimulate an increasing number of firms to develop transistor equipments in the near future.

As far as thermionic amplifiers were concerned there was very little new to be seen. The Chapman 306 integrated stereo amplifier was new. Other integrated equipments by Lowther, Whiteley and Symphony foretell that the day is perhaps not far distant when the separate pre-amplifier might be a thing of the past.

### Tape Recorders

Following the tremendous growth in the development and use of tape recorders over the past two or three years, it is perhaps natural that few radically new models were introduced this year, but detail refinements have been made.

The Brenell STB1 presented a great many facilities. Essentially it is a four-speed mono/stereo half-track recorder with associated pre-amplifiers. Other facilities include mixing, superimposition, comparison of recording against original signal, variable bias and an additional playback head with pre-amplifiers to enable replay of quarter track, mono, or stereo pre-recorded tapes. Two models were exhibited, the STB1/5/2 suitable for use with spools up to 8 $\frac{1}{4}$ in diameter, and the STB1/510/2 suitable for 10 $\frac{1}{2}$ in diameter spools.

A portable tape recorder by Loewe-Opta, the 414, is a two-track, 3 $\frac{3}{4}$ in/sec transistor recorder. The speed control circuit uses an 80-100kc/s oscillator, which is switched on by a centrifugal switch when the motor speed exceeds 3,000 r.p.m. The rectified output of the oscillator is fed back to control the motor speed. The Planet demonstration of deck remote control by radio and multi-core cable attracted much attention. The use of the tape

recorder for language teaching is going to become more popular. Stuzzi Recorders and Tandberg both demonstrated their recorders in this application.

Tape recorder accessories were much in evidence. New mixer units were shown by Fi-Cord (three inputs, transistor amplifier and 200ohms output impedance), and Vortexion. Included in the Vortexion range of mixers was a version which provides recording erase and bias, playback and echo facilities.

The Grampian transistor reverberation unit (dry-battery operated) is intended for the improvement of the quality of recorded sounds in "dead" conditions. Two input channels are provided; one for



EMI Type 311 reversible head block tape recorder.

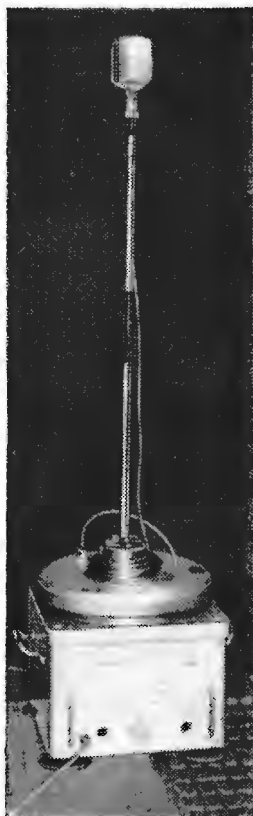

A.K.G. directional characteristic plotter.

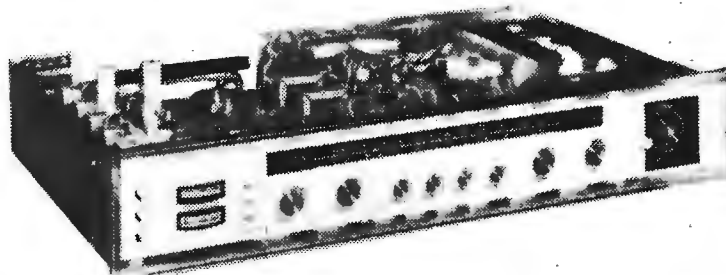

Sherwood Model XPI prototype all transistor, f.m. stereo multiplex/a.m. receiver. (200W. output.)

Pye transistor amplifier Model HFS 30TC.

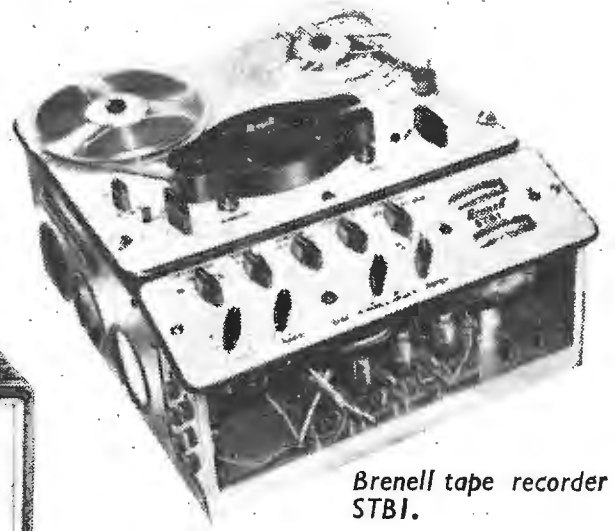
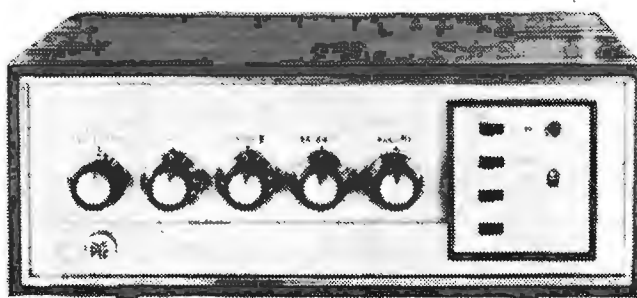

Brenell tape recorder STB1.

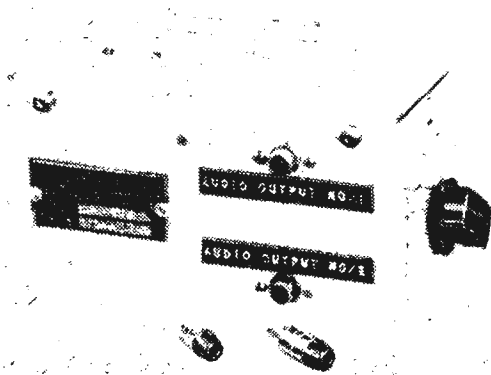

Lowther audio test set Type ATU.

a 600 $\Omega$  microphone input and the other, a high-impedance channel, for signals from other types of equipment.

E.M.I., in order to cater for tapes wound to Anglo-American and European standards (oxide surface wound inside or outside) introduced their reversible head block tape recorder Type 311, a professional unit. The mechanical unit can be supplied separately from the electronic equipment.

### Tuners

A number of new a.m./f.m. tuner units were shown. The f.m. tuners all boasted provision for multiplex adaptors if and when stereo broadcasting becomes a reality. At the Sherwood demonstration room f.m. stereo transmissions were broadcast (G.P.O.-licensed at 1mW). The programme source was a stereo disc. A Sherwood encoder fed a Marconi TF1066B f.m. signal generator, the output of which was transmitted to a Sherwood F.M. receiver in the same room.

Other new tuners included the Chapman Type FM 1005 (a.m. 16-50m, 50-195m, 195-550m, 800-2000m; f.m. 87.5-108Mc/s), the Trio Type AFX-210 (a.m. 535-1605kc/s; f.m. 80-108Mc/s), and the Clarke

and Smith tuner unit Type 658 (a.m. 525-1520kc/s 150-265kc/s; f.m. 87.5-108.5Mc/s).

### Miscellaneous

The A.K.G. directional characteristic plotter used for the measurement of microphone characteristics was demonstrated. The equipment consists of three units, a turntable complete with amplifier, remote control unit and a cathode-ray oscilloscope. The microphone under test is placed on the turntable in the open or in an anechoic chamber. The remote controller and oscilloscope can be some 50 meters distant. Signals generated in the microphone emanating from a fixed loudspeaker are rectified and fed via the turntable amplifier to a potentiometer, which is mechanically coupled to the turntable by a magnetic clutch. The output of the potentiometer consists of two varying voltages 90° out of phase with each other. These are fed to the vertical and horizontal amplifiers of the oscilloscope. A standing picture of the directional characteristics of the microphone is thus produced.

A small low-priced transistor oscillator test unit manufactured by Lowther fulfills the need of test signals for the home constructor and for setting up stereo amplifiers. On the standard instrument, test frequencies of 100, 1000, 5000 and 8000c/s are available. There are two outputs both at the same level. It is claimed that the above facilities are sufficient for checking and determining azimuth (tape recorder heads), speaker location and phasing and channel balancing (stereo).

A display combining the audio and visual arts attracted much attention. This was the Chromosonics demonstration arranged by *Amateur Tape Recording* and Stuzzi Tape Recorders. The display consisted of colour screens illuminated by electric lamps triggered on by impulses recorded on magnetic tape.

## R.C.A. Switchable-standards Video Recorder

A NEW transistorized switchable-standards video recorder—the TR-22—which has been recently introduced by R.C.A. is compatible with other rotating head transverse-track recorders.

An unusual method is, however, adopted for standards switching in this recorder. Normally the various circuit charge (or discharge) times are altered by adding additional components—either by laboriously plugging them in or by a complicated relay switching system (with its attendant contact resistance and reliability problems). In the TR-22 the capacitors which are charged in the various circuits are permanently connected by resistances to one of four busbars; these are switched to either 0 or 20V in various combinations. The busbar potentials determine the capacitor charging currents and thus the circuit charging times. These busbars are also used to change inverting amplifiers to non-inverting amplifiers, to switch potentiometers in and out of circuit and, by altering the bias to the input transistors, to allow signal flow in either the 5 or 5.5Mc/s bandwidth demodulation filter (for 60- or 50-field standards respectively).

Another feature of this recorder is the multistage servo control system adopted on replay (called Pixlock) to provide a video signal exactly synchronous with a locally-generated sync signal. The capstan is locked to this sync signal by comparison first with a tape control track signal and then with a tape frame pulse signal. The headwheel servo is then locked to this sync signal in

three stages; by comparison first with a signal generated by a magnetic tonewheel on the motor shaft, secondly with the tape sync vertical signal and finally with the tape horizontal sync signal.

### “Servicing Transistor Receivers”

THE ubiquitous transistor portable receiver and its printed circuit has presented servicemen all over the world with new problems requiring in many cases a different approach from that with which they have been accustomed to tackle larger valve receivers.

A well known practical manual by Leonard Lane, an American author, has been edited by E. A. W. Spreadbury, M.Brit.I.R.E. (Technical Editor of *Wireless and Electrical Trader*) and translated into an idiom (both text and drawings) which can be more easily assimilated by the British reader and is now published by Iliffe Books Ltd., price 42s.

It is written in a style eminently suited to the practical man and after a description of how transistors work and of the kind of circuits in which they are used, it gets down to servicing methods and how these should be conducted to avoid damage. The tracing and repair of faults in the printed circuit boards is given a separate chapter and the book concludes with a quick reference service guide to faults and their causes.

# Transistor High-quality Amplifiers

## 2.—10-WATT AMPLIFIER OPERATING IN "π-MODE" CLASS-AB

By R. OSBORNE,\* B.Sc. and P. THARMA,\* B.Sc.(Hons.)

(Concluded from p. 225 of the previous issue)

**T**HE Class-AB circuit discussed previously is re-arranged as a transformerless circuit with capacitance-coupled load, as shown in Fig. 6. The output transistors require to be driven from a low-impedance source and hence the driver transistors are used in emitter-follower configuration to simplify the design of the preceding phase splitter (otherwise a high-power phase splitter will be required).

In Fig. 6 resistor  $R_{16}$  decoupled by capacitor  $C_5$  together with potential divider resistors  $R_{10}$  and  $R_{11}$  define the emitter current and collector-to-emitter voltage of the output transistor  $Tr_5$  so as

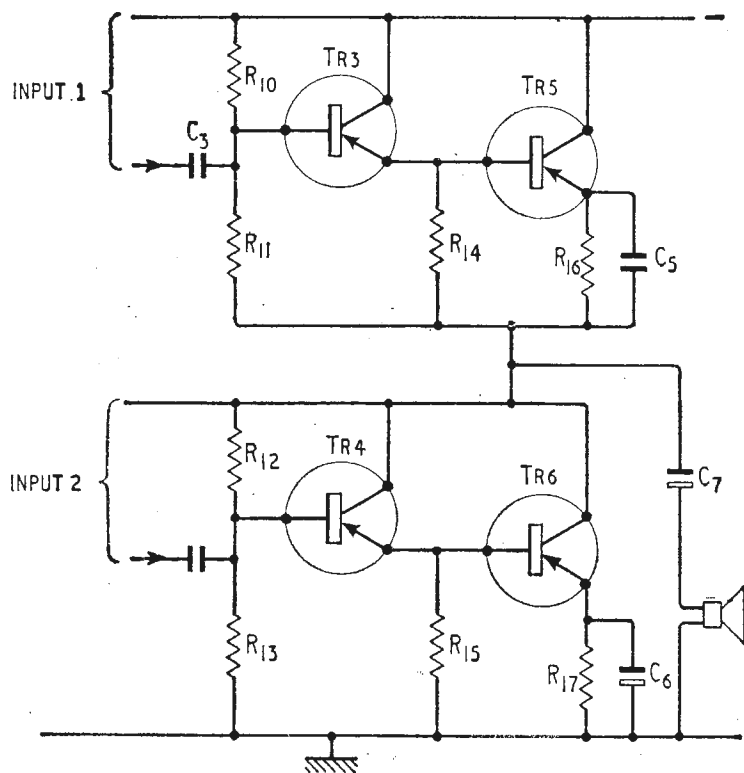

Fig. 6. Class-AB output stage with capacitance-coupled load.

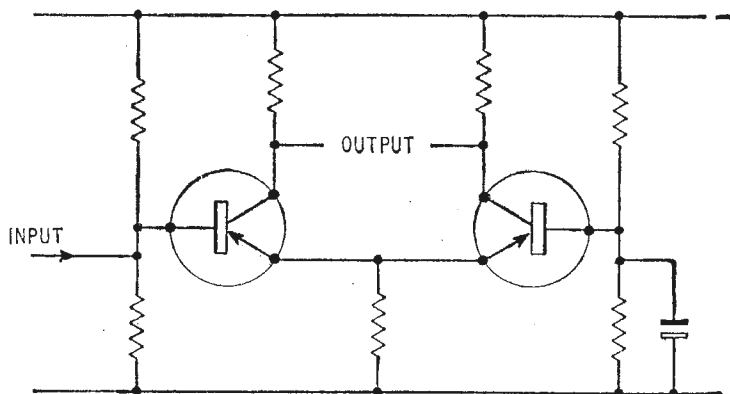

Fig. 7. Conventional phase splitter.

to give "π mode" operation and similarly for output transistor  $Tr_6$ . Resistor  $R_{14}$  and  $R_{15}$  are necessary to allow reverse base current to flow in the output transistors for reasons discussed in an earlier section.

A long-tailed pair is used as the phase splitter because of its symmetry of output and its low distortion. Other forms of phase splitters such as p-n-p/n-p-n combinations or a single transistor with equal emitter and collector loads, have unequal output impedances resulting in dissimilar frequency response of the two halves of the system.

A conventional long-tailed pair is shown in Fig. 7. The disadvantage with this arrangement is that the collector currents can vary due to transistor spreads and temperature variations. This disadvantage is overcome by having separate emitter resistors and by capacitance-coupling the emitters, as in the final circuit, Fig. 8. Also stability of the collector currents is ensured by direct-coupling the phase splitter to the output stage and by overall d.c. negative feedback. Thus the quiescent current through the output transistors is defined by one feedback loop and the mid-point voltage by the other feedback loop.

The collector resistors  $R_{12}$  and  $R_{14}$  in Fig. 8 are chosen to give the low impedance necessary for Class-AB operation. They must be matched to within 5% in order to minimize even-harmonic distortion. The voltages across these resistors are such that the emitter-to-collector voltages of the output transistors are slightly higher than that required for a maximum output of 10 watts. This is to ensure that the phase splitter is not cut off when the output stage is driven to 10 watts. Hence at this power the phase splitter is not working in the non-linear low-current region.

In the final circuit of Fig. 8 the load is in the emitter circuit of transistor  $Tr_7$  and the drive is applied between the base of  $Tr_5$  and a.c. earth. This is necessary for the Class-AB operation. Similar conditions exist for transistor  $Tr_8$  as in this case the drive is applied between the base of  $Tr_6$  and the live end of the load.

Overall negative feedback of 44dB is applied from the output to the base of the input transistor of the phase splitter. As the three stages within the loop are directly coupled, except for the emitters of the phase splitter, low-frequency instability cannot occur. The high-frequency stability of the three stages is no problem as the phase splitter uses alloy diffused transistors with very high cut-off frequencies.

\*Mullard Applications Research Laboratory.

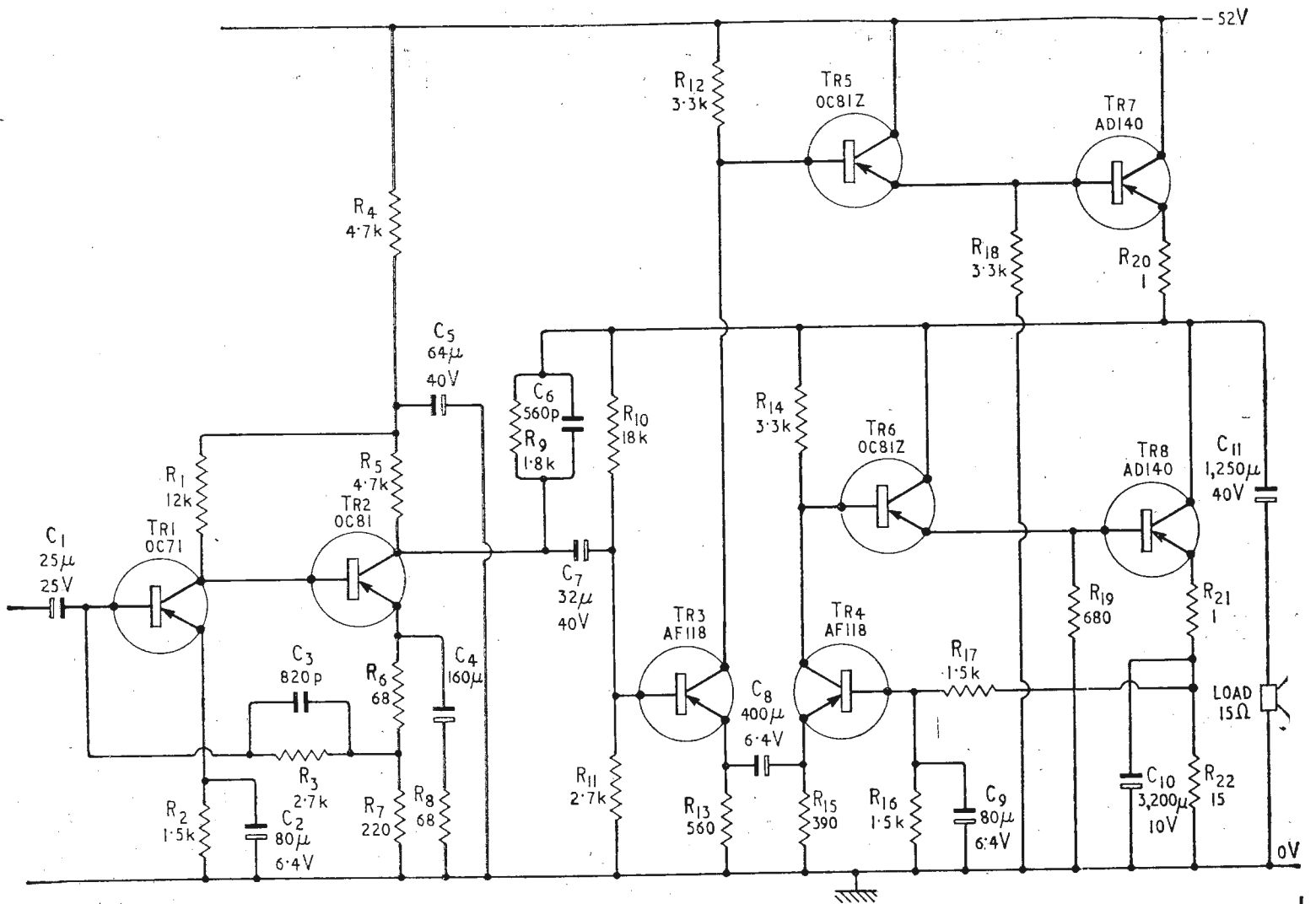

Fig. 8. Complete circuit diagram of 10-watt Class AB high-quality transistor amplifier and (below) components list.

#### RESISTORS

|                 |       |     |                             |
|-----------------|-------|-----|-----------------------------|
| R <sub>1</sub>  | 12kΩ  | 5%  | 1/8 watt                    |
| R <sub>2</sub>  | 1.5kΩ | "   | "                           |
| R <sub>3</sub>  | 2.7kΩ | "   | "                           |
| R <sub>4</sub>  | 4.7kΩ | "   | "                           |
| R <sub>5</sub>  | 4.7kΩ | "   | "                           |
| R <sub>6</sub>  | 68Ω   | "   | "                           |
| R <sub>7</sub>  | 220Ω  | "   | "                           |
| R <sub>8</sub>  | 68Ω   | "   | "                           |
| R <sub>9</sub>  | 1.8kΩ | "   | 1/4 watt                    |
| R <sub>10</sub> | 18kΩ  | 5%  | 1/8 watt                    |
| R <sub>11</sub> | 2.7kΩ | "   | "                           |
| R <sub>12</sub> | 3.3kΩ | "   | 1/4 watt                    |
| R <sub>14</sub> | 3.3kΩ | "   | 1/4 watt                    |
| R <sub>13</sub> | 560Ω  | "   | 1/8 watt                    |
| R <sub>15</sub> | 390Ω  | "   | "                           |
| R <sub>16</sub> | 1.5kΩ | "   | "                           |
| R <sub>17</sub> | 1.5kΩ | "   | 1/4 watt                    |
| R <sub>18</sub> | 3.3k  | 10% | 1/2 watt                    |
| R <sub>19</sub> | 680Ω  | "   | 1/8 watt                    |
| R <sub>20</sub> | 1Ω    | "   | 1/2 watt                    |
| R <sub>21</sub> | 1Ω    | "   | "                           |
| R <sub>22</sub> | 15Ω   | 5%  | 3 watt (For normal loading) |
| R <sub>22</sub> | 22Ω   | 5%  | 2 watt (For low loading)    |

Matched to within 5%

#### CAPACITORS

|                 |        |                 |      |
|-----------------|--------|-----------------|------|
| C <sub>1</sub>  | 25μF   | Electrolytic    | 25V  |
| C <sub>2</sub>  | 80μF   | "               | 6.4V |
| C <sub>3</sub>  | 820pF  | Tubular Ceramic |      |
| C <sub>4</sub>  | 160μF  | Electrolytic    | 10V  |
| C <sub>5</sub>  | 64μF   | "               | 40V  |
| C <sub>6</sub>  | 560pF  | Tubular Ceramic |      |
| C <sub>7</sub>  | 32μF   | Electrolytic    | 40V  |
| C <sub>8</sub>  | 400μF  | "               | 6.4V |
| C <sub>9</sub>  | 80μF   | "               | 6.4V |
| C <sub>10</sub> | 3200μF | "               | 10V  |
| C <sub>11</sub> | 1250μF | "               | 40V  |

#### TRANSISTORS

|    |         |       |                |
|----|---------|-------|----------------|
| T1 | Mullard | OC71  |                |
| T2 | "       | OC81  |                |
| T3 | "       | AF118 |                |
| T4 | "       | AF118 |                |
| T5 | "       | OC81Z | } Matched pair |
| T6 | "       | OC81Z |                |
| T7 | "       | AD140 | } Matched pair |
| T8 | "       | AD140 |                |

The overall negative feedback is applied by R<sub>9</sub> and C<sub>6</sub>, the latter removing overshoot to give a good pulse response.

The phase splitter is driven by a two-stage current amplifier. Negative feedback is applied over this two-stage amplifier to minimize distortion and to obtain the correct sensitivity. The sensitivity of the complete amplifier is 140μA r.m.s. for 10 watts.

The input impedance is very low, being of the order of 20 ohms.

#### Performance of the Amplifier

The feedback capacitor C<sub>6</sub> determines the upper frequency response and the rise time of the amplifier. If this is chosen to give adequate margins of stability with resistive, resistive and capacitive, and inductive and capacitive loads, then the pulse responses shown in Fig. 9 will be obtained. The frequency response and power response are shown in Fig. 10. The rise time of the amplifier is about



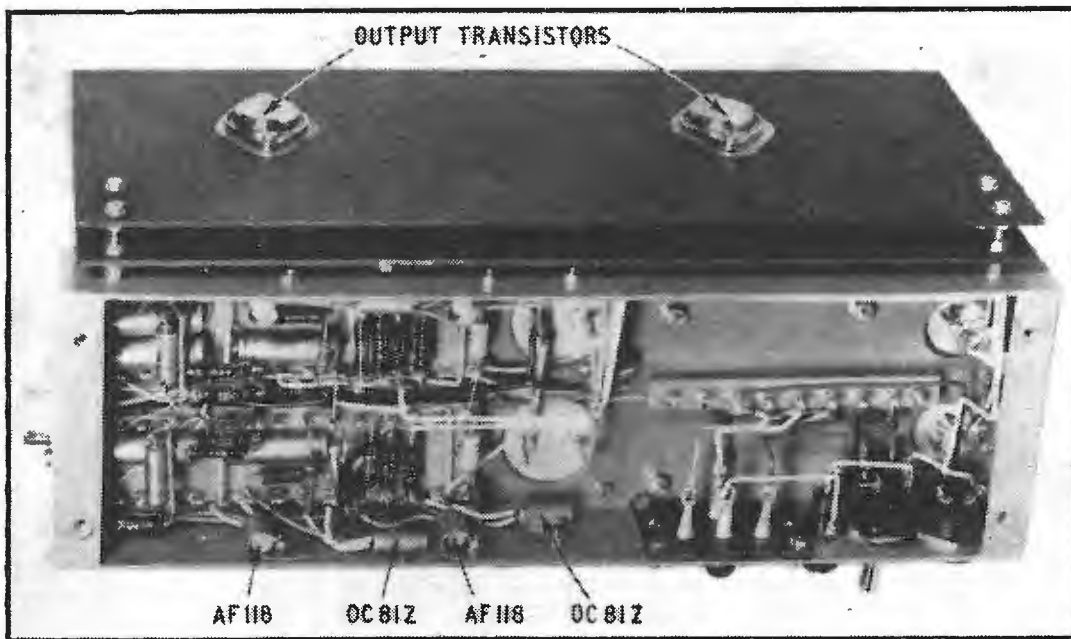

Two views of a prototype 10W+10W stereo amplifier ("π mode" Class AB) showing the positions of the principal components.

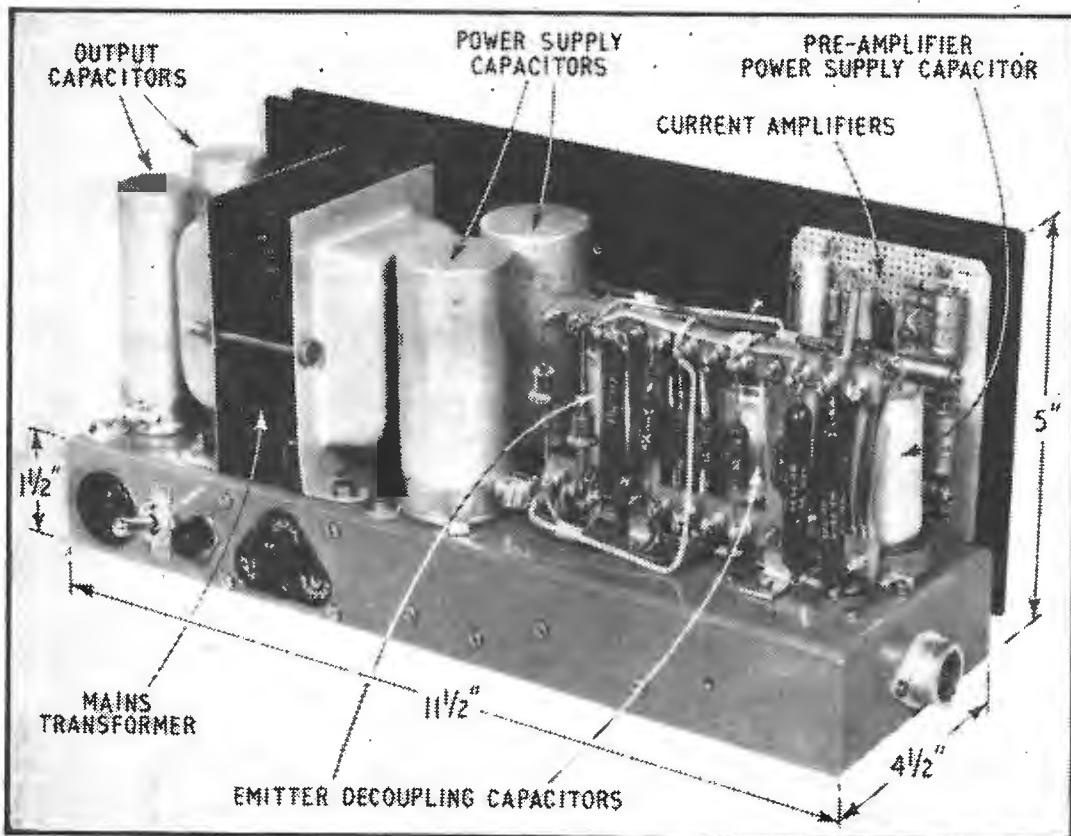

8μsec. As mentioned before, it is preferable to restrict the h.f. response of the amplifier to about 20 kc/s. If  $C_6$  is made 4700pF then the upper -3dB point becomes 20 kc/s and the rise time becomes 20μsec. The stability margin is, of course, considerably increased.

The second- and third-harmonic distortion components and the total harmonic distortion at 1 kc/s are plotted against output power in Fig. 11. The total harmonic distortion at 10 watts is 0.06%.

Intermodulation distortion measured by the gain deviation method mentioned earlier was found to be less than 1.5% at 10 watts. High-frequency intermodulation products were measured by passing white noise confined to a band of 16 kc/s to 20 kc/s through the amplifier and measuring the resultant noise below 10 kc/s. The intermodulation products were found to -60dB relative to the white-noise level.

The low-frequency stability was checked by driving the amplifier with square waves of 1 second duration. The output appeared as shown in Fig. 12, indicating a good low-frequency stability.

The output impedance is less than 0.2 ohms over the frequency range 30 c/s to 10 kc/s.

### Dissipations of the Transistors

The nominal collector dissipations for the output transistors is 9.2 watts per transistor. Allowing for this to increase by 33% due to mains variations, resistor tolerances etc., the maximum dissipation becomes 12.2 watts. The heat sink shown in Fig. 13(a) has a thermal resistance of 2.0°C/watt. If the AD140 output transistor is mounted directly on to the heat sink with silicone grease to improve conductivity, then the total thermal resistance from junction to ambient expressed as the rise in junction temperature for unit power dissipation, is 3.7°C/watt. The AD140 transistor has two maximum junction temperature ratings: the maximum continuous junction temperature is 90°C, whilst intermittent operation (total duration 200 hrs.) up to 100°C is permissible.

Hence for normal dissipation—

Junction temperature  $T_j$  of 90°C corresponds to ambient temperature  $T_a$  of 56°C

$T_j$  of 100°C corresponds to ambient temperature  $T_a$  of 66°C

With maximum dissipation (all spreads unfavourable)

$T_j$  of 90°C corresponds to  $T_a$  of 45°C

$T_j$  of 100°C corresponds to  $T_a$  of 55°C

In the above cases the ambient temperature should never exceed 55°C whilst the maximum allowable sustained ambient is 45°C.

The circuit can be made to work under low loading conditions by reducing the quiescent current through the output stages, and this has the advantage that the resulting reduction in collector dissipation makes possible the use of smaller heat sinks. With this condition the amplifier will still give 10 watts output "speech and music power." The quiescent current can be reduced simply by increasing resistor  $R_{22}$ .

In the prototype the quiescent current was reduced to 0.27 amps and the amplifier was still capable of giving 10 watts output for a drive of 25 cycles of a 1 kc/s signal. Alternatively, 5 watts output power

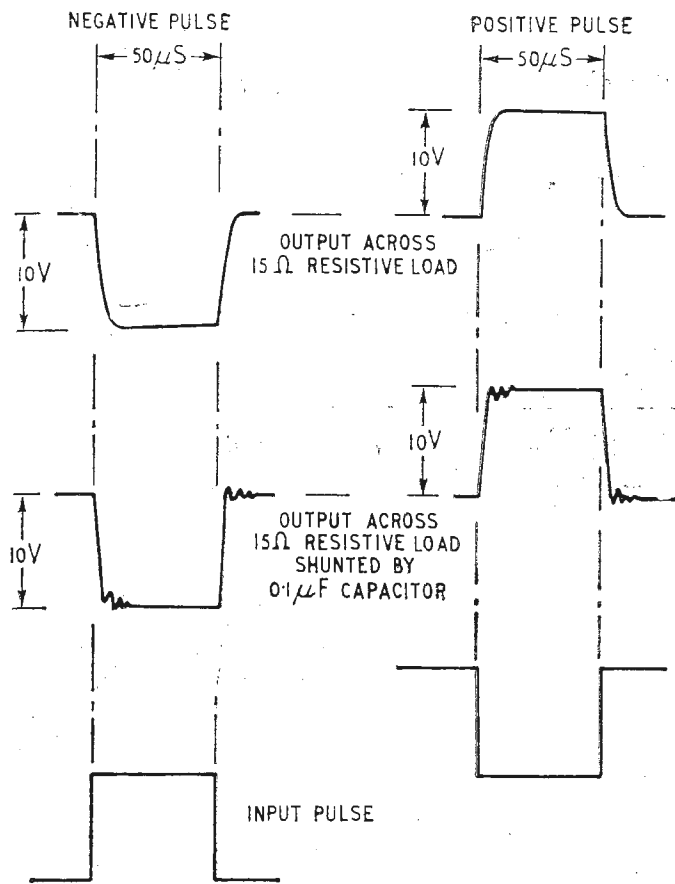

Fig. 9. Pulse response of 10 watt high-quality transistor amplifier.

will be maintained for constant sine-wave drive.

Under these conditions the nominal collector dissipation is 6.2 watts whilst the maximum dissipation is 8.3 watts. The heat sink shown in Fig. 13(b) has a thermal resistance of 4.2°C/watt per transistor as it allows two transistors to be mounted provided they are electrically insulated by mica washers. The resulting thermal resistance from junction to ambient is 6.2°C/watt.

Hence for nominal dissipation

$T_j$  of 90°C corresponds to  $T_a$  of 52°C

$T_j$  of 100°C corresponds to  $T_a$  of 62°C

With maximum dissipation

$T_j$  of 90°C corresponds to  $T_a$  of 39°C

$T_j$  of 100°C corresponds to  $T_a$  of 49°C

Hence in this case the ambient temperature should never exceed 49°C whilst the maximum allowable sustained ambient is 39°C.

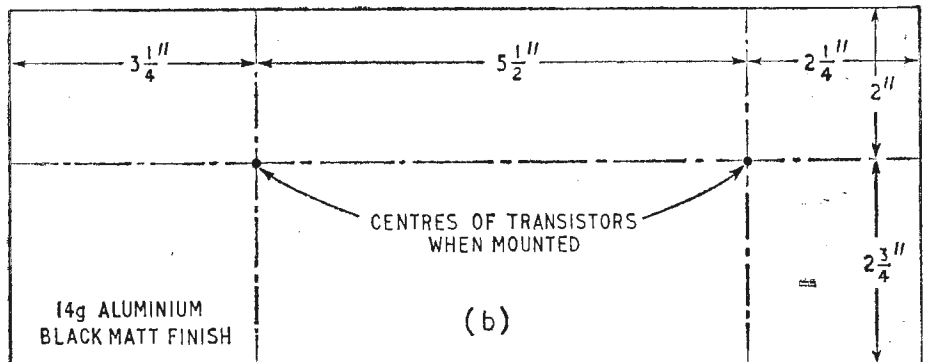
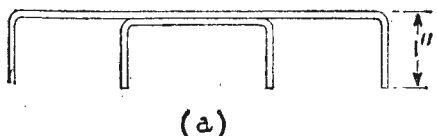
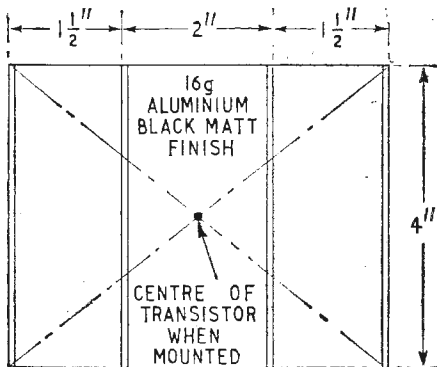

Fig. 13. Dimensions of heat sinks (a) for each output transistor under normal loading conditions and (b) for a pair of transistors under low loading conditions.

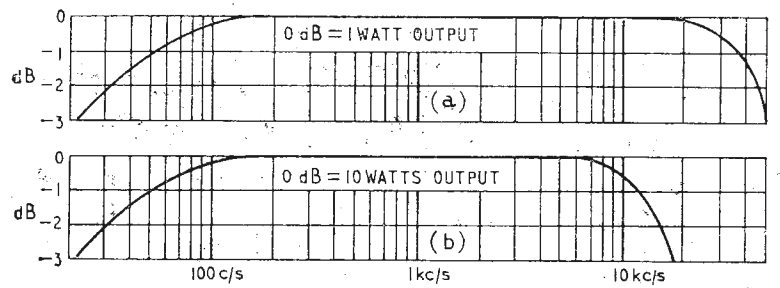

Fig. 10. Frequency response of amplifier (a) at low and (b) at high level.

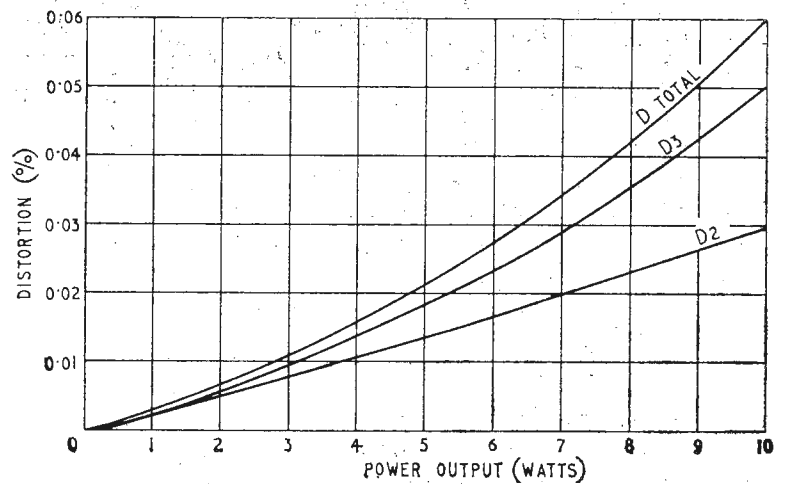

Fig. 11. Results of measurements of distortion.

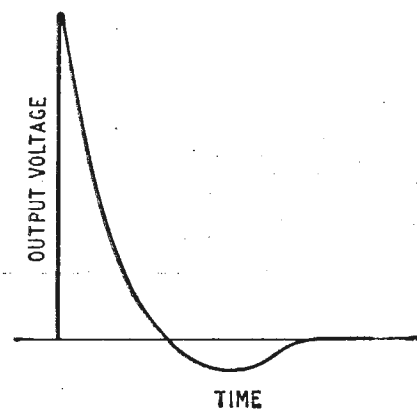

Fig. 12. Response of amplifier to a step input.

The nominal dissipation of the OC81Z driver transistors is 500mW and hence these must be mounted on heat sinks of at least 35 sq cm. The nominal dissipation of the AF118 phase splitter transistor Tr3 is 160mW. This transistor should be used with a cooling fin. Because of its lower collector-emitter voltage, transistor Tr4 has a lower dissipation of the order of 20mW and need not have a cooling fin.

For the normal loading condition the power supply must be capable of supplying 0.4 amps at 52 volts.

and for the low-loading condition, 0.27 amps at 52 volts. If a stereo version is required, in either case the current requirement is doubled.

In order that the hum level may not exceed 75dB below full output power, the smoothing of the supply should be such that the ripple level on the 52 volt line is not greater than 100mV peak-to-peak.

The capacitor  $C_{11}$  feeding the loudspeaker should have an adequate ripple rating and a low equivalent series resistance (e.g. Mullard Type C431BE/G1250).

## Commercial Literature

Imhof's 1963 catalogue, "This year of Hi-Fi," contains 44 pages and in addition to listing record turntables, amplifiers, pickups, speakers, tuners, etc., there are separate sections on tape recorders, radiograms, record players and Imhof's range of hi-fi cabinets. It also contains clear introductions to hi-fi and stereo, and each section has notes on what to look for when choosing various items. This catalogue is available from Imhof's (Retail) Ltd., 112-116 New Oxford Street, London, W.C.1. (751)

Quartz crystal units are described, including physical and operating details, in a brochure issued by Brush Crystal Co. Ltd., Hythe, Southampton, Hants. (752)

An information sheet on Foliac conductive cement, a ceramic adhesive containing a dispersed metal filler, is now available from Graphite Products Ltd., Point Pleasant, Wandsworth, London, S.W.18. (753)

The International Nickel Company (Mond) have introduced a new booklet giving details of some of their technical publications. One of the publications referred to deals with the properties and applications of nickel-containing magnetic materials (No. 2144). Copies of the booklet are obtainable from the Publicity Department, The International Nickel Company (Mond) Limited, 20 Albert Embankment, London, S.E.1. (754)

Revised copies of the Fry's 16-page booklet "Fluxes for Electrical Work" are now available from Fry's Metal Foundries Ltd., London, S.W.19. (755)

An application report on silicon controlled rectifiers has been released by A.E.I. It covers the basic theory of operation, general application considerations and their use in a.c. and d.c. power circuits. The 36-page report is available from Associated Electrical Industries Ltd., Electronic Apparatus Division, Valve and Semiconductor Sales, Carholme Road, Lincoln. (756)

Italian Industry Directory.—A 762-page catalogue, covering domestic sound and television receivers, audio equipment, components, and measuring instruments, has been prepared by the (ANIE) Associazione Nazionale Industrie Elettrotecniche, Via Donizetti 30, Milan. Trade names and addresses are listed. (757)

A leaflet describing the Hudson FM113 one-watt "hand portable" v.h.f. radiotelephone equipment is available from Hudson Electronic Devices Ltd., 4 Sydenham Hill, London, S.E.26. It gives the technical specification of this Post Office approved f.m. 71-175 Mc/s transmitter-receiver. (758)

A photomultiplier tube booklet giving full characteristics, both in graphical and tabular form, and the applications of various types of tubes, is available from the Valve Division, E.M.I. Electronics Ltd., Hayes, Middlesex. (759)

Home Constructors.—A 173-page catalogue containing details on most of the needs of the home constructor is available from Home Radio (Mitcham) Limited, 187 London Road, Mitcham, Surrey, at a cost of 2s 6d.

## H. F. PREDICTIONS—JUNE

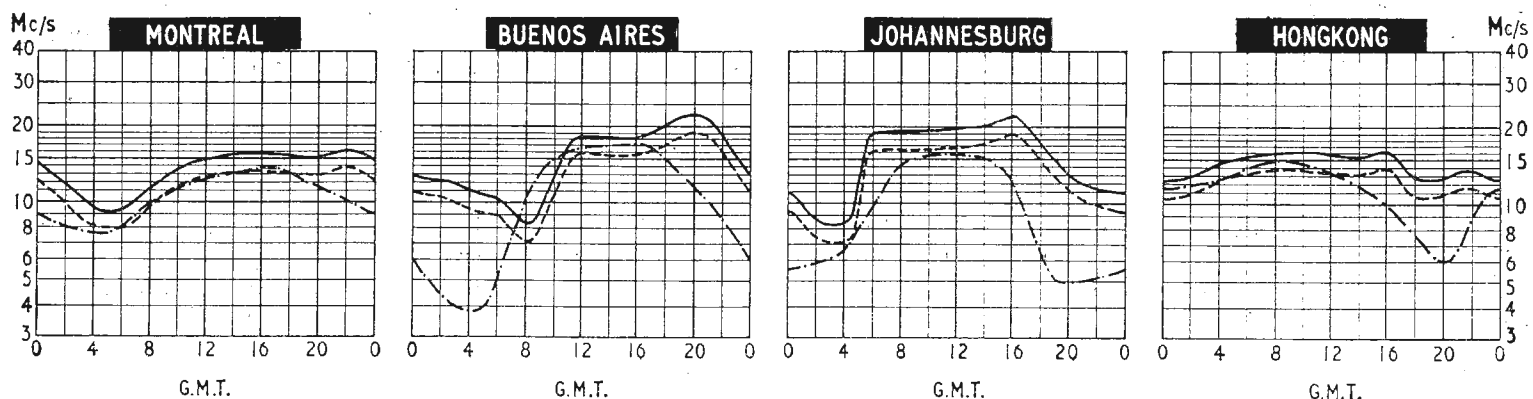

THE prediction curves now show the median standard MUF, optimum traffic frequency and the lowest usable high frequency (LUF) for reception in this country. Unlike the standard MUF, the LUF is closely dependent upon such factors as transmitter power, aerials, local noise level and the type of modulation: it should generally be regarded with more diffidence than the MUF. The LUF curves shown are those drawn by Cable and Wireless, Ltd., for commercial telegraphy and they serve to give some idea of the period of the day for which communication can be expected. The LUF curve for Montreal takes account of auroral absorption.

————— MEDIAN STANDARD MUF  
 - - - - - OPTIMUM TRAFFIC FREQUENCY  
 - · - · - · LOWEST USABLE HF

During the summer months in the minimum of the solar cycle past experience has shown that frequencies considerably higher than the predicted standard MUF can at times be received. This effect is mainly confined to daytime on the radio path and has been especially noted on reception in the U.K. from the Far East. The cause is thought to be associated with sporadic-E ionization.

# NON-LINEARITY

By "CATHODE RAY"

**A** THING I have had for many years on my list of subjects to explore is the meaning of the term "inductance" as applied to iron-cored coils. But whenever I have started thereon it has always encouraged me to turn to something else. I suspect that this goes for most other people too, judging from the lack of clear published guidance on the subject. There are not lacking those who, for a considerable sum of money, will provide you with a bridge or other apparatus for measuring the inductance of iron-cored coils, but do they explain precisely what it is that you are measuring?

The basic difficulty, however, is not really inductance but non-linearity. That is difficult enough, so for a first approach the sensible thing would seem to be to study it in its simplest manifestation. Inductance involves the *rate of change* of current, and (as the chemist would say) is never found in the pure state, being invariably combined with resistance. So we really would be sticking our necks out if we chose inductance as a first exercise in non-linearity.

Resistance is far safer, because its relationship to current and voltage is simpler, and it commonly occurs in a state that can be regarded for practical purposes as pure. And so far as we are concerned it commonly occurs in non-linear states. In fact, electronics could almost be defined as those parts of electrical engineering that involve non-linear resistance. Yet except in post-graduate works of a forbidding character, non-linearity is dodged. For example what is called the anode resistance of a valve,  $r_a$ , is referred to as a "constant," although it is plainly no such thing. And calculations concerning amplifiers and oscillators are based on the false assumption that all the circuit parameters — resistance, inductance and capacitance — are constant over the ranges of current considered. If this really were so there would be no distortion. The existence of distortion cannot be denied—in fact, it is one of the most discussed subjects in *Wireless World* circles—but it rarely emerges quantitatively from circuit calculations.

The reason for this, of course, is that non-linearity makes all circuit calculations far more difficult. We relatively-moderate-brows (as I venture to assume) are so used to taking linearity for granted that we find ourselves at a loss to know how to proceed without it—like arriving in a place where we can no longer get along on the comfortable assumption that everybody understands English. Our old stand-by, Ohm's law, for example, fails us. So do many of the other circuit laws. And we are whirled relentlessly about in vicious circles, unable to find the current because we need it as one of the data. And the very meanings of familiar terms such as "resistance" become veiled by doubts.

A certain French reviewer was once kind enough to credit me with an ability to show how complicated and difficult even the most familiar subjects are,

and then to wave a magic wand and make everything clear. In case any easily-influenced readers are already beginning to look forward eagerly to such a dénouement in the present instance, I must say at once that this part of the performance is unlikely to take place. It would be quite wrong of me to encourage anyone to expect a quick and easy solution to the problem of non-linearity.

In elementary books we first come across resistance in connection with d.c. It then appears as the ratio of voltage across to current through the part of the circuit concerned. And it is constant with respect to current or voltage, as Ohm demonstrated in his most celebrated work. So if one knows two of the three things—current, voltage and resistance—the third can be calculated with the greatest of ease.

When we get on to a.c. the situation is complicated by inductance and capacitance, and resistance can only be calculated in the same way as for d.c. in those exceptional circuits where these other two features are negligible or cancel one another out.

Fig. 1. At any instant, the rate at which any resistance  $R$  carries away energy from the circuit is equal to  $EI$ . This is so, whether  $R$  is linear or not, if  $E$  and  $I$  are instantaneous values.

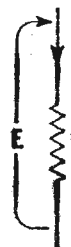

Moreover, a.c. resistance in general is not the same as d.c. resistance. In any circuit, resistance is essentially that characteristic of it that takes away energy "for keeps." Inductance and capacitance accept energy too, but only on loan; they pay it back in full. In a d.c. circuit the only permanent remover of energy is resistance (in its narrower sense)\*, but in an a.c. circuit there are other ways in which energy can depart—as radiation, and in hysteresis losses and dielectric losses, for example. These can all be expressed as resistance in ohms, the number of ohms depending on the frequency of the a.c. and on where these equivalent resistances are supposed to be in the circuit. For instance, the radiation resistance of an aerial is usually expressed as the resistance that would take away energy at the same rate if it were in series with the aerial at the input and radiation could be eliminated.

The general principle for evaluating any kind of resistance should now be clear. Find the average, over a representative period, of the rate at which energy is being carried away by it, and calculate the number of ohms that would carry it away at the same rate if connected in a suitable part of the circuit.

Rate of energy removal (or power) is usually

\* It could be argued that a motor also removes energy permanently from the circuit, but on the other hand it could be argued that it is capable of returning it.

reckoned in watts, which in a pure resistance are volt-amperes. In Fig. 1, for example, the power,  $P$ , is equal to  $EI$ . And we know that  $E=IR$ , so

$$P = I^2 R = \frac{E^2}{R} \quad \dots \quad (1)$$

and so

$$R = \frac{P}{I^2} = \frac{E^2}{P} \quad \dots \quad (2)$$

If then we have a part of a circuit, represented in Fig. 2 by a box, which we know is carrying away energy at a certain rate, then the energy-removing part of it can be represented by a resistor carrying the same current ( $I$ ) or bearing the same e.m.f. across it ( $E$ ), and having resistance calculated by (2).

Don't miss the point about averaging over a "representative" period of time. A quarter cycle would clearly not be representative, because inductance and capacitance both remove energy for half a cycle at a time, and we don't want to find ourselves reckoning them as resistance. No; it should be one whole cycle, or any whole number of whole cycles, covering the period for which we are interested in the resistance.

It is by making use of this principle in reverse that we arrive at the root-mean-square (r.m.s.) value of current or voltage. There is no difficulty, of course, with a perfectly square waveform, because the voltage is, say,  $E$  throughout the positive half-cycle, and  $-E$  throughout the negative (Fig. 3). The current is, say,  $I$ ; so  $P$  is  $EI$  during the positive half and (thanks to  $-1 \times -1 = 1$ )  $EI$  during the negative half. So far as power dissipation is concerned, it is the same as if there were no reversal—the same, in fact, as with d.c. So  $E$  and  $I$  are the correct values of voltage and current for calculating  $P$ , given  $R$ ; or  $R$ , given  $P$ .

The most important waveform in practice is the sinusoid (Fig. 4). Since the values of current and voltage are varying all the time, it is important to define clearly what we mean by any number of volts or amps we may quote in connection with such a waveform. There is the voltage or current as a continuously variable quantity, for which the small letters  $v$  or  $e$  and  $i$  are commonly used when there is need to distinguish them. But obviously these instantaneous values are useless for answering such a question as "What is the voltage of your supply?" Then there are peak values, usually denoted by  $E_{\max}$ ,  $I_{\max}$ , etc. These would do, because once they and the waveform are specified, the values of  $e$  and  $i$

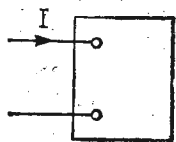

Fig. 2. If energy is being carried away from part of a circuit (represented here by a box) at rate  $P$ , the equivalent resistance is  $P/I^2$ . In an a.c. system,  $I$  is the r.m.s. current, and  $P$  the average power dissipation over a whole cycle.

Fig. 3. The r.m.s. value of a square wave is easy enough to calculate; it is the same as for d.c.

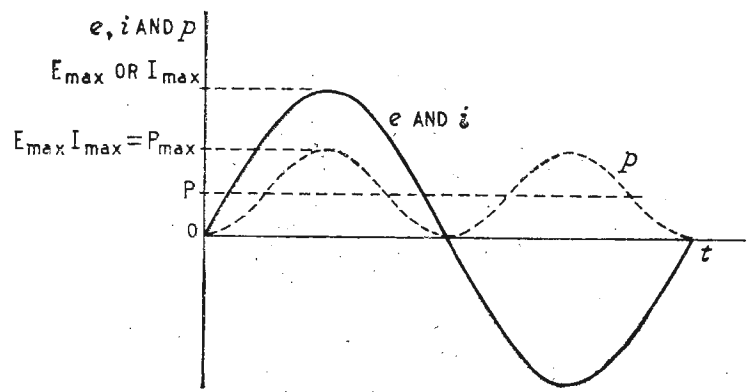
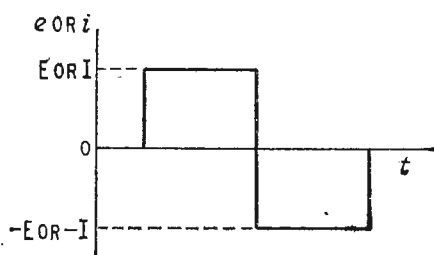

Fig. 4. A sine wave is a little more difficult. One way of finding the r.m.s. value is graphically, as here.

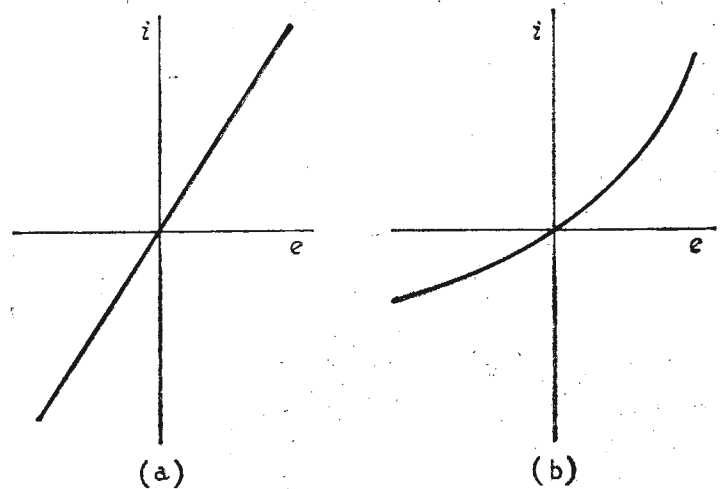

Fig. 5. The difference between linear and non-linear resistance is most clearly seen by looking at graphs of  $i$  against  $e$  (or  $2e$  against  $i$ ).

at every other phase of the cycle are known. They can be shown graphically, as in Fig. 4, or expressed mathematically, as  $i = I_{\max} \sin 2\pi ft$ . But they suffer the disadvantage that they cannot be used as  $I$  and  $E$  in equations (1) and (2).

To find values that can be used in these equations we follow our general principle and find the average power dissipation over a whole cycle. One way of doing this is by multiplying  $i$  by  $e$  at intervals in order to plot a curve of "instantaneous" power,  $p$ , as in Fig. 4. This turns out to be a double-frequency sine wave standing on the base line. It is not hard to see that its average is half its maximum  $P_{\max}$ . We have seen that the average is the significant figure, so we can denote it by the symbol  $P$ . Similarly it is customary to denote by simple  $E$  and  $I$  those values of current and voltage which, if constant, would dissipate the same power as the alternating quantities we actually have.

$$\text{Because } P = P_{\max}/2 = E_{\max} I_{\max}/2 = I_{\max}^2 R/2 = I^2 R$$

$$I^2 = \frac{I_{\max}^2}{2}$$

$$\text{and } I = \frac{I_{\max}}{\sqrt{2}} \quad \dots \quad (3)$$

$$\text{Similarly } E = \frac{E_{\max}}{\sqrt{2}}$$

The more adult method of doing the averaging is by the integral calculus, as shown in any textbook on electrical engineering. The same method can be (Continued on page 307)

# Vortexion quality equipment

Will deliver 120 watts continuous signal and over 200 watts peak Audio. It is completely stable with any type of load and may be used to drive motors or other devices to over 120 watts at frequencies from 20,000 down to 30 cps in standard form or other frequencies to order. The distortion is less than 0.2% and the noise level -95 dB. A floating series parallel output is provided for 100-120 V. or 200-250 V. and this cool running amplifier occupies 12½ inches of standard rack space by 11 inches deep. Weight 60lb.

## 120/200 WATT AMPLIFIER

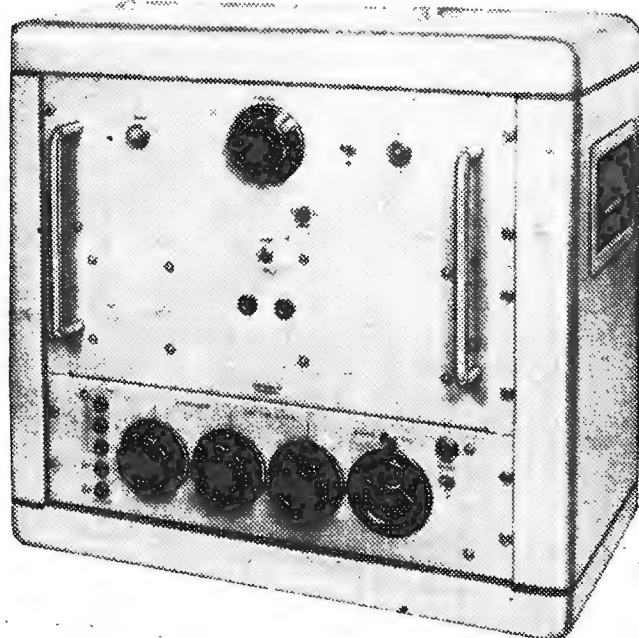

## 30/50 WATT AMPLIFIER

Gives 30 watts continuous signal and 50 watts peak Audio. With voice coil feedback distortion is under 0.1% and when arranged for tertiary feedback and 100 volt line it is under 0.15%. The hum and noise is better than -85 dB referred to 30 watts.

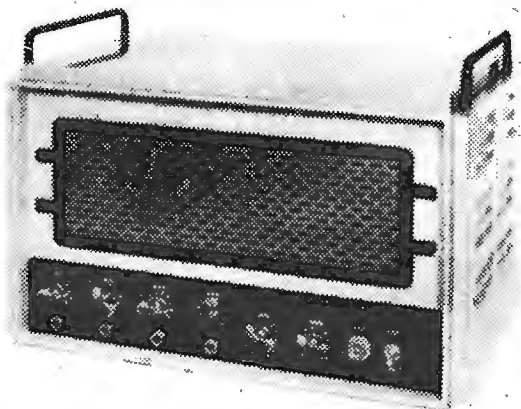

It is available in our standard steel case with Baxandall tone controls and up to 4 mixed inputs, which may be balanced line 30 ohm microphones or equalised P.U.s to choice.

Price with 4 mixed inputs **£59.0.0d.**

The 12-way electronic mixer has facilities for mixing 12 balanced line microphones. Each of the 12 lines has its own potted mumetal shielded microphone transformer and input valve, each control is hermetically sealed. Muting switches are normally fitted on each channel and the unit is fed from its own mumetal shielded mains transformer and metal rectifier.

Also 3-way mixers and Peak Programme Meters.

Price **£60.0.0d.**

4-way Mixers from **£40.8.6d.**

2 x 5-way stereo mixers with outputs for echo chambers, etc. available.

## ELECTRONIC MIXER/AMPLIFIER

This high fidelity 10/15 watt Ultra Linear Amplifier has a built-in mixer and Baxandall tone controls. The standard model has 4 inputs, two for balanced 30 ohm microphones, one for pick-up C.C.I.R. compensated and one for tape or radio input. Alternative or additional inputs are available to special order. A feed direct out from the mixer is standard and output impedance of 4-8-16 ohms or 100 volt line are to choice. All inputs and outputs are at the rear and it has been designed for cool continuous operation either on 19 x 7in. rack panel form or in standard ventilated steel-case.

Size 18 x 7½ x 9½ in. deep.

Price of standard model **£49.**

## 12-WAY ELECTRONIC MIXER

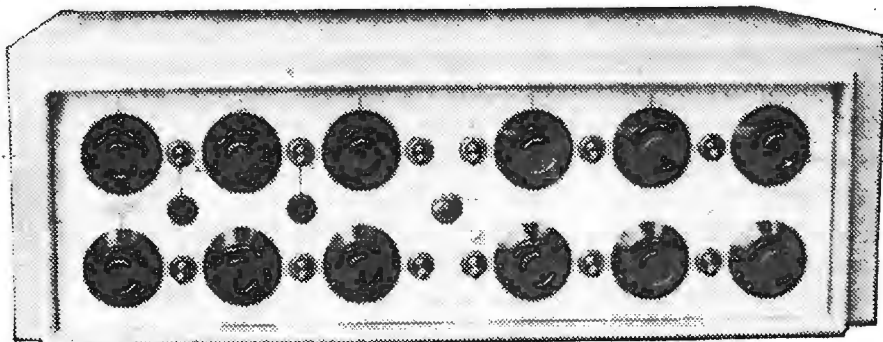

Price of standard model **£98.0.0d.**

Full details and prices of the above on request

**VORTEXION LIMITED, 257-263 The Broadway, Wimbledon, London, S.W.19**

Telephones: LIBerty 2814 and 6242-3

Telegrams: "Vortexion, Wimble, London"

SWITCH TO

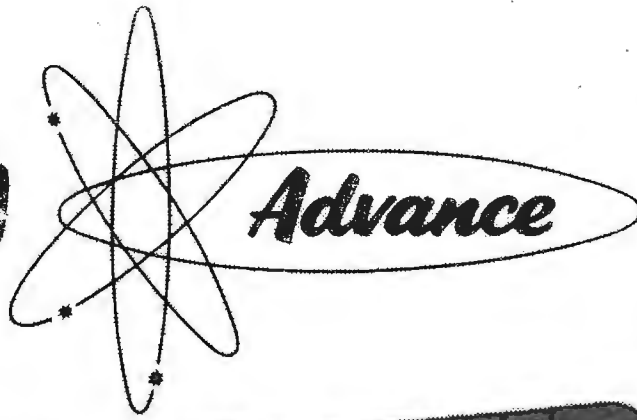
for in-circuit  
transistor  
testing**THE NEW TRANSISTOR TESTER TT1S (CT472)**

This portable battery-operated instrument is an invaluable laboratory and servicing tool for engineers working on transistor circuits. A bridge circuit and special clip-on probes allow in-circuit testing, avoiding possibility of damage to components and printed circuit boards. Facilities allow for balancing out the standing currents shunting the collector of the transistor under test. The TT1S will measure in circuit the Beta of transistors (n.p.n. or p.n.p.) in the range 10-500, and out of circuit other characteristics of transistors and diodes. The drum type meter enables measurements to be made quickly and accurately.

Full technical details and specifications are available on request. ● Tests n.p.n. or p.n.p. types ● Measurement of diode characteristics ● Beta range 10-500 ● Leakage current measurements. NETT PRICE IN U.K. £47.

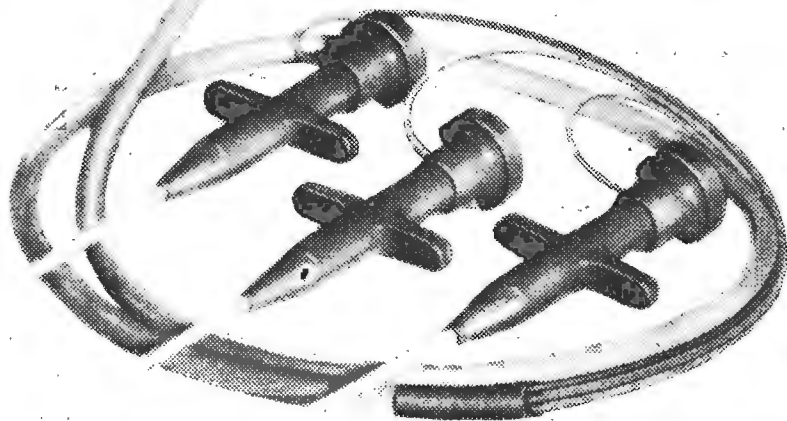

A1/1

**ADVANCE COMPONENTS LIMITED**

INSTRUMENT DIVISION

ROEBUCK ROAD, HAINAULT, ILFORD, ESSEX. TELEPHONE: HAINAULT 4444

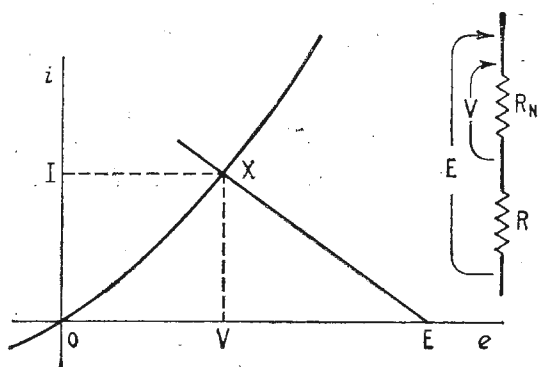

Fig. 6. Familiar graphical method of finding the current in non-linear resistive circuits under specified conditions.

applied to finding the r.m.s. value of any waveform that can be expressed mathematically. Theoretically, that includes any waveform. But except in fairly straightforward cases the graphical method is likely to be less tedious, especially if one has a planimeter for measuring the area under the  $p$  curve.

Now at last we are ready to take a cautious look at non-linear resistance. Just in case anyone is not quite sure what "linear" and "non-linear" mean in this context, Fig. 5 shows two graphs of current through resistance against voltage across it. Graph (a) is a straight line, so is described as linear. No matter what point one chooses on it, the ratio of voltage to current represented there, which is the resistance to that particular current, is the same. This graph, in fact, exemplifies Ohm's law. Graph (b), on the contrary, is not straight, so is called non-linear. It indicates a resistance that varies according to the amount of current passing through it.

And here we get involved at once in two kinds of resistance: the kind denoted as hitherto by the ratio  $e/i$  at any point on the curve, and the slope or incremental resistance denoted by  $\delta e/\delta i$  at that point. The latter is the kind usually considered in valves and transistors when we are interested in relatively small variations in current and voltage (i.e., signals) around a fixed point established by bias. Restricting the inquiry to such small variations that the part of the graph covered by them can be assumed to be straight is a favourite technique for dodging the difficulties of non-linearity. But it is self-defeating if, for example, we want to calculate the distortion in an amplifier. And it can hardly avail with large-signal amplification, which involves us inescapably in non-linear incremental resistance. But for the present let us continue to consider currents and voltages reckoned from zero.

We note first of all that whereas both (a) and (b) in Fig. 5 represent resistances, value  $e/i$  ohms, numerical scales of  $e$  and  $i$  in (a) would enable one at once to answer the question "Yes; but how many ohms?", whereas this question could not, even with d.c., be answered from (b) until the current or voltage was specified—and, as it happens in this case, its direction as well as its magnitude. And if what we know is, say, the total voltage applied to a circuit of which this non-linear resistance is a part, and the values of the other resistances, we are in one of those vicious circles I mentioned—unable to calculate the current until we know the resistance, and unable to find the resistance until we know the current.

There is, fortunately, a graphical way out of this impasse, familiar to users of valve and transistor

characteristic curves. Fig. 6 is just a reminder of it. Suppose  $E$  is the known constant voltage applied to a known resistance  $R$  in series with the non-linear resistance  $R_N$  represented by the curve. From the point on the  $e$  scale representing  $E$ , draw a straight line representing  $R$  to the same scale as the curve represents  $R_N$ , but backwards towards the origin because it shows voltage deducted from  $E$  by  $R$ . Where this line meets the curve, at  $X$ , we can read the current ( $I$ ) through  $R_N$  and  $R$  and the voltage ( $V$ ) across  $R_N$ .

The great advantage of this method, besides its simplicity, is that it works with all  $i/e$  characteristics, not only those that can be expressed mathematically. There is no difficulty in calculating the power dissipated in  $R_N$ ; it is  $IV$ .

If you think we are getting on splendidly in spite of my gloomy prognostications, allow me to point out that so far we have only had to deal with d.c., which the serious writer dismisses as "trivial".

Our first example of a.c., the square wave of Fig. 3, is in the near-trivial class, because it is merely a periodically reversed d.c. Even so, with an unsymmetrical or partially-rectifying characteristic such as that of Fig. 5(b) there are slight complications because conditions during one half-cycle are not just the reverse of those of the negative half. If a square-wave voltage generator with no internal impedance is applied directly across the non-linear resistor in question, there is merely the fact that the current half-cycles are unequal. In this particular example the negative half will be smaller than the positive

Fig. 7. Current resulting from applying a voltage square wave directly across a non-linear resistor of the Fig. 5(b) type. There is a d.c. component, shown dotted.

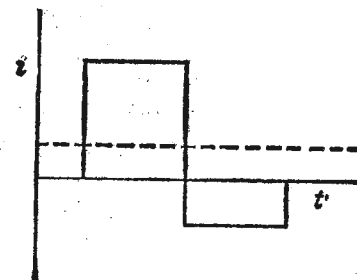

(Fig. 7) this inequality being more marked the greater the value of  $E$ . The average of the two currents can be taken as the value to multiply by  $E$  to give the power loss. But of course it can *not* be used in Fig. 5(b) for reading off "the" resistance, nor is it an r.m.s. value, either by definition or for squaring and multiplying by the resistance (which?!) to get the power.

Note, incidentally, that although the voltage is purely alternating, the current can be regarded as a pure a.c. (the average value just mentioned) plus d.c. equal to the difference between this average and either "peak". This d.c. is marked by a dotted line in Fig. 7.

The zero generator impedance is an unlikely condition in practice, and when it is not zero we have the same difficulty as with d.c. in calculating the current, only twice over. The method of Fig. 6 can be applied to the negative half too, as shown in Fig. 8. Note that the voltage across the non-linear resistor now has a unidirectional component too; its *positive* half-cycle is the smaller one.

Next we consider voltage of pure sine waveform. When we apply it to a non-linear resistance, the result is a distorted current, which can be analysed Fourier-wise into a fundamental and harmonics. Now it is proved in almost any book on the calculus



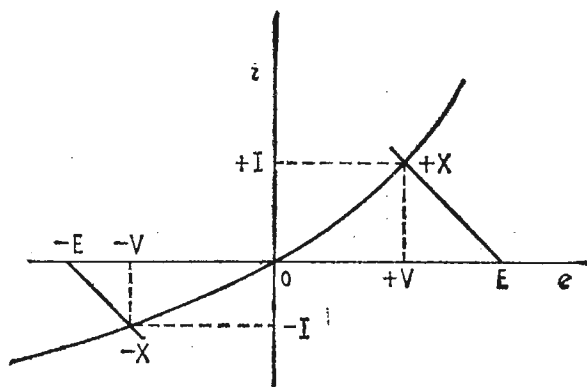

Fig. 8. Extension of the method of Fig. 6 to deal with square-wave a.c.

that the average, over a combined cycle, of two sine waves multiplied together is zero, unless they both have the same frequency. In symbols,

$$\int_0^{2\pi} \sin m\theta \sin n\theta \, d\theta = 0 \dots \dots \dots (4)$$

$(n \neq m)$

(Either or both of the sines can be replaced by cos without affecting the result.) So when the pure voltage is multiplied by the composite current to give the power, only the fundamental component of the current yields anything; the harmonics are not associated with any power.

Does this surprise you? Frankly, it did me. To think of alternating currents flowing through a resistance without any more power being dissipated than if they were not there, seems wrong. A reactance stores energy during half of each cycle and returns it all during the other half, but a resistance can't store electrical energy.

If you are not surprised by this news, then it must be because you reckon (quite rightly) that while the harmonic currents augment the fundamental current at times, they equally reduce it at other times, so the effects cancel out. That may seem obvious, so long as you have never read "Values"\* or its equivalent elsewhere, which shows that when you have currents of different frequencies in the same circuit, the total r.m.s. current is contributed to by all, thus:

$$I = \sqrt{I_1^2 + I_2^2 + I_3^2 + \text{etc.} \dots \dots \dots (5)}$$

And I went on to dispose of the objection that harmonic currents look as though they would cancel out over a complete fundamental cycle because a bit added here is offset by an equal bit subtracted there. Actually a bit added near a fundamental peak adds more to the r.m.s. value than an equal bit elsewhere subtracts from it, and things work out that harmonics always add, in the manner expressed by (5).

The contradiction is only apparent, of course. The explanation is that in the latter case linearity was assumed (as it usually is), so a harmonic current necessitated a corresponding harmonic voltage, and therefore harmonic power. But harmonic currents can be generated by a sinusoidal voltage only when the resistance is non-linear. That is the essential difference. While it is true that the average value of any sine wave—current, voltage or what have you—is zero over a complete cycle, in the special (but almost always assumed) condition of linearity, every current implies a voltage of the same waveform, and as power is calculated by multiplying the two together it can also be calculated from the square of the current at every instant (equation (1)), and

\* Originally published in the October 1946 issue, and now appearing as Chapter 37 in *Second Thoughts on Radio Theory*.

hence the use of r.m.s. values and the rightness of (5).

There is another catch in all this. It comes when one begins to consider the relationship between the non-linearity of a resistor and the current harmonics produced therein by a sinusoidal voltage. (Everything about this applies equally, of course, to the distorted voltage produced across it by a sinusoidal current.) If there is a first-power relationship between current and voltage, as graphed in Fig. 5(a), the result is a first-order or fundamental only. That is linearity. Suppose however that  $i$  was proportional to  $e^2$ , as in Fig. 9. (I can't think of any actual type of resistor like this, but one does come across mixtures of Fig. 9 and Fig. 5(a). I am just showing the square-law part separately for clarity.) Then the resulting current consists exclusively of second harmonic. The power would be nil, because whatever was dissipated during the positive half-cycle of  $e$  would be recovered during the positive half, when  $i$  would be flowing against  $e$ . (I said this kind of resistor wasn't found in nature.) Calculating the resistance in the basic way already explained, as  $P/I^2$ , one is bound to conclude it is zero\*—notwithstanding that at any point on the curve there is a ratio of  $e$  to  $i$  which is finite resistance. The positive values on the right are cancelled by the negative values on the left.

In the more practical situations where linear and square-law are mixed, so that the equation of the graph can be written

$$i = ae + be^2$$

we find that  $R$  is  $1/a$  just as if the bend in the curve didn't exist.

We might easily assume that the same principle held for other types of non-linearity, expressed by

\* If on the other hand we calculate it from  $E^2/P$  we find the resistance is infinitely large. There is no real contradiction between these two rather widely different estimates. Which of them is appropriate depends on the circuit configuration assumed; i.e., whether the resistance in question is in series or parallel with any others.

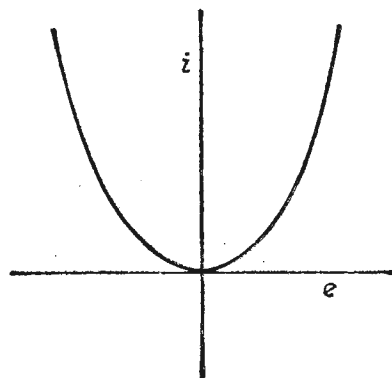

Fig. 9. Pure square-law characteristic, often found in combination with linearity, as in Fig. 5(b) for example.

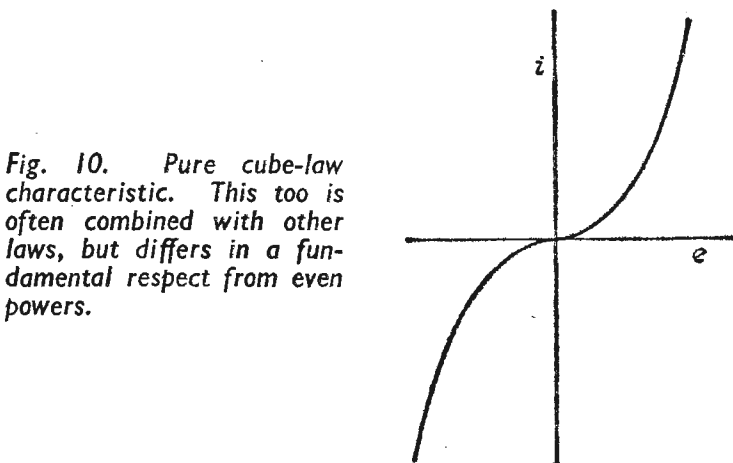

Fig. 10. Pure cube-law characteristic. This too is often combined with other laws, but differs in a fundamental respect from even powers.

other powers of  $e$ . However, if we take the trouble to work out the results for a cube-law characteristic,  $i = ce^3$ , as in Fig. 10 (which incidentally is not so far off some actual types of commercially available resistor) we find that it yields a figure for resistance. The actual value is  $4/3cE_{\max}^2$ , where  $E_{\max}$  is the peak value of the sinusoidal  $e$ . If we go to a fourth power law, however, the resistance is again zero. And so on, alternately.

Looking at Fig. 10 we can guess the explanation. Notwithstanding that this is a pure cube-law curve, *the current resulting therefrom is not a pure third harmonic*. There is a fundamental component as well. It is, in fact, three times as large as the third harmonic itself. The shape of Fig. 10 shows that this is bound to be so, because  $ei$  is always positive; whatever the polarity of  $e$ , that of  $i$  is the same. Therefore there is power dissipation, and therefore resistance.

Any kind of non-linearity (barring discontinuities) can be expressed as a power series,

$$i = ae + be^2 + ce^3 + de^4 + \dots \dots \dots (6)$$

but only the odd-power coefficients ( $a$ ,  $c$ , etc.) have any influence on the resistance. And except for the linear component,  $1/a$ , the resistance depends on the amplitude of  $e$ .

From all the foregoing we can now extract a rule for reckoning the resistance in any situation where current or voltage is purely sinusoidal, i.e., consists of fundamental only. Because any voltage or current harmonics due to non-linearity of resistance are

accompanied by no currents or voltages of the same frequency, they are powerless and can be ignored (though we must remember that all odd harmonics are accompanied by relatively large extra fundamental components). So the power in a pure resistance is  $EI$ , where  $E$  and  $I$  are the r.m.s. values of *fundamental* voltage and current; and the resistance, according to eqn. (2), is

$$R = \frac{EI}{I^2} = \frac{E}{I}$$

just as in any Chapter 1.

To allow for the possible presence of reactance in series, we must note the phase difference,  $\phi$ , between  $E$  and  $I$ . The power then is, in the familiar a.c. formula,  $EI \cos \phi$ , and

$$R = \frac{E \cos \phi}{I}$$

That seems a natural point for breaking off. The relationships between types of non-linearity, harmonic distortion, and effective resistance are now, I hope, quite clear. Of course we have only considered one "signal" at a time, and the great importance of non-linearity in radio and other pursuits is the production of sum and difference (intermodulation) frequencies, desirably in radio receivers and undesirably in audio amplifiers. But all that is well covered at various levels in the literature. It ought to be easier to follow after considering the foregoing introductory points, which are too often omitted.

Next time we shall tackle non-linear inductance.

## BOOKS RECEIVED

**Solar Activity and the Ionosphere** by N. Ya. Bugoslavsky (translated from the Russian by G. O. Harding) is intended for radio communications engineers. Fundamental facts about the composition of solar radiation and the connection between geomagnetic ionospheric storms and radiation from active regions of the sun are discussed. The latter part of the book deals with the eleven-year cycle of solar phenomena and the effects of the ionosphere on short wave radio communications. Pp. 39. Pergamon Press, Oxford. Price 12/6.

**Computer Basics Vol. 6 (Solid-State Computer Circuits)** by Technical Education and Management Inc. Solid state computers are rapidly superseding their thermionic valve equivalents. The purpose of this book is to provide a practical treatment of transistorized circuits in logic and arithmetic elements as well as in magnetic-core memory devices. Circuitry applicable to both analogue and digital computers is discussed from theoretical and practical viewpoints. The last two chapters consider the aspect of mechanical design and computer maintenance. Pp. 223. Howard W. Sams & Co. Inc., Indianapolis 6, Indiana. \$4.95.

**Microwave Engineering** by A. F. Harvey, D.Phil., B.Sc(Eng), M.I.E.E., provides a comprehensive record of the principles, techniques and applications of microwave engineering. Those new to the subject may use the work as a guide: research workers will find it useful as a source of reference, since an unusually extensive bibliography completes each of the twenty-six chapters. Pp. 1,313. Academic Press Inc. (London), Ltd., Berkeley Square House, Berkeley Square, London, W.1. Price £12 10s.

**Technical Television**, by A. V. J. Martin is intended as a textbook for students in technical colleges and deals primarily with the circuit elements of monochrome and colour receivers, their function and basic design using the minimum of mathematics. There is an introductory chapter on the American NTSC standards, on which this book is based. Pp. 557. Prentice-Hall International, 28, Welbeck Street, London, W.1. Price 88s.

**E.E.A. Guide to the Servicing and Testing of Electronic Equipment Containing Semiconductor Devices**. Issued with the object of assisting in the re-orientation of skills acquired with valve equipments to the servicing of the new generation of semiconductor devices. Pp. 10. The Electronic Engineering Association, 11, Green Street, London, W.1. Price 3s.

**Technical Reports published by the Electrical Research Association.**

*Low Temperature Breakdown in Semiconductors*, by V. V. Paranjape. Pp. 22. Price 15s.

*Electrical Contact Erosion*, a theoretical study of pip and crater shape by J. Pullen. Pp. 15. Price 12s 6d.

*Thermal Endurance of Enamelled Wires Using Twisted Wire Specimens*. Statistical analysis of test results by H. Goldenberg. Pp. 17. Price 10s 6d.

*Life Tests on Oil Impregnated Paper Capacitors for Power Factor Correction*. A further report by Z. Krasucki. Pp. 15. Price 15s.

*Dielectric Effects of Flaws in Hydrogen Bonding—II*, by Vera Daniel. Pp. 13. Price 12s 6d.

The reports were issued to members of the association some time before general publication. All may be obtained from the British Electrical and Allied Industries Research Association, Thorncroft Manor, Dorking Road, Leatherhead, Surrey.

# TRANSISTOR AMPLIFIER OUTPUT STAGES

## 6.—HIGH POWER OUTPUTS FROM THE CASCODE CIRCUIT

By O. GREITER

THE type of circuit discussed last month is probably the type which will become the common form in the 10-20 watt class. Readers with short memories may care to be reminded that this used a compound p-n-p/p-n-p pair and an n-p-n/p-n-p pair in a half-bridge output-transformerless circuit. From Santa Monica to Mitcham this circuit has its adherents. For higher power levels we can consider the rather brutal solution provided by parallel operation, and one particularly striking form shown at the 1962 I.E.A. Exhibition used thirty-two OC28s in a traditional class-B push-pull stage to give 500 watts. This, we might say, is a bit much, but we must accept the fact that the American practice of talking in terms of 50-100 watts is bound to spread. The descendants of King Knut\* still stand in our exhibition halls, although they, unlike Knut, take themselves seriously.

Although the use of parallel transistors is a practical solution, and at a lower level two OC36s in parallel are used for each arm of the Orthophase half-bridge output circuit, most designers find the high current demand an embarrassment. The general practice, even for valve circuits, has always been to push up the voltage as the power demand has risen. When we are using OTL circuits our freedom is rather limited by the loudspeaker impedances which are available, but it is very pleasant to feel that there is some freedom to manoeuvre. One circuit type which we must consider is the cascode circuit, which has already appeared in some high-power amplifiers.

The basic circuit of a cascode stage is shown in

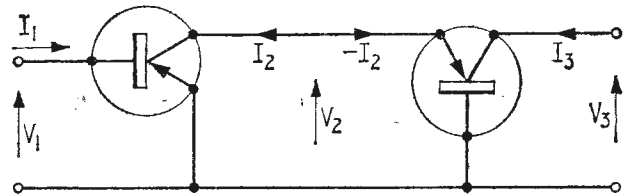

Fig. 28. Basic cascode configuration.

Let us use the notation shown on Fig. 6.1, so that

$$\begin{aligned} V_1 &= h'_{11} I_1 + h'_{12} V_2 \\ I_2 &= h'_{21} I_1 + h'_{22} V_2 \end{aligned}$$

and

$$\begin{aligned} V_2 &= h''_{11} I_2 + h''_{12} V_3 \\ I_3 &= h''_{21} I_2 + h''_{22} V_3 \end{aligned}$$

In this set of equations the  $h'_{nm}$  terms are the common-emitter parameters for the first transistor, while the  $h''_{nm}$  terms are the common-base parameters for the second.

We can transform these equations to the form

$$V_1 = \frac{1}{h'_{21}} [-\Delta h' V_2 + h'_{11} (-I_2)]$$

$$I_1 = \frac{1}{h'_{21}} [-h_{22} V_2 + (-I_2)]$$

and a similar equation in terms of the  $h''_{nm}$  relating  $V_2 I_2$  to  $V_3 I_3$ . In these equations we have substituted  $\Delta h$  for  $h_{11} h_{22} - h_{12} h_{21}$ . We now insert in the pair given above the expressions for  $V_2, I_2$  in terms of  $V_3, I_3$  from the similar equations in  $h''_{nm}$ . After sorting out we find that we have

$$V_1 = \frac{1}{h'_{21} h''_{21}} [(\Delta h' \Delta h'' - h'_{11} h''_{22}) V_3 + (-\Delta h' h''_{11} + h'_{11})(-I_3)]$$

$$I_1 = \frac{1}{h'_{21} h''_{21}} [(h'_{22} \Delta h'' - h''_{22}) V_3 + (-h'_{22} h''_{11} + 1)(-I_3)]$$

Fig. 28. It consists of a common-emitter stage followed by a common-base stage, and is sometimes drawn in the form shown in Fig. 29, which shows the biasing arrangements for the two transistors. We

Now it becomes merely a matter of transforming the equations back into hybrid form to achieve, for the hybrid parameters of the composite structure, the results below:

$$\begin{aligned} H_{11} &= (h'_{11} - \Delta h' h''_{11}) / (1 - h'_{22} h''_{11}) \\ H_{12} &= \frac{(\Delta h' \Delta h'' - h'_{11} h''_{22})(1 - h'_{22} h''_{11}) - (h'_{11} - \Delta h' h''_{11})(h'_{22} \Delta h'' - h''_{22})}{(1 - h'_{22} h''_{11}) h'_{21} h''_{21}} \\ H_{21} &= -h'_{21} h''_{21} / (1 - h'_{22} h''_{11}) \\ H_{22} &= (h'_{22} \Delta h'' - h''_{22}) / (1 - h'_{22} h''_{11}) \end{aligned}$$

may profitably derive the overall parameters of the stage, since no one else seems to have done so. No doubt this *has* been done elsewhere, and the author and some readers would be glad to know of any reference.

\* Knut, not Canute is the spelling used by those of the author's friends who actually bear this name.

There are, no doubt, readers of such energy and determination that they will proceed onwards to translate these into functions of the common-emitter parameters throughout. We shall content ourselves with an examination of some simpler results.

Let us first look at  $H_{21}$ . We have

$$H_{21} = -h'_{21} \cdot h''_{21} / (1 - h'_{22} h''_{11})$$

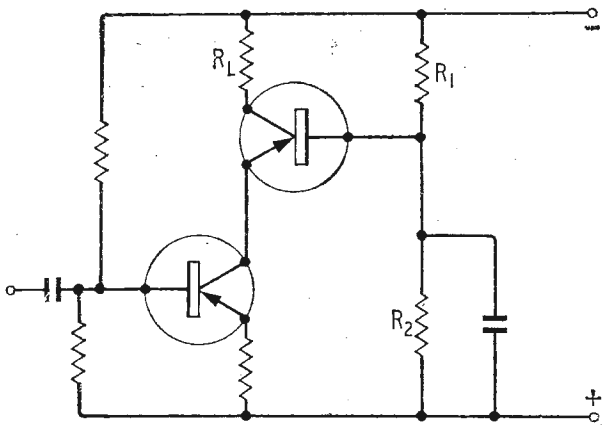

Fig. 29. Cascode circuit with bias resistors, as usually drawn.

which, for the OC71, selected only because all its parameters are given, gives us

$$H_{21} = +h'_{21} \cdot 0.976 / (1 - 42 \times 10^{-6} \times 35) \\ = h'_{21} (0.977)$$

The current gain term is thus almost the same as that of the first transistor in the common-emitter mode.

The reduction of the feedback term,  $H_{12}$ , to a form which can be managed involves a great deal of heavy slogging which would be quite out of place here. In fact we shall find that the approximation of approximations is  $H_{12} = h'_{12} h''_{12}$  which for the OC71 gives us  $H_{12} = 7 \times 7.6 \times 10^{-8}$

We can see why this is so. The first transistor is working into the relatively low input impedance of the second, common base, transistor and thus the voltage  $V_2$  will be very small. Only this very small voltage is available to feed back through the first transistor so that the voltage produced by feedback at the base must be correspondingly reduced. The cascode system thus gives very good isolation between input and output.

The input impedance will be very close to  $h'_{11}$ , for the emitter input impedance of the second transistor is, for practical purposes, a zero impedance load on the first transistor. The output impedance will be high, for the second transistor has a high impedance, the collector impedance of the first transistor, in its emitter lead, giving the characteristic high impedance of a current feedback circuit.

The reader who is considering carrying through the algebra should, perhaps, be warned that he is doing this, as they say on the pin-tables, for amusement only. An associate of considerable pertinacity reports that he expects to have guard dogs set on him the next time he asks for the hybrid parameters of power transistors. Whether these figures will ever reach the light of day, who can tell? It is hard to see how they have achieved the status of the *Goncourt Journal*, "The Mint," or Casement's Diaries. While this secrecy persists we must be satisfied to abbreviate our analysis and to accept qualitative results.

The significant result given by the analysis is the very substantial reduction in feedback,  $H_{12}$ . It is rare that this effect will be of value in the design of audio frequency power amplifiers using the transistors which we should normally find convenient. With transformer input and output to the power stage and with transistors having better frequency characteristics than the transformers one can envisage the amplifier operating as an oscillator. Certainly the cascode circuit is useful as a high-frequency amplifier

but to use it for achieving stability in an audio-frequency amplifier would indicate a rather misplaced sophistication.

It is when we come to consider the operating conditions of the transistor that the cascode circuit is seen to have advantages. A simple way of looking at what the cascode stage can do for us is to consider that we have two transistors in series in each arm of the bridge and we can therefore safely operate at twice the normal working voltage. It is a pity that this is completely misleading.

Let us begin by considering the operating conditions which must be established for the lower transistor, operating in the common-emitter mode. The maximum current which can flow must be  $V_{cc}/R_L$ , where  $V_{cc}$  is the supply voltage and  $R_L$  is the load. The correction for bottoming voltage can be neglected at this stage. This current fixes a working point on the transistor characteristic, the point P in Fig. 30, if we assume that minimum dissipation is our aim.

This common-emitter mode transistor is operating into a load equal to the common-base input impedance of the second transistor. We know that there is a load resistance  $R_L$  beyond this transistor but all that can be seen from the collector of the first transistor is the emitter-base diode of the second, plus some feedback effects which we know how to take into account. We can therefore draw a loadline PQ having, typically, a slope of about 1/10 ohm. It will be apparent that we shall not get more than a very few volts appearing at the collector of this transistor. We shall need to know the voltage at the point R, the nominal working point.

At R we have a small current, the quiescent current,  $I_q$ . Much of the reasoning will apply, indeed, even if the stage is operated in class-A, but we shall use the language of class-B. We must now turn our attention to the second transistor, the transistor which is operating in the common-base mode. The emitter of this transistor is to be held at some voltage  $V_R$  when a current  $I_q$  is flowing, and thus the base must be fixed by the bias system at  $(V_{be} + V_R)$  negative with respect to the positive line. This will be only 2 to 3 volts. Clearly almost the whole of the supply voltage will appear across the collector-base diode of the second transistor.

Before going on we may just note that the first transistor operates to give us current gain into what is virtually a short-circuit load, pumping current into the impedance-converting action of the second

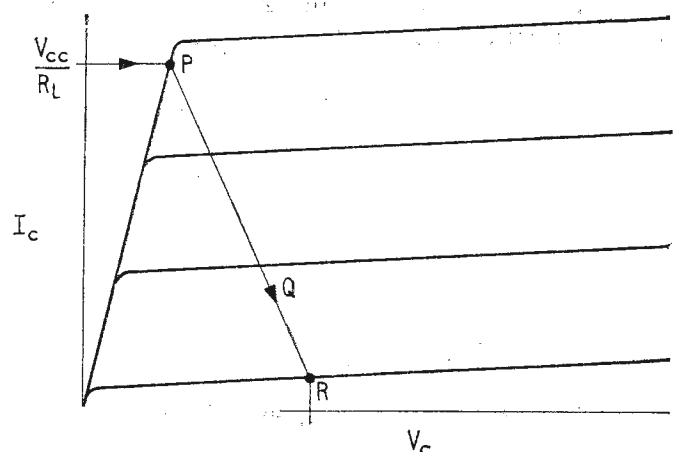

Fig. 30. Fixing the working point for the first (lower) transistor.

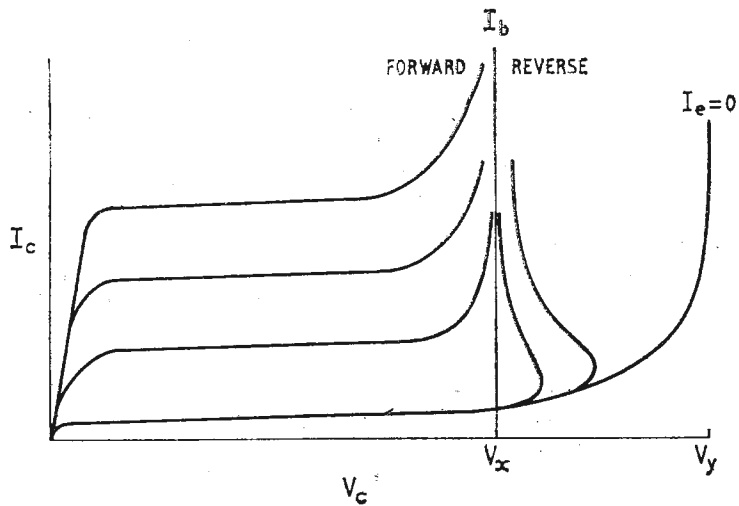

Fig. 31. Operating conditions in the second (upper) transistor.

transistor. Since we need a very small voltage drive for a common-base transistor the common-emitter driver can operate with a correspondingly small collector voltage.

The first transistor has a very easy life. The low voltage operation makes it impossible to get high dissipation so that this transistor is likely to run cool. The effect of this way of operating the transistor on  $I_{c0}$  is difficult to assess in general terms. When the leakage current is produced by surface effects the current will be very dependent on supply voltage. When it is due to avalanche multiplication the Ebers-Miller factor is nearly unity at low voltages and  $I_{c0}$  tends to be constant. This conclusion, taken from one of the standard papers, does not make too much sense and it seems reasonable to assume that at low voltages we shall get very little leakage current. The transistor data sheets are confusing, quoting leakage currents at different temperatures as well as voltages. But there is not likely to be much of a problem in holding the common-emitter transistor stable.

The second transistor is the one which really does the work. Almost the full supply voltage appears across it at low currents and, of course, the full load current must flow through it. What advantage have we gained by introducing two transistors where we might think that one would do the job? We find the key in the fact that the second transistor is operated in the common-base mode. Let us consider the transistor output characteristics shown in Fig. 31. These show the usual flat-topped characteristics on the left, but as the supply voltage approaches some value  $V_x$  we see that the collector current begins to rise. This is the result of avalanche multiplication in the carrier depletion layer between base and collector.

When the collector voltage is taken above  $V_x$  we have a situation in which the current gain factor  $\alpha$  exceeds unity. Readers who have had experience with point contact transistors will remember that instability could easily be produced by any resistance in the base circuit. If we attempt to control a transistor by a base signal in this region we shall find that, as the curves indicate, the current just runs up to the limit set by the external circuit. Thus  $V_x$  is the limiting voltage which can be allowed to appear between collector and emitter if the transistor is in the common-emitter mode. If the emitter is open-circuited, however, the situation is very much better. The avalanche current no longer gets driven back

into the base to be multiplied by the common-emitter current gain and so the limiting voltage becomes some higher value  $V_y$ . We can, in fact, show that  $V_x = V_y(1-\alpha)^{1/n}$ , where  $n = 3$  for p-n-p alloy germanium transistors.

We see the practical values associated with this effect in the data sheets, where for the OC35 we see that  $V_{ce}(\max)$  at  $I_c = 500\text{mA}$  is  $-48$  volts, while  $V_{cb}(\max)$  at  $I_e = 0$  is  $-60$  volts. Operation in the common-base mode offers us the possibility of a 25% increase in supply voltage and thus a 25% increase in power at constant current, or just over 50% at constant load. This last factor can be the crucial one, for our load is usually not easily varied if we wish to avoid using transformers.

An analysis in more detail will reveal that the limiting voltage depends on the ratio of emitter resistance to base resistance but we need not worry over-much about this. The emitter of this transistor sees as its source the output impedance of the common emitter transistor, which will be high. The base resistance can be made very low by using diodes biased in the forward direction to act as quasi-Zener diodes giving a low resistance to changes of current but providing the few volts needed at a reasonable current drain.

Turning now to the problem of the frequency characteristic, we see that the first transistor, in the common-emitter mode, could well be our limiting factor. We have already examined the way in which emitter resistance feedback and low source impedance can be used to extend the frequency response towards the common-base cut-off frequency. We also have an extra degree of freedom in that we can use a very low voltage type of transistor here. This enables us to search the catalogues with a less critical eye, looking only at current, cut-off frequency and price. The second transistor, of course, is operating up to the common-base cut-off frequency and will not raise any awkward problems in an audio-frequency amplifier. Here, then, we concentrate our attention almost entirely on the voltage rating. As you can see the two transistors split the specification requirements between them. Just to give an example there is the ACY22, which will pass a peak current of 1 amp. but which we should be wise to limit to 15 volts  $V_{ce}$ , which has a cut-off frequency in the common emitter mode which is above 20 kc/s ( $f_1 = 1.1 \text{ Mc/s}$ ,  $\alpha' = 50$ ). The OC36, however, can be used with  $V_{cb} = 80$  volts, so that the pair in cas-

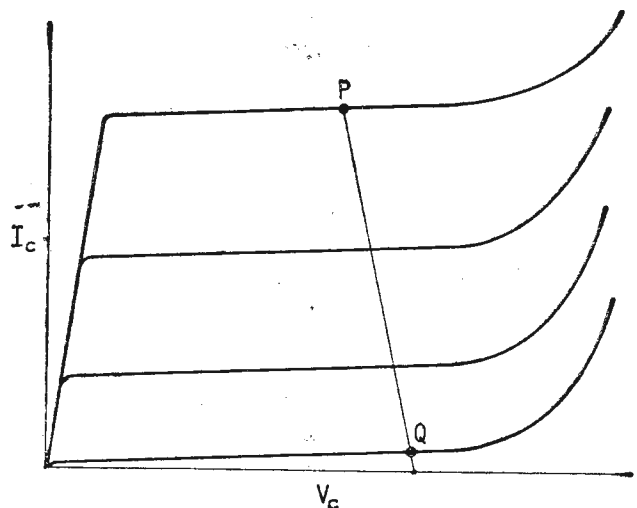
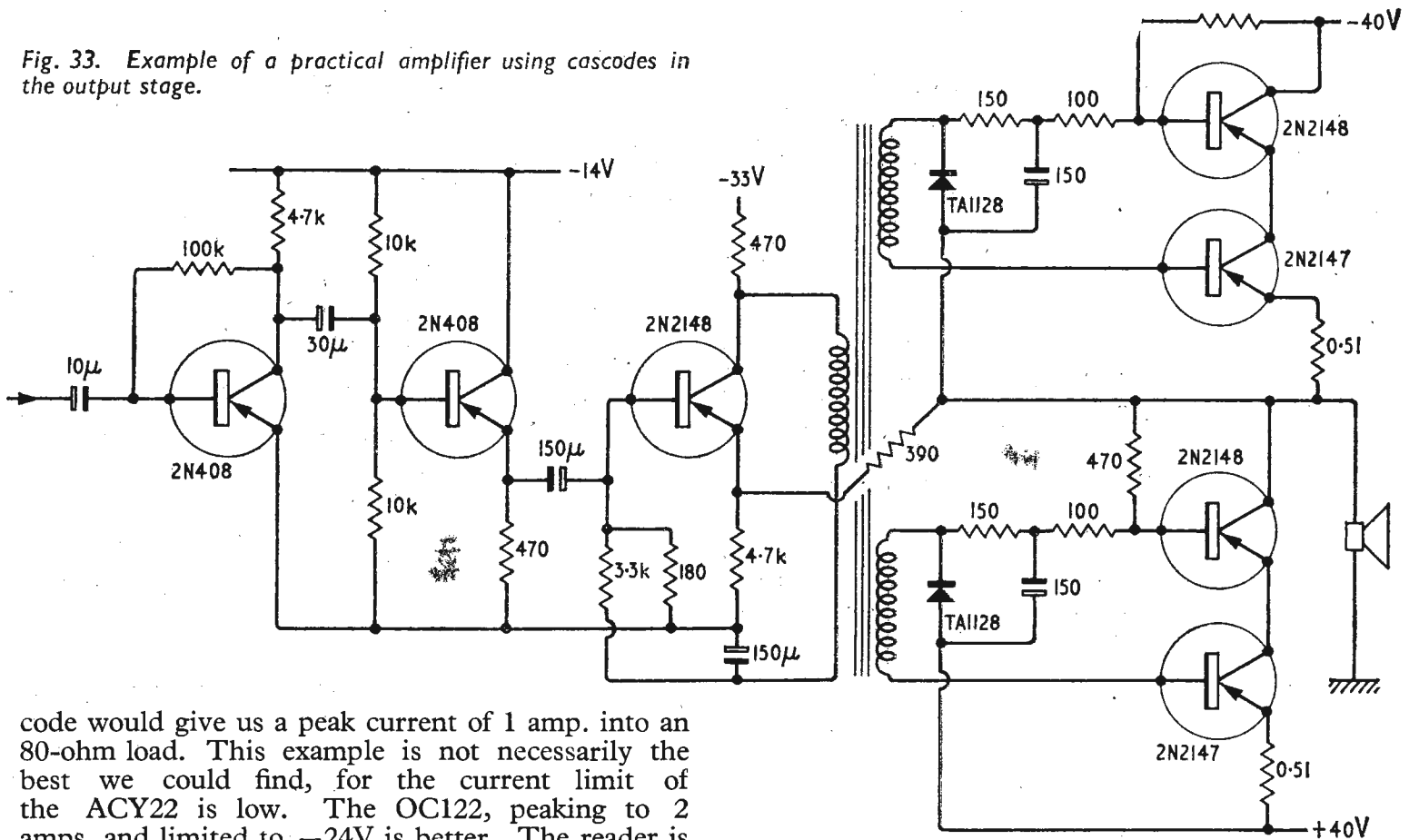

Fig. 32. Alternative working points.

Fig. 33. Example of a practical amplifier using cascodes in the output stage.



code would give us a peak current of 1 amp. into an 80-ohm load. This example is not necessarily the best we could find, for the current limit of the ACY22 is low. The OC122, peaking to 2 amps. and limited to  $-24V$  is better. The reader is left to explore the catalogues himself. The principle is clear.

We have an alternative method of design, however. Instead of choosing the point P in Fig. 30 we can choose the point Q in Fig. 32. The slope of the loadline to be considered for the first transistor is still very nearly that of a short-circuit, the input resistance to a common-base stage. Q is now determined by criteria which the author finds difficult to assess. Clearly  $V_Q$  must be safely below the transistor limiting collector-emitter voltage. The dissipation in the transistor will, in fact, be the real limitation and here we really need a crystal ball. Will the user apply a square wave input, so that the average dissipation is  $\frac{1}{2}V_Q I_P$ ; will he even apply a really low frequency square wave, so that averaged over 20 milliseconds the dissipation can be  $V_Q I_P$ ? A good many designers assume that all the user is going to amplify is music and they base their dissipation requirements on this assumption.

The maintenance of the supply at the point  $V_Q$  is, of course, very simple. The upper transistor acts as an emitter follower to keep its emitter just about at the voltage chosen for the base. The resistors  $R_1$  and  $R_2$  in Fig. 29 will fix, neglecting the  $V_{be}$  term, the collector voltage of the lower transistor. We may, of course, wish to make  $R_2$  a Zener diode.

With this design philosophy we are into the real power class. Shutting our eyes to the problem of dissipation we see that we might use two OC28s the one at 60 volts and the other at 80 volts, making a 140 volt supply in all and moving down conservatively to 120 volts and 5 amps we should have 300 watts output from a push-pull double pair. The indicated load impedance is 24 ohms. With a 15 ohm. load, 90 volts supply and 6 amps. peak current gives 270 watts nominal power. One interesting feature of this sort of design is that it carries us a step towards the a.c.-d.c. amplifier, the chief feature of which is the absence of any transformers at all.

A circuit which is actually in use is shown in Fig. 33. This is believed to originate from RCA and it has several features of interest. We have seen that the basic design conditions for the lower transistor are just those for a common emitter stage and here we see the use of 0.51 ohm emitter feedback resistances to give the negative feedback so useful in keeping the working point at a low quiescent current. The drive comes from a power transistor, RC-coupled to a phase-splitting transformer and there is negative feedback from the output to the emitter of this driver transistor to ensure that it really drives current into those bases at high frequencies.

A detail of this circuit which is of some interest is the way in which the base of each of the upper transistors is not decoupled to the "earthy" end of the pair. In drawing the loadline PQ in Figs. 29 and 32 we have used a straight line, although even the most cursory glance at the shape of a  $V_e, I_e$  characteristic shows that the resistance at the emitter is far from constant as the current is varied. The undecoupled term  $R_B$  will appear as an additional series resistance  $R_B(1-\alpha)$  and will do something to linearize the input characteristic and thus the loadline PQ. Lacking data on the transistors used we cannot say whether it will also affect the overall slope although the rating of the resistors suggests that it will not do so. Indeed, any action of this kind would be at the expense of power in the load.

With this examination of the cascode circuit we must conclude this present survey of the techniques available for the design of audio frequency power amplifier stages. Looking back to our struggles in the thirties with valve amplifiers we see that we have more problems in detail now than we had then, but we are probably better equipped to deal with them. The essential step, now as then, is to realise that the problems have been shown to be soluble and therefore require only skill, and information, for new solutions to be found.

# MANUFACTURERS' PRODUCTS

## NEW ELECTRONIC EQUIPMENT AND ACCESSORIES

### *Valve Voltmeter*

MEASUREMENTS of alternating and direct voltages up to 1,500V and resistance from  $0.2\Omega$  to  $1000M\Omega$  to within  $\pm 0.2\%$  of indicated value are possible with the GR Electronic Voltmeter Type 1806A. The frequency range extends to 1,500 Mc/s. Input impedance for d.v. measurement is  $100M\Omega$ , and that for a.v. is  $25M\Omega$  in

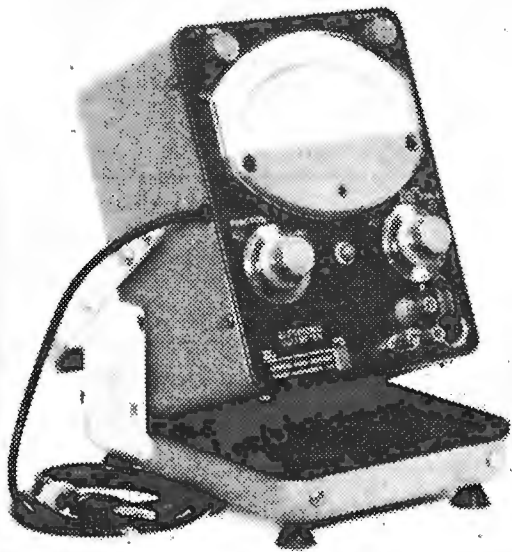

General Radio electronic voltmeter Type 1806A.

parallel with  $2pF$  on all ranges but the highest. Here, the impedance is  $15pF$  in parallel with  $25M\Omega$ . A compact probe is provided. The instrument is available for rack mounting or as a bench model. The GR agents in the U.K. are Claude Lyons Ltd., Valley Works, Hoddesdon, Herts.

For further information circle 760 on Service Card.

### *Transistor Power Unit*

DESIGNED primarily for the testing of transistor receivers, the Nombrex Type 61 power unit provides a regulated d.c. source continuously variable from 1 to 15V. Dependent on voltage setting the maximum power output varies from 50mW to 1.5W. The maximum ripple

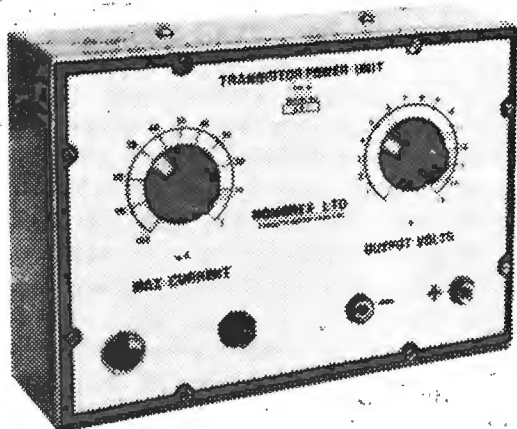

Nombrex transistor power supply Type 61.

current is 1 mA at full load. An automatic overload protection device protects both the circuit under test and the power supply itself. In operation, the voltage output is selected by one of two front panel variable controls, the other is adjusted to the maximum current requirement of the circuit under test. When the maximum indicated current is exceeded the voltage falls rapidly, limiting the current drawn by the circuit under test to a safe value. The power unit is manufactured by the Nombrex Instrument Division, Estuary House, Camperdown Terrace, Exmouth, Devon. Price £5 17s.

For further information circle 761 on Service Card.

### *Illuminated Magnifier*

INTENDED for inspection of printed circuit boards and small components, the Dazor Floating Magnifier has many other uses in the electronics industry. Basically the equipment consists of a head containing a 5in diameter, double convex lens and three 6W fluorescent lamps, a multi-joint arm allowing wide manoeuvring of

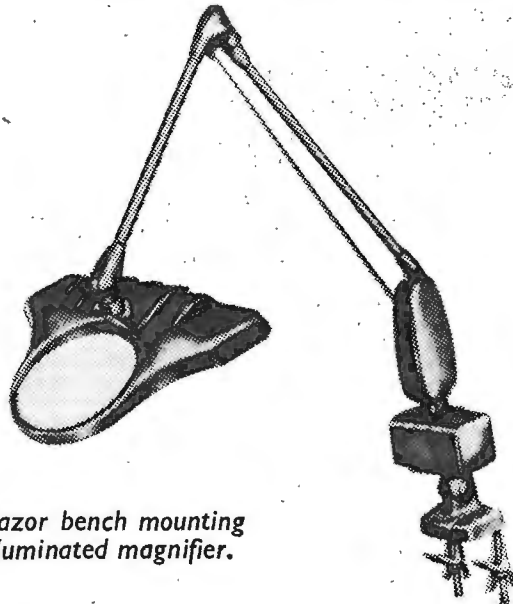

Dazor bench mounting illuminated magnifier.

the head and a base which, at the buyer's option, can be a clamp fitting or a heavy weight for desk use. The mechanics of the magnifier allow the head to be guided with one hand to the desired position where it will remain without locking. The units will operate from a 220-240V a.c. mains supply. The magnifiers can be obtained in the U.K. from Severn Lighting Limited, 51 Crawford Street, London, W.1. The basic price is £23. For further information circle 762 on Service Card.

### *Logarithmic Voltmeter*

PRIMARILY intended for the plotting of response curves the Houston Instrument Corporation Model HLVC-150 voltmeter covers the range 1mV to 316V. A 14in logarithmic scale is used, with a movable decibel scale adjacent to it, whose reference point can be adjusted over a  $\pm 75$  dB range. D.c. or a.c. (10c/s-50kc/s) inputs are provided, and the input impedance on all ranges is over  $11M\Omega$ . Only linear elements are used to obtain the logarithmic scale shape with, it is claimed, a corres-

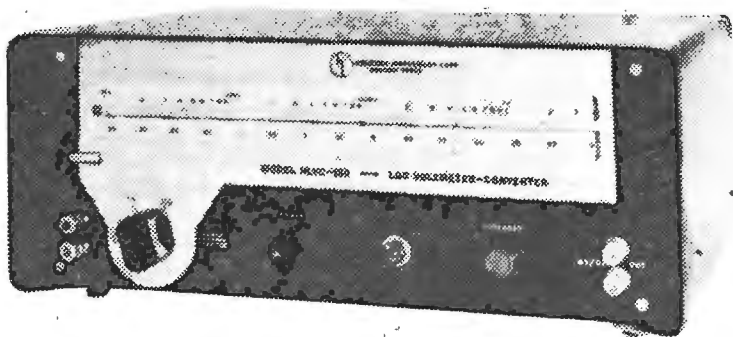

Houston logarithmic voltmeter. The pointer is servo-operated.

ponding increase in accuracy and frequency response over circuits using diodes and non-linear potentiometers. A 1mV output is available for recording purposes. The instruments are available from the British distributors, Scientific Furnishings Limited, Poynton, Cheshire. For further information circle 763 on Service Card.

### High-power Microwave Terminations

THE Morganite Resistor Company have produced a range of silicon carbide load resistors for use during testing and adjustment of high-power radar transmitters. Designated "Termilodes" by the manufacturers they are available in a range of waveguide sizes from WG10

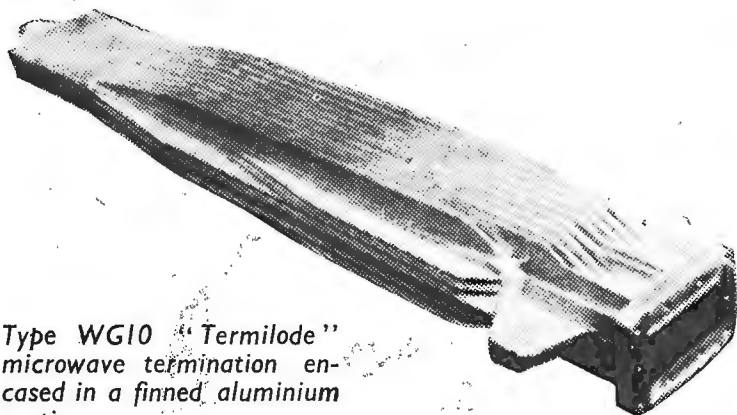

Type WG10 "Termilode" microwave termination encased in a finned aluminium casting.

to WG18. During the development of the Goonhilly Downs tracking station, a "Termilode" successfully absorbed the 4kW continuous output of the transmitter. For further information circle 764 on Service Card.

### Load Cell and Indicator Unit

THE high sensitivity of silicon strain gauges is exploited in the J. Langham Thompson semi-conductor load cell Type BCL2 and indicator unit. This equipment is battery-powered and portable. The compression load

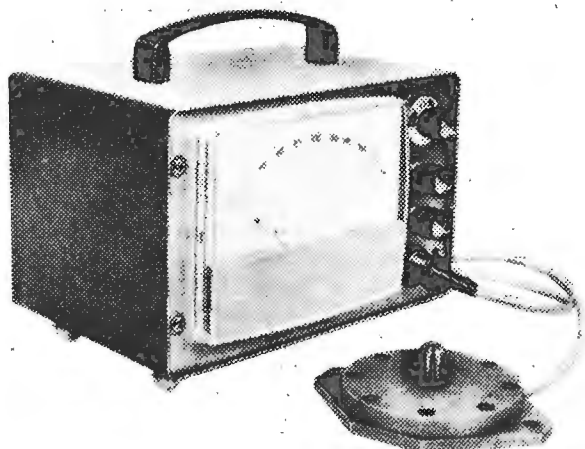

J. Langham Thompson semi-conductor load cell and indicator unit.

cell is a bonded strain gauge type with a diaphragm stress member. P-type silicon piezo-resistive gauges bonded to the diaphragm are connected as a 4-arm bridge to sense the strain induced by loading.

Included in the indicator unit is a calibration check circuit. Applications include weighing, monitoring the bearing-pressures in calender machines and measuring the force applied to a die during a drawing process. The equipment may be used over a temperature range of  $-20^{\circ}$  to  $60^{\circ}\text{C}$ . The load range extends to 500lb with an overall sensitivity of better than 1%.

For further information circle 765 on Service Card.

### Air-stable Arsenic

AMORPHOUS lumps of 99.9999% pure arsenic are now available from the Pure Elements Division of L. Light & Co. Ltd. Expensive handling techniques are avoided as this  $\beta$  form of arsenic is not affected by air even after several hours exposure. The lumps are easily broken by light percussion. At room temperature the surface remains untarnished after several weeks' exposure. This type of arsenic transforms to metallic form at  $280^{\circ}\text{C}$ . Since no ampoules are required this form is considerably cheaper than the metallic variety.

For further information circle 766 on Service Card.

### Transistor Single-sideband Equipment

LABGEAR Ltd., of Cambridge, announce that they are manufacturing a range of transistor single-sideband transmission and reception equipment. The first models in this new range are a 100W fixed station and a 100W mobile station. Both use identical "plug-in" receiver/exciter units, providing selectable sideband operation on four channels located anywhere in the range 2 to 15 Mc/s.

For further information circle 767 on Service Card.

### Radio Receiver Kit

ONE of the newest additions to the Heathkit/Daystrom catalogue is their Model RA-1 basic amateur bands receiver. Frequency coverage is provided for all the amateur bands from 160 to 10 metres, each band being calibrated on a separate scale. Tuning is facilitated by a two-speed drive. This permits fast coverage of a band but allows a small section to be tuned at a very slow rate.

Special features include a ready assembled and aligned r.f. and mixer section, a variable noise limiter circuit and provision for an external power supply for field use. An

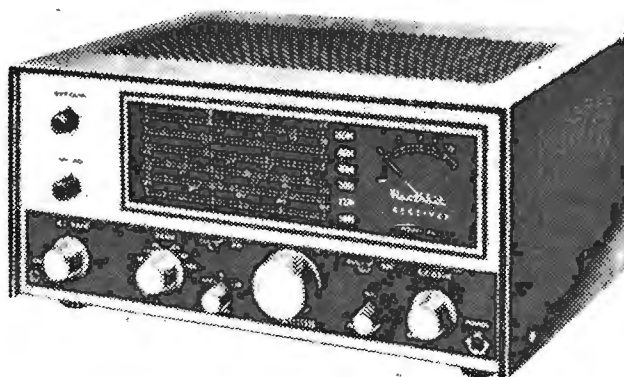

Heathkit basic amateur receiver Model RA-1.

optional crystal calibrator can be fitted. The intermediate frequency is 1,621 kc/s. Sensitivity is quoted at  $2\mu\text{V}$  for 10dB S/N ratio. The input impedance is  $75\Omega$  while the output impedances are  $3\Omega$  for speaker and  $600\Omega$  for phones. For an input signal of  $8\mu\text{V}$  the output is 2W.

For further information circle 768 on Service Card.



# UNBIASED



By "FREE GRID"

## A Prophecy Fulfilled

EVERYBODY has heard of Francis Bacon even if only because, according to some schools of thought, he spent a lot of time doing Shakespeare's homework for him. Nowadays, however, most people are inclined to think it was Marlowe rather than Bacon who "ghosted" for Shakespeare. If this be true Bacon had more time to do his own writing.

I have just been reading an extract from his "New Atlantis" written in 1624 and published in 1627, a year after his death, sent to me by the Editor. He tells me that he is indebted to the secretary of the Dartford Tape Recording Society (of which Miss Daphne Oram, a pioneer of "radiophonic" music, is president) for reminding him of it.

In this imaginative work Bacon envisaged a kind of research college (he called it Solomon's House) which was to have many chambers in which experiments were made to uncover the laws of Nature and to exploit them for the benefit of the community. The passage dealing with acoustics reads:—

"Wee have also Sound-houses, wher wee practise and demonstrate all Sounds, and their Generation. Wee have Harmonies which you have not, of Quarter-Sounds, and lesser Slides of Sounds. Diverse Instruments of Musick likewise to you unknowne, some sweeter then any you have; Together with Bells and Rings that are dainty and sweet. Wee represent Small Sounds as Great and Deepe; Likewise Great Sounds, Extenuate and Sharpe; Wee make diverse Tremblings and Warblings of Sounds, which in their Originall are Entire. Wee represent and imitate all Articulate Sounds and Letters, and the Voices and Notes of Beasts and Birds. Wee have certaine Helps, which sett to the Eare doe further the Hearing greatly. Wee have also diverse Strange and Artificiall Echo's, Reflecting the Voice many times, and as it were Tossing it: And some that give back the Voice Lowder then it came, some Shriller, and some Deeper; Yea some rendering the Voice, Differing in the Letters or Articulate Sound, from that they receyve. Wee have also meanes to convey Sounds in Trunks and Pipes, in strange Lines, and Distances."

Could there be a more colourful anticipation of the science of synthetic sound as it is now practised

with the aid of oscillators, amplifiers, filter networks and tape recorders. He even seems to anticipate hearing aids.

## Etymological Exactitude

THE Editor has asked me to step in where angels fear to tread by trying to get a little consistency in the names we give to certain pieces of apparatus and even in the way we spell them. This is a job which should rightly be assigned to a commission of learned men who could bring to bear on the matter vast resources of philological lore, and hear evidence from witnesses of extensive electrical and radio engineering experience.

The whole matter arose through a letter received from the managing director of a well-known firm who informed the Editor that he had written to the British Standards Institution drawing attention to the crying need for some sort of verbal reform in this matter. He pointed out to the Institution that among other things the term rotary converter seemed to be used indiscriminately for d.c.-d.c. and d.c.-a.c. types of machine, and that the B.S.I. itself, in one of its publications, used the word "invertor" although most people seemed to favour "inverter."

Let us first take the terminations "er" and "or." The "er" suffix is the English or Anglo-Saxon one, and I always resent the high-falutin efforts that are so common nowadays to alter it to one of Latin or Greek origin. The most irritating example of this is surely the spoliation of the good old word "harper," which is rendered as such in the magnificent English of the authorized version of the Bible (Rev. xiv, 2 and xviii, 22), but is nowadays debased into "harpist."

This "ist," of course, comes to us ultimately from Greek, and so is eminently suitable for words of purely Greek origin, such as psychiatrist. It is, however, a striking instance of our perverse etymological habits that we incorrectly use the English suffix "er" when we wish to describe somebody who is learned in philosophy, another word of purely Greek origin.

The Latin suffix "or" has even become falsely attached to those who man our ships, who in the days when they took Henry V and his army across the channel to Agincourt were known as "sailers," but later became called by the hotch-potch name of sailors. When we come to conver-

tors, invertors and suchlike, however, it will be seen that as they are derived from the Latin verb *vertere*, meaning to turn or to change, the Latin "or" termination is obviously the correct one.

With regard to what word to employ to describe an a.c.-d.c. machine we might use the Latin-derived "vertor," and change to the Greek "tropitron" for a d.c.-a.c. one. We could also be guided by the progenitors of the decimal system and use a Greek prefix to indicate a machine in which the output voltage was greater than the input one and a Latin prefix for the reverse condition. These rough suggestions are, of course, only made to be sat upon\* by the learned commission which will, I sincerely hope, eventually be appointed.

[\* "Pondered at length," not "quashed," we hope!—ED.]

## Psicymatics

I MUST take this earliest opportunity of publicly apologizing to "Cathode Ray" for misrepresenting what he said when I wrote in the April issue under the heading of Agnoia Waves. What he says about it ("Letters," May issue) has made me feel like a nervous curate who has, in his sermon, mistakenly attributed heretical views to his vicar.

As for my age which "C. R." calls into account, my only comment is to recall the fact that when a small child I once attended a church in which during the prayer for the Royal family, following that for "our sovereign Lady Queen Victoria," the rector included the words "Adelaide the Queen Dowager."

"Cathode Ray's" reminder in his letter that in November 1958, he said that "electrons were waves of what nobody knows," gives me the opportunity to accept his implied invitation to suggest a tidying-up in our nomenclature.

Everybody knows that nowadays we have not only electrical engineers but also electronics engineers in our midst. It has often struck me that the latter term has a rather unsatisfactory sound about it and that it is not yet in line with the dignity with which the term electrical engineer has invested itself.

What we need is a dignified designation for a highly-skilled electronics engineer such as "Cathode Ray" himself. Let us see if we can find a title which carries the same status as, for instance, the word physicist. Surely after what "Cathode Ray" has said, the ideal word is psicymatist. The derivation is simple and sound. We know that electrons are  $\psi$  waves, or in other words psi-waves. Now the word "electron" only means an agency or thing by means of which shining or glittering is brought about. It was used by the ancient Greeks to denote other glit-

tering things apart from amber. Homer in particular used the word in the Odyssey to describe an alloy of gold and silver.

Obviously we want a name which specifically means only that sort of electrons with which we deal. What better word could there be than psycymata which simply means psi-waves. This would allow us to use the word psycymatist as already suggested. It would sound fully as dignified as physicist. But the word "psycimics" as the equivalent, in its own sphere as "physics" would have to be "psycimatics" unless we are to bring down on our heads the wrath of the etymologists.

We could also have psycymatician to describe the "other ranks" who also earn their living by means of psycimatics. We could even speak of a psycymatic engineer instead of a psycymatist but please not psycymatronic engineer or psycymatronics.

### Cable Complex

HAVE you noticed the growing tendency of people to use the word "cablegram," or its recognized abbreviation "cable" when referring to a message received from, or sent to, a ship in midocean?

It seems such an obvious and foolish misnomer, and is on a par with speaking of a car radiator as a boiler, whereas its normal function is exactly the opposite. There is, perhaps, some slight excuse for the latter misnomer, inasmuch as a radiator in a furred-up condition does occasionally act as a boiler when the car is ascending a steep hill. In the case of a ship, however, the word "cable" is absurdly wrong at all times—except, of course, for the anchor rope or chain.

A correspondent who has written to me about the matter reminds me of the fierce competition between wire and wireless in the early days of the latter, when, of course, it would certainly have been a feather in the cap of the advertisement manager of any one of the cable companies if he could have got the word "cablegram" or "cable" used on ship-board.

The correct word to use nowadays for all telegraph communication is "telegram" because in the case of a long distance message it may be routed partly by cable and partly by wireless. Unfortunately "telegram" is rather a long word, and I don't much fancy the naval word "signal"; the abbreviation "gram" suggests itself because it does mean a message. But, whatever is done, let us get rid of the word "cable" for marine messages. It only tends to confuse the simple minded who may imagine that a ship trails a telegraphic cable after her, or picks up an undersea cable with a grappling iron and taps into it in order to send "cables."

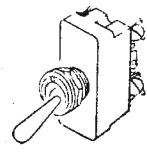
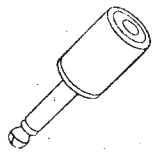
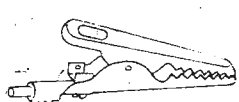
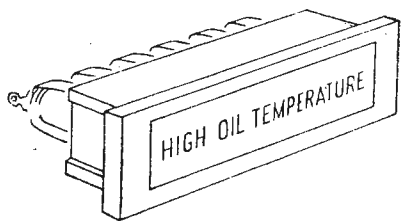

# COMPONENTS

# AT THE

# R.E.C.M.F.

# EXHIBITION

# STAND 304

OLYMPIA, MAY 21-24

To Buyers, Technicians, Engineers and Designers looking for advanced, high quality Electrical and Electronic Components we extend a cordial invitation to visit us at this exhibition. Our Technical Staff will be in attendance and many new and unique component designs displayed, together with a wide selection from our range of

OVER 10,000 VARIETIES

Send now for our new comprehensive catalogue which provides illustrations and full technical details of our entire range. Now available at price 2/6 post free or FREE to Trade Letterhead or Order.

Quote Ref. 203/C.

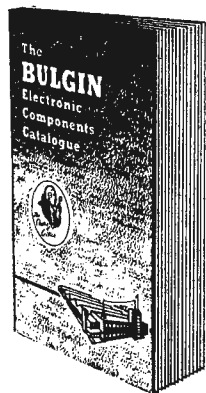

**A. F. BULGIN & CO. LTD., BYE-PASS ROAD, BARKING, ESSEX. TELEPHONE: RIPpleway 5588**

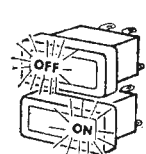
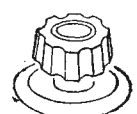
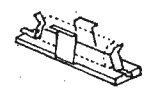
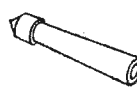
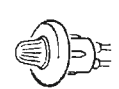
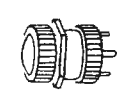
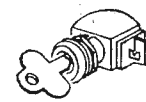
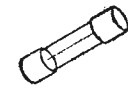
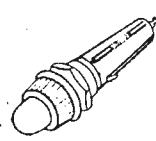
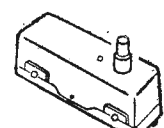
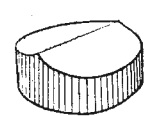
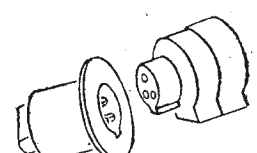
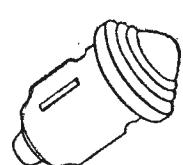
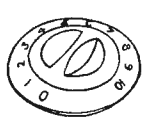
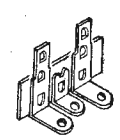
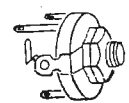
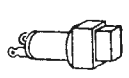
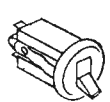
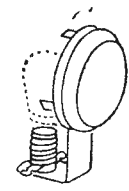
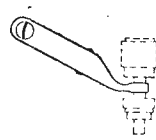
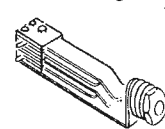

# TELEVISED CARRIER LANDINGS

Sequence of photographs taken from a television monitor/recorder showing a jet aircraft making a deck landing as recorded by the Ampex/Marconi Pilot Landing Aid Television (PLAT).

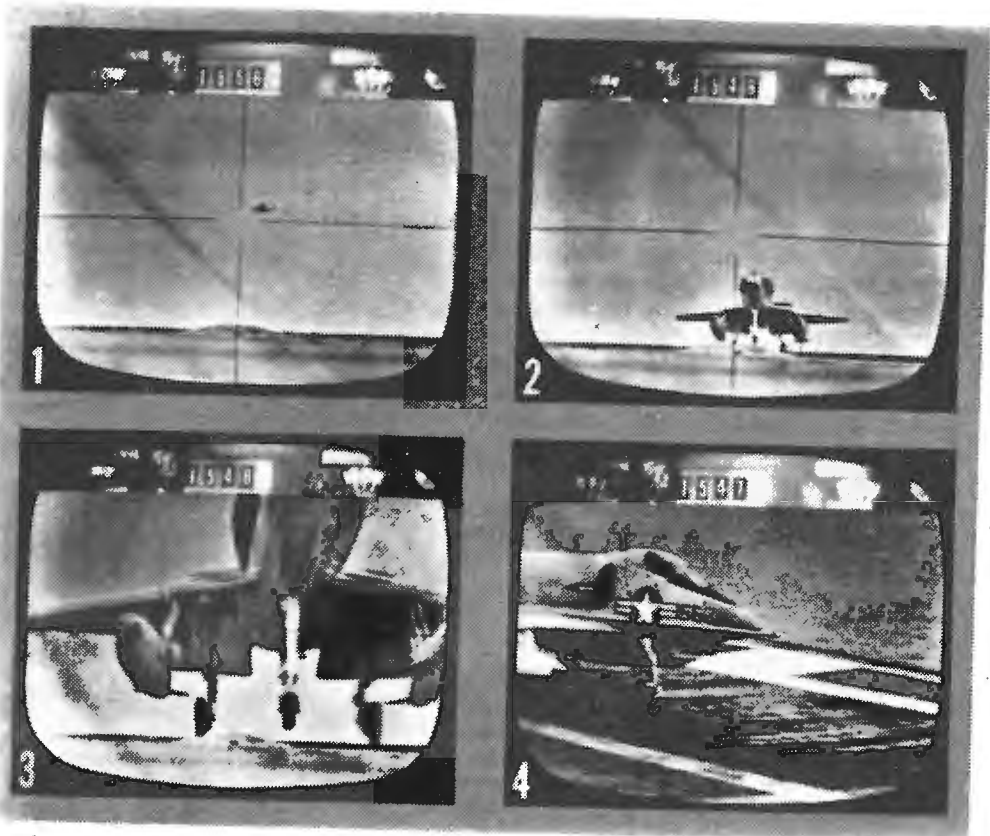

A MULTICHANNEL television monitoring/recording system, called Pilot Landing Aid Television (PLAT), has been designed to improve the proficiency of both pilots and landing control personnel concerned in carrier landings. After each operation is completed, pilots and landing control personnel can watch every detail of the complete landing within a matter of minutes after touchdown, enabling any errors of procedure or judgment to be assessed while the events are still fresh in their minds.

Four Marconi television cameras are used in the PLAT system. Two 4½ in image orthicon cameras are buried in modified lighting wells near to the touchdown point in the angled flight deck, with mirrors to align the optical axis of the camera with correct aircraft approach path. Both of these are remote controlled and they have crossed hairlines in the camera optical systems to help define the correct line of approach. A third camera, a manually controlled 4½ in image orthicon with a zoom lens, is sited on the island bridge, some 40 feet above the flight deck, and is used to follow the

aircraft throughout the landing run and then to establish which of the four arrestor wires was picked up by the aircraft. It can also be used to follow-through an overshoot. The fourth camera, a miniature vidicon, is permanently focused on a data display board in the control room to record the date, time, wind velocity, aircraft approach speed, etc. The picture from this camera is combined with any one of the other three cameras in a simultaneous display, and the composite picture is recorded on an Ampex Videotape recorder. Conversation between the pilot and landing operation personnel is recorded simultaneously on one of two audio channels on the same tape. The second audio channel is kept as a "cue" track for additional commentary.

This system was first demonstrated in 1960, on board the U.S.S. *Ranger* using Ampex/Marconi equipment, and is now to be fitted to ten American aircraft carriers by the Ampex Corporation who are the sole distributors of Marconi television and sound broadcasting equipment in the United States.

## Microminiature Integrator

THIS integrator, forming part of a rocket guidance system, has been developed and produced for the Space Department of the Royal Aircraft Establishment by Mullard Limited. It contains some 3,438 components of which 1,221 are semiconductors, and is the first fully

engineered item of microminiature equipment to be produced in this country.

There are 164 micro-circuits in the integrator and each micro-circuit is carried on a thin glass substrate measuring 1.18 × 0.78 × 0.039 in. The passive elements of the micro-circuits—resistors, capacitors and interconnections—are formed by vacuum deposition of thin metals and dielectrics on to the glass substrates. Common materials in this process are copper, nickel, gold, nichrome and silicon monoxide. The active elements—transistors and diodes—are then soft soldered to the deposited film on the glass substrate to complete the process.

The micro-circuits are stacked, and encapsulated, in four hermetically sealed blocks. Interconnections are made using standard wiring techniques and external connections are made via glass-sealed pins.

Dimensions of this small unit are a mere 3.8 × 2.6 × 1.8 in and it weighs a little over 1½ lb. An electrically similar unit using conventional printed wiring techniques would be about 100 times larger and considerably heavier.

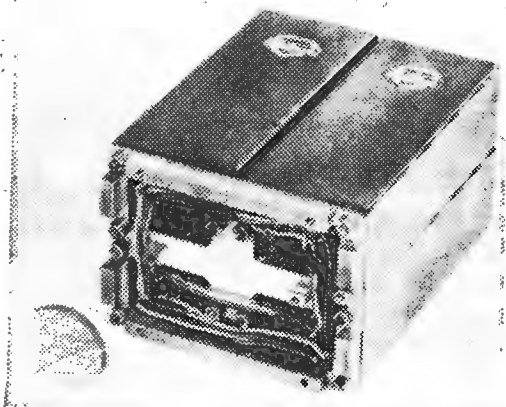

A threepenny piece is included in this picture of the Mullard microminiature integrator for size comparison.