

Wireless World

DECEMBER 1952

VOL. LVIII. No. 12

A Queer Committee

LAST month, in reporting that the Television Advisory Committee was to be reconstituted to deal with the problems of v.h.f. sound broadcasting as well as vision, we suggested this body might well take on much greater importance than hitherto. Progress on medium frequencies is at an end; the future lies within the bands above 30 Mc/s, and, that being so, the T.A.C. will ultimately assume responsibility for advising the Postmaster-General on the technical and organizational development of *all* broadcasting.

Since then, the facts about the new T.A.C. have been announced by the Postmaster-General. The terms of reference are wide, but pretty much as expected: "To advise the P.M.G. on the development of television and sound broadcasting at frequencies above 30 Mc/s and related matters, including competitive television services and television for public showing."

The Chairman of the new Committee is Admiral Sir Charles Daniel, and there are nine members. With seven of them we are not especially concerned, except to say that most of them will probably have to lean heavily on their technical advisers—surely not an ideal state of affairs. They are Sir Edward Herbert, the Hon. Charles McLaren and E. M. Fraser, all with wide experience in industry; Sir Ian Jacob, Director-General of the B.B.C., and an as-yet-unnamed senior official from the Treasury, the Ministry of Supply and the Post Office. It is with the remaining two members, G. Darnley Smith and C. O. Stanley, of the Radio Industry Council, that we are here mainly concerned. We will consider first the suitability of Mr. Stanley.

One of the first things the T.A.C. has to advise upon are the characteristics of the proposed v.h.f. sound service, which must include the system of modulation. Mr. Stanley and members of his firm (Pye, Ltd.) have for years expressed strong and uncompromising opinions in favour of amplitude modulation. These opinions, though they conflict with those of the majority, may possibly be right; at any rate, *Wireless World* has given much space to the airing of them. But that is not the point; Mr. Stanley is on record as having pre-judged an important issue on which the T.A.C. has to make up

its mind. And more, he is one of the moving spirits of the Associated Broadcasting Development Company, a firm recently formed in the hopes of being able to set up, among other things, a television service in competition with the B.B.C. Is Mr. Stanley, then, to take part in advising the P.M.G. on the highly controversial issue of the conditions under which his own company should be licensed?

And so with Mr. Darnley Smith, chairman of the Radio Industry Council, who is managing director of Cinema Television. Though this firm does not operate cinemas which might seek licences from the P.M.G., it is part of the J. Arthur Rank organization and has, in fact, already developed big-screen projection television apparatus to a high state of excellence. Mr. Darnley Smith has an obvious—and at present unique—interest in this field.

Wireless World has studied the composition of advisory committees in general, and can find nothing approaching a precedent for the state of affairs to which we are now drawing attention. Industrial or commercial interests are not necessarily a barrier to membership; on the contrary, they are sometimes a qualification for it. But the positions of Mr. Darnley Smith and Mr. Stanley, as heads of firms with unique specialist interests, are quite exceptional, and service on the T.A.C. would subject them to criticism that they should not be asked to bear. Their position is made still more difficult by the fact that, although the P.M.G.'s statement implies that they represent the Radio Industry Council, we are given to understand that they serve in their personal capacities.

Wireless World does not question the integrity, altruism or capabilities of Mr. Darnley Smith and Mr. Stanley. Indeed, we cannot think of any better representatives for the industry on an advisory committee dealing with almost any other subjects. But we feel they have both been shanghaied into T.A.C. at short notice and without mature consideration, and should be allowed to resign with honour. Harm has already been done to broadcasting by throwing it into the party-political arena. More harm may be done if dissensions within the industry are provoked by the Government's choice of unsuitable industrial representation on the T.A.C.

Deflector Coil Construction

Method Using Simple Jigs

By W. T. COCKING, M.I.E.E.

IN the course of experimental work, the writer has had occasion to make quite a number of deflector-coil assemblies and has tried a good many different ways of doing it. Some of these proved more satisfactory than others and it is considered worth while to record the one which proved the best.

The basic method is to wind a flat slab coil and then bend it to the required final shape. A special winding former and bending jig are necessary and it is essential to keep these as simple as possible. Elaborate tools are justified only when large numbers of coils are to be made.

A complication is brought about by the fact that the line and frame coils are not alike. However, with a little care in design it is possible to use the same winding former for both. The jig can be made to do for both also by making a part of it adjustable.

The winding former consists of two pieces of sheet brass, spaced apart by a centre piece 2.1 mm thick and measuring 1 in by 1½ in. Its function is only to space the cheeks correctly and so the only important dimension is the thickness. The two cheeks measure 4½ in by 2½ in and can be of any convenient thickness; the thicker they are the better, since they will be stiffer.

The two cheeks and the spacer are bolted together and have a centre hole through which a spindle can be passed. Holes are drilled through both cheeks at suitable points and carry pins, over which the wire is wound. Four pins are inserted initially and the wire for the first section of the coil is run on, then four more pins are inserted and the next section is wound and so on.

By doing this, the sections can be kept close together for the sides of the finished coil but spaced apart for the ends. In the final bending process these ends are drawn together. Each section can be tied together during winding and it has been found advisable to make the winding depth of each section equal to the winding thickness. Tying the sections then holds them firmly whereas, if the depth and thickness differ greatly, it does not.

It is essential that the holes for the pins should be accurately positioned and very careful marking out and drilling are necessary. The best procedure is to true up the two cheeks with a file and to find the centre by drawing two diagonal scratch lines between the corners. Lightly centre punch their crossing, see (a) Fig. 1. Draw a scratch line BC parallel with the long edges through this centre A (b). From now on, all marking off is done with a pair of dividers from this horizontal line and the centre. Set the dividers for a radius of about 20 mm and with centre A describe arcs cutting BC at D and E, (c). With centres D and E and any convenient radius draw arcs intersecting at

F and G, (d). Draw a scratch line through F and G. If the setting out has been carefully done, this line will be at right angles to BC and will pass through A. It is labelled HI.

For clarity in the sketches, the setting-out lines are now ignored and we start now with the lines BC and HI intersecting at right angles at A, as shown in (e).

It is now necessary to mark out diagonal lines at 31° to the horizontal BC. To do this, describe arcs with centre A and radius 24 mm cutting HI at J and K. Describe arcs with centre A and radius 40 mm cutting BC at L and M. Then with centres J and K and radius 40 mm and with centres L and M and radius 24 mm describe arcs intersecting at N, O, P and Q. Draw scratch lines through NQ and OP. These should cross at the centre A. The construction is shown at (f) and the resulting diagonal line at (g).

Fig. 1. These drawings illustrate the marking out procedure for the cheeks of the winding former. The dimensions are given in the text.

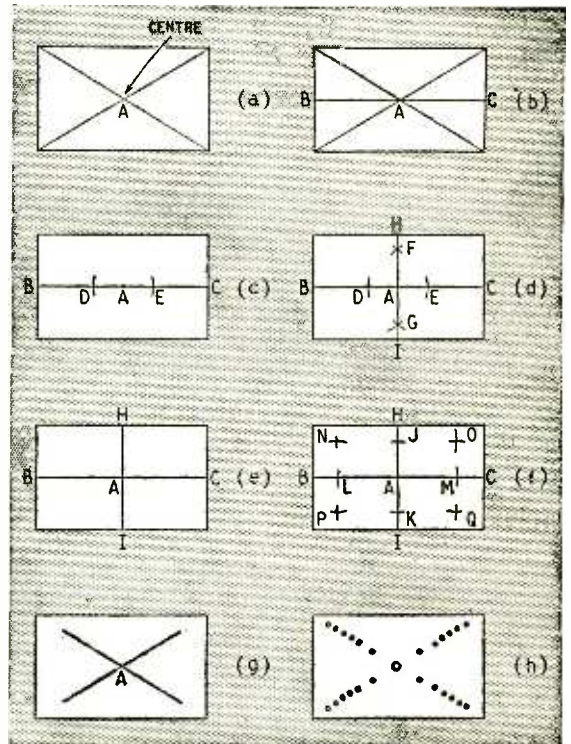

With centre A and radius 30 mm describe arcs cutting these lines, repeat with radii of 36, 42, 48 and 54 mm. This gives the positions of the 20 holes for pins. Describe similar arcs with a radius of 18 mm to give the positions of four holes for clamping the cheeks and core together. Carefully centre punch all 24 points and drill the centre and the four clamping holes 8 BA clearance. The clearance must be tight, not loose; the correct drill is a No. 42. Drill a centre hole through the second plate and clamp the two plates together with a centre screw and nut; then, using the first as a template, drill the second for the four clamping holes. Screw the two together with four 8 BA screws and nuts.

Then drill both plates together for the remaining 20 holes with a 5/64 in drill. Separate the plates and lightly countersink all holes to remove burrs. Drill a centre hole in the spacer and screw it to the original marked plate and drill the four clamping holes 8 BA. Clamp all three pieces together by the four screws and enlarge the centre hole to the correct size for the winding spindle, 2 BA is usually convenient.

Clamp the two plates together and put four saw-cuts down each long edge to just below a line joining the inner holes for the pins. These are to enable the coil to be tied up while in the former. Separate the plates and remove all burrs. The three parts now have the form of the sketch of Fig. 2. With a flat-faced punch, turn the corners of the edges of the saw-cuts outwards very slightly to prevent the wire from catching on them when winding. Only the corners which face the wire need to be turned. Carefully polish the inside faces of the plates.

The 20 pins required should be $\frac{1}{2}$ in long or more and are conveniently cut from steel knitting needles. Gauge 15 is suitable and is a loose fit in the holes. The pins must be quite smooth and the cut ends must be free from any burrs.

For winding, the former is best supported on a length of 2 BA rod in a hand-drill clamped in a vice or a lathe. A revolution counter is convenient but not essential. Before starting to wind, place lengths of sewing cotton about a foot long through each pair of saw-cuts so that they lie across the former parallel to the spindle. The ends can be twisted round the spindle, to keep them out of the way while winding, and held to the spindle by pieces of wire wrapped round. Insert four pins in the inner holes.

Fig. 3 shows the assembled former with the first four pins inserted and the eight lengths of cotton ready for winding. Now bring the wire into the former through a saw-cut and wind on the proper number of turns for the first section. Then free the ends of the cotton and tie up the section with a double knot on each cotton. Bring out the cotton ends again, insert four more pins in the next holes, and continue winding. Continue in this fashion, tying up each section when it is wound, until the coil is finished.

To remove the coil, take out the winding spindle and then pull out all pins. On the first diagonal they will be tight because of the tension of the wire, hence the need for smooth pins if the enamel of the wire is not to be damaged. The other three corners will be quite free, however. Then unscrew the four nuts holding the former together and remove one cheek. The coil then has the appearance shown in Fig. 4 and can be lifted off.

Usually, the wire gauge must be changed at intervals during winding. The join must always come at one of the short sides of the coil which will form the bent-up

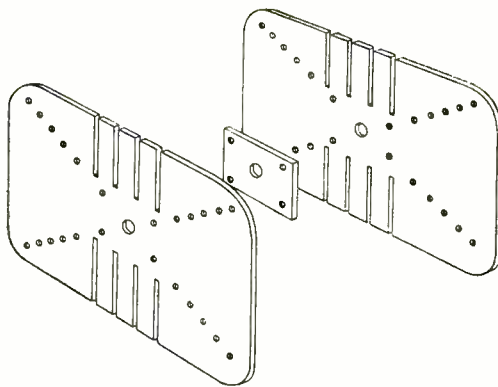

Fig. 2. This sketch shows the three parts of the winding former.

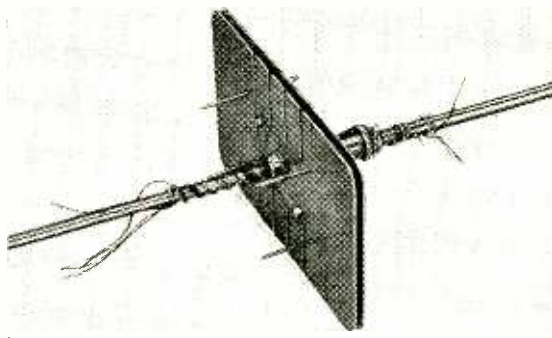

Fig. 3. The winding former is shown here assembled and with four pins inserted ready for winding. The eight lengths of cotton for tying up the coil are also in place with the ends wrapped round the spindle and held to it by a turn or two of wire.

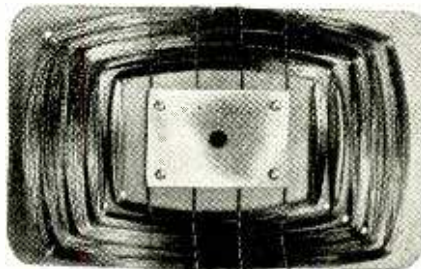

Fig. 4. The coil with one cheek of the former removed is shown here.

ends of the finished coil. Cut the wire so that the end will lie down in the former just beyond the middle and scrape the enamel off for half an inch. Similarly, bare the end of the new wire and slip an inch length of thin sleeving over it. Tin the ends of both wires, twist them together and solder. Slip the sleeving over the junction and continue winding. Where there are two junctions in a coil arrange for one to come at one end and the other at the other end of the former.

Four coils are needed for the assembly and they are

all wound in exactly the same way. They form two pairs for the line and frame deflection and the two coils of each pair must always be identical. The two pairs, however, are not necessarily the same in turns or wire gauge. Details are given in Table 1.

When they are wound, the coils must be bent to the proper shape and a simple jig is needed for this. A second jig is needed for making the former and for assembling the four coils.

Former

For making the former and for the final assembly of the coils a wooden cylinder is needed. This must be of hard wood and must be precisely 35.5 mm diameter with a smooth, if not polished, surface. It should be about 12 in long and one end should be turned off square.

Clamp one end in a vice and wrap around it a single turn of thin paper overlapping about one-half inch. Fix it in place with a couple of rubber rings—one at each end. The paper should be quite thin; the kind used for making carbon copies in typewriting is suitable.

Then wind on over the paper an overlapping layer of 1-in gummed paper of the sort used for packing parcels. The paper should be wound with its gummed side *outwards* and the overlap should be about $\frac{1}{4}$ inch. A length of 3 inches or so along the former should be wound in this way.

Then wind a second layer with the gummed side *inwards* starting at the opposite end to the first so that the turns all cross those of the first at an angle.

While winding, make sure that the gummed side of the paper is thoroughly wet so that it sticks properly.

Put the former on one side to dry for at least 24 hours. Then pull it off the cylinder with the paper lining and carefully remove the latter if it has stuck to it anywhere. Owing to the shrinkage of the paper while drying it will be a tight fit but no difficulty should be experienced in working it off.

Now slip the former over the wooden cylinder

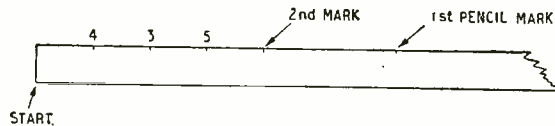

Fig. 5. Illustrating the method of dividing a cylinder into segments by a strip of paper.

TABLE 1

Section	10 mH		20 mH		30 mH	
	Turns	Wire S.W.G.	Turns	Wire S.W.G.	Turns	Wire S.W.G.
1.	50	32	71	34	89	36
2.	27½	32	38½	34	48½	36
3.	19	30	27	32	31	32
4.	42	30	60	32	70	32
5.	12½	30	17½	32	20½	32
	20	28	29	30	30	30
	29	28	41	30	42	30
Total	200		284		331	

All wire enamel insulation.

without any lining. It should be a loose fit. Leave one end projecting over the squared-off end of the cylinder and with a razor blade cut off the end of the former square against the cylinder. Do the same thing with the other end of the former so that the result is a very thin-walled paper tube 2 inches long with square cut ends.

Now again wrap a turn of thin paper over the wooden cylinder, this time with one end projecting beyond the end of the cylinder. Now work the former back on to the cylinder. It should be a really tight fit but, because the paper overlaps the end and it can be got inside the former, it can be got on quite easily. Work it on so that there is plenty of the cylinder on each side of it. Give the former three coats of shellac varnish, letting it dry between each.

The shellac will stick the paper to the former, but this does not matter. The thing to guard against is the paper sticking to the wooden cylinder for, if it does, it will be impossible to remove the former. It will only stick if too much shellac is allowed to get on the paper so that it soaks through it. Therefore, the ends of the former should be only lightly shellacked and any surplus on the paper should be wiped off at once.

After each coat of shellac, and before it is really hard, check that the paper has not stuck by grasping the former and rotating it with the paper on the cylinder. This will free any slight tendency to stickiness.

Bending Jig

A cylinder of hard wood about 12 inches long is needed for the bending jig. It must be 37 mm diameter and finished smooth. It is necessary to draw four longitudinal lines along the surface, two on the opposite ends of a diameter and the other two inwards from them by 45°.

If no proper instruments are available, the easiest way of marking out is as follows:—

Draw one longitudinal line as a reference base. This is easily done by placing the cylinder on a flat surface and then placing a ruler with parallel edges against both the cylinder and the flat surface. Care must be taken to hold the ruler firmly in contact with both along its edges. A pencil can then be run along its edge.

Take a strip of paper and place one end precisely on the ruled line. Wrap it tightly round the cylinder and make a pencil mark on it precisely where it overlaps the start.

Remove the paper and, by measurement, divide the marked length into two equal parts. Mark this point (2nd mark), Fig. 5. Divide one of these halves into four equal parts by pencil marks at 3, 4 and 5.

Wrap the paper around the cylinder again, placing the starting end precisely on the reference line and mark off on the surface of the cylinder opposite the end the 2nd, 4th and 5th marks on the paper.

Shift the paper a couple of inches or so along the cylinder and repeat. Join the marks.

It is now necessary to describe three pencil rings around the cylinder precisely. These are best done in the lathe but, if this is not available, they can be done by measuring from the squared end of the cylinder. One ring should be near the middle of the cylinder and the other two precisely 29 and 39 mm from the first ring.

The intersections of the lines are now marked off

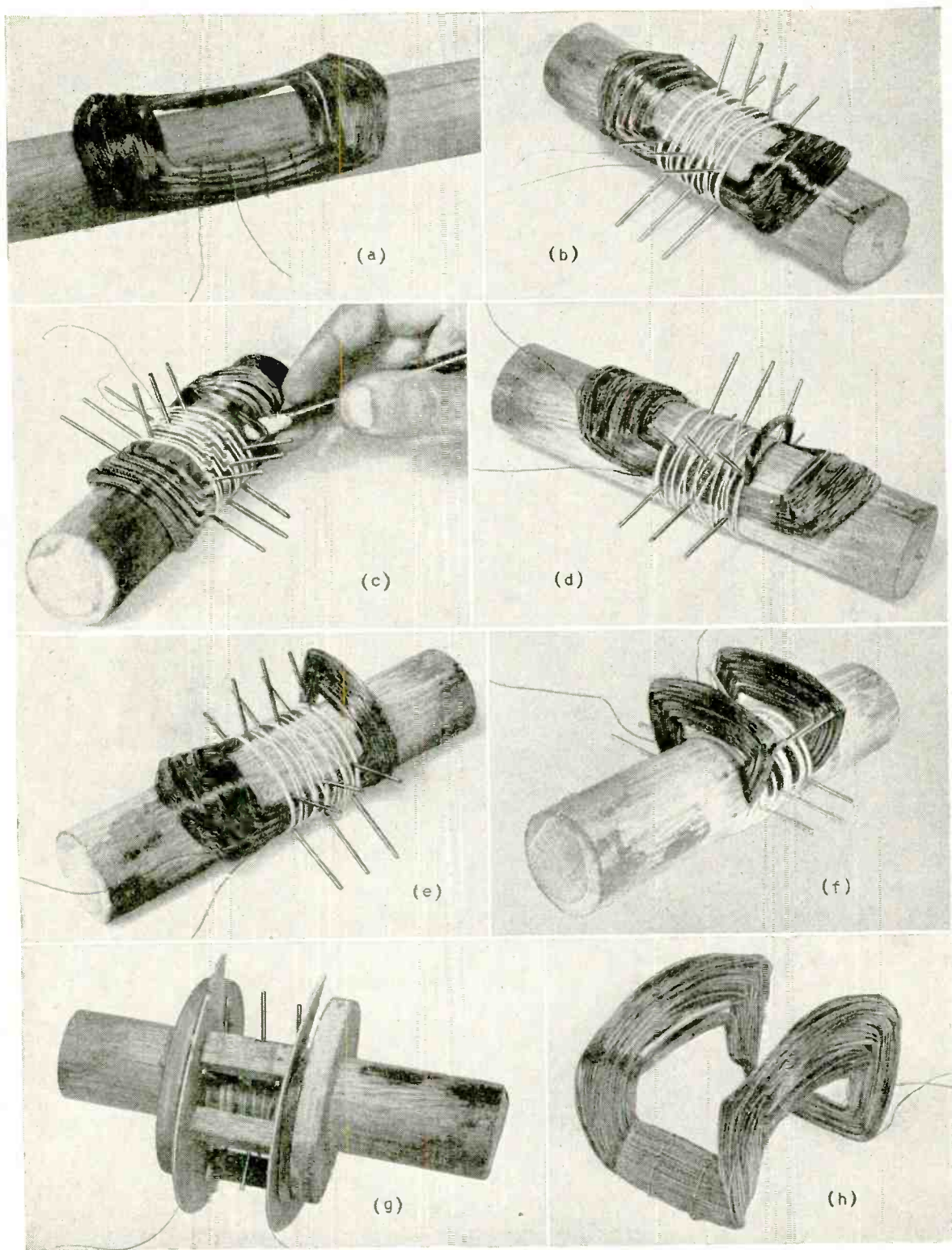

Fig. 6. A coil is shown at (a) with its initial simple bend around the cylinder, and a frame coil tied to the bending jig at (b). The start of the bending process is illustrated in (c) and the first section of a frame coil fully bent at (d). The coil with the whole of one end bent is shown at (e) and with both ends bent at (f). The bent coil with simple clamps for holding the ends flat while the shellac is drying appears in (g), while (h) shows one finished coil.

and drilled to take pins. The holes should be appreciably smaller than the pins so that the latter must be driven in with a hammer. As in the case of the winding former the pins can be cut from 15-gauge steel knitting needles. They should project about $\frac{1}{4}$ inch from the former and to be firm they should enter it as much.

All these 12 pins must be precisely located if the finished coil is to come out true and to size. Four more pins, one on each line, must be inserted mid-way between those spaced 29 mm but as long as they are on the longitudinal lines their precise position does not matter.

The same jig is used for both line and frame coils, but the full 16 pins are used for the line whereas only 12 are employed for the frame, all four pins on the 39-mm ring being removed.

Coil Bending

Clamp one end of the 35.5-mm cylinder, which still has the former on it, in the vice. Place a coil on it with its long sides parallel to the axis so that it rests on its short sides. By hand, press down the long sides to rest on the face. This bends the short sides of the coil. It will spring back a bit, but this does not matter. In fact, this bending need not be accurately done, but it helps in positioning the coil in the jig. The coil so bent is shown in Fig. 6(a) on the cylinder.

All four coils can be done one after the other and this is a good plan, for all four must be bent the same way. The "way round" of the coils can be seen by the positions of the start and finish of the winding.

Now take the jig and clamp one end in a vice. Remove the pins from one inner longitudinal line. Take a coil and place one side between the two rows of pins and bend the other side down to meet the outer row of the other two rows. Then replace the pins of the inner row; there are three or four pins according to whether the coil is being bent as a frame or as a line coil.

Take a length of thick linen thread, run a slip knot in one end and slip it over coil and jig at about the middle of the coil; pull it tight. This will pull down the long sides of the coil on to the face of the cylinder.

Before going further, check that the inner section of the coil is centred on the pins. For the line coils the inside length of the long sides is slightly greater than the pin spacing and for the frame coils it is appreciably greater; it is necessary to have the distance between the pins and the corners the same at all four corners. If the distances are unequal they must be made equal by sliding the sides along the cylinder. Check also that the outer sections of the coil have not slipped. They can do so, since they are only tied together along these long sides.

When satisfied, bind the coil to the cylinder along its length with the thread. The binding turns should be $\frac{1}{4}$ inch or so apart and it is best to proceed from the middle to one end. Then place two turns tightly together just outside the four end pins.

Continue binding backwards with an open binding on top of the first, right to the other end of the coil, where there should again be two tight turns outside the pins. Continue back towards the middle and finish off by tying the end to one of the middle pins. A frame coil so tied to the jig is shown in Fig. 6(b).

During the binding process, it is necessary to bed down the wire between the pins with the thumb. It is necessary to make the wires fill the whole space between the pins. If left to themselves they will tend

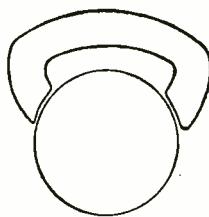

Fig. 7. The end turns after bending should take the form shown here. This is important for the frame coils, but less so for the line.

to bunch together towards the inner row of pins and this is especially the case towards the end of the coil. This tendency must be resisted and can easily be done by pressing the wires into place while binding.

The ends of the coil will spread longitudinally along the former, but this does not matter.

The bending can now be done. Take a smoothed surface tool, such as a blunt polished screwdriver or a similarly shaped piece of hard wood and slip it under the end turns of the first (inner) section of the coil at one end. Move it towards one end and lever upwards, as shown in Fig. 6(c), then to the other and lever. As soon as the wire is bent up enough to get hold of, use the fingers. The main bending must take place where the wires come out from the sides and here the wires should be bent sharply at right angles.

Shape the wire with the fingers so that both sides are alike and the wires bend away from the cylinder and the ends of the coil tend to the shape shown in Fig. 7.

Do the same thing with the second section, bending it up so that all its wires lie outside those of the first, and so on with all the others. The first section is the most difficult because the wires in it are the shortest. When one end is bent the coil should look like Fig. 6(e).

Then do the other end in exactly the same way. The coil will then be as in Fig. 6(f).

When satisfied with the bending, shellac the whole coil liberally, including the sides. Take two thin-card discs with holes to clear the cylinder and push them against the outer ends of the coils. Then put on two tightly-fitting wood blocks and push them home. These blocks should be a tight fit on the cylinder and quite solid.

Slip similar, but rather thicker and semi-circular, cards inside the ends. Three lengths of wood, one in the centre and one between each pair of pins can then be inserted to back up the cards, as in Fig. 6(g). The whole forms a simple clamp which squeezes the two ends simultaneously.

Leave for the shellac to dry. When the shellac is dry, but not hard, remove the wooden pieces and card. Unbind the coil, remove one inner row of pins and carefully remove the coil. It will stick to the cylinder slightly, but should come away quite easily with a little care, and appear as in Fig. 6(h).

The second line coil is made identical with the first.

The frame coils are bent in exactly the same way but using three pins (29-mm spacing between the outer ones) instead of four in each row. It is more important to get the coil initially centred than in the case of the line coils and it is very necessary to bend up the inner section so that the turns are normal to the face of the cylinder. Any cutting of corners must be avoided, otherwise the coils will not bed down properly over the line coils. All parts of the end *must* clear the cylinder by at least the coil thickness.

When all four coils have been removed, sleeve the leading-out wires and bring them all out on the turned-

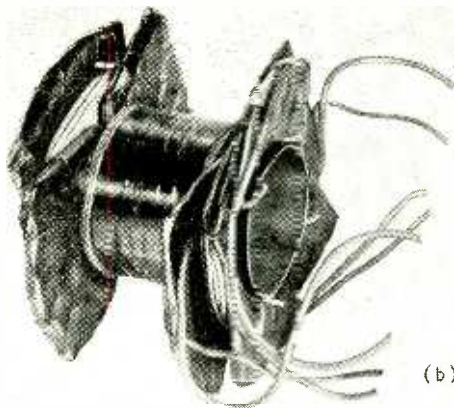
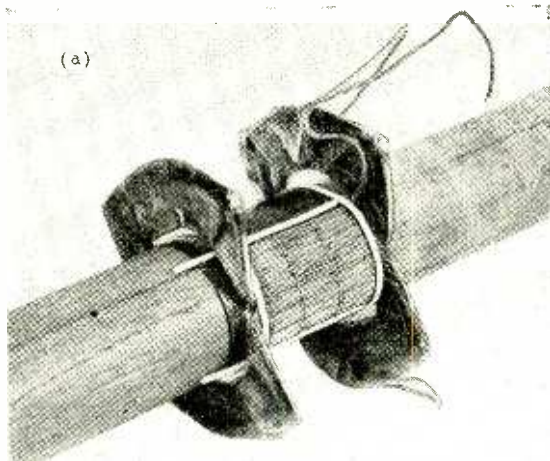

Fig. 8. A pair of line coils tied to the former is shown at (a). Note the lengths of p.v.c. string placed against the edges of the coils to insulate them from the frame coils. The assembly of four coils appears in (b) and the p.v.c. string wound between the ends of the line and frame coils can be seen at one end.

up ends, then tape the turned-up ends *only* with $\frac{1}{2}$ -in cellulose adhesive tape.

Assembly

The next step is to assemble the four coils. Mark four longitudinal lines on the 35.5-mm cylinder. The lines are to be 90° apart around the circumference and can be marked off by a strip of paper in the way previously described. These lines serve as guides in positioning the coils.

Place the former on the cylinder and then place the two line-scan coils on it, using rubber bands to hold them in place temporarily. Centre the coils longitudinally on the former and place them so that the adjacent edges of the two coils touch and coincide precisely with one pair of diagonally opposite lines on the cylinder. Place four lengths of p.v.c. string against the other edges then tie the coils tightly in this position by some four turns of linen thread at each end immediately adjacent to the turned-up ends. This is a permanent binding which is not removed, and the coils are now as shown in Fig. 8 (a).

Remove the rubber bands and tie the centre part down with a temporary open binding of thread. The two coils should now be quite firmly fixed to the former and yet not so rigidly that they cannot be moved slightly. Now position them very carefully so that the two sets of adjacent edges come very precisely over one pair of diagonally opposite lines on the wooden cylinder.

Now check the overall diameter of the assembly, not including the binding thread. It must not exceed 41.5 mm. If it does, apply methylated spirit to the longitudinal members of the coils to soften the shellac and then press the windings down with the thumb to spread the wire. No trouble will be experienced if the wires have been properly spread to fill the space in the bending jig. Any carelessness here, however, will result in the coil section being too thick at one part and too thin at another. Fortunately, quite a bit of correction is possible when assembling.

When satisfied, shellac the coils and former liberally and leave to set hard. When hard, remove the temporary open binding in the centre, leaving the close

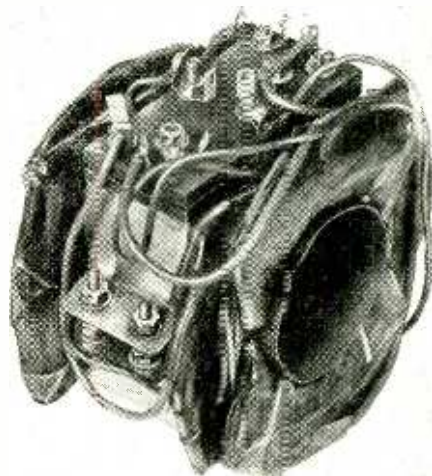

Fig. 9. The complete deflector-coil assembly with its iron yoke.

binding at the ends. Place two layers of cellulose adhesive tape around the coil and former, bedding it down around the steps at the coil edges. This, together with the length of p.v.c. string, provides the insulation between the line and frame coils.

Now assemble the pair of frame coils in exactly the same way, but lining up the adjacent edges on the diagonal at right angles to the one used for the line coils. This lining-up is important for the raster will only be rectangular if it is carried out accurately. After assembly, shellac the coils thoroughly and leave to dry. Then place two layers of cellulose adhesive tape over the coils.

The next step is to wind p.v.c. string between the turned-up ends of the line and frame coils at each end to provide insulation between them. Care must be taken to bed the string down well for the first turns and the winding need be carried only far enough to prevent any possibility of the line and frame coils

coming into contact. The assembly is shown in Fig. 8 (b). The iron yoke must now be fitted. This comprises a 1-in stack of M. and E. No. 134, 0.014-in, Silcor 3, laminations. These are semi-circular laminations and are conveniently held in a light metal frame of tin plate or brass. The internal diameter of the iron is 42 mm and it should fit around the coil assembly without any great pressure.

The final step is to finish off the coil leads on to a six-tag board which it is convenient to fit to the frame holding the iron yoke. In each pair of coils the adjacent edges, which in winding were the outsides of the coils, must be joined together and it is necessary to join them at one accessible tag, since it is desirable to connect to this point in some circuits. The complete assembly is shown in Fig. 9.

In order that the direction of winding may be continuous when adjacent edges are thus joined, one coil must be reversed in assembly. This is obtained automatically if all coils are wound and bent in the same way. If a mistake is made it cannot be corrected by reversing the leads, for this would bring high-potential points together and the insulation would be inadequate.

In each pair of coils if one starts at the inside of one and follows the wire round to the inside of the other one must proceed continuously in the same direction, so that the magnetic flux produced by one coil is additive to that produced by the other.

Tested in the manner described in "Deflector-Coil Characteristics," *Wireless World*, March, April and May, 1950, the LI^2 figure is 1.4 mH-A² for the line coils and 1.6 mH-A² for the frame with an R/L figure of 1.9 Ω /mH for line and 1.8 Ω /mH for frame. These are for a 53° tube at 5 kV.

Data on a number of coils constructed in this way are given in Tables 1 and 2. Table 1 contains winding data for coils of nominally 10, 20 and 30 mH inductance and Table 2 gives the measured figures. Line coils of all three inductances have been made but frame coils only of the 10-mH type. It is not considered practicable to wind frame coils by this method to a high-enough inductance to avoid the use of a transformer. The wire would be so thin that there would be a serious risk of a breakage in the bending process. It is convenient, therefore, to standardize on the 10-mH type for the frame and to choose the transformer ratio to suit the circuit.

For the line, the inductance needed depends very much on the circuit. 10 mH is again convenient in a heavily damped circuit with a transformer, and 30 mH is a suitable choice for an efficiency circuit without a transformer¹.

The efficiency figure of 1.4 mH-A² is directly comparable with one of 2.9 mH-A² for an earlier design² and represents a 100 per cent improvement in efficiency. It permits the final anode of the c.r. tube to be operated at 10 kV instead of 5 kV without increasing scan power.

Quite a number of coil assemblies have been made in the manner described. The construction has been found to be quite easy and no failures have resulted. The coils have been in use for nearly two years, and in this time only two breakdowns have occurred, and both were due to faulty construction. In one case, the connections to the line coils had been reversed in assembly so that the remote, instead of the adjacent,

TABLE 2

Coil	Inductance (mH)	Resistance (Ω)
10mH Line	10.9	21
10mH Frame	11.8	20.7
20mH Line	22	39
30mH Line	29.6	58.6

edges of the coils were joined together. This meant about 1,500 V peak between the adjacent edges. The surprising thing was that a breakdown did not occur at once, but only after some weeks of use. In the other case, a metal arm was soldered to the yoke frame of a complete assembly without removing it from the coils. The heating damaged the insulation and caused a breakdown.

Some individual assemblies of the 30-mH line-coil type have by now had about a year's normal use without any trouble at all. It is felt, therefore, that the design is a sound one and can be relied upon to give a reliable performance.

It should be pointed out that the grading of turns quoted in Table 1 represents a compromise between raster distortion and defocusing, and the results obtained depend also on the screen curvature of the tube. For any given type of tube there is a particular distribution of turns which gives a rectangular raster and another, usually different, distribution which gives an even focus over the raster. The flatter the face of the tube the greater is the difference between the two.

It is possible that, in the future, it may become necessary to design the deflector coils to meet the focus requirement and to correct the raster distortion by fitting small magnets around the face of the tube. This is hardly necessary yet and the turns distribution given represents an acceptable compromise between the two requirements. With tubes of the flatter type, such as the G.E.C. 6705A, there is very slight pin-cushion distortion and a very good focus over the screen. With tubes having a slightly more curved face, such as the Mullard MW 31-16, the focus in the corners is not quite so good, but the raster is nearer a perfect rectangle. The distribution can be regarded as a satisfactory one for most tubes of this general type.

As it stands, the design is not suitable for 70° tubes. These tubes have a slightly larger neck diameter and the coils must be shorter to avoid shadowing. The same principles of construction can be used, of course, but the dimensions of all formers and jigs would need alteration and the turns-distribution would be different. In addition the coils would have to be wound with thinner limbs to fit inside a standard iron ring.

It is unfortunate that deflector coil design must be largely empirical because it makes it rather a laborious process. Unless one is very lucky it is necessary to make at least three or four assemblies before one arrives at a satisfactory arrangement. The writer feels that he should give this warning to those who otherwise might rather light-heartedly set about a re-design for a 70° tube.

¹ "Simple Line-Scan Circuit," by W. T. Cocking, *Wireless World*, August 1952, pp. 305.

² "Television Receiver Construction," Parts 2 and 3, *Wireless World*, February and March 1947, pp. 40 and 103.

"All-Dry" Signal Tracer

*Battery-operated Instrument for
Fault Finding in Receivers*

By E. J. FAULKNER

SIGNAL tracing as a method of fault finding in radio receivers appears to have been completely ignored in this country. There is practically no mention of it in any of our technical journals, nor in any of the various guides to radio servicing by British authors. It is fairly certain, however, that many servicing technicians in this country do use the technique in one form or another.

The procedure with signal tracing is the reverse of the normal servicing procedure adopted in this country. Our usual technique with the "dead" set is to work backwards from the output to the input, eliminating step by step the loudspeaker, a.f. section etc., to the first r.f. stage. The signal tracing method is to work forward from the input by injecting a suitable signal through successive stages to the output. The position of the fault is then indicated when the signal is lost.

The procedure recommended in American textbooks is to use a signal generator to inject the signal and a valve voltmeter as the signal tracer. When signal tracing is used by British servicing technicians on broadcast receivers, however, the usual practice is to make use of the broadcast signal and trace it through the set by means of a signal tracer. Essentially a signal tracer is nothing more than a suitably sensitive detector followed by one or two stages of a.f. amplifica-

tion, with provision made for direct a.f. pick up to trace the a.f. signal past the receiver's detector stage.

Naturally there are advantages and disadvantages in both methods, but with the increasing use of new ranges of valves without grid top caps the author is beginning to find a signal tracer almost indispensable in servicing. Moreover, the particular signal tracer described here is proving itself most valuable when dealing with the compactly built radio chassis so prevalent to-day.

By using a germanium crystal and 1.4-V B7G-type valves, it was possible to dispense with the mains as a source of power. For the case an old instrument box was used, measuring overall $9\frac{1}{2}$ in \times $6\frac{1}{2}$ in \times $7\frac{1}{2}$ in. The chassis fitted into the lid, which was 2 in deep, and the "all-dry" battery (B103 type) went into the main compartment. There was just room for the valves to fit in alongside the battery with the lid closed. The loudspeaker used was the normal workshop test speaker, and was clipped on to the contacts brought out from the secondary of the midget output transformer. The screened cable was ordinary 50-ohm television coaxial cable. The r.f. probe was made up in the cylindrical can of an old electrolytic capacitor, while the a.f. probe was fashioned out of a disused fountain pen. The valves used were Mullard types DAF91, DAF91 and DL94. An attempt was made to

Circuit diagram of the signal tracer including the two probes.

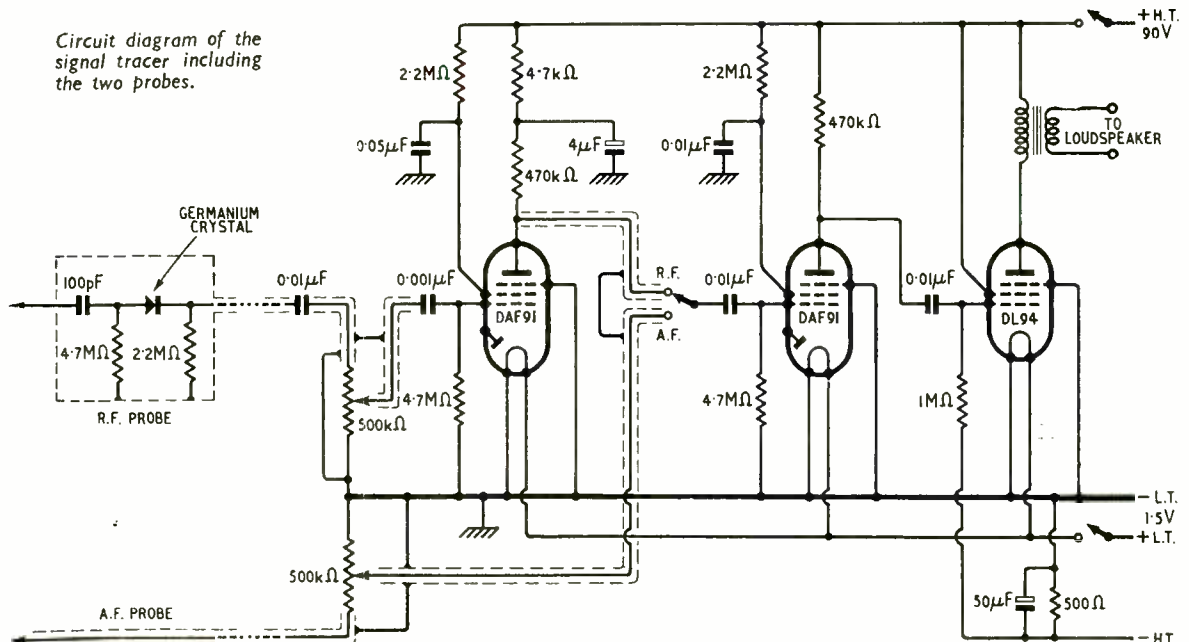

use a DAF91 for the r.f. probe (with the diode section in place of the germanium crystal) but this did not prove at all successful.

The author has found this signal tracer to be adequately stable and free from that plague of all such instruments—hum. Since bringing it into use there have been many examples in both sound and television receivers where it has solved some nasty headaches in a surprisingly short time. It has been particularly

useful, for instance, with faults such as intermittent noise (due, in one case, to a paper capacitor just breaking down), and also in finding out where distortion was originating.

One great advantage in having the instrument battery-operated is when it is used for testing a.c./d.c. sets. There is no need to go through the tiresome procedure of electrical isolation which is such a bugbear with this type of receiver.

ETCHED CIRCUITS

IN November, 1946, we published a brief note on a new system of printed circuitry which consisted of printing the pattern required with a special ink on a metallized film applied to an insulating base of Bakelite, and then removing the unwanted metal by an etching process.

Since then progress has been made and the process, now known as the Technograph System, has reached a stage where the production of complete radio apparatus, sub-assemblies and components is a practical proposition.

The latest system includes a recovery process for the metal removed in the etching bath, as this would otherwise involve a considerable wastage of valuable material and of the chemicals used for etching.

Where simple circuit patterns not involving crossovers are required the patterns can be printed on a single metallized foil bonded to one surface of the insulating base, but where crossovers are inevitable a metal-insulator-metal sandwich must be used. In this case both surfaces of the insulating plate, or sheet, can be metallized and the circuit completed by punching holes and inserting rivets at the appropriate points.

The Technograph system enables circuit patterns to be printed on foil bonded to flexible insulants which can be produced in the form of a long strip or roll some hundreds of feet long, which may be cut and folded to build up the particular unit required.

One application of this kind, unusual though it may seem, is the production of mains transformers. A section of a printed strip before and after partial folding is shown in the accompanying illustration. In the latter the centres of the "plates" have been punched out to form the core tunnel.

It is easy by this method of construction to grade the thickness of the "wire" to give thicker conductors on the inside and thinner on the outside, where heat radiation is greatest, to achieve a more even temperature gradient throughout the winding than is possible with normal wire winding methods.

This process is now being extended to armature windings on electric motors.

The company handling the system is Technograph Printed Circuits Ltd., 32, Shaftesbury Avenue, London, W.1, who have just issued a booklet describing the system.

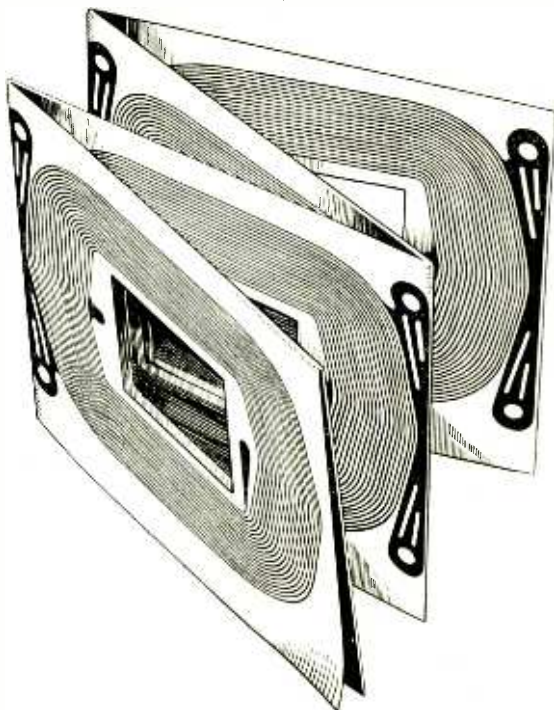
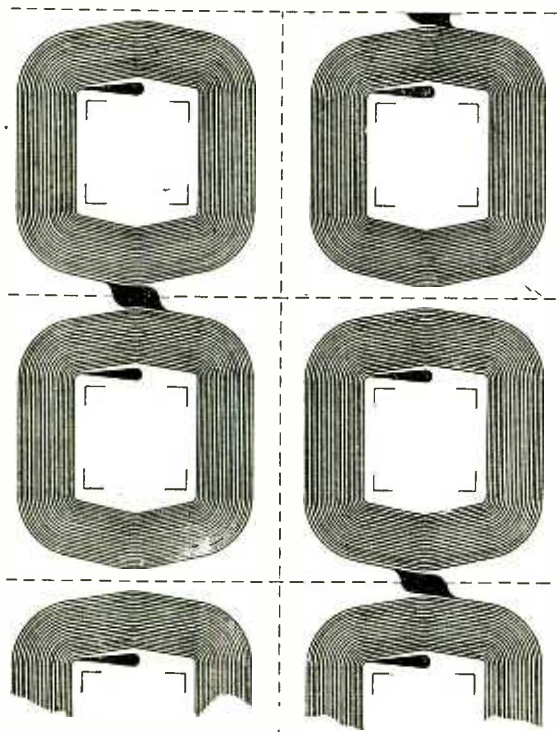

Details of Mains Transformer "winding" produced by the Technograph process.

Radio-Controlled Jet Plane

Proportional Control on

Four Channels

JET propulsion has been used in model aircraft for a good many years now, but jet propulsion plus radio control is something of a novelty. An example of this exciting combination was to be seen recently at the "Model Engineer" Exhibition in London, in the shape of a radio-controlled, rocket-propelled delta-wing aircraft. It was shown by the Low Speed Aerodynamics Research Association, who will eventually be using it for research into the aerodynamics of full-scale delta-wing aircraft. The model on view was actually a mock-up, with the fuselage cut away to show the positions of the rockets and radio equipment, but the real thing, now in the process of construction, is identical. It has a wing span of 64in and weighs about 10lb. Motive power is provided by two ducted rockets which will last for a matter of 30-40 seconds and give the model a probable speed of over 100 m.p.h.

The control surfaces for manœuvring the aircraft in flight are actuated by servo-mechanisms controlled by a four-channel radio system—this was designed by the L.S.A.R.A. radio man, D. W. Allen. The principle of the system is to transmit four trains of square pulses and use them for controlling the servo-mechanisms by varying their respective mark/space ratios. In the aircraft the received pulse trains are smoothed out by storage capacitors to give four voltages which vary in proportion to the mark/space ratios. Each voltage varies above and below a certain reference value and so drives its associated servo-mechanism and control surface either one way or the other about a neutral position.

The four pulse trains, which have repetition fre-

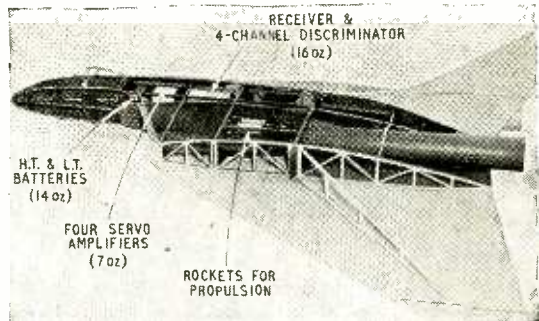

Demonstration model of aircraft with fuselage cut away to show disposition of radio equipment.

quencies of about 30 p.p.s., are transmitted by sub-carrier frequencies of 6.2 kc/s, 8.5 kc/s, 14 kc/s and 20 kc/s, which modulate a carrier frequency of about 27 Mc/s. (Actually the sub-carriers are not modulated by square-pulse waveforms in the conventional way. Each sub-carrier oscillator is biased off and triggered by a 30-c/s sawtooth waveform to give bursts of oscillation at the 30-p.p.s. repetition frequency. The operator varies the bias voltage so that the oscillator is triggered at different levels on the sawtooth. In this way he varies the duration of the bursts of oscillation, and hence the mark/space ratio of the resultant pulse train.) In the aircraft the 27-Mc/s signal is picked up by a superhet receiver. The four pulsed sub-carrier frequencies are then selected by tuned circuits and demodulated to give the original four pulse trains.

As can be seen from the illustration, the superhet receiver is a noteworthy example of miniaturization. In addition to the receiver proper (r.f. stage, oscillator, mixer, two i.f. stages, two power amplifiers), it contains the four tuned circuits and four associated detector-limiter valves. All the valves are hearing-aid types and they consume altogether less than one watt of l.t. power and one watt of h.t. power.

Left : One of the servo-mechanisms coupled to a demonstration section of a control surface ; its positioning accuracy is 0.1 to 0.5 per cent. Right : The miniature receiver unit showing the 4-channel discriminator on the far side of the screen.

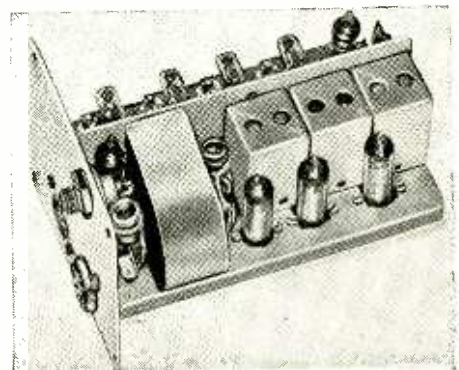
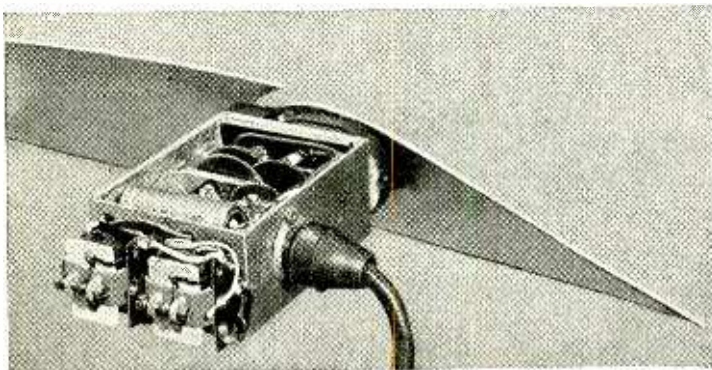

Metal Cone Loudspeaker

By F. H. BRITTAIN*

Part 2—Further Constructional Details: Alternative Methods of Mounting

The advantage of the metal cone in reducing harmonic and intermodulation distortion, and the expedients adopted to overcome its disadvantages from the point of view of frequency response were discussed in the article in the previous issue. The author now gives details of other aspects of the G.E.C. high-quality loudspeaker design and suggests types of mounting having a performance compatible with that of which the unit is capable.

RIGIDITY of the cone diaphragm is of paramount importance if harmonic and intermodulation distortion are to be kept to the minimum, and the proportions as well as the material of which the cone is constructed must be taken into account.

Cone Diameter.—The cone diameter has a direct bearing not only on its rigidity but also on its efficiency as a radiator of low frequencies. It is difficult to make a large cone which is both rigid and light in weight. On the other hand a small cone must be allowed a greater excursion if it is to radiate as much power at low frequencies as a larger one, and this increases the problems of designing a suitable surround, centring device, speech coil and magnet assembly. It was found possible to make a rigid cone of six inches diameter, and that size has been standardized, at least for the present.

Speech Coil.—It was found that a speech coil of one inch diameter was just large enough to dissipate all the heat evolved in driving the cone to its maximum permitted excursion at the lowest frequency. The length of the speech coil was determined by the method discussed in the previous article under the heading "Driving-force Distortion." In order to achieve rigidity, the former on which the speech coil is wound is turned from solid Duralumin, and is welded to the cone. It is unlikely to distort, even if seriously overheated, and it is virtually impossible to bend or buckle it, no matter how severe the overload on the loudspeaker may be. The solid metal coil former also greatly reduces the change of impedance associated with the low-frequency resonance and the rise normally met with at the higher frequencies.

Suspension System.—This comprises a corrugated centring device, of conventional design, mounted between the cone and the magnet top plate, and a plastic material between the periphery of the cone and the loudspeaker bowl, which permits a peak displacement of 2 mm from the rest position. The particular plastic used was chosen for its low mechanical loss when subjected to vibration. It must retain its characteristics over very long periods of time, and be unaffected by heat and moisture.

Power-handling Capacity.—There are a number of ways in which the power-handling capacity of a loudspeaker may be limited. Maximum permitted ex-

curSION of the cone, excessive distortion of the sound, damage to the assembly, overheating of the speech coil, etc. In the case of the metal cone loudspeaker, the cone is extremely strong, and there is virtually no deterioration in the quality of reproduction, even when the loudspeaker is handling its maximum peak electrical power of 10 watts. The continuous rating is, of course, much lower than this extreme peak value, which must never be exceeded. During trials, it was necessary to run one single unit at a power of 30 watts for several hours on normal B.B.C. programmes in order to damage the loudspeaker. The limit is set by the danger of burning out the speech coil, which can easily occur, because the loudspeaker itself gives very little warning, in the form of audible distortion, that it is being grossly overrun. There is also the possibility of excessive travel of the speech coil if the loudspeaker is operated with a small or inadequate box or baffle. When this happens, audible warning is given by the speech coil former striking the safety stops. This will also happen, even with a large baffle, if the amplifier is slightly overloaded. The first indication of this may well be a slight displacement of the cone, which is quite easily visible and indicates asymmetry in the output waveform.

Mountings.—Some form of baffle is necessary, as with all types of cone loudspeaker, to prevent circula-

* Research Laboratories of the General Electric Company

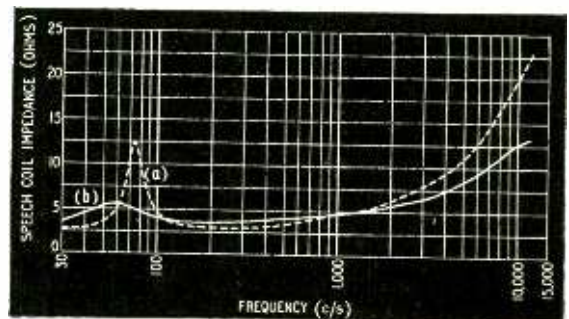

Variation of speech-coil impedance with frequency: (a) with paper coil former; (b) with metal coil former.

tion of acoustic energy directly between back and front of the diaphragm. The plane baffle is simple in principle, but inconvenient in practice, since it must be at least 10ft square for frequencies down to 50 c/s. A hole in the wall is excellent, but not often practicable. If this method is adopted care must be taken to treat the space at the rear of the diaphragm with sound-absorbing material to suppress reflections and resonances which might react on the cone. It is generally more convenient to construct the baffle in the form of a cabinet.

Closed Box.—In this simple case, the back of the diaphragm is completely enclosed, the front of the cone acting as a single-source radiator. The disadvantage is that the size of the enclosure must be relatively large, since the air enclosed behind the loudspeaker adds considerable stiffness to the cone suspension, raising the low-frequency resonance of the cone. With this form of cabinet, a constructional difficulty arises from the high sound pressures which are set up against the walls of the box, which has to be very strongly constructed to prevent the sides from vibrating and radiating sound which is "coloured" by their resonant frequencies. Reflections from the interior of the box must be prevented by placing sound-absorbing material inside it.

Bass Reflex or Vented Cabinet.—This form of cabinet is often used with those more ambitious reproducers which attempt to radiate frequencies as low as 40 or 50 c/s. It consists essentially of a Helmholtz resonator, the loudspeaker being mounted in one of its walls. The resonator is tuned to the main low-frequency resonance of the cone, to which it is tightly coupled by virtue of the fact that one part of the resonator wall is the cone of the loudspeaker. This tight coupling produces the appearance of a double-peaked resonance curve, both peaks of which are smaller than the single peak of the closed box. The interior of the resonator must be treated with damping material¹ to suppress secondary resonances and reflections. The walls of the resonator, like those of the closed box, are subject to high sound pressures, and must be carefully constructed to prevent vibration, and consequent re-radiation of sound.

Details of how to design a vented cabinet have already appeared in *Wireless World*.² The method of adjusting the magnitude of the upper resonance peak is carried out to a first approximation by the following simple test. The loudspeaker, including its transformer, is excited at its modified low-frequency resonance, by means of a suitable transient. In one case the transient is supplied from a source having a very low internal impedance, and in the other case, from a source whose impedance is similar to that of the amplifier which is to be used with the loudspeaker and the reflex cabinet. The low-impedance source will be found to produce a more damped response than that obtained from the higher-impedance source, damping material should be added to the bass reflex cabinet until a similar damped response is obtained under both conditions.

A convenient practical method of carrying out the test is to place a suitable resistance simulating the amplifier impedance across the loudspeaker transformer primary and then to apply and remove one or two dry cells across the primary. When the cells are applied, they are a low impedance themselves and

Right: Three metal-cone units mounted in a vented cabinet. This assembly is rated for 15 watts maximum continuous input.

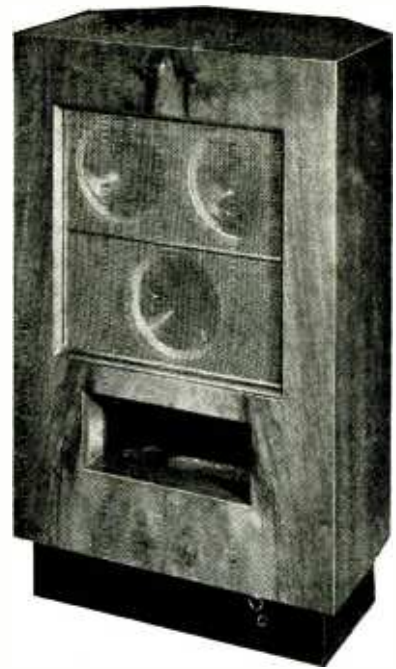

Below: Experimental acoustic labyrinth constructed with inexpensive materials.

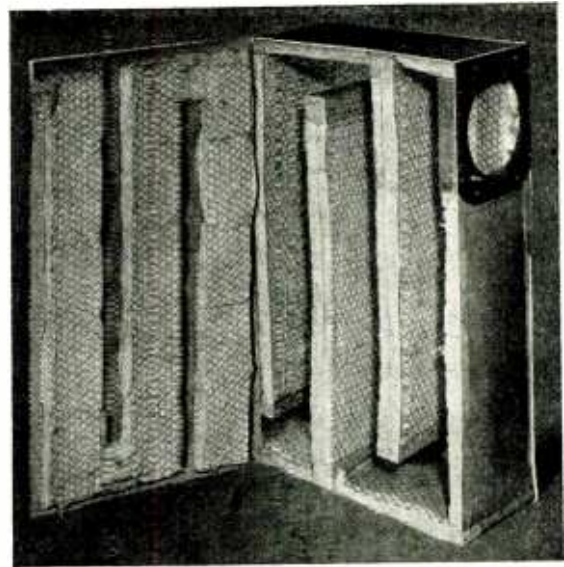

shunt the resistance. When they are removed, the amplifier simulating resistance alone remains. The ear is an excellent judge of the "tick" or "boom" which is produced by this test. It is necessary to produce a "tick" or almost a "tick" in both cases. There should be practically no "boom" at all.

Acoustic Labyrinth.—This consists of a pipe or duct with sound-absorbing walls; it is virtually a silencer for the sound generated by the back of the loudspeaker. The dimensions of the labyrinth should be so chosen that its length is comparable to half the wavelength of the main resonance of the loudspeaker, but, in practice, a shorter length will be found to be quite efficacious. If the low-frequency absorption is adequate it is quite immaterial whether the end of the labyrinth is open or closed. The cross-sectional area of

¹ See, for example, "Loudspeaker Cabinet Design," by D. E. L. Shorter, *Wireless World*, Nov. and Dec., 1950.

² "Vented Loudspeaker Cabinets," by C. T. Chapman, Oct., 1949.

the duct is usually made similar to that of the cone. If care is taken in the design to prevent sound leaking through the walls of the labyrinth, it may be constructed from very cheap materials, such as wood-wool, wire-netting and cardboard. The sound absorbing nature of the walls eliminates standing waves and reflections. In effect, an acoustic resistance is tightly coupled to the loudspeaker cone, damping it and absorbing acoustic power, making the labyrinth somewhat less efficient than either the closed box or the bass reflex cabinet. This resistance also helps to present a constant impedance to the cone and reduces the violent impedance changes encountered when the loudspeaker is operated in a living room. Its chief disadvantages are that it is rather bulky, and that apparatus such as output transformers or filters cannot be installed inside it.

By reducing the efficiency of the damping material it is feasible to construct a duct having characteristics intermediate between those of a labyrinth proper and a tuned pipe.

High-frequency Reproduction.—So far, special devices have been considered in connection with low-frequency reproduction, but a cone loudspeaker usually radiates high frequencies in a beam of narrower angle than low frequencies. It is sometimes necessary to design the cabinet to spread this high-frequency beam. This may be done either by refraction or reflection, bearing in mind that sound waves can only be refracted or reflected by objects comparable

with their own wavelength. However, since it is the high frequencies that have to be spread, the wavelength is small and the size of the device need not be excessive. A more serious difficulty arises from multiple reflections which may occur between different parts of the refractor or reflector and the cone itself. For instance, the loudspeaker cone may be placed behind a narrow slot which will refract the sound and give excellent dispersion. This method is unsuitable for use with the highly reflecting metal cone, and the reaction on the cone motion produces "muddled" reproduction compared with that obtainable with free forward radiation. It has been found that the only satisfactory method is to use a reflector in such a way that none of the sound is ever reflected back on to the cone.

It is customary for æsthetic reasons to disguise the loudspeaker cone by placing it behind a gauze or grille. It is important that this gauze or grille should neither reflect sound back on to the cone, nor absorb it. It is difficult to find satisfactory materials which are opaque to light and yet transparent to sound. Woven glass fabric has been found to be satisfactory in some applications, but for the critical listener using the metal cone loudspeaker, all materials so far used have produced an audible impairment in quality; even the ordinary black muslin dust bag. The most satisfactory material is a very open wire mesh, but this material is not capable of completely hiding the loudspeaker.

RADIO RELAY REPORTING

A SOMEWHAT unusual problem in radio communication arose when the *Birmingham Mail* and the *Liverpool Daily Post* came to make arrangements for transmitting to their offices photographs of the recent opening by the Queen of the new dam for the Birmingham Corporation's water supply system at Claerwen, in the Welsh hills.

The distance to the nearest point on the telephone

system was not great (some 18 miles), but the site of the dam, in a deep valley, made it impossible to find a workable line-of-site path, and recourse had to be made to a radio relay.

For this purpose, mobile v.h.f. relaying equipment was taken to the top of Craig Fawr, a 1,500ft rugged peak some 2½ miles from the dam. From here the picture signals were relayed to another v.h.f. mobile station located on the Llandrindod golf course, whence they were sent by local telephone line to the G.P.O. centre in the town 2½ miles away.

Marconi Type H16A radio telephone equipment installed in a vehicle with a Muirhead picture transmitter, and adjacent to another vehicle containing a mobile dark room, was used at the dam site while on Craif Fawr and the golf course, Marconi H16 mobile transmitter-receivers were used.

The equipments are all similar in frequency range and power. They are crystal controlled and operate on a single frequency in the band 78 to 100 Mc/s giving about 10 watts r.f. output to the aerial.

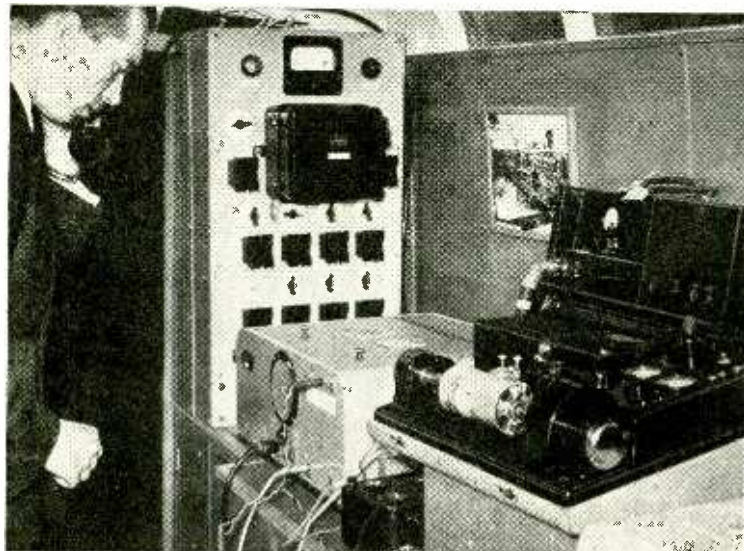

Equipment used at the Claerwen dam comprised a Muirhead picture transmitter and Marconi v.h.f. radio equipment type H16A.

LETTERS TO THE EDITOR

The Editor does not necessarily endorse the opinions expressed by his correspondents

"Too Many Recording Characteristics?"

I AGREE with Ruth Jackson (your August issue) that the fewer different standard characteristics in use the better, and I would like also to stress the importance of standard characteristics being so designed that correct reproducing apparatus can be constructed cheaply, and without the need for chokes. The reproducer designer finds it difficult to deal with the shape of some of the characteristic curves presented to him. This requirement may add a little complication at the recording end, but cost there is relatively unimportant.

Welwyn, Herts.

J. M. LITTLE.

Exiled Radio Engineers

I RETURNED home to England during the summer, and tried hard to find a job. But, as I had half expected, there seem to be no jobs in England which I can afford to take. This is a very serious matter, not so much from my personal viewpoint, but in the wider national interest. In every capital in Europe, in every industrial city of America you will find a few British engineers like me: we are, I suppose, moderately good designers or administrators, because we keep our jobs in spite of the language problem and the competition of the natives; we must be moderately energetic to have uprooted ourselves from the relative security of England and the social teas of Savoy Place. Some of us are prepared to stay forever in our new country; some, like myself, would like to return to England with our broadened experience. But we cannot afford it.

I am quite aware of the problems of the national economy: the newspapers and the serious weeklies will not let me overlook the problems of the export market, as viewed from editorial chairs. It is when I apply the available data to my own problem that I become uneasy. *The London and Cambridge Economic Service Bulletin* (New Series, No. 3) states that a weekly wage-earner received 175% of his 1938 pay in 1947, and 219% in June, 1952. The retail price index, of course, has risen more than this, but that is quite a separate issue.

The professional engineer usually gets an annual increment of about 5% of his salary: this represents the increasing value of his services. A young engineer who was earning the same as a skilled tradesman in 1938 should therefore now be earning twice as much, and thus should now have four times the money income which he had in 1938. This is, indeed, just about what I am receiving for my work in another country. My contemporaries in England must be satisfied with a gross income 30% lower, and a standard of living which is even more depressed.

You may think, Sir, that I have found some happy Schachtian economy, cut off from the economic storms. This is not so: the equipment I design is mainly for export, and is sold in embarrassing quantities in direct competition with British exports. Low salaries are not the way to produce exportable engineering products: I suspect that too many engineers in England are spending too much time on the problem of making both ends meet, instead of on engineering. There is always a shortage of engineers, and the fatuous suggestion of a speaker at an I.E.E. discussion that the engineering committees of the engineering industry can cure this shows a complete lack of any sense of reality. Engineering as a profession is priced out of the market, and in the words of *The Economist*, this will go on "so long as enough suckers are available to accept fixed returns in funny money."

There are two problems here. The first a personal one: should I return to England to pay increased taxes on a greatly reduced income? The taxes I accept,

because they represent the process of solving the national problem, but the income reduction is too great. The second problem is a national one. Somewhere in the line from design to sales there is something wrong: too expensive products come from underpaid designers. Management is failing to carry out its essential function, which is to manage, and is allowing things to drift in accordance with Mary Follett's "logic of the situation." To cheapen the product, reduce wages: to increase output, increase hours. Like most policies of "logical drift," this is a bankrupt policy and a policy of bankruptcy. It leads to a flourishing export business in engineers and skilled tradesmen, and when they leave, the Bank of England cannot enter the capital of their skill on form CD3; the Board of Trade shows no hard currency return in the balance of trade.

JOHN DOE.

Helping the Army

I WAS pleased to see Wm. A. Richardson's letter in the October issue. I think it will be of interest to your readers that Royal Signals now have a special job for the radio amateur and others with technical or operating ability. I have the honour to command the Army Wireless Reserve Squadron, SR, now in course of formation.* The only training liability is 15 days' annual camp. We have an important part to play in National Defence, and I sincerely invite those interested to write to me, without obligation, for further details.

DENNIS W. J. HAYLOCK, Maj. (G3ADZ).
230, Devonshire Avenue,
Southsea, Hants.

*Details of the constitution of the Army Emergency Reserve, of which the Wireless Reserve is a part, are given on page 503.—Ed.

V.H.F. as an "Extra"?

I HAVE been following with interest the discussion on the desirability and/or necessity of v.h.f. broadcasting in this country. I would like to point out that the number of people interested in the reception of very high fidelity broadcasts are only a small minority of the total listening public. This statement is, in my opinion, amply upheld by the fact that the normal production-type receiver is usually incapable of doing full justice even to the normal B.B.C. transmissions.

If the listening public were to desire better quality, surely manufacturers would be forced to provide them with their needs and produce sets with push-pull, infinite impedance detection, reasonable baffle area, etc.

However, since we live in a democracy and the minority have a right to satisfaction, I suggest that by all means v.h.f. should be developed, but a surcharge should be applied to those licences which cover sets tuning to these frequencies. This would then cover the cost of maintaining and operating the special equipment, and thus spare the public in general having to bear the cost, either directly or indirectly, of the services for the minority.

Manchester, 4.

PETER DEAN.

I.F. Inquiry

AS a result of difficulties arising from the Copenhagen Plan, a questionnaire was sent out by the European Broadcasting Union to associations representing receiver manufacturers in nine different countries, to ascertain their views on the choice of an i.f. for broadcast receivers.

The results of this investigation have now been published by the E.B.U. in the form of a document (No. CT45-E) the introduction to which refers to my article

on this subject published in your September, 1949, issue. In general, the document appears to agree substantially with the findings of that article.

The E.B.U. is now about to institute an analogous inquiry concerning television receivers, to which I have been requested to contribute.

London, N.W.5.

G. H. RUSSELL.

BOOKS RECEIVED

Electronic Measurements by F. E. Terman, Sc.D and J. M. Pettit, Ph.D. An extensively revised second edition of Prof. Terman's "Measurements in Radio Engineering" which now covers pulse techniques, microwaves, television and radar in addition to conventional radio communication. Pp. 707+xiii; Figs. 448. McGraw-Hill Publishing Co. Ltd., 95, Farringdon Street, London, E.C.4. Price 72s 6d.

Principles of Radio by Keith Henney and Glen A. Richardson. Completely revised 6th edition including chapters on television, f.m., radar, wave-shaping circuits and test equipment. Pp. 655; Figs. 407. Chapman and Hall, 37, Essex Street, London, W.C.2. Price 44s.

The Use of Radar at Sea. Edited by Capt. F. J. Wylie, R.N. (ret.), for the Institute of Navigation. Foreword by Sir Robert Watson-Watt. An exposition of the principles and potentialities of marine radar, with practical guidance on the interpretation of displays. Pp. 279+xv; Figs. 170. Hollis and Carter, 25, Ashley Place, London, S.W.1. Price 30s.

The Resonant Cavity Magnetron by R. S. H. Boulding, B.Sc., M.I.E.E., F.Inst.P. Principles underlying its operation; performance charts; descriptions of practical magnetrons and their associated circuits. Pp. 147+vii; Figs. 80. George Newnes, Ltd., Tower House, Southampton Street, London, W.C.2. Price 21s.

Radio Research 1951. Report of the Radio Research Board together with the report of the Director of Radio Research, Department of Scientific and Industrial Research. Pp. 36+iv; Figs. 7. H.M. Stationery Office, York House, Kingsway, London, W.C.2. Price 1s 6d.

Vacuum Technique by A. L. Reimann, Ph.D., D.Sc. Survey of methods of producing high vacua by pumps and

"getters," glass manipulation and seals, and pressure measurement. Pp. 449+ix; Figs. 184. Chapman and Hall, 37, Essex Street, London, W.C.2. Price 50s.

Physics as a Career by Norman Clarke, B.Sc., F.Inst.P. A guide to the posts open to physicists in industry, Government service, hospitals, etc. and to the avenues of training leading to the recognized qualifications. Published by the Institute of Physics, 47, Belgrave Square, London, S.W.1. Price 6s.

Textbook on Sound by J. W. Winstanley, M.Sc., A.Inst.P. Basic classical acoustics in concise form with some reference to their practical applications. Primarily intended for use in schools. Pp. 239+xi; Figs. 153. Longmans, Green & Co. Ltd., 6 and 7, Clifford Street, London, W.1. Price 12s 6d.

Applied Electronics Annual 1952. Edited by R. E. Blaise, A. M. Brit., I.R.E. International year book and directory (including classified buyer's guide) for radio and electronic equipment. Pp. 240 (illustrated). British-Continental Trade Press, Ltd., 222, Strand, London, W.C.2. Price £2.

Wireless Fundamentals by E. Armitage, M.A., B.Sc. Assumes an elementary knowledge of electricity and adopts the physical and experimental approach to the subject. Pp. 368+x; Figs 334. Sir Isaac Pitman & Sons Ltd., Parker Street, Kingsway, London, W.C.2. Price 18s.

Examples in Electrical Calculations 1952 (BR158/52). Written primarily for the guidance of Naval students of electrical technology, this textbook covers also the requirements of students preparing for Preliminary and Intermediate Grade examinations of City and Guilds or the Ordinary National Certificate in electrical engineering. Pp. 507; Figs. 263. H.M. Stationery Office, York House, Kingsway, London, W.C.2. Price 17s 6d.

Elements of Radio Engineering by H. I. F. Peel, M.Sc. Tech., A.M.I.E.E. Textbook designed to cover requirements of Radio and Telecommunications (Principles) 1 and 2 of City and Guilds' five-year course. Pp. 232; Figs. 153. Cleaver-Hume Press Ltd., 42A South Audley Street, London, W.1. Price 10s 6d.

Reports on Progress in Physics Vol. XV 1952. Edited by A. C. Stickland. Includes papers on "Ferrites" by A. Fairweather, F. F. Roberts and A. J. E. Welch and "Travelling Wave Tubes" by R. Kompfner. Pp. 338; Figs. 134. The Physical Society, 1 Lowther Gardens, Prince Consort Road, London, S.W.7. Price (to non-Fellows), £2 11s 6d by post.

New Miniature Valves

An R.F. pentode with characteristics similar to those of the well-known American 6AK5 has been added to the Mullard range of miniatures. Known as the EF95 the new pentode is of all-glass construction with a B7G base. Its low noise qualities and low input and output capacitances render it particularly suitable for use in v.h.f. equipments. Other features of interest are: low heater consumption, e.g., 175 mA at 6.3 V, optimum performance obtainable with only 180 V h.t. and quite good results with 120 V.

Another new Mullard valve is a novel tuning indicator said to be the first of its kind that can be used in all-dry battery receivers as well as in mains sets.

Of sub-miniature construction, it has no base and is intended to be wired into the set. The DM70, as it is known, is a triode and has a plate-type control grid with an aperture shaped like an exclamation mark and through which the anode is viewed. The anode is coated with fluorescent material and the illumination produced is controlled by the negative potential on the control grid.

The indicator operates normally at 90 V h.t. and consumes 0.24 mA, but it will also function at 60 V if necessary. With 90 V h.t. the grid extinction voltage is -11 and with 60 V it is -9.5 V. The filament is directly heated and requires 1.4 V at 25 mA.

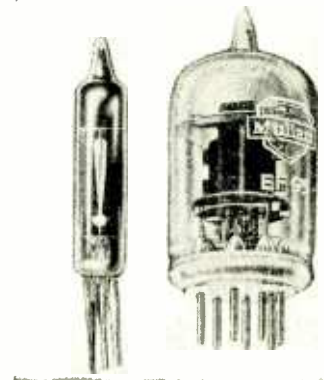

Two new Mullard valves, the EF95 (6AK5 equivalent) and sub-miniature tuning indicator, DM70.

WORLD OF WIRELESS

Television Society Show ♦ Extended Amateur Facilities ♦ Business
Radio ♦ New Technological Award

Television Show

THE annual exhibition of the Television Society will be held on January 23rd and 24th at 155, Charing Cross Road, London, W.C.1, by invitation of the Edison Swan Electric Co. It will be open on the first day from 6.0 to 9.30 when admission will be restricted to members of the Society. On the second day it will be open from 10.30 a.m. to 9 p.m. when the holders of invitation tickets will be admitted. These tickets are available from members of the Society and G. T. Clack, the Lecture Secretary, 43, Mandeville House, Notre Dame Estate, Clapham, S.W.4.

It is anticipated that there will be about 40 exhibiting firms who have been invited by the Society to show equipment relating to television engineering or production, or to the production of television programmes. Individual members of the Society may also exhibit items which they have designed or constructed, or for which they have had a substantial degree of technical responsibility.

It is anticipated that the Society's 405-line vision transmitter will be operating at the show. A signal distribution system is being installed so that some of the equipment exhibited will be seen in use.

W/T Training for Scouts

SPECIAL transmitting licences for the training of Boy Scouts in wireless telegraphy are now being issued by the Postmaster General. The licences authorize the operation for training purposes of a 5-watt fixed transmitting and receiving station to work a given number of 1-watt portable stations operating within a radius of 10 miles.

The network of stations will operate on W/T only, on one frequency in the 144-146 Mc/s band and the portable stations will use the call sign of the fixed transmitter with the suffix "/1," "/2," etc.

Conditions of operation are in general those stipulated for amateur transmitters. Enquiries concerning this special licence should be addressed to the Engineer-in-Chief, Radio Branch, WM3/3, General Post Office, London, E.C.1.

Amateur 21-Mc/s Band

AS was expected when the announcement was made in June that amateurs could use the 21-21.2 Mc/s band for telegraphy, it has now been extended to 21.45 Mc/s. This

brings British amateurs into line with their opposite numbers in North America.

In extending the band, the G.P.O. announced that permission has been granted provided no interference is caused with other services operating in the band. Amateurs are also reminded to guard against the emission of second harmonics in the television band.

V.H.F. Radio

IT is estimated by the R.I. Council that the police, fire and ambulance services in this country now operate nearly 4,000 v.h.f. radio-telephone stations (fixed and mobile) and that the number of stations operated by transport, water, sewage, gas, electricity and other public utility services probably exceeds 500, an increase of about 80 per cent in just over a year. In addition, there are a large number of stations licensed to taxi-cab operators.

So much for the land mobile use of v.h.f. radio. In the maritime world there is also a growing demand for v.h.f. radio-telephone equipment. Little more than a year ago only 25 ships using the Thames had been fitted by Rees Mace Marine with Pye v.h.f. equipment whereas to-day over 100 are equipped. Similar progress has been made with regard to vessels using other ports.

C.G.I.A.

THE City and Guilds of London Institute has introduced an award at a considerably higher level than that of its Full Technological Certificates. This Insignia Award in Technology (C.G.I.A.) will lay stress upon technical training based on practical experience and theoretical study as distinct from the more academic approach to training. It is intended "to be a mark of distinction for those who have combined with a sound, practical training an adequate knowledge of the fundamental scientific principles of their industry, and who possess a capacity for leadership and administration."

Copies of the regulations governing the award are available from the Director, Department of Technology (I.A.), 31, Brechin Place, London, S.W.7.

Radio Mechanics' Salaries

THE claim of radio mechanics employed in civil aviation for a new salary scale of £460 at the age of 25 rising by £20 annually to £570 at 31 has been rejected by the Ministry of Civil Aviation. A few days before this issue appears the dispute is to be heard by the Civil Service Arbitration Tribunal.

At present the salary scale is £370 at 25 with the same increments rising to £450 at 31.

PERSONALITIES

H.R.H. The Duke of Edinburgh, K.G., has extended his patronage to the Radio Society of Great Britain.

Captain F. J. Wylie, R.N. (Ret.), director of the Radio Advisory Service of the Chamber of Shipping and the Liverpool Steamship Owners' Association, has been elected chairman of the Executive Committee of the Institute of Navigation. Captain Wylie, whose nautical career (1909-1947) was closely associated with radio, was director of radio equipment at the Admiralty from 1944-1946. He was general editor of "The Use of Radar at Sea," recently published by the Institute of Navigation.

D. T. N. Williamson recently visited Toronto and gave a lecture at a joint meeting of the Acoustical Institute and the Toronto Branch of the American I.R.E., attended by about 500. For his demonstration he used an experimental pick-up, a Williamson amplifier and an Acoustical Corner Ribbon loudspeaker.

P. G. A. H. Voigt, who has been in Canada for the past two years and, until recently, has been part-time instructor in electronics at the Ryerson Institute of Technology, Toronto, is now with Engineered Sound Systems of Toronto.

J. R. D. Sainsbury has relinquished his appointment as export manager of Ultra Electric, Ltd., which he joined in 1946, to become general sales manager of Chassay Bros., radio manufacturers, of Bulawayo. Prior to joining Ultra he served from 1939 in the Royal Navy as a Signal Officer reaching the rank of Lieutenant Commander. He is well known in amateur circles as G8HV, and in the Royal Naval Volunteer Wireless Reserve.

J. L. Furner has been appointed sales manager of the Telecommunications Division of the Plessey Co. in succession to Air Commodore T. P. Fagan, who is now acting as liaison between the Company and foreign Governments and Government Departments. Mr. Furner was for 26 years with Mullard, during the last three of which he was a member of the Communications and Industrial Valve Division.

J. W. M. Swanson, who joined the staff of the B.B.C. in 1934 as an assistant maintenance engineer at the North Regional transmitting station at Moor-side Edge, has been appointed engineer-in-charge, Newcastle. In 1943 he became assistant engineer-in-charge at the B.B.C.'s Monitoring Station at

Caversham and held this post until his present appointment.

L. Atherton, B.Sc., A.M.I.E.E., has joined Mullard's Equipment Division to take charge of the Special Products Commercial Group which specializes in ultrasonic equipment and laboratory and industrial applications of electronic techniques. He was previously at the Ministry of Supply Atomic Energy Factory. During the recent war he was seconded from the R.A.F. to T.R.E.

G. Darnley Smith, managing director of Bush Radio, Ltd., and Cinema-Television, Ltd., has been appointed a member of the Government's reconstituted Television Advisory Committee. He has been chairman of the Television Policy Committee of the Radio Industry Council since its formation in 1948 and is this year's chairman of the R.I.C.



(Copyright Douglas Glass)

G. DARNLEY SMITH

C. O. Stanley, C.B.E., who has also been appointed to the Television Advisory Committee, is chairman of Pye, Ltd., and is a director of the Associated Broadcasting Development Co., recently formed to promote sponsored television in this country, and High-Definition Films, Ltd., formed to develop the use of electronic apparatus in the film industry. He is one of the eight radio industry representatives on the Radio Rearmament Advisory Committee of the Ministry of Supply.

H. L. Bowen, a technical executive of the Valve Division of Mullard's, recently completed 25 years' service with the Company, and to mark the occasion was presented with an inscribed gold watch and a cheque. He joined the Company as an outside representative, and, after acting as assistant to T. E. Goldup for eight years, took charge of the Company's Technical Service Department. He has been closely associated with the work of the British Radio Valve Manufacturers' Association, and is now chairman of its Technical Committee. He is also a member of the Valve Standardization Committee of the International Electro-technical Commission.

Edgar Lipworth, M.Sc., of Salford, Lancs, is among the six recipients of RCA Fellowships awarded by the Radio Corporation of America to young scientists and graduate engineering students. He is in the Physics Department at Columbia University. He received his Bachelor of Science degree from Manchester University in 1947, and his M.Sc. from Columbia University in 1949. From 1942-1945 he was with the Air Ministry.

OBITUARY

J. J. Honan, who for many years contributed frequently to both *Wireless World* and *Wireless Engineer* died at Limerick, Eire, on October 27th, at the age of 69. He was an associate member of the I.E.E. and on his retirement from the Patent Office was an assistant examiner.

OUR AUTHORS

H. Stibbé, contributor of the article "Microphony in Superhet Oscillators" in this issue, is assistant head of the Government Contracts Section of the design and development laboratories of Bush Radio. He was previously in the radio laboratories of Mitcham Works, Ltd., and the Plessey Co. During the war he served as W.O.II Armament Artificer (Wireless) in R.E.M.E. He has served on the Brit. I.R.E. Education and Examination Committee since 1950 and is now examiner in radio reception (receiver design and practice) for the Institution's graduateship examination.

Dr. de Bruyne, who contributes the article on the use of a Fresnel lens for the magnification of television images (p. 502), was formerly fellow and lecturer of Trinity College, Cambridge, and worked at the Cavendish Laboratory under Lord Rutherford until 1934, when he started his own firm (Aero Research, Ltd., of Duxford) of which he is managing director.



C. O. STANLEY, C.B.E.
(See "Personalities")

IN BRIEF

Receiving Licences.—At the end of September there were 12,843,595 broadcast receiving licences current in the United Kingdom including 1,655,446 for television (an increase of 57,500 during the month) and 163,886 for car radio receivers.

Radio Show, 1953.—The dates of the 20th National Radio Exhibition have now been confirmed by the Radio Industry Council—September 1st to the 12th at Earls Court, London.

Other Exhibitions.—Announcements have been made by the organizers of the dates of the following 1953 exhibitions: British Industries Fair (Olympia and Earls Court, London and Castle Bromwich), April 27th-May 8th; British Plastics Exhibition and Convention (Olympia), June 3rd-13th; and the Ideal Home Exhibition (Olympia), March 3rd to 28th.

U.S. Television Stations.—According to figures published in the October issue of *Electronics*, the number of applications for permission to build television stations in the United States was at the end of August double that of a year ago—855 compared with 424. The number of stations operating is given as 109 and there are 34 transmitters under construction. During the same period medium-wave broadcasting stations increased from 2,292 to 2,356. There were 112 stations being built and outstanding applications for a further 291. F.M. stations decreased from 645 to 622 during the year, but there are 21 stations under construction and 12 outstanding applications for licences.

A Prototype of the Ekco Airfield Radar Approach Aid has been ordered by the U.S. Air Navigation Development Board for evaluation. It uses a small dish-shaped scanner producing a pencil-like beam and is manually controlled in the vertical plane but linked with a v.h.f. direction finder for azimuth scanning. Range and bearing are recorded and the controller can talk the aircraft down by v.h.f. radio-telephone. The equipment has been in use experimentally at the Southend Airport for some time.

Guided Weapons.—The Research Laboratories of the G.E.C. are to set up a unit at the Long Range Weapons Establishment, S. Australia, for trials and further development of guided weapon equipment.

E.I.B.A.—The Electrical Industries Benevolent Association records in its report for 1951 that collections at the London Radio Industries Club luncheons contributed £238 to its funds. The B.B.C., the Radio Industry Council and a number of radio manufacturers are included in the list of donors. The object of the Association is to assist directly or indirectly any deserving and necessitous person (excluding manual workers) who are or have been engaged primarily in any branch of the electrical industry.

Institute of Navigation.—In the report of the Institute presented at the annual meeting on October 17th, it is recorded that the membership at the end of June was 1,254—92 more than the previous year.



H. L. BOWEN
(See "Personalities")

"Navigation Today" is the title of an exhibition which is to be held at the Science Museum, South Kensington, from April 1st next year.

"Come into my parlour" said the spider to the valve, mistaking it for a fly. We do not know whether spiders have bad eyesight or not, but at any rate this electrode structure of a sub-miniature hearing-aid valve is not very much bigger than a blue-bottle, and the spider (common garden type) can hardly be blamed for investigating it. The valve is a typical example of the products of a new experimental factory set up by Mullard at Whyteleafe, Surrey, specially for the mass-production of miniature, sub-miniature and "reliable" valves.

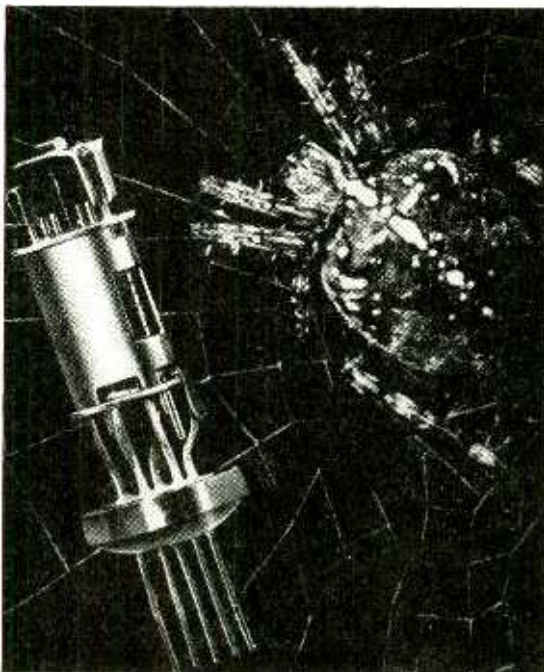

Twenty-seven inch c.r.t. with metal shell and weighing 29 lb is being produced by the Radio Corporation of America for "de luxe home television receivers." The overall length of the new tube is slightly shorter than its 21-in predecessor.

R.A.E. Results.—Figures issued by the City & Guilds of London Institute for the Radio Amateurs' Examination held in May record that the number of entries was 70 fewer than in 1951. Of the 534 entrants 423 (79.3%) passed. The percentage of passes in 1950 and 1951 were 79.4 and 83.6 respectively. Examiners report that candidates work was again of a fairly high standard.

"The Old N'Ions."—Lord Eustace Percy will be the guest of honour at the 25th annual dinner and reunion of The Old N'Ions Association (Northampton Engineering College Past Students' Association) on November 28th at the Connaught Rooms, London, W.C.2.

Swiss Television.—It has been decided by the Swiss Federal Parliament that the Posts and Telegraphs Dept. should build a television station in Zurich which will be operated experimentally by the Swiss broadcasting authority (S.S.R.) for three years. It is planned to have the 625-line station operating next spring.

German Communication and Transport Exhibition, which will be held in the Munich Exhibition Park (Ausstellungspark) from June 20th to October 11th next year, will cover all sections of modern transport and communications.

German Visitors.—A group of eight heads and deputy heads of German technical colleges recently visited this country to study the training of technicians for industry. The tour, which was arranged by the British Council at the request of the Foreign Office, covered colleges and training establishments in London (including E.M.I. Institutes), Rugby (B.T.H.), Coventry, Birmingham, Manchester, Bolton, Edinburgh and Glasgow.

PUBLICATIONS

B.o.T. Directory.—The Board of Trade has issued a directory giving the functions, addresses and telephone numbers of the various sections of the Board. The directory, which was published as a supplement to the *B.o.T. Journal* and is now available from H.M.S.O., price 9d, also includes a detailed list of the industries for which each of the Ministries or Departments is primarily responsible so far as the allocation of materials is concerned.

Capacitor Paper.—"Measurement of the Thickness of Capacitor Paper" is the title of a 10-page Circular (No. 532) by Wilmer Souder and S. B. Newman, which is issued by the U.S. National Bureau of Standards. It is available from the Government Printing Office, Washington 25, D.C., price 20 cents, including postage.

FBI Register.—The twenty-fifth edition of the "F.B.I. Register of British Manufacturers," which includes a classified Buyers' Guide listing over 6,000 F.B.I. member firms under some 5,000 alphabetically listed products and services, is published by Kelly's Directories and Iliffe & Sons, price 42s. It also includes in its 922 pages alphabetical lists of member firms, trade associations, trade names and trade marks.

CABMA Register.—The Canadian Association of British Manufacturers and Agencies (CABMA), which was formed for the development of British trade with Canada, has arranged with our Publishers and Kelly's Directories to issue next June the first officially-sponsored directory of British manufacturers and exporters whose products and services are available in Canada. It will contain classified lists of names, addresses, proprietary names and trade marks, products and services of U.K. manufacturers and exporters trading with Canada.

"CQ-TV," the quarterly bulletin of the British Amateur Television Club, is now in its fourth year of publication.

Devoted entirely to the interests of the amateur television transmitter, the October issue includes short articles on a flying-spot scanner video amplifier, simple master pulse generator and a 70cm modulator. Particulars of the Society are obtainable from M. Barlow, G3CVO, Cheyne Cottage, Dukewood Drive, Gerrards Cross, Bucks.

Patents.—A brief guide to the collection of Patent Specifications in the City's Technical Library has been issued by the Manchester Public Libraries. The 8-page booklet summarizes the library's five million or more specifications and other patent publications. In addition to British specifications, the library houses U.S. specifications from 1893, Australian from 1904 and Irish from 1928, and also indexes to Canadian, New Zealand and South African specifications.

BUSINESS NOTES

Leevers-Rich Maintenance, Ltd., is the name of the company recently formed by Leevers-Rich & Co. for the servicing of its studio recording equipment, and the testing of all equipment manufactured by its associated company, Leevers-Rich Equipment, Ltd. It will be under the management of Bernard J. Brown. It is pointed out that the repair and testing facilities are available to private users.

Marconi Marine radio-communication equipment is to be fitted in each of the seven cargo ships being built at the Hindustan Shipyard, Vizagapatam, for the Scindia Steam Navigation Co.

Luxor Electronic SA (Pty.), Ltd., the recently formed Johannesburg branch of Luxor Radio A/B, Sweden, would like to hear from English manufacturers able to supply components for broadcast receivers. Communications should be addressed, in the first instance, to their correspondents Lawrence Wilkinson & Co., 2, Bythorn, Bronshill Road, Torquay.

Canadian Agency Enquiry.—Technical Materials Corporation of Canada, 160, Metcalfe Street, Ottawa, 4, want to obtain the agency of a United Kingdom manufacturer of radar, echo sounders and communications equipment for the Ottawa district of Canada. Communications should be sent direct to Ottawa marked for the attention of Douglas Carroll. In order that the Trade Commissioner at Ottawa can be informed and thus be in a position to offer any assistance that may be required, interested manufacturers are asked to notify the Board of Trade, C.R.E. Dept., Horse Guards Avenue, London, S.W.1, quoting ref. CRE/34679/52.

High Definition Films, Ltd., announce that A. M. Spooner has joined the staff for work associated with electronic process shots and artificial scenic devices. Until the end of July he was a member of the Designs Department of the B.B.C.

Dynatron Radio, Ltd., is celebrating its silver jubilee this year. It was formed jointly in 1927 by R. H. and A. G. Hacker (originally as H. Hacker & Sons) for the manufacture of the first radio-gramophone using the name Dynatron.

Coming of Age.—Founded in 1931 by R. N. Wellington, the managing director, Sound Sales, Ltd., attained its majority on September 19th.

Marconi's have received an order for the supply of nine 20-kW high-frequency transmitters for installation

at Paradys near Bloemfontein. Although the Union of South Africa is not, except for a comparatively small area, in the tropics, it is permitted to use the frequencies allocated for tropical broadcasting (3,200-3,400, 4,750-4,995 and 5,005-5,060 kc/s).

NEW ADDRESSES

Film Industries, Ltd., manufacturers of sound reproducing equipment, have moved their offices and repair section from Paddington Street, London, W.1, to 90, Belsize Lane, London, N.W.3. (Tel.: Hampstead 9632/3.)

Telecraft, Ltd., manufacturers of television aerials and accessories, have opened an aerial sales and erection depot at Canford Chambers, St. Peter's Road, Bournemouth. (Tel. Bournemouth 2282.)

Homelab Instruments, manufacturers of signal generators and test equipment, of 68a, Cobden Road, London, E.11, have moved to 615-617, High Road, Leyton, London, E.10 (Tel.: Leytonstone 5651).

Electrical Remote Control Co., manufacturers of automatic electrical control apparatus, have moved to Elremco Works, East Industrial Estate, Harlow New Town, Essex (Tel.: Harlow 3032).

MEETINGS

Institution of Electrical Engineers

Radio Section.—"A Survey of Present Knowledge of Thermionic Emitters," by D. A. Wright, M.Sc., at 5.30 on December 3rd.

Discussion on "How to Plan a Radio Project," opener J. Thomson, M.A., Ph.D., D.Sc., at 5.30 on December 15th.

Education Discussion Circle.—Discussion on "The B.B.C. School, Evesham," and "The Post Office School, Stone," openers K. R. Sturley, Ph.D., B.Sc., and H. R. Harbottle, O.B.E., B.Sc.(Eng.), at 6.0 on December 10th.

The above meetings will be held at Savoy Place, London, W.C.2.

Cambridge Radio Group.—"Television Camera Tubes" by R. Theille, Dr. Phil., at 8.15 on December 9th at the Cavendish Laboratory.

Merseyside and N. Wales Centre.—Discussion on "The Impact of Television on Sound Broadcasting," opener G. Parr, B.Sc., at 6.30 on December 1st at the Liverpool Royal Institution, Colquitt Street, Liverpool.

North-Eastern Radio Group.—"Harmonic Response Testing Apparatus for Linear Systems," by D. O. Burns, B.Sc.(Eng.) and C. W. Cooper, B.Sc.(Eng.) at 6.15 on December 1st at King's College, Newcastle-on-Tyne.

North Midland Centre.—Discussion on "Technique of Teaching," opener A. Machennan, at 6.30 on December 2nd at Huddersfield Training College, Queen Street South, Huddersfield.

North-Western Centre.—"Electronic Telephone Exchanges," by T. H. Flower, M.B.E., B.Sc.(Eng.), at 6.15 on December 2nd at the Engineers' Club, 17, Albert Square, Manchester, 2. (Joint meeting with the North-Western Centre of the Institution of Post Office Electrical Engineers.)

South-East Scotland Sub-Centre.—"Microwave Radio Links," by A. T. Starr, M.A., Ph.D., and T. H. Walker, B.Sc.Tech., at 7.0 on December 17th at the Heriot-Watt College, Edinburgh.

South Midland Radio Group.—"Colour Television: Some Subjective and Objective Aspects of Colour

Rendering," by G. T. Winch, at 6.0 on December 1st at the James Watt Memorial Institute, Great Charles Street, Birmingham.

Southern Centre.—"Principles of Colour Television," by J. H. Mole, Ph.D., at 6.30 on December 10th at the Dorset Technical College, Weymouth.

British Institution of Radio Engineers

London Section.—"The Production of Television Receivers," by Frank Allen at 6.30 on December 10th at the London School of Hygiene and Tropical Medicine, Keppel Street, W.C.1.

West Midlands Section.—"A programme of technical films at 7.15 on December 9th at the Wolverhampton and Staffordshire Technical College, Wulfruna Street, Wolverhampton.

North Eastern Section.—"The Development of the Radio and Electronics Industry in India," by G. D. Clifford, at 6.0 on December 10th at the Institution of Mining and Mechanical Engineers, Neville Hall, Westgate Road, Newcastle-on-Tyne.

Merseyside Section.—"The Technique of Frequency Measurement in Telecommunications," by H. Hipple and A. Phipps, at 7.0 on December 18th at the Electricity Service Centre, Whitechapel, Liverpool.

Scottish Section.—"The London to Kirk o'Shotts Television Cable/Radio Link," by J. H. H. Merriman, M.Sc. (P.O. Engineering Dept.), at 7.0 on December 4th at the Department of Natural Philosophy, University, Drummond Street, Edinburgh.

Television Society

London.—"The Television Society's Transmitter"—Part I by H. Banting, H. Fairhurst and C. Banthorpe on December 11th, Part II by C. Banthorpe, D. N. Corfield and E. A. Dedman on December 17th.

Both the above meetings will be held at 7.0 at 164, Shaftesbury Avenue, London, W.C.2.

Bristol & South Western Centre.—"The Television Society's 405-line Transmitter" by H. Banting at 7.0 on December 2nd at Carwardines, Baldwin Street, Bristol, 1.

Leicester Centre.—"Electrostatics and their Applications to the Field of Television," by A. Chadfield at 7.0 on December 8th in Room 45, The Leicester College of Technology.

North Western Centre.—"Television: The Producer's View," by Berkeley Smith (B.B.C.), at 7.30 on December 17th at the College of Technology, Sackville Street, Manchester, 1.

British Kinematograph Society

Television Division.—"The Quality of Television and Kinematograph Pictures," by L. C. Jesty, B.Sc., and N. R. Phelps, at 7.15 on December 10th at the Gaumont-British Theatre, Film House, Wardour Street, London, W.1.

British Sound Recording Association

London.—"Equalizers, Filters and Tone-Control Systems," by N. H. Crowhurst, at 7.0 on December 19th at the Royal Society of Arts, John Adam Street, London, W.C.2.

Manchester Centre.—"Mechanics of Hearing," by J. E. I. John (Assistant Lecturer in Audiology, Manchester University) at 7.30 on December 15th at the Engineers' Club, Albert Square, Manchester.

Physical Society

Acoustics Group.—"Methods of Measurement of Elasticity of Solids," by

G. Bradfield, at 5.0 on December 8th at the Science Museum, London, S.W.7.

Institute of Physics

South Wales Branch.—Annual General Meeting followed by "Some Properties of Electrical Contacts," by Dr. A. Fairweather (Post Office Research Station) at 2.0 on December 6th at the University College of Swansea.

North-Eastern Branch.—"Some Aspects of Transistor Physics," by Dr. H. K. Henisch (University of Reading), at 6.15 on December 2nd at King's College, Newcastle-on-Tyne.

Radio Society of Great Britain

Annual General Meeting at 6.30 on December 9th at the Institution of Electrical Engineers, Savoy Place, London, W.C.2.

Radar Association

Ringstead Radar Station Reunion at 7.30 on December 2nd at Bedford Corner Hotel, Bedford Square, London, W.1.

Institute of Practical Radio Engineers

"Synchrophase," by member of the staff of the English Electric Co. at 8.0, on December 2nd at the Wheatsheaf Hotel, Market Place, Kingston-on-Thames.

CLUB NEWS

Birmingham.—The Annual General Meeting of the Birmingham and District Short Wave Society, which is the Birmingham Chapter of the British Short Wave League, will be held on December 8th. The Society meets on the second Monday in each month at the Colmore Inn, Church Street, Birmingham. Secretary: A. O. Frearson, 66, Wheelwright Road, Erdington, Birmingham, 24.

Birmingham.—Three members of the Slade Radio Society—M. Fowler, T. J. Hayward and G. Nicholson—will give a transmitting lecture at the meeting on December 5th. Meetings are held at the Church House, High Street, Erdington, on alternate Fridays at 7.45. Secretary: C. N. Smart, 110, Woolmore Road, Erdington, Birmingham, 23.

Coventry.—In addition to the fortnightly meetings of the Coventry Amateur Radio Society, which are held at the Y.W.C.A., Queen's Road, Coventry, at 7.30 on alternate Mondays, the Society organizes a "night-on-the-air" in the top band on the second Thursday of each month at 8.0. Secretary: K. G. Lines, 142, Shorncliffe Road, Coventry.

Peterborough.—A Brains Trust and a discussion on B.B.C. programmes are listed for the first two meetings of the Peterborough Radio and Scientific Society (G3DQW) for December. The Society meets each Thursday at 7.30 at its headquarters in St. Paul's Road, Peterborough. Secretary: S. Woodward, 72, Priory Road, Peterborough.

South Shields.—Meetings of the South Shields and District Amateur Radio Club are held each Friday at the Trinity House Social Centre, Laygate, South Shields, at 7.30. Secretary: W. Dennell, 12, South Frederick Street, South Shields.

Stockport.—In addition to the fortnightly meetings of the Stockport Radio Society on Tuesdays at the Blossoms Hotel, Buxton Road, Stockport, classes are now being held in preparation for the Radio Amateurs' Examination. The club membership is now 60. The next meeting is on December 9th. Secretary: G. R. Phillips, 7, Germans Buildings, Buxton Road, Stockport.

Reducing Fire Risks

New Method of

Safeguarding Receivers

By F. R. W. STRAFFORD,* M.I.E.E.

ACCORDING to a paper by H. W. Swann¹ there were 450 fires attributed to wireless sets for the year 1950, but the table from which this figure has been extracted gives figures of 1,132 for refrigerators, 1,092 for electric fires, heaters and radiators, and 2,250 for defective or overloaded wires and cables. When one considers the enormous number of sound and television receivers in operation compared, say, with refrigerators, the figure of 450 is not unduly alarming.

Nevertheless, the rate of increase from 1946 to 1950 is disturbing because the rate of increase due to electric heaters and faulty cables is low and shows evidence of decline, whereas the radio fires have risen steadily from 120 (in 1946).

It is customary to connect receivers to mains-outlet sockets which are backed by either 5- or 15-amp fuses according to the type of outlet used. The maximum current drawn by receivers rarely exceeds 1 amp, so that a sustained fault may not increase the current consumption to an extent sufficient to blow the house fuses, particularly when they are of 15-amp rating. In this event an unattended receiver constitutes a severe fire risk, particularly as it is often close to inflammable curtains or furnishings.

It should be remarked that the higher incidence of fire with electric heaters, refrigerators and faulty cables may be due largely to the fact that they are often unattended and may do their evil work when all are asbed. Most fires caused by electricity give early warning by pungent smells and smokes, thanks to the sulphur or phenol used in many insulators.

Since the television receiver is invariably attended, and the broadcast receiver generally so, except for neglect in switching off, the figure of 450 fires for 1950 must have arisen mainly from neglect. But neglect is the principal cause of fires, so that the set designer cannot ignore fire risk on the grounds that his is an "unattended" apparatus.

It is possible to design a receiver completely free from fire risk by removing inflammable materials. The cabinet could be pressed from metal and all compo-

nents could have ceramic insulation, and all wiring could be sleeved with non-inflammable insulants. Any transformers could embody heat-operated switches to clear circuits under overload fault conditions. Obviously the suggestion is impracticable because it is uneconomic and might easily treble the cost of the receiver. Nor is it possible to provide complete protection by the use of heat-operated switches. By "heat-operated" is meant that the switch opens its contacts when the ambient temperature of the surrounding air (or materials, if it is embedded) rises to a dangerous value. In other words, the switch is not current-operated but works by radiated or conducted heat.

The heat-operated switch may consist of a pair of springy contacts tacked together with a low melting-point eutectic bead, the spring being constrained so that they fly apart when the bead melts. An alternative method is to make one contact blade rigid and to use a bi-metal strip as the other blade. Bi-metal strip is made by welding together two rectangular blocks of dissimilar metals of greatly differing thermal expansion (e.g., steel and brass) and rolling the assembly through mills to the desired final thickness, finally slitting the

sheets to provide the desired strip width. On the application of heat the bi-metal flexes by curvature in the direction of the metal with the lower thermal expansion (Fig. 1).

The use of heat-operated switches is restricted to receivers operating through conventional mains transformers. This is because the transformer reflects the breakdown or overload of many other components in the circuits which follow it. It is only those components which give rise to increased currents when they fail which can introduce a fire risk, and increased current is reflected in the transformer as a rise in temperature which may operate a heat switch embodied in its windings.

It is possible to have a dangerous fault resulting in a fire in which a heat-operated switch would not work. In Fig. 2, for example, a mains-operated rectifying and smoothing circuit is drawing 113.5mA through the rectifier, of which 100mA is accounted for by the general load and 13.5mA by a subsidiary load comprising 22-k Ω and 2.2-k Ω resistors in series. The 22-k Ω resistor might be the effective anode to cathode

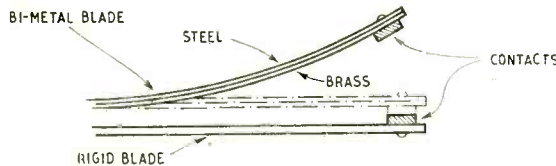
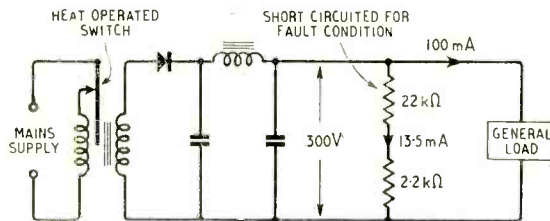

Fig. 1. Essentials of a simple bi-metal heat switch.

Fig. 2. A dangerous fault condition which may not operate the heat switch on the transformer.



* Belling & Lee.

¹ H. W. Swann, "Domestic Electrical Installations—Some Safety Aspects," *Proc. I.E.E.*, Vol. 99, Part II, p. 255 (1952).

resistance of a valve, the 2.2-k Ω resistor being used for biasing. It is assumed that the 2.2-k Ω resistor is rated at $\frac{1}{2}$ watt so that it is running within its rating. It is mounted upon a sheet Bakelite panel together with other components.

A fault condition arises which effectively short circuits the 22-k Ω resistor and the current rises to 135mA through the 2.2-k Ω resistor, an increase of nearly a hundred times the safe dissipation for it. But the current demand on the transformer has risen by a factor of approximately two, or four times the power. Owing to the thermal inertia of the bulky transformer it may be some minutes before the temperature rises high enough to operate the heat switch.

In the meantime the overloaded resistance, because of the degree of overloading and its low thermal inertia, bursts into flames and ignites the Bakelite panel which continues to burn after the resistor becomes destroyed and open-circuited by the overload. Fig. 3 is a photograph showing the result of an experiment based on the foregoing fault conditions and does not seem to warrant any further comment.

It should be remarked that resistors prone to this behaviour are of the carbon composition rod type which are unprotected. The type which are enclosed in a ceramic sleeve crack and become open-circuited before sufficient heat can be generated to ignite the Bakelite panel. This is probably due to the inequality of the expansion coefficients of the ceramic sleeve and the resistor rod, which may introduce internal stresses capable of causing a fracture.

Apart from building protective heat or current overload switches into every component, or designing them so that they cannot burn or set fire to neighbouring parts, it is impossible to allow for instances of this sort. But the example has been dwelt upon in case anyone may be misled into the belief that complete fire protection can be obtained by the use of one or two heat- or current-operated switches. A heat-operated switch placed in the roof of a receiver cabinet would be useless in such a case because the fire would be well under way before the excess temperature was conveyed to the switch. The switch would ultimately disconnect the mains supply, but not before the receiver was badly damaged. Nevertheless, a large proportion of faults, such as breakdowns of smoothing capacitors, will operate heat switches embodied in mains transformers, and they do materially reduce fire hazards wherever the transformer would have been the centre of combustion.

The simple fuse consisting of a filament of wire

Fig. 3. Burning of Bakelite panel by grossly-overloaded resistor : (a) the resistor before ; (b) after burning.

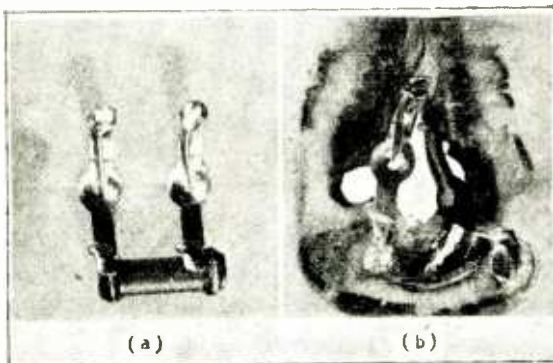

enclosed in a tube possesses the serious disadvantage of extremely low thermal inertia and is therefore sensitive to very brief current surges which are common in transformer and rectifier circuits. The writer discussed this problem at length in *Wireless World* some years ago.² Steps have been taken to improve the surge-carrying capabilities of fuses but it is still often necessary to use a higher rating than is actually required in order to avoid blowing on surges. In these circumstances a steady overload, while dangerous, may not clear the fuse before further damage or fire results. A new type of fuse, designed and used in the U.S.A. and on the Continent, consists of a heating element and a eutectic solder joint under spring tension, all enclosed in the conventional cartridge. This, however, is expensive to manufacture for consistent and reliable operation, and once blown, like all simple fuses, must be replaced.

The extensive use of a.c./d.c. technique in modern receivers still further complicates the fusing problem. The very short surges are largely removed but are replaced by longer surges (admittedly of lower amplitude) resulting from the "cold" resistance of the series valve-heater chain. Moreover, the use of metal rectifiers for h.t. supplies increases the capacitor charging surges through the smoothing circuits.

So simple fuses must still be chosen with care and must be overrated to avoid blowing on surges.

The term "cut-out" covers a very wide variety of thermo-mechanical or electro-mechanical switches whose duties may range from protecting fractional horsepower motors to power sub-stations supplying many thousands of kVA.

Cut-outs must not be confused with thermostats, which are regulating switches designed to maintain an operating temperature within close limits in spite of variations in ambient temperature. The cut-out is designed to operate on a dangerous thermal and/or current overload, and to remain open until the danger has passed. In some cases it is returned to its operating condition by hand; in others it automatically "cuts-in" depending on the application.

In general the cut-outs used in the electrical industry are fairly complicated and quite expensive when compared with the cost of a radio fuse plus its mounting arrangement. Allowing for the replacement of a few fuses over a period of years the cost of the cheapest cut-out for protecting a small motor is many times greater. On the other hand, the operating properties of cut-outs lend themselves ideally to radio and electronic circuit protection. For this type of application they have the following highly desirable features :

- (a) The ability to withstand momentary overloads of 30 to 40 times their rated current.
- (b) The ability to operate at high temperatures with and without current overload.
- (c) The ability to be reset after the fault has been cleared without the risk (as with fuse replacement) that an incorrect rating may be substituted.
- (d) A clear indication that they have opened (a fuse filament is often difficult to see and must be given some electrical continuity test).

The question remains whether these features can be retained when the cut-out is designed to operate on the lower current ranges from 100mA to 1 amp, and when its construction is miniaturized, and, most important, when it is made suitable for mass produc-

² F. R. W. Strafford, "Mains Transformer Protection," *Wireless World*, February, 1947, p. 51.

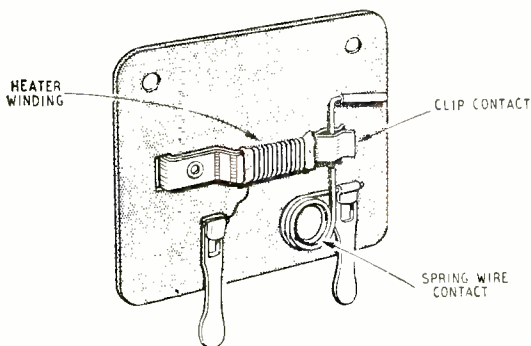

Fig. 4. Heat-operated overload cut-out designed for protection of receivers, shown slightly over actual size.

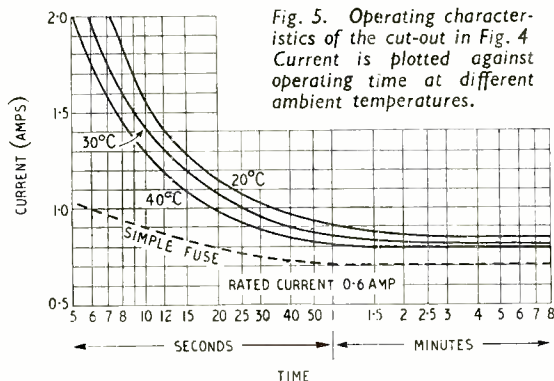

Fig. 5. Operating characteristics of the cut-out in Fig. 4. Current is plotted against operating time at different ambient temperatures.

tion techniques. It has been found possible to achieve these requirements in performance and size while maintaining something which can be produced economically.

Fig. 4 is a full-scale sketch of a simple cut-out* expressly designed for radio receiver circuit protection, but it has many other obvious applications in electronic equipments and instruments. The basic feature is the use of a contact strip constructed from a single piece of bi-metal strip folded back upon itself. It is folded so that the higher expansion metal is on the inner faces and the clip opens at its extremity upon the application of heat. The other contact is a piece of spring wire with a "safety pin" curl at its hinge. The straight portion engages in the clip and the end is bent over and carries a coloured sleeve to draw attention to a "cleared" fault. A heater winding wound over an asbestos former completes the device and is in series with the contacts. The initial pressure of the bi-metal clip and the amount of tension on the spring have been chosen to fulfil the following requirements:

(a) To remain in contact when carrying the rated current and subjected to bump and vibration tests in accordance with specification R.I.C.11.

(b) To remain in contact under normal rated conditions with surrounding temperatures up to 50°C—thereby making the operation independent of room temperatures ranging from a coal-less winter to a summer heat-wave!

The thermal inertia of the heater and bi-metal strip assembly is such that an overload of at least 40 times the rated current can be sustained without opening circuit or causing damage for a period of one-fiftieth

* Patent pending.

of a second. When a circuit protecting device is included in the primary of a mains transformer in a receiver overload currents of the above order and duration can occur, as pointed out in the earlier *Wireless World* article. Further, the thermal inertia also permits harmless overloads of a few hundred per cent which persist only for a few seconds.

The curves in Fig. 5 bring out these points, while the broken-line curve is that obtained by the use of a simple silver-filament fuse of the same rating, namely, 0.6 amp. For blowing times less than 5 seconds (not shown in Fig. 5) the overload required to operate the cut-out rises enormously as compared with that of the simple fuse which continues to rise fairly linearly until operating times of less than 0.5 second are reached. The curves show that, while the ambient temperature has a slight effect upon the normal operating conditions up to about 60 seconds, the curves begin to close up at the longer times, that is, under normal "no fault" conditions.

The cut-out must also be capable of dissipating considerable spark energy, for it may often be used in a d.c. circuit including a fairly large inductance, for example, a smoothing inductance of 30 henries. The breaking of such a circuit will produce a large back e.m.f., and unless a wide separation of the contacts is effected at high speed an arc is likely to strike and hold with disastrous results to the contacts. These considerations have been taken into account in the design, and 200 mA of d.c. at a pressure of 350 volts can be interrupted through a 30-henry choke without damaging the contacts.

It is possible to achieve a range of ratings for the cut-out between 100 mA and 1 amp with a dissipation as low as 0.3-0.4 watt in the heater winding. When a number of the cut-outs are required this dissipation is an important matter. But when one remembers that the general run of equipments have power consumptions of anything from 25 watts upwards, it will be seen that the dissipation is reasonably small.

It is important that the cut-out be compact and preferably flat so that it may be fixed in a chassis tray or otherwise made inaccessible to the unskilled user. It would be manifestly unwise to place a device with obvious resetting facilities in an accessible position. Preferably, it should be placed close to the component it is most likely to operate in the event of breakdown, as this will assist the servicing technician in tracing the fault quickly. It is likely to be used in direct association with mains transformers, reservoir and smoothing capacitors, and possibly in the cathode circuit of certain valves where high peak-to-peak anode currents occur and there is a greater possibility of a breakdown.

The question of where to introduce the cut-outs into

Fig. 6. Useful positions for two of the cut-outs in an a.c. d.c. receiver circuit.

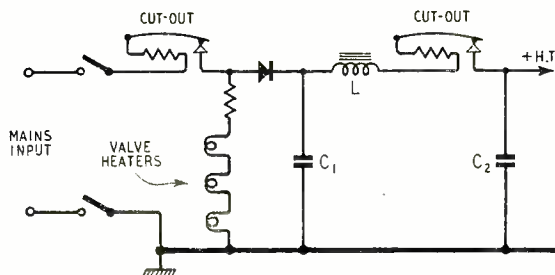

a circuit is rather difficult to answer. As a rough guide, the mains input circuit, backed by 5- or 15-amp household fuses, must be given first consideration. A fair proportion of major faults are reflected as a moderate rise of current in this circuit, particularly in a.c./d.c. techniques or where a mains transformer of good regulation (low internal resistance) is used. Reservoir and smoothing capacitors for the h.t. supply are vulnerable points and must not be overlooked. The e.h.t. supplies to cathode ray tubes are not so serious because of the low currents involved and the poor regulation of the associated circuits. Thus, a fair degree of protection may be afforded by a single cut-out in series with the mains input, while a considerable improvement may be effected by another one in series with the h.t. smoothing capacitor.

Fig. 6 is part of the basic circuit of an h.t. supply to a broadcast receiver, based on a.c./d.c. technique, in which two cut-outs are included. The one in series with the mains supply will cope with a short circuit of the rectifier or the reservoir capacitor C, individually or collectively. The one in series with the smoothing choke, L, will be actuated by a short circuit of the smoothing capacitor, C₂, or any excessive load caused by component short circuits which can reflect 100 per cent or more current overload into the cut-out winding. The example shown in Fig. 2 and described in the text would be an exception. Provided that care is taken in the selection of such vulnerable components and their positioning with respect to inflammable materials the fire hazard due to their breakdown will be small, possibly negligible.

Flat Television Magnifier

More Efficient Utilization of Screen Area

By N. A. de BRUYNE,* M.A., Ph.D., F.Inst.P.

LORD RAYLEIGH showed that there are circumstances in optical instruments where there is no need to magnify much or even at all in one plane† and that there may be an unnecessary loss of light by so doing.

With this in mind it occurred to me that the use of a conventional magnifying lens in front of a television screen was not perhaps the best way of obtaining an enlarged image. It would be preferable to increase the height of the real image on the screen by adjustment

of the controls and then to place a cylindrical lens in front of this distorted image. In this way the circular screen could be used efficiently with a wide angle of view in a vertical plane.

Fig. 1 (a) shows the image on the screen of a 9-in diameter tube with a picture of aspect ratio 4:3 and dimensions 7.5in wide and 5.6in deep. As will be seen the circular screen is not very efficiently used. A square picture of a 7.5-in side as shown in (b), in which the corners lie outside the screen, will give an increase of twenty per cent in the area used and hence in the total light output from the screen. Admittedly the corners of the picture are lost, but in all

* Aero Research, Ltd.

† Scientific Papers, Vol. V, 1902-1910, p. 442. published by Cambridge University Press, 1912.

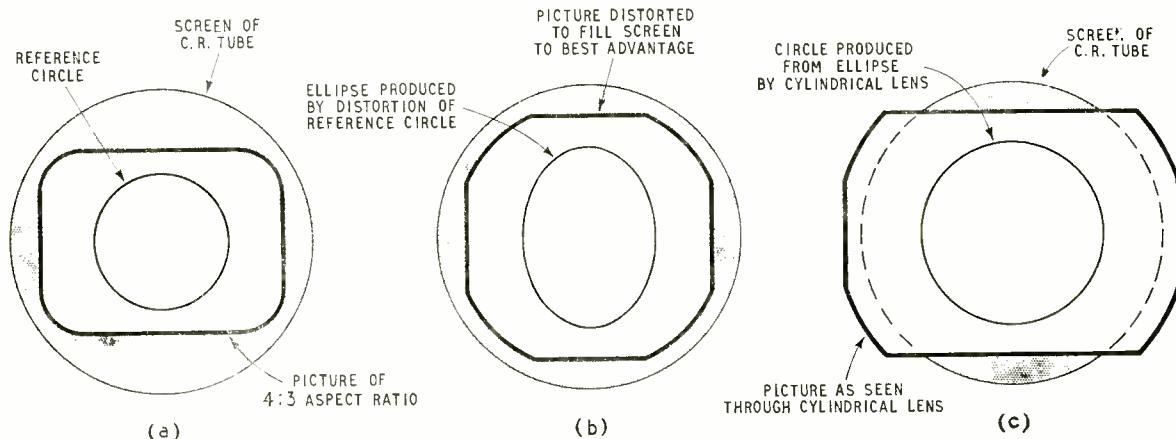
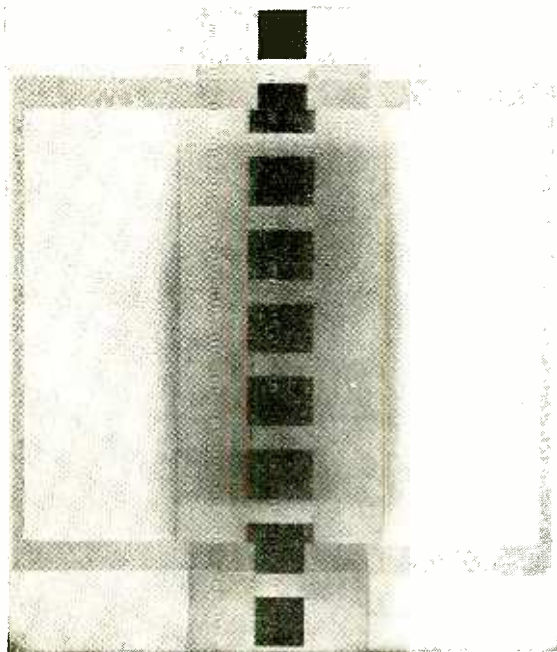

Fig. 1 Illustrating the action of the magnifier. (a) The picture as normally displayed, with a circle drawn to represent a circular object in it. (b) The picture has been distorted by the height control into a square with rounded corners, and the circle has become an ellipse. (c) The distortion is removed by horizontal magnification and the picture is now seen as in (a) but enlarged.



Left: Fig. 2 Experimental plano-convex cylindrical lens partially filled with liquid paraffin.

Below: Showing the effect of the flat magnifier on a line of 1-in black squares. The enlargement is in the horizontal direction only and it draws the squares out into rectangles of approximately 4:3 aspect ratio.



direct viewing receivers the corners are rounded off by a mask anyway.

In the square-shaped image the picture will be distorted and the familiar clock face will appear elliptical. To restore the picture to its correct aspect ratio it is necessary to put a cylindrical lens in front; or in more general terms to view the picture through a suitably astigmatic optical system. This lens will absorb light, but one always uses a protective screen to guard against implosion so there need be no additional loss due to it. The effect of the cylindrical lens is to give a virtual image 10in wide by 7.5in deep, as shown in Fig. 1 (c).

Initially I used a plano-convex cylindrical lens made of Perspex sheet cemented with a glacial acetic acid and filled with liquid paraffin, as shown in Fig. 2. This is quite easily made as the Perspex has only to be bent to a single curvature as compared with the double curvature of an ordinary magnifying lens. I used a saucepan of about six inches diameter as a pattern round which to form the front sheet. This cylindrical lens gave satisfactory results but is rather clumsy.

A far better method is to use a Fresnel lens made as a flat sheet. Such a lens was made for me by Techne (Cambridge), Ltd., of Duxford, Cambridge, and it has all the properties of a cylindrical lens. It consists of a large number of parallel rulings on the surface of a $\frac{1}{8}$ -in sheet of Perspex, each ruling being

a narrow prism. It is in fact a stepped cylindrical lens similar in principle to a lighthouse lens. Each prism is 0.4mm wide and its angle corresponds to that of an equivalent cylindrical lens of plano-hyperbolic shape. Since the edges of these prisms are invisible at distances greater than about twelve inches, one is unaware of the presence of the vertical rulings and the effect is the same as though one were looking through a smooth cylindrical lens.

ARMY EMERGENCY RESERVE

TO ensure that a man's peace-time skill will be used to the best advantage by the Army in an emergency, the Supplementary Reserve has been reconstituted as the Army Emergency Reserve. Units of the A.E.R. are raised on a trade or "skill" basis and not territorially as is the case with the Territorial Army, and there is no provision for regular training other than a 15-day camp each year. Elsewhere in this issue we publish a letter from the Officer Commanding the Army Wireless Reserve Squadron formed to enlist the services of radio amateurs and others with operating and technical experience. At present the age limits for enlistment are 18-42 and the period of service varies from two to four years. There is a bounty of £9 p.a. for Other Ranks, and in addition, allowances at ordinary army rates and travelling expenses for the annual camp.

It is also planned to form a Wireless Reserve Pool, for which there is no training, and, therefore, no bounty. Particulars of the Wireless Reserve and the Pool are obtainable from the Commandant, Col. R. H. Copeland, H.Q., A.E.R., Royal Signals, Blacon Camp, Chester.

The A.E.R. is also in need of technicians to maintain radar and other electronic equipment in R.E.M.E.

Information about all sections of the A.E.R. and methods of joining can be obtained from any Army Recruiting Office or from the War Office (AG10), London, S.W.1.

Manufacturers' Literature

Constant-frequency A.C. Supply, using a crystal oscillator, frequency dividers and amplifier to give a 50-c/s output stable to within 0.001 per cent. Three models are available, with outputs of 10, 50 and 100 watts. Described in a leaflet from Radio-Aid, Ltd., 29, Market Street, Watford, Herts.

Small Soldering Iron (weight 4oz) with adjustable bit described briefly in a leaflet from Kenroy, Ltd., 152, Upper Street, London, N.1.

Flexible Coaxial Cables; double braided type for preventing leakage at high frequencies and non-microphonic type for reducing parasitic voltages generated by flexing and vibration. Characteristics and nominal dimensions of both types given in a leaflet from The Telegraph Construction and Maintenance Co., Ltd., Telcon Works, Greenwich, London, S.E.10.

Transmitting Capacitors for medium- and high-power working; constructed on ceramic tubes with glazed rims for reducing voltage gradients and corona losses. Technical Bulletin No. 26 from The Telegraph Condenser Co., Ltd. (Radio Division), North Acton, London, W.3.

Television Aerials and accessories; a catalogue of loose leaflets from Wolsey Television, Ltd., 75, Gresham Road, Brixton.

Hermetically Sealed Terminals; wire terminal posts sealed into metal mountings by insulating globules of glass. Various shapes and sizes listed in a booklet "Glass-Metal Seals" from The Edison Swan Electric Co., Ltd., 155, Charing Cross Road, London, W.C.2

Sapphire Gramophone Needles; discussion of their characteristics and brief descriptions of four new IM types: "standard" for insertion at an angle, "trailer" for vertical insertion, "miniature" for light-weight pickups and "microgroove" for 33 $\frac{1}{3}$ -r.p.m. long-playing records. Leaflet from Alfred Imhof, Ltd., 112-116, New Oxford Street, London, W.C.1.

Crystal Microphones; a catalogue giving specifications and response curves of their most popular types from Ronette, Piezo-Electric Industry N.V., Amsterdam, Holland.

Microphony in Superhet Oscillators

By H. STIBBÉ,* A.M.Brit.I.R.E.

Part I—What Causes It

SINCE the advent of the superheterodyne receiver in the 1930s the greater sensitivity and adjacent channel selectivity of domestic receivers, particularly on the short wave bands, have considerably increased the risk of microphony. In particular, oscillator microphony tends to be very troublesome. The degree of freedom from oscillator microphony which will be achieved in production cannot be predicted at all accurately during the design period, but by taking suitable precautions in the design the amount of work and modification necessary during the development period can be very considerably reduced. Unless proper precautions are taken there is a real danger that the mechanical design of the receiver may have to be revised at a time very close to the start of production, and, indeed, it may prove impossible to achieve the required degree of freedom from oscillator microphony in time for production.

Mechanism of Microphony

Before attempting to devise ways and means of reducing oscillator microphony, it is obviously essential to understand its mechanism. Consider a constant-amplitude unmodulated r.f. signal at the aerial terminal of the receiver. The resulting i.f. signal produces a constant d.c. voltage at the output of the diode detector. The magnitude of this voltage (if the signal is large) is directly proportional to the amplitude of the i.f. signal producing it.

A typical i.f. response curve (measured at the control grid of the frequency-changer) is shown in Fig. 1. If the receiver is not quite correctly tuned, as may easily happen on the short wave bands, especially if the local oscillator drifts in frequency, then an ordinate erected on the incorrect i.f. so produced may intersect the curve on one or other of its flanks. If the oscillator is now frequency modulated to an extent such that its maximum frequency excursion does not cause the i.f. produced to move beyond the head of the curve of Fig. 1 there will be an alternating voltage superimposed on the d.c. output of the detector at the same frequency as the modulating signal, due to the i.f. amplifier and diode detector together acting as a frequency discriminator or demodulator. The a.c. component of the detector output will be fed to the speaker after amplification. If the frequency is within the range capable of reproduction by the speaker, a sound of this frequency will be emitted. If the sound energy vibrates a component in the oscillator circuit whose position determines the frequency of the oscillator, then this will cause frequency modulation of the oscillator at the same frequency as that of the original source of frequency modulation. And if the acoustic feedback

is such that the resulting frequency modulation is in phase with that already produced (by the original source) then the frequency modulation will be sustained, provided that the feedback to the frequency-determining component of the oscillator circuit is sufficiently large.

If this is the case the original source of frequency modulation is not required, and whenever the receiver is switched on and suitably detuned from the r.f. carrier there will be a sustained a.f. output from the speaker. This is the phenomenon of oscillator microphony.

Methods of Prevention

The prevention of oscillator microphony may be achieved either (a) by preventing the i.f. amplifier and detector from acting as a frequency discriminator or by reducing their sensitivity as such, or (b) by reducing the feedback between the speaker and the frequency determining component(s) of the oscillator circuit.

Since the sensitivity of the discriminator formed

* Bush Radio, formerly Philips Electrical (Mitcham Works).

Fig. 1. Typical i.f. response curve measured at the control grid of the frequency-changer.

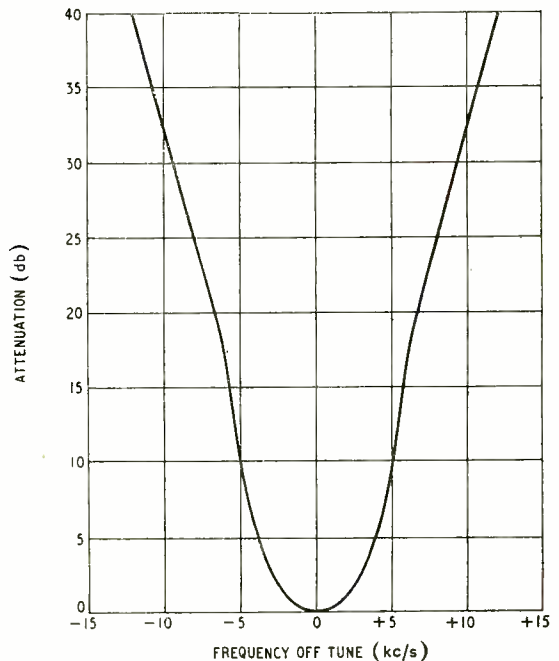

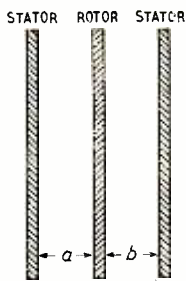

Left: Fig. 2. Representing a rotor plate and its two adjacent stator plates in a tuning capacitor.

Right: Fig. 3. Graph showing how the capacitance of a rotor plate to its adjacent stator plates varies with the position of the rotor plate.

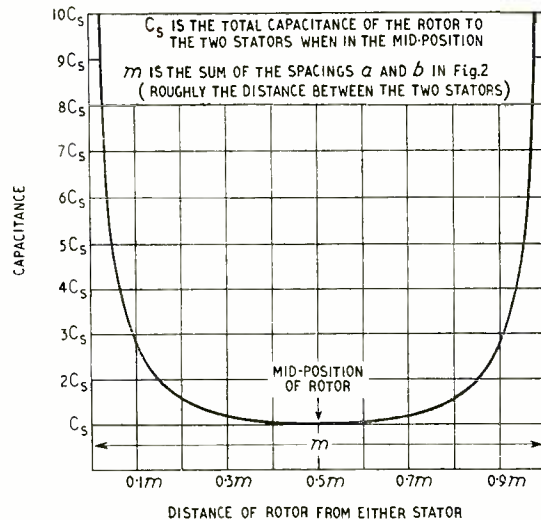

by the i.f. amplifier and detector is proportional to the slope of the flanks of the overall i.f. response curve, microphony can be reduced by decreasing this slope. This, however, would worsen the adjacent channel selectivity and can hardly be recommended as a cure, except that the shape of the flanks should be made no greater than is necessary to obtain the required adjacent channel selectivity.

The slope of the curve flanks in an over-critically coupled i.f. amplifier is equal to that of the same amplifier with the same inductances, capacitances and Q-factors in the transformers but using critical coupling. As is well known, the head of the response curve of an over-critically coupled i.f. amplifier is broader (for a given reduction in gain, say 3 db) than that of a critically coupled amplifier, and double-humping occurs. The use of such an amplifier does not reduce microphony once it starts, but the oscillator has to drift (or be detuned) further than with the critically coupled amplifier in order to bring the ordinate of the incorrect i.f. produced to a position where it will intersect the steep flank of the response curve. If the oscillator drift can be kept small enough the use of an over-critically coupled amplifier may prove to be an advantage. In such an amplifier the coupling factor of the transformers should be made as high as possible, consistent with not making the trough in the response curve too deep, so that the peak separation is large; then a relatively large amount of drift is required to provoke the receiver into microphony.

Susceptible Component

The component which is perhaps the most susceptible to microphony in the oscillator circuit is the tuning capacitor. Vibration of either the rotor or stator plates will cause changes in its capacitance. Consider any one rotor plate and the two adjacent stator plates with the notation of Fig. 2. If the stators are fixed the sum of the distances a and b is constant and independent of the position of the rotor between the stators. Let $a + b = m$. The capacitance of two parallel plates is k/d , where k is a constant determined by the area of the plates and the permittivity of the medium separating the plates, and d is the distance between the plates. Then the capacitance of the rotor plate to the stator plates is

$$C = k \left(\frac{1}{a} + \frac{1}{b} \right) = k \left(\frac{1}{a} + \frac{1}{m-a} \right)$$

$$= \frac{km}{am - a^2}$$

It is obviously desirable that the rate of change of C with respect to a be a minimum in the interests of

freedom from microphony. Equating $\frac{dC}{da}$ to zero, we have

$$\frac{dC}{da} = \frac{km(m-2a)}{(am-a^2)^2} = 0$$

$$\therefore m = 2a$$

This shows that the best position for each rotor is exactly midway between the adjacent stators. Fig. 3 is a graph of the total capacitance of a rotor plate to the two adjacent stator plates as a function of the distance from the rotor to either of the two stators; the m is the sum of the distances from the rotor to each of the two stators as in Fig. 2. From Fig. 3, we can see that for one complete cycle of oscillation of the rotor about its position of rest, when this position is exactly midway between the adjacent stators, there will be two complete cycles of capacitance variation. Therefore there will be two complete cycles of frequency modulation, thus producing at the output of the detector a signal whose frequency is twice that of the rotor excitation. However, it is quite safe to say that in practice the rotor plates are never exactly centrally spaced between the stators, and from Fig. 3 it will be seen that for each cycle of vibration of the off-centred rotor there will be one cycle of capacitance, and hence frequency variation, and sustained microphony may be set up.

The frequency of the microphony due to the vibration of the rotor plates is their mechanical resonant frequency, which is often of the order of 2kc/s. Should the split end vanes (used for law adjustment in manufacture) be instrumental in producing microphony they may vibrate at a rather higher frequency, but it is difficult to determine from just the frequency whether it is the end vanes or the others which are vibrating.

We will now consider the order of capacitance change required on the short wave band to alter the oscillator frequency by a few kc/s. Suppose a receiver is tuned to a signal of frequency 6Mc/s, and the i.f. is 470kc/s. The oscillator frequency will be 6.47Mc/s. In order to cause detuning of the oscillator by 6.47kc/s (1 part in 10^3) the change in tuning capacitance must be 2 parts in 10^3 . Assuming a total tuning capacitance of 500pF, the required change is

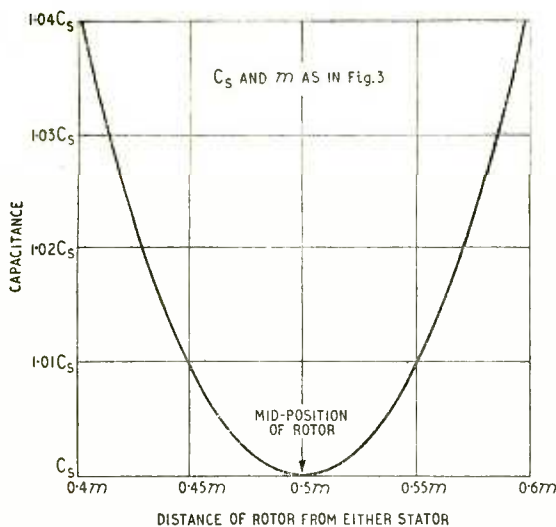

Fig. 4. Small portion of Fig. 3 drawn on a larger scale to show the rapidity of capacitance change as the rotor is decentred.

1pF. When it is realized that the order of the distance separating a centrally spaced rotor plate from the adjacent stator in a typical tuning capacitor is 0.01in, it will be appreciated that only a very small plate movement is required to produce a change of 1pF in the capacitance.

The order of magnitude of this movement will now be examined. If each rotor plate is asymmetrically spaced only to the extent that it is 0.009in from one adjacent stator and 0.011in from the other, the total capacitance will be

$$C = Nk \left(\frac{1}{11} + \frac{1}{9} \right) = \frac{20.2 Nk}{100}$$

where k is a constant and N is the number of stator plates (when the outside plates of the capacitor are both rotors). For an increase of 0.2% in the total capacitance, if all the rotors move identically

$$C = Nk \left(\frac{1}{a} + \frac{1}{20-a} \right) = 1.002 \frac{20.2 Nk}{100} = \frac{20.24 Nk}{100}$$

where a is the spacing (measured in thousandths of an inch) between each rotor and its nearest stator.

$$\begin{aligned} \therefore \frac{20}{20a - a^2} &= \frac{20.24}{100} \\ \therefore a &= 10 \pm 1.089 \end{aligned}$$

For a decrease of 0.2% in the capacitance

$$\begin{aligned} \frac{20}{20a - a^2} &= \frac{20.16}{100} \\ \therefore a &= 10 \pm 0.89 \end{aligned}$$

Thus with the spacings of 0.009in and 0.011in from each rotor plate to each of its adjacent stator plates respectively, a movement of all the rotor plates towards the nearer stators of 0.000089in and a movement away from them of 0.00011in will produce a frequency modulation of approximately 6.5kc/s when the receiver is tuned to an incoming signal of 6Mc/s. A small portion of Fig. 3 is redrawn on a larger scale in Fig. 4

to show the rapidity with which $\frac{dC}{da}$ increases as the rotor plates are decentred by even a small amount.

These calculations are not presented with the idea of calculating with any exactness the magnitude of the physical movements of the plates. This is not practicable, for some plates may be spaced asymmetrically by greater or larger amounts than those chosen in the example given; moreover some plates may be spaced asymmetrically in opposite directions from others, and may vibrate with different amplitudes. The calculations serve only to illustrate the extreme susceptibility of the tuning capacitor in producing sustained oscillator microphony.

(To be concluded)

Micro Switches

SWITCHES operated by very light pressure or by a very small movement or by a combination of both have come to be known colloquially as "micro switches." In the case of the range made by Bulgin, which are based on the design of the Acro snap switches made by the Acro Manufacturing Co. of America and interchangeable with this make, they are known as micro-sensitive switches.

The unusual mechanism employed enables the switch to be operated with as little as $1\frac{1}{2}$ oz of pressure and with a movement as small as 15 thousandths of an inch, yet the switches are robust and capable of handling quite large currents, up to 10 A if necessary.

Every switch is basically a single-pole two-way and it can be used as on/off, off/on or changeover. Heavy silver contacts are fitted and all spring leaves are made of beryllium copper.

Briefly, the mechanism of the switch is that an insulated stud A compresses a spring leaf B and after a small movement an intermediate spring C, held under tension by contact with the leaf D, snaps down and causes the two electrical contacts E and F to fly apart. In so doing the moving contact E snaps hard against the other fixed contact G. Release of the pressure reverses the sequence.

Various schemes have been evolved to translate rotary, oscillating and sideways movements of the actuating bodies into the limited up-and-down motion necessary to operate the switch; levers, cams, rollers and other devices being pressed into service, thus enabling the switch to be used for a multitude of functions.

A wide range of models are made, covering requirements of high or low current and voltage, light or relatively heavy operating pressure and large or small travel of the actuating stud.

The makers are A. F. Bulgin & Co., Ltd., Bye-Pass Road, Barking, Essex.

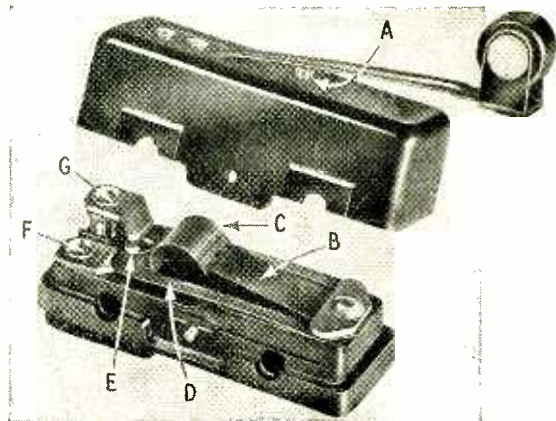

Internal mechanism of the Bulgin micro-sensitive switch.

Soldering Technique

Abstract of a Technical Paper Dealing with Industrial Methods

MANY interesting details on solder and soldering are given in a paper* read at the Australian Institution of Radio Engineers earlier in the year. Being unable to attend in person yet wishing to retain the personal touch the author recorded the address and sent it to Australia for reproduction at the meeting. As its title implies, the paper deals with industrial soldering and in particular the technique used in the British radio industry, though all users of soldering irons will find in it much of general interest and instruction. A knowledge of the characteristics and qualities of the materials and tools employed cannot fail to make soldering more interesting and improve the quality of the work.

Correct selection of the tools for every job is important and soldering is no exception. Quite early in the paper consideration is given to the various types of soldering irons and the advantages and disadvantages are discussed at some length of electrically-heated types, heating by gas or electric muffles and gas-heated irons.

Bit Temperature

The correct temperature of the copper bit is often overlooked, or dismissed too casually, but not so in this paper. It has an important bearing on the life of the bit and incidentally the iron itself. Excessive heat radiated from the iron can be very distressing to the user especially over long periods of time.

For most radio production purposes it seems that a bit temperature of about 40 deg C above the liquidus, or free-flowing temperature, of the solder is a satisfactory target. This information is not always available, since the usual custom is to rate irons on the basis of the watts consumed, and it is explained in the paper that different irons of the same wattage can show very wide variations in bit temperature.

When dealing with one of the more undesirable effects of bit temperature, the author says . . . "More harm has been done to components such as resistors and condensers by using too low a bit temperature than a too high one. If a low bit temperature is used there is a tendency to keep the iron on the component much too long so as to obtain a satisfactory joint, with the result that the heat is conducted down the wire to the vital part of the component." The use of thermal shunts is not discussed but perhaps these useful devices are a little too clumsy for assembly-line production.

The melting point, or more strictly speaking the solidus, of all tin-lead solders is given as 183 deg C . . . "but there is a variation in the plastic range of 43 deg C between the solidus and liquidus of alloys having tin contents between 60 and 40 per cent. Incidentally, when quoting alloys the tin content is always mentioned first.

"It is practicable in radio and television assembly to

use any alloy having tin contents between 63 and 40 per cent. No useful purpose is served in using an alloy having a higher tin content than 63 per cent because such an alloy has a higher melting point than 63/37. At first glance it would seem that the 'ideal' alloy to use would be the eutectic, that is 63/37 alloy. The eutectic alloy has no plastic range, it changes instantly from solid to liquid at 183 deg C whereas all other alloys have a variation between the solidus and liquidus temperatures." Liquidus state is the free-flowing condition.

When comparing the qualities of the different usable alloys for solder the standard one nearest to the eutectic, namely 60/40, is said to be the one most commonly used in England by the radio industry since it has the lowest melting point, but as the author says . . . "As the cost of tin is five to seven times that of lead, there is obviously good reason for considering the use of the lower tin content alloys than 60/40. Providing sufficient bit temperature is available there is no reason why an alloy having as low as 40 per cent tin cannot be used. One manufacturer using 40/60 alloy states that the average consumption of 18 s.w.g. is one ounce of solder per two hundred joints." It should be understood that throughout this paper all references are to the flux-cored solders.

Against any economy effected by the use of a lower tin content it has to be remembered that lead is the heavier constituent, so that with more lead the total amount of solder wire in a pound by weight is less than with a higher tin content. This is an important point well brought out in the papers. For example, it is stated . . . "for 16 gauge in 60/40 alloy 98 feet to the pound is obtained, whereas in 40/60 the length is 91 feet to the pound. This means that for the lower tin content alloy 7 feet of solder is lost."

An interesting sidelight on the use of widely dissimilar alloy solders is seen in the following passage . . . "For some soldering purposes where it is required to make two joints to opposite ends of a tag at different times and there is a possibility of the solder on the first joint being melted when the second joint is made the difficulty can be overcome by using pure tin for the first joint and a standard tin/lead alloy for the second. Alternatively, if careful technique is observed a 20/80 alloy could be used for the first joint."

The use of solder with coloured fluxes is mentioned in passing, it being said that some advantages can be found where part of the sub-assembly is done by sub-contractors and the final assembly by the main constructor. Coloured fluxes enable the final inspection to establish responsibility for specific joints.

A great deal of useful data has perforce had to be omitted from this brief synopsis, but it is hoped enough has been said to give some idea of the scope and nature of the paper. Soldering is a much-neglected, but all-important, subject.

Printed copies of the transcription can be obtained from Multicore Solders Ltd., Multicore Works, Maylands Avenue, Hemel Hempstead, Hertfordshire.

*"Considerations of Soldering Technique in Radio and Television Assembly." by Richard Arbib, Multicore Solders Ltd.

Two-Range Test Oscillator

By H. B. DENT

New Approach to the Problem of Switching Radio-Frequency Circuits

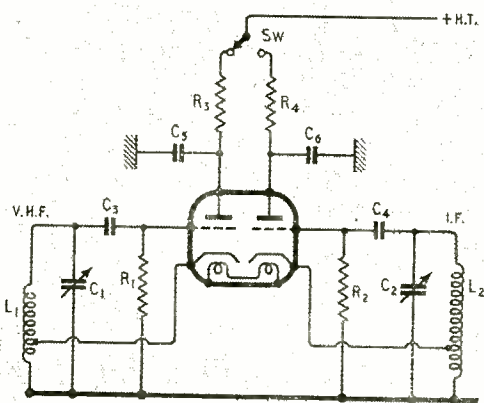

Fig. 1. Basic circuit of the double-triode two-range oscillator.

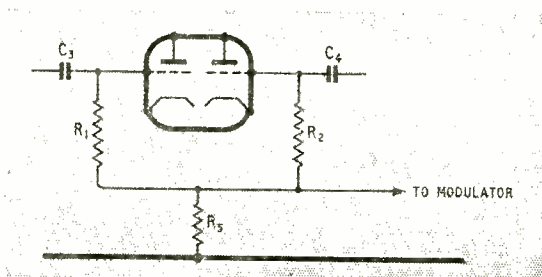

Fig. 2. Method of applying modulation to the double-triode oscillator.

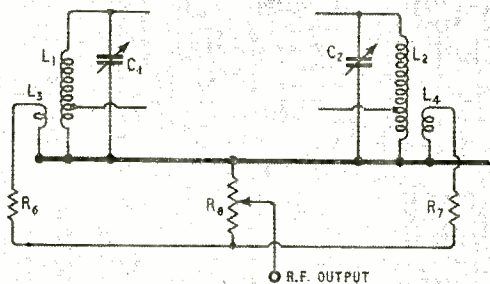

Fig. 3. R.F. output circuit of two-range oscillator which obviates switching.

WHILST thinking over the design for a simple two-range modulated test oscillator and wondering how best to arrange the band switching—for one range had to cover 100 Mc/s and the other 10 Mc/s—the idea emerged to use a double-triode valve with each section functioning as a separate oscillator and for range selection switch the h.t. supply to the appropriate anode. The basic idea is shown in Fig. 1, where L_1C_1 is a v.h.f. oscillator and L_2C_2 an i.f. oscillator and the two tuning capacitors C_1 and C_2 are the two sections of a split-stator variable capacitor.

A single tuning dial serves for both ranges and the actual frequency scales can, if desired, be marked directly on the dial, one half accommodating the 100-Mc/s band and the opposite half the 10-Mc/s one.

Duplication of parts may seem extravagant, but the total number is small and the range switch a simple

Some idea of the compactness of the unit is obtainable from this view.



single - pole changeover toggle, whereas for switching the actual r.f. circuits a low-capacity ceramic wafer type, or something similar, would have to be used. Thus the ultimate cost is very much the same in both cases, but the double triode scheme has the advantage that it permits a more satisfactory layout of the r.f. circuits.

Tone modulation was required and of the several ways in which it could be applied that shown in Fig. 2, which is a simple form of grid modulation, is adopted. The grid leaks R_1 and R_2 of the two oscillators are connected to a common resistor R_3 , one end of which is connected to the earth line and the modulating signal applied across this resistor. It has the advantage that no switching is required apart from an on-off switch for the modulator and this is in the h.t. supply to the valve.

Switching is avoided also in the output circuits of the oscillators by employing a small pick-up coil coupled to each oscillator, L_3 and L_4 , in Fig. 3, and connecting them, via isolating resistors R_6 and R_7 , to

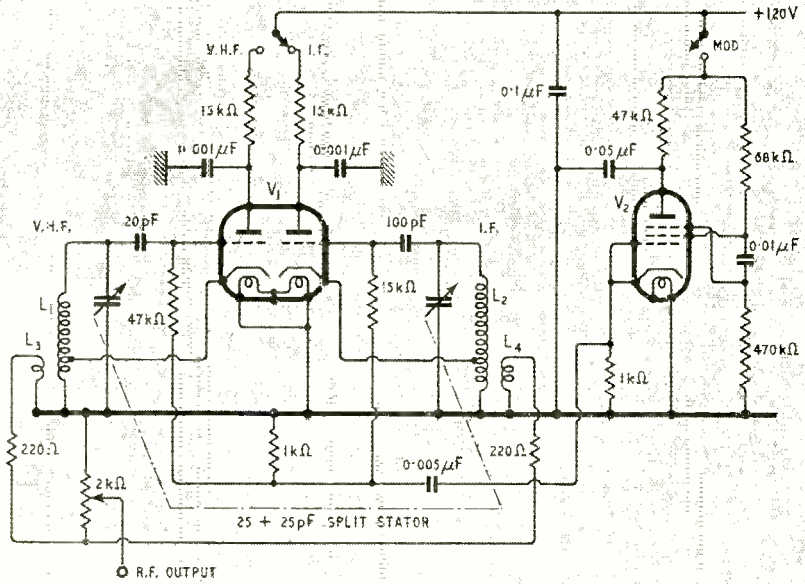
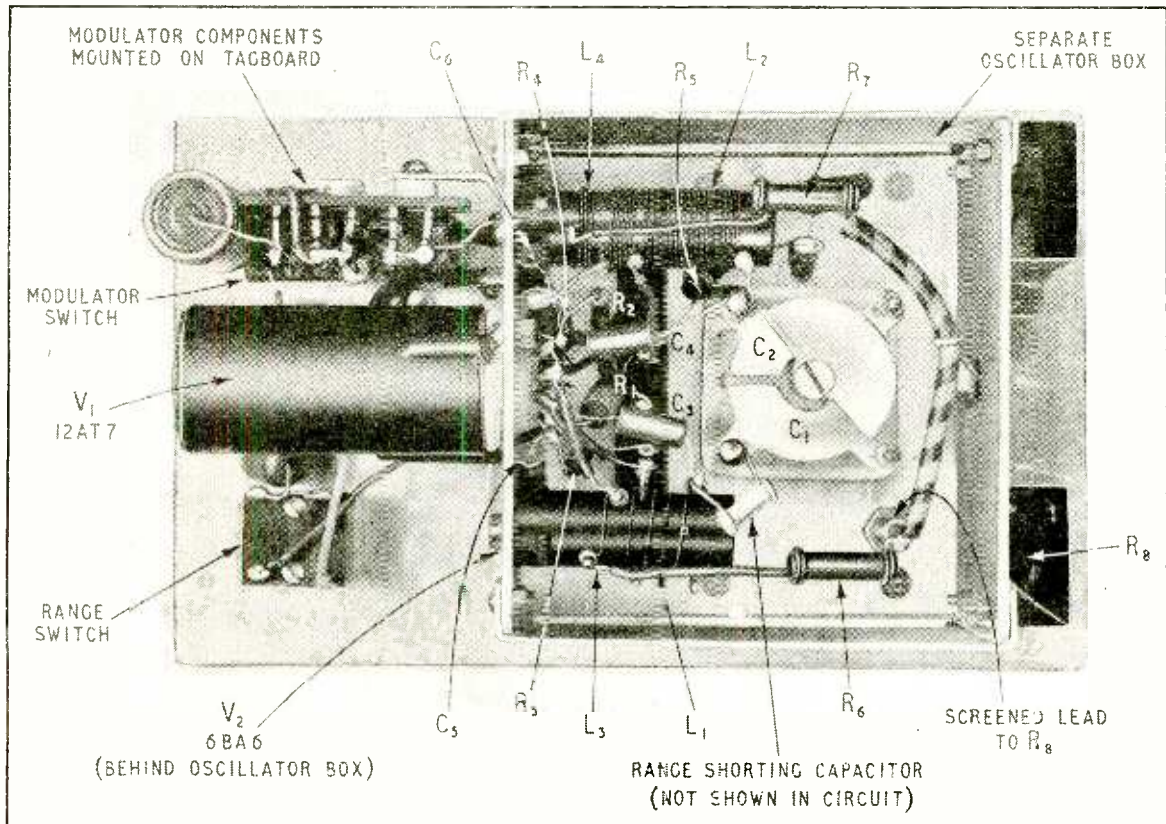
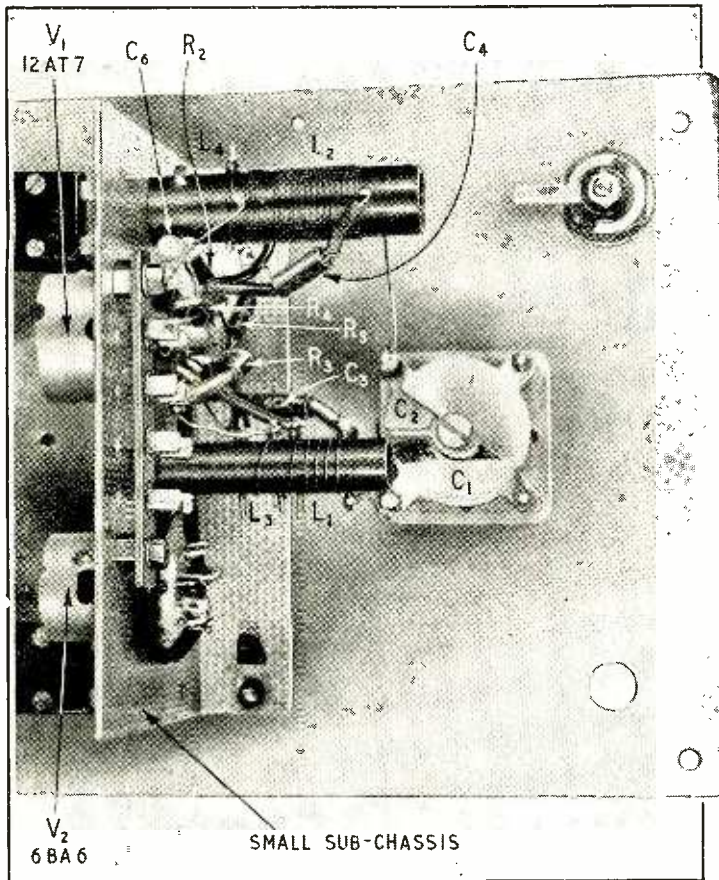

Fig. 4. Complete circuit diagram of the two-range oscillator and transistor modulator.

In this model the r.f. oscillator is separately screened. Modulator valve (not shown) is between this box and the panel. An insulated coupler is used for the two capacitors. The tag board to the right of the oscillator valve carries the modulator components.





Partially built alternative unit with modulator and oscillator valves side by side on a small sub-panel. R.F. oscillator not separately screened.

Fig. 5. Details of the coil assemblies $L_1 L_3$ and $L_2 L_4$ for a 100-Mc/s v.h.f. range and a 10-Mc/s i.f. range. Hardwood formers of $\frac{1}{2}$ in dia shellacked before and after winding can be used in place of Paxoline tubes.

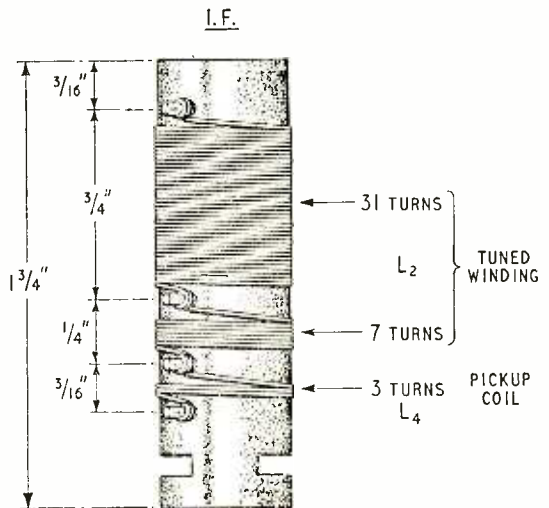
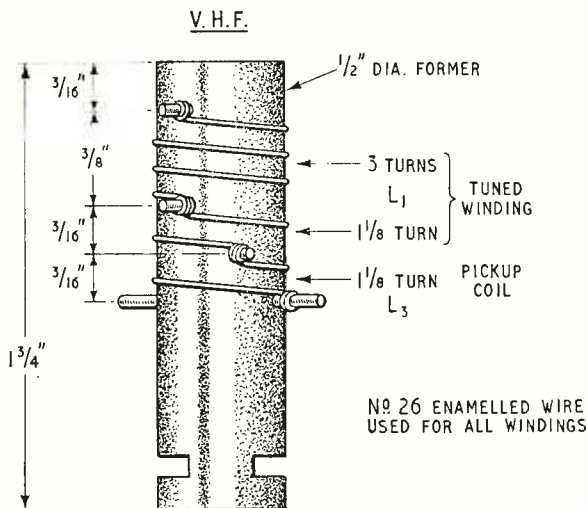

a potentiometer output control R_8 , which is common to both ranges.

No attempt has been made to fit a calibrated attenuator, although apart from the difficulty of making one that behaves rationally at 100 Mc/s with limited facilities, there is no reason why some device of this kind should not be employed.

The oscillators and the modulator are required to fit into a small metal box measuring 7 in \times 4 in \times 5 in deep, and it is necessary therefore to avoid the use of bulky items and employ miniature parts throughout. A small enough iron-cored coil was not available at the time, so a type of a.f. oscillator was sought that did not require a large inductance. A satisfactory substitute was found in a resistance-capacitance transitron arrangement. Coupled with the use of miniature valves and tuning capacitor no difficulty is found in housing the unit in the aforementioned sized box.

The power supply is not included with the oscillators as it is considered more economical to use a separate power unit and operate various items of test apparatus from a common source having several output sockets.

For the oscillators a Brimar 12AT7 valve is used, operated at 6.3 volts l.t. and about 80 to 90 volts h.t. The tuning capacitors C_1 and C_2 are the two sections of an Eddystone miniature ceramic insulated "Microdenser" of 25 \pm 25 pF. This capacitor measures

$1\frac{3}{8} \times 1\frac{3}{8}$ in square and $1\frac{1}{2}$ in deep and fits in well with the general scheme. The only disadvantage is that the capacitance is rather small for some purposes; for example, one 25-pF section will not quite cover the whole television band, generally taken as 40 to 70 Mc/s for test equipment, and the most that can be expected is 40 to 60 Mc/s or 47 to 70 Mc/s, whichever part of the band happens to be the more useful.

A miniature valve is used also for the modulator, in this case a Brimar 6BA6 which has a B7G base. The

12AT7, by the way, has a B9A base now sometimes called a "Noval."

The full circuit of the modulated oscillator is given in Fig. 4 and a few details of the two coil assemblies, L_1 and L_3 for a v.h.f. coverage of 70-110 Mc/s and L_2 and L_4 for an i.f. coverage of 8-11 Mc/s in Fig. 5.

Calibrating an oscillator of this kind needs care and no little patience; while harmonics of crystal-controlled oscillators will give a reliable and accurate calibration it is not always easy to identify them accurately. When it is remembered that a crystal-controlled oscillator will generate usable harmonics up to the 100th or more this difficulty becomes understandable. Moreover, not only do harmonics of the crystal oscillator produce beats with the fundamental frequencies of the variable oscillators, but they can produce beats also with harmonics of the variable oscillators. These possibilities have to be watched carefully and it is essential therefore to have some other means of checking the frequency, even though the alternative aid is approximately accurate only. Its accuracy need be no more than sufficient to differentiate between any two adjacent harmonics of the crystal-controlled oscillator.

A short wave receiver, or the short wave range in a broadcast receiver, will generally suffice for the i.f. range, but the v.h.f. range cannot be quite so easily dealt with. If it happens to be the television band no great difficulty will be experienced as at least two fixed points can always be found if a television set is available. If not, a simple converter must be made up which will receive, in conjunction with any handy existing set, the nearest television station.

This could also be done in the case of the 100-Mc/s range within about 50 to 60 miles of Wrotham, Kent, and two fixed points will again be available. These should enable the crystal oscillator's harmonics in this region to be located and identified. A crystal of about 1.5 to 2 Mc/s will be quite useful for calibrating and if one of 500 kc/s is available also, so much the better.

A useful aid, and one which prevents any ambiguity in identifying the crystal oscillator's harmonics, not directly but via the variable oscillator, is an absorption wavemeter. The Eddystone model has been found particularly useful for these purposes as its upper limit is 160 Mc/s. An absorption wavemeter is the only device of its kind, in a simple form, that does not respond to harmonics of an oscillator direct, but registers only on its fundamental frequency. Therefore, when endeavouring to identify harmonics of the crystal oscillator the harmonic must first be made to beat with the fundamental of the variable oscillator and the frequency of the latter checked against the absorption wavemeter. Response to harmonics is possible with fairly strong oscillators and transmitters but here we are concerned with low-power stages only.

BUS-BELL INTERFERENCE

AS is well known, the electro-magnetic system of a bell or buzzer functions as a surprisingly effective transmitter when deliberately connected to an aerial. It also acts as a producer of heavy interference when it happens that the associated wiring acts fortuitously as a good radiator. Oscillations are produced by the discharge across the contact points of the very considerable voltage built up across the

magnet winding, and are transferred to the external wiring.

It appears that conditions for strong radiation often exist on motor omnibuses and trolley buses, where serious interference with television reception is caused by the familiar stop-start bell.

According to A. P. Hale, of Belling and Lee, the suppression of bus-bell interference is not particularly difficult, but no one kind of treatment is necessarily suitable for all cases. The methods advocated are:—

- (a) Isolation of the bell from its external radiating wiring by r.f. chokes.
- (b) Removal of the higher harmonics by connecting a capacitor across the contact points.
- (c) Prevention of undue rise in voltage across the magnet winding.

The last-mentioned method is stated to be generally the most effective and also the simplest and cheapest. A non-inductive paper-dielectric capacitor of 1 or 2 μ F is merely connected across the magnet winding by means of the shortest possible leads. A word of warning is, however, necessary when a high note buzzer is used instead of a bell; too high a value of shunt capacitance may unduly lower the note.

Short-wave Conditions

Predictions for December

THE full-line curves given here indicate the highest frequencies likely to be usable at any time of the day or night for reliable communications over four long-distance paths from this country during December.

Broken-line curves give the highest frequencies that will sustain a partial service throughout the same period.

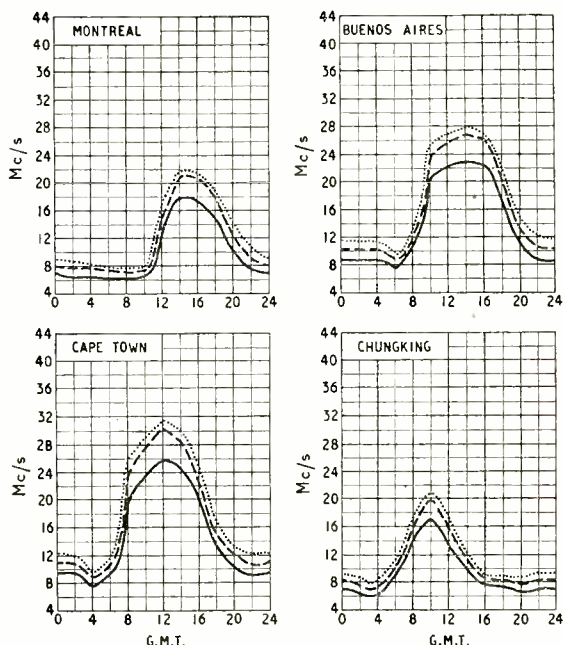

— FREQUENCY BELOW WHICH COMMUNICATION SHOULD BE POSSIBLE ON ALL UNDISTURBED DAYS
 - - - PREDICTED AVERAGE MAXIMUM USABLE FREQUENCY
 FREQUENCY BELOW WHICH COMMUNICATION SHOULD BE POSSIBLE FOR 25% OF THE TOTAL TIME

Control desk for the low-level modulation transmitter at Kirk O'Shotts.



Low-Level Modulation

Greater Efficiency from High-power Television Transmitters

WHEN the Wenvoe television station begins to radiate its full 50 kilowatts of vision signal some time towards the end of this year, the B.B.C. will have completed its plan for giving us four new high-power television transmitters. Superficially these transmitters all look alike, and, indeed, one might assume from the way they have sprung up within a year or so of each other that they are all of the same standardized design. Actually, they represent quite an interesting schism in the technical world—the old controversy of high-level modulation versus low-level modulation. Sutton Coldfield and Holme Moss use the first kind, while Kirk O'Shotts and Wenvoe have the second, so there is quite an effective “balance of power,” if not in terms of actual kilowatts.

It may be that the B.B.C., with typical impartiality, arranged this state of affairs deliberately, but more likely it came about accidentally: at the beginning high-level modulation was the only thing possible, then subsequent technical developments made it seem

that low-level modulation might be better. At any rate both systems are now equally represented, and the B.B.C. is regarding the situation as a kind of competition between them—rather like the competition between a.m. and f.m. that was staged at Wrotham.

When the Carrier Carries

The terms “low-level” and “high-level” modulation probably do not mean very much to the average radio man. They really refer to the particular level of carrier in the transmitter's chain of r.f. amplifiers at which the modulating signal is introduced. At Sutton Coldfield and Holme Moss, for example, Fig. 1(a), the modulating vision signal is introduced at the very highest level possible—at the output stage in fact—whereas at Kirk O'Shotts and Wenvoe (b) it goes in at low level soon after the crystal oscillator.

This means that in (a) the vision signal has to be amplified up to considerable power before it can

Fig. 1. Simplified block diagrams of (a) the high-level modulation transmitters at Sutton Coldfield and Holme Moss, and (b) the low-level transmitter used at Kirk O'Shotts and Wenvoe.

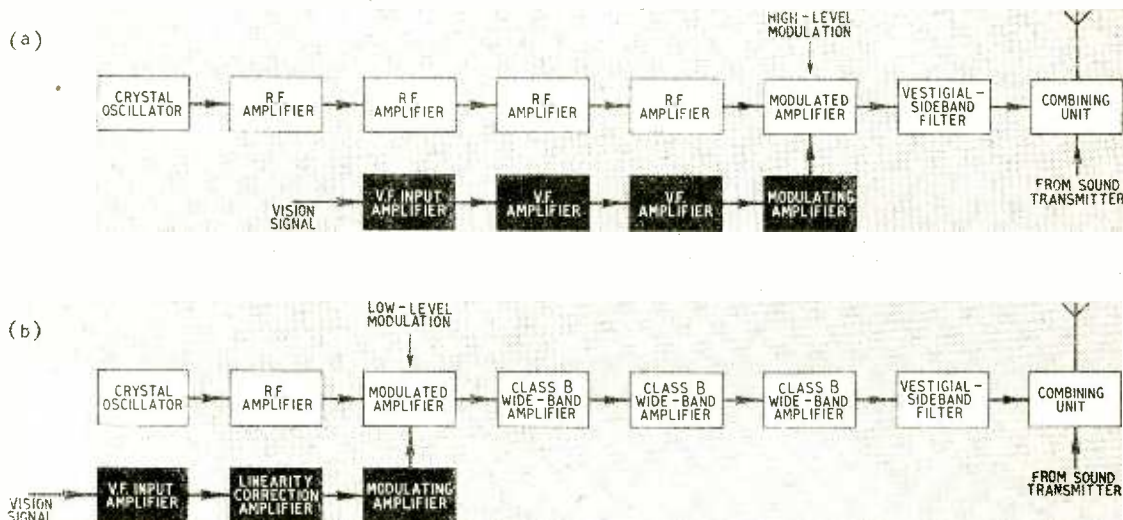

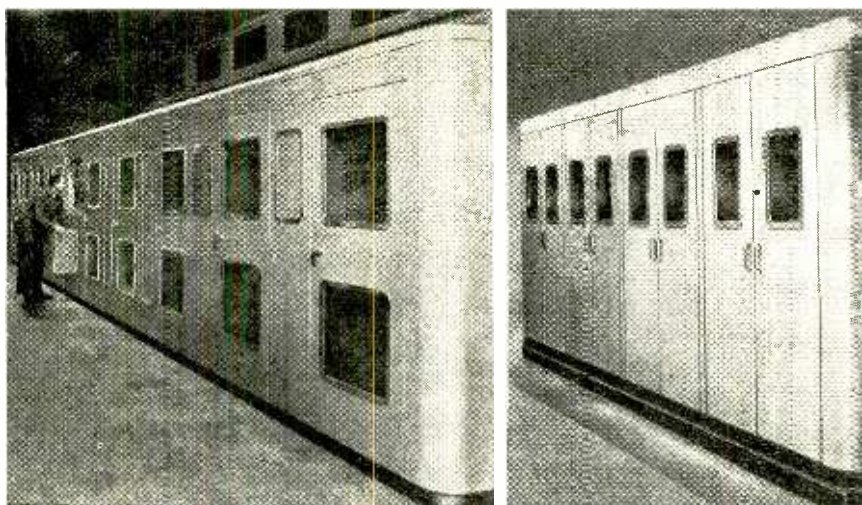

Fig. 2. Showing the difference in size between the vision transmitters at Sutton Coldfield (left) and Kirk O'Shotts (right).

modulate the transmitter and a chain of increasingly large valves is necessary; whereas in (b) very little power is needed for modulating the transmitter at the low-level point and receiving-type valves can be used. And, of course, the power supplies needed for the modulating chain in (a) are very much bigger—electrically and physically—than those for the receiving-type valves in (b). Consequently the transmitter with high-level modulation is necessarily a somewhat larger and more expensive affair than the one with low-level modulation. What the actual difference in size amounts to can be seen from the comparison of the Sutton Coldfield and Kirk O'Shotts vision transmitters in Fig. 2. Kirk O'Shotts, with the considerably greater output power, is only a little over half the size of Sutton Coldfield.

Another significant thing to note from Fig. 1 is that in the high-level system the main chain of r.f. amplifiers only has to amplify a fixed unmodulated carrier frequency, whereas in the low-level system it has to deal with a modulated carrier and sidebands—in fact a band of frequency several megacycles wide. This means that the amplifiers in (b), which are Class B, incidentally, have to be not only linear but wide-band amplifiers—a requirement that involves quite a number of problems in design, construction and maintenance. The chief trouble seems to be in lining up the inter-valve couplings and eliminating various resonances and selective feedback circuits which affect the response at sideband frequencies. For this reason the low-level system has acquired a reputation for being somewhat critical in adjustment—but it has other advantages to set against this.

The Electricity Bill

Perhaps the most important advantage is its greater efficiency as a machine for converting raw electricity into radiated power. The transmitters at Kirk O'Shotts and Wenvoe, for example, only require 2 kW from the mains supply for every kilowatt of peak-white r.f. power they radiate, but the high-level ones at Sutton Coldfield and Holme Moss need almost 4 kW. To the average radio man, who doesn't have to worry much about the amount of electricity his equipment is consuming, this may not seem very important. But to the B.B.C., whose television electricity bill runs

into tens of thousands of pounds per annum, it represents a considerable saving in running costs. In fact, it is probably the main reason why low-level modulation was adopted for the later transmitters.

Thus the real advantage of the low-level system is in its lower cost—lower initial cost because of the reduction in size and lower running cost because of the increase in efficiency. Apart from this, the system is more adaptable when it comes to designing

transmitters of different output powers—all one has to do is to add or take away a few more wide-band r.f. amplifiers. As for the possible unreliability of the wide-band amplifiers, that may well be balanced by the greater reliability which comes from having fewer high-power valves and fewer high-voltage power supplies.

The two low-level transmitters were built by Electric and Musical Industries, and are identical in design as well as in principle. The modulated amplifier, Fig. 1(b), uses a pair of ACT26 air-cooled

Fig. 3. Output stage of the Kirk O'Shotts vision transmitter, showing the water-cooled BW165 valves (left) and the output feeder (right).

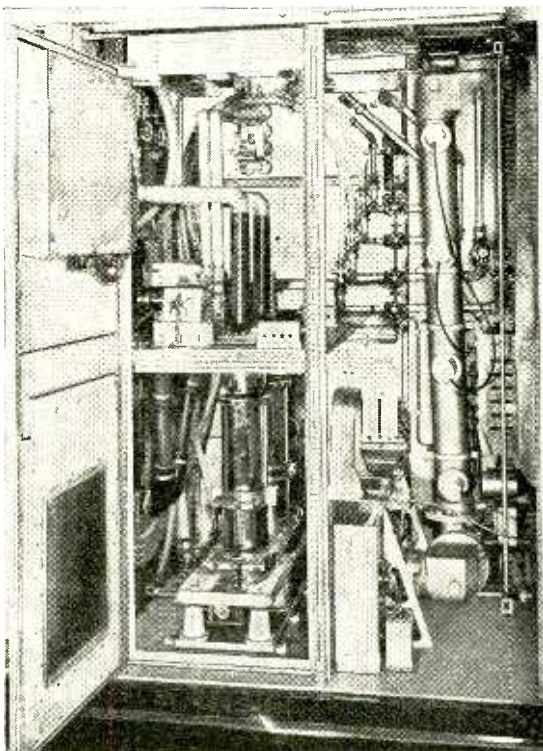

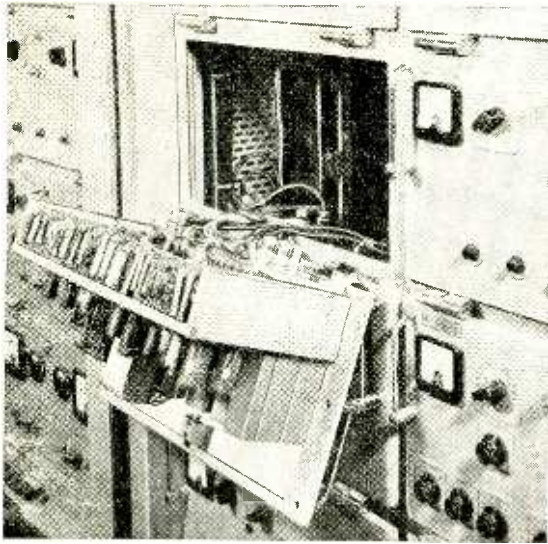

Fig. 4. One of the small amplifiers in the modulating unit at Kirk O'Shotts lowered for inspection.

triodes, which operate in push-pull with earthed grids and give an output of about 600 watts peak white. The three wide-band amplifiers following it are also of the earthed-grid push-pull type. The first uses a pair of ACT27 air-cooled triodes giving an output of 3 kW, the second a pair of ACT26s giving an output of 12 kW, while the third, the output stage, has a pair

of BW165 water-cooled triodes giving an output of 70 kW peak white (Fig. 3). The high emission of these BW165 valves, made possible by thoriated-tungsten filaments, is the main reason why Kirk O'Shotts and Wenvoe have a higher output power than the earlier transmitters. In fact, we understand that the output power could be raised to the region 80-100 kW if necessary.

As mentioned above, the modulating amplifier chain uses receiving-type valves throughout (Fig. 4). It consists of a three-stage d.c. amplifier, a linearity correction amplifier, and an amplifier with a cathode-follower output delivering 200 V peak-to-peak to the grids of the modulated amplifier.

At the input of this final video amplifier the black level of the vision signal is finally clamped—and here we have another difficulty associated with low-level modulation. Because this final clamping is done so far away from the transmitter output, there is some danger that the actual transmitter black level will vary as a result of fluctuations in the chain of wide-band r.f. amplifiers. The difficulty is overcome, however, by a feedback system which measures the black level at the output of the transmitter and injects a correcting signal into the vision circuits. This also helps to reduce any mains hum introduced by the wide-band r.f. amplifiers.

The sound transmitters at Kirk O'Shotts and Wenvoe are of conventional design and were built by Standard Telephones & Cables. Modulation is applied at the anodes of both the penultimate and final r.f. stages. The transmitters use air-cooled valves throughout and have an output of 18 kW at 100 per cent modulation.

TELEVISION BOOSTER STATION

Fringe Area Repeater

INEXPENSIVE equipment providing the means for extending the range of a television transmitter into fringe areas has been developed by E. K. Cole Ltd., and used experimentally under G.P.O. licence for the past few months in Essex. Intended for installation at a vantage point in the area to be served, the equipment retransmits the received sound and vision signals on different frequencies, and with a change of polarization, providing a first-class service over an area of approximately 150 sq miles. The change of frequency—to that of a distant station—and of polarization allows direct reception of the original transmission to be continued in the locality without interference. The experimental station, which is installed at the Water Tower, Hadleigh, operates in the Kirk o' Shotts channel.

The equipment at the booster station is housed in a 4ft high rack containing a pair of high-gain receivers, frequency-changer units, low-level amplifiers and sound and vision transmitters.

It is claimed that the quality of the retransmitted signals suffers no appreciable deterioration in the process. Although the experimental equipment operates on 405 lines it can, of course, be adapted to operate on other transmitting standards.

In the top section of the 4-ft rack is the vision transmitter below which is the sound and vision input and frequency conversion units followed by the sound transmitter and the power unit.

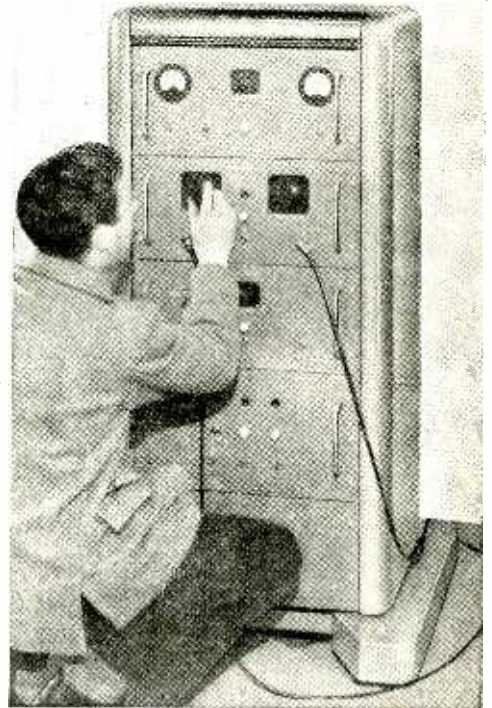

Electron-Coupled Oscillators

Explaining How They Keep the Frequency Stable

By "CATHODE RAY"

JUDGING from published information, there is a good deal of confusion about electron-coupled oscillators. It seems that some people are under the impression that the characteristic feature of an electron-coupled oscillator is the "live" cathode tapped up the oscillator coil as in Fig. 1. A still commoner impression is that in this type of circuit, with the second grid functioning as the oscillator anode, the coupling to the actual anode is electronic only and does not involve the oscillator tuning circuit. Still another confusion is about the advantage of this type of oscillator. There would probably be agreement that the main object of the arrangement is constancy of frequency, but whereas some would say that the idea is to keep the frequency from being affected by changes in the output (anode) circuit, others would say that it is to keep the frequency from being affected by changes in h.t. voltage. Perhaps most of us are not too clear which particular enemies of constant frequency it is aimed at, or how it combats any or all of them, but have a vague impression that it is the circuit to use when one wants the frequency to stay where it is put.

The origin of the electron-coupled oscillator is generally traced to a paper by J. B. Dow in *Proceedings of the Institute of Radio Engineers*, December, 1931. So it is interesting to note that the Fig. 1 cathode tapping is not to be seen in any of the circuits in that paper. Not all oscillator circuits with this feature are electron-coupled, and not all electron-coupled oscillator circuits have this feature. That is one fallacy disposed of. Next, Dow described how this class of circuit can be made to keep the frequency constant against variations in h.t. voltage, and also against variations in output circuit; but some of the electron-coupled circuits used now—and particularly

pentode circuits—cannot achieve both of these advantages at once. Then most of those who explain that in electron-coupled oscillators the anode is coupled to the oscillator only through the electron stream passing through the second grid illustrate their remarks with a circuit of the Fig. 1 type. They seem not to have noticed that to get back to the cathode this same electron stream has to pass through the output circuit and part of the oscillator circuit in series, as shown more clearly in Fig. 2. Is one therefore safe in assuming that nothing one does with the output circuit can affect the oscillator circuit?

Let us begin at the beginning and assume we want a stable-frequency oscillator that we can do things with; it may be a master oscillator for a transmitter, or a signal source for making tests. Obviously we will shut up the tuning circuit in a metal screening box to prevent it from being influenced by the movements of hands and other objects around. But if the oscillations are to be used in any way there must be some connection with the outer world. This connection must be strictly one-way; nothing that happens in the outer world must be allowed to change any capacitance or inductance forming (intentionally or otherwise) any part of the oscillator tuning circuit. So inductive or capacitive coupling is definitely out. The obvious one-way link is a valve. Just any valve won't do, of course; a triode has quite enough capacitance between anode and grid for adjustments in the anode circuit to alter the total capacitance of the grid circuit. A screened valve stage, such as is used for r.f. amplification, is all right. Because the primary purpose of this one-way stage is to protect the oscillator from the influence of the output circuit rather than to amplify it is called a buffer stage.

The thrifty experimenter, always on the lookout for

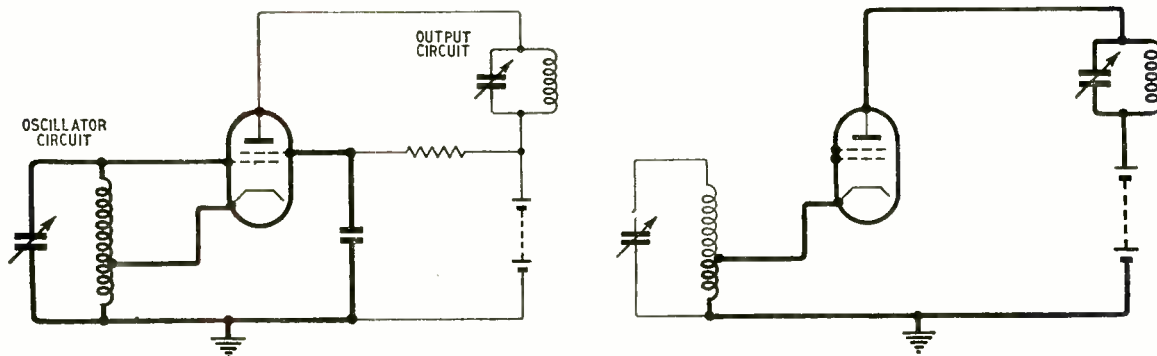

Left: Fig. 1. One variety ("live cathode") of electron-coupled oscillator. In this and the diagrams of other varieties (Figs 3 and 4) the oscillator part of the circuit is emphasized, and only the bare essentials are shown. Right: Fig. 2. The output part of Fig. 1 emphasized, to show how it includes part of the oscillator tuning circuit.

opportunities to make one valve do the work of two, naturally grudges a whole valve merely as a buffer. Dow pointed out that by taking appropriate precautions a single valve can be made to combine the duties of oscillator and buffer stage. The ordinary oscillator circuit won't do, because both input and output (grid and anode) are parts of the oscillator system, so anything attached at the anode end is more than likely to shift the frequency. Dow's scheme, which is the basis of electron-coupled oscillators, is to use another grid as the oscillator anode. What is actually called the anode need not then form part of the oscillator circuit, yet the current through it is varied at oscillatory frequency by the other electrodes. Provided that the valve is of such a kind that changes in anode potential don't affect current in the electrodes used for the oscillator, and that the anode can be screened off from the oscillator, it is suitable. The oscillator is connected in a one-way manner to the output circuit by the stream of electrons through the valve, much as a policeman can connect himself in a one-way manner to a rioter by a stream of water from the fire hose he is holding. Anything the rioter does with the water at his end has no effect on the policeman.

Use of a Tetrode

Dow used a tetrode, with the cathode and the two grids as a conventional earthed-cathode triode oscillator, and took the output from the anode (Fig. 3). Since the second grid in this arrangement is at oscillating potential, the capacitance between it and anode would have spoiled the system by its two-way action if Dow hadn't balanced it out by neutralization. This is a technique that was much used in the 'twenties, before screened valves had superseded it, to overcome back-coupling through anode-to-grid capacitance. Most of the present generation of radio enthusiasts may not even have heard of it, and since it is obsolete I will not confuse the issue by going into its details—they can be found in the older textbooks. And in any case Dow went on to point out that if a pentode is used, as in Fig. 4, there is no need for neutralization, because the suppressor grid (g_3) is an earthed screen between oscillator "anode" (g_2) and the output anode (a).

Fig. 4 is more convenient to use than Fig. 3 plus neutralization. But it sacrifices an advantage obtainable with Fig. 3. For reasons that are rather too involved to turn aside to examine here, the frequency of oscillation is slightly affected by the h.t. voltage. In a tetrode it is shifted one way by an increase in anode voltage and the opposite way by an increase in g_2 voltage. If the same increase is applied to both, the g_2 effect overbalances the a effect, but by feeding g_2 from an adjustable potential divider across the h.t. supply the two effects can be equalized so that they cancel out, and this setting holds good at least approximately over a reasonable range of h.t. voltage fluctuation. This may save the cost of a voltage stabilizer, which is even more worth while than using an electron-coupled oscillator instead of a separate buffer stage. Unfortunately, a balance point is not obtainable with the pentode oscillator.

I hope I have managed to make these two quite different frequency-stabilizing devices clear. Using a circuit of the Fig. 3 type, elaborated by a pre-set potential divider across the h.t. source for g_2 supply, one can stabilize the oscillator frequency against h.t. voltage fluctuations; but it is not a pure electron-

coupled oscillator as it stands, because there is coupling back from output to oscillator circuit via the g_2 -a capacitance. Dow got over this by neutralization, which necessitates another and far more tricky pre-set adjustment, so is not popular. His alternative type, Fig. 4, is very good as an electron-coupled system protecting the frequency of oscillation from anything that may be done in the output department, but not to the fullest extent from variation in h.t. voltage.

Output Circuit Variations

Since then the earthed- g_2 (Fig. 1) type has appeared. (The capacitance between g_2 and earth is made large enough to offer negligible impedance at the frequency of oscillation.) When used with a tetrode, as here, it offers the advantage of stabilization against h.t. variations, if a potential divider is substituted for the series resistor feeding g_2 . But what about variations in output circuit, caused, say, by tuning or other adjustments? Currents at oscillation frequency are flowing there, and they set up corresponding voltages at the anode, their amplitude and phase depending on the amount and nature of the output circuit impedance. Since g_2 is firmly tied to earth it cannot be affected by these voltages through inter-electrode capacitance. And for the same reason it acts as a screen for g_1 and the cathode, so all points of the oscillator circuit are protected. Valve characteristic curves show, however, that g_2 current is determined to some extent by anode voltage, so presumably the g_2 oscillatory current in this oscillator will be determined to some extent by the nature of the output circuit. But in a tetrode it

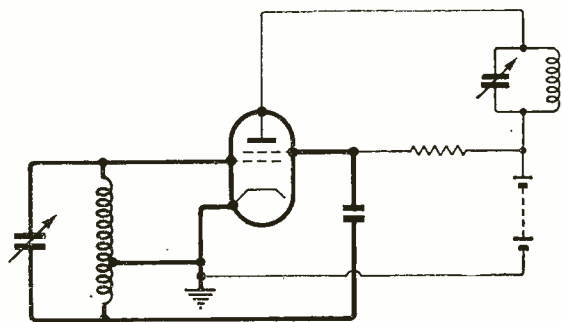

Fig. 3. Dow's original earthed-cathode tetrode electron-coupled oscillator circuit, drawn for comparison with Fig. 1, and omitting the necessary capacitance neutralization.

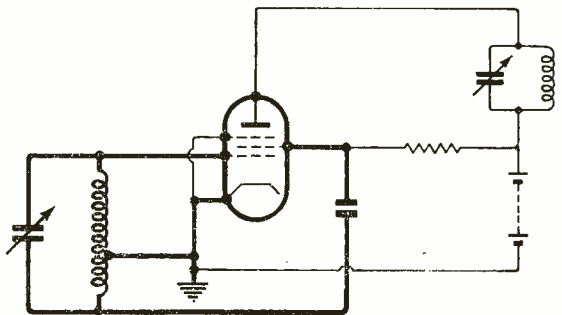

Fig. 4. Pentode variety of Dow's electron-coupled oscillator, needing no neutralization.

is a very small extent, and in a pentode it is a smaller extent still, so a pentode is usually preferred to a tetrode in Fig. 1. Incidentally, it gives better capacitance screening too, or alternatively permits the earthed-cathode arrangement of Fig. 4, but at the sacrifice of h.t. voltage compensation as we have just seen.

Lastly, if the oscillating-cathode (Fig. 1) arrangement is adopted, what about the scare I raised at the start—about the output circuit and the lower part of the oscillator tuning circuit being in series (Fig. 2), so that adjustments of one affect the other? Well, theoretically at least, this can cause unwanted frequency variations. The oscillator current produced in the anode circuit has to get back to the cathode, and in this arrangement it undoubtedly can only do so by passing through part of the oscillator tuning circuit. As already mentioned, the amplitude and phase of this current depends on the output circuit impedance. In particular, tuning it through resonance swings the phase rapidly from leading to lagging, or vice versa. Now if a leading current is added to the normal current in the oscillator tuning circuit, it is equivalent to adding capacitance to that circuit; and a lagging current is equivalent to inductance. (This is the basis of the "reactance valve" in automatic tuning correction systems.) So one would expect to find that the frequency of oscillation would vary as the output circuit tuning was adjusted in the neighbourhood of resonance. Since this danger is not mentioned in the books that deal with electron-coupled oscillators I thought I had better check it by experiment before saying too much about it.

Measuring Frequency Disturbance

I used the circuit shown in Fig. 5 (a), tuned to oscillate at a nominal 1 Mc/s, so that frequency fluctuations in c/s would also be parts in 10^6 , which is the usual basis for comparing them. Actually it was tuned to give an audible beat with the carrier wave of Hilversum (1.007 Mc/s) which presumably could be relied upon to stay constant within about 1 c/s. This audible beat was compared with a calibrated audio oscillator, so that any changes in it could be measured fairly accurately. The output circuit was made a little less lively by the 25-k Ω shunt, because preliminary tests had shown that without it the tuning of the output circuit caused very noticeable frequency disturbance even with the arrangement as shown (earthed cathode). It had been checked that this disturbance was not by direct coupling of the circuits but must be through the valve. The 100-turn oscillator coil was tapped for the cathode 20 turns from one end, and tests were made with that end connected in turn to g_1 and to g_2 . These two tests were repeated with the earth transferred to g_2 , as in Fig. 5 (b). The frequency disturbance caused by swinging the output circuit through resonance was noted for each of these four conditions; and also the disturbance caused by varying the h.t. voltage from 180 to 240. The results are shown in the table.

I must emphasize that with an experiment like this one has to be careful not to jump to too many conclusions. The thing being measured is at most a small fraction of 1 per cent, and is liable to be affected by incidental consequences of the circuit changes made. For instance, I suspect that some of these effects may have tended to balance one another out, and the extent to which they did so might depend a good deal on the precise details and arrangement of the circuit, type

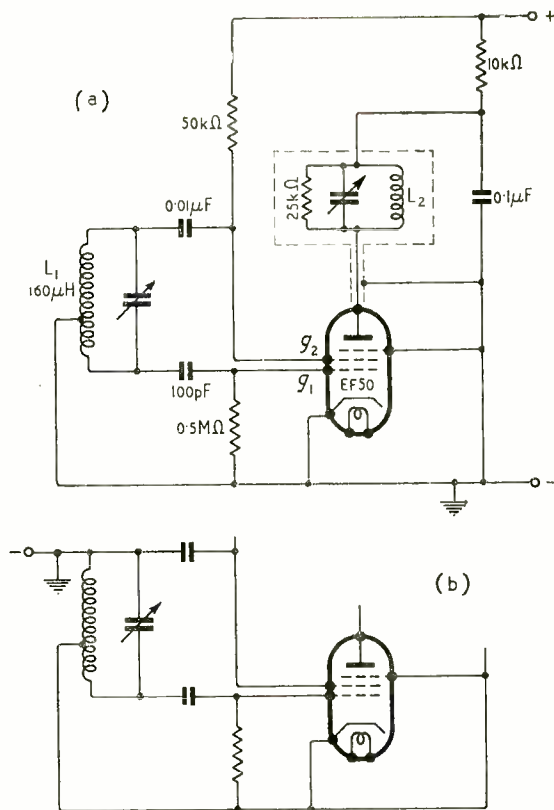

Fig. 5. Test circuit used in the experiments described. (a) is the earthed-cathode variety, and (b) the live-cathode modification.

Connections of L_1	Frequency disturbance, in c/s or parts in 10^6 , due to :	
	Tuning anode through resonance	Shifting h.t. from 180 V to 240 V
(1) Cathode earthed and near g_1 end ..	600	90
(2) Cathode earthed and near g_2 end ..	140	15
(3) g_2 end earthed and near cathode tap ..	100	110
(4) g_2 end earthed; cathode tap near g_1 end	610	110

of valve, and so forth. The very good stability against h.t. voltage in arrangement (2) might be a case in point.

So, with this warning to have a pinch of salt handy, here is my theory to account for the figures in the middle column. The most noticeable feature is the relatively high frequency shift when the cathode tap is near the g_1 end. The fact that in this case the biasing back of the grid is less, and oscillation is fiercer, may have something to do with it; but I suspect the main factor is that the g_2 current has to go through a larger part of L_1 to get back to the cathode, so any phase

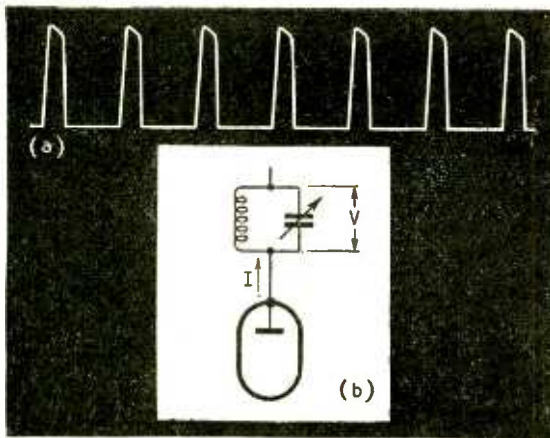

Fig. 6. With such a distorted waveform as (a), representing the anode current I in (b), would one expect V to have a practically pure sine waveform?

shifting of part of this current, due to influence of the anode as already described, has more effect than when the cathode is near the g_2 end. Note that the earthing or otherwise of the cathode doesn't affect this action, so if it is the major action the near-equality of (1) and (4) is not surprising.

The other influence, due to phase shift in the anode current itself passing through part of L_1 , seems to be relatively small. In (1) and (2), of course, it would be non-existent. According to my reckoning, the direction of the phase shift should tend to oppose the g_2 current effect; and this is borne out by the smaller frequency shift in (3), where both influences are present at once, than in (2). By the same reckoning, it should be slightly less in (4) than in (1); but as the g_2 effect is so much larger than the anode effect in this case it would probably need a more accurate test to show it up; or, more likely, there is some secondary consequence of the change of connection.

At least one reason why the anode current effect should be relatively small is the very high internal anode resistance of a pentode, which dwarfs the external load impedance. In the test circuit, the valve resistance would be at least 50 times the load impedance at resonance, and of course more than that in relation to *changes* in load impedance caused by tuning it.

Position of Coil Tap

The main fact that seems to emerge is the desirability of keeping the tapping near the g_2 end. Compared with that, the question of whether or not to earth the cathode is unimportant. The very satisfactory figure in the right-hand column of (2) may of course be due to a lucky combination of conditions with the particular oscillator tested, but if it were confirmed for the oscillator one proposed to use I would be inclined to plump for this number, unless the fact that in (3) one terminal of the oscillator tuning capacitor can be earthed weighs heavily in its favour. All the right-hand figures are pretty good, bearing in mind that one would not normally be so pessimistic as to expect the voltage to fluctuate between 180 and 240. As for the apparent advantage of (3) over (2) as regards output tuning, the difference is not very im-

portant, and the frequency shift could almost certainly be reduced by shifting the tap still nearer g_2 and abolished altogether by tuning the output to a harmonic of the oscillator frequency instead of the fundamental. (Apart from anything else, this might save still another valve—a frequency multiplier!) For the oscillatory current in the anode circuit is very far from being a pure sine wave, as was seen by short-circuiting L_2 and open-circuiting the 0.1- μ F by-pass and using the oscilloscope on the voltage waveform across the 10-k Ω anode decoupling resistor. With the anode tuning circuit restored, the waveform across it was a beautiful sine wave at whatever fundamental or harmonic frequency it was tuned to.

Although it doesn't concern electron-coupled oscillators more than any other kind, this distortion-eliminating effect of a tuned circuit is sufficiently remarkable to be entitled to the little space that is left. Of course, everybody knows that a tuned circuit greatly encourages signals of the particular frequency to which it is tuned, but I doubt whether everybody realizes quite how effectively it gets rid of harmonics in a poor waveform. If you had an oscillator that was grossly overloading, giving anode currents with a waveform such as Fig. 6(a), for example, would you not expect the output to be just a little distorted, even if taken from across a moderately good tuned circuit (b)? The fact is, however, that even with the grossest distortion in I it is unlikely that there would be more than a fraction of 1 per cent of any harmonic in V . Does that surprise you?

Reduction of Harmonics

It is one of the basic facts about parallel resonant circuits that the oscillatory current surging around between coil and capacitor (which is the current responsible for the voltage across the circuit, V in Fig. 6(b)) is Q times the current fed in (I in Fig. 6(b)) at the same (fundamental) frequency. But harmonics are not only not magnified; they are reduced. The reduction factor depends on the number of the harmonic; here are the first few figures, in terms of voltage:

Harmonic	Voltage relative to fundamental
1 (fundamental)	1
2	2/3Q
3	3/8Q
4	4/15Q
5	5/24Q

For example, a medium Q for an r.f. tuned circuit is 100, so the second-harmonic voltage would be only 1/150th of the percentage second harmonic in the anode current. Even if the current were so badly distorted as to have 100 per cent second harmonic, the output voltage would have only 0.67 per cent. A third harmonic of 100 per cent (fearful thought!) would be reduced to 0.375 per cent; and so on. High harmonics are reduced approximately to $1/nQ$, where n is the number of the harmonic.

That is with a straightforward connection, as in Fig. 6(b). If the tuned circuit is tapped, the calculation is rather more complicated. Anybody who is interested should refer to E. B. Moullin's "Radio Frequency Measurements" (2nd edition), p. 111.

V.H.F. RADIO

Review of the Various Systems at Present in Use

By E. G. HAMER, B.Sc.(Eng.), Hons.*

DURING the last five years, frequencies in the 70-500 Mc/s range have been used increasingly for fixed and mobile communications and for links in mixed line and radio services. One of the main reasons for this is the overcrowding of the h.f. bands, while an advantage is the restricted maximum range of the very high frequencies under normal propagation conditions. It is thus possible to have radio systems on the same frequency a few hundred miles apart, geographical separation being sufficient to avoid mutual interference. The extreme range of v.h.f. systems is usually 30-70 miles, depending on the frequency, the transmitted power, and the location of the transmitting and receiving aerials. Propagation is usually line-of-sight, but at the lower frequencies considerably greater ranges may be obtained owing to diffraction effects. Over short ranges, considerable reflection also takes place, so that v.h.f. is particularly suitable for mobile communications.

Typical users of mobile v.h.f. radio services are police, ambulance and fire services, aircraft, shipping domestic and "business radio." The fixed services are usually broadcast, or the radio equipment may be designed to operate with multi-channel equipment and forms part of trunk telephone or teleprinter networks.

The 1947 International Telegraph Union conference held in Atlantic City, U.S.A., discussed the allocation of frequencies in the v.h.f. and u.h.f. regions. Certain recommendations were made regarding the use of various frequencies in different parts of the world, but their exact interpretation rests with the appropriate authorities in individual countries.

Table I shows the Atlantic City recommendations for the use of frequencies in the region 70-585 Mc/s. Although there would appear to be plenty of channels available, in fact the lower frequency bands are now almost fully occupied. In this country this is partly because the Post Office have endeavoured to allocate each individual service a separate channel free from interference by other users. Owing to the very large number of users in the United States, many have to share a common channel.

The various users and services have here been classified into two groups: (a) mobile services, and (b) static services including broadcast and multi-channel systems. V.h.f. broadcast services have recently been described² and will not be elaborated further. Many techniques are common to several types of schemes, although equipment for multi-channel working is usually of more elaborate design, much greater bandwidth, and higher cost.

For the majority of mobile installations there is the choice of frequency and type of modulation, and

various arguments have been advanced as to the relative merits of one type of modulation over another. For single fixed station schemes, however, the small theoretical differences are completely overshadowed by such factors as the reliability of the equipment, the degradation of performance with time and vibration, the valves used, the effects of spurious outputs and responses, and the susceptibility of the receiver to blocking and cross-modulation. Comparative tests are misleading if different types of equipment, such as one set being several years older than the other, are used. If identical equipments are used as far as possible, the basic design is nearly always more suitable for one type of modulation, particularly in regard to the radio frequency bandwidth. Usually the f.m. receiver will have a smaller radio frequency bandwidth than the a.m. receiver which has a comparable performance when subjected to impulse noise. This apparent anomaly is caused by the type of noise-limiting circuits used in the a.m. receiver. They are operated by pulses of noise, and the shape of these

TABLE I
Atlantic City and F.C.C. Recommendations for use of Radio Frequencies, 1947

Band of frequencies, in Mc/s	Use in England	Use in U.S.A.
72-76	Fixed and mobile services	Fixed service
76-88	Broadcast, fixed and mobile services	Television F.M. Broadcast
88-100	Broadcast	
100-108	Broadcast	Aeronautical radio-navigation Aeronautical mobile
108-118	Aeronautical radio-navigation	
118-132	Aeronautical mobile	Aeronautical mobile Aeronautical mobile
132-144	Fixed and mobile services	
144-146	Amateur	Amateur Amateur Public mobile services
146-148	Amateur	
148-174	Fixed and mobile services	
174-216	Broadcast, fixed and mobile services	Television
216-220	Fixed and mobile services	Television
220-225	Amateur	Amateur Amateur
420-450	Aeronautical radio-navigation and amateur	
450-460	Aeronautical radio-navigation, fixed and mobile services	Public and broadcast services
460-470	Fixed and mobile services	"Citizens radio"
470-585	Broadcast	Broadcast

* G.E.C. Research Laboratories, Wembley.

¹ "V.H.F. Broadcasting," *Wireless World*, January 1952, pp. 10-11.

² "F.M. in Germany," *Wireless World*, April 1952, pp. 141-144.

pulses must be maintained up to the receiver detector and noise-limiter circuits. If the a.m. receiver were made a narrow bandwidth, the peaks of impulse noise would be rounded off and reduced in magnitude, and the limiter circuits would be ineffective.

The choice of type of modulation will largely depend upon the particular manufacturer's preference, any regulations laid down by the licensing authority, and the desire to standardize different schemes. It may also be influenced by the availability of suitable low-priced test equipment. Frequency modulation is nearly always used in the U.S.A., and amplitude modulation in England.

Most mobile schemes are operated in simplex (i.e., one station transmits at a time) and this reduces the power drain at the mobile station and the necessity for having two aerials or elaborate aerial filters. Two separate frequencies are necessary for duplex working, while a single frequency only can be used for simplex working. Single frequency simplex would appear to be advantageous for car-to-car working, but the range is usually restricted to 1 to 5 miles, depending upon locality. Double frequency simplex can increase the range of car-to-car working to the full system range, since the fixed station acts as a repeater when the output of its receiver is coupled to the input of its transmitter. This system has the advantage that the fixed station operator has overriding control and can break in with an urgent message to all mobiles except that actually transmitting.

Fig. 1 is a block schematic diagram of a double frequency simplex scheme, using a single fixed station and arranged for car-to-car working. Either amplitude or frequency modulation may be used. Double frequency simplex might appear more wasteful of radio frequencies than single frequency simplex but, where many systems are in use, a saving is obtained since schemes using the same frequencies can be more closely spaced geographically. The main high-power fixed station transmitter of one scheme, sited on a hill, will not interfere with the signal received from a mobile station at the fixed station receiver of adjacent schemes, although this might occur if adjacent schemes were using single frequency simplex on the same frequency.

Fixed Station Requirements

There are several variations of these simple mobile schemes, for example additional radio channels may be used to connect the fixed station sited on a hill to the operational control centre; or land lines may be used for the purpose, and the fixed station be unattended, all switching being done from the control centre. For any given town or area, the number of suitable station sites is limited and several fixed stations on different frequencies may use the same site. Extra aerial filters and specially designed receivers may be necessary to prevent a high-power transmitter blocking a nearby receiver. Several 100-watt transmitters may be radiating only a few yards away from a receiver with a sensitivity of $0.5 \mu\text{V}$, and on a frequency differing by, say, 10 per cent.

Considerable trouble may be experienced due to blocking and cross-modulation from one transmitter, or from several transmitters, causing intermodulation products to be radiated from any non-linear circuit in close proximity. These non-linear circuits may occur at any metallic junction, particularly between dis-

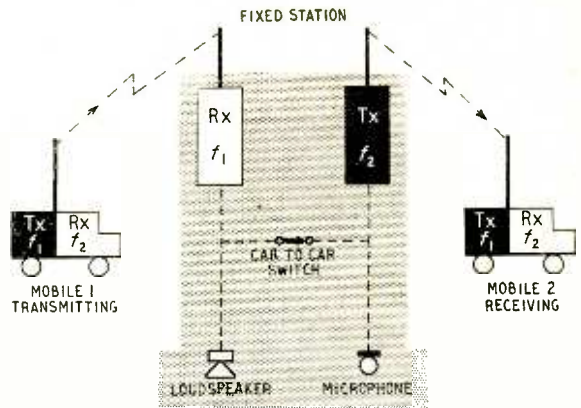

Fig. 1. Double frequency simplex scheme adapted for car-to-car working.

similar metals. This "rusty bolt" effect cannot usually be removed by the use of aerial filters since some of the intermodulation products may lie inside the pass band of the receiver. These possible troubles are additional to those caused by spurious outputs from the transmitters, and spurious responses of the receivers. Many of the defects due to spurious responses, blocking and cross-modulation have been eliminated in modern receivers, but the remedies are expensive and do not constitute an immediate improvement unless older type receivers have been tried and found unworkable.

Mobile Receiver Characteristics

Receivers for use in mobile radio schemes are designed to have the maximum permissible gain, and the performance is limited either by man-made noise at the lower frequencies, or thermal noise at the higher frequencies. To reduce the noise threshold to a minimum, the receiver bandwidth is narrowed as much as possible consistent with the requirements of drift of components, passing the modulation sidebands, and allowing the limiters to cope effectively with impulse noise. The usual receiver r.f. bandwidth varies from 20 to 50 kc/s (being larger at the higher frequencies), with receiver noise factors of 4-8 db at 100 Mc/s to 6-12 db at 200 Mc/s. Present designs give audio-to-noise ratios of 15-20 db for input signals of $2 \mu\text{V}$. Subjective intelligibility of the speech at low signal-to-noise ratios is improved by adding post detector filters set to give a rising characteristic from 300 to 1,000 c/s and a sharp cut-off at 3,000 c/s. The exact characteristic must be determined by subjective listening tests and depends on such factors as the background acoustic noise at the location of the microphone.

Muting or squelch circuits are often fitted to the receivers to reduce the amount of noise during the no-signal period. These may be either operated by relays or electronically, and are controlled either by the incoming carrier level or by the amount of noise present with the speech. Transmitter powers vary from 20-100 watts at the fixed stations to 5-15 watts at the mobile stations, the power outputs of the mobile units depending on the operating frequency.

Owing to the use of carbon microphones and small loudspeakers in the mobile units and to the general

nature of the service, it is not practicable to keep harmonic distortion at a very low value. Distortion of the order of 10-15 per cent for speech signals is common. Such services are essentially a means of exchanging information and, except in the case of mobile telephone services, may be operated at the limit of intelligibility. At the extreme edge of the service area, the system will be giving 50 per cent intelligibility, requiring the repetition of parts of the message. Owing to diffraction and reflection of the radio frequencies, a complex pattern of standing waves is set up, and the radio frequency carrier level may vary 10-20 db when the vehicle moves, say, one foot. As a result, a moving vehicle at the edge of the service area may receive a speech signal that has bursts of noise cutting in at a rate dependent on the radio frequency and the speed of the vehicle. For telephone-type services, the receiver muting circuits are set so that there is no receiver audio output unless the audio-to-noise ratio is greater than, say, 30 db.

Where a large number of mobile units is in use, or with telephone-type services, some form of selective calling may be used. Although all the mobile units then receive the audio signals, only the selected unit, or units, is able to hear the message. In certain cases, all the units not hearing the signals have their transmitters locked out to prevent the inadvertent interruption of the return conversation from the other mobile. Two methods are in general use for operating selective calling systems, one uses a series of impulses, and the other combinations of tones. The two systems are very similar in technical performance. The multi-tone system, especially at the mobile station, is more compact and consumes less power. Both systems are found to work on signal-to-noise ratios smaller than can be used for speech, so that there is no restriction on the effective service area. Both systems can be arranged to call either individual mobile units, groups of units, or every mobile unit in the event of certain emergency calls.³

Multi-station Schemes

To increase the service area of mobile schemes, systems are now in use where several fixed stations on the same nominal frequency are in use simultaneously. The main problems are the elimination of beat frequencies in the audio frequency speech band, and the distortion which might occur due to multi-path propagation effects.

With a.m., the transmitter frequencies are spaced so as to make the beat notes inaudible. Where many stations are in use, the receiver bandwidth must therefore be increased in order to receive all the signals. Also, owing to the supersonic beats, that part of the spectrum above the speech band cannot be used for signalling or selective calling signals.

Where f.m. is used, the transmitters are all operated either at the same radio frequency, or within 30 c/s of the mean radio frequency. Here the disadvantage is that an additional radio channel is required for synchronizing or closely maintaining a small frequency difference between the various transmitters. With the f.m. scheme there is no limit to the number of fixed station transmitters which may be used. With recent developments in quartz-cutting techniques and improved temperature-controlled ovens, it may become possible for independent transmitters to work on the

same nominal frequency using either a.m. or f.m., without causing serious distortion in the equi-signal regions. Both types of system have been adequately dealt with previously^{4, 5} and need not be described further.

F.M. or A.M

With double frequency simplex schemes, an elaboration of the scheme as shown in Fig. 1 can be used for car-to-car working. Using a.m., the audio output of the appropriate receiver is used to feed its associated transmitter, all the fixed stations' frequencies being spaced to avoid beat notes. With f.m., a true repeater station may be used, the frequency changing from the incoming to the outgoing frequency without demodulating the signal. The outgoing frequencies are then all nominally the same, the only errors being those due to the shift crystal. This type of station is discussed in more detail later. Fig. 2 shows a block schematic diagram of a double frequency simplex area coverage scheme. The satellite stations S_1 , S_2 and S_3 are used as repeaters for both outgoing and incoming calls. Satellite S_1 is located on a hill, giving general coverage, adjacent to it is fixed station S_{1A} having equipment on the same frequencies as the other mobiles. It is really a "fixed" mobile station connected by land line to the main control centre C_1 . Stations S_2 and S_3 are installed in important towns, the acrials being sufficiently high for them to be able to work with S_{1A} . In the case of an outgoing signal from C_1 , the signal at frequency f_2 from S_{1A} is received and repeated at frequency f_1 by all three satellites. Mobile 1 receives its signal via S_1 or S_2 , but mobile 2 can only be reached through S_3 . On the return signal, the reverse procedure applies. At satellite S_2 auxiliary control circuits are taken by land line to control centre C_2 which can then contact any mobile in the service area of satellite S_2 . In this case C_2 does not operate the

⁴ Brinckley, J. R., "A Multi-Carrier V.H.F. Police Radio Scheme," *Jour. Brit. I.R.E.*, 8, No. 3, pp. 128-142, May-June 1948.

⁵ Cole, W. P., and Hamer, E. G., "Multi-Station V.H.F. Communications using Frequency Modulation," *Jour. Brit. I.R.E.*, 10, No. 7, pp. 244-258, July 1950.

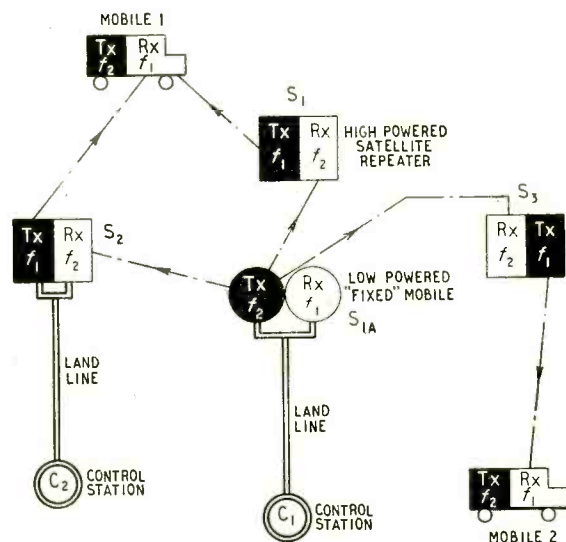

Fig. 2. Double frequency simplex area coverage scheme.

³ Fairbairn, E. P., "Switching Methods for V.H.F. Networks," *Jour. Brit. I.R.E.*, 11, No. 12, pp. 576-584, December 1951.

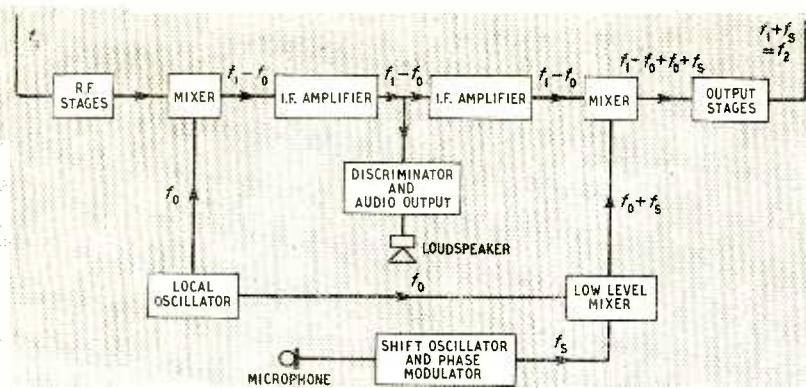

Fig. 3. Non-demodulating repeater station using frequency modulation.

whole scheme and can only use S_2 alone. Where f.m. is used, any number of low-powered satellite stations in various towns may be added, provided they can always work the control satellite S_{1A} . Only one station need be sited on a hill, all other stations can be located in the towns. This is a major advantage over schemes requiring several main stations on high sites, since site development costs form the main cost of any radio scheme. In addition, the same equipment is used for outgoing and incoming circuits, giving reductions in the amount of equipment used and in maintenance charges, and increasing reliability.

Multi-channel Relay Systems

In the v.h.f. range, nearly all multi-channel relay systems use frequency or phase modulation, although simple pulse modulated systems have been tried at the higher frequencies. The use of f.m. is dictated as the distortion and cross-modulation products must be small. The distortion in an f.m. system is mainly due to circuits which have a varying phase characteristic, or time delay with radio frequency; hence valves are excluded. With tuned circuits the distortion can be predicted and the circuit Q values, coupling factors, or resonant frequency, set to give the required distortion figures. The lower the circuit Q the smaller the distortion, but the Q value requires to be as high as possible to achieve a reasonable stage gain, and to give the required selectivity. To a first order approximation, second harmonic distortion is due to circuits being off tune, and third harmonic distortion is due to the phase characteristic, and is decreased by lowering values of circuit Q.

Other major sources of distortion are the modulating and demodulating circuits. Advantage is often taken of the use of f.m. to change the frequency by heterodyne methods at repeater stations, thus avoiding the need for demodulating and remodulating the signal. If a.m. were used, the circuit design becomes very difficult if not impossible. Since the modulation is carried completely through each unit, all valve circuits must be linear and, with a.m., class C amplifiers cannot be used in the transmitter circuits. This would cause a very uneconomic design, since large numbers of class A linear amplifiers would be required to obtain adequate radio frequency power.

Fig. 3 shows a block schematic diagram of a non-demodulating repeater station suitable for frequency-

modulated signals, which has facilities for a local engineer's channel. A standard receiver is used, but the i.f. output feeds a transmitter mixing circuit in addition to the local discriminator circuits. At the transmitter mixing circuit, the i.f. is combined with a new oscillator frequency to give the required outgoing frequency. The accuracy of the output frequency is not dependent upon the receiver local oscillator frequency, the only errors being those due to the variation of the shift frequency

crystal. Assuming a frequency of 15 Mc/s, a crystal with a temperature coefficient of 2 parts/ 10^6 /degree, and a thermostatic oven with a range of $\pm 1^\circ$ C, the maximum error between the incoming and outgoing frequencies will be ± 30 c/s. The smallness of this error is important where a long chain of repeater stations is in use since the harmonic distortion depends on the amount by which the r.f. and i.f. circuits are off-tune. A similar type of station may be used as a repeater for mobile schemes, as shown in Fig. 2.

From the designer's point of view, one of the most difficult parts of the equipment is the i.f. amplifier, which is carrying the full system deviation but at a low radio frequency. The circuits must have sufficient bandwidth to cause low phase distortion and yet provide the required selectivity and gain. Other problems are the transmitter driver and multiplier stages, where the valves must work into low Q circuits and yet provide a reasonable power output. Aerials and aerial feeders are another source of distortion, the distortion from the aerials being due to their phase characteristic, and that due to the feeder being caused by echoes. Any echo signal may cause distortion and may be due to multi-path propagation from a single transmitter, echoes due to feeder cables, or the same intelligence from two transmitters on the same frequency in area coverage schemes. Its effect is more deleterious with f.m. than with a.m.

Harmonic Distortion

With f.m., the harmonic distortion is proportional to the ratio of the echo signal to the main signal, whereas with a.m. the harmonic distortion is proportional to the square of the ratio of the echo signal to the main signal, assuming that the echo signal is at least 30 db less than the main signal and that the depths of modulation are small. With an echo due to a feeder cable, the magnitude of the echo (and, in the f.m. case, the harmonic distortion) will be proportional to the product of the reflection coefficients at the ends of the feeder. It is difficult to obtain a good match between the transmitter output and the feeder, and yet a reasonable power output, so the reflection coefficient at the aerial junction must be kept at a very low value.

Some typical values of s.w.r. (standing-wave ratio) at the aerial junction are 1.05 at the centre of the modulation band and 1.15 at the edge of the modulation band. Such low values of s.w.r. call for

extreme care in the selection of feeders and types of aerial, and require fairly elaborate measuring equipment to check them at v.h.f.

The harmonic distortion increases with increased feeder length and increasing modulating frequencies, and is therefore most troublesome with wideband systems employing large numbers of channels.

With small numbers of channels, the audio band of frequencies in use may be less than an octave so that second harmonic distortion would not appear to be a problem. However, in addition to the second harmonic distortion, other modulation products due to higher order harmonics are always generated and will appear as crosstalk or noise in the speech channels whether the multi-channel equipment is octave, or non-octave working.

A consideration of the technical difficulties and requirements mentioned leads to the following system requirements. The radio links should be line-of-sight to avoid any possibility of multi-path propagation effects; aerial feeders should be kept as short as possible and should be well matched, both to the aerial

and to the radio equipment. Aerials should have the maximum gain consistent with a low standing-wave ratio over the modulation bandwidth. Non-demodulating repeater stations should be used wherever possible.

A primary requirement for multi-channel relay systems is reliability, but often certain stations will be unattended and especially those in remote localities. This calls for the provision of standby equipment and automatic monitoring and changeover in the event of a breakdown. In the event of a failure and changeover to standby, special signals are usually sent along the "engineer's channel" giving an indication at the terminal stations which station has changed to standby, and on what unit the fault has occurred. These requirements for automatic changeover and fault signalling are often the largest and most expensive single piece of equipment and themselves tend to increase the unreliability. A realistic view should be taken of the fault signalling and equipment changeover requirements, so as to reduce the ancillary equipment to the minimum.

DRYING OUT TRANSFORMERS

Techniques for Preventing Breakdowns in

Tropical Climates

By J. MACINTOSH,* A.M.Brit.I.R.E.

TEMPERATURE: 90.9 degrees maximum, 71.7 degrees minimum. Maximum humidity: 99 per cent. These are not unusual figures for Malaya during the rainy season. In the tropical climate of that country, one of the most humid in the world, nearly all radio components wound with wire take up moisture from the atmosphere, and breakdowns are quite common. The chief items affected are mains and audio frequency transformers and chokes, and impregnation of the windings does not prevent moisture being picked up. In Malaya and other tropical countries a good air-cooled transformer should not require drying out if left out of commission for a period not longer than about three months. In the United Kingdom this period could be doubled, provided the transformer is in a well-ventilated chamber.

Insulation Resistance Readings

As a result of the complete breakdown of the primary winding of a mains transformer (supplying 1,100 volts at 300 mA), experiments were conducted over a period of several months in order to discover the best method of drying out and so reduce the risk of such breakdowns. A large number of transformers were available and careful measurements were taken on a Megger of the resistances (a) primary winding to framework, (b) secondary winding to framework, (c) primary to secondary, on each one under test. The

transformers to be dried out—generally two or three at a time—were placed under an inverted packing case, which was covered with an old blanket to keep in the heat. Two or three electric light bulbs, each 75 to 100 watts, were placed under the packing case and fairly close to the transformers, care being taken to prevent damage from fire or excessive heat. The current was then switched on and the drying out commenced. At the end of every 24 hours a fresh set of resistance readings was taken, and so on for three days or more. The resistances were read at the end of the

TABLE 1
Insulation Resistance Readings in Megohms between Primary and Frame

Apparatus	At Start	1st day	2nd day	3rd day	4th day	when cold
h.t. transformer	10	0.7	0.8	0.9	3.5	40
l.t. transformer	7	0.6	1.2	1.8	12	50
h.t. and l.t. transformer	10	5	5.5	—	—	20
h.t. and l.t. transformer	13	9	17	—	—	50
receiver transformer ..	17	7	5	4.5	6	30

* Amateur radio station GM31AA (ex VS1AA, Malaya).

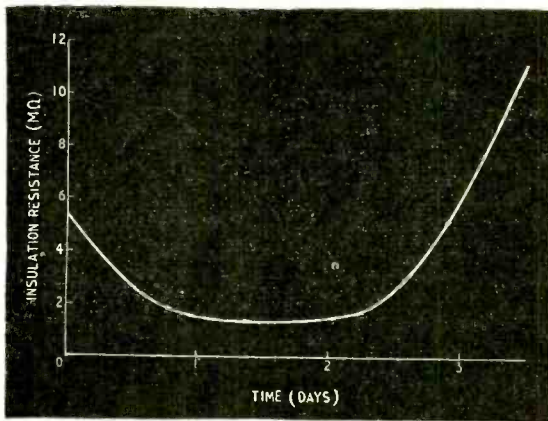

Fig. 1. Typical graph of insulation resistance readings.

drying out period and then again when the transformers had cooled. The results are shown in Table I. As the primary winding is the one which usually fails, the readings given here are confined to the insulation resistance between the primary winding and the frame of the transformer.

The progress of drying-out can be followed easily by keeping a record of such readings taken at regular intervals. For the first 12 to 36 hours, depending on how much moisture has been absorbed, the insulation resistance falls (Fig. 1). During a certain period the reading remains steady at a low figure. It then begins to rise, at first slowly, then more quickly. At this point the drying-out can be discontinued. When the transformer has cooled off the final figure should be 10 to 20 megohms or higher. All insulating materials have a lower resistance at higher temperatures and the increasing resistance as the transformer cools off is quite normal.

Potted Transformers

Several of the transformers undergoing this process behaved in a strange manner, and all these had one thing in common—they were either potted or dipped in bitumen compound. Two typical sets of readings for potted transformers are shown in Table 2. The peculiarity about this type of potted or dipped transformer was that the insulation resistance dropped to begin with, as before, but then refused to rise during the process of drying out. At the end of ten days one of the transformers was taken out of the drying box and while it was being allowed to cool off readings were taken every 10 or 15 minutes. The rise in insulation resistance was remarkable, the figures (in megohms) running like this: 5, 6, 8, 10, 15, 20, 25, 40 and eventually over 50. The writer then got in touch with R. E. Earle of the Singapore Harbour Board and sought his advice. Mr. Earle suggested the possibility of a slight acidity in the bitumen compounds which becomes active if the transformer is permitted to absorb moisture. This, of course, is impossible to prevent if the apparatus is left out of service for long intervals. The transformers using these compounds appear to have a low insulation resistance at the drying-out temperature, and this

might prove serious, for example, in a fully loaded rectifier transformer working with a high voltage to earth.

All these experiments were carried out using a drying box. However, it has been pointed out that a relatively easy and most effective way of drying out *in situ* would be to apply half the mains voltage to the primaries of all transformers by introducing a bank of lamps in series-parallel formation in one of the leads to the mains. If this method is used, care should be taken to measure the voltage across the primaries and adjust it when necessary. If the voltage is too low more or larger bulbs are required, and if it is too high the bulbs should be changed for ones of smaller wattage. When using this arrangement the centre tap to all secondary windings of h.t. transformers should be broken, or the h.t. otherwise disconnected, as rectifiers must be on full load before the h.t. is applied. The writer uses switches inserted in the centre taps of the windings.

Care should be taken not to overrun any of the lamps. It is better to use two low-wattage bulbs than to run one big one all out.

Need for Ventilation

A long time ago some experiments were carried out in Malaya by one of the Services in an endeavour to find a cure for breakdowns in audio and power transformers and in paper and old-type mica capacitors. A very large receiver was installed in a cast metal case, complete with glands for controls and a rubber joint for the bolted and flanged lid. This receiver broke down in a much shorter time than did old semi-enclosed receivers, in spite of its being in frequent service. When opened up the connections inside were mildewed, copper was coated with verdigris and the inner surface of the case was covered with moisture. It was considered that the solution to the problem was to ventilate as freely as possible unless it was feasible to exhaust and seal hermetically.

With amateur radio equipment in tropical countries the answer is to ventilate freely and keep the apparatus in more or less continuous use. If the apparatus is out of commission for about two months it should be given a dry-out for two or three days—and this applies especially during the rainy season when humidity is at its peak.

So far the writer has been unable to trace any information on this subject in amateur periodicals or handbooks, so he hopes that this article will prove of some value to amateurs, especially to those situated in the tropics. In conclusion the writer wishes to thank Mr. Earle, the Chief Electrical Engineer of the Singapore Harbour Board, for the most useful advice which he furnished during the course of these experiments.

TABLE 2
Insulation Resistance Readings in Megohms for Two Potted Transformers

At Start	1st day	2nd day	3rd day	4th day	5th day	6th day	7th day	8th day	9th day	10th day
5	2.3	1.7	2.5	2.2	2.1	1.75	1	0.5	0.7	2.2
15	5.5	1	0.85	0.6	0.45	0.5	0.6	0.55	0.4	0.7

Manufacturers' Products

NEW EQUIPMENT AND ACCESSORIES FOR RADIO AND ELECTRONICS

Crystal Pickup

THE GP80 pickup recently introduced by Chancery Precision Instruments, Ltd., 64, George Street, London, W.1, is designed to appeal to those who require, among other things, a wide frequency response, and the output is claimed to be within ± 2 db from 50 to 11,000 c/s. Separate heads are provided for 78-r.p.m. and long-playing records with stylus radii of 0.0025 and 0.001 in respectively. Stylus pressure is adjustable in the range 14-16 gm for 78-r.p.m. and 8-9 gm for long-playing records. The price, with the two heads, is £4 16s 8d (including tax) or the heads can be purchased separately for £1 16s each (including tax). The tone arm with one head costs a total of £3 0s 8d.

Electronic "Stethoscope"

VERY low frequencies—some of them below the audible range—can be picked up and amplified by a new type of instrument recently introduced for visual and aural observation of the functioning of the heart and lungs. Described as an "auscultoscope" by its designer, Dr. E. A. Maury, of Paris, it is made under licence by Leland Instruments, Ltd., of 22, Millbank, London, S.W.1. The sounds are picked up from the body by a small electro-dynamic transducer, and the output of this is amplified and applied to a loud-speaker and a c.r. oscilloscope display system. The transducer has an extended low-frequency response to enable it to pick up the sub-audible frequencies of the fundamental heart and lung movements, with a sharp cut-off at the high-frequency end to avoid noises produced by surface contact with the patient's skin.

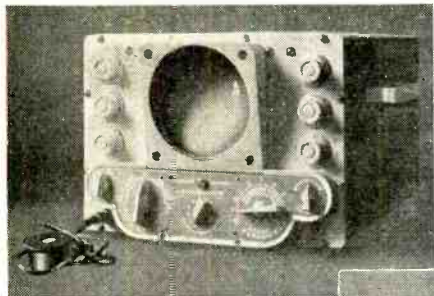

(1) Leland Instruments electronic auscultoscope. (2) Leavers Rich Model ER31B plastic magnetic tape bulk eraser. (3) Chancery type GP80 crystal pickup.

The 6-in cathode ray tube of the oscilloscope display system has a long-persistence screen to permit observation of very low frequency traces. The time base provides low horizontal sweep frequencies which can be adjusted to the rate of the patient's heart beat, and the control for doing this is calibrated to indicate the number of beats per minute. A sync control enables the time base to be locked to the fundamental frequency of the heart beat.

Recording Tape Eraser

A NEW technique for erasing old recordings from magnetic tape is to place the whole spool of tape in an intense alternating magnetic field. It has several advantages over the more usual method of running the tape through an erase head, the principal ones being saving in time, less wear and tear on plastic tape and the release of the recording machine for more useful purposes.

A device of this kind has recently been introduced by Leavers Rich Equipment, Ltd., 37, Wardour Street, London, W.1. It consists of a light alloy die-cast base with a plastic panel let into the top and housing a powerful electro-magnet. This is supplied with a.c. at 220-250 V at 50 c/s and will demagnetize a 7-in diameter spool of plastic tape in a few seconds. No rewinding is required; the spool of tape is merely placed on the spindle of the bulk eraser, as it is called, rotated and on removal all trace of the old recordings will have vanished leaving the tape completely demagnetized and ready for use again.

The "Leeraser," as it is called, weighs $7\frac{1}{2}$ lb and consumes 1.8 A; price is £7 10s.

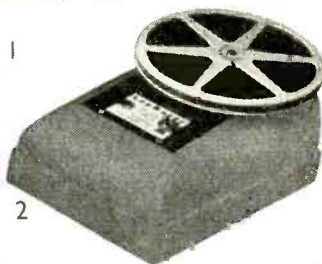

New TRIX Quality SOUND EQUIPMENT

AC/DC AMPLIFIER

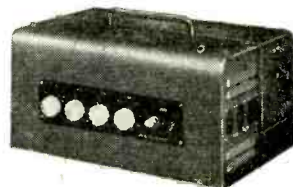

MODEL U885, 20 WATT.

A most useful and adaptable 20 watt Amplifier, designed for universal AC/DC operation. Inputs for two microphones and gramophone. Outputs both high and low impedance. Completely enclosed and ventilated. Nine valve circuit with negative feedback. Also available as complete portable equipment—U885 P.

MINIATURE HORN SPEAKER

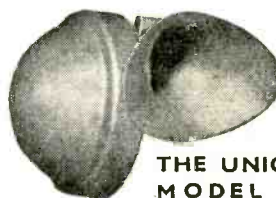

THE UNICORN
MODEL H21

The Unicorn (regd.), a miniature exponential horn type speaker of novel design and construction. Ideal for mobile equipments, factory call systems, railway stations, airports, and other noisy locations.

SEND FOR CATALOGUE AND
PRICE LIST OF THE LATEST
RANGE OF TRIX SOUND
EQUIPMENT.

The TRIX ELECTRICAL CO. LTD.

1-5 Maple Place, London, W.1
Telephone: MUSeum 5817.
Telegrams: TRIXadio, Wesdo, London.

AMPLIFIERS—MICROPHONES—LOUDSPEAKERS

RANDOM RADIATIONS

By "DIALLIST"

Television Coverage

THE ANNOUNCEMENT that reception of the Coronation television broadcasts would be made possible in Tyneside and in the Belfast area by the use of mobile transmitters has been well received. With output powers of 1kW and ½kW for vision and sound, respectively, these stations will extend the television service to another two million possible viewers, which should raise its coverage of British homes to over 80 per cent. I don't know what the American figure is, but I doubt if it's anywhere near as high. One great difficulty about providing a truly nation-wide service in the United States is that that country contains enormous areas in which the population is still sparse and scattered. We have similar problems, though, naturally, on a much smaller scale. There's one noteworthy difference between the British and American systems. The American sponsored stations derive their revenue from advertisers who naturally want their expensive programmes to be seen and heard by the greatest possible number of likely purchasers of their wares. Hence the layout of such a system is always likely to be that which covers the largest number of homes for the smallest expenditure on transmitting equipment. Our sound and vision services need not necessarily pay their way. The B.B.C. is, therefore, able to provide services in areas that advertisers would regard as valueless.

A Polarization Point

From the B.B.C. I learn that the transmissions from both of the temporary television stations are to be horizontally polarized. The reason is no doubt to avoid interference from the stations with which they will share frequencies (Pontop Pike with Wenvoe and Belfast with London). You will recall that at the recent Stockholm Conference (see p. 433, October) the U.K. representatives made a great point of the conclusion, reached as a result of B.B.C. field trials, that the amount of interference between two metre-wave transmitters using the same channel is at a minimum when they are polarized at right angles to one another. The Conference didn't

officially accept this as an established truth, but the allocations made appear to have been largely based upon it. One point about the polarization of the Pontop Pike and Belfast transmissions should, I feel, be made clear to the uninitiated. I've already heard people saying: "Not much fun going to the expense of putting up a horizontal aerial if you'll have to scrap it and put up another when the permanent service gets going." There's no question of anything of the kind. Unlike the transmitters themselves, which are temporary, horizontal polarization will continue to be used when the five permanent medium-power stations come into action.

A Different Sky Line

We've become so used to the sprouting of single vertical dipoles and of H, X and inverted V aerials as part of our urban and village sky lines that we shall feel that we have strayed into some strangely different region when we make future visits to Tyneside and Belfast and see the horizontal contraptions above the roofs. I wonder whether any householder (or perhaps any group of householders) will make use of an array developed for the wartime GLII radar transmitter? This consisted of a line of four half-wave

dipoles, spaced at half-wavelength intervals, with a wire-netting reflector about 0.1 wavelength behind them. It's an effective and highly directional arrangement, signal strength being down to one-half at 5 deg either side of the direct transmitter-receiver path. Suitably spaced—and suitably oriented—chimney stacks would be needed. That might be one snag; another (unless my memory is playing tricks) is that the array becomes rapidly less and less effective as the vertical angle of the incoming wavetrain is reduced below about 15 deg.

Apprentice Servicemen

THE RECENTLY ANNOUNCED apprenticeship scheme for radio and television servicemen seems to be an admirable idea. Incidentally, an apprenticeship scheme has been in operation in Scotland for some years. What it comes to, briefly, is that youngsters with a bent for radio will be able to indenture themselves for five years to approved master craftsmen. They will be paid from the start and there will be an annual increase in the weekly rate. The right sort of youngster will, I imagine, work for some registered qualification, such as the City and Guilds' radio or television servicing certificates. The result should be



"WIRELESS WORLD" PUBLICATIONS

	Net Price	By Post
RADIO INTERFERENCE SUPPRESSION as Applied to Radio and Television Reception. G. L. Stephens, A.M.I.E.E. ...	10/6	10/11
RADIO VALVE DATA: Characteristics of 2,000 Receiving Valves and C.R. Tubes. Compiled by the Staff of "Wireless World." 3rd Edition ...	3/6	3/9
SOUND RECORDING AND REPRODUCTION. J. W. Godfrey and S. W. Amos, B.Sc., A.M.I.E.E., in collaboration with the B.B.C. Engineering Division ...	30/-	30/8
MICROPHONES. By the Staff of the Engineering Training Dept. B.B.C. ...	15/-	15/5
ADVANCED THEORY OF WAVEGUIDES. L. Lewin. ...	30/-	30/7
FOUNDATIONS OF WIRELESS. M. G. Scroggie, B.Sc., M.I.E.E. 5th Edition ...	12/6	13/-
TELEVISION RECEIVING EQUIPMENT. W. T. Cocking, M.I.E.E. 3rd Edition ...	18/-	18/8
SHORT-WAVE RADIO AND THE IONOSPHERE. T. W. Bennington. 2nd Edition ...	10/6	10/10
WIRELESS SERVICING MANUAL. W. T. Cocking, M.I.E.E. 8th Edition ...	12/6	12/11
RADIO LABORATORY HANDBOOK. M. G. Scroggie, B.Sc., M.I.E.E. 5th Edition ...	15/-	15/5

A complete list of books is available on application.

Obtainable from all leading booksellers or from

ILIFFE & SONS LTD., Dorset House, Stamford Street, London, S.E.1.

that, quite painlessly and without any kind of compulsion, the radio trade in this country will receive a steady influx of trained and certificated master servicemen. And it can be only a matter of time (and not such a long time either) for the bulk of our servicing work to pass into the capable hands of such men. In the United States people have been pressing vainly for years for the compulsory testing and registration of radio and television servicemen. I can't help feeling that we've found a better way of solving the servicing problem—or, rather, of making it solve itself.

Student Exchange

THE EXCHANGE of students between the seventeen member countries of the International Association for the Exchange of Students for Technical Experience (IAESTE) has continued to develop, and during the summer of this year 3,493 students participated in the scheme. The annual figures since the formation of the Association in 1948 to 1951 are 920, 1,236, 1,672 and 2,433 respectively.

So far as this country is concerned 488 students were sent abroad—an increase of 66 on the previous year—and 602 foreign students were received for experience in organizations in this country. Sweden received the highest number of students (820) and Germany sent the largest number abroad (682).

The period of attachment to industry is 8-10 weeks during the summer vacation. The student pays his travelling expenses and the industries receiving the students undertake to pay them sufficient each week to cover their cost-of-living expenses. The average rate of payment varied last year from £3 12s in Yugoslavia, which received 103 students, and £24 10s in Israel, where 44 students were received.

In the table classifying the subjects studied by the students, radio and electronics are not listed separately, but included under the general heading of electrical engineering. However, from a perusal of the list of organizations—both in this country and abroad—receiving students, it is apparent that a considerable number of the 509 electrical engineering students (the second largest individual group) are studying radio and allied subjects.

Details of the IAESTE, which is recognized by UNESCO, are obtainable from J. Newby, Imperial College, South Kensington, London, S.W.7.

"The Choice



of Critics"

Regd. Trade Mark

GROUP THEM IN ROWS
These new connectors, moulded in high grade phenolic thermo-setting plastic, are intended for inter-connection of chassis and structures (e.g., chassis/rack connections) in reliable and unfailing manner, and can be grouped and used to provide non-reversible or polarised connections.

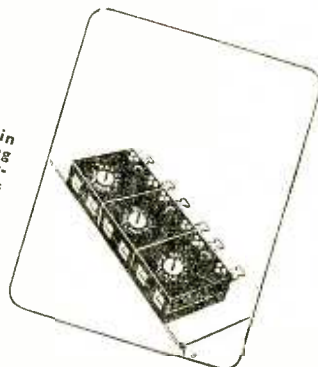

RELIABLE

GROUP THEM IN BLOCKS
Suitable for up to 500V. between adjacent poles and to chassis, and for up to 10A., when used as separable under load, 250W. max. loading is suggested.

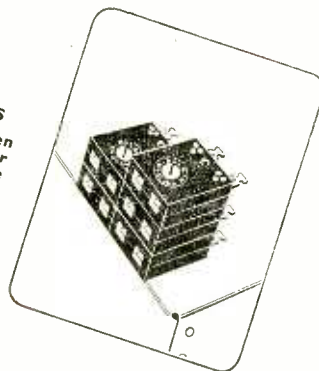

AUTOMATIC

GROUP THEM IN PILES
Fixing is by single screw or rivet, a keying spigot being provided for chassis or base, with counter-hole(s) for key(s) from further unit(s) when stacking, as shown. Also provided with colour-key "sinks," but supplied un-coded.

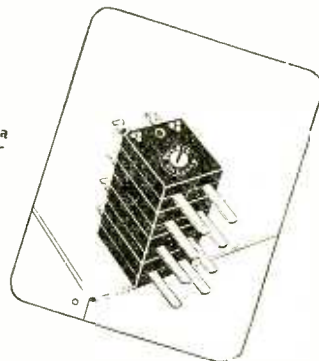

CONNECTIONS



The Bulgin "DOMINA" Multi-pole Chassis Plug and Socket.

List No. P.491 (Socket).

List No. P.490 (Plug).

Send for
Illustrated
Catalogue
Ref. No. 190/WW
Price 1/- post free.

MANUFACTURERS OF RADIO AND ELECTRONIC PRODUCTS

BULGIN
Components

A.F. BULGIN & CO. LTD
BYE-PASS ROAD BARKING
TELEPHONE Rippleway 3474 (3 lines)

UNBIASED

By FREE GRID

Dehydrated Sailorizing

SOME time ago (March, 1947) I found it necessary to rebuke the Editor in these columns because he had permitted details to be published of the wireless installation in R.M.S. *Queen Elizabeth* but made no mention at all of the men in charge of it (November, 1946). With becoming contrition he cried *Peccavi* and rectified the omission. Now, however, I find a well-known B.B.C. personality, whose very bread and butter depends on radio communication, ignoring not only these men but the ship's wireless apparatus itself.

I refer to Mr. Richard Dimpleby who has earned much well-deserved popularity and fame in his "Down-your-way" series of broadcasts. A few weeks ago he took us aboard the world's biggest ship as she crossed the Channel to Cherbourg. I listened eagerly to this broadcast for I have a passionate interest in ships although I know little or nothing about them. In fact, all I know for certain is that "port is red" no matter whether it be the famous wine from the Oporto district or a ship's left-hand navigation light. This useful mnemonic was given to me by a sailor in a pub as he gazed with withering contempt at the small bottle of port I had



Port is red.

ordered for him in response to the meaning look he gave at his empty tankard.

Naturally I expected that Mr. Dimpleby would stir my blood and my interest by taking his microphone all over the ship to interview people whose occupation was of a nature only to be found at sea, and that as it is radio which has made his name a household word he would begin by interviewing the Chief Radio Officer or one of his underlings who could tell us something of the ship's wireless and radar equipment; but I was doomed to bitter disappointment for instead we heard interviews with the

ship's "Nannie" and other members of the "hotel" staff.

It is only fair to say that we did hear interviews with the Staff Captains, the Chief Engineer and a rather lugubrious lamprimmer. I must confess that I rather feared for Mr. Dimpleby's safety on the perilous descent into the engine room, and I thought he was wise to avoid clambering up into the crows nest, for as he himself will readily admit, he does not exactly fulfil Gilbert's description of "light and airy, like a fairy."

I did not, of course, expect that we should get an interview with the Captain or that the microphone would be allowed on the bridge while the ship was in the busy waters of the Channel, but could not these things have been done and recorded before the ship cast-off? I did not even hope to hear the men "chanting" the unexpurgated version of "I met a maid from Amsterdam" as they trudged round the anchor windlass, but neither did I expect a conducted tour of a hotel.

The Snails Whiz By

AS long ago as October, 1943 I first raised the question of the speed of the ordinary tame domestic current which lights our homes and does the more menial tasks in our radio sets—like cathode cooking—as distinct from the "hotted-up" electrons which flit about our valves and c.r. tubes and rend the heavens in a thunderstorm. Two months later I said that I gathered from a perusal of Morecroft and other authorities on these matters that the current in our more mundane circuits shuffles along in its carpet slippers at almost walking pace.

I briefly referred to the matter again early last year (March, 1951) and I make no apologies for returning to it now for I have just discovered that I was hopelessly wrong in my interpretation of the facts, and, of course, to leave an error uncorrected in *Wireless World* is almost as unthinkable as for a politician to admit one.

My error and, therefore, my shame has just been revealed to me by a perusal of one of the latest works on electrical matters ("Fundamentals of Technical Electricity," by H. G. Mitchell). From it I gather that the maximum velocity of the electrons crawling along a copper conductor is 0.43 centimetre per second. Now because I like nice round figures—due perhaps to my experience as a judge at bathing-beauty contests—I am going to call it 0.5 cm per sec as then we need only multiply both the centimetres and the seconds by sixty to get another round figure of 30 cm per minute. Now we all know that

there are approximately 2.5 centimetres in an inch and so obviously we get a velocity of 12 inches per minute, or in other words 60 feet or 20 yards per hour, which is a speed of which even a snail would be ashamed.

If your electricity supply is d.c. it means that the electrons which are now crawling round your lamp filament must have left the generating station several days ago—unless you happen to live quite close to it. In the case of ordinary 50 c/s a.c. it is obvious that it is always the same old gang of electrons which are giving you light, and they don't move more than a tiny portion of an inch before they have to do a smart "about



In the headmaster's study.

turn." In fact, all the electrons do is to shift their weight uneasily from one leg to the other as I recollect doing long years ago when standing before the bar of justice in the headmaster's study.

What of radio frequencies, more especially those of television and the centimetre wavelengths? To us the electrons seem almost static, but taking an electron's-eye view the distance travelled each half-cycle is "galactic" compared with their diameter. No doubt some heresy-hunting technical Athanasius will debunk my words and I shall hang as high as Haman. My tombstone will bear the words "Here Free Grid lies still as he did in life."

Radio Jubilee

I AM not one of those who believes in change for change's sake, nor, I hope, is the Editor of *Wireless World*. Otherwise he may see next year a reason—or an excuse—for putting the new-fangled word "radio" into the title of this journal. Radio as a word celebrates its jubilee in 1953, having been introduced by the Germans at the first International Conference on Wireless Telegraphy held in Berlin in August, 1903. So long as all our activities are governed by the Wireless Telegraphy Act, the old word is good enough for me.