

Wireless World

RADIO AND ELECTRONICS



APRIL 1949

2/-

Vol. LV. No. 4

IN THIS ISSUE: DEVELOPMENTS IN RADIO COMPONENTS

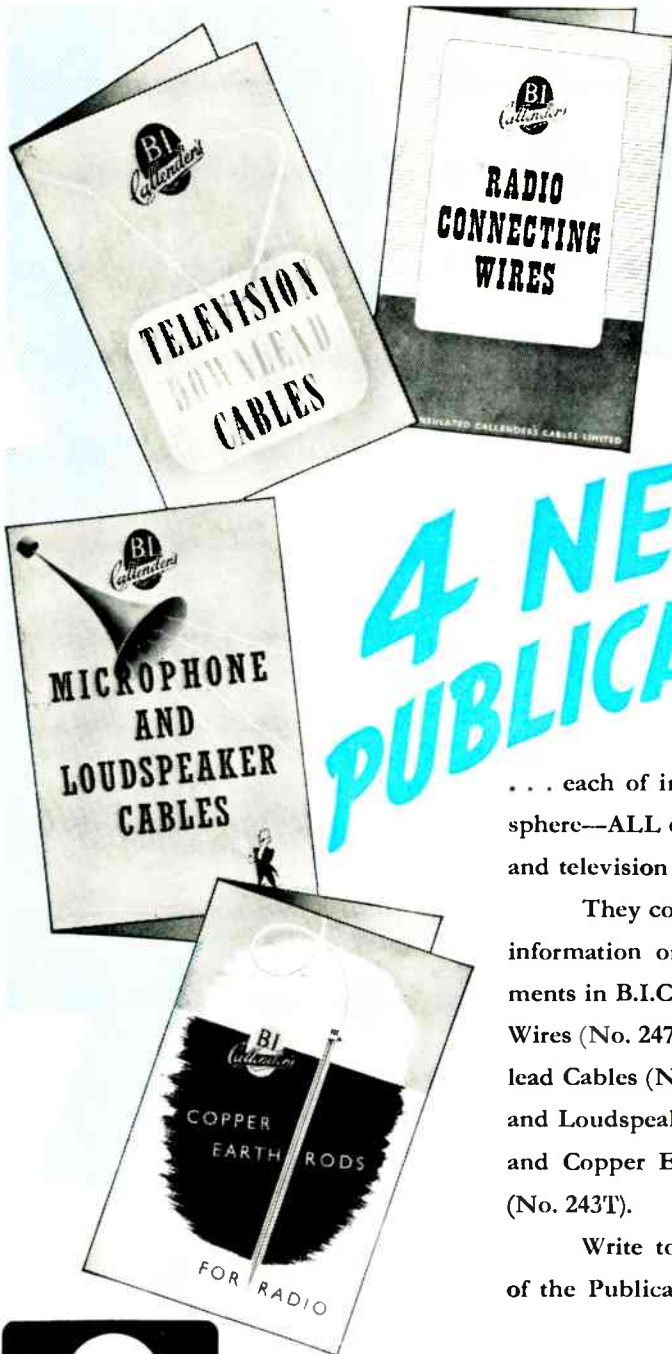

4 NEW PUBLICATIONS

... each of importance in its own sphere—ALL of importance to radio and television engineers.

They contain useful technical information on the latest developments in B.I.C.C. Radio Connecting Wires (No. 247T), Television Downlead Cables (No. 244T), Microphone and Loudspeaker Cables (No. 245T) and Copper Earth Rods for Radio (No. 243T).

Write to-day for a free copy of the Publication you need.



RADIO EQUIPMENT

BRITISH INSULATED CALLENDER'S CABLES LIMITED
NORFOLK HOUSE, NORFOLK STREET, LONDON, W.C2

Servicing **MUST** be done

Use this up-to-date
SIGNAL TRACING
method



"AVO"
ELECTRONIC TESTMETER — £35

1 Inject a signal from the "AVO" Signal Generator. This can be R.F. into the Aerial or I.F. circuits, or A.F. into the Audio Circuits.

2 Trace the signal through the set with the A.C. Voltage ranges of the "AVO" Electronic Testmeter. (Accurate Voltage measurement from 20c/s to 300 Mc/s.)

3 Having arrived at the point where the signal does not appear, then identify the nature of the fault by tests with the D.C. Voltage, resistance and capacitance ranges of the "AVO" Electronic Testmeter.

0-10,000 v. D.C.
0-1,000 megohms
100pF. —50uF.

**Time - saving
& dependable**

Fully descriptive leaflets available from the Manufacturers of "AVO" Electrical Testing Instruments—

THE AUTOMATIC COIL WINDER & ELECTRICAL EQUIPMENT CO., LTD.
WINDER HOUSE · DOUGLAS STREET · LONDON · S.W.1 TELEPHONE: VICTORIA 3404/9

ETM.2

WORKSHOP - KITCHEN - DINING ROOM - LOUNGE - BEDROOM
 — switch the radio on or off from wherever you are!

The 'LONG ARM' REMOTE CONTROL

If you haven't yet installed a "LONG ARM," you are missing one of radio's most amazing developments — remote control listening.

Remember that this Whiteley "exclusive" operates any number of "Stentorian" speakers (Senior, Junior or Cadet models) from any radio receiver, and costs only 35/-. (Suitable speakers from £4.0.0.)

Other Whiteley products include Loudspeaker Chassis Units, Microphones, Valveholders, Switches, Transformers and Chokes.

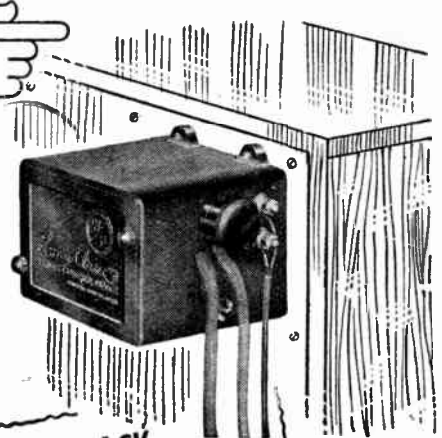

BROUGHT BACK BY POPULAR DEMAND

Stentorian

Visit us: Stand No. G16 B.I.F. OLYMPIA

LOUDSPEAKERS & RADIO COMPONENTS
 WHITELEY ELECTRICAL RADIO CO · LTD · MANSFIELD · NOTTS

*The better they are made
 the more outstanding the results*

MADE IN THREE PRINCIPAL MATERIALS.

FREQUELEX. An insulating material of low Dielectric Loss, for Coil Formers, Aerial Insulators, Valve Holders, etc.

PERMALEX. A High Permittivity Material. For the construction of Condensers of the smallest possible dimensions.

TEMPLEX. A Condenser material of medium permittivity. For the construction of Condensers having a constant capacity at all temperatures.

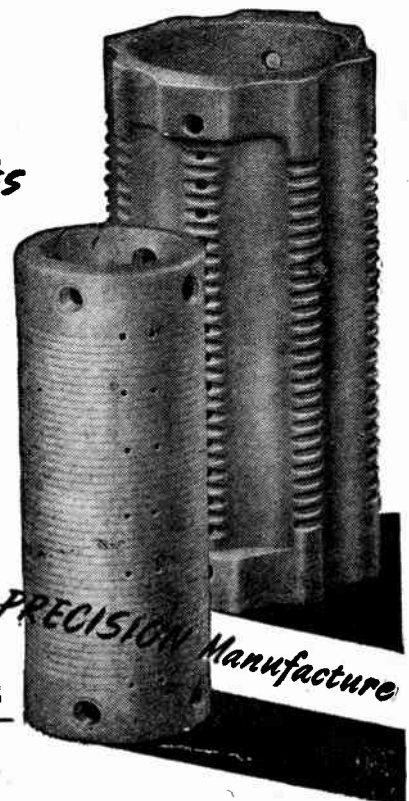

Bullers

Specialize in PRECISION Manufacture



BULLERS LOW LOSS CERAMICS

BULLERS LTD., 6, Laurence Pountney Hill, London, E.C.4. Phone: Mansion House 9971 (3 lines)
 Telegrams: "Bullers, Cannon, London."

* Perfect Reproduction?

•PROBLEMS REFERRED TO IN PREVIOUS NOTES

Spatial Distribution of Sound.

Echoes in the Listening Room.

Limitations of Single Channel.

Limitations of the Human Ear.

Distortions and Faults caused by
Apparatus.

The Radio Link.

Frequency Response.

NON-LINEARITY Our last article began to discuss the audio circuits of the receiver and reached the conclusion that the frequency response of the amplifier does not give the designer any real headache.

Distortion is a horse of a different colour. Valve characteristics are by nature so non-linear that at first sight gross distortion would appear quite inevitable. In inexpensive receivers there is little that can be done, apart from ensuring that no stupid mistakes are made. Where more money is available, tremendous improvements can be made by the use of negative feed-back. Perhaps a simple illustration of the way in which distortion is reduced by it will be valuable here.

Imagine an amplifier fed with an input and producing an output. If a portion of the output is fed back to the input, one of two things will happen, depending upon the phase of the feed-back. If it is in phase, the system as a whole will tend to oscillate; if it is in anti-phase, the gain of the amplifier will be reduced.

Suppose now that in its passage through the amplifier the input signal suffers a wave form distortion—in other words harmonics of the input signal are developed. When feed-back is used these harmonics are also introduced at the input to the amplifier, and as these travel through the chain they will tend to cancel out the production of them by any non-linear elements. There is no theoretical limit to the harmonic reduction which can be achieved in this way; all that is necessary is to build an amplifier of very high gain, and to feed back a large percentage of its output. In practice, troubles arise with high degrees of feed-back, since it is difficult to ensure that the phase of the feed-back remains right over a sufficiently wide frequency band. What nearly always happens is that the system as a whole goes into oscillation at either a very high or a very low frequency.

Another advantage which accrues from negative feed-back is that it tends to level out the frequency response. This can be seen at once, for if an amplifier gain tends

to fall at any frequency, so does the negative feed-back and hence the reduction in gain due to the feed-back decreases, and compensates for the original fall. Nor do the advantages of negative feed-back end here. It can be shown that the effective impedance of a valve can be drastically reduced if feed-back is applied in the proper way. Now, one of the main disadvantages of the pentode output valve is that its output impedance, being high, fails to provide the resistive component which is desirable to damp the bass resonances of the loudspeaker. In the presence of feed-back, this damping can easily be provided, and in fact the pentode can, for the same overall sensitivity, be made to be more effective in this way than a triode valve.

From all this one might be led into thinking that under almost any condition feed-back is a good thing. There are, however, many pitfalls which can beset the unwary. For example, it is only too easy to end up with an amplifying system which tends to be unstable, either at a very high frequency or a very low frequency—or both. If the instability is obvious, there is no great harm done, for the amplifier is unusable and a cure must be provided. But it may be that the instability is not obvious, the only effect being the introduction of distortion or spurious frequencies into the desired output.

***murphy radio
limited***

Measurement by Mullard

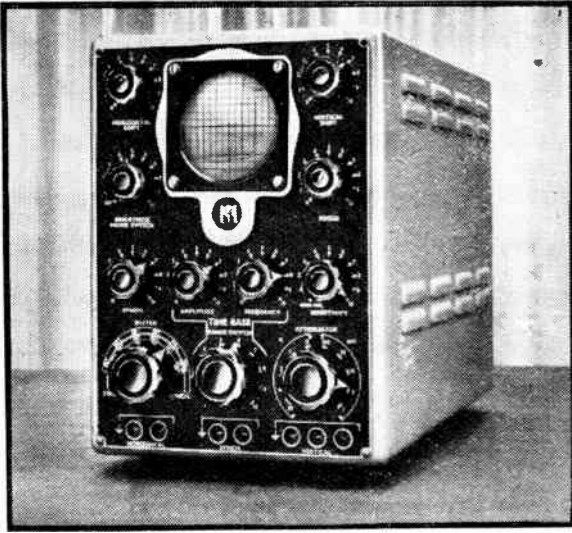

Mullard Oscillograph type E.800/1

The name of Mullard has for long been connected with cathode ray oscillographs, and their experience in this field is unequalled. Mullard cathode ray tubes, Mullard valves and Mullard circuitry have been combined to produce the accepted standard oscillograph.

Type E.800/1

Time base frequency 0.25—16,000 c/s.
Amplifier response (2 dB loss) 0.1—40,000 c/s.
Amplifier sensitivity (Max. Gain) 1 mV.rms/cm.
Delivery—Ex stock.

Type E.805

Time base frequency 5 c/s—150 Kc/s.
Amplifier response (3 dB loss) 2 c/s—2 Mc/s.
Amplifier sensitivity (Max. Gain) 5 mV. rms/cm.
Delivery—Ex stock.



Mullard

Electronic Products Ltd.

Electronic Equipment Division

ABOYNE WORKS, ABOYNE ROAD, LONDON, S.W.17.

(MI.276)



Here are sets to delight the expert

★ WITH 2 YEARS' FREE ALL-IN SERVICE IN THE HOME ★

Apply any test you wish to these Sobell 5-valve superhet table receivers. You will find that every component is superbly engineered. Check the circuits, the signal rectification, the I.F. selectivity, the audio sensitivity—and any other points you like. They'll all satisfy your critical judgment.

We'll say nothing about the obvious—the pleasing cabinets, the simple controls, the easy-to-read 3 wave band tuning dials, the special gramophone pick-up sockets with automatic switches, the provision for external loudspeakers—because these are "musts" in sets designed to the highest standards.

The two models illustrated are 519P and 519W respectively, working on 200-250 volts A.C. only. There's a Sobell dealer in your district—he'll be glad to arrange a thorough demonstration.

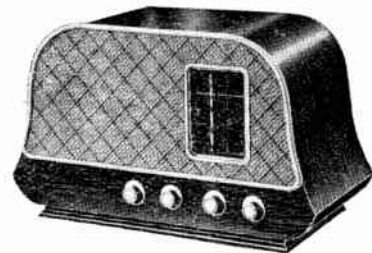

SOBELL

RADIO
AND TELEVISION

Adv't. of Sobell Industries Limited, Langley Park, Nr. Slough, Bucks.

*Phone: Slough 22201/5

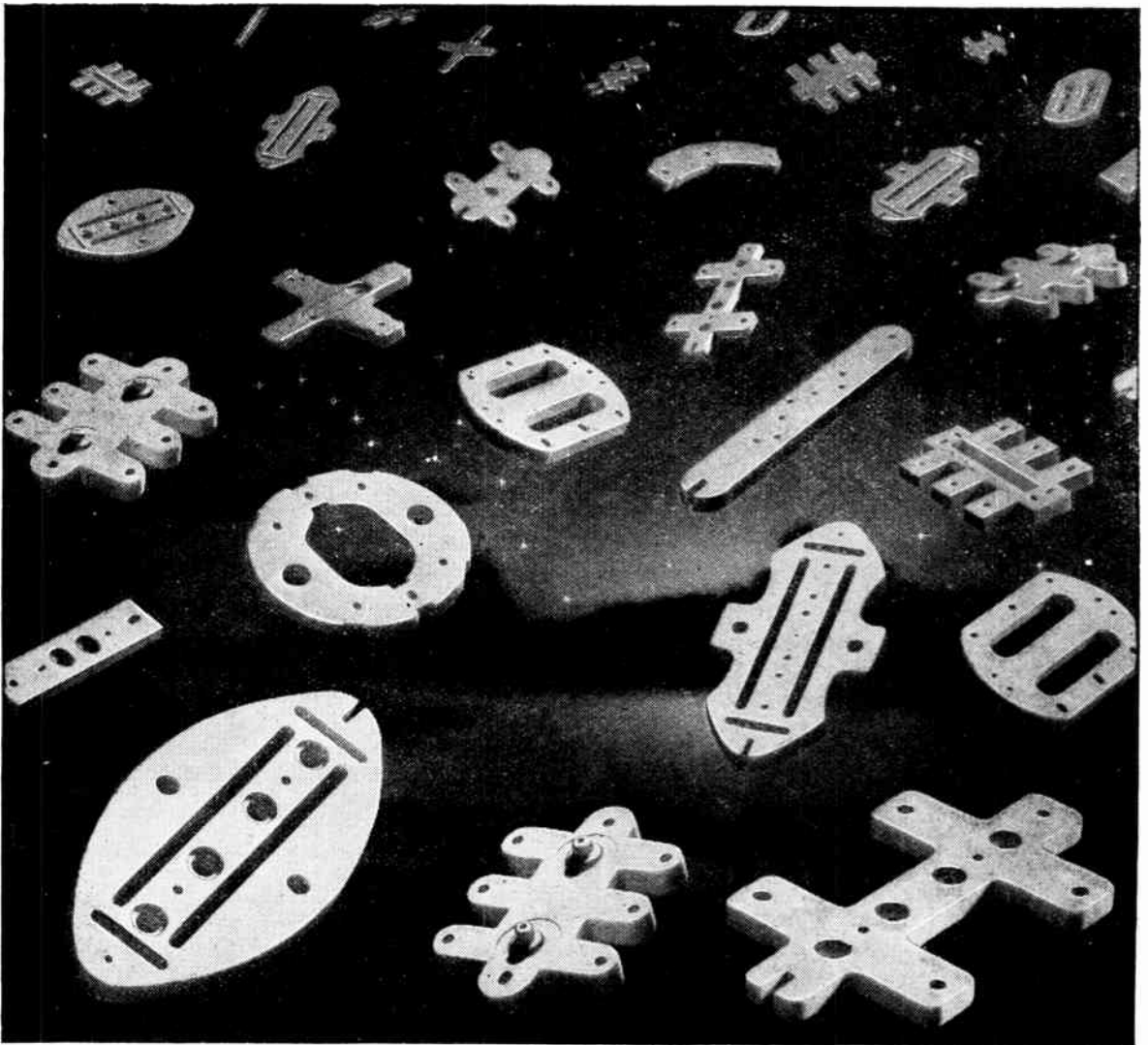

CERAMICS

FOR ELECTRODE SUPPORTS
and all radio components
FREQUENTITE — FARADEx — TEMPRADEx

STEATITE & PORCELAIN PRODUCTS LTD.



Stourport on Severn, Worcester

Telephone: Stourport 111

Telegrams: Steatoin, Stourport

S.P.53

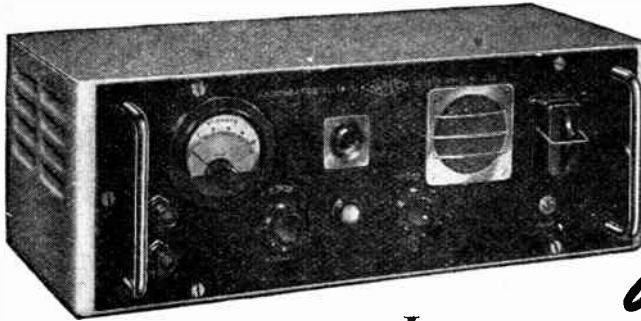

*It saved
its COST
in TWO weeks!*

B.I.F. OLYMPIA
STAND No. C.314



INSTALLED BY a well known manufacturer of fractional h.p. motors, this Airmec Ionisation Tester achieved savings in two weeks that more than covered its initial cost. Maybe this is exceptional, but to any manufacturer of capacitors, transformers, choke coils or similar components, or insulating materials this equipment can be extremely valuable. Ionisation is indicated aurally and leakage by a magic eye indicator. No damage or breakdown is caused when testing. Please write for full information or demonstration of this new and particularly safe instrument.

ELECTRONIC IONISATION and INSULATION TESTER

AIRMEC LABORATORIES LTD · HIGH WYCOMBE · BUCKS · ENGLAND

TELEPHONE : HIGH WYCOMBE 2060 CABLES : COMMLABS, HIGH WYCOMBE

Manufacturers of all types of Industrial Electronic Equipment and Test Gear

Wharfedale OUTPUT TRANSFORMERS

O.P. 3

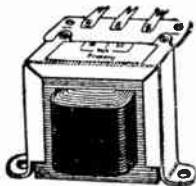

Wharfedale Transformers have been in steady demand since their introduction 14 years ago, and have built up a high reputation for reliability. Returns from all causes are less than $\frac{1}{2}\%$.

TYPE P

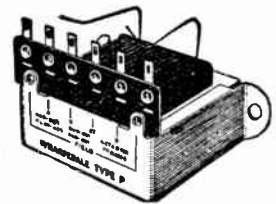

LIST PRICES

O.P. 3, 3 ratios	6/9	De Luxe, 6 ratios with C.T.	22/6
Type P, 4 ratios with C.T.	8/-	W.12, 3 ratios with C.T.	21/
G.P. 8, 8 ratios with C.T.	11/6	W.12—Any ratio to order	25/-
Universal, 6 ratios with C.T.	13/6		

WHARFEDALE WIRELESS WORKS

BRADFORD ROAD, IDLE, BRADFORD

Telephone : IDLE 461.

Telegrams : Wharfdel, Idle, Bradford



MAY 2-13

These Dates are Important—
**to Manufacturers, Merchants, Trade Buyers,
 Salesmen and all who are concerned with
 Britain's industrial recovery**

THIS is our twenty-eighth annual trade fair. The world's greatest national assembly of manufacturers and buyers, at which three thousand exhibitors will reveal their latest products in a million square feet of exhibits. This vast market place is a testing ground of the year's effort—a significant spectacle—which concerns us all since Britain's future depends upon her productive skill.

For many months, in 33 languages, details of this display have been reaching leading buyers overseas. During the Fair they will land in Britain from every country in the world, and in numbers exceeding a thousand daily. These are our customers, the most important visitors of the year.

For Trade buyers from home or overseas 'BIF' means business, and during the special hours of public admission it offers spectacular evidence of national recovery for us all.

INFORMATION

LONDON—Earls Court and Olympia. *Weekdays 9.30 a.m.—6 p.m. Buyers Badges and Catalogues, 2/6 each, obtainable only at Fair. Public admitted Wednesday, Saturday and Wednesday (May 4, 7, 11) 1/6 each building.*

BIRMINGHAM—Castle Bromwich. *Weekdays 9.30 a.m.—6 p.m. Buyers Badges and Catalogues, 2/6 each, obtainable only at Fair. Public admitted daily from 2 p.m. (all day Saturday) 2/6.*

KOLECTRIC AUTOMATIC COIL WINDING MACHINE

Type AI/1



This machine is precision built and it embodies all the latest improvements in coil winding technique. It is suitable for winding coils up to 5" (127m/m) diameter and 7½" (190.5m/m) long. Minimum length of coil 7/32" (5.6m/m).

Among the many features to be found on the Type AI/1 machine are the following:—

- A clear Wire Gauge Indicator is fitted with a glass window and calibrated in mils, or millimetres, as desired. The machine can be quickly set to wind any required wire gauge .020" (.508m/m) and .001" (.0254m/m).
- For setting purposes, micrometer adjustments are provided on the trip rod. These enable the machine to be set to the required width of coil to fine limits. The wire feed carriage automatically reverses its direction of travel when the trip rod operates.
- The railstock is fully adjustable along its bed and the centre is spring loaded to enable rapid change of the coil former.

Please write to us for illustrated leaflets AI/1, AI/2 and RT/1, which contain a full technical specification on the machine and reel stand.

KOLECTRIC LIMITED

BEVERLEY, EAST YORKS.

Wireless World April, 1949

QUALITY COMPONENTS
CAREFUL DESIGN AND
EXCLUSIVE CRAFTMANSHIP
MAKE FURZEHILL INSTRUMENTS
THE FINEST IN ELECTRONICS

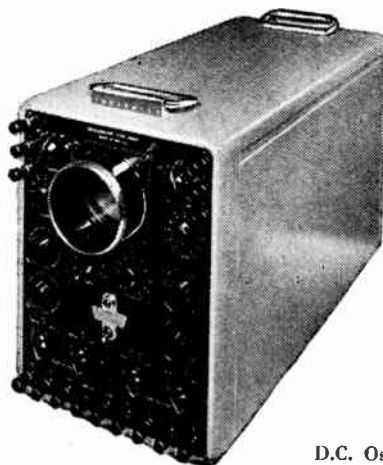

D.C. Oscilloscope
1684D/2

AN EXAMPLE from the Furzehill range of fine instruments is this high-grade oscilloscope for industrial, radio and television applications. Identical d.c. coupled high sensitivity amplifiers are provided for both axes having symmetrical inputs and a level frequency characteristic from zero to 3 Mc/s. Particularly valuable features are the instantaneous action of the shift controls, expansion of the time base scan from ½ to 5 screen diameters, negligible phase shift in the amplifiers and automatic amplitude limited synchronisation.

For full details of this, and other instruments in the Furzehill range, write for our new illustrated catalogue.

FURZEHILL LABORATORIES LIMITED
BOREHAM WOOD, HERTS Tel. ELStree 1137

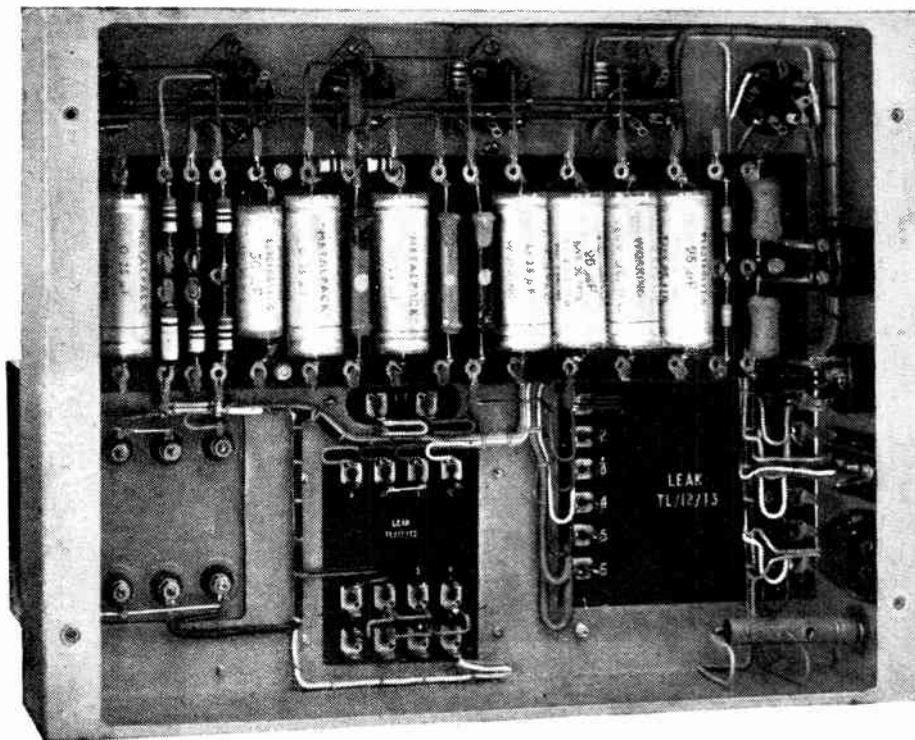

UNDER CHASSIS VIEW OF THE TL/12 POWER AMPLIFIER

LEAK equipment is built to laboratory standards in materials and workmanship by experienced men.

REMOTE CONTROL PRE-AMPLIFIER RC/PA

£6 - 15 - 0 list.

An original feedback tone-control circuit which will become a standard.

No resonant circuits employed.

- Distortion: Less than 0.05%.
 - Switching for Pick-up, Microphone and Radio, with automatic alteration of tone-control characteristics.
 - High sensitivities. Will operate from any moving-coil, moving iron or crystal P.-U.; from any moving-coil microphone; from any radio unit.
 - Controls: Input Selector; Bass Gain and Loss; Treble Gain and Loss; Volume.
- Output Impedance: 0-30,000Ω at 20 kc.p.s.

The unit will mount on motor-board through a cut-out of 10½ in. x 3½ in., or it can be bolted to the power amplifier, when, with a top cover, the whole assembly becomes portable.

For use only with LEAK amplifiers.

Used with the RC/PA pre-amplifier and the best complementary equipment the TL/12 power amplifier gives to the music-lover a quality of reproduction unsurpassed by *any* equipment at *any* price. It is designed in a form so that the power amplifier can be housed in the base of a cabinet and the small pre-amplifier mounted in a position best suited to the user. If you would like to know more about amplifiers in general, and the TL/12 and RC/PA in particular,

WRITE FOR BOOKLET W/TL/12.

H. J. LEAK & CO. LTD. (Est. 1934)

BRUNEL ROAD, WESTWAY FACTORY ESTATE, ACTON, W.3.

Phone: SHEpherds Bush 5626.

Telegrams: Sinusoidal, Ealux, London.

Foreign: Sinusoidal London.

TL/12 12W. TRIPLE LOOP POWER AMPLIFIER

£25 - 15 - 0 list.

A Leak triple loop feedback circuit, the main loop giving 26 db. feedback over 3 stages and the output transformer.

- Push-pull triode output stage. 400 V. on anodes
- No H.T. electrolytic smoothing or decoupling condensers.
- Impregnated transformers; tropically finished components.
- H.T. and L.T. supplies for pre-amp. and radio units.
- Distortion: at 1,000 c/s and 10 W. output, 0.1%; at 60 c/s and 10 W. output, 0.19%; at 40 c/s and 10 W. output 0.21%.
- Hum and Noise: -80 db. on 10 W.
- Frequency response: ±0.1 db., 20 c/s-20 kc/s.
- Sensitivity: 160 mV.
- Damping Factor: 20. Input impedance: 1 MΩ. Output impedances: 2Ω; 7-9 Ω; 15-20 Ω; 28-36 Ω. Phase margin 20° ± 10°. Gain margin 10 db ± 6 db.

25 W. model available at £27.10.0.

ROLA

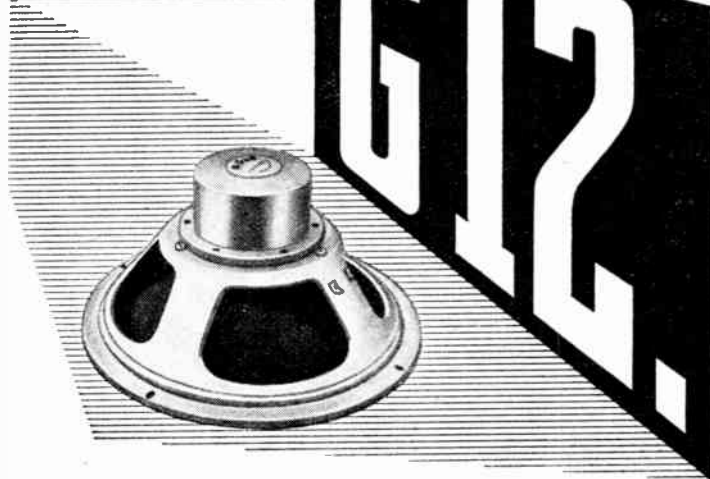

Maximum sensitivity with uniform frequency response from a more compact speaker, appreciably reduced in weight—that is what Rola technicians have achieved with the new G.12. Special features include dust-proof suspension completely protecting coil and magnet gap and the powerful Alcomax II magnet. Write for details and also for particulars of Rola 3" and 4" P.M. models, dust-proofed and equipped with Alcomax II magnets.

**best
of the
BIG
speakers**

BRITISH ROLA LTD. · FERRY WORKS · SUMMER ROAD · THAMES DITTON · SURREY
Telephone : EMBERBROOK 3402 (5 lines)

Television Aerial Downloads

**recommended
types for use
with these
receivers**

CUT THIS OUT FOR REFERENCE

Cat. 339 — 1/- Yd.
Cat. 386 — 1/6 Yd.
Cat. 341 — 1/3 Yd.
Cat. 387 — 6d. Yd.

Aerialite

TELEVISION AERIALS AND EQUIPMENT

	TYPE OF AERIAL PLUG	CAT. NO.	TYPE OF DOWNLOAD RECOMMENDED	Impedance (OHMS)
BAIRD	2-Pin Special Standard	339 or 387	Balanced Twin	80
COSSOR	Standard Coaxial Plug	341	Coaxial	80
DENCO	Terminals only	341 or 339	Coaxial or Balanced Twin	80
EKCO	Auto Type Special	341	Coaxial	72
FERGUSON	Standard Coaxial Plug	341	Coaxial	75
FERRANTI	Octal Plug	387 or 339 or 386	Balanced Twin	80
G.E.C.	2-Pin Special	341	Coaxial	80
MARCONIPHONE	3-Pin Special	341 or 386	Coaxial	50
McMICHAEL	Standard Coaxial Plug	341	Coaxial	80
MURPHY	Standard Coaxial Plug	341	Coaxial	80
PHILLIPS	2-Pin Screened Plug	386	Twin Screened	80
PHILCO	Auto Type Special	341	Coaxial	70
RGD	Standard Coaxial Plug	341	Coaxial	80
SOBELL	Standard	341	Coaxial	75
ULTRA	3-Pin Special	339 or 387	Twin Unscreened	80
VIDOR	Standard Coaxial Plug	341	Coaxial	80
PYE	Standard Twin Plug	339	Balanced Twin	75

MADE BY AERIALITE LIMITED AT THEIR CASTLE WORKS, STALYBRIDGE, CHESHIRE, ENGLAND.

Construction Materials

for THERMIONIC VALVES

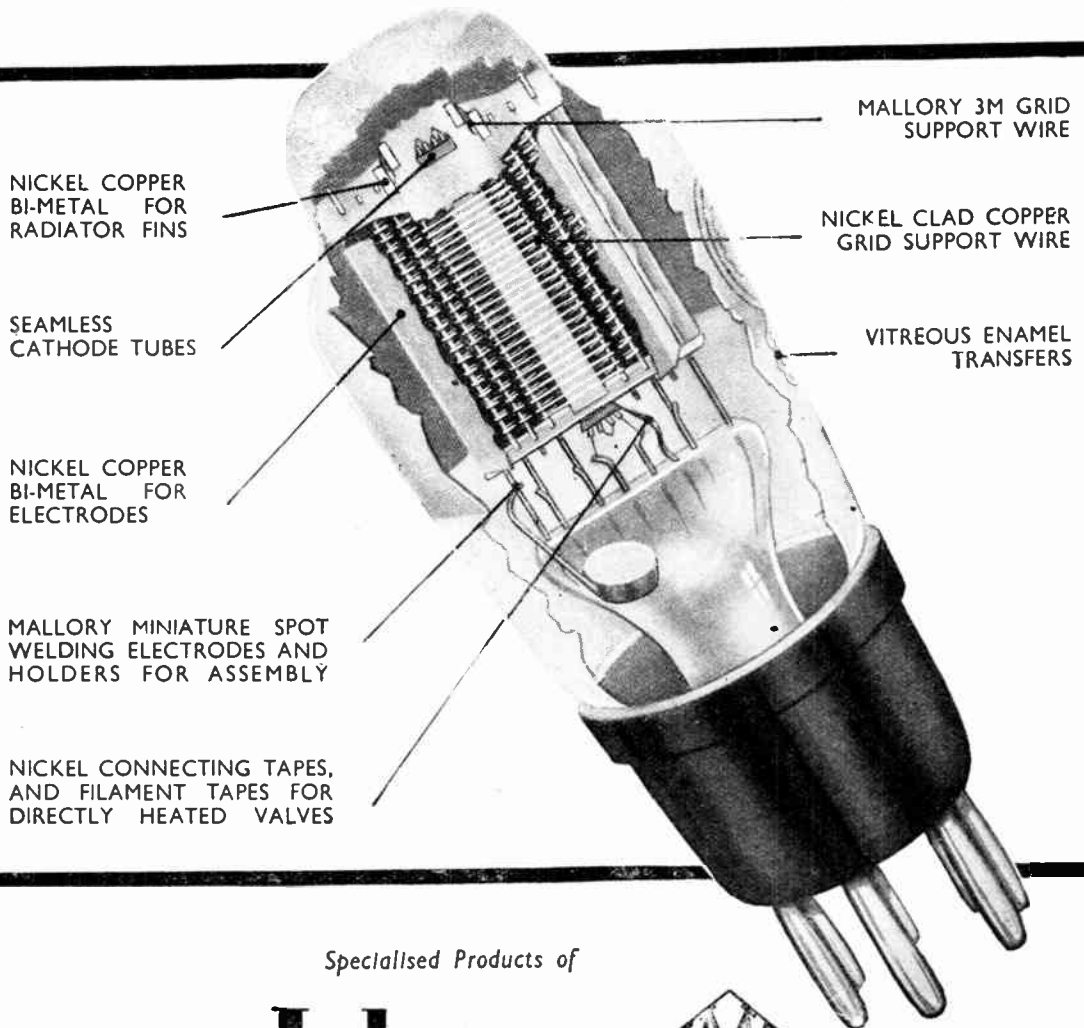

Specialised Products of

Johnson 
Matthey

JOHNSON, MATTHEY & CO., LIMITED, HATTON GARDEN, LONDON, E.C.1

Telephone : HOLborn 9277

The
MAGNAVISTA
TELEVISION LENS

MANUFACTURERS' ANNOUNCEMENT TO ALL TELEVIEWERS

In line with national policy and the lead given by Television Receiver Manufacturers, MAGNAVISTA announce SUBSTANTIAL REDUCTIONS IN THE PRICES OF ALL LENSES. These have been made possible by a new "DIRECT TO DEALER" MARKETING POLICY resulting in LOWER DISTRIBUTION COSTS and also by RAPIDLY GROWING SALES and correspondingly INCREASED PRODUCTION. The accruing financial advantages are being passed on to the consumer whilst the UNSURPASSED QUALITY OF MAGNAVISTA TELEVISION LENSES remains, of course, unchanged.

REDUCED MAGNAVISTA PRICES

TYPE	Tube	£ s. d.
A.7	6"	3 3 0
A.1, A.2, A.4, A.5	9"	4 14 6
B.1, C.1	10" & 12"	5 5 0
D.1	15"	5 15 6
A.3 (Universal) ..	9"	6 16 6
B.2 (Universal) ..	10"	7 7 0

METRO PEX LTD

38, Gt. Portland St., London, W.1
(*Phone: Museum 9024-5)

Webb's RADIO



EDDYSTONE '640'

COMMUNICATIONS RECEIVER

For A.C. Operation 110/250 volts

This famous short-wave receiver has specification and performance equalling communication receivers costing many times the price:—

- Coverage 31 to 1.7 Mc/s.
- Electrical Band-spread throughout range.
- Eight Valves (plus rectifier).
- One R.F. and Two I.F. Stages.
- Efficient Noise-limiter.
- 10, 20, 40, 80 and 160 metre Amateur Bands calibrated.
- Beat Frequency Oscillator.
- Fly-wheel Control on Band-spread.
- Vacuum mounted Crystal filter.
- Adaptor for Battery Operation.

May we send you details of attractive Hire Purchase scheme. Deposit £5.15.0 followed by 78 weekly payments of 6/-.
payments of 6/-.

Cash Price — £27 10s.

BATTERY OPERATION OF "640" by specially designed Eddystone Vibrator Pack No. 687 for 6 volt accumulator. Connections by cable plugs. No. 687 Pack £7 - 10 - 6.



EDDYSTONE LOUDSPEAKERS

For matching your communications receiver, also make neat extension speakers.

No. 688—5in. P.M. unit in black diecast housing. 7in. in dia. £2-17-6. (Also in brown or grey.)

No. 652—3½in. P.M. unit in black or grey. Overall dia. 5in. £1-17-6.

Webb's Radio, 14, Soho St., Oxford St., London, W.1

Phone : GERrard 2089. Shop Hours : 9 a.m.—5.30 p.m. Sats. 9 a.m.—1 p.m.

THIS NEW SIGNAL GENERATOR

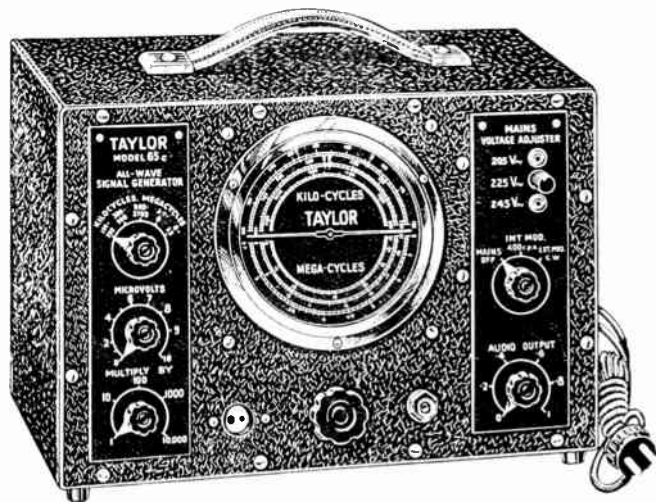

COVERS

100 Kc/s

TO

160 Mc/s

MODEL 65c

This new mains operated Signal Generator has been designed by a highly skilled team of Taylor development engineers. It is an accurate, reliable, and compact instrument which meets all the requirements of present-day practice. Furthermore, future developments in the television field have been met by the wider frequency ranges which hitherto were confined to expensive instruments of the Laboratory type.

LIST PRICE £17.15.0

Write for details of H.P. Terms and information on other WINDSOR & TAYLOR Products

- 7 ranges. Six covering 100 Kc/s to 80 Mc/s on fundamentals and the seventh 80 Mc/s to 160 Mc/s on 2nd harmonic.
- Accuracy better than 2% on all ranges.
- Scale calibrated in Kc/s and Mc/s with total length of 30 ins.
- 400 cycle internal or external modulation.
- Both coarse and fine R.F. attenuation available.
- Up to 1 volt of 400 c/s Audio output available.
- Direct radiation reduced by mains filter.
- AC. mains operated. Voltage adjustment covers 110V. and 200-250V. 40/100 c/s.

OTHER PRODUCTS INCLUDE ; MULTIRANGE A.C. D.C. TEST METERS SIGNAL GENERATORS ● VALVE TESTERS ● A.C. BRIDGES ● CIRCUIT ANALYSERS ● CATHODE RAY OSCILLOGRAPHS ● HIGH AND LOW RANGE OHM-METERS ● OUTPUT METERS ● INSULATION TESTERS ● MOVING COIL INSTRUMENTS

TAYLOR ELECTRICAL INSTRUMENTS LTD
419-424 MONTROSE AVENUE, SLOUGH, BUCKS, ENGLAND



Telephone SLOUGH 21381 (4 lines)
Grams & Cables TAYLINS, SLOUGH

Connoisseur

Gramophone motor now ready!

At last a gramophone motor to match the performance of the famous Connoisseur Pick-up.

SPECIFICATION :

Voltage : 200-250 volts A.C., 50 cycles. Rim drive with speed variation. No governors and no gearing. Heavy non-ferrous turn-table, machined to run dead true, fly-wheel action—no "WOW." Main turn-table spindle hardened, ground and lapped to mirror finish, running in special phosphor-bronze bearings. Motor runs in needle-point, self-adjusting bearing.



Motor Board fin. plastic. Pressure on Drive-Wheel released when not in use, to obviate forming flats and noisy action.

Retail Price, complete with Pick-up £15 19s. 0d. plus £6 18s. 2d. P.T.

" " without Pick-up ... £13 5s. 0d. " £5 14s. 10d. P.T.

Coupling Transformer when required 13s. 0d.

Made by

A. R. SUGDEN & CO. (ENGINEERS) LTD., BRIGHOUSE, YORKS.

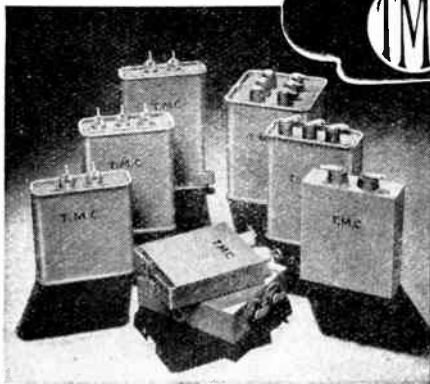

T.M.C.

PRECISION CAPACITORS

Engineers speak with no small pride when they say that their apparatus is to "Communications Standards."

We feel equal pride in the ever-increasing number of Engineers who specify their requirements from our comprehensive range of high grade "Precision" capacitors.

To Designers who must have the best we offer:—

PAPER DIELECTRIC TYPES

for the not so exacting conditions.

CLAMPED MICA DIELECTRIC TYPES—

for heavy current duty.

SILVERED MICA DIELECTRIC TYPES—

for use where small size and weight are important.

Special types available for the most exacting temperature conditions.

T.M.C. Capacitors for general use in Radio and Television, Electronic, Telecommunications, and Public Address equipment are made in a wide range of capacitances. Working voltages up to 10,000 D.C.

Send for Descriptive Brochures F.1003 F. & K.

TELEPHONE MANUFACTURING COMPANY LIMITED

Capacitor Dept., St. Mary Cray, Orpington, Kent.

Telephone: Orpington 2650

Neostron COLD CATHODE TETRODES

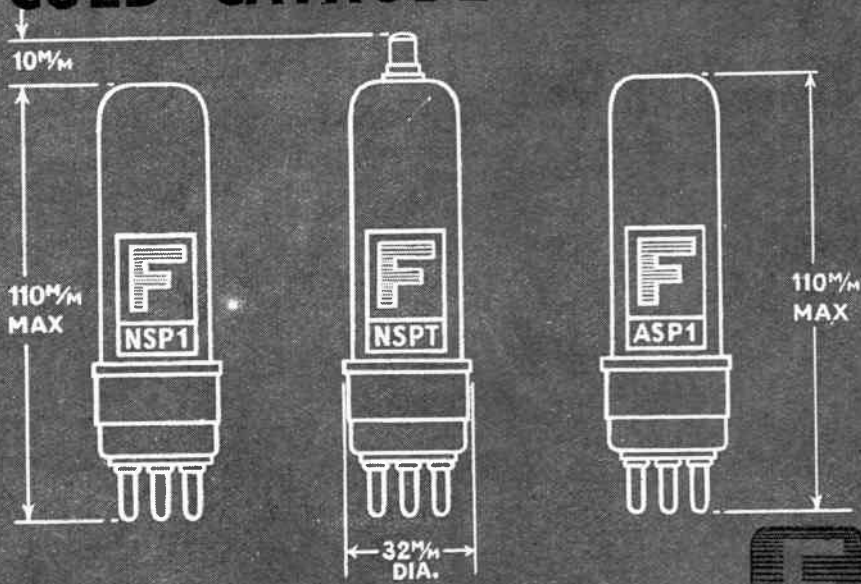

IMMEDIATE DELIVERY



The Ferranti Neostron is a cold cathode tetrode filled with neon, designed for use as a stroboscopic light source, a flashing indicator, or an electronic relay.

The discharge in the anode is started by initiating a glow discharge between the screen and grid electrodes, the screen being at a fixed positive bias, a negative impulse being applied to the grid.

Operating Characteristics	NSP1	NSPT	ASP1
Max. Anode Voltage	400	650	400
Normal Anode Voltage	300	600	300
Mean Anode Current	40-100* mA	40-100* mA	40-100* mA
Peak Anode Current	250 Amps.	250 Amps.	250 Amps.
Max. Operating Frequency	250 c.p.s.	250 c.p.s.	300 c.p.s.
Anode Connection	in base	Top cap	in base
Gas Filling	Neon	Neon	Argon

**Dependent upon frequency of operation*

All types can be supplied with English 4 pin or American 4 pin bases.

FERRANTI LTD ELECTRONICS DEPT. MOSTON MANCHESTER 10

"VICTORIA" at the B.I.F

Visitors to our stand will be interested in the development of Victoria instruments during the past twelve months. New, advanced instruments and their applications will be demonstrated, and technicians will be at hand for advice on any matters relating to our products.

PORTABLE TEST SETS

Robust moving iron Instruments. Suitable for the Electrical Contractor or Automobile Electrical Engineer.

Size: $3\frac{3}{4}'' \times 3\frac{3}{4}'' \times 2\frac{1}{2}''$ overall complete with carrying strap

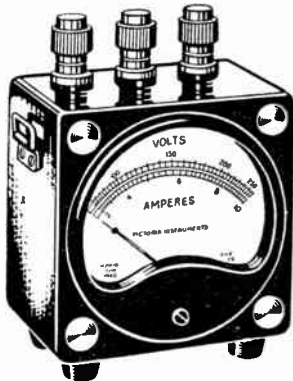

These combined instruments are made in many standard ranges. Combination examples:

260V A.C. or D.C.

15A A.C. or D.C.

25V A.C. or D.C.

25A A.C. or D.C.

Other Combinations to order.

B.I.F. OLYMPIA • Stand No.C.52

VICTORIA INSTRUMENTS

Proprietors: V.I.C. (Bournemouth) Ltd.

MIDLAND TERRACE • LONDON • N.W.10

Telephone: ELGar 78711/2

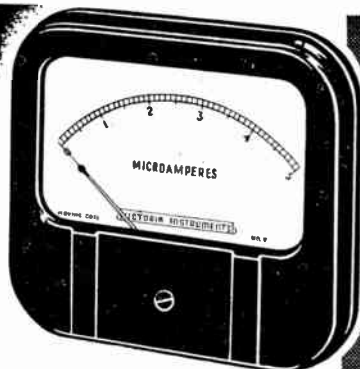

SQUARE FLANGE METERS

4" Large Open Scale. Mirror Scale can be supplied if required.

RANGES:

A.C. From 1V-10kV

25uA-100 Amps.

D.C. From 5mV-10kV

5uA-5000 Amps.

*Victoria Instruments
are made
uncommonly well*

let "Mighty Midget"

Boost Your Sales

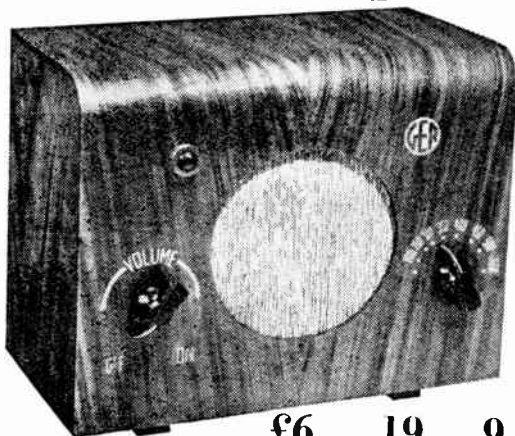

£6 . 19 . 9

INC. P.T.

- 3 valve, plus rectifier, midget radio receiver; 200-250 volts A.C. or D.C.
- **Cabinet:** Fully seasoned wood, finished in polished walnut
- **Valves:** Latest British Octal and Ballast Type
- **Coils:** High "Q" iron cored on "low-loss" formers
- **Wave-range:** 200-550 metres
- **Chassis:** Steel, plated for reliability & long life
- **Loudspeaker:** 5" dia. "Monobolt" construction, to which is fed 3 watts of Audio Power
- **Guarantee:** 12 months
- Apart from Mains, the only connection is an aerial supplied with the set

Volume, Tone and Sensitivity are remarkable from a Radio measuring $8\frac{1}{2}'' \times 7'' \times 4\frac{1}{2}''$. The advertising campaign now getting into its stride, will be increased in volume and tempo, as space becomes available

GENERAL ELECTRICAL RADIO

21-29 SHENE STREET, BATH STREET, LONDON E.C.1

DUBILIER TUBULAR CAPACITORS

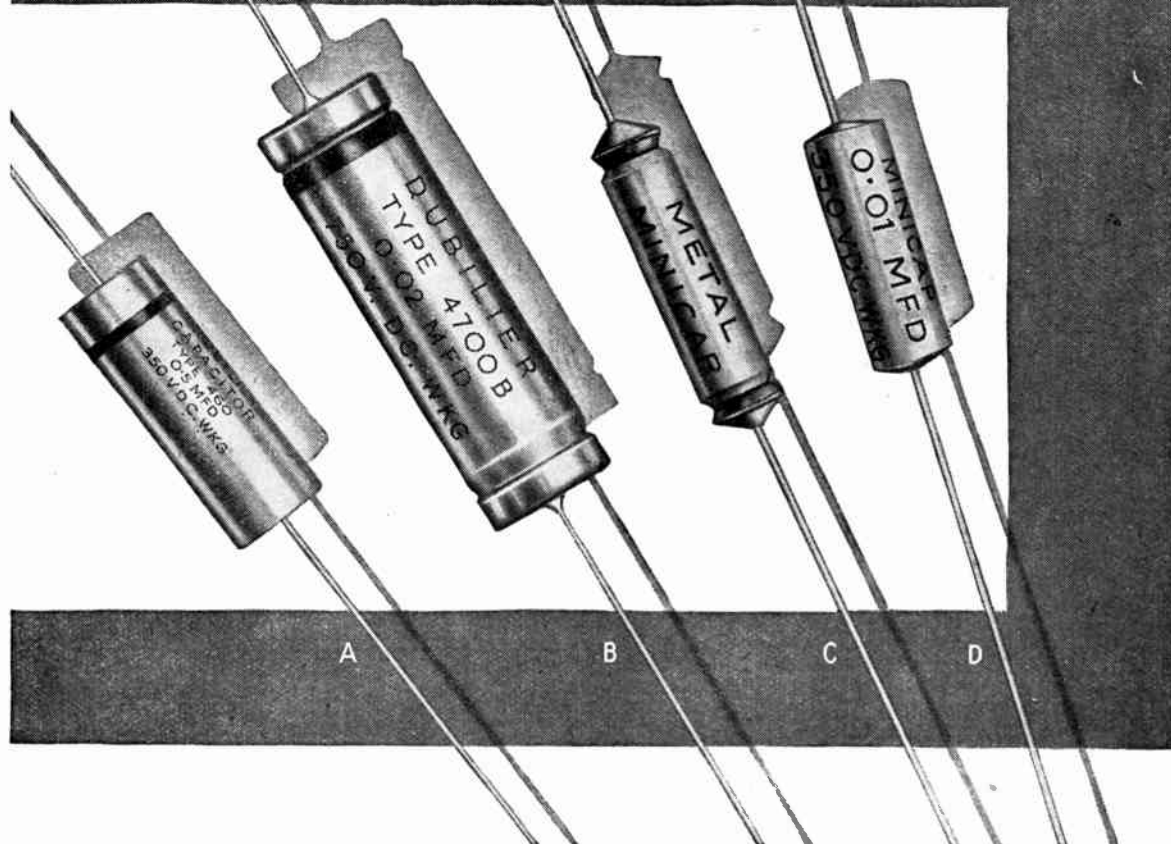

Of the many forms of capacitors available, one of the most popular is the Tubular Paper, which fits most conveniently into any wiring assembly. In order to meet specific requirements, Tubular Capacitors must be chosen with care by the designer and engineer; Dubilier Tubular Paper Capacitors are produced in a wide range covering all needs, for instance:—

A. Type 460 Tubular Paper Capacitors for all general requirements.

B. Metal-cased Tubular Paper Capacitors for use in Tropical conditions.

C. Metal-cased "Minicap" Tubular Paper Capacitors to withstand severe tropical conditions and high altitudes.

D. "Minicap" Tubular Paper Capacitors for miniature application combining minimum size and weight with excellent electrical properties.

We shall be pleased to forward full technical details of these Capacitors upon request, and our technicians are always at your service for consultation with regard to their use.

DUBILIER

CONDENSER CO. (1925) LTD.

CAPACITORS

MAKERS OF THE WORLD'S FINEST CAPACITORS
 DUBILIER CONDENSER CO. (1925) LTD., DUCON WORKS, VICTORIA ROAD, NORTH ACTON, W.3
 'Phone: Acorn 2241 (5 lines). 'Grams: Hilvolcon, Phone, London. Cables: Hilvolcon, London. Marconi International Code



TO that exclusive coterie—The 'Sound Repro' Engineers, Technicians and Recordists, the initials M.S.S. need no introduction. Much that is today acknowledged as standard practice in Disc Recording was conceived and developed by M.S.S.

During the war the Company was greatly enlarged and development was accelerated to provide improved disc recording equipment of all kinds for the Service Departments. Now, however, enhanced facilities coupled with improved material supplies are making M.S.S. Equipment available to a wider circle of users.

The well-tryed and well-proven advantages of M.S.S. technique are at the service of all who seek the highest possible fidelity and operating efficiency in Disc Sound Reproducing Equipment.

Among the users of M.S.S. equipment are:—

The British Broadcasting Corporation,
The Admiralty,
The Ministry of Supply,
The General Post Office
and
Broadcasting Authorities
& professional recordists
in all parts of the world.

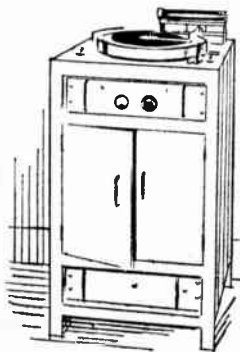

The illustration shows the Type D.S.R. Reproducing Console as used by broadcasting stations, commercial studios and theatres, etc.

Details of the M.S.S. Range available from:—

M.S.S. RECORDING COMPANY LIMITED
POYLE CLOSE, COLNBROOK BUCKS. Tel: Colnbrook 115 & 87

The RIMINGTON JEWEL

will bring new life to

GRAMOPHONE REPRODUCTION



Straight for Crystal pick-up only.



Lightweight for new miniature pick-up.



Trailer type for Heavier pick-up.

- ★ Reproduces the maximum recorded frequency range.
- ★ Wear on records is negligible, the jewel is scientifically designed to follow the groove of the record lightly and smoothly.
- ★ Preserves the higher frequencies delicately imprinted in the record, so easily destroyed, and reproduces them!
- ★ Jewel well set and angle correct.
- ★ Contained in plastic box well packed and mounted.
- ★ LIFE. It is not possible to state categorically the life of a jewel point, but in the interest of quality it is advisable to replace the jewel after 1000 playings—it is a matter of personal discretion.
- ★ The Rimington Jewel has had exhaustive tests by Messrs. W. R. Prior Ltd., microscope manufacturers, of Bishops Stortford, who have stated that the needles are free from blemish and perfect in detail.
- ★ The Rimington Jewel needle reveals new beauties in your records which you have heretofore unsuspected.

PRICE—Most reasonable. The Rimington Jewel is the finest sapphire on the market and it retails at only 9/9.

Order your Rimington Jewel NOW and revolutionize your gramophone reproduction.

TRADE ENQUIRIES INVITED

RIMINGTONS

RIMINGTON, VAN WYCK LTD., 42-43 Cranbourn St., London, W.C.2
Gerrard 1171

RIMINGTON, VAN WYCK (Mail Order) LTD., 28a Devonshire St., Marylebone, London, W.1 Welbeck 4695

• CONSTANT VOLTAGE • POWER SUPPLY UNITS

NEW SERIES 101

Our new Laboratory Power Supplies, Series 101, are based on our well-known Model 101-A, but incorporate a number of improvements and refinements.

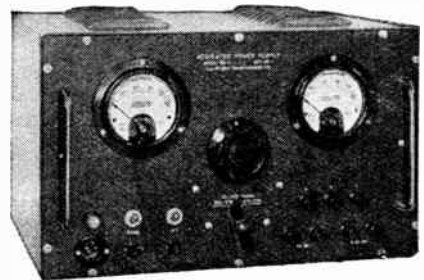

DETAILS ON REQUEST.

ALL-POWER TRANSFORMERS LTD.

8a, GLADSTONE ROAD, WIMBLEDON, S.W.19

Tel.: LIBerty 3303.

They speak for themselves...

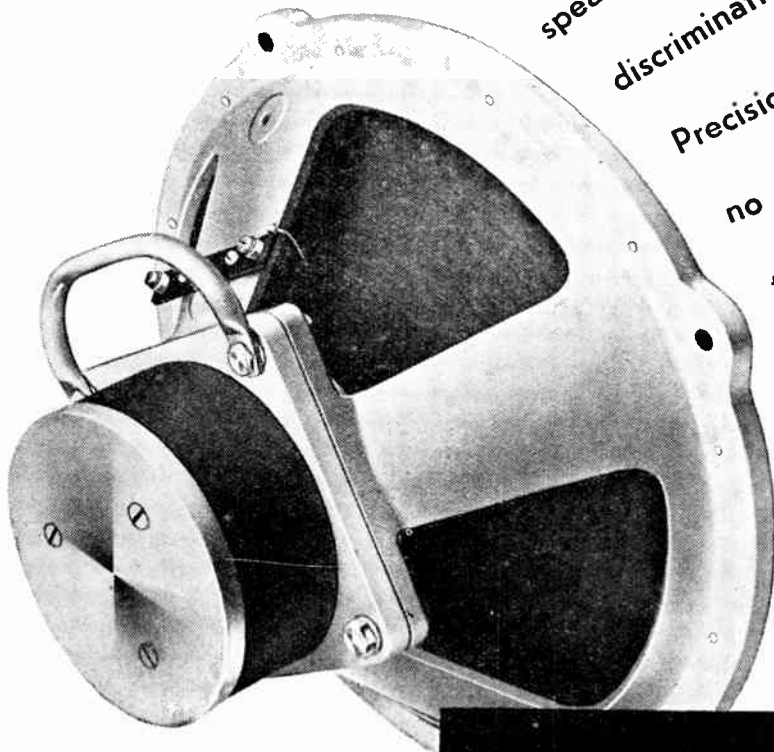

fidelity of response

speaks for itself to the

discriminating ear.

Precision manufacture is

no less eloquent to the

trained engineer. These

qualities make

TRUVOX speakers famous

The SS10A 12-inch Heavy Duty Speaker, illustrated, offering a frequency response from 55 to 11,000 c.p.s. and handling 10 watts is a typical example of TRUVOX workmanship.

TRUVOX

TRUVOX ENGINEERING CO. LTD · EXHIBITION GDS · WEMBLEY · ENGLAND

1247

Installations

Large and small Multi-Unit Rack Assemblies for all types of installations.

The illustration shows a typical 2 channel Radio System with automatic microphone switching.

Acoustical
MANUFACTURING COMPANY LIMITED

HUNTINGDON Telephone: HUNTINGDON 361



Speaking of operations, a delicate but highly successful one has been carried out in striking the balance of correctly matched voice coil and curvilinear cone for our new 12" loud speaker. By carefully

suiting the weight of coil to cone we have reduced the peaks and secured a freedom from break-up, while the very high flux density of the large Alcomax magnet considerably increases the sensitivity, especially in the higher frequencies. All very worth while as you may see, or rather hear.

Overall diam. 12 1/2". Depth 6". Weight 7lb. 15 ozs. Voice Coil Impedance 15 ohms. Fundamental resonance 60 cycles. Flux density 14,000 lines per. sq. cm. Frequency range 50-7,000 c.p.s. Fixing holes 4 holes 1/2" diam. spaced 90° on P.C.D. 12 1/2".

**DELIVERY FROM STOCK
LIST PRICE £6-10-0**



GRAMPIAN REPRODUCERS LTD
Hampton Road, Hanworth, Middx. Phone: Feltham 2657



Inductance Meter

TYPE M148-2

This instrument has been designed to provide simple and direct reading measurement of inductance values between 0.05 microhenry and 100 millihenrys. A stable variable-frequency oscillator is

used to resonate the unknown inductance with a fixed standard capacitor. Provision is made for the measurement of Q at resonance frequency. Price £38.5.0.

Wayne
Kerr

WAYNE KERR LABORATORIES LIMITED, NEW MALDEN, SURREY.

**THE LEADERS
IN THE FIELD
OF MAGNETIC
RECORDING**

THE
Soundmirror
MAGNETIC TAPE RECORDER



RECORDS & REPRODUCES
ANY RADIO PROGRAMME
SPEECHES & LECTURES
BOARD MEETINGS Etc
PERSONAL EVENTS

Made in England. Protected by British and Foreign Patents and Patents pending.

Made by the Makers of the famous



LOW COST DICTATING UNIT



MAY 2-13
OLYMPIA &
EARLS COURT

SEE OUR EXHIBIT

STAND No. E66
OLYMPIA

THE "SOUNDMIRROR" IS HERE. Made in England by the electronic designers and engineers of Thermionic Products Ltd., the "Soundmirror" opens up enormous fields in the development of mobile or static recording and reproducing.

RECORDING—Using reels of magnetized tape, the "Soundmirror" gives 30 mins. of high fidelity, continuous recording. Changing of reels is quickly and simply done. The hand microphone packs easily into the handsome polished cabinet.

REPRODUCTION—Life-like tonal quality of any desired volume equal to the best radio receivers. The recordings are permanent and can be played an indefinite number of times without loss of quality. The recording tape can be cut and spliced to join up short recordings or edit unwanted parts. Recordings can be erased and the reels of tape used indefinitely.

The "Soundmirror" Recorder is a complete electronic unit. Contains speaker, amplifier, microphone and is equipped with jacks for easy hook up to radio, public address and other electronic audio systems. Enquiries invited.

THERMIONIC PRODUCTS Ltd.
Leaders in the Field of Magnetic Recording

Head Office: **Morris House, Jermyn Street, Haymarket, London,**

Phone : WHitehall 6422/3/4.

S.W.1

NEW DESIGNS
in the range of
U.I.C.
High Stability
CAPACITORS

1 LEAD-THROUGH "HI-LOAD" CAPACITOR

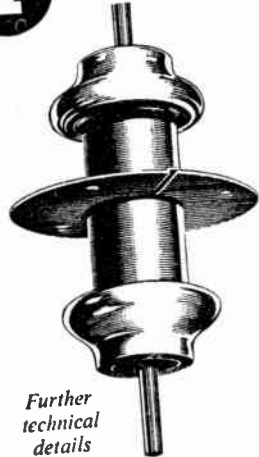

Further technical details furnished on request

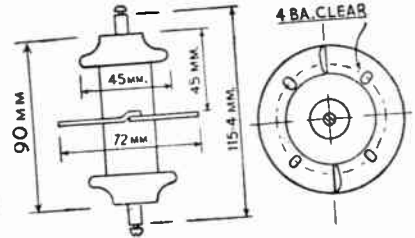

This new Ceramic "Hi-Load" Capacitor has been specially designed as H.T. or Heater By-Pass and Lead-Through Capacitor. Although very small in dimensions the capacitor has a capacitance of 1,000 pF and it is rated at 40 KVA R.F. with a maximum R.F. current of 20 amps. The sturdy rod forming the lead-through connection is capable of handling all normal currents. The high rating also makes the capacitor suitable as a tank capacitor.

UNITED INSULATOR CO. LTD., OAKCROFT RD., TOLWORTH, SURBITON, SURREY

Telephone : Elmbridge 5241 (6 lines)

Telegrams : Calanel, Surbiton



"BONNIE CATCHES THE EYE!"

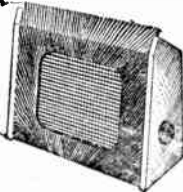

Latest Baffle Extension Speaker has new Richard Allan 6½" p.m. chassis (type 680). Cabinet in walnut or mahogany veneer; polished cream ends and top. Exceptional quality reproduction—better than many larger speakers—yet size only 8½" x 8½" x 4½".

FROM GOOD RADIO DEALERS **49'6** Walnut
52'6 Mahogany
Transformer 6/- extra

Made and Guaranteed by—

Richard Allan RADIO LTD.
CALEDONIA ROAD, BATLEY, YORKS

from the range of  instruments

The **CONSTAC**
Constant Voltage Transformer

A versatile transformer which provides a fully stabilised 6.3v. heater supply in addition to a variety of stabilised H.T. outputs. Originally designed for use in E.I.L. instruments, the CONSTAC* is now available to manufacturers of high grade equipment.



TYPE A

*Made under licence by
The Banner Electric Co., Ltd.

Input: 160 to 260v. 50 c/s.
L.T. Output: 6.3v. 2A.
H.T. Output: 350v. 25 mA or 700v. 15 mA
or 350v. 15 mA and 170v. 25 mA

ELECTRONIC INSTRUMENTS LTD
17 PARADISE ROAD • RICHMOND • SURREY





A good thing in a small package

OSRAM MINIATURE VALVE

TYPE Z77 HIGH-GAIN PENTODE

It is a high-gain pentode, mounted on the B7G base and is suitable for use in television, wide-band radio, amplifier and electronic instrument circuits.

INTERESTING FEATURES

Small size and rugged construction make it an eminently suitable valve for use in mobile and portable equipment. Suitable for operation up to 100 megacycles per second. Owing to smallness of size and low thermal capacity the valve rapidly reaches a stable operating condition.

List Price 17/6. Purchase Tax 3/10 extra.



 PHOTO CELLS	 CATHODE RAY TUBES	 VALVES
--	--	--

THE GENERAL ELECTRIC CO., LTD., MAGNET HOUSE, KINGSWAY, W.C.2.

CONSISTENTLY *Accurate* PULLIN SERIES 100 TEST SET

SENSITIVITY 10,000 OHMS/VOLT

with

A.C./D.C. Voltage Multiplier
for 2,500 V. and 5,000 V.Volts A.C. and D.C. Range .
10, 25, 100, 250, 500, 1,000.Milliamps D.C. only :
2.5, 10, 25, 100, 500.

Ohms : 0-10,000 and 0-1 megohm.

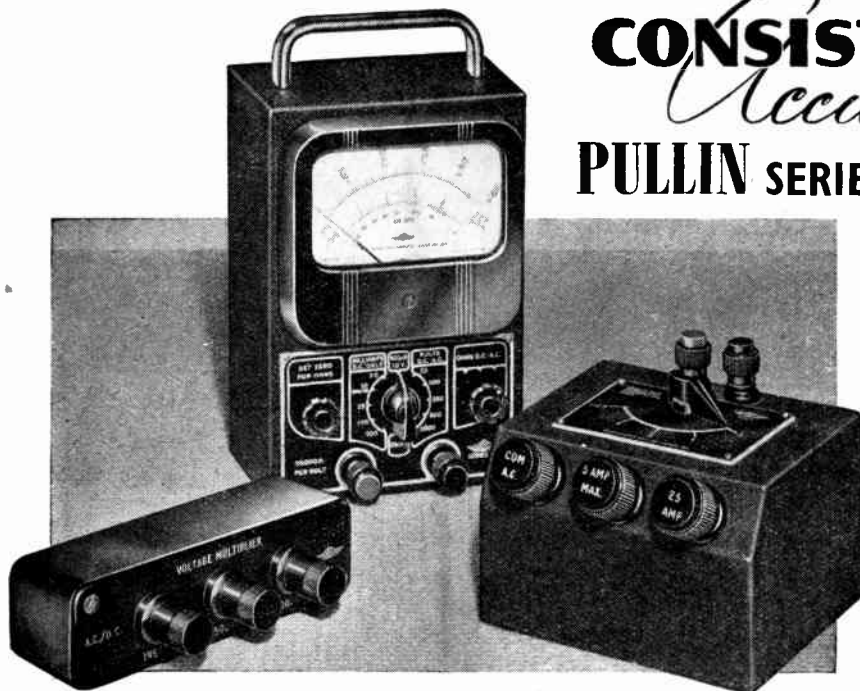
A.C. Current Transformer
Range : 0.025, 0.01, 0.5, 1.0, 5.0,
25.0 Amps.We can give early deliveries—
Address all enquiries to:

MEASURING INSTRUMENTS (PULLIN) LTD

DEPT. J. ELECTRIN WORKS, WINCHESTER STREET, LONDON, W.3. Tel: ACOrn 4651/3 & 4995

LAMINATIONS

FOR

All Radio and Electrical Uses.**In Silicon, Dynamo, Intermediate
and Transformer Qualities.****Permalloy, Mumetal, Radiometal.****Screens for all Electrical Uses.****Transformer Shrouds
for 35 and 74 Lams.****General Precision Engineers.****Heat Treatment.****Sheradising to the Trade.****Electrical Sound & Television Patents Ltd.**12 Pembroke Street, London, N.1. — TERminus 4355
2/4 Manor Way, Boreham Wood, Herts. — ELSTREE 2138

TYPE 26 V.H.F. CONVERTER

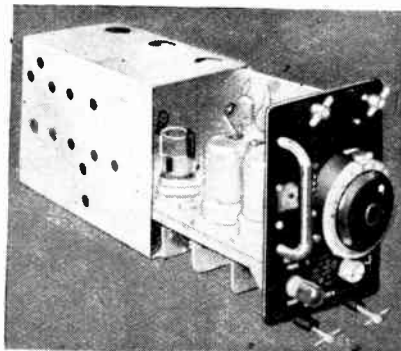
We are pleased to be able to offer Type 26
R.F. U.H.F. Converter Unit as illustrated.This unit covers 50-60 M/cs without modification. Can
be used with any super-het covering 7.5 M/cs (40
metres). Requires 6.3 v. 1 amp. for heaters, 250-300 v.
30 m.A. H.T. Three tuned stages R.F., mixer and
oscillator. Fitted with Muirhead Slow Motion Drive.
All internal parts and chassis silver-plated. Ideal for
5-metre and Birmingham television bands.**BRAND NEW. IN ORIGINAL
CARTONS. Order at once
to avoid disappointment. 35/-**In addition to the above, many other bargains are available. Send
3d. in stamps for our No. 8 special offers list and Raymart new
illustrated catalogue and price list.**RADIOMART** 48 HOLLOWAY HEAD
BIRMINGHAM, 1
Tel.: Midland 3254

Announcing

A NEW ADDITION TO
A TRUSTED RANGE

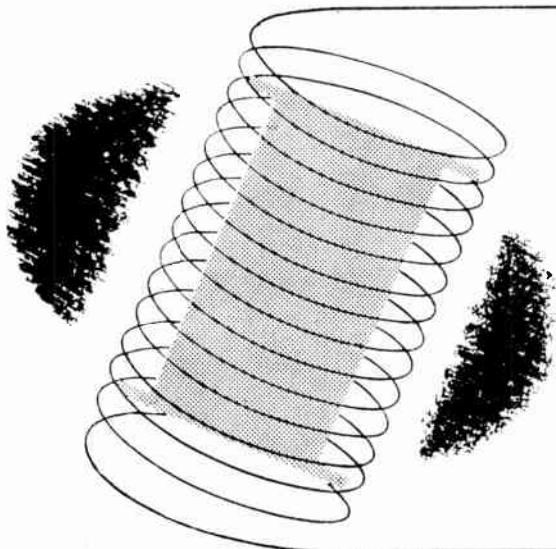

HYMEG

SOLVENTLESS
VARNISH

for Electrical Windings & Coils

Since the Introduction of HYMEG Synthetic Insulating products, their outstanding properties have become well-known, and the expansion of their use in the Electrical Industry has been responsible for a considerable improvement in both the finished machine and its method of production. Now, in response to a wide demand, Berger announces the addition of a SOLVENTLESS VARNISH to the HYMEG range.

HYMEG SOLVENTLESS VARNISH offers these considerable advantages:

1. It is ready for use as supplied, either for dipping or vacuum impregnation, *without* heating up before use.
2. No catalysts are required before use.
3. The product has the characteristic Hymeg through-drying properties.
4. As a result of (1) and (2), the stability in the customer's plant is even better than with standard Hymeg, which itself represents a considerable advance over all other insulating varnishes.
5. It is suitable for tropical service.
6. Coils impregnated with Hymeg Solventless Varnish run at lower temperatures than usual, due to improved thermal conductivity with resulting longer life.

HYMEG

S O L V E N T L E S S
V A R N I S H

Patent applied for.

A *Berger* PRODUCT

LEWIS BERGER & SONS LIMITED 35 BERKELEY SQ., LONDON, W.1

9B/1

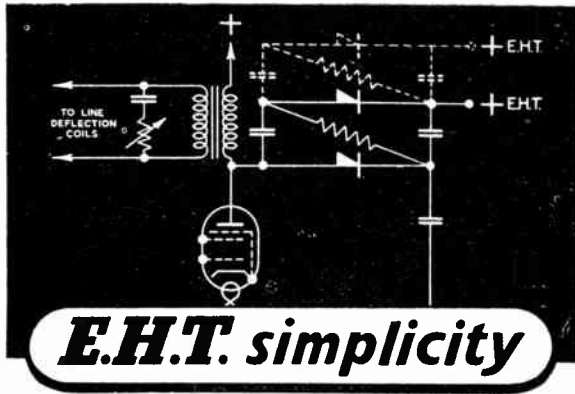

Three type 36EHT35 rectifiers, each only 3" long X 1/2" dia, will, from a peak pulse input of approx. 2,500V obtained from the standard line scanning output transformer, give an output of about 6kV at 100µA, used in the tripler circuit shown on the left.

E.H.T. may be obtained from the standard line scanning output transformer without any alteration whatever. Simply add three 36EHT35 rectifiers in a tripler circuit and

you will obtain 6kV for your tube anode supply. Simple efficient reliable. Other sizes of rectifier available for lower or higher outputs.

WESTINGHOUSE
WESTALITE
36EHT METAL RECTIFIERS

Write for data sheet No. 60, to Dept. W.W.4.

Westinghouse Brake & Signal Co., Ltd., 82, York Way, King's Cross, London, N.1.

A NEW B.P.L. INSTRUMENT



THE VOLTASCOPE—A combined valve-voltmeter and oscilloscope. **VALVE-VOLTMETER**—Infinite Input Resistance for D.C. ranges 0 to 300 volts. A.C. ranges 0 to 150 volts in 5 ranges. 3 1/2 inch scale meter. **OSCILLOSCOPE**—3 inch screen tube provided with balanced amplifiers for Y and X plates giving a 5 times trace expansion. Maximum sensitivity 150mV/cm. Response from D.C. to 100 kcs.

Limited quantity available for early delivery.

BRITISH PHYSICAL LABORATORIES
 HOUSEBOAT WORKS, RADLETT, HERTS.

Tels: Radlett 5874-5-8



FOR THE RADIO SERVICEMAN DEALER AND OWNER

The man who enrolls for an I.C.S. Radio Course learns radio thoroughly, completely, practically. When he earns his Diploma, he will KNOW radio. We are not content merely to teach the principles of radio, we want to show our students how to apply that training in practical, every-day radio service work. We train them to be successful.

Write to the I.C.S. Advisory Dept. stating your requirements. Our advice is free.

You may use this coupon.....

INTERNATIONAL CORRESPONDENCE SCHOOL Ltd.
 DEPT. 38, INTERNATIONAL BUILDINGS, KINGSWAY, LONDON, W.C.2

Please explain fully about your instruction in the subject marked X.
 Complete Radio Engineering Radio Service Engineers
 Radio Service and Sales Advanced Short-Wave Radio
 Elementary Electronics, Radar, and Radio

and the following Radio examinations:—
 British Institution of Radio Engineers
 P.M.G. Certificates for Wireless Operators
 City and Guilds Telecommunications
 Wireless Operators and Wireless Mechanics, R.A.F.
 I.C.S. Students for Examinations are coached till successful

Name Age.....
 (BLOCK LETTERS PLEASE)
 Address



For all Electrical Tests



ALL-IN-ONE RADIOMETER



with internal battery and multi scale the PIFCO All-in-One Radiometer tests everything electrical, Radio and P.A. Equipments, Household appliances of all kinds. Car Lighting Systems, Bell and Teleprinter Circuits. May be used on AC or DC mains.

● **CIRCUIT TEST**
Tests for open or faulty circuits in all radio and electrical apparatus and domestic appliances. Equally for testing car lighting and starting circuits.

● **L.T. TEST**
0.6 volts AC or DC.
● **MILLIAMPERE TEST**
0/23 m.a. scale for testing total discharge from battery or testing single cell.

● **H.T. TEST**
0-240 volts. May be used direct on any mains, AC or DC

● **VALVE TEST**
Made by inserting valve in socket on front of meter.

Write for full details and Export terms. Overseas Agency enquiries invited.

PIFCO LTD., PIFCO HOUSE, WATLING STREET, MANCHESTER, 4
and at PIFCO HOUSE, GT. EASTERN STREET, LONDON, E.C.2

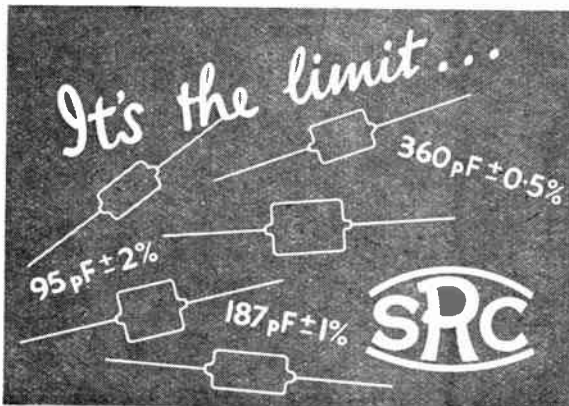

Our Silvered Mica Capacitors reach the limit of accuracy which can be achieved in a mass-produced radio component. Our recognised technical standards will satisfy those set manufacturers who wish their tuning scales to be "dead on line."

STABILITY RADIO COMPONENTS LTD

14, NORMAN'S BUILDINGS,
CENTRAL STREET, LONDON, E.C.1

Telephone: CL Erkenwell 5977.

M.R. SUPPLIES Ltd.

offer only first-class material and give careful and prompt attention to all orders, small or large. All prices nett.

HIGH DUTY RECTIFIER UNITS. Operation on 200/250 volts 50 c. D.C. Output at 122 deg. F., 36 volts, 54 amps. (This output can be considerably increased at normal temperatures). Metal rectified, fitted switch and fuses, contained in steel housing, height 1 1/2 in., width 2 1/2 in., depth 2 1/2 in. (weight approx. 2 cwt.). For heavy duty battery charging, plating and welding. Approx. cost £75. We have fifteen only, new and perfect, at £21 each. These must be collected.

MAINS VOLTAGE RECTIFIER UNITS. Input 200/250 v. 50 c. Output 220 volts D.C. (Nominal rating at 122 deg. F., 0.5 amp—double this rating at normal temperatures) Smoothed to 5 per cent ripple. Metal rectified, fitted fuses and switch, in steel housing, 16 by 14 by 10 1/2 inches. Very useful in labs. and for testing D.C. apparatus from A.C. supply. New and perfect, £7/10/- (despatch 6/-).

A.C. MAINS CONTACTORS. Coil 230 v. 50 c. Contacts 3-pole each 10 amps., supplied with these wired in parallel for 30-amp switching. Smart action, silent in use. On panel 6 1/2 in. by 4 1/2 in., with cover, 17/6.

MEASURING INSTRUMENTS. 6 in. switchboard types, first-grade jewelled movements, calibrated at 50 cycles: 0/20 volts (mirror scale) 32/6 (des. 1/6) 0/300 volts, 37/6 (des. 1/6). This is a good opportunity for the A.C. instruments. Also very attractive offer of m/c Miniature Micro-ameters, deflection 0/500 micro-amps, only 1 1/2 in. diameter, neatly graduated in white on black dial, with back terminals, 12/6 Also 2 1/2 in. m/c Milliammeters, 0/20 m.a., 9/6. Also 2 in. square flange m/c 0/150 m.a., 9/6. Please note—all instruments by best makers, brand new.

FRACTIONAL MAINS MOTORS. 200/250 v. A.C. Brand new, shaded pole. Running torque 400 gram cms, 1300 r.p.m., 100 per cent starting torque. Silent in operation. Shaft 1 1/2 in. long by 1/4 in. Frame 3 1/2 in. by 3 1/2 in. Shaded pole motors, being subject to temperature rise, should be used in slip-stream, unless for 1 to 1 hour periods. 32/6.

EXTRACTOR FANS (Delco) Operation 200/250 volts A.C. Fitted induction motor, silent and very efficient. With mounting frame. With 8 in. impeller, 65/6. With 10 in. impeller, 75/6 (des. either 1/6).

ELECTRIC WATER PUMPS. Special offer of brand new ex-A.M. Immersion self-priming type. Approx. 18 in. long and 2 in. diameter, with adjustable mounting flange. A precision made motor within the tube actuates the centrifugal impeller, the whole assembly being completely water (or oil) tight. These cost over £20 each Duty approx. 300 g.p.h. Operation 12/24 v. AC/DC 22/6 each or with Mains Transformer, 200/250 v. primary, enabling the pump to be operated from standard A.C. mains, 47/6 complete (des. 2/-).

SYNCHRONOUS ELECTRIC CLOCK MOVEMENTS. 200/250 v. 50 c. Fitted spindles for hours, mins., and seconds hands. Single hole mount, silent running. Fitted dust cover, 3 1/2 in. dia. and 2 in. deep, and flex, ready for use, 37/6. Set of three Hands to fit, suitable for 5/6 inch dial, 2/- (not sold separately).

SELENIUM RECTIFIERS. (S.T.C.) For charging up to 12 volts, (input 17/18 v.), 6/8 amps, full-wave, 29/6. 3/4 amps., 22/6. STEEL TRIPODS for P.A. Speakers, extending to 12 ft. Sturdy type, rigid under all weather conditions, 55/- (des. 5/-).

SIGNAL GENERATORS. Admiralty pattn. W-4999, range 6.5/12 then continuous, in 3 ranges, to 93 mc/s, £25 (des. 5/-). Also Marconi TF144 Standard instrument, £75 (des. 8/6). Further details on request.

Please include sufficient for packing/despatch.

M. R. SUPPLIES Ltd., 88, New Oxford Street, London, W.O.1

Telephone: MUSeum 2958

For
NON STOP
"Performance"

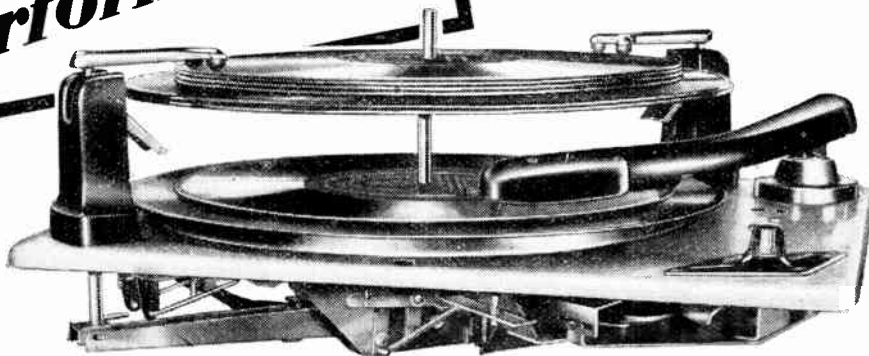

The RC49 . . . a new, reliable Automatic Record Changer featuring PERFORMANCE, LIGHTNESS and LOW COST

Collaro's new Model RC49 more than fills a long felt need . . . it brings you a reasonable priced record changer incorporating all the refinements hitherto associated only with expensive instruments . . . plus many new features not to be found in any other record changer.

The RC49 loads, unloads, selects, plays repeats or rejects 10" or 12" records mixed in any order, by the operation of one single control knob.

The powerful induction-type MOTOR is suitable for 100/130 and 200/250 volts A.C., and incorporates the new "Rim Drive." Beautifully simple and completely reliable, the RC49 will give years of trouble-free service.

The

COLLARO

RC49

Automatic Record Changer

COLLARO LTD.,

RIPPLE WORKS, BY-PASS ROAD, BARKING, ESSEX

Telephones : Rippleway 3333

Telegrams : "KORRLARO, BARKING "

★ Write to-day for trade terms and interesting free leaflet which fully describes the Collaro Automatic Record Changer.

MAKERS OF FINE QUALITY GRAMOPHONE COMPONENTS, INCLUDING: COLLARO GRAMOPHONE UNITS, INDUCTION MOTORS, DE LUXE MICROGRAM PORTABLE ELECTRIC GRAMOPHONES.

You simply MUST make a WIRE RECORDER

CAPSTAN (PULLING WIRE AT CONSTANT SPEED)

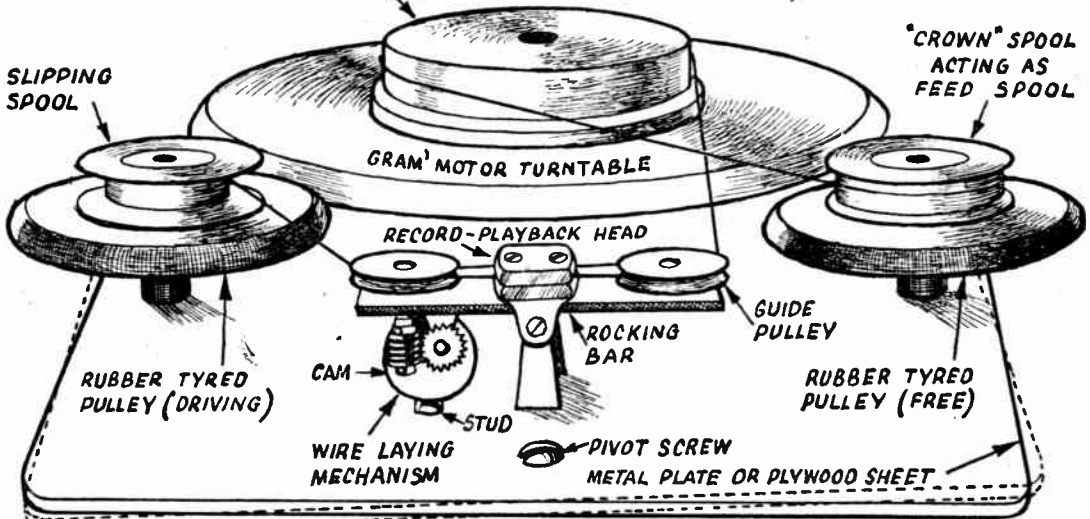

More thrilling than Radio—More gripping than Television. Complete constructional "Gen." 5/-.
All Components in stock. DEMONSTRATIONS BY APPOINTMENT.

PARK RADIO 676-8, Romford Road, London, E.12 Phone: ILFORD 2066



THE NEW S.T.7 MODEL
7-valve superhet, 4 bands, A.C./
D.C. 110 or 230/250.

Alternative wave bands:—

13-30, 30-70, 70-180, 200-550
13-30, 30-70, 200-550, 800-2,000

Specify wave bands & voltage when ordering
International octal valves—high
gain R.F. stage—10" moving coil
speaker. Radiogram input and
extension speaker connections—
all sets fully tropicalised.

18 gns.
PLUS 4 GNS.
PURCHASE TAX

PARKER Radio

PARKER RADIO CORPORATION LTD., Paraco Works,
7, Regal Lane, Regents Park, London, N.W.1. Gulliver 1843

SOME OUTSTANDING ADVANTAGES OF THE RF E.H.T. SYSTEM

- (1) **Low Cost.** 5.5KV E.H.T. unit at £13/15/- complete. 8 KV E.H.T. for 15in. tubes, at £15/5/-. No Purchase Tax.
- (2) **AC/DC Technique.** Can be used for providing E.H.T. where no mains transformer is utilised.
- (3) **Weight.** Total weight of 5.5 KV unit, 14 ozs. This means lighter chassis and cabinet (E.H.T. units ready for mounting anywhere on chassis or in cabinet).
- (4) **Picture Quality.** Excellent regulation and no line linearity distortion. Both these troubles are frequently encountered with flyback E.H.T.
- (5) **Independent Operation.** Adjustment of Line Time Base controls do not affect the E.H.T. as with line flyback method, thus facilitating adjustments.
- (6) **No Burnt-Out Transformers.** An accidental or permanent short of the E.H.T. to ground will not harm circuit.
- (7) **Non-Lethal.** Due to the high source impedance of these supplies they are very much safer than a conventional 50 c/s unit.

Consider these technical and economic advantages and change to RF, E.H.T. now.

From all principal component stockists. In case of difficulty write to:—

HAZELHURST DESIGNS LIMITED

186, Brompton Road, Knightsbridge, S.W.3



Specialists in
 Lightweight Pneumatic
 and Electric Portable Tools

DESOUTTER BROS. LTD., THE HYDE, HENDON, LONDON, N.W.9. TELEPHONE: COLINDALE 6346-7-8-9. TELEGRAMS: DESPNUCO. HYDE, LONDON
 C.B.C. 104



THE COMPLETE SERVICE FOR SOUND RECORDING AND REPRODUCTION

- ★ Mobile, static and specialised recording units
- ★ Recording amplifiers, speakers, microphones, etc
- ★ Sapphire cutting and reproducing stylii
- ★ Blank recording discs from 5in. to 17in. Single and Doublesided
- ★ Groove locating and cueing devices
- ★ A comprehensive range of accessories to meet every requirement of the sound recording engineer
- ★★ A development of special interest to users of sapphire and delicate pick-ups—THE SIMITROL. This is a controlled micro-movement easily fitted for use with any type of pick-up
- ★★★ OUR CDR48A RECORDER UNIT complete and self-contained, measuring only 22in. x 14in. x 13½in., incorporating 7-valve amplifier, recorder unit, light-weight pick-up, speaker and microphone and with many exclusive features, is now ready for early delivery.



Portable Twin Channel Continuous Recording System incorporating CDR48A Recorder/Amplifier DR48A Recorder and EM48A Electronic 4 Channel Mixer

OUR WELL-EQUIPPED WORKSHOPS ARE AVAILABLE FOR THE DEVELOPMENT OF EQUIPMENT TO MEET SPECIAL NEEDS.

SIMON SOUND SERVICE, Recorder House, 48/50, George St., Portman Square, London, W.1.

CABLES: Simsale, London.

TELEGRAMS: Simsale, Wesdo, London.

TELEPHONE: Welbeck 2371 (4 lines)

Only with **CO-AX**
R.F. **CABLES**
AIR-SPACED ARTICULATED

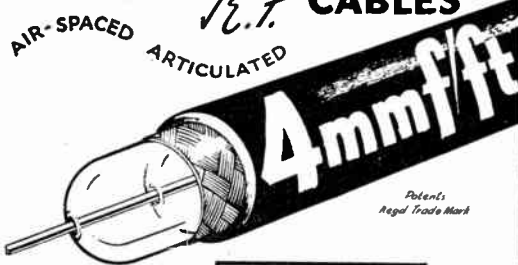

Patent's Regd. Trade Mark

THE LOWEST EVER CAPACITANCE OR ATTENUATION

IMMEDIATE DELIVERIES FOR HOME & EXPORT

Write or cable for data sheets or deliveries to the distributors of flexible or space-filling cables.

TRANSRADIO LTD
CONTRACTORS TO THE GOVERNMENT
138A CROMWELL ROAD LONDON SW7
Cables, TRANSRAD, LONDON

LOW ATTEN TYPES	IMPED OHMS	ATTEN db/100ft	LOADING SW of 100 Ohms	OD'
A 1	74	1.7	0.11	0.36
A 2	74	1.3	0.26	0.44
A34	73	0.6	1.5	0.88
LOW CAPAC TYPES	CAPAC. pF/ft	IMPED OHMS	ATTEN db/100ft	OD'
C 1	7.3	150	2.5	0.36
PC.1	10.2	132	3.1	0.36
C.11	6.3	173	3.2	0.36
C 2	6.3	171	2.15	0.44
C22	5.5	184	2.8	0.44
C 3	5.4	197	1.9	0.64
C33	4.8	220	2.4	0.64
C44	4.1	252	2.1	1.03

HIGH POWER FLEXIBLE

PHOTOCELL CABLE

VERY LOW CAPACITANCE

HIVAC
THE SCIENTIFIC VALVE
BRITISH MADE

Pioneers & Specialists in Small Valves



Messrs. Hivac Ltd
Greenhill Crescent
Harrow-on-the-Udder, Middx.

THE address for:
Subminiatures-Midgets-Miniatures and Cold Cathode Tubes

FOR WIDEBAND R.F. AMPLIFIERS AND FREQUENCY CHANGING IN TELEVISION

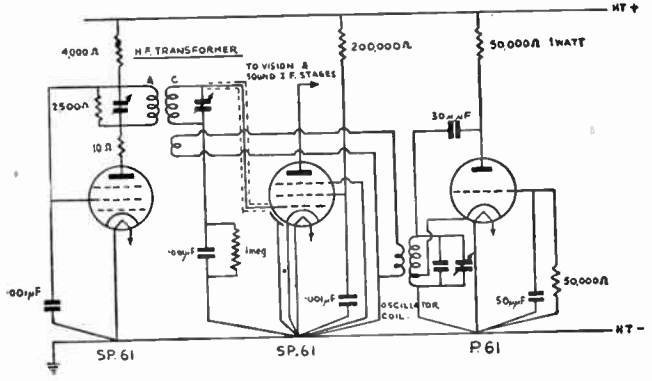
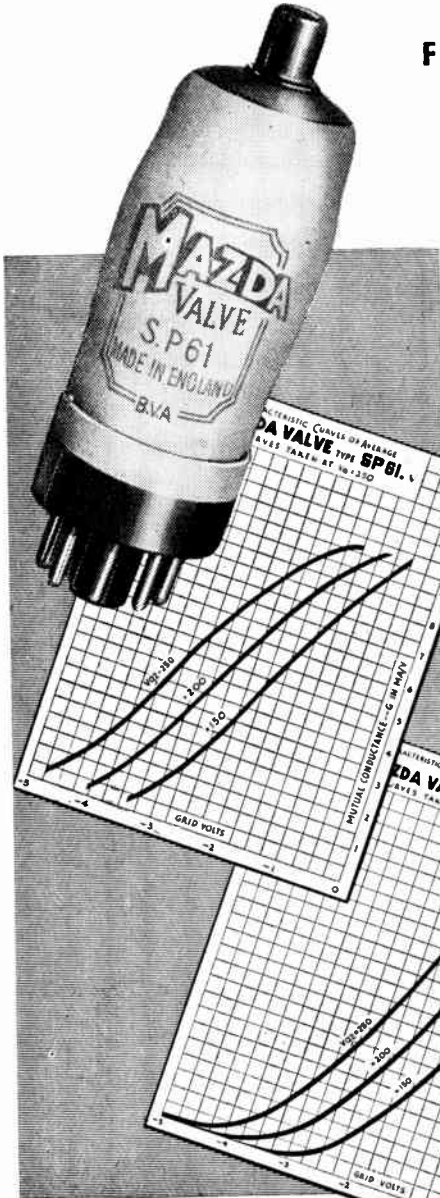

SP.61 TELEVISION PENTODE

This representative circuit shows the use of the S.P.61 as a mixer and the P.61 as an oscillator, in a television receiver. The circuits are for use in a receiver operating with a vision I.F. of 13 megacycles, and a sound I.F. of 9.5 megacycles. It should be realised when designing oscillators for operation at these frequencies (32 megacycles) that the constants given can only apply to one particular layout, as very small changes in the disposition or length of the leads of the oscillator circuit will appreciably affect its performance. Unless the valve holder tag for the cathode pin can be soldered direct to the common earth point it is essential to connect the .001 μ F. condenser in the grid circuit of the SP.61 to the cathode tag of that valve and not to chassis.

RATING

Heater Voltage	6.3
Heater Current (Amps.)	0.6
Maximum Anode Voltage	250
Maximum Screen Voltage	250
*Mutual Conductance (mA/V)	8.5

* Taken at $V_a=200v$; $V_g 2=200v$; $V_g 1=-1.5$

LIST PRICE 10/6

EDISWAN

MAZDA

RADIO VALVES AND CATHODE RAY TUBES

THE EDISON SWAN ELECTRIC CO. LTD., 155 CHARING CROSS ROAD, LONDON, W.C.2
v.110

MINIATURE VITREOUS ENAMELLED RESISTOR

TYPE M.V.1

RATING 3 watts for 250°C. rise.

RESISTANCE RANGE 1-4700 ohms.

Full rated watts over the whole resistance range.

DIMENSIONS. - 15/32" × 13/64".

*Agents in Belgium: Monsieur Paul Groeninckx, 43, Avenue Jean Stabbeerts, Bruxelles.



Actual size of resistor

TYPE APPROVED



KINGSTHORPE, NORTHAMPTON.

hallicrafters IFTs
 Ex-US Army - Brand new sets of five transformers for **AM-FM** models **S27 & S36** comprising IFT 1, 2 & 3 with variable selectivity IFT4 diode coupling, and IFT5 discriminator.

Air-spaced TRIMMERS

IFT4 (T13) Diode coupling
 IFT5 (T14) Discriminator

IFT 1, 2, 3, (T10, T11, T12)

5.2 Mc/s COMPLETE SET of 5 TRANSFORMERS **3/6s**
 With complete circuit. Post Free.

Ruby INDICATORS
 Single 1/2" hole fixing for panels up to 1/2" thick.
4 for 5/-
 6.3 volt NBC bulbs to fit 1/2"-es. Post 6d.

HIGH QUALITY USA make
 Oil-filled paper condensers, with fixing clips.
 4mfd 1000v **7/6**
 1mfd 1500v **3/6**
 Post 6d each

5 pin ENGLISH H.V.
 Moulded Valve holders 7000v. insulation. Type L302
24 for 5/-
 Post 6d.

BI Electrolytics
 BRAND NEW
 All 500v working
 Card carton type
 4mfd 3/2
 8mfd 3/6
 16 mfd 4/7
 8-8 4/9
 8-16 6/1
 16-16 6/11

Vertical Metal Cans
 4mfd 4/4 16mfd 5/4
 32 8/4 8-8 5/9
 16-16 8/6
 Post 3d each
 12 assorted Post Free

WODEN Transformers and chokes for the E.E. Televisor.
 Main Transformer **98/6** HT Transformer **65/-**
 Sky 250ms Choke **29/-** 10hy 90ma Choke **17/-**
POST FREE.

LATEST LISTS FREE! ON REQUEST

Frith RADIOCRAFT Ltd.
 69-71 CHURCH GATE-LEICESTER
 GEORGES G38V1 G2R1

DIRECT CURRENT to RADIO FREQUENCY

The only oscilloscope combining . . .



- Linear Response from Zero Frequency (DC) to Radio Frequency (0-100 k/c.)
- High Deflection Sensitivity on both axes (70 mV. cm.)
- Complete freedom from amplifier drift under D.C. conditions.
- Absolute independence of controls.
- Perfect synchronising at all Frequencies.
- True portability (weight only 18lbs.)
- Price **£32. 0. 0**
- Six months guarantee.

Model 1400 B Visual Alignment Signal Generator shows the shape and characteristics of a tuned circuit response curve on the oscilloscope screen. Perfect Alignment of I.F. or R.F. circuits is easily accomplished without an additional signal generator.

Price **£8. 10. 0**

Write for Specifications

INDUSTRIAL ELECTRONICS

99, Gray's Inn Road, London, W.C.1.

Tel.: HOLborn 9873/4.

Makers of Precision Instruments.

LONDON CENTRAL RADIO STORES

Government Surplus - Immediate Delivery from Stock

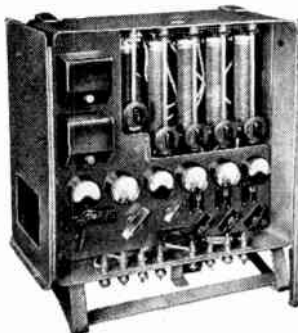

CHARGING BOARDS

Control Panels Only

24 v., 1,260 watts. Includes five 1 1/2 in. moving coil ammeters (1, 0-40 a., 4, 0-15 a.). One moving coil voltmeter 0-40 v. Five heavy duty sliding resistances, etc., complete in metal case as shown with fold-back doors. Size, 18 x 17 x 8 1/2 in. Offered at less than half the component value. Price, carriage extra

£4.19.6

THE FAMOUS EDDYSTONE 358 COMMUNICATIONS RECEIVER

Great Reduction in Price

Range 31 Mc's to 90 kc/s, 9 Plug-in coils, 7 valves and rectifier, variable selectivity, B.F.O. stand-by switch, A.V.C. switch, band-spread dial, valve check meter. In heavy black crackle finished steel cabinet with chrome fittings. Complete with 200-250 v. A.C. Power Supply Unit. Carriage and packing 17/6 extra.....



£20

NEW MILES H.T. UNITS (Everlasting)

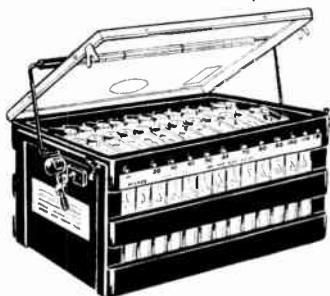

120 v. 600 mA. Will charge from 6 v. accumulator

67/6

TELEPHONE LINE OR UNISELECTOR SWITCHES

Brand New.

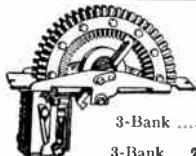

3-Bank 38/6.
Used
3-Bank, 20/-. 6-Bank, 25/-

R1155 10-VALVE COMMUNICATIONS RECEIVERS

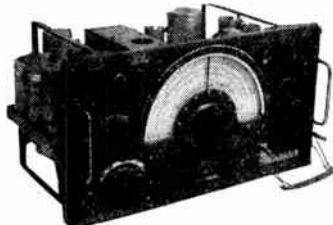

These sets are as new. Freq. range 7.5 mc s, 75 kc/s in five wavebands. Complete with 10 valves, including magic eye. Enclosed in metal case. Every receiver is aerial tested. Complete with Power Pack and Loud speaker, for A.C. mains 200-250 v. Carr. 14 paid

£14

FREE with each receiver! Complete circuit, description and modifications for civil use reprinted from "A.W.W." July, 1946.

MISCELLANEOUS BARGAINS

1/30th H.P. MOTORS. Constant speed. Double-ended spindles. 220-250 v. These motors are new, not surplus conversions and are suitable for 16 mm. projectors and many other purposes.

A.C./D.C., with feet .. 57/6

A.C., without feet .. 52/6

EX-R.A.F. CINE CAMERA. Type G45B. To take 16 mm. film. Fixed focus lens approx. 5 cm., f/3.5. In metal case. Dimensions 12 x 3 1/2 x 2 in. With 12 v. motor drive. Spare small 24 v. Motors for above, 8/9. £3

EX-ARMY TEST SET-NEW Type Demolition Mk. 1. For circuit continuity and general testing. In hard-wood carrying case.....

42/-

NEW, LATEST PLASTIC COVERED WIRE. Red or Black, by Armaduct. 100 yard coil

9/6

METAL RECTIFIERS. 620 v. at 3 mA. 13 in. long

8/6

75 OHM, per doz. yds. ...

8/-

FIVE-WAY RUBBER COVERED CABLE. Suitable for all purposes. Per doz. yds.....

6/-

EX-GOVT. 100M. COPPER AERIALS. ebonite chain insulators, 30ft. guy rope.....

4/3

SMALL SLIDING RESISTANCES Ex-Admiralty. Finest quality. Suitable for Voltage Controls, Speed Regulators. 50 ohms, 0.5 amp. Dimensions 6 in. x 4 in. x 2 1/2 in. high ..

8/6

7-VALVE U.H.F. RECEIVER Type R1147A Range approx. 200 megacycles (with 4 Acorn valves). A Real Opportunity. Beautifully constructed and fitted with micro-condenser drive. Valve types: two EF36, one EBC33, three 954, one 955. In black metal case, 8 x 7 x 6 in. Set complete with

£1-17-6

N.B.—All carriage paid unless otherwise stated. We do not issue lists or catalogues. We have hundreds of items in stock too numerous to list. So when in Town pay us a visit.

R.A.F. 6-VALVE SUPERHET RECEIVING UNIT No. 25

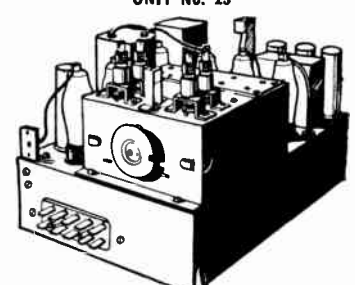

Easily adapted for short-wave reception for home use. Contains two EF36, two EF39, one EK32, one EBC33 valves, condensers, resistances, etc. Free circuit diagram, 9 in. x 19 in., showing all components, supplied with each set. Diagram separately, 2/-,

25/-

WESTINGHOUSE METAL RECTIFIERS, Style LT42

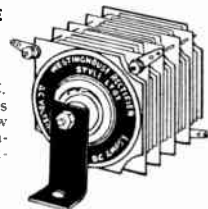

A.C. volts 11, D.C. volts 6, D.C. amps 1. Brand new condition. Complete with mounting bracket.

12/6

PHOTO-ELECTRIC CELLS Type G816

These cells are the gas-filled type with caseium Cathode. Made by Cintel. Minimum sensitivity 100µA/lumen, working volts 100 D.C. or peak A.C. Projected cathode area 16 sq. cm. Suitable for 16 mm. Home Cinema Talkie equipment, Safety Devices, Colour and Photo Matching, Burglar Alarms, Automatic Counting, Door Opening, etc. Brand new in original cartons... ..

42/6



LONDON CENTRAL RADIO STORES, 23, LISLE ST. (GERrard 2969) LONDON, W.C.2

Closed Thursday 1 p.m. Open all day Saturday and weekdays 9 a.m.—6 p.m.



New Ranges of Special Replacements

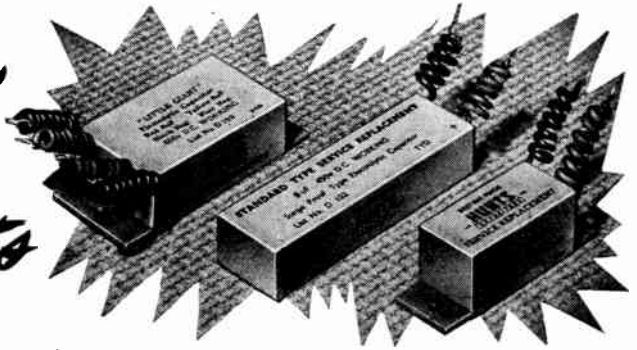

TYPE L.24

Standard and Little Giants in cardboard cartons with fixing feet and 6" wire leads — all 450 volts D.C. wkg.

Introduced in response to repeated requests from the Trade, invaluable in servicing older types of receivers. Dimensions reduced considerably in a representative range of popular types. Order without delay : details on request.

Also available are types L.28, card insulated aluminium tubes with wire leads; and L.36, cylindrical aluminium cases with 6" leads and single hole mountings.

'LITTLE GIANTS'						
List No.	Cap. uF.	D.C. Wkg. Volts	Dimensions L. W. D.			List Price
D.100	8	450	2 1/4	1 1/16	1 1/8	3/6
D.103	8+8	450	2 7/8	1 1/4	1 1/16	6/3
D.104	8+16	450	3 7/16	1 1/4	1 1/16	6/9

'STANDARD TYPE'						
List No.	Cap. uF.	D.C. Wkg. Volts	Dimensions L. W. D.			List Price
D.101	8	450	2 3/8	1 5/16	1 3/8	3/6
*D.102	8	450	4 1/8	1 1/4	7/8	3/6
D.105	8+8	450	3 7/16	2	1 3/16	6/9
D.106	8+16	450	3 7/16	2	1 5/16	7/3

No Fixing Feet *

Note: Dual Units have four separate leads for connection as separate units, common positive or common negative.

A · H · HUNT LTD

BENDON VALLEY · GARRATT LANE · LONDON · S.W.18



CHARLES AMPLIFIERS

FOR THE
UTMOST
REALISM FROM
RECORDS AND
RADIO



The CONCERTO Amplifier

... acclaimed by music lovers for its exceptionally high fidelity, this magnificent amplifier covers all normal requirements for home or concert hall. Distortion level below 0.5 per cent. Two channels of bass boost ensure unusually smooth balance and depth. Designed for any type of pick-up. Radio input socket provided. Two year guarantee. Price £27.10.0. Heavy perforated steel cover with bottom plate and rubber feet, 37s. 6d. extra. Delivery by passenger train, Carriage Paid. 10s. deposit (returnable) for crate.

DEFERRED TERMS NOW AVAILABLE

Charles
AMPLIFIERS
LTD

"LIVING MUSIC"

... our fully illustrated 16pp catalogue showing complete range of amplifiers and tuning units. Write for your copy today, enclosing 5d. in stamps.

1m PALACE GATE KENSINGTON, LONDON, W.8
Telephone : WEStern 3350

Our equipment can now be seen and heard at
UNIVERSITY RECORDING CO. 16 BURLEIGH PLACE, CAMBRIDGE
Telephone : CAMBRIDGE 54947

Special Waxes
FOR THE

ELECTRICAL INDUSTRIES

Manufacturers of electrical and radio materials and components are invited to investigate

OKERIN

WAXES AND DI-JELLS

for insulating, waterproofing, impregnating, sealing and finishing condensers, cables, transformers, batteries, resistances, etc.

For technical data and samples please telephone TEMPLE BAR 5927

Sales Department
ASTOR BOISSELIER & LAWRENCE LTD
NORFOLK HOUSE · NORFOLK STREET · STAND · W.C.2

Works and Laboratories: West Drayton, Middlesex

Presenting...

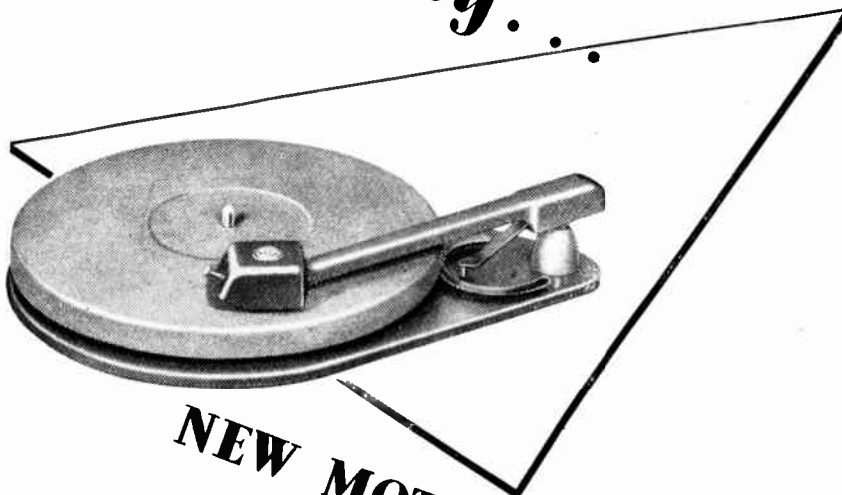

NEW MOTOR UNIT TYPE G.U.2

- ★ The B.S.R. Gramophone Unit sets a high standard in design and production skill at an attractive price. The finish and presentation of the G.U.2 are of a new conception, departing entirely from the dowdy colours of the past.

Two models are available for set makers and home constructors:

G.U.2 complete, Unit Plate and Pick-up	£3 17s. 6d., plus £1 3s. 2d. tax
T.U.2 Gramophone Motor and Turntable only	£2 5s. 0d., plus 19s. 3d. tax

- ★ **THE PICK-UP**
High output magnetic unit. Correct Tracking Angle. Smooth even response. New Polymerised Chloroprene damping material. No perishable or age-hardening materials. Withstands tropical conditions. Weight at needle point, 2 oz. Reduced record wear with standard needles. Superb tonal quality. Highly attractive tone arm.
- ★ **THE MOTOR**
A two-pole induction type of new design. High torque and speed constancy. Free from "wow." Silent in operation. Vibration-free mounting by double mechanical filtering. Re-designed, adjustable auto-stop. Precision machined die-castings. Self-oiling Compo bearings. Turntable: machine turned die-casting cushioned with velvet soft flock.



Birmingham Sound Reproducers Ltd.

Claremont Works, Old Hill, Staffs. Phone Cradley Heath 6212/3.

Wireless World

RADIO AND ELECTRONICS

APRIL

1949

39th YEAR OF PUBLICATION

Proprietors: ILIFFE & SONS LTD.
Managing Editor: HUGH S. POCKOCK, M.I.E.E.
Editor: H. F. SMITH

Editorial, Advertising and Publishing Offices:
DORSET HOUSE, STAMFORD STREET
LONDON, S.E.1.

Telephone: Waterloo 3333 (60 lines).
Telegrams: "Ethaworld, Sedist, London."

PUBLISHED MONTHLY

Price: 2/-

(Publication date 26th of preceding month)

Subscription Rate: 26/- per annum. Home and Abroad

Branch Offices:

Birmingham: King Edward House, New Street, 2.
Coventry: 8-10, Corporation Street.
Glasgow: 26B, Renfield Street, C.2.
Manchester: 260, Deansgate, 3.

In This Issue

OUR COVER: London—Birmingham Television Relay Tower
(See Page 156)

EDITORIAL COMMENT	121
SINGLE-VALVE FREQUENCY-MODULATED OSCILLATORS. By K. C. Johnson	122
RANGE OF V.H.F.—2. By M. V. Callendar	124
ELECTRONIC CIRCUITRY. By J. McG. Sowerby	126
NOTES ON THE "WIRELESS WORLD" TELEVISION RECEIVER	128
ELECTROMEDICAL STIMULATORS. By O. B. Sneath and E. G. Mayer	129
DEVELOPMENTS IN COMPONENTS	133
WORLD OF WIRELESS	139
TELEVISION INTERFERENCE BY AIRCRAFT. By A. H. Cooper	142
AMERICAN MICROGROOVE RECORDS. By D. W. Aldous ..	146
SHORT-WAVE CONDITIONS	148
RADIO INTERFERENCE. By "Cathode Ray"	149
UNBIASED. By "Free Grid"	154
LETTERS TO THE EDITOR	155
RANDOM RADIATIONS. By "Diallist"	158
RECENT INVENTIONS	160

2845



New Approach COMPONENTS

Keeping abreast of fast-moving technical development calls for a new approach to production problems. The "WEARITE" Pressed Circuit System represents a substantial advance in production science to speed assembly and lower costs. The first of these "Wearite" New Approach Components is a Coil Pack comprising coils, switches, trimmers and padders completely wired and ready for instant incorporation into any standard Superhet circuit.

Sides removed for clarity of illustration.

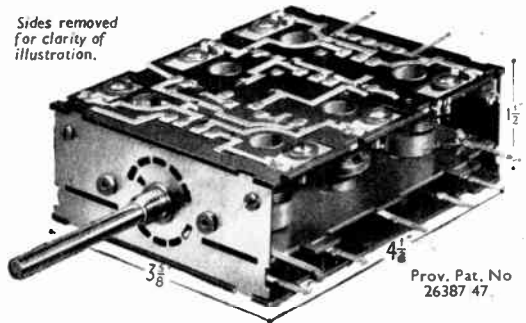

Prov. Pat. No 26387 47

- 3 ranges
- Gram switching
- 2-hole fixing at 1 1/8" centres
- All trimmers and adjusters conveniently placed in one surface

Manufacturers are urged to write for full technical details.

Owing to raw material restrictions supplies, for the time being, are confined to Radio Receiver Manufacturers at home and abroad.

Wright and Weaire Limited

138, SLOANE ST. · LONDON · S.W.1 TEL SLOANE 2214/5 FACTORY: SOUTH SHIELDS, CO. DURHAM



Valves and their applications

THE EF42 IN THE INPUT STAGE OF A WIDE-BAND OSCILLOGRAPH AMPLIFIER

The input stage of an oscillograph is generally less difficult to design than are the output stages as the operating conditions

are rather less stringent. The inter-electrode capacitances appearing on the anode of the stage are rather lower in the former case so that a satisfactory frequency response is more easily obtained; in addition the fact that only relatively small voltages are required to drive the output stages means that the valve can be run under much lower current conditions.

For these reasons it is convenient to arrange for the input stage of the amplifier to provide as much gain as possible so that the overall sensitivity of the oscillograph shall be high.

A single valve circuit suitable for feeding the output stages*, is illustrated in Fig. 1. As can be seen, cathode compensation has again been used, and the condenser C_k can conveniently be 200-400pF, when the anode load R_L is 4.7 K Ω .

On the whole, this method of operation is rather wasteful since so much of the amplification is thrown away at low frequencies in order to boost the H.F. response, and a rather better solution can be obtained if the effects of the stray capacitances to earth at the anode of the stage can be reduced. In the case of a complete oscillograph amplifier this can be done by feeding a signal from the anode of the first valve, when, by positive feedback, the effective capacitance to earth appearing across the anode circuit is reduced, but only up to the frequencies amplified by the

output stage. When this is carried out, C_k can be increased to 500 μ F, thus giving full gain at low frequencies, and R_L can

be as high as 10K Ω . The complete response curve of such a practical amplifier - C.R.T. combination is illustrated in Fig. 2; curves 1 and 2 are obtained respectively without and with the positive feedback network. The sensitivity is such that a 15mV signal (peak to peak) gives a trace of 1 cm. on the tube, while the transient response gives only a 5 per cent. "overshoot" to a square wave of 0.2 micro-secs rise time.

In practice, some compensation is necessary for the phase delay introduced in the amplifier as this makes the positive feedback network operate at low efficiency at some frequencies but the simple correcting network illustrated in Fig. 3 is found to be quite effective.

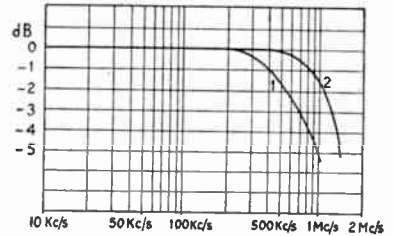

FIG. 2

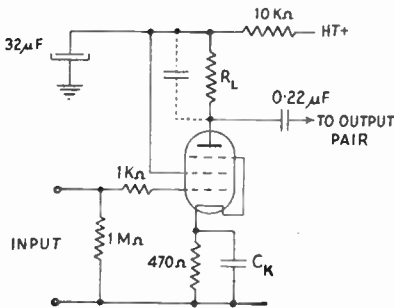

FIG. 1

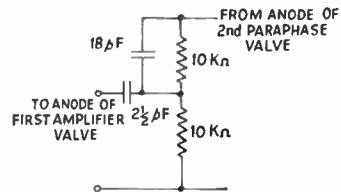

FIG. 3

* See "The EF42 in the Output Stage of Wide-Band Oscillograph Amplifier." - *Wireless World*, January, 1949.



Reprints of this report from the Mullard Laboratories, together with circuit diagram of the input stage and feedback network, can be obtained free of charge from the address below.

MULLARD ELECTRONIC PRODUCTS LTD., TECHNICAL PUBLICATIONS DEPARTMENT, CENTURY HOUSE, SHAFTESBURY AVE., W.C.2

Wireless World

VOL. LV. NO. 4

APRIL 1949

RADIO AND ELECTRONICS

Comments of the Month

PROGRAMME—COMPLETE WITH INTERFERENCE

WHEN so much attention is being paid to interference in television reception, we think that more notice should be taken of a form of interference which is apparently being radiated from Alexandra Palace itself along with the programme! Few viewers can have failed to notice a pattern of vertical or near-vertical bars which appear as a background to the picture. Sometimes the bars are steady, but more often they are continually varying in position and angle.

Were it not for one fact, we should hardly have the temerity to suggest that the B.B.C. could be to blame, but there seems to be conclusive evidence that this is so. The interference appears only when a particular camera is in use. When several cameras are employed to give different angles of view, as in the transmission of a play, it is most evident that the interference occurs only with one of them. The trouble disappears instantly whenever a change is made to one of the others.

The interference varies in intensity from time to time, but was extremely bad during the play "And so to Bed" on 6th March, and greatly detracted from the entertainment value of the production. It has been noticeable now for some eighteen months and while we do not doubt that the B.B.C. is aware of it and has attempted to cure it, we do feel that it is high time that some more active measures were taken.

The pattern appears to be produced by c.w. interference of a frequency in the neighbourhood of 1 Mc/s and this agrees with the suggestion which we have heard that it is actually due to pick-up of the Brookmans Park Home Service signal on the camera circuits. Certainly the appearance of the interference coincided, as far as we can remember, with the bringing into service of the new aerial system at Brookmans Park.

If this suggestion be correct, we think that the B.B.C. should take viewers into their confidence. Uncertainty and confusion as to the nature of this particular form of interference should be dispelled as quickly as possible. Until the trouble is overcome, use of the affected camera channel should cease. At present it must be doing considerable harm to television as in many areas it is far more noticeable than ignition interference.

WHAT IS A COMPONENT?

COMING so soon after the impressive and highly successful annual exhibition recently staged by the Radio Component Manufacturers' Federation, the raising of this question is perhaps rather ungracious. But the task of those whose duty it is to record happenings in the world of wireless is not being made any easier by the inclusion of more and more complex devices under the general classification of components.

To say that components should be defined as "devices represented by a single symbol on a circuit diagram" is obviously an over-simplification. According to that, a built-in loudspeaker could properly be described as a component but, by ordinary usage, an extension speaker certainly could not. Such things—and valves as well, for that matter—are commonly described as "accessories." That word, in its turn, we have heard defined rather fancifully as "devices capable of useful separate existence." As we understand this definition, a normal plug-in valve would be an accessory, while a wire-end miniature, of the kind used in hearing aids, would be a component.

All this is becoming very difficult and confusing. Clearly enough, there is so much room for differences of opinion that any classification—if indeed we need one—must come from some body endowed with dictatorial powers.

SINGLE-VALVE FREQUENCY-

New Principle Giving Wide Coverage

By K. C. JOHNSON, B.A.

IN order to vary the frequency of an oscillator it is generally necessary to change the resonant frequency of a tuned circuit, and there are many applications, such as "wobblers," a.f.c. systems, or f.m. signal generators, where this has to be done electronically. Usually, for these devices, the well-known "reactance-valve" arrangement has been used, in which a resist-

tion in the phase-shifting network, so that the coverage can only be small even at low frequencies, whilst at high frequencies the valve input capacitance becomes serious, making the network design difficult and the coverage extremely small. Lastly, there is the practical consideration that although a reactance valve must necessarily be separate from an oscillator, the arrangement to be described allows the two functions to be combined and a single valve to be used.

Modulation Principle.—The alternative method of "direct reactance modulation," which can give constant amplitude over a wide frequency range, does not use phase-shift networks at all, but depends on the principle* that the effective value of any impedance can be altered simply by arranging that although the current flows unchanged, the voltage actually applied to the impedance is only a definite fraction of the whole. Fig. 1 indicates how this principle can be used to obtain a large effective inductance, for if the valve is considered as an ideal cathode-follower, then the voltage swing actually applied to L is only $\frac{r}{R}$ of the swing across the terminals, but the whole of the current swing in L flows in at the terminals, so that they appear as an inductance taking less current, that is as a larger inductance, than L.

But valves are more suitable for dividing currents than voltages, since the suppressor grid of a pentode divides the cathode current between the anode and the screen in a ratio depending directly on the suppressor voltage and which can therefore be varied electronically; fortunately the principle holds just as well if it is the current which is divided instead of the voltage. That is to say that the effective value of any impedance can be altered by

arranging that although the voltage is applied unchanged, the current actually passing through the impedance is only a definite fraction of the whole. It is not possible to give a simple circuit to illustrate this, but it can be used to obtain electronic modulation of impedances over wide ranges.

A particularly useful variation of this current division principle is possible with inductances, however, using the property of mutual inductance, for if L is the inductance of a coil carrying an alternating current $i_o \sin pt$, and a fraction $\frac{1}{x}$ of this same current flows in an ancillary winding with a mutual inductance M between the two, then the voltage across the first coil is $(i_o p L \cos pt + i_o p \frac{M}{x} \cos pt)$. Thus the effective inductance of the first coil is $L + \frac{M}{x}$, and it is possible to arrange that M is negative by winding so that the current flows round in opposite directions in the two coils. If the second coil is wound with more turns than the first and the flux leakage kept small, it is even possible to have M greater than L, so that the effective inductance

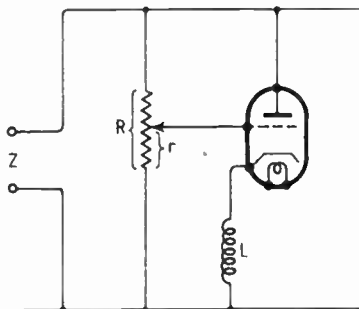

Fig. 1. Indicates how an ideal cathode-follower may be used to obtain a large effective inductance

$$Z = L \left(\frac{R}{r} \right).$$

nce-capacitance phase-shift network is connected between the anode and the grid of a variable-mu pentode. A phase-shift between the anode current and the anode voltage is thus introduced, so that the anode impedance is effectively reactive and, moreover, the value of the reactance depends on the slope and hence the bias of the valve. If this reactance is used as part of the tuned circuit of a conventional oscillator, it is possible to modulate the oscillation frequency by means of the bias voltage applied to the reactance valve.

This arrangement, however, cannot be made to give a very wide frequency coverage, for the phase-shift network must be designed to give a shift of as nearly as possible 90° throughout the range, so as to avoid variations in the oscillation amplitude as well as the frequency. This means that there must be heavy attenua-

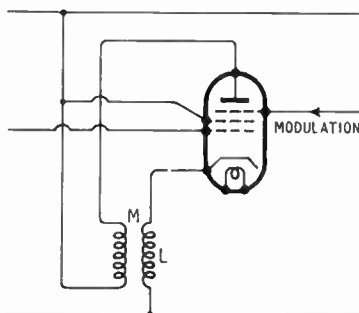

Fig. 2. The effective cathode load of this valve is $(L + M \frac{I_a}{I_k})$ and it can be modulated by the suppressor grid voltage.

can be reduced from L right down to zero as the division fraction $\frac{1}{x}$ is increased.

Fig 2 shows how this principle

* Prov. Pat. applied for.

MODULATED OSCILLATORS

can be used to obtain a cathode load in a valve circuit whose effective value is always inductive but can be varied in magnitude electronically. The first coil, with self-inductance L , is placed in the cathode lead and carries the whole alternating cathode current I_k , while the second coil, with a

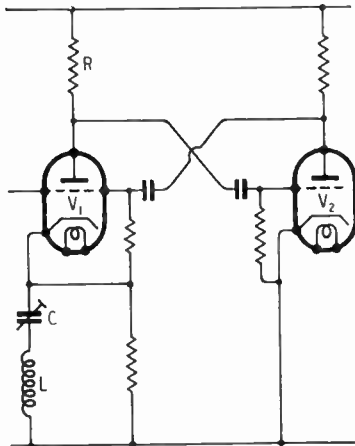

Fig. 3. An oscillator in which the tuned circuit elements are in series with a valve.

mutual inductance of M to the first, carries only the anode current I_a . But the action of the suppressor grid in a pentode is to divide the cathode current, between the anode and the screen in a ratio which depends on the suppressor voltage, but not on the cathode current itself, so that the effective cathode lead inductance is $(L + M \frac{I_a}{I_k})$, where $\frac{I_a}{I_k}$ is the fraction of the total current which flows to the anode and so through the second coil.

Oscillator Circuits.—In order to use this principle to modulate the frequency of a practical oscillator, it is necessary to devise a circuit in which the actual oscillatory current flows through a valve in series with the tuned circuit elements. Fortunately this is easier than it might appear, since to make a "series tuned circuit" oscillate a voltage must be forced across it proportional to the current flowing (see E. W. Herold "Negative Resistance,"

Proc. I.R.E., Oct., 1935), and this is most easily arranged by the circuit shown in Fig. 3. Here the resistance R develops a voltage proportional to the current flowing in L and C , which is phase-inverted by the second valve and applied to the tuned circuit by cathode-follower action in the first valve, so as to increase the current and excite oscillations.

But the second valve in this circuit is merely serving to invert the voltage, like the second valve in the familiar Franklin oscillator, and it can be quite satisfactorily replaced by a phase-inverting auto-transformer to give the circuit of Fig. 4 which is otherwise similar to Fig. 3. This transformer consists of a coil tuned to the central oscillation frequency and tapped so as to give a small gain, but heavily damped by a shunt resistance so that it cannot introduce undesirable phase-shifts, so tending to control the oscillation frequency, and reduce the range of frequency modulation obtainable.

The Completed Oscillator.—The completed frequency-modulated oscillator combines the mutual inductance modulation principle shown in Fig. 2 with either of the oscillator circuits of Figs. 3 and 4. The two valve circuit is slightly easier to make up, in practice, but the more economical single-valve circuit is shown in Fig. 5 and it will be seen that a mutually inductive coil in the anode of a pentode is used to modulate the effective value of the main tuning inductance without disturbing the oscillatory circuit seriously.

This means that the amplitude of oscillation can be very nearly constant over frequency ranges at least as great as $\pm 15\%$, and at central frequencies up to at least 10 Mc/s, since all the effects of cir-

cuit capacities can be tuned out and the valve input capacitance is unimportant. It is hoped to

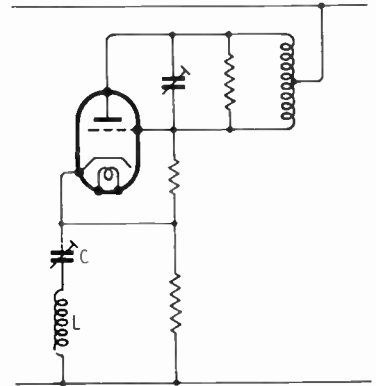
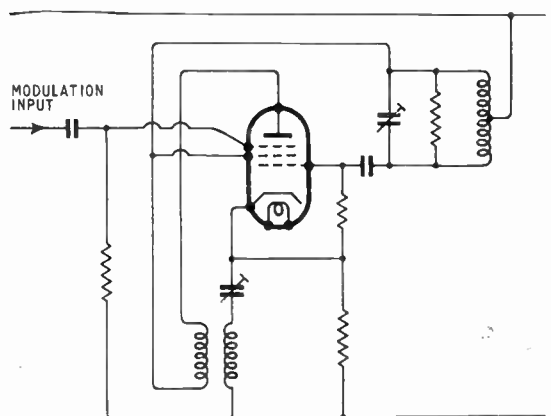

Fig. 4. The second valve in Fig. 3 can be replaced by a phase-inverting transformer.

deal with many of the more practical features of this circuit and in particular to give details of single-valve scanning oscillators for broadcast and television receiver alignment, in a second article to be published shortly; but it will already be clear that it has many advantages over the more usual reactance-valve arrangement, particularly as regards the frequency range covered and the higher central frequencies obtainable.

Fig. 5. Completed circuit of a single-valve frequency-modulated oscillator capable of $\pm 15\%$ deviation.



RANGE OF V.H.F.

Part 2.—Ground Communication

By M. V. CALLENDAR, M.A., (E. K. Cole. Ltd.)

THE actual range of communication between two stations on the ground is more difficult to estimate than the range between a ground station and an aircraft, owing to the greater number of obstacles usually intervening in the line of sight in the former case. However, even for ground-to-ground

ably small deficiencies in the receiver and losses in transmission lines, etc., can, however, be allowed for by choosing the appropriate column in the table.

Explanation of Tables.

Use columns A, B, C, and D in Tables as follows:—

Loss is intended to cover the effects of:—

(a) Loss in signal due to obstructions, hills, houses, rigging on ships, etc.

(b) External interfering noise, other than cosmic noise.

(c) Any deficit in noise factor, or signal/noise ratio, of the actual receiver relative to a standard efficient receiver of noise factor = 10dB (or signal/noise ratio of 10dB for 30 per cent mod. at 1,000 c/s at 3μV from 70 ohms).

(d) Deficiencies in aerials and feeders relative to a standard dipole.

Loss of 10 dB corresponds to an average efficient equipment using a high slope r.f. valve, etc., in average country or open suburban areas, and represents the maximum likely loss over sea.

Loss of 20 dB should be allowed for in range estimates for cases

TABLE I

RANGE IN MILES OVER LAND												
Height of Aerials	30 Mc/s				80 Mc/s				160 Mc/s			
	A	B	C	D	A	B	C	D	A	B	C	D
6ft/6ft ...	2.0	3.5	6	10.	1.8	3	5	8	1.8	3	5	8
12ft/12ft ...	2.5	4.5	7.5	12	3.0	5.0	8.5	14	3.5	6	9	14
6ft/30ft ...	4.5	7.5	12	19	4	6.5	10	16	4	6.5	10	15
6ft/100ft ...	8	13	20	30	6	10	16	25	7	11	16	24
6ft/600ft ...	15	22	32	45	13	20	30	44	13	20	30	42
30ft/30ft ...	5.5	9	15	25	6.5	11	18	26	8	13	20	28
100ft/100ft or ... 30ft/330ft	15	22	32	45	16	26	38	52	19	28	38	49
100ft/1000ft ...	35	50	70	90	45	60	75	90	50	60	70	80

transmission much useful information can be gained from propagation theory, especially with regard to comparative ranges on different wavelengths, with different powers, or using aerials at different heights.

The minimum field required for intelligible reception at a fully efficient receiver is about 3μV/m at 160 Mc/s and 2 μV/m at 80 Mc/s and 30 Mc/s, cosmic noise being the limiting factor at the latter frequency.

The distance at which the field falls to the minimum required has been calculated for a variety of conditions from the available formulæ (see Appendix) and the following tables give the range in miles for communication between two stations using vertical dipole aerials at the heights stated above ground. They are not intended to cover cases where a miniature battery portable, a super-regenerative set, or some other relatively inefficient receiver is used; reason-

TABLE II

RANGE IN MILES OVER SEA									
Frequency	30 Mc/s			80 Mc/s			160 Mc/s		
Worst Height H_w	180 ft			40 ft			14ft		
Aerial Heights	B	C	D	B	C	D	B	C	D
Aerials Low (<.5 H_w) ...	40	55	75	16	25	37	7	12	20
6ft/30ft ...	40	55	75	15	23	35	7	12	20
6ft/100ft ...	40	55	75	17	27	39	15	23	32
30ft/30ft ...	40	55	75	14	22	33	8	14	22
30ft/100ft ...	40	55	75	16	25	37	16	25	34
100ft/100ft ...	37	50	70	19	30	44	28	38	49
100ft/1000ft ...	55	75	95	55	70	85	60	70	80

Worst Height H_w for transmission over sea : when the height of either aerial above the sea is within about ± 50% of H_w , range is actually less than for very low aerials; the maximum loss in range is between 20% and 30% and occurs when both aerials are at a height = H_w . Range figures are greater than for land when one or both aerial heights are less than H_w .

where low aerials are used in fully built-up areas, though larger losses may be encountered in blind spots close to houses or behind hills, especially on the high-est frequencies.

Aerials

(a) Plain vertical dipoles are assumed for the tables above. If horizontal aerials are used, the range will become progressively less if the height of either aerial is reduced below 0.5λ over land or below H_w over sea.

(b) If aerials must not exceed 5ft total length, range is reduced 10 to 40 per cent (depending upon earth) on 30 Mc/s only.

(c) If optimum directors are used at both dipoles, range is increased to that for ten times higher power. Simpler arrangements, e.g., reflectors at one or both aerials, will give less increase and 3 element arrays slightly more.

TABLE III

Loss	Power Radiated				
	0.1w	1.0w	10w	100w	1Kw
0dB	B	C	D		
10dB	A	B	C	D	
20dB		A	B	C	D

(d) *Aerial Height* is that to centre of aerial: in the case of an aerial on a hill, in a valley, or on a tall building, it may be measured relative to the average height of the ground between the stations.

The Tables should give fairly reliable figures for average range obtained and for the variation of this average range with height of aerials and with transmitter power, etc. For example, we find that a given increase in power has a much greater effect than in the case of communication with aircraft; under most conditions we have here an increase of ten times in transmitter power increasing range by about 70 per cent.

However, when the range is great (much over 20 miles at 30 Mc/s or 10 miles at 160 Mc/s) the rate of increase in range with power becomes progressively less than that given by the above rule. Again, it is seen that doubling of the height of both aerials is equi-

valent to an increase of 16 times in power in most cases over land, but this rule does not hold for most practical heights over sea, nor for very low or very high aerials over land.

It is evident that horizontal aerials should not be used for transmission over sea, or for

reasons and apart from the low power available:—

(a) Noise factor is worse for sets using battery valves.

(b) The aerial is restricted in length and suffers increased electrical losses if the set is carried or worn when in use.

The following table assumes a

TABLE IV

Average Range for Portable		30 Mc/s		80 Mc/s		160 Mc/s	
Aerial Length	Aerial Height	Land	Sea	Land	Sea	Land	Sea
4ft	6ft (worn)	1.5	18	1.4	9	0.9	3
$\lambda/2$	6ft	3.0	30	1.7	10	1.0	3
$\lambda/2$	30ft	8	30	7	8	4	3

mobile operation with low aerials over land (except on 160 Mc/s), and that the lower frequencies should have preference when working over sea.

The two main factors which are not under control—viz., obstructions in the line of sight, and electrical interference—will often have a large effect in reducing the range obtained in any specific practical case. However, they should not greatly affect the relative ranges except in the following respects:—

(a) Electrical interference is mainly that due to car ignition systems, and this is most serious around 30 to 60 Mc/s. If such interference is serious, a "loss" at the receiver is, of course, no longer of importance within limits (e.g., 10 db loss at receiver is no longer equivalent to a reduction of ten times in transmitter power). This interference is less serious when horizontal aerials are used.

(b) Screening by houses, hills, etc., becomes progressively more serious as the frequency increases. This will tend to cancel, or even override, the effects of the reduced interference encountered at these frequencies.

The Tables may be taken to apply equally to amplitude or to frequency modulation systems, but the signal/noise ratio may be better with the latter type of modulation once the receiver is within the service area.

Range for the lightweight portable type set is normally less than that tabulated above for two

set using 1.4-volt valves, with a 2-watt d.c. input and 0.2-watt transmitter output. Figures for 4ft-aerial refer to the case where the set is worn when in use, while those for the $\lambda/2$ aerial assume the station to be temporarily on the ground. Theoretical range (0 db loss) is about 1.5 times that shown, and range under poor conditions is about half that shown. Ranges given for 160 Mc/s might not be attainable above about 140 Mc/s owing to difficulties with valves.

APPENDIX

As in Part 1 on air to ground communication, the figures here are based upon a paper on "Range of Low Power Radio Communication" by the present writer in *Jour. I.E.E.* for November, 1948. This paper should be consulted if more complete formulae and references are desired.

The horizon distance bears no simple relation to range when the aerials are at low heights. The following well-known simple formula is applicable to a good proportion of

$$\text{cases, } E = \frac{88 h_1 h_2}{\lambda d^2} \sqrt{P} \text{ where } E$$

is field in V/m. P is power radiated in watts and h_1, h_2 are aerial heights above ground; λ is wavelength and d is distance, all in metres. To cover the case of low aerials with vertical polarization, we must make the following simple correction:

Substitute 0.5λ (or $2.5\lambda^{3/2}$ if over sea) for h_1 or h_2 in all cases where h_1 or h_2 is less than the critical height of 0.5λ (or $2.5\lambda^{3/2}$ over sea).

For horizontal polarization the uncorrected formula holds down to the lowest practical heights.

However, at long distances

Range of V.H.F.—

additional attenuation occurs due to the earth's curvature, this extra attenuation reaching 3db at a distance of $13 \lambda^{1/3}$ miles, and 8-10db at double this distance. This correction, and also smaller corrections required for very high aerials (over about 300ft) and for aerials

near the critical height (or the "worst height" $1.8 \lambda^{3/2}$ over sea) have been allowed for in the tables. Average constants ($K = 10$) are assumed for land.

The simple law given in the text for variation of range with power corresponds, of course, to the simple square law formula.

The reference potential V_r is supplied by the drop across V_2 which is supplied through a ballast resistor from an auxiliary source—such as a time base or amplifier power pack. When V_r is large compared with the grid base of V_1 , the stabilisation ratio, S_0 , is given by :

$$S_0 = 1 + r_{a1} \frac{I_{a1}}{V_0} + \frac{\mu_1}{V_0 V_r + 1} \quad (\text{approx.})$$

Where r_{a1} = anode resistance of V_1 , I_{a1} = anode current of V_1 and μ_1 = amplification factor of V_1 .

ELECTRONIC CIRCUITRY

Selections from a Designer's Notebook

By J. McG. SOWERBY (Cinema Television Ltd.)

AS readers are well aware, the sensitivity of an electrostatic cathode-ray tube is inversely proportional to the final accelerating potential. Consequently, if a cathode-ray tube is to be more than a rather approximate device, and if any serious measurements are to be taken with it, this point must

Voltage Stabilizer for C.R. Tubes

be allowed for. When recording photographically (in particular) some form of stabilized supply potential for the cathode ray tube should be provided. The type of circuit to be used will depend very much on the supply potential required, and at low voltage (up to 750 volts, say) the conventional series¹ or shunt² stabilizer is

circuits is well brought out by consideration of one of them—as shown in Fig. 1. This represents a simplified series degenerative stabilizer. The reference potential is supplied by the drop across V_3 (100volts, say), and this is compared with the fraction of the output V_0 (2500 volts, say), obtained across the potential divider R_1, R_2 . Any difference between these potentials is ampli-

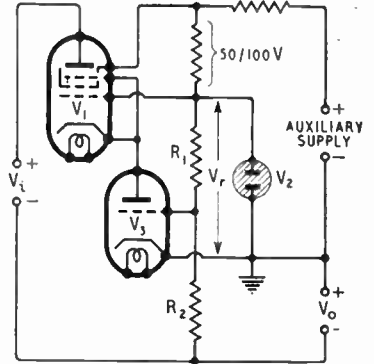

Fig. 3. Improved E.H.T. stabilizer.

If we now put in reasonable values for the parameters in this relation — assuming an EL38, ($I_{a1} = 2$ mA, $r_{a1} = 100$ kΩ, $V_0 = 2,500$ volts, $V_r = 100$ volts, and $\mu_1 = 100$), we find $S_0 = 5$. This means that mains fluctuations will be reduced by a factor of 5 before reaching the cathode-ray tube. Although this is a step in the right direction, the advantages of the stabilizer are not very marked.

An improved circuit³ used by the writer with some success is shown in Fig. 3, and it will be seen that another valve has been added in series with V_1 of Fig. 2.

When this circuit is analysed we find that the stabilisation ratio is :

$$S_0 = 1 + \frac{\mu_1 r_{a3} I_{a3}}{V_0} + \frac{\mu_1 \mu_3}{V_0 V_r + 1} \quad (\text{approx.})$$

If we assume that $\mu_3 = 50$ and $r_{a3} = 30$ kΩ, and take the other parameters as before ($V_r = 100$, $V_0 = 2500$ volts, etc.), we find $S_0 = 2000$ approximately. This, of course, is a very useful figure.

It will be noticed that V_3 may

³ Patent applied for.

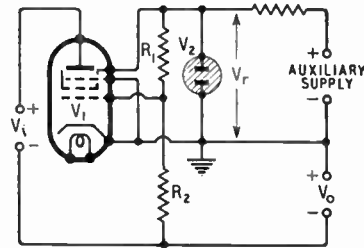

Fig. 2. Simple E.H.T. stabilizer.

fied by V_2 and applied to V_1 in such a way as to tend to keep V_0 constant. As the cathode-grid potential of V_1 will be small (10 volts, say), the anode-cathode potential of V_2 will approach V_0 —taking the given figures it will be about 2400 volts. Now this is greatly in excess of the rated anode-cathode voltage of almost—if not quite—all small amplifier triodes and pentodes. Consequently, the circuit is rather unpractical and an alternative must be found.

A circuit which might be used to achieve the required result is shown in Fig. 2. Here V_1 is a so-called "time-base" pentode or tetrode rated at 10/30 watts dissipation with a top-cap anode rated to withstand several kilovolts peak. The EL38 is a typical example of this class of valve.

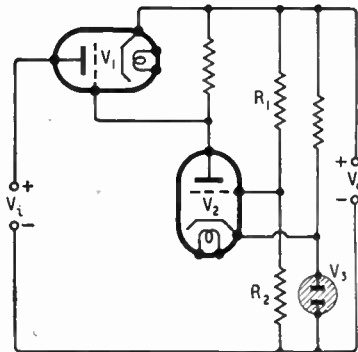

Fig. 1. Conventional series stabilizer.

quite satisfactory. At higher potentials (750V to 5kV) the use of these conventional circuits is hampered by the lack of suitable valves among those currently available.

The difficulty with conventional

¹ Scroggie, M. G. *Wireless World*, October, November, December, 1948.

² Sowerby, J. McG. *Wireless World*, June, 1948.

be almost any sort of triode provided it has a reasonably high amplification factor, and is capable of passing the load current for the cathode-ray tube and bleeder network (about 2 or 3 mA altogether). The maximum anode-cathode potential of V_3 is roughly V_r plus the working grid bias of V_1 , and need never exceed 150 volts at the maximum. Thus, the potential by which V_i exceeds V_0 appears almost entirely across V_1 , and this may be a valve of the EL38 class capable of withstanding about 3 kV.

The resistance looking back into the stabilizer terminals is approximately $R_0 = \frac{1}{g_{m3}} \cdot \frac{V_0}{V_r}$, but this is not usually of much interest; if it is, in some particular application, then to maintain a low R_0 , V_3 should be a valve having a large mutual conductance.

A further point should be noted; provided V_i is switched on only when V_1 and V_3 are "hot," V_1 need only withstand the fluctuations of the supply potential plus a margin for safety. Thus, with ordinary receiving valves stabilized output voltages up to about 10 kV may be obtained by the use of this circuit.

For the best results the heater of V_3 should be supplied via a "constant-voltage" transformer, and the network R_1, R_2 —and any part of it which may be variable for adjusting V_0 —should be screened.

IT sometimes happens in electronic control applications that one is required to close a relay momentarily (e.g. for 1/10 to 1/2 sec.) each time a relatively short pulse occurs somewhere in the circuit.

A Pulse Stretcher

A typical example is the need to operate an electro-mechanical counter whenever a light beam falling on a photocell is interrupted. The natural choice of circuit for this sort of service would be a time-delay trigger circuit of one kind or another as previously discussed in these columns. It is not always remembered that an otherwise undesirable quality of a cathode follower can often be utilized for the purpose, and this sometimes

leads to a considerable simplification with resultant economy.

The circuit of the cathode-follower pulse stretcher is shown in Fig 4. A simple analysis of the circuit shows that, provided the amplitude of the input pulse is considerably greater than the grid base of the valve, C_k charges (input increasing positively), with a time constant C_k/g_m approximately, where g_m is the mutual conductance of the valve. When the input pulse collapses from its peak to zero, V_1 is cut off and C_k discharges through R_k , until V_1 again conducts, with a time constant of $C_k R_k$ —exactly as would be expected. Consequently, for an input waveform as shown in Fig 5(a), an output waveform as at (b) will be obtained provided

$$R_k \gg \frac{1}{g_m}$$

It is convenient to note that the ratio of the rising and falling time

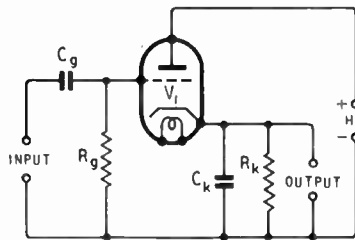

Fig. 4. Cathode-follower pulse stretcher.

constants is simply $g_m R_k$, so that for large inputs one may loosely say that the input pulse duration can be multiplied by the factor $g_m R_k$. It will sometimes happen that a relatively long time constant $R_k C_k$ will be needed, and it is worth remembering that it is generally preferable to increase R_k rather than C_k , to obtain the desired result. The rate of rise of cathode potential is limited by C_k/g_m , and if the rate of rise of grid potential is in excess of that possible at the cathode, the valve will run into grid current in an attempt to charge up C_k rapidly. A valve with high mutual conductance will help to reduce this trouble, and will also operate correctly with a lower input amplitude than is the case with a low g_m valve.

If we use an EF50 for V_1 , make $R_k = 100 \text{ k}\Omega$, and choose C_k with due regard for the input waveform, an input pulse duration may

certainly be stretched 100 times, or more, and the output waveform used to operate a valve controlling a relay or any other device. If pulse stretching by a greater

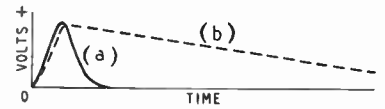

Fig. 5. Response (b) of the stretcher to a typical pulse input (a).

factor than this is needed it will usually be desirable to revert to the more complicated but more flexible time-delay trigger circuit.

MANUFACTURERS' LITERATURE

Leaflet describing the "Bafflette Bonnie" extension loudspeaker, from Richard Allen, Caledonia Road, Bately, Yorkshire.

The 1949 catalogue of components and accessories made by Belling and Lee, Cambridge Arterial Road, Enfield, Middlesex, has now been issued and is available to manufacturers, government and professional organizations. Copies will be sent automatically to those who already have previous editions.

Data sheet of valves and c.r. tubes, from Ferranti (Electronics Dept.), Moston, Manchester, 10.

Technical publication No. 21 ("Sorbsil" Silica Gel for water and organic vapour adsorption), from Joseph Crossfield and Sons (Chemical Dept.), Warrington, Lancashire.

Data sheets for the following transmitting valves: DET18, ACT19, BR124, BR125 and TT12, from Marconi's Wireless Telegraph Co., Ltd., Chelmsford.

Illustrated leaflet describing the new Type "A" potentiometer, from Morgan Resistors, Paulsway, Bede Trading Estate, Jarrow, Co. Durham.

Leaflet giving technical details of the Redifon Type G41 short-wave transmitter (5-7 1/2 kW), from Redifusion, Ltd., Broomhill Road, Wandsworth, London, S.W.18.

Information sheets showing the application of electronic control methods in industry, from Sargrove Electronics, Sir Richard's Bridge, Walton-on-Thames. Examples are given of the many uses to which the Sargrove rectifier-photocell and "Phasitron" circuits can be put for counting, inspection and machine protection.

Folder giving dimensions and electrical data of "Gecadloy" radio dust cores, from Salford Electrical Instruments, Silk Street, Salford, 3, Lancashire.

NOTES ON THE Wireless World TELEVISION RECEIVER

THE performance of the line time base is greatly affected by the core material of the line-scan transformer. Core losses are relied upon very largely for damping and the linearity control, although it does provide additional damping, does not give sufficient for some grades of iron.

During flyback, the equivalent

capacitance effect of C_s of the original diagram is now provided by a shunt capacitance on the secondary. This is represented by C_A and C_B in parallel.

A variable capacitor of 0.0015 μ F maximum should meet all requirements and C_B would then be unnecessary. Such a capacitance is readily obtained from

tical line or band on the right of this expanded portion, reduce the resistance by R_{19} — R_{23} . If the left-hand side is linear but folded over, increase the resistance. Adjust the resistance until there is a small amount of expansion on the left.

Next increase picture width. The expansion will be reduced and may disappear and be replaced by a foldover. If so, increase the resistance. A vertical white line an inch or so from the left may now appear. Adjust C_A to minimize it. Continue the process until the proper width is obtained. Check the fly-back time on the test pattern. If it is too great, C_A must be reduced and this will necessitate reducing the width slightly and readjusting the resistance.

It is normally possible slightly to overscan the tube so that there should be no difficulty in obtaining the full width. When the values are approximately correct, the resistance adjustment is not very critical, but C_A needs precise setting.

The circuit has been used successfully with transformers having cores of Silcor II, 0.018-in. laminations, and Silcor III, 0.02-in. With core materials of greater loss, the original circuit is preferred.

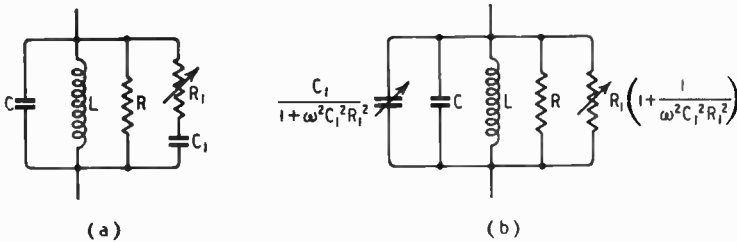

Fig. 1. Equivalent circuit of output stage (a) and an alternative equivalent (b) which is approximately valid during the fly-back.

circuit has the form shown in Fig. 1 (a), where L is the total effective inductance, C the shunt capacitance, R the resistance simulating the core losses and R_1 and C_1 the components of the linearity control. The circuit must have a natural frequency of about 34kc/s, so that one-half cycle is about equal to the fly-back time, and be so damped that the overshoot on the half cycle is only a few per cent.

At any single frequency R_1 and C_1 can be replaced by a capacitance and resistance as shown in Fig. 1 (b). A variation of R_1 thus varies simultaneously both the capacitance and resistance of the equivalent circuit. Under normal conditions the resistance variation predominates. However, if the transformer core losses are abnormal, the range of control given by the circuit is inadequate, for it is then necessary to change C_1 as well as R_1 . This does not form a satisfactory arrangement, however, for the optimum value of C_1 is quite critical under some damping conditions.

It has been found better to modify the circuit to the form shown in Fig. 2, so that the damping resistance is directly in shunt with the transformer secondary. The

a 3-gang capacitor with its sections in parallel, but while this is convenient experimentally, it is rather clumsy as a permanent feature of the set. It is practically convenient, therefore, to make C_A of 500pF only and to add an appropriate fixed capacitance C_B in shunt. This must be found by trial, but will usually be 500pF. The capacitor should be rated for 750V peak. An ordinary bakelite-dielectric reaction capacitor has been used successfully for C_A and is both cheap and compact. While the voltage is considerably above that normally used on such a component, one has been working satisfactorily for some time. No damage to other components is likely to result from a breakdown. The capacitor must be mounted with its shaft earthy.

As an alternative to C_A and C_B , a 100-pF variable capacitor can be connected across the transformer primary. As this component must withstand up to 3-kV peak, it is usually easier to use the larger capacitance on the secondary.

The adjustment of C_A is critical. Adjust the width for about a 6-in picture and examine it carefully. If the left-hand side is expanded and there is a whitish ver-

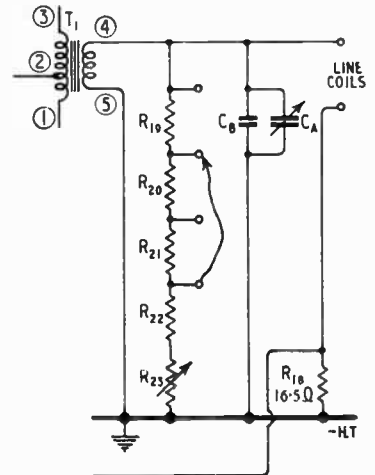

Fig. 2. Modified damping circuit recommended for transformer cores having low losses. The references are as on the original diagram except for the new parts C_A , C_B .

ELECTROMEDICAL STIMULATORS

Application of Radar Circuit Techniques for Diagnosis and Treatment

By **O. B. SNEATH, B.Sc.,**
and E. G. MAYER, D.Sc.
(Multitone Electric Company)

IN physiotherapeutic and orthopaedic practice it is desirable to have available certain electric currents for the purpose of stimulating muscle and nerve tissue. The reactions enable assessment to be made of faults in these tissues, and the stimulation can also be used to treat muscle and nerve fibres.

By passing a d.c. current through muscle tissue, a contraction is obtained and in the past this was supplied by a source of d.c. passed through a mechanical interrupter to the electrode in contact with the body surface. The interrupter usually took the form of a "Metronome" having a curved crossbar at the top of the inverted pendulum, one end dipping into a bottle containing mercury at each stroke and thus gave the necessary interruptions. The speed of the "Metronome" controlled the length of shock and repetition rate, the shock length varying approximately from 0.3 to 1.0 second.

Nerve tissue responds to comparatively short shocks which have no effect on muscle fibre, and for nerve stimulation damped waves were used. These were produced by means of a "Faradic Coil" which consisted of a vibrator interrupting a direct current through the primary of a double-wound transformer, the current in the secondary being applied to the tissue where stimulation was required.

For diagnosis, muscle reactions to d.c. shocks were noted and also the effect of damped waves applied to motor nerves controlling the muscle. Large variations were encountered due to varying "Metronome" and vibrator speeds, neither of which was generally very accurately measured; at best the results of tests were described by different people in varying ways.

The current generators described above were more satisfactory in the treatment of muscles and

nerves by stimulating exercise, but were extremely uncomfortable to the patient and the constant increase and decay of current to contract and relax a muscle at a natural speed in many cases caused such pain that sufficient output could not be tolerated.

Experiments were carried out by Professor A. E. Ritchie, now

muscle tissue in such a manner that the voltage necessary at each pulse length to produce a given stimulation could be accurately read. A graph could then be drawn showing voltage against pulse length. This makes accurate diagnosis possible by showing the point when response falls, and the degree of nerve and muscle degeneration.

It was found that the square voltage pulse output of the electronic apparatus was comfortable compared with older forms of mechanical generators and interrupters, and so this technique was applied to treatment units. These units first took the form of multi-current generators producing long, medium and short duration pulses, sinusoidal and uninterrupted direct currents, all of which could be applied in various modified forms with fast and slow repetition rates, and surged from zero to a pre-set maximum strength. A further instrument has been produced to replace the old "Faradic Coil." The output is 0.3 millisecond pulses repeated 50 times per second, and this output can be surged at five different rates with adequate spacing between surges for muscle relaxation.

Pulse generators have been extensively developed in connection with radar and telecommunication, and whilst electromedical apparatus is not generally required to give as great a stability of pulse length and interval as radar, it is necessary to be able to obtain, by switching, pulses of widely varying lengths and repetition rates. The pulse lengths commonly employed are 1 second, 100, 10, 1, 0.1 and 0.01 milliseconds, though the longest and shortest of these are often dispensed with. The repetition rate required may be 50 per second to produce continuous nerve excitation and also one or several per second as does the "Faradic Coil."

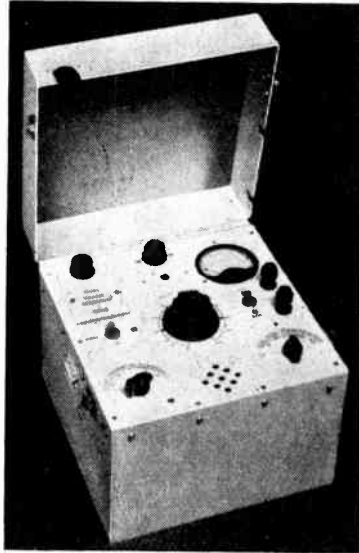

Ritchie-Sneath stimulator unit
for diagnostic work.

at St. Andrews University, who found that long pulses of approximately 0.1 millisecond duration produced with electronic square-wave generators, stimulated muscle tissue, whilst shorter pulses affected motor nerves only, the reaction falling away rapidly at 0.01 milliseconds. Professor Ritchie collaborating with O. B. Sneath, then perfected a muscle stimulator producing pulses of 100, 10, 1, 0.1 and 0.01 milliseconds which could be applied to

Electromedical Stimulators

In apparatus for treatment, as distinct from diagnosis, the rapidly repeated pulses require to be surged or varied from zero to maximum at a rate from 6 to 100 times per minute depending on the treatment. Spacing between surges should be sufficient to allow muscle tissue to relax and though this may be achieved manually by moving the strength control, it is far more convenient and accurate for this to be done automatically.

It will be realized that the long pulse lengths and slow repetition rates involved raise problems of coupling and decoupling somewhat different from those usually met with in radio practice.

In addition to square pulses, sinusoidal and continuous currents may be required, and provision must be made for surging these; a further requirement is to apply alternate surges, either with reversed polarity or to different pairs of electrodes in order to stimulate opposing muscles in turn.

One of the chief problems in the design of the apparatus is to produce this wide variety of currents without undue complexity in the switching, and to avoid the use of an excessive number of valves. In general, the maximum output voltage required is approximately 100 volts at 100 mA, although for short pulses of 1 millisecond or less nearly double these values may be necessary.

The only standard valves suitable for such relatively high

current-to-voltage ratios, are output valves designed for use in a.c./d.c. instruments as for example 35L6's or Mullard CL33's in parallel. By connecting the screens to h.t. + through suitable resistors the drop across the anode load, when the grid is not biased, may be made only a fraction less than the h.t. supply voltage. Applying pulses to the grids, which are normally biased to cut-off, causes the valves in the output stage to resemble a high-speed relay in their action.

The best-known circuit for producing square-topped pulses is probably the multivibrator em-

To overcome this difficulty the anode of one of the valves in the multivibrator may be coupled to the grid of the output valves which serve merely as an "on-off" switch for the current.

A factor of importance in this application of the multivibrator is the limitation of the maximum ratio obtainable between the periods of the two phases. This depends on the fact that the valve which is "blocked" for the long period has to have its grid condenser recharged during the short period, and is of the order of the ratio of the maximum value of grid leak employed to the anode

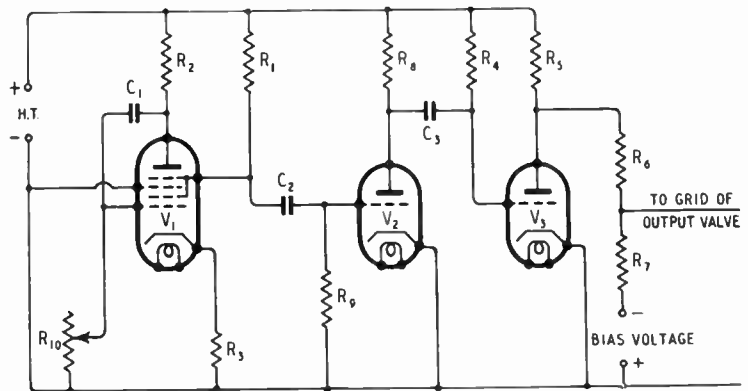

Fig. 2. "Miller integrator" type of circuit using a hexode as oscillator.

playing two triodes. The output may be obtained from a potentiometer in the anode of one of these triodes, but variations in output load, and most methods of surging the power would, in normal circuits, vary the pulse length.

load impedance. It is not generally satisfactory to use a grid leak of more than 10 megohms; thus if the anode impedance is 10,000 ohms the interval-to-pulse ratio will be limited to approximately 1,000/1 although by using a power valve biased to cut-off on the shorter pulses, a higher ratio can be obtained. There is no need for the valves to be similar, and a high-impedance valve with a higher resistor in the anode circuit could be used in conjunction with the power valve.

A modified form of "multivibrator" circuit devised by O. B. Sneath enabling 10 or 100 microseconds, or 10 or 100 millisecond pulses to be repeated once a second, employs a triode and hexode as shown in Fig. 1. It will be seen that the triode V1 is coupled to both the inner and outer control grids of the hexode V2, the condensers C2 to C6, coupling it to the inner grid, vary the pulse lengths. When the time factor of

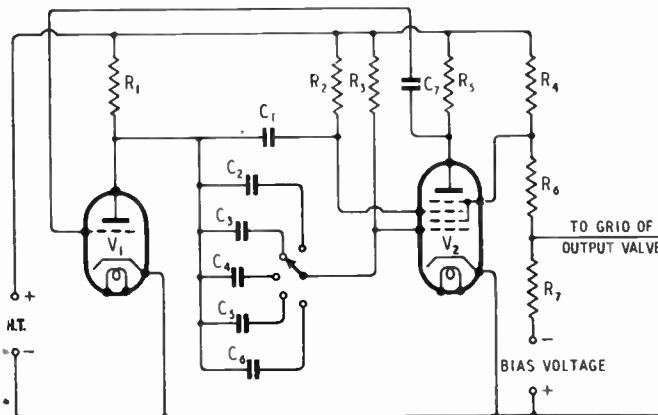

Fig. 1. Modified multivibrator circuit giving variable pulse length and spacing.

the coupling to the inner grid is greater than that of the outer, the circuit behaves as a normal multivibrator. The outer grid only being

the outer grid takes the place of the suppressor, and the two coupled screens that of the single screen of the pentode. The behaviour of the circuit is as follows.

Assume the inner grid of V_1 to be biased, the bias will gradually decrease as C_1 discharges through R_{10} and both screen and anode voltage will fall. The valve V_1 causes the time constant of

This causes grid current to flow as in the normal multivibrator until the anode and inner grid drops back and stability is reached, with the inner grid not completely biased to cut-off.

The resistor R_{10} has one end taken to h.t. — rather than to h.t. +, as this reduces the values of C_1 and R_{10} for a given pulse repeat rate, it also reduces frequency instability with varying h.t. supply. The output of V_1 is taken from the screen and not the anode, as this circuit has a lower impedance. It is coupled to V_2 through a resistance-capacitance coupling of long time constant compared with the pulse length, and this triode V_2 has its anode coupled to the grid of V_3 . The coupling condenser C_3 and resistor R_4 between the grid of V_3 and h.t. + controls the length of the pulse.

The pulse is produced once in each complete cycle of V_1 , when the screens of V_1 suddenly become positive, causing the anode potential of V_2 to drop, and V_3 to be biased to cut-off. The steepness of the termination of the pulses is increased by raising the gain of V_3 , so that a smaller change in grid voltage is required to carry it out of the cut-off condition to the low anode potential position.

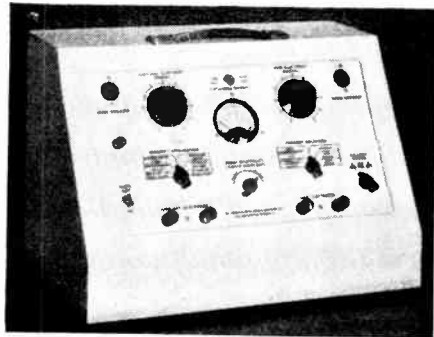

Multi-treatment unit providing all types of current required in physiotherapy.

biased when V_2 is not passing current owing to the outer grid being biased to cut-off; this condition applies for pulses of one millisecond or longer, using condensers say C_2 to C_4 .

For short pulses the anode of V_2 remains positive for a period depending on the coupling to the outer control grid, which is adequate to charge the condenser C_2 , but the screen from which the output is taken remains positive for a shorter time depending on the coupling condensers C_3 or C_4 . Under this condition the output from the screen is not a true multivibrator output, as the un-biasing of the inner screen is gradual, but allowing for steepening effect due to the gain of the output valve it can be made satisfactory.

Another method of producing square waves is to apply the output from a multivibrator, both constants of which are longer than the required pulse length, through a capacitor and resistor giving the required period to the grid of an amplifier which serves as or contains a limiter.

Instead of the usual multivibrator circuit, a form of circuit which has been previously described in *Wireless World* under the titles "Miller" or "Blumlein" oscillators may be employed, and is the start of the circuit for producing square pulses shown in Fig. 2. It was, however, found advantageous to employ a hexode rather than a pentode valve, as this enables the anode to be biased off by the outer grid with a lower value of cathode resistor;

C_1 and R_{10} to be multiplied by a factor equal to one plus the effective amplification factor of the valve in conjunction with its anode resistor R_2 , and hence the circuit is very convenient where long time intervals are required. As the current increases, a point will be reached where this increase continues but the anode current falls and anode potential starts to rise, due to the cathode resistor R_3 increasing bias on the outer grid; the rise in anode potential is communicated through con-

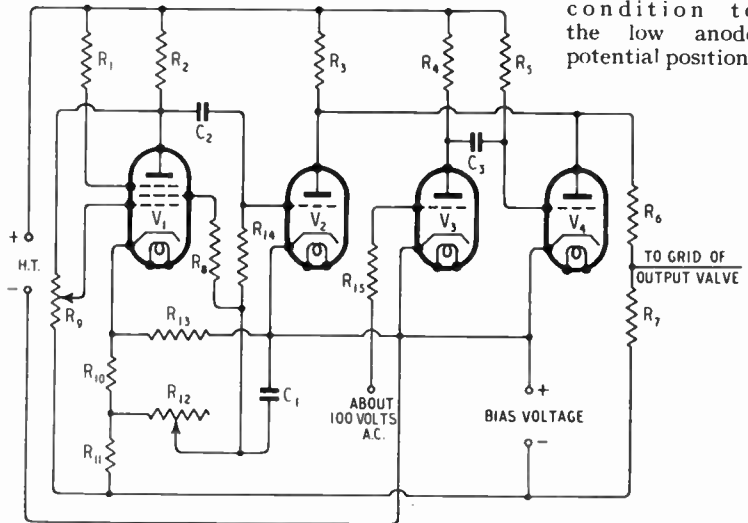

Fig. 3. Circuit for periodic amplitude control or surging of pulses at mains frequency.

denser C_1 to the inner grid, and the screen current suddenly rises until the anode current is cut off by the bias on the outer grid, and the inner grid is driven positive.

The most obvious way to surge a series of rapidly repeated pulses at a slow rate would appear to be to vary the h.t. supply to the output valves. This, however,

Electromedical Stimulators—

involves a duplication of the power valves and also an increase in the initial h.t. voltage and power dissipation, as there is bound to be a voltage drop in the surging valve even when the surge is at maximum. An alternative method is to couple the grid of the output valve to the anode of two valves connected together, one of these valves shown as V_4 in Fig. 3 ceasing to pass current during each pulse, and the other, V_2 , being arranged to pass minimum current at the peak of the surge. The output valve only passes current when V_4 is "blocked" out, the amount of such current depending on the state of bias on V_2 . Fig. 3 shows a circuit for producing surged pulses at a repetition rate of mains frequency. The circuit of the surge-producing valve V_1 is capable of producing surges with both a gradual rise and a gradual decay, but the rise and decay may be different, and the ratio is controlled by the value of the resistors R_{10} , R_{11} and to a lesser extent by the potentiometer R_9 .

The cycle of operation is as follows. Assuming the suppressor grid of the pentode V_1 is at zero potential or has only a small negative bias, the anode will then pass current, and if R_2 is sufficiently high, will be at fairly low potential. Owing to the coupling through the potentiometer R_9 , the inner grid will, however, be somewhat biased, and the total cathode current fairly low. This will cause the cathode potential to be low, and the negative bias on the suppressor will gradually increase, due to the current flowing through R_{12} charging C_1 . Finally a point is reached where this bias causes the anode voltage to rise, which causes a rise of the inner grid voltage, and, provided that the screen resistor R_1 is low, a sudden rise in total current through V_1 and also of cathode voltage. The suppressor grid will now gradually lose bias until the anode becomes relatively negative again and the cycle is completed. Suitable values of resistors to obtain this result are: — R_9 , 220k Ω ; R_1 , 22k Ω ; R_{13} , 15k Ω and R_8 , a 1M Ω potentiometer. A source of negative bias is required of about the same voltage as the high tension. The voltage across R_1 is

fairly steady at a low value for a part of the cycle and at a higher voltage for the remainder, but at the junction of R_{12} and C_1 there is a fairly steady rise followed by a fairly steady fall of negative bias. The total length of the cycle is controlled by R_{12} . The junction of R_{12} and C_1 is coupled through a high resistance to V_2 which surges the pulses, these can be produced by applying a.c. at about 100 volts, 50 c/s to the grid of V_3 through a resistance. Approximately square pulses are produced on the anode of V_3 , which is coupled through a con-

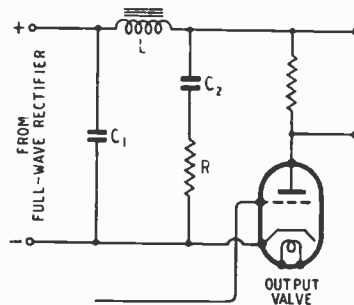

Fig. 4. Stabilizing circuit for h.t. supply when using long pulses.

denser C_3 to the grid of V_4 . This condenser and a resistor R_6 to h.t. + determine the pulse length.

The form of surge usually desired is a gradual rise followed by a rapid decay. The surge should be effective for about a quarter of the time, which in general means that it should be over half value for about a quarter of the time. It is of little consequence how much of the remaining time the pulses are absent or at a low level. It is probably almost as effective to have a gradual rise followed by an instantaneous decay, and a number of well-known circuits similar to those used for television scanning can be adapted for this purpose. Many of these circuits can only be varied over the required range, while retaining their wave form, by employing ganged controls.

It is desirable to provide a source of constant amplitude sinusoidal voltage and also to surge this voltage at varying repeat rates. Whilst "continuous sinusoidal" is, of course, obtainable from the secondary of the mains transformer, it is very involved

to surge this without entirely changing the waveform. Probably the simplest method is to produce surged square pulses of approximately 10 milliseconds in length at a repeat rate of 50 per second and to connect in parallel with the output a 50-c/s resonant circuit.

A special problem arises in connection with the longer pulses, and is due to the gradual fall in voltage after the start of the pulse owing to the discharging of the reservoir condensers in the power pack. This could be solved by the use of a stabilizing device normally drawing current comparable with that of the pulse, but this would greatly increase the power dissipation of the apparatus, and is therefore undesirable. The arrangement shown in Fig. 4 has been employed,* and the general effect is that when the valve starts to draw current, this is obtained from the condenser C_2 charged to open circuit power pack voltage, but the voltage is dropped by the resistor R . As the current continues, the voltage of C_2 falls, but the effect is compensated by the rise of current through the choke L . Owing to the non-linear nature of the rectifier resistance and the complication due to the first reservoir condenser, no simple formula can be given for the value of R and perfect squaring is not achieved, but reasonably good results were obtained with R , 600 ohms, L , 12 henrys, C_1 , 16 μ F and C_2 32 μ F.

* Patent has been applied for in connection with this arrangement.

REFERENCES

- Walter, W. Grey and Ritchie, A. E., "Electronic Stimulators," *Electronic Engineering* 1945, Vol. 17, p. 585.
Ritchie, A. E., "Thermionic Valve Stimulators," *British Journal of Physical Medicine* 1948, Vol. 11, p. 101.

PORTABLE RECORD PLAYER

DESIGNED for operation from a.c. mains, the "Karrigam" record player made by the V.S.E. Construction Co., 5-7, Denman Street, London, W.1, employs the new all-class B8A miniature valves and the heaters are fed in series through a capacitor. Negative feedback is employed, and the output is 2½ watts to a flat-type 6½in moving-coil loudspeaker mounted in the lid of the rexine-covered carrying case. A lightweight Garrard turntable unit is used and bass-boost at 3.8db per octave is provided in the 3-valve circuit which works in conjunction with a high-quality magnetic pick-up. The weight of the player is 16½ lb and the price is £26 19s 8d.

Two rare valves - the answer lies in using types to **BRIMARIZE!**

TYPE 1LA₄ and 1LB₄ are small output valves used in portable battery equipment. Two substitute valves are available: type 3D6 which requires slightly more filament current, or type 1A5GT which necessitates a change of socket.

To keep battery consumption to a minimum, only one half of the 3D6 Filament is employed, Pins 7 and 8 of the socket being joined together for this purpose.

For AC/DC Battery operation type 1A5GT is the only suitable substitute as the filament ratings of all the valves must be identical in such receivers.

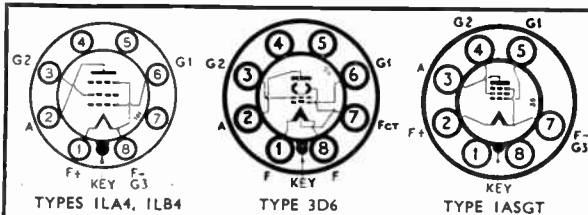

CHARACTERISTICS

	TYPES 1LA ₄ , 1ASGT	TYPE 1LB ₄	TYPE 3D6 (One Filament)
Filament Voltage	1.4	1.4	1.4 volts
Filament Current	0.05	0.05	1.1 amp.
Anode and Screen Voltages	90	90	90 volts
Anode Current	4.0	5.0	4.2 mA
Screen Current	0.8	1.0	0.65 mA
Control Grid Voltage	-4.5	-9.0	-4.5 volts
Mutual Conductance	0.85	0.93	1.2 mA/V
Optimum Load	25,000	12,000	20,000 ohms
Power Output	0.12	0.2	0.185 watts

CHANGE VALVE		CHANGE SOCKET		CHANGE CONNECTIONS		OTHER WORK NECESSARY	PERFORMANCE CHANGE
FROM	TO	FROM	TO	FROM OLD SOCKET	TO NEW SOCKET		
1LA ₄	3D6	Loctal NO CHANGE		Disconnect any wires to Pin 7. Join Pins 7 and 8 of socket together		—	INCREASED OUTPUT
	1ASGT	Loctal	Octal	Pin No. 1 " " 2 " " 3 " " 6 " " 8	Pin No. 2 " " 3 " " 4 " " 5 " " 7	—	NO CHANGE
1LB ₄	3D6	Loctal NO CHANGE		As for 1LA ₄		Decrease Bias Resistor to give 4.5 volts bias only	NO CHANGE
	1ASGT	Loctal	Octal	As for 1LA ₄		As above.	REDUCED OUTPUT

BRIMAR says...
watch our next advertisement for a special announcement

BRIMAR
RADIO VALVES

STANDARD TELEPHONES AND CABLES LIMITED, FOOTSCRAY, SIDCUP, KENT.

PUNCH HOLES HERE

INSTRUCTIONS: Punch holes where indicated, cut away this portion and file sheets in order of appearance. This column will then form a quick reference index.

1LA₄
1LB₄

Vortexion

“STEREOPHONIC” AMPLIFIER

This new amplifier with triode cathode-coupled output stages has the effect of making the reproduction more like the original than ever before. A small proportion of this improvement results from the reduction of the Doppler effect, which is achieved without lowering the damping factor on the speakers, with the consequent distortion and transient loss which would follow.

When listening to an orchestra the low frequencies are usually heard towards the right, and the high frequencies towards the left. When reproduced through the Vortexion “Stereophonic” amplifier with low and high frequency speakers suitably spaced according to required listening angle, the high and low frequencies are heard in their relative positions simulating the effect and appreciation of the original.

This speaker placing is necessary because our ears are on a horizontal plane. The effect would be lost if our ears were positioned one above the other, as can be proved by inclining the head sideways.

Our efforts to achieve “Stereophonic” results by the use of various choke and condenser cross-over networks between the amplifier and speakers were unsuccessful, due to the large variation of speaker impedance at various frequencies, unevenly loading the resonant circuits.

After many months of research we finally achieved our aim with what is basically two special low-distortion, high-damping factor amplifiers in one, each covering a portion of the audio spectrum with a sharp cut per octave at change-over frequency. The acoustical efficiency of the bass and treble speakers may vary, so a balancing control is fitted to the amplifier. This simplifies the choice of speakers, since each speaker has only a narrow frequency coverage.

The “Stereophonic” amplifier is now in production, and we invite you to hear a demonstration of what we believe to be something new and which will add to your enjoyment of music.

Chassis complete with valves

Price **36½** gns

VORTEXION LIMITED, 257-261 THE BROADWAY, WIMBLEDON, LONDON, S.W.19
Telephones: LIB 2814 and 6242-3

Telegrams: “Vortexion, Wimble. London”

DEVELOPMENTS IN COMPONENTS

R.C.M.F. Exhibition, 1949

THIS year's annual private exhibition of radio components and accessories, organized by the Radio Component Manufacturers' Federation, was held in London from March 1st-3rd. The following survey of exhibits is classified under headings of the main products, with lists of makers. A general list of exhibitors, with their addresses, is given at the end.

CAPACITORS

With few exceptions the general tendency in the design of capacitors, both variable and fixed, is to reduce size as far as practicable.

A notable development along these lines is a new range of fabricated plate (FP) electrolytic capaci-

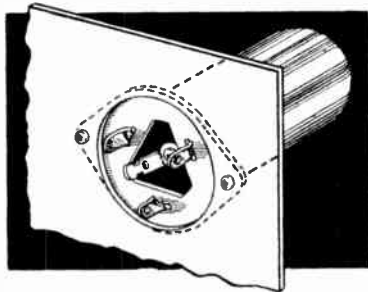

New method of fixing used on British Electrolytic Condenser FP capacitors

tors in aluminium cases made by the British Electrolytic Condenser Company, one of the Plessey group of companies. By using a gauze-like material on which pure aluminium is deposited, the effective area presented to the electrolytic is increased by as much as twelve times compared with plain foil. A 16- μ F, 350-V FP type, for example, measures $\frac{3}{8}$ in diameter and $1\frac{1}{4}$ in high only. Capacitors of from 2 to 50 μ F

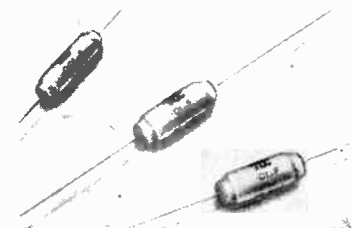

T.C.C. miniature Metalmite capacitors

are available at up to 450V d.c. working in this pattern; multiple types were also shown.

Coupled with this development is

the introduction of a new method of fixing. Short lugs are formed on the base of the cylindrical case, and these are inserted in slots arranged round a centre clearance hole in the chassis. The lugs are then twisted to anchor the component.

Plessey adopts this method of fixing and so also does Dubilier for their latest range of small-sized electrolytic capacitors in aluminium cases. They are called "Ear-mounting" Drilitics. As an interim measure small base plates with the necessary fixing slots and centre hole are available for eyeletting or bolting to the chassis. Hunts also employ this method of fixing.

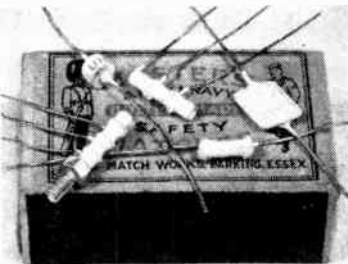

Group of United Insulators miniature silvered ceramic capacitors. The match box gives a good indication of their size.

Plastic film is now being used by T.C.C. for the dielectric in some of their latest types. These capacitors are known as "Plastapacks" and the advantages claimed are very high insulation resistance, of the order of 250,000 megohms/ μ F and a power factor equal to the best mica. They also have a negative temperature co-efficient. In small tubular types this range is from 50 to 5,000 pF. T.C.C. have also made some additions to their Metalmite range, the latest models being very small in size and covering capacitances of from 200 pF to 0.01 μ F.

A range of sub-miniature silvered ceramic capacitors made of a new ceramic, Unilator K3000, was shown by United Insulators in various

forms. There was a tiny wafer type measuring $\frac{1}{8}$ in \times $\frac{3}{16}$ in with wire ends in 680, 1,000 and 1,500 pF, a small pearl-shaped model of from 0.47 pF to 470 pF, a tiny tubular in sizes of 680 pF to 0.01 μ F and some double and triple types up to 2,200 pF.

Erie had a new post-type Ceramicon smaller than made hitherto. It, also, is a silvered ceramic and is available as single, dual



Dubilier Drilitic capacitor with new "Ear-mounting" feature

or triple units and up to 1,800 pF.

So far as variable capacitors are concerned the main feature noticed was even better finish than hitherto. Small subsidiary band-spread units embodied in the main assemblage is used by Wingrove and Rogers (Polar) and Plessey. The former were showing an extended range of miniature types of silvered brass

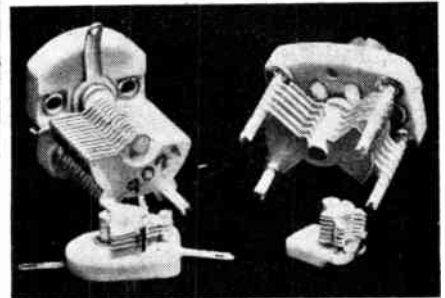

Group of Polar miniature air-dielectric trimmers

construction for v.h.f. use and these included a sub-miniature air trimmer on a $\frac{3}{16}$ in \times $\frac{3}{16}$ in ceramic base and in sizes of 1.5 and 1-10 pF.

Makers*: Bird (T. V.), British Electrolytic Condenser (E.), B.I. Callenders (E. P.), British N.S.F. (P. M.), Bulgin (T. Daly (E.), Dubilier (C. E., M. P. T.), Erie (C. T.), Ferranti (E. P.), Hunt (C. E., M. P. T.), Jackson (T. V.), London Electrical Manufacturing (C. M.), Mullard (T.), Plessey (T. V.), Stability Radio (M.), Standard Telephones (M. P.), Static Condenser (P.), Telegraph Condenser Co. (C. E., M. P. T.), Telephone Manufacturing Co. (M. P.), United Insulators (C. M.), Walter Instruments (T.), Wego (C. M. P.), Welwyn (T.), Wingrove & Rogers (T. V.).

*Abbreviations: C, ceramic; E, electrolytic; M, mica; P, paper; T, trimmers and pre-set; V, air dielectric variables.

Developments in Components—

RESISTORS

Negative temperature resistors are a comparatively new development and they are beginning to find applications in a.c./d.c. receivers to safeguard valves and dial lamps when first switching on. When cold the resistance is extremely high and it falls rapidly with a rise in tem-

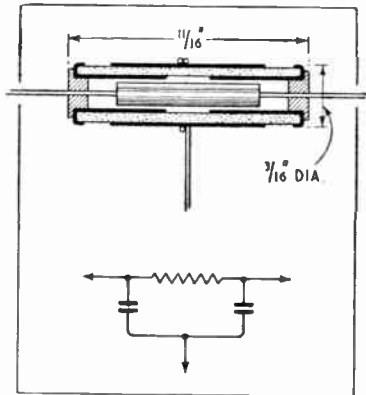

One of the new Erie combined units: a diode filter with circuit shown below

perature, or with increase in current through the element. For example, the latest Standard Telephones "Brimistors" can provide a change in resistance from 5,000 ohms when cold to 50 ohms or so at 250°C. In terms of current the type CZ1 with 0.1-A valves limits the initial surge to 0.12 A, its resistance change being 3,000 ohms when cold to 200 ohms with 0.1 A. There are other types for 0.15-A and 0.3-A circuits as well as for many other purposes.

Serving the same function is the new Mullard Varite. This employs a ceramic type of material and is made in a variety of types to suit the function it is required to perform. In addition to surge limiting in a.c./d.c. sets it is being employed as an automatic picture height control in television receivers as well as for many other purposes.

High-stability resistors where constancy is of vital importance, such as in attenuators and measuring equipment, were more in evidence this year. Welwyn Laboratories have developed a new type especially for use in v.h.f. circuits and said to be entirely reliable at 100 Mc/s and possibly far beyond. Discs and rods for embodying in co-axial lines were shown. Mullard were showing the high-stability type in four sizes, ½- to 2-watts rating, while Dubilier and Erie each had a comprehensive range, fully insulated models being available in either make.

Little change has been made in the ubiquitous rod-type resistor except that Morganite now have a new range with axial wire ends. In ½-watt size the range is 47 ohms to 4.7 megohms and the 1 watt extend from 22 ohms to 10 megohms.

Makers: Advance (A), Belling & Lee (S), British Electrical Resistance (P, R, V, W), British N.S.F. (P, W), Bulgin (P, W), Colvern (P, W), Dubilier (C, HS, P, S, V, W), Erg (HS, V, W), Erie (C, P, S), Igranite (W), Morganite (C, P), Mullard (HS, NC), Oliver Pell (R, W), Painton (A, P, V, W), Plessey (P), Standard Telephones (NC), Welwyn C, HS, V, W).

***Abbreviations:** A, attenuators; C, composition; HS, high stability; NC, negative coefficient type; P, potentiometers; R, rheostats; S, suppressors; V, vitreous; W, wire-wound, fixed and pre-set.

RESISTOR-CAPACITOR SUB-ASSEMBLIES

The combined resistance-capacity unit, once very popular for a.f. couplings, has now reappeared in a new dress. Some of the assemblies are r.f. and i.f. diode filters, while others are a.f. couplings and decouplings. They were shown by Dubilier and Erie.

A twin capacitor which needs only the addition of a resistor to form a diode filter unit was shown by Stability Radio. This provides 100+100pF and is of silvered mica construction.

COILS AND TRANSFORMERS

Radio Frequency.—The design of signal and intermediate-frequency coils for broadcast equipment has become, if not standardized, at least stabilized and the well-tried practice of the past is still followed. Perhaps the only change which is noticeable in the greater number of miniature types.

Examples of air-core coils were shown by Automatic Coil Winder, and Wearite had their well-known P range. The latter firm also had a tuning unit on view. This has three bands for aerial and oscillator tuning and has dust-iron core coils adjustable for trimming. The type 705 covers long, medium and one short-wave band whereas the 706 covers 3-23 Mc/s in two bands as well as medium waves.

Miniature i.f. transformers usually have adjustable dust-iron cores for trimming and are commonly ½ in to 1 in square and about 1½ in high. Models were shown by Plessey, Wright and Weaire and Igranite.

Makers: Advance Components, Automatic Coil Winder, Igranite, Plessey, Teledictor, Wright & Weaire.

Mains and A.F.—The advantages of the so-called high-frequency power supplies for aircraft apparatus were well brought out by a range of mini-

ature transformers shown by Ferranti. Hermetically sealed and designed to withstand a shock test of 60g a transformer for 70 VA weighs only 1.17 lb and measures 1½ in by 1½ in by 3½ in. The operating frequency is 1,100 c/s but models for frequencies of 800 c/s to 2,800 c/s can be supplied.

The 50-c/s types of transformer show little change. Impregnation is now quite general and most firms can supply hermetically-sealed types for arduous conditions. Some of these are fitted with pressure-equalizing bellows.

The range of a.f. transformers shown by Varley includes intervalve types. Output transformers are made by most transformer and loud-speaker manufacturers.

Makers: Acoustic Products, Advance Components, Associated Electronic Engineers, Automatic Coil Winder, Bulgin, British Electric Resistance, British Rola, Celestion, Electro-Acoustic Industries, Ferranti, Goodmans Industries, Igranite, Oliver Pell Control (Varley), Parmeko, Partridge Transformers, Plessey, Reproducers & Amplifiers, Taylor Electrical Instruments, Teledictor, Truvox, Vitavox, Woden, Wright & Weaire.

Television Coils.—Both Igranite and Plessey showed television deflector coils of the "bent-up end" type together with line- and frame-

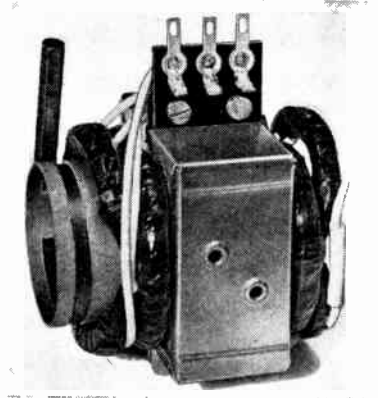

Igranite television deflector-coil assembly.

scan transformers and blocking-oscillator transformers. Plessey also had a frame yoke on view designed for use with a self-oscillating drive stage. It is of the U-shaped type with the windings on the bottom member, the deflecting field being produced across the sides of the U.

Makers: Igranite, Plessey.

CHASSIS FITTINGS

One or two new switch designs have made their first appearance. Bulgin were showing a new toggle switch (S.258) with improved ter-

minals designed to take large conductor cables, and an all-moulded toggle switch (S.377) rated at 250 V, 6 A with insulation greater than 40MΩ at 250 V. This latter type is suitable for non-earthed apparatus and meets the requirements of many Continental countries. A.B. Metal Products were showing a light-action lid-operated switch (Type DS1) for use in personal portable receivers and also the prototype of a coupled switch unit for radio-gramophone-television sets.

Makers: A. B. Metal Products (S), Antiference (PS), Associated Electronic Engineers (TB), Belling & Lee (C, CRH, PS, S, T, VH, VT), British Electrical Resistance (K), B. I. Callender's (C), British Mechanical Productions (C, CRH, F, MS, P, PS, ST, T, VII, VP), British N.S.F. (S), Bulgin (C, F, G, J, K, L, MS, PS, S, T, VII, VT), Carr Fastener (C, CRH, E, F, L, MS, PS, ST, TB, VA, VP, VT), Clarke (P), Colvern (TB), Edison Swan Electric (CRH), Electrothermal (S, VR), Erie (S), Hallam, Sleigh & Clouston (I), Igranic (PS), Imhof (CH, P, R), Jackson (D), Long & Hambly (PS, RM, TM, VR), McMurdo (K, VI), Oliver Pell (S), Pain ton (K, PS, S, T), Plessey (C, D, PS, S, VI), Reliance Electrical Wire (C, PS), Reslosound (PS), Ripaults (C, T), Salford Electrical Instruments (D), Erwin Scharf (K), Shipton (J, S), Standard Telephones & Cables (C, PS, S), Taylor Electrical (K, S, T), Telegraph Construction & Maintenance (C, PS, T), Telephone Manufacturing Co. (J), Tucker Eyelet (E, T, VT), J. & H. Walter (CH, P, R), Walter Instruments (S), Wingrove & Rogers (D), Wright & Weaire (S).

Abbreviations: C, connectors; CRH, cathode ray tube holders; CH, chassis; D, drives; E, eyelets; F, fuses and fuse-holders; G, group boards; I, instrument mountings; J, jacks; K, knobs; L, lamp-holders; MS, mounting strips; P, panels; PS, plugs and sockets; R, racks; RM, rubber mountings; S, switches; ST, soldering tags; T, terminals; TB, terminal blocks; TM, television masks; VH, valve holders; VP, valve pins; VR, valve retainers; VT, valve top connectors.

VIBRATORS

Little change has occurred in vibrators for h.t. supplies and both synchronous and non-synchronous types were in evidence. Input voltages range from 2 V to 24 V, but 6 V and 12 V are the most usual, while the power ratings are 10-120 W. Complete vibrator power units were also shown.

Makers: Bulgin, Plessey, Wimbledon, Wright & Weaire.

AERIALS

Those firms concerned with the production of aerial equipment have given quite a lot of thought to the design of television aerials and accessories. These call for good engineering practice since in the main they are self-supporting structures. For example, Antiference have introduced a 3-element array for "fringe areas" consisting of a director one-eighth wavelength in front of the aerial element and a reflector a quarter wave behind.

Belling-Lee outdoor television aerials are now constructed of a high-tensile light-weight alloy, thereby considerably easing erection and lessening the strains and stresses on the fixing harness or wall brackets. A new type of pole cap is employed, which in conjunction

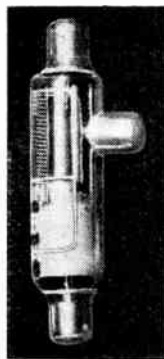
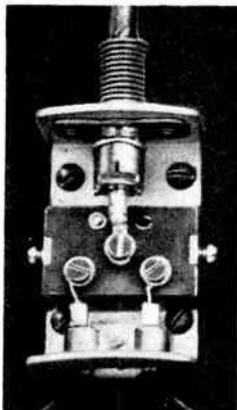

Ferranti KD60 stabilizer

Television aerial outlet box feeding two receiver points, shown by Antiference (Left)

with a limited number of standard parts, enables aerials to be assembled on the site for every likely form of mounting. Belling and Lee also have a range of indoor television aerials, the newest being the "Doorod" model. The upper half of this aerial is a copper rod but the lower half is a length of 300-ohm twin polythene insulated flexible which can be run at right angles to the vertical element, straight down, below the carpet or even coiled.

Makers: Antiference (AI, B, T), Belling & Lee (AI, B, F, T), B.I. Callenders (AI, F), London Electric Wire Co. & Smiths (W), Reliance Electrical Wire (W), Ripaults (W), Telegraph Construction & Maintenance (F).

Abbreviations: AI, anti-interference; B, broadcast; F, feeders; T, television; W, aerial wire.

VALVES

Miniature valves with the B7G, B8A and B9A bases are far from being new, but what is new is the appearance of complete ranges for all purposes from broadcast receivers to e.h.f. input stages. An example of the last is the Brimar 12AT7, a double triode with a 12.6-V heater centre-tapped for use on 6.3 V. Each section has a mutual conductance of 6.6 mA/V and the valve will oscillate up to 700 Mc/s. It is suitable for use as a grounded-grid input stage.

Mazda valves include a range with 0.1-A heaters for series operation. Among them is a high-g r.f. pentode, the 10F3, with a mutual

conductance of 9 mA/V, while a triode-heptode frequency-changer, a variable- μ pentode and a duodiode-triode are included in addition to an output tetrode.

The Osram television pentode has the B7G base. It is the Z77 and has a 0.3-A heater.

Mullard exhibited valves ranging from the well-known E50 series to sub-miniature types for hearing-aids. A series of valves designed for series-heater operation in a.c./d.c. television sets was shown; the PL38, a line-time base output valve is similar to the EL38 but has a 30-V, 0.3-A heater.

Among the range of Ferranti valves, the KD60 neon voltage-stabilizer is of interest. With a normal drop of 63 V it will give regulation of ± 0.4 V for a current of 0.125-2.5 mA. The tube has end caps and can be used as a visual indicator.

Makers: Ediswan, Ferranti, G.E.C., Mullard, Standard Telephones & Cables.

CONTACT RECTIFIERS

Copper-oxide and selenium rectifiers now find wide application in telecommunications. Their use in power supplies is well known and there is hardly any limit to the range of voltages and currents with which they will deal. Compact types for up to 2.5 kV at 0.5 mA were shown by Westinghouse, who also had e.h.t. supply units on view. These provide some 4 kV from a 350-0-350 V input.

In addition, signal-frequency types are made and find great application at the lower radio and audio frequencies, especially in telephone equipment. Bridge rectifiers for meters are also popular and the Salford types have a bakelite case for the rectifier elements, the whole being sealed under pressure in a polythene outer case. The 1-mA type has a frequency response extending to 100 kc/s.

Makers: Salford, Standard Telephones & Cables, Westinghouse.

CATHODE-RAY TUBES

The television tubes shown were universally for magnetic deflection and were chiefly 9in and 12in types, although Mullard had a 2 $\frac{1}{2}$ in projection tube. This is the MW6-2. It is intended for use with a Schmidt optical system to give a picture 15in by 12in with a 25 kV h.t. supply. The well-known 9in and 12in types were also shown.

The Ferranti Tr2/46 is a 12in tube with a triode gun rated for operation at 7 kV with a peak beam current of 150 μ A, and needing 24 V

Developments in Components—

signal input. Brimar showed a flat-faced 12in tube—the Cr2B—with an aluminized screen which draws 200 μ A at 12kV. This firm also had a 9in type of more normal design. Aluminizing is not only claimed to give a brighter picture but also to give freedom from ion burn.

Flat-face 9in tubes were displayed on the G.E.C. stand. There are several models, the differences being mainly in the presence or absence of external graphite coatings and in the type of heater used.

Ediswan showed 9in and 12in types with triode guns.

Makers: Ediswan, Ferranti, G.E.C., Mullard, Standard Telephones & Cables.

INTERFERENCE SUPPRESSORS

The radio interference suppressors shown at this exhibition can be broadly divided into two classes: those that are incorporated in, or in some way connected to, offending electric appliances and those that are interposed between the radio receiver and the mains supply point. The function of the former is to prevent intermittent voltage or current surges being radiated or being injected into the supply mains while that of the latter is to prevent any such surges on the mains reaching the radio receiver.

Makers: Belling & Lee (Ap, M, R), Dubilier (Ap, M), Erie (M), Hunt (Ap), Morganite (M), Static Condenser (Ap), Telephone Manufacturing Co. (Ap, R), Telegraph Condenser Co. (Ap, R).

*Abbreviations: Ap, appliance; M, motor car; R, receiver type.

SOUND REPRODUCTIONS

Pickups.—A new B.T.H. lightweight pickup has been introduced by Edison Swan Electric. It is of the moving-iron type and makes use of a special needle designed for ease of replacement. The weight at the needle point is 0.6 oz, and the output is of the order of 3.5 mV with an impedance of 20 ohms.

There seems to be a trend towards the use of high-impedance windings in high-fidelity pickups in order to obtain an output of the order of 0.3 to 0.5 V without the use of a step-up transformer. Both Collaro and Garrard fit pickups of this type in their record changers.

Plug-in pickup heads are also the order of the day, and Garrard can supply three alternative heads—“Standard” for ordinary needles, output 0.5 V, impedance 9,000 Ω , needle pressure 2 oz; “Miniature” for miniature steel needles, output 0.3 V, impedance 4,000 Ω , needle pressure 1 oz; and “High Fidelity” with natural sapphire point, output 0.35 V, impedance 6,500 Ω , stylus

pressure 1 oz. Plessey can also supply alternatively a crystal, “Decca” moving-iron, or a dynamically balanced moving-coil

outfit includes a variable-ratio output transformer, and a three-position tone equalizer adjusted to suit H.M.V., Decca and the American N.A.B. recording characteristics.

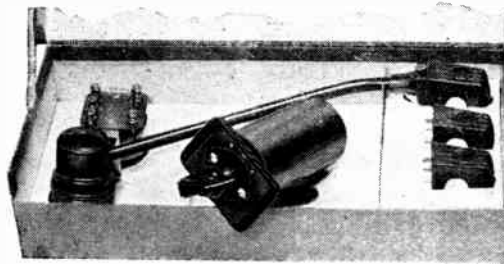

Goldring “Headmaster” pickup with three interchangeable heads having styli of different radii. A tone compensation unit provides correction for the principal British and American recording characteristics.

pickup head in their single record-player unit.

Erwin Scharf (“Goldring”) have produced a pickup outfit of particular interest to quality enthusiasts. It has been named “Headmaster” and includes as standard three interchangeable lightweight moving-iron heads with sapphire styli having tip radii of 2, 2½ and 3 mils, the first for deeply cut records, the second standard and the third for worn or noisy grooves. A head can thus be chosen to suit any type or condition of record, and a microgroove head can be added later if required. The

The new Cosmocord type GP15 “Microcell” crystal pickup is approximately ¼in diameter and ¾in deep and has an interchangeable stylus arm. Sapphire points of 0.0025in radius for standard 78-r.p.m. records and 0.001in for microgroove records are available and a single-pivot tone arm has been designed. When using the microgroove point,

the pressure required is only 7 gm and an extra weight is provided to bring the pressure up to the still low figure of 14 gm for standard records. The output is 0.75 V on standard records and 0.5 V on microgroove.

In an alternative arrangement (Type GP17), in course of development, a bakelite capsule will be used for microgroove and a separate metal capsule for standard 78 r.p.m. records, thus automatically ensuring the correct relationship between weight and tip radius.

Makers: Collaro, Cosmocord, Edison Swan Electric, Garrard, Plessey, Erwin Scharf.

Record Changers.—The Garrard RC70, which will play up to ten 10-in or ten 12-in records with a change cycle time of 4 seconds, is normally supplied with an a.c. motor, but for use in countries where mains supplies may not be available a permanent magnet d.c. motor, with a large-diameter horizontal governor mechanism has been designed, for supply voltages as low as 6V. Ample power is developed for an expenditure of only 12 watts.

In the Collaro RC49 a rim-drive mechanism has been fitted in which the idler wheel is automatically retracted when the motor is switched off, thus preventing the formation of “flats” on the circumference, due to the overrun of the turntable. Another interesting feature of this record changer is the safety device which prevents the tone arm from being lowered unless there is a record on the turntable; it is impossible to “play the cloth” or damage the pickup movement.

Makers: Birmingham Sound Reproducers (DR, GM, GU), Collaro (DR, GM, GU, RC), Garrard (DR, GM, GU, RC), Plessey (GU, RC).

*Abbreviations: DR, disc recorders; GM, gramophone motors; GU, gramophone units; RC, record changers.

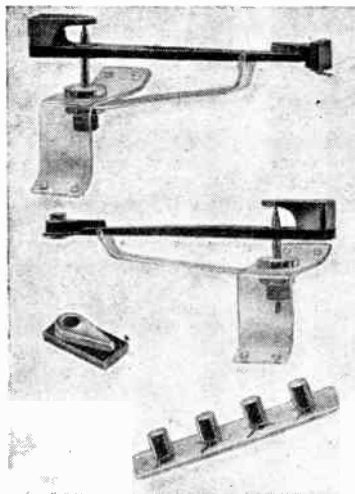

Cosmocord “Microcell” crystal pickups. (Top to bottom) single-pivot tone arm with type GP17 head; tone arm for Type GP15 head; additional needle pressure weight for 78 r.p.m. recordings; and a group of Type GP15 cartridges.

Loudspeakers. — An interesting corner-cabinet reproducer based on the design of P. W. Klipsch was shown by Vitavox. It makes use of the new K15/40 15-inch unit working into a re-entrant horn for the lower register (30-500-c/s), and a Type S2 pressure unit and H.F. horn for the range 500-15,000 c/s. The cabinet is of excellent design and workmanship and the instrument as a whole should appeal to the connoisseur; the price is £135. Incidentally the K15/40 unit is obtainable separately with alternative diaphragms for horn or baffle loading.

The Goodmans 12 in range of loudspeakers is now available with dust-proof construction comprising a bakelized linen back centring diaphragm and hemispherical gauze front cover inside the diaphragm. A high-flux version (Type R22) of the single-diaphragm T2 is now

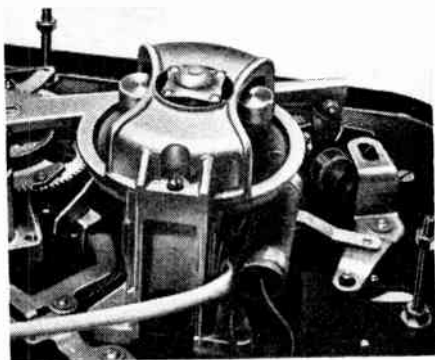

Permanent-magnet low-voltage driving motor with large-diameter governor, used in the Garrard RC70 record changer.

available with a density of 17,500 gauss in the 1½ in diameter gap.

Loudspeakers for the set manufacturers were mostly of the low-leakage centre-pole magnet type, notable examples being shown by Acoustic Products (Lectrona), British Rola, Celestion, Electro Acoustic Industries, Plessey and Telelector.

The new "700" series shown by Reproducers and Amplifiers was notable for the high-quality standard finish and included a 12-in size. Truvox have introduced an elliptical loudspeaker (Type BX4) measuring 4 in x 6 in approximately, which should solve many of the problems met with by designers of compact portables.

Makers: Acoustic Products, British Rola, Celestion, Edison Swan Electric, Electro Acoustic Industries, Goodmans Industries, Plessey, Reproducers & Amplifiers, Resosound, Telelector, Truvox, Vitavox.

Microphones.—The new "Sinter-

cell" crystal microphone made by Cosmocord incorporates a front diaphragm of porous sintered bronze, which acts as an acoustic filter and gives a smoother response than normal diaphragm crystal types.

Resosound were showing a ribbon microphone (Type RV) of very compact design with a ribbon area of only 0.15 sq in and 2½ microns thickness.

For ultrasonic measurements Cosmocord have produced a "pressure standard" (Model S11) consisting of a probe microphone and pre-amplifier head. The pickup head is a hermetically-sealed crystal unit of small diameter, to minimize diffraction errors, and the useful frequency range is 100 c/s-20 kc/s in air and 100 c/s-100 kc/s in water.

Makers: Birmingham Sound Reproducers, Cosmocord, Resosound, Vitavox.

Magnetic Recorders.—A console type magnetic tape recorder (BCS-3254) shown by Salford Electrical Instruments is now in production and has a playing time of 1 hour 50 minutes. A total length of 1,000 yds of iron-oxide coated tape is accommodated in the 1½ in diameter reels.

In the "Tape Deck" magnetic recorder, produced by Wright and Weaire as a unit for incorporation in any type of equipment, the method of loading the tape has been considerably simplified and no threading is necessary. The reels hold 1,250ft of tape, giving a playing time of 70 minutes at 3½ in/sec, or 35 minutes at 7 in/sec. A foot-age indicator is included. If desired, two tracks can be recorded in the width of the tape and played either consecutively or simultaneously. The controls are simple and operation is virtually foolproof.

Makers: Salford Electrical Instruments, Wright and Weaire.

MATERIALS

Magnetic Alloys.—In addition to the standard range of high-permeability alloys such as Mumetal, Rhometal and Crystalloy, the Telegraph Construction and Maintenance Co. were showing H.C.R. alloy which has been developed specially for use in transducers for magnetic amplifiers.

"Tape Deck" magnetic recorder, by Wright and Weaire.

The Permanent Magnet Association were showing for the first time

two new permanent magnet alloys containing the comparatively rare element niobium. From the following table it will be seen that higher coercivities have been obtained without sacrifice of energy (BH max). Alcomax II which has been in use for some time is included for reference.

	Remanence	BHmax	Coercivity
Alcomax II ...	12,400	4.3 × 10 ⁶	570
Alcomax III	12,200	4.75 × 10 ⁶	650
Alcomax IV	11,200	4.3 × 10 ⁶	760

Examples of short centre-pole magnets for loudspeakers and special pickup magnets using the new alloys were shown.

Wires and Cables.—Instrument wires with safe working temperatures of 110°C and dielectric strength of 600 volts per mil. were exhibited under the name of "Lewmex" by London Electric Wire Co. and Smiths. The enamel is a synthetic compound of polyvinyl acetal modified with phenol formaldehyde and shows improved mechanical and solvent-resisting qualities over conventional oil-based enamels.

A range of special microphone and loudspeaker cables has been developed by British Insulated Callender's Cables for the public address industry. Type T3108 contains twin screened-core microphone cables and two additional conductors for relay or signalling circuits in a p.v.c. outer sheath only 0.13 in in diameter. The cables for loudspeaker surface wiring (R9001 and R9002) are twin flat cables with 0.036 in and 0.050 in conductors insulated with polythene and sheathed with p.v.c. The range of connecting wires made by this firm includes silicone rubber and p.c.p. (polychloroprene).

Insulants.—The outstanding development since last year has been the introduction of polytetrafluoroethylene, a substance similar in appearance to polythene but with improved electrical properties and greater thermal stability. Examples of the application of this material in the construction of valveholders, connectors, etc., were shown by British Mechanical Productions ("Clix").

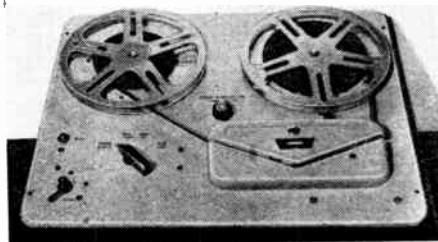

Solders.—A new shape of core with a fluted cross-section has been

Developments in Components—

developed by H. J. Enthoven and Sons, who state that the reduction in the thickness of the solder wall gives better dispersion of the flux on fusion. A similar development is announced by the Du Bois Company.

Multicore solders have introduced a new two-core solder with "Arax," a non-resin, extra-active, acid-free flux for difficult soldering problems. It is not intended to replace "Ersin" three-core solder, which is more suitable for radio and electrical work.

Makers*: Antiference (C.W.), Associated Technical Manufacturers (CO, IM, IS, PVC, W), Bray (CE), B. I. Callender's (C, CO, PVC, S, W), British Rola (L), Bullers' (CE), Clarke (IM, MI), De La Rue (IM, IS, W), Du Bois (S), Duratube & Wire (B, IM, IS, PVC, W), Enthoven (S), Hellermann (IM, IS), London Electric Wire Co. & Smiths (IS, W), Long & Hambly (IM), Magnetic & Electrical Alloys (DC, L, M), Mullard Electronic Products (C, M), Multicore (S), Murex (M, MO, T), Permanent Magnet Association (M), Plessey (DC), Reliance Electrical Wire (B, C, CO, PVC, W), Ripaults (B, C, CO, IS, PVC, W), Salford Electrical Instruments (DC), G. L. Scott (L), Spicers (IM, IS), Standard Telephones & Cables (C, CO, M, PVC, W), Steatite & Porcelain (OE), Sulfex (B, CO, IS, PVC, W), Symons (IM, IS, PVC, V), Taylor, Tunncliffe (CE), Telegraph Construction & Maintenance (C, CO, IM, IS, L, M, PVC, W), Telephone Manufacturing (DC), United Insulator (CE).

*Abbreviations: B, Braiding; C, cables; CE, ceramics; CO, cords; DC, dust cores; IM, insulating materials; IS, insulating sleeving; L, laminations; M, magnetic alloys; MO, molybdenum; MI, mica products; PVC, polyvinyl chloride tapes, wires, etc.; S, solder; T, tungsten; V, varnished materials; W, covered wires.

LIST OF EXHIBITORS

A.B. Metal Products, Ltd., Hatton Works, Feltham, Mdx.
Acoustic Products, Ltd., 50-58, Britannia Walk, City Road, London, N.1.
Advance Components, Ltd., Back Road, Shernhall Street, London, E.17.
Antiference, Ltd., 67, Bryauston Street, London, W.1.
Associated Electronic Engineers, Ltd., Dalston Gardens, Stanmore, Mdx.
Associated Technical Manufacturers, Ltd., Vincent Works, New Islington, Manchester 4, Lanos.
Automatic Coil Winder & Electrical Equipment Co., Ltd., Winder House, Douglas Street, London, S.W.1.

Belling & Lee, Ltd., Cambridge Arterial Road, Enfield, Mdx.
Bird, Sydney S., & Sons, Ltd., Cambridge Arterial Road, Enfield, Mdx.
Birmingham Sound Reproducers, Ltd., Claremont Works, Old Hill, Staffs.
Bray, Geo., & Co., Ltd., Leicester Place, Blackmans Lane, Leeds 2, Yorks.
British Electric Resistance Co., Ltd., Queensway, Ponders End, Mdx.
British Electrolytic Condenser Co., Ltd., 52, Vicarage Lane, Ilford, Essex.
British Insulated Callender's Cables, Ltd., Surrey House, Embankment, London, W.C.2.
British Mechanical Productions, Ltd., 21, Bruton Street, London, W.1.
British Moulded Plastics, Ltd., Avenue Works, Walthamstow Avenue, London, E.4.
British N.S.F. Co., Ltd., Ingrow Bridge Works, Keighley, Yorks.

British Rola, Ltd., Ferry Works, Summer Road, Thames Ditton, Surrey.
Bulgin, A. F., & Co., Ltd., Bye-Pass Road, Barking, Essex.
Bullers, Ltd., 6, Laurence Pountney Hill, Cannon Street, London, E.C.4.

Carr Fastener Co., Ltd., Brantwood Works, Tariff Road, London, N.17.
Celestion, Ltd., Ferry Works, Summer Road, Thames Ditton, Surrey.
Clarke, H., & Co. (Manchester), Ltd., Atlas Works, Patricroft, Manchester, Lancs.
Collaro, Ltd., Ripple Works, Bye-Pass Road, Barking, Essex.
Colvern, Ltd., Mawneys Road, Romford, Essex.
Cosmocond, Ltd., 700, Great Cambridge Road, Enfield, Mdx.

Daly (Condensers), Ltd., West Lodge Works, The Green, Ealing, London, W.5.
Dawe Instruments, Ltd., 130, Uxbridge Road, Hanwell, London, W.7.
De La Rue Insulation, Ltd., Imperial House, 84, Regent Street, London, W.1.
Dubilier Condenser Co. (1925), Ltd., Ducon Works, Victoria Road North, Acton, London, W.3.
Du Bois Co., Ltd., 15, Britannia Street, King's Cross, London, W.C.1.
Duratube & Wire, Ltd., Faggs Road, Feltham, Mdx.

Edison Swan Electric Co., Ltd., 155, Charing Cross Road, London, W.C.2.
Electro Acoustic Industries, Ltd., Stamford Works, Broad Lane, Tottenham, London, N.15.
Electrothermal Engineering, Ltd., 270, Neville Road, London, E.7.
Enthoven, H. J., & Sons, Ltd., Croydon Works, 230, Thornton Road, West Croydon, Surrey.

Erg Industrial Corp., Ltd., 10, Portman Square, London, W.1.
Erie Resistor, Ltd., Carlisle Road, The Hyde, Hendon, London, N.W.9.

Ferranti, Ltd., Hollinwood, Lancs.

Garrard Engineering & Mfg. Co., Ltd., Newcastle Street, Swindon, Wilts.
General Electric Co., Ltd., Magnet House, Kingsway, London, W.C.2.
Goodman's Industries, Ltd., Lancelot Road, Wembley, Mdx.

Hallam, Steigh & Cheston, Ltd., Widney Works, Bagot Street, Birmingham, 4, Warwick.

Hellermann Electric, Ltd., Tinsley Lane, Crawley, Sussex.
Hunt, A. H., Ltd., Bendon Valley, Garratt Lane, London, S.W.18.

Igranic Electric Co., Ltd., Elstow Road, Bedford.
Imhof, Alfred, Ltd., 112-116, New Oxford Street, London, W.C.1.

Jackson Bros. (London), Ltd., Kingsway, Waddon, Surrey.

London Electric Wire Co., & Smiths, Ltd., 24, Queen Anne's Gate, London, S.W.1.
London Electrical Mfg. Co., Ltd., 459, Fulham Road, London, S.W.6.
Long & Hambly, Ltd., Empire Works, Slater Street, High Wycombe, Bucks.

Magnetic & Electrical Alloys, Ltd., 101-103, Baker Street, London, W.1.
McMurdo Instrument Co., Ltd., Ashted, Surrey.
Measuring Instruments (Pullin), Ltd., Electric Works, Winchester Street, Acton, London, W.3.
Metro Pex, Ltd., 71, Queen's Road, Peckham, London, S.E.15.
Morganite Resistors, Ltd., Bede Trading Estate, Jarrow, Co. Durham.
Mullard Electronic Products, Ltd., Century House, Shaftesbury Avenue, London, W.C.2

Multicore Solders, Ltd., Mellier House, Albemarle Street, London, W.1.
Murex, Ltd., Rainham, Essex.

Oliver Pell Control, Ltd., Cambridge Row, London, S.E.18.

Painton & Co., Ltd., King-thorpe, Northampton.
Parmeko, Ltd., Percy Road, Aylestone Park, Leicester.
Partridge Transformers, Ltd., Roebuck Road, Tolworth, Surrey.
Permanent Magnet Association, 301, Glossop Road, Sheffield, 10, Yorks.
Plessey Co., Ltd., Vicarage Lane, Ilford, Essex.
Plessey International, Ltd., Vicarage Lane, Ilford, Essex.

Reliance Electrical Wire Co., Ltd., Staffa Road, Leyton, London, E.10.
Reproducers & Amplifiers, Ltd., Frederick Street, Wolverhampton, Staffs.
Resolound, Ltd., 369, City Road, London, E.C.1.
Ripaults, Ltd., Southbury Road, Enfield, Mdx.

Salford Electrical Instruments, Ltd., Peel Works, Silk Street, Salford, Lancs.
Scharf, Erwin, 49-51, De Beauvoir Road, London, N.1.

Scott, Geo. L., & Co., Ltd., Cromwell Road, Ellesmere Port, Cheshire.
Shipton, E., & Co., Ltd., Ferndown, Northwood Hills, Mdx.
Spicers, Ltd., 19, New Bridge Street, London, E.C.4.

Stability Radio Components, Ltd., 14, Norman's Buildings, Central Street, London, E.C.1.
Standard Telephones & Cables, Ltd., Connaught House, Aldwych, London, W.C.2.
Static Condenser Co., Ltd., Tontley Works, Wokingham, Berks.

Steatite & Porcelain Products, Ltd., Stourport-on-Severn, Worcs.
Sulfex, Ltd., Aintree Road, Perivale, Greenford, Mdx.
Symons, H. D., & Co., Ltd., Park Works, Kingston Hill, Surrey.

Taylor Electrical Instruments, Ltd., 419-424, Montrose Avenue, Slough, Bucks.
Taylor Tunncliffe (Refractors), Ltd., Albion Works, Longton, Stoke-on-Trent, Staffs.

Teledictor, Ltd., 214, Birmingham Road, Dudley, Warwicks.
Telegraph Condenser Co., Ltd., Wales Farm Road, North Acton, London, W.3.
Telegraph Construction & Maintenance Co., Ltd., 22, Old Broad Street, London, E.C.2.

Telephone Mfg. Co., Ltd., Hollingsworth Works, Martell Road, West Dulwich, London, S.E.21.

Truvox Engineering Co., Ltd., Truvox House, Exhibition Grounds, Wembley, Mdx.
Tucker, G., Eyelet Co., Ltd., Walsall Road, Birmingham, 22, Warwick.

United Insulator Co., Ltd., Oakeroft Road, Tolworth, Surbiton, Surrey.

Vitavax, Ltd., Westmoreland Road, London, N.W.9.

Walter Instruments, Ltd., Garth Road, Lower Morden, Surrey.
Walter, J. & H., Ltd., Farm Lane, Fulham, London, S.W.6.

Wego Condenser Co., Ltd., Bideford Avenue, Perivale, Mdx.
Welwyn Electrical Laboratories, Ltd., Links Road, Blyth, Northumberland.
Westinghouse Brake & Signal Co., Ltd., 82, York Way, King's Cross, London, N.1.

Wimbledon Engineering Co., Ltd., Garth Road, Lower Morden, Surrey.
Wingrove & Rogers, Ltd., Polar Works, Old Swan, Liverpool, Lancs.
Woden Transformer Co., Ltd., Moxley Road, Bilston, Staffs.
Wright & Weaire, Ltd., 138, Sloane Street, London, S.W.1.

THE "BELLING-LEE" PAGE

Providing technical information, service and advice in relation to our products and the suppression of electrical interference

Distant Television Reception

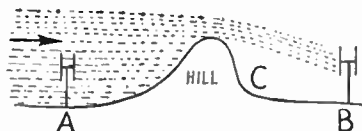

There are many cases on record of viewers getting a consistently poor television picture, while others, miles further away from the television transmitter obtain results beyond expectation. The reason generally given for this inconsistency may be illustrated as above. The dipole "A" may be considered to be fifty miles from the transmitter. The waves close to the ground at this point have been attenuated considerably, but those higher up are still strong, they pass over the hill and the (un-attenuated) waves bend down and meet the dipole "B" which may enable the viewer to enjoy a much stronger signal. Close in under the shadow of the hill, at "C" there would probably be a "dead" spot where little or no signal would be received.

*1. "Doorod" Television Aerial.

We have been somewhat alarmed at the results reported from this new fully dimensioned indoor dipole. Reports come in that they are being used, with considerable satisfaction, in places as far from Alexandra Palace, as Southend and St. Albans, i.e. 30 and 18 miles respectively. Whereas, we first claimed five or six miles and later eight to ten miles.

We have made calculations based on known field strengths and find that the results are less surprising than was first thought

The only condition against which one must guard is the presence of concealed pipes, girders or other conductors in the walls (outside drain pipes), etc. which happen to be a functional distance from any proposed indoor dipole.

A Need for Caution.

It should not be overlooked that a new Television receiver is in its first flash of high gain, the valves are giving full emission, everything is just right. Such a receiver may give satisfactory results with an indoor aerial at exceptional distances, but,

it is quite possible that after a few months use, the gain of the receiver drops, you can no longer hold synchronisation, and disappointment sets in. Everything is normal, and an outside aerial is necessary.

Use of "Doorod" *1. as a "Veerod" *2.

The "Doorod" *1 may be used as a "Veerod" *2 either inverted or "V" style thus endowing it with directional properties at the expense of slight loss in pick-up. The "Doorod" *1 may be so arranged on the wall of the hall of a house as indicated in the diagram. On the ground floor, upstairs landing, or for maximum results in the loft. In certain positions an extension length of coaxial cable will be necessary.

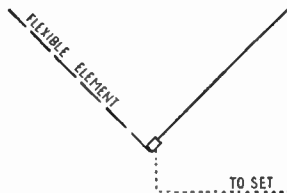

In locating a "V" shaped dipole to take advantage of its directional properties, start with one element pointing in the direction of the transmitter. It may be useful to bear in mind that the "Veerod" has a very marked minima at right angles. This feature may be used to reduce interference.

The Why and Wherefore of the "Veerod."

It is all a question of polarisation. In a house it is difficult to be certain what you are dealing with—vertical or horizontal. The signal leaves the

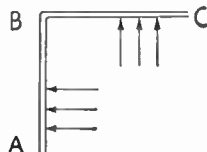

transmitter vertically polarised. Refer now to sketch.

It is picked up on a gaspipe A-B which has currents induced in it. The pipe goes round the corner and conforms to B-C. with the same currents as A-B. But now they are horizontally polarised.

Which has most influence on any indoor aerial? At a guess there is

New addition of "Belling-Lee" main catalogue.

This 84-page publication is now off the press, it is however not for general distribution but has been prepared for the use of designers of electronic equipment, electrical engineers etc.

about a fifty-fifty chance and it does not really matter if the "Veerod" is upright or inverted.

Undoubtedly the most efficient position in which to use it as an indoor aerial is in the loft, as high up as possible, with its apex tucked right up out of the way of water-pipes etc., which, in the loft, mostly run in a horizontal plane. But if a "Doorod" is being used as a "Veerod" it is generally more logical to use it as a "V" as illustrated, as this will allow a shorter run to the receiver, but a ladder will have to be used so as to fix the free end of the flexible element. A real practical advantage in using the "Doorod" with the apex uppermost i.e. as an inverted "V," is the fact that the rigid element can be fixed with the apex out of reach while you are comfortable with both feet on the floor. The flexible element can then be held in position and fixed with tacks or drawing pins. In this case the lead must drop from the apex.

Combined Broadcast and T.V. Aerials.

We have had a number of letters from readers asking if it is a fact that anti-interference systems can be applied to television. The answer is yes and no. We have never claimed to offer an interference free television aerial but "Belling Lee" were the first to take advantage of the fact that the mast of a television aerial could be used as a collector of broadcast programmes, and could be used to feed an anti-interference system. It is easy to see how the misunderstanding occurred.

*1. "Doorod" (Reg. app. for) indoor T.V. aerial 30/-.

*2. "Veerod" (Reg. app. for) Attic Model 52/6. Chimney model 90/-.



ENGLAND

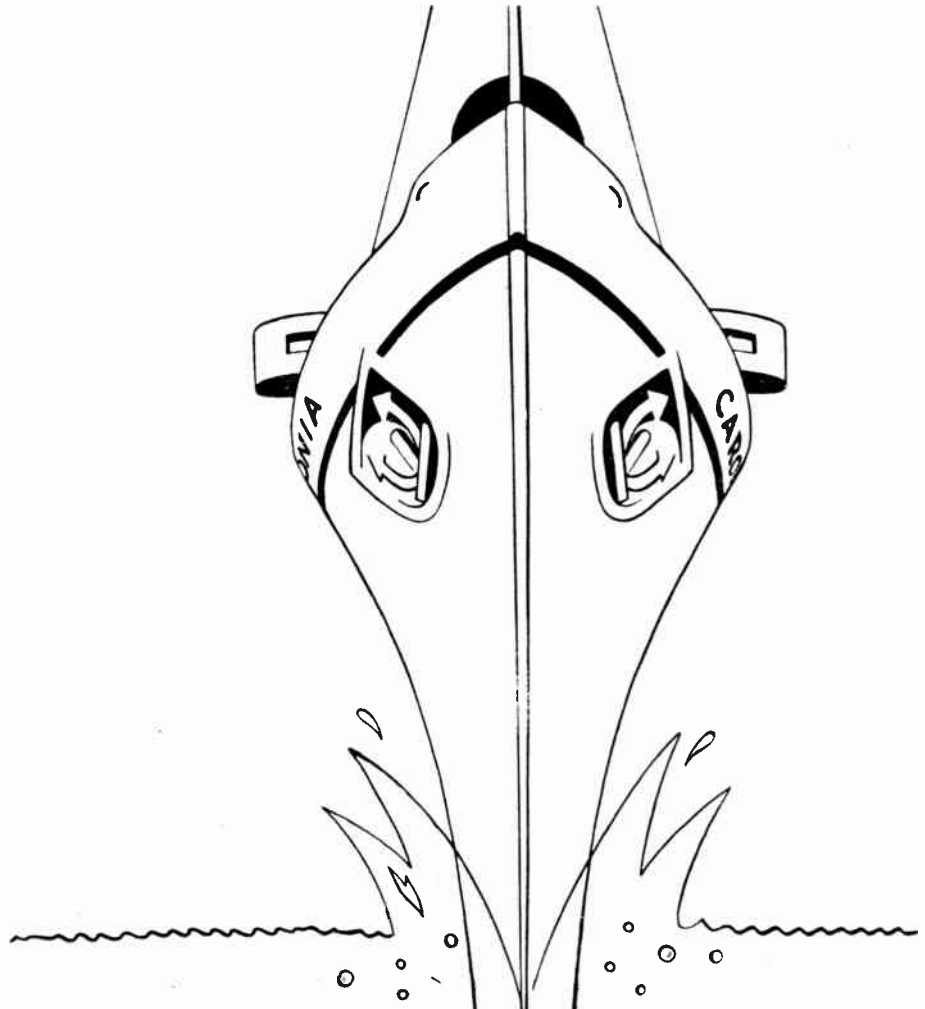

"Caronia" passengers telephone by 'Standard Radio'

Direct inter-continental telephone conversations, either from public booths or private staterooms, are enjoyed by passengers in the new Cunard White Star liner "Caronia".

The first passenger vessel to be fitted for transmission and reception of single-sideband telephony sets a new standard in ship-to-shore communication. Equipment by 'Standard' of course

R.M.S. "CARONIA" IS FITTED WITH THE FOLLOWING STANDARD' EQUIPMENT . . . The D.S.9 Single-sideband Telephony Transmitter, having an output of 300 watts on 4-22 Mc/s.

The R.X.9 Independent-sideband Receiver. Capable of receiving either or both channels of a double-channel circuit. Whilst one channel is busy with 'subscriber' calls, the other can be used as an 'order wire'. Suitable for reception of high-fidelity double-sideband telephony. Automatic frequency control.

The E.S.4-B dual purpose transmitter providing telegraphy at 1 kW or double-sideband telephony at 300 watts on 24 pre-set channels grouped in the marine h.f. bands.

Standard Telephones and Cables Limited

REGISTERED OFFICES: CONNAUGHT HOUSE, ALDWYCH, LONDON W.C.2



RADIO DIVISION

OAKLEIGH ROAD, NEW SOUTHGATE, LONDON, N.11, ENGLAND

WORLD OF WIRELESS

New Servicing Certificate ♦ Extending Television ♦ Exhibition Plans

Television Servicing

A SCHEME has been drawn up jointly by the City and Guilds of London Institute and the Radio Trades' Examination Board to provide a recognized qualification in the servicing of television receivers similar to the Radio Servicing Certificate.

Candidates must have passed one of six approved examinations in radio servicing in order to enter for the examination, the first of which will be held next year. It is proposed that from 1955 candidates must possess the City and Guilds and R.T.E.B. Radio Servicing Certificate in order to be eligible for entry.

Application forms for the Television Receiver Certificate Examination, which will comprise two written papers each of three hours' duration and a three-hour practical test, are obtainable from the R.T.E.B., 9, Bedford Square, London, W.C.1. The examination fee is three guineas.

The syllabus covers light and vision; production of the picture signal, including principles of scanning; reproduction of the picture from a signal, including principles of c.r.t.; t.r.f. and superhet. receivers; sync separation; aerial and feeder systems; and the cause and correction of picture defects.

E.H.F. Cost

EXPENDITURE by the B.B.C. during the past twelve months on e.h.f. transmitting equipment was stated by the P.M.G. to be £85,000. This equipment is for the new Wrotham, Kent, station, which will initially transmit both frequency modulation and amplitude modulation on e.h.f.

Television Topics

AS work proceeds apace on the erection of the Sutton Coldfield station speculation continues on the date it is likely to start transmitting, which officially remains as "in the autumn." In order to enable servicemen in the area to benefit by the knowledge and experience gained in the London television area, B.R.E.M.A. has organized a conference covering such subjects as servicing and interference suppression for dealers in the Midland service area.

In reply to a question in the

House, the P.M.G. has stated that the estimated capital cost, at present-day prices, of the proposed five stations—Birmingham, S. Lancs, Scotland, S.W. England and N.E. England—is about £1.75 million. This figure does not include the cost of providing the necessary links.

The World's Journals

A FEATURE of our sister journal, *Wireless Engineer*, is its 20-page Abstracts and References Section in which is included abstracts from and references to articles in the world's technical journals. An index to the year's abstracts is published separately and that for 1948 will be available shortly, price 2s 8d including postage.

In addition to the usual subject and author indexes it includes a list of most of the 200 or more journals regularly scanned for abstracting. This list includes the addresses of the publishers or editorial offices and the abbreviated titles used in references in both *W.W.* and *W.E.*

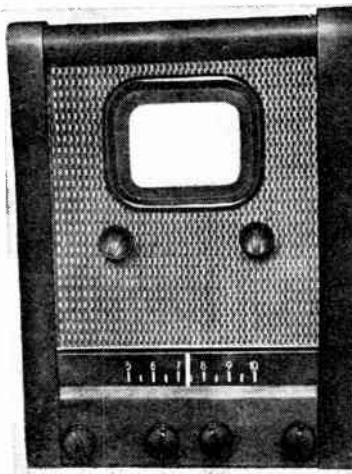

RUSSIAN TELEVISION.

Internal and external views of the "Moskvitch" television receiver which is being mass produced in Moscow. The set, which incorporates a comparatively small tube, gives a picture of 135 x 100 mm. 5.4 x 4in.

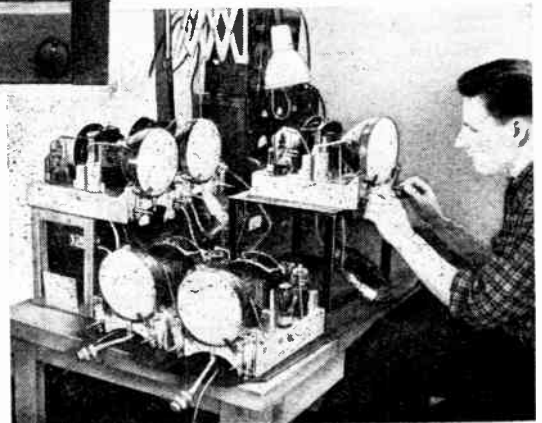

Radiolympia

AS is to be expected, television will be a feature of the 16th National Radio Exhibition which, as already announced, will be held at Olympia from September 28th to October 8th. A new television aerial is to be erected on the roof of Olympia and improved arrangements are being made for visitors to view television.

For the first time since the war, exhibits by the Navy, the Army and the R.A.F. will be included. The D.S.I.R., G.P.O. and Ministry of Supply will also be exhibiting.

The section of the show devoted to communications equipment, radio navigational aids and industrial electronics will be considerably enlarged.

PERSONALITIES

A.V.M. E. B. Addison has been appointed Director-General of Signals, Air Ministry. During the war he was engaged on the development of radio counter-measures.

D. A. Bell, M.A., B.Sc., who contributes to both *Wireless World* and our sister journal *Wireless Engineer*, has been appointed a lecturer in electrical engineering at Birmingham University. Since 1946 he has been with British Telecommunications Research, Ltd., prior to which he was with A. C. Cossor, Ltd.

C. H. Davis, of the Reliance Electrical Wire Company, has been invited by the President of the Board of Trade to become a member of the Exhibitions Advisory Committee which advises the B.O.T. on exhibitions at home and overseas.

M. M. Macqueen (G.E.C.) has been elected chairman of B.R.E.M.A. for 1949 in succession to H. Slater (Philips). The new vice-chairman is P. H. Spagnolotti (Kolster-Brandes).

T. R. Porter, M.B.E., has been appointed superintendent of the Control and Radio Department of Metropolitan Vickers. He joined the company in 1920, was appointed senior production engineer in 1934, took charge of radar production in 1938 and since 1944 has

World of Wireless—

been assistant superintendent of the Transmitter Department.

C. I. Orr-Ewing, B.A., who until recently was in charge of B.B.C. television outside broadcasts, has been appointed technical commercial advisor to A. C. Cossor Ltd., and a director of Cossor Radar. Prior to joining the B.B.C. in 1938 he was with H.M.V. During the war he held a number of radar administrative positions in the R.A.F.

W. G. Richards (Marconi's W/T Co.) is representing the Radio Industry Council on the B.I.F. Council of Exhibitors.

IN BRIEF

A Record Increase of 19,050 television receiving licences has been announced by the Post Office for January, making the total 111,850. The increase in "sound" licences was 84,050. The total receiving licences in force in Great Britain and Northern Ireland at the end of January was 11,559,900.

Radio Relays.—In reply to a question in the House of Commons, the P.M.G. stated that, as radio relays were closely linked with the general question of broadcasting in this country, they would be considered by the Committee of Enquiry on the B.B.C.'s Charter. The licences granted to operators of relay exchanges have been extended to the end of 1951.

R.G.D. is providing the 150 portable radio-telephone transmitter-receivers required by the harbour authorities at Liverpool to be used in conjunction with the recently installed Sperry harbour-supervision radar. The sets will be used by the pilots to enable them to communicate with the radar supervisor whilst bringing vessels into port in poor visibility. They will presumably operate on 156.8 Mc/s, the frequency allocated at Atlantic City for harbour control communications.

"Television Receiver Construction."—A further quantity of reprints of the series of ten articles describing the construction of a television receiver, which appeared in *Wireless World* in 1947, is now available. The straight set described is designed for reception of the London transmissions and is not, therefore, suitable for receiving the asymmetric sideband transmissions from Birmingham. Copies of the forty-eight page booklet can be obtained by post from our Publisher, price 2s 9d or from booksellers and newsagents price 2s 6d.

Telecommunications.—A new quarterly journal is being issued by the Post Office. The primary object of the *Post Office Telecommunications Journal*, as it is called, is to give wider publicity to the papers on telecommunications delivered to local groups of Post Office workers and to provide a forum for the discussion of problems associated with the P.O. services. In the first issue Sir Archibald Gill, Engineer-in-Chief, contributes an article on engineering developments.

Marconi radio, radar and d.f. equipment has been installed in the new 11,500 ton Port Line motor-vessel *Port Brisbane*.

Aerial Classification.—The Panel of the R.C.M.F. which prepared the classification of broadcast receiving aerials to which reference was made last month (page 113) is now considering the classification of television aerials.

Five-metre Band.—The P.M.G. announces that amateurs will not be permitted to use the frequency band 58.5 to 60 Mc/s after March 31st. It will be recalled that this band, which was not allocated to amateurs in the Atlantic City Agreement, has been used temporarily by British amateurs since January 1st.

G.C.A.—Ground Controlled Approach equipment has been installed and is now in operation at Belfast (Nutts Corner) aerodrome. This is the sixth aerodrome in the United Kingdom to be equipped with G.C.A. The other five are London, Prestwick, Liverpool, Northolt and Hurn.

Revised "Q" Code.—Applicants for the Civil Aircraft Radio Operators' exam. for certificates of competency are reminded by the Ministry of Civil Aviation that the "Q" Code as amended at Atlantic City will be used. The amended code is given in the Ministry's publication DOC.6100, COM/504, which will soon be obtainable from H.M.S.O., price 2s.

I.S.W.C.—To mark the twentieth anniversary of the formation of the International Short-wave Club a DX contest is being organized. Particulars of the contest, which covers reception of both s.w. broadcasting and amateur stations, are obtainable from the I.S.W.C., 100, Adams Gardens Estate, London, S.E.16.

S.T.C.—A wall chart showing the Atlantic City frequency allocations has been issued by Standard Telephones and Cables. To facilitate identification, the various services are arranged in separate columns; these are subdivided into the three Regions which are coloured to correspond with a regional map of the world included on the chart. Frequencies allocated to each service are over-printed in black on the colours. The chart, size 40x25in, is obtainable from Standard Telephones and Cables, Connaught House, Aldwych, London, W.C.2, price 3s 9d, including postage.

E.M.I. Reprints.—Our note on the E.M.I. reprints of papers on quality recording and reproduction last month was a little ambiguous. Each paper is reprinted separately and costs 2s 6d. The next one to be issued will be on magnetic tape recording.

Cintel.—In the description of the Cintel metal detector on page 86 of the March issue, it should have been stated that the equipment was designed and made by and not for Cinema Television, Ltd. We regret the use of the wrong preposition.

Waste Paper.—The Waste Paper Recovery Association states that the fact that more paper is generally available and, too, that some manufacturers have announced that their cartons and packing need no longer be returned, must not be taken as an indication that there is now no need to salvage waste paper.

FROM ABROAD

U.S.S.R. Television.—According to the *Bulletin* of the International Broadcasting Organization regular transmissions have been radiated from the Soviet television station in Leningrad since last August. The 6.5-kW vision transmitter operates on 32.5 Mc/s. Scanning rate is 441 lines with 25 frames interlaced. The sound transmitter is frequency modulated. Another transmitter, is in operation in Moscow and two new stations are being erected at Kiev and Sverdlovsk.

Canadian Television.—In view of the fact that some 1,200,000 Canadians are within the service area of American television stations, the Radio Manufacturers' Association of Canada has decided to start producing television receivers. The estimated output for this year is given as 12,700.

Citizen's Radio.—Approval has been given by the F.C.C. for the production of miniature transmitter-receivers for civilian use in the 465-Mc/s band allocated in the U.S. for citizen's radio. The sets measure only 6in x 2½in x 1½in and weigh 11 ounces including the folding aerial which extends from one end of the case. The total weight, including earpiece and battery, is 2½ lb.

Pakistan.—The first short-wave broadcasting station in Pakistan has been opened at Dacca, East Bengal. The 7.5-kW transmitter operates on 11.89 Mc/s. A new high-speed radio-telegraphic service was recently opened between east and west Pakistan.

Belgian Amateurs are now permitted to operate on the following frequencies:—3.51-3.625, 7.02-7.28, 14.05-14.35, 28-30, 144-146, 420-460, 1,215-1,300, 2,300-2,400, 5,650-5,850 and 10,000-10,500.

Facsimile equipment has been installed at the United States Federal Weather Bureau and Chicago Airport for the transmission and reception of weather reports.

EXPORT

"Tropic Proofing" is the title of a pamphlet issued by H.M. Stationery Office, which gives some of the results of the research being undertaken at the Ministry of Supply Establishment in Nigeria to combat the ravages of weather, insects and fungi on, among other things, radio equipment.

Exports.—The export target for the radio industry in general for 1949 has now been set by the Government. The monthly target at the end of last year was £1.2 million which has been increased to £1.32 million for 1949.

Exporting Television.—The Belgo-Dutch television delegation which recently came to this country at the invitation of the Government, visited the Marconi Works at Chelmsford to see a demonstration of the company's 625-line television equipment. It will be recalled that this was the standard agreed upon by three of the main British manufacturers of transmitting equipment and the Dutch firm of Philips. The High Commissioner for Australia also visited the works recently and inspected 625-line equipment in which the Austra-

Ilan Government is known to be interested for its projected television service.

Decca Navigator Co. is to erect a chain of three stations in the Bahrain area of the Persian Gulf for the American Bahrain Petroleum Company to enable its surveyors to fix their position when undertaking surveys for oil beneath the sea bed.

Pye e.h.f. mobile radio-telephone equipment to the value of £10,000 has been supplied to the Netherlands Government.

G.E.C. two-channel frequency-modulated e.h.f. gear, costing £25,000, is to be supplied to the Hong Kong police to provide a communication system between mobile units and headquarters.

South Africa.—Tenders for the supply of a variety of test equipment, including signal generators, field-strength measuring sets and precision condensers, is called for by the South African Railways' Stores Department, Johannesburg. The specification, No. 8022, can be obtained from the B.O.T. Commercial Relations and Exports Department, Room 1076, Thames House, North, Millbank, London, S.W.1., quoting reference C.R.E.(1B)556/49. Closing date is May 5th.

Portugal.—The Lisbon firm of Viuva de Eduardo A. Fernandes and Cia. are anxious to secure the agencies for British radio components in Portugal. Quotations and literature should be sent direct to the company at Rua da Alandega 118, 2° D., Lisbon.

INDUSTRIAL NEWS

Festival of Britain.—In preparation for the 1951 "Festival of Britain" the Council of Industrial Design is compiling a "Stock List" which is a photographic card index of products for submission to the panel of selectors. Manufacturers are asked to send photographs of representative equipment for inclusion in the list. The exhibitions will largely consist of "end products" to illustrate scientific development in various fields. In selecting the products design will be considered from the aesthetic, engineering and functional aspects.

R.C.E.E.A. Council.—The names of Pye and Standard Telephones Cables should have been included among the firms listed last month as members of the R.C.E.E.A. Council for 1949.

Marconi's have established a Main Air Service Depot at Croydon Airport where aircraft fitted with the company's gear can have it tested and repaired. In addition to the repair and maintenance section there is a demonstration room where instruction can be received in operating the latest aircraft radio equipment.

Preventing Corrosion.—Although only remotely connected with radio, manufacturers may be interested to learn of a recent book, "Prevention of Iron and Steel Corrosion; Processes and Published Specifications," issued by the Louis Cassier Co., Dorset House, Stamford Street, London, S.E.1., priced 5s.

Telcon.—The telephone number of the Telcon Works of the Telegraph Construction and Maintenance Company is now Greenwich 3291.

Industrial Finishes.—The first exhibition in this country of industrial finishes will be held at Earls Court, London, from August 31st to September 13th. Sir Edward Appleton is serving on the honorary advisory council.

I.M.R.C.—The administrative, technical and stores departments of the International Marine Radio Company have been transferred from Leicester Street, Southport, Lancs, to the company's new offices and factory at 21, Progress Way, Purley Way, Croydon, Surrey.

A.B. Metal Products, Ltd., have opened a London office at Ludgate House, 107, Fleet Street, E.C.4 (Tel.: Central 5667/8).

Raymond Electric, Ltd., are now at Brent Crossant, North Circular Road, London, N.W.10 (Tel.: Elgar 6687/8).

Electro-Acoustic Developments have moved to 18, Broad Road, Lower Willington, Nr. Eastbourne, Sussex.

Clix.—British Mechanical Productions, Ltd., are now centring their production at their No. 2 factory at Barton Hill Works, Bristol, 5 (Tel.: 57823/4), to which all correspondence should be sent.

MEETINGS

Institution of Electrical Engineers

The fortieth Kelvin Lecture on "Semi-Conductors and Rectifiers," by Prof. N. F. Mott, M.A., F.R.S., at 5.30 on April 21st.

Discussion on "The Scheme for the Interchange of Information on Electrical Engineering Laboratory Practice," opened by E. Bradshaw M.Sc. Tech., Ph.D., and on "Transient Display Apparatus," opened by A. C. Normington, B.Sc. (Eng.) at 6.0 on April 11th.

Radio Section.—"Hot-Cathode Thyratrons: Practical Studies of Characteristics," by H. de B. Knight, M.Sc., at 5.30 on April 6th.

Informal lecture on "Radio-Frequency Heating" by R. H. Barfield, D.Sc., at 5.30 on April 12th.

All the above meetings will be held at the I.E.E., Savoy Place, London, W.C.2.

Cambridge Radio Group.—Informal lecture on "Printed Circuits, including Miniature Components and Sub-miniature Valves," by J. E. Rhys-Jones, M.B.E., and G. W. A. Dummer, M.B.E., at 6.0 on March 29th, at the Cambridge Technical College.

"Meteors," by A. C. B. Lovell, O.B.E., Ph.D., at 8.15 on April 26th at the Cavendish Laboratory.

North-Eastern Centre.—Faraday lecture on "Television" at 7.0 on March 29th at the City Hall, Newcastle-on-Tyne.

Sheffield Sub-Centre.—"Speech Communication under Conditions of Deafness or Loud Noise," by W. G. Radley, C.B.E., Ph.D. (Eng.), at 7.0 on March 30th at the Scunthorpe Technical School.

North-Western Radio Group.—Discussion on "Audio Reproduction," opened by G. J. Scoles, B.Sc. (Eng.), A. G. F. Smith and G. I. Thomas, B.Sc., at 6.30 on April 27th at the Engineers' Club, Albert Square, Manchester.

Scottish Centre.—Faraday lecture on "Television" at 7.0 on April 5th at the Central Hall, Tollcross, Edinburgh.

South Midland Radio Group.—Informal lecture on "Television Developments," by K. R. Sturley, Ph.D., at 6.0 on March 28th at the James Watt Memorial Institute, Great Charles Street, Birmingham.

North Staffordshire Sub-Centre.—"Scientific Work of the Post Office," by L. E. Ryall, Ph.D., at 7.0 on April 6th at Duncan Hall, Stone. (Joint meeting with the Institute of Post Office Electrical Engineers.)

British Institution of Radio Engineers

London Section.—Discussion on "Frequency Modulation and Amplitude Modulation," at 6.0 on April 21st at the London School of Hygiene and Tropical Medicine, Keppel Street, London, W.C.1.

South Midlands Section.—"Electronic Voltmeters," by R. A. Lampitt, at 7.0 on April 28th at the Technical College, The Butts, Coventry.

West Midlands Section.—"Broadcast Reception for Rediffusion Systems," by M. Exwood, at 7.0 on April 27th, at the Wolverhampton and Staffordshire Technical College, Wulfruna Street, Wolverhampton.

Merseyside Section.—"Modern Technique in Radio Telecommunication Systems," by M. M. Levy at 7.0 on April 6th at the Incorporated Accountants' Hall, Derby Square, Liverpool, 2.

N.W. Section.—"The Measurement of F.M. Transmitter Performance," by D. R. Willis at 6.45 on April 8th at the College of Technology, Sackville Street, Manchester, 1.

Scottish Section.—"Pulse Testing," by Prof. M. G. Say, Ph.D., M.Sc., at 6.30 on April 12th at the Herriot-Watt College, Edinburgh, 1.

N. Eastern Section.—"R.F. Coil Design and Tracking Methods in Super-heterodyne Receivers," by A. E. Coghlan, at 6.0 on April 13th at the Neville Hall, Westgate Road, Newcastle-on-Tyne.

British Sound Recording Association

"Developments in Magnetic Sound-on-Film," by Dr. O. K. Kolb, at 7.15 on April 6th at the G.B. Theatre, Film House, Wardour Street, London, W.1. (Joint meeting with the British Kinematograph Society.)

Television Society

Midlands Centre.—"Electronic Testing Instruments," by A. E. Crawford, at 7.0 on April 8th at the Chamber of Commerce, New Street, Birmingham.

Radio Society of Great Britain

"Some Aspects of High-Quality Sound Recording and Reproduction," by R. W. Lowden, at 6.30 on April 29th at the I.E.E., Savoy Place, London, W.C.2.

Institute of Navigation

"The Influence of Echo Sounding," by A. J. Hughes, O.B.E., at 5.0 on April 15th at the Royal United Services Institution, Whitehall, London, S.W.1.

Junior Institution of Engineers

Informal meeting, including two films, "Kelvin—Master of Measurement" and "Kelvin-Hughes Marine Radar," introduced by R. Bagot and E. F. Alldritt, at 6.30 on April 1st at 39, Victoria Street, London, S.W.1.

TELEVISION INTERFERENCE

Its Nature and How to Reduce It

By A. H. COOPER, B.Sc.

(E.M.I. Engineering Development)

IT is exceptional for the short waves used for television broadcasting to be reflected from the ionosphere to any point within the service area of the transmitter, so that normal fading is almost unknown in television. An effect which is exactly similar does, however, occur when an aircraft takes the place of an element of the ionosphere; waves reflected from the aircraft interfere with the direct waves from the transmitter and produce changes in the received signal like natural fading.

In the television case there is one essential difference which arises from the importance in television reception of the "fine structure" of the received signal. The indirect wave reflected from the ionosphere or from an aircraft will have travelled by a longer

simplified signal (simply a white bar down the middle of a grey picture) is shown in the top line, and below it is a similar signal, attenuated four to one. This second signal, which typifies the indirect wave, is shown in units of two picture-lines, each pair of lines being progressively delayed by an eighth of a line. These attenuated and delayed signals are then combined with the "direct" signal shown immediately above them; the first picture-line is assumed to be arriving so that the two carriers are in phase, so that they add; the second picture-line in each pair is assumed to repre-

direct signal is apparent in the combined signal, even in the presence of the much greater direct signal; in the "in-phase" cases there is a weak echo of the main white-line signal in the middle of the picture, which moves progressively across the frame as the path-difference increases, as is shown at *x* in the bottom row. This implies that the white line will be accompanied by a weaker white ghost, spaced away from it. But between each in-phase state and the next there will be an anti-phase state, and here the signals subtract; the ghost of the white line is black, as seen at *y* in the bottom row.

We can now add the second ingredient to our fading phenomenon; the picture is accompanied by a ghost which moves across the frame, but which alternates between positive and negative according as the picture has at the moment faded up or down. If the reflected wave is not very intense and if the picture is not one which will show strong echoes, the effect may not be noticed except for one part of the picture-line which is always present and always likely to produce a good echo, namely, the sync pulse. The converse is also true; elements of the picture may be echoed into the sync pulse interval so that this pulse will lose either its sharp edges or its depth, or both; when this happens the fading of the picture is accompanied by a break in synchronizing, usually happening once every fading cycle.

The frequency of the fading cycle will depend on the position and velocity of the aircraft with respect to the transmitter and receiver. Three sets of cases have been computed, which by symmetry cover eight courses separated by 45° ; these are reproduced in Fig. 2. On each course it is assumed that the aircraft flies uniformly on a straight course, passing at a stated distance from the receiver at its nearest point; this distance is the direct para-

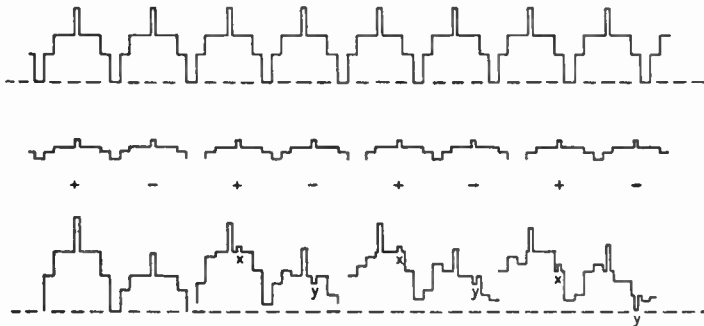

Fig. 1. This diagram illustrates how fading and ghost images occur. The directly-received signal is shown at the top, with various forms of reflected, and so delayed, signal below. Their combination is given in the bottom row.

path than the direct wave, and will arrive correspondingly later at the receiver. In sound broadcasting there is no means available to the ordinary listener of knowing that the reflected wave is arriving some milliseconds later than the direct wave; one merges with the other and cannot be aurally disentangled. But in a television picture, each element of the received signal has a separate significance and does not merge with other elements in anything like the same manner.

Fig. 1 shows what happens to a television signal, idealized for simplicity, when a weaker and delayed signal combines with it. A

sent the state of affairs when the aircraft has moved so that the difference between the direct and indirect path-lengths has changed by half a wavelength; the carriers are now in anti-phase and combine subtractively. The eight combined waveforms in the bottom row therefore represent eight "snapshots" of the signal as received while the aircraft moves and changes the difference between the lengths of the direct and indirect paths.

In each case it will be seen that the first of each pair of waveforms is larger than the second; this is the equivalent of the straightforward amplitude fade in sound reception. But, in addition, the fine structure of the in-

BY AIRCRAFT

tion and may be horizontal, vertical or oblique, and various values have been taken varying from 200 feet (a near approach) to 5,000 feet. The aircraft is assumed to be flying at 250 feet per second, and the signal frequency is taken as 45 Mc/s.

These curves show a frequency range from about 25 c/s down to zero, the changes in frequency taking place most rapidly around the time of nearest approach. The more complex case of curved courses will give rise to frequencies of the same order, but the actual values and the rate of change will be more complicated. An aid to visualizing the complex cases is the family of ellipses in Fig. 3, which represents a plan of the neighbourhood of the receiver, each line representing a crest in the fading pattern. (The lines have been drawn much farther apart than they would be on any reasonable scale, simply for clarity.) If the aircraft flies along one of these ellipses, it produces no variation in the signal, which is either permanently increased or decreased, with any echoes retaining their position; in fact, such accuracy of flight is almost impossible, a sideways movement of only a few feet taking the aircraft from the crest to an adjacent trough. Any other course will, in general, give a flutter of varying frequency which can be estimated by laying off the course on the plan and noting the intersections of the course and the ellipses.

The amplitude of the fade will depend on many factors (such as the shape and attitude of the aircraft and its position relative to the transmitter and receiver) which are not amenable to calculation. The writer has the mixed fortune to live very close to two airfields, namely London Airport (Heathrow) and Langley, which provide opportunities for observing the effect every few minutes, so that it is possible to substitute a mass of individual results, in a wide variety of circumstances, for the alternative difficult (and possibly over-simplified) calculations. Taking the sum total of all observations, it is clear that there is

no significant difference between the various directions in which the aircraft may be; taking the observations singly, it is clear that there is usually a distinct position or positions of the aircraft for maximum reflected signal at the receiver in each case, but that the direction of this maximum varies

from case to case. A complete picture of the whole range of observations would be virtually impossible to reproduce and if there is any preferred direction which gives the maximum reflected signal, it varies from one occasion to another.

The fading trouble will be worst (indeed it may be said only to be seriously apparent) in locations which are near or beyond the horizon of the transmitter. In such

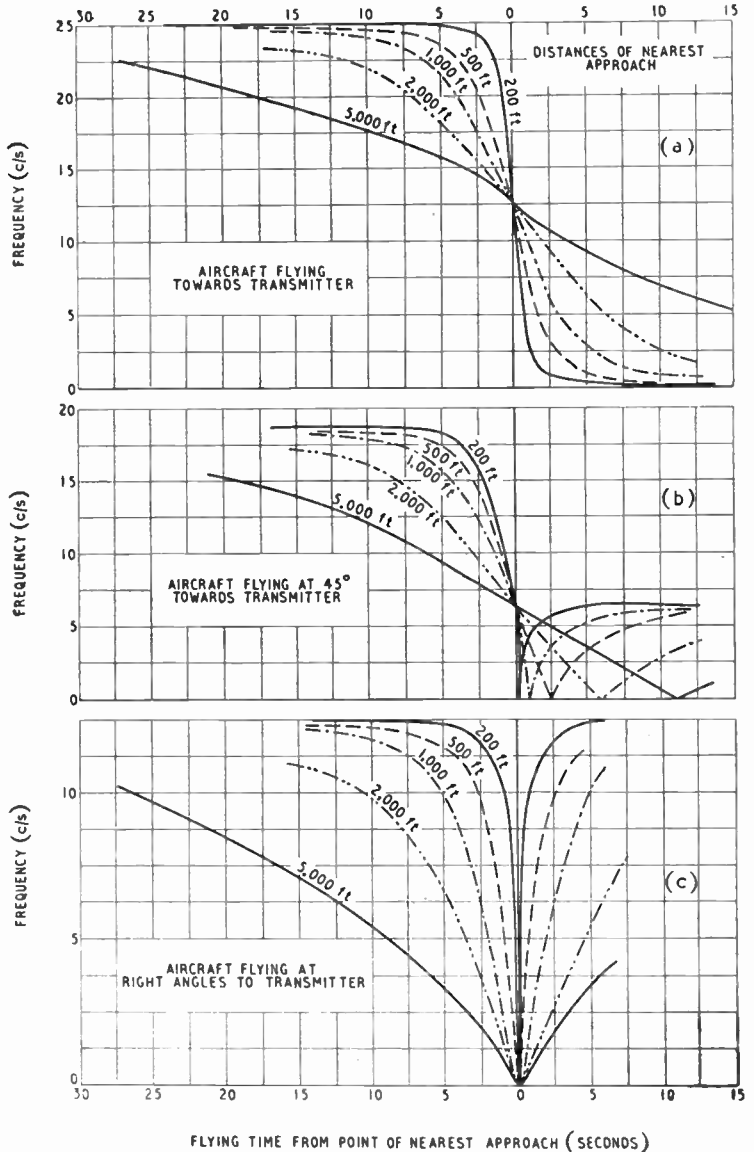

Fig. 2. Calculated curves showing the frequency of the fading cycle against flying time from the point of nearest approach for an aircraft speed of 250 ft per second. Curves (a) are for an aircraft flying towards the transmitter, (b) for one on a course at 45° to the foregoing and (c) for a course at 90°.

Television Interference by Aircraft—locations, from which the transmitter can hardly be "seen," if at all, the direct wave is attenuated, but the reflected wave from the aircraft (which being higher can "see" the transmitter without obstruction) is relatively much more powerful.

Reciprocity would suggest that a similar effect should be experienced with a receiver near the horizon when an aircraft flies near the transmitter; but no evidence can be offered of actual observations. It would, however, be expected that exact symmetry would not occur in the two cases between (1) when the aircraft is near the receiver and (2) when it is near the transmitter, since the geometry of the two aerial locations, and their polar diagrams, will, in general, be different.

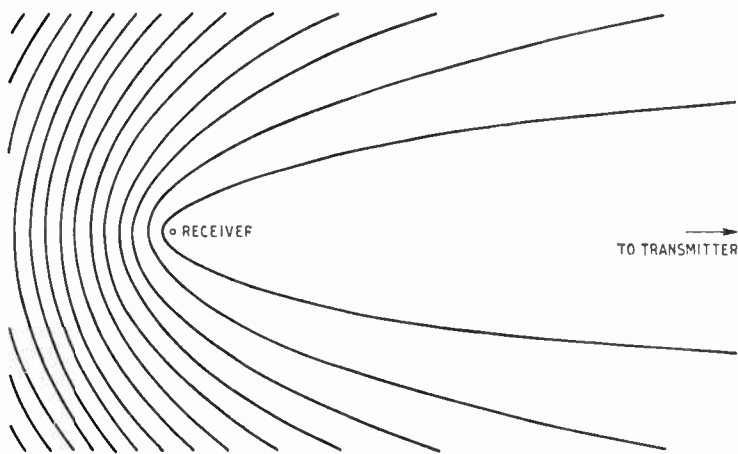

Fig. 3. Family of ellipses representing aircraft courses along which the direct and indirect rays combine to give a constant signal at the receiver.

The first method that comes to mind as a cure for fading is automatic gain control, but this is not nearly as useful as in sound reception. There is the practical difficulty of obtaining the a.g.c. voltage, particularly with positive modulation as used in this country; although, even with negative modulation, there are difficulties as is shown by the fact that a.g.c. is being omitted from this year's American receivers. But more important is the fact that a.g.c. only evens out the variations in picture brightness; it does not affect the extent of the ghost images and, indeed, by increasing

the gain during the downward fades it increases the severity of the negative ghosts. Nor does a.g.c. have any effect upon the intrusion of ghosts into the sync pulses; with a.g.c. the picture loses hold as easily as before.

Directional aerials are another popular remedy, but they do not contribute much. The dipole-plus-reflector, which is most people's idea of a directional aerial, does no more than reduce to some extent the reception from the direction away from the transmitter; this is not a particularly serious source of reflected interference and this kind of directivity would probably produce no noticeable effect. Directivity of a far higher order, such as can be had from a three- or four-element array, or a long-wire aerial, can be a real help by reducing the interference to

is "behind" the receiver, so that directional aerials of almost any sort would be worth while. The difference between the results attained in these articles and in practice, lies in the simplifying assumptions on which the articles depend; assumptions which reduce the mathematics from being impossible to being merely extremely difficult. Their results are true for substantially vertical reflecting surfaces (e.g., an aircraft); they are not true when the reflecting surface is horizontal, nor when it lies between the transmitter and receiver, in which case it sometimes acts as though it were an element of the ionosphere.

One powerful cure is to reduce the relative intensity of the reflected signal by raising that of the direct signal; this can, in most cases, be done by raising the height of the receiving aerial. An additional effect results from the distortion of the plane of polarization in the neighbourhood of roofs of houses, so that a low vertical aerial may not be optimum for the direct signal but will, on occasion, be in the right direction for the rotated polarization of the reflected signal; raising the aerial into a region where the polarization of the wanted signal is more truly vertical has therefore a double effect in reducing the relative intensity of the reflected wave. It is the writer's experience that this is the most powerful single cure for this trouble and the amount of civil engineering required to raise the aerial is usually less than that required to make even the simplest form of directional aerial.

It has been noticed that certain receivers are less disturbed by aircraft; in these receivers, the designers† have deliberately degraded the d.c. component of the signal to less than 100 per cent in order to avoid the ill effects of too great contrast or gamma variations which may occur, for example, in News Reel transmissions. Conversely, there are many receivers in which all the ill effects of aircraft reflections are exceptionally bad because the d.c. component is over 100 per cent.

This leads to a modification of the receiver with an effect comparable with that of a.g.c. but

the time when the aircraft is between the receiver and the transmitter; at this time the interference will be as bad as ever but, in cases where the trouble is often present, it is a relief to be able to reduce the time of its incidence even if it cannot be eliminated or reduced in amplitude.

Reference must be made to two articles,* from which it would appear that the worst trouble is to be expected when the aircraft

* D. I. Lawson, "Multipath Interference in Television Transmiss.on," *J. Instn. Elect. Engrs*, 1945, Vol. 92, Part II, p. 125; D. A. Bell, "Approximate Method of Calculating Reflections in Television Transmiss.on," *J. Instn. Elect. Engrs*, 1946, Vol. 93, Part III, p. 352.

† C. L. Faudell and N. Atkinson, British Patent 505,899.

which is far easier to apply; i.e., the removal of the d.c. component from the signal. Figs. 3, 4 and 5 show that the fading frequency cannot rise so high as 50 c/s and it therefore appears to be an advantage also to attenuate the lower frequencies. The position is, in fact, not so simple as this; the fading trouble is not merely the addition of a low-frequency component to the received signal; it is a modulation of the received signal at the fading frequency.

syno pulses from the previous level, here shown chain-dotted. The last column shows the signal as reproduced on the cathode ray tube; i.e., with all parts of the wave-forms lying below the preset black level suppressed. The dotted lines indicate the signal as it would be in the absence of fading and make it clear that a considerable advantage is gained by making the brightness swell and shrink around its mean level rather than with respect to the "blacker-than-black" level of the bottom of the sync pulses.

2 seconds. It remains, therefore, to design a filter* which will attenuate frequencies between 1 and 25 c/s. In practice, this filter is incorporated in the network comprising the previously mentioned a.c. coupling. The addition of a suitably delayed d.c. component helps to provide freedom from aeroplane disturbance.

The actual circuit modification is normally associated with the video amplifier which usually has circuit elements which can be readily adapted to a filter network. By way of example, the modified circuit of a commercial receiver is shown in Fig. 5, where the a.c. coupling comprises the capacitance C_2 and the resistance R_3 and where the d.c. path through the resistances R_4 and R_5 is delayed by the time constant $C_3 R_5$, whose value may be controlled by the choice of a suitable value for C_3 . This arrangement gives an attenuation of the order of 20 db at 3 c/s. Suitable values of components are indicated on the diagram.

This discussion has so far been confined to the effect on the received picture; sound reception suffers similarly though, generally, to a much less extent. The eye is very worried by a flutter producing a 10% change in brightness, but the corresponding 1-db change in sound level would pass unnoticed except perhaps on a constant tone. It could, of course, be made negligible by a.g.c., but, if conditions are such as to warrant a.g.c. on sound, the picture would be quite intolerable.

* C. D. Faudell, British Patent App. 20726/47.

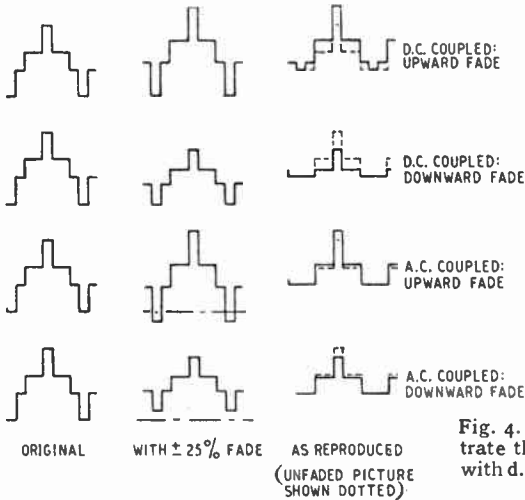

Fig. 4. These diagrams illustrate the effects of interference with d.c. and a.c. coupling to the cathode-ray tube.

As a result, the signal amplitude swells and shrinks about the zero axis, giving an exaggeration of the depth of fading; by removing the d.c. component we cause the signal amplitude to swell and shrink about its mean brightness level, so that the mean picture brightness does not fluctuate.

This improvement is demonstrated in Fig. 4, which takes a signal similar to the one previously used to demonstrate the "echo" effects, and subjects it to a fade of $\pm 25\%$. In the left-hand column, the signal is in its original form; in the second, it is combined, either in or out of phase, with a "reflected" signal of a quarter of its amplitude to simulate the fade (although in practice the matter would be complicated by the presence of echoes, here omitted). The first two examples (reading downwards) are for plain d.c. coupling; the third and fourth are for d.c. suppression, which results in variations of the absolute level of the signal, as is shown by the departure of the bottom of the

to attain a dramatic effect, will all be reproduced as though they were normally illuminated and the automatic suppression of the scanning return-lines, which is a feature of constant-black-level working, does not take place. Some other method must therefore be provided to prevent these undesirable effects.

The most satisfactory solution to this aspect of the problem is inherent in the observed fact that the disturbance becomes much less objectionable if the frequency of the disturbance can be reduced below one cycle in 1 or

Fig. 5. Circuit of the v.f. stage of a commercial receiver modified to reduce the effects of aircraft interference.

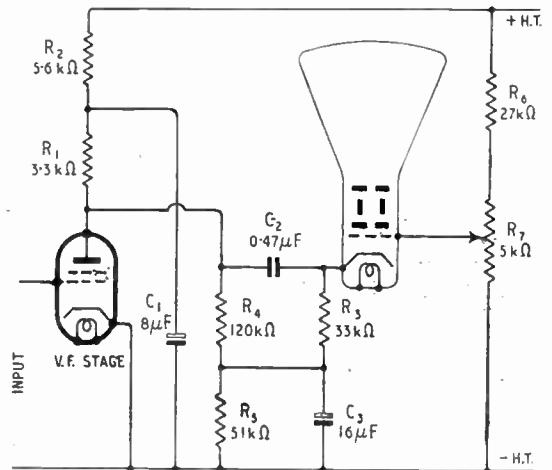

AMERICAN MICROGROOVE RECORDS

Some Details of New Commercial Developments

By DONALD W. ALDOUS

IT has long been the aim of the gramophone record industry to produce a practicable long-playing high-quality disc of the customary 10in or 12in diameter. Many attempts have been made to introduce records with increased playing-time into the commercial record field, e.g., by making use of the constant linear speed method, but they were not a technical success.

It is also of interest to recall the Pathé discs, 11 and 20in diameter, of the early 1900s,

grade vinylite, with a rotational speed of $33\frac{1}{3}$ r.p.m., providing about $5\frac{1}{2}$ - $5\frac{1}{2}$, 15 and $22\frac{1}{2}$ minutes per side respectively. These long playing times are made possible largely by the combination of reduced rotational speed and increased grooves per inch from the conventional 96-100 to 224 up to 300.

As it was found necessary to reduce the groove width to about

was the result of the combined efforts of Dr. Goldmark, William S. Bachman, Director of Engineering Research and Development for Columbia Records, and their associates.

It is appropriate to mention that, in 1939, when Columbia Records, Inc., were taken over by C.B.S., the possibility of long-playing records was envisaged and, consequently, in all sessions from that year onwards Columbia masters were cut on 16in lacquer discs at $33\frac{1}{3}$ r.p.m., as well as on the standard 78 r.p.m. masters. The frequency response claimed for these masters was from 50 to above 10,000 c/s. Thus a considerable repertoire of recorded material was available to launch these new "Microgroove" records.

We come now to an outline of the technical problems that had to be solved before a satisfactory "microgroove" record could be produced. The two significant contributions were the development of a first-class lightweight pickup that would trace a waveform accurately with very low forces at the needle tip, and the manufacture of a satisfactory inexpensive slow-speed rim-driven turntable motor to provide constant speed free from rumble.

For Columbia "Microgroove" discs a 0.001in tip radius needle, operating with a total force of $\frac{1}{2}$ oz, has been achieved in the Philco "phono-combination," using a crystal cartridge, the first record-player for these records to be put on sale (at 29.95 dollars) in the U.S.A.

The "Microgroove" bottom radius is less than 0.0002in and the groove shape has an included angle of $87^\circ \pm 3^\circ$. The change in rotational speed from 78 to $33\frac{1}{3}$ r.p.m. decreases the linear speed and the recorded wavelength by a factor of about 2.35, but as the playback tip radius has been reduced by a factor of 2.5 to 3, the high-frequency loss with changing diameters is less than with ordin-

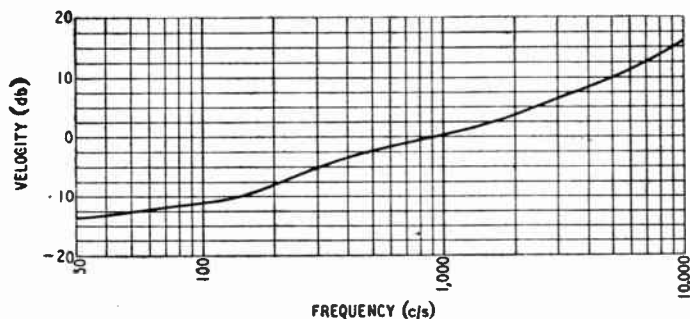

Fig. 1. Columbia LP "Microgroove" recording characteristic.

which can be regarded as attempts to tackle the running-time problem. Outside the domestic record field one can instance the first 16in slow-speed "talkie" discs and, of course, to-day lacquer discs up to 17 $\frac{1}{2}$ in diameter are regularly employed by the B.B.C. and other organizations for specific applications requiring extended playing time.

The impact on the record industry of "wrapped up" magnetic wire and tape systems, providing playing time limited only by the length of the carrier or medium used, has stimulated developments, and the "record conscious" American public has recently been offered long-playing "microgroove" records, presumably as the answer to the belief of some enthusiasts, chiefly record collectors, that the disc system is obsolescent.

What is a "microgroove" record? It is a name given to the 7-, 10- or 12-in pressings in high-

one-third the size of normal record grooves, the name "Microgroove" was coined originally by Columbia Records, Inc., for their $33\frac{1}{3}$ r.p.m. records, but it would now appear to be used in America as a generic term for all such fine-pitch records.

Before discussing the recording characteristic adopted for these records and the exacting technical requirements in processing and reproducing equipment that have to be met to ensure optimum quality, a few notes on the early research will not be amiss.

Dr. Peter Goldmark, Director of Engineering Research and Development of the Columbia Broadcasting System, which owns Columbia Records, Inc., initiated the experiments in 1945, and this research project was later transferred to the laboratories of Columbia Records, to adapt it to commercial recording and manufacturing conditions. The final "Microgroove" record marketed

any records. In fact, an improvement in useful frequency response of 1.28 times, with reduced inter-modulation distortion at small diameters near the centre of the record, is claimed.

The actual recording characteristic employed for Columbia "Microgroove" recording is very similar to the N.A.B. (National Association of Broadcasters) standard for lateral transcriptions, except at the low-frequency end, below 100 c/s, where the characteristic is approximately 3 db. higher. With this characteristic the treble response is pre-emphasized, reaching some 16 db. at 10,000 c/s, relative to the 900 c/s level. (See Figs. 1 and 2.) The absolute level recorded is only about 4 to 6 db lower than that on normal records. The recording characteristic has gradually changing slopes, so that precise equalization can be obtained with simple RC networks.

The salient technical features of Columbia "Microgroove" records are shown in the table.*

COLUMBIA "MICROGROOVE" DIMENSIONAL SPECIFICATIONS.

	10in records	12in records
Diameter... ..	9 $\frac{7}{8}$ in \pm $\frac{1}{32}$ in	11 $\frac{7}{8}$ in \pm $\frac{1}{32}$ in
Centre hole diameter ...	0.286in \pm 0.001in -0.002in	0.286in \pm 0.001in -0.002in
Thickness (to be measured at 1in from the edge at four points 90° apart).	0.075in \pm 0.010in	0.075in \pm 0.010in
Lead-in spiral	To start at outer edge of the music grooves and to consist of at least one complete turn before reaching recording pitch.	
Concentricity	The indicated run-out of the music grooves relative to centre hole shall not exceed 0.010in.	
Diameter of first groove at recording pitch.	9 $\frac{1}{8}$ in \pm 0.02in	11 $\frac{1}{8}$ in \pm 0.02in
Minimum inside diameter of recording.	4 $\frac{1}{8}$ in	4 $\frac{1}{8}$ in
Groove shape:—		
Included angle	87° \pm 3°	87° \pm 3°
Bottom radius	Under 0.0002in	Under 0.0002in
Width of groove	0.0027 to 0.003in	0.0027 to 0.003in
Rotational speed	33 $\frac{1}{3}$ r.p.m.	33 $\frac{1}{3}$ r.p.m.
Eccentric run-out groove diameter.	4 $\frac{7}{16}$ in	4 $\frac{7}{16}$ in
Run-out relative to centre hole.	0.250 \pm 0.015in	0.250 \pm 0.015in
Groove shape	Contour approximately same as music grooves: min. depth 0.003in.	

As examples of the recorded material available Columbia offers

* The author acknowledges with thanks information received from Mr. C. J. Lebel, Vice-President, Audio Devices, Inc., U.S.A.

the entire Dvorak "New World" Symphony on one 12in disc, price 4.85 dollars, and the Mozart Symphony in G Minor, K.550 on a double-sided 10in record, price 3.85 dollars. Items of less than one side in length are recorded in sections, so that any one can be selected as desired. Six or more popular dance tunes can be recorded on one "Microgroove" disc. The 7in Columbia "Microgroove" disc is called LP Junior, and gives a playing-time comparable with an ordinary 12in 78 r.p.m. record, at less cost.

The conception of fine-pitch records is not new, but to summarize the technical considerations of "Microgroove" recording that have made commercial applications practicable, one may add to the lightweight pick-up, miniature stylus, rumble-free and wow-free motor, the recent refinements of processing technique and the use of suitable plastics providing a lower noise level, consequently an adequate dynamic range.

The purchaser, too, must handle and store the records carefully to prevent any surface scratches.

What are the reactions so far of

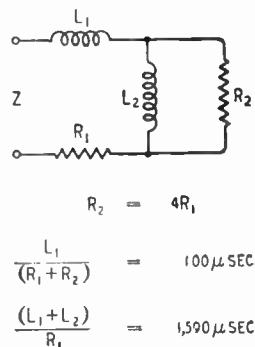

Fig. 2. The curve, shown in Fig. 1, is identical in shape to the impedance/frequency characteristic of the network shown here.

the American public and record dealers to this innovation? Enthusiasts claim that "Microgroove" records are the greatest single step forward in the history of phonograph records," but the record shops in New York do not share their enthusiasm.

The situation at the moment is, to say the least, confusing. The RCA-Victor organization has just introduced a new 7in fine-pitch record known as "Victorgroove," rotating at a new speed of 45 r.p.m. These records have a 2in centre hole, surrounded by a thick ring from which the disc proper extends as a thinner rim. The purpose of this ring is to prevent the record surfaces from coming into contact in storage or when stacked on the new RCA-Victor auto-change player, which has a 2-second cycle when handling eight "Victorgroove" 7in records, providing a total playing-time of about 42 minutes.

Radiogramophone and record-player manufacturers in America have got to decide whether to make units that will play 33 $\frac{1}{3}$, 45 and 78 r.p.m. records, or, say, any two of these speeds, and the scramble to get apparatus on the market has started. For instance, Webster-Chicago has a new Model 133 "Microgroove" changer available; the Crosley and Admiral firms are producing two-speed auto-changers. Special needles have been developed, with either sapphire or osmium-alloy tips.

The importance of extreme care and skill in manufacture to avoid even the slightest blemish arising in any process, cannot be overstated, and it is reported that each individual pressing is checked.

American Microgroove Records

The manufacturers of recording equipment, too, are very active, and such well-known companies as Presto and Fairchild are already producing special disc recorders able to meet the rigid require-

ments of the new "microgroove" technique.

The battle of the r.p.m. has begun. It need hardly be added that British record manufacturers are following the conflict very closely.

SHORT-WAVE CONDITIONS

February in Retrospect : Forecast for April

By T. W. BENNINGTON and L. J. PRECHNER (Engineering Division, B.B.C.)

DURING February, the average maximum usable frequencies for these latitudes increased very considerably, both by day and night. The daytime increase—mentioned in this column for February—was due to the normal seasonal trend after the "Midwinter Effect," while the night-time increase was also in accordance with the usual trend towards the midsummer maximum. The much increased sunspot activity in February probably accentuated these increases.

As the month was much less disturbed than January, long-distance communication on higher short-wave frequencies was good to most parts of the world. The rise in m.u.f.s after the "Midwinter Effect" was very noticeable, particularly in the middle of the month. Frequencies as high as 50 Mc/s were practically never usable, although reception of transmissions from the United States on 47 Mc/s has been reported. Transmissions on 28 Mc/s from New Zealand, travelling via the long path, have been received in the evening very much earlier than is usually the case for this time of the year. Reception conditions were, on the whole, quite good, and some of the short-lived storms, which were usually associated with large sunspots, affected frequencies of the order of 14 Mc/s much more than the higher frequencies. During the night, frequencies as low as 7 Mc/s continued to be workable, although the corresponding January value was 3.5 Mc/s.

Again an abnormally high rate of incidence of Sporadic E for this time of the year was recorded, the value being much higher than in January, and more than three times the corresponding value for February, 1948.

Sunspot activity in February was much greater than in January. No fewer than eight fairly large groups were observed, which crossed the central meridian of the sun on 2nd, 5th (two groups), 16th, 19th, 20th,

27th and 28th. The first three groups could be clearly seen with the naked eye in many localities, owing to the sun's glare being dimmed by fog.

February was a much less disturbed month than January. Ionosphere storms were observed on 7th, 22nd and 27th, those occurring on the first two days being fairly violent.

"Dellinger" fadeouts were recorded in February on a number of occasions, those occurring on 1st and 11th being very severe.

Long-range tropospheric propagation was observed on a few occasions at irregular intervals.

Forecast.—During April, the daytime m.u.f.s in the Northern Hemisphere should begin to decrease towards the midsummer minimum, while the night-time m.u.f.s should continue their increase towards the midsummer maximum. The effects of these variations will be modified on most transmission paths by longer duration of daylight, and moderately high frequencies will remain in use for considerably longer periods. Consequently while, during April, working frequencies for most transmission paths will be somewhat lower than in March during the full daylight period, they will be somewhat higher during the morning and evening periods, and considerably higher during the full darkness period.

Daytime communication on high frequencies (like the 28-Mc/s band) should be still frequently possible, but is likely to be somewhat less than of late. Over many circuits, frequencies as high as 15 Mc/s—and even higher in some cases—should remain usable till well after midnight. Frequencies lower than 9 Mc/s will be seldom required at any time during the night.

For transmission distances between about 600 and 1,000 miles the E layer will often control transmissions during the daytime, so that higher working frequencies may be called for at such times than

would otherwise have been the case.

Sporadic E may begin to increase, although the real increase usually occurs in May. As, during this year so far, the incidence of sporadic E has been abnormally high, it may be that it will be more prevalent in April than is usually the case.

Below are given, in terms of the broadcast bands, the working frequencies which should be regularly usable during April for four long-distance circuits. (All times G.M.T.) In addition, a figure in brackets indicates the highest frequency likely to be usable for about 25 per cent of the time during the month for communication by way of the regular layers:—

Montreal :	0000	11Mc/s	(16Mc/s)
	0200	9 "	(14 ")
	0800	11 "	(16 ")
	1000	15 "	(20 ")
	1200	17 "	(23 ")
	2200	15 "	(19 ")
2300	11 "	(16 ")	
Buenos Aires :	0000	15Mc/s	(19Mc/s)
	0200	11 "	(17 ")
	0700	15 "	(21 ")
	0800	17 "	(24 ")
	0900	21 "	(28 ")
	1100	26 "	(34 ")
	1800	21 "	(26 ")
	2100	17 "	(22 ")
2200	15 "	(20 ")	
Cape Town :	0000	15Mc/s	(19Mc/s)
	0300	11 "	(16 ")
	0500	15 "	(22 ")
	0600	17 "	(27 ")
	0700	21 "	(29 ")
	0800	26 "	(34 ")
	1800	21 "	(27 ")
	2000	17 "	(22 ")
Chungking :	0000	9Mc/s	(12Mc/s)
	0300	11 "	(16 ")
	0500	15 "	(20 ")
	0600	17 "	(23 ")
	0800	21 "	(28 ")
	1400	17 "	(23 ")
	1600	15 "	(19 ")
1900	11 "	(14 ")	

April is usually a moderately disturbed month. At the time of writing it would appear that ionosphere storms are more likely to occur during the periods 1st/2nd, 10th/11th, 13th/14th, 16th/18th, 29th/30th, than on the other days of the month.

AIR v. WATER COOLING FOR VALVES

AT a discussion meeting of the Radio Section of the I.E.E. on February 15th, 1949, it was pointed out that air cooling, which was at present suitable for powers up to about 5 kW, might be expected to show still further improvement, but had to contend with strong competition, so far as higher powers were concerned, from modern closed-circuit water-cooling systems in which comparatively small volumes of water with a supernatant atmosphere of nitrogen were used with induced-draught coolers.

*A sure way to far better reproduction—
far less record wear*

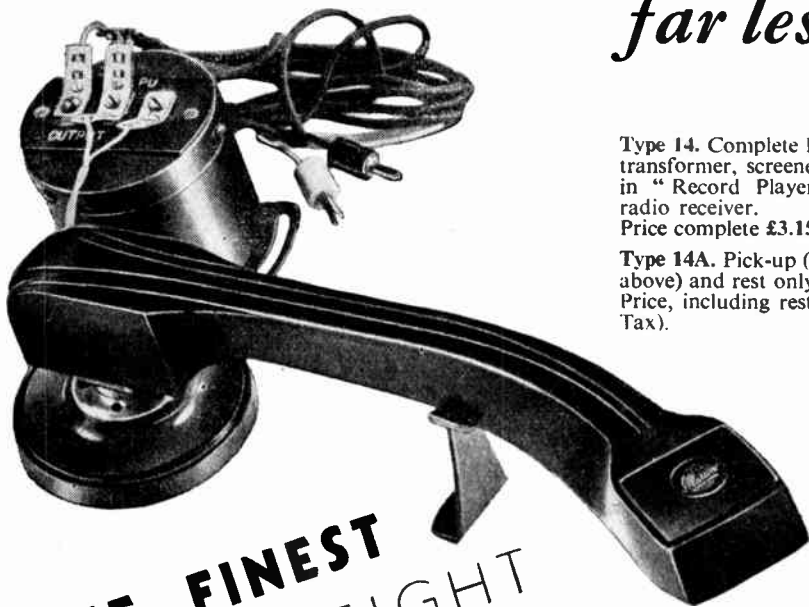

**THE FINEST
LIGHTWEIGHT**

PICK-UP

Type 14. Complete Pick-up unit with rest, matching transformer, screened lead and plugs for insertion in "Record Player" or "Pick-up" sockets of radio receiver.

Price complete £3.15.0 plus £1.1.8 (Purchase Tax).

Type 14A. Pick-up (identical with type 14 described above) and rest only.

Price, including rest, £2.10.0 plus £1.1.8 (Purchase Tax).

- **Minimum Record and Needle Wear.** This Marconiphone Pick-up is designed to provide the highest quality reproduction with the absolute minimum of record and needle wear. To those whose record library contains specimens that are irreplaceable this is a most important advantage.

- **Extended Frequency Response.** The frequency response has been greatly extended and by the elimination of any spurious resonances a perfect balance of tone is obtained over the musical range. It is sensibly linear over the section 50 — 8,000 c.s.

- **Adaptability.** By means of the special matching

transformer supplied, which incorporates a tone compensation circuit, the pick-up provides more than sufficient volume with almost any radio receiver to which it may be connected. The pick-up may be used without this transformer in conjunction with record reproducing equipment of individual design.

- **Pick-up-output** for average record, 6 mV.

Output at secondary of matching transformer is 1.5V.

- **Needles.** Needle changing is simple (no needle screw to operate) and up to 100 playings with steel needles and 2,000 playings with all-sapphire needles are possible. Ordinary needles must not be used with these instruments. Recommended types are the Columbia 99, Columbia Permanent sapphire or Columbia Miniature Thorn.

• **MARCONIPHONE** - *the REAL thing*

The Marconiphone Company Limited, Hayes, Middlesex

M.100

S.R.E.* for all purposes

Philips have supplied through traders and others throughout the world S.R.E. for almost every conceivable application. While specialized equipment is produced whenever necessary, a very wide range of standard apparatus units minimizes the need for this, and simplifies installation and maintenance.

As it can be shown to be much better engineering practice to use one large amplifier instead of a lot of little ones to feed one load, the standard range includes three large rack amplifiers.

Features include triode valves throughout, four push-pull stages, no electrolytics, and three separate anode supplies.

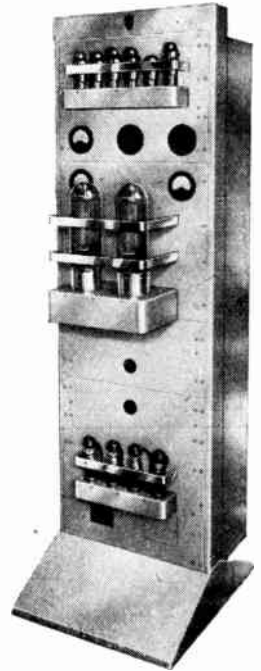

250 watt	£255
500	„	£325
1,000	„	£425

S.R.E. available through the trade on hire purchase or rental terms.

* What expression should be used to refer generally to amplifiers, and related apparatus? "Public Address?" This hardly applies to gear that may well be used in private for purposes other than addressing. "Sound Equipment?" This can also mean tomtoms, or brewery apparatus in sound condition!

We have adopted the Navy's term "S.R.E." or "Sound Reproducing Equipment", as in our submission there is no other so accurate or so generally applicable.



PHILIPS ELECTRICAL LIMITED

Amplifier Dept., Century House, Shaftesbury Avenue, London, W.C.2. (A48T)

G.E.C.



QUARTZ CRYSTAL UNITS FOR STABLE FREQUENCY GENERATION

FEATURES

Low temperature co-efficient - less than 2 in 10⁴ per °C. Patented nodal suspension. Mounted in vacuum; performance independent of climatic conditions. Exceptionally high Q value. High stability. Small size, 3" x 3/4" overall excluding pins. Fits standard miniature deaf aid valve socket.

FOR FREQUENCY SUB-STANDARDS

Type JCF/200. 100 KC/S. Available from stock adjusted to 0.01%. Higher accuracies supplied to special order.

The type JCF/200 unit illustrated is representative of the wide range of vacuum type unit available for low and medium frequencies.

PRICE
£2 - 15 - 0

SALFORD ELECTRICAL INSTRUMENTS LTD.

PEEL WORKS, SALFORD 3, LANCS. Telephone BLAckfriars 6688 (6 lines) Telegrams & Cables SPARKLESS Manchester

Proprietors THE GENERAL ELECTRIC CO., LTD., OF ENGLAND

RADIO INTERFERENCE

THE subject of radio interference is of such public importance nowadays that even Members of Parliament are expected to know something about it. What some of them did or didn't know, came to light during the debate on the Wireless Telegraphy Bill.

There may be a few things about it that even *Wireless World* readers do not know. For instance could they all give a satisfactory answer to the question, "Why does switching things on and off cause radio interference?" To the technically ignorant outsider the whole of radio is so mysterious that there is nothing about this interference business that is likely to strike him as more than usually difficult to explain. But every *Wireless World* reader knows that a receiver is tuned to one particular radio frequency (or, more accurately, a narrow band of frequencies), and that it generally succeeds quite well in rejecting all other frequencies. The frequency at which an electric light or other appliance is switched may be only once in several hours or days, so in comparison with radio frequencies is almost infinitely low. How then, does varying an electric current at a very low frequency indeed produce something that can force its way in past the selectivity of the set?

Admittedly, the interference resulting from switching consists only of isolated clicks, so is not very annoying. It is a different matter with certain types of motor-driven appliances, which cause an apparently continuous rattling or buzzing. The chief offender is the "universal" motor with its commutator, which is just a name for a special type of self-operated switch making and breaking connections several times per revolution of the motor. But even in the fastest motor this frequency of switching is still too low to be classed as a radio frequency; so the perplexity remains. By contrast, current coming from the 50 c/s supply causes no radio interference, yet

How It Is Caused by Switching D.C. or Low-frequency Circuits

By "CATHODE RAY"

by its very nature it stops and starts 100 times a second—much more frequently than any hand-operated switching.

The older readers, with memories of spark transmitters, will be quick to point out that the silent alternations of a.c. occur sparklessly, whereas switches (or any of the other appliances that cause noises to come out of the loudspeaker) are unintentional spark transmitters. The reason

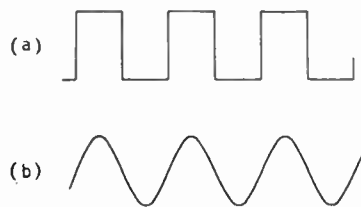

Fig. 1. Electrical power having a low-frequency sine waveform (b) is confined to one frequency, but if it has a steep-sided waveform (a) it is distributed over a wide range of frequencies.

why spark transmitters were abolished—one of the reasons, anyway—was that they interfered badly by coming in over a wide band of receiver tuning. If we retort that spark transmitters did at least have recognizable frequencies or wavelengths at which they could be tuned in, whereas the unintentional sparkers come in almost everywhere, the old hands may explain that a spark transmitter sparked into properly designed tuned circuits, whereas the circuits affected by the noise-making appliances are likely to be anything but sharply tuned.

Well, that explanation is all

right so far as it goes, but it doesn't go very far towards making it clear to the readers who are too young to take spark transmitting for granted just *why* interrupting a direct or low-frequency current "sparkily" generates radio frequencies. And it completely fails to explain the fact that certain low-frequency generators cause radio interference without any sparks at all. For instance, about ten years ago* *Wireless World* published a description of a 400 c/s oscillator that could be heard over all the wavebands in a receiver, even up to 20 Mc/s. There was no deception—its signal was picked up as a genuine radio frequency by the r.f. tuning circuits, not by low-frequency induction or any such backstairs method.

And there we have the key to the mystery, if it is a mystery. Since your copy of this key (if you ever had it) may have been lost in the blitz or sacrificed to the paper-saving campaign, I will explain that the oscillator in question generated a square wave with very steep—almost instantaneous—sides, as in Fig. 1(a). (An actual multivibrator waveform is slightly more complicated, but the steep sides are the essential features.) If the 400-c/s oscillator had a smooth sine wave as in Fig. 1(b) it certainly wouldn't cause radio interference. But, as is well known, distortion of this fundamental waveform inevitably generates higher frequencies—harmonics—which are multiples of the fundamental frequency. With the small amount of distortion that is considered tolerable in reproduction of programmes, the 2nd and 3rd harmonics are the only ones that are likely to amount to more than one per cent of the fundamental (though in fact much of the audible unpleasantness may be due to minute traces of harmonics as high as the 9th or 11th). But with the aforementioned waveform, harmonics can be detected up to at least the 50,000th! The frequency of the 50,000th

* "Monarch Multivibrator," April 13th, 1939, p. 349.

Radio Interference—

harmonic is $50,000 \times 400 \text{ c/s} = 20 \text{ Mc/s}$, so there is no further question about where the radio frequencies come from.

Mathematicians can calculate the relative amplitudes of all the harmonics necessary to build up any given periodic waveform. ("Periodic" means a waveform that exactly repeats again and again, so has a definite fundamental frequency.) They show that a perfect square wave wouldn't have a 50,000th harmonic—or any even harmonic—but it would have a 50,001th, which is $\frac{1}{50,001}$ times the amplitude of the fundamental. And similarly for the other harmonics, up to infinity.

A good way of showing the ingredients of a waveform is by means of a spectrum. Fig. 2 is part of the spectrum of a 400-c/s

amplitudes of the harmonics.

If you find it as difficult as I did to believe that combining a sufficient number of sine waves will form a perfect square wave, you may be interested in Fig. 3, reproduced from p. 359 of the December, 1945, issue of this journal. Here, in the left-hand half-cycle, are drawn all the odd harmonics up to the 15th, in proportionately decreasing amplitude, and all starting off in phase. The heavy line is the result of adding them all together. It is not by any means a perfect square wave, but it is so obviously tending that way that it is not too difficult to believe that if the odd harmonics up to (say) 50,001 were added it would approximate very closely indeed. The fact that so many (25,001) sine waves were made to start in step would mean that the combination of them all would have a slope 25,001 times

the end of half a fundamental cycle, forming an equally precipitous descent. In between, their ups and downs tend to cancel out, forming the "flats."

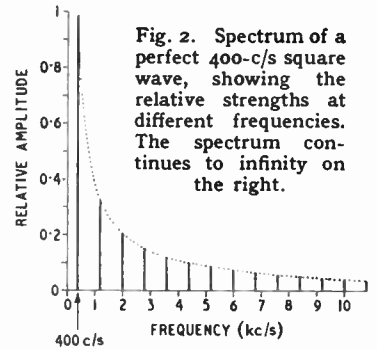

Fig. 2. Spectrum of a perfect 400-c/s square wave, showing the relative strengths at different frequencies. The spectrum continues to infinity on the right.

The mathematical analysis of a 400-c/s square wave is borne out in practice by the fact that a radio receiver picks up a continuous succession of oscillations that become gradually weaker as the frequency arises. One might expect them to come in at 800 c/s intervals, but since a multi-vibrator does not generate a

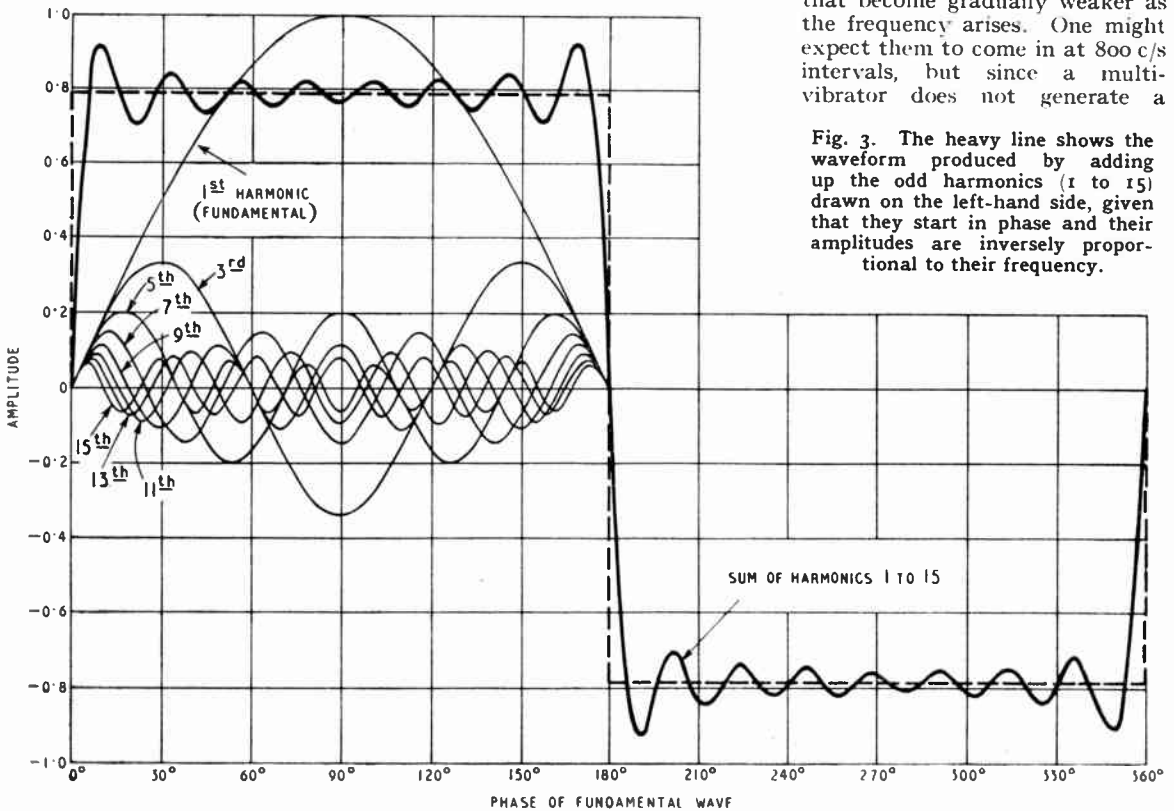

Fig. 3. The heavy line shows the waveform produced by adding up the odd harmonics (1 to 15) drawn on the left-hand side, given that they start in phase and their amplitudes are inversely proportional to their frequency.

square wave. Each harmonic is represented by a vertical line at the appropriate point on the frequency scale, and the heights of the lines indicate the relative

as steep as that of one of them, so would be practically vertical. And because they are all odd harmonics they next come into step (in the opposite direction) at

perfect square wave the even harmonics are not quite zero, and signals are generally detectable every 400 c/s.

In any case, the lower the fre-

quency of the fundamental, the closer the harmonics are spaced. A 1-c/s square wave could be generated by switching d.c. on and off once each way every second, the switching operations being spaced at exact half-second intervals. Harmonics would occur at 2-c/s intervals from 1 c/s upwards and would extend theoretically to infinity. But unless the amount of current interrupted was 400 times greater than in the 400-c/s multivibrator, the interference at any given frequency would be less. Just over 1 Mc/s, for example, we would have the 2,500th harmonic of the multivibrator, but the 1,000,000th harmonic of the switch.

Reducing the frequency of the switching still more, finally to one

when they are operated, and these set up much stronger interference, as one would expect from theory.

There is one other sort of wave that can be analysed fairly easily, and to which some sorts of interference approximate. It is the sharp narrow pulse, Fig. 4(a). As before, the spectrum consists of separate harmonic frequencies, but instead of their amplitudes falling off in proportion to the number of the harmonic, they are almost equal to the fundamental until the frequency is not much less than that of the pulses if they were close enough together to have equal positive and negative half-cycles. That sounds terribly involved, but should be quite clear if we take an example. Suppose pulses occur at 400 c/s,

Fig. 4. Example of pulse waveform (a), the fundamental frequency being 400 c/s. The spacing of the lines in the spectrum is determined by this frequency, as in Fig. 2, but the falling off in amplitude is slower the narrower the pulses, as at (c), (where the lines are too close together for all of them to be shown). If the pulses were pushed together to make positive and negative half-cycles equal, their frequency (5 Mc/s) would mark the place in the spectrum at which amplitude had fallen 36 per cent.

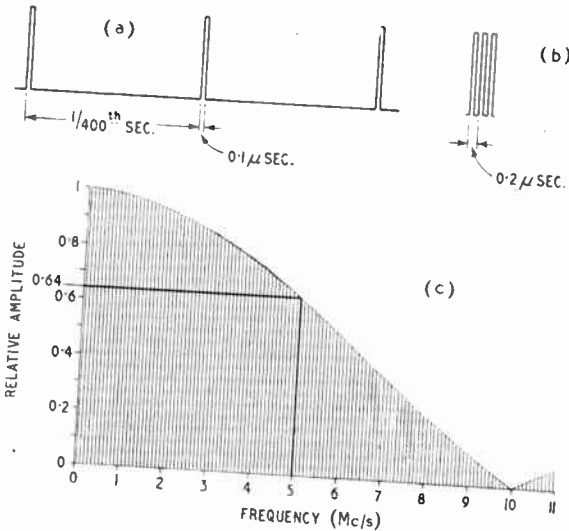

and each pulse lasts for 0.1 micro-second (one ten-millionth of a second). Then if these pulses were square waves, Fig. 4(b), each cycle would last 0.2 μsec, and their frequency would be 5 Mc/s. All harmonics up to about 5 Mc/s would be nearly as strong as the fundamental. The actual relationship is shown in Fig 4(c). Amplitudes above the first zero (10 Mc/s in this case) are relatively small.

So one would expect brief pulses of current like this to be more serious interferers. And so they may be unless carefully screened, as aircraft radio engineers know well enough. The pulses of engine ignition current, and radar pulses if any, could cause much trouble if unshielded.

isolated operation, the spectrum resolves itself into lines so close together as to be a continuous mass, so that they cover all frequencies; but they would be very weak. It is a fact of experience that a good clean make or break of current causes very little audible interference, probably none at all when the sensitivity of the receiver is reduced by a local station's carrier wave and unless the aerial is closely coupled to the circuit being switched. Most switches, however, cause a rapid series of current variations

New TRIX Quality SOUND EQUIPMENT

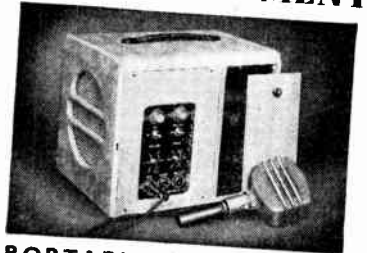

PORTABLE MODEL—B65
A completely self-contained low power P.A. system. Battery Operated.

This exceptionally compact equipment incorporates the amplifier complete with loudspeaker, rotary transformer, 6 volt unspillable accumulator, and microphone with cable, all self-contained in an easily portable case. Independent switches allow valve filaments to be kept warm in the non-operating condition at about 1/3rd normal battery consumption. Power output is approximately 5 watts, and for outdoor use the addition of a separate projection type speaker substantially increases the range. A most useful outfit for motor coaches, buses, police, auctioneers, and numerous other applications where no electric supply mains are available. Send for details.



TRIX RIBBON MICROPHONE

is designed for high quality reproduction. Frequency response substantially linear from 60-10,000 c.p.s. Minimum feedback. Send for full details.

THE TRIX ELECTRICAL CO. LTD
1-5 Maple Place, Tottenham Court Road
London, W.1. Phone: MUSEUM 5817
Grams & Cables: "Trixdio, Wesdo, London."

AMPLIFIERS · MICROPHONES · LOUDSPEAKERS

Radio Interference—

We can sum up the findings so far by saying that sharp corners or spikes in a waveform must have high-frequency ingredients, just as a mosaic with fine detail must include small pieces and couldn't be made exclusively of unhewn mountain boulders. Therefore the act of causing d.c. to stop or start suddenly, as in Fig 5(a), brings into temporary existence a wide range of frequency, theoretically infinite. The same applies to 50 c/s a.c. Even if you happen to catch it at the moment when it is zero, the sharp corner at the start causes some disturbance, (Fig. 5(b)).

According to theory, then, d.c. and a.c. transients such as these might be expected to create interference over a wide band of frequency, but falling in strength with rising frequency. It is a fact that most interference is worst on long waves, less on medium waves, and often inaudible on short waves. But not always. One has only to think of ignition interference with television.

That is because the waveform theory is only part of the story. In real life, current can never spring instantly from one value to another, because there is always some inductance in any

infinitely large current would be necessary to change it in zero time. One effect of the inevitable L and C, then, is to round off the sharp corners and ease the precipitous gradients, cutting down

another way of saying it has inductance), and a magnetic field contains energy. When the current is cut off, the energy expresses itself as an e.m.f. that tends to keep the current flowing, and

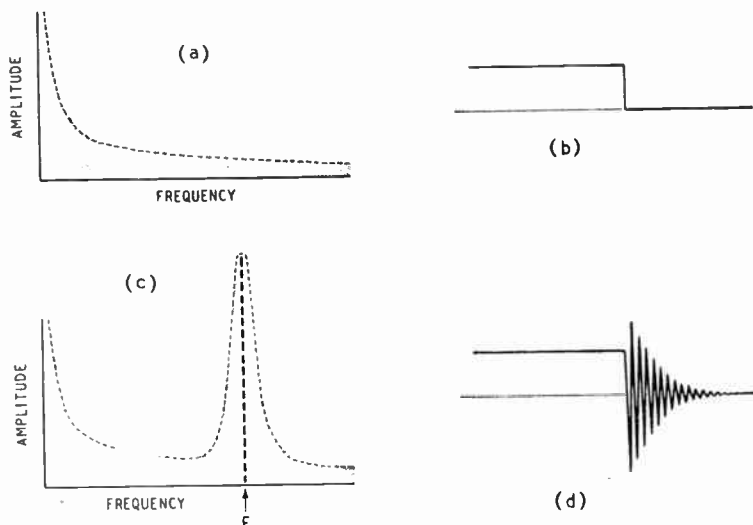

Fig. 6. When the current in a resistive circuit is switched off the waveform is a "step" (b) and the spectrum like (a) (i.e. similar to Fig. 2 but no separate lines). But if the inductance and capacitance are sufficient, the interference at some frequencies will be accentuated by oscillation, spectrum (c) and waveform (d).

the spectrum at the high-frequency end.

Another feature of L and C is

sparks angrily if it is thwarted. Similarly the voltage across a capacitance cannot be brought to zero without the stored electrical energy manifesting itself as a discharge current. A sudden release of energy in either case spreads over a wide band of frequencies.

More important still, often, inductance and capacitance in combination considerably modify the distribution of frequency. In Fig. 6, (a) shows the spectrum of the perfect switch-on or -off, waveform (b). The amplitude is inversely proportional to frequency. But if L and C resonate together at any frequency in this range, say F in Fig. 6 (c), then interference in that region of frequency may be enormously increased. The waveform, instead of being a plain "step," will be obviously oscillatory (d).

A good example is the interference caused by the ignition systems of cars. The dimensions of the sparking-plug circuits cause them to resonate at the very-high frequencies, so that instead of the pulses of current in these

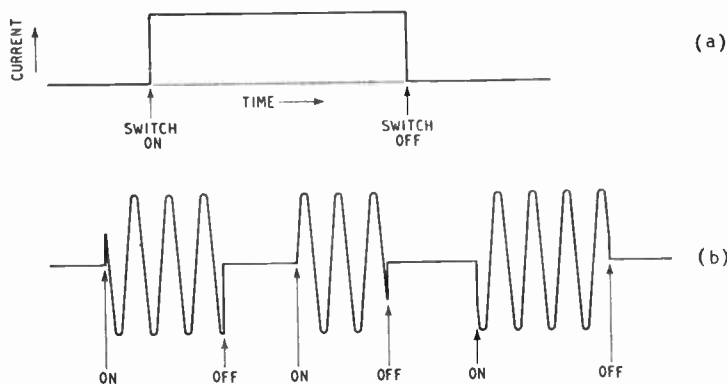

Fig. 5. "Waveforms" of switching d.c. (a) and a.c. (b) on and off. With a.c., the steepness of wavefront depends somewhat on the phase at which switching takes place.

circuit, and if the current in it were to change at an infinitely rapid rate it would develop an infinitely large back e.m.f. Voltage can't change infinitely fast either, because there is always some capacitance in a circuit, and an

that they store energy. If there were such a thing as a purely resistive circuit, when the current in it was switched off it would just cease. But no real circuit can carry current without setting up a magnetic field (that is

circuits setting up interference almost equally at all frequencies, it is much the most troublesome on television and other v.h. frequencies. Putting resistances of the order of 15,000Ω in series with the ignition leads into these circuits damps down the resonances, to the great benefit of the viewing public.

One might ask why, if capacitance may make matters worse, it is the chief ingredient in many of the "interference suppressors" on the market. One answer is that their capacitance is generally made so large that any resonance due to it is below radio frequency. Another is that its purpose is to short-circuit radio-frequency currents, preventing them from wandering through lengths of circuit which radiate them or

couple them to receptive aerials.

As a tailpiece I offer a hint on how to become a radio expert in a single one-minute lesson. When people complain about their sets it is generally because of interference or weak reception or both. You ask "Are you using an outdoor aerial?" If they say "Yes" you are stuck. But nine times out of ten their reply will be "No." Thereupon, assuming an appearance of infinite wisdom, you advise them to install a good outdoor aerial. The number of times this prescription brings about a sensational improvement will quite overwhelm the awkward experiences when the trouble happens to be due to a dud output valve or grit in the loudspeaker, and your local prestige will be immense.

NEWS FROM THE CLUBS

Birmingham.—Commencing on April 11th the general meetings of the Birmingham and District Short-Wave Society will be held on the second Monday of each month at the Colmore Hotel, Church Street, Birmingham, 1. The club room at 220, Moseley Road, Birmingham, 12, will be open on the third and fourth Mondays. Sec.: N. Shirley, 14, Manor Road, Stechford, Birmingham, 9, Warwicks.

Chester.—Fortnightly meetings of the Chester and District Amateur Radio Society are held at the United Services Club, Watergate Street, Chester. Next meeting, April 5th at 7.30. Sec.: H. Morris, G3ATZ, 24, Kingsley Road, Boughton Heath, Chester.

Dorking.—Meetings of the Dorking and District Radio Society are held each Tuesday at 7.30 at the club's headquarters, 5, London Road, Dorking. The society's transmitter, G3CZU, is operating on 80 and 160 metres on both 'phone and c.w. Sec.: J. Green-

well, G3AEZ, 7, Sondes Place Drive, Dorking, Surrey.

Edinburgh.—At the next meeting of the Lothian's Radio Society at 7.30 on March 31st in the Chamber of Commerce Rooms, 25, Charlotte Square, Edinburgh, D. T. N. Williamson—designer of the Williamson Amplifier—will give a lecture on sound reproduction. The society meets on the last Thursday of each month. Sec.: I. Mackenzie, 41, Easter Drylaw Drive, Edinburgh, 4.

Leicester.—The Leicester Ham Radio Society's permanent headquarters is now at the Holly Bush Hotel, Belgrave Road, Leicester, where meetings are held at 7.30 on the first Friday of each month. Sec.: J. Milnthorpe, 3, Minster Drive, Thurmaston, Leicester.

Portsmouth.—The South Hants Radio Transmitting Society continues to meet on the last Thursday of each month at 7.30 at the Civic Centre, Cosham, Hants, but is endeavouring to secure permanent headquarters where a transmitter can be installed. Sec.: H. G. Martin, G3ACM, 184, Kirby Road, North End, Portsmouth, Hants.

Southall.—The annual general meeting of the West Middlesex Amateur Radio Club, attendance at which is restricted to members, will be held at 7.30 on April 13th at the Labour Hall, Uxbridge Road, Southall, where the club meets on the second and fourth Wednesday of each month. Sec.: C. Alabaster, 34, Lothian Avenue, Hayes, Middlesex.

Southend.—A committee has been set up by the Southend and District Radio Society to organize a Field Week at the Boy Scouts' International Jamboree to be held at Rochford in August. The vice-chairman of the society, J. E. Nickless, G2KT, will lecture at the next meeting on April 1st at 7.15 in the Municipal College, Southend. Sec.: J. H. Barrance, M.B.E. (G3BUJ), 49, Swanage Road, Southend-on-Sea, Essex.

P.V.C. WIRE STRIPPER

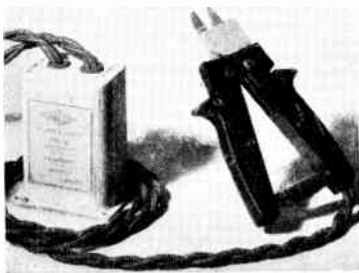

This electrically heated tool ("Stan-elco: Standard Telephones and Cables) is for stripping P.V.C. insulation from connecting wires; it is designed to prevent nicking or breaking of solid or stranded conductors.

NEW!

This fine new streamlined Junction Unit is now a part of every Antiference Television Aerial for outdoor mounting.

Engineered in robust plastic it has been designed to embody every practical refinement by the firm consistently in the forefront of Television Aerial development.

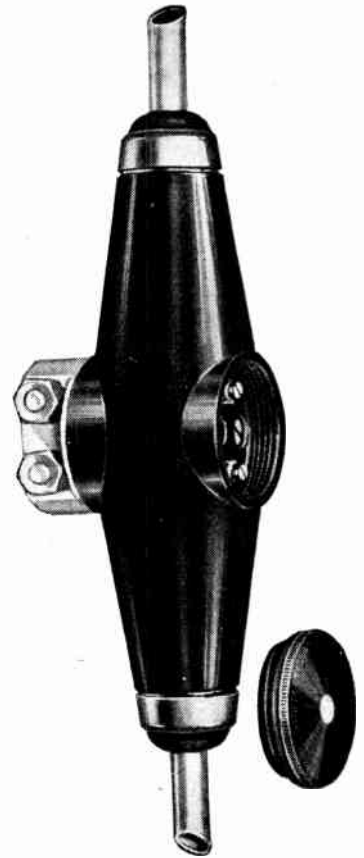

THERE IS NO INCREASE IN PRICE in the Antiference range of television aerials incorporating this new unit. When ordering specify Series 5 (e.g. WD5, LD5, WD5R, PD5R, LD5R, PD5R/M).

ANTIFERENCE LIMITED
67 BRYANSTON ST., LONDON, W.1
A14

Unbiased

Peccavi?

THOSE of you who resisted the undoubted attraction of playing noughts and crosses in school when you ought to have been studying European history may recollect that Catherine the Great, of Russia, although a lady of remarkable achievements who certainly left her mark on the map of Europe, once expressed her great sorrow that she had no appreciation of music whatsoever. To her it was just nothing but noise. There are, of course, many like her in this modern world. I, personally, know of one eminent figure in the realm of radio who has said unashamedly that he is so far lacking in musical appreciation that he only recognizes the difference between the National Anthem and the sound of a pneumatic drill by the fact that men remove their hats and women stop talking when they hear the former.

As for myself, I am, I suppose, in a sort of halfway house in the matter of musical appreciation, for I do recognize that, in the words of the popular song, "some sort of music makes me sick and you sick, while some sort is noble and grand." But the music which really does annoy me is the sort that is interpolated in the midst of a programme of dialogue, or more usually comic polylogue, in order to give a breathing space to actors and some necessary relaxation of attention to listeners.



Competitive Polylogue.

My objection is that after carefully adjusting the set to give adequate volume for the dialogue so that none of a comedian's gags be lost, the musical interlude suddenly crashes out with a volume that rattles all the ornaments on the old Victorian chifonier and sends one flying to the volume control, which must, of course, be turned up again as soon as the dialogue is resumed.

Now I don't want to get myself bogged down in the quagmire of scale distortion and suchlike things, and I do realize that, no matter with what Agagian delicacy I walk along this thorny path, I am laying myself open to a devastating flank attack by both the musical and technical sections of my readers. What I ask is that the B.B.C. boost up the volume of the dialogue or, alternatively, that set designers provide us with a special kind of audio a.v.c. which will distinguish between speech and music and so do the job at the listener's end.

Let me make it quite clear that I am complaining of programmes which contain a mixture of music and dialogue; I fully realize that I must expect to readjust my volume control when the programme changes from the peaceful quietude of a "twilight hour" programme to a nerve-shattering brass band performance.

Sheer Ignorance

ONE not infrequently finds abysmal ignorance flourishing like a weed in places where one would expect to find only the fair flower of learning. A classic example is provided by the late Lord Curzon, whom a contemporary so aptly described as "a very superior purzon." He once astonished the Upper Chamber by pronouncing the cockney word "beano" as if it were of Italian origin, as indeed he thought it was. It did not altogether inspire me, therefore, one Sunday afternoon a little while back, when the erudite members of the two teams in the B.B.C. Round Britain Quiz programme floundered hopelessly concerning the question of the international distress signal used by ships and aircraft.

They were asked what was the radio-telegraphic equivalent of the radio-telephonic distress call "Mayday." It was obviously meant as a trap for those who take the B.B.C. or the popular press as their sole source of learning and information, and accord to their pronouncements an aura of *ex-cathedra* infallibility. In saying this I am not in any way seeking to belittle the efforts of these two very worthy public institutions. They are, like the pianist, doing their best; and it is their misfortune rather than their fault that they have not been brought up to observe the same strict standards of accu-

acy as *Wireless World* and myself. I correctly anticipated that the quiz savants would wrongly reply SOS, but I certainly didn't expect the question master to pass the answer as correct. I was a little surprised, also, that these scions of, figuratively speaking, the Cam and Isis



"... sole source of learning ..."

should be so hesitant over the "*M'aidez*" origin of "Mayday."

The SOS heresy became established in the public mind as the international radio distress call at the time of the loss of the ill-fated *Titanic* in April, 1912. Some enterprising journalist, who badly needed a course at a theological college to enable him to distinguish between body and soul, even told us that SOS meant "Save Our Souls." The same enterprising gentleman, disregarding grammar, further informed us that the CQD call, also sent out by the *Titanic* (*vide* official report of enquiry) meant "Come Quick, Danger."

The so-called SOS signal had, at the time of the disaster, only recently come into force to replace the CQD call, which was merely the still-current CQ call followed by D—the prefix to an urgent message. But the international distress call, which took the place of CQD, was not SOS at all but simply It is no more SOS than it is VMS or a host of other literal combinations (not necessarily three-letter ones) which an imaginative mind could construct if spacing were as meaningless as punctuation is to most women. The B.B.C. is, of course, largely to blame for perpetuating this error by using the expression "SOS messages" for urgent appeals which, since they are telephonically transmitted, could very aptly and alliteratively be called Mayday messages.

But possibly the B.B.C. has never heard of Mayday, and thinks that the Mayday Hospital at Croydon was founded by the Labour Party.

LETTERS TO THE EDITOR

Land-water Signal Paths ♦ Television Aspect Ratio: Test Card for Interlacing ♦ "Piped" Television ♦ "S" Meter Functions ♦ Relay Circuit

"Propagation Over Coastlines"

BY way of a footnote to the abstract in your March issue (p. 117) of my letter to *Nature*, it should perhaps be stressed that the extent of the phenomenon depends upon the wavelength used and upon the earth constants of the land. The figure of 12 db. was given for the specific conditions of the experiment and is not, as your abstract implies, a constant associated with the general phenomenon. It was difficult within the space of a short letter to make this clear, though I suggested in my introductory remarks that it varied with conditions. The phenomenon is essentially a ground-wave one, and would be difficult to detect and of little practical significance with horizontal polarization.

G. MILLINGTON.

Baddow Research Laboratories,
Marconi's W.T. Company.

"Television Goodness Factor"

MAY I deal briefly with one or two points concerning my article in last month's *Wireless World* which have been raised by readers? Some readers (and the writers of some books) do not agree with my assumption that the aspect ratio of a television image is that of the long (horizontal) to the short (vertical) sides of the visible portion of the transmitted pattern. They maintain that it is, in fact, the ratio of these sides of the entire theoretical image transmitted: that is, that it includes initial and final blacks as well as "blacker than black" sync pulses. I have it on the best authority that for the B.B.C. service the aspect ratio is—and that for all services it should be—that of the visible part of the whole image. It is, in fact, the area covered by the active portions of the active scanning lines. For B.B.C. transmissions the aspect ratio of the whole transmitted pattern is $5 \times 99 / 83.5 : 4 \times 405 / 377 = \text{approx. } 5.9 : 4.3$.

L^2_{an}

The equation $f_{min} = \frac{L^2_{an}}{2}$ appearing in some books must be a relic from the old scanning disc days which has somehow escaped revision.

In the article in question I was careful to stress the fact that f_{min}

is the minimum modulation bandwidth for anything like equality in horizontal and vertical definition. The optimum bandwidth is probably about $1.5 \times f_{min}$. It follows that the most desirable definition ratio is not unity. It is attained when

$$\frac{f_{mod}}{f_{min}} = 1.5$$

Hence $D_{opt} = 1.5$.

Detective interlacing is a not uncommon fault in television receivers. Would it not be a great help to designers, manufacturers and servicemen if a test card containing 188½ black and 188½ white lines were used from time to time? The card would, of course, have to be drawn with extreme accuracy and to be positioned exactly in the field of the transmitting Emitron camera. Very careful monitoring at the transmitting end would also be necessary.

R. W. HALLOWS.

"Television Distribution"

I READ with interest this article in your January issue.

I think it is pertinent to point out that a television distribution system was developed and installed in a number of blocks of flats prior to the war by the company to which I was chief engineer. I am not clear in what essentials the system described by your contributor differs from that to which I refer. Can it be that some of the installations mentioned by Mr. Adorian were in fact made by my colleagues?

In view of this I find it surprising that no acknowledgment has been made to those, whom so far as I am aware, were the only engineers concerned with the original scheme.

W. B. J. HACKNEY.

London, S.E.5.

Value of an "S" Meter

G₂MC's letter in your January issue has raised several points which need clarifying when discussing S meters.

A clear understanding of the true function of an S meter, its advantages and its disadvantages, sum up to it being a necessary addition to an amateur receiver, providing always, readings are interpreted in conjunction with several other known factors, including aerial characteristics, etc.

First and foremost an S meter is



THE "FLUXITE QUINS" AT WORK

"Don't tell me to hurry!" bawled EE
"I'm being as quick as can be.
Fixing wires with FLUXITE
is child's play all right,
But these seagulls come perching here, see!"

See that FLUXITE is always by you — in the house — garage — workshop — wherever speedy soldering is needed. Used for over 40 years in Government works and by leading engineers and manufacturers. Of all Ironmongers—in tins, 10d., 1/6 & 3/-.

TO CYCLISTS! Your wheels will NOT keep round and true unless the spokes are tied with fine wire at the crossings AND SOLDERED. This makes a much stronger wheel. It's simple—with FLUXITE—but IMPORTANT.

The FLUXITE GUN puts FLUXITE where you want it by a simple pressure. Price: 1/6, or filled, 2/6



ALL MECHANICS WILL HAVE
FLUXITE
IT SIMPLIFIES ALL SOLDERING

Write for Book on the ART OF "SOFT" SOLDERING and for Leaflets on CASE-HARDENING STEEL and TEMPERING TOOLS with FLUXITE. Price 1d. each.

FLUXITE LTD.
(Dept. W.W.), Bermondsey Street, S.E.1

Letters to the Editor—

usually an indication of a.v.c. and a.g.c. characteristic, and as such will give an indication only of the r.t. conditions as applied across the input of the receiver. And as the a.v.c. characteristic of the average amateur receiver is not linear with frequency, the same input at different frequencies will not give the same S meter readings unless the receiver has been developed to have a constant gain over the frequency range in which it is used. I am pleased to hear that one manufacturer claims to have arranged the radio frequency section of his receiver to have a flat response over the amateur bands and that a similar S meter reading is indicated over the whole band for a constant level input.

Two other points that are very necessary in S meter circuits are: (a) The determination of what input level shall represent S_1 , in terms of microvolts per meter input, and this again will be governed to some extent by the signal-to-noise ratio of the receiver or its "goodness factor." (b) What ratio of input increase will represent an increase of one S point?

The popular school of thought in the industry seems to be that a change of 6 db input will raise the S meter reading by 1 point, so that using a scale of 0 to 9 an S_9 signal signifies an input of carrier to the receiver of 54 db above the receiver threshold level. G2MC's suggestion that a report of "loud and clear" would be more useful than an S meter report does not hold water in view of the various ideas that most amateurs have of what constitutes

OUR COVER

Towers, 130 feet high, have now been erected by the G.E.C. on the sites of the four relay stations—at Harrow, Dunstable, Byfield and Rowley Regis—for the G.P.O. London-Birmingham television link. These masts, erected for the field tests, will be used for the initial working of the system until the specially constructed towers have been built. This month's cover illustration shows the mast at Harrow. The smaller paraboloid has been fitted so that a signal can be transmitted direct from the G.E.C. Laboratories at Wembley during tests, thus avoiding routing transmissions via the terminal station in London.

a full 100 per cent modulation level.

"Loud and clear" reports would be based on aural judgments made on loudspeaker or headphone outputs and so give no indication of carrier level, but only an indication of modulation fullness.

Hence Station A, with a low-level carrier modulated in the neighbourhood of 120 per cent could be given a "loud and clear" report, whereas Station B, with a higher carrier level modulated to an average depth of 30 per cent would, by the same standard, be given a lower assessment of output.

In conclusion, I would say that an S meter reading from a reporting receiving station is definitely useful if given together with: a statement of aerial conditions, i.e., height above ground, type of array, and feeder system used; the receiver performance in terms of signal-to-noise ratio for a detector current reference; a statement of modulation depth as indicated on an oscilloscope or its equivalent; and a statement of distortion factor or content including 50- or 100-c/s hum level.

In the case of a c.w. report, one

should remember to correct S meter readings for the displacement due to the local b.f.o., which does affect the a.v.c. characteristic of most receivers, however well designed they may be.

Instead of a modulation report, a c.w. operator might welcome a few words on his keying characteristic by a nearby reporting station.

In testing with a receiving station if the first S meter reading is taken as an arbitrary level, then immediate subsequent readings are of a definite value to a transmitter making test adjustments and assessing their effect on the radiated signal. H. HARDY, G4GB.

Ruislip, Middx.

Long-delay Relay Circuit

THIS circuit, described in your February issue, works well in practice, and I have used it for a year or more. The best results are obtained by using a high-slope triode having a short grid base, and I have recently found that an EC91 (miniature triode) used with $C=2$ mfd. and $R=3.3$ megohms will easily enable a 5-minute time delay to be attained.

A similar result can be obtained by connecting R_c in the anode instead of the cathode circuit of the valve, and C from anode to grid, instead of grid to h.t. negative.

Whichever circuit arrangement be used, the time constant CR becomes effectively multiplied by the amplification factor. If any of your readers are seeking more information they might be interested in an article by the writer published in *The Engineer* of 29th October, 1948, in which these circuits are described and analyzed. J. H. LUCAS.

Mullard Electronic Research Laboratory.

"Simple Tone Control Circuit"

I SHOULD like to draw your attention to the fact that a tone-control circuit exactly similar to that described by E. J. James in your February issue, except for the slight differences in values of elements, was designed by our engineer



Books Published for "Wireless World"

	Net Price	By post
RADIO VALVE DATA. Characteristics of 1,600 Receiving Valves	3/6	3/9
FOUNDATIONS OF WIRELESS. Fourth revised Edition, by M. G. Scroggie, B.Sc., M.I.E.E.	7/6	7/10
RADIO LABORATORY HANDBOOK. Fourth Edition, by M. G. Scroggie, B.Sc., M.I.E.E.	12/6	12/11
WIRELESS SERVICING MANUAL, by W. T. Cocking, M.I.E.E., Seventh Edition	10/6	10/10
TELEVISION RECEIVER CONSTRUCTION. A reprint of 10 articles from "Wireless World"	2/6	2/9
TELEVISION RECEIVING EQUIPMENT, by W. T. Cocking, M.I.E.E., Second Edition	12/6	12/11
RADIO DATA CHARTS, by R. T. Beatty, M.A., B.E., D.Sc., Fourth Edition—revised by J. McG. Sowerby, B.A., Grad.I.E.E.	7/6	7/11
HANDBOOK OF TECHNICAL INSTRUCTION FOR WIRELESS TELEGRAPHISTS, by H. M. Dowsett, M.I.E.E., F.Inst.P., and L. E. O. Walker, A.R.C.S., Eighth Edition	30/-	30/8
WIRELESS DIRECTION FINDING. By R. Kean, M.B.E., B.Eng. (Hons.), Fourth Edition	45/-	45/9

Obtainable from all leading booksellers or from
LIFFÉ & SONS LTD., Dorset House, Stamford Street, London, S.E.1.

Michael Volkoff as early as July, 1939, when the first amplifier embodying this circuit was built. We have used this circuit ever since then, and there are now over one

thousand amplifiers in Belgium with this tone control built in.

WILLY L'HOEST.

Rocke International, Ltd.
Brussels.

SENSITIVE ELECTRONIC RELAY

R.F. Oscillator Controlled by External Capacitance

A RANGE of electronic units designed for industrial use and functioning on the principle that the proximity of a substance, whether solid, liquid or a gas, trips a relay has been introduced by Fielden (Electronics) Ltd., Holt Town Works, Manchester, ro.

The tripping of the relay can be utilized to perform a variety of functions, for example, counting the number of items passing a given point, giving warning when the level

the circuit is set up to be in an oscillating state, the proximity of a body, liquid or gas to the remote electrode will stop oscillation. Conversely, it can be made to start oscillation.

The behaviour of the oscillator is easily utilized for any number of functions, mechanical or electrical, by rectifying the radio frequency or even using the change in anode current between the oscillating and non-oscillating state.

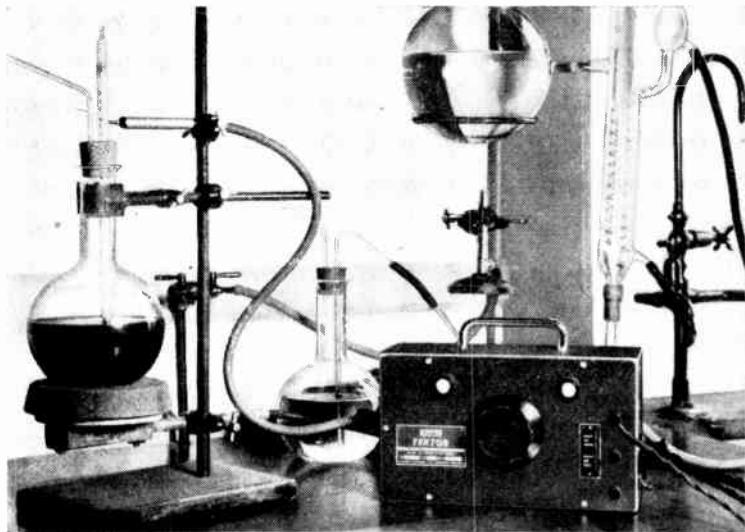

Fielden Tektor proximity switch attached to a thermometer and arranged to give remote warning when a liquid reaches a pre-determined temperature.

of a liquid has reached or fallen below a certain level, or, alternatively, to operate mechanism to stop or start the flow of liquid. Many other applications will suggest themselves.

In the case of objects, it is not necessary that they be conductors, and the devices will be actuated by any body of a reasonable size, be it jam-jars, biscuits, bricks, motor cars or people.

The apparatus is known as the "Tektor" and consists of a valve oscillator with a capacitance bridge in the feedback circuit and arranged so that a change of capacitance at the end of a cable joined to the bridge reverses the phase of the oscillator feedback voltage. Thus if

At present the Tektor is available in four different forms, a proximity switch, a proximity counter, a double Tektor for recording movement in two directions such as high and low levels of liquid in a container, and a meter relay which is actuated by current or voltage readings on an indicating meter. This unit has an additional pointer on the meter which can be moved to any part of the scale and when the normal indicating pointer comes opposite the fixed pointer the electronic relay is actuated and can be made to sound an alarm.

The apparatus operates from the a.c. supply mains and consumes between 20 and 25 watts according to the functions required.

GALPINS

ELECTRICAL STORES

408, HIGH ST., LEWISHAM, LONDON, S.E.13

Telephone Lee Green 0309. Near Lewisham Hospital.

TERMS: CASH WITH ORDER. NO C.O.D.

MAINS TRANSFORMERS. Input 200-250 v. 50 cys., in steps of 10 v. Output 450/0/450 v. 250 m/a., 4 v. 4 a., 5 v. 4 a., 6.3 v. 8 a., 6.3 v., 8 a., 6.2/6. Ditto 450/0/450 v., 250 m/a., 6.3 v., 4 a., 5 v. 4 a., 4 v. 8 a., 4 v. 8 a., 6.0/-. Another 500/350/0/350/500 v., 250 m/a., 6.3 v. 8 a., 0, 4, 5 v. 4 a. twice, 6.3 v. tapped at 2 v. 2 a., 67/6. Another 350/0/350 v., 300 m/a., 4 v. 8 a., 4 v. 4 a., 6.3 v. 4 a., 6.3 v. tapped 2 v. 2 a., 57/6. Another 500/0/500 v., 300 m/a., 6.3 v. 8 a., 6.3 v. 8 a., 6.3 v. 4 a., 4.4 a., 5 v. 4 a., 67/7.

MAINS TRANSFORMERS, all 200/250 v. 50 cys., 1 phase, input, output, 700/0/700 v. 70 m/a., 4 v. 2 1/2 a., 12 v. 1 a., 30/- each. Another 525/525 v. 150 m/a., 6.3 v. 5 a., 5 v. 3 a., 37/- each. Another 2,350 v. at 500 m/a., 85/- each. Mains Smoothing Chokes, 10 Hy. 100 m/a., 6/-; 150 m/a., 8/6; 350 m/a., 25/-; 5 Hy. 250 m/a., 17/6.

EX-GOVERNMENT (G.E.C.) ELECTRIC FANS. 12 v. a.c./d.c. laminated field, complete with 5 1/2 in. impeller. New, boxed, 20/- each, post 1/-.

MAINS TRANSFORMERS (Auto Wound). Voltage changers tapped 10, 20, 25, 90, 130, 150, 190, 210 and 230 v., all at 1,000 watts, a combination of 24 voltages can be obtained from this transformer, new ex-Government stock, £5/10/- each, carriage 5/-. Mains Booster Transformer, tapped 0, 6, 10, 19, 175, 200, 220, 225, 240 and 250 v. at 1,500 watts (new, ex-Government), £5/5/- each, carriage 5/-. Another Auto Wound, tapped 0, 110, 150, 190, 210 and 230 v. at 1,500 watts, £6/10/- each, carriage 5/-. Ditto, 2,000 watts, £7/5/- each, carriage 5/-.

ELECTRIC LIGHT CHECK METERS (Watt Hour). A.C. 50 cys. 200/250 v. 5 amp. load, 13/6, post 2/-; 10 amp., 21/-, post 2/-; 20 amp., 25/-, post 2/-; also a few only Pre-Payment 1/- slot type, 20 amp. load, less coin box, complete with synchronous motor, 35/- each, carriage 3/6.

SPECIAL OFFER METERS, all new, boxed. Moving Coil, first grade instruments, 0 to 20 v., 10/- each, or 3 for 25/-; 0 to 40 v., 12/6 each; 0 to 10 amps., 15/- each, all 2 in. scale. 0 to 23 v. A.C. calibrated 50 cycles, 25/- each; 0 to 40 amps., thermo-coupled, 25/- each.

CHARGING SWITCHBOARDS, size 17 1/2 in. x 16 1/2 in. x 8 in., containing 5 circuits, 5 Moving Coil 0 to 15 Ammeters, 10 to 50 V/Meters, 4 1-ohm 12 amp. Resistances, 1 14-ohm 1-4 amp. Resistance, all variable, also Switches, Fuses, etc., condition as new, £4/10/- each, carriage 10/-.

EX-R.A.F. CRYSTAL MONITORS, type 2, complete in wooden carrying case, the frequency depending on crystal used, 5/- each. Short Wave Aerial Coupling Units (Wavemeters), 5/- each.

MAINS TRANSFORMERS. Input 230 v. 50 cys., output 42 to 50 v. at 100 a., £15 each, carriage 10/-. Another input, 200/250 in steps of 10 v. Output tapped 6, 12, 18 and 24 v. at 10/12 a., 45/- each, carriage 2/-; another 230 v. input, output 12 v. at 8 1/2 a., 25/- each, carriage 2/-; another 220 v. input, output tapped 12 1/2, 25, 37 1/2, 50, 60, 75, 87 1/2, 100, 110 v. at 1,100 watts, £4/15/- each, carriage 7/6. (These Transformers are all double wound.)

MAINS VARIABLE RESISTANCES (slider type), new, ex-Govt., 14 ohms, carry 1 to 4 amps., graduated, useful as dimmers, etc., 17/6 each; another 0.4 ohms, carry 25 amps., 17/6 each, post 1/6. Ex-Govt. Moving-coil Cell Testers, 3-0-3 v. (new), 15/- each.

EX-R.A.F. MICROPHONE TESTERS (new). These consist of a Ferranti 0 to 450 m/a. 2 1/2 in. scale meter shunted to 1 m/a incorporated Westinghouse Rectifier, the whole encased in polished teak case, calibrated at present 0 to 10 v., 25/- each.

EX-R.A.F. ROTARY CONVERTERS, 12 v. D.C., input 230 v. A.C. 50 cys. 1 phase at 100 w. output, 85/- each, carriage 3/6. Ditto, 24 v. output, 65/- each, carriage 3/6. 10 amp. load, 42/6 each, carriage 3/6.

PRE-PAYMENT 1/- SLOT ELECTRIC LIGHT CHECK METERS, 200/250 volts, 50 cys. 1 ph., 2 1/2 amp. load, 30/- each, carriage 3/6; 5 amp. load, 35/-, carriage 3/6.

RANDOM RADIATIONS

By "DIALLIST"

A Clever Gadget

IT IS OFTEN a whole lot easier to explain the principle underlying an electrical or electronic process if you can think out a mechanical analogy, or, better still, make a working model to demonstrate the analogy. As neat a working model of this kind as I have seen for a long time was in use on the Westinghouse stand at the R.C.M.F. Exhibition to explain the operation of the Cockcroft and Walton type of "ladder" voltage multiplier, which is used in the "Westekt" e.h.t. unit. It's not easy to describe without the aid of drawings, but I'll do my best. Take in imagination a four-foot length of metal trough of semicircular section, half an inch in diameter. Bend it into a series of V-shaped zig-zags, each zig and each zag being six inches long. Done that? Very well; you now have four zigs from, say, left to right and four zags from right to left. Next, solder or spot-weld the whole zig-zag track to a metal rod about three feet long. At either end of a base-board, some three feet long by one foot wide, fix a bearing for the rod, arranging matters so that the bearing at the end of the rod nearest you is roughly two inches higher than that at the far end. Make a motor-driven device that will, at intervals of about ten seconds, turn the rod (and the zig-zaggery mounted upon it) thirty degrees to the right and then thirty degrees to the left. Starting from the end of the semicircular channel nearest you, fix up a simple one-way gate an inch from the apex of each V. A gate consists of a small metal arm, lightly spring-loaded, hinged to one wall of the semicircular trough and provided with a stop which makes it possible for it to open only in the direction away from the end of the channel nearest you. Now introduce a polished steel ball half an inch in diameter into the near end of the channel and set the motor to work.

How It Works

At the first swing the ball travels up the first zig, passes the gate and (owing to the downward inclination

of the rod carrying the channels) reaches a point a little beyond the apex of the first V. Whatever happens, it cannot run back because of the one-way gate behind it. The next swing takes the ball along the first zag and through the second gate. Each apex reached represents one stage of voltage magnification. Eventually the ball reaches the far end (point of highest voltage) of the ladder. At the next swing of the rod it drops through a hole and is returned to its starting point for the whole cycle to begin anew. Actually, the number of balls in use is equal to that of the zigs. At any moment each zig or each zag contains a ball on its way up to a higher level. The analogy is by no means perfect—few analogies ever are; but it does provide a graphic illustration of the way in which voltage multiplication is carried out by ladder methods. The one-way gates represent the rectifiers, whilst the "storing" of the balls now in the apices on the left and now in those on the right simulates the charging of the capacitors and their subsequent discharges.

Television Bandwidth

ONE OF THE greatest needs at the present day is a method of transmitting television images of high definition by means of a band of modulation frequencies a good deal smaller than that required by any system now known. Unless and until something of the kind is discovered it is difficult to see how any such thing as 1,000-line television can ever become a vehicle of ordinary home entertainment. Increase the number of scanning lines and the width of the modulation band of frequencies goes up at an alarming rate. Alarming? Yes, because it is impossible by any means now in our power to keep pace with it in the kind of television that the ordinary man or woman can afford to buy. At present it's about as much as we can do to turn out at popular prices television receivers responding adequately to the 2.7-Mc/s bandwidth of the B.B.C.'s 405-line service. If the carrier and both sidebands are dealt with in the s.f. and i.f. stages,

this means a total bandwidth of 5.4 Mc/s. Even with single-sideband working there must be a good response to approximately $2.7 + 1 = 3.7$ Mc/s. Receivers able to deal with the bandwidths three or four times as great required by television of much higher definition can no doubt be produced; but their cost must, so far as one can see, be so high that they can find a place only in the homes of the wealthy, or, used in conjunction with big-screen projection systems, in the cine theatre. At the recent Paris Television Conference one inventor read a paper on an attempt to reduce by the use of a "Knight's-move" system of scanning. I have not yet been able to get hold of a copy of this paper; but I can't see how, according to our present lights, any juggling with the movements of the scanning spot can get over the fact that each and every change from white to black, or *vice-versa*, needs one half-cycle of the modulating voltage. And it's those half-cycles that add up to the almost astronomical requirements of high-definition television.

Ups and Downs

WRITING FROM CHICAGO, an American friend gives me two interesting bits of news about television in his country. The first is that the link-up with New York is now completed and that a vast improvement in programmes has occurred in consequence. No mean achievement, that linking, by the way. It is over 700 miles as the crow flies (if you can imagine even an American crow flying 700 miles) and a good deal more as the link system is laid out. The second piece of news is that at the moment considerable over-production of television receivers appears to have taken place in America, particularly in those high-priced console models which cover "sound" broadcasting as well as television. My friend tells me that he sees sets of this kind offered in the shops at not much over half price. He does not believe that there is anything more than a temporary slump, or that it will affect any but the more expensive sets. Some of these sets are too large and—dare one say it?—too ugly to be welcome in the modern American home. Again, people in several parts of the States may grow tired of local programmes of mediocre quality and little in-

terest. The rapid extension of the New York service to the East Coast town and to the Middle West should make a vast difference there.

Future Policy

One only hopes that neither American manufacturers nor our own will jump to the hasty conclusion that the prices of televisions must be cut at all costs; and that the real money-maker is the cheap instrument, giving an indifferent picture accompanied by poorly reproduced sound. I've always held that a big mistake was made here in educating the public down instead of up in the matter of broadcast reception. A similar process could take place in television. Both eye and ear are accommodating and fairly readily accept poorish reproduction, if nothing better is available. It would therefore be possible, by cutting out all refinements and sacrificing accuracy in both vision and sound reproduction, to go on producing cheaper and cheaper televisions. Even that wouldn't enormously matter so long as the public was told plainly: "The performance of these sets isn't too bad; it's the best that can be had for the money; but if you go for a better set, costing a bit more, you will get far superior results." The fatal thing is to lead people to believe by sheer weight of publicity that the cheap radio or television receiver puts up the finest possible performance and that it's foolish to pay more for home entertainment equipment. There's plenty of room for both high-grade and cheap televisions, as is the case with motor cars, cameras, musical instruments and many other things. The worst thing that could happen would be for the mediocre receiver to become the standard type and the good set the rare exception.













Believe It or Not

HONESTLY, see that wet, see that dry, I did overhear this conversational gem between two charming elderly ladies.

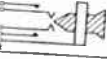
First Lady: "You know, I think there's something funny about this National electricity we're getting now. My wireless sounds quite different."

Second Lady: "Yes, I know, and have you noticed how an electric fire dries your throat up nowadays?"

BULGIN PRESS SWITCHES

Push-pull operation.	Push (Biased) operation.
S.410 	S.420 
S.411 	S.421 
S.412 	S.422 
S.413 	S.423 
S.414 	S.424 
S.415 	S.425 

*Every
Bulgin
Product
Guaranteed*

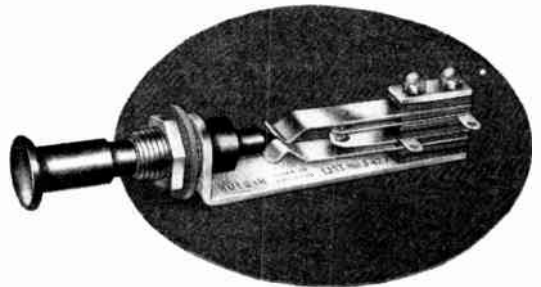

This new range of Jack type switches covers single- and double-pole switching, on-off, off-on, change-over, for push-pull or push (momentary-contact, biased plunger) operation. Fixing by one hole, $\frac{1}{8}$ " to panels of 20 swg. - $\frac{1}{16}$ " thickness. Rear of panel depth, $2\frac{1}{8}$ ". Max. "panel area", $\frac{1}{2}$ " x $\frac{3}{4}$ ". Fitted with pure Ag. contacts, for 0.001-250v. ~, to switch loads of 25W. max., with 3A. max. current limit. Plunger displacement, $\frac{3}{16}$ " approx. Bulgin switches are type-tested @ 15c/min for 25,000ops., = SEVENTY TIMES A DAY FOR A YEAR!

Retailers, have you obtained the new TRADE catalogue yet ?

The Choice



of Critics

A. F. BULGIN & CO., LTD., - BARKING - ESSEX

RECENT INVENTIONS

Bandspread Tuning

RELATES to the tuning control of a superhet receiver, particularly of the bandspread type, covering at least two alternative wavebands. The object of the invention is to reduce the cost of the circuit components, and to apply a single-point method of trimming or lining them up.

Two inductances L_1, L_2 , of the semi-fixed type, in parallel with variable condensers C_1, C_2 , are used to tune the r.f. and local oscillator circuits respectively. When the short-wave button B_1 is depressed, to bring the L-shaped contacts of the switches S_1, S_{10} into the full-line positions shown, trimming condensers K_1 and K_{10} are inserted in parallel with the variable tuning condensers. Alternatively, the long-wave button B operates switches S and S_0 to replace the condensers K_1, K_{10} by condensers K, K_0 of the fixed type.

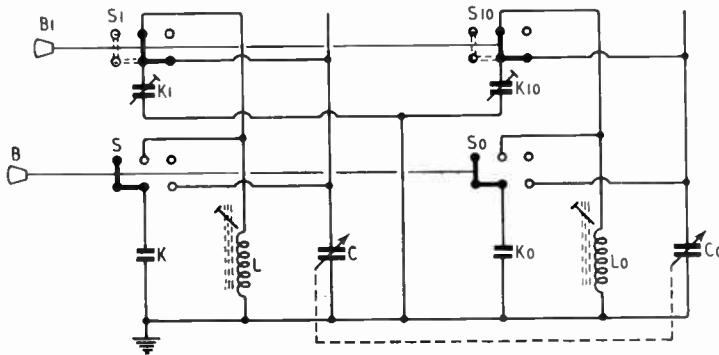

Bandspread switching circuit.

For lining-up, the button B is first depressed, and the inductance L is adjusted for a selected spot frequency, and then locked in position. The button B_1 is next operated to allow the condenser K_1 to be trimmed. The local oscillator circuits are similarly set, but so as to produce the required beat frequency.

A. C. Cossor, Ltd., and A. H. A. Wynn. Application date, December 20th, 1945. No. 605377.

Suppressing Interference

DISTURBANCES due to meter ignition systems and other sources of impulsive interference, are eliminated by taking advantage of the fact that their slope, or rate of rise of potential, is steeper than that of an ordinary amplitude-modulated signal.

The rectified signal is fed to a diode valve, the anode of which is coupled to a direct-current source through a resistance shunted by a capacity, the last two having a time constant of pre-determined value. This is designed to cope with voltage variations corresponding to the maximum frequency and amplitude of the signal to be received, but not with the more rapid

A Selection of the More Interesting Radio Developments

voltage rises created by short, impulsive disturbances, which are therefore prevented from passing through the diode. Preferably two diodes are used, one to suppress positive-going and the other negative-going disturbances.

D. Weighton and Pye, Ltd. Application date, October 24th, 1945. No. 605206.

Onlaid Circuits

THE component parts of a radio set are connected together by conductors which have been etched out from a metallic coating laid over a panel of thermoplastic material forming the chassis.

A sheet of tin-plated copper foil is hot-pressed on to a sheet of bakelite which has first been coated with a

the other hand, pervades a given frequency band, without showing any symmetrical characteristic. Advantage is taken of this essential difference to design a receiver in which impulsive types of interference are automatically balanced out.

Preceding the second detector in a superhet, three separate signal channels are provided, the first and second of which are identical and include the usual r.f. and i.f. stages. The third includes a local oscillator, carefully tuned to the carrier frequency, and also a modulator and phase inverter. All the three channels are in parallel. The output from the third channel includes the signal sidebands, and also sidebands produced as the result of modulating the impulsive disturbances. These are all in phase-opposition with the incoming signals and disturbances, and so can be used to neutralize the contents of the second channel, leaving a residual set of "interference" sidebands to eliminate those in the first or primary signal channel, which alone feeds the loud-speaker.

I. M. Jones. Application date, July 31st, 1945. No. 602488.

F.M.-A.M. Reception

THE invention is based on the fact that the mutual conductance of a four-electrode valve depends upon the transit time of the electrons passing between the auxiliary grid and the anode. Accordingly, if amplitude-modulated signals are applied to the control grid, anode detection will occur automatically, the best results being obtained when the spacing between the auxiliary grid and the anode, and the applied biasing potentials, are such as to make the electron transit time equal to the periodic time of the carrier wave to be detected, or a whole multiple of it.

The mutual conductance of the valve is also found to vary with frequency, so that the same circuit can be used to convert a frequency-modulated carrier, applied to the control grid, into an amplitude-modulated carrier in the anode circuit, from which the signal can be rectified in any known way. In this case, the best results are secured when the spacing of the electrons, and their operating potentials, are such as to make the electron transit time equal to two-thirds of the periodic time of the unmodulated carrier.

Philips Lamps, Ltd. Convention date (Netherlands), January 15th, 1941. No. 605808.

liquid adhesive. A stencil is used to mark out the circuit pattern in acid-resisting paint, and apertures for contact tags, valveholders and the like are made by drilling or punching. The unprotected parts of the metal foil are then dissolved in a solution of ferric chloride, and the acid-resisting paint is removed from the circuit that is left, together with the adhesive originally used to secure it. If necessary, the conductors so formed can be strengthened by electro-deposition.

Alternatively, the metal foil is coated with a photo-sensitive solution and exposed to light through a "positive" stencil, so as to leave an insoluble circuit pattern under subsequent development.

Sir E. T. Fish and W. Seby. Application dates, August 23rd, 1945, and March 30th, 1946. No. 602492.

Eliminating Interference

THE ordinary type of signal is radiated as a carrier wave with sidebands. These are formed as sum and difference frequencies in the process of modulation, in symmetrical pairs on each side of the centre or mean frequency. Impulsive interference, on

The British abstracts published here are prepared with the permission of the Controller of H.M. Stationery Office, from specifications obtainable at the Patent Office, 25, Southampton Buildings, London, W.C.2, price 2 - each.

Take a look inside the
ERIE Insulated
 High Stability RESISTOR



**FULLY PROTECTED
 AGAINST SOLDERING
 AND MECHANICAL
 DAMAGE DURING
 ASSEMBLY**

QUALITY IS BUILT INTO EVERY DETAIL

ERIE High Stability Resistors, besides displaying characteristics well within the limits laid down in the current R.C.S.C. Specification, are fully insulated, fully tropical and extremely robust; and are, therefore, eminently suitable for operation in restricted spaces and under the severest of conditions. Type

100, 1/2 watt, illustrated above, is the first to be released and will be followed in due course by Type 108, 1/4 watt; and Type 109, 1/2 watt. All standard tolerances down to ±1%. Manufacturers and Research Establishments are invited to write for full details.

ERIE Resistor Limited

CARLISLE ROAD, THE HYDE, LONDON, N.W.9, ENGLAND
 Telephone: COLindale 8011
 Factories: London and Gt. Yarmouth; Toronto, Canada; Erie, Pa., U.S.A.
 Cables: Resistor, London
 2756

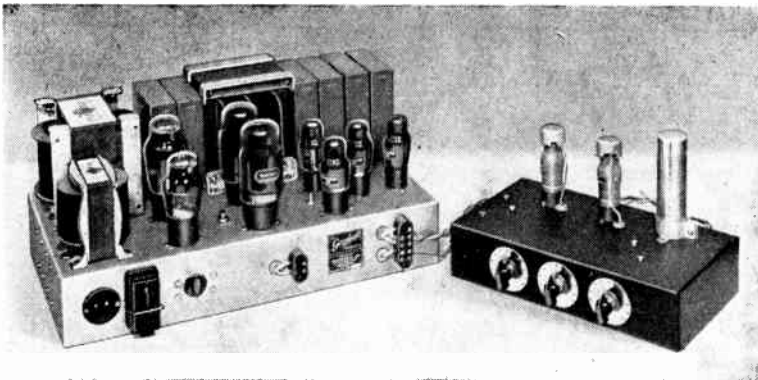

15 WATT HI-FIDELITY AMPLIFIER

AS DESCRIBED BY
T. D. N. WILLIAMSON
IN W.W. MAY 1947

*Illustrated Brochure
now available*

AS ILLUSTRATED WITH TWO SEPARATE
H.T. SUPPLIES £27 6 0

COMPLETE RANGE USING P.X.4's, K.T.66's OR
P.X.25's AVAILABLE FROM £17 17 0

tone control as illustrated giving sep-
arate control of bass and treble with
L.63's £6 0 0

with E.F.37's for high gain £6 6 0

PARTRIDGE TRANSFORMERS AND B.V.A VALVES AS STANDARD

MANUFACTURED
BY

GOODSELL LTD., 40, GARDNER ST., BRIGHTON

TELEPHONE BRIGHTON 6735

Easy Terms from LONDON RADIO SUPPLY CO., BALCOMBE, SUSSEX

MYCALEX

(REGD. TRADE MARK)

THE INSULATOR

*May solve your Insulation Problems
with the following*

UNIQUE COMBINATION OF PROPERTIES

- HIGH DIELECTRIC STRENGTH
- NON-TRACKING
- LOW-LOSS FACTOR
- RESISTANT TO FUNGUS GROWTH
- HEAT RESISTING
- WILL NOT SHRINK OR WARP
- MANUFACTURED TO CLOSE TOLERANCES
- LOW EXPANSION CO-EFFICIENT

MACHINED TO CUSTOMER'S REQUIREMENTS OR AVAILABLE
IN SHEETS, RODS AND MOULDINGS

Also makers of INGRAM MYCALEX Capacitors utilising MYCALEX
as a dielectric with plates moulded in, to form a sealed unit

Phone: CIRENCESTER 400 or send enquiries to

MYCALEX COMPANY LTD · ASHCROFT ROAD · CIRENCESTER GLOS

... but there is a difference in **VITAVOX** sound equipment

The BP 28 Beam Projector Loudspeaker, especially suitable for outdoor and marine installations and for overcoming high noise levels in factories, is an example of the high quality of VITAVOX products



Retail Price :
£16 0s. 0d.



VITAVOX LTD., WESTMORLAND RD., LONDON, N.W.9. Tel. COLindale 8671

MASTERPIECE IN MINIATURE

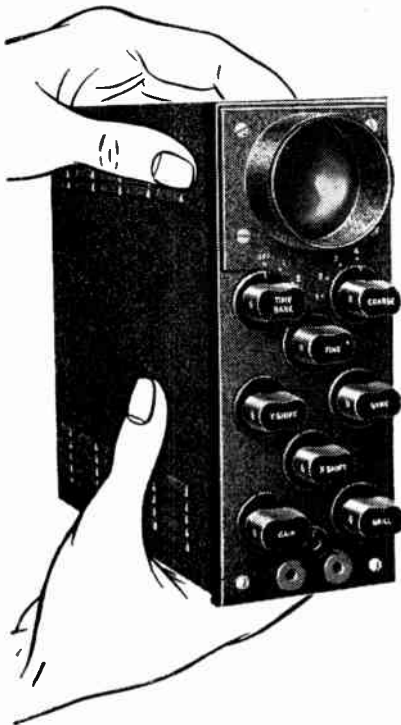

WIDTH	2½"
HEIGHT	6¾"
DEPTH	9¼"
C.R.T. DIAMETER	1½"
NETT WEIGHT	7½lbs

Miniscope

MINIATURE CATHODE RAY OSCILLOSCOPE BY **G.E.C.**

Full specification from: THE GENERAL ELECTRIC CO., LTD., MAGNET HOUSE, KINGSWAY, LONDON, W.C.2



MICRO-CELL

PICK-UP
CARTRIDGE

ESTABLISHES NEW
STANDARDS IN
PICK-UP DESIGN

The G.P.15 Micro-cell represents a great advance in the technique of sound reproduction. This new pick-up element can be used with equal facility on both standard 78 rpm. and microgroove recordings—the stylus pressure is only 7 grammes for long-playing records. The G.P. 15 unit is non-hygroscopic, and the crystal and stylus are afforded complete protection from mechanical damage.

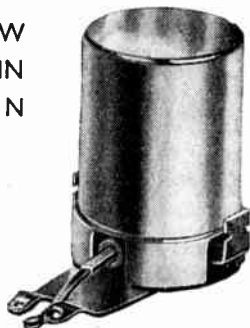

AN ACHIEVEMENT BY **COSMOCORD**

FAMOUS FOR RESEARCH
ON PIEZO-ELECTRIC
DEVICES

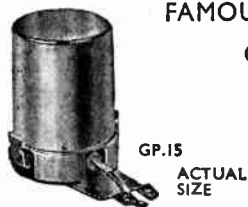

COSMOCORD LTD - ENFIELD - MIDDX.

*Phone: ENfield 4022



ELECTRONICALLY, the Mullard LSD3 is an extremely efficient light source device. Photographically, it is the ideal tube for lightweight portable equipments because of its compact dimensions, stable triggering and low trigger voltage, and very long life.

Some data is given here, and if you would like full details, including recently published articles on flash circuits, please write to the address below.

PRINCIPAL CHARACTERISTICS OF LSD3

Max. Energy of Discharge ...	100 joules
Operating Voltage ...	2,000-2,700V
Trigger Voltage ...	3,000-3,500V
Approx. Flash Duration ...	150 micro-secs
Peak Light Output ...	40 mega-lumens
Integrated Light Output ...	4,000 lumen-secs
Base ...	4-pin U.X.
Light Quality ...	Closely resembling daylight

Basic circuit for portable battery-operated flash equipment

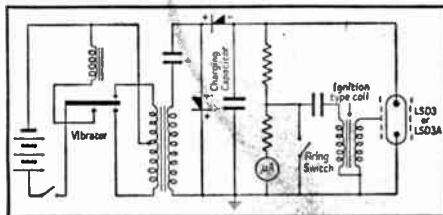

Mullard

Thermionic Valves & Electron Tubes
Mullard Electronic Products Ltd., Transmitting & Industrial
Valve Dept., Century House, Shaftesbury Avenue, W.C.2.



**Twin-cone
assembly
brings
new realism
to sound reproduction**

GOODMAN'S 'AXIOM TWELVE' is a high fidelity Loudspeaker that brings within reach of all the means of achieving a degree of fidelity usually obtained only from the most expensive and elaborate equipment. From the rich pulsation of the organ's pedal register to the delicate whisper of the E-string of the violin, the whole complement of the orchestra is strikingly recreated, and all the varied inflections of the human voice are so naturally rendered that this may truly be called "Living Reproduction." Send for fully descriptive leaflet D.49.

With the 'Axiom-Twelve' it is essential to use equipment specifically designed for High Fidelity reproduction.



GOODMANS

**AXIOM-TWELVE
12" P.M. LOUDSPEAKER**

Tully Dustproof

For use with 'Axiom Twelve' Goodmans High Fidelity Output Transformer Type H.4 is recommended. Supplied wound to individual specification.

GOODMANS INDUSTRIES, LTD., LANCELOT ROAD, WEMBLEY, MIDD. Phone: Wembley. 1200. Cables: "Goodaxiom, Wembley."

De
Luxe
&
Potted
Type

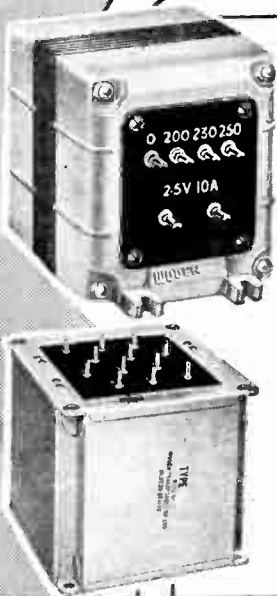

**WHEN ORDERING
TRANSFORMERS**

Specify

WODEN FOR RELIABILITY

TYPES AVAILABLE FOR:—

**TELEVISION EQUIPMENT,
QUALITY AMPLIFIERS,
TRANSMITTERS, ETC.**

send for Illustrated Catalogue and Price List of full range.

WODEN TRANSFORMER CO LTD

MOXLEY ROAD · BILSTON · STAFFS

TEL: BILSTON 41959.

OUTSTANDING OFFERS

for the discerning Amateur

BC454B. (The Famous "Command" Communications Receiver)
 Fitted 6 valves, types as follows: 3 12SK7's, 1 12K8, 1 12SR7, 1 12A6. Frequency Range 3-6mc's (50m-100m) IF value 1415kc's.
BC455B. Exactly the same specification but Frequency Range 6-9.1 mc's (30m-50m) IF value 2830kc's.
 Brand new in sealed cartons. **Unbeatable Value.**

each **30/-** Post 1/3

Full Circuit Diagram 1/-

Either set convertible to Medium Waves with our Special Coil Assembly, Price 10/- including Diagram of Connections.
 Special Press-in Tuning Spindle and Knob, 2/6.

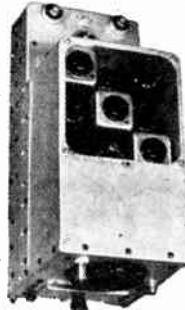

230v. A.C. COMMAND POWER PACK FOR BC453, BC454, BC455

45/-
 post paid

Wired and Tested. Fitted 6x5 Rectifier. Just Clip On. No Alterations to Wiring. Mains Cord fitted ready for instant use.

These units are manufactured by us exclusively to highest standard.

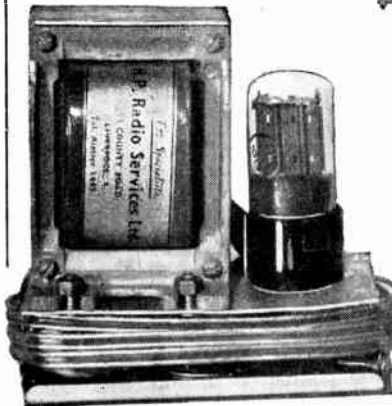

DELIVERY PER RETURN GUARANTEED

A few brand new BC348 Receivers, modified to 230 v. A.C. £19/10/-, R107 famous Army 9 valve Communication Receiver, perfect condition. £16/10/0.
Receiver BC1066B. 3 Valves 1D8GT and two acorns VT277. 2 Toggle switches, jack socket panel light, 2 precision dials. Frequency 150-225 mcs. Cabinet 14 x 8 x 8 matt black finish. Canvas carrying case. Chassis size 6in. square. Circuit supplied. Easily converted for 2 metre band. All parts specially designed for very high frequencies. Perspex mounted coils and tuning condensers etc. **BRAND NEW.** 21/- post paid.,
 R1132a, 11 valves, 100-126 Mc/s, good condition £32/6.
 R1355 Receivers, 10 valves, brand new in original crates. 49/6 carriage paid.
 RF25 and 26 units, brand new in original cartons. RF25 19/6; RF26 30/-; postage 1/3.
Wavemeters, class "C" No. 1, 3 ranges, 1360/7510 kc/s., excellent condition, ridiculous price to clear, 25 only, £1 each, carriage paid.
BC357 Marker Beacon Receiver, 62-80 Mc/s., fitted super relay, with 12C8 and 12SQ7. 9/-, less valves 3/6.
Milliammeters, brand new in sealed cartons, 0-1.5 mA. 5/-, postage 6d.
Transmitter Tuning Units, brand new. TU5B 22/6, TU6B and TU8B 19/6 carriage paid.
BC966A Geared Motor Generator, 13 valves, 7 6SH7, 3 6H6, 3 7193. AR88 Owners should get one of these for the valves alone (65H7 replaces 6SG7). 30/- each, carriage 5/-.
456B Modulator Units, 1625, 1215, UR150, brand new in sealed cartons. 19/6 carriage paid, or less valves 7/6.
I.F. Transformers for BC454 or BC455. 10/- per set of 3.
Amplifier Vibrator Packs, 12 volt, OZ4 and 6K6, new. 25/-
Mains Transformers, half shrouded, brand new, 350-0-350, 60 mA., universal L.T.'s. 19/- post paid.
Upright type 28 v. L.T., 220-0-220, 80 mA., 25/- post paid.

H.P. RADIO SERVICES LTD.

Britain's Leading Radio Mail Order House
 55 COUNTY RD., WALTON, LIVERPOOL, 4

Established 1935 Telephone: Aintree 1445
 STAFF CALL SIGNS GDGL G3DLV

BRIERLEY MICROARMATURE PICKUP

Type JB/P/A/I

Frequency range, 30 to 20,000 c/s.
 Permanent Point 6 times longer wearing than sapphire.
 Average point pressure, 1/2 oz.
 Floating Element design prevents arm torsional resonance.
 Output voltage: Model (a) 1/12th v. Model (b) 1/50th v.
 Price: Model (a) complete with mumetal screened coupling transformer and including Purchase Tax, £8/19/6. Model (b) (no transformer required), £7/17/8, including Purchase Tax.
 Point replacement, £1.

The illustration shows: A. Standard Armature and Needle. B. Miniature Needle to which is normally attached an armature or coil. C. The Brierley Microarmature complete with point. Wide frequency range necessitates small size, particularly if one rejects the possibility of working within and above the resonance band. Small size also permits the use of low point pressure with corresponding increased point life and lower record wear, but it also inevitably results in lower output.

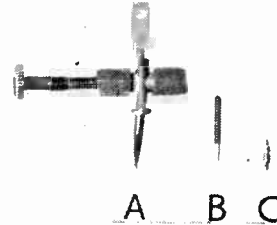

The Brierley Microarmature Pickup will not work with most domestic wireless sets but the output is high enough for most amplifiers and above the level below which the inexperienced are troubled with amplifier problems. The movement is robust and suitable for adult family use. Point life—on the basis that a sapphire tip will play 150 records with 1/2 oz.—is about 2,000 records. Details of this pickup, together with information on our new specialised JB/P/R/2 Ribbon Pickup—now provided with feedback ribbon and available with either standard or diamond point—will be sent on request.

J. H. BRIERLEY (GRAMOPHONES & RECORDINGS), LTD.,
 46, TITHEBARN STREET, LIVERPOOL.

TELE-RADIO (1943) LTD.

Components suitable for the "Williamson Quality Amplifier."

Chassis finished in attractive colour punched suitably for all components 27 6

TRANSFORMER AND CHOKES.

Mains transformer (Partridge) T425/150A 60 0

Output transformer (to specification) 100 0

WWOF/1.7 31 6

Partridge choke C13/200 16 0

Partridge choke C25/60 36 6

VALVES.

Matched Pair KT66, per pair 9 2

Osram L63 Triode each 18 3

Osram U52 Rectifier each 7 6

CONDENSERS.

T.C.C. 8-8 mfd. 450 v. wkg. 505 v. surge CE27P each 7 6

" 8 mfd. 500 v. 600 v. surge CE10P, each 6 6

" 8 mfd. 600 v. 700 v. surge type 922, each 15 0

" .25 mfd. 500 v. metalpack CP47S, each 2 10

" .05 mfd. 350 v. metalmite CP35N, each 2 0

Covern Potentiometer 100 ohms w/w, each 5 6

Bulgin Mains input plug and socket, each 3 0

Belling & Lee Panel mounting fuseholders, each 3 4

Belling & Lee 7-pin plug and socket, each 2 0

All specified resistances at list prices. Please include sufficient for postage and packing.

177, EDGWARE RD., PADDINGTON, LONDON, W.2
 'Phone: AMB 5393. PAD 6116, 5606.



It's got to be good

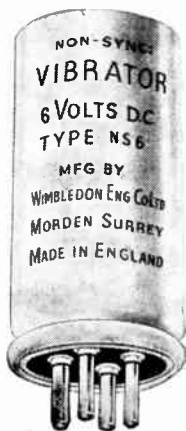

The heart of a Vibrator Power Unit (which supplies H.T. Current from low power D.C.) is the vibrator itself. Unless that gives a first class performance and goes on giving it for many, many hours, you have a heap of trouble on your hands. Hence the popularity of the "Wimbledon" Vibrator among many well known radio and electronic engineers. We have done a great deal of work on this Vibrator and we think it is just a little better than any other you can get. We are producing both synchronous and non-synchronous Vibrators and a complete range of Vibrator Power Units. Write for full details and judge them for yourself.

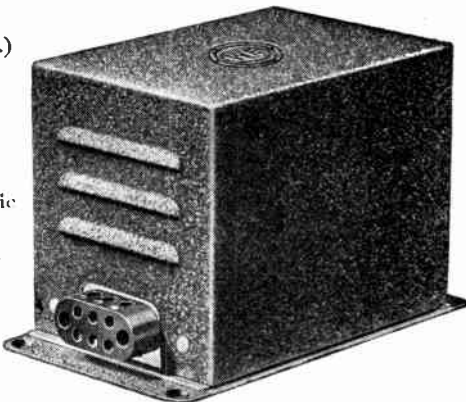

WIMBLEDON ENGINEERING COMPANY · LTD

GARTH ROAD · LOWER MORDEN · SURREY · TEL.: DERWENT 4814, 5010

CRC3

CELESTION SPEAKERS

The new and special magnets used in the construction of the Celestion 5in. and 6½in. speakers detailed below, provide a degree of efficiency hitherto unobtainable with permanent magnets. They represent the very latest method of speaker design and construction.

Chassis Model P6Q is also available as a Cabinet Speaker (size 9in. x 8in. x 4½in.). The attractive cabinet is fitted with volume control. Cabinet finish in Green, Cream or Brown. Ask for Cabinet Model CT115. Price £2/17/- (without transformer), suitable for outputs 1-5 ohms; or, price £3/3/- (with universal transformer). Suitable for all receivers.

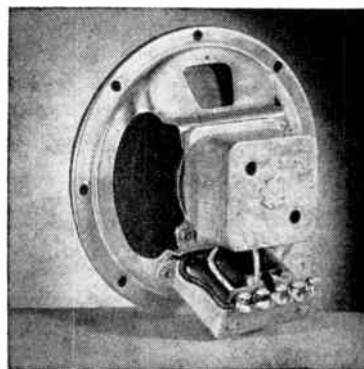

P5Q

WHERE TO BUY CELESTION SPEAKERS

The Public are requested to order from their local Radio Dealer.

Wholesalers are supplied by the sole Distributors: CYRIL FRENCH LTD., High Street, Hampton Wick, Middlesex. Phone: KINGston 2240.

Manufacturers should please communicate direct with CELESTION LTD.

Chassis Diameter	MODEL	Voice Coil Impedance (ohms)	Pole Diameter	Flux Density (Gauss)	Total Gap Flux (Maxwells)	Peak Power Handling Capacity
5"	P5Q	3.0	1 1/2"	8,500	26,000	2W
5"	P5T	3.0	1 1/2"	10,500	32,000	2W
6 1/2"	P6Q	3.0	2 1/2"	8,500	21,000	3W
6 1/2"	P6T	3.0	2 1/2"	10,500	32,000	3W

Write for Brochure "W.W." It gives details of all Celestion chassis and Cabinet Speakers.

CELESTION LTD., SUMMER ROAD, THAMES DITTON, SURREY

Telephone: EMBERBROOK 3402-5



BROWN—E.R.D. 13 inch Portable Disc Recorder
An Important S. G. Brown product

Brown-E.R.D.

DISC RECORDER

Incorporating the latest advances
in Sound-on-Disc Recording

Write for interesting brochures presenting full technical details of this latest development in Sound-on-Disc recording. Also 17 inch models for the Professional user.

S. G. BROWN LTD., Shakespeare St., WATFORD

Established in Electro Acoustics and high precision Engineering for over 40 years. Manufacturers of the world-famous 'BROWN' Gyro Compass.

Telephone : Watford 7241

Headphones which uphold British Prestige



TYPE "K."

S. G. BROWN, Type 'K'
Moving Coil Headphones, supply that High Fidelity Reproduction demanded for DX work, monitoring and laboratory purposes, etc.

OUTSTANDING CHARACTERISTICS.

D.C. RESISTANCE, 47 Ohms.
IMPEDANCE, 52 Ohms at 1,000 c.p.s.

SENSITIVITY, 1.2 x 10⁻¹⁰ Watts at 1kc. = .0002 Dynes/cm².

Descriptive Literature on request.

PRICE **£5.5.0** PER PAIR

Your Local Dealer can supply

For details of other S. G. Brown Headphones (prices from 30/- to 63/-) write for illustrated Brochure "W.W."

HEADPHONES WHICH UPHOLD BRITISH PRESTIGE

Telephone :
Watford 7241.

S. G. Brown, Ltd.

SHAKESPEARE STREET, WATFORD, HERTS.

Smallest — Best — Inexpensive! OSMOR "Q" COILPACKS

One-Hole Fixing—only 5 connections

HIGH "Q"

LOW-LOSS FORMERS

ADJUSTABLE CORES

NO WHISTLES

SIZE 3½ x 2½ x 1½

GIVES 20% IMPROVEMENT.

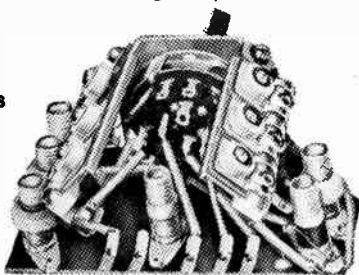

ALIGNED IN ACTUAL RECEIVER

MAKES A FACTORY JOB OF A HOME-BUILT SET

6 SEPARATE COILS

FULL CIRCUITS SUPPLIED.

S'HET (465 k/c) L.M.S., 33/-, M.S.S. and L.M. SHIPPING, 35/-, T.R.F. (L. & M.W.), 30/-. BATTERY MODEL, and other types available; also ATTRACTIVE GLASS DIAL ASSEMBLY in 3 colours, 7" x 7", calibrated for L.M.S. and L.M. SHIPPING.

INDIVIDUAL MIDGET COILS, ONLY 1" HIGH. HIGH "Q," IRON DUST CORED, S'HET and T.R.F., 3/- each. PROGRESSIVELY WAVE-WOUND, PERMEABILITY-TUNED COILS, T.R.F.

MATCHED RADIO and TELEVISION COMPONENTS AT ATTRACTIVE PRICES.

Write for particulars and bargain list (Trade enquiries invited).

OSMOR RADIO PRODUCTS LTD.

BRIDGE VIEW WORKS, BOROUGH HILL, CROYDON, SURREY
Tel. CRO. 1220.

Technical Excellence

combines with beauty and soundness of DESIGN in the

"OXLEY"

DIFFERENTIAL AIR DIELECTRIC TRIMMER

OXLEY DEVELOPMENTS CO., LTD.,
ULVERSTON, N. LANCs. Tel. Ulverston 3305

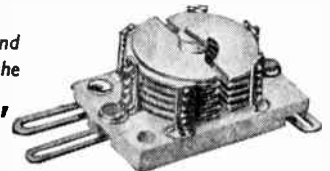

★ Width: 16.5 m/m Length: 26 m/m

Height:

1.5 to 8pF—8 m/m

1.8 to 20pF—10.5 m/m

2 to 26pF—11.5 m/m

2 to 32pF—12.5 m/m

Low: Straight line capacity

Power Factor: Less than .001

Insulation: Over 2,000 megohms

Voltage: 500 D.C.

JOSEPH ENOCK LTD.

Manufacturers and suppliers of the Enock Diamond Pick-up, the Enock Amplifier and the Mordaunt Loud Speaker, all built to the exacting specification which has made the Enock Instrument the finest music reproducer in the world.

JOSEPH ENOCK LTD., 273a HIGH ST. BRENTFORD, ENGLAND.
EAL ng 8103

Success through constant research—can we help you?

LOW LOSS CERAMICS

by

TAYLOR TUNNICLIFF

TAYLOR TUNNICLIFF (REFRACTORIES) LTD.,
Albion Works, Longton, Stoke-on-Trent, Staffs.
London Office: 125 High Holborn, W.C.1.
Phones: Stoke-on-Trent 5272 & Holborn 1951/2.



I.A.S./T.T.82

COULPHONE RADIO PRODUCTS MAINS TRANSFORMERS

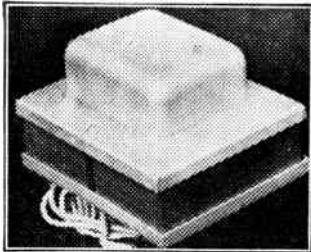

SELECTED EX-GOVT. SURPLUS

In response to numerous requests from clients in all parts of the U.K., I have decided to stock carefully selected ex-Govt. Radio Surplus—only equipment in sound condition being considered. If interested kindly send an extra 2½d. stamp for separate 18 page illustrated catalogue—the prices are the lowest in the country—it will save you £'s.
C. Coulbourn, G3AJM

EXAMPLES.

ROTHERMEL TORPEDO CRYSTAL MICRO-PHONES. Brand new in Maker's cartons. Current List Price is £18/18/-. My price, post paid, is £2/18/6.
A.M. BATTERY ELIMINATORS. A Super H.T. Eliminator for 200-250 v. A.C. Mains. Output 120 v. 30 mA. Voltage stabilised with VR150. Brand new in Maker's wrappings. Grey enamel case. Post paid for £1/17/6.
T.1154 TUNING PANELS. A real snip. Two single gang and one 2-gang tuning condensers with geared reduction drives, click stop mechanism and three 2½in. coloured knobs. Don't think I've made a mistake in the price? Post paid for 3/6.

Terms: C.W.O. or C.O.D.

15/6 Postage and Packing 1/6 extra

Coulphone Mains Transformers are made to the highest electrical standards and are fully guaranteed. We supply them to the Ministry of Supply Atomic Research Stations, so they will no doubt meet your requirements. Special quotations for quantities and types to order.

Standard Replacement Types. Drop-through chassis type with top shroud. Impregnated and interwound. Screened Primaries tapped for 200/250/280 volts.

- (a) 250-0-250 v. 60 mA. 6.3 v. 3 A., 5 v. 2 A. ... 15 6
- (b) 250-0-250 v. 60 mA. 4 v. 4 A., 4 v. 2 A. 15 6
- (c) 250-0-250 v. 80 mA. 0/4/6.3 v. 4 A. C.T., 0/4/5 v. 2 A. 18 0
- (d) 300-0-300 v. 80 mA. 0/4/6.3 v. 4 A. C.T., 0/4/5 v. 2 A. 18 0
- (e) 350-0-350 v. 80 mA. 0/4/6.3 v. 4 A. C.T., 0/4/5 v. 2 A. 18 0
- (f) 250-0-250 v. 100 mA. 0/4/6.3 v. 4 A. C.T., 0/4/5 v. 2 A. 21 0
- (g) 300-0-300 v. 100 mA. 0/4/6.3 v. 4 A. C.T., 0/4/5 v. 2 A. 21 0
- (h) 350-0-350 v. 100 mA. 0/4/6.3 v. 4 A. C.T., 0/4/5 v. 2 A. 21 0
- (i) 350-0-350 v. 150 mA. 0/4/6.3 v. 8 A. C.T., 0/4/5 v. 3 A. 38 0
- (j) 425-0-425 v. 180 mA. 6.3 v. 4 A. C.T., 6.3 v. 4 A. C.T., 5 v. 3 A. 43 6
- (k) 425-0-425 v. 180 mA. 4 v. 5 A. C.T., 4 v. 4 A. C.T., 4 v. 4 A. 43 6
- (l) 425-0-425 v. 180 mA. 6.3 v. 4 A. C.T., 4 v. 2 A. C.T., 4 v. 2 A. C.T., 5 v. 3 A. 46 0

Types (a) (b) (c) (d) (e) (f) (g) (h) (i) illustrated on left. Types (j) (k) (l) upright shrouded type.

WILLIAMSON OUTPUT TRANSFORMER

A super job exactly to author's specification. Upright mounting £3/12/6

Send 2½d. Stamp for New 32-page Catalogue.

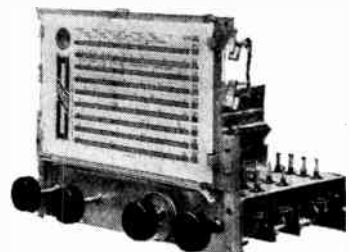

FEEDER UNITS

MODEL B DE LUXE (illustrated above). High gain R.F. stage operative on all nine wavebands. 45/145 M., 190/550 M., 900/2000 M. Plus six ranges of Bandspread, 13.5-14.8, 16-17.4, 19-20.5, 24.2-26, 30-32, 41-43.5 metres. Large colour printed glass dial, 10in. x 6in. aperture. Horizontal drive. Wave-range indicator and magic eye. Switched pick-up sockets. Volume and Tone Controls. Completely aligned ready for connection to audio amplifier. Price less valves £18/7/6.
Valves required, 6E50, 6K8G, 6K7G, 6Q7G, Y63. Price for set of five valves, £21/11/6.
MODEL A. A first class feeder unit with R.F. stage operative on all wavebands, 16/50, 190/550, 900/2000 metres. Switched pickup sockets. Volume control. Glass dial 8in. x 6in. in colour. Completely aligned ready for connection to audio amplifier. Price less valves, £10/6/6.
Valves required, 6K7G, 6K8G, 6E7G, 6Q7G. Price for set of four valves, £2/11/3.
A.F. AMPLIFIER POWER UNIT. Specially designed for use with above units. Employs 6V6G output (4 watts) and 5Z4G rectifier. Price less valves £4/10/-.
Two valves if required, £1/13/10.

NEW GOODS ONLY

COULPHONE RADIO 53 BURSCOUGH ST. ORMSKIRK, LANCs.

"The Return of Post Mail Order Service"

Tel.: Ormskirk496

THE NEW "75" SIGNAL GENERATOR Model 1

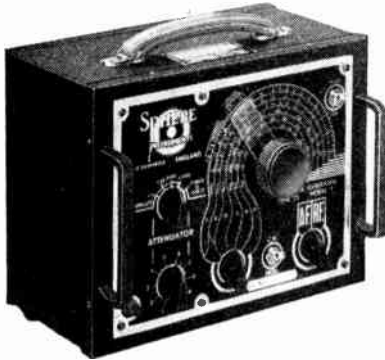

Frequency Range
110 to 50 Megacycles.
With calibrated extension covering London, & Midland Television frequencies, at over 60 Megacycles.

Modulation
400 C.p.s. sinusoidal.
Attenuator
5-step ladder, with fine control.

Output
Switched via single test-lead. R.F. and A.F. 1 volt Max.

External Radiation
Less than 1 micro-v.
For A.C. mains operation. Complete with Standard Dummy Aerial.



LIST **12 1/2** GNS. SUBJECT.

EXCELLENT PERFORMANCE
ATTRACTIVE APPEARANCE
LOW PRICE
HIGH EFFICIENCY

INQUIRIES INVITED:

SPHERE RADIO LIMITED
HEATH LANE, WEST BROMWICH, ENGLAND

Johnnie get your Gun!

YOURS FOR ONLY
6/6 MONTHLY
£1 DEPOSIT SECURES
10 monthly payments of 6/-



Get instant soldering heat!
Send your deposit to-day for this ultra-rapid electric soldering gun. Invaluable for radio servicemen, engineers and home mechanics. Simply plug in, press the button, and in seven seconds the iron's hot! Absolutely safe, the bit cools instantly button is released and lies clear of bench when not in use. Complete with two spare bits and four yards of flex. Suitable for A.C. 200-250 v. or 100-130 v. State model required. Limited stock. No interest charge. Leaflet on request.

Cash price £3. 19s. 6d. complete

BURGOYNE
SECOND Instant Heat
SOLDERING GUN

SEND YOUR DEPOSIT Today TO -

Ring Lamp Co.,
81, City Road, London, E.C.1.
Telephone: CLE. 7103

— Best Buy at Britain's —

LATEST RELEASES FROM THE MINISTRY AND

All absolutely Brand New in Makers' original packing. Rest assured that we have selected only those which were stored under perfect conditions, thus ensuring that no deterioration has taken place.
FIRSTLY — R3084. A 200 Mc/s Receiver employing 13 valves and ideal for conversion to a vision Receiver, containing as it does a 30 megacycle I.F. Strip and low consumption EF50 valves. Valve line up 2 EF54, 1 EC52, 7 EF50, 1 VU39A, 1 HV2R, 1 EA50 together with hosts of small components. Circuit diagram and full instructions for modification are supplied with each Receiver. COMPLETE IN WOODEN CRATE. Price £3/15/- plus 10/- carriage and packing. Order early.
AND — R1132A. Primarily for the UHF enthusiast. Covers 124-110 Mc/s and incorporates 10 valves, 5 meter, all in handsome metal case with slow motion dial. Power supply required is 200 v. H.T. 6v. L.T. READILY CONVERTED TO THE NEW 144 M/c HAM BAND! Priced at £4/19/6 plus 10/- carriage and packing. BRAND NEW IN WOODEN CRATE.

ALSO — R1224. This 5-valve battery superhet contains 2 VP23, FC2A, HL2 and KT2. Frequency coverage is 30-300 metres. Batteries required are H.T. 120 v., G.B. 9 v., L.T. 2 v. A communications receiver of sterling quality and outstanding performance, the R1224 is particularly suited for operation aboard trawlers and similar vessels. SUPPLIED BRAND NEW IN MAKERS' PACKING, and most reasonably priced at £4/19/6 plus 7/6 carriage and packing.

E.H.T. Transformers for the VCR97 Tube. Specifications: Primary 230 v. 50 cycles; Secondary 2,500 v. at 5 m/a., 4 v. at 1.1 amps (for CRT heater), and 4 v. (centre tapped) at 1.5 amps, thereby allowing either 4 v. or 2 v. high voltage rectifiers to be used. BRAND NEW AND GUARANTEED. ONLY 35/- POST FREE.

Postscript for all prospective TV constructors: Do not be alarmed into paying exorbitant prices for the RF25 Unit. We have available the RF24 at 10/6 which, with our concise instructions accompanying every Unit, is modified in a matter of minutes to suit the 45 M/cs band. A limited number of brand new RF24 Units also available, at 16/6 post free.

OUR STOCKS ARE HUGE AND VARIED. WHY NOT VISIT US AT OUR EASILY ACCESSIBLE LONDON PREMISES. A FULLY COMPETENT TECHNICAL STAFF ALWAYS IN ATTENDANCE. SEND FOR LIST "WW" NOW.



CHARLES BRITAIN (RADIO) LTD.
11, UPPER SAINT MARTIN'S LANE, LONDON, W.C.2
Shop hours 9-6, half-day Thursday. Open all day Saturday

"Cyldon"

MICA-DIELECTRIC
TRIMMER
CAPACITORS

Type No. 10
on: 1 1/2"
wide: 1 1/2"
high: 3/8"

SYDNEY S. BIRD & Sons, Ltd.
CAMBRIDGE ARTERIAL RD., ENFIELD, MIDDLESEX
Phone. Enfield 2071-2 "Grams: "Capacity. Enfield"

Varley
REGD. TRADE MARK

Products of
Quality & Reliability

MAINS TRANSFORMERS
A. F. TRANSFORMERS
THERMAL DELAY SWITCHES
SMOOTHING CHOKES
POWER RESISTANCES

Made by
OLIVER PELL CONTROL LTD
Telephone: WOOLWICH 1422-1426
CAMBRIDGE ROW • WOOLWICH • S.E.18

Irrespective of taxation your best investment for entertainment will be

The Amazing New Eleven Valve

Polyphonic Console

Wave range, **5-2,000** metres including Television Sound band

Circuit: R.F., Oscillator, two I.F. with Variable Selectivity, Diode Detection, Magic Eye indicator, two Tone Control Valves, terminated by our latest paraphase coupled push-pull amplifier with negative feedback, driving a Phase Inverter Dual Suspension Auditorium Speaker.

A combination that not only covers the Television Sound band, but provides the best possible reproduction, compatible with transmission.

CONSOLE **£65**, purchase tax ?

AUTO-RADIOGRAM **£79**, purchase tax ?



AGENTS: Barnes & Avis, Reading; Bowers & Wilkins, Worthing; Binns Ltd., Newcastle; Dalton & Sons Ltd. Derby; Clark & Sons, Isle of Wight; Hickie & Hickie Ltd., Reading (and branches); Holley's Radio Stores, London, S.E.5; Jewkes & Co., Birmingham; Thomas Lynn & Sons, Andover; Merriotts Ltd., Bristol; G. McCartney & Co., Belfast; Pank's Radio, Norwich; Sound Ltd., Cardiff; Bernhard Smith, Barnstable; Sound Services, Jersey, C.I.; Precision Services, Edinburgh; Seals Ltd., Southsea; G. E. Samways, Hazel Grove; Waybridge Radio Electric, Weybridge; West End Radio, Farnham; Vallance & Davison Ltd., Leeds (and branches).

Overseas Stockists in Canada, South Africa, Channel Islands, etc.

Sound Sales Ltd. WEST STREET, FARNHAM, SURREY

Telephone: Farnham 6461/2/3.

London Office: 57, St. Martin's Lane, W.C.2. Telephone: Temple Bar 4284.

University Radio, Limited

OFFER GUARANTEED USED EQUIPMENT AT ATTRACTIVE PRICES

Avo Model 7 A.C./D.C. Test Meter.		Hambander, complete with speaker. As new	£14 10 0	Latest model Columbia Record Player in case. As new	£9 0 0
As new at	£13 10 0	Eddystone 358X, with coils, speaker and power pack	£18 10 0	Collaro Motor and Pick-up Unit, rim drive	£4 10 0
Avo D.C. Minor. As new	£2 12 6	AR. 88, model D. Perfect condition	£37 10 0	Collaro Unit with Pick-up, not rim drive	£6 10 0
Avo Signal Generators. As new	£10 0 0	Hallicrafter, S.27. Perfect condition	£25 0 0	Garrard Mixer Type Record Changer, R.C.65/D16C. New	£18 0 0
Avo Minors. As new. A.C./D.C.	£5 10 0	Advance Signal Generators, Model B.C.3. As new	£15 0 0	Decca Light-weight Pick-up Head, latest model. As new	£2 10 0
Avo Cap. Res. Bridge. As new	£8 0 0	B.S.R. 10-watt portable Amplifier, with record player	£25 0 0	Ditto, with arm. As new	£4 0 0
Avo Model 40 Test Meter. As new	£11 10 0	B.S.R. P.A.20 Amplifier, portable	£20 0 0	Lexington Senior Pick-up with transformer. As new	£4 10 0
Avo Valve Testers. As new	£12 0 0	Rothermel, 4½ watt, quality Amplifiers. New	£8 10 0	Lexington Plug-in Heads, Garrard type	£3 0 0
Evershed Vignoles 500 V. Bridge Meggers	£20 0 0	Meico 30-watt Amplifier. As new	£16 10 0	Senior Crystal Pick-ups with volume control. New	£1 17 6
Wee Meggers, 500 V., with case	£8 10 0	Gray 30-watt Amplifier, special offer, with valves	£10 10 0	Ditto, without volume control. New	£1 15 0
Taylor Circuit Analyzer. As new	£10 10 0	Trix 30-watt Amplifier, in oak case, with gram unit and 12in. P.M. Speaker, Trix Mike and Stand	£45 0 0	Rotary Convertors of all types, D.C. to A.C.	£8 0 0
Taylor 20,000 O.P.V. Test Meter. As new	£14 0 0	Emor Globe type all-wave Radio Sets. New	£9 17 6	Goodman 12in. P.M. Speakers. As new	£4 0 0
Taylor Oscilloscope, Model 30. As new	£20 0 0	Crystaltone Record Player in case. As new	£6 0 0	Goodman's Axiom 12in. Speaker. As new	£5 17 6
Taylor Valve Testers. As new. Model 45AS	£13 10 0	Collaro Record Player in case. As new	£8 10 0	B.T.H. 12in. Speaker, P.M. As new	£4 0 0
Taylor Combined Valve Tester and A.C. D.C. Test Meter	£20 0 0				
Hunts Cap. and Res. Bridge, latest model. As new	£11 10 0				
Precision Instruments, Valve and Test Meter, portable	£17 0 0				
Weston 20,000 O.P.V. Model E772. As new. A.C., D.C. meter	£19 10 0				

Hundreds of other items too numerous to list at Bargain Prices. Please state requirements. No lists and no C.O.D. cash or cheque with order. All items listed are CARRIAGE PAID.

22 LISLE STREET, LEICESTER SQUARE, LONDON, W.C.2

Phone GERrard 4447 & 8582. Hours 9 to 6 Thursdays 9 to 1

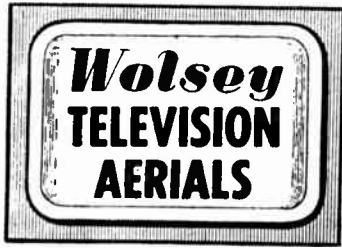

SIX TYPES INCLUDING TRIPLE REFLECTOR ARRAY

Specially designed for areas on the fringe of or beyond normal limits of transmission. Many reports have been received of very satisfactory results obtained with the Wolsey TR/MI Aerial in South and South West coast areas, also East Coast up to Gt. Yarmouth.

Brief Specification: Half Wavelength Dipole with Three Reflectors spaced at one-eighth wavelength. Reflector elements positioned at one-sixteenth wavelength from one another. Constructed of steel tubing, zinc plated. Duralumin Rods with Polythene V.H.F. Insulators and P.V.C. water-proof bushes. Weight only 5½ lbs. AERIAL ONLY

£6 15 0

Lashings and 16ft. Pole 67/6 extra.

New Models for **BIRMINGHAM**

Tele. Aerials Installed

now available from stock. Send for details.

over a radius of 40 miles from our works.

★ **Send For Illus. Brochures**

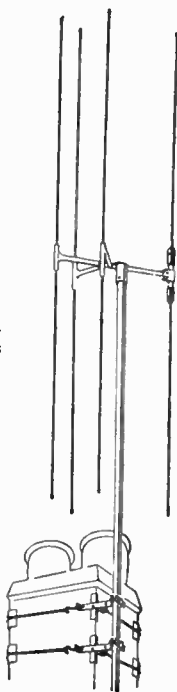

WOLSEY TELEVISION LTD,
75, GRESHAM RD., BRIXTON, LONDON, S.W.9
Phone: BRixton 6651/2 Established 1934

WILKINSON'S OF CROYDON

ELECTROLYTICS, 8 MFD 500 v. BR850, 3/- each, 34/- doz.
GOODMAN SPEAKERS, 8in. with transformer, in wall case, (Government Surplus) 21/-.

POWER UNIT, employing a 5Z4G and a high voltage rectifier 8U2150A, together with a .1mf. condenser, 2.5 kv. and other components, 17/6, postfree.

TELEVISION Unit, 2HP stages, 1 detector and 1 video amplifier, complete with 4 valves, adjustable iron cored coils, etc., brand new, only 45/-.

CATHODE RAY tube Unit, type 97, with 14 valves, C.R. Tube and various condensers, resistors, etc. Our price, only 65/-, carriage paid.

CATHODE RAY Receiver Indicator Unit. Brand new! Ex-U.S. Navy. Employing 40 useful valves, 2 Cathode Ray tubes, power pack, motor blower, Milliammeters, etc. The following are the valves: 13 6BN7GT, 8 6AC7, 2 6L6, 6 6L6G, 3 VR150-30, 1 2X2, 3 6U4G, 2 6X5G, 2 6H8. **SPECIAL PRICE £16/10/-.**

MUIR "AD SLOW MOTION DRIVES," 7/6 EACH.

VOLTMETERS, 0-300 volts A.C., moving iron, 2½in. dial, flush type, 17/6 EACH.

ARE SPARES KIT, including 32 valves individually boxed, 18 6SH7, 6 6HG, 8 7198, also many useful relays, Resistors, Condensers, and a Dynamotor with extended Spindle which will work as a powerful motor on 200/250 A.C. mains without alteration. 145 items in all, brand new, properly packed, 70/- complete.

CRYSTAL MULTIPLIER UNIT, 2 to 6.67 Mc/s in 3-switch steps, 807 Oscillator and tuning control. Brand new with two 807 valves, instruction books, etc. 55/- EACH.

RF AMPLIFIER, 100/124 Mc/s for 2VT62 Triodes in push, pull, standard 19in. rack mounting, easily modified for 144 Mc/s. Brand new 75/-.

"OHAN" PETROL GENERATING SETS, 12/15 Volts D.C. 30 amp., £35. List 24/-.

L. WILKINSON, 204, Lower Addiscombe Road, CROYDON.

Why you should use...



- 1 Maximum "Wetting" Capacity.
- 2 Accelerated Fluidity.
- 3 Moderate soldering bit temperatures.
- 4 Mechanical bonding and perfect Electrical conductivity ensured.
- 5 Minimum amount of solder used per joint.
- 6 Residue sets hard, is non-corrosive, and of high dielectric strength.
- 7 No harmful fume deposits.
- 8 Continuous, unvarying core.
- 9 Even distribution of activator in core.
- 10 Approved by Air Ministry and General Post Office.

Supplied in a wide range of Gauges and Alloys on 1 lb and 7 lb reels, works coils, or as required. Prices on application.

Sole Manufacturers:

H. J. Enthoven & Sons, Ltd., 15-18 Lime Street, London, E.C.3.
*Phone: MANston House 4533. Works: Rotherhithe, Croydon, Derbyshire.

FOR THE EXPERT



MOVING-COIL MICROPHONES

WITH THE WONDERFUL PATENTED DIAPHRAGM SUSPENSION

For recording, broadcasting and quality P.A. work, the Lustraphone models cannot be bettered. Send for details.

LUSTRAPHONE LTD.
84 BELSIZE LANE, N.W. 3.
HAMPstead 5515 and 5389

COVENTRY RADIO

COMPONENT SPECIALISTS SINCE 1925

SPECIAL OFFER

Parcel of components, contains 50 Resistors, 50 Condensers, 24 Valve Holders, a good selection of Tag Panels, Screws, Knobs, Lamp-holders, Sleaving and useful components.

ALL NEW AND UNUSED LIST VALUE OVER £5, Offered for £1 only, Carr. Paid.

Do not miss this opportunity to stock your workshop (only 500 parcels)

COVENTRY RADIO
DUNSTABLE ROAD, LUTON, BEDS.

MORSE CODE TRAINING



There are Candler Morse Code Courses

for **BEGINNERS AND OPERATORS**

Send for this Free "BOOK OF FACTS"

It gives full details concerning all Courses.

THE CANDLER SYSTEM CO.
(Room 55W), 121 Kingsway, London, W.C.2
Candler System Co., Denver, Colorado, U.S.A.

CRYSTAL OVENS TEMPERATURE CONTROLLED

(Admiralty Pattern 3190)

These ovens which are mains operated from 230 v. 50 cycle supplies, are ideal for quartz crystal standards and will give a stability with suitable crystals of better than two parts in a million. They are fitted with precision thermostat and external thermometer. Operating temperature, 50° Cent. Dimensions, Box, 6in. x 5in. x 10½in. deep. Panel 6½in. x 6½in. Weight, 13½ lb.

PRICE £4 17s. 6d. each.

Send for list of test gear

PIKE BROS.
86 MILL LANE, LONDON, N.W.6
Telephone: HAMPSTEAD 4219

Rate 6/- for 2 lines or less and 3/- for every additional line or part thereof, average lines 6 words. Box Numbers, 2 words plus 1/-. Press Day: May 1949 issue, first post Monday, April 4th. No responsibility accepted for errors.

WARNING

Readers are warned that Government surplus components which may be offered for sale through our columns carry no manufacturers' guarantee. Many of these components will have been designed for special purposes making them unsuitable for civilian use, or may have deteriorated as a result of the conditions under which they have been stored. We cannot undertake to deal with any complaints regarding any such components purchased.

NEW RECEIVERS AND AMPLIFIERS

H.R.O.-MX receiver, 9 coils, cabinet speaker, 2 power packs, a.c., and 6v battery; £75.—A.C.S. Radio, 44, Widmore Rd., Bromley, Kent.

24 V.C.R. 97 tube, single large, s.a.e. T.H. Products, 92, Leathwaite Rd., S.W.11, Bt. 4889.

ONE only Marconi VRC5A television and Radio Console, brand new 1949, price £110; buyer collects.—595, Christchurch Rd., Boscombe, Hants. [312]

19 49 bandspread feeder unit with R.F. stage, nine wavebands, 13.5-2.000 metres; 2 1/2 stamp for illustrated brochure.—Coulphone Radio, Ormskirk, Lancs. [2528]

FELICITY 5 watt amplifier, now only £14/19/9, response flat 40-15,000 distortion under 1%; extended range 8 watt amplifier, £27/10.—F.S.R. Ltd., 87a, Upper Richmond Rd., London, S.W.15.

AMPLIFIERS, new 60 watt heavy duty p.a. models, built for continuous rating and rack mounting, £40; early delivery, send for spec.—Broadcast & Acoustic Equipment Co., Ltd., Tomland, Norwich. [2905]

R.A.F. model 1155 new, complete with valves, £8/10, plus carriage; converted models, power packs, quality amplifiers, speakers, auto changers and cabinets reduced prices; send for list.—Broadcast & Acoustic Equipment Co., Ltd., Tomland, Norwich. [2906]

THE AC/2 pre-amplifier is now available, less power supply unit, complete in case for direct connection to the vision receiver's power supply unit via plug and socket; price £4/16 complete (Type A2); available soon a long-distance six-element aerial.—Particulars from Spencer West, Quay Works, Gt. Yarmouth, [3094]

TUNING units.—Full range of Denco, Lowther and Eddystone goods available, 5 to 10 wave-band gram chassis covering 3 to 60 Mc/s. 150 to 1,500 Kc/s, amplifiers for every use, television kits, radio kits, s.a.e. for leaflet of single items or illustrated catalogue, price 9d.—Mason's (W.W.), Wivenhoe, nr. Colchester, [3093]

CONNOISSEUR'S receiver—world-wide communication receiver or, by change of switch, very high quality reception of local stations on non-super-heric high fidelity receiver; basis R1155, 9-1,500 metres; bass and treble controls (auto to cut), gram input, P×4 push pull output, and all refinements.

FEEDER units as above, for use with external high quality amplifiers; write for details, or call for demonstration, R1155 specialists, receivers repaired and re-aligned, also modified as above, or to your requirements, R1155 circuit and valves, 2/- post free.—R.T.S., Ltd., 5, Gladstone Rd., Wimbledon, S.W.19. Tel. Lib. 3303. [1266]

C.J.R. ELECTRONIC & ELECTRONIC DEVELOPMENT Ltd., Hubert St., Birmingham, 6 (Aston Cross 2440), the Midlands specialist manufacturers of high fidelity equipment, for 'W.W. Williamson', 'Electronia', and other quality amplifiers built strictly to specification with finest components available; also tone control stages, loudspeaker cross-over units, contrast controls, and radio receivers; send 2 1/2d stamp for full details and prices. £2/33

THE Mighty Midget radio with the monster voice! a.c./d.c. 200-250v, 3-valve plus rec., highly polished walnut cabinet, high 'Q' coils, 200-500 metres, 5in speaker, 3-watts output, sent by return, £6/19/9, plus 9/6 carr., 12 months' guarantee, c.w.o. or c.o.d.; also 4-watt audio amplifiers, pick-up and tuner inputs, volume, tone and neg. feedback controls, fitted output trans., 2-3 ohms, 100-250v a.c., £5/19/6.—N.R.S., 102, Parkhill Rd., London, N.W.3. Culver 1453. [3126]

UNIVERSAL ELECTRONIC PRODUCTS, 356, Marylebone High St., W.1. Welbeck 4058. Specialists in the design and manufacture of high grade fidelity gramophone reproducers and radio units. If you are interested in obtaining the finest possible reproduction from recorded music we invite you to hear our equipment demonstrated in conjunction with the Wilkins and Wright coil pick-up and the Wharfedale corner cabinet speaker. We will gladly give you a quotation or the conversion of your existing gramophone into a first-class reproduction instrument, or for the design and construction of equipment to your own special requirements. Write for descriptive leaflets of our range of fidelity amplifiers and radio tuning units.

Partridge News

ALL COMPONENTS INDIVIDUALLY WOUND

★ ★ ★
OPEN, SHIELDED OR HERMETICALLY SEALED CONSTRUCTION

★ ★ ★
12 MONTHS GUARANTEE

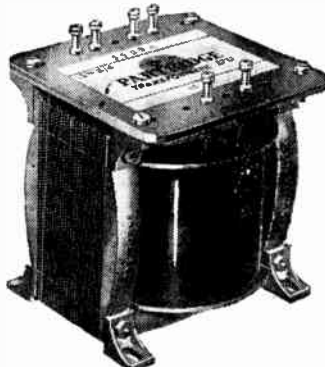

5 VA TO 25 KVA

★ ★ ★
SPECIAL TYPES WOUND TO ORDER IN 28 DAYS

★ ★ ★
IMMEDIATE DELIVERY OF OVER 100 DIFFERENT ITEMS FROM STOCK

(Price-list on request)

TELEPHONE **ELMBRIDGE** 6737-8

PARTRIDGE TRANSFORMERS LTD

Roebuck Road, Tolworth, Surrey

H.F. stage quality radio feeder unit, M. and L. wavebands, 8gns; local station feeder unit, 5gns, 6-watt push-pull high fidelity amplifier, 20-20,000 cycles response triode output, 12gns; complete with valves and guaranteed 12 months; technical data sheets on request; demonstrations at our offices any time by appointment.—Electro-Acoustic Developments, 18, Broad Rd., Lower Willingdon, Sussex. Tel. Polegate 534

MESSRS. JACKSONS (Hammersmith), Ltd., 171, King St., W.6, have been appointed agents for the sale of the R.T.M.C. Williamson amplifier; as quality specialists Messrs. Jacksons can thoroughly recommend the R.T.M.C. version of this now famous amplifier as being the finest reproducer so far made; built of finest components, first-class workmanship and offered at the right price, every quality fan should possess one of these amplifiers; 7-valve model, £27/10; 9-valve model with pre-amplifier, £32/10.—Call for demonstration or write for full details. [3025]

WILLIAMSON amplifier, now universally recognised throughout the world (vide large export orders) as the best quality reproducer manufactured to-day, the model made by R.T.M.C. (Ealing), Ltd., has been acclaimed as the best radio product on the market as no expense has been spared in producing a real quality job; we doubt whether any other amplifier even at 3 times the price has a better all-round performance; all seekers after quality reproduction should send for details; built of superb quality parts on extra heavy chassis with special cover; price £27/10; for use in the home or factory it should be the proud owner of a 'Williamson', gram motor, speakers, tuners, etc., also supplied; also sets of transformers and chokes; stamp for full details from pioneer makers.—R.T.M.C., Ltd., Laurel House, 141, Little Ealing Lane, W.5. Ealing 6962

RAM 25 watt amplifier and 10 watt speaker, both as new, £20.—Box 4755. [3044]

HRO, 4 coils, 30 mc/s, bandspread, £24.1 meter; £25, offer.—Box 4296. [2966]

G.W. SMITH & Co. (RADIO), Ltd., offers the following sound and perfect:—TELEVISION receivers, ex W.D.C., X.R. 3585, containing a complete 45m/c unit which comprises 5 TRF stages (EF50s), 1 diode stage (EA50) and Video stage (EF50), together with 18 other valves and many very useful component parts, brand new, £5/10; receiver type R3084A, brand new in sealed boxes, using EF50 valves, supplied complete with modification sheet, a cheaper but very good t/v unit, 75/1. R.4709 'Responcer Unit', 10-valve television receiver with a reception range up to 150 miles; this sounds silly, but we have a client using one at this distance and getting good results, a modification circuit is supplied, price 52/6, limited number only; type 26 U.T. units for the Birmingham t/v, brand new and boxed, 35/- each; spare dials for same, 5/- each; type 1355 for use with the 26 unit or 25 for the London area, 26/6 each; have you got the 'Inexpensive Television' book, 10/- free at 1/6?; this gives you all the information on the R1355; chokes 250ma, 7 henry, 8/6; 400ma, 5 henry, 3/6 each; 100ma, 7 henry, 6/6 each; 10 henry, 400ma, 9/6 each; transformers, 230 input, 1.25X1.250-volt, 800ma, with L.T. winding, 27/6 each; 380X380-volt, 300ma, no L.T. winding, tapped primary, 9/6 each; 5-amp L.T. chokes, 5/- each, nice large core, suitable for rewinds, 2,000mtd, 25-volt condensers, 3/6 each; 0.01 0.000-volt test condensers, 1/3 each; 0.02 ditto, 1/6 each; 1mfd, 2,000-volt working, 4kv test, 1/6 each; 1mfd, 1,000-volt working, 3/- each; 15pf, 2-gang, 1/- each; 15pf single gang, 6d each; meters, thermo coupled, 0-5amp, 0-5amp, 0-4amp, 0-6-amp, 2/9 each; 0-5ma m/c, 4/9 each; 0-20amp a.c., 7/6 each; wound television coils, 6d each, 5/6 dozen; Polystyrene, with dust cores, 4in formers only, with cores, 6d each, 4/9 doz; No. 18 receivers, brand new less valves, 12/6 each; callers only bargains, ex-R.A.F. E.H.T. power packs, type 280, complete with valves, 19/6 each; S.T.C. 30-watt a.c. mains amplifiers, less valves, 45/- each; ex-Admiralty a.c. mains amplifiers, 60-watt output, push-pull, 25/- each; 12-volt cutouts, 3/6 each; 12-volt starter relays, 3/6 each; E.H.T. sleeves, extra heavy, 3d lengths; 2-volt vib packs, 5/6 each; 24-volt vib packs, 2/6 each.

G.W. SMITH & Co. (RADIO), Ltd., 3, 11st London, W.C.2. Tel. Gerrard 8204. Open all day Saturday

R.C.A. AR88, 540kc/s-32mc/s, 14 valve [3156] perfect condition; offers near £65.—Box 4903, W.W. 8 watt Q amp., gram, pre-amp and tuner unit, new Dec., spare valves; £35.—Box 4301. [2972]

A.R.88 receiver, frequency range, 540 kc/s to 32 mcs, 7 spare valves; £60 or near offer.—Box 4748. [3010]

H.R.O. Senior, 8 coils (B.C. and Ham), s. meter Ktal, a.c. pack, speaker, realigned perfect, offers.—Box 4762. [3064]

3 only, as new Ferranti 12v car radio, surplus to requirements; to clear, £18, list price £36/19.—Enfields, 77, High St., Midsomer Norton. [2607]

A.R.88, slight damage, elect. O.K., £33; R1116, perfect tune, and cons. meter, £16/10; R1155N power pack and L.S., £18; Scotland, Box 4300. [2971]



ROUND THE WORLD IN ? DAYS.

Phileas Fogg, if you remember who he was, took eighty. An American bomber recently did it in four. In our case we admit, with some reluctance, that it has taken us longer. The first 215 speaker was sold late in 1946. Now, two and half years later, its performance and reputation span the earth, or circumnavigate, or sound round it—anyway, you know what we mean.

Why a small firm like us, with very little advertising, should be known and respected from Hollywood to New York, from Dublin to Durban, from Sydney to Singapore (not to mention Auckland to the Arctic) is just one of those things.

Obviously we cannot prove to a man 10,000 miles away, and before he has heard it, that the Hartley-Turner 215 is the one and only speaker he has really been looking for. He either takes our word for it, which displays a quite exceptional trust in human nature, or he likes our sane outlook on the weighty problems of high fidelity reproduction. But he buys it, and then he tells his friends to buy it too.

Our speaker is our ambassador, but it is not trained to tell lies politely. It tells the truth, whether you like it or not. But in a world tormented with political dogmas of all colours people are beginning to find that the truth is the one thing that matters.

In musical reproduction the Hartley-Turner speaker states the facts plainly and without distortion. All the other problems can be solved by reading "New Notes in Radio," now a "best-seller" in the U.S.A. as well as in Britain.

The speaker costs £9 (3s. part cost of carriage and packing in Britain); "New Notes in Radio" is half-a-crown, and our descriptive literature is free for the asking. And, if you want sure guidance in the buying of records the Hartley-Turner Selected Record Catalogue at 25s. will save its cost many times over.

H. A. HARTLEY CO. LTD.
152, HAMMERSMITH RD., LONDON, W.6. R/Verseid 7387

B.S.R. P.A.20 amplifier, as new, £28; 3
Rothermel Senior p.u.s, £1 each.—du Bois, 47, York Place, Edinburgh, 1. [2824]

1155, complete, self-contained; 18-1-1948. Cymbrkiewicz, Bayswater Court, 1, St. Stephens Gardens, W.2. [3007]

BAIRD T5 television, reconstructed for direct viewing, new 15in cr tube; £60.—Levy, 6, Amberden Ave., N.3. Pin. 2440. [3008]

FOR sale, Hallcrafters, S27 communications receiver, FM/AM 27-145 mc/s, in excellent condition; what offers?—Box 4897. [3104]

SCOTT Imperial auto-radiogram, 23 valves, 4 wavebands, 3 speakers; £95.—A.C.S. Radio, 44, Widmore Rd., Bromley, Kent. [2978]

TWO only Murphy V114 television superhet. 1948, price £55 each; buyer collects.—595, Christchurch Rd., Boscombe, Hants. [3133]

BAIRD console television 15½in tube, seen working, £45; also electro dynamic converter if needed.—2, Albert Gdns., E.1. [3125]

R1155 receiver with power pack for 220v a.c., built-in one-stage amplifier, 6F6, 8in Rola speaker, comp. mod. carr. paid; £42.99. [3133]

HALLCRAFTER Super Skyriider SX17, crystal S-meter amplifier, recently overhauled.—5, Station Rd., Benton, Newcastle-on-Tyne. [3133]

TELEVISION—Cossor 1210 Console, 15in C.R.T. plus A.W. radio, good order; £59/10; delivery anywhere.—223 Fleet Rd., Fleet, R.C.A. AR8D 535 kc/s to 32 mc/s, world's best communication receiver, new condition, perfect performance, complete with instruction manual; £60 or offer.—Box 4749. [3133]

B.C.348 communication receivers, ten valves, crystal gate, P.F.O. super dial, 200k/s to 18mc/s, with built-in carr. paid; £18/10.—G. Lawrence & Co., 3, Slater Place, Liverpool. [3133]

R.C.A. AR77, complete with speaker, in perfect condition, £35; also brand new Murphy A.104 baffle receiver, £23.—Thrift & Co., Penn Fields Terminus, Wolverhampton. [3133]

H receiver, in excellent condition, complete with power pack, loudspeaker and set of 6 coils; offers.—2112, Wm. Porteous & Co., Glasgow. [3133]

BENDIX R.A.I.B. 8-valve communication receiver, first-class condition, with power pack, speaker, service manual and spare valves; £25.—East, Cleaford, Lincs. Tel. 546. [3133]

NATIONAL H.R.O. Senior, power pack, coils, SX16, £20; many other items; s.a.e. list.—Cross, Skerries, Grange, West Kirby, Cheshire. [3203]

AMPLIFIER B.S.R. 11.8watts undistorted 25V radio connections; heavy duty energised speaker, all complete. £20; Phillips radio, walnut cabinet, mono control, £10.—363, Clayhall Ave. Hford. [2902]

A R88D, in cream and chrome table, cabinet, fitted with 1100k/s crystal calibrator, matched speaker and phones, used only 1 month, guaranteed perfect; £60 or offer.—107, Tower Hill, Birmingham, 22a. [3080]

MUST sell—BC348 receiver, excellent condition, 150w, 14/28 mc/s, Tx, rack mounted, 25w, 3.5 mc/s, Tx, rack mounted, both complete; no reasonable offer refused.—Button, 81, Woodbridge Rd., Guildford, Surrey. [3076]

HALLCRAFTER receiver typ SX24, Xtal, S meter, etc., 0.5 mcs to 46 mc/s; also Cossor D.B. model 339 oscilloscope, both absolutely as new; consider carrying in exchange, or offers about £50 for both.—Apply Box 4926. [3176]

15 gram. amplifiers complete, rack mounting, twin chassis, heavy duty iron cored components; 2 PX 25 in pp with valves, £8/15; less valves £4/10, plus carriage.—Broad-cast & Acoustic Equipment Co., Ltd., Tombland Norwich. [2907]

AMERICAN Scott Imperial receiver (chassis), full range, hi-fidelity, 27 valves, 35 watts output, volume expander, 3 speakers, spare valves, splendid instrument, recently overhauled by Alfred Imhoff, Ltd.; £65 or nearest offer. Box 4756. [3035]

R 1124 receivers, six universal valves, works on mains or batteries, conversion diagram with gen for television sound channel adaptability; bargain, 18/6, carriage paid; 1155s and AR88 for sale.—J. Rae, 39, Penn Rd., Wolverhampton. [3176]

BC342 receivers, complete, for 200-230v, 50 cycles a.c., 1.5-18mc/s, in six ranges, Xtal Gate, etc., guaranteed O.K.; £18/10; carr. extra.—Metropolitan Radio & Tele-Rentals, Ltd., 67, Lender Hs, 57, W.1. Battersea 4761. Bus 77 and 77a, tram 34, 26. [3091]

19/6, receiving units with 6 valves: 2 VR3, 2 VR56, 1 VR55, VR57; 79/6, portable mains receiver-transmitter, 4in x 8in x 10½in, 2 wavebands, 2 to 8 mc, 5 valves; 17/6, Duplex hand generator 6.3v 2amp, 350v 60ma, 120rpm; 15/-, control unit for T1154/R1155.—B.E.R., 39, Brighton Rd., Birmingham. [3095]

"W.W." qual. amp. phase splitter circuit, PP Kt66's, Williamson output trans., sound sales DX plus 1, radio feeder and phase inverter, speaker, tone control unit, G.E.C. design, H.M.V. playing desk with Hyper-ten pick-up; £55.—R. T. North, "The Nags Head," Sunningdale, Berks. Tel. Ascot 707. [3012]

CLEAR out bargains offered subject to being consold; National 1-10 receivers, complete power pack and all coils, £13/10; BC348, fully converted, with speaker (black crackle) to match, £25; Peter Pan 4-valve, 2 wave kits at £9/10; RCA 807s, boxed, 9/-; 1124 receivers, £1/10; sets by famous makers at less than cost; don't delay.—Enquiries with 2/6d stamp to Radio Constructors, 28, Spital Hill, Sheffield, 4. [3161]

AMAZING BARGAIN

Ex. M.O.S.
NEW & UNUSED ELECTRIC MOTORS

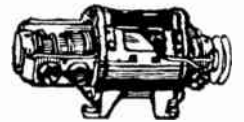

A.C. single phase, approx. one-sixth h.p., for 200/250 volts, 50 cycles. They're worth £'s. Dimension 11½in. long x 5½in. x 5in. Weight 16lb., shaft ½in. x 1in. Keyed ready for pulley. **See Die Cast Pulley 3½in. O.dia.** Supplied at 7/6 extra. Post Free.

25/- plus 6/- for carr. &c.

MOVING COIL HEAD & MICROPHONE SETS (Brand new)



Made by the same famous maker, these units must have cost the Government many pounds.

Our Bargain Price

PER SET **13/6** Post Free.

Send stamped address envelope for illustrated list.

WIRELESS INSTRUMENTS (LEEDS) LTD.
54-56, THE HEADROW, LEEDS 1.
Tel. 22262.

AMC TELEVISION

Manufactured to "Electronic Engineering" Telesivisor Specification.

NEW Improved LINE OUTPUT TRANSFORMERS

NEW Improved SET OF GANTRIES COMPLETE

NEW Improved FOCUS COILS

All Steel CADMIUM PLATED POWER AND TIME BASE CHASSIS valve-holders, 3 point and single socket and all necessary cut-outs.

SOUND PANEL CHASSIS ASSEMBLY, fitted with screens, valve-holders, formers and dust cores.

VISION PANEL CHASSIS ASSEMBLY, fitted with screens, valve-holders, formers and dust cores.

9" C.R. TUBE SUPPORT for mounting on top of Gantry Assembly.

9" CREAM MASKS.

5, SHAKESPEARE RD., FINCHLEY, N.3
*Phone: FINchley 2188

TELRAD ELECTRONICS, 70, Church Rd., Upper Norwood, London, S.E.19. Condensers 10pt to 500p, 8 ea., 6/- doz; 0.001mfd to 0.01mfd, 30 ea., 7/6 doz; 0.01mfd 2500v 1/3 ea., 12/- doz; 25mfd 25v, 1/3 ea., 4mfd 2/6 ea., 8mfd 3/- ea., 16mfd 4/- ea., 32mfd 5/9 ea., all 450v working; latest J.B. dials, 3 W.B. 24/- ea., with spin wheel drive 25/- ea.; Denco. Weare coils and components; new from stock at lowest prices, all specified components for W.W. and E.E. televisions; state your requirements.—Write, call or phone Liv. 4879. 3209

TELEBOOSTER for long range television. Input type R.F.2, slug and variable tuned. Input 40-48m/cs, 2 valve, 3 stage, coaxial plugs and sockets, size 5 1/4 in long, 2 1/4 in wide, 2 in deep; to be inserted in series with aerial wire, h.t. and l.t. from receiver chassis, V.R.91 valves (EQ. to EF50), glass approx. 30; constructed in steel and sprayed blue or grey; price £23/12/- R.F.1 as above but single valve, 4 tuned circuits, price £2/12/6; power units can be supplied, same size as chassis, price £4; s.a.s. for leaflet.—Boscombe Rad. Co. 595, Christchurch Rd., Boscombe, Bants. 1314

RECOYTE comprising Mag slip transmitter and receiver, as well as auto-transformer for operation direct from 200-240 volt mains, few only at 57/6 per set. complete with instructions, send also for list with data on other, coaxial and 45lb per inch torque; also 10 watt linear wirewound Berco M10 potentiometers, 1K 4/9, 50K 5/-; 2-gang carbon pots, 1 meg-1 meg, 3/6; all goods ex-Govt., but fully guaranteed and post free.—H.pton Ltd., 1, High Rd., London, S.W.16, Streatham 6165.

GEE ELECTRIC for reliable lines at competitive prices; satisfaction guaranteed; 6in C.R.T. mask for V.C.R.97, etc., blk., 3/6; 6in C.R.T. enlarger, 27/6+p.p. 1/8; ex-Govt. photoelectric cells, type C.M.G.25, 100v w., 7/- each; 12 in p.m. speaker, 10 in ex-53 set high 1/6; 75/-; new ex-Govt. 24v d.c. input, 230v a.c. output, 50v 100 watt rotary converters, only 55/-; centre zero 5-0-5 ma. meter, 2 1/4 dia., new, 8/6 each; 10-pin large octal plug and socket, ex-A.M., 2/-; 1-pin ditto, 1/9 pr.; phone plug and socket, P.40 3/-; pr. ex-53 set high 1/6; 50c headphones and mic., 10/6 set; 50mfd 50v w. electrolytic condensers, metal tubular, 2/- each; flexible screened and insulated mica, 9d yd, 8/6 dozen; 5 meg carbon pots, 1/4 in spindle, 2/6; a large selection of new ex-Govt. standard 2-pin plug-in crystals, 7/6 each (list available of same); postage extra; bulk inquiries invited.

GEE ELECTRIC, 15, Little Newport St., London, W.C.2. Ger. 6794. 3154

ELECTROLYTICS, Cans 8-16mfd, 450v, 3/11 ea., 38/- doz; 16-32mfd, 350v, 3/11 ea., 36/- doz; 32mfd, 350v, 2/6 ea., 27/- doz; 50mfd, 12v, 1/9 ea.; P.M. speakers, best makes, 5in L/T 10/6, 5in with transformer 12/11, 8in L/T 12/11, with trans. 16/9, 10in with trans. 23/9; chassis (resistor 16 ea. 6/-; minimum 10 ea. 8/-; 2 1/2 in 3 1/2 in 12/-; 2 1/4 in 4/3, 16-9-2 1/2 in 5/3, 20-8-2 1/2 in 6/8; Midget chassis 9/-; 4 1/2-1 1/2 in, fully punched for 4v T.R.F. 3/6; selenium rectifiers, small size, 600V 40ma H.W. 3/- ea., 30/- doz; 250V 55ma H.W. or V.D., 2/9 ea., 20/- doz; 250V 55ma H.W. or V.D., 6/6 ea., 36/- doz; 30ma H.W. 1/4 ea., 48/- doz; 120-0-120v F.W. 100ma, 3/- ea., 30/- doz; 120-0-120v F.W. 40ma, 2/9 ea., 27/- doz; 12v 1/4, 1/6 ea., 12/9 doz; R.A.F. test buzzers with Morse key and battery 3/9 ea.; Morse keys, super quality, 4/6; 4v battery, 1/6 ea.; 4v battery, new and used, 22v/4v, ea. 15/- doz; ex-Govt. block electrolytics, 32mfd 450v 1/9 ea. 16/6 doz; c.w.o. or c.o.d. post 1/- extra. All goods new and unused. Satisfaction guaranteed. Send 2/6 stamp for full list. Trade supplied.—Radio Supply Co., 15, Queen Square, Leeds, 2. PR209

21 only brings you one of the famous 21 model 30 coil packs; this pack has gained universal renown among amateur and professional radio engineers for its high quality workmanship and performance; brief specification: 3-watt band (L.M.S.) superhet pack for 465 kc/s I.F. single hole fixing, 6 individual high "Q" iron-cored coils, high stability close tolerance padders and trimmers; can be supplied completely aligned at an additional cost of 3/-; 5-volt circuit diagrams forwarded with each pack. In response to many requests we are now supplying a set of components, aligned and matched to each other, for the construction of the H.F. portion of a superhet receiver at only 69/-; this set comprises a 30 coil pack, 1 pair M.L. I.F. transformers, 2-gang condenser and the new superb horizontal J.B. tuning assembly with spin-wheel tuning and complete with bronze escutcheon and three-colour glass scale on black backing plate, a really magnificent unit! Also in stock: Model 40 coil pack, similar to model 30 but with provision for H.F. stage, £2/2 only; I.F. transformers at 10/- pair, and a comprehensive range of radio and television components at the lowest prices. The Home Constructor's Handbook contains details of all our products, many circuit diagrams, complete catalogue, colour codes, technical information, and radio constructional and repair information. This hand book which is normally priced at 2/6, we are now supplying entirely free with any order amounting to £1 or more. SUPACOILS, 98, Greenway Ave., London, E.17. [3114



Resistances. Special offer. Parcel containing 100 popular assorted values 1-watt type, 8/6 per 100, 1-watt type, 11/6 per 100. (Trade enquiries invited.)

M/Coil Speakers. Well-known mfrs.' surplus, all 2/3 ohms and P.M. 10in., 23/8; 8in., 17/- (15 ohm, 18/9); 6in., 10/6; 5in., 10/11 and 12/9 (with Transf., 18/8); 3in., 13/9; 2 1/2 in. 14/9. Energized also available in all sizes.

Tuning Cond. (Twin band). .0005 mfd. ceramic, 7/6 (with Trim., 8/8); .0003 mfd. with Trim., 8/6. Midget .0001 mfd., 6/-; Midget .0005 mfd., with Trim., 10/8; Midget .00035 mfd., 1 1/4 x 1 1/4 x 2 1/2 in. 10/8. 4-Gang .0005 mfd., 5/9; 3-gang .0005 mfd., 7/6.

Coils T.R.F. Matched pair, M. & L. 6/9. Weymouth ditto, 9/6 pair. 8/Eft. matched, 8.M. & L. 8/9, 10/6 and 11/8 pair. All Weare "P" Coils, 3/- each, including R.F., B.F.O. and A.F.

Vibrator Transf. 8V in, 250-0-250 v. 100 ma. out (also available in 12 v.), 9/6.

I.F. Transf. 465 kc. New well-known mfrs. surplus. 4in. x 1 1/2 in. 1 1/2 in. Perm. Tuned, 9/- each.

Potentiometers. Centralab. 5K, 10K, 25K, 50K, 100K, 1, 4, 1 and 2 Meg. less Switch, 4/3. With Switch, 6/-. Midget with Switch, 4/3 and 1 Meg. 6/-. Special 75 dia. with Switch, 4/6.

Electrolytics. B.E.C. Midget Can 8 mfd 450 v. 2/11; 8-8 mfd. 450 v. 7 dia. x 1 1/2, 4/9; 8-16 mfd. 450 v. 4/11. Dubilier 8 mfd. 500 v. Card. Tub., 4/-; T.M.C. 32 mfd. 450 v., 4/9 (and many other types).

Motor Rectifiers. Westinghouse. 0-5 ma, 4/9; 0-10 ma, 7/8; 0-1 ma, 10/6.

Selenium Rectifiers. H.T. hi-vac; 250 v. 50 ma, 5/9; 200 v. 100 ma, 5/9; 250 v. 100 ma, 7/6; 250 v. 300 ma, 13/9; Bridge Rect. 1 v. 1 1/2 amp., 6/9; 12 v. 1 1/2 amp., 12/6; 12 v. 3 amp., 24/-; 12 v. 6 a., 37/8; 10 v. 1 1/2 a., 37/8. Also L.T. 2 1/2 volt at 1 amp., 3/8.

Transformer. Each has input 230 v., outputs 24 v. (tapped 15 and 4 v.), 3 amps., 27/8; 2 v. (tapped 15 and 9 v.), 3 amps., 25/8; 15 v. (tapped 9 v.) 3 amps., 17/6.

Filament Transf. Input 200-250 v., output 6.3 v., 1 1/2 amp., 9/-; also with output 4 v., 1 1/2 amp., 9/-.

Ex-Govt. T.M.C. Reed-type Headphones, 70 ohms, 1/9 each (3/6 pair with leads). Single earphones, 75 ohms, with adjustable Headband, 1/8. Midget Output Trans. 32-1, and Paraflex Tfr., 4-1, both 1in. x 1 1/2 in. x 1 1/2 in., 3/- each. P/Pull Intervalve 2.5-1 each half. Output Tfr. 60-1, both 1 1/2 in. x 1 1/2 in., 3/- each. Transon Transf. Carbon Mike Inset, 6/9. Midget Intervalve Transf. 3-1, 5-1 or 10-1, 3/9 each. Multi-ratio Matching Transf. 4 windings (3 C.T.) over 10 ratios between 1.0 and 100-1, 2in. x 1 1/2 in. x 1 1/2 in., 12/9. 12 volt D.C. motor suitable for models, 19/6. Moving Coil Mike with R/R Switch, 2/6. M/Coil Headphone, 2/-. Carbon Hand Mike, with 3/8 inch dia. 2 1/2 in. 1 mfd., 5/00 volt Mainbridge 8/9. 2 1/2 mfd. 2,000 v. Mainbridge, 1/8. Throat Mikes, 3/6 5 mfd. 2 kv., 2/-.

Garrard A.C. 100/250 v. Gram. Motor with Turntable and Pick-up, Auto-stop, £5 18s. 6d.

Plessey Auto Changer, A.C. 100/250 v., 8 records mixed, Mag Pick-up, £18 8s. 6d.

Collaro Gram. Motor, Auto Stop, Turntable, A.C. 100/250 v., £5 18s. 6d.

L.F. Chokes. Midget 10 Hny. 250 ohm 40 ma, 3/6. Standard 16/90 Hny. 250 ohm 60 ma, 6/6. 20 Hny. 300 ohm 100 ma, 12/8; 5 Hny. 50 ohm 250 ma, 18/6. 30 Hny. 250 ohm 120 ma, 18/6.

Coil Packs. Osmer Midget 3 1/2 in. x 1 1/2 in. x 2 1/2 in. covers 8-M-L Wave, Iron Dust Core Coils, 33/-; Weymouth Standard, covers 8-M-L waves, 36/8.

Output Transf. Wharfedale Midget 30-60 or 90-1, 6/9. Filston Multi (over 12 ratios some O.T. for 12 v. 1 1/2 amp., 2/6). Kingsway Multi Ratio, all C.T. for P/Pull, out PX4, 61L, etc., handle 13 watts, 24/9 (also available in 30 watt type, 30/-).

Moving Iron A.C. Meter, 2 1/2 in. 0-300 volt, 12/9.

Rotary Transf. New. Input, 230 v. A.C., output, 12 v. D.C. 65 ma., 22/6. Also gives 490 v. A.C., output 12 v. D.C. (or 230 v. In. input 49 v. D.C. out), 19/8.

3-Watt Amplifier Kit. Consists of complete kit of parts, including M/Coil Speaker, to construct small Amplifier, ideal for home use on gram., price 72/6 (circuit supplied). Similar complete kits, with detailed instructions, can be supplied for Amplifiers with between 5 to 30 watt output.

★ Send 2d. stamp for very full Stock Lists. When ordering please cover packing and postage.

STERN RADIO LTD.
109 & 115, FLEET STREET, E.C.4.
Telephone: CENtral 5814 and 2280.

I.F.T.s 465, 6/- pr. 3 W.B. coil pack kit; eyelets, 8mfd, 450v, 2/-; 10P PF100 PF 8d; 1/3 gross; 0.3amp. 820ohm drop pers 2/3; mains transformers, 16/6; 50 PF trimmers 4d, knobs 4d. E.C. adaptors 5d; send for cheapest list in England.—Sussex Electronics Ltd. (C), Riley Rd., Brighton. [3126 4445.

FOR sale any reasonable offers considered. 5,000 Dubiler Minicap 0.01mf, 350v working; 9,000 Dubiler Minicap 0.01mf, 350v working; 10,000 Dubiler Minicap 0.005, 350v working; 6,000 T.C.C. type 543 0.01mf, 500v working; 5,000 T.C.C. type 543, 0.01mf, 500v working.—Apply Box No. A 2237, Haddons, Salisbury Square, London, E.C.4.

EX-GOV'T. buzzer repeaters, contain 8amp Morse key, high resistance earpiece, miniature surface switch, brass S.B.C., matten amp-holder, wired up, all mounted on heavy bakelite, Admiralty pattern, all for 5/11; eight bank multi auto-selector switches, 2/-, perfect, 15/-; 5ma instrument rectifiers, 2/-; transformers 230 in. out, 2-0-2 output, 6/-; electric 2 1/2 in screwdrivers, three for 2/-.—Fassingham (Dept. W.W.), North St., Keighley, Tel. 3680. [3166

RADIO CLEARANCE, Ltd., 27, Tottenham Court Rd., London, W.1.—Special clearance offer: Receivers, R.1481; to gain space, we offer the remainder of our stock of these well-known recs., brand new, in transit boxes complete with vaucou tuning meter, circuit diagram, etc., at £4/19/6, carr. pad.; receivers, R.U.19, 6-vacua straight rec., with 3 R.F. stages, using plug-in coils, H.R.O. type, valves 5-83, 2-7/5, 1-1642, back crackle case, 15x5x8in x 1 1/2 in., complete with 10 valves and 6 coil packs, covering 181-305, 281-455, 524-644, 1245-2155, 2960-4620, 3665-6265, 5075-7780, 8750-13950 c/s, £4/10, carr. paid; persons receivers, B.C.728, 7-vacua rec., using 1.4v valves, with 4 push-buttons covering 10 mc/s, supplied brand new, complete with 2 and 12v transformers, 2v A.C.C., telescopic A.E., etc., £9/9, carr. paid; mains trans., all primaries 200/250v 50c/s, sec. 230-0-250v 100ma, 5v 2a, 6.3v 2a C.T., 15/6; sec. 275-0-275v 120ma 4v 2a 4v 3a, 5/6; sec. 460v 200ma, 210v 100ma, 6.3v 5a, 16/6; step down trans. 200/250v to 110v, 60w rating, enclosed, 19/6; smoothing choke, 5v 120ma, 140l 5/-, 5h 200ma 90l 7/6, 15h 200ma 150l 9/6 (6 1/2 x 4 1/2 x 3 1/2 in.), 20h 300ma 150l 11/6 13/6 (size 7 x 5 x 5 20/-); electrolytics, 8mf 10v 1/9, 8mf 350v 2/5, 8mf 450v 2/6, 16mf 350v 3/7, 8mf 450v 8/8, 8 450v card 4/-, 8-24 350v 3/-, 16+16 350v 4/-, 16+24 350v 4/6, 16+16+16 450v card 4/6, 16+16 500v can 5/-, 8-32 450v can 5/-, 16+32 450v can 5/-, 32+32 450v card 5/-, 16+24-8 450v can 5/-, 24+32 450v card 6/6, 500mf 15v 1/6, 500mf 15v 1/6, 8mf 450v 8/8, 8 450v card 4/-, 8-24 350v 3/-, 16+16 350v 4/-, 16+24 350v 4/6, 16+16+16 450v card 4/6, 16+16 500v can 5/-, 8-32 450v can 5/-, 16+32 450v can 5/-, 32+32 450v card 5/-, 16+24-8 450v can 5/-, 24+32 450v card 6/6, 500mf 15v 1/6, 500mf 15v 1/6, 8mf 450v 8/8, 8 450v card 4/-, 8-24 350v 3/-, 16+16 350v 4/-, 16+24 350v 4/6, 16+16+16 450v card 4/6, 16+16 500v can 5/-, 8-32 450v can 5/-, 16+32 450v card 5/-, 32+32 450v card 5/-, 16+24-8 450v can 5/-, 24+32 450v card 6/6, 500mf 15v 1/6, 500mf 15v 1/6, 8mf 450v 8/8, 8 450v card 4/-, 8-24 350v 3/-, 16+16 350v 4/-, 16+24 350v 4/6, 16+16+16 450v card 4/6, 16+16 500v can 5/-, 8-32 450v can 5/-, 16+32 450v card 5/-, 32+32 450v card 5/-, 16+24-8 450v can 5/-, 24+32 450v card 6/6, 500mf 15v 1/6, 500mf 15v 1/6, 8mf 450v 8/8, 8 450v card 4/-, 8-24 350v 3/-, 16+16 350v 4/-, 16+24 350v 4/6, 16+16+16 450v card 4/6, 16+16 500v can 5/-, 8-32 450v can 5/-, 16+32 450v card 5/-, 32+32 450v card 5/-, 16+24-8 450v can 5/-, 24+32 450v card 6/6, 500mf 15v 1/6, 500mf 15v 1/6, 8mf 450v 8/8, 8 450v card 4/-, 8-24 350v 3/-, 16+16 350v 4/-, 16+24 350v 4/6, 16+16+16 450v card 4/6, 16+16 500v can 5/-, 8-32 450v can 5/-, 16+32 450v card 5/-, 32+32 450v card 5/-, 16+24-8 450v can 5/-, 24+32 450v card 6/6, 500mf 15v 1/6, 500mf 15v 1/6, 8mf 450v 8/8, 8 450v card 4/-, 8-24 350v 3/-, 16+16 350v 4/-, 16+24 350v 4/6, 16+16+16 450v card 4/6, 16+16 500v can 5/-, 8-32 450v can 5/-, 16+32 450v card 5/-, 32+32 450v card 5/-, 16+24-8 450v can 5/-, 24+32 450v card 6/6, 500mf 15v 1/6, 500mf 15v 1/6, 8mf 450v 8/8, 8 450v card 4/-, 8-24 350v 3/-, 16+16 350v 4/-, 16+24 350v 4/6, 16+16+16 450v card 4/6, 16+16 500v can 5/-, 8-32 450v can 5/-, 16+32 450v card 5/-, 32+32 450v card 5/-, 16+24-8 450v can 5/-, 24+32 450v card 6/6, 500mf 15v 1/6, 500mf 15v 1/6, 8mf 450v 8/8, 8 450v card 4/-, 8-24 350v 3/-, 16+16 350v 4/-, 16+24 350v 4/6, 16+16+16 450v card 4/6, 16+16 500v can 5/-, 8-32 450v can 5/-, 16+32 450v card 5/-, 32+32 450v card 5/-, 16+24-8 450v can 5/-, 24+32 450v card 6/6, 500mf 15v 1/6, 500mf 15v 1/6, 8mf 450v 8/8, 8 450v card 4/-, 8-24 350v 3/-, 16+16 350v 4/-, 16+24 350v 4/6, 16+16+16 450v card 4/6, 16+16 500v can 5/-, 8-32 450v can 5/-, 16+32 450v card 5/-, 32+32 450v card 5/-, 16+24-8 450v can 5/-, 24+32 450v card 6/6, 500mf 15v 1/6, 500mf 15v 1/6, 8mf 450v 8/8, 8 450v card 4/-, 8-24 350v 3/-, 16+16 350v 4/-, 16+24 350v 4/6, 16+16+16 450v card 4/6, 16+16 500v can 5/-, 8-32 450v can 5/-, 16+32 450v card 5/-, 32+32 450v card 5/-, 16+24-8 450v can 5/-, 24+32 450v card 6/6, 500mf 15v 1/6, 500mf 15v 1/6, 8mf 450v 8/8, 8 450v card 4/-, 8-24 350v 3/-, 16+16 350v 4/-, 16+24 350v 4/6, 16+16+16 450v card 4/6, 16+16 500v can 5/-, 8-32 450v can 5/-, 16+32 450v card 5/-, 32+32 450v card 5/-, 16+24-8 450v can 5/-, 24+32 450v card 6/6, 500mf 15v 1/6, 500mf 15v 1/6, 8mf 450v 8/8, 8 450v card 4/-, 8-24 350v 3/-, 16+16 350v 4/-, 16+24 350v 4/6, 16+16+16 450v card 4/6, 16+16 500v can 5/-, 8-32 450v can 5/-, 16+32 450v card 5/-, 32+32 450v card 5/-, 16+24-8 450v can 5/-, 24+32 450v card 6/6, 500mf 15v 1/6, 500mf 15v 1/6, 8mf 450v 8/8, 8 450v card 4/-, 8-24 350v 3/-, 16+16 350v 4/-, 16+24 350v 4/6, 16+16+16 450v card 4/6, 16+16 500v can 5/-, 8-32 450v can 5/-, 16+32 450v card 5/-, 32+32 450v card 5/-, 16+24-8 450v can 5/-, 24+32 450v card 6/6, 500mf 15v 1/6, 500mf 15v 1/6, 8mf 450v 8/8, 8 450v card 4/-, 8-24 350v 3/-, 16+16 350v 4/-, 16+24 350v 4/6, 16+16+16 450v card 4/6, 16+16 500v can 5/-, 8-32 450v can 5/-, 16+32 450v card 5/-, 32+32 450v card 5/-, 16+24-8 450v can 5/-, 24+32 450v card 6/6, 500mf 15v 1/6, 500mf 15v 1/6, 8mf 450v 8/8, 8 450v card 4/-, 8-24 350v 3/-, 16+16 350v 4/-, 16+24 350v 4/6, 16+16+16 450v card 4/6, 16+16 500v can 5/-, 8-32 450v can 5/-, 16+32 450v card 5/-, 32+32 450v card 5/-, 16+24-8 450v can 5/-, 24+32 450v card 6/6, 500mf 15v 1/6, 500mf 15v 1/6, 8mf 450v 8/8, 8 450v card 4/-, 8-24 350v 3/-, 16+16 350v 4/-, 16+24 350v 4/6, 16+16+16 450v card 4/6, 16+16 500v can 5/-, 8-32 450v can 5/-, 16+32 450v card 5/-, 32+32 450v card 5/-, 16+24-8 450v can 5/-, 24+32 450v card 6/6, 500mf 15v 1/6, 500mf 15v 1/6, 8mf 450v 8/8, 8 450v card 4/-, 8-24 350v 3/-, 16+16 350v 4/-, 16+24 350v 4/6, 16+16+16 450v card 4/6, 16+16 500v can 5/-, 8-32 450v can 5/-, 16+32 450v card 5/-, 32+32 450v card 5/-, 16+24-8 450v can 5/-, 24+32 450v card 6/6, 500mf 15v 1/6, 500mf 15v 1/6, 8mf 450v 8/8, 8 450v card 4/-, 8-24 350v 3/-, 16+16 350v 4/-, 16+24 350v 4/6, 16+16+16 450v card 4/6, 16+16 500v can 5/-, 8-32 450v can 5/-, 16+32 450v card 5/-, 32+32 450v card 5/-, 16+24-8 450v can 5/-, 24+32 450v card 6/6, 500mf 15v 1/6, 500mf 15v 1/6, 8mf 450v 8/8, 8 450v card 4/-, 8-24 350v 3/-, 16+16 350v 4/-, 16+24 350v 4/6, 16+16+16 450v card 4/6, 16+16 500v can 5/-, 8-32 450v can 5/-, 16+32 450v card 5/-, 32+32 450v card 5/-, 16+24-8 450v can 5/-, 24+32 450v card 6/6, 500mf 15v 1/6, 500mf 15v 1/6, 8mf 450v 8/8, 8 450v card 4/-, 8-24 350v 3/-, 16+16 350v 4/-, 16+24 350v 4/6, 16+16+16 450v card 4/6, 16+16 500v can 5/-, 8-32 450v can 5/-, 16+32 450v card 5/-, 32+32 450v card 5/-, 16+24-8 450v can 5/-, 24+32 450v card 6/6, 500mf 15v 1/6, 500mf 15v 1/6, 8mf 450v 8/8, 8 450v card 4/-, 8-24 350v 3/-, 16+16 350v 4/-, 16+24 350v 4/6, 16+16+16 450v card 4/6, 16+16 500v can 5/-, 8-32 450v can 5/-, 16+32 450v card 5/-, 32+32 450v card 5/-, 16+24-8 450v can 5/-, 24+32 450v card 6/6, 500mf 15v 1/6, 500mf 15v 1/6, 8mf 450v 8/8, 8 450v card 4/-, 8-24 350v 3/-, 16+16 350v 4/-, 16+24 350v 4/6, 16+16+16 450v card 4/6, 16+16 500v can 5/-, 8-32 450v can 5/-, 16+32 450v card 5/-, 32+32 450v card 5/-, 16+24-8 450v can 5/-, 24+32 450v card 6/6, 500mf 15v 1/6, 500mf 15v 1/6, 8mf 450v 8/8, 8 450v card 4/-, 8-24 350v 3/-, 16+16 350v 4/-, 16+24 350v 4/6, 16+16+16 450v card 4/6, 16+16 500v can 5/-, 8-32 450v can 5/-, 16+32 450v card 5/-, 32+32 450v card 5/-, 16+24-8 450v can 5/-, 24+32 450v card 6/6, 500mf 15v 1/6, 500mf 15v 1/6, 8mf 450v 8/8, 8 450v card 4/-, 8-24 350v 3/-, 16+16 350v 4/-, 16+24 350v 4/6, 16+16+16 450v card 4/6, 16+16 500v can 5/-, 8-32 450v can 5/-, 16+32 450v card 5/-, 32+32 450v card 5/-, 16+24-8 450v can 5/-, 24+32 450v card 6/6, 500mf 15v 1/6, 500mf 15v 1/6, 8mf 450v 8/8, 8 450v card 4/-, 8-24 350v 3/-, 16+16 350v 4/-, 16+24 350v 4/6, 16+16+16 450v card 4/6, 16+16 500v can 5/-, 8-32 450v can 5/-, 16+32 450v card 5/-, 32+32 450v card 5/-, 16+24-8 450v can 5/-, 24+32 450v card 6/6, 500mf 15v 1/6, 500mf 15v 1/6, 8mf 450v 8/8, 8 450v card 4/-, 8-24 350v 3/-, 16+16 350v 4/-, 16+24 350v 4/6, 16+16+16 450v card 4/6, 16+16 500v can 5/-, 8-32 450v can 5/-, 16+32 450v card 5/-, 32+32 450v card 5/-, 16+24-8 450v can 5/-, 24+32 450v card 6/6, 500mf 15v 1/6, 500mf 15v 1/6, 8mf 450v 8/8, 8 450v card 4/-, 8-24 350v 3/-, 16+16 350v 4/-, 16+24 350v 4/6, 16+16+16 450v card 4/6, 16+16 500v can 5/-, 8-32 450v can 5/-, 16+32 450v card 5/-, 32+32 450v card 5/-, 16+24-8 450v can 5/-, 24+32 450v card 6/6, 500mf 15v 1/6, 500mf 15v 1/6, 8mf 450v 8/8, 8 450v card 4/-, 8-24 350v 3/-, 16+16 350v 4/-, 16+24 350v 4/6, 16+16+16 450v card 4/6, 16+16 500v can 5/-, 8-32 450v can 5/-, 16+32 450v card 5/-, 32+32 450v card 5/-, 16+24-8 450v can 5/-, 24+32 450v card 6/6, 500mf 15v 1/6, 500mf 15v 1/6, 8mf



5 SOLON MODELS

SOLON electric soldering irons have proved their capacity for continuous service under the most exacting conditions. 5 models; 240 watt oval tapered hot; 125 watt oval tapered and round pencil bits and 65 watt oval tapered and round pencil bits. Each model complete with 8 feet of Henley 3-core flexible. Now available from stock. Write for folder Y.10.



W. T. HENLEY'S TELEGRAPH WORKS CO. LTD.
81-83 Hatton Garden, London, E.C.1

TRANSFORMERS & COILS TO SPECIFICATION.

MANUFACTURED OR REWOUND
Filter Coils + 1% a Speciality.

JOHN FACTOR LTD.
9-11 EAST STREET, TORQUAY, DEVON
Phone: Torquay 2162

HILL & CHURCHILL LTD.

BOOKSELLERS
SWANAGE, DORSET

Available from stock

- "Radio Handbook"—Smith—11th Edition—U.S.A. 21/-
- "Antenna Manual"—Smith—latest ed. 21/-
- "Theory of Thermionic Tubes"—Chaffee 39/-
- "Principles of Radio Engineering"—Glasgow 30/-
- "Television"—Zworykin & Morton ... 42/-
- "Fields and Waves in Modern Radio"—Ramo & Whinnery—U.S.A. 33/-
- "Electric Circuits and Wave Filters"—Starr—English 25/-
- "R.F. Measurements by Bridge and Resonance Methods"—Hartshorn—4th Imp. 21/-

Postage Extra.

CATALOGUE ON APPLICATION

G. A. RYALL, "Utopia," Mayfield Rd., Herne Bay, Kent; mail order only; postage or carriage extra; c.o.d. £1 or over; special list for the trade; U.S.A. tubular metal cased wire ended 0.1m.f. 500v 7/6 doz., 350v 5/4 doz.; U.S. tubular metal cased wire ended 0.5m.f. 350 7/6 doz.; Mansbridge 1m.f. 500v wkg. 3-2/-; Mansbridge 4m.f. 400v wkg. 2/3 each; silver mica 10p.f., 40p.f. 200p.f., 300p.f., 400p.f., 500p.f. 3/6 doz.; mica 0.01m.f. 5-1/3; all condenser guaranteed; Amphenol type British 5-1/3; chassis valve holders, 3/6 doz.; international octal chassis valve holders, paxolin. 4/-; bar type 3-gangs 5/-; bar type 4-gangs 5-/-; resistors 1/2 watt and 1/4 watt assorted 100 ohms to 2 meg. level assortment 40-5/-; switches, SB. 2P 6w miniature 1/6. 3B. 2P 6w five poles total 2/3 each; SB. 9w 2/-, 2B SP 6w 1/6. SB. SP. 3w 1/-, 2B. 3P. 3w 2/-, SB. 2P. 4w 1/3; twelve-way group boards with 9-1w and 1/2w resistances, etc., 2/-, all new; twenty other types in stock; octal plugs, cap and chassis socket, 3-3/-; with tags 3-3/6; high resistances, phones with sponge earcaps, with good class microphone, all wired into plug type 10H 10991, 10/9 pair; metal boxes, black finish with quarter inch paxolin panel, fixing lugs and corner sockets, size 8 1/2 x 7 1/2 x 3 1/2 deep, 6/9 each new; 10,000 ohm bakelite case volume controls medium spindle 1/6; metal cased minimum depth 1/2 meg vols., short spindle 1/6 each; special list for trade. [1613]

GENUINE bargains by post.—Potentiometers, wire wound, 1K, 5K, 10K, 20K, 25K, 2/-; Selenium rectifiers, 1/2 watt, 80ma., 3/9; tuning condensers, 0.0005 2-gang, 7/3; volume controls with switch, 1/4, 1/2, 1meg. 5/11; output transformers, pentode, 4/6; filament transformers, input 200-250v, output 6.3v 1.5a 7/6, 6.3v 3a 9/-; p.m. speakers, well-known manf., 5in with trans. 15/-; 8in with trans. 17/-, 10in with trans. 22/-; electrolytics: 16mfd 350v, all. can. 2/3; 32mfd 350v, all. can. 2/3; 16-18mfd 450v, all. can. 4/6; 25mfd 25v, all. can. 1/3; 8mfd 500v, card tub., 3/9; 2mfd 350v, card tub., 1/3; special offer, 0.02 by 8K, 4/9; i.f. chokes: 20henries 360ohms 60 ma., 7/6; 10henries 100ohms 100ma., ex-Govt., 4/-; 10henries 200ohms 150ma., 14/-; 5henries 120ohms 250ma., 18/-; send 2/6 stamp for complete lists; mail order only; please cover cost of postage and packing, cash with order.—A.R.K., 4, Queen Sq., Brighton, Sx. [3186]

WESTECTORS, WX6 and W112, clean, unused, 9d each; switches, rotary, 2-bank each, 3-pole 3-way, 2/3 each, 6 for 12/-; 2-bank each, 2-pole 2-way, no stop, 1/11 each; 1-bank 1-pole 2-way, no stop, 1/11 each; sockets; B/L 7-pin chassis socket and pin; 1/6 pr. 3 for 4/-; Systoflex 1mm 1/2 x 1/4 in co-ax polythene, 75ohm, 9d yd; valve holders, 6-pin amphenol, 6d; int. oct. 6d; EF50 ceramic, 1/-, diode cradle, 6d; BBA, 2/-; speakers, Celestion, 3 1/2 in, bargain, as new, high quality guaranteed, 15/6; Plessey 5in, less trans 16/6, with trans 18/-; meters, San West 1ma, 2in rd. fl. 12/6, 9/6; San West 5ma, 1 1/2 in rd. fl. m/c, scaled 0-100, 18/-; Ferranti 1ma, 2 1/2 in rd. fl. m/c, 16/-; San West 5ma, 2in sq. fl. m/c, 12/6; San West 30ma, 2 1/2 in rd. fl. m/c, 10/6; San West 100ma, 2in sq. fl. m/c, 12/6; Ferranti 0-300v 2in sq. fl. with resistor, 8/6; 1132A receivers, new in makers cartons, £4/12/6, packing and carriage 10/-; also 3084A receivers, new apply for details; c.w.o. only; orders under 30/- add postage; s.a.e. for lists.—G. N. Pill & Partners, 49, Coburg St., Plymouth, Tel. 2239.

TELEVISION 1 and components exact to E.E. designer's specifications, vision chassis fitted valveholders, coil formers, 22/6; sound ditto chassis, 18/6; time base ditto, 18/6; power ditto chassis, 25/-; set gantries, clips, control panel, 10/-; complete chassis assembly with gantries, etc. £4/15/6; Aerial, deflector coil assembly, 32/6; line transformer, 32/6; focus coil, 32/6; set 8 coils, fully wound, with h.f. chokes, 15/-; television aerials, Hunts 0.1mfd tubular condenser with clip, 7.000v w., 14.000v test, 19/6; rubber mask for 9in tube, 11/-; Mag-navista screen enlarger, 6gms; co-axial cable, 1/3 per yard; e.h.t. transformer 4.000v, 2.0-2v, 60/-; ditto, 5.000v, 2.0-2v, 65/-; E.E. Manual, A. Modern Home Built Television, 2/9; s.m.l. wave horizontal drive assembly complete with escutcheon, size of glass dial 9in x 4 1/2 in, 24/-; ditto flywheel tuning, 25/-; glass s.m.l. dial, 6x8in, 4/6; American throat microphones, boxed, 3/- each; condensers, 8mfd 450v 2/6; 16mfd 350v, 8mfd 350v, 2/-; 8x16mfd 450v, 5/6; 16x16mfd 450v, 5/6; chokes, 150ma, 10hy, 14/-; walnut cabinet, complete with ornamental speaker, grill and escutcheon, size 15 1/2 in x 6 1/2 in, out. 200-450v 50ma, or as motor, d.c. mains, 15/-; drive cord in 2 1/2 yd spools, 3/6 each; miniature 2-gang condensers, fitted trimmers with perspex cover, for personal receivers, 10/6 each; buzzers, 2/- each; 4-pin vibrators, 6v, 6/- switches, Yaxley type, 3-pole 2-way 2/-, 4-pole 3-way 3/-, 4-pole 4-way 3/6, 6-pole 4-way 4/6, 14-pole 3-way 7/6; mini. switches, 4-pole 3-way 3/-, 4-pole 2-way 3/-; enamelled copper wire, various gauges, in 1/2 lb reels; tinned copper wire, 18, 20, 22, at 1/6 per 1/2 lb reel; transformers, heavy duty push-pull for 6L6, ditto 6V6, 21/-; filament transformers, 6.3v 1.5amp 8/-, 4v 3amp 12/6; t.r.f. coils, M/L wave, with circuit, 7/6 per pair; M. wave ditto, 5/- per pair; p.m. speakers less trans, 3in 12/6 each, 5in 12/6 each, 8in 17/6 each; with trans, 5in 17/8 each, 8in 21/- each, 10in 27/6 each; full greenick, list, at 2/6d, postage all orders.—Greenick Ltd., 265, Whitechapel Rd., London, E.1. Bis. 5079. [3196]

GOVT. SURPLUS, UNUSED

CONDENSERS of all types . . .

We can offer, FOR IMMEDIATE DELIVERY from very generous stocks, a wide range of ultra-high quality fixed paper Condensers, from .001 μF to 8 μF. Also STOCKS of small, genuine MICA Condensers from .00001 (10 pf) to .01 μF (10,000 pf). Prices are exceedingly moderate.

Enquiries are invited for manufacturers' requirements, wholesale and export only for bulk quantities, and for scheduled deliveries over a period, as required. Most condensers are now available for immediate delivery.

Please request our 4 page bulletin CONSEVEN 01114

CLAUDE LYONS LTD.

180 Tottenham Court Rd., London, W.1 and 76, Oldhall St., Liverpool 3, Lancs.

TELEVISION RECEIVERS SCANNING and FOCUS COILS TIME BASE COMPONENTS 7KV. EHT, RF, UNITS and TRANSFORMERS



Publications post free
HAYNES RADIO LTD.
Queensway, Enfield.

A BRILLIANT NEW AMPLIFIER

"THE RD JUNIOR."

This outstanding addition to our range of high fidelity products, announced last month, is now being demonstrated at our Hampstead premises.

The amplifier may be heard working in conjunction with the Decca pick-up, and some of the leading high fidelity loudspeakers.

Do not let the price of this amplifier give you the impression that the performance is in any way inferior. We feel confident in stating that, in it's particular price class, this is the finest amplifier available to-day, with a performance usually only associated with more expensive equipment.

An illustrated brochure describing the RD Junior in full is available, and will be forwarded on request.

Amplifier wired and tested £19 10 0

ROGERS DEVELOPMENTS CO.

106, Heath Street, Hampstead, London, N.W.3. HAMpstead 6901.

GOVERNMENT surplus bargains! all prices carriage paid U.K.: Bendix radio compasses, MN26, 150-1500 kc/s, 25v d.c. input, as new, £5/10; Philco receiver, BC96A, 1500 kc/s, 15w motor, 13 valves, as new, £4/5K; ABK5, similar with 10 valves, as new, £1/15; as new 1155A, £12; test set 73, 230v a.c., 50 c/s, £5; power unit 297, input 24v d.c., contains motor and voltage stabiliser, 15v; frequency conversion kit, crystal units MMC 509, invaluable for amateur mitter constructors, as brand new, in makers' cartons, £5; as new 1132As, in transit boxes, £6; frequency meter BC 906D, with sig. generator and receiver BC 1066, £6/10; as new, 100 kc/s crystals-10/-; 1 milliammeter meter rectifiers, 2/6; condensers, 2mfid, 600v, 2/-; 4mfid, 800v, 3/-; 0.1mfid, 1000v d.c., 4/- per doz.; head sets, U.S.A. HS 30, 5/-; if there is something you require and cannot get, let us quote you for it; your enquiries are invited.—Dept. B, Buchanan Dunlop & Co., Ltd., 27, Denmark St., London, W.C.2.

TROUBLED by noise from fridges, vacuum cleaners or electric blankets? Fit a suppressor, 4-sect. cast case, dust cores, 16 swg, 4 0.1 cond., carry 10a, size 4 1/2 x 4 x 2, 5/9; vit. resistors, 31, 4K, 5K, 7K, 50K, 80K, 30v, 350, 12+2K, 50K, 75K 75v, 1/6; 150, 7K, 20K, 25K, 100v; 225, 150, 450, 850, 7K, 10K, 12K, 20K, 25K, 40K, 75K, 200v, 9/; 100 or 3000ohm presets, 6d; selenium rectifiers, 2d per watt; 24v min. vtz. 1a, 6a, 24v, 1/4a 200v 8/4, 75ma 500V 6/3; 20v buzzers, 2/-; junct. boxes, 8x5x2, 1/-; 750v wkg. oil cond., 10-8mf 3/9, 5mf 3/9, 0.1 bahe tube, 6d; 0.5 hp. pow. or 2mf 250v, panel lamps, 200v, 250v 5A switches, 6d; enclosed holders, 2 10a fuses, 9d; 4-way, 1/6; block connectors, 2-way 4d, 4-way 6d; cr. inst. cases, 11x7x8, 2/6; 18ft dipoles, 7/6; 24v 5w bulbs, 6d; 6oz 33 swg, 1/-; terminals 1/3 doz; 2ba ch. 2in 4d doz, 4ba 3/4 rh, 3/4 ch, mixers 1d doz, all wiring nuts; 18 pins, 1/6; wire and sleeve, approx. 12ft. 9d; post free over 5/-; no c.o.d., 49, Allerton Grange Way, Leeds, 7, Tel. 66146.

AMAZING radio surplus bargains! Searchlight radar control receivers (EL3, EL4), broadband, freq. 200mc/s, splendid cabinet, a beautiful job for high gain TV or amateur conversion, unused, in maker's packing, 60/-; med um wave conversion coils for BC453 and BC455, genuine BC453 plug-on dynamos, 14v or 28v, 12/6; new power relays, 230v a.c. operated, switch 1kw, 17/6; television units, type RF26, guaranteed, unused, maker's packing, 35/-; unused 3cm radar scanning units, parabolic, reflector waveguide, 11mc/s, 250v, 25/-; guaranteed speakers by famous makers, 8in with transformer, 16/3; 5in with transformer, 7,000 ohms, high flux type, 14/3; less transformer 12/3; receivers, type 76, 150-circuits, 3-valves, unused, in fitted case, with 505kc/s, 3-valves, unused, in fitted case, with 505kc/s, 3-valves, unused, in fitted case, with 9D6, ideal for deaf aid amplifiers, etc., 15/-; receivers R125, 2 valves, freq. approx. 30mc/s, ceramic valveholders, complete w.th circuits, 8/-; aerial tuning units, type 126, rotatable inductance, R.F. amplifier, rev. control, 7/-; Morse practice set, quality key high note buzzer, new, 4/10; unused, perfectly new, MOPA tuning units, CAY47155, 1.5-3mc/s, precision dials, ceramic switches (stud type), instrument cabinets, 17/6; absolutely perfect, new, in leather cases, American 8mc/s, 250v, 25/-; instrument cabinets, with instructions, 3/-; Antenna tuning units, BC306, variometer type, S.M. dial, ceramic switch, 11/-; R.C.A. quality amplifiers, 20 watts, 230v a.c., push-pull 6L6s, negative feed-back, complete cabinets, unused, in maker's case, 16/6; American tube model, 25 watts, chromium fittings, £25; American scope units, BC929, tube 3BP1, panel controls, for focus, shift, brilliance, etc., unused, 70/-; unused control boxes BC1366, Yaxley type, potentiometer, knobs, 3/-; push-button units, BC602, 5 buttons, 5/6; guaranteed electrolytics, 32/350v 2/6, 8-16/450v or 16-16/450v, 6/6; all can type; transmitter receivers, RDF No. 1, 13 valves, 145-mc/s, 35/-; new, unused American box kites for elevating antenna, alloy framework, 16/-; terms c.w.o.; prices include carriage; no lists.—Lawrence's, 61, Byrom St., Liverpool 3, Cen. 4430. [3200]

WANTED, EXCHANGES, ETC

WANTED, feeder unit for W.W.Q.A.—Ainscough, 46, Elm Av., Upton, Wirral, [3087]
WANTED, W.W. circuit for Colver, Perth, [3088]
WANTED, Meggs, 50, Barnabas Villas, S.W.8.
AMERICAN manuals, instruction books, and catalogues.—Harris, Strouds, Pangbourne, Berks. [3052]
"WIRELESS World" Jan., 1943, to Dec., 1948; offers.—73, Mill Rd., Burgess Hill, Sussex. [3099]

MANUAL for reception set R.201; purchase or loan.—Harris, Strouds, Pangbourne, Berks. [3050]
WANTED, "W.W." for Feb., March, June, July, 1947; full price and postage paid.—Box 4772. [3090]
WE pay top prices for used test equipment.—University Radio Ltd., 22, Lisle St., London, W.C.2. Tel. Ger. 4447 and Ger. 9592. [3992]

WANTED, recording, playback and crating heads as used Magnetophone or similar recorders.—Carter, 2, Laleham Rd., Shepperton Middlesex. [3146]

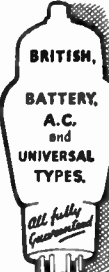

BRITISH BATTERY A.C. and UNIVERSAL TYPES.
All fully guaranteed

VALVES from 5/10 up. All at B.O.T. prices. You can order C.O.D. any Valve—even if not listed—we may have it.
Equivalents Charts, including Quick Reference Index, 1/8. RECTIFIERS, Etc.
BRIMAR—R32, R3, 6U4E, 80, 5Y4G, 6Z30, 7Z4G, 6V40, 1D5, 6Z74D, 1D7, 6X50, 3Z74G, 6X50R, —608BU, 442BU, 431U, 451U, 408UA. **MARCONI OSRAM**—U10, U14, MU14, U18/20, U50, U63, U31, U70, U74, U76, U143. **MAZDA**—U4, U404, U200, U300. **MULLARD**—DW2, DW4/350, IW4/350, DW4/800, IW4/500, FW4/500, FW4/800, AZ1, AZ31. **URIC**—URAG, EZ35, GZ32. **EYEBE** READY—811A, 811D, PHILLIPS—1867, 1891, GY31.

BARRETT TYPES. 161, 301, 302, D15, 303, 304, 340, C1, C1C, CY1, 328, 367, 68519 (Ediswan).
A.C. TYPES. **BRIMAR**—8A1, 8A1A, 8A1B, 318TH, 413G, (5M) 3P5Pen7, MVS Pen. 5 & 7 pin, M-1Pen, DL4, DD2, 41MTL, 41MHL, 41MP, 5 & 7 pin, 420T, PT10, PT41, 4X, 2P, 420TDD, 41MXP. **MARCONI OSRAM**—MX10, VMP4G, MS45, 5 & 7 pin, KT241, D41, MH14, MH4, MH14A, MH41, ML4, 5 & 7 pin, KT41, PX4, PX25, DA30, VM34B, DN41, 830. **MAZDA**—AC/TH1, (5)AC/VF1(7), AC/VF2, AC/SV, G914, ACP, AC2Pen, AC5Pen, PF3250, PF5/400, AC/SV9M, ACTP, H:LA4, HL41DD, TH41, SP41, Pen45DD, VF41, P41, DD41, Pen45, HL42DD, ME41. **MULLARD**—TH4B, 2D4A, TD4A, Cor ME1, 164V, TT4, 5 & 7 pin, Pen 44, FM24M, FM24A, Pen4DD, AC/DA, DQ24, DQ30.

ALL DRY TYPES. **BRIMAR**—1L4G, 1LNs, 1LH4, 1LD5, 1N60, MULLARD—DK32, DOCT3, DL35. **OSRAM**—Z14, HD14, N14, N16. **LACTALS.** **BRIMAR**—7C5, 706, 787, 7Y4, 707, 7H7, 14A7/12B7, MULLARD—EBL21, EBCh, ULB21, UCH21, UY21, X148. **OSRAM**—X143, X143, DN143, W148.

AC/DC TYPES. **MARCONI OSRAM**—N145, X145, N145, DL145, U145, MAZDA—10P3, U01, 10P13, 10LD11, 10A04, 10P14. **MULLARD**—UAF42, UCH42, UL41, UY41. **CAR RADIO.** W81, DB81, X81, KT81, DL82, U82.

MINIATURE REDES. **MARCONI OSRAM**—N17, W17, X17, ZD17, D77, Z77. **BRIMAR** COSSOR—834, 1T4, 1R5, 1R5, 1R4, 6A15, 8D5. **MAZDA**—1P10, 1F3, 1C1, 1F49, 6P2, 6P2. **MULLARD**—DL92, DF91, DK91, DAF91, EB91, EL91, EP91. **AC/DC TYPES.** **BRIMAR**—1B3D, 1D2, 9D2, 8D2, 10D1, 11D3, 11D5, 4D1, 7D3, 7D5, 7D6. **COSSOR**—2028TH, 302TH, 13VPA, 13PA, 202DD2, 402PenA, 383, TH232, —VP1322, TH2321, VP133, TP2620, Pen 383, TH232, Pen453DD, HL133DD. **MULLARD**—TH21C, TH300, FC13C, FC13D, SP190, TD130, HL13C, VP13A, HL13, P13, Pen3DC, CL4, Pen4DD.

E SERIES. **CBL**, CB131, CL33, OCH35, 3A3, DAF91, DF51, DF70, DF91, DK91, 1D1, DL72, DL92, EA60, EA91, EB34, EB41, EB91, EB11, EB121, EB131, EHC3, EBC33, EC31, EC32, EC33, ECH21, ECH33, ECH412, EF9, EF92, EF36, EF37, EF39, EF42, EF50, EF64, EF91, EF92, EK3, EK32, EL2, EL3, EL31, EL32, EL33, EL35, ELK2, EL38, EL43, EL50, EL91, EM1, EM4, EM34, EY91, EY91, EZ35.

MISCELLANEOUS TYPES. **ON4**, OM8, OM10, 1A5, 1A5A, 1R42, VPT4, 5 pin, 2A3, DD6, 32P2Pen, 142BT U10, X101, DH101, W101, W43, 7K7, 7D3, 22D.

INTERNATIONAL OCTALS. **BRIMAR**—6AGG, 6AB7G, 6AGC9, 6AL5G, 6A8G, 6B7G, 6B9G, 6C5G, 6F6G, 6F7G, 6F10, 6H6G, 6J7G, 6J7G, 6J8G, 6K6G, 6K7G, 6K8G, 6L6G, 6L7G, 6N7G, 6N7G, 6S7G, 6S7G, 6S7G, 6S7G, 6T7G, 6U5G, 6U7G, 6V6G, 6X6G, 6G6G, 7Q7G, 7Y4G, 787G, 12A6G, 12J6G, 12J7G, 12K7G, 12K8G, 12Q7G, 12S7G, 12B7G, 12C7G, 12G7G, 12H7G, 12L7G, 12M7G, 12N7G, 12P7G, 12Q7G, 12R7G, 12S7G, 12T7G, 12U7G, 12V7G, 12W7G, 12X7G, 12Y7G, 12Z7G, 12AA7G, 12AB7G, 12AC7G, 12AD7G, 12AE7G, 12AF7G, 12AG7G, 12AH7G, 12AI7G, 12AJ7G, 12AK7G, 12AL7G, 12AM7G, 12AN7G, 12AO7G, 12AP7G, 12AQ7G, 12AR7G, 12AS7G, 12AT7G, 12AU7G, 12AV7G, 12AW7G, 12AX7G, 12AY7G, 12AZ7G, 12BA7G, 12BB7G, 12BC7G, 12BD7G, 12BE7G, 12BF7G, 12BG7G, 12BH7G, 12BI7G, 12BJ7G, 12BK7G, 12BL7G, 12BM7G, 12BN7G, 12BO7G, 12BP7G, 12BQ7G, 12BR7G, 12BS7G, 12BT7G, 12BU7G, 12BV7G, 12BW7G, 12BX7G, 12BY7G, 12BZ7G, 12CA7G, 12CB7G, 12CC7G, 12CD7G, 12CE7G, 12CF7G, 12CG7G, 12CH7G, 12CI7G, 12CJ7G, 12CK7G, 12CL7G, 12CM7G, 12CN7G, 12CO7G, 12CP7G, 12CQ7G, 12CR7G, 12CS7G, 12CT7G, 12CU7G, 12CV7G, 12CW7G, 12CX7G, 12CY7G, 12CZ7G, 12DA7G, 12DB7G, 12DC7G, 12DD7G, 12DE7G, 12DF7G, 12DG7G, 12DH7G, 12DI7G, 12DJ7G, 12DK7G, 12DL7G, 12DM7G, 12DN7G, 12DO7G, 12DP7G, 12DQ7G, 12DR7G, 12DS7G, 12DT7G, 12DU7G, 12DV7G, 12DW7G, 12DX7G, 12DY7G, 12DZ7G, 12EA7G, 12EB7G, 12EC7G, 12ED7G, 12EE7G, 12EF7G, 12EG7G, 12EH7G, 12EI7G, 12EJ7G, 12EK7G, 12EL7G, 12EM7G, 12EN7G, 12EO7G, 12EP7G, 12EQ7G, 12ER7G, 12ES7G, 12ET7G, 12EU7G, 12EV7G, 12EW7G, 12EX7G, 12EY7G, 12EZ7G, 12FA7G, 12FB7G, 12FC7G, 12FD7G, 12FE7G, 12FF7G, 12FG7G, 12FH7G, 12FI7G, 12FJ7G, 12FK7G, 12FL7G, 12FM7G, 12FN7G, 12FO7G, 12FP7G, 12FQ7G, 12FR7G, 12FS7G, 12FT7G, 12FU7G, 12FV7G, 12FW7G, 12FX7G, 12FY7G, 12FZ7G, 12GA7G, 12GB7G, 12GC7G, 12GD7G, 12GE7G, 12GF7G, 12GG7G, 12GH7G, 12GI7G, 12GJ7G, 12GK7G, 12GL7G, 12GM7G, 12GN7G, 12GO7G, 12GP7G, 12GQ7G, 12GR7G, 12GS7G, 12GT7G, 12GU7G, 12GV7G, 12GW7G, 12GX7G, 12GY7G, 12GZ7G, 12HA7G, 12HB7G, 12HC7G, 12HD7G, 12HE7G, 12HF7G, 12HG7G, 12HH7G, 12HI7G, 12HJ7G, 12HK7G, 12HL7G, 12HM7G, 12HN7G, 12HO7G, 12HP7G, 12HQ7G, 12HR7G, 12HS7G, 12HT7G, 12HU7G, 12HV7G, 12HW7G, 12HX7G, 12HY7G, 12HZ7G, 12IA7G, 12IB7G, 12IC7G, 12ID7G, 12IE7G, 12IF7G, 12IG7G, 12IH7G, 12II7G, 12IJ7G, 12IK7G, 12IL7G, 12IM7G, 12IN7G, 12IO7G, 12IP7G, 12IQ7G, 12IR7G, 12IS7G, 12IT7G, 12IU7G, 12IV7G, 12IW7G, 12IX7G, 12IY7G, 12IZ7G, 12JA7G, 12JB7G, 12JC7G, 12JD7G, 12JE7G, 12JF7G, 12JG7G, 12JH7G, 12JI7G, 12JJ7G, 12JK7G, 12JL7G, 12JM7G, 12JN7G, 12JO7G, 12JP7G, 12JQ7G, 12JR7G, 12JS7G, 12JT7G, 12JU7G, 12JV7G, 12JW7G, 12JX7G, 12JY7G, 12JZ7G, 12KA7G, 12KB7G, 12KC7G, 12KD7G, 12KE7G, 12KF7G, 12KG7G, 12KH7G, 12KI7G, 12KJ7G, 12KK7G, 12KL7G, 12KM7G, 12KN7G, 12KO7G, 12KP7G, 12KQ7G, 12KR7G, 12KS7G, 12KT7G, 12KU7G, 12KV7G, 12KW7G, 12KX7G, 12KY7G, 12KZ7G, 12LA7G, 12LB7G, 12LC7G, 12LD7G, 12LE7G, 12LF7G, 12LG7G, 12LH7G, 12LI7G, 12LJ7G, 12LK7G, 12LL7G, 12LM7G, 12LN7G, 12LO7G, 12LP7G, 12LQ7G, 12LR7G, 12LS7G, 12LT7G, 12LU7G, 12LV7G, 12LW7G, 12LX7G, 12LY7G, 12LZ7G, 12MA7G, 12MB7G, 12MC7G, 12MD7G, 12ME7G, 12MF7G, 12MG7G, 12MH7G, 12MI7G, 12MJ7G, 12MK7G, 12ML7G, 12MN7G, 12MO7G, 12MP7G, 12MQ7G, 12MR7G, 12MS7G, 12MT7G, 12MU7G, 12MV7G, 12MW7G, 12MX7G, 12MY7G, 12MZ7G, 12NA7G, 12NB7G, 12NC7G, 12ND7G, 12NE7G, 12NF7G, 12NG7G, 12NH7G, 12NI7G, 12NJ7G, 12NK7G, 12NL7G, 12NM7G, 12NO7G, 12NP7G, 12NQ7G, 12NR7G, 12NS7G, 12NT7G, 12NU7G, 12NV7G, 12NW7G, 12NX7G, 12NY7G, 12NZ7G, 12OA7G, 12OB7G, 12OC7G, 12OD7G, 12OE7G, 12OF7G, 12OG7G, 12OH7G, 12OI7G, 12OJ7G, 12OK7G, 12OL7G, 12OM7G, 12ON7G, 12OO7G, 12OP7G, 12OQ7G, 12OR7G, 12OS7G, 12OT7G, 12OU7G, 12OV7G, 12OW7G, 12OX7G, 12OY7G, 12OZ7G, 12PA7G, 12PB7G, 12PC7G, 12PD7G, 12PE7G, 12PF7G, 12PG7G, 12PH7G, 12PI7G, 12PJ7G, 12PK7G, 12PL7G, 12PM7G, 12PN7G, 12PO7G, 12PP7G, 12PQ7G, 12PR7G, 12PS7G, 12PT7G, 12PU7G, 12PV7G, 12PW7G, 12PX7G, 12PY7G, 12PZ7G, 12QA7G, 12QB7G, 12QC7G, 12QD7G, 12QE7G, 12QF7G, 12QG7G, 12QH7G, 12QI7G, 12QJ7G, 12QK7G, 12QL7G, 12QM7G, 12QN7G, 12QO7G, 12QP7G, 12QQ7G, 12QR7G, 12QS7G, 12QT7G, 12QU7G, 12QV7G, 12QW7G, 12QX7G, 12QY7G, 12QZ7G, 12RA7G, 12RB7G, 12RC7G, 12RD7G, 12RE7G, 12RF7G, 12RG7G, 12RH7G, 12RI7G, 12RJ7G, 12RK7G, 12RL7G, 12RM7G, 12RN7G, 12RO7G, 12RP7G, 12RQ7G, 12RR7G, 12RS7G, 12RT7G, 12RU7G, 12RV7G, 12RW7G, 12RX7G, 12RY7G, 12RZ7G, 12SA7G, 12SB7G, 12SC7G, 12SD7G, 12SE7G, 12SF7G, 12SG7G, 12SH7G, 12SI7G, 12SJ7G, 12SK7G, 12SL7G, 12SM7G, 12SN7G, 12SO7G, 12SP7G, 12SQ7G, 12SR7G, 12SS7G, 12ST7G, 12SU7G, 12SV7G, 12SW7G, 12SX7G, 12SY7G, 12SZ7G, 12TA7G, 12TB7G, 12TC7G, 12TD7G, 12TE7G, 12TF7G, 12TG7G, 12TH7G, 12TI7G, 12TJ7G, 12TK7G, 12TL7G, 12TM7G, 12TN7G, 12TO7G, 12TP7G, 12TQ7G, 12TR7G, 12TS7G, 12TT7G, 12TU7G, 12TV7G, 12TW7G, 12TX7G, 12TY7G, 12TZ7G, 12UA7G, 12UB7G, 12UC7G, 12UD7G, 12UE7G, 12UF7G, 12UG7G, 12UH7G, 12UI7G, 12UJ7G, 12UK7G, 12UL7G, 12UM7G, 12UN7G, 12UO7G, 12UP7G, 12UQ7G, 12UR7G, 12US7G, 12UT7G, 12UU7G, 12UV7G, 12UW7G, 12UX7G, 12UY7G, 12UZ7G, 12VA7G, 12VB7G, 12VC7G, 12VD7G, 12VE7G, 12VF7G, 12VG7G, 12VH7G, 12VI7G, 12VJ7G, 12VK7G, 12VL7G, 12VM7G, 12VN7G, 12VO7G, 12VP7G, 12VQ7G, 12VR7G, 12VS7G, 12VT7G, 12VU7G, 12VV7G, 12VW7G, 12VX7G, 12VY7G, 12VZ7G, 12WA7G, 12WB7G, 12WC7G, 12WD7G, 12WE7G, 12WF7G, 12WG7G, 12WH7G, 12WI7G, 12WJ7G, 12WK7G, 12WL7G, 12WM7G, 12WN7G, 12WO7G, 12WP7G, 12WQ7G, 12WR7G, 12WS7G, 12WT7G, 12WU7G, 12WV7G, 12WW7G, 12WX7G, 12WY7G, 12WZ7G, 12XA7G, 12XB7G, 12XC7G, 12XD7G, 12XE7G, 12XF7G, 12XG7G, 12XH7G, 12XI7G, 12XJ7G, 12XK7G, 12XL7G, 12XM7G, 12XN7G, 12XO7G, 12XP7G, 12XQ7G, 12XR7G, 12XS7G, 12XT7G, 12XU7G, 12XV7G, 12XW7G, 12XX7G, 12XY7G, 12XZ7G, 12YA7G, 12YB7G, 12YC7G, 12YD7G, 12YE7G, 12YF7G, 12YG7G, 12YH7G, 12YI7G, 12YJ7G, 12YK7G, 12YL7G, 12YM7G, 12YN7G, 12YO7G, 12YP7G, 12YQ7G, 12YR7G, 12YS7G, 12YT7G, 12YU7G, 12YV7G, 12YW7G, 12YX7G, 12YY7G, 12YZ7G, 12ZA7G, 12ZB7G, 12ZC7G, 12ZD7G, 12ZE7G, 12ZF7G, 12ZG7G, 12ZH7G, 12ZI7G, 12ZJ7G, 12ZK7G, 12ZL7G, 12ZM7G, 12ZN7G, 12ZO7G, 12ZP7G, 12ZQ7G, 12ZR7G, 12ZS7G, 12ZT7G, 12ZU7G, 12ZV7G, 12ZW7G, 12ZX7G, 12ZY7G, 12ZZ7G.

2 VOLT BATTERY TYPES. **COSSOR**—220T, 210 pin, 210VPA, 2108PT(7), 2101H, 210HF, 210DDT, 215P, 320PA, 220PT, 230XP, 2400P, 2166G, 210LF. **MARCONI OSRAM**—4-7 pin, Z23, HL2K, HD24, LP2, KT2, X22, P2, QP21, B23, KT34, Z21. **MULLARD**—VP210, SP210, HL21DD, P220. **STP PRES**—W.W. VALVE DATA, 3/6. 10-foot sectional rods, suitable as Television or other aerials, 5/-. Speaker Cabinets, plywood, ivory shade, fawn fabric grill, 4 x 4 x 2in., very attractive, unrepeatable, 6/-. Please mention "W.W." when ordering.

RADIO BULLS VALVES
 246 HIGH ST. HARLESDEN ROAD

WANTED immediately, Cambridge instrument dynamometer test set, must be in good condition.—Box 4764. [3064]
LONG wave receiver, any type, from 15kc to 100kc or more; please give details and price.—Harris, Strouds, Pangbourne, Berks. [3051]
WANTED surplus receivers, with platinum contacts, in any condition, large or small quantities; highest prices paid.—Box 4304.
EXCHANGE Rola G.12 energised speaker and 12in B.T.H. energised speaker for good small camera—Blake, 140, Broadway, Leigh-on-Sea.
CARRIER telegraph and telegraph equipment of all types in any condition wanted; also teleprinter and teletypewriter apparatus.—Harris & Gillow, 93, Wardour St., W.1. [3036]
AVO Minor, d.c., wanted; this instrument must be of the H.R. type having a resistance of 20,000ohms per volt.—Write, stating condition and price required, to Box 4754. [3027]
WE buy for cash, new, used, radio, electrical equipment, all types; especially wanted, radios, radiograms, test equipment, motors, chargers, recording sets, etc.—If you want to know the maximum price call, write or phone to University Radio, Ltd., 22, Lisle St., Leicester Sq., W.C.2. Ger. 4447.

REPAIRS AND SERVICE
MAINS transformers rewound, new transformers to any specification.
MOTOR rewinds and complete overhauls; first-class workmanship fully guaranteed.
F.M. ELECTRIC Co., Ltd., Putney Bldgs., Warsley Gate, Nottinghams, 1917, Tel. 3855.
REWINDS—Vac drill armatures, etc., 14/6; repetition work a speciality, good deliveries, work guaranteed.—Details Box 4928. [3136]
LOUDSPEAKER repairs, British, American, any make, moderate prices.—Simon Speakers Ltd, Pembroke St., London, N.1. Tel. 3555.

REWINDS and conversions to mains and output transformers, from 4/6; p.p. equipment a speciality.—N.L. Rewinds, 4, Brecknock Rd., N.7, Tel. Arnold 3590. [6283]
MAINS transformers rewound or constructed to any specification; prompt delivery.—Bede Transformer Co., Ltd., Bedesway, Bede Trading Estate, Jarrow. [3198]
REWIND service which duplicates or modifies as required; transformers, loudspeakers, etc.; prompt returns.—Raids Services, 49, Lf. Addiscombe Rd., Croydon, Cen. 6537.
EVERY make of electrical measuring instruments repaired and standardised.—The Electrical Instrument Repair Service, 329, Kilburn Lane, London, W.9, Tel. 4640.

RADIO MAINTENANCE SERVICE for guaranteed repairs and repairs; armatures; P.H.P. motors vac. units, etc.; good deliveries.—139, Goldhurst Terrace, N.W.6. Mal. 6153.
"SERVICE with a smile.—Repairers of all types of British and American receivers; coil rewinds; American valves, spares, line cord.—F.R.I., Ltd., 22, Howland St., W.1. Museum [1575]
"STURDY" rewinds, mains transformers, chokes and fields, first-class work, prompt deliveries and satisfaction guaranteed.—Sturdy Electric Co., Ltd., Dip-ton, Newcastle-on-Tyne, [2430]

REWINDS—Mains transformers, chokes, fields, O/P transformers, etc.; prompt deliveries and satisfaction guaranteed.—Thomas Bolton & Co., 20, Heath Terrace, Leamington Spa, Tel. 18. [2483]
ACCURATE coil winding; tuning coils, I.F. coils, etc.; and mains transformers rewound and wound to specifications; wave and progressive wave winding.—Rynford, Ltd., 17, Arwenack St., Falmouth. [2497]
REPAIRS to moving coil speakers, clock transformers, clock coils rewound; guaranteed satisfaction, prompt service; we do not rewind mains trans.—Closed Sat. [2497]
L.S. REPAIR SERVICE, 49, Trinity Rd., Upper Tooting, London, S.W.17. Balham 2359.

A SECOND to none rewound service, reliable, clean, neat; returns of post, new transformers, standard or to specification, EHT, 2HT, choke; stamp quotations.—R.E.F., 137A, Ashton Rd., Oldham. [2379]
REWINDS, mains transformers, speaker field coils, chokes, high-grade workmanship, fast delivery; new transformers constructed to custom specifications, singly or in quantities.—Metropolitan Radio Service Co., 1021, Finchley Rd., N.W.11. Speedwell 3000. [3719]

24-HOUR service, 6 months guarantee, any month; transformer rewind, mains outputs and i.f.s., etc.; all types of new trans., etc. supplied for trade prices.—Majestic Winding Co., 180, Windham Rd., Bournemouth.
L.T.P. rewind service, all rewinds are layer wound, vacuum impregnated, pressure tested at 2,000 volts and guaranteed for three 48-hour service.—Enquiries London Transformer Products, Ltd., L.T.P. Works, Cobbold Estate, N.W.10, Tel. Willesden 6486.

NATIONAL RADIO SERVICE &

Pennine RADIO ANNOUNCE

NEW LOW PRICED AUDIO SIGNAL GENERATOR

WIDE FREQUENCY RANGE
40 CPS.-16000 CPS. WITH 3
WATTS OUTPUT SUITABLE
FOR CHECKING.

★ **AUDIO AMPLIFIER**
FREQUENCY RESPONSE

★ **RADIO RECEIVERS**

★ **MODULATORS**

CAN ALSO BE USED FOR

★ **LOUDSPEAKER BUZZ**

TESTS AND PRODUCTION

TESTING EMINENTLY SUIT-

ABLE FOR SERVICE ENGIN-

EERS. RADIO HAMS. RADIO

AND RELAY ENGINEERS

PRICE £9.9.0

Write for particulars

PENNINE AMPLIFIERS
SOUTHGATE, ELLAND
YORKSHIRE, ENGLAND

The "ADCOLA" Soldering Instrument

Reg. Trade Mar.



Designed for Wireless Assembly
and Maintenance.

Working temperature reached in 1½ mins.
consumption 25 watts. weight 2½ ozs.
Supplied in voltage ranges from 6 V. to 230/250V
½" diam. Copper Bit (standard model) 22/6.
1" diam. Copper Bit 25/-.

Replacement Unit Bit Elements available.
British and Foreign patents.

Sole Manufacturers:

ADCOLA PRODUCTS LIMITED
Alliance House, Caxton Street, London S.W.1
Write or Phone: WHI. 0030.

SURPLUS STOCK

A few thousand only, genuine Paper
Tubular Bypass Condensers by
well-known British Manufacturer.
Waxed cardboard tubes, wire ends.
0.1 µF. 450 Volts DC working.

Whilst available, 7/6 per dozen
(minimum) including postage.

WIRELESS SUPPLIES UNLIMITED,
264-266, Old Christchurch Road,
BOURNEMOUTH, Hants.

TRANSFORMERS and chokes to specification
single or quantities; finest quality work
and finish; all units fully tested and guaran-
teed.—Millett & Holden Ltd., Card Garage,
Mews Nelson St., Southend-on-Sea, Essex.

REWINDS and repairs, mains transformers.
R.O.P trans., clock coils, field coils, pick-
ups; vacuum and gram. motors; new trans-
formers to any specification; guarantee work;
competitive prices; delivery 2/3 days.—W.
Groves, Manufacturing Electrical Engineer, 154,
Icknield Port Rd., B'ham, 16. [1482]

A.W.F. TRADE SERVICE offers you speedy
loudspeaker repairs, loudspeaker cone
assemblies, mains transformer rewinds from
15/-; new transformers at keenest trade prices;
transformers built to your own specifications;
lists 1d.—A.W.F. Radio Products, Ltd., Borough
Mills, Bradford, Yorks. Tel. 22838. [1164]

REWINDS.—Send your "burn outs" to be
rewound; no technical data wanted; post
transformer, etc., labelled with your name, ad-
dress, and marked "for rewind"; our wind-
ings are double wound, interleaved and im-
pregnated.—Southern Trade Services, Ltd.,
297-299, High St., Croydon, Tel. 4870. [3110]

WE make wireless and radiogram cabinets for
home and export; immediate deliveries.—
Radiac, Ltd., 26, Brondesbury Rd., London,
N.W.6. Malda Vale 8792. [8025]

RADIO mfrs. can undertake development and
assembly of radio or electronic equipment;
winding shop with vacuum impregnation plant;
ample space and labour available.—Box 68,
London, W.1. [12359]

ALL types of equipment, A.M., F.M. and T.V.
receivers, control and test gear designed
and/or built to specification.—Write for quota-
tion to J. Mort, B.Sc., A.M.I.E.E., BCM/
HIPPEL, London, W.C.1. [2939]

LET us quote you on the foundation for your
new radio or amplifier, etc., chassis made
to order, precision machining, cellulose spraying
complete units to your specification.—P. G.
Fielding & Son, 71, Chassen Rd., Flixton, Lancs.

FIRST-CLASS transformers and chokes
manufactured. Complete lines available, also
special manufacturers' components made to
specifications; armatures and fields wound and
motors assembled.—Avis & Baggs, Ltd., 140-
141, Friar St., Reading, Berks. [2715]

DRRAWING and tracing work for radio and
electrical engineering, jig and tool and
light engineering, photoprinting; full sets of
drawings undertaken to commercial or Ministry
standards.—Drawing & Tracing, Ltd., 456a,
Ewell Rd., Tolworth, Surbiton, Elmbridge 7406.

WE now have the capacity in our works to
cope with the building of electronic gear to
your specification; we are specialists in rack
work, and are actual builders of test gear for
the G.P.O., quality workmanship guaranteed.—
For further information apply to Gem & Radio
Service Co., 235, Cricklewood Broadway, London,
N.W.2. Tel. Cricklewood 6133. [2741]

MISCELLANEOUS

NO room.—Ex-2BHO gear, must sell; s.a.e.—
7, Tudor Drive, Watford, Tel. 7323.

GENERAL printing, 7-day service.—Central
London Press, 1a, Wood St., E.C.2. Mon. 1779.

Q.S.L.s. and "G.P.O." approved log books,
5 samples free.—Atkinson Bros., printers,
Elland. [13082]

SALE, "Wireless Engineer" Sept., 1945
August, 1946; good condition; best offer.
—Box 4904. [3120]

PROC. I.R.E., "Electronics," "F.M."...
totaling 154 issues: £12.—For details
ring Brixton 776. [13099]

LONG range television with the Q5R9 aerial,
folded dipole, two or multi-element; s.a.e.—
Emdo, Moor Lane, Staines. [2786]

WALNUT radiogram and television cabinets,
manuf. samp.es. few only; stamp details.—
Walters, 501, Hale End Rd., E.4. [1763]

ROTARY beams for amateurs, 2½ to 20
metres; masts, lashings, rotators, etc.;
s.a.e.—Emdo, Moor Lane, Staines. [2787]

TRADe transfers, gold and black, your word-
ing, 7 days' delivery; also decorative trans-
fers; list free.—W. W. Axon, Jersey C.I. [2160]

80 ohm co-axial cable, 30ft lengths with Pye
connector; 7/6, post paid.—Electron
Works, Department 92, East Ham, London, E.6.
[1937-40, 1946-7, 1947-8]

WIRELESS Engineer, 1937-40, 1946-7,
"Proc. I.R.E.", 1936-40, for sale.—
Library, Marconi Instruments, Ltd., St. Albans,
Herts. [3017]

CHASSIS, panels, racks and metal cabinets,
stock sizes or made to specification.—Reo-
sound Engineering & Electrical Co., Coleshill
Rd., Sutton Coldfield. [2901]

CIRCUITS, BC-453, 4, 5, -946, -1206A, B, C;
454 OHF converter, 6SN7 Scope twin-tracer,
CW46048D, 1/6; fluorescent starters, 4/-.—Wil-
liams, 25, Glenmore Rd., Birkenhead. [3143]

ALUMINIUM chassis and panels, standard
sizes by return, any other sizes promptly
made, holes punched for valveholders, etc.;
cellulose and crackle finishing of our or your
panels, chassis, etc.; estimate free.—Electro-
Acoustic Dev., 18, Broad Rd., Lower Willing-
don, Sussex. [3112]

150 tons cable, 1 to 15 core, connector, coup-
lings, junction boxes, fuse boxes and
various wireless and electrical parts, new and
unused ex M.O.S. trade enquiries in confidence;
all at half list price, special quotations quanti-
ties; state your requirements.—Robertson (Edin-
burgh), 43-50, Giles St., Leith, Edinburgh, 6,
Leith 36132. [3048]

THE HEART OF A FIRST-CLASS RADIO-GRAM

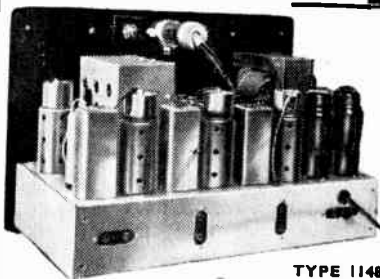

TYPE 1148
Radio-gram Chassis

Developed from the popular type 1047, this
receiver will form the basis for a Radio-gram
of unsurpassed performance, and at great saving
in cost. Principal features include:
12 stage superhet circuit • 11 valves with magic
eye indicator • 4 wavebands (11-2,000 metres)
• R.F. Amplifier • 2 I.F. stages • 4 stages
AVC • 10 watts push-pull output • Separate
treble and bass controls • Tropicalised com-
ponents.

Other Peerless equipment of interest to the enthusiast
includes: 16-valve Communications Receiver Type
1346 • R/F Feeder Unit (comprising R/F portion
of Type 1148 Receiver) • A/F Unit and Power Pack
Type 1. All details on request.

PEERLESS RADIO LIMITED

174 KENSINGTON HIGH STREET, LONDON W.14
Telephone: WEStern 1221

INDUSTRIAL FINISHING CRACKLE

STOVE ENAMEL • ALL COLOURS

Stoving ovens and spray service at your disposal.
Prompt return after final inspection. Chassis,
Panels, Cabinets, Photographic Equipment, etc.
Black 1/-. Colours 1/3 per sq. ft. (Flat surfaces, one
side). Carriage extra. Special quantity quotations.
We make anything in metal to your requirements.

Full particulars on request.

Buccleuch Radio Manufacturers

6 Wheatfield St., Edinburgh, 11
Grams: "Therm" Telephone 64596

YOUR METER DAMAGED ?



Leading
Electrical
Instrument
Repairs to the
Industry.

Repairs by skilled craftsmen to all makes and types of
Voltmeters, Ammeters, Microammeters, Multirange Test
meters, Electrical Thermometers, Recording Instruments,
Synchronous Clocks, etc. 14 days' Service—for speedy
estimate send defective instrument by registered post to:



L. GLASER

SCIENTIFIC & ELECTRICAL INSTRUMENT REPAIRERS
341 CITY ROAD, E.C.1.
Tel. Terminus 2489

DO YOU FIND RADIO HARD WORK?

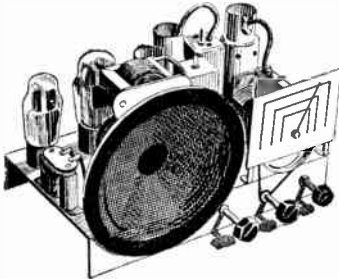

WHY USE A SIGNAL GENERATOR WHEN YOU CAN BUY THE NEW ALIGNED & SEALED 3 WAVEBAND

L.T.C. TUNING UNIT for only 48/6 (post free)

This comprises the now world famous Model 30 Coil Pack, a matched two gang condenser, pair of "MM" I.F. transformers and 3 colour Dial, the whole completely aligned as a unit, also a copy of the new "Home Constructor's Handbook." This book, which is finding a place on thousands of radio men's shelves, contains full details of many magnificent Superhets., Amplifiers, Feeder Units, etc., each complete with circuit, data and components. It also gives valuable hints, formulæ and many other items of interest. Make sure of your copy while we are offering this famous 2/6d. handbook once again for 1/- only.

Send NOW—this offer is limited!
RODING LABORATORIES
(Electronics)

Postal orders to:
70, Lord Avenue, Ilford, Essex.
Callers to: 694 Lea Bridge Road, Leyton, E.10

CRYSTALS FOR AIRCRAFT MARINE AND AMATEUR TRANSMITTERS

ALL LOW TEMP. CO-EFF. CUTS.
BROOKES CRYSTALS LTD.
10, STOCKWELL ST., GREENWICH, GRE. 1828. LONDON, S.E.10.

BRASS cheese head screws and nuts, 4B.A. x 1/4 in. 6/9 gross; 4B.A. x 1/4 in or 3/8 in. steel screws only, 3/6 gross; specials to drawings; reduction for quantities.—Sambrook, 40, Regent Rd., Dudley, W. 223. [268]

SPARKS' data sheets provide complete constructional details and full-size draughtsman-prepared prints showing drilling, assembly and wiring plans of tested and guaranteed designs by L. Ormond Sparks.
LAZEST releases.—The Challenger portable, an a/c/dc 3-valve (plus rect.) T.R.F. circuit having an exceptional performance on med. and long waves, the ideal set for radio in any room, no aerial or earth; 6in Stentorian speaker gives amazing power and quality; no complicated switching or adjustments; data sheet 2/9.
COMPONENTS can now be supplied; send a stamp for list giving full details of the 34 designs available.

SPARKS' DATA SHEETS (W.), 9, Phoebe Rd., Brockley S.E.4. Tel. Lee Green 0220.

RADIO supervisors and technicians should join their appropriate trade union, the Association of Supervisory Staffs, Executives and Technicians.—Write for free pamphlet to ASSET, 110, Park St., London, W.1. Tel. Mayfair 8541-2.

BRITISH Short-Wave League (founded 1935). Over 20 departments (QSL Bureau; DX Certificates; Technical; Translations, etc.) for membership details send s.a.e.—H.Q.(W), 145, Uxendon Hill, Wembley Park, Middlesex.

PLASTICS—Small injection mouldings in thermoplastics (polystyrene, polythene, cellulose acetate, etc.) for electrical and instrument industry, high standards, reasonable price, delivery promises kept.—Write "W.W." c/o Dixons, 45, Great Marlborough St., London, W.1.

FLLORESCO.—A complete kit of parts, 40 watt tapped choke, 200-250V a.c., p.f. cond., two bi-pin holders, terminal block, bleeder res., g.w. starter and holder, suppressor and circuit, but less the 4ft tube; 31/9; buy your tube locally.—Malden Transformer Supplies, 200, Cambridge Rd., Norbiton, Surrey. [3172]

COPPER wire, enamelled, tinned, Litz, cotton silk covered, all gauges; BA screws, nuts, washers, soldering tags, eyelets; ebonite and laminated bakelite panels, tubes, coil formers; Tunol rod; headphones, flexes, etc.; latest radio publications, full range available; list s.a.e., trade supplied.—Post Radio Supplies, 33, Bourne Gardens, London, E.4. [1454]

RADIO cabinets, good class walnut veneered, French polished, undrilled, 12x7x7 1/4 (internal), 32/6 each, including dial; also speaker fabric, latest two colour inter-woven, cut from the roll, 14in wide, 1/8 per foot, 18in 3/6 per foot; add accordingly; s.und absorbing felt, 52in wide, 10/- per yard; post paid.—Burmans, 64, Reighton Rd., Clapton, London, E.5. [2874]

SITUATIONS VACANT

Vacancies advertised are restricted to persons or employments excepted from the provisions of the Control of Engagements Order, 1947.

ROYAL NAVY.—Short service commissions in the electrical branch.

SHORT service commissions of five years are offered in the Electrical Branch of the Royal Navy to ex-R.N.V.R. officers under 35 years of age on 1st January, 1949, who served in the Torpedo, Special, Electrical or Air Branches and were employed on technical duties connected with radar, wireless, air radio, air electrical or ships' electrical equipments. Candidates will be entered in the substantive rank held on release, with seniority adjusted by the time out of the Service. Promotion will be in accordance with the regulations in force at the time for R.N. officers (e.g., a Lieutenant (L) is at present eligible for promotion to Lieutenant-Commander (L) at eight years' seniority). Officers who complete the full period of five years on the 1st January List will be eligible for a gratuity of £500 (tax free). Daily rates of pay are as follows: Sub-Lieutenant (L), 13/-; Lieutenant (L) on promotion, 17/-, after two years 19/-, after four years £1/4, after six years £1/6; Lieut-Comdr. (L) on promotion, £1/2, thence in biennial increments of 2/- per day to a maximum of £2/2. Marriage allowance of £337 per annum if aged 25 or over, or £146 if under 25, is payable, and accommodation and rations are provided free, or allowances in lieu.—Apply to the Director, Electrical Department, Admiralty, Queen Anne's Mansions, London, S.W.1. for fuller details and application forms. [2620]

RADIO and television engineer required; full particulars to: Seaford Radio, 39, High St., Seaford, Sussex. [3141]

RADIO service engineer with knowledge of television, able to drive, permanent position with progressive firm in Croydon.—Box 4765. [3069]

RATEFIXERS with experience of mass production of light electrical and radio equipment.—Write Box 5715, A.K. Adv., 212a, Shaftesbury Ave., W.G.2. [2727]

RADIO service engineer, fully qualified, finely equipped workshop, good working conditions.—State experience and salary to Gerry, 36, Bank St., Newquay, Cornwall. [3167]

VACANCY exists for scientifically minded person, preferably with experience, to undertake the processing of quartz crystals.—Write, stating wages required, to Box 3516. [2626]

SERVICE engineer, conversant all principle makes receivers, television experience an advantage, man just released from Services might suit; able to drive; single; East Anglia.—Box 4303. [2994]

R1224 A.5 VALVE BATTERY SUPERHET.

Another purchase of these superb ex-R.A.F. receivers enables us to re-offer them to all who were disappointed two months ago. Covers 1-10 mcs in 3 switched bands, and circuit employs RF stage. Has Muirhead precision slow motion dial, aerial trimmer, sensitivity control, reaction control, etc., etc. Operating voltages 120v. H.T., 9v. GB, 2v. LT. Complete with valves in BRAND NEW MAKERS PACKING. ONLY 99/6 (carriage 7/6). Jack plug, if required, 2/6.

THE AC R.1155 RECEIVER. This famous Bomber Command receiver can now be supplied for use on A.C. mains, and complete with speaker, for ONLY £18/10/-. The specification is too well known for us to repeat here, but a fully illustrated leaflet is available on request.

1 1/2 METRE SUPERHET APW 4790. Contains 9 valves; 1 each RL7, RL16, EA50, and 6 of SP61. Has 6 I.F.T.'s of 12 mcs with 4 mcs bandwidth. Ideal for use as a vision receiver. These are BRAND NEW, but some have had the coils removed for alteration by the makers, and in this case are supplied with three 11 mm formers for the coils to be wound to the range required. ONLY 59/6 (carriage etc. 5/-).

INDICATOR UNIT 62A. A fresh purchase of these excellent units which contain so many EF50 valves and the VCR97 short persistence tube. The complete valve complement is as follows: 12 of EF 50, 2 EB 34, 4 SP 61, and 3 diodes EA 50. Saves pounds for anyone constructing a superhet TV. ONLY 89/6 (carriage 10/-, plus 10/- deposit on packing case).

TEST SET TYPE 74. These are R.A.F. scopes used on VHF equipment, and only require modification to the time bases for normal use. Has built in power pack for normal A.C. mains, and contains 3in tube VCR 139, 3 valves SP 61, 1 6J5G, 1 6Q7, 1 E 1148, 1 5Z4, 1 SU 2150A. Undoubtedly a "buy" at 110/- (carriage etc. as above).

BATTERY SUPERSEDERS. Vibratopacks operating from only 2 volt input, and delivering 90 volts and 180 volts at 35 mills. A complete fully smoothed unit originally made for the Canadian Army by Electronic Laboratories of America, for use on "Walkie Talkies." Instruction book giving circuits is supplied with each unit, enabling necessary adaptation for use on normal commercial receivers to be made. Illustrated leaflet sent on request. ONLY 60/- (postage 2/-), or with 2 American "Willard" accumulators in steel case 90/- (carriage 5/-).

THE RADAR UNITS FOR TELEVISION CONVERSION as advertised last month are still available, although the demand is increasing. The data costs only 7/6 and this amount will be credited if the two radar units costing £8/10/- are purchased within 14 days. Send for your copy NOW.

C.W.O. please. S.A.E. for lists.

U.E.I. CORP., THE RADIO CORNER,
138, Gray's Inn Road, London, W.C.1.
(Telephone TERminus 7937)

LOCKWOOD makers of Fine Cabinets and woodwork of every description for the . . . Radio and allied trades

LOCKWOOD & COMPANY
Lowlands Road, Harrow, Middx.
Phone: BYRon 3704

Specialists in

HIGH-POWER AMPLIFIERS from 250W to 1kW

W. Bryan Savage Ltd

WESTMORELAND ROAD, LONDON, N.W.9

Telephone: Colindale 7131



Time Limit fixed under Town & Country Planning Regulations! Work has been started on the last batch of Domesdale Reflector Tube Corner Horns to be made at this address. Price in the white £47-10-0 ex-works. Future outlook "unsettled", order immediately. Re-units see March review, page 103.

**VOIGT PATENTS LTD.,
15, SILVERDALE, S.E.26**

Owing to Mr. Voigt's ill-health, demonstrations only by special arrangement.

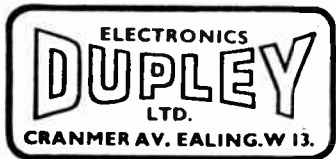

PHONE EALING 5688

**WILLIAMSON AMPLIFIER
COMPONENTS**

**OUTPUT
TRANSFORMER £4 7 6**

TO DESIGNERS' SPECIFICATION

MAINS TRANSFORMER £4 2 6

CHOKE, 20 HEN. 150 MA. £1 7 6

CHOKE, 35 HEN. 20 MA. 9 6

Send for details of above and full range of standard transformers and chokes.

Manufacturers' enquiries invited

PROMINENT engineering firm in North-West requires senior engineer having experience in development of centrimetric radio aerials and waveguide technique.—Reply Box 3515. [2623]

TRANSFORMER manufacturer of repute (London district) requires chief engineer; exp. in design of audio and power transformers.—Write, stating exp. and salary.—Box 4235.

SALES manager required to take full charge of the marketing of a range of domestic television equipment for a large manufacturing company having world-wide connections.—Apply Box 4032. [2824]

REPRESENTATIVE required with technical knowledge to call on radio manufacturers; state full particulars of past experience, together with details of radio connections, salary required, to: Box 4900. [3109]

RETAILERS in West Central London require manager and senior assistant; experience of component and constructors' trade preferred; retail experience essential; wage and commission.—Apply Box 4927. [3135]

EXPERIENCED radio engineers required for expanding retail firm.—Apply in the first instance by letter, giving qualifications, experience and salary required, to Holt & Crompton 6, Station Parade, Sutton, Surrey. [3018]

WANTED, engineer for recording studio, experienced in i.f. amplifiers; recording experience preferred but not essential.—Please write, Sound Recording Department, 8, Hinde St., Manchester Sq., London, W.1. [3070]

VALVE engineers required by a manufacturer in S.E. England.—Application should be made giving full particulars of qualifications and experience in the design and development of valves, quoting Ref. 213, to Box 4773. [3102]

SENIOR radio tester, accustomed to testing marine radio equipment, required for test department; must be able to work on own and take charge of small staff; only those with experience need apply; S.W. area.—Box 4757.

E. K. COLE, Ltd., radio division, have vacancies for additional sales representatives; knowledge of the industry desirable and experience of marketing essential.—Applications in writing to Ekco Works, Southend-on-Sea.

EXPERIENCED radio and television service engineer required by old-established retailer; some sales ability and pleasant personality essential; preferably resident North London; state experience and wages required.—Box 4902. [3117]

EXPERIENCED man required to take charge of a coil winding shop attached to factory in Cambridgeshire manufacturing scientific instruments; excellent prospects; send details of experience and wage required, to Box 4906. [3122]

DRAUGHTSMAN required for transformer division of well-known West of England manufacturers, preferably with some experience of small transformers up to 50 kVA; interview and preliminary training in London area.—Write Box 4036.

ALL grades of draughtsmen with experience of light electrical products required by large company in N.W. England for D.O. work on switchgear, control boards, fusegear, small transformers; please send particulars, quoting ref. D.O.43 to—Box 4767. [3076]

PHYSICISTS required by manufacturers in South-East England to carry out work on semi-conductors, phosphors, etc.; applicants should preferably have some experience of work on electronic equipment.—Apply, quoting Ref. 192, to Box 4027. [2796]

EXPERIENCED anal inspector required for radio type apparatus; good technical radio background essential; 5-day week; canteen; East London district; please apply giving full particulars and salary required.—Apply Box A.2239, Haddons, Salisbury Sq., London, E.C.4.

SALES representative required for London and the South; active men with previous sales experience and technical knowledge of electronic equipment are invited to apply for this interesting vacancy; send full details and salary required, quoting ref. 210 to—Box 4768

INTERMEDIATE and senior grade draughtsmen required by large radio manufacturing company in S.E. England; draughtsmen with experience of development of installation D.O. work on telecommunication equipment are asked to send details quoting ref. D.O.42 to—Box 4766. [3074]

SALES engineer, must possess qualifications and experience of R.F. cables and ability to act as technical representative active man used to own initiative; part time also considered.—Write fullest details and salary to B.B.J., c/o Dixons, 43, Great Marlborough St., London, W.1. [3037]

WORKS manager for London factory of leading manufacturers of electrical and radio components; position calls for energy, initiative and drive; consideration will only be given to applicants with experience in the manufacture of electrical components.—Write, giving fullest particulars, to Box 4755. [3034]

REQUIRED immediately, radio-radar technician as chief assistant in the Project Department; interesting post for man with extensive experience in radio-radar equipment, including design, manufacture and operational use.—Write Manager, Flight Refuelling Ltd., Tarrant Rushton Aerodrome, Nr. Blandford, Dorset. [3032]

ENGINEERS!

Whatever your age or experience, you must read "ENGINEERING OPPORTUNITIES". Full details of the easiest way to pass A.M.I.Mech.E., A.M.I.E.E., A.M.I.C.E., CITY & GUILDS, MATRICO, etc. on

**108 PAGES
Free!**



"NO PASS—NO FEE" terms and details of Courses in all branches of Engineering—Mechanical, Electrical, Civil, Auto., Aero., Radio, etc., Building, etc. If you're earning less than £10 a week, tell us what interests you and write for your copy of "ENGINEERING OPPORTUNITIES" today—FREE!

B.I.E.T.

397, Shakespeare Hse., 17-18, Stratford Place, London, W.1.

BRITISH INSTITUTE OF ENGINEERING TECHNOLOGY

EDDYSTONE

'640' £27 10s. 9d.

H.P. Terms available.

Orders now being booked in strict rotation.

Full range of components.

All C.O.D. orders promptly executed.

Send for Catalogue, 1/- post free.

SPECIAL OFFER

P.M. Speakers

Goodman's, Truvox, Rola (as available).

5 inch 13/-; 6 inch 14/-; 8 inch 16/-

including packing and postage.

B.T.S.

THE Radio firm of the South.

63, London Road, Brighton 1, Sussex.

'Phone : Brighton 1555

PHOTO-ELECTRIC CELLS

for

Talking Picture Apparatus.

Catalogue now available

RADIO-ELECTRONICS LTD.,

St. George's Works, South Norwood, London, S.E.25.

IAN BAILEY REPRODUCER Series 2



Associated Equipment :—

IAN BAILEY Tuner

A high fidelity

T.R.F. unit giving

sensibly flat re-

sponse 30 - 10,000

c.p.s. on 4 switched

stations.

PRICE £7-10-0

Our new tone con-

trol feeder unit at

£5-5-0

The **IAN BAILEY**

8-10 watt Ampli-

fier at £15-0-0

PRICE £33

Send stamp for details.

ELMSLEIGH RADIO CO.

1102 London Rd., Leigh-on-Sea, Essex
Leigh-on-Sea 75169

YOU can become a first-class RADIO ENGINEER

We are specialists in Home-Study Tuition in Radio, Television and Mathematics. Post coupon now for free booklet and learn how you can qualify for well-paid employment or profitable spare-time work.

T. & C. RADIO COLLEGE

King Edward Ave., Aylesbury, Bucks.

(Post in unsealed envelope, i.e. stamp)

Please send me free details of your Home Study Mathematics and Radio courses.

NAME

ADDRESS

w.w.82

LOUDSPEAKER REPAIRS AND TRANSFORMER REWINDS

To radio dealers and service engineers.

Send 1d. for our latest "Monthly Bulletin"

A.W.F. Radio Products Ltd. Borough Mills, Bradford.

PUBLIC address systems for business firms, representatives fully experienced, both technically and commercially, by national organization; London, Birmingham, and Glasgow areas, must have good sales record in this type of equipment; salary, commission, expenses; own status informed.—Box 4760. [3055]

A VARIETY of positions vacant for experienced senior and junior development, research engineers and draughtsmen, for radio, electronics, television, radar, speakers, preference B.Sc., H.N.C., also inspectors, commission, service engineers, etc.—Technical Employment Agency, 175 Clapham Rd., S.W.9 (Brixton 3487). [2927]

TELEVISION assembly line foreman required by expanding manufacturer in North-West London area; applicants must have ability to organise female labour and have extensive and recent experience of quality mass production of television receivers; a permanent post and good salary for a man with the right qualifications.—12966 Box 4179.

DRAUGHTSMEN for development and design of radio communication equipment; drawing office experience in the production of electro-mechanical apparatus essential; applicants should be of National Certificate standard.—Apply to the Secretary, Faraday's Research Telegraph Co. Ltd., New St., Chelmsford, stating age, education, experience and salary required. [2818]

EXPERIENCED draughtsman required for the design of electronic apparatus and light electro-mechanical mechanisms for instrument manufacturer; previous experience essential.—Write, giving full details, education, qualifications, experience and salary required, to Box A.C.434, c/o Central News, 17, Moorgate, London, E.C.2. [3039]

WANTED ex-R.A.F. radar mechanics not below Senior N.C.O. rank, by the Government of India for service as civilian radar instructors in Royal Indian Air Force training schools, in India on a contract basis for 3 years.—Apply Air Adviser's Department, Office of the High Commissioner for India in the United Kingdom, India House, Aldwych, London, W.C.2. [2810]

PHYSICIST or electrical engineer required to take charge of circuit development of industrial electronic equipment, with well-known manufacturers in Midlands; preferably Honours graduate, 30-35, with previous experience in this type of work; salary commensurate with qualifications and experience; send full particulars and salary required, quoting ref. 214, to: Box 4899. [3107]

ELECTRONIC development engineer wanted for the Australian Division of a large aircraft organisation, minimum qualifications are engineering or physics degree, with three years' research and development experience; single men preferred due to accommodation difficulties in Australia; applications should give full details of education, experience, and salary required.—Box 4213. [2890]

SENIOR designer draughtsman required for department producing prototype models of electronic measuring equipment mainly for Government development contracts; applicants must have ability to produce mechanical designs to electrical engineers' requirements and to act as liaison between laboratory and drawing office.—Applications in writing, stating full details, to Personnel Manager, The Plessey Co., Ltd., 5020, Ilford. [3020]

SANGAMO WESTON, Ltd., have two vacancies in their instrument sales correspondence section; applicants should have had a good general technical training, with some specialisation in electrical measuring apparatus; they should be capable of expressing themselves clearly and concisely both in conversation and correspondence.—Applications should be sent in strict confidence to the Employment Manager, Sangamo Weston, Ltd., Great Cambridge Rd., Enfield, Middx. [3054]

APPLICATIONS are invited by a company situated within 25 miles radius of London for the position of senior engineer to take charge of a laboratory engaged upon design, development and application of R.F. heating; applicants should have an Honours degree in engineering and previous experience of the work upon which the laboratory is engaged; salary £700 to £1,000 p.a. according to qualifications.—Applications should be addressed to Box 4753.

MURPHY RADIO, Ltd., invite applications for the following vacancies in the electrical design laboratory: (1) Senior radio engineer with good honours degree in physics or electrical engineering and several years' industrial experience in television or radio receiver development. (2) Radio engineer, with good academic qualifications in physics or electrical engineering, preferably with some industrial experience. Apply to Personnel Dept., Murphy Radio, Ltd., Welwyn Garden City, Herts. [2618]

TECHNICAL representative for capacitor sales department of well-known, long-established manufacturers of telephone and electrical equipment and accessories, with factory 15 miles S.E. of London; applicants must have sound knowledge of capacitor usage as applied to the electrical, telecommunications and allied trades, and be prepared for extensive travel covering the British Isles; (minimum age 27 years; no overtime; stating age, experience and salary, to Box U1013, A.K. Advtg., 212a, Shaftesbury Ave., London, W.C.2. [3042]

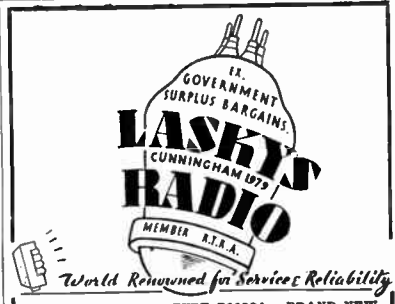

EX-A.M. RECEIVER TYPE R1182A. BRAND NEW AND UNUSED IN ORIGINAL WOOD CRATES. Specifications: 11 valve superhet, 100/124 Mc/s. Large tuning scale with super slow motion drive. 0.5 m/a moving coil tuning meter. R.F. and L.F. gain controls, jack sockets for line and monitor. VALVE LINE UP: R.F. amplifier VR65; local oscillator VR64; first I.F., VR53; second I.F., VR53; third I.F., VR53; second detector and AVC, VR54; L.F., amplifier VR67; L.F., amplifier 6J5; BFO, VR53; voltage stabiliser VR70. The set is totally enclosed in grey metal cabinet, front panel grey with all controls clearly marked on plated handles. Size: 18in. wide, 10in. high, 11in. deep. Weight when packed 54 lbs. Calibration chart and circuit diagram supplied with each set. **LASKY'S PRICE 99/6.** Carriage 10/- extra. **INDICATOR UNIT TYPE 62A.** Contains 20 valves and a 4in. cathode ray tube type WCR97 (short persistence.) Valve line up: 16 8P6, 2 EA50, 2 EB34. Dozens of useful components, condensers, resistances, coils, 117 Mc/s. crystal, 16 pot/meters, etc. Totally enclosed in metal case, size: 18in. x 8 1/2in. x 11in. Weight about 40 lbs. Enamelled grey with coloured control knobs. **LASKY'S PRICE 59/6.** Carriage 7/6 extra. All cathode ray tubes tested before despatch. **THE IDEAL INDICATOR UNIT AT THE LOWEST POSSIBLE PRICE FOR CONVERSION TO TELEVISION.** **EX-A.M. RECEIVERS TYPE 3084A. BRAND NEW AND UNUSED, IN MAKER'S ORIGINAL WOOD TRANSIT CASES.** This radar receiver contains 14 brand new valves: 7 EF50, 2 VR136, 1 VR137, 1 EA50, 1 HVR2, 1 R3, 1 V1607. A 5 stage I.F. strip, small motor. Dozens of useful components, resistances, condensers, switches, plugs, etc. Totally enclosed in metal case, size: 19in. x 8 1/2in. x 7 1/2in. Weight when packed 40 lbs. **EASY CONVERSION TO TELEVISION.** **LASKY'S PRICE 75/-.** Carriage in wood transit case 10/- extra. (Case included.) **INDICATOR UNIT TYPE 62A.** Contains 21 valves, 117 Mc/s. crystal and 6in. cathode ray tube type WCR97, 6in. (short persistence). Valve line up: 12 EF50, 2 EB34, 4 8P6, 3 EA50, also condensers, resistances, switches, pot/meters, and hosts of other useful components. Totally enclosed in metal cabinet, size: 18in. x 8 1/2in. x 11in. Weight 40 lbs. **LASKY'S PRICE 99/6.** Carriage 7/6 extra. **WHY NOT MAKE YOUR OWN TELEVISION AERIAL? AERIAL RODS.** These are of the sectional type. Each rod is 12in. long, and is made of steel, heavily copper plated. Any number of rods can be fitted together. **LASKY'S PRICE 2/6.** per dozen. Post free. Send 2jd. stamp for our current monthly bulletin, giving full details of our Ex. Government stocks. **LASKY'S RADIO** 370, HARROW RD., PADDINGTON, LONDON, W.9. (Opp. Paddington Hospital) Telephone: CUNNINGHAM 1979 Hours, Mon.—Sat. 9.30 a.m. to 6 p.m. Thurs. Half-day.

OLDCHURCH LABORATORIES
Announce
The "LABCHURCH 1" A.C. Superhet Design. Three Circuit and Layout Blueprints with Instruction Leaflet covering 3-waveband "short" superhet chassis design, incorporating Iron-cored Coils. This is a sound and practical design of good performance without unnecessary "frills". Complete Data 7/6a. Post free.
TELEVISION AND OSCILLOSCOPE EXPERIMENTERS
E.H.T. Transformer, 37/6 post free.
2,000v. at 5 m.a. 4c. C.T.—2a. 4v. C.T.—2a.
A First-class component which has passed the most stringent tests.
SPECIAL OFFER
G.E.C. Miniscope, secondhand, as new £15/0/0
"Advance Components" Signal Generator Type B.C.3., secondhand, perfect..... £16/0/0
Just Arrived
The one and only "Muirhead" Drive, Ex-Govt. New and Boxed, 10/6 each.
L. P. DISMORE,
52c, Oldchurch Road, Chingford, E.4.

L-R-S FOR **PROMPT & EFFICIENT SERVICE**
CASH OR EASY TERMS

Goodman's "Axiom Twelve" Speaker Unit Cash price £8 8 0
 Goodman's Standard 12" Speaker " £8 15 0
 Barkers Natural Loudspeaker " £15 15 0
 Callenders B.I. all-wave Anti-interference aerial " £6 18 0
 Avo Model 7 Meter " £19 10 0
 Avometer AC/DC Meter " £8 10 0
 Avo New Wide Angle Signal Generator " £25 0 0
 Avo Valve Tester, Complete " £18 10 0
 Collare Radiogram Units—various models.
 Stuart Centrifugal Electric Pumps for all pumping purposes.

*Specifications of all the above on request.
 Please write for our EASY TERMS.*

PERSONAL ATTENTION TO ALL ENQUIRIES

The LONDON RADIO SUPPLY CO.
 Est. 1925
BALCOMBE, SUSSEX

WE OFFER

A large range of used and new Test Equipment, Converters, Recorders, Amplifiers, Motors, Transformers, etc.

All guaranteed and at very attractive prices.

We buy good modern used equipment of all types for spot cash.

UNIVERSITY RADIO LTD.
 22 LISLE STREET, LONDON, W.C.2.
 Tel.: GER 4447 & 8582.

RANSOM
FOR RADIO VALVES

SPEAKERS. P.M. 5in. 10/6; 6in. 12/-; 8in. 14/6; 8in. with transformer 18/-; 8in. Mains Energised 24/-.

TOGGLE SWITCHES. S.P., S.T., 8 amp. 2/6; S.P., D.T., 8 amp. bakelite, 9d.; S.P., D.T. Metal 1/6.

CONDENSERS. 32 mfd. 350 v. 4/11; 16x8 mfd. 450 v. 4/6; 16 mfd. 450 v. 2/3; 25 mfd. 25 v. 1/8; 4 mfd. 600 v. 0/1 3/-; 2 mfd. 350 v. 0/1 1/6; 5 mfd. 350 v. 9d.; .02 mfd. 400 v. 3d.; .01 mfd. 1000 v. 4d.; .001 mfd. 1000 v. 4d.; 8 mfd. 450 v. 1/9; 1 mfd. 350 v. 1/-; 2 mfd. 150 v. 6d.; 50 mfd. 12 v. 6d.

VALVE TYPE SWITCHES. 2 way 4 pole 2/4; 2 way 6 pole 2/6; 3 way 3 pole 2 bank 2/6; 3 way 3 pole 3 bank 3/-.

VALVE HOLDERS PAXOLIN. B.V.A. 4 pin 3d.; 5 pin 4d.; U.S.A. Octal 6d.; Amphenol B.V.A. 4 pin 5d.; U.S.A. Octal Ed.; Mazda Octal 6d.

SLEEVING. Dozen yards 9d.

VOLUME CONTROLS. 1 meg. 75,000 and 3,000 ohms all 1/- each.

OUTPUT TRANSFORMERS. 5,000 ohms 2/6; 8,000 ohms 2/6.

RADIO KNOBS. Assorted 2/6 dozen.

ENAMELLED WIRE. 4oz. coils, 24 swg. 1/10; 26 swg. 2/-; 28 and 30 swg. 2/1; 32 and 34 swg. 2/6.

VALVES. Most types now available 10,000 stocked. All new, at official B.O.T. prices. Valve list available Clearance Price List printed each month, send for our list it will pay you.

34, BOND STREET, BRIGHTON.

A PPLICATIONS are invited by a Government Department in respect of vacancies in the field of electronic development and research; the posts in question will carry a salary ranging from £400-£25 per annum, according to qualifications.—Write Box 4759. [3053]

S ENIOR draughtsmen with electro mechanical D.O. experience or mechanical D.O. experience on automatic machinery, required for interesting work on industrial electronic equipment; vacancies with reputable firm in Midlands are permanent and offer good prospects.—Send full details quoting Ref. D.O.45, to Box 4898. [3106]

D RAUGHTSMEN are required by the Research Laboratories of the General Electric Co., Ltd., North Wembley, Middlesex, for work in the field of radio or telecommunications; vacancies exist for seniors with several years' experience as well as for more junior candidates.—Apply to the Director, stating age, academic qualifications and experience. [3004]

R EQUIRED as technical assistant to chartered patent agent in Patent Department of the General Electric Co., Ltd., at Research Laboratories, Wembley, Middx., a young man with an Honours degree or similar qualifications and preferably with some experience or knowledge of radio engineering and electronics; suitable opening for ex-R.A.S. Signals officer; the assistant would receive training for qualification as a chartered patent agent.—Apply by letter to the Director, stating age, academic qualifications and experience. [3004]

E LECTRICAL engineers, sound electrical knowledge to Degree standard, background training in process development, including welding technique, electrical measuring control devices, H.F. measurements and electrical measurements generally; write age, details of experience, etc.; also juniors, age 20 to 25 years, free from Military service, taking technical course at day or night school, for position as laboratory assistants; Enfield district, N. London.—Write Box 6360, Frost-Smith Advg., 64, Finsbury Pavement, E.C.2 [2806]

C OMMUNICATIONS officers required for Middle East service duty; candidates required to possess first-class B.M.G. Certificate for seagoing duties, or equivalent, and be experienced in installation/maintenance; desirable age limit 35; salary (incremental) from £460, plus allowances £140-£450 (dependent on size of family), plus free accommodation and messing; married applicants required to serve singly for first three years.—Write, quoting No. 289 to Box 2729, c/o Charles Barker & Sons Ltd, 31 Budge Row, London, E.C.4.

M IDDLESEX Hospital Medical School, London W.1. Electronics technician wanted by the Clinical Electrophysiology Unit, Department of Physiology, to design, construct and maintain equipment for clinical electro-encephalography and electro-physiological research; must have wide knowledge of audio and radio frequency techniques, cathode ray oscillography and photographic recording; workshop experience an advantage; salary range £360-£435 according to experience; family allowance and superannuation.—Apply in writing to the Secretary. [3033]

G RADUATE lecturer in mathematics required for E.M.I. electronics college; applicants should possess a good degree in mathematics with physics and knowledge of radio; duties include lecturing to City & Guilds mathematics for telecommunications V standard; commencing salary, according to age, qualifications and experience, not less than the appropriate Burnham (Technical) Scale for London district; superannuation benefits in addition.—Apply giving fullest possible particulars to Professor H. F. Trewman, M.A. (Cantab.), M.I.E.E., M.I.Mech.E., M.Brit.I.R.E., E.M.I. Institutes, Ltd., 43, Grove Park Rd, London, W.4. [3065]

L ONDON COUNTY COUNCIL.—Required at West Norwood Technical College, Knight's Hill, West Norwood, S.E.27, to commence on September 1st, 1949, senior assistant teacher of telecommunication engineering for the City and Guilds final certificate and British Institution of Radio Engineers graduateship examinations; applicants should possess a degree or its equivalent in telecommunication engineering, with teaching and industrial experience; salary £700 X £25-£800, plus London allowance and graduate and training additions as appropriate.—Application forms (stamped addressed foilscape envelope necessary) from the principal at the College, returned by 1949. (209) [3049]

A PPLICATIONS are invited for a vacancy in the grade of senior experimental officer (unestablished) in Ministry of Supply Headquarters, London; the duties include the co-ordination of thermionic valve requirements and supervision of an information service on valves for Government Departments and associated organisations; candidates must be at least 35 years of age, should have, preferably, a degree or equivalent qualification in physics or electrical engineering; a knowledge of thermionic valves and their application to service uses is desirable, and experience in the valve industry would be an asset; some administrative experience is essential; salary, based on qualifications and experience, is within the range £735 to £935 (men), £610 to £830 (women).—Application forms obtainable from Technical and Scientific Register (K), York House, Kingsway, London, W.C.2, quoting D.69/49-A. Closing date 14 days from date of publication. [3041]

RADIOMENDERS LIMITED
FOR SPECIAL TRANSFORMERS AND REWINDS

We specialise in—
AMATEURS' WINDINGS, TRANSFORMERS ALL TYPES, CHOICES, PICK-UP COILS, INSTRUMENT COILS, Etc.

LOUD SPEAKER SERVICE
 Highest workmanship. Good Delivery

★
RADIOMENDERS, LTD.
 123-5-7 Parchmore Road,
THORNTON HEATH, SURREY
 LIV 2261. Trade enquiries invited. Est. 16 years

THE Q59 HIGH PERFORMANCE AERIAL FOR BETTER TELEVISION.

Folded dipole, multielement design; executed in high duty alloy, provides wide bandwidth, high gain, low noise, and results in higher definition and longer range.

★ FD2. 2 Element 5 db gain, 7 1/2 lbs. weight.
 ★ FD3R. Triple reflector, for low interference.
 ★ FD3E. 3 Element long range, 71 db gain

Brochure from:—
EMDO LIMITED, AGE WORKS, STAINES.

AUDIO FILTERS

Field-free, Hi-Q, Toroidal Windings. Permalloy Cores—Permanent Accuracy. Low, High, Band-pass or Cross-over. ADJUSTABLE Whistle and Scratch Extractors.

LYNCAR LABORATORIES
 29, Camborne Road, Morden, Surrey. LTB. 3 247

"PERIMET" ELECTRODE Soldering and Brazing Tool
 Operates from 4 or 6 Volt Accumulator or Transformer



15s. Post free

HOLBOROW & CO.,
 71, Weymouth Bay Avenue, Weymouth.

SOUND VALUES

The best sound value is from **G. L. Products' range of EIGHTEEN SOUND AMPLIFIERS.**

A selected few:—

1. G/10 Home Gram. Reproducer ... 8 1/2 gns.
2. GP/12G P.P. Concert 12w ... 11 gns.
3. GP/12Mc as above Mic. & Gram ... 12 gns.
4. GP/15G P.P. 15w Concert Gram ... 14 gns.
5. GP/15Mc as above Mic. & Gram ... 16 gns.
6. GP/25 General P.A. Mic. & Gram ... 18 gns.

All in attractive cabinets, Nos. 4, 5, 6 bass and treble lift and treble cut. 18CA/12 Dual AC-6v. DC Mic. & Gram. 17 gns.

"Car Announcer" 9/10w P.A. for your car. Size 8 x 7 x 3" deep ... 15 gns. Speakers, mics, vibrators, etc. extra.

For details on the "Eighteen" and the "SOUND MAGNET" Tape recorder, write:—
 (Please enclose 2/6 stamp)

GENERAL LAMINATION PRODUCTS LTD., DEPT. 8R., 294, BROADWAY, BEXLEYHEATH, KENT.

EMPHASIS ON

TECHNICAL

BOOKS

W. H. SMITH & SON give special attention to the requirements of technical men and students. Books not in stock, but obtainable from publishers, are supplied within a few days. Students' needs for examinations are given priority.

GO TO
W.H. SMITH & SON
1500 BOOKSHOPS AND BOOKSTALLS

THE
BRITISH NATIONAL
RADIO SCHOOL
ESTD. 1940

Passing Examinations
Becomes a
MATTER of COURSE
when it's
A B.N.R.S. COURSE
City and Guilds, A.M.I.E.E.,
A.M.Brit.I.R.E., P.M.G. (Theory),
also the most comprehensive
Course available anywhere on
RADAR & Radio Aids to
NAVIGATION

Six months' trial period without
obligation to continue

Write for free booklet to:—

STUDIES DIRECTOR
BRITISH NATIONAL RADIO SCHOOL
66, ADDISCOMBE ROAD, CROYDON
Phone: Addiscombe 3341

CONTINUED expansion of the E.M.I. Electronics College has created further vacancies for lecturers in radio communications; two lecturers whose duties will include some technical writing are required immediately; applicants should possess a degree or electrical engineering degree and also experience in radio, television, etc.; age 22-28; commencing salary, according to age, qualifications and experience, not less than appropriate Burnham Scale; superannuation benefits in addition.—Applying in fullest possible particulars to Professor H. P. Trewwin, M.A. (Cantab.), M.I.E.E., M.I.Mech.E., M.Brit.I.R.E., E.M.I. Institutes, Ltd., 43, Grove Park Rd., London, W.4. Tel. Chiswick 4417/8. [3066]

B.E.C. invites applications for a post in the Television Section of the Research Department at Kingswood, Surrey. Applicants must possess a University degree, or equivalent qualification, in physics or electrical engineering, and should be acquainted with the basic principles of tele-communication; practical experience and a knowledge of television technique will be an advantage. The work will include research on problems contributing to the general appraisal of television systems, both monochrome and colour. Ample scope for initiative. The salary is in a grade with annual increments of £30 and a maximum salary of £680 per annum.—Applications, stating age, qualifications and experience should reach the Engineering Establishment Officer, Broadcasting House, London, W.1, within 7 days of the appearance of this advertisement. [3068]

SUNDERLAND EDUCATION COMMITTEE, The Technical College, Principal, D. A. Wrangham, M.Sc., Sen.Wh.Sch., D.I.C., M.I.Mech.E., A.C.G.I. Applications are invited for the post of lecturer in electrical engineering. Candidates should have a degree in electrical engineering; teaching and industrial experience would be an additional recommendation; salary in accordance with the Burnham Technical Scale; the commencing salary will include an allowance for approved industrial experience after the age of 21 years; forms of application and further particulars may be obtained from the Registrar, The Technical College, Sunderland, Co. Durham; applications should be returned to the undersigned within two weeks of the appearance of this advertisement. Canvassing will be a disqualification.—W. Thompson, Director of Education, Education Office, 15 John St., Sunderland, Co. Durham. [3067]

THE RADIOCHEMICAL CENTRE. Applications are invited for the post of senior physicist to take charge of department engaged upon the following work: the standardization of radioactive materials; control of radiation hazards; instrument development; and general nuclear physics; applicants should be men of good professional standing, who have experience of applied nuclear physics and laboratory administration, the successful candidate will be required to develop the work of the department on his own initiative, and to collaborate with other institutions; applicants should be between the ages of 25 and 45, and they will be required to pass a medical examination, a substantial salary will be offered commensurate with the candidate's experience and qualifications, a superannuation scheme is in force, and housing accommodation is available at Amer-sham; the successful candidate will be appointed to the staff of Thorium Ltd. (Managing Agents to the Minister of Supply) to whom applications should be sent at the Radiochemical Centre, White Lion Road, Amer-sham, Wokinghamshire. [3072]

THE DECCA NAVIGATOR Co., Ltd. are supplying a chain of radio stations for use by a well-known oil company engaged in the Persian Gulf; the following staff are required immediately for duty in this area on the basis of an initial 2-year term of service:—Engineer-in-charge. Salary £1,000 per annum. Applicant must be well-qualified radio engineer with considerable experience in the erection and operation of radio stations in the field. He will be responsible for the erection of the equipment in the Persian Gulf and for its subsequent efficient operation. Engineer Assistant. Salary £750 per annum. He will be responsible to the Engineer-in-Charge for operation of the chain, and will be required to carry out specialised maintenance work of the radio receivers used by the survey units. He must be prepared to act as relief for the Engineer-in-Charge when necessary, and to take control of any of the radio stations. Station Supervisors. Salary £600 per annum. Applicants must be well-qualified practical radio engineers with considerable experience in the erection of radio stations under field conditions. These men will be required to operate in isolated positions, and must be quite confident of maintaining the efficient operation of the stations under these conditions. Selected applicants will be required to pass a medical examination. Air-conditioned accommodation, messing and medical treatment will be provided free in the area of duty. Up to three months' initial specialised training provided in this country; paid leave with return passage to U.K. after two years' overseas service. This work calls for keen, capable men who are prepared to work on their own initiative.—Please write full details of your past experience, age and qualifications, indicating which position you are applying for, to the Decca Navigator Co., Ltd., 1-3, Brixton Rd., S.W.9. [3058]



★ USE DENCO "MAXI Q" COILS—High "Q" with miniature size.

There is one for all wavebands from 3.6 to 2,000 metres. Wound with Litz on Polystrate. Formers with adjustable Iron Dust Cores—Aerial, H.F., or Oscillator types available. 465 K/C or 1.6 m/c.

Prices—Chassis Mtg., 3/9 (with React. 4/9), or Pin Base type, 4s Octal Valve Holder, 4/- (with React. 5/-).

DENCO Famous Turret Tuning Units—Renowned for EFFICIENCY and RELIABILITY.

TYPE C.T.6. Completely assembled, designed for Superhet using Triode Hexode or similar Mixer on 465 K/C's, and covers 5 WAVEBANDS:—

10—50 Metres. 200—360 Metres.
25—75 " 750—2000 "

75—200 " and GRAM position.
Use of Polystrate Insulation, Plated Contacts and High "Q" Coils, with adjustable Iron Dust Cores and Close Tolerance Condensers, ensures very high performance.

Price £21/9/6 (plus 21/3 P.T.)
Includes 3-Gang Cond., Trimmer, Padders, etc. Has attractive Glass Dial, 8in. x 6 1/2in., with five clear vertical scales, showing Station Names and 8/Motion Cord Drive Tuning. Circuit and full instructions included.

TYPE C.T.7. Similar in appearance and construction as C.T.6, having same Dial and Calibration, but has important addition of an R.F. Stage, Flywheel Tuning and a Double Pole Switch which isolates Radio Circuits when switched to GRAM and vice versa.

Price £27/5/6 (plus 30/6 P.T.)
Includes circuits and detailed instructions.

Television Components. Efficiently Screened Line Output Transf., 27/-; Scanning Coil, Assembly for 9in. and 12in. Tubes, 30/-; Focus Coils, Thumb Screw Adjustment, with Electronic circuit, 25/-; Line Time Base Blocking Oscillator Unit, 25/-.

L.F. Transf. Litz. Wound, Perm. Tuned, gives variation of ± 5% by adjustment of Core available for 465 K/C, 1.6, 3.5 or 10 M/c. size 1 1/2in. sq. x 3in. Price 16/6 pr. (Also miniature type available, 1/2in. sq. x 2 1/2in., 18/- pr.)

The New Denco 1949 COMPLETE KIT OF PARTS to build 4 Valve (plus Rect.) MIDGET A/C/D SUPERHET covering Long and Medium Waves, and using the new highly efficient MULLARD TYPE B.8.A MIDGET VALVES. Easy to follow building instructions supplied. Price £6/17/6 (plus 29/5 P.T.)

B.F.O. Unit for 465 K/C or 1.6 M/c. 12/6.
L.F. Filter. Iron Dust Core Adjustment, 2/9.
E.F. Chokes. Polystrate Formers used. Frequency coverage 5 to 150 Metres, 2/3; 5 to 2,000 Metres, 3/6.
Feed Through Insulators. Polystrate Insulated, sizes 1 1/2in., 1/4; 1 1/2in., 1/8; 2 1/2in., 3/3; 3 1/2in., 3/9.
Stand Off Insulators, using Polystrate Rod. Sizes 1 1/2in., 1/2; 1 1/2in., 1/1; 2 1/2in., 1/2; 3 1/2in., 1/4; 4in., 1/2.

MAINS INTERFERENCE FILTER. 4/6.
Other available Denco Products are listed in a most comprehensive and detailed Catalogue. Price 6d EXPORT and TRADE ENQUIRIES INVITED

DENCO DISTRIBUTORS LTD.
115, FLEET STREET, E.C.4.
Tele.: CENTRAL 5814 and 2280.

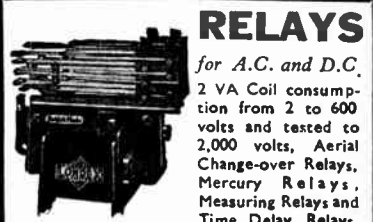

RELAYS

for A.C. and D.C.
2 VA Coil consumption from 2 to 600 volts and tested to 2,000 volts, Aerial Change-over Relays, Mercury Relays, Measuring Relays and Time Delay Relays.

Multiple Contact Relay L.F.

Ask for leaflets RE/W/W

LONDEX LTD.

Manufacturers of Relays
207 Anerley Road, London, S.E.20. 8YDENHAM 6258

BULLS RUISLIP DEPOT OFFER

TELEVISION AERIAL—tubular aluminium—designed for fitting in the loft, bedroom, boxroom, etc., 15/- post free. Outdoor type 37/6.

WASK white plastic—designed to suit 6in. tube. Will put professional finish to your home-built television. 7/6 post free.

MAGNIFIER—mjer quality—39/6, others very good from 27/6.

SPARES—electrolytics, 450—500 v. working; 8 mfd.—1/11, 16 mfd.—2/8, 8 mfd. x 16 mfd.—3/4, 16 mfd. x 16 mfd.—3/9; 350 v. working: 8 mfd.—1/6, 16 mfd.—1/11, 32 mfd.—1/11; 200 v. working: 25 mfd. plus 25 mfd.—3/11, 32 mfd.—1/9; Cathode bias types 60—12 v.—10d. 25 v.—5d. v.—1/5, 25 v.—25 v.—1/-, 10 v.—25 v.—10d.

P.M. SPEAKERS—best makes Rola R. & A. Plessey, etc.—3in.—11/8, 6in.—11/8, 8in. with O.P.T.—13/9, 6in. with O.P.T.—17/8, 8in. with O.P.T.—17/9, 10in. with O.P.T.—27/9.

MAINS TRANSFORMERS—standard primaries, 6.3 v. 3 amps, 5v. 2 amps, 250-0-250, 60-70 m.a. 13/9, plus 1/3 postage.

NOTE—All the above parts are recently manufactured definitely not Government Surplus. Orders over £3 post free, otherwise include extra 2/- for postage.

CO-AX CABLE 80Ω EX. GOVT.—new and perfect 9d. yd. **YOU SHOULD CALL** at once during transmitting times to see our latest "W.D. TELEVISION," it really gives super results. All parts are available from stock cost being £18. If you can't call to-day then write to-day enclosing 7/6 for the constructional data and price list. Everything can be sent to you. H.P. terms available if required.

WE ARE OPEN UNTIL 5 P.M. ON SATURDAYS.

ELECTRON HOUSE, WINDMILL HILL, RUISLIP MANOR, MIDDLESEX.

WAVE WINDINGS TO YOUR OWN SPECIFICATION

We can also offer you a standard range of adjustable iron dust cored coils of exceptional efficiency and stability, suitable for super-het and T.R.F. receivers.

MONOCHORD RADIO

(Established 1929)
17, Streatham Hill, London, S.W.2.
Phone: Tulse Hill 1061.

WESTERN GATEWAY HEADQUARTERS for Radio Equipment and Components

66YA COMMUNICATIONS RECEIVERS 62BAR

"EDDYSTONE 640." The popular priced British Communication receiver, for all interested in long-range Short-Wave reception. Has many refinements, with Crystal phasing, B.F.O. and Noise limiter. 257/10s. Very reasonable hire purchase terms available. Send P.O. for full details.

"EDDYSTONE 670." Marine receiver. For export only, either direct, or for use aboard a foreign-going vessel. Descriptive literature forwarded. 237/10s.

CONDENSERS. Govt. Surplus. New. 0.15 plus 0.15 mfd., 7 kv., oil-filled, 15/-, 4 plus 4 mfd., 3 kv., 25/-, 4 mfd., 2 kv., 12/6 plus postage.

CHOKES. 10H 100 m/a 100 ohms, 7/6. 20 H 100 m/a 350 ohms, 10/6. 12 H 200 m/a super potted job, 20/-, 15-20H 500 m/a 80 ohms, 25/-. Carriage extra.

E.P. UNIT. Regulated 140-120 v. up to 60 m/a. 200/250 v. Input. Ideal for bias supply or battery receiver. 35/-, plus 2/6 carriage.

AMPLIFIER, 25 WATTS OUTPUT, TG10, with valves: 3 6L6, 3 6N7, 2 6B37, 5U4G, less motor and P.E. coil, 110 v. A.C. input. 27/12/6. Auto-transformer, 21/- extra, plus 10/- carriage.

TUBES. 6VR135A tube. This is a super tube for scope work, complete with base, 30/- each, plus 1/6 postage.

Agents for "Eddystone," "Deneo," "Labezar" and "Baymark." We guarantee satisfaction with all our equipment. Write to us for all your requirements. Export Enquiries invited.

ARTHUR H. RADFORD A.M.I.E.E.
28, BEDMINSTER PARADE, BRISTOL, 3.
Tel.: 64314.

Open Saturdays: 9—5.30 p.m.

MINISTRY of Civil Aviation—Appointments of Radio Mechanics, Grade II. Applications are invited for appointments as radio mechanics, Grade II, at civil aviation stations in the United Kingdom. Candidates will also be eligible for duty overseas. Candidates must be at least 21 and under 40 years of age at the time of application, and must possess a knowledge of the fundamental principles of radio and radar with a general knowledge of one or more of the following radio aids for navigation: Direction finding, loran, gas radar beacons, A.C.R. or G.C.A. They should also have had practical experience in the use of tools, filing, drilling, hard and soft soldering, cabling and wiring, and be experienced in the use of electrical and radio measuring instruments including cathode ray oscilloscopes. The possession of City and Guilds certificates in radio communication and technical electricity will be an advantage. The pay will be 115/- per week, inclusive, rising by annual increments of 3/- a week to a maximum of 130/- a week. Candidates should apply by postcard for a form of application to the Ministry of Civil Aviation, Establishment Division (B) 10, Fleet St., London, E.C.4, quoting reference EST/174. [3019]

SITUATIONS WANTED

ENGINEER, several years' experience, seeks change, A.M.Brit.I.R.E.E., C. and G. finals, tech., elec. and radio comm., H.N.C.—Box 4770.

SERVICE engineer, 16 years' practical radio and television, Assoc. Brit. I.R.E. and City and Guilds' Radio Communication Grade 3 seeks situation London western suburbs.—Box 4901. [3116]

A B.Sc. (Hons.), M.Sc., A.M.I.E.E., present head of large radio development laboratory engaged on u.f.i. and radar equipment development, would like a change to a progressive firm with technical and financial resources in television, radio mobile gear, radar, mathematical analysis, antennae design, communication receivers, marine, radio and domestic receivers, marine radio and domestic receiver design. America-trained in technical administration; salary of less importance than opportunity. Box 4752. [3022]

RADIO and electrical lock-up, North Birmingham residential district, well established, no opposition; £400, plus s.a.v. (about £400); vendors' house for sale with business or later.—Box 4769. [3081]

ADVERTISERS seek light engineering firm/persons England or U.S.A., interested formation television receiver mig. concern, Midlands.—Principals write Box 4751. [3014]

TECHNICAL TRAINING

A.M.I.E.E., City and Guilds, etc., on "No Pass—No Fee" terms; over 95% successes; for full details of modern courses in all branches of electrical technology send for our 112-page handbook free and post free.—B.I.E.T. (Dept. 388A), 17, Stratford Place, London, W.1. [6270]

TUITION

THE British National Radio School

OFFERS you a career.

WRITE to-day for free booklet describing our wide range of training courses in radio, Radar, telecommunications, principles, mathematics, physics, and mechanics, correspondence and day classes for the new series of C. & G. examinations; we specialise in turning "operator" into "engineers," and for this purpose our "Four Year Plan" (leading to A.M.I.E.E. and A.M.Brit.I.R.E.E. with C. & G. Certificates as interim rewards) is unsurpassed; our guarantee has no rivals attached.—Studies Director: B.Sc., A.M.I.E.E., M.Brit.I.R.E.E., 66, Addiscombe Rd., Croydon, Surrey. [6811]

UNIVERSITY COLLEGE, Southampton.—Diploma in Electronics.

AN advanced course of Honours Degree Standard covering the entire field of electronics with special emphasis on receiver design and line technique, will commence at the beginning of October, 1949. The course will be full-time for one academic year. The college will grant a Diploma by examination to students who successfully complete the course. Entry qualification is normally a university degree or its equivalent.—Further details may be obtained from the Academic Registrar. [3005]

RADIO training.—P.M.G. exams and I.E.C. Diploma; prospectus free.—Technical College, Hull. [10611]

A.M.I.Mech.E., A.M.I.E.E., City and Guilds, etc., on "No Pass—No Fee" terms, over 95% successes; for details of exams, and courses in all branches of engineering, building, etc., write for 108-page handbook—free.—B.I.E.T. (Dept. 387B), 17, Stratford Place, London, W.1.

NEW comprehensive system of tuition.

Matric. Special Entrance, First M.B., Common Preliminary, etc. Exams. of Institutes of Civil, Electrical and Mechanical Engineers. Also electrical and telecommunications engineering courses.—Write Dept. W., Comprehensive Correspondence Schools, Ltd., 411, Oxford St., London, W.1. [3063]

FUNDAMENTALS of television—Conference, April 1st-2nd, Primrose Hill, Birmingham. In this course of lectures given by leading research engineers, will deal with latest developments in television of special interest to physics graduates or specialists in industry.—Details from Director Extra-Mural Studies, University, Edmund St., Birmingham. 3. [3038]



THE SERVICE ENGINEER'S FIRST CHOICE

THE COIL PICK-UP

Pleases the Eye as well as satisfies the Ear

WILKINS & WRIGHT LTD.
Utility Works, Holyhead Rd., Handsworth, Birmingham 21.

NEW DUAL TESTOSCOPE



Ideal for high and low voltage testing: 1/30, 100/850 A.C. and D.C.

Allowance made on old models.

Send for interesting leaflet (R.14) on Electrical and Radio Testing, from all Dealers or Direct.

POST RADIO SUPPLIES

OFFER EX-STOCK

COPPER INSTRUMENT WIRE. ENAMELLED, TINNED, LITZ. COTTON AND SILK COVERED. Most gauges available.

B.A. SCREWS, NUTS, WASHERS, soldering tags, eyelets and rivets, EBONITE AND BAKELITE PANELS, TUFNOL ROD, PAXOLIN TYPE COIL FORMERS AND TUBES, ALL DIAMETERS.

Latest Radio Publications.

Send stamped addressed envelope for comprehensive lists. Trade supplied.

POST RADIO SUPPLIES

33, Bourne Gardens, London, E.4.
*Phone: CLissold 4688

ENGINEERING OPPORTUNITIES



This unique handbook shows the easiest way to secure **A.M.I.Mech.E., A.M.Brit.I.R.E.E., A.M.I.E.E., City and Guilds, etc.**

We Guarantee—

"NO PASS—NO FEE."

Details are given of over 150 Home-study Diploma courses in all branches of **Civil, Mech., Elec., Motor, Aero, Radio, Television and Production Engineering, Tracing, Building, Govt. Employment, R.A.F. Maths, Matriculation, etc.**

Secure your future; send for your copy at once—**FREE.**

B.I.E.T., 387, SHAKESPEARE HOUSE 17, STRATFORD PLACE, LONDON, W.1.

★ Electronics

By F.C. Spreadbury, A.M.Inst.B.E., Lecturer in Physics and Mathematics at the Working Men's College, London. This is the most up-to-date, comprehensive and reliable guide yet published to electronic theory and its applications, and is equally helpful to the student of modern physics and to practical workers in this field, including radio and electrical engineers and technicians.

700 pages. Illustrated. 55/- net.

"A very useful work of reference."
—*Journal of the Institution of Electrical Engineers.*

PITMAN

Parker Street, Kingsway, London, W.C.2

SOUTHERN RADIO'S WIRELESS BARGAINS

R.A.F. MK.14 BOMBSIGHT COMPUTERS. Brand new with Sperry gyro, 2-28 volt motors, rack and worm gearing, barometric bellows, counters, etc. In shockproof mountings. 55/-, carriage 5/3.

BENDIX COMMAND RECEIVERS. BC454 (3-6 mega.) and BC465 (6-8.1 mega.). 6 valves. 12SK7 (3), 12SR7 (1), 13A6 (1) and 12K8 (1). Ideal for conversion to AO/DO or car receivers. Brand new, 35/-, either set, post 1/6.

DRIVE ADAPTOR AND KNOB FOR BC453/4/5. Gives slow motion drive. 2/6 each, post 3d.

CONTROL BOXES FOR BC453/4/5. Three slow motion dials and drives, three 50,000 ohms. volume controls and six rotary switches. In makers cartons. 12/6 each, post 1/4.

DRIVE CABLES FOR BC453/4/5. 14 feet long 8/6 each, post 1/4.

CONTACTOR TIME SWITCHES by Smiths or Venners, 10 hour movement giving two impulses per sec. Thermostat control. Ideal for darkroom work. In oak or paroline case. 10/-, post 1/6.

R-28/ARC-5 RECEIVERS. 100-156 mega. 10 valves. 717 (4), 12SH7GT (3), 12SL7GT (2), 12A6GT (1). Ideal for 2-metre converter. Complete with 1/60 h.p. tuning motor. In makers sealed cases. 23/15/-, carriage 5/-, inclusive of circuit.

WESTROTORS W.X.6 and W.112. 6/- per doz., post 4d.

FOURTEEN FEET COPPER AERIALS in 7 interlocking sections. 4/6, post 6d.

LUBREA HOLE CUTTERS. Adjustable to 3/16 in. 5/-, post 6d.

THERAT MICROPHONES. Low impedance, 3/6, post 4d.

BATTERIES. M.C.R.1. type, 90 v. H.T. and 7 1/2 v. L.T. 6/8 each, post 6d.

EVER READY MINIMAX. 67 1/2 v., 5/6, post 4d.

BEAM AERIAL MOTORS. 230 v. 50 c.p.s. Sync. 8.75 f.p.m. 100 lbs. torque. 2/4 each, carriage 5/-.

SEND 2/4. FOR FULL RADIO PUBLICATIONS LIST.

Southern Radio Supply Ltd.
48, LISLE STREET, LONDON, W.C.2.
GERRARD 6653

ENGINEERING careers and qualifications.

BOTH Government and industry have announced and emphasized that young men with technical knowledge and qualifications must receive every chance to rise to the highest positions within their capacity, in post-war engineering and allied industry; write to-day for "The Engineer's Guide to Success"—200 courses free—which shows you how you can become A.M.I.E.E., A.M.I.Mech.E., A.F.R.Ae.S., etc., and covers all branches in radio, automobile, mechanical, electrical, production, aeronautical, etc.

THE Technological Institute of Great Britain, 82, Temple Bar House, London, E.C.4. (1176)
TELEVISION postal course for radio trades
Examination Board's diploma, also postal courses for P.M.G. 2nd and 1st class Certificates and Amateur Radio Transmitting licence. Apply British School of Telegraphy, Ltd., 179, Clapham Rd., London, S.W.9. (40 years' experience in coaching students in wireless telegraphy and allied subjects.) [2586]

RADIO ENGINEERING SCHOOL, Air Service Training, Hamble, Southampton, provides the best full-time training for responsible positions in industry or aviation; students coached for C. & G. Inter. and Final Certs. in radio or tele-communications; Graduateship of Brit. I.R.E., M.C.A., radio engineer licence, and for air and marine radio officers' licences; full details from the Commandant. [2260]

THE Institute of Practical Radio Engineers have available Home Study Courses in every phase of radio and television engineering, specialising in the practical training of apprentices in the retail trade; enrolments limited, fees moderate.—The Syllabus of Instructional Text may be obtained post free from the Secretary, I.P.R.E., Fairfield House, 20, Fairfield Road, Crouch End, London, N.8. [1614]

FREE booklet, Training for Electronics, includes description of postal course on industrial electronics prepared by E.M.I. experts (H.M.V., Marconi, Columbia, etc.). Course describes circuit details, gives instruction on the functioning of many industrial electronic devices and their aid to increased productivity. Booklet also contains details of other postal and attendance courses.—Write to E.M.I. Institutes, Ltd., Dept. W.W., 43, Grove Park Rd., Chiswick, London, W.4. Tel. Chiswick 4417-8. [3192]

BOOKS, INSTRUCTIONS, ETC.
WEBB'S 1948 radio map of world, new multi-colour printing, with up-to-date call signs and fresh information, on heavy art paper, 4/6, post 6d; on linen on rollers, 11/6, post 9d.—Webb's Radio, 1-4, Soho St., W.1. Gerrard 2089.

YOURS for the asking; grand new catalogue of over 100 new publications dealing with every aspect of radio, television and electrical engineering; also 6-page ditto of exceptional bargains in radio and gram equipment, and the pick of current Government releases, s.a.e. please, to: Radio Unlimited, 16, Carnarvon Rd., Leyton, E.10. [2251]

BRANS' Radio Valve Vade-Mecum." 1948 1st edition (two vols.), 12/6, only one copy per address; Brans' "Radioschemas," five vols costs and servicing data for Continental sets, sons British and Americans included, Vol. 1 13/6, 2 17/6, 3 20/-, 4 14/-, 5 15/-; postage 10d per vol; set 5 vols 2/4, postage 2/6, only one copy each vol. per address; index available.—Peter Armstrong, 136, Bickenhall Mansions, London, W.1. Weilbeck 4893. [3006]

FOR SALE AS A GOING CONCERN, a well equipped engineering business, producing high class recording equipment. Write in first instance to Box 4943 c/o "Wireless World"

THIS Does these



ACCURATELY and QUICKLY Chassis, Brackets, Shrouds, Condenser and Transformer clips—**TREPARNING** Steel or Aluminium. Five sizes—18" to 36" *Full particulars from*
A. A. TOOLS (W), 197A, WHITEACRE ROAD, ASHTON-UNDER-LYNE

SPENCER - WEST TELEVISION PRE-AMPLIFIERS are improving results for many viewers. Type AC/2 10 gns. Type A2 £4 16 0.

Particulars from SPENCER-WEST, Quay Works, Gt. Yarmouth.

THE ULTIMATE in your quest for REALISTIC REPRODUCTION will be found at "LOWTHER HOUSE"

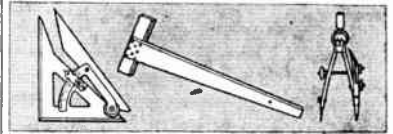

Geometricians tell us that the shortest distance between two points is a straight line

YOURSELF

LOWTHER HOUSE

Therefore, pay us a visit, hear, examine and judge for yourself our complete range of reproducing equipment.

Daily demonstrations at

THE LOWTHER MANUFACTURING CO.
Lowther House, St. Mark's Road, BROMLEY, KENT.

Rav. 5225.

MAINS TRANSFORMERS, SCREENED, FULLY INTERLEAVED AND IMPREGNATED.

H.S.43. Input 200/250, Output 250/0/250, 60 mA, 6.3 v. at 3 amp., 5 v. at 2 amp.	15/6 Half
H.S.40. Windings as above, 4 v. at 4 amp., 4 v. at 2 amp.	Shrouded
F.S.2. Input 200/250, Output 250/0/250, 80 mA	19/6 Fully
F.S.3. Input 200/250, Output 350/0/350, 6.3-4-0 v. at 4 amp. 5-4-0 v. at 2 amp.	Shrouded
H.S.2. Windings as F.S.2, 80 m/A	17/6 Half
H.S.3. Windings as F.S.3, 80 m/A	Shrouded
F.4. Filament Transformer, 200/250 Input, 4 v. at 2 amp. Output, at ...	7/6
F.6. Filament Transformer, 200/250 Input, 6.3 v. at 2 amp. Output, at ...	7/6
F.44. Filament Transformer, 200/250 Input, 4 v. at 4 amp. Output, at ...	13/6
F.12. Filament Transformer, 200/250 Input, 12.6 v. tapped at 6.3 v. at 3 amp., at ...	15/6
F.24. Filament Transformer, 200/250 Input, 24 v. tapped at 12v. at 3 amp., at ...	21/6
Multi-Ratio Output Transformer at Midget Pentode Output Transformer, at ...	5/- per dozen 33/-
C.W.O. (add 1/- in the £ for carriage) over £2. Carriage paid.	

ALL THE ABOVE ARE NEW GOODS

H. ASHWORTH
676, GREAT HORTON RD., BRADFORD, YORKS.

INDEX TO ADVERTISERS

Table listing various companies and their page numbers, including A.A. Tools, Acoustical Mfg. Co., Ltd., Adcoia Products, Ltd., Aerialite, Ltd., Alrmec Laboratories, Ltd., Albert Mfg. Co., All-Power Transformers, Ltd., Allan, Richard, Radio, Ltd., Antiference, Ltd., Armstrong Wireless & Television Co., Ltd., Ashworth H., Astor Boisselier & Lawrence, Ltd., Automatic Coil Winder & Electrical Equipmt. Co., Ltd., A.W.F. Radio Products, Ltd., Barker, A. C., Belling & Lee, Ltd., Berger, Lewis, & Sons, Ltd., Bird, S. S., & Sons, Ltd., Birmingham Sound Reproducers, Ltd., Brierley, J. H. (Gramophones & Recordings), Ltd., Brighton Tele-Services, Ltd., Britain Chas. (Radio), Ltd., British Industries Fair, British Institute of Engineering Technology, British Insulated Callender's Cables, Ltd., British National Radio School, British Physical Laboratories, British Royal, Ltd., Brookes Controls, Ltd., Brown, S. G., Ltd., Buccleuch Radio Manufacturers, Bulgin, A. F., & Co., Ltd., Bull, J. & Sons, Ltd., Bull's Ex-Govt. Depot, Bullers, Ltd., Candler System Co., Cawkell, A. E., Celestion, Ltd., Charles Amplifiers, Ltd., Collaro, Ltd., Cosmocord, Ltd., Couplhone Radio, Coventry Radio, Davis, Aec., Supplies, Ltd., Denco Distributors, Ltd., Desoutter Bros., Ltd., Dismore, L. P., Dubliner Condenser Co. (1925), Ltd., Dupley Electronics, Ltd., Edison Swan Electric Co., Ltd., Electradix Radios, Electric & Musical Industries, Ltd., Electrical Sound & Television Patents, Ltd., Electro Technical Assemblies, Electronic Instruments, Ltd., Elmsleigh Radio Co., Emco, Ltd., Enock, J., Ltd., Enthoven, H. J., & Sons, Ltd., Erie Resistor, Ltd., Factor, J., Ltd., Ferranti, Ltd., Filmer, J. T., Fluixite, Ltd., Frith Radiocraft, Ltd., Furzehill Laboratories, Ltd., Galpins, General Electric Co., Ltd., General Electrical Radio, General Lamination Products, Ltd., Glaser, L., Goodmans Industries, Ltd., Goodsell, Ltd., Gramplan Reproducers, Ltd., Gray, A., Ltd., Hartley, H. A., Co., Ltd., Haynes Radio, Ltd., Hazlehurst Designs, Ltd., Henley's, W. T., Telegraph Works Co., Ltd., Hill & Churchill, Ltd., Hivac, Ltd., Holborow & Co., Holt, Stan, H.P. Radio Services, Ltd., Hunt, A. H., Ltd., Industrial Electronics, International Correspondence School, Johnson, Matthey & Co., Ltd., Kolectric, Ltd., Lasky's Radio, Leak, H. J., & Co., Ltd., Lockwood & Co., Londex, Ltd., London Central Radio Stores, London Radio Supply Co., Lowther Mfg. Co., Lustraphone, Ltd., Lyncar Laboratories, Lyons, Claude, Ltd., Mail Order Supply Co., Marconi Instruments, Ltd., Marconiphone Co., Ltd., The Measuring Instruments (Pullin), Ltd., McMurdo Instrument Co., Ltd., Metro Fex, Ltd., Midland Instrument Co., Modern Book Co., Monochord Radio, M.R. Supplies, Ltd., M.S.S. Recording Co., Ltd., Mullard Electronic Products, Ltd., Multicore Solders, Ltd., Murphy Radio, Ltd., Mycalex, Ltd., Oliver Pell Control, Ltd., Osom Radio Products, Ltd., Oxley Developments Co., Ltd., Painton & Co., Ltd., Park Radio, Parker Radio Corpn. Ltd., Partridge Transformers, Ltd., Peerless Radio, Ltd., Pennine Amplifiers, Philips Electrical, Ltd., Pike Bros., Pikeo, Ltd., Pill, G. N. & Partners, Pitman, Sir Isaac, & Sons, Ltd., Post Radio Supplies, Premier Radio Co., Quartz Crystal Co., Ltd., Radford, A. H., Radio-Electronics, Ltd., Radiomart (B'ham), Ltd., Radiomenders, Ltd., Radiospares, Ltd., Ransom, H., Record Electrical Co., Ltd., The Reliance Mfg. Co. (Southwark), Ltd., Reproducers & Amplifiers, Ltd., Rimington Van Wyck, Ltd., Ring Lamp Co., Roding Laboratories (Electronics), Rogers Developments Co., Runoaken Electrical Products, Salford Electrical Instruments, Ltd., Sangamo Weston, Ltd., Savage, W. Bryan, Ltd., Scharf, Erwin, Simon Sound Service, Smith, W. H., & Son, Ltd., Soeell Industries, Ltd., Sound Sales, Ltd., Southern Radio Supply, Ltd., Sphere Radio, Ltd., Stability Radio Components, Ltd., Standard Telephones & Cables, Ltd., Steatite & Porcelain Products, Ltd., Stern Radio, Ltd., Sugden, A. R., & Co. (Engineers), Ltd., Taylor Electrical Instruments, Ltd., Taylor Tunncliff (Refractories), Ltd., Teie-Radio (1943), Ltd., Telegraph Condenser Co., Ltd., Telephone Mfg. Co., Ltd., Teleradio Co., Thernionic Products, Ltd., Transradio, Ltd., Trix Electrical Co., Ltd., Truvox Eng. Co., Ltd., T. & C. Radio College, United Insulator Co., Ltd., Universal Electrical Instruments Corpn., University Radio, Ltd., Valradio, Victoria Instruments, Vitavox, Ltd., Voigt Patents, Ltd., Vortexion, Ltd., Wayne Kerr Labs., Ltd., The Webb's Radio, Westinghouse Brake & Signal Co., Ltd., West, Spencer, Wharfedale Wireless Works, Whiteley Electrical Radio Co., Ltd., Wilkins & Wright, Ltd., Wilkinson, L., Wimbledon Eng. Co., Ltd., Wireless Instruments (Leads), Ltd., Wireless Supplies Unlimited, Woden Transformer Co., Ltd., Wolsey Television, Ltd., Wright & Weaire, Ltd.

POTENTIOMETERS



by RELIANCE

Wire-wound and Composition types. Single, Ganged, Tandem Units. Characteristics: linear, log., semi-log., non-inductive, etc. Full details on request. RELIANCE MFG. CO. (SOUTHWARK), LTD., Sutherland Road, Higham Hill, Walthamstow, E.17. Telephone: Larkwood 3245

FREQUENCY STABILITY IS ANOTHER GOOD FEATURE

Conversion of D.C. to A.C. for use with television receivers and other apparatus requiring maximum frequency stability means that the converter used must be dependable under the most adverse conditions. VALRADIO VIBRATOR CONVERTERS are becoming increasingly used for this very reason.

MODEL 230/175/24 D.C. input 24 volts, A.C. output—230v./175 watts, 50 or 75 c.p.s. £16 Telephone: GULLIVER 5165 LTD. 57 Fortress Rd., London, N.W.5

Printed in Great Britain for the Publishers, ILLIFFE AND SONS LTD., Dorset House, Stamford Street, London, S.E.1, by THE CORNWALL PRESS LTD., Paris Garden, Stamford Street, London, S.E.1. "Wireless World" can be obtained abroad from the following—AUSTRALIA AND NEW ZEALAND: Gordon & Gotch, Ltd. INDIA: A. H. Wheeler & Co. CANADA: Imperial News Co.; GORDON & GOTCH, LTD. SOUTH AFRICA: Central News Agency, Ltd.; WILLIAM DAWSON & SONS (S.A.), LTD. UNITED STATES: The International News Co.

For Interference Suppression

call in the Experts !



T.C.C.'s long experience in the application of suppression devices enables them to offer a wide range of suppressors of proved efficiency. In addition, T.C.C.'s specialised manufacturing techniques have produced extremely compact types which are easily fitted to equipment and provide effective suppression over an exceedingly wide band of Radio frequencies. Where specialised applications, not covered by standard types, are required, T.C.C.'s Technical Department will be glad to advise. The new Wireless Telegraphy Bill will bring you many suppressor problems—T.C.C. can solve them for you. Write to-day for full details and literature.

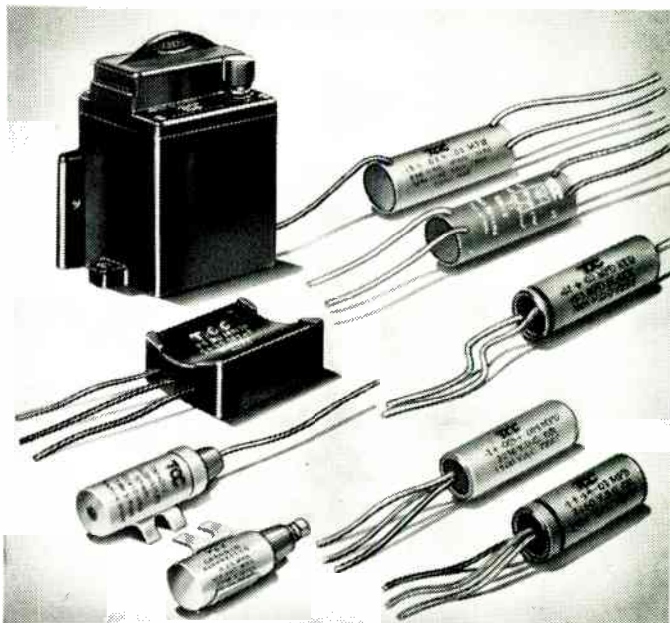

SUPPRESSOR *Condensers*

IN THE BEST EQUIPMENT YOU'LL SEE **TCC**

THE TELEGRAPH CONDENSER CO. LTD.

RADIO DIVISION

NORTH ACTON · LONDON · W.3

Telephone. ACORN 0061

THE FINEST CORED SOLDER IN THE WORLD

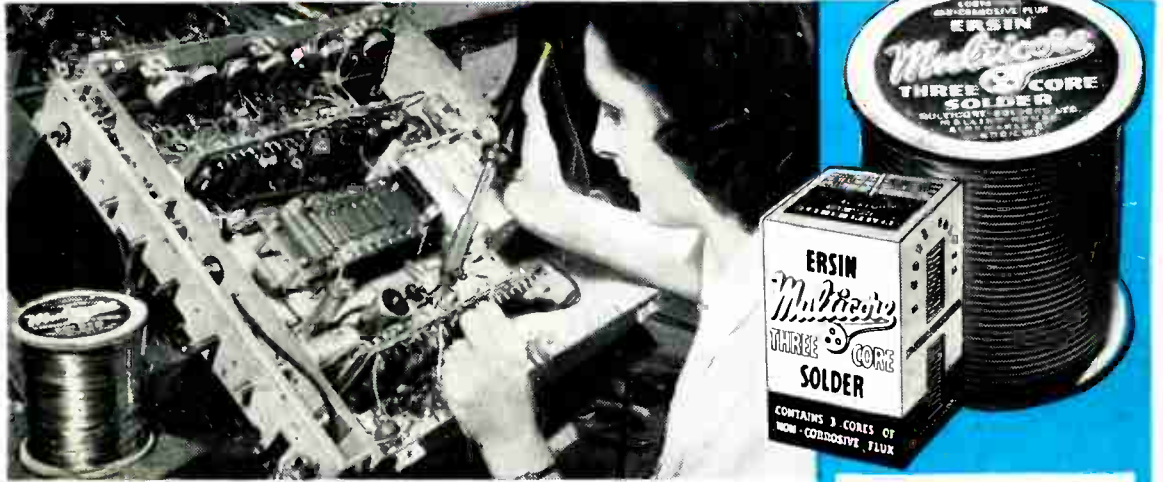
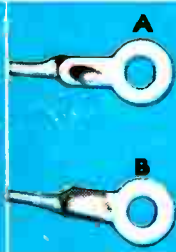

Photo by courtesy of "His Master's Voice".

At "His Master's Voice" (E.M.I.) factories at Hayes, Middlesex, Ersin Multicore Solder is used in the manufacture of television and radio receivers and radio gramophones.

Ersin Multicore Solder is supplied for factories in 5 alloys and 9 gauges on 7 lb. reels. Bulk prices on request.



The extra speed of Ersin Flux enables less to be incorporated in all three cores than in the one core of most single-core solders. Thus you obtain more solder for a specific weight and save money.

SINGLE CORE v. ERSIN MULTICORE

A, soldered with single-core rosin solder. Solder has adhered only to the copper wire. A typical "dry joint." B, soldered with Ersin Multicore Solder has spread evenly over tinned copper wire and oxidised nickel tag. A sound mechanical and electrical joint.

The easiest way in which to see the three cores in Ersin Multicore Solder is to hold a length over a flame, and, when the solder is heated slightly, pull sharply.



The apparatus illustrated here is used in Multicore Research Laboratories to pass A.C. and D.C. currents through fine wires and soldered joints whilst they are subjected to climatic conditions equivalent to the Arctic or the Tropics



Above are seen soldered joints being made on Automatic Telephone Exchange Equipment at Siemens Brothers & Co. Ltd. Woolwich Works, where many millions of Ersin Multicore Solder joints are made per week.

Ersin Multicore

THREE CORE SOLDER

MULTICORE SOLDERS LTD., MELLIER HOUSE, ALBEMARLE STREET, LONDON, W.1.

Tel. REGent 1411

Size I Cartons are available in the following Specifications:

Catalogue Ref. No.	Alloy Tin/Lead	S.W.G.	Approx. length per carton	List Price per carton (subject)
C 16014	60/40	14	32 feet	s. 6 d. 0
C 16018	60/40	18	84 feet	6 9
C 14013	40/60	13	20 feet	4 10
C 14016	40/60	16	44 feet	5 3