

# Wireless World

RADIO AND ELECTRONICS

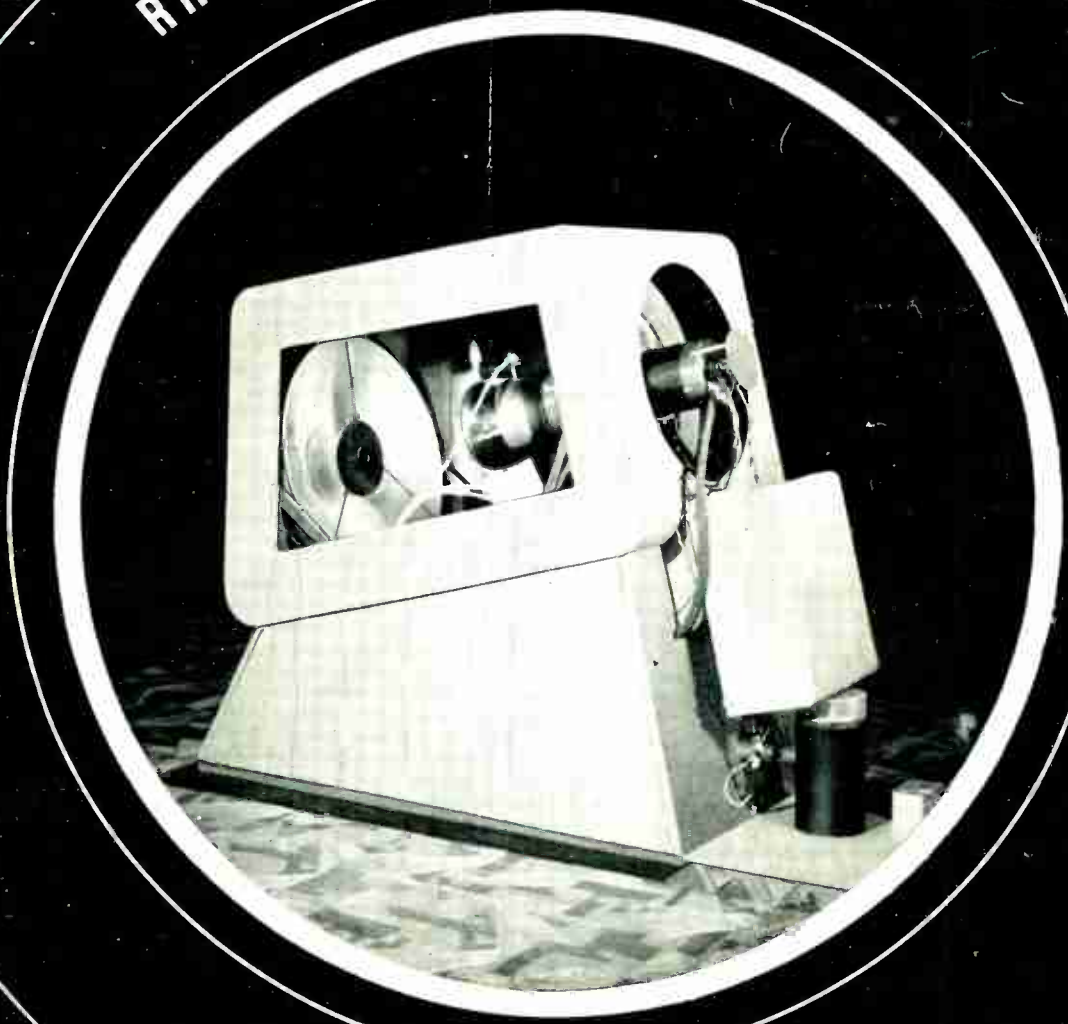

JAN. 1949

2/-

Vol. LV. No. 1

IN THIS  
ISSUE :

MEASUREMENT OF "Q"

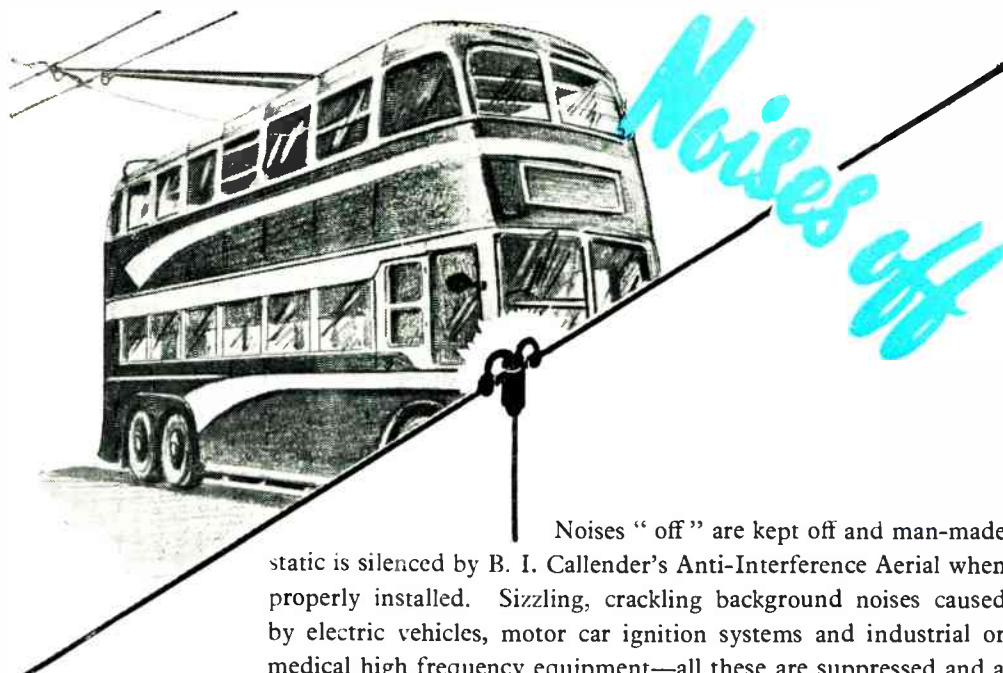

Noises "off" are kept off and man-made static is silenced by B. I. Callender's Anti-Interference Aerial when properly installed. Sizzling, crackling background noises caused by electric vehicles, motor car ignition systems and industrial or medical high frequency equipment—all these are suppressed and a quiet background established for radio programmes. Reception is improved, for a maximum number of programmes can be enjoyed on all wavelengths.

The aerial is a 60 ft. polyethylene insulated dipole type, with suspension insulators and matching transformer. The 80 ft. down lead is a fully screened coaxial cable with polyethylene plugs moulded to each end and is matched to the receiver by a transformer with

easily fixed suction mounting.

B. I. Callender's All-Wave Anti-Interference Aerial will give you better listening and reveal many stations you never heard before. Write to-day for the descriptive folder No. 221s on the Anti-Interference Aerial.

*Licensed under Amy Aceves & King, Inc. Patents Nos. 413917, 424239 and 491220.*

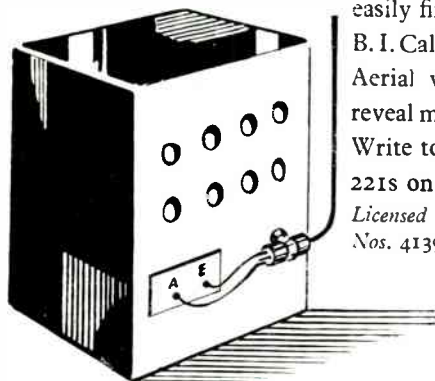

**BI**  
*Callender's* **All-Wave**  
**ANTI-INTERFERENCE AERIAL**

BRITISH INSULATED CALLENDER'S CABLES LIMITED  
NORFOLK HOUSE, NORFOLK STREET, LONDON, W.C.2

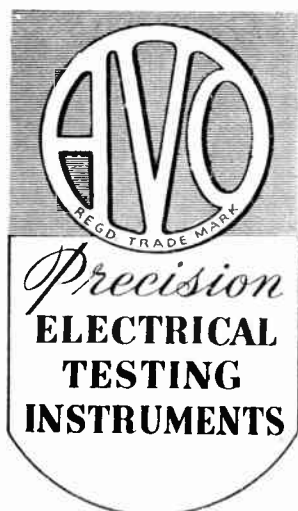

BRITISH MADE

PRICE  
£35

This instrument, which is an up-to-date example of current instrument practice, has been developed to meet the growing demand for an instrument of laboratory sensitivity built in a robust and portable form, for use in conjunction with electronic and other apparatus where it is imperative that the instrument should present a negligible loading factor upon the circuit under test.

The instrument consists basically of a balanced bridge voltmeter. It incorporates many unique features and a wide set of ranges so that in operation it is as simple to use as a normal multi-range testmeter.

The instrument gives 49 ranges of readings as follows:—

D.C. VOLTS: 2.5mV. to 10,000V.

(Input Resistance 111.1 megohms).

D.C. CURRENT: 0.25 $\mu$ A. to 1 Amp.

(150mV. drop on all ranges).

A.C. VOLTS: 0.1V. to 2,500 V. R.M.S. up to 1 Mc/s. With external diode probe 0.1V. to 250V. up to 200 Mc s.

A.C. OUTPUT POWER: 5mW. to 5 watts in 6 different load resistances from 5 to 5,000 ohms.

DECIBELS: -10db. to +20db.

CAPACITANCE: .0001 $\mu$ F. to 50 $\mu$ F.

RESISTANCE: 0.2 ohms to 10 megohms.

INSULATION: 0.1 megohm to 1,000 megohms.

The thermionic circuit gives delicate galvanometer sensitivity to a robust moving coil movement. It is almost impossible to damage by overload. The instrument is quickly set up for any of the various tests to be undertaken, a single circuit selector switch automatically removing from the circuit any voltages and controls which are not required for the test in question.

Fully descriptive pamphlet  
available on application.

Sole Proprietors and Manufacturers —

**The AUTOMATIC COIL WINDER & ELECTRICAL EQUIPMENT CO. LTD.**  
WINDER HOUSE · DOUGLAS STREET · LONDON · S.W.1 Telephone: VICTORIA 3404/9

E.T.M. 3



# For High Fidelity reproduction

## GOODMANS *AXIOM TWELVE* Loudspeaker

This instrument is sufficiently outstanding to arouse the lively appreciation of all High Fidelity enthusiasts. If your equipment can provide a practically faultless output, we have no hesitation in saying that its performance with the Axiom Twelve Loudspeaker will impress you agreeably.

It must be emphasised, however, that the Axiom Twelve is a High Fidelity Reproducer and *must* be used with equipment which has also been specifically designed for this purpose. If

the signal includes any distortion, this will be reproduced, possibly with unpleasant aural results. That is why, for general requirements, we still recommend our standard 12" model T2.

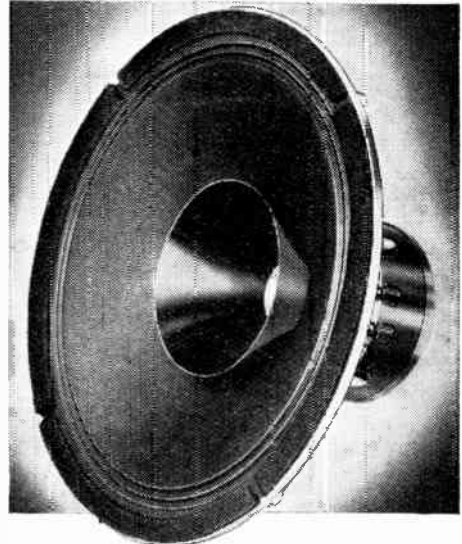

### FIDELITY



SPECIFICATION:—			
Frequency Range ..	40-15,000 c/s.	Flux Density ..	13,000 gauss.
Fundamental Resonance ..	65 c/s.	Total Flux ..	145,000 max wells.
Voice Coil Impedance ..	15 ohms.	Power Rating ..	12 watts peak A.C.
Voice Coil Diameter ..	1 1/2".	<i>Write for fully descriptive Folder D-19.</i>	

### EFFICIENCY

GOODMANS INDUSTRIES, LTD., LANCELOT ROAD, WEMBLEY, MIDD. 'Phone: Wembley, 1200. Cables: "Goodmans, Wembley 1200."

## Simon SOUND SERVICE

### THE COMPLETE SERVICE FOR SOUND RECORDING AND REPRODUCTION

- ★ Mobile, static and specialised recording units
- ★ Recording amplifiers, speakers, microphones, etc.
- ★ Sapphire cutting and reproducing stylii
- ★ Blank recording discs from Sin. to 17in. Single and Double-sided
- ★ Groove locating and cueing devices
- ★ A comprehensive range of accessories to meet every requirement of the sound recording engineer
- ★★ A development of special interest to users of sapphire and delicate pick-ups—THE SIMITROL. This is a controlled micro-movement easily fitted for use with any type of pick-up
- ★★★ OUR CDR48A RECORDER UNIT complete and self-contained, measuring only 22in. x 14in. x 13 1/2in., incorporating 7-valve amplifier, recorder unit, light-weight pick-up, speaker and microphone and with many exclusive features, is now ready for early delivery.

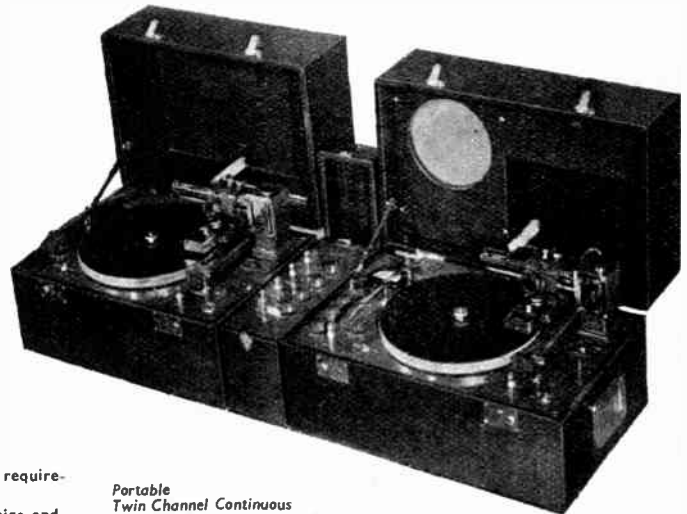

Portable  
Twin Channel Continuous  
Recording System incorporating  
CDR48A Recorder/Amplifier  
DR48A Recorder and EM48A Electronic  
4 Channel Mixer

OUR WELL-EQUIPPED WORKSHOPS ARE AVAILABLE FOR THE  
DEVELOPMENT OF EQUIPMENT TO MEET SPECIAL NEEDS.

**SIMON SOUND SERVICE, Recorder House, 48/50, George St., Portman Square, London, W.1.**

CABLES: Simsale, London.

TELEGRAMS: Simsale, Wesdo, London.

TELEPHONE: Welbeck 2371 (4 lines).



# HIGH STABILITY CAPACITORS

## TECHNICAL INFORMATION BULLETIN No 1

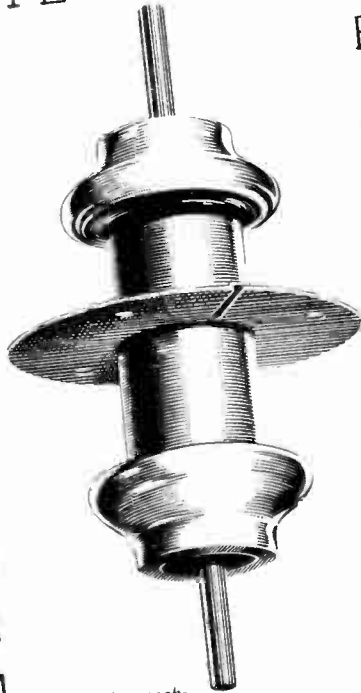

Further technical details furnished on request.

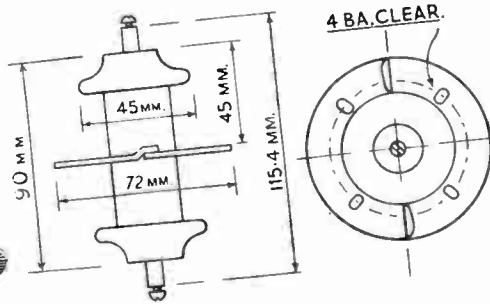

### LEAD-THROUGH "HI-LOAD" CAPACITOR

This new Ceramic "Hi-Load" Capacitor has been specially designed as H.T. or Heater By-Pass and Lead-Through Capacitor. Although very small in dimensions the capacitor has a capacitance of 1,000 pF and it is rated at 40 KVA R.F. with a maximum R.F. current of 20 amps. The sturdy rod forming the lead-through connection is capable of handling all normal currents. The high rating also makes the capacitor suitable as a tank capacitor.

UNITED INSULATOR CO. LTD. OAKCROFT RD. TOLWORTH SURBITON SURREY  
 Telephone: Elmbridge 5241 (6 lines)      Telegrams: Calanel, Surbiton

**The best—**

**HIGH**

**and**

**LOW**

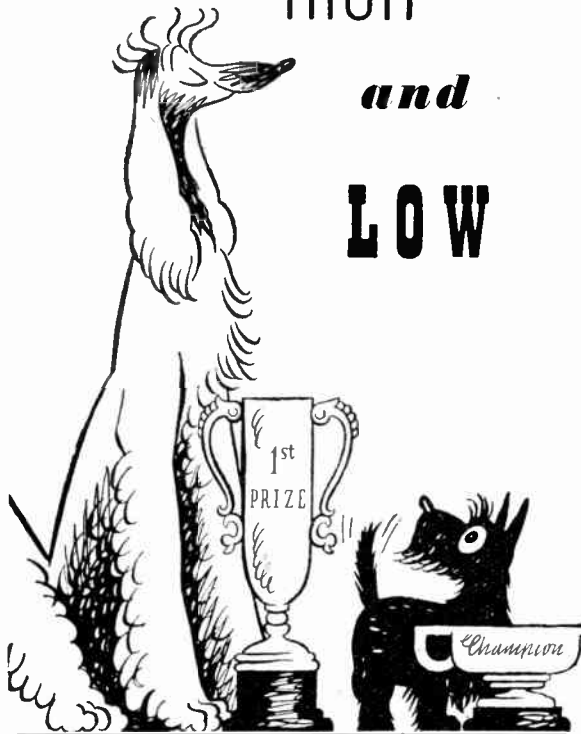

**Exide**

L.T. ACCUMULATORS

and

**Drydex**

H.T. BATTERIES

**for better  
battery radio reception**

ISSUED BY THE CHLORIDE ELECTRICAL STORAGE COMPANY LIMITED

**E.H.T.**

FROM LINE  
FLY BACK ●

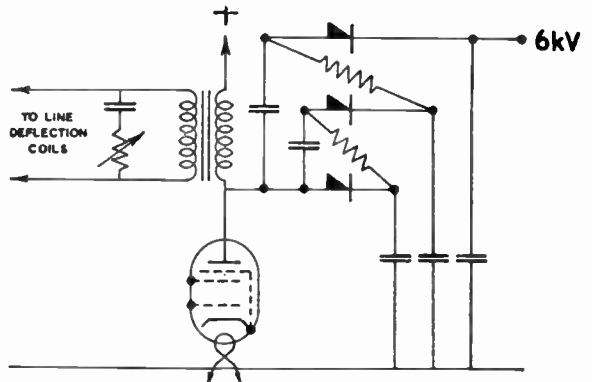

Tripler circuit using

**WESTINGHOUSE**  
**WESTALITE**

**TYPE 36EHT35  
RECTIFIERS**

Peak pulse input approximately 2,500V.  
Output approximately 6kV at 100  
micro-amperes.

Simple . . . efficient . . . and reliable

Write for data sheet No. 60, to Dept. W.W.1

**WESTINGHOUSE BRAKE & SIGNAL  
CO., LTD.**

**82 YORK WAY, KING'S CROSS, LONDON, N.1**

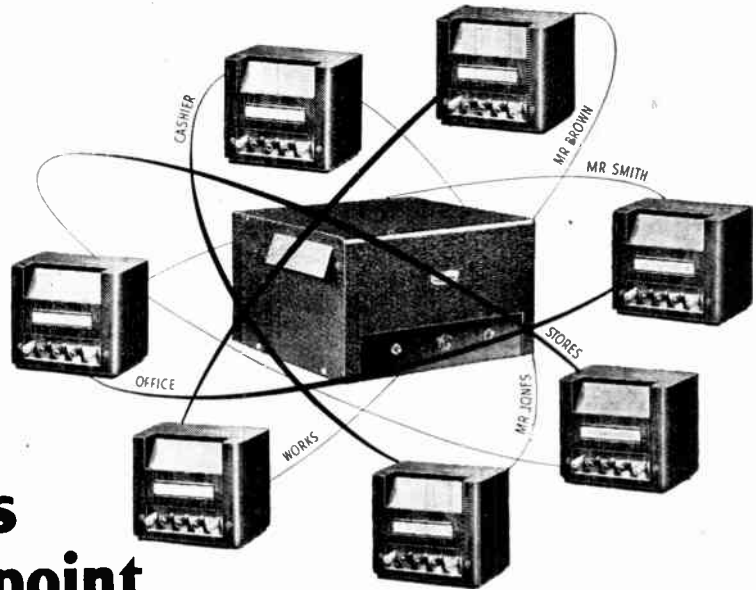

# Make calls from any point with the Hadley **MULTICOM**...

The first system of its kind to provide complete loudspeaker intercommunication between all points. Up to seven Departments are instantly in touch with one another by the flick of a switch. All stations are identical. Priority of call is provided on the principal unit.

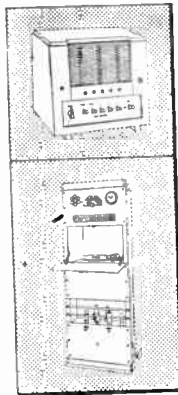

### Other Hadley Products

#### THE HADLEY INTERCOMMUNICATOR

designed for personal communication between master unit and any or all of the sub-stations and also incorporates the novel feature of a desk radio which can be relayed to the sub-stations. An inexpensive aid to efficiency.

#### THE HADLEY INDUSTRIAL UNIT

proved to be well in advance of any similar equipment. Provides all facilities for 'Staff Location,' 'Music for the Workers,' 'Time Signals,' etc.

All Hadley Equipments are available on Cash Purchase or Rental Maintenance terms.

All export enquiries to be addressed to our export agent:

**CHARLES BAGLIN**

**411 COVENTRY ROAD, BIRMINGHAM, 10**

Telegrams: Pentagons, Birmingham

# Hadley

Sound

Equipments

Phone: BEARwood 2575/6

BEARWOOD ROAD, SMETHWICK, STAFFS.



**PATIENCE  
NO LONGER  
A VIRTUE**

# WHERE *SOLDERING'S* CONCERNED

**AMATEURS! SERVICE MEN! ENGINEERS!**

Don't be patient. You are wasting your time. Use the Burgoyne Seven Second Solder Gun and take the patience and waiting period out of your soldering.

The wonderful clean heat which you get with the Solder Gun will ensure that you do not get dry joints, no fussy re-tinning required. Use like an ordinary iron but press the trigger and solder immediately.

Send for fully descriptive folder free.

Sole manufacturers:

EXPORT ENQUIRIES INVITED.

**BURGOYNE ENGINEERING CO. LTD.,**  
1-3, Robert Street, Hampstead Road, London, N.W.1  
Telephone: EU5ton 6094.

# 7 SECOND

PRICE COMPLETE

## 79'6

With Two spare Bits and 4 yards of Flex. Model 5.471 for 100-130v. A.C.  
Model 5.472 for 200-250v. A.C.

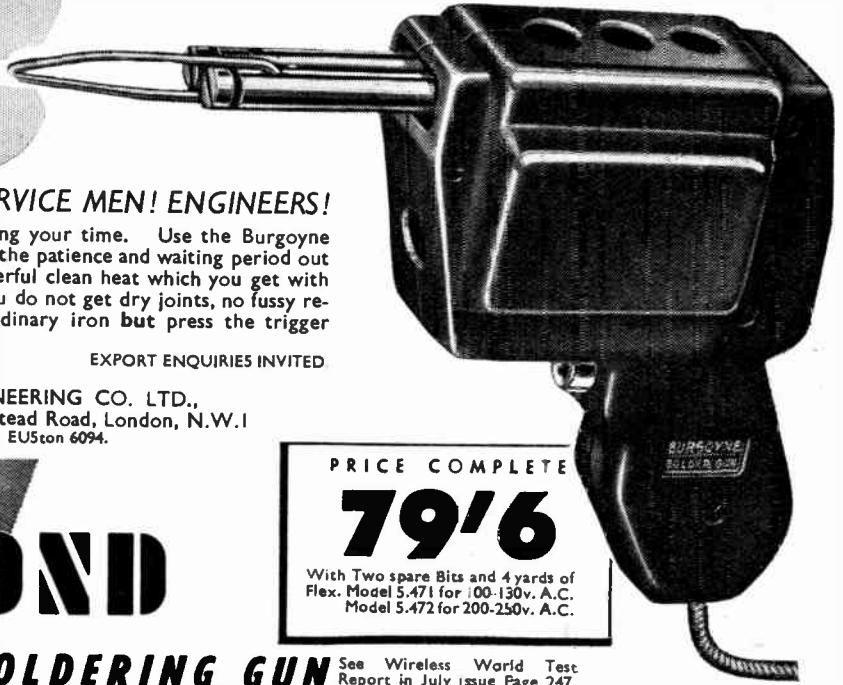

**INDUCTION SOLDERING GUN** See Wireless World Test Report in July issue Page 247.

## BUILT TO LAST

M.C.T. RANGE · CHASSIS MOUNTING  
FULLY IMPREGNATED



TYPE	USE	PRIMARY	SECONDARY
M.C.T.100	Mains Transformer	0-200-230-250 v. 40-100 Cps.	300-0-300 v. 75 m/a. 4 v. 4 amps. 4 v. 2 amps.
M.C.T.101	Mains Transformer	0-200-230-250 v. 40-100 Cps.	300-0-300 v. 75 m/a. 6.3 v. 3 amps. 5 v. 2 amps.
M.C.T.110	Auto Transformer	0-100-110-200-230- 250 volts 40-100 Cps. 100 w.	
M.C.T.120	Mains Transformer	0-200-230-250 v. 40-100 Cps.	350-0-350 v. 75 m/a. 4 v. 4 amps. 4 v. 2 amps.
M.C.T.121	Mains Transformer	0-200-230-250 v. 40-100 Cps.	350-0-350 v. 75 m/a. 6.3 v. 3 amps. 5 v. 2 amps.
M.C.T.124	Mains Transformer	0-200-230-250 v. 40-100 Cps.	350-0-350 v. 120 m/a. 4 v. 4.5 amps. 4 v. 2 amps.
M.C.T.125	Mains Transformer	0-200-230-250 v. 40-100 Cps.	350-0-350 v. 120 m/a. 6.3 v. 3 amps. 5 v. 2 amps.

4 V. & 6.3 V. types  
75 M/A ... 37/6  
120 M/A ... 45/-  
M.C.T. 110 ... 37/6

# Rm MAINS TRANSFORMERS

R.M. ELECTRIC LTD.,  
TEAM VALLEY,  
GATESHEAD, II



The G.E.C. has always supplied the fullest possible technical data on **OSRAM VALVES** to assist designers and service engineers using the wide range of electronic devices marketed by the Company.

Copies of data sheets embodying all details on Ratings, Dimensions, Operating conditions, and Characteristic curves may be had on specification of type required to the

**OSRAM VALVE TECHNICAL DEPT. Magnet House, Kingsway, W.C.2**

**Osram**  
PHOTO CELLS

**S.E.C.**  
CATHODE RAY TUBES

**Osram**  
VALVES

THE GENERAL ELECTRIC CO. LTD., MAGNET HOUSE, KINGSWAY, W.C.2.

# Measurement by Mullard

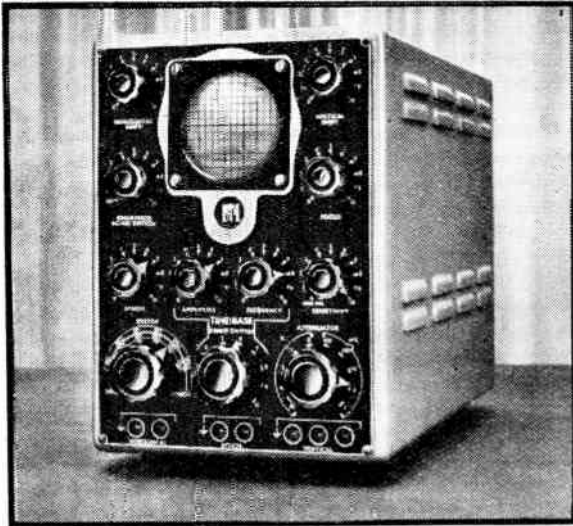

Mullard Oscillograph type E.800/1

The name of Mullard has for long been connected with cathode ray oscillographs, and their experience in this field is unequalled. Mullard cathode ray tubes, Mullard valves and Mullard circuitry have been combined to produce the accepted standard oscillograph.

## Type E.800/1

Time base frequency 0.25—16,000 c/s.  
Amplifier response (2 dB loss) 0.1—40,000 c/s.  
Amplifier sensitivity (Max. Gain) 1 mV.rms/cm.  
Delivery—Ex stock.

## Type E.805

Time base frequency 5 c/s—150 Kc/s.  
Amplifier response (3 dB loss) 2 c/s—2 Mc/s.  
Amplifier sensitivity (Max. Gain) 5 mV. rms/cm.  
Delivery—Ex stock.



# Mullard

## Electronic Products Ltd.

*Electronic Equipment Division*

ABOYNE WORKS, ABOYNE ROAD, LONDON, S.W.17.

(MI.276)

**THE**

*NO*

*Distortion*

**TELEVISION**

**LENS**

*Enlarges the Picture  
for ALL to See*

A PRODUCT OF  
**METRO PEX LTD**

71, Queens Road,  
London, S.E.15.

'Phone: New Cross 2442.



The world acknowledges British leadership in the television field. An important factor contributing to this supremacy is the consistent high standard, of quality and performance, of the components used in television apparatus. Dubilier Nitrogol Capacitors are produced with scrupulous regard to the fact that in all television circuits there are positions where only capacitors of the highest technical merit and proven reliability will suffice.

In such radio and electronic applications as undersea cable repeaters, radar apparatus, high quality amplifiers, and industrial electronic devices, the use of outstanding capacitors is a prime necessity; here,

too, experienced engineers specify Nitrogol Capacitors.

We shall be pleased to forward full technical details of these Capacitors upon request, and our technicians, backed by a competent laboratory organisation, are always ready to advise upon their use.

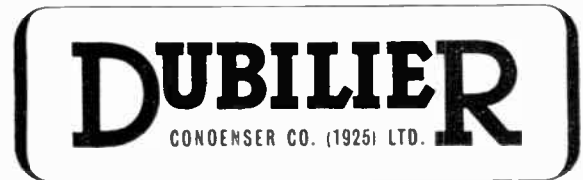

MAKERS OF THE WORLD'S FINEST CAPACITORS

DUBILIER CONDENSER CO. (1925) LTD., DUCON WORKS, VICTORIA ROAD, NORTH ACTON, W.3

\*Phone : Acorn 2241 (5 lines)

\*Grams : Hilvoltcon, Phone London.

Cables : Hilvoltcon, London.

Marconi International Code D21



# Advance

SUB-STANDARD

## Signal GENERATOR

TYPE  
**B4**

Model A  
100 Kc/s  
-70 Mc/s

Model B  
30 Kc/s  
-30 Mc/s

Accuracy  
± 1db

### Features

- CALIBRATION ACCURACY:** ± 1% Directly Calibrated.
- OUTPUT VOLTAGE:** 1μV—150 mV up to 30 Mc/s. 1μV—100 mV above 30 Mc/s Monitored by crystal voltmeter
- OUTPUT IMPEDANCE:** 75 ohms, terminated by 75 ohms terminating pad type TP,IA, providing impedance of 37 ohms, 10 ohms, and 10 ohms standard dummy aerial.
- MODULATION:** Internal: 400 c/s. 0-50% External: 100-10,000 c/s ± 6db, 0-80%.
- AUDIO-OUTPUT:** 0-15 volts at approximately 400 c/s into a load not less than 5,000 ohms.
- R.F. LEAKAGE:** Negligible—less than 1μV.
- POWER SUPPLY:** 110-210-230-250 volts, 40-100 c/s, 22 watts.
- DIMENSIONS:** 13ins. x 12ins. x 6ins. deep.
- WEIGHT:** 25 lbs.

Send for illustrated brochure giving full Specification.

## Covering all Television Ranges

- Model A.** 100 Kc/s to 70 Mc/s in 6 Bands
- Model B.** 30 Kc/s to 30 Mc/s in 6 Bands

- Negligible Stray Radiation.
- Output accuracy 1db.
- Directly Calibrated.

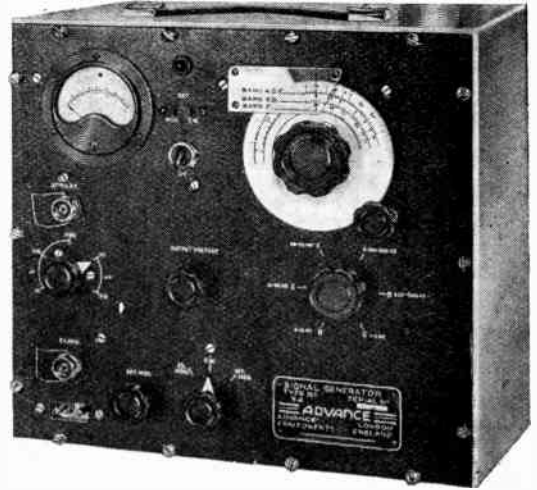

**ADVANCE COMPONENTS LTD.,** Back Rd., Shernhall St., Walthamstow, E.17. 'Phone: LARKSwood 4366-7

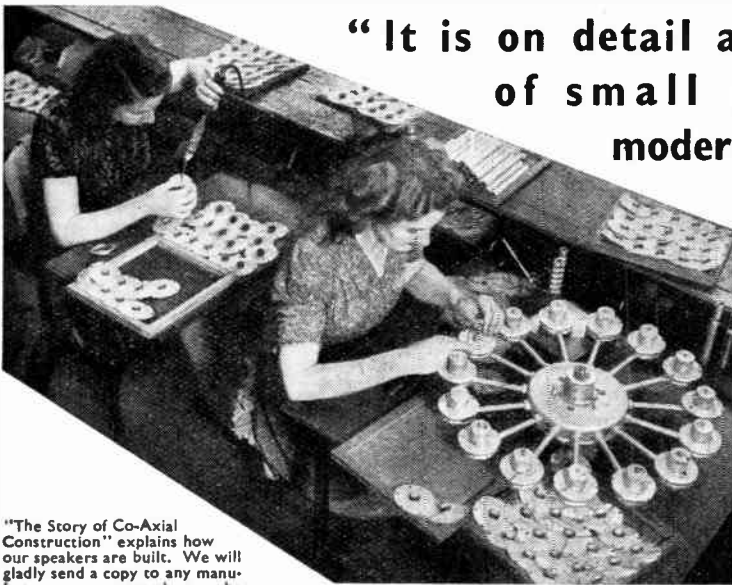

“It is on detail and care in design of small points that the modern set stands or falls”

“Radio Times,” Sept. 24, 1948

Attention to details of manufacture and assembly; revolutionary design and the provision of highly accurate specially designed jigs, ensure that in each R. & A. Reproducer the cone, voice coil centre and outer pole are inevitably and automatically aligned upon the axis of the speaker. This is why R. & A. Reproducers are free from mechanical defects. Continuous inspection at all stages is a further insurance that no defect can be present in the complete speaker.

“The Story of Co-Axial Construction” explains how our speakers are built. We will gladly send a copy to any manufacturer or overseas buyer who writes for one.

Voice coil and centering member sub-assembly.

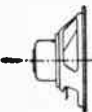

**REPRODUCERS AND AMPLIFIERS LIMITED**  
**FREDERICK ST. WOLVERHAMPTON ENGLAND**  
 Telephone Wolverhampton 22241  
 Telegrams “Audio Wolverhampton”



# EDISWAN

## SPECIAL PURPOSE VALVES

*for* R.F. HEATING  
COMMUNICATIONS  
ELECTRONIC APPLICATIONS

**ESA 892**  
5 KW-TRIODE  
Forced Air Cooled



**EHA 5000**  
5 KW-TRIODE  
Forced Air Cooled



**EAT 1500**  
1.5 KW-TRIODE  
Forced Air Cooled



**ESW 892**  
10 KW-TRIODE  
Water Cooled



**EHW 5000**  
5 KW-TRIODE  
Water Cooled

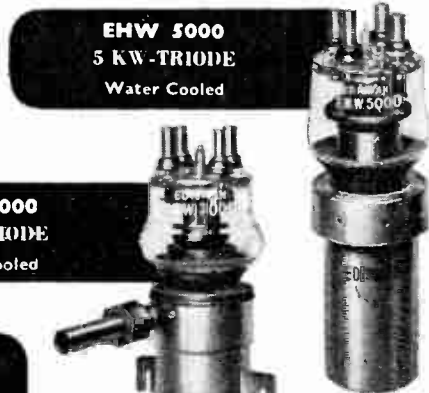

**EHW 3000**  
3 KW-TRIODE  
Water Cooled



**EHA 2500**  
2.5 KW-TRIODE  
Forced Air Cooled



Industrial Valve  
Folder available  
on request.

**THE EDISON SWAN ELECTRIC CO. LTD.**

155, CHARING CROSS ROAD, LONDON, W.C.2

V.73

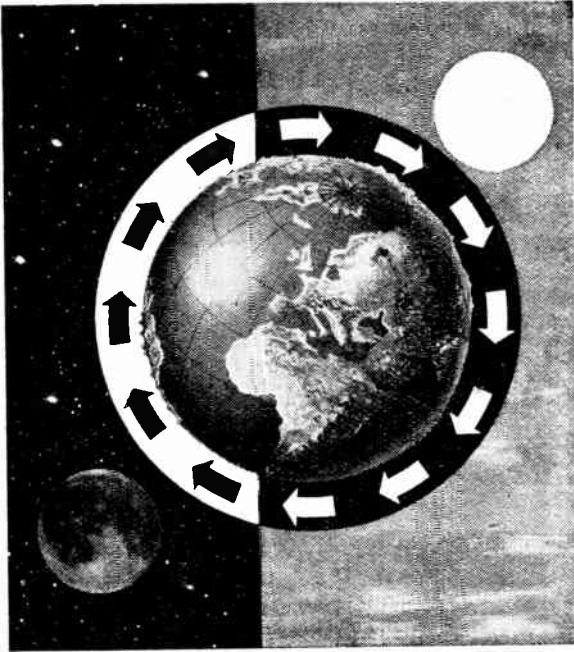

**Continuously in Service,  
Day and Night**

Noon over Nanking. Dawn over the Atlantic. Blackness over the Andes. In all parts of the world, at all times of the day and night, Marconi built stations are in operation, broadcasting or sending telegraph messages and giving unrivalled service. Wherever ships and aircraft are plying, you will find Marconi apparatus guiding them, every hour of the day, every day of the week. Pioneers in Wireless Communication fifty years ago, Marconi's still maintain their leadership. Behind every new development there will be Marconi's accumulated experience. Behind every new piece of Marconi equipment there will be the honoured name as an assurance of maximum efficiency.

*Marconi* 

**the greatest name in wireless**

MARCONI'S WIRELESS TELEGRAPH COMPANY LTD.,

MARCONI HOUSE, CHELMSFORD, ESSEX.

**SILENT  
POWER**

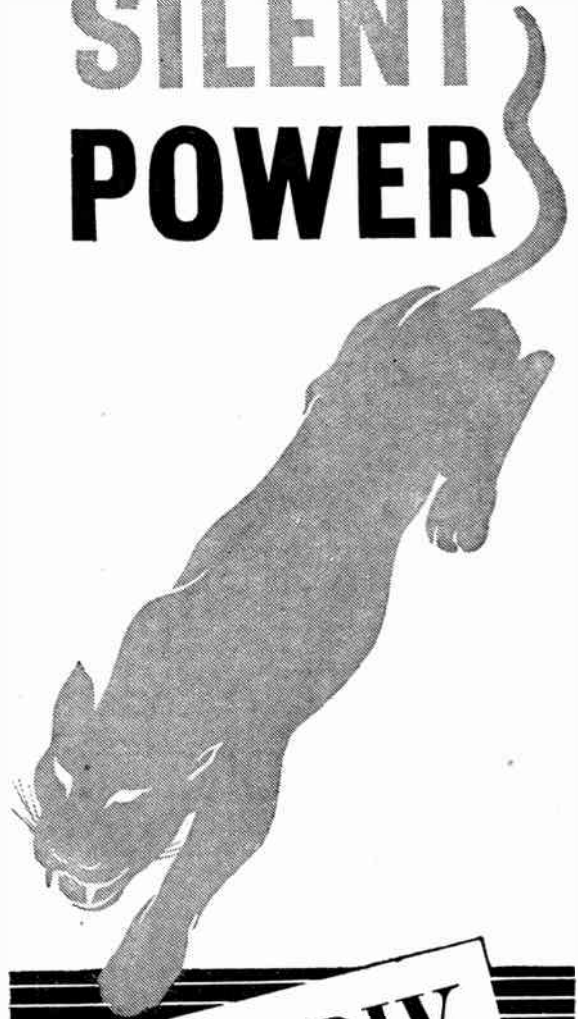

**PERTRIX**  
RADIO BATTERIES  
*'Always worth more!'*

P5

For clean, crisp reception a silent source of power is essential. Pertrix Radio Batteries give silent power.

**HOLSUN BATTERIES LIMITED**  
137 Victoria Street • London • S.W.1



NEW

# LEAK "POINT ONE"

AMPLIFIERS



## REMOTE CONTROL PRE-AMPLIFIER

£6 - 15 - 0 *list.*

An original distortionless feedback tone-control circuit which will become a standard. No resonant circuits employed.

Switching for Pick-up, Microphone and Radio, with automatic alteration of tone-control characteristics.

High sensitivities. Will operate from any moving-coil, moving-iron or crystal P.-U.; from any moving-coil microphone; from any radio unit.

Controls: Input Selector; Bass Gain and Loss; Treble Gain and Loss; Volume.

Output Impedance: 0-30,000Ω at 20 kc.p.s.

The unit will mount on motor-board through a cut-out of 10 $\frac{1}{8}$ in. × 3 $\frac{1}{8}$ in., or it can be bolted to the power amplifier, when, with a top cover, the whole assembly becomes portable.

## 12W. TRIPLE LOOP POWER AMPLIFIER

£25 - 15 - 0 *list.*

A Leak triple loop feedback circuit the main loop giving 26 db. feedback over 3 stages and the output transformer.

Push-pull triode output stage. 400 V. on anodes. No H.T. electrolytic smoothing or decoupling condensers.

Impregnated transformers; tropically finished components.

H.T. and L.T. supplies for pre-amp. and radio units.

Distortion: at 1,000 c/s and 10 W. output, 0.1%.

Hum and noise: -80 db. on 10 W.

Frequency response: ±0.1 db., 20 c/s-20 kc/s.

Sensitivity: 160 mV.

Input impedance: 1MΩ.

Output impedances: 2Ω: 7-9Ω: 15-20Ω: 28-36Ω.

Damping Factor: 20 (Regulation: 0.2 db.). 25 W. model available at £27/10/-.

### WRITE FOR LEAFLET W.T.L.12.

**TECHNICAL ACHIEVEMENT.** In June, 1945, H. J. Leak revolutionised performance standards for audio amplifiers by designing the original "Point One" series. Our figure of 0.1% total distortion was then the occasion for considerable astonishment, and even for incredulity, but it slowly became the standard towards which others were to strive. This is a factual matter recorded in our announcements in the technical press.

**WORKMANSHIP.** This equipment is built to laboratory standards in materials and appearance by experienced men.

**PRICE.** A very large initial contract for the export market has enabled us to produce, at these prices, equipment of our traditional standards.

## H. J. LEAK & CO. LTD. (Est. 1934)

BRUNEL ROAD, WESTWAY FACTORY ESTATE, ACTON, W.3.

Phone: SHEpherds Bush 5626.

Telegrams: Sinusoidal, Ealux, London.

Foreign: Sinusoidal London.

**Insist on**

**AERIALITE**  
Aerials & Equipment  
**Cables**

**ASHTON Cables**

For first-class performance, and utter reliability, you can safely recommend **AERIALITE** Radio and Television Aerials and equipment. These together with **ASHTON** Cables for radio and general electrical needs are all designed and produced by **AERIALITE LTD.** at their **CASTLE WORKS, STALYBRIDGE, CHESHIRE.**

## PLAN YOUR CAREER

RADIO • TELEVISION  
and other INDUSTRIAL  
ELECTRONIC subjects  
ELEMENTARY and  
ADVANCED COURSES

★ Ask for  
particulars of  
*Evening Classes*  
at the Institute

**WRITE NOW FOR FREE BOOKLET** summarising the careers available in Electronics and giving particulars of Training Courses offered by E.M.I. Institutes Ltd.

The booklet contains full details of **CORRESPONDENCE COURSES** in Radio, Television, Telecommunications, Mathematics and Industrial Electronics.

Daytime and Evening Attendance Courses, and Special Courses for candidates taking examinations such as those of City & Guilds, Brit. I. R. E., etc. are also available.

*Payment for tuition can be made in easy instalments*

### E.M.I. INSTITUTES LTD.

Dept. 16, 43 Grove Park Road, Chiswick, London, W.4. Telephone CH1swick 4417/8

E.M.I. Institutes — backed by the Electronic Organisation which includes "H.M.V.", Columbia, Marconiphone, etc.



E.102

## HOOVER LTD CHOSE TANNOY SOUND EQUIPMENT

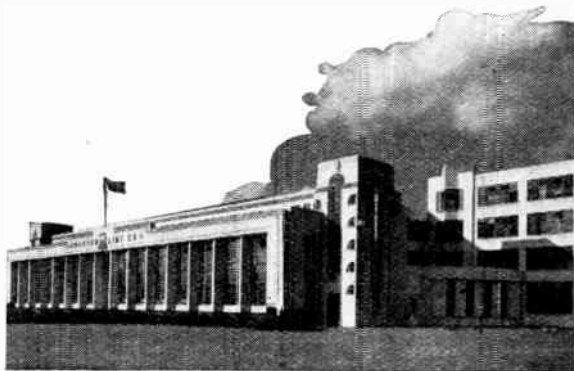

COURTESY OF HOOVER LTD.

**MAKE IT YOUR CHOICE TOO !**

SOLE DISTRIBUTORS SOUND RENTALS LTD.,  
CANTERBURY GROVE, LONDON, S.E.27. 'Phone GIP 1131

As a  
SET DESIGNER  
I'm on my toes . . .



The race is to the swift all right, but you have to be early off the mark. You have to be abreast with every new development . . . in the "know" almost before developments occur.

That's why I like to pioneer with pioneers. That's why I value my friends in the T.C.C. technical department. In the design, development and manufacture of Condensers, they seem to be always first in the field. If I'm tight for space, if I'm up against the prospect of rough usage, super tropical temperature, or even a temperamental customer, then there's always a T.C.C. type to see me through.

For advanced design and technique, for a truly comprehensive range of types, and—most important—for sheer dependability, I'm on safe ground with T.C.C. Condensers.

I keep on my toes . . . with



A TYPICAL EXAMPLE from the T.C.C. RANGE  
Designed for small portable apparatus, "Metalmites" are a miracle of compactness and efficiency. Temperature ranges extend from  $-30^{\circ}\text{C}$  to  $+100^{\circ}\text{C}$ . They are resistant to tropical conditions including extreme humidity. Send for literature giving details of the full range of these and other T.C.C. Condensers.

IN THE BEST SETS YOU'LL SEE



**THE TELEGRAPH CONDENSER CO., LTD.**

RADIO DIVISION

NORTH ACTON · LONDON · W·3

Telephone. ACORN 0061



## PORTABLE V.H.F. COMMUNICATIONS EQUIPMENT

## The B.C.C. Hand-Portable Transceiver



The new Model L59 is a hand-portable transmitter receiver designed to provide reliable and efficient two-way communication over 1-5 miles between sets. This range is greatly increased when used between a mobile or central station and distances of 15-20 miles have been obtained with a clear audible signal.

The model L59 is but one of the many items of V.H.F. equipment, developed and manufactured by B.C.C. It is the result of many years' experience in the design of Miniature Transportable Communications Equipment.

Other outstanding achievements in this field by B.C.C. are the new L45 One-man Pack Set ('Walkie-Talkie') and the new Low Power Consumption 4-watt Mobile.

### PRINCIPAL FEATURES OF THE MODEL L59

Size  $6\frac{1}{2}'' \times 10\frac{1}{2}'' \times 5\frac{1}{2}''$  Weight 11 lb  
Crystal controlled transmitter and receiver. Operates on any spot frequency in the range of 75-100 Mc/s A.M. Patented flexible aerial ensures full mobility to user. Strong, sturdy, watertight case. Approved by the G.P.O.



MODEL L59  
Hand-Portable  
Transceiver

For full information  
write to:

## BRITISH COMMUNICATIONS CORPORATION LIMITED

Electronic Development and Research Engineers,  
Contractors to H.M. Government, A.I.D. Approved

GORDON AVENUE, STANMORE, MIDDLESEX

Tel. GRIMSDYKE 1455

# "Cyldon"

SYDNEY S. BIRD & Sons, Ltd  
CAMBRIDGE ARTERIAL RD., ENFIELD, MIDDLESEX  
Phone: Enfield 2071-2 Grams: "Capocitr, Enfield"

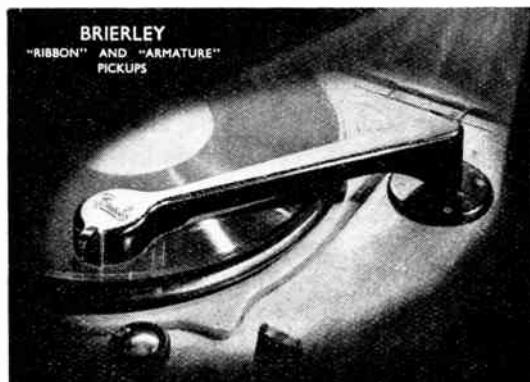

### RIBBON PICKUP, type JB/P/R/1

(TYPE JB/P/R/1m FOR FINE LINE RECORDINGS)

Frequency range, 20 c/s to 40,000 c/s.  
Permanent point 6 times harder than sapphire and more robust.  
Point pressure, 1/8 oz.  
Output voltage, 10 to 15 mV. across 15,000 ohms approx.  
"Floating Element" design prevents arm torsional resonance.  
Price in U.K., including special mumetal screened transformer and Purchase Tax, £10/14/11.

The "torsional resonance"—which is due to the mass of the head and in part the arm vibrating in a rotational direction controlled by the torsional compliance of the arm—occurs in the middle of the frequency range. In view of the fact that the arm is most critical and sensitive to middle frequencies, this resonance, however small or highly damped, is most unfavourably situated.

In the BRIERLEY RIBBON PICKUP the ribbon element is isolated from the arm for all lateral and rotational vibrations, the torsional resonance being completely eliminated by what we term the "floating element" design.

Our Pickup Booklet deals with this and other design factors of interest to the quality enthusiast, and will be sent together with details of our other products, including Amplifiers, Pre-amplifiers, Filters, Silent Turntables, etc., on request.

J. H. BRIERLEY (GRAMOPHONES & RECORDINGS), LTD.,  
46, TITHEBARN STREET, LIVERPOOL.

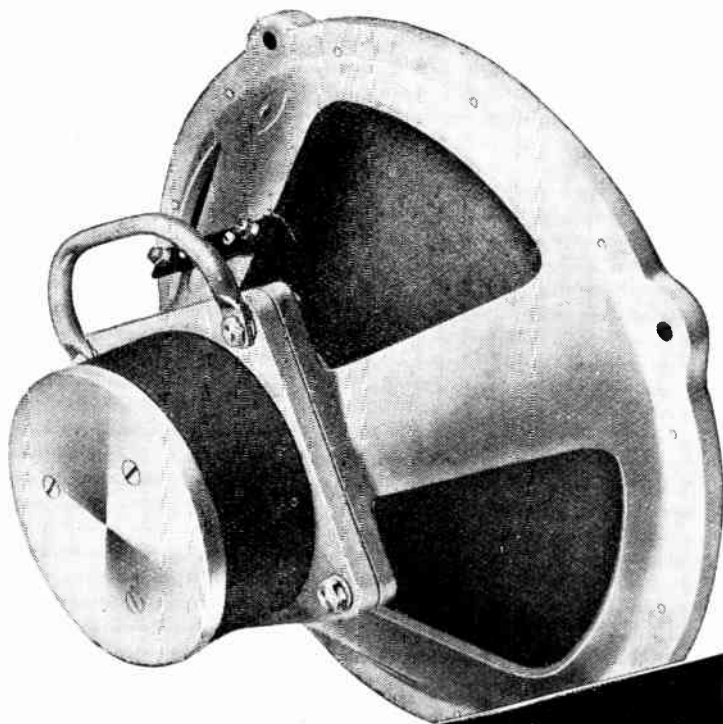

**They speak  
for  
themselves...**

*The SS10A 12-inch Heavy Duty Speaker, illustrated, offering a frequency response from 55 to 11,000 c.p.s. and handling 10 watts is a typical example of TRUVOX workmanship.*

Fidelity of response speaks for itself to the discriminating ear. Precision manufacture is no less eloquent to the trained engineer. These qualities are making TRUVOX speakers famous.

# TRUVOX

TRUVOX ENGINEERING CO. LTD · EXHIBITION GDS · WEMBLEY · ENG

P. X. 39

# GOOD NEWS!

in response to hundreds of requests



## The 'LONG ARM'

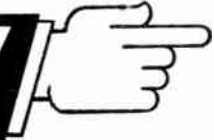

REMOTE CONTROL

# IS BACK!

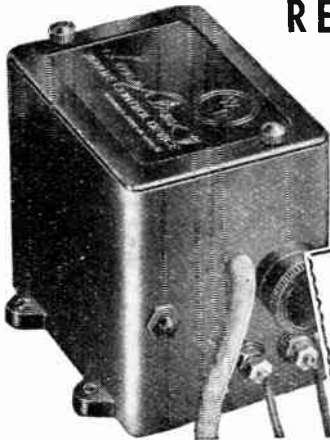

**SWITCHES THE RADIO ON OR OFF FROM ANY STENTORIAN EXTENSION SPEAKER**

Now you can enjoy the convenience of remote control: in whatever room you are listening, you can switch the radio on or off from the loudspeaker. One "Long Arm" unit will operate any number of Stentorian extension speakers and may be used with any make of set. Easily installed in a few minutes: ask your local dealer for a demonstration of this unique radio development—an exclusive Whiteley product.

**PRICE 35/- NO PURCHASE TAX**

Stentorian cabinet speakers (for use with the "Long Arm") are available from 80/-.

WHITELEY ELECTRICAL RADIO CO · LTD · MANSFIELD · NOTTS

You get years of faultless service from...

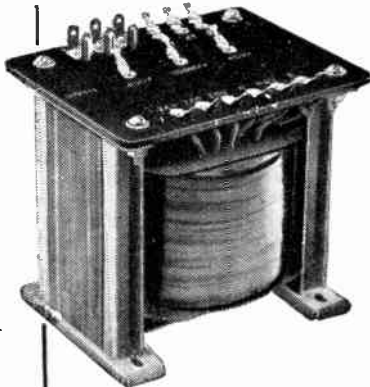

because they are :—  
INDIVIDUALLY DESIGNED  
RIGOROUSLY TESTED  
MECHANICALLY SOUND  
ELECTRICALLY PERFECT

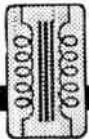

**"PURPOSE-BUILT" Savage TRANSFORMERS LTD.**

51, NORTHGATE STREET, DEVIZES. Phone 536

12113A



URELY TESTED

with the

# MICOVAC

## ELECTRONIC TESTMETER

22 RANGES

VOLTS  
D.C., A.C., R.F.

CURRENT  
From few micro-amps to 1.5 A.D.C.

RESISTANCES  
Up to 100 MΩ.

A versatile valve voltmeter for laboratory or test bench. Being battery operated, it is instantly ready for use. Probe for V.H.F. measurements.

**ELECTRONIC INSTRUMENTS LTD**  
17 PARADISE ROAD · RICHMOND · SURREY

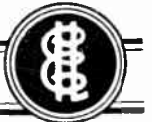



# Webb's

FOR DIVERSITY OF STOCK

## EDDYSTONE '640'

### COMMUNICATIONS RECEIVER

For A.C. Operation 110/250 volts

This famous short-wave receiver has specification and performance equalling communication receivers costing many times the price:—

- Coverage 31 to 1.7 Mc s.
- Electrical Band-spread throughout range.
- Eight Valves (plus rectifier).
- One R.F. and Two I.F. Stages.
- Efficient Noise-limiter.
- 10, 20, 40, 80 and 160 metre Amateur Bands calibrated.
- Beat Frequency Oscillator.
- Fly-wheel Control on Band-spread.
- Vacuum mounted Crystal filter.
- Adaptor for Battery Operation.



Cash Price £27 10s.

May we send you details of attractive Hire Purchase scheme. Deposit £5.15.0 followed by 78 weekly payments of 6/-.

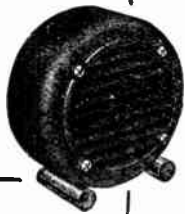

### EDDYSTONE LOUDSPEAKERS

For matching your communications receiver, also make neat extension speakers.

No. 688—5in. P.M. unit in black diecast housing, 7in. in dia. £2-17-6. (Also in brown or grey)

No. 652—3½in. P.M. unit in black or grey. Overall dia. 5in. £1-17-6.

★ ★ ★

**BATTERY OPERATION OF "640"**  
by specially designed Eddystone Vibrator Pack No. 687 for 6 volt accumulator. Connections by cable-plugs.

No. 687 Pack — £7 - 10 - 6.

## Loudspeakers

STOCKED AND DEMONSTRATED AT WEBB'S INCLUDE:—

### WHARFEDALE W12CS and W10CSB

The two units employed in renowned "Corner Cabinet." W12CS £7.5.0. W10CSB £7.0.0

### WHARFEDALE "SEPARATOR"

For low-impedance division of bass and treble between two speakers - - - £3.5.0  
Purchasers of the three Wharfedale components supplied on request with details for home constructor's "Corner Cabinet.")

### B.T.H. SENIOR R.K.

Curved cone gives excellent response 30 to 12,000 cps. - - - £6.15.0

### GOODMANS "AXIOM TWELVE"

Famous twin-cone, outstanding bass and treble response - - - £8.8.0.

### ROLA "G12"

Improved version of well known pre-war standard of comparison - - - £6.10.0

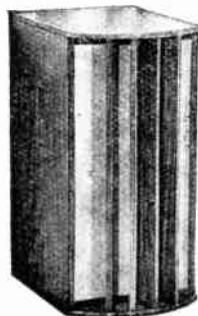

SOUND SALES "PHASE INVERTER" £12 - 10 - 0



WHARFEDALE "CORNER CABINET" £48 - 10 - 0

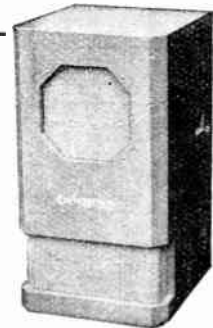

ACOUSTICAL "LABYRINTH" £19 - 10 - 0

# WEBB'S Radio

14, SOHO STREET, OXFORD STREET, LONDON, W.1

Phone : GERard 2089.

Shop hours : 9 a.m.—5.30 p.m. Sats. 9 a.m.—1 p.m.

# ONE MILLIVOLT TO 100 VOLTS

10 c/s TO 560 kc/s

THE NEW Furzehill Sensitive Valve Voltmeter Type 378 B/2 has an extended frequency range, now going down to 10 c/s and up to half a megacycle.

This, coupled with the already established features of high sensitivity, high output impedance and logarithmic scale providing constant reading accuracy and immunity from damage by overload, makes this an essential instrument in the communications laboratory. Feedback circuiting ensures stability of calibration over both long and short periods.

£75  
AVAILABLE  
FOR EARLY  
DELIVERY

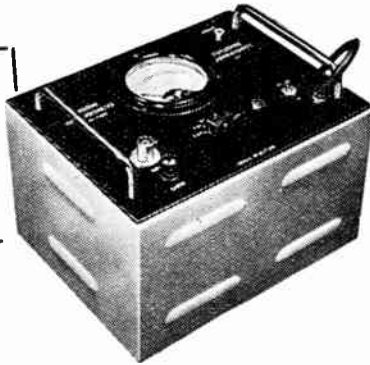

For further particulars please write for our new brochure of Electronic Instruments.

*Furzehill*

LABORATORIES LTD



BOREHAM WOOD · HERTFORDSHIRE  
TELEPHONE - - ELSTREE 1137

## the finest in electronic valves



### carry this emblem

Supplied to ADA by R.C.A., ADA electron valves are designed to satisfy completely the requirements of radio receivers, service, amateur and laboratory equipment. Sturdily constructed and thoroughly tested, every ADA valve is guaranteed to give long, trouble-free use.

The ADA trademark is your assurance of dependable performance and durability.

Other ADA products :

- Household and Commercial Refrigerators
- Radios and Components
- Home Appliances

**AD. AURIEMA, INC.** 89 Broad St., New York 4, N.Y., U.S.A.

Cable Address : AURIEMA, NEW YORK

## Headphones which uphold British Prestige

**S. G. BROWN, Type 'K'**  
Moving Coil Headphones,  
supply that High Fidelity  
Reproduction demanded for  
DX work, monitoring and  
laboratory purposes, etc.



TYPE "K."

### OUTSTANDING CHARACTERISTICS.

D.C. RESISTANCE, 47 Ohms.  
IMPEDANCE, 52 Ohm: at 1,000 c.s.

SENSITIVITY,  $1.2 \times 10^{-12}$  Watts  
at 1kc. = .002 Dyne/cm<sup>2</sup>.

Descriptive Literature on request.

PRICE **£5.5.0** PER PAIR

Your Local Dealer can supply

For details of other S. G. Brown Headphones (prices from 30/- to 63/-) write for illustrated Brochure "W.W."

HEADPHONES WHICH UPHOLD BRITISH PRESTIGE.

Telephone :  
Watford 7241.

**S.G. Brown, Ltd.**

SHAKESPEARE STREET, WATFORD, HERTS.

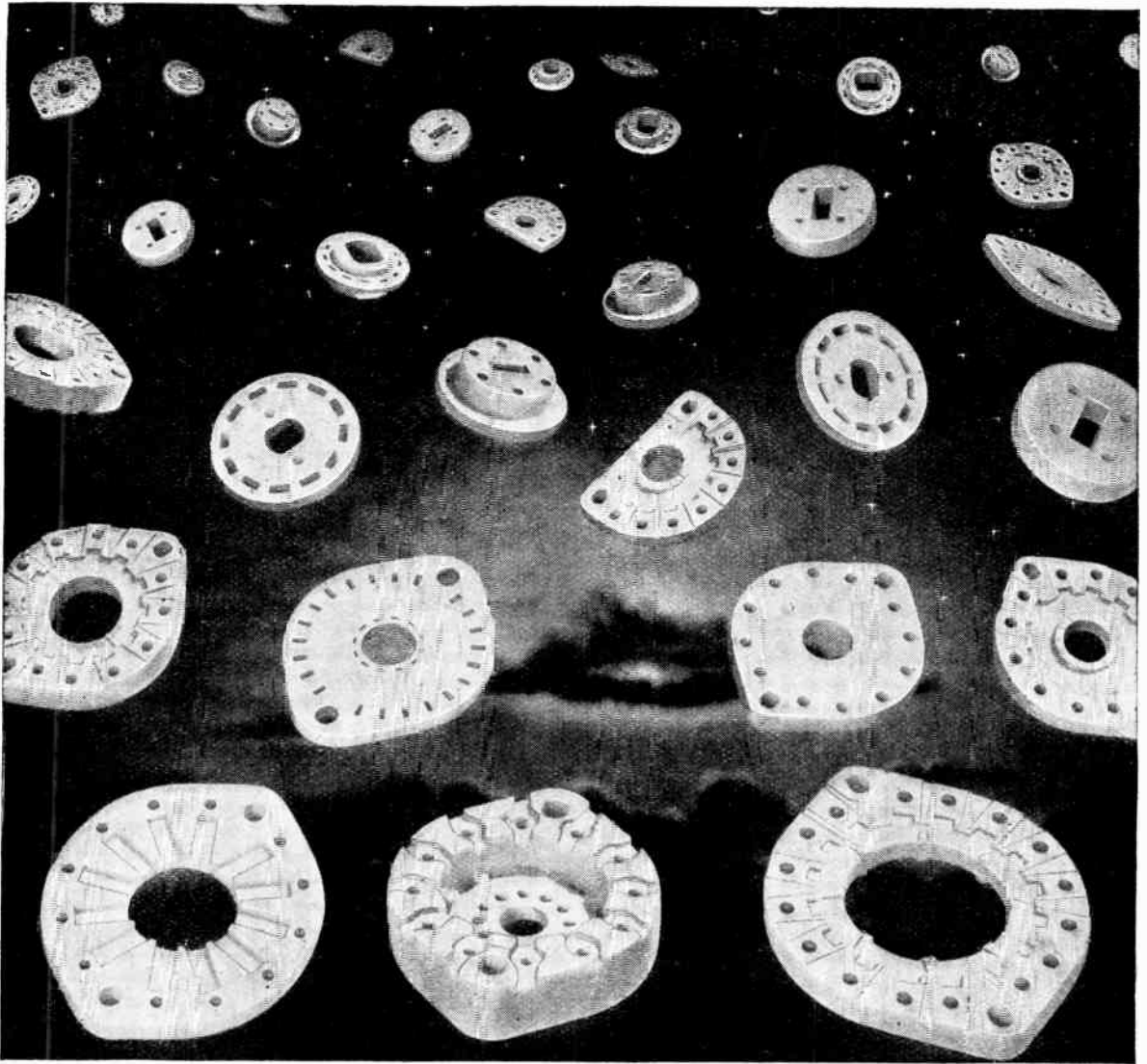

# CERAMICS

**FOR SWITCHES**

and all radio components

**FREQUENTITE-FARADEX-TEMPRADEX**

**STEATITE & PORCELAIN PRODUCTS LTD.**

Stourport on Severn, Worcester

Telephone: Stourport 111

Telegrams: Steatoin, Stourport



S.P. 54





18, TOTTENHAM COURT ROAD, LONDON, W.1

Tel: MUSeum 2453

Tel: MUSeum: 4539

Shop hours: Monday-Friday 9-5.30. Saturday 9-1

**AERIALS.** Copper plated steel "whip" type aerials. Fully extended 14ft. long. Collapses into 7 sections. Ideal for aerial or fishing rod. Price 3/6, plus 9d. postage.

**BAKELITE.** 1st grade bakelite sheet (postage 3d extra on stated prices).

	Approx. 1/16in. thick.	Approx. 1/32in. thick.
6x6ins. . . . .	1/6	1/3
12x6ins. . . . .	3/-	2/3
12x12ins. . . . .	4/-	3/-
12x24ins. . . . .	6/-	4/6

**ERIE RESISTORS.** (Post free). Our normal stock includes over 80 values of 1/2 and 1 watt resistors all of which are at the reduced price of 4d. each. Also a wide range of 1 watt resistors at 5d. each, available from stock.

**METERS.** New and unused boxed meters 2in. square flush panel mtg. type, postage 9d. extra.

0-5mA. moving coil at 6/- ea.  
0-150 m.A. moving coil at 6/- ea.  
0-0.5 amp. Thermocouple at 5/- ea.  
0-250 volts moving coil at 6/- ea.

**MIDGET ELECTROLYTICS.** (Postage 4d. each extra.)

B.E.C. 8-8 Mid. 450 v. d.c. wkg. 1/2in. dia. x 1 1/2in. price 5/- ea.  
B.E.C. 8-16 Mid. 450 v. d.c. wkg. 1in. dia. x 1 1/2in. price 5/6 ea.  
Hubber 16 Mid. 450 v. d.c. wkg. 1in. dia. x 2in., price 4/6 ea.

**HIGH WATTAGE RESISTORS.** (All surplus but unused.) (Postage 6d. on each.)

50,000 ohms Vitreous enamel, size 1in. dia. x 7 1/2in. long. Approx. 125 watt, 3/6.  
40,000 ohms Vitreous enamel, size 1in. dia. x 9 1/2in. long. Approx. 125 watt, 3/6.  
20,000 ohms Vitreous enamel, size 1in. dia. x 7 1/2in. long. Approx. 125 watt, 3/6.  
2,900 ohms Vitreous enamel, size 1/2in. dia. x 4 1/2in. long. Approx. 30 watt, 1/6.  
2,500 ohms Vitreous enamel, size 1/2in. dia. x 3 1/2in. long. Approx. 30 watt, 1/6.  
1,600 ohms Vitreous enamel size 1/2in. dia. x 5in. long. Approx. 30 watt, 1/6.  
50 ohms carbon, size 1in. dia. x 9 1/2in. long. 1/3.  
125 ohms 60 Amp wire wound resistor, 1 1/2in. x 4in. long. 1/6.

5 ohms 10 watt wire wound resistor, 1in. x 3 1/2in. long. 1/3.

**TELEVISOR COILS.** Wound on standard Aladdin formers and complete with dust-over single hole fixing.

L1, L2 Aerial coils for vision, 2/-.  
L3 1st R.F. Anode, 1/6.  
L4 2nd R.F. Anode, 1/6. H.F. choke approx. 15 ml r.p. Hys, price 1/6.  
L5 3rd R.F. Anode, 1/6.  
L6, L7 Pre-detection for vision, 2/-.  
L8, L10 Aerial coil for sound, 2/-.  
L11, L12 H.F. coil, 2/-.  
L13, L14 Pre-detection, 2/-.  
Postage 3d. per coil or 6d. for two or more.

**OUTPUT TRANSFORMERS**

**Quadral Midget Q05.** Ratios 30, 60, 90:1. Max. d.c. 50 mA. Size 1 1/2 x 1 1/2 x 1 1/2in. Price 6/-.

**Wharfedale OP3.** Ratios 30, 60, 90:1. Max. d.c. 30 mA. Size 1 1/2 x 1 1/2 x 1 1/2in. Weight 6 ozs. Price 6/9.

**Elstone multi-ratio 24:1 to 114:1** in 12 ratios including push-pull. Size 2 1/2 x 2 x 2in. Price 9/-.

**Wharfedale Type F.** Ratios 30, 45, 60, 90:1. Max. d.c. 50 mA. Weight 12 1/2 ozs. Leakage inductance. 6 Hy. Price 8/-.

**Wharfedale GPR.** Ratios 12, 18, 24, 30, 36, 48, 60, 72:1. Max. d.c. 50 mA. Weight 12 1/2 ozs. Price 11/6.

**Rola multimatch.** Ratios 24, 41, 48, 58, 82, 116:1. Size 2 1/2 x 2 1/2in. Price 10/6.

**Elstone MR7 7/10 watt.** Multi-ratio. Push-pull or straight. Size 3 1/2 x 2 1/2 x 3in. Price 18/9.

**Quadral Q04.** Multi-ratio 10 watt type. Max. d.c. 100 mA. Size 3 1/2 x 2 1/2 x 2 1/2in. Fully shrouded. Price 21/6.

**Keston high quality push-pull 20 watt** Transformer with tapped secondary for 3, 7 1/2 and 16 ohm speech coils. Size (approx.) 4in. x 3in. x 3 1/2in. Price 21.

Available for anode to anode impedances of 6,000, 8,000 or 10,000 ohms.

**Stewart high quality push-pull 10 watt** transformer with tapped secondary for 3, 7 1/2 and 15 ohm speech coils. Fully shrouded. Size (approx.) 3 1/2 x 2 1/2 x 3 1/2in. Price 21/0.

Available for anode to anode Impedance of 6,000, 8,000 or 10,000 ohms.

**RESISTORS.** (1/2 watt Carbon). 10, 15, 27, 33, 47, 56, 68, 75, 82, 100, 120, 150, 200, 220, 250, 270, 330, 390, 470, 510, 590, 750, 1,000, 1.2K, 1.5K, 2 K, 2.2K, 2.5K, 2.7K, 3.3K, 3.9K, 4.7K, 5.1K, 5.6K, 6.8K, 7.5K, 10K, 12K, 15K, 18K, 20K, 22K, 23K, 27K, 33K, 39K, 47K, 51K, 56K, 68K, 75K, 82K, 100K, 120K, 150K, 200K, 250K, 270K, 330K, 390K, 470K, 510K, 560K, 680K, 750K, 820K, 1Meg, 1.2Mg, 1.5Mg, 2.2Mg, 2.5Mg, 3.9 mg, 4.7mg, 10mg, 50mg.

**RESISTORS (1 watt Carbon).** +91% 820Meg, 3Meg, 5.1Meg. Not 450Meg.

**RESISTORS (1 WATT CARBON).** 47, 100, 120, 150, 180, 220, 270, 330, 470, 680, 1K, 1.8K, 1.5K, 2.2K, 3.3K, 4.7K, 5.1K, 6.8K, 8.2K, 10K, 15K, 20K, 22K, 24K, 33K, 47K, 51K, 56K, 68K, 100K, 150K, 200K, 220K, 470K, 510K, 680K, 1Meg, 1.5Meg, 1.8Meg, 2Meg, 2.2Meg, 3Meg, 3.3Meg, 8.2Meg, 60Meg.

**RESISTORS (2 WATT CARBON).** 10, 15, 50, 220, 1,000, 4.7K, 8.2K, 5.6K, 10K, 15K, 30K, 33K, 39K, 47K, 120K, 1Meg. Price 1/3 ea.

**RESISTORS (3 WATT CARBON).** 1.2K, 5.6K, 6.8K, 10K, 20K, 33K, 47K, 60K, 68K, 82K, 120K, 150K, 220K, 330K, 470K, 1Meg, 2.2Meg, 6.2Meg. Price 1/6 ea.

**W/W 6 WATT:** Other values are available from time to time. 200, 500, 2,500, 10,000 ohms. Price 1/6 ea.

**WIRE.** Tinned copper wire in 1lb. reels. (Postage 6d. per reel extra.) 16SWG, 1/6; 18SWG, 1/6; 20SWG, 1/6; 22SWG, 1/6; 24SWG, 1/6; 26SWG, 1/6; 28SWG, 1/6; 30SWG, 1/6; 32SWG, 1/6; 34SWG, 1/6; 36SWG, 1/6; 38SWG, 1/6; 40SWG, 1/6.

**SYSTOFLEX.** Wide range of colours and bore. Price per length of approx. 1 yd., 2d.

**VCR97A.** New and crated 6in. surplus electrostatic tubes. Callers only please. Price 39/6 ea.

**SPECIAL OFFER.** Midget telephone transformers for converting low impedance phones into high impedance circuits. Many other similar applications. Price 7/6 each plus 9d. extra for postage. 20 yard lengths twin 28/36 SWG wire with PVC covering. Only 7/6, plus 1/3 for postage.

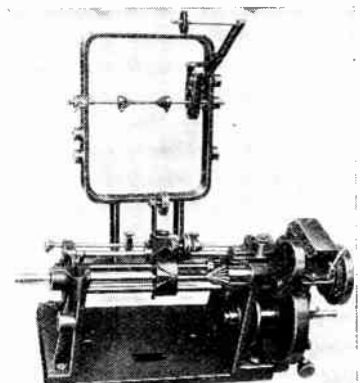

Sole Agents Abroad.

K. G. Khosla & Co., 22, School Lane, New Delhi, India.

Etablis Octave Houart, 14, Quai de L'Industrie, Sclessin-lez-Liege.

J.P. Fielding Co. (Canada) 131 Ontario Street, St. Catharines, Ontario.

Heftey & Frogg, Oslo, Norway, Storgaten, 15.

MODEL "Q"

**AUTOMATIC COIL WINDING MACHINES AND HAND WINDING MACHINES**

Machines supplied complete with stand motor and Two-Speed Friction Clutch

**ETA TOOL CO**

(LEICESTER) LTD.  
29a, WELFORD ROAD, LEICESTER  
Phone—5386

**MODERN SERVICING METHOD**

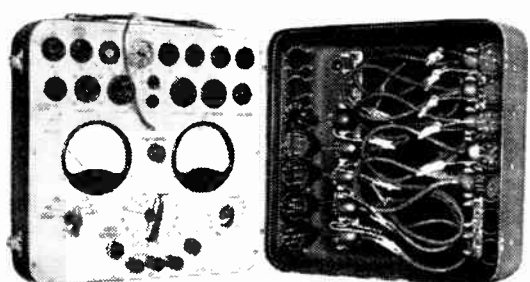

The "L.S.L." Servicing Method is a combined fault analyser and circuit tester; simultaneously capable of indicating all voltage, current and resistance on each valve electrode without removing the chassis from the cabinet. Readings can be taken whilst the set is under actual operating conditions. The "L.S.L." Analyser is a combination of multi-range instrument and valve tester.

PRICE: £18. 18. 0 Subject.

**THE "LSL" PORTABLE ANALYSER**

★ Saves time and trouble. ★ Greatly increases Profit in the Service Department. ★ Is portable, can be used on the bench or in the home. ★ Is simple to operate.

Send for further particulars from the sole distributors



WARTON ROAD, STRATFORD, LONDON, E.15.  
Telephone: Maryland Mill AND BRICKS  
Rabbit Address: 23-26 St. DUNSTONS HILL, E.C.1

# A PLAYING Proposition

Demonstrate the "De Luxe" Microgram in your showroom today. Invite your customers to hear their favourite records as they were meant to be heard and they'll prove to you that the "De Luxe" Microgram sells itself!



The **COLLARO**  
"DE LUXE"  
**Microgram**  
Portable Electric Gramophone

The "De Luxe" Microgram with the new Collaro light-weight Crystal Pickup Automatic Stop and 6½" Speaker—complete in handsome imitation lizard-skin carrying case. A.C. Supply 200/250 volts.

Retail Price £19 19 0. Plus  
Purchase Tax £8 12 11.

Trade Terms and Literature from:

COLLARO LTD., RIPPLE WORKS, BY-PASS ROAD, BARKING, ESSEX (Telephone: RIPPLEWAY 3333)

# PRECISION COMPONENTS



## CORD DRIVES

Now available in five types as illustrated (left to right) Standard, R/V, Reverse, "D" type and "A" type.

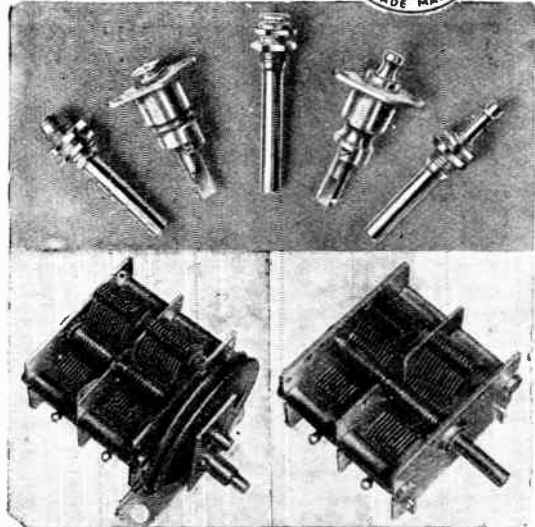

## GANG CONDENSERS

A wide range is now available in 1, 2, 3 or 4 gang types of various capacities.

Write for Catalogue No. (W.W.1.)

# JACKSON

**BROS (LONDON) LIMITED**  
 KINGSWAY · WADDON · SURREY  
 TELEPHONE: CROYDON 2754-5      TELEGRAMS: WALFILCO,  
 PHONE LONDON

## A NEW B.P.L. INSTRUMENT



**THE VOLTASCOPE**—A combined valve-voltmeter and oscilloscope. **VALVE-VOLTMETER**—Infinite Input Resistance for D.C. ranges 0 to 300 volts. A.C. ranges 0 to 150 volts in 5 ranges. 3½ inch scale meter. **OSCILLOSCOPE**—3 inch screen tube provided with balanced amplifiers for Y and X plates giving a 5 times trace expansion. Maximum sensitivity 150mV/cm. Response from D.C. to 100 kcs.

Limited quantity available for early delivery.

**BRITISH PHYSICAL LABORATORIES**  
 HOUSEBOAT WORKS, RADLETT, HERTS.

Tel: Radlett 5674-5-6

## STEWART TRANSFORMERS

**RELIABLE  
 TRANSFORMERS  
 AND CHOKES FOR  
 CONTINUOUS  
 SERVICE.  
 OPEN AND TOTALLY  
 ENCLOSED TYPES.**

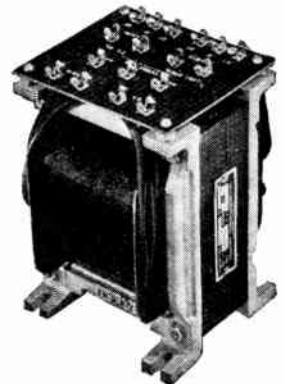

● *EHT Transformers for Television.  
 Medium and Low Voltage Types for  
 Radio and Industrial Use.*

● *Ex Stock: Transformers and Chokes  
 for "Electronic Engineering" Televisor.*

**STEWART TRANSFORMERS Ltd.**  
 1021 FINCHLEY RD., LONDON, N.W.11

Tel.: SPeedwell 3000 and 3533



# LONDON CENTRAL RADIO STORES

Delivery from Stock Government Surplus - Immediate

## R.A.F. 6-VALVE SUPERHET RECEIVING UNIT No. 25



Covers 4.3 to 6.7 mc/s.  
Contains two EF36, two EF38, one EK32, one EBC33 valves, condensers, resistances, etc. **25/-**

### ROTARY CONVERTER

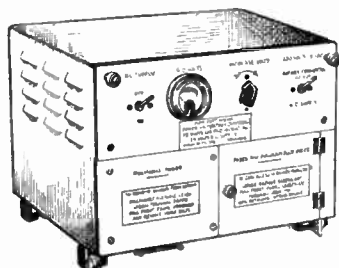

Input 24 v. D.C. Output, 230 v. 50 cycles  
75 watts. In metal cabinet. Size 13in. x 12in. deep x 14 high

### ROTHERMEL CRYSTAL MICROPHONE



This "Torpedo" model has a driver type of crystal element. A new method of suspension eliminates unwanted peaks and background noise. Sensitivity level is minus 54 D.B. Has high impedance of 80,000 ohms. at 2,000. Frequency response is fairly flat from 30- to above 6,000. Dimensions 8 1/2 x 3 1/4. **£3-19-6**

### TELEPHONE LINE OR UNISELECTOR SWITCHES Brand New.

3-Bank, 38/6. 5-Bank, 45/-  
Used  
3-Bank, 20/- 6-Bank, 25/-

## MISCELLANEOUS BARGAINS

### CATHODE RAY TUBES, Ex-Govt.

6in. VCR97 ..... 32/6  
6in. VCR517 ..... 22/6  
12in. VCR140 ..... £8  
12in. VCR85 ..... £8

### METAL RECTIFIERS 35V, 24 amp. .... 15/-

### EX-GOVT. TELEPHONE HANDSETS

Self-Energising. Needs no battery or current. Less Wall bracket. Each ..... **7/6**

### PHOTO ELECTRIC CELLS

Small infra-red image, glass converter tube. Type C.V. 143 50-100v. Suit. **14/6**

See April issue for illustration

### U.S. ARMY MIDGET LIGHTWEIGHT HEADPHONES. 200 ohms. Suitable for Deaf Aids **15/-**

### THE FAMOUS EDDY-STONE 358 COMMUNICATIONS RECEIVER

Range 31 mc/s to 90 kc/s, 9 Plug-in coils, 7 valves and rectifier, variable selectivity, B.F.O. stand-by switch, A.V.C. switch, bandspread dial, valve check meter. In heavy black crackle finished steel cabinet with chrome fittings. Complete with 200-250 v. A.C. Power Supply Unit. Carriage and packing 17/6 extra. **£25**

### R1155 10-VALVE COMMUNICATIONS RECEIVERS

These sets are as new. Freq. range 7.5 mc/s to 75 kc/s in five wavebands. Complete with 10 valves including magic eye. Enclosed in metal case. Every receiver is aerial tested. Complete with Power Pack and Loudspeaker, for A.C. mains 200-250v. **£14-10**

(Carr. and pkg. 10/6 extra)

**FREE** with each receiver! Complete circuit, description and modifications for civil use, reprinted from "W.W." July, 1948.

### EX-G.P.O. TABLE MICROPHONES

With plug and lead ..... **5/6**

### NEW MILNES H.T. UNITS (Everlasting)

120 v. 60 mA. Will charge from 6 v. accumulator. For Callers Only..... **67/6**

N.B.—All carriage paid unless otherwise stated. We do not issue lists or catalogues. We have hundreds of items in stock too numerous to list. So when in Town pay us a visit!

### 3-VALVE R.F. AMPLIFIERS V.H.F. Types 24 & 25

40/50 mc/s. Complete with 3 SP41 valves. In metal case. Brand new in carton ..... **10/6**

Plus carriage & packing 1/6

### RADAR VIEWING UNITS Type 182A. With 6in. VCR517 C.R. Tube, three EF50, four SP61, one 5U4 valves, 8 potentiometers, condensers, etc. .... **37/6**

Carr. and pkg. 7/6.

### NEW 3-VALVE AMPLIFIER PANELS with three IT4 valves, condensers, etc. .... **18/6**

New spare valves for above, 5/- each.

### RECONDITIONED 5-VALVE SUPERHET RECEIVERS

3 wavebands S.M.L. A.C. or D.C. mains, 200-250 v. Size 20x11x9in. As new ... **£9-17-6**

### Complete Ex-Govt. 100ft. COPPER AERIALS, with ebonite chain insulators, with 30ft. guy rope ..... **4/3**

### 2-VALVE UNIVERSAL RECEIVERS Type 1125

13 v. heaters. Fixed frequency. Less Power Pack ..... **9/6**

### MOVING COIL HAND MICROPHONE, 5/6

**2-VOLT POWER PACKS complete with Vibrator**

Output approx. 200 v. 60 mA. Size 9x5x3 1/4in. A first-class job, complete with accumulator in carrying case. Plus 5/- carr. & pkg. **£3-7-6**

### TRIPLETT Universal TEST METERS. Ex-Govt.

1,000 ohms per volt. Volts A.C. or D.C. 0-10, 0-50, 0-250, 0-1,000, 0-5,000. Milliamps, 0-10, 0-100, 0-500. Ohms, 0-300, 0-1 meg. Slightly used **£4-10-6**

### 7-VALVE U.H.F. RECEIVER. Type R1147A

Range approx. 200 megacycles (with 4 Acorn valves). A Real Opportunity!

Beautifully constructed and fitted with micro-condensens drive. Valve types: two EF30, one ERC33, three 954, one 955. In black metal case, 8x7x6in. Set complete with valves ..... **£1-17-6**

### Ex-ARMY TEST SET—NEW Type Demolition Mk. 1.

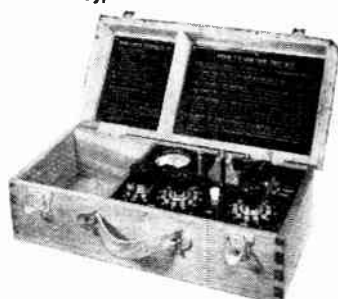

For circuit continuity and general testing, in hardwood carrying case. **42/-**

### EX-R.A.F. CINE CAMERA. Type G45B

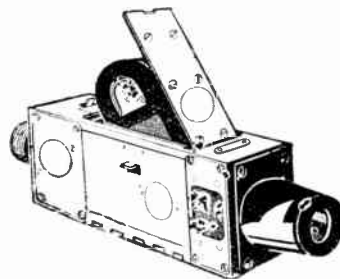

To take 16 mm. film. Fixed focus lens approx. 5 cm., f/3.5. The illustration shows loading chamber partly open. In metal case. Dimensions 12 x 3 1/2 x 2in. With 12 v. motor drive ..... **£3**  
Spare small 24 v. Motors for above, 8/9.

### AZIMUTH RELEASE RELAY

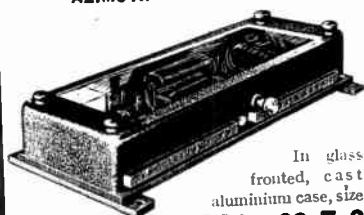

In glass fronted, cast aluminium case, size 12x4x2in. Contains A.C. Relay, D.C. Relay, Alarm Relay, etc. .... **£2-7-6**

**SMALL SLIDING RESISTANCES** Ex-Admiralty. **Finest quality.** Suitable for Voltage Controls, Speed Regulators. 50 ohms, 0.5 amp. Dimensions 6in. x 4in. x 2 1/2in. high ..... **8/6**



**A.C./D.C. FRACTIONAL H.P. MOTORS** 24 v. Reversible. with worm drive, Can be converted for driving gramophone turntables ..... **12/6**

LONDON CENTRAL RADIO STORES, 23, LISLE ST. (GERrard 2969) LONDON, W.C.2

Closed Thursday 1 p.m. Open all day Saturday and weekdays 9 a.m.—6 p.m.

## Are you interested in 145 Mc/s?

If so, make a point of seeing the new EDDYSTONE 145 Mc/s GUIDE. It describes a compact and efficient converter using readily obtainable valves and a crystal-controlled transmitter capable of an excellent performance. Both units are tried and tested, and you can rely on getting really good results. Advice is also given on aerials.

Perhaps you are a little doubtful about 2 metres? It is an easy band on which to get going, and the units described in the Eddystone 145 Mc/s Guide will not take you long to put together.

Or do you just want a receiver? The converter in the Guide is very fully described, and construction has been simplified without sacrificing performance. Difficult metal work is avoided if you obtain the ready drilled chassis, etc. The converter can be used with any receiver which tunes to 10 Mc/s.

EDDYSTONE 145 Mc/s GUIDE 1/6

## EDDYSTONE SHORT WAVE COMPONENTS

The new illustrated EDDYSTONE CATALOGUE is now available at your Dealer. Many new lines are included and the range of components and accessories offered is very comprehensive. Prices have, in a number of cases, been reduced. You will find it most interesting to scan through the catalogue, which represents a really good sixpennyworth. By choosing Eddystone you get quality and reliability.

ILLUSTRATED EDDYSTONE CATALOGUE 6d.

Please obtain from your Eddystone Dealer—we do not supply direct.

# STRATTON & Co., LTD

EDDYSTONE WORKS

WEST HEATH

BIRMINGHAM 31



## RADIOMART'S

### New Year Offers

**H.R.O. SENIOR.** Complete with standard coils and 230 v. Power Supply. £37/10/-.

**H.R.O. JUNIOR.** Ditto. £25/-/-.

**NATIONAL NC120.** Built in power supply for 110 v. Requires auto transformer for 230 v. £30/-/-.

**AR.88-LF.** Coverage 75-550 kc/s—1.5-30 mc/s. £39/15/-.

**EDDYSTONE 358.** Complete with 7 coils. £22/10/-.

**NOTE:** For all the above add 10/- for carriage.

**ALL ABOVE RECEIVERS IN GOOD WORKING ORDER AND INDISTINGUISHABLE FROM NEW.**

**WAVEMETER Type 1191A.** Portable type in steel case, finished grey. Operates from 60 v. H.T. and 2 v. L.T. Frequency coverage in 8 ranges 200 c/s to 20 mc/s. Complete with all charts and 1,000 kc/s crystal. Can be modulated by the setting of an M.C.W. switch on the front panel. £5/15/- plus 7/6 carriage.

**WAVEMETER CLASS D. No. 1 Mk. II.** Frequency covered 1900-8000 kc/s. Also provides check frequency points spaced 1 mc/s apart up to 25 mc/s. Operation from 6 v. accumulator. Built in Vibrapak for H.T. total current 1 amp. £5/-/- plus 5/- carriage.

**DITTO,** but for operation from 230 v. A.C. mains, £6/-/- plus 5/- carriage.

**LAVOIE Laboratory Microwave Frequency Meter.** This Frequency Meter is a precision built instrument entirely portable, complete with calibration charts. Frequency range 375-725 mc/s check points every 10 mc/s. Operates from dry batteries, 45 v. H.T., 1.5 v. L.T. Fitted with automatic time switch to conserve voltage supply. An excellent Laboratory instrument. Brand new. £15/-/-.

**AVO Model 48A.** A.C./D.C. Multi range. 3,600 v. Multiplier, 480 amp. and 120 amp. shunt. 240 amp and 60 amp transformer shunt. In polished wood case containing all parts, leads etc. £22/-/-.

Send S.A.E. for standard Raymart list "W" and Special Offers list "S.O."

## RADIOMART

CSNI (SHAM) LTD.

48, HOLLOWAY HEAD, BIRMINGHAM, 1.

Tel: Mid. 3254.

## NEW G/10 AUDIO

8½ gns.



**GRAMO/RADIO AMPLIFIER.** 8/10 watts, now greatly improved. Our standard case, cover, baseplate is supplied as shown. Increased gain and fidelity. Attractively presented.

**PP/11** 10 w. P.P., 11 gns.

**GP/15** Gram. Only, 14 gns.

**GP/15** Gram/mic., 18 gns.

**GP/25** Gram/mic., 18 gns.

All these models are fitted in our attractive cases. Series 15 and 25 have three tone controls, bass and treble lift and treble cut. All models have two inputs.

**KITS.** High quality P.P.15 watts, three tone controls, gramo/radio inputs. GPK/15. £12. Prints 2/6.

**FIDELITY.** Three channel sound systems for high quality. Super-tone model, £25. Bestone model, £16.

Send for "Sound Reproducers" brochure. 3d.

## TRANSFORMERS

**Trade-Amateur-Export.** Type SS as shown.

350-0-350 v. 100 ma. 5 v. 2 a. 6.3 v. 3 a., c.t.

32/6. Single shroud drop thro', 31/6.

Trade and export invited. Catalogues on request. Larger types are made. Outputs, chokes, autos. Quality transformers for quality circuits.

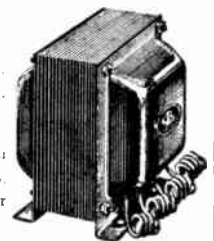

Goods shipped to all parts. agents in principal countries.

## GENERAL LAMINATION PRODUCTS LTD.

294, Broadway, Bexleyheath, Kent.

# PRECISION DRAWN WAVE GUIDE TUBING

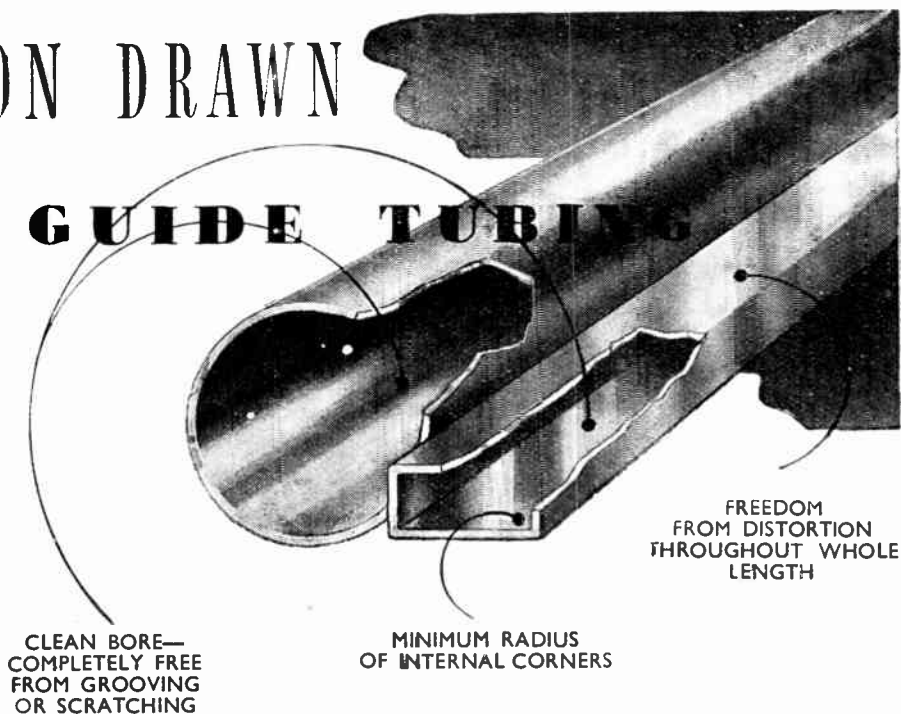

This seamless high accuracy wave guide tubing is designed to meet the requirements of modern Navigation, Radar and communication equipment. The tubing is hard drawn, has a highly finished bore and dimensional accuracy is maintained throughout each length. Non-preferred sizes can be manufactured to specification.

*Available in the following materials :*

COPPER	BRASS
7½% COPPER SILVER	10% COPPER SILVER
SILVER LINED COPPER	SILVER LINED BRASS

*Dimensions :*

Available in 10 ft. lengths  
Rectangular tubes up to 1" x 0.5"  
Round tubes up to 1.5" dia.

*Details of preferred sizes are available on request.*

*One of the Specialised Products of*

**Johnson**   
**Matthey**





## Get into Top Gear.

Marconi Test Gear is in the top class. This is worth remembering because the quality of your repair work is only as good as can be judged by your test gear. If you could make thorough and *accurate* measurements instead of comparative tests, no limitation would be imposed on your technique. You could raise it to the highest level and so give unrivalled service to your customers. You could, in fact, restore a receiver to its original performance — make it as good as new! And all you need, to get into “top gear” is the Marconi Receiver Tester — a complete laboratory in itself. Ask us to demonstrate it, or write for full particulars.



## The MARCONI PORTABLE RECEIVER TESTER TYPE TF 888

## Marconi Instruments Limited

Dept. 31WD ST. ALBANS, HERTFORDSHIRE • Telephone: St. Albans 6161/5.  
 Northern Office: 30 Albion Street, Hull, Phone: Hull 16144. • Western Office: 10 Portview Road, Avonmouth, Phone: Avonmouth 438.  
 Southern Office and Showrooms: 109 Eaton Square, London, S.W.1. Phone: Sloane 8615.

## M.R. SUPPLIES Ltd.

For selected material in first-class condition, immediate despatch and assurance of satisfaction. All prices nett.

**THERMOSTATIC SWITCHES** (ex A.M.) Capacity 1.5 amp. On at 32 deg. F., off at 49 deg. F., therefore right for frost protection. Adjustable. 4/6, or 45/- doz.

**REMOTE THERMOMETERS** (thermo-coupled micro-ammeter type). Scaled - 35° to + 55° C. (covering 0 to 160 deg. F.). 2in. luminous dial. With approx 10ft. wire to temperature rod. Ideal for soil-warming readings and for reading, in situ, outside temperatures. Extremely handy instruments, 15/-.

**ROTARY TRANSFORMERS** (Anode Converters). This is the really useful one for mobile radio, etc., for an adequate supply of H.T. from L.T. Input 12 v. D.C., output 250 v. 125 m.a. D.C. Brand new, by Hoover, in original cartons, 21/-.

**CENTRIFUGAL PUMPS**, 12/24 v. A.C./D.C. Immersion type, self-priming, approx. 1 1/2in. long. Diameter of tube 2in. Fitted precision motor and expensively made. Remarkable duty—approx. 200 g.p.h. Many uses. Brand new in makers' cartons, 32/6. Also a new delivery of the well-known **Stuart Pumps**, operation 220/250 v. A.C./D.C. No. 11 (300 g.p.h.), 27 (des. 2/6). No. 12 (600 g.p.h.), 35/10/- (des. 2/6).

**LARGE CENTRIFUGAL BLOWERS**, rated for 100 v. D.C. (suitable for non-continuous running on A.C.) Diameter of impeller housing 1 1/2in., overall length 1 1/2in. Outlet 2in. Motor is 3/8th H.P. Very powerful blast. Mounted on base 1 1/2in. by 1 1/2in., fitted 2-pole ironclad switch, new 28/10/- (des. 5/-).

**"FUZZIT" WIRE JOINTERS**, by S.T.C. Electrically weld all wires (copper and resistance), 30 to 50 S.w.g. Operation 200/250 v. A.C. With portable transformer (sec. 45 v. 5 amps. continuous), carbon-electrode Hand-Tool etc., ready for use, brand new 28/6/- model for 45/- (des. 2/-). The excellent transformer alone is worth more.

**CLOSE-RANGE-AUTO-TRANSFORMERS**, for adjustment of mains volt-drop. Covers range of 200/250 volts in 10 v. taps, loading 500 watts, 27/6 (des. 1/6).

**SYNCHRONOUS ELECTRIC CLOCK MOVEMENTS**, 200/250 v. 50 c. Spindles for hours, mins., and secs., centre bush mount. Silent and fully reliable. With plastic dust-cover 2 1/2in. dia., 1 1/2in. front to back, and flex lead, 37/6. Set of three Hands to fit, in good style, to suit 5/6in. dial, 2/-.

**HAND-BEARING COMPASSES**, type 06A. Prismatic, alcohol floated. Dia. 3 1/2in. Torch illuminated (battery not supplied). Overall length 8 1/2in. In wooden transit case, in new condition, 55/- (des. 1/6).

**EXTRACTOR FANS** (can be used as blowers). Tank model, brand new. 12.24 v. A.C./D.C. Overall 7in. Diameter of impeller, 5 1/2in. Ideal for extraction or cooling in confined spaces—excellent motor, 15/6 (des. 1/6).

**HIGH-SPEED MOTORS**, 12/24 v. A.C./D.C. Full 1/6th H.P. 6,400 r.p.m. Length of body 5in. New, slightly soiled, perfect electrically, 25/- (des. 1/6).

**GOVERNED MOTORS**, 24 v. D.C. or 60 v. A.C. Centrifugal device controls speed at 2,520 r.p.m. (can be adjusted). Overall length 7 1/2in. Expensively made for Teleprinter. Brand new, 27/6 (des. 1/6).

**MILLIAMMETERS**, 2in. square, panel mount, 0/1 m.a. new, boxed, 9/6.

**CAMBRIDGE THERMO-COUPLES** for instruments. Rated 5 m.a. (max. 10 m.a.) With standard 4-pin valve cap. Boxed, with test-data label, 7/6.

**STAGE LIGHTING DIMMERS**. Controlling stated load from full-bright to blackout at 220/240 v. Sliding type: 100-watt, 32/6. 200-watt, 37/6. 500-watt, 59/6 (des. 2/-). Screw-motion type with Handwheel: 500-watt 23/18/6, 1,000-watt 27/2/6, 1,500-watt 28/12/6, 2,500-watt 29/15/- (des. 4/6).

**SIGNAL GENERATORS** by Marconi, R.C.A. and Cosmor, etc., as fully described in our December advertisement. A few of each model available at time of going to press.

**ANY RATING of Mains Transformers and Variable Resistances supplied to order. Please send enquiries. First-class material only.**

M. R. SUPPLIES Ltd., 6C, New Oxford Street, London, W.C.1

Telephone: MUSeum 2958

## Compact-Efficient

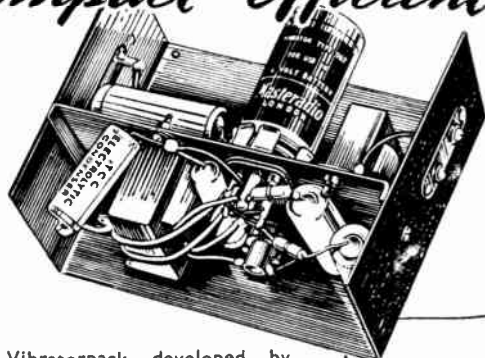

This Vibratorpack developed by Specialists will enable users of battery sets to operate from a 6-volt car accumulator, thus eliminating expensive H.T. battery replacements. Careful design has eliminated all interference. Consumption is less than 1/2 amp.

**SMALLER**  
 than a H.T.  
 Battery.  
 Size: 7 x 5 1/2 x 3



## Masteradio VIBRATORPACK

MASTERADIO LTD., Sales Dept., 319/321, Euston Road, London, N.W.1

# The NEW

## "STANELECT" LOUDSPEAKERS ARE — HERE!

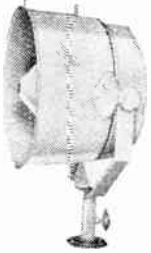

Giant 6 unit  
Hailer type "S"



Standard Marine  
Hailer type "C"



Controlled Beam  
Duo-Directional  
Loudspeakers



Duo-Directional  
Loudspeaker for  
Ceiling Mounting



Wall Mounting  
Loudspeaker

Speakers for every purpose, from Water-tight Marine Loud-hailers for Ocean Liners, to Paging Units suitable also for "Music while you Work" in Factories.

Representing a remarkable advance in constructive and aesthetic features, the new Stanelect speakers are encased in durable Alloy Die Castings.

In this range there are units which are ideal for any installation you may have in mind, even so, if you are a bulk user, Standards can design and make speakers especially for your needs.

*Standard Electric*  
LONDON

**STANDARD ELECTRICAL ENGINEERING CO.,**  
MAKERS OF PRECISION COMMUNICATION APPARATUS  
**STANELECT HOUSE 16, HENEAGE LANE, LONDON, E.C.3.**

Telephone : AVENUE 1633

Telegrams : "STANESCO" LONDON

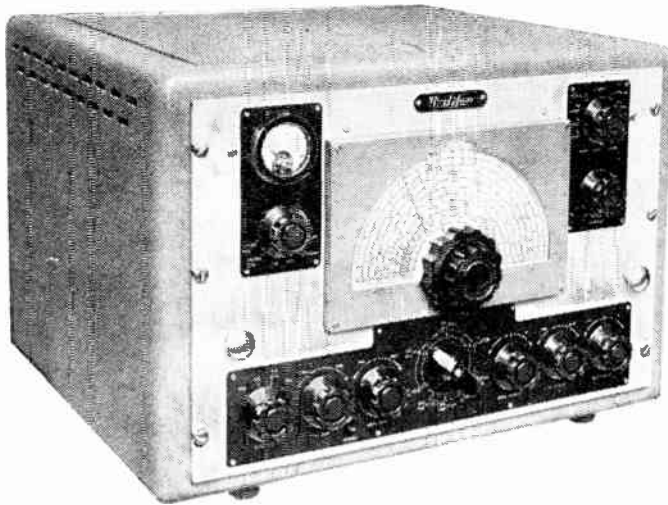

R.50  
COMMUNICATIONS RECEIVER

This high-grade communications receiver incorporates the most highly developed techniques in modern receiver design. Five degrees of selectivity, including a crystal gate and crystal filter are provided, and the sensitivity is such that an input of between 1-5 microvolts gives a signal/noise ratio of at least 10 dB over the entire frequency range of 13.5 to 26 kc/s and 95 kc/s to 32 Mc/s. Separate power units for A.C. or D.C. operations are available.

**REDIFFUSION LIMITED, BROOMHILL ROAD, WANDSWORTH, S.W.18**  
DESIGNERS & MANUFACTURERS OF RADIO COMMUNICATION & INDUSTRIAL ELECTRONIC EQUIPMENT Phone PUTney 5691

RC 201

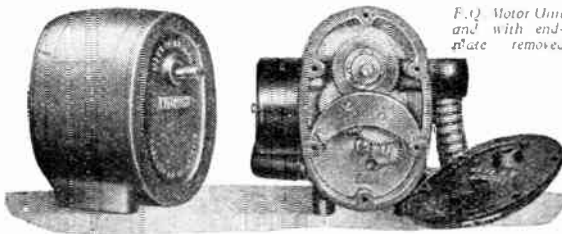

F.O. Motor Units and with end-plate removed

**SMALL GEARED MOTOR UNITS**

The Drayton "R.Q." is a 25-watt motor unit geared to a final shaft, to which may be fitted eccentrics, arms or cranks, gears, links or pulleys for actuating valves or dampers, movements, switchgear or other devices.

Supplied continuous running or reversing, with or without self-switching, for 100/110 or 200/250 volts A.C.

Both types are fitted with an auxiliary two-way switch actuated by movement of the final shaft, for operating auxiliary gear such as fan motors, pumps, interlocking devices, etc.

**Final Shaft Speeds:**

600 r.p.m./27 min. per rev.

Torque: 60 in. lbs. Consumption: 25 W.

**DRAYTON 'R.Q.'**

Send for List No. N302-1

**DRAYTON REGULATOR & INSTRUMENT CO., LTD., WEST DRAYTON, MIDDLESEX.**

RC7

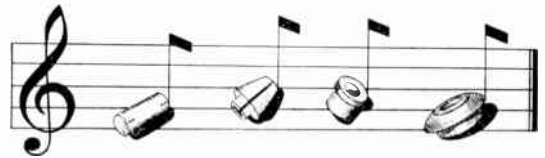

*make a note of Thompson's wood turnings*

for

Operating Valves, Dampers Rheostats, Cinema Projectors, Rotating Screens, Illuminated Signs, Small Working Models, Geneva Movements for Drum-type Switches, Rocking Baths, Work Movement, Soldering and Welding Fixtures, Continuous Turning, Feed of Light Strip under Process.

If you have a special fitting in mind which you think could be made better, or more economically or quicker in wood ask Thompson's advice on it—wood-turnings for 1001 trades.

Any turning in any wood to engineers' precision standards from blueprints, drawings or samples.

**W. & J. R. THOMPSON (WOODTURNERS) LIMITED. EST. 1862 CROSS HILLS, KEIGHLEY, YORKSHIRE.**

Phone: Crosshills 2312 (two lines)

Grams: Turuwood, Crosshills







# MASTERPIECE IN MINIATURE

WIDTH	2½"
HEIGHT	6¾"
DEPTH	9¼"
C.R.T. DIAMETER	1½"
NETT WEIGHT	7½lbs

## Miniscope

MINIATURE CATHODE RAY OSCILLOSCOPE BY **S.E.C.**

Full specification from: THE GENERAL ELECTRIC CO., LTD., MAGNET HOUSE, KINGSWAY, LONDON, W.C.2

"SETTING  
A NEW  
STANDARD"

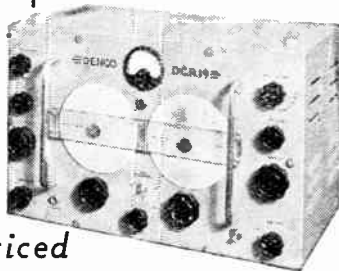

in

moderately priced

COMMUNICATION RECEIVERS

# DENCO

DCR  19

- Sensitivity less than 1 microvolt with constant gain 2-36 Mc/s.
- A.C. mains power supply included (110-250 v.).
- Six ranges 0.175 to 36 Mc/s. (1.6 I.F.).
- Calibrated Band-Spread 5 Bands.
- Crystal Calibrator: Noise limiter.
- 5-position selectivity: Xtal and Audio filter.
- High slope miniature R.F. pentodes (B7G).
- Robust, Compact, Lightweight —too many good points to enumerate here!

Write for leaflet and full details to:

**DENCO (CLACTON) LTD., OLD ROAD, CLACTON, ESSEX**  
Telephones: Clacton 807-8      Telegrams: Denco, Clacton

## TELE-RADIO (1943) LTD. 177 EDGWARE ROAD, W.2

TELEVISION COMPONENTS	
Scanning Coils (Scanco) .....	25 6
Focus Coils (Scanco) .....	30 0
Line Output Trans. (Scanco) .....	25 6
<b>WODEN MAINS TRANSFORMER</b>	
350-350, 250 mA, 4 v. 3 a., 6.3 v. 6 a., 4 v. 8 a., 0-2-6.3 v. 2 a. ....	98 6
<b>WODEN EHT TRANSFORMER</b>	
4 kV. 0-2-4 v. Heaters .....	63 0
<b>WODEN CHOKE</b>	
5 H. 250 mA. ....	29 0
10 H. 80 mA. ....	17 0
All the above are approved for the "E.E." Teletisor.	
<b>WODEN 100-watt Auto Transformer</b>	
Output Transformer, 10,000-10,000 ohms A.-A., 15 ohm secondary with 15 ohm feed back winding, suitable for valves in push-pull. 6P6, 6L6, 6V6, 6A6, 6B5, 33 .....	26 3
<b>WODEN OUTPUT TRANSFORMER HIGH FIDELITY</b>	
6,000-6,000 ohms A.-A., 3.75 and 15 ohms secondary. Suitable for valves: 6L6, 6V6, 6A3, etc. ....	40 0
<b>GRAMOPHONE MOTORS AND PICKUPS, etc.</b>	
Collaro AC47 .....	25 18 4
" AC47, with auto stop .....	27 7 0
" Universal .....	29 3 6
" Auto Changer .....	22 4 6
Garrard "8" Unit with pick-up .....	25 19 5
Plessey Auto Changer .....	218 9 8
Sound Sales Non-Magnetic Turntable .....	22 0 6
" Rubber Mats .....	8 6
" Connoiseur with Transformer .....	24 10 2
" Rothermel Crystal type S8 and S12 .....	23 0 8
" Marconi: type 14A .....	23 11 8
" " 14 with Trans. ....	24 16 8
" Lexington Jun. SPECIAL REDUCED PRICE .....	23 10 0
<b>ROTHERMEL CRYSTAL MICROPHONE (TORPEDO). Original price £18. 0. 0, our Special price. ....</b>	
	24 4 0

Please forward sufficient for postage and packing.

1949 Catalogue now available, 1 - post free.

**TELE-RADIO (1943) LTD.**  
**177 EDGWARE RD., LONDON, W.2**

A.M.B. 0393.

P.A.D. 6116/5606

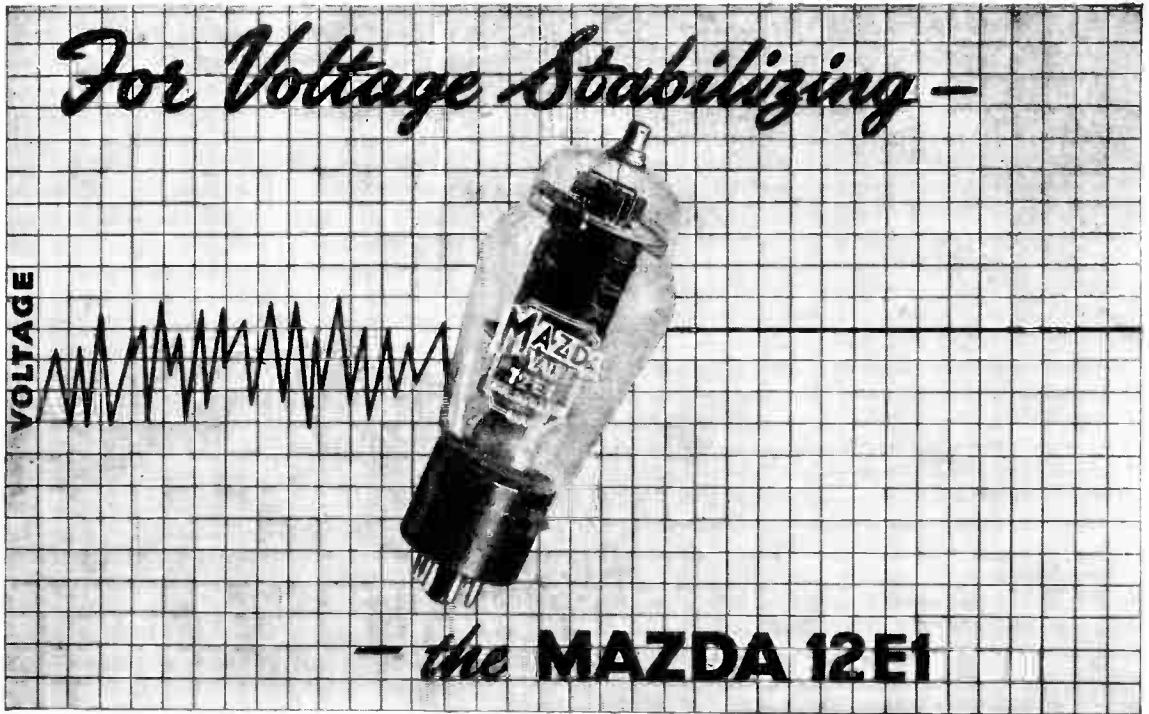

The Mazda 12E1 is an indirectly heated Beam Tetrode designed for use as a series or shunt control valve in stabilized power packs. Although comparable in size to the average large Output Tetrode it is capable of passing a maximum control current of 300 mA.

*Further details on request.*

**RATING**

Heater volts ... ..	6.3
Heater current (amps.) ... ..	1.6
Max. Anode volts ... ..	800
Max. Screen volts ... ..	300
Max. Grid No. 1 volts ... ..	100
Max. Grid 1 to screen volts ... ..	400
Max. Anode dissipation (watts) ... ..	35
Max. Screen dissipation (watts) ... ..	5.0
Max. Cathode current (mA) ... ..	300
Max Heater to Cathode volts (Cathode positive) ... ..	300

**DIMENSIONS**

Maximum overall length (mm.) ... ..	150
Maximum diameter (mm.) ... ..	54

# EDISWAN

## MAZDA

**RADIO VALVES AND CATHODE RAY TUBES**

v.76

THE EDISON SWAN ELECTRIC CO. LTD., 155 CHARING CROSS ROAD, LONDON, W.C.2



# The 'CINTEL' UNIVERSAL OSCILLOSCOPE

*A highly versatile laboratory instrument of outstanding performance*

Designed on the unit principle the 'Cintel' Universal Oscilloscope offers a basic instrument which is expandable at will to meet your requirements. Units now available include:

- Basic unit, comprising console, Cathode Ray Tube and power pack and calibration device.
- Simple time Base with frequency range from 5c/s to 200 Kc/s.
- Amplitude Stabilised Time Base with calibrated frequency range from 5c/s to 150 Kc/s.
- A.C. Amplifier with frequency range from 5c/s to 1.5 Mc/s.
- D.C. Amplifier with frequency range from 0c/s to 5 Mc/s.
- Double Beam Switch Unit.
- Five Beam Switch Unit.



**CINEMA - TELEVISION Ltd.**

**WORSLEY BRIDGE ROAD,  
LONDON, S.E.26**

Telephone: H1Ther Green 4600

Manufacturers of Scientific Instruments and Photo-electric Cells

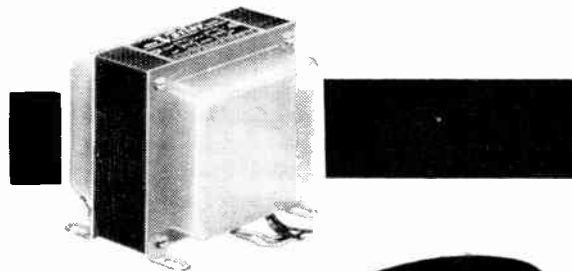
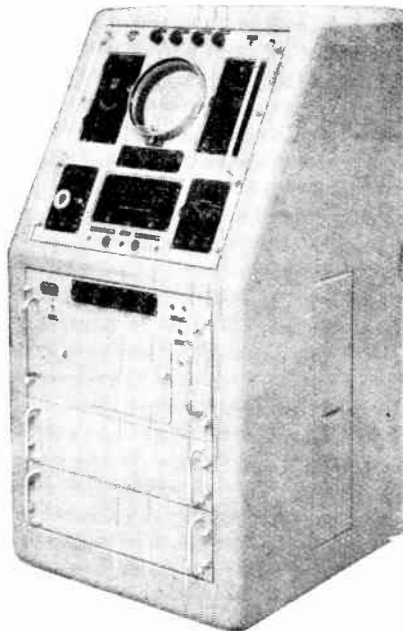

## **MAINS TRANSFORMERS & CHOKES**



All "Varley" products are manufactured from the highest quality materials.

Transformers etc., are individually wound and have interleaved windings with ample insulation, ensuring freedom from breakdown.

The comprehensive range of Shielded and Open type Transformers available meets the requirements of every circuit.

MADE BY

Write for list etc.

**OLIVER PELL CONTROL LTD**  
CAMBRIDGE ROW · WOOLWICH · S.E.18  
Telephone: WOOLWICH 1422

## **NEW** and now available

If you are interested in the mechanics of good reproduction, you should have this book. It contains 83 pages of valuable, detailed information, together with 36 diagrams. The first edition of 5,000 copies has already been sold out. The second edition containing only minor alterations is now available.

The following extract from recent reviews gives an idea of its worth:—

**July issue of American Magazine ELECTRONICS.**

"Written for domestic high fidelity addicts—presents the essentials for intelligent selection and evaluation of loudspeakers—informa the critical listener of the technicalities of reproduction. It is a pleasure to see the Doppler effect correctly presented as a trivial problem."



## **LOUDSPEAKERS**

*The Why and How of Good Reproduction*  
by G.A. Briggs **5/-** per Copy

**ASK YOUR DEALER OR POST  
COUPON FOR YOUR COPY**

Published by

**WHARFEDALE  
WIRELESS WORKS**

BRADFORD ROAD,  
IDLE,  
BRADFORD, YORKS.

**POST COUPON FOR  
YOUR COPY.**

Please send immediately copy of your book **LOUDSPEAKERS**. I enclose P.O. value 5/- in full payment.

Name .....

Address .....

# HUNTS

## New Ranges of Special Replacements

SINGLE HOLE MOUNTING TYPE L.36						
List No.	Cap. uF.	DC Wkg. Volts.	Type of Anode	Dimensions L.	Dimensions Dia.	List Price s. d.
*K417	30+30	150	C	3½"	1"	10 0
*K418	50+50	150	C	3½"	1"	11 0
K412	16	350	B	3½"	1½"	7 3
K419	32	350	C	3½"	1"	8 3
K413	16+24	350	C	3½"	1½"	10 0
K414	24+24	350	C	3½"	1½"	10 6
K415	32+32	350	C	3½"	1½"	13 0
K400	8	450	A	3½"	1"	6 3
K401	16	450	A	5"	1½"	8 0
K402	16	450	C	3½"	1"	7 6
K403	24	450	C	3½"	1"	8 9
K404	32	450	C	3½"	1½"	10 0
K405	8+8	450	A	5"	1½"	9 6
*K416	8+8	450	C	3½"	1"	8 6
K406	8+16	450	A+C	5"	1½"	11 0
*K407	8+16	450	C	3½"	1"	10 0
K408	16+16	450	C	3½"	1½"	11 0
K410	16+32	450	C	3½"	1½"	14 0
K409	24+24	450	C	3½"	1½"	14 0
K411	32+32	450	C	5"	1½"	16 6

\*Case Negative

First capacitance is outer winding and should be used as Reservoir

**TYPE L.36**  
Cylindrical Aluminium Cases with 6" flexible leads and single hole mounting.

Also available are Standard and "Little Giant" Electrolytics in cardboard cartons with and without fixing feet and "Minitubes" with wire leads and cardboard sleeves. These new ranges of special replacement electrolytics will be invaluable in servicing older types of Radio Equipment. Place your order now for



**HUNTS**  
**CAPACITORS**  
**A · H · HUNT LTD**

BENDON VALLEY · GARRATT LANE · LONDON · S.W.13

**Design** for purpose is as important in radio servicing as in nature. The Weston Model E772 Analyser has been designed to make the detection of electrical faults as simple and speedy as possible. Its features include high sensitivity (20,000 ohms per volt on all D.C. ranges), wide range coverage and robust construction—its quality is unsurpassed. Please write for details.

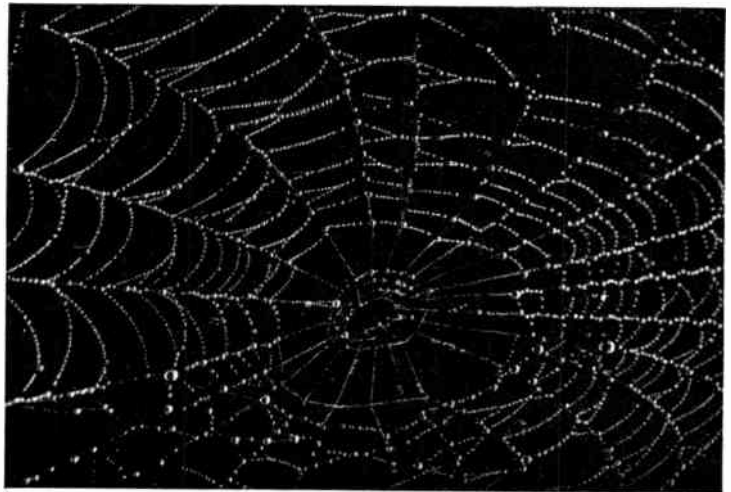

**WESTON**<sup>E 772</sup> *Analyser*

SANGAMO WESTON LTD. · ENFIELD · MIDDX. Telephone: Enfield 3434 & 1242



Specialists in  
Lightweight Pneumatic  
and Electric Portable Tools

DESOUTTER BROS. LTD., THE HYDE, HENDON, LONDON, N.W.9. TELEPHONE: COLINDALE 6346-7-8-9. TELEGRAMS: DESPNUCO, HYDE, LONDON

C.R.C. 19J



# Wireless World

RADIO AND ELECTRONICS

JANUARY

1949

38th YEAR OF PUBLICATION

Proprietors: ILIFFE & SONS LTD.  
 Managing Editor: HUGH S. POCKOCK, M.I.E.E.  
 Editor: H. F. SMITH

Editorial, Advertising and Publishing Offices:  
 DORSET HOUSE, STAMFORD STREET  
 LONDON, S.E.1.

Telephone: Waterloo 3333 (60 lines).  
 Telegrams: "Ethaworld Sedist London."

PUBLISHED MONTHLY  
 Price: 2/-

(Publication date 26th of preceding month)

Subscription Rate: 26/- per annum. Home and Abroad

Branch Offices:

Birmingham: King Edward House, New Street, 2.  
 Coventry: 8-10, Corporation Street.  
 Glasgow: 26B, Renfield Street, C.2.  
 Manchester: 260, Deansgate, 3

## In This Issue

OUR COVER: Cinema Television Projector (See Page 10)

EDITORIAL COMMENT .. .. .	1
LOW-IMPEDANCE VARIABLE-VOLTAGE TAPPINGS. By M. G. Scroggie .. .. .	2
"Q" METERS. By H. G. M. Spratt .. .. .	7
DISTORTION: DOES IT MATTER? .. .. .	11
AMATEUR RADIO SHOW .. .. .	13
BOOK REVIEWS .. .. .	15
COMPACT MARINE RADAR .. .. .	16
TELEVISION DISTRIBUTION. By P. Adorian .. .. .	18
VERSATILE POWER SUPPLY. By K. F. Butcher .. .. .	21
ELECTRONIC CIRCUITRY. By J. McG. Sowerby .. .. .	23
WORLD OF WIRELESS .. .. .	25
ADMITTANCE. By "Cathode Ray" .. .. .	29
SHORT-WAVE CONDITIONS .. .. .	32
UNBIASED. By "Free Grid" .. .. .	34
LETTERS TO THE EDITOR .. .. .	35
RANDOM RADIATIONS. By "Diallist" .. .. .	38
RECENT INVENTIONS .. .. .	40

2845



# New Approach COMPONENTS

Keeping abreast of fast-moving technical development calls for a new approach to production problems. The "WEARITE" Pressed Circuit System represents a substantial advance in production science to speed assembly and lower costs. The first of these "Wearite" New Approach Components is a Coil Pack comprising coils, switches, trimmers and padders completely wired and ready for instant incorporation into any standard Superhet circuit.

- 3 ranges
- Gram switching
- 2-hole fixing at 1 1/8" centres
- All trimmers and adjusters conveniently placed in one surface

Manufacturers are urged to write for full technical details.

Sides removed for clarity of illustration.

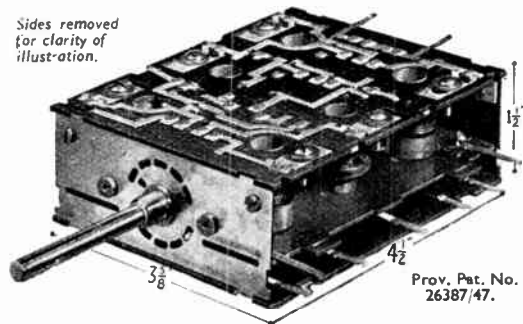

Owing to raw material restrictions, supplies, for the time being, are confined to Radio Receiver Manufacturers at home and abroad.

# Wright and Weaire Limited

138, SLOANE ST. · LONDON · S.W.1 TEL SLOANE 2214/5 FACTORY: SOUTH SHIELDS, CO. DURHAM



# Valves and their applications

## THE EF42 IN THE OUTPUT STAGE OF A WIDE-BAND OSCILLOGRAPH AMPLIFIER

In the design of a high-gain amplifier for a C.R. oscillograph, it is usually necessary to consider the output stages first, as the major frequency limitations usually occur at this point.

A C.R. tube presents a largely capacitive load to the preceding stage which must therefore have a low anode load resistance, while the voltage swing required for full deflection of the beam entails a high maximum current.

When an ECR35 C.R. tube operating at 1.2 kV is used, a total signal of 180V (peak to peak) must be provided on the most sensitive plates (allowing, say, 25% over-deflection) and if this is derived from two EF42s in push-pull, each must give 90V.

With a 250V H.T. line, the EF42 will give this signal swing across a 5K $\Omega$  anode load resistance provided that a little non-linearity can be tolerated at the lower limit of current. This is quite permissible as over-deflection has been allowed for. The bias resistor necessary for this condition is 180 $\Omega$ .

This amplifier-C.R. tube combination has a frequency response falling by rather more than 3db at 1 Mc/s., but this may be improved by compensation. One of the most convenient methods of doing this is to arrange that negative feedback shall appear in the amplifier at low frequencies, while at high frequencies the full amplification shall be used. This can be carried out in a variety of ways, but the most convenient and economical in components is that in which the existing cathode resistor is partially by-passed by a small capacitor.

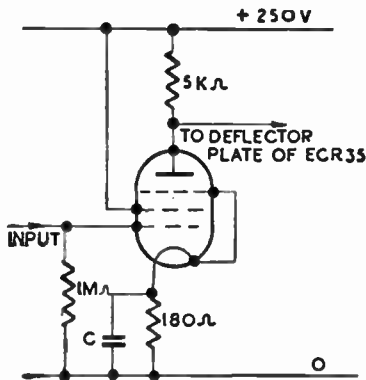
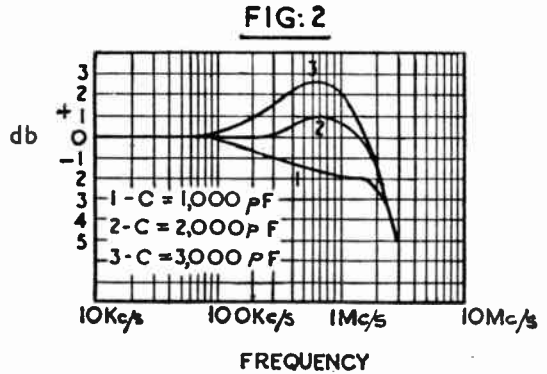

FIG:1



The circuit of the amplifier then becomes that shown in Fig. 1, while Fig. 2 indicates the frequency responses that can be obtained when three different values of cathode by-pass capacitor (C) are used. It must be remarked, however, that at high frequencies the full sweep available at low frequencies will not be obtained from the valve owing to the current swing limitation.

The transient response of the amplifier — usually a more important feature where oscillographs are concerned — is such that a square wave with a rise-time of 0.2 $\mu$ s is reproduced with an “overshoot” of 0%, 10%, or 20% when the cathode capacitor is 1,000pF, 2,000pF or 3,000pF respectively.

On this basis, a capacitor of 1,500pF would probably be satisfactory in most cases, but if the preceding amplifier stages were found to limit the response severely, up to 2,000pF could be used, as such rapidly rising transients would never reach the output stages. The amplifier gives a voltage gain of 15 times when used under these conditions.



Reprints of this report from the Mullard Laboratories, together with complete circuit diagram of a push-pull amplifier and circuit notes, can be obtained from the address below.

**MULLARD ELECTRONIC PRODUCTS LTD.,  
TECHNICAL PUBLICATIONS DEPARTMENT,  
CENTURY HOUSE, SHAFTESBURY AVE., W.C.2**

(MVM81)

# Wireless World

VOL. LV. NO. 1

JANUARY 1949

RADIO AND ELECTRONICS

## Comments of the Month

### POPULARIZING TELEVISION

**C**ONSIDERING that there is only one transmitter at present working in this country, the spread of television may be regarded as satisfactory. But the time will probably come when the potential output of receivers is greater than public willingness to absorb them; this state of affairs will certainly come about all too soon unless energetic steps are taken to dispel doubts, which still seem widespread in the lay mind, as to the adequacy of picture quality. The desirable end can best be achieved by well-organized public demonstrations, and we are glad to see that the Radio Industry Council has already made a start in this direction.

So far, most members of the public have gained their first impressions of television from demonstrations in retail shops. Without belittling the efforts of individual dealers, many of whom have shown great resource and enterprise, it is true to say that conditions in shops are inherently unfavourable, or even unfair, as they are worse than those obtaining in the average home. The interference level prevailing in a busy thoroughfare is higher than in most residential districts. Moreover, the average person naturally hesitates to visit a shop unless he has almost made up his mind to buy a television set.

Co-operation between industrial organizations and public bodies seems to be needed to ensure that in every large centre of population where a service is available the interested citizen can see demonstrations that fill all the requirements. We believe that in the whole of London the only place satisfying these requirements is the Science Museum at South Kensington, where the public can see the transmissions every afternoon. No doubt many comparable institutions within the service areas of the present and of future transmitters would be willing to grant facilities for regular demonstrations. Even if reception condi-

tions are not ideal in conveniently central situations, most of the difficulties could be overcome at a cost that would not be excessive for a co-operative effort. We suggest that in this effort both the industrial organizations and the B.B.C. might cooperate with advantage.

### “STATIC”

**T**HIS synonym for “atmospherics,” “interference,” or even sometimes “jamming,” is a word which *Wireless World* tries to avoid. We were glad to see that a contributor, writing in our December issue, refuses to accept “precipitation static” as a term to describe corona discharge interference. Though this may have a static origin, conditions are anything but static when the interference manifests itself.

A misleading—if not meaningless—statement due to a mis-translation ascribable to the currency of the deplorable term “static” has just come to our notice—and in an official publication at that. Below are given short extracts from the parallel French and English texts in the report in the *Journal des Télécommunications*\* (Berne) on the Maritime Regional Radio Conference, Copenhagen. The italics are ours.

#### ARTICLE 12.

Les administrations prendront, en ce qui concerne leurs stations côtières, les mesures nécessaires: .....

(b) pour éviter toute émission parasite susceptible de causer des brouillages nuisibles.

#### ARTICLE 12.

With regard to their coast stations, administrations shall take the measures necessary: ....

(b) to avoid any static emission likely to cause harmful interference.

\* September, 1948; p. 353.

Comment is hardly necessary, but we cannot help saying that the figurative French use of the word *parasite* for “interference” seems to be hardly less confusing than the Anglo-American “static,” and to be even more to blame.



# LOW-IMPEDANCE VARIABLE

## The Cathode Follower as a D.C.

### Potential Divider

By M. G. SCROGGIE, B.Sc., M.I.E.E.

IN previous issues<sup>1</sup> the series type of voltage stabilizer has been considered in some detail. It is, as we have seen, essentially a cathode follower with amplified feedback. The amplification enables a very high degree of stabilization and absence of internal resistance to be achieved, but introduces difficulties when the output voltage is required to be variable below about +100 V. It is also rather elaborate if several independently-variable stabilized outputs are to be provided.

The internal resistance of a plain cathode follower, being approximately  $1/g_{m0}$ , is relatively high—of the order of  $150\Omega$ —but is nevertheless far lower than that of a potential divider across the main stabilized output, even if the resistance of the potential divider were made so low as to waste most of that output. The various types of Marconi "Stabilivolt" provide from one to four tapplings, with internal resistance in some types as low as  $40\Omega$ , but are limited to certain fixed voltages, generally multiples of 70 V. Cathode followers, on the other hand, can be controlled to provide continuously variable outputs from nearly zero up to that of the main supply, are simple and cheap, and in most cases their internal resistance is less than 1 per cent of the load resistance and therefore practically negligible. They can be added to any existing stable-voltage unit, or incorporated in the design; so the whole becomes a very flexible equipment for laboratory use. The same idea has been applied in power units forming parts of equipment such as amplifiers, to supply constant screen-grid potentials, and was devised for that purpose by the late Dr. Partridge.<sup>2</sup>

Fig. 1 shows the very simple

essentials of the "electronic tapping." The symbols have been chosen to fit on to those used in the previous articles dealing with the main unit.  $V_0$  can therefore be assumed to be a stabilized output, variable, say, from 200 to 400 V.  $R_{10}R_{11}$  is a wire-wound potentiometer of about  $0.1\text{ M}\Omega$ , controlling the tapping voltage,  $V_t$ .  $R_{12}$  is a grid-current limiter to take care of the valve under conditions when  $R_{10}$  and the load resistance,  $R_L$ , are low.

The question is, what sort of valve should be chosen? The answer quickly becomes clear if one takes any valve characteristic curves and uses them to calculate the performance. Short-circuiting preliminary bad guesses, let us start with a type that will turn out to be particularly suitable in most respects—the Mullard EC52. (This happens to be intended primarily for very high frequencies, up to 400 Mc/s, so it is perhaps not the most obvious

setting of the  $V_t$  control (assuming no grid current to cause a drop in  $R_{12}$ ).

What we want, of course, is not a curve of  $V_1$  against  $I_t$  for a fixed  $V_t$ , but  $V_t$  against  $I_t$  (the so-called regulation curve) for any fixed  $V_1$ . Under these conditions, when  $V_0$  varies owing to a change in  $I_t$  drawn,  $V_a$  is altered by the same amount. But with a high- $\mu$  valve such as this ( $\mu = 50$ ) the effect of the change in  $V_a$  is quite negligible. So far as the characteristic curves are concerned—in particular, the  $I_t/V_0$  relationship corresponding to any value of  $V_1$ —it is legitimate to disregard the difference between  $V_t$  and  $V_1$ , and to use the  $V_t$  scale as a scale of  $V_1$ .

Supposing for example that  $V_1$  is set to 250 V, then; zero  $I_t$  is represented in Fig. 2 very nearly by point A, where  $V_g$  is  $-3.5$ , so the corresponding  $V_t$  must be 253.5, represented by point A', set off to the left by a distance corresponding to  $V_g$ . Looking upwards from A, we can read off at intervals the decreasing values of  $-V_g$  (and hence of  $V_t$ ) corresponding to increasing load

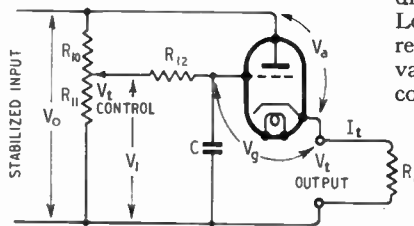

Fig. 1. Stable-voltage "electronic tapping," with output adjustable over nearly the whole range of  $V_0$ .

choice for a zero-frequency application).

Fig. 2 consists of the ordinary  $I_a/V_a$  curves, which as regards Fig. 1 are  $I_t/V_a$  curves. Since  $V_t = V_0 - V_a$ , we can easily mark a scale of  $V_t$  for any given  $V_0$ . This is done in Fig. 2 for  $V_0 = 400$ . We can at once see the available range of  $I_t$  at any specified  $V_t$ . Suppose, for example, that with  $V_0$  set at 400,  $V_t$  is 250. The curves show that anything up to 18 mA is available, at  $V_g$  from 0 to  $-3.5$ . One has only to add this variable  $V_g$  to the specified  $V_t$  to get the relationship between  $I_t$ , the current drawn, and  $V_1$ , the

currents, and set them off to the left. The limiting point is where grid current starts to flow, causing a voltage drop in  $R_{10}$  and  $R_{12}$ . Voltage stabilization then fails. The start of the grid current varies from valve to valve of the same type, and in the EC52 lies between 0 and  $-1$  V. The dotted curve at  $-0.5$  represents an average, and in the assumed circumstances is met when  $I_t$  is 14.5 mA (point B).

From the way in which the regulation curve A'B has been derived it is obviously the familiar  $I_a/V_g$  curve (for  $V_a = 150$  in this case), crowded on to the  $V_a$

<sup>1</sup> Oct., Nov., Dec., 1948.

<sup>2</sup> The Partridge Manual, p. 16. (Partridge Transformers Ltd., Kingston By-Pass, Tolworth, Surrey).

# VOLTAGE TAPPINGS

scale. That being so, it represents a resistance equal to  $1/g_m$ , confirming cathode-follower theory when  $1/\mu$  is neglected. Thus, over the range 0 to 14.5 mA, the variation in output voltage is

vertical voltage scale, we can draw it as in Fig. 3, constructed from data transferred from Fig. 2. For preliminary purposes it should be enough merely to inspect the valve makers' curves

ly to this assumption, so that  $I_a/V_t$  characteristic should not be expected to represent this part of the curve accurately. So far as regulation is concerned, that matters little, seeing that it is a condition one avoids; but it does slightly affect the risk of over-running the valve. Experimental results (with  $R_{10}, R_{11} = 0.1 \text{ M}\Omega$ ;  $R_{12} = 0.25 \text{ M}\Omega$ ) have been plotted in Fig. 3 for comparison. Whereas the difference between them and the theoretical plots is imperceptible over most of the flat part, the experimental curve slopes less steeply in the unstabilized condition.

Regulation curves for other settings of  $V_1$  can very quickly be added to Fig. 3 if the corresponding  $I_a/V_g$  are available; failing which, the data can be derived from the  $I_a/V_a$  curves of Fig. 2 as previously. This exercise makes it clear that on open circuit the output voltage is equal to the  $V_1$

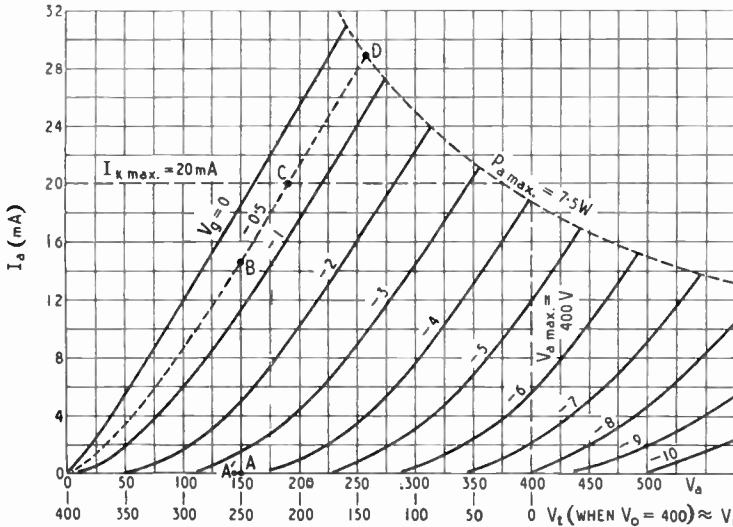

Fig. 2.  $I_a/V_t$  characteristics of EC52, illustrating properties and design of electronic tapping.

3 V. If this variation were uniform, it would indicate a generator resistance of  $3/0.0145 = 207\Omega$ . Actually, as the curves show, it is greater than this for small  $I_t$ , and decreases to about  $140\Omega$  in the region of  $V_g = -1$ .

Assuming that  $R_{12}$  is large enough to keep  $V_g$  constant at  $-0.5 \text{ V}$  as  $I_t$  is increased beyond point B, we must now follow the dotted line. In due course this would bring us into the zone fenced off by the maximum cathode current rating for the valve (20 mA). If it were not for this, one could proceed as far as point D, on the boundary set by the maximum anode dissipation (7.5 W). With other valves or conditions, especially with low  $V_t$ , it is possible to strike the anode dissipation limit first. A third limit, maximum rated  $V_a$ , is shown as a vertical dotted line. Exclusion of the area to the right of it conservatively assumes that  $V_t$  is liable to go right down to zero.

If we prefer a regulation curve in the more usual form, with a

turned through  $-90^\circ$ . This is because the regulation curve comprises two regimes; the first, A'B, in which stabilization is effective, consists of the  $I_a/V_g$  curve for the appropriate  $V_a$  ( $\approx V_0 - V_1$ ), and with a high- $g_m$  valve is nearly level. The second, BC, follows (unless the  $I_{kmax}$  or  $P_{amax}$  limits have intervened) when the tapping is overdrawn so that grid current flows. If  $R_{12}$  were so large that further reduction in  $-V_g$  could be neglected, this part of the regulation curve would coincide with the  $I_a/V_a$  curve for  $V_g$  corresponding to the start of  $I_g$  (the dotted curve OBCD in Fig. 2). There are practical disadvantages in making  $R_{12}$  large enough to approximate very close-

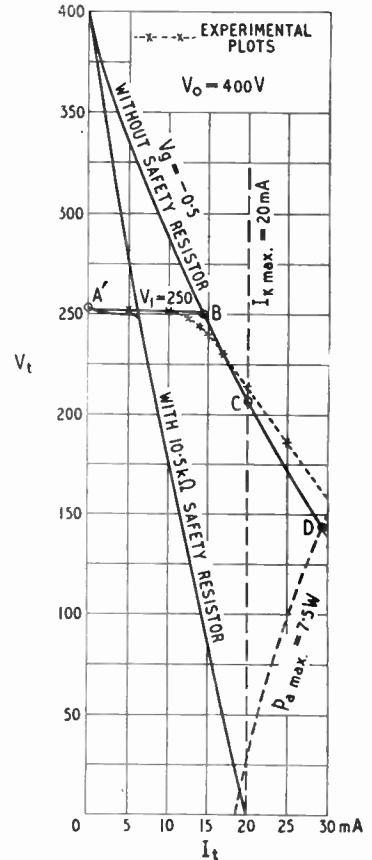

Fig. 3. Regulation curve, A'BC, derived from Fig. 2, with the voltage control set at  $V_1 = 250$ . An experimental curve is dotted in for comparison. The modification due to a fixed resistor in series with the anode, sufficient to prevent the rated limits from being exceeded under any conditions, is also shown.

### Low-Impedance Variable-Voltage Tappings—

setting plus a voltage that ranges from practically zero when  $V_1 = V_0$  to  $V/\mu$  when  $V_1 = 0$ . The maximum stabilized output current increases from zero at  $V_1 = V_0$  to approximately the zero- $V_g$  anode current of the valve at  $V_a = V_0$  when  $V_1 = 0$ , subject to  $I_{kmax}$  and  $p_{amax}$  ratings.

If  $V_0$  is altered,  $V_1$  obviously changes in proportion; and so (approximately) does  $V_t$ .

The relationship of output to load resistance can be examined by drawing the usual load line from the point  $V_t = 0, I_t = 0$ , to the working point, in either

sents  $-20$  V on the voltage scale,  $d$  is a point on  $a'b$ . Dropping a vertical from  $d$  to meet the  $V_g = -20$  curve gives a point on the accurate regulation curve, which, when completed, is  $a''b$ . The correctness of the construction can be seen by observing that  $cg$  represents  $V_a$  at the  $I_a$  and  $V_g$  considered, and  $ef = dc = V_g$ , so  $fg$  represents  $V_a + V_g$ , which is  $V_0 - V_1$ , and  $V_1$  is thus represented by  $fh$ ,  $f$  being on  $ab$ , which was drawn to mark  $V_1$ .

For most valves the difference between  $a'b$  and  $a''b$  is imperceptible on an ordinary curve sheet.

It should now be clear what

90 V. On the other hand, high  $\mu$  means high  $r_a$ , which means that the current output at voltages not much below  $V_0$  is very limited. Fig. 2 or 3 shows that with the EC52 the stabilized  $I_t$  from a tapping 100 V below  $V_0$  is only about 8 mA, whereas the PX4 yields about 65 mA.

In estimating the current requirements, allowance must be made for any modulation of the mean current drawn. While the peak  $I_t$  can be allowed to overstep the  $p_{amax}$  and  $I_{kmax}$  limits (so long as the mean  $I_t$  or working point is within), it should not exceed the limits of stabilization, or unexpected effects may occur in the apparatus being fed.

When neither of these special requirements settles the  $\mu$  question, the fact that high- $g_m$  triodes are generally more easily obtained with low  $\mu$  may be relevant. It must be remembered, however, that  $g_m$  is not constant, but decreases to zero as  $I_t$  is reduced. So if  $I_t$  is small relative to the maximum available, the nominally high- $g_m$  valve may actually be inferior. For supplying, say, 5 mA, the EC52 would not only give a  $V_t$  much closer to the  $V_1$  setting but would have a higher working  $g_m$  than the PX4, which would be under-loaded at that current. Alternatively one could keep clear of the bottom bend by using a shunt across the load.

Among other triodes which might be considered, there is the ECC32 with its two sections in parallel, totalling 10 W dissipation and 50 mA output but a lower  $g_m$  and  $V_{amax}$  than the EC52, and the ECC35 with  $\mu = 68$  but maximum current only 16 mA.

A rather expensive but effective way of increasing the stabilized range of high-current, while retaining the high- $\mu$  advantages and reducing the internal resistance, is to connect valves in parallel. The performance is indicated by multiplying the  $I_t$  scale by the number of valves used.

One might ask, why not use a tetrode or pentode, seeing that there is a wider choice of these, and they offer high current, high  $g_m$ , and very high  $\mu$ ? The practical difficulty, which will be discussed later, is the need for keeping the screen grid at a constant voltage above the cathode. Such valves can be con-

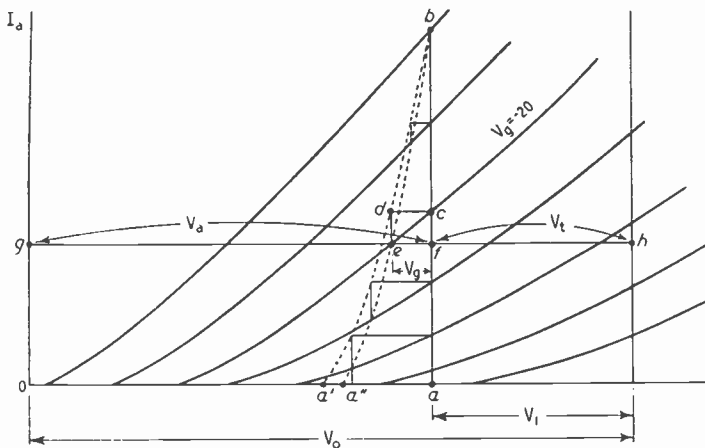

Fig. 4. Construction for drawing an accurate regulation curve,  $a''b$ , taking account of  $V_g$  being at the expense of  $V_a$ .  $a'b$  is the approximate curve of the type shown in Figs. 2 and 3.

Fig. 2 or Fig. 3. The output power is a maximum when the working point lies on the line  $V_t = V_a$ , at the highest permissible current.

The foregoing analysis has been based on the assumption that  $\mu \gg 1$ . This undoubtedly applies to the EC52, with a  $\mu$  of 50; in fact  $\mu$  has to be exceptionally small for the error to be significant. If it makes one happier to obtain the more exact result, it can be done quite easily, as shown in Fig. 4. Here  $ab$  is a vertical line representing the selected  $V_1$ . The approximate regulation curve,  $a'b$ , has been obtained as before, by setting off distances to the left of  $ab$  to represent  $V_g$ . Consider, for example, the curve marked  $V_g = -20$ , which crosses  $ab$  at  $c$ . Then if  $cd$ , drawn horizontally, repre-

sents a sort of a valve one should look for to fulfil the requirements. If the most important need is good regulation, which can be reckoned in terms of low internal resistance, clearly high  $g_m$  is the most important feature. But of a number of valves having similar  $g_m$ , should preference be given to high  $\mu$  or low  $r_a$ ? We have already seen that high  $\mu$  is convenient for design purposes, in that one can neglect the fact that  $V_0$  is obtained at the expense of  $V_a$ . And if one wants to be able to control the output voltage to practically zero, a high  $\mu$  is again an advantage. Looking at Fig. 2, the output voltage when  $V_0 = 400$  and  $V_1 = 0$  is never higher than 8, even on open circuit; whereas with a low- $\mu$  valve of similar  $g_m$  (the Osram PX4, see Fig. 5) it is nearly



nected as triodes, however. The clue to their triode  $\mu$ , if it is not stated, is their  $\mu_{g2-g1}$ , which is of the same order, and is beginning to be quoted more freely by valve manufacturers. It can be deduced from  $I_a/V_g$  curves, if they are shown for more than one  $V_{g2}$ , by noting the increment of  $V_{g2}$  needed to maintain constant  $I_a$ , per volt of  $V_g$  increment. The triode-connected Osram KT61 offers a useful combination of high  $g_m$  and high  $\mu$ .

The valve's rated limits  $P_{max}$ ,  $V_{amax}$  and  $I_{kmax}$  must of course be taken into account. Unfortunately the published figures do not always include all three, and sometimes the voltage limit may seem lower than it need be on purely technical grounds. It is clear from the diagram that if  $V_0$  is never greater than the  $V_a$  at which the zero- $I_b$  bias line first meets a limit line (e.g. point C in Fig. 2) there is no need to worry about over-running the valve; the output terminals can be short-circuited at any setting of the  $V_1$  control.

The valve can be made similarly foolproof for any higher value of  $V_0$  by inserting in series with its anode sufficient resistance to drop the excess voltage. Suppose in Fig. 2 that the maximum  $V_0$  is 400. Then the line representing the minimum fully safe resistance

is the steepest that can be drawn from 400 on the  $V_a$  scale to meet the zero- $I_b$  curve without crossing a limit boundary. In this case it joins point C; without the  $I_{kmax}$  limit it would have been D. The slope of the line shows that the resistor should be just over 10 k $\Omega$  and its maximum wattage  $0.02 \times 210 = 4.2$ .

Unfortunately such a resistor if fixed is in effect an increase in the valve's  $r_a$  so it degrades the performance correspondingly. The modified characteristics can easily be drawn by an obvious construction, in Fig. 3, shifting the points on the  $V_g = -0.5$  curve downwards sufficiently to represent the voltage drop in the safety resistor. The "level" part of any regulation curve begins at the original point and meets the new curve at the same voltage, so obviously must slope more. It can be seen how seriously the current range is restricted at the lower settings of  $V_1$ .

As a compromise, to ensure safety when the widest possible range of adjustment is liable to be made in an experiment, but to retain maximum  $I_t$  and constancy of voltage in less severe conditions, the safety resistor can be made variable, from the safety value for maximum  $V_0$ , down to zero, and fitted with a scale marked in ohms and also in the value of  $V_0-V_t$  at

which safety is assured. When the load resistance can be relied upon to be not less than the figure on the rheostat scale corresponding to  $V_0-V_1$  equal to the maximum that will be used, the safety resistance can be turned to zero.

For  $V_0^{max} = 400$  in Fig. 2, the scale markings would be :

R(k $\Omega$ )	$V_0 - V_t (= V_a)$
0	0-190
0.5	200
1.75	225
3.0	250
4.25	275
5.5	300
6.75	325
8.0	350
9.25	375
10.5	400

A suitable value for the resistor  $R_{12}$  is 0.25 M $\Omega$ , rated to take maximum  $V_0$  across it. Lower values cause the valve to reach its rated limits sooner, while higher values tend to encroach on the "level" part of the regulation curve. Both these effects are illustrated to some extent by the experimental curve in Fig. 3.

There are at least three possible causes of hum in the output. The most straightforward of these is hum in the input,  $V_0$ . Regarding the arrangement as a cathode follower, and assuming  $\mu \gg 1$ , load resistance high, and grid current nil, it is easy to see that the proportionate unsteadiness in  $V_t$  is approximately equal to that in  $V_1$ , which in turn is equal to that in  $V_0$ . The errors in this approximation, due to load resistance and  $\mu$  not being infinite, tend to cancel out. Since the main stabilized supply presumably is extremely smooth (e.g. in a unit designed on the lines described in the preceding articles it was 1 mV or less) this cause is not likely to be troublesome in practice.

A relatively enormous amount can be introduced via the heater, if the heater winding is not screened, and especially if it is wound next the H.T. coil. Permissible maximum heater-to-cathode voltage forbids the heater from being tied to a constant-potential point, except for very limited ranges of  $V_t$ ; and the maximum heater-to-cathode re-

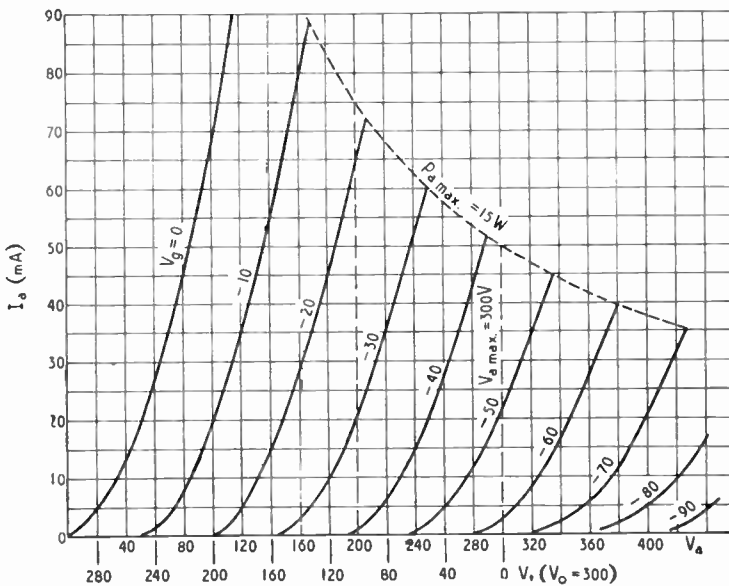

Fig. 5. Characteristic curves of low- $\mu$  valve (PX4), for tapping to provide relatively heavy current.

### Low-Impedance Variable-Voltage Tappings—

sistance rating forbids one to leave it floating. So one is obliged to join the heater to cathode. Between the heater winding and any others there should therefore be a screen connected to the common negative point.

The grid circuit, owing to its high resistance, is sensitive to

Fig. 6. A more elaborate type of tapping, to provide heavy current at voltages as high as  $V_0$ .

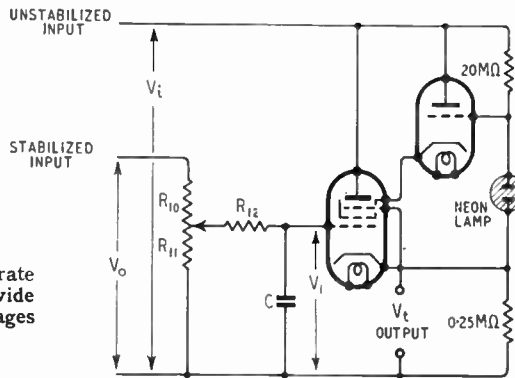

hum, and should be laid out so as to minimize pick-up. What is unavoidable can be reduced to a low level by about 1 or 2  $\mu\text{F}$  connected to negative (C in Fig. 1): This confers the additional benefit of smoothing out contact irregularities as the voltage control is operated.

The overall hum is generally least at some middle setting of this control, depending on the load resistance. That is because, as already mentioned, the hum voltage increases in proportion to  $V_t$  towards the maximum  $V_t$ ; and it also increases near minimum  $V_t$  because (with constant load resistance) the output current tends to be cut off, and with it the low cathode-follower output resistance which "holds down" hum.

In case it occurs to anyone to insert a voltage-calibrated milliammeter in series with the negative end of the voltage-control potentiometer for indicating the voltage of the main stabilized supply, it may be as well to point out that the reading is pulled down appreciably if the tapping valve runs into grid current.

The fact that the available current output falls off to zero as  $V_t$  is brought right up to  $V_0$  may be a disadvantage. To get over it, the anode voltage must be supplied from a more positive point. The pentode (and tetrode) property of anode current being almost independent of anode voltage above a fairly low figure is an attractive one in this

connection; especially such a valve as the Mazda 12E1, with rated limits at 35 W, 700 V, and 300 mA. The snag is constancy of  $V_{g2}$ . It is possible to provide it by means of an auxiliary cathode

lamp, without internal resistor, maintains about 160 V at currents of a few microamps, which are small enough not to cause serious trouble at the cathode end of the potential divider; and the resulting  $V_{g2}$  fits the 12E1 nicely.

This arrangement is rather tricky to design, however, and is subject to a number of limitations which make it not entirely suitable for general use. It is not easy to find a cathode follower valve rated to stand the anode voltage when  $V_t$  is low, nor to arrive at values of the potential-dividing resistors that are satisfactory over wide ranges of  $V_t$  and  $I_t$ . If low values of  $V_t$  are ruled out, one might as well revert to series stabilization, with its much better performance.

Nevertheless it is mentioned, because it might be quite useful in special circumstances.

follower and neon tube, as in Fig. 6. An ordinary "beehive"

## ELECTRONIC MOISTURE CONTROL

### Manual or Fully Automatic Operation

THE customary method of judging the degree of dryness of textiles during manufacture is by feel. Human judgment being far from infallible, electronics has now stepped in and apparatus is available for giving a more exact measure of the moisture content during the drying process.

The Fielden Drimeter can be used with any type of textile drying machine in which the material passes at a pre-determined speed between drying elements.

Operation of the Drimeter is based on the fact that the dielectric constant of the material passing between two flat electrodes varies with its moisture content. Thus by con-

electrodes and setting the pointer of the indicating meter to a pre-determined zero. A knob is provided on the unit for this purpose. Alternatively, a moisture calibrating unit can be employed.

When the drying machine is in operation it is then only necessary to regulate its speed so that the needle of the indicator remains steady. The Drimeter can be supplied either with the indicating meter built-in or on a separate unit including the adjusting knob.

A more recent development is the production of a companion unit which gives full automatic control of the drying process. Control is electronic and the operating voltages are derived from the Drimeter and also from a small alternator driven off the main shaft of the machine.

It functions on



Fielden Drimeter with indicator and control embodied in a single unit.

stantly monitoring the capacitance of these electrodes variations can easily be converted into changes in current and applied to a visual indicator.

The equipment is first set up by inserting a sample of material, dried to the desired degree, between the

the difference principle and produces a voltage that is applied to an electric motor which operates the speed control mechanism of the drying machine.

The equipment is made by Fielden (Electronics), Ltd., Holt Town Works, Manchester, 10.

# "Q" METERS

## Function and Application

By **H. G. M. SPRATT**,  
B.Sc., M.I.E.E.

At his desk the radio engineer is, perforce, a purist. He precisely separates, and maintains separated, his inductances, capacitances and resistances. It is the most convenient basis for his calculations and, as frequencies rise, he clings to it until defeated by an invasion of lines, waveguides and resonant cavities.

At the bench, however, such an attitude is impossible. His Cs have some L, his finest R always contains L and C as trace elements, but, most annoying of all, his L always has some R. Furthermore he cannot separate these quantities physically. Yet, in most cases, he must determine their separate values if his design is to go forward.

On the average, of all components, inductors fall farthest short in their standard of purity and so, whenever a high-quality tuned circuit is required, the primary consideration is the goodness of the coil. Now it is not an easy task, and certainly not a speedy one, to measure directly and accurately the inductive and resistive components of any arbitrary coil at any arbitrary frequency with simple radio apparatus. As a result, the Q meter has been evolved, an instrument designed for the express purpose of effecting this by what is known as Q measurement.

### Fundamental Considerations

The fundamental definition of the Q-factor of any component is the ratio

$$\frac{\text{Energy stored}}{\text{Energy dissipated}}$$

and this is applicable to all components and conditions. In ultra-high-frequency circuits, where inductance, capacitance and resistance are distributed throughout each component, it is indeed the only definition, but at lower frequencies, where lumped components are involved, it is convenient to convert this ratio to the more practical form,

$$Q = \frac{\text{reactance}}{\text{resistance}}$$

Furthermore, since, as suggested

above, the limiting factor in the majority of tuned circuits is the goodness of the coil, it is usual to ignore the Q of the capacitor and consider that of the inductor alone, namely  $\omega L/R$ . Now  $\omega L/R$  is the ratio of the voltage developed across the coil inductance in the tuned circuit to the voltage injected in series with the circuit and is what used to be termed the circuit magnification. It is essen-

uses have been found for it. It is perhaps obvious, from what has already been said, that if the Q measurement of coils is possible with it, the same should apply to capacitors. What is not so obvious is that the technique can be extended to the determination of the characteristics of transmission lines, the residuals of resistors and the dielectric constant and power factor of insulating materials and the like, the last named being an enormous field by itself.

There is a number of methods of measuring Q but one only has found favour in the majority of Q meters as manufactured and marketed today. Considering the case of a coil measurement, an oscillator injects a known voltage into a measuring circuit. This measuring circuit includes a calibrated low-loss variable capacitor, the resonant circuit being completed by the component under test. A calibrated valve voltmeter is connected across the variable capacitor and the circuit tuned to resonance; i.e., to maximum voltage reading. Then

this maximum voltage reading is a measure of the Q of the component.

This method has for a start the great advantage of speed. In the case of a coil measurement, one reading only is needed, and that reading is the Q itself. Other components may demand more than one measurement and one reading but the method is still a quick one. Accuracy is, of course, dependent upon the absolute calibration of the meter but in the rare case where extreme accuracy is essential, the instrument can be used as it stands to measure the Q by another method, a lengthier one in which the resonance curve is plotted and in which the important factors are the accuracy of the capacitor

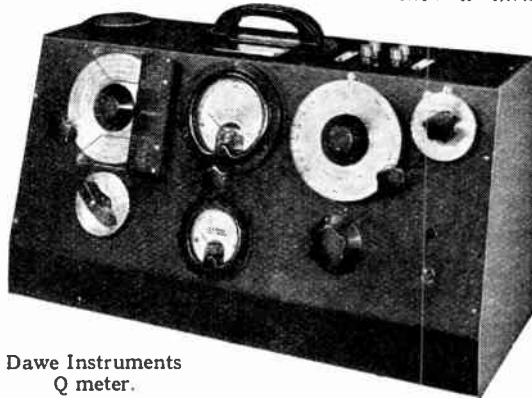

Dawe Instruments  
Q meter.

tially this circuit magnification which is measured by the Q meter, though such a term is hardly appropriate when applied outside the realm of coil measurement. Nevertheless, the fundamental nature of the measurement is such that it is applicable not only to coils and inductances, but to any electrical element which has both a reactive and a resistive component. It, therefore, applies to virtually all electrical elements.

The Q meter, intended primarily for coil measurements, naturally does not cover infinite ranges of frequency, reactance or resistance. Nevertheless, the ranges usually provided are so wide and the versatility of this instrument so great, that several other important



**"Q" Meters—**

calibration and the relative accuracy of the meter calibration.

**Main Design Details**

The modern Q meter is designed to cover a wide frequency range, generally from 50 kc/s up to at least 50 Mc/s, this coverage being, of course, effected by coil switching. In addition provision is often made for connection to an external oscillator, should operation at still lower frequencies be desired. Coupled to the oscillator coil is a second circuit consisting of a thermo-ammeter and a very small non-inductive resistor, this resistor forming part of the measuring circuit as well.

an extremely small resistance of an amount which is negligible, except where high Q values, particularly at the higher frequencies, are involved. A correction for this small resistance in the circuit can easily be made where considered justifiable, as is shown later.

The measuring circuit also includes the calibrated variable capacitor, terminals for the connection of test components in series and parallel and the valve voltmeter. The latter must cover a wide voltage range, have a low input admittance and maintain a fixed calibration over the whole frequency range. The voltmeter circuit used depends upon the

coil is carried out by connecting it across the series terminals and adjusting the oscillator frequency and voltage level to the correct values. The variable capacitor is then tuned to resonance at this frequency and the Q value read directly off the meter. This is the effective Q, which is adequate for most purposes, but whose value differs slightly from that of the real Q owing to the fact that the self-capacitance  $C_0$  of the coil has not been taken into account. There are two easy methods of determining  $C_0$  on the Q meter itself and then the true Q can be determined from the equation—true  $Q = \text{effective } Q (1 + C_0/C_1)$  where  $C_1$  is the

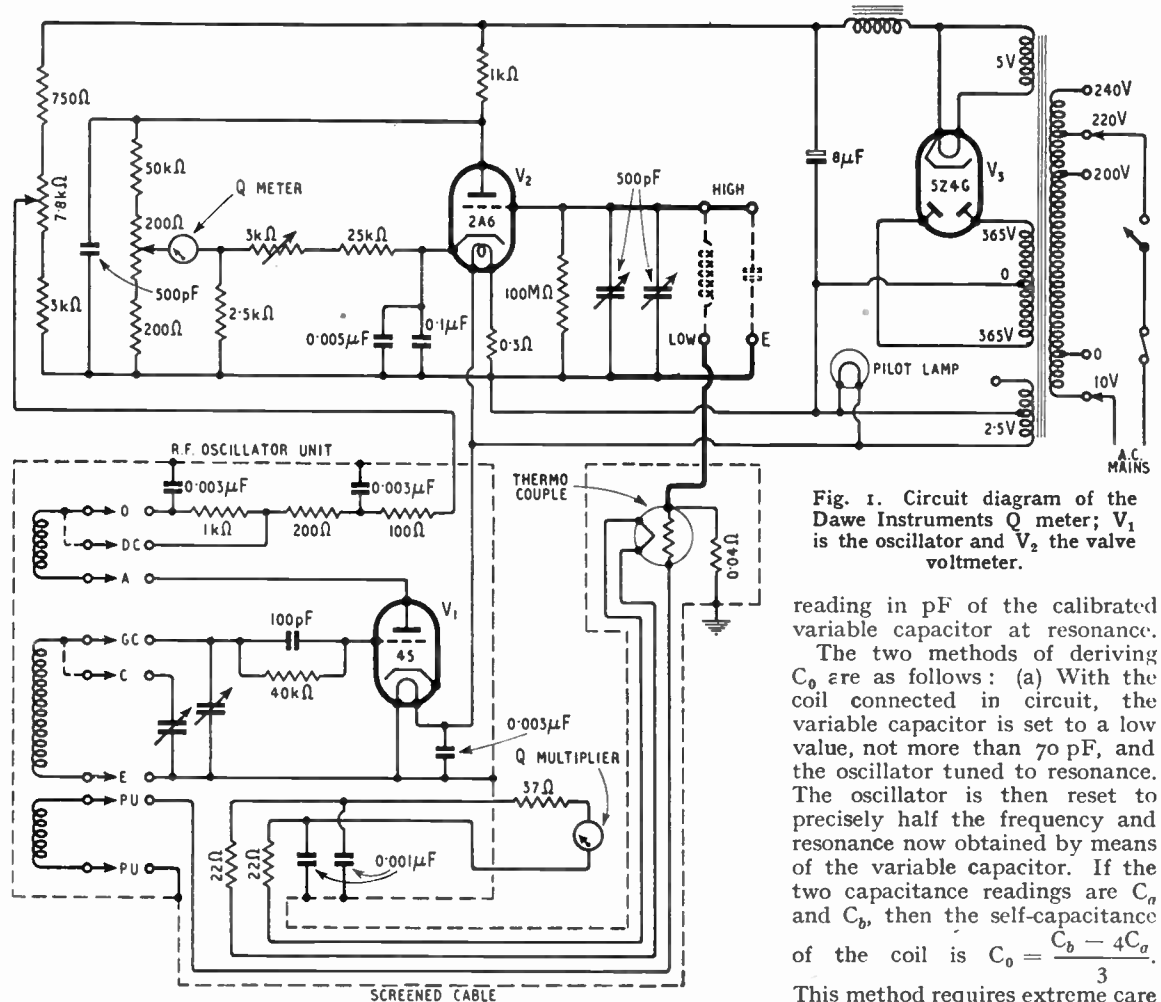

Fig. 1. Circuit diagram of the Dawe Instruments Q meter;  $V_1$  is the oscillator and  $V_2$  the valve voltmeter.

reading in pF of the calibrated variable capacitor at resonance.

The two methods of deriving  $C_0$  are as follows: (a) With the coil connected in circuit, the variable capacitor is set to a low value, not more than 70 pF, and the oscillator tuned to resonance. The oscillator is then reset to precisely half the frequency and resonance now obtained by means of the variable capacitor. If the two capacitance readings are  $C_n$  and  $C_b$ , then the self-capacitance of the coil is  $C_0 = \frac{C_b - 4C_n}{3}$ .

This method requires extreme care if accurate results are to be obtained.

In method (b) readings, with the coil connected, are taken of

(See Fig. 1). Thus the measuring circuit has injected into it a small but definite voltage across

individual preference of the manufacturer.

The measurement of a normal

resonant frequency  $f_c$  and capacitance  $C_c$  with  $C_0$  at about 400 pF. The test coil is then removed and resonance obtained with a shielded coil of 1/20-1/30 the inductance of the test coil at a frequency  $f_d$ , about 10 times  $f_c$ . When resonance has been obtained, the test coil is connected in parallel and resonance again sought. If the tuning capacitance has to be changed, the oscillator frequency must be changed, (an increase in frequency for an increase in capacitance), the test coil removed, the shielded coil re-resonated and the effect on tuning again observed when the test coil is replaced in parallel. This process is continued until no change in tuning capacitance is required when the test coil is included in the circuit. At this frequency,  $f_d$ , the test coil is self-resonating and its self-capacitance  $C_0$  is given by—

$$C_0 = \frac{C_c}{(f_d/f_c)^2 - 1}$$

which for most cases  $\approx (f_c/f_d)^2 C_c$ .

From the above data the true inductance  $L_t$  of the coil can be obtained from the formula

$$L_t = \frac{25,300}{f^2 C_1 (1 - C_0/C_1)} [\mu\text{H, pF, Mc/s}]$$

This takes account of the self-capacitance of the coil. The effective inductance  $L_e$  at the frequency  $f_1$  is given by the simpler formula

$$L_e = \frac{25,300}{f^2 C_1} [\mu\text{H, pF, Mc/s}]$$

Similarly the true series resistance of the coil  $R$  is given by

$$R_s = \frac{159,000}{f C_1 Q} \cdot \left( \frac{C_1}{C_1 - C_0} \right)^2$$

[ $\Omega$ , pF, Mc/s]

and the effective resistance  $R$  at the frequency  $f$  by

$$R_e = \frac{159,000}{f C_1 Q} [\Omega, \text{pF, Mc/s}]$$

As suggested above, in the case of high  $Q$  values at high frequencies the additional accuracy obtained by correcting for the internal resistance of the measuring circuit may be desirable. This is effected as follows: If the value of the internal resistance is  $R_i$ , (generally 0.05  $\Omega$  or less), the net coil resistance is  $R_s - R_i$ . Then the absolute  $Q_a$  of the coil is

$$Q_a = \frac{6.28 f L_t}{R_s - R_i} [\mu\text{H, } \Omega, \text{Mc/s}]$$

All these measurements can

be carried out and the values determined in a similar manner in the case of low-inductance coils by introducing a larger coil and taking measurements on it with and without the small coil in series.

### Capacitors

Measurements on small capacitors are carried out by introducing a suitable coil to complete the tuned circuit and then taking



Dawe Instruments production Q tester.

readings with and without the test capacitor connected across the internal calibrated capacitor, the setting of the latter being adjusted to resonance as required. If the readings taken are  $C_1$ ,  $C_2$  and  $Q_1$ ,  $Q_2$  then the capacitance of the test component is  $C_1 - C_2$ ;

$$\text{its } Q \text{ value} = \frac{(C_1 - C_2) Q_1 Q_2}{C_1 (Q_1 - Q_2)}$$

$$\text{and its power factor} \approx \frac{100 C_1 (Q_1 - Q_2)}{(C_1 - C_2) Q_1 Q_2}$$

Other formulae will give the values of the effective series and parallel resistances.

For the highest accuracy when dealing with small capacitors of high  $Q$ , an external standard variable capacitor can be introduced into the measurement, the internal variable capacitor being left untouched throughout the measurement.

Limitations on measurement of capacitors are set by the high order of  $Q$  value associated with the components. Whereas the  $Q$  value of coils can be expected to range from 100-500 the corresponding values for capacitors will be 1000-6000 and even higher for high-quality air components. A value of 6000 will be about the

highest that can be measured on most commercial  $Q$  meters. Most  $Q$  measurements on capacitors involve the determination of small differences between two comparatively large quantities and reasonable accuracy can only be obtained by taking careful measurements.

Another limitation is size, but capacitors above 400 pF up to about 0.1  $\mu\text{F}$  can be measured by connecting them, in series with a small coil, across the coil terminals. Measurements are then made with and without the capacitor short circuited and appropriate formulae enable the  $Q$ ,  $R$  and power factor figures to be determined.

### Resistors

Two ranges of resistance values can be measured without difficulty on the  $Q$  meter, namely, the ranges corresponding to the normal effective series and parallel resistances of coils within the  $Q$  range of the instrument. Thus resistors of about 1-30  $\Omega$  and 0.1-2.0  $\text{M}\Omega$  are dealt with by connecting them in series with a suitable coil or in parallel with the internal capacitor of the  $Q$ -meter instrument. Measurements are taken with the resistor in and out of circuit and the resistive and reactive components derived from the results. Thus, suppose we are concerned with a resistor of about 20  $\Omega$ . A suitable coil is connected to the instrument and resonance obtained at the desired frequency  $f$ , giving readings of  $C_1$  and  $Q_1$ . The resistor is then connected in series with the coil and readings again taken, giving values  $C_2$  and  $Q_2$ .

Then the effective series resistance of the resistor is

$$159,000 \frac{Q_1 C_1 / C_2 - Q_2}{f^2 C_1 Q_1 Q_2} [\text{pF, Mc/s}]$$

If  $C_2$  is less than  $C_1$  the effective reactance of the resistor is inductive, the inductance being equal to

$$25,300 \frac{C_1 - C_2}{f^2 C_1 C_2} [\text{pF, Mc/s}]$$

If  $C_2$  is greater than  $C_1$ , the reactance is capacitive, the series capacitance being  $\frac{C_1 C_2}{C_2 - C_1}$ .

The  $Q$  factor of the resistor can be determined but its value is seldom of interest.

A figure of much greater import.

**"Q" Meters—**

ance is the time constant, given by  $L/R$  or  $RC$  measured in henrys, ohms and farads, and obtainable direct from the above data. The higher range of resistance values is dealt with in a similar fashion only here measurements are made with the resistor first out of circuit and then connected in parallel with the capacitor.

The measurement of the dynamic resistance of a parallel-tuned circuit is merely a variant of the measurement of a high resistor. With a suitable coil connected to the  $Q$  meter, resonance is obtained at the desired frequency  $f$ , giving values  $C_1$  and  $Q_1$ . The tuned circuit is then connected across the capacitor terminals and itself tuned to give resonance again. If the altered value of  $Q$  is  $Q_2$ , the dynamic resistance value is:

$$\frac{0.159Q_1Q_2}{fC_1(Q_1 - Q_2)} \text{ [pF, Mc/s, M}\Omega\text{]}$$

**Insulating and Dielectric Materials**

The essential qualities of these materials are revealed by the dielectric constant and the power factor, these parameters usually being determined by arranging for the material under test to form the dielectric of a capacitor. There are standard recognized procedures recommended for effecting this and it is not proposed to discuss them in detail. One method is to use mercury electrodes, while in another a sheet of the material is thinly coated with petroleum jelly and tinfoil of appreciably less area pressed down on both sides. In the case of a liquid a suitable vessel has to be constructed. Whatever method is followed, edge effects must be avoided by a generous margin of uncovered material around the edge of the sample. Suitable leads are fitted to the electrodes and taken to the capacitor terminals of the  $Q$  meter. The sample is then measured as a capacitor at the desired frequency. If the capacitance of the sample determined in the way described above is  $C$  pF the thickness  $d$  cm, the covered area  $A$  cm<sup>2</sup>, then the dielectric constant  $\epsilon = \frac{11.3Cd}{A}$ .

The  $Q$  and, hence, the power

factor are determined by taking measurements as described above for small capacitors. Then

$$Q = \frac{(C_1 - C_2) Q_1 Q_2}{C_1(Q_1 - Q_2)}$$

and the power factor  $\approx 100/Q$ .

**Transmission Lines**

There are two methods by which transmission-line constants can be determined with the  $Q$  Meter. In the first, the frequency in c/s is fixed and a line length  $l$  metres, less than  $\lambda/8$ , is chosen. With the far end open circuited, the capacitance  $C_0$  in farads and resistance  $R_0$  in ohms are measured following the usual procedure for small capacitors. The resistance value is then transformed into the equivalent conductance  $G_0$  mhos. With the far end short-circuited, the line is now measured as a coil and its inductance  $L_s$  henrys and series resistance  $R_s$  ohms measured. Then the characteristic impedance

$$Z_0 = \sqrt{\frac{R_s + j2\pi fL_s}{G_0 + j2\pi fC_0}} \text{ [}\Omega\text{]}$$

or for low values of  $R_s$  and  $G_0$

$$Z_0 = \sqrt{L_s/C_0}$$

The attenuation  $A$  is given by

$$\frac{1}{8.69 \times 2l} \times \frac{G_0 Z_0 + R_s/Z_0}{1 + (2\pi f)^2 L_s C_0} \text{ db per metre}$$

and the velocity of propagation by

$$\frac{1}{2\pi f C l} \text{ metres/sec.}$$

The second method avoids the measurement of very small or large reactances and enables any length of line above  $\lambda/4$  to be used. With a line of length exactly  $\lambda/8$  or an odd multiple of it, the numerical value of the reactance is equal to the characteristic impedance, being positive or negative depending upon the multiple and whether the far end is open or short

circuited. The line is connected to the  $Q$  meter as a capacitor and the frequency adjusted until the capacitance on short and open circuit are equal and opposite in sign.

$$\text{Then } Z_0 = \frac{1}{\omega \sqrt{C_s C_0}} \text{ [}\Omega, \text{ c/s, F]}$$

At even multiples of  $\lambda/8$  the input impedance becomes a very high or very low pure resistance, depending again upon the multiple and whether the far end is open or short circuited.

By adjustment of the  $Q$ -meter frequency a high-resistance condition is selected and this high resistance  $R_L$  measured.

The attenuation is then given by

$$A = \frac{Z_0}{8.69 R_L l} \text{ db/metre}$$

If in one of these measurements the frequency is  $f$  and the number of  $\frac{1}{8}$  wavelengths  $n$ , then the velocity of propagation is

$$v = \frac{8lf}{n} \text{ metres/sec.}$$

**Conclusion**

The measurements which have been described are now recognized as well within the capabilities of the  $Q$  meter and are treated as standard practice. No doubt additional uses will be found from time to time. The outstanding advantages of the instrument throughout are its wide frequency ranges, direct reading features and ease and speed of operation. The last two features have led to the appearance of a modified form of  $Q$  meter, generally known as the  $Q$  Comparator. It is intended for repetitive and comparison testing and has in consequence been simplified by the removal of the thermoammeter, although the constancy of the injected voltages is still assured.

**OUR COVER**

A 27-in circular mirror and an 18-in diameter plastic correcting plate is incorporated in the television projector illustrated on the front cover. This equipment, which has been developed by Cinema-Television Ltd. for use in cinemas, operates on 405 lines with an anode voltage of 50,000. Experimental equipment has been in operation in a cinema in Bromley, Kent, for some time and it is hoped to give a description of the equipment and the proposed method of linking London cinemas in a future issue of *Wireless World*.



# For a resounding Christmas **BRIMARIZE**

TYPE 89 is a low consumption output pentode used mainly in car radio receivers. It may be replaced most conveniently by type 41, or with change of socket, by type 6K6G. Type 6V6GT may also be employed together with change of socket and bias resistor.

89

PUNCH HOLES HERE

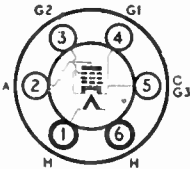

Type 41

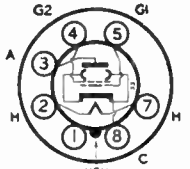

Types 6K6G, 6V6GT

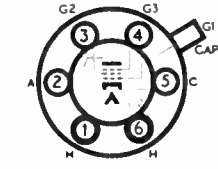

Type 89

CHARACTERISTICS			
	TYPE 89	TYPES 41, 6K6G	TYPE 6V6GT
Heater Voltage	6.3	6.3	6.3 volts
Heater Current	0.4	0.4	0.45 amp.
Anode Voltage	250	250	250 volts
Anode Current	32	32	32 mA
Grid Bias	-25	-18	-15 volts
Cathode Resistor	680	470	390 ohms
Optimum Load	7000	7500	7500 ohms
Power Output	3.4	3.4	3.3 watts

CHANGE VALVE		CHANGE SOCKET		CHANGE CONNECTIONS		OTHER WORK NECESSARY	PERFORMANCE CHANGE
FROM	TO	FROM	TO	FROM OLD SOCKET	TO NEW SOCKET		
Type 89	Type 41		U.X. 6 pin No Change	Pin 1 " 2 " 3 " 4 " 5 " 6 Top Cap	Pin 1 " 2 " 3 Disconnect Pin 5 " 6 " 4	Change bias resistor if necessary. The correct value for type 41 or 6K6G is 470 ohms 1 watt	NEGLIGIBLE
89	6K6G		U.X. 6 Pin Int. Octal.	Pin 1 " 2 " 3 " 4 " 5 " 6 Top Cap	Pin 2 " 3 " 4 Disconnect Pin 8 " 7 " 5		
89	6V6GT		U.X. 6 Pin Int. Octal.	As for Type 6K6GT		Change bias Resistor to 390 ohms 1 watt See NOTE.	HIGHER SENSITIVITY

NOTE.—In 12-volt receivers where the heater of the 89 is connected in series with one of the other valves a balancing resistor may be required in the heater circuit.

**BRIMAR** says  
BEST WISHES AND  
BETTER LISTENING

**BRIMAR**  
RADIO VALVES

STANDARD TELEPHONES AND CABLES LIMITED, FOOTSCRAY, SIDCUP, KENT.

22

INSTRUCTIONS: Punch holes where indicated and cut away this portion. Cut out and file them in the order in which they appear. This column will then give you a quick reference index.

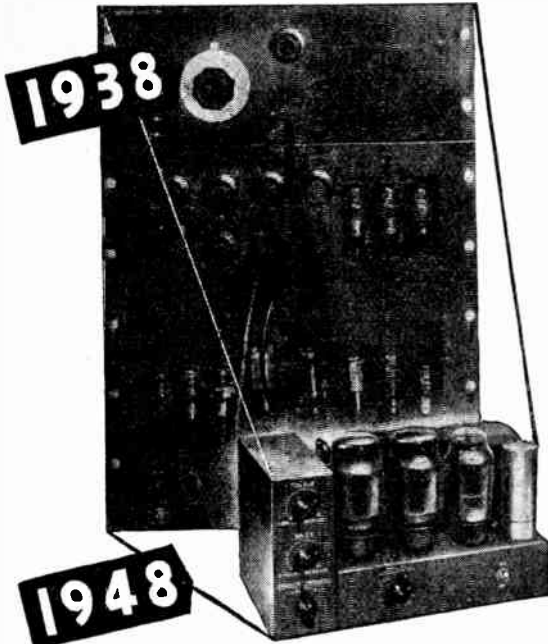

## Evidence of PROGRESS

The illustration above shows an ACOUSTICAL product of ten years ago—an amplifier designed for high quality reproduction of records and radio programmes. Using push-pull triodes throughout—RC coupled throughout—independent treble, middle and bass controls etc., it was considered about the best that could then be obtained. Indeed the circuit is often specified today for high quality reproduction.

A comparison of the performance with that of the QA12/P reveals the extent of recent developments.

	Pre-War	QA12/P	Improvement achieved
Output deviation within 20-20,000 c.p.s. range ...	3 db	0.3 db	7 times better (% power change).
Frequency range within $\pm 1$ db ...	30-15,000 c.p.s.	15-30,000 c.p.s.	Increase of two octaves.
Total distortion at 10 watts (Both models rated 10-12 watts).	2%	0.1%	20 times less distortion.
Sensitivity (r.m.s. for full output) ...	0.2 v	0.0015 v	120 times more gain with no background increase.
Background noise (equivalent r.m.s. at input) ...	120 microvolts	1 microvolt	
Background for equal (low) gain ...	-65 db	-80 db	15 db lower background.
Load impedance Internal Impedance	2	12	Better damping.
Treble and bass controls ...	variable extent of boosts and cuts	variable slope of boosts and cuts.	Wider range of control and slopes of controls more accurately designed for small room listening conditions.
PRICE ...	£60	£38	50% less cost.

A poor life this  
if full of care,  
You end with voltage  
through your hair,

No time to sing  
and dance and play,  
Because your volts  
aren't under way.

No time to step out  
just because,  
Your step-up system's  
full of flaws.

No time because  
tests have revealed,  
That your Transformers  
are not sealed.

'Gainst moisture - cold -  
vibration - dust -  
Heat - humidity and rust,  
Fumes and fungus, sudden shocks,  
Altitude and hearty knocks.

No time to seal  
hermetically,  
AS Mercury  
emphatically.

If you've no time  
to take this care,  
You'll end with voltage  
through your hair.



PARMEKO of LEICESTER

Makers of Transformers for the Electronic and Electrical Industries

**ACOUSTICAL**  
Acoustical Manufacturing Co., Ltd.,  
HUNTINGDON.      Tele.: Huntingdon 361.

# DISTORTION: DOES IT MATTER?

*Further Discussion by the I.E.E. Radio Section*

AT a meeting of the Radio Section of The Institution of Electrical Engineers on Tuesday, 9th November, 1948, P. P. Eckersley re-opened a discussion on "To What Extent Does Distortion Really Matter in the Transmission of Speech and Music?"

He began by saying that the overall impression left by the first discussion<sup>1</sup> on the subject was that none of us knew a great deal about the subject, but many found it as engrossing as ever. Two questions still remained to be answered, namely, was it worth while to try to find out more and, if so, what line of attack against obscurities would be the best?

Although the final judgment of a transducer must be subjective, surely much could be learned by objective tests. For instance, the fact revealed, as we were told, by measurement, that the loudspeaker generated harmonics, should stimulate someone to produce an instrument that did not. Then the ear would judge whether the improvement in eliminating harmonics and combination tones were substantial. Further experiments with audiences listening to live performances, the sounds of which were modified artificially, ought to tell us a great deal more about what to aim for. Precise information could thus be obtained about the preferences of the ear.

## Artificialities

This led to observations concerning a misunderstanding that was revealed during the previous discussion regarding certain suggestions made in the opener's previous remarks, namely, that in the presence of inevitable artificialities due to the circumstances of reproduction of broadcast programmes and gramophone records, other artificialities might, with advantage, be introduced. The object of these suggestions was that the impact of the

reproduction upon the senses might be the more certain to "evoke emotion" in the hearer than if an exact copy of the original were reproduced. Some speakers seemed to imagine that he proposed a wholesale cutting away of parts of the spectrum. There was, in fact, no proposal, explicit or implicit, to perform any major operation upon the spectrum, but rather, as in beautifying by plastic surgery, to reduce exaggerated features and to encourage those that were weak. By such methods, the reproduction should gain in beauty, even though the means to that end were artificial.

## Judges of Quality

Turning to detail, the dispute about the competence of musicians to judge loudspeakers was not resuscitated in the introduction, but it was raised apparently from the dead, during the discussion. It was revealed that B.B.C. engineers had discovered that certain of their musical colleagues could not form useful judgments on the qualities of loudspeakers. This was a limited discovery. Pursued a little further, it would be found that some musicians had sensibilities which transcended those of some technicians. Continued research would reveal that the co-operation of each person, according to competence rather than trade or calling, would be of greater benefit than the dismissal of one class of persons by ill-considered generalities.

This second introduction, bridging the two discussions, must once more stress the importance of providing better transmission facilities. As it was, the best of loudspeakers had no value since the conditions of radio transmission and often the background noise on gramophone records, made it impossible to use the upper parts of the audio spectrum. Thus, while there was no demand for a good loudspeaker because the lower and middle regis-

ter sufficed to give pleasure to most ears, there would, in the face of the poor transmission facility, be not much use for it even if it existed.

The contention remained that, if transmission facilities were improved, an insistent demand would be created for a better reproducer. For nearly 30 years we had used the same type of radio transmitter and for 20 years the same type of receiver had cut off more and more of the spectrum broadcast at greater and greater levels. A solution of the problem of programme distribution, be it by frequency-modulated transmission or by the use of the much simpler wire networks to link microphone and transmitter, would put us on the way to find out which distortions did and which did not matter. We might also discover, in terms of a widespread high-fidelity service, how to shape an artificial spectrum for the greater benefit of the art of sound reproduction.

## Heresy

The discussion which followed was by no means restricted to the technical and engineering aspects of transmission and reception. Valuable contributions came from representatives of the programmes department of the B.B.C., who put forward what to high-fidelity purists must have seemed paradoxical, not to say heretical views. In the broadcasting of eye-witness accounts the presence of considerable distortion, it was contended, would not only be tolerated by the listeners but would convey an atmosphere of actuality and excitement which could not be put over if the transmission had the impeccable quality of a studio broadcast. Even when distortion was so bad as to threaten intelligibility, there was still justification for re-broadcasting, for example, Mr. Churchill's speeches from the other side of the Atlantic.

In the broadcasting of symphonic music the best place for the microphone was not, according to one

<sup>1</sup> Reported in *Wireless World*, March, 1948.



**Distortion : Does It Matter?—**

speaker, just above the conductor's head, or, indeed, any position which faithfully reproduced the sound in the immediate vicinity of the instruments. The experienced concert-goer did not like his oboe "neat," but always chose, if he could, the 10th or 20th row back, where the higher-order harmonics were to some extent absorbed. Too much "top" was often associated with what musicians would dismiss as a bad hall. Often it was also a symptom of faulty tone production, which would incur the conductor's displeasure; yet engineers were always trying to preserve what the musician wished to get rid of.

**Atmosphere**

Support for this view was given by an authoritative statement that broadcasts of the Scottish Orchestra, which met with wide approval among the musically informed, were restricted to an upper frequency of little more than 6,000 c/s; but the acoustics of the studio were exceptional. This quality, which might be likened to the background scenery and lighting of a stage presentation was largely fortuitous; we could avoid the grosser errors in studio design and reduce the bad effects of existing halls by placing the microphone closer to the performers, but much remained to be learned before the creation of naturalness, perspec-

tive and "atmosphere" could be described as a known art.

One speaker thought that the comparatively simple task of reproducing the voice of a solo artiste with naturalness had not yet been solved, and suggested that the "invention" of the crooner was an engineer's subterfuge to circumvent this particular problem. Musicians often tried to persuade those responsible for "Balance and Control" to place the microphone farther away, "because it sounds better," but they did not always appreciate that an estimate of the optimum distance made by direct listening would not hold for the microphone, which was a monaural device and would make the reverberation components of the sound seem more pronounced. It was for this reason that the engineers insisted on bringing the microphone closer to the performer.

Few listeners took much trouble to improve the acoustic background of their rooms. It was true that the scope for such treatment was limited, and one speaker revived the suggestion that high-quality headphones might solve the problem when conditions proved intractable.

It was agreed that comparisons of quality, using as a reference standard the sound that one imagined would come from the mouth of the loudspeaker if it were, in fact, an aperture in the wall separating the living room from an adjacent concert hall—the "Pyramus and Thisbe" theory, as the opener put

it—could be of value in judging the performance of equipment; but the opinion of those who had had actual experience of listening to "live" performances under these somewhat unusual conditions was that the quality was far from satisfying and not much to be desired.

The aesthetics of listening covered such a wide field, and tastes were so varied that in the opinion of some speakers the B.B.C.'s function should not extend beyond the transmission of a "facsimile" of the original. It should then be left to the listener to modify this by tone and volume controls "according to his perversity." The difficulties of sustaining a wide audio-frequency spectrum on programmes of varied origin was recognized and a plea was made for adequate top cut at the source when intermodulation distortion, which would be at once revealed by modern high-grade loudspeakers, could not be avoided. One speaker thought that binaural transmission would be a more welcome development than efforts to extend the higher frequency response.

**Physiology of Hearing**

All agreed that studies of listeners' preferences should be extended, but that the results should be analysed with due caution to avoid drawing false conclusions. Much remained to be learned about the physiology of hearing and the importance or otherwise of phase distortion. The difficulty was to measure the true phase relationships of the sound at the observer's ear, and experiments which were based on observations of the input waveform to the loudspeaker were of little value, without detailed knowledge of the transient response of the diaphragm and its effect on the acoustic output. Clear thinking was necessary before making generalizations, and comparisons of aural quality involving changes in the make-up of complex waveforms from similar spectral components were invalidated if there were redistribution of energy with time. An interesting case was cited of a series of pulses of random sign and amplitude, equally spaced in time, which on analysis showed a continuous spectrum like that of random noise. The aural effect, however, bore no resemblance to the characteristic hiss of random fluctuations.



**Books Published for "Wireless World"**

	Net Price	By post
GUIDE TO BROADCASTING STATIONS, Fourth Edition ...	1/-	1/1
FOUNDATIONS OF WIRELESS. Fourth revised Edition, by M. G. Scroggie, B.Sc., M.I.E.E. ...	7/6	7/10
RADIO LABORATORY HANDBOOK. Fourth Edition, by M. G. Scroggie, B.Sc., M.I.E.E. ...	12/6	12/11
WIRELESS SERVICING MANUAL, by W. T. Cocking, M.I.E.E., Seventh Edition... ..	10/6	10/10
TELEVISION RECEIVING EQUIPMENT, by W. T. Cocking, M.I.E.E., Second Edition ... ..	12/6	12/11
RADIO DATA CHARTS, by R. T. Beatty, M.A., B.E., D.Sc., Fourth Edition—revised by J. McG.Sowerby, B.A., Grad.I.E.E. ...	7/6	7/11
HANDBOOK OF TECHNICAL INSTRUCTION FOR WIRELESS TELEGRAPHISTS, by H. M. Dowsett, M.I.E.E., F.Inst.P., and L. E. Q. Walker, A.R.C.S., Eighth Edition ...	30/-	30/8
WIRELESS DIRECTION FINDING. By R. Keen, M.B.E., B.Eng. (Hons.), Fourth Edition ... ..	45/-	45/9

Obtainable from all leading booksellers or from  
**ILIFFE & SONS LTD., Dorset House, Stamford Street, London. S.E.1.**

# AMATEUR RADIO SHOW

## New V.H.F. Equipment at the R.S.G.B. Exhibition

CONSIDERING that for the past three months amateur radio circles have buzzed with discussions on 2-metre operation, it was a foregone conclusion that V.H.F. would be the dominant note at the 1948 Amateur Show organized by the Radio Society of Great Britain. Despite the comparatively short time that has elapsed since the 145-Mc/s band was opened to amateurs all the radio manufacturers catering for this market had something of interest to show.

A complete new range of miniature variable condensers on 1½ inch square ceramic plates and with heavily silver plated metal parts was shown by Stratton. Included was an 8+8pF butterfly type with wide-spaced vanes as well as several split-stator models with staggered sections of from 15 to 40pF. The first-mentioned condenser is used in a new 145-Mc/s tuning unit consisting of an adjustable hairpin coil and coupling loop.

A well-finished four-element beam array for 2 metres, with a folded dipole radiator matching to a 72 ohm co-axial feeder, exemplified the compactness of high-gain aerial systems for these frequencies. Made of enamelled brass tubing it costs £6 5s complete.

An interesting example of ingenuity was the 3-element beam shown by G.E.C. and made entirely of standard light-alloy electric conduit and die-cast fittings. All parts screw together and only a hacksaw is needed to cut the rod elements to the required length. Tubing screwed at one end and up to 10 feet in length is readily obtainable.

Several V.H.F. transmitters exemplifying the best of modern miniaturisation technique were seen among the exhibits on the Tele-Radio stand. Although capable of quite a large power output, the sets are extraordinarily compact and serve as excellent examples of the advantages attendant on frequency modulation which is the system favoured. Narrow or broad band systems are applicable.

Among their receiving equipment was a neat converter for 2, 5 to and 11 metres using plug-in coils, miniature valves and parts, and having a built-in A.C. power supply. It costs £21.

A few new valves for the very high frequencies are now becoming

available to amateurs and several are in course of development, according to the prototypes seen on Mullard's stand. Their double R.F. power pentode is now known as the QQV07-40. It is an improved version of the American 829B, and fits the same valveholder. Some new miniatures on the B7G base were also seen, notably the EL91 pentode suitable for early stages in a transmitter, the EC91 grounded grid triode for R.F. amplification at E.H.F., and a double triode, the ECC91.

For final amplifiers in low-power V.H.F. transmitters, G.E.C. has now available an improved version of the TT15 double R.F. power tetrode. It can be used effectively to 200 Mc/s and at 300 volts on the anodes in a push-pull circuit gives 18 watts R.F. output for 90mA consumption. A feature of the valve is that the two electrode assemblies are virtually separate and can be used independently if required. An application of this kind was demonstrated in a 145-Mc/s transmitter.

Other Osram valves of interest to the amateur include the DET10 (Re34 equivalent) a new high slope R.F. receiving pentode, the Z77 on a B7G base, the B65 double triode (GSN7 equivalent), and a range of A.F. power valves for modulators.

Some transmitting valves were shown by E.M.I., while Ediswan had a comprehensive range of receiving valves, such as the Mazda 6F12 RF pentode on the B7G base. It is a close equivalent, electrically, to the SP61.

Although components dominated the Webb's Radio stand, several interesting pieces of apparatus were also shown. For example, there was a 145-Mc/s transmitter, a variable frequency oscillator of high stability and a useful radio globe divided into amateur call-sign zones. Of the components a mention might be made of some valveholders for the 829 type valve. One is a screened version with built-in bypass capacitors on all contacts except the control grids (anodes being on top of the valve) and the other is a ceramic plate

Four new Osram valves comprising the B65, TT15, W81 and Z77.

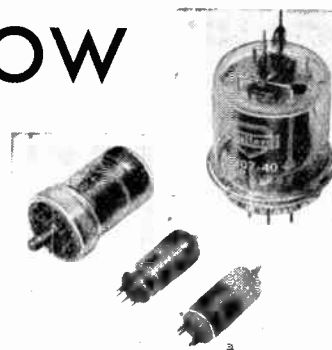

Mullard valves for V.H.F., the QV04-7, ECC91, EC91 and (at back) the QQV07-40.

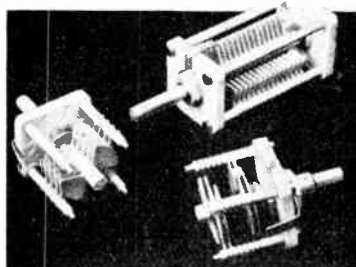

Eddystone ceramic Microdensers.



Panel handles made by Imhof.

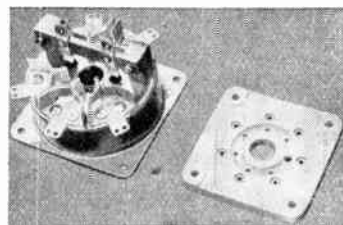

Webb's Radio screened and open style valveholders for the 829 type valve.



**Amateur Radio Show—**  
type. The former costs 17s 6d, the latter 5s 6d.

With so much new V.H.F. equip-



(Left) Tele-Radio V.H.F. converter with coils for the 2-, 5-, 6- and 11-metre bands.

(Below) Denco model DCR19 communications receiver.

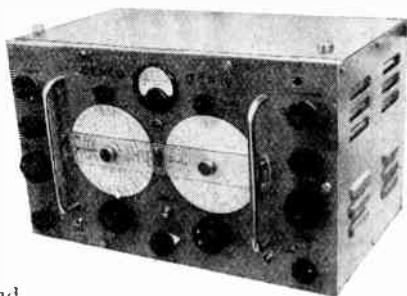

A unique feature of the Denco DCR19 communications set is the use of a rotating coil turret fitted with dust-iron-cored coils wound on polystyrene formers. It is a 12-valve set, covers 175 kc/s to 30 Mc/s in six ranges with bandspread on the five amateur bands. It includes a 500-kc/s crystal calibrator, noise

limiter, three I.F. stages at 1.6 Mc/s and a calibrated "S" meter. The price is under £50.

High selectivity combined with good second-channel rejection is obtained in the new Commander communications set made by Radiovision by using the double superhet principle. The first I.F. is 1.6 Mc/s and the second 100 kc/s; coverage is 1.7 to 31 Mc/s in five switched bands with electrical bandspread on all the amateur bands including 21 Mc/s. It employs eleven valves with voltage stabiliser for the oscillators, B.F.O. and "S" meter. The price is £48 10s.

A comprehensive selection of test equipment, multi-range meters and panel meters was shown by Sangamo Weston, Taylor Electrical and Automatic Coil Winder and Electrical Equipment, while transformers for power supplies, audio amplification and modulation were prominent on the stands of Oliver Pell Control (Varley) and Woden.

Among the wide range of fixed capacitors shown by T.C.C. were seen a number of new and improved models, a range that should interest makers of miniature equipments being the latest Metalite additions. A 0.01  $\mu$ F 200-volt capacitor in an hermetically sealed aluminium tube measures  $\frac{3}{8}$  in long and  $\frac{1}{4}$  in diameter. In this size capacitors range from 0.01 to 0.0002  $\mu$ F.

A comprehensive range of metal cabinets with and without chassis, rack assemblies and a selection of chromium-plated panel handles were shown by Imhof. A typical receiver or transmitter cabinet, such as the type 1053A measuring  $15\frac{1}{4} \times 9 \times 8$  in overall and fitted with a  $14 \times 7 \times 3$  in chassis and 4 in panel handles costs £4 5s complete. Handles range in size from 4 in to  $8\frac{3}{4}$  in in eight different styles and cost from 3s to 7s each.

ment, the more orthodox H.F. sets and parts were inclined to be overshadowed, but there was nevertheless a good selection in all classes. Components were shown by Denco, Odeon Radio, Radiocraft, Southern Radio and Electrical Supplies, Stratton, Tele-Radio and Webbs.

A range of 25-watt C.W. transmitters for all amateur bands from 28 to 1.7 Mc/s with and without self-contained A.C. power supplies was shown by Radiocraft, while Odeon Radio had a 3-tier miniature rack transmitter measuring less than a foot high complete in every detail including plate current meter and giving 10 watts output on all bands.

Some fine examples of modern communications receivers were shown at this exhibition, but only an all-too-brief mention of them can be made here. The G.E.C. model BRT400 is a 14-valve receiver with six switched bands covering 150 kc/s to 33 Mc/s and it uses the latest miniature all-glass valves. It has two RF stages, mixer and oscillator, two I.F. amplifiers at 455 kc/s and a six-position selectivity switch for bandwidths of 500 c/s to 9 kc/s.

Another set of the same general category is the new E.M.I. communications receiver covering 550 kc/s to 30.5 Mc/s in six bands, and having a double 4-gang condenser with large and small capacitance sections. The five-stage selectivity switch makes available bandwidths of 100 c/s to 5 kc/s. An interesting feature of the design is that the A.G.C. line is accessible for connection to other receivers for diversity reception or for the injection of muting pulses from the keying circuit of a transmitter. It has a noise limiter and an "S" meter.

## LIST OF EXHIBITORS

Alfred Imhof, Ltd., 112-116, New Oxford Street, London, W.C.1.  
Automatic Coil Winder and Electrical Equipment Co., Ltd., Winder House, Douglas Street, London, S.W.1.  
Denco (Clacton), Ltd., 355-359, Old Road, Clacton-on-Sea, Essex.  
Edison Swan Electric Co., Ltd., 155, Charing Cross Road, London, W.C.2.  
E.M.I. Sales and Service, Ltd., Wadsworth Road, Greenford, Middlesex.  
General Electric Co., Ltd., Magnet House, Kingsway, London, W.C.2.  
Mullard Electronic Products, Ltd., Century House, Shaftesbury Avenue, London, W.C.2.  
Odeon Radio, 56, College Road, Harrow, Middlesex.  
Oliver Pell Control, Ltd., Cambridge Row, Burrage Road, Woolwich, London, S.E.18.  
Radiocraft, Ltd., 11, Church Road, Upper Norwood, London, S.E.19.  
Radiovision (Leicester), Ltd., 58-60, Rutland Street, Leicester.

Sangamo Weston, Ltd., Great Cambridge Road, Enfield, Middlesex.  
Salford Electrical Instruments, Ltd., Peel Works, Silk Street, Salford, Lancs.  
Southern Radio and Electrical Supplies, 85, Fisherton Street, Salisbury, Wiltshire.  
Stratton and Co., Ltd., Eddystone Works, Alvechurch Road, West Heath, Birmingham, 31.  
Taylor Electrical Instruments, Ltd., 419-424, Montrose Avenue, Slough, Bucks.  
Tele-Radio (1943), Ltd., 177a, Edgware Road, London, W.2.  
Telegraph Condenser Co., Ltd., Wales Farm Road, North Acton, London, W.3.  
Webb's Radio, 14, Soho Street, Oxford Street, London, W.1.  
Woden Transformer Co., Ltd., Moxley Road, Bilston, Staffordshire.



# BOOK REVIEWS

**Ionospheric Radio Propagation.** By the staff of the National Bureau of Standards. (Circular 426). Pp. 209; figs. 205. Supt. of Documents, U.S. Govt. Printing Office, Washington 25, D.C., U.S.A. Price \$1; outside U.S.A. \$1.33.

WRITTEN by a team of eleven experts, under the direction of the heads of the Central Radio Propagation Laboratory of America, this publication should, and does, contain a great deal of useful information about the ionosphere, and about radio propagation by its means. It is, in fact, the most comprehensive work on the practical use of ionospheric data so far published.

The book is divided into nine chapters, the first of which is merely an explanation of the scope and purpose of the book. Chapter II deals with the theory of wave propagation, and, considering that the book is intended to be of some use to those with only an elementary radio knowledge, this chapter might have been more lucid had the mathematical treatment been supplemented with more complete and somewhat less disjointed prose explanations of the physical processes involved. In Chapter III the details of the measurement, not only of ionospheric, but also of other atmospheric phenomena affecting radio transmission and reception, are well described, the principles of the equipment employed, as well as the techniques themselves, being briefly dealt with. Chapter IV deals with the main features of the ionospheric structure on a world-wide basis, so far as they are known. In Chapter V are described the very involved ionospheric variations with time, including those connected with the sunspot cycle. Chapter VI is perhaps the most important in the book, containing, as it does, not only a good explanation of the basis upon which are founded the methods for finding the M.U.F.s for any path at any time, but also full details of the operational procedures employed for this purpose, some of which, it is explained, have been established by other processes than theoretical ones. Chapters VII, VIII and IX deal with all those phenomena which affect the L.U.H.F. (lowest useful high frequency) or, alternatively, the L.R.R.P. (lowest required radiated power). These things include ionospheric absorption, fading, different forms of radio noise, radiated power, differences in aerial or set performance, etc., and finally, the calculation techniques employed. The

whole subject is dealt with at considerable length, and some very useful graphs and diagrams are included.

Summing up, the book appears to be an almost indispensable publication for the ionospheric worker and for the specialist short-wave engineer, whilst it contains much that will be of use to the less specialized engineer and to the radio student. It is doubtful whether it will appeal to the amateur radio man, the techniques described being, in general, far too involved and cumbersome to suit his particular needs.

T. W. B.

**Electronic Musical Instruments.** By S. K. Lewer, B.Sc. Pp. 101, with 52 diagrams. Published from the offices of *Electronic Engineering*, 28, Essex Street, London, W.C.2. Price 3s 6d.

IN his introductory remarks the author defines an electronic musical instrument as one in which electrical oscillations are produced under the direct creative control of the performer. He excludes pipe organs with electrically operated

actions, the amplification or reproduction of recorded sound and also synthetic sound tracks, but includes electric pianos and guitars as borderline cases.

The treatment covers a wide field and the author has obviously made a diligent search of the files of the Patent Office and of the world's technical literature for any information bearing on his subject. The fruits of this search are recorded in a bibliography running to seven pages. The facts are marshalled under headings determined by the principles of operation of the various instruments, and a chapter is devoted to an explanation of the method of classification. The emphasis throughout is on principles, and would-be amateur constructors of electronic organs will not find immediate answers to all their practical problems. Diagrams are chiefly schematic and circuit values are given only in a few isolated cases.

As an historical survey and a comparative analysis of principles and methods, this monograph is strongly recommended. F. L. D.

## BOOKS RECEIVED

**Electronic Engineering.** Edited by E. Molloy. A general survey of applications of electronic methods to research and industry. Subjects covered include C.R. tubes, thyratrons light-sensitive cells, radio-frequency heating, etc. Pp. 108, with many diagrams and illustrations. George Newnes, Southampton Street, London, W.C.2. Price 5s.

**Dictionary of Photography.** 17th edition, revised by A. L. M. Sowerby, Editor of *Amateur Photographer*. A reference book for amateur and professional photographers dealing with all aspects of modern practice. Pp. 705; 67 illustrations. Fountain Press, 46, Chancery Lane, London, W.C.2. Price 15s.

**40 Abaques de Radio.**—By A. de Gouvernain. A collection of abacs for making design calculations graphically, each on a loose sheet card, with a 72-page book describing the method of use (in French). Société des Editions Radio, 9, Rue Jacob, Paris 6. Price 1,000 francs.

The following volumes in the Radiation Laboratory Series (Massachusetts Institute of Technology, U.S.A.) are written by a number of authors. They are published in this country by McGraw-Hill Publishing Company, Ltd., Aldwych House, London, W.C.2. All are fully illustrated. Prices given are those applying in U.K.

**Microwave Transmission Circuits.** Edited by George L. Ragan. A comprehensive treatise on the theory and practice of the transmission of microwave power along coaxial cables and waveguides and in their ancillary com-

ponents, such as motional joints, impedance transformers, filters and power dividers. Pp. 725. 51s.

**Loran.**—Ed. J. A. Pierce, A. A. McKenzie and R. H. Woodward. Operation and design of the long-range navigational aid, mainly devoted to equipment now in operational use. Pp. 476. 36s.

**Pulse Generators.**—Ed. G. N. Glasoe and Jean V. Lebacqz. Theoretical and practical treatment of the generation of power pulses. Pp. 741. 54s.

**Microwave Magnetrons.**—Ed. George B. Collins. Theory, design and application of multi-cavity magnetrons for 1,000-24,000 Mc/s. Pp. 806. 54s.

**Klystrons and Microwave Triodes.**—Ed. D. R. Hamilton, J. C. Knipp and J. B. H. Kuper. Low-power valves as local oscillators, signal generators and transmitters are discussed and there is a theoretical treatment of their use as mixers, amplifiers, oscillators and frequency multipliers. Theory and use of two-cavity and reflex klystrons is discussed. Pp. 533. 45s.

**Principles of Microwave Circuits.**—Ed. C. G. Montgomery, R. H. Dicke and E. M. Purcell. A fundamental treatment of guided electromagnetic waves. Pp. 486. 36s.

**Microwave Duplexers.**—Ed. L. D. Smullen and C. G. Montgomery. Methods of using a single aerial for both transmission and reception, as in radar. Pp. 437. 39s.

**Cathode Ray Tube Displays.**—Ed. T. Soller, M. A. Starr and G. E. Valley. Basic characteristics, principles of operation and methods of applications. Pp. 746. 60s.

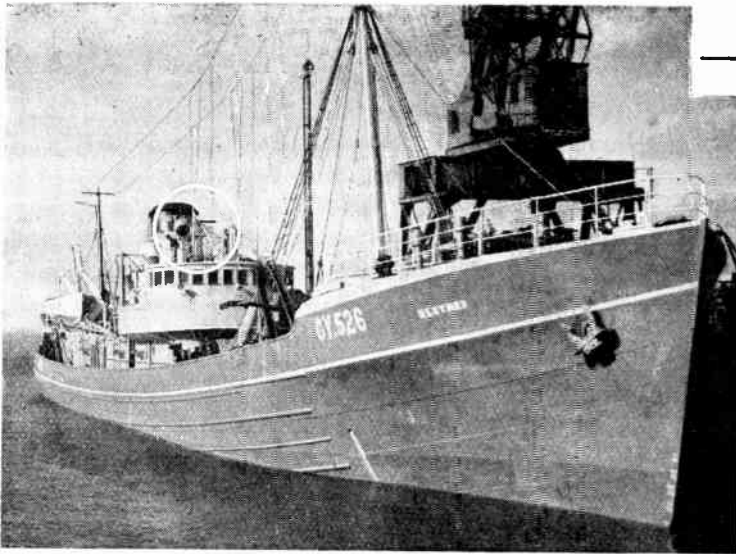

Kelvin-Hughes radar installation in a large trawler. An enlargement of the unit *in situ* is shown at the top of the opposite page.

# —COMPACT

with automatic starter and control unit.

The virtue of combining the transmitter-receiver unit with the aerial scanner is that a short fixed waveguide, fully protected from moisture and mechanical damage, is possible. The transmitter-receiver unit is housed in a steel casing provided with three large hermetically-sealed doors. A thermostatically-controlled heater prevents icing in the aerial head.

Components have been kept small by using a high-frequency (500c/s) power supply, as is common practice in aircraft radar equipment. The magnetron heater transformer and pulse transformer are contained in an

**T**HERE is a current belief that navigational radar is a luxury for the big ships of the more opulent steamship companies. This may have been true in the early days after the war when the prototypes of mercantile radar were based on some of the larger Admiralty equipments, but now that designers have had an opportunity of exercising their ingenuity, the possibility is within reach that not only small coasters, but even fishing vessels may be able to avail themselves of this paying aid to navigation.

The latest Kelvin-Hughes equipment, which incidentally was one of the first commercial radar sets to obtain the Ministry of Transport's certificate of conformity with the Marine Radar Performance Specification, 1948, is a good example of the trend towards compactness and ease of installation. It has been fitted in a large trawler and has proved invaluable in locating fishing marker buoys in thick weather as well as for general navigation.

There are three main units: (1) the aerial, consisting of a rotating "cheese" reflector mounted directly on top of an "ironclad" case containing the transmitter, receiver and power supply units; (2) the display console, measuring 4ft 3in x 23½in x 19½in, with which are incorporated supervisory controls; and (3) a motor generator

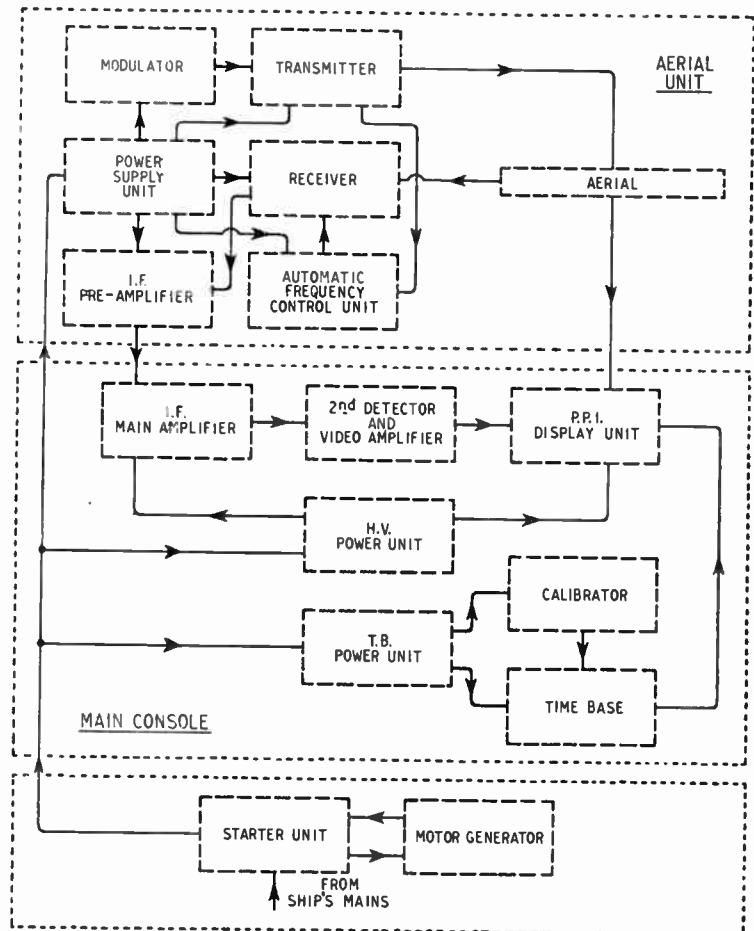

Block schematic diagram of the Kelvin-Hughes marine radar equipment.

# MARINE RADAR—

## Some Details of the Latest Kelvin-Hughes Installation

oil-filled tank immediately below the magnetron valve. Peak power is 30kW in a 0.2- $\mu$ sec pulse having a repetition frequency of 1,000 per sec. The approved frequency band is 9434-9524 Mc/s.

A common T.R. waveguide switch, with gas cells, is employed and the frequency changer of the

wheel projecting slightly below the underside of the top panel for fingertip control. This, and the substantial handholds on either side of the console indicate that the designers have had ample experience of operation in small vessels in a seaway.

There is an electronic marker, indicating ship's head, and also a centre expansion control to facilitate

(Left) Aerial unit with inspection covers open. (Below) Display console with sliding front down, showing supervisory control panel and rear view of console, showing method of withdrawing units for inspection.

the observation of bearings of nearby objects. An auxiliary gain control is available to reduce sea clutter near the origin, according to weather conditions. There is an illuminated bearing cursor which enables bearings to be taken with an accuracy of 1°.

The supervisory controls—stop-start switch, supply voltmeter, focus, brilliance, etc.—are mounted on a sloping panel in front of which is a sliding door—normally kept closed to prevent interference with the settings. All units are mounted on guides and can be readily withdrawn from the back for inspection. Fuses are readily accessible.

We have seen the equipment in operation and were impressed by the neatness and simplicity of the layout. The display was notable for the sharpness of focusing and the general clarity of the picture.

receiver comprises a CV720 klystron local oscillator and a mixer crystal. The intermediate frequency is 60Mc/s with a bandwidth of 10Mc/s; there is a pre-amplifier in the aerial unit and the main I.F. amplifier is in the display console.

The magnetic deflector coils surrounding the neck of the 9in C.R. tube are rotated mechanically by servo motors coupled to the aerial scanner drive. The speed of rotation is 30 r.p.m.

There are three range scales with maxima of 5, 9 and 27 miles, and concentric calibrator rings are provided at intervals of 1,000, 2,000 and 4,000yds, according to the range. In addition there is a continuously variable range-marker ring working in association with a calibrated dial on the top of the console. The manual control for the range marker is particularly neat and practical, and consists of a knurled edgewise

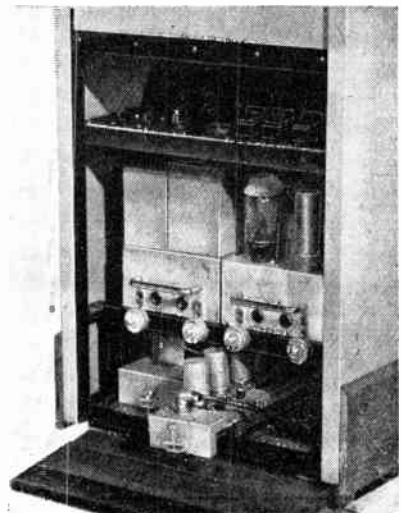
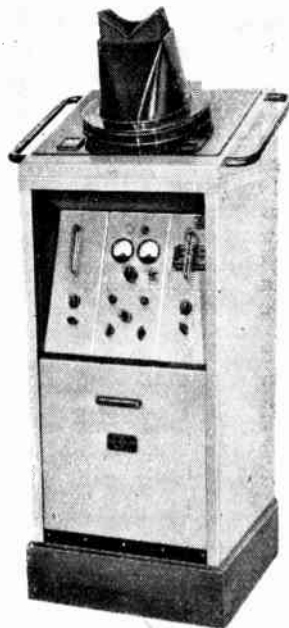
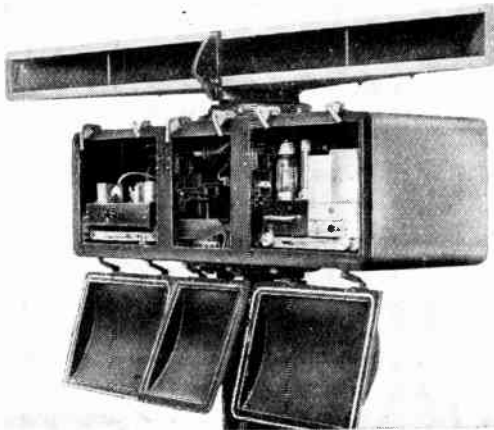
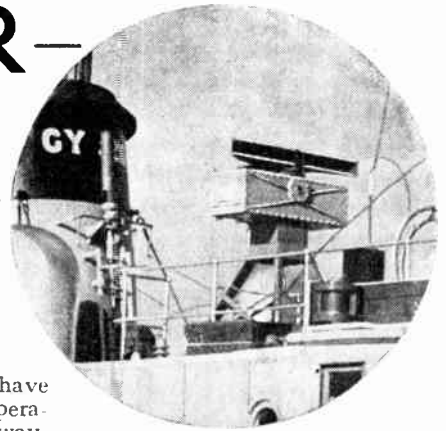



# TELEVISION DISTRIBUTION

## Details of a Communal System

By PAUL ADORIAN (Central Rediffusion Services)

(Adapted from a paper read before the International Television Convention, Zurich)

IN closely populated areas, and in particular in blocks of flats, the siting of television aerials presents many difficulties to individual householders.

It is usually possible to locate a good television aerial system at the top of a block of flats so that it gives reasonably good reception. The remaining problem, therefore, is to distribute the signal received by this aerial to the tenants in the block of flats concerned.

The same problem applies to groups of houses sharing a communal television aerial. The advantages of the latter case may not be fully appreciated but it has been established in practice that there is a considerable variation in signal to noise ratio at sites quite close to one another, depending on the relative position of the receiving aerial, transmitting aerial and sources of interference. Thus, while on one side of a road considerable interference may be caused by passing traffic, on the other side of the same road, by the use of a reflector on the receiving aerial, this interference can be reduced very considerably. It is obvious that it is a great advantage to bring up the quality of reception on both sides of the road to the same level.

Ultimately, one can visualize large groups of such local wire television distribution systems interconnected by a main distribution system.

The present paper is limited to the problem of local distribution, but reference is made to use of the wire distribution system for the simultaneous distribution of radio broadcast programmes.

**Choice of System.**—There are several methods by which television programmes can be distributed; we will consider the main systems.

Distribution at video frequencies, say 0.5 Mc/s, might at first sight seem the most advantageous owing to the simplicity of

the receiving sets. It also has the advantage that for very short distances the various H.T. and other power supplies could also be transmitted on cables as well as the audio-frequency sound programmes so that the viewer would have an extension loudspeaker for sound reproduction and a cathode-ray tube display unit for picture reproduction with little additional equipment and no direct local connection to the electric mains supply.

to be avoided. It must be remembered that at video frequencies, the attenuation along wire lines of the low and high frequencies is very different, and such attenuation will vary considerably along the line. In addition, correction must be made for phase distortion. Thus, such systems are very critical as regards variation in load, which would entail expensive engineering operations.

Distribution at an intermediate-frequency carrier on which the modulation could be superimposed has also been considered. A carrier of the order of 10 Mc/s was considered with modulation of up to  $\pm 5$  Mc/s.

This system has the advantage of simplifying the television re-

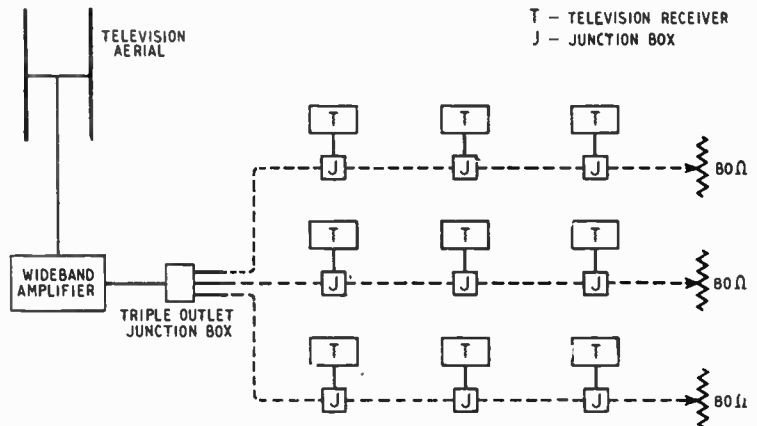

Fig. 1. Arrangement of a direct carrier distribution system.

After practical examination of this system, the conclusion was reached that the saving made in cost of receiving equipment would be counterbalanced by the cost of special cables and distribution equipment required. Further, it was thought, right from the beginning, that eventually, due to mass production, the price of television sets would come down to such a low figure that the technically simpler sets such as envisaged by this system but made in smaller quantities, could not be made at much lower prices.

A further technical difficulty that must be taken into account in this system is that at video frequencies careful correction of lines is necessary if serious distortion is

receivers by eliminating the radio frequency part of the equipment. However, it introduces more complicated sending-end equipment, and on balance could only be justified with very large systems.

**Direct Carrier Distribution.**—The third system which was considered consists of receiving, amplifying and distributing over wire lines the complete carrier and sidebands of the transmitted programmes. So far as the B.B.C. television service is concerned, this involves the transmission of a frequency band of from 41 to 49 Mc/s.

The advantages of this system are numerous. First, subscribers connected to the system can utilize any television receiver suitable

for the London transmission. Next, the distribution equipment is extremely simple and, what is considered most important, the system is not particularly critical as regards load variation and, once a television supply feeder is constructed and laid out to the plan described below, there is no further engineering involved except normal maintenance.

A disadvantage of this system may be that as a relatively high carrier frequency is used, a more expensive cable may have to be employed than for a system distributing at lower frequencies, but in practice this difference in cost is almost negligible in relation to the total cost of the installed system.

It has been found in practice that this type of distribution system can be operated with line lengths up to 500 metres.

A further advantage of this system is that as the frequencies below 40 Mc/s are not used for main television distribution, the same concentric cable can be used for providing aerial inputs to broadcast receivers and possibly, at a later date, when high television subscribed densities are obtained, a second television programme, if available, could be simultaneously transmitted on the system in accordance with the intermediate system referred to above.

**Details of the System.**—In view of the foregoing considerations this system was adopted and at the time of preparing this paper 57 systems have been installed, making television service available to 6,400 households, of which approximately 600 are subscribing to the system.

In view of the interest already shown, it is expected that this number will be considerably increased in future, and work is in hand for the installation of similar systems for several other groups. The system used as shown schematically in Fig. 1.

A conventional vertical dipole with reflector is used which is connected to a broad-band amplifier, and from this connection is made to up to three concentric cables through a matching arrangement. In the diagram the concentric distribution cables are shown in dotted lines.

It should be noted that, as explained later, the junction boxes

include a loss pad which, near the sending end, introduces a 40-db loss between line and receiver, while the matching pads farther away from the sending end introduce a loss of 20-db between line and receiver.

The wide-band amplifier has four reactance-coupled stages, and gives approximately uniform gain of 55 db from 42 to 48 Mc/s. The response falls off symmetrically at each end and the response is about 6-db down at 41.5 Mc/s and 48.5 Mc/s respectively. The output voltage is of sufficiently high level so that when followed by a three-way matching pad connected to three 80-ohm lines, an input of 0.75 volt is available to each line. All the four amplifying valves are of the same type and a valve rectifier is used in the built-in A.C. mains power unit.

A concentric semi-air-spaced polythene-insulated cable with the following dimensions and characteristics is used for distribution:—

Overall diameter: 0.685 cm.

Inner conductor diameter: 0.091 cm.

Outer conductor diameter: 0.533 cm.

Loss per metre at 45 Mc/s: 0.062 db.

Loss per metre at 1 Mc/s: 0.009 db.

Characteristic impedance of cable: 75-80 ohms.

supply under these conditions up to about 30 television receivers on each line spread over a length not longer than 480 metres.

Fig. 2 shows the performance of such a feeder, 480 metres in length with 32 television receivers connected, distributed uniformly along the feeder.

The top graph in this diagram shows the attenuation along such a feeder in a completely unloaded condition, but at the end the line is terminated with an 80-ohm resistance, which is always used. The middle graph shows the actual line voltage due to the attenuation caused by the connection of the television receivers, while the bottom graph shows the actual voltages as applied to the inputs of the television receivers along the line. It should be noted that the first 16 receivers are connected through 40-db pads, while the second 16 receivers are connected through 20-db pads. (As the receiver input impedances are about 75-80 ohms each, in the case of 40-db pads a 7,500-ohm series resistance is used, while in the case of 20-db pads a 750-ohm series resistance is used at the appropriate junction boxes.)

**Increasing the Scope.**—While the system described above is able to supply over 90 television sets on three lines, a further extension of the system has been developed

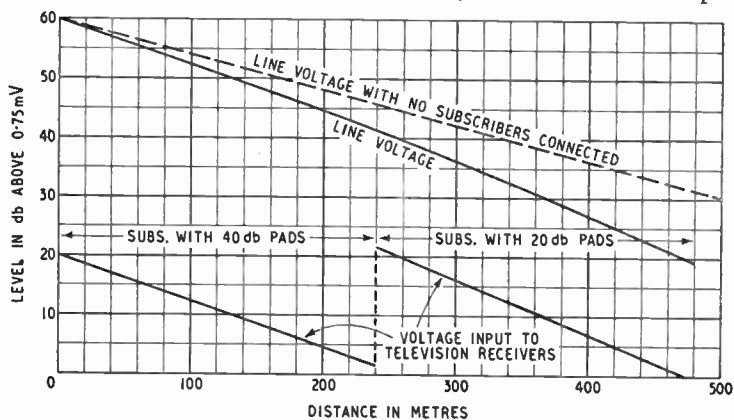

Fig. 2. Performance of the system shown in Fig. 1, giving line distribution characteristics (one subscriber per 15 metres).

The system has been so designed that the input voltage to receivers at different positions along the lines is not less than 0.75 millivolt and not more than 7.5 millivolts.

The system is designed to

by means of which it is possible to feed up to 15 lines and a total of about 450 subscribers.

In this arrangement the output of the wide-band television amplifier is connected to the inputs of up to three output units. Five

**Television Distribution—**similar cathode followers are incorporated in each output unit, and each of these one-stage "buffers" can feed one line. Thus, 15 lines can be supplied. Fig. 3 shows the general arrangement.

A further extension of the system is possible by extending the length of the feeders by the introduction of repeater amplifiers, but up to the time of writing this paper, this has not yet been necessary in practice.

**Television and Broadcast.—**The

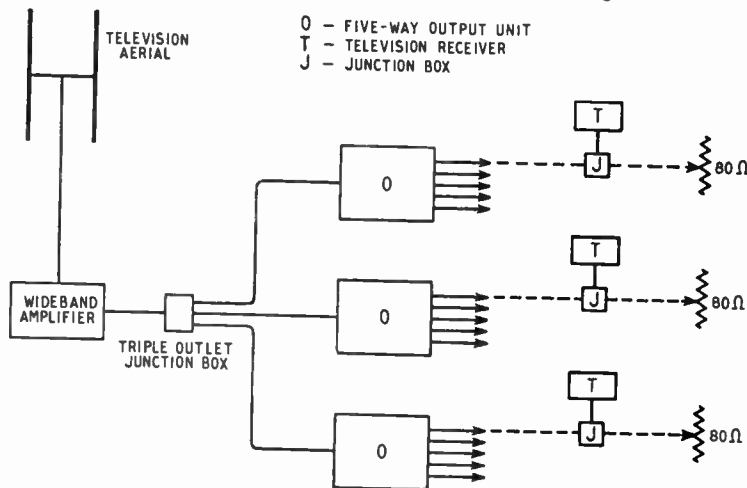

Fig. 3. Extending the system to feed more receivers.

system has been further developed for use as a combined television and broadcast aerial system, in its

present form for the distribution of medium- and long-wave broadcast inputs and the television distribution described above. The general sending-end arrangement used is shown in Fig. 4 and is self-explanatory.

It will be noted that no wide

## NEWS FROM THE CLUBS

**Basingstoke.**—Two series of lectures—one on A.C. theory and the other on television theory and practice—are being given to members of the Basingstoke and District Amateur Radio Society during this session. The lectures will be held on alternate Tuesdays at 7.45 at the British Workmen's Assembly Rooms, Potters Lane, Basingstoke. Sec.: L. S. Adams, 16, Brambllys Drive, Basingstoke, Hants.

**Chatham.**—Two thousand people visited the exhibition organized by the Medway Amateur Receiving and Transmitting Society in Rochester from November 24th to 27th. Among the manufacturers exhibiting were:—Mullard, Decca, Denco, S.T.C., Philco and Automatic Coil Winder Co. On the Admiralty stand was included W.T. equipment, radar gear, and the Decca Navigator. Meetings of the society are held on Mondays at 7.30 at the Co-operative Employers' Welfare Club, 207, Luton Road, Chatham. Sec.: H. Howell, G5FN, 39, Broadway, Gillingham, Kent.

**Derby.**—The annual general meeting of the Derby and District Amateur Radio Society will be held on January 5th at 7.30 in the Club Room, 67B, London Road, Derby. The society, which now has its own transmitter licensed under the call G3ERD, meets on alternate Wednesdays. Sec.: F. C. Ward, G2CVV, 5, Uplands Avenue, Littleover, Derby.

**Edinburgh.**—The general monthly meeting of the Lothians Radio Society will be held in the Chamber of Commerce Rooms, 25, Charlotte Square, Edinburgh, on January 27th at 7.30. Meetings are held on the last Thursday in each month. Sec.: I. Mackenzie, 47, Easter Drylaw Drive, Edinburgh, 4.

**Nottingham.**—New premises have been secured by the Nottingham Short-Wave Club, and weekly meetings are now held on Mondays at 7.15 at the

band amplifier is shown in conjunction with the broadcast aerial as this is not necessary at sites

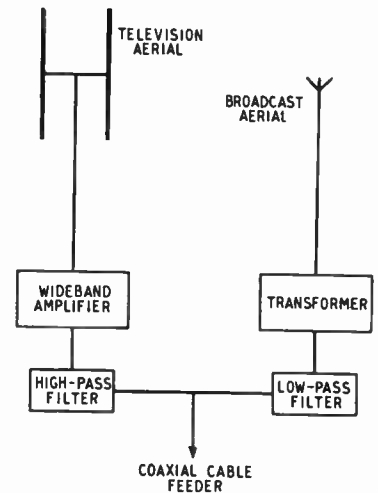

Fig. 4. Communal distribution system for both television and sound broadcasting.

where strong broadcast signals are available, but such an amplifier could be included between the aerial and the low-pass filter if necessary.

**Acknowledgment.**—The author wishes to thank H. J. Barton Chapple and R. I. Kinross, of London Rediffusion Service, who have been mainly responsible for this development and who have assisted in the preparation of this paper.

**Old Boys' Club,** Middle Street, Beeston, Notts. The club's transmitter, G3EKW, was officially opened on December 6th by F. R. Sharp, Radio Editor of the *Nottingham Evening Post*. It is situated at Chilwell and at present radiates on 1.7Mc/s. Sec.: N. W. Adcock, "Bryn-gates," Harlaxton Drive, Long Eaton, Notts.

**Oldham.**—Meetings of the Oldham Radio Society are held on alternate Wednesdays at 7.30 at the Civic Centre, Clegg Street, Oldham. The next meeting is on Dec. 29th. Sec.: E. Hulme, G3BQT, 20, Parkway, Chadderton, Lancs.

**Romford.**—The late secretary of the Romford and District Amateur Radio Society, R. C. E. Beardow, has emigrated to Canada and has taken with him his 10-metre transmitter (G3FT). The new secretary of the club, which meets on Tuesdays at 8.0 at the Y.M.C.A., Western Road, Romford, is D. Coppendale, G3BNI, 9, Morden Road, Chadwell Heath, Essex.



# VERSATILE POWER SUPPLY

## Wide Range Voltage Control with Simplified Switching

By K. F. BUTCHER

**I**N experimental work there often arises the need of a power supply giving a wide range of voltages at various currents and which is easily and quickly set to any desired value. The unit described here covers most requirements of light current work and has proved well worth the time expended in its construction.

It will be seen from the circuit diagram that the main supply is in three steps of 150 volts with four half-wave selenium rectifiers giving 120 mA maximum. This is not the most efficient arrangement, but it keeps the switching simple. There is a fourth 150-volt winding feeding a potentiometer comprising  $R_1$  and  $R_2$  which is connected in series with the other windings. This is a more convenient method of regulating the voltage than the usual series resistance, or potentiometer across the output. Also the potentiometer current is supplied by the transformer and not by the rectifiers. This is rather wasteful at the lower voltages but the convenience is well worth it. Two potentiometers were used in series as there did not appear to be a single one listed of the correct value and wattage in a reasonable physical size. This necessitated  $S_3$  to switch the sliders for each half as required. In use this was found to be an advantage rather than otherwise, inasmuch that the scale is approximately 600 degrees for 150 volts variation, which is 4 degrees movement per volt, and it was found quite easy to adjust the value to within 0.25 volt. This gives a smoothness of control which is a pleasure to use.

A 32- $\mu$ F reservoir capacitor was specified by the makers for the rectifiers, and it was considered desirable to allow for a working voltage of 1,000. These are not listed in electrolytic types

so a series-parallel combination of four standard T.C.C. 500-volt working capacitors is used. It was not necessary in this case to put equalizing resistances across the series circuit, but it is advisable to check the voltage distribution and fit them if it is unequal, otherwise at the higher voltages one half may well exceed the permissible rating, as on light load the maximum voltage will be at full peak value, about 840 volts.

There are two other rectified outputs, a screen supply of 100 or 200 volts nominal, and a bias supply of 25 or 50 volts. The

ably constant for a given voltage, and usually amount to only a few milliamps, resistance smoothing has been used, but a choke and capacitor can be added externally with the series resistance if needed. The current output of 30 mA allows for the drain of a high-resistance potentiometer if a variable voltage is required.

The bias supply has a bridge-type rectifier and double resistance smoothing, the reservoir and first

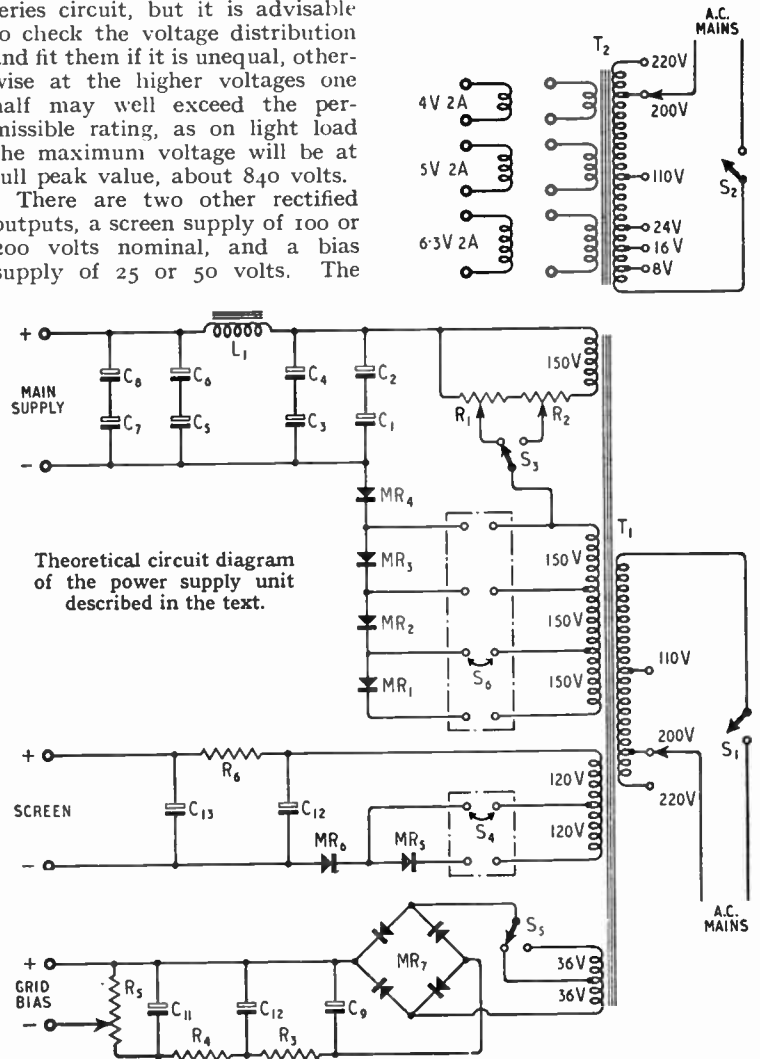

Theoretical circuit diagram of the power supply unit described in the text.

screen supply will give 200 volts at 30 mA, or proportionately higher at a lower current. As most screen currents are reason-

ably constant for a given voltage, smoothing capacitors being 8 $\mu$ F, but the final one is 32 $\mu$ F. The output is across a 20,000-ohm potentiometer  $R_6$ , and the current

**Versatile Power Supply—**

is limited to 1 mA. This will allow for any reasonable grid current encountered and has been found adequate. It was felt that at low voltages a wider scale would be advantageous so the input to the rectifier is in two halves which doubles the scale of the potentiometer.

It is apparent that with the addition of a filament supply we have a complete unit that will supply a single valve hook-up, amplifier or radio chassis. Also it is possible to take a complete family of curves of most valves in general use. Consequently a heater transformer is incorporated having double windings of 4, 5, and 6.3 volts at 2 A each and with appropriate terminals brought out to the panel. Three eight-volt tappings on the primary enables the correct voltage to be obtained when using one valve or several.

When taking valve curves it is advisable to put a bleeder resistance across the main output when on low currents as there is a visible delay of the potentiometer setting due to the charge on the capacitors.

In conclusion, any stampings available will do for the two transformers, in this case 144 pairs of I.S.C.O. 435A (Stalloy 35A) were used for  $T_1$ , which worked

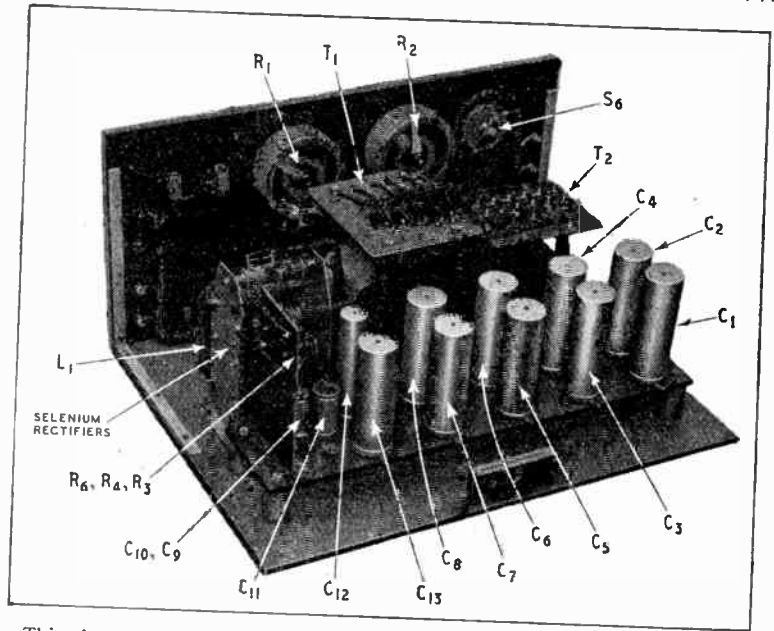

This photograph shows the form of construction adopted and the position of the main components.

150 volts at 0.3 A, one of 150 volts at 0.6 A, two of 120 volts at 0.07 A, and one of  $36 \div 36$  volts at 0.01 A.  $T_2$  requires six 2-A windings for the three heater voltages.

## MANUFACTURERS' LITERATURE

Descriptive leaflet of screws and small parts made by the Anglo-Swiss Screw Co., Trout Road, West Drayton, Middlesex.

Leaflet giving details of the Type NMS industrial noise measuring instrument made by A. E. Cawkell, 7, Victory Arcade, The Broadway, Southall, Middlesex.

List No. 5 of disposals radio and electronic equipment from Clydesdale Supply Co., 2, Bridge Street, Glasgow, C.5.

Leaflets describing Type 1210A frequency meter and photoelectric pick-up unit, and Type 1250A dynamic balancing machine, from Dawe Instruments, 130, Uxbridge Road, Hanwell, London, W.7.

Folder giving ratings and operating data on the Mazda B8A range of valves, from the Edison Swan Electric Co., 155, Charing Cross Road, London, W.C.2.

Leaflets dealing with Type XE and Type H15 (heavy duty) relays, from Electro Methods, 112, Brent Street, London, N.W.4.

Data sheets of sound reproducing equipment made by Granpian Reproducers, The Hanworth Trading Estate, Feltham, Middlesex.

Illustrated leaflet describing electronic audio-frequency mixer units made by Hifi, Ltd., Lye, Worcs.

Catalogue C262 of replacement capacitors made by A. H. Hunt, Bendon Valley, Garratt Lane, London, S.W.18. Available to members of the distributive and service trades.

Leaflet describing the Pennine Ranger Model E54/2 superheterodyne receiver made by Pennine Amplifiers, Southgate, Eiland, Yorks.

Illustrated folder giving details of television receivers, from Ultra Electric, 62, Buckingham Gate, London, S.W.1.

An illustrated booklet issued to the trade by Whiteley Electrical Radio, Mansfield, Notts, gives details of the "Long Arm" system of remote control, production of which has now been resumed.

## CRYSTAL CALIBRATION SERVICE

Measurements of the resonant frequency of quartz crystals of all types with an accuracy of at least 5 parts in a million are undertaken by Salford Electrical Instruments, Q.C. Department, Birch Mill, Birch in Hopwood, Heywood, Lanes. A fee of 5s (which includes return registered postage) should accompany each crystal, which should be sent by registered post and marked "Frequency Calibration Service." The full name and postal address to which the units are to be returned should, of course, be included.

## COMPONENT VALUES

$C_1-C_3, C_{13}$	$32\mu F$ 500 V electrolytic
$C_9, C_{10}$	$8\mu F$ 100 V "
$C_{11}$	$32\mu F$ 100 V "
$C_{12}$	$16\mu F$ 500 V "
$R_1, R_2$	$225\Omega$ , 0.66 A toroidal-wound potentiometer (Berco Type 100)
$R_3, R_4, R_6$	$1k\Omega$ , 2-watt (carbon)
$R_5$	$20k\Omega$ , 2-watt wire-wound potentiometer
$S_1, S_2$	S.P.S.T. switch
$S_3, S_4, S_5$	S.P.D.T.
$MR_1-MR_4$	Half-wave selenium rectifier (S.T.C. Type H35-14-IL)
$MR_6, MR_8$	Half-wave selenium rectifier (S.T.C. Type H18-12-IL)
$MR_7$	Half-wave selenium rectifier (S.T.C. Type B18-4-IL)

out at 1.85 turns per volt, and 80 pairs of I.S.C.O. 460A (Stalloy 33A) for  $T_2$  at 4 turns per volt.  $T_1$  requires three windings of

# ELECTRONIC CIRCUITRY

## Selections from a Designer's Notebook

By J. McG. SOWERBY (Cinema Television Ltd.)

**T**HERE are now several interval timers available commercially, intended for measuring times from one millisecond to one second or so. Most of these operate much as shown in Fig. 1. A constant current circuit (e.g., a pentode) is adjusted to pass a current  $i$ ; this current passes through the switch S which is closed for the duration of the time interval to be measured and charges the condenser C. The potential difference, E, appearing across C is measured by a valve voltmeter V. The equation for E is

$E = it$  where  $t$  is the time for which S is closed.

### Interval Timers

If now a resistance R is placed in parallel with C, and S closed, the p.d. across it will be

$E_0 = iR$  . . . . . (1)  
We may now adjust  $i$  until  $E_0$  produces full scale reading on the valve voltmeter. In the absence

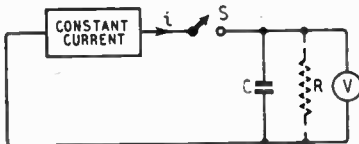

Fig. 1. Schematic circuit of interval timer.

of R, full scale will be produced by S remaining closed for a time given by

$$t_0 = \frac{E_0 C}{i} \dots \dots \dots (2)$$

Now substituting the value for  $i$  from (1) in (2) we obtain

$$t_0 = RC$$

Thus the instrument is calibrated in terms of R and C exclusively, and provided good drift-free components are chosen for R and C the calibration should remain unchanged over long periods of time. Various ranges may be obtained by varying  $i$ , C or  $E_0$  in known steps, yielding full scale readings of about 1 millisecond to 1 second.

For much longer times with C becomes uneconomically large, or  $i$  becomes awkwardly small. Much shorter times can be measured by means of more complicated circuits but these will not be considered here.

A typical circuit used for this work is shown in Fig. 2.

Suppose  $S_1$  to be open and that  $E_1$  is sufficient to make  $V_1$  conducting. The resistances are chosen so that  $V_1$  and  $V_2$  form a trigger circuit, and  $V_2$  is consequently cut off. If  $S_2$  is now

Fig. 2. Combined trigger and charging circuit.

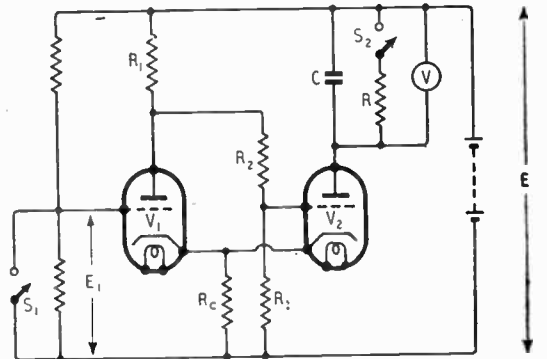

closed temporarily any remanent charge on C is removed, and the valve voltmeter V indicates zero.  $S_1$  is now closed for the duration of the interval to be measured,  $V_1$  cuts off and  $V_2$  conducts, behaving much as a cathode follower passing a current of

$$i = \frac{ER_3}{(R_1 + R_2 + R_3) R_c} \text{ (approximately).}$$

This current flows into the condenser until  $S_1$  is opened and the trigger reverts to its rest state of  $V_1$  conducting and  $V_2$  cut-off. The voltmeter is calibrated in terms of time with the aid of R as described above. The current may be adjusted by variation of  $R_c$ .

The input circuits are not, of course, limited as that shown in Fig. 2, and may be arranged in a variety of ways so that measurements of the time between two pulses, the duration of a pulse or light flash, etc., may be made.

The main design difficulty of this type of device is the elimination of drift, due to charge accumulating on C, both before and after a measurement is made. This drift

appears as a slow change of voltmeter reading. Taking Fig. 2 as a sample of the numerous circuits available, drift can arise from one or more of the following causes:—

- (1) Leakage in C. (2) Leakage in  $V_1$ . (3) Leakage across the valve holder of  $V_2$ . (4) Leakage across the insulators of the electrode assembly of  $V_2$ . (5) Failure of  $V_2$  to cut off completely. (6) Emission of photo-electrons by the anode of

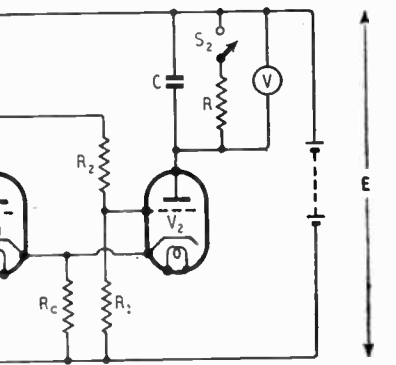

$V_2$  (7) Leakage across  $S_2$ . This seems a formidable array of difficulties, but all can be overcome with care, and drifts in good commercial instruments seldom exceed 5 per cent of full scale on the indicating meter per minute.

**T**HE phase shifting device of Fig. 3 is well known; it is described for instance in Puckle's "Time Bases" (p. 190). Readers of that useful work will remember that if the reactance of the condenser is made about one tenth of the maximum value of R a very useful phase shift from about 20° to about 160° can be

### Transformerless Phase Shifter

about 20° to about 160° can be

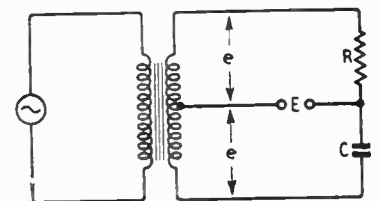

Fig. 3. A well-known phase-shifter circuit.



**Electronic Circuitry—**

obtained, and that if no load is imposed on the output terminals, the output voltage  $E = ze$ .

When it is desired to phase shift a wide band of frequencies (for which a number of condensers of varying capacities will be needed, chosen in rotation by a switch) the design of the transformer presents difficulties. It is not always realised that an excellent alternative\* is the circuit shown in Fig. 4. Here

Fig. 4. Transformerless phase shifter. Typical values:  $V = EC91$ ;  $R_L = R_C = 2.2 \text{ k}\Omega$ ;  $R_b = 100 \Omega$ ; H.T. supply 250 V, 10 mA. At input frequency about 100 kc/s,  $C = 50 \text{ pF}$ .  $R = 50 \text{ k}\Omega$  (carbon),  $r = 8.2 \text{ k}\Omega$ .

quite normal and straightforward and familiar to readers. Two signal voltages  $e$  are obtained, and their "centre-tap" is virtually

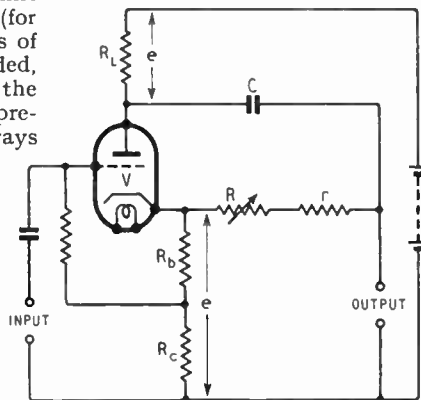

network is applied between anode and cathode as shown. The overall gain is about 1.8 for usual designs. Care must be taken to make the impedance of the R.C. circuit large compared with  $R_L$ , and so an additional resistance  $r$  is used to prevent the resistive arm being reduced to zero resistance.

This circuit finds many uses, one of which is in the generation of circular and elliptical time bases for cathode ray oscillography.

The writer has used this circuit at 1 Mc/s quite successfully to obtain a  $45^\circ$  shift, employing a miniature high-slope triode and low values of  $R_L$  and  $R_C$ ; but this is probably near the limit, because as the frequency increases the loading on  $R_L$  increases and the available range of phase shift is reduced.

the valve is arranged as a "concertina" phase splitter and  $R_L = (R_C + R_b)$ . The design is

the earth line. Consequently the valve replaces the transformer of Fig. 3, and the R.C. phase shifting

\* Dome, R. B., *Electronics*, Dec. 1947, p. 111.

## NEW DOMESTIC RECEIVERS

A CONSOLE version of the A52 bandspread receiver for A.C. mains reviewed in our issue of March, 1948, has been produced by E. K. Cole, Southend-on-Sea. It is known as the C87 and costs £40 19s, including tax. A special export version of the Ekco "Consort" A.C./D.C. transportable has also been introduced. With the type number U83, this model has

waverrange covers 200-550 metres. The walnut veneered cabinet measures  $8\frac{1}{2} \text{ in} \times 7\frac{1}{2} \text{ in} \times 4\frac{1}{2} \text{ in}$  and houses a frame aerial in addition to the 5in moving coil loudspeaker.

Two new table models for A.C. mains have been announced by Pye, Ltd., Radio Works, Cambridge. The Model 19A is a superhet. (3 valves plus rectifier) with the following waverranges: 16m, 31m and 49m (bandspread), 200-550m and 1,000-2,000m. In the Model 19D (4 valves plus rectifier) there are additional bandspread ranges centred on 13m, 19m and 25m and a wider range from 38 to 110m. The Model 19A has a 6 $\frac{1}{2}$ in loudspeaker, a five-position tone control and costs £21 13s 4d, while the 19D with eight-position tone control and 8in loudspeaker costs £26 15s 4d, including tax.

The circuit of the new Ultra table Model T457 for A.C. mains comprises a frequency changer, I.F. amplifier, detector and phase-splitter, and push-pull output valves, delivering 6 watts to an elliptical loudspeaker. The six waverranges cover 10.7-18m, 18.7-20m, 24.2-26.3m, 30-51.8m, 200-550m and 1,000-2,000m with bandspredding on the ranges centred on 19 and 25m. The

price is £37 14s 4d and the makers are Ultra Electric, Western Avenue, London, W.3.

In the Invicta Model T102 television set the T.R.F. vision receiver is fitted with an interference limiter, and the time base circuit has a positive interlace filter with grid blocking line and frame scan oscillators. The picture size is  $7\frac{3}{4} \text{ in} \times 6 \text{ in}$  and the price is £55 5s 9d, including tax. A console version (Model T103) is available at £66 17s 3d; the makers are Invicta Radio, Parkhurst Road, London, N.7.

Brief details have also been received of a new television receiver (Model MTS389) made by Mullard Electronic Products, Century House, Shaftesbury Avenue, London, W.C.2. It is housed in a table model cabinet  $25\frac{1}{2} \text{ in} \times 17 \text{ in} \times 13 \text{ in}$  and employs a 9in tube with black and white screen. The price is £61 14s 5d, including tax.

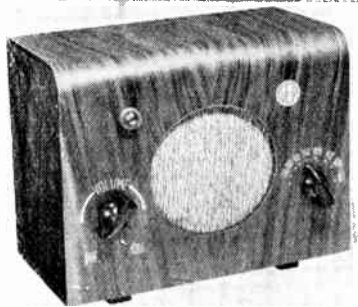

General Electrical Radio "Mighty Midget" A.C./D.C. receiver.

three waverranges covering 1,500-560 kc/s, 8-3 Mc/s, and 22-7.5 Mc/s.

The "Mighty Midget" A.C./D.C. receiver made by General Electric Radio, 92, Charlotte Street, London, W.1, sells for the unusually low price of £6 19s 6d, including tax. It is a straight set with 12K7 R.F. amplifier, 12J7 detector, 35L6 output valve, 35Z4 rectifier (or metal rectifier) and 1669 barretter regulator. The single

An elliptical loudspeaker is fed from a 6-watt push-pull output in the Ultra Model T457 receiver.



# THE "BELLING LEE" PAGE

Providing technical information, service and advice in relation to our products and the suppression of electrical interference

## The Wireless Telegraphy Bill

By the time this is published, it is expected that the Bill will have passed the committee stage and many "Wireless World" readers will have been asked what it is all about. There really has been a lot of fuss over very little. Anyone who has a wireless licence has already given permission for the representatives of the Post Master General to enter at reasonable times. There is a similar clause in the contract regarding the supply of gas and electricity.

Among the most prevalent causes of electrical interference are thermostats in electric bed-warmers (pads, blankets and imitation hot water bottles).

## Advice to the Culprit

Many domestic appliances can be very efficiently dealt with by fitting flex lead suppressors\*1 preferably close to the appliance. Every few inches of lead count. These suppressors will prove adequate, except in particularly fierce cases of earthed (3 core flex) portable appliances used in blocks of flats where neighbours, with radio sets in close proximity, might still hear some residual interference unless they have taken special precautions with their aerials. More thorough suppression requires the filter component fitted inside the appliance. If in doubt, go to your local radio dealer or write to "Belling-Lee."



Flex lead suppressor L.301 (3 core)

## Advice to the Sufferer

If a person is being troubled by outside interference, the first question should be: "What do you do about an aerial?" There must be tens of thousands who do nothing about it, or at best dangle a bit of wire about the room. Some kind of outside aerial is necessary before a listener can expect sympathetic help from official channels. The simplest remedy is a "Winrod" window mounting aerial\*2 This is not an anti-interference aerial, but in most cases will greatly improve reception.

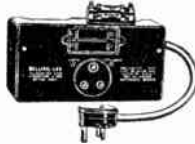

L.300/3 Set lead suppressor

In circumstances where interference is very severe, or where exceptional quality is the aim of the listener, it will be necessary to erect a "Skyrod" vertical aerial\*3 with "Eliminoise" transformers and a screened down lead. In cases where interference is reaching the receiver via the mains, i.e. mains borne, a set lead mains filter\*4 will be necessary. This is fitted at the power plug supplying the receiver. It is a simple "plug-in" device.

## Car Interference with Television



L.630

Most of the cars on the roads just now can be dealt with by unscrewing the central lead from the distributor, and in its place screwing a two shilling resistor,\*5 into which the original lead will go. This is all that need be done unless car radio is fitted in which case the car should already be suppressed for optimum results.

## Alexandra Palace Television in Cape Town

There have been an increasing number of cases reported, of very long distance reception of television. Sunspots are said to be responsible. The writer well remembers sitting up with an amateur in the very early 'twenties and hearing the first reported reception in the country, of American amateur transmissions. This soon became commonplace. It is appreciated that the two cases may not be comparable and "Belling-Lee" do not advocate the sale of television equipment outside the normal range of Alexandra Palace, except experimentally, but it is of interest to readers of this page that at least one viewer in Capetown reports that he was unable to resolve the picture until he had erected a "Belling-Lee" dipole and reflector.\*6 Please note that no elaborate array was used.

## A New Indoor Television Aerial

The "Doorod"\*7 is a fully dimensioned half-wave dipole with one

rigid and one flexible element for use within six or seven miles of Alexandra Palace and where interference is not severe. It is so named as it is thought that the most likely place for its fixing will be by the side of the door frame.

The "Doorod" must not be confused with miniature or compressed dipoles. All indoor aerials have their limitations and the best position must be found by trial and error. They should not be placed too near the receiver. The great thing to avoid is the effect of people walking about near the aerial. Don't forget that in a semi-detached house or in flats, there may be fluctuations in picture strength caused by the unconscious movements of neighbours on the other side of the party wall. Any indoor dipole will also be affected by the presence of standard lamps or metal pipes, girders, etc., even though they are behind plaster, bricks and mortar.

If an outside dipole is impossible, an inverted "V" in the loft will always give better results than any television aerial in the same room as the set.

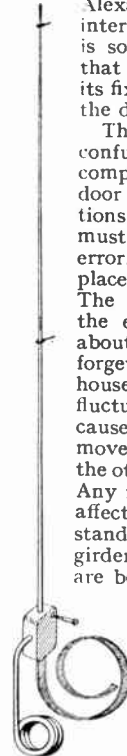

\*1 Flex lead suppressors. L.301 (3 core), 15/6. L.1174 (2 core), 9/6.

\*2 "Winrod" window mounting aerial. L.581, 19/6 each, sold in cartons containing 6.

\*3 "Skyrod" anti-interference aerial. L.638/K, chimney mounting. £10.

\*4 Set lead filter. L.300/3, 59/6.

\*5 L.630, distributor suppressor, 2/-.

\*6 "Viewrod" television aerial. L.502/C, for mast mounting, 88/-.

\*7 "Doorod" indoor television aerial. L.645, 30/-. (Registration and patent applied for.)

The words "Winrod," "Skyrod" and "Viewrod" are Registered Trade names.



ENGLAND



... but there is a difference in **VITAVOX** sound equipment

The K12/10 and K12/20 Moving Coil Loudspeakers, designed especially as good quality single unit reproducers, can be relied upon, as can all VITAVOX products, to give an outstanding performance under exacting conditions.



Retail Price :  
 K12/10 £7 0 0  
 K12/20 £11 0 0

VITAVOX LTD., WESTMORLAND ROAD, LONDON, N.W.9. Tele : COLindale 8671.

# SOMERFORD

## TRANSFORMERS & CHOKES

This COMPLETE range will meet ALL your normal needs . . .

The requirements of the Electronic Industries are many and varied. It is to meet such demands that the "Sommerford" range of Transformers and Chokes exist. No matter whether you are engaged in radio, the manufacture of industrial or domestic appliances, or laboratory work, if you are looking for components that will give you accuracy and dependability at an economical cost, you will do well to choose GARDNER products. Research, skill and modern manufacturing methods have been combined to produce components that will withstand the most arduous working conditions and meet the exacting demands of present day standards. The "Sommerford" range comprises 141 different types—a type for every normal need.

Ready for IMMEDIATE DELIVERY

Full details and specifications will be sent on request.

# GARDNERS RADIO

SOMERFORD, CHRISTCHURCH, HANTS. *Ltd*



## WORLD OF WIRELESS

### P.T. Concession ♦ Industry's Enterprise ♦ More Amateur Wavebands ♦ E.H.F. Broadcasting

#### P.T. on Communication Sets

AFTER consultation with the Radio Communication and Electronic Engineering Association, the Commissioners of Customs and Excise have agreed that, in general, receivers which are designed, and offered for sale solely for amateur or professional communication reception shall for the present be regarded as not chargeable with purchase tax. It is pointed out, however, that this exclusion from tax does not apply to sets which are of "the domestic or portable types used for the reception of public broadcast programmes."

Manufacturers of communication receivers are advised to secure confirmation of non-liability to tax from the Commissioners at City Gate House, Finsbury Square, London, E.C.2, submitting (in duplicate) full specification, descriptive literature and other appropriate information including frequency coverage, incorporation of B.F.O., ranges, wholesale price, etc.

#### Radiolympia

THE R.I.C. has announced the dates on which the 16th National Radio Exhibition will be held at Olympia this year—from September 28th to October 8th. There will be a preview with admission by invitation only on September 27th.

#### Interference Suppression

THE Radio Industry Council is to be congratulated on its efforts to correct misconceptions regarding the effect and cost of suppressing electrical equipment causing interference with radio and television reception. By staging a demonstration at the height of the debate on the Wireless Telegraphy Bill, of types of interference and its suppression, it gave Members of Parliament, Press representatives and manufacturers an opportunity of obtaining first-hand knowledge of the main causes of interference and the most effective methods of suppression.

Technical members of the staff of the manufacturers, whose identity was not revealed, gave convincing demonstrations of the interference caused by vacuum cleaners, thermo-

statically controlled electric irons and electric dry shavers and, too, of the effect of fixing a flex-lead suppressor costing 9s 6d. It was not possible to demonstrate the effect on television reception of suppressing car ignition interference. However, by installing two aerials—one at a normal height of about 25 feet and the other at about 120 feet—and switching from one to the other, visitors were shown how good television can be when ignition interference is eliminated.

#### Amateur Frequencies

WHEN the provisions of the Atlantic City Telecommunication Convention come into operation on January 1st a number of additional or extended wavebands will become available to amateurs in this country. Amateurs will then be permitted to operate in the following bands, but those marked with an asterisk are released on a non-interfering basis:—

Mc/s	Mc/s
1.715 - 2.0	144 - 146*
3.5 - 3.635	420 - 460*
3.685 - 3.8	1,215 - 1,300*
7.0 - 7.3	2,300 - 2,450
14.0 - 14.4	5,650 - 5,850
28.0 - 30.0	10,000 - 10,500

Frequency modulation as well as amplitude modulation will be permitted on all bands from 420 Mc/s upwards and on all these, as well as on 144-146 Mc/s, an input power of 25 watts will be permitted.

The R.S.G.B. has negotiated with the G.P.O. for the retention of the 5-metre band (58.5-60 Mc/s), allocated to television, and this has been granted temporarily.

#### B.B.C. on E.H.F.

IN the very small amount of space devoted to the engineering side of broadcasting in the 1949 *B.B.C. Year Book*, reference is made to the research which has been undertaken to determine the possibilities of common-wave working on ultra-short waves.

Elsewhere in this 190-page book of general information for the broadcast listener and viewer, it is stated that as a long-term solution to the ever-growing congestion in the M.W. and L.W. bands, a chain of extra-short-wave stations is planned. In addition to the 25-kW frequency-modulation transmitter at Wrotham, Kent, an 18-kW A.M. trans-

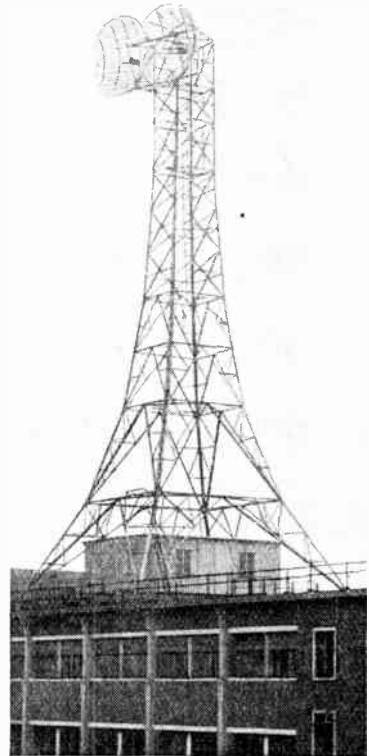

TOWERING 175 feet above London's streets is this new aerial, the first of six to be erected between the capital and Birmingham for the television link. The paraboloids have built-in electrical heaters for de-icing. This terminal station, designed by G.E.C., is at the Museum telephone exchange, Tottenham Court Road.

mitter is to be installed. Both transmitters will work in the 87.5 to 94.5-Mc/s band.

The *Year Book* costs 3s 6d.

#### City and Guilds Exams

READERS may like to be reminded of the dates on which entries to the various City and Guilds Examinations in radio subjects should be made.

Those proposing to enter for the Telecommunications Engineering examination, the Radio Service Work intermediate examination and that for the radio amateur's licence should make their entries through local technical colleges or the local education authority by March 1st.

Candidates for the Radio Servicing Certificate final examination should apply to the Secretary, Radio Trades Examination Board, 9, Bedford Square,

### World of Wireless—

London, W.C.1, by February 1st on the special entry form obtainable either from the City and Guilds, Department of Technology, 31, Brechin Place, London, S.W.7, or from the R.T.E.B. When candidates' eligibility has been confirmed by the R.T.E.B, they should enter for the written papers in accordance with the normal C. and G. procedure, i.e., through a technical college or local education authority.

The dates given apply only to candidates in Great Britain and Northern Ireland.

### Radio Regulations

A PHOTOSTATIC copy of the English version of the Radio Regulations annexed to the Atlantic City International Telecommunication Convention has been issued by the G.P.O. This volume, of some 300 pages, includes such generally useful information as the complete tables of frequency allocations to the various services, international call signs, revised classification of types of transmission and the "Q" codes. It is obtainable from H.M. Stationery Office, price 3s 6d.

### Sir Edward Appleton

THE appointment of Sir Edward Appleton as Principal and Vice-Chancellor of Edinburgh University was announced at the end of November. This means that he will be leaving the Department of Scientific and Industrial Research. He has been Secretary of the Committee of the Privy Council for Scientific and Industrial Research since 1939.

Sir Edward, who was recently awarded the Valdemar Poulsen Gold Medal by the Danish Academy of Technical Sciences for "outstanding contributions to radio technics and particularly for remarkable achievement in research on the ionosphere," was Wheatstone Professor of Physics at London University from 1924 to 1936. He was Jacksonian Professor of Natural Philosophy at Cambridge from 1936 to 1939. His ionospheric researches are too well known to need reiteration.

He was knighted in 1941 and a year ago was awarded the Nobel Physics prize. Among the positions now held by Sir Edward, who is 56, are: chairman of the B.B.C. Scientific Advisory Committee, president of the International Scientific Radio Union and a member of the Government Television Advisory Committee. He is a Fellow of the Royal Society.

### Radio Research

THE appointment of a new member to the Radio Research Board (see "Personalities") makes it opportune to give some information on its constitution and functions. There are at present sixteen members of the Board which advises the Lord President of the Council (as the Minister responsible for D.S.I.R.) on radio research matters in general and in particular on what research should be undertaken. The decisions made by the R.R.B. are put into effect by Dr. R. L. Smith-Rose,

who is Director of Radio Research at D.S.I.R.

The present members of the Board are:

Sir A. Stanley Angwin (Chairman), Cable and Wireless; Prof. H. E. M. Barlow, Professor of Electrical Engineering, University College, London; F. S. Barton, Director of Communications Development, M.O.S.; H. Bishop, Chief Engineer, B.B.C.; E. Brundett, Controller of Physical Research, Admiralty; A. J. Gill, Engineer-in-Chief, G.P.O.; Brig. J. B. Hickman, Director of Telecommunications Research and Development (Defence), M.O.S.; Dr. L. G. H. Hanley, Electrical Engineering Dept., Birmingham University; Sir N. Johnson, Director of Meteorological Office, Air Ministry; Capt. E. M. Knapp, Director of Radio Equipment, Admiralty; Prof. H. S. W. Massey, University College, London; J. A. Radcliffe, Cavendish Laboratory, Cambridge; Air Com. F. H. Richardson, Director of Signals, Air Ministry; Prof. F. J. M. Stratton, Deputy Scientific Adviser to the Army Council, War Office; Dr. H. W. H. Warren, Managing Director, B.T.H.; and G. M. Wright, Engineer-in-Chief, Marconi's.

### Slow Morse Transmissions

READERS wishing to learn morse may be interested to have details of the latest schedule of slow morse transmissions radiated by a number of amateurs whose efforts are co-ordinated by C. H. L. Edwards, G8TL, 10, Chestow Crescent, Newbury Park, Ilford, Essex. The times are G.M.T.

20.00 1900 kc/s	G2AJU (Stutton, Ipswich).
20.00 1800 kc/s	G2LJS (Bournemouth).
21.00 1900 kc/s	G3BLN (Bournemouth).
<b>Tuesday</b>	
22.00 1806 kc/s	G8TL (Ilford).
23.00 1820 kc/s	GM4AN (Kirkaldy).
<b>Wednesday</b>	
22.00 1800 kc/s	G3DLC (Grays).
<b>Thursday</b>	
22.00 1806 kc/s	G2BCX (South Woodford).
22.30 1803 kc/s	G30B (Manchester).
<b>Friday</b>	
19.00 1900 kc/s	G3BLN (Bournemouth).
20.00 1900 kc/s	G2AJU (Stutton, Ipswich).
20.00 1860 kc/s	G3AKW (Wirral).
20.30 1868 kc/s	G8LZ (Gravesend).
23.00 1820 kc/s	GM4AN (Kirkaldy).

### PERSONALITIES

Sir Ernest Fisk, managing director of E.M.I., has been given the Silver Medal of the Royal Society of Arts for his paper on "The Development of Sound Recording and Reproduction" read before the Society last session.



E. G. ROWE, M.Sc., who has joined Standard Telephones and Cables.

W. S. Barrell, technical director of E.M.I. Studios, who is president of the B.S.R.A., recently visited the U.S.A. and during his stay addressed the Audio Engineering Society in New York.

G. M. Wright, B.Eng., Engineer-in-Chief of Marconi's W.T. Co., has been appointed a member of the Radio Re-



G. M. WRIGHT, B.Eng.

search Board of D.S.I.R. During the war he was at the Admiralty and became Chief Scientist at the Admiralty Signal Establishment. He returned to Marconi's as Engineer-in-Chief in 1946. Prior to his war service he was head of Marconi's research department.

E. G. Rowe, M.Sc., who has been with the M.O. Valve Co. since 1933 and for the past eight years has been in charge of valve design and development, has resigned to join Standard Telephones and Cables, where he will be in charge of valve engineering and technical control of production. He has been a member of the B.R.V.M.A. Technical Committee for some years and has served as its chairman for the past two years.

### IN BRIEF

**Licences.**—A record monthly increase of 7,200 in the number of television licences in force was recorded at the end of September, when the total was 73,800. The number of broadcast receiving licences (including television) in force in Great Britain and Northern Ireland was 11,329,400.

**Cost of Television.**—In reply to a question in the House, the P.M.G. stated that whereas the cost of operating the B.B.C. television service during the financial year 1947-48 was £700,000, the gross revenue from television licences for the same period was £91,100.

**Magnetic Recording Standards.**—A committee has been set up by the British Standards Institution to consider the standardization of terms, engineering practice, etc., for magnetic recording. The chairman of the committee is M. J. L. Pulling, vice-president of British Sound Recording Association. Three sub-committees have also been formed to deal with magnetic sound film; disc and tape; and wire. The chairmen are Dr. O. K. Kolb, R. W. Lowden and P. T. Hobson, respectively.

**Can Electronics Help?**—During his opening speech at the Electronics Symposium organized by the Scientific Instrument Manufacturers' Association, Sir Edward Appleton stated that the Department of Scientific and Industrial Research had set up a small group of advisers to visit firms with a view to assisting them in assessing the possibilities of using electronic equipment in industrial processes.

**Railway Radio.**—After six years' experimenting a new V.H.F. train radio system is being introduced in Sweden. F.M. equipment operating on approximately 2 metres with a range of 20 km is to be used, it having been found the most satisfactory in view of the extensive electrification of Swedish railways. The service is not yet available to passengers.

**Denmark's new 50-kW S.W.** broadcasting station at Herstedvester, near Copenhagen, operates daily from 2400-0130 G.M.T. on 9.520 and 15.105 Mc/s.

**British Council Scholarships.**—It may not generally be known by overseas readers that scholarships are awarded to overseas graduates or to others of like status to help them to undertake a year's specialized study at a British university, college or other educational institution. Particulars are obtainable from the offices of the British Council, 3, Hanover Street, London, W.1, or from Government representatives overseas.

**"Britain Goes Ahead."**—Radio is featured at the "Britain Goes Ahead" exhibition being staged at Charing Cross London Transport Station. Muirhead photo-telegraphic equipment, linked by line to Cable and Wireless headquarters, is being demonstrated. Two television sets—Cossor and Ekco, a Hughes supersonic flaw detector and a "Rebecca" transmitter-receiver made by E.M.I. are also on view.

**Radio S.E.A.C.**—It is understood negotiations are being made for the transfer of control of the Forces broadcasting station, Radio Seac, in Colombo to the Ceylon Government. It is to be known as Radio Ceylon. The 7.5-kW transmitter radiates on 6.075, 7.185, 9.520, 11.770, 15.120, 17.730, 17.770, 17.820, 21.470 and 21.620 Mc/s.

**Ionosphere Research.**—A permanent ionosphere research station is being established in Singapore. The experiments are to be conducted by the Ionosphere Recorder Team of the U.K. Department of Scientific and Industrial Research, whose officer in charge, B. W. Osborne, has arrived in Singapore.

**Canadian Television.**—Applications have been made to the Canadian Broadcasting Corporation for licences to erect six privately operated television transmitters. Four are for Toronto and two for Montreal. The Corporation has recommended that they should not be licensed until agreement has been reached on the questions of technical standards and co-operative action by private and national interests.

**Business Radio Licences** are now being issued by the Australian Government to newspapers and utility services.

**D.S.I.R.**—The headquarters administration of the Department of Scientific and Industrial Research (excluding the Intelligence and Overseas Liaison Divisions) has been transferred to Dorland House, 14-16, Regent Street, London, W.1 (Tel.: Whitehall 9788). The Intelligence Division is at 4-12, Regent Street, and the Overseas Liaison Division at Africa House, Kingsway, London, W.C.2.

**Industrial Electronics.**—A special course of six lectures on electronics in industry, by L. I. Farren, of G.E.C. Research Laboratories, will be given on Fridays at 6.30 at the Regent Street Polytechnic, commencing on February 4th. The fee for the course, which covers ultrasonics, R.F. heating and control systems, is 10s. Enrolment forms are obtainable from the Head of the Electrical Engineering Department, 307, Regent Street, London, W.1.

**C.G.I.**—In the 1947 report of the City and Guilds of London Institute, it is shown that there was an increase of 3,813 in the number of entrants for the telecommunications engineering group of examinations compared with the previous year. The year's total was 18,754.

**Noise in the Home.**—A report on the results of a survey to obtain information on the incidence of noise in houses and flats, published by H.M.S.O. under the title "A Survey of Noise in British Homes," shows that although the sound of neighbours' radio is "noticed" by the largest proportion of the 2,000 people questioned, it was considered by them to be much less troublesome than what is classed "banging of doors."

**Australian F.M.**—For some time the Postmaster-General's Department has been conducting tests with F.M. transmitters in Melbourne and Sydney. The Government has now announced its intention to proceed with F.M. as a service in all the capital cities of Australia. No licences will be issued to commercial broadcasters and the service will be controlled by the Government.

#### FERRY RADAR.

The London Midland Region of British Railways has installed Cossor radar equipment at its Riverside Station, Tilbury, which, together with Marconi R.T. gear on the steamers, enables the ferry service to be maintained in foggy weather. The transmitter operates on a frequency between 9,425 and 9,524 Mc/s. The indicator unit has three ranges—0.8, 1.2 and 3 nautical miles. In this photograph of the display a ferry can be seen leaving the landing stage.

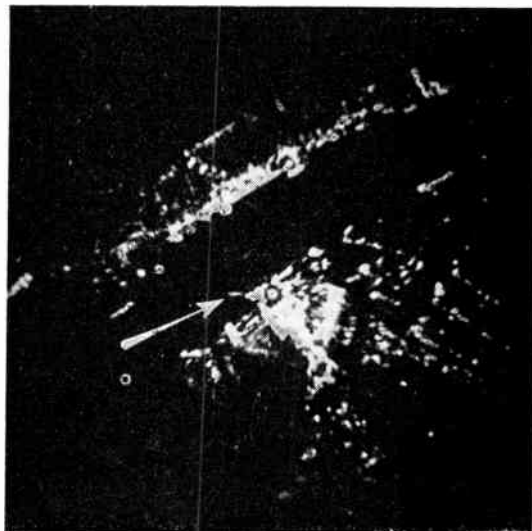

**"World Radio Handbook,"** the fourth edition of which is now available, is being distributed in this country by Wm. Dawson and Sons, Cannon House, Macklin Street, London, W.C.2. Printed in English, although published in Denmark, the book, which costs 6s 6d, gives information on the world's broadcasting stations and schedules of regular transmissions.

**N.P.L. "Open Days"** will be held next year on May 26th for representatives of industry and 27th for members of university staffs and Government Departments.

**Exhibitions.**—The 1949 British Industries Fair will be held in London and Birmingham from May 2nd to 13th. The 26th *Daily Mail* Ideal Home Exhibition will be held at Olympia from March 1st to 26th.

**Great Circle Map.**—In our note on the new edition of the *Wireless World* Great Circle Projection Map in last month's issue, the cost, including postage and packing should have been given as 3s.

**Radio in the House.**—It has been announced that it is hoped to provide facilities for the reception of broadcast and television programmes in the new House of Commons.

#### INDUSTRIAL NEWS

**Hunt-Mycalex.**—The world selling rights for the Mycalex capacitor, which in future will be known as the Hunt-Ingram capacitor, have been taken over from the Mycalex Company by A. H. Hunt, Ltd., of Bendon Valley, Garratt Lane, Wandsworth, London, S.W.18, to whom all enquiries should in future be made.

**Marconi marine radar and radio apparatus** is being installed in the new 28,000-ton Orient liner *Orcades*. The equipment includes the M.I.M.C. Co.'s new Mercury and Electra marine receivers. The Mercury is a medium and long-wave receiver covering the frequencies 15 to 40 kc/s and 100 kc/s to 4 Mc/s. The Electra is principally for



**World of Wireless—**

short-wave work but covers the frequencies 250 to 520 kc/s as well as 1.5 to 25 Mc/s. Both receivers are capable therefore of reception on the calling and distress frequency of 500 kc/s. A wire recorder forms part of the ship's sound-reproducing equipment.

Marconi communications equipment, to the value of £15,000, has been ordered by the government of Saudi Arabia. The equipment consists of short-wave R.T. and C.W. transmitters which will provide a communications network linking the principal cities of Saudi Arabia. The company is also supplying two-way V.H.F. radio-telephone equipment to the Singapore police. Two 200-watt transmitters will be installed on high ground in the interior of the island and will operate in double-diversity. The transmitters, spaced several miles apart, will be controlled by a 10-watt transmitter at the police headquarters.

T.C.C. has acquired the premises of S. G. Brown, Ltd., adjacent to their own factory in North Acton. The additional space will be used for development and research work. The company asks us to correct two errors which appear in their advertisement in the December issue. The price of the Visconol capacitor Type CP58QU should be 15s and the maximum working voltage 7,000.

Pye television equipment was recently used in Cambridge by the town's Accident Prevention Council to transmit on a closed circuit scenes from a busy thoroughfare during a "Safety First" campaign. The amplifiers and control equipment were linked by 1,500ft of cable to receivers at the road safety exhibition.

Beethoven.—All departments of Beethoven Electric Equipment, Ltd., have been transferred from Chase Road, London, N.W.10, to the company's new factory at Chapel Lane, Sands, High Wycombe, Bucks (Tel.: High Wycombe 1152-3).

Scophony, Ltd., has taken over two companies—John Logie Baird, Ltd., who have recently introduced a television receiver incorporating a mains aerial, and its associated transformer manufacturing concern, W. Andrew Bryce and Co.

H.M.V.—For the benefit of the eighty or more delegates from overseas parliaments and legislatures attending the recent meeting of Empire Parliamentary Delegates in London, H.M.V. installed a television receiver with a 15-in C.R.T. at the Savoy Hotel where throughout the conference the delegates took their meals.

Portable Record Player.—The price of the Vidor battery-operated record player was incorrectly given in our last issue. It is 14 guineas *exclusive* of tax.

Wolsey Television, Ltd., which recently moved to 75, Gresham Road, Brixton, S.W.9, has now changed its telephone number to Brixton 7566.

E.I.B.A.—The Electrical Industries Benevolent Association benefited to the extent of over £500 as a result of the Electrical Industries Ball recently held at Grosvenor House.

French Television.—The system developed by the firm Radio-Industrie is to be officially adopted. According to a Government decree, the national system will have a definition of 819 lines with positive modulation and A.M. sound. The 455-line transmitter now serving the Paris area will remain in operation until January 1st, 1953. It is expected that the first high-definition transmitter will be installed in Paris in 1949 and that a second station will be built at Lille in 1950.

Philips organization has recently established a factory in Sao Paulo, Brazil, for the manufacture of radio receivers and electric lamps.

"F.B.I. Register."—Nearly 1,000 pages, giving details of the members of the Federation of British Industries and their products, are included in the 1948-49 edition of the "F.B.I. Register" which was published last month. The price is 42s. Home orders should be sent to Kelly's Directories, Ltd., 196, Strand, London, W.C.2, and overseas orders to our Publisher.

**EXPORT**

South Africa.—Agencies from British manufacturers for radar, R.F. heating, communications and P.A. equipment and electronic control and testing apparatus are required by Dowson and Dobson, Ltd., P.O. Box 7764, Johannesburg. Further information can be obtained from the Export Promotion Department, Board of Trade, Thames House North, Millbank, London, S.W.1, quoting reference E.P.D. 42959/48.

Philco (Overseas), Ltd., is the name of the recently formed British subsidiary of the Philco Corp. of Philadelphia, U.S.A., for the purpose of selling British-made Philco products in all export markets. The managing director is R. W. Cotton, who was with British Rola until 1945.

Ceylon.—It is reported by the U.K. Trade Commissioner at Colombo that there is a wide scope in Ceylon for a moderately priced receiver, about Rs250 (£18 15s), covering short and medium waves.

**MEETINGS****Institution of Electrical Engineers**

Radio Section.—"Double-ratio A.C. Bridges with Inductively Coupled Ratio Arms," by H. A. M. Clark, B.Sc. (Eng.) and P. B. Vanderlyn, and "A Direct Capacitance Aircraft Altimeter," by W. W. Watton, B.Sc., and M. E. Pemberton, on January 11th. (Joint meeting with Measurements Section.)

"Some Aspects of Design of Balanced Rectifier Modulators for Precision Applications," and "The Effects of an Unwanted Signal Mixed with a Carrier Supply of Ring-and-Cowan Modulators," by D. G. Tucker, D.Sc., Ph.D., on January 12th.

"Should British Universities Consider the Establishment of Special Degrees in Radio." Discussion opened by Prof. E. B. Moullin, M.A., Sc.D., on January 18th.

"Small Power Transformers for Aircraft Electrical Equipment," by A.

Langley Morris, on January 20th. (Joint meeting with the Measurements and Utilization Sections.)

The above meetings will be held at 5.30 at the I.E.E., Savoy Place, London, W.C.2.

Cambridge Radio Group.—"The Testing of Communication-type Receivers," by W. J. Bray, M.Sc. (Eng.), and W. R. H. Lowry, B.Sc., at 6.0 on January 11th at the Cambridgeshire Technical College.

Mersey and North Wales Centre.—"Communication of Technical Ideas," by H. E. Dance, M.Eng., at 6.0 on January 19th, at 24, Dale Street, Liverpool. (Joint meeting with the Liverpool Engineering Society.)

North-Western Radio Group.—"Three Dimensional C.R.T. Displays," by E. Parker, M.A., and P. R. Wallis, B.Sc. (Eng.), at 6.30, on January 19th, at the Engineers' Club, Albert Square, Manchester.

South Midland Centre.—Faraday lecture on "Television," by Sir Noel Ashbridge, B.Sc. (Eng.), at 6.0, on January 25th, at the Town Hall, Birmingham.

South Midland Radio Group.—"Television Developments," by K. R. G. Sturley, Ph.D., at 6.0 on January 24th, at the James Watt Memorial Institute, Great Charles St., Birmingham.

Western Centre.—"A Résumé of V.H.F. Point-to-point Communication," by F. Hollinghurst, B.Sc. (Eng.), and C. W. Sowton, B.Sc., at 5.0 on January 10th, at the South Wales Institute of Engineers, Park Place, Cardiff.

Sir Noel Ashbridge's Faraday lecture on "Television" at 6.30 on January 19th, at the Victoria Rooms, Bristol.

**British Institution of Radio Engineers**

London Section.—"Developing an Indicator Unit for H<sub>2</sub>S Equipment," by R. T. Croft, at 6.0 on January 20th, at the London School of Hygiene and Tropical Medicine, Keppel Street, London, W.C.1.

South Midlands Section.—"Telecommunications in Turkey," by A. E. Harold at 7.0 on January 27th, at the Technical College, The Butts, Coventry.

Merseyside Section.—"Radar Experiments," by E. V. Jacobs, at 6.45, on January 5th, at the Incorporated Accountants' Hall, Derby Square, Liverpool, 2.

**British Sound Recording Association**

"Gramophone Record Processing," by E. D. Parchment, at 7.0 on January 28th, at the Royal Society of Arts, John Adam St., London, W.C.2.

**Royal Society of Arts**

"Radar and its Application to the Science and Art of Marine Navigation," by Lieut. P. Satow, D.S.C., R.N., at 6.0 on January 4th at the R.S.A., John Adam Street, London, W.C.2.

**Radio Society of Great Britain**

Annual General Meeting followed by a discussion on "420 Mc/s Work," opened by W. A. Scarr, M.A., and D. N. Corfield, D.L.C. (Hons.), at 6.30 on January 28th, at the I.E.E., Savoy Place, London, W.C.2.

**Institute of Navigation**

Three films on radio navigation systems with a commentary by R. F. Hansford, at 5.30 on January 10th, at the Royal Geographical Society, 1, Kensington Gore, London, S.W.7.

## "SUPER FIFTY WATT" AMPLIFIER



This **AMPLIFIER** has a response of 30 c/s. to 25,000 c/s. within  $\frac{1}{2}$  db, under 2 per cent. distortion at 40 watts and 1 per cent. at 15 watts, including noise and distortion of pre-amplifier and microphone transformer. Electronic mixing for microphone and gramophone of either high or low impedance with top and bass controls. Output for 15/250 ohms with generous voice coil feedback to minimise speaker distortion. New style easy access steel case gives recessed controls, making transport safe and easy. Exceedingly well ventilated for long life. Amplifier complete in steel case, with built-in 15 ohm mu-metal shielded microphone transformer, tropical finish. As illustrated, Price **36 $\frac{1}{2}$  Gns.**

## FOUR-WAY ELECTRONIC MIXER

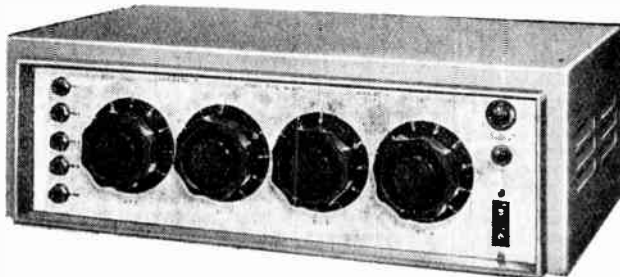

This unit has 4 built-in, balanced and screened microphone transformers, normally of 15-30 ohms impedance. It has 5 valves and selenium rectifier supplied by its own built-in screened power pack: consumption 20 watts. Suitable for recording and dubbing, or large P.A. installations since it will drive up to six of our 50 watt amplifiers, whose base dimensions it matches. The standard model has an output impedance of 20,000 ohms or less, and any impedance can be supplied to order. Price in case with valves, etc., **£24.**

All types of **MICROPHONES, STANDS and SPEAKERS** available from stock including 12 in. **GOODMAN P.M. SPEAKER**

•  
30-Watt **RECORD REPRODUCER** in metal case  
PRICE 30 $\frac{1}{2}$  Gns.

•  
10-Watt **RECORD REPRODUCER** with **MICROPHONE STAGE**, in case  
PRICE 25 $\frac{1}{2}$  Gns.

•  
**CP20A AMPLIFIER** for A.C. Mains and 12-volt Battery  
PRICE £28.0.0

**OUR FRIENDS OVERSEAS** are invited to write for Export Terms

*Vortexion*  
**LIMITED**

**257-261, THE BROADWAY, WIMBLEDON, LONDON, S.W.19, ENGLAND**

TELEPHONES: LIberty 2814 and 6242-3.

TELEGRAMS: "VORTEXION, WIMBLE, LONDON."

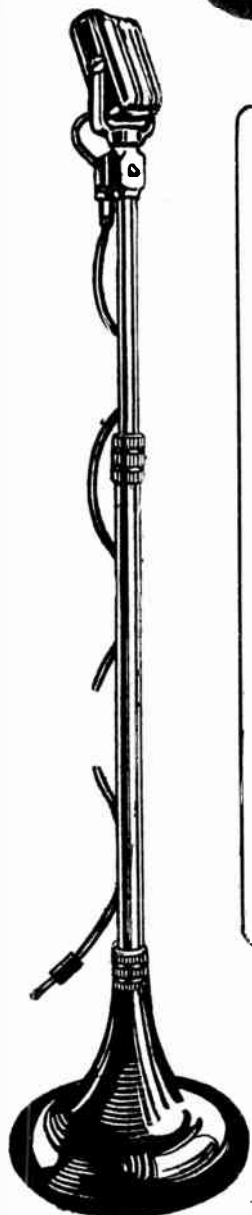

# 25 WATT & 50 WATT AMPLIFIERS

*New high standard of stability and reproduction. Very high degree of amplification. Simplicity of operation.*



**EXTREME SENSITIVITY.** Perhaps the most noteworthy feature of these amplifiers is their high sensitivity, which allows wide-range pick-up with low-level high fidelity microphones.

For example, the 25-watt has an overall power amplification of 133 d.b. or twenty-million-million-times. This is mainly achieved by the inclusion of a high-gain input stage completely enclosed in a rubber-mounted magnetic screening case.

**OUTPUT.** The output transformer of each amplifier is of generous size, and has an eight-sectioned primary in order that it can be included in the inverse feed-back loop. The following outputs are provided:—

- Max. undistorted voltage (R.M.S.) 100, 50, 25 volts.
- Load impedance (25-watt) - - 400, 100, 25 ohms.
- Load impedance (50-watt) - - 200, 50, 12.5 ohms.

These amplifiers are normally intended to use with the 100-volt-line system in which each loudspeaker has its own transformer. This allows simple parallel connection of the loudspeaker load, the use of long lines, and the rating of loudspeakers in terms of their actual power consumption in watts.

**MICROPHONE INPUT**  
Input required for full drive  
0.8 millivolts  
Impedance - - 1 megohm

**GRAMOPHONE INPUT**  
Input required for full drive  
90 millivolts  
Impedance - - 0.25 megohm

 **PHILIPS ELECTRICAL**  
LIMITED

AMPLIFIER DEPARTMENT,  
CENTURY HOUSE, SHAFTESBURY AVENUE, LONDON, W.C.2

## If you are after . . .

- I.E.E.,
- BRIT.I.R.E
- CITY & GUILDS . . .

*IN YOUR OWN INTERESTS* first find out the regulations governing the above examinations before taking a course of study. Ask us for this information and also that concerning *EXEMPTION* from Brit.I.R.E. examinations obtained by taking our *POSTAL COURSES*.

We will gladly supply the necessary information together with our *FREE BOOKLET* which gives details of *POSTAL* and *ATTENDANCE* courses covering the above and other examinations—Postal Courses in Radio, Television, Maths, etc.—2 and 3 year Day Courses in Telecommunications Engineering.

Special terms for groups of five or more postal students enrolling together. Students not requiring full courses may take parts at correspondingly reduced fees.



Write for Booklet to:

**E.M.I. INSTITUTES LTD.**

Dept. 16a, 43 Grove Park Road, Chiswick, London, W.4.  
Telephone CH15wick 4417/8

*E.M.I. Institutes—backed by the Electronic Organisation which includes "H.M.V.", Marconi-Phonograph, Columbia, etc.* No. 108

## RHO-METAL SCRATCH FILTER CHOKE

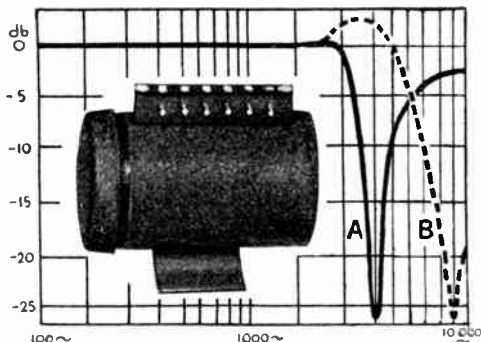

### TYPICAL RESPONSE CURVES

- A Tuned for maximum rejection at 4,000 cycles
- B Tuned for maximum rejection at 9,000 cycles

**WHERE SURFACE NOISE IS THE LIMITING FACTOR TO SUPREME QUALITY OF REPRODUCTION**, fit a Sound Sales alloy cored steep trough tuneable filter. We know the problem of removing Surface Noise or Heterodyne whistle is not easy to solve, but the steep trough filter has so far produced the most encouraging results we have encountered when using a compact component which can be incorporated in existing apparatus.

**CHOKE TYPE.** C SF, Dia. 2 1/4", length 3 1/4". **PRICE £1.8.9** each.

**SOUND SALES LIMITED**

Specialist manufacturers of Transformers and Chokes of all types since 1930

**WEST STREET, FARNHAM SURREY**



# ADMITTANCE

## Better Than Impedance for Some Calculations

By "CATHODE RAY"

**T**HE only units associated in the minds of most people with admittance are shillings or other monetary quantities. In print, such association is peculiarly binding and rigid, not readily set aside except perhaps by ingenious and agile boys. But in the pages of this journal, admittance if mentioned at all would generally be reckoned in mhos. My impression is that it is not mentioned at all, or (at most) rarely. Writers assume, I think, that although impedance is understood, admittance might not be, and so go out of the way to avoid it. It is different in the learned stratosphere of *Wireless Engineer*, of course.

I have not hired a Mass Observation Service but rely entirely on guesswork for the following order of familiarity in which I place the electrical "-ances." Resistance is easily first, followed at some distance by impedance and reactance. Impedance can be mentioned in circles of doubtful technicality with rather more confidence than reactance, though perhaps the day has passed when reactance was often understood to mean the thing that squealed if you turned it too far clockwise. Conductance may actually be encountered earlier in the pursuit of learning than impedance, but is soon discarded when it is found to involve a different and rather queer-looking unit of measurement. Admittance, as I said, is hardly legal tender even among *Wireless World* readers; and as for susceptance. . . .

### Choice of System

What I want to do is to show that the admittance-conductance-susceptance group of terms has other uses than for throwing about to create an impression of unscalable height of brow. Anyone who is familiar with impedance, resistance and reactance ought to have no difficulty with them and should soon be able to choose whichever group is the more suitable for the job in hand.

In the very early stages we learn that resistances in series can simply be added to give the total resistances:

$$R = R_1 + R_2 + R_3 \text{ etc.}$$

When we come to resistances in parallel the thing looks awkward in print:

$$R = \frac{1}{\frac{1}{R_1} + \frac{1}{R_2} + \frac{1}{R_3} \text{ etc.}}$$

and the arithmetic of working it out is still more awkward. Conducting paths in parallel are reckoned much more simply as conductances, when the formula corresponds exactly to resistances in series:

$$G = G_1 + G_2 + G_3 \text{ etc.}$$

The relationship, of course, is

$$\text{Conductance (G)} = \frac{1}{\text{Resistance (R)}}$$

That is all very well, you may say, but the values of "conducting paths" are always given in ohms, and to convert them to mhos, add them up, and convert them back to ohms, is exactly what one does according to the clumsier formula. And it wouldn't be any solution to mark series resistances in ohms and parallel resistances in mhos, because sometimes a resistance is both in series and in parallel at the same time. If they were all marked in both units it would be very convenient for adding them and inconvenient in every other respect. In practice it has to be one or the other. Although conductors are, on the whole, more important than resistors, it is not so often important to know their numerical values; so it is natural for ohms to be used rather than mhos.

When one has become used to reckoning quantities in one unit it is very difficult to think of them in another unit. That is why ridiculous units like stones and jars take so long to die out. Although the fact that I have understood the official meanings

of V.H.F., U.H.F., S.H.F. and E.H.F. since their inception is proof (according to the Editor) that I have phenomenal ability to absorb new ideas, I confess that after all these years I still have to convert frequencies to wavelengths to know where I am with them, in the medium waveband at least. So I do agree that there is some ground for a prejudice against methods of reckoning that necessitate different units for the same things—and not even directly-proportional units, easy to convert.

### A New Symbol?

Mhos are handicapped in another way by having been allotted no abbreviation. Ohms have their  $\Omega$ , but the only thing one can do with mhos, other than writing the word out in full, is to say "amps per volt" and abbreviate it A/V. And of course the same for mA/V and  $\mu$ A/V to stand for millimhos and micro-mhos. This roundabout system is actually used in this country for mutual conductances. But can you imagine anybody tolerating the volt-per-amp as a unit of resistance! So the sooner the poor mho is given a symbol the better. My suggestion is  $\mathfrak{H}$ . I shall probably be told that in handwriting it would be mistaken for v. But that objection seems to have been successfully overruled in the case of  $\omega$  and  $w$ .

By the way, the name "mho" itself has from birth suffered the stigma of doubtful legitimacy. I believe that when it was brought up for consideration by the appropriate international body the German representative objected on the ground that it was derogatory to Dr. Ohm to have his name officially reversed for any purpose whatever; so as part of the appeasement programme it was dropped. It seems a good chance now, before we are obliged to adopt the zhdanov or

**Admittance—**

the vishinsky, to get mho fully installed.

Talking about mutual conductance, it is rather curious that this has become generally accepted, even by the assistant who sells valves over the counter. Seeing that nearly everybody thinks in terms of resistances rather than conductances, one would have expected to find  $r_m$ , the mutual resistance. The ratio of  $r_a$  to  $r_m$  would be  $\mu$ . Since one conductance (even in mA/V!) seems to have got by, why not others?

Take the output resistance of a valve, for instance. That is to say, the resistance the valve appears to have from the point of view of the load. In a straight-forward amplifier it is equal to  $r_a$ . According to the usual "valve equivalent circuit" (Fig. 1b), this resistance is in series with the load, causing the voltage available across the load to be less

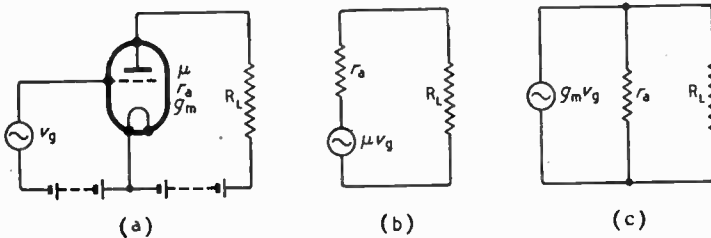

Fig. 1. Simple valve amplifier circuit (a), and the usual theoretical equivalent (b). For some purposes it is more helpful to use the alternative equivalent (c).

than that generated in the valve ( $\mu v_g$ ). In a pentode,  $\mu v_g$  and  $r_a$  are generally both very large, and it is often more helpful to think in terms of the alternative (but much less used) "equivalent," Fig. 1(c). Here the valve is considered as generating a current,  $g_m v_g$ , some of which (but not much in a pentode) is wasted in the shunt  $r_a$ .  $R_L$  and  $r_a$  being in parallel, it would be convenient to treat them as conductances were it not that they are usually specified in ohms. Besides, Fig. 1(b) is an easy enough circuit to calculate when it is as simple as shown. In practice, however, one often has to take account of several paths in parallel; for example, stray capacitances across valve and load. A series-parallel circuit is always awkward to calculate; it is much easier to have all one or

the other, and that is where Fig. 1(c) may help.

Then think of the cathode follower, where one effect of the 100 per cent negative feedback is to alter the output resistance from

$r_a$  to  $\frac{r_a}{\mu + 1}$ . This is usually manipulated into  $\frac{1}{g_m + \frac{1}{r_a}}$ . If one

were to work in conductances, it would be converted into the simpler form  $g_m + g_a$ , where  $g_a$  is the anode conductance ( $\frac{1}{r_a}$ ). And

if there were a cathode resistor  $R_c$  to be taken into account, its reciprocal,  $G_c$ , could simply be added. Apart from arithmetic, some people may see the cathode follower more clearly as two conductances in parallel across the output terminals than as a resistance divided by  $\mu + 1$ .

I haven't forgotten that the title of this article is Admittance. But we are going to get round to it via that unfrequented passage, susceptance. Susceptance stands in relation to reactance as conductance does to resistance; that relationship, of course being reciprocal. And its symbol is B;

$$\text{so } B = \frac{1}{X}.$$

Reactances as all radio men know, are of two kinds—inductive and capacitive. The formula for inductive reactance ( $X_L = 2\pi fL$  or  $\omega L$ ) is simple and convenient and as inductances are more often in series than in parallel (being rather like resistances in that respect) there is seldom much inducement to dabble with inductive susceptances.

Capacitances on the other hand, habitually occur in parallel; and it is a happy circumstance that the total is calculated so simply, by just adding them. But when—

Fig. 2. This is an extremely simple circuit, but is not at all simple to calculate in terms of resistance, reactance and impedance. It is quite easy in terms of conductance, susceptance and admittance.

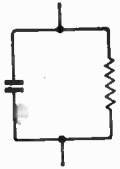

as often happens—it is necessary to work in capacitive reactances, it is quite a different matter. Even converting a single C to  $X_c$  or vice versa, usually with large negative powers of 10 coming into the calculation, is bad enough on paper and quite maddening mentally. And if there are several capacitive reactances in parallel, they have to be combined the awkward way, like resistances. So capacitive susceptance

$$(B_c = 2\pi fC \text{ or } \omega C)$$

is by comparison rather a pleasant thing to use. If  $f$  is in c/s and C in F, or  $f$  in Mc/s and C in  $\mu F$ , B will be in mhos; and if  $f$  is in Mc/s and C in pF, B will be in micromhos.

A very common combination, especially in high-frequency work, is C and R in parallel (Fig. 2). That is because stray capacitances are everywhere. Now just consider what happens when one works out the impedance of this very simple combination. The result, in one form, is

$$Z = \frac{1}{\sqrt{\frac{1}{R^2} + \frac{1}{X_c^2}}}$$

Or using the  $j$  technique one can work it into a form without any square root:

$$Z = \frac{X_c R (X_c - jR)}{X_c^2 + R^2}$$

That doesn't look very attractive, either. But in terms of conductance and susceptance nothing could be simpler:

$$Y = G + jB$$

Here at last we have managed to gain admittance, denoted by Y. It is reciprocal of Z.

For example, the maker's data concerning a certain valve include:

- Input resistance at 50 Mc/s 4,000  $\Omega$
- Input capacitance 8.3 pF.

From these,  $G = 250 \mu\text{mhos}$  and  $B = 2\pi \times 50 \times 8.3 = 2600 \mu\text{mhos}$ . So the admittance is  $250 + j 2600 \mu\text{mhos}$ . Since  $B$  is so much greater than  $G$ , there will not be much difference in the values of  $B$  and  $Y$ . (Try working it out,  $Y = \sqrt{250^2 + 2600^2}$ ). The input of the valve looks like a capacitor with a rather poor power factor—somewhere near 10 per cent.

If at any time it is necessary to use inductive susceptance, one thing to remember is that it is negative; the opposite way round to reactance, of which the capacitive kind is negative.

Another possibly catchy point is that although  $G = 1/R$  and  $B = 1/X$  when  $R$  and  $X$  are alone or in parallel, it is not so when  $R$  and  $X$  are in series. Then  $G = R/(R^2 + X^2)$  and  $B = X/(R^2 + X^2)$ .

But that is getting on to book work. All I am anxious to do is to show that admittance-conductance-susceptance is not a good set of things to know nothing about. Besides being useful for working out actual quantities in circuits, they make it easier to talk and think clearly about circuits in general. For instance, suppose we are explaining how valve amplification at, say, 50 Mc/s differs from that at 1 Mc/s or lower. There is, we say, a marked tendency for amplification to be less, because of the input impedance of the valve. That is not clear, because the more input impedance the valve has the better. We might say "because of the lowness of the valve input impedance"; but

"lowness of impedance" is really a clumsy way of saying "admittance."

Or one might say that the coupling in the filter circuit shown in Fig. 3(a) depends on the capacitance,  $C$ . That may be roughly true, but is not precise, because  $10\text{pF}$  at 2 Mc/s has more effect than at 1 Mc/s. It would be true in a sort of way to say the coupling depends on the reactance,  $X$ . But it is an up-

side-down sort of way, for the greater  $X$  is, the less the coupling. The most precise and simple statement is that the coupling depends on the susceptance,  $B$ ; being, in fact, very nearly directly proportional to it. In Fig 3(b), however, it would be most appropriate to say that the coupling depends on  $X$ .

When discussing the behaviour of a valve it is advisable to make clear what sort of theoretical equivalent you are considering. Are you regarding it simply, as in Fig. 1, as something that gives a certain voltage out when a voltage is put in at the grid, and shunts the output terminals with a certain resistance (or conductance if you have Fig. 1(c) in mind!)? Or are you taking into account the valve susceptances; that is to say, the A.C. paths provided by the inter-electrode capacitances, regarding them as pure or loss-free capacitances? Or, more exactly still, are you taking account of the valve admittances; allowing not only for the inter-electrode capacitances but also for their losses? Use of the correct terms may not make understanding of your meaning certain, but it will make it more probable.

So much for admittance and its component parts.

There may be room this month

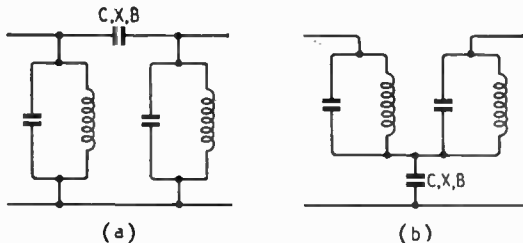
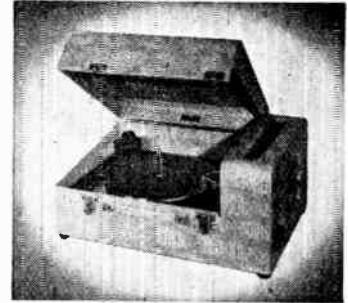

Fig. 3. While the coupling in (b) is appropriately said to be due to the reactance  $X$ , in (a) it is better to ascribe it to the susceptance,  $B$ .

for a more general note. Many of the subjects I discuss in these pages are those which readers have written to me to say they have difficulty in understanding. Provided that I am not expected to write individual replies, I am glad to receive such letters, especially from readers overseas who may find it difficult to get light on their problems. They should be addressed to "Cathode Ray," c/o *Wireless World*.

New  
**TRIX**  
Quality  
**SOUND EQUIPMENT**



**"TRIXETTE"**  
Automatic Model  
**PORTABLE  
ELECTRIC  
GRAMOPHONE**

This instrument is fitted with the latest type Garrard Automatic Record Changer which operates with ten 10in. or 12in. records. Magnetic pick-up, first-class amplification and a 6½in. dia. high-efficiency loud-speaker provide excellent quality of reproduction with adequate volume.

Volume and tone controls are provided and the whole unit is designed to operate on A.C. Mains. The case is covered in best quality leather cloth with rubber feet and rust-proofed fittings. All components are tropicalised.

As an alternative there is a Single record player instead of the automatic changer.

Both these models have had an enthusiastic reception in many export markets and are now available in limited quantities for home buyers.

Send for illustrated lists and full details.

**THE TRIX ELECTRICAL CO. LTD.**  
1-5 Maple Place, Tottenham Court Road,  
London, W.1. Phone: MUSEum 5817.  
Grams & Cables: "Trixradio, Wesdo, London."

AMPLIFIERS · MICROPHONES · LOUDSPEAKERS



# SHORT-WAVE CONDITIONS

## November in Retrospect : Forecast for January

By T. W. BENNINGTON and L. J. PRECHNER (Engineering Division, B.B.C.)

**D**URING November, while the average daytime maximum usable frequencies for these latitudes were much higher than in October, the night-time M.U.F.s were somewhat lower than during that month, in accordance with the seasonal trend.

Owing to the exceptional amount of ionosphere storminess working frequencies were rather lower than expected, and, so far as is known, very few long-distance contacts were made on the phenomenally high frequencies which became usable during the winter of 1947/48. However, there was occasional reception of harmonics of U.S.A. and South America transmissions on frequencies of the order of 50 Mc/s, as well as frequent reception of U.S.A. police transmissions in the 40-Mc/s band. Owing to storminess, reception on the 28-Mc/s band was often none too good, and there was also considerable attenuation on the lower night-time frequencies.

Abnormally high rate of incidence of Sporadic E for this period of the year was recorded, the value being higher than in October. It is worth noting that during the last few months both the rate of incidence of Sporadic E and the duration of disturbed reception conditions have been abnormally great, which may perhaps point to some connection between these two sets of phenomena.

Long-range tropospheric propagation was observed on very few occasions, mostly at the beginning and the end of the month. This propagation was probably due to the favourable weather conditions; for example, the widespread fog towards the end of the month.

Sunspot activity in November was less than in October. Two fairly large groups were observed, which crossed the central meridian of the sun on the 18th and 20th respectively. However, the latter group had already started decreasing rapidly on the 17th.

The month was again exceptionally disturbed, although rather less so than in October. The disturbances usually lasted for a long period. Ionospheric storms were observed on 1st-6th, 18th-25th and 27th-28th, those occurring on 2nd, 4th, 20th-23rd being particularly violent.

Very few "Dellinger" fadeouts have been recorded in November, and none was really severe.

**Forecast.**—There should not be much change in either daytime or night-time M.U.F.s as between December and January. Therefore, daytime M.U.F.s will be, as in December, probably lower than during November, because of the mid-winter effect in the northern hemisphere. However, daytime working frequencies will still be relatively high, and long-distance

communication on very high frequencies should therefore be possible in all directions from this country. The 28-Mc/s amateur band should be regularly usable at suitable time of the day, but conditions on higher frequencies for long-distance contacts will not be as favourable as in November. The night-time M.U.F.s will fall to their lowest values for the winter, so that the night-time working frequencies will be as low as 7 Mc/s over many long-distance circuits, and they will be in use for relatively long periods.

Below are given, in terms of the broadcast bands, the working frequencies which should be regularly usable during January for four long-distance circuits running in different directions from this country. (All times are G.M.T.). In addition, a figure in brackets is given for the use of those whose primary interest is the exploitation of certain frequency bands, and this indicates the highest frequency likely to be usable for about 25% of the time.

Montreal :	0000	7 Mc/s	(11 Mc/s)
	1000	9 "	(12 "
	1100	11 "	(15 "
	1200	17 "	(23 "
	1300	21 "	(27 "
	1400	26 "	(33 "
	1700	21 "	(28 "
	1800	17 "	(24 "
	1900	15 "	(22 "
	2000	11 "	(17 "
	2100	9 "	(14 "
	2300	7 "	(10 "

Buenos Aires :	0000	9 Mc/s	(13 Mc/s)
	0400	7 "	(11 "
	0700	9 "	(16 "
	0800	15 "	(20 "
	0900	21 "	(28 "
	1000	26 "	(32 "
	1900	17 "	(25 "
	2000	15 "	(20 "
	2200	11 "	(16 "
	2300	9 "	(13 "

Capetown :	0000	9 Mc/s	(13 Mc/s)
	0200	7 "	(11 "
	0600	15 "	(20 "
	0700	21 "	(32 "
	0800	26 "	(34 "
	1500	21 "	(29 "
	1800	17 "	(25 "
	2000	15 "	(22 "
	2100	11 "	(16 "
	2300	9 "	(13 "

Chungking :	0000	7 Mc/s	(10 Mc/s)
	0500	9 "	(14 "
	0600	15 "	(21 "
	0700	17 "	(24 "
	0800	21 "	(29 "
	0900	26 "	(33 "
	1100	21 "	(27 "
	1200	15 "	(19 "
	1300	11 "	(15 "
	1500	9 "	(12 "
	1700	7 "	(10 "

## SELECTIVE AMPLIFIERS

**D**ESIGNED as an A.C. bridge amplifier, the Type GSA1 made by Mullard Electronic Products, Century House, Shaftesbury Avenue, London, W.C.2, is designed for the detection of harmonics in conjunction with a suitable indicator. A frequency range of 16 c/s to 200 kc/s is pro-

vided in five steps and the response is 20db down at 1.5f and 0.8f, and 40 db down at 2f and 0.5f, where f is the resonant frequency. Two feedback networks of the twin T null type are employed and give negative feedback of unwanted frequencies. The amplifier is designed for operation from A.C. mains (110-245 V, 50 c/s) and the dimensions are 19in by 7in by 10in for rack-mounting. The price is £82.

Mullard selective amplifier type GSA1. The controls include two variable frequency scales, frequency selection switch and gain control.

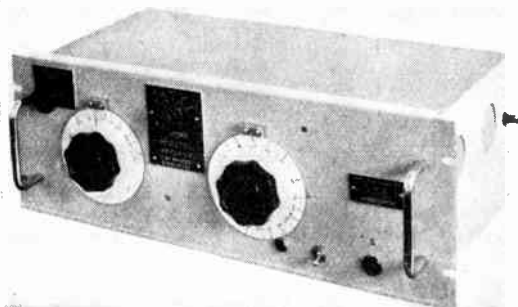

Ionosphere storms are not very frequent in January, but if they do occur during period of darkness they are very troublesome on account of the already very low ionisation prevailing during the winter night. At the time of writing it would appear that such disturbances are more likely to occur within the periods 4th/5th, 12th/14th, 17th/19th, 23rd/24th, than on the other days of the month.

## PORTABLE DISC RECORDER

Details of the H.M.V. Model 2300H

THE specification of this recording equipment is of a high standard and makes it suitable for professional and commercial applications as well as for home recording. It is divided into three units, the heaviest of which weighs 72½ lb; the total weight is 125 lb.

The recorder unit consists of an 18-lb balanced turntable, belt-driven by a 1/20 h.p. motor. Blanks from 5in to 13½in diameter can be accommodated. A protected lead screw gives a groove pitch of 95 to the inch, and there is a safety device which automatically lifts the cutter and stops the traverse at the minimum cutting diameter. A scale is provided which indicates the correct starting position for records of various diameters. The traverse clutch is engaged and the stylus is lowered on to the disc by a three-position lever.

The recording head is of the moving-iron type, and is said to have a frequency response flat within 3db from 50 to 8,000c/s. An adjustment is provided for depth of cut, and the head is rotatable to facilitate the insertion of a fresh cutter. A small lamp is mounted on to the underside of the traverse arm to illuminate the disc in the vicinity of the stylus.

A lightweight play-back pickup is provided, and a swarf brush and groove inspection lens are included. The recorder unit also houses the power pack, the output of which is taken to the amplifier and control unit through a 10-way cable.

There are four stages in the amplifier, which delivers 8 watts from the push-pull output valves. Bass cut and top lift tone controls are provided, and a 4-way master control switch has positions for recording either from the low-impedance

ribbon microphone supplied, or from a high-impedance source; also direct play-back, or "public address" using the microphone and monitoring loudspeaker. A jack is also provided for high-impedance monitoring headphones.

The loudspeaker unit is fitted to carry the microphone and all connecting cables. The case forms a baffle for the twin elliptical permanent-magnet loudspeaker.

Operation of the equipment should present no difficulty, and the monitoring meter gives reliable indication of the recording level. An instruction book gives useful general information on the art of cutting good records, and when a little experience had been gained in controlling the swarf and learning the importance of a clean stylus, etc., we were able to produce some excellent noise-free recordings.

The makers are the Gramophone Company, Hayes, Middlesex, and the price of the complete outfit is £235, including tax.

### MEASURING RECEIVER PERFORMANCE

MUCH useful technical information on methods of checking the performance of radio receivers and television sets is contained in a booklet "Radio Measurements," issued by Marconi Instruments, Longacres, St. Albans, Herts. It assumes that faults have been traced and cleared and that it is desired to check that the performance has been restored to the required standard. Chapters are devoted to each of the following instruments and their applications:—Type TF888 receiver tester, Type TF894 audio tester, Type 887 valve voltmeter, Type TF899 valve millivoltmeter, and Type TF913 F.M. receiver tester.

Copies of the booklet are available to servicemen who apply on business note-paper.



H.M.V. Model 2300H disc recorder. For transport, the equipment packs into three carrying cases.

## NEW ECONOMICAL A Two-Purpose Loudspeaker which Saves Capital Expenditure



Pat. Applied For



Always there has been the difficulty in many applications, whether the Horn type loudspeaker with its high power possibilities, or the Cone type with its greater frequency range for the same size, is to be used for any particular installation. Both types have their advantages and limits. This new design by F.I. enables the major components of two types to be interchangeable. Main flare, fixing device and assembling nut are common to either of two assemblies. Add centre section and L.S.7. unit for a complete re-entrant horn type 42 REH, or add PAC 6 and special mounting to have a cone and directional baffle system: 42 RC.

Whichever type suits you most, you have the opportunity of acquiring the components for the alternative assembly when you are in need of them.

**F.I. for P.A.**  
HORN LOUDSPEAKERS  
CONE LOUDSPEAKERS  
MICROPHONES

**FILM INDUSTRIES LTD.,**  
60, PADDINGTON STREET, W.1

Telephone: WELbeck 2385

# Unbiased

By FREE GRID

## "Respite Finem"

I WAS greatly moved by the argument put forward by the unknown scribe in the October issue of *Wireless World* in defence of 405-line television; so much so, in fact, that I feel like addressing to him a suitable paraphrase of King Agrippa's famous remark. The trouble is, of course, to get the television-buying public to believe it. Most of them dwell in technical darkness and are an easy prey to the suggestion, which has undoubtedly been put into their minds by writers who ought to know better, that definition is directly proportional to the number of scanning lines and to nothing else. It is going to be a hard job to persuade them otherwise. The trouble is that the argument of "More lines, more detail" sounds so very logical on the face of it.

The whole thing is, of course, analogous to the idea which listeners got into their heads—or had put there—when broadcasting began, that range was directly proportional to the number of valves in their sets. The result of this was that no set manufacturer dare market any multi-valve receiver which did not by hook or by crook bring in an earful of strange noises.

Some semblance of stability was usually achieved in such sets by positively biasing the so-called H.F. valves, with the result that



A Radio Nero.

they became virtual passengers. I well recollect that one of the less scrupulous manufacturers almost made a fortune by adopting my suggestion that he make some of the valves real passengers by bypassing them altogether and feeding the input direct to the detector. In this manner he saved the expense of so-called potentiometers and other adjuncts to positive bias and actually increased the set's range by enabling the reaction control to be given its head unhampered and

unhamstrung by damping devices. His advertisements were, I need hardly say, refused by *W.W.*, for obvious reasons, despite his specious arguments about the end justifying the means since his sets undoubtedly gave better results than those of manufacturers who remained within the fold. Unfortunately for the cause of morality he prospered, despite the words of the psalmist, and had the temerity to offer me a substantial cheque as commission, which, of course, I promptly refused.

To return to 1948, however, there is in my opinion only one way to deal with this insidious idea of "More lines, more detail." It is, to take the bold course and appear to yield to it by announcing that from a certain date B.B.C. transmissions will be on a thousand-line system and that technicians would call at viewers' homes to alter existing sets for a small fee. The technicians could then be instructed to take the back off each set and fiddle for an hour or so. Surely that shouldn't be too difficult in these days.

## Heresy Column

I JUST hate to be a spoilsport and strike a discordant note in the Hallelujah Chorus that is being sung by radio writers everywhere over the provisions of the Wireless Telegraph Bill but, although, like Galileo, I may be in a minority of one, I cannot for that reason cast truth aside and bow to the popular clamour. Rather than eschew truth and live, I would have my say and then step into the waiting tumbrel with a quiet mind and a stout heart.

Let me say first that as a lover of Anglo-Saxon I am glad that the P.M.G. follows the example of *Wireless World* and retains the good old English word "wireless" instead of the alien "radio." I am sorry, however, that the equally alien "telegraphy" is retained and this hybrid perpetuated. One might with equal lack of justification call this journal "*Wireless Spheroid*." Since the act makes "telegraphy" embrace telearchy, telegoniometry and "Uncle Tom Cobley and all" why not turn the word "wireless" into an all-embracing noun as most listeners do anyway?

But my great complaint concerns the "interference" section of the

Bill for it makes no mention of what is by far the worst and most offensive form of interference to the peaceful enjoyment of broadcast listening. Since it does not mention it, I take it that such interference will be allowed to go on unchecked. I rejoice with "Diallist" that the P.M.G. will no longer be tied down to ineffective polite requests so far as *electrical* interference is concerned but in the matter



The shadow of "the Widow."

of *acoustical* interference the P.M.G. will, I take it, still be fettered and forced to rely on the feeble and ineffective bleatings made during summer months by the B.B.C. regarding this nuisance.

This omission from the Bill means that the sufferer from this menace has only one legal weapon left to him and that is to buy a much larger amplifier and loudspeaker than the man next door and thereby achieve the results so graphically suggested by the line of the famous hymn where the author tells of volume so tremendous that it "drowns all music but its own."

Yet another injustice in the Bill is that by obtaining powers to control reflection as well as radiation the P.M.G. stops my enjoying my hitherto undoubted legal right of installing without a licence a private telegraph service by setting up a reflector near a V.H.F. broadcasting station and using and modulating some of the available energy. Almost the only freedom left is for me to sit up in the gallery of the House and warm my coupon-starved body with the hot air rising so freely from the floor.

But come, the driver of the tumbrel is getting impatient and so are the ghoulish mob gathered round the foot of the steps leading up to "the widow" judging by the angry murmur I hear in the distance.



## LETTERS TO THE EDITOR

Trade Delays ♦ Sound Reproduction Level ♦ Thoughts on the Copenhagen Plan ♦ Bi-directional Aerial ♦ Voltage Multipliers ♦ Dial Lamps ♦ Are Signal Meters "Useless"?

### Export Drive

**I**N my report of the R.C.M.F. October show in Stockholm (your December issue) I mentioned the need for more information. May I add a footnote to my report? Messrs. X have now written to tell me that their catalogue will appear in February. My old friend Y still has not sent me the samples he promised within a week: I even offered him cash—sterling or kronor. This sort of thing really will not sell components, even to a willing buyer.

YOUR CORRESPONDENT.  
Stockholm.

### "Siting" of Radar Sets

**F**OR twenty years I have sat at "Free Grid's" feet and have listened, with wonder and admiration, to his views on many subjects: but when he waves an angry umbrella at the word "sited" (*Wireless World*, December, 1948). I must draw my own gamp in its defence.

It was found early in the war that the accuracy of elevation measurement on the radar set GL Mk. 1 (with Bedford attachment) was dependent on the irregularities in the surrounding terrain. Later, on 200 Mc/s, it was found that the amount of clutter on Early Warning sets depended greatly on the positioning of the set in relation to the natural contours of the ground. Later still, on 3cm, it was found that a change of position of the radar set of only 20 yards could turn a bad, cluttered presentation into a good one.

Some concise word was required that should mean "choosing the spot of ground that best suits the radar set." *Location* was already in use with another specialized meaning; *position* and *place* were in general and ill-defined use; *site* had the right connotation of dependence on terrain, and was adopted.

Its chief disadvantage was the possible confusion between "siting trials" and "sighting trials."

If the Southend equipment was put on the roof regardless of technical requirements, then I agree with "Free Grid" that there are better words; but if its position was

deliberately chosen with care for field of view, for avoidance of local horizons and for freedom from clutter, then Site is Right.

IAN B. R. CATER.  
Aberporth, Cardiganshire.

### "Scale Distortion—Again"

**I** APPEAR to have trodden somewhat heavily on "Cathode Ray's" corns (*Wireless World*, November) by saying that in his article in the March 10th, 1938, issue he "had been advocating remedies for scale distortion" and that he visited the Queen's Hall "... to prove that there was such a difference between the actual and reproduced levels of sound that a weighting network was necessary...."

I should have mentioned that I had also been reading his original article of September 24th, 1937, in which he said about scale distortion: "Is there any way of getting over the difficulty? I know of no automatic this or that which can be fitted into the receiver to do the job. The only solution is to make intelligent use of a fairly flexible system of tone control." Also in the same article appears: "But there is still one condition, and an awkward one.... The programme must be reproduced at the original volume. When a military or dance band, a symphony orchestra or a cathedral organ are playing with all their might, the original intensity of sound must be reproduced in the home listening room." In the March 10th, 1938, article describing the Queen's Hall measurements he said: "I will admit right away that there was a closer agreement between the original loudness and what could be done with an ordinary receiver at home than I had supposed."

In other words, he went to the Queen's Hall to prove his article of September 24th, 1937, correct in all aspects, but was compelled by the results to modify his beliefs on the total power required for comparable pressures in the home. To me the most valuable part of "Cathode Ray's" work was the establishment of 1½W for this power level instead of the 15 to 18W normally quoted.

# And now the STANDARD RACK

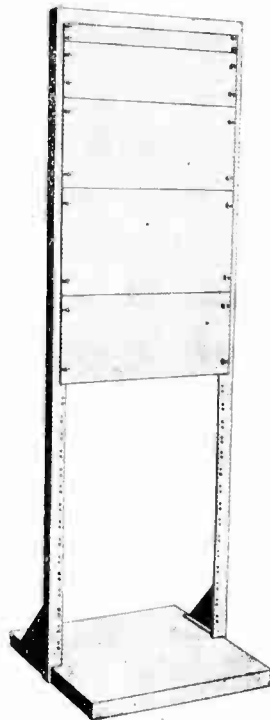

Latest edition to the Imhof range of cases is the new Standard Rack and Panel assembly. Of heavy gauge mild steel angle, it is strongly constructed with welded corners, and finished in grey stove enamel. Standard 19" Rack panels of ¼" thick mild steel plate are available in four sizes:—1½", 5½", 8½" and 10½" deep finished in grey stove enamel.

Prices:—  
Standard Rack frame 5' 6" high £4 15s. 0d. each  
Panels 19" x 10½" ... .. 11s. 3d. ..  
" 19" x 8½" ... .. 8s. 9d. ..  
" 19" x 5½" ... .. 5s. 7d. ..  
" 19" x 1½" ... .. 3s. 2d. ..  
Plated chassis with associated mounting brackets 15s. per set

## IMHOF'S

PRECISION BUILT INSTRUMENT CASES  
112-116, NEW OXFORD STREET,  
LONDON, W.C.1

Telephone: MUSeum 5944

Letters to the Editor—

I do not therefore feel that "Cathode Ray" has any ground for such strong statements as misrepresentation and corruption, but I leave it to your readers to judge. I may have been guilty of wrong emphasis; if so, I humbly beg his pardon.

H. S. CASEY.

Beckenham, Kent.

"Metering Programme Appeal"

I DO not think that "Diallist" (your December issue) can be accused of exaggeration when, after an outline of the Danish programme appeal checking system, he states that "The system has a good few limitations." Surely the domestic wireless receiver is not the only type of electrical equipment which causes harmonic distortion in the mains? What of accumulator charging rectifiers, etc.?

Also, will not the amount of distortion produced depend largely upon the type and condition of the receiver? There must be a big difference between the results obtained from A.C. and A.C./D.C. sets, for example.

N. MORLEY.

Cranwell, Lincs.

Copenhagen Broadcasting Plan

THANKS are due to *Wireless World* (November) for publishing such a complete survey of the Copenhagen wavelength plan.

While the completion of any such plan obviously represents a very considerable achievement in present conditions, a preliminary study suggests the following reflections:—

(1) The number of listeners who tune to foreign stations has progressively declined, due largely to the increasing difficulty of receiving them satisfactorily, and the listener who wishes to hear stations other than those in his own country should have a rather better chance under the new plan than at present.

This applies especially to the long waveband, which has been almost useless to many people for some years. Further, most countries have at least some clear channels in the medium waveband.

(2) Certain countries seem to have emerged from the conference with much improved allocations, in some cases out of all proportion to the state of their broadcasting development.

(3) The increasing tendency towards still higher powers will cause some misgivings, particularly in respect of the long-wave transmitters. At the present time, "Luxembourg effect" practically ruins

reception of a few otherwise satisfactory medium-wave stations on the Continent, and with powers increased to 400kW and over, this seems likely to become a serious problem.

(4) Surely the tardy allocations to Germany must cause trouble in the long run; without entering into politics, Germany has had one of the most developed broadcasting systems in Europe, and also a high proportion of licence holders. The allocation of only two channels to each zone (both shared and one below 200m) with a third for the occupying forces, seems bound to lead to "piracy" at some future date.

(5) The continuance of the B.B.C. European Services with anything like the present coverage would appear to be impossible with the new allocations.

G. H. STURGE.

Welwyn Garden City, Herts.

New Aerial

A SHORT-WAVE receiving aerial developed in our laboratories by T. S. Popham, for use overseas, may be of interest to your readers.

The problem posed was that of providing radio programme inputs for a rediffusion system in Trinidad from transmitters located at London and New York. An obvious solution would have been to provide rhombic aerials; double diversity reception requiring a total of four such aerials. However, the amount of space available at the receiving site would not permit of this arrangement and an alternative was devised.

This new bi-directional aerial is based upon the following appreciation:—

The radiation pattern of a single

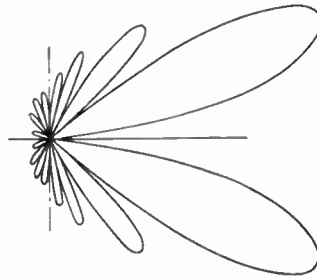

Fig. 1

straight horizontal wire carrying a progressive wave is of the form shown in Fig. 1, the pattern being a figure of revolution about the wire as axis. If now a second wire be placed parallel to the first in the same horizontal plane and fed in opposite phase a new pattern will arise due to the addition of the

effects of each individual wire. By adjusting the distance between them suitably, a state can be achieved where reinforcement of the radiation takes place in four directions lying in the cone of maximum radiation of the single wire and being symmetrically disposed on either side of the horizontal and ver-

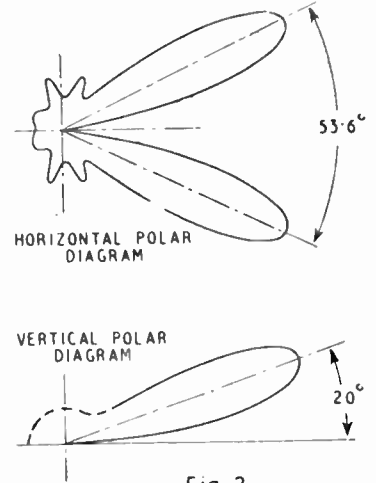

Fig. 2

tical planes through the common axis of the wires, while cancellation will take place in the vertical plane through the axis of symmetry of the wires. If, further, these two wires are placed horizontally above a "perfect" earth and their height suitably adjusted, cancellation will take place in the horizontal plane while reinforcement takes place in two directions having the same angles of elevation and lying on either side of the axis of the wires. This arrangement exactly met the requirements.

If the lengths of the wires are reduced, the angle between the two lobes increases and the lobes themselves become broader, the radiation pattern tending to a figure-of-eight form. Thus for reasonable directional properties and gain, the angle between the two lobes must not exceed 90°. If the lengths of the wires are increased the angle between the two lobes is reduced and the lobes become longer and narrower. Hence the only limitation to reduction of the angle between the lobes is that of the physical size of antenna which can be tolerated, while the performance of the antenna will steadily improve as the length is increased.

Experiments made with a model working on a wavelength of 9cm gave the radiation pattern shown in Fig. 2. In practice the two wires are fed in "push-pull" and terminated by a resistance so that there is no reflection at the far end.

The pattern will, of course, be modified by the presence of an imperfect earth and by the exact details of the termination, but the above example gives a simple picture of the mode of operation of this new aerial.

R. P. GABRIEL, Chief Engineer,  
Central Rediffusion  
Services, Ltd.  
London, S.W.1.

### E.H.T. for Oscilloscopes

MANY readers must have been intrigued, as I was, by the article in *Wireless World* for May, 1948, describing voltage multiplier circuits. Faced with the problem of providing E.H.T. for a modified version of the oscilloscope mentioned in the same issue, I decided to use a multiplier for the purpose. The straightforward Cockcroft-Walton circuit was preferred for its simplicity, and as the input voltage was to be 250V A.C., a three-stage network was envisaged. Obviously a unit bulkier than the "Westekt" was inevitable, because the latter has to supply only the beam current for a television tube, whereas an oscilloscope calls for the rather heavier potential-divider current also. Hence larger capacitors than those used in the "Westekt" were indicated.

Accordingly 1- $\mu$ F paper condensers and 30-mA type selenium rectifiers (both Government surplus) were employed in the circuit shown;

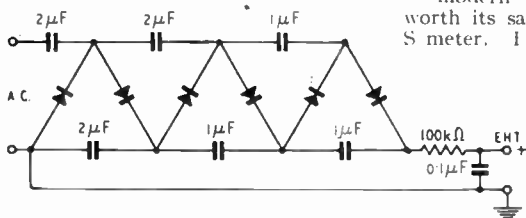

the smoothing condenser, of course, was a high-voltage type. The whole assembly, mounted on a paxolin base to insulate the condenser cases, measured 12in x 5in x 3½in. The total cost was less than £1.

The smoothed output voltage fell from 2,100V at no load, to 1,500V for a load current of 1.5mA. This denotes a regulation (inclusive of smoothing) of approximately 2% per 100  $\mu$ A change. The ripple voltage at the multiplier output, with 1.5mA load, is shown by the formulae to be about 10%; the smoothing will reduce this to 1.5%. Hence the regulation and ripple are rather better than they need be. This, however, does not permit reduction of the reservoir capacities, since even with 1mA drain the output falls by 400V from the maximum.

With an input of 350V A.C., a two-stage multiplier should give approximately the same output, and improved regulation. C.A.R.

### Series Capacitor Heater Circuits

WHEN in my letter appearing in the October issue of *Wireless World*, I drew attention to the limitations of use of capacitors, I made no reference to dial lights.

These, like all other components, have their drawbacks which I enumerate as follows:

(1) Designed for intermittent use in torches, these "flash lamp" bulbs have a nominal life of only ten hours under conditions of continuous operation at full rated voltage.

(2) Such lamps operate at incandescence whereas valve heaters function at bright red heat.

(3) This dissimilarity of operating conditions make the important consideration to be the voltage across the lamp rather than the current flowing through it.

(4) The peak voltage across the lamp, for even short periods, should be restricted to roughly 1.25 times the rated voltage if a reasonable life is to be obtained.

J. PARKINSON.

Uxbridge, Middx.

### Value of an S Meter

IT appears an accepted fact that no modern communications set is worth its salt unless fitted with an S meter. I have often wondered if this fitment has any real value.

As an amateur transmitter it has more than once puzzled me why a local station should give an S5 report "according to the meter" which another 30 or 40 miles away upsets soon after by reporting that it is an S8 signal. According to the accepted standard that is something like 8db difference in signals.

The type of aerial must make a vast difference while if S1 on the meter is taken as receiver noise level, the design of the pre-selector stages must play a significant part.

Four or five gradations of signal strength should suffice, not nine, while for telephony a report such as loud and clear is more useful than S8 which incidentally is only the carrier level and takes no account of the modulation depth. Is there any justification for the S meter, apart from a modified form for telegraphy reports?

G2MC

Pinner, Middlesex.

# M. WILSON LTD

Mr. and Mrs. Wilson  
and Staff wish all  
Wireless World  
readers a  
Merry Christmas and  
a Happy New Year

### Now available from stock

A NEW TUNING H.F. UNIT, 6 wavebands 5-2000 metres with High Gain R.F. stage.

### Brief Specification

1 R.F. stage, F.C. with separate Oscillator, 1 stage of I.F., using our new I.F. Transformers, iron cored, permeability tuned, with a Q of 155, feeding into second detector of the cathode follower type, using our new Audio filter unit.

Fitted with its own power pack and smoothing ready to attach to any good L.F. Amplifier

### Controls

Main tuning control, no band-spread required. Sensitivity control working on the first R.F. valve. I.F. gain control with selectivity control incorporated. 6 wave-band switch.

The chassis is built of 16 s.w.g. Aluminium, rigid corners. Box type 6 wave-band coil unit, fitted with our latest iron cored, high Q coils, completely screened.

A.V.C. Magic eye tuning indicator. Measurements 9½in. x 8½in. x 11in. high.

A limited supply is available from stock.

We honestly believe this to be the finest Tuning Heart on sale, for sensitivity, selectivity and the High Fidelity obtained on the Medium waveband, due in measure to the cathode follower detector valve with its distortionless output, in conjunction with its filter system.

### Price on application

As above but with three wavebands, Long, Medium and Short (16-50). Not available in Kit form.

### BLUE PRINT SERVICE

Full size practical (above and below chassis) and theoretical blue prints for circuits of :  
6 wavebands with 2 R.F. stages, 14 valves, 15/- per set ; 6 wavebands with 1 R.F. stage, 9 valves, 7/6 per set ; 3 wavebands with Aerial and Osc., 5 valves, 7/6 per set ; 3 wavebands with A. and Osc. Battery, 4 valves, 1.4v., 7/6 per set ; 2 wavebands with A. and H.F. T.R.F., 5 valves, 7/6 per set.

Audio Frequency Filter Choke Unit. Size 3in. x 2in., 15/-.

**307, HIGH HOLBORN.**  
LONDON W.C.1. Phone: HOLborn 4631



# RANDOM RADIATIONS

By "DIALLIST"

## *New Magnetic Alloy*

A NEW MAGNETIC ALLOY, which seems to possess remarkable qualities, was announced during this autumn's meeting of the British Association. It is a lineal descendant of the nickel-aluminium-cobalt-iron family, but it differs from its predecessors in containing a minute percentage of the rare metal niobium. It appears that an alloy containing the above-mentioned four basic ingredients plus a small amount of vanadium was produced for use in jet propulsion engines, in which it proved most successful. Then it occurred to someone to investigate its magnetic properties and it was found to have unexpectedly high coercivity. The Permanent Magnet Association and the Electrical Research Association collaborated in experiments and it was suggested that even better results might be found if niobium, which belongs to the same group in the periodic table of the elements, were used instead of vanadium. This has proved to be the case and in the new alloy, of entirely British origin, we have a metal which seems superior to anything in the world in its resistance to demagnetization. The old idea that iron was capable of only temporary magnetization and that steel was required for permanent magnets must go by the board. Like Alnico, the new alloy, which doesn't yet seem to have been given a name (how would "Niobalnic" do?) can't be classed as a steel; for, though it consists of some 56 per cent of iron, it has no carbon content.

## *Sea-spray Ducts*

A CURIOUS EFFECT has been noticed recently in some of the radio links used to enable the telephone service to span wide estuaries or to connect small islands with the mainland. The E.H.F. transmitters and receivers and their aerial systems are usually designed for ample coverage of the distances involved but not for any greater range. It was found that at times some of the signals could be received strongly at distances two or three times as

great. This freak effect has not yet been completely investigated; but the data so far obtained appear to show that rough water caused by high winds and an air temperature some degrees below that of the water form the combination of weather conditions in which reception at phenomenal distances is most likely to occur. In such circumstances the air above the surface of the water may become laden with salt spray up to a height of many feet above the surface of the water. It is suggested that in this way ducts, or wave-guides, may be formed in the air which have bending effects on centimetre waves very similar to the summer-time atmospheric ducts which are often responsible for reception at ranges far beyond the quasi-optical.

## *U.S.A. Television Standards*

IT IS EXCEEDINGLY difficult to obtain any reliable information concerning the ranges of modulation frequencies sent out by transmitting stations or faithfully dealt with by receivers in the United States. This is perhaps understandable in the case of transmitters, which have been installed and are being operated by a number of different bodies. So far as I can discover there is no standard adopted—or at any rate aimed at—by all. Each transmitter is erected and worked as a commercial proposition which must pay its way, either directly by the advertising revenue brought in, or indirectly by promoting the sales of television receivers made by those who finance it. The quality of the transmission is, therefore, likely to depend largely on the capital that its owners are willing to invest in the station and the extent of the possible short-term losses that they are prepared to stand with a view to long-term profits. As regards televisions, manufacturers are largely content to lay stress on the wonderful performance of their products, without giving data about the bandwidth that can be handled by their amplifying stages. If my calculations are right, the modulation frequency range required to produce

a 525-line, 30-image-per-second display with a balance of horizontal and vertical definition as good as that of our 405-line, 25-image pictures is in the neighbourhood of 5.5 Mc/s. I make bold to doubt whether any normal U.S.A. transmitter or any receiver sold in the ordinary way for home use can deal with anything like this enormous frequency range.

## *A Form of Astigmatism*

Unless the horizontal and the vertical definition, or "sharpness" are evenly balanced the result is to produce on the screen of even the best designed and most carefully corrected C.R.T. what amounts to a form of astigmatism. The eyes of those who suffer from ocular astigmatism cannot focus an object in both horizontal and vertical axes simultaneously. If you suffer from such astigmatism, your oculist prescribes glasses which correct it by giving a shorter (or longer) focus at the angle at which the focus of Nature's optical system is too long (or too short). I'm not suggesting that the optical axes are at right-angles to one another; the angle may be quite small. You can see what it is in your own case, if you have astigmatism, by looking at your oculist's prescription. But in television the two axes are at right-angles and, though the analogy isn't exact for this reason, an image with better vertical than horizontal definition may be likened to what a person suffering from optical astigmatism sees when he views the world without the help of glasses.

## *When is a Circle not a Circle?*

One gathers that linearity is not the strong point of U.S.A. television in general. Here's a quotation from the American journal *Radio-Electronics* which is illuminating. An article telling servicemen how to make the best use of the test patterns which some stations radiate says:—

"Many TV owners are extremely fussy about having the circles exactly round. Some of them check the circles by holding a small plate in front of the screen and others measure the wedges to see if they are of equal lengths. In some TV areas this makes life extremely difficult for the television technicians,

because it is an unfortunate fact that some stations do not transmit good linearity. Also, the linearity may be different from one camera to another. In one particular city, if the receiver is adjusted so the test-pattern circle is round on the first station, the second station will be egg-shaped vertically and the third station will be egg-shaped horizontally . . ."

The test patterns are nothing like so elaborate as those sent out by the B.B.C. One understands why "in a few test-patterns all circles are intentionally omitted." Our transmissions are pretty good as regards linearity; but I'm far from claiming that all receivers are equally blameless. Perhaps it's fortunate for servicemen that few of our viewers display fussiness about the roundness of circles!

### Good Luck to It

ONE HOPES THAT the clauses of the Wireless Telegraphy Bill which deal with interference won't be so toned down before the Bill becomes the law of the land that they will become more or less ineffectual. If television is ever to have the success it deserves as a form of home entertainment, the P.M.G. must be armed with powers sufficient to enable him to prevent the radiation of interference with its reception. The effects of interference on television and broadcast reception can be so devastating; the cure is, as a rule, neither difficult nor costly. The rather pumped-up stuff about the invasion of privacy struck me as just silly. After all, the men who read the gas and electricity meters already have a right of entry into the home and no one minds that. If you have a telephone, the Post Office people are entitled to take a look at it if they suspect either that it is out of order or that you have fitted unauthorized gadgets to it. Should you create a nuisance by keeping pigs under your next-door-neighbour's back windows, you'll have the sanitary inspector round fast enough. Then why shouldn't the P.M.G. inspector descend upon you, if you create a nuisance by spoiling the broadcast or television reception of your neighbours? A while ago someone invented the silly word "snooping." It has since been run to death, and, having become what A. P. H. would call a "witch word," should be avoided by sensible people.

# BULGIN SWITCHES

### Glazed-Porcelain-Body-Types :

S. 53	
S. 55	

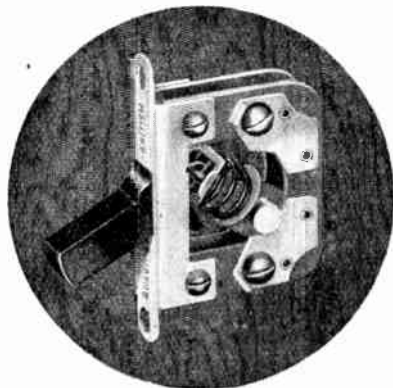

### S.R.B.P.-Board-Body-Types :

S. 393	
S. 395	

*Every Bulgin Product  
Guaranteed*

Q.M.B. roller-contact-Toggle or Lever Switches, with normally-black polished moulded (Thermo-setting) dollies, rapid Q.M.B. spring action, 6 B.A. terminals for connections (max. cable acceptance 16 s.w.g. or 23/36 or equiv.) and contacts heavily Ag.-plated. Frame and spring heavily rustproofed. Fixing by two .187"  $\phi$  holes at  $1\frac{3}{16}$ " symmetrical crs., with dolly hole  $\frac{1}{2} \times \frac{5}{16}$ " (60-65° chamfer for thick panels, or equivalent parallel hole). Rated (50 c/s) 4A. (on-off) or 3A. (C-O) @ 250V. (max.) ~ 8A. and 6A. @ 2-6V. (min.), or intermediately. (Peak current ratings). Type-tested for 25,000 ops. (15/min.max.) = NEARLY 70 TIMES A DAY FOR A YEAR!

*"The Choice*



*of Critics"*

**A. F. BULGIN & Co. Ltd., - BARKING - ESSEX**

# RECENT INVENTIONS

A Selection of the More Interesting Radio Developments

## Intervalve Couplings

THE diagram shows a pair of I.F. amplifiers connected by a network which allows the coupling to be increased without altering the tuning of either of the circuits, though causing the peaks of their frequency response curves to move further apart.

Coupling is controlled by means of a switch S, and three star-connected condensers, of which C<sub>2</sub> and C<sub>4</sub> are equal in value, whilst C<sub>3</sub> is always common to both the valve circuits. With the switch in the full-line position, the anode circuit L, C<sub>1</sub>, C<sub>2</sub>, C<sub>3</sub> of the first amplifier is coupled to the grid circuit L<sub>1</sub>, C<sub>5</sub>, C<sub>2</sub>, C<sub>3</sub> of the second amplifier through the common condensers C<sub>2</sub> and C<sub>3</sub>. When the switch is moved over to the right, the tuning is unaltered, because the condenser C<sub>4</sub> is equal in value to C<sub>2</sub>. The coupling between the two circuits is, however, changed from that due to the condensers C<sub>2</sub> and C<sub>3</sub> in series, to that due to the condenser C<sub>3</sub> alone, the extent of the change, and the resulting shift of the resonance peaks, being deter-

mined by the comparative values of the two condensers concerned.

particularly at close range. The application of gain control to the amplifiers offers one possible remedy, though it is difficult, in practice, to fix an optimum value for the control. If the gain is high it makes it easier to detect an aircraft at long range, though harder to follow once its echo comes inside the reach of the accentuated "ground clutter." On the other hand, if the gain is kept low the intensity of the ground echoes is certainly reduced, but so, too, is the distance at which it is possible to detect an approaching aircraft.

According to the invention, the amplifiers are subjected to a gain control which changes from a fixed high value during the period of one time-base sweep, to a fixed low value during the next sweep, and so on, in alternate cycles. The gain-control voltages are developed by a known type of multi-vibrator circuit, which is triggered from one to the other of its two conditions of stability by pulses derived from the time-base generator.

R. H. A. Carter. Application date, September 14th, 1945. No. 600494.

The purpose of the coil L<sub>1</sub> is to feed back to the grid from coil L<sub>1</sub> the necessary fraction of voltage required to

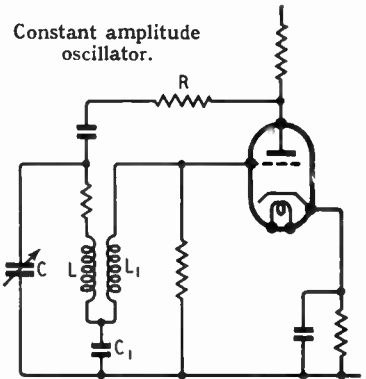

maintain the grid-cathode potential constant at all operating frequencies. A general formula equating the circuit values necessary to ensure this result (including the resistance of the coil L and its turns ratio to the coil L<sub>1</sub>) is given in the specification, together with numerical examples for certain specified ranges of frequency.

The General Electric Co., Ltd.; D. W. Berry; and R. Mawson. Application date, June 8th, 1945. No. 599149.

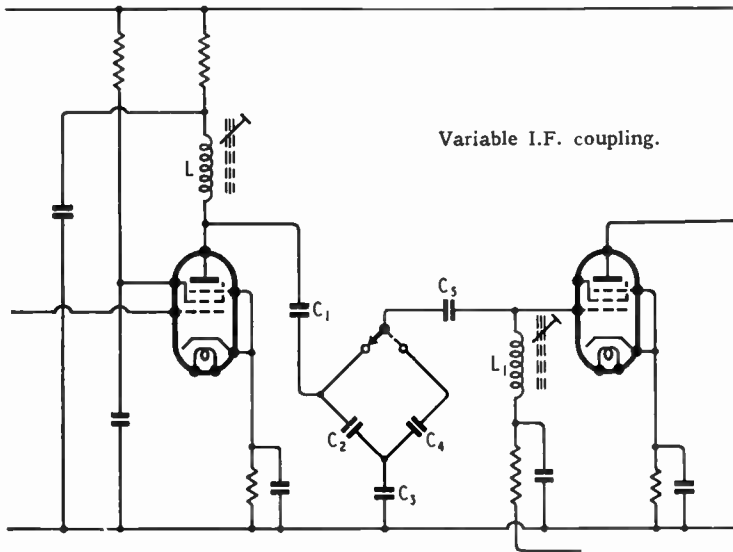

Variable I.F. coupling.

mined by the comparative values of the two condensers concerned.

Murphy Radio, Ltd.; P. C. Cullen; and C. C. Holmes. Application date, November 24th, 1944. No. 598662.

## Radar Indicators

WHEN a land-based installation is used for detecting the approach of aircraft, the echoes returned from nearby fixed objects, such as local buildings and hills, are often sufficiently powerful to mask the traces given by the craft under observation,

## Oscillation Generators

THE circuit shown is characterized by the property of generating oscillations of substantially constant voltage over a considerable range of frequencies.

Feedback occurs through a resistance R connected in series with the main oscillatory circuit. This is connected across the grid, and consists of a tuning condenser C in parallel with a two-part inductance comprising a main coil L, coupled to a grid coil L<sub>1</sub>, both in series with a fixed condenser C<sub>1</sub>.

## Waveguide Radiators

A RECTANGULAR waveguide with suitably flared ends is commonly used for the directional transmission and reception of short-wave signals, particularly in combination with a parabolic reflector or mirror. In practice it is found that a certain amount of energy is reflected back from the mouth of the flare or horn. This sets up standing waves, which give rise to mis-matching and other losses.

According to the invention, one or more reactive elements, preferably in the form of narrow metal strips or bars, are placed across the aperture of the horn, close to the mouth and in contact with selected sides. These act as variable reactances and can be adjusted to provide the terminating load or surge impedance required to prevent reflection losses.

E. Wild and C. S. Wright. Application date October 10th, 1945. No. 601280.

The British abstracts published here are prepared with the permission of the Controller of H.M. Stationery Office, from specifications obtainable at the Patent Office, 25, Southampton Buildings, London, W.C.2, price 2 - each.



# Standard Radio Ahead of Radio Progress



1922

500 WATTS

1948

200 kW

SINCE the earliest days of radio broadcasting *Standard* have set the pace in the development of one of Britain's largest industries . . . indeed, the story of broadcasting is the story of *Standard Radio*.

One of the six guarantor members of the British Broadcasting Committee, *Standard* in 1922 were responsible for the installation and operation of station 5IT (Birmingham). Since that time their countless improvements in design, valves, and components, and in the technique of high quality broadcasting is reflected in B.B.C. installations to extend existing services on the Home and Overseas programmes, and in similar transmitters supplied to administrations throughout the world.

*Standard* installations for the B.B.C., include six Short Wave broadcasters at Skelton, the world's most powerful station, and two C.M.10 high-quality transmitters, first post-war radio broadcasters, and first of a series of new designs and power ratings in the *Standard* range.

**Standard Telephones and Cables Limited** Radio Division

(Regd. Office: Connaught House, Aldwych, London, W.C.2.)

OAKLEIGH ROAD, NEW SOUTHGATE, LONDON N.11, ENGLAND

# COULPHONE RADIO VALVES

**10,000 IN STOCK**

Send for the valve you want and have it by 'Return of Post.' E.O.T. Prices. Valves sent C.O.D.

**WILLIAMSON OUTPUT TRANSFORMER.**

"LAB" Precision Job to Author's Specification. Impregnated tropical finish. Note the Price £37/6.

**GOODMANS AXIOM TWIN CONE HI-FI SPEAKER.**

12in. P.M. for the Connoisseur, £8/8/-.

**PLESSEY AUTOMATIC RECORD CHANGER.**

The very latest. Takes only 4 seconds to change records. Takes eight 10in. and 12in. records mixed. £18/4/-.

**UNDRILLED POLISHED ALUMINIUM CHASSIS.**

4 sides, 3in. deep. 10in. x 6in., 10in. x 8in., 8/6; 12in. x 9in., 10/6; 14in. x 9in., 16in. x 8in., 11/6; 20in. x 8in., 12/6.

**CARBON RESISTORS.**

All values 1/2 watt, 4d. each. 1 watt 8d. each, 2 watt, 1/3 each.

**LINE CORD.**

Highest quality, .3 amp. 60/7052 per foot. 2-way, 1/3 yard; 3 way 1/6 yard.

**COMPLETE RANGE EDDYSTONE SHORT WAVE COMPONENTS**

**640 RECEIVER £27. 10. 0**

Terms: C.W.O. or C.O.D.

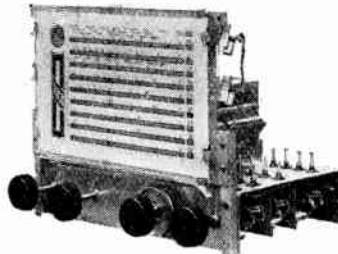

**FEEDER UNITS**

**MODEL B DE LUXE** (illustrated above). High gain R.F. stage operative on all nine wavebands.

45/145 M., 190/550 M., 900/2000 M. Plus six ranges of Bandsread, 13.5-14.8, 16-17.4, 19-20.5, 24.2-26, 30-32, 41-43.5 metres. Large colour printed glass dial, 10in. x 6in. aperture. Horizontal drive. Wave-range indicator and magic eye. Switched pick-up sockets. Volume and Tone Controls. Completely aligned ready for connection to audio amplifier. Price less valves £18/7/6. Valves required, EF50, 6K8G, 6K7G, 6Q7G, 763. Price for set of five valves, £3/11/5.

**MODEL A.** A first class feeder unit with 2 F. stage operative on all wavebands, 16/50, 190/550, 900/2000 metres. Switched pickup sockets. Volume control. (Glass dial 8in. x 8in. in colours. Completely aligned ready for connection to audio amplifier. Price less valves, £10/8/6. Valves required, 6K7G, 6K8G, 6K7G, 6Q7G. Price for set of four valves, £2/11/3.

**A.F. AMPLIFIER POWER UNIT.** Specially designed for use with above units. Employs 6V6G output (4 watts) and 5Z4G rectifier. Price less valves £4/10/-.

Two valves if required, £1/3/10.

**MAINS TRANSFORMERS**

15/6

Postage and Packing 1/6 extra

New Goods, Fully Guaranteed, Not Surplus Regular Lines

Standard Replacement Types. Drop-through chassis type with top shroud. Impregnated. Primaryes 200/230/250 v.

- (a) 250-0-250 v. 60 mA. 6.3 v. 3 A., 5 v. 2 A. .. 15 6
- (b) 250-0-250 v. 60 mA. 4 v. 4 A., 4 v. 2 A. .. 15 6
- (c) 250-0-250 v. 80 mA. 0/4/6.3 v. 4 A. C.T., 0/4/5 v. 2 A. .. 18 0
- (d) 300-0-300 v. 80 mA. 0/4/6.3 v. 4 A. C.T., 0/4/5 v. 2 A. .. 18 0
- (e) 350-0-350 v. 80 mA. 0/4/6.3 v. 4 A. C.T., 0/4/5 v. 2 A. .. 18 0
- (f) 250-0-250 v. 100 mA. 0/4/6.3 v. 4 A. C.T., 0/4/5 v. 2 A. .. 21 0
- (g) 300-0-300 v. 100 mA. 0/4/6.3 v. 4 A. C.T., 0/4/5 v. 2 A. .. 22 0
- (h) 350-0-350 v. 100 mA. 0/4/6.3 v. 4 A. C.T., 0/4/5 v. 2 A. .. 23 0
- (i) 350-0-350 v. 150 mA. 0/4/6.3 v. 6 A. C.T., 0/4/5 v. 3 A. .. 38 0
- (j) 425-0-425 v. 180 mA. 6.3 v. 4 A. C.T., 6.3 v. 4 A. C.T., 5 v. 3 A. .. 43 6
- (k) 425-0-425 v. 180 mA. 4 v. 8 A. C.T., 4 v. 4 A. C.T., 4 v. 4 A. .. 43 6
- (l) 425-0-425 v. 180 mA. 6.3 v. 4 A. C.T. 4 v. 2 A. C.T., 4 v. 2 A. C.T., 5 v. 3 A. .. 46 0

Types (i) (j) (l) are fully shrouded upright type.

**SMOOTHING CHOKES**

40 mA. 360 Ω 5/-, 60 mA. 425 Ω 6/6, 90 mA. 180 Ω 7/-, 100 mA. 400 Ω 12/6, 200 mA. 150 Ω 21/-, 200 mA. 350 Ω 22/6, 250 mA. 220 Ω 25/6.

NEW GOODS ONLY

**COULPHONE RADIO**

"The Return of Post Mail Order Service"

**58 DERBY STREET, ORMSKIRK, LANCS.**

Tel.: Ormskirk 496



**FOR THE RADIO SERVICEMAN DEALER AND OWNER**

The man who enrolls for an I.C.S. Radio Course learns radio thoroughly, completely, practically. When he earns his Diploma, he will KNOW radio. We are not content merely to teach the principles of radio, we want to show our students how to apply that training in practical, every-day radio service work. We train them to be successful.

Write to the I.C.S. Advisory Dept. stating your requirements. Our advice is free.

You may use this coupon.....

**INTERNATIONAL CORRESPONDENCE SCHOOL Ltd.**  
DEPT. 38, INTERNATIONAL BUILDINGS, KINGSWAY, LONDON, W.G.2

Please explain fully about your instruction in the subject marked X.  
Complete Radio Engineering Radio Service Engineers  
Radio Service and Sales Advanced Short-Wave Radio  
Elementary Electronics, Radar, and Radio

And the following Radio Examinations:—  
British Institution of Radio Engineers  
P.M.G. Certificates for Wireless Operators  
City and Guilds Telecommunications  
Wireless Operators and Wireless Mechanics, R.A.F.

I.C.S. students for Examinations are coached till successful.

Name..... Age.....  
Address.....

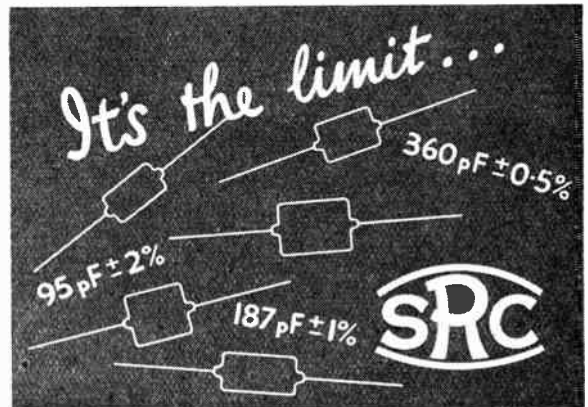

Our Silvered Mica Capacitors reach the limit of accuracy which can be achieved in a mass produced radio component. Our recognised technical standards will satisfy those set manufacturers who wish their tuning scales to be "dead on line".

**STABILITY RADIO COMPONENTS LTD**

14, NORMAN'S BUILDINGS, CENTRAL STREET, LONDON, E.C.1

Telephone: CLErkenwell 5977.

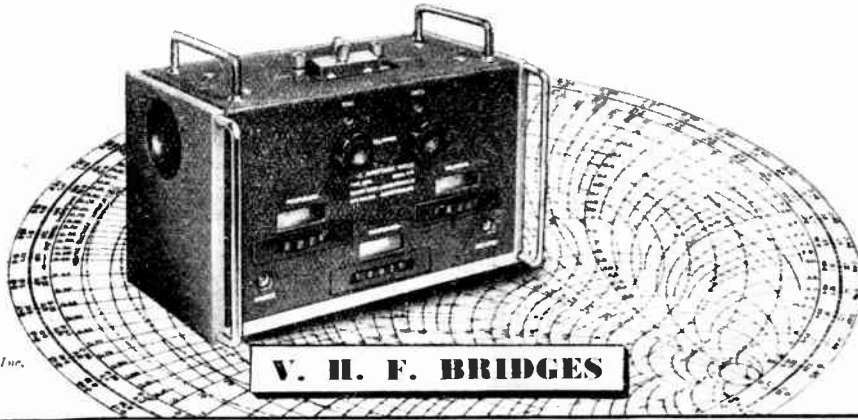

Diagram by courtesy of  
McGraw Hill Pub'g. Co. Inc.

**V. H. F. BRIDGES**

**for balanced and unbalanced measurement at frequencies between 1 Mc/s and 100 Mc/s.**



THE WAYNE KERR LABORATORIES LIMITED, NEW MALDEN, SURREY. PHONE: MALDEN 2202

**Begin  
Sound  
Recording**

**WITHOUT CAPITAL OUTLAY**

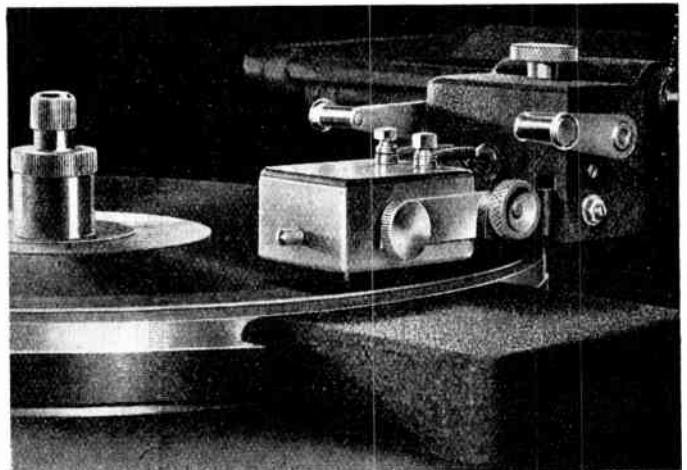

With the DR33M Disc Recorder you can now start your own recording studio without capital outlay, and receive free training, guidance and maintenance through the new B.S.R. Hire Maintenance Plan.

The new DR33M has several new features and is the finest instrument of its kind. It is individually constructed for the discriminating user and backed by a unique service.

Hire maintenance is available over 18 months, 3 years or 5 years. Send for details immediately.

Illustration shows close-up view of the DR33M cutting head.



**BIRMINGHAM SOUND REPRODUCERS LTD, Claremont Works, Old Hill, Staffs. Phone : Cradley Heath, 6212-3**





Hearty Christmas Greetings  
to you, our friends in the trade, and may your  
business prosper greatly in 1949

**McMichael Radio**  
LIMITED

London Office & Sales: 190 Strand, W.C.2

Tel.: TEM 2085

Grams: RADIEATHER, LONDON

Works: Slough, Bucks. Tel.: Slough 22311

**AMBASSADOR**  
4756 Chassis

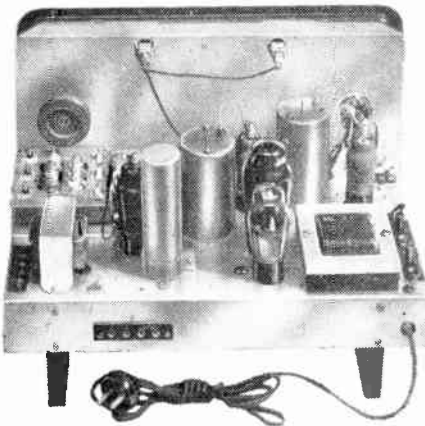

**SPECIFICATION:**  
5 valve A.C. or A.C./D.C. Super-Het. 6 wave bands covering from 9.4 to 1940 metres. (Electrical Band Spreading.) 10" P.M. Speaker. £22.8.2 TAX PAID.

Immediate Delivery can be given.

WRITE FOR FULL DETAILS TO:—R. N. FITTON LTD.

**AMBASSADOR RADIO WORKS**  
HUTCHINSON LANE, BRIGHOUSE, YORKS.

★ ★ Stars for Sale!

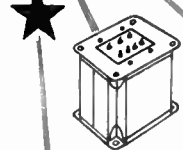

**WODEN** De Luxe Potted Transformers & Choke:  
Mains 0-205-225-245 v. 300-0-300/120 mA; 5 v.; 6-3 v. C.T. - - - 39/6  
Output, primary 7000 Ω A-A Sec. - - - 29/6  
0-3-15 Ω, 25 watts - - - - - 25/-  
Smoothing choke 8 H 150 mA - - - - -  
Post 1 - each extra.

Set of 3 above together with tip-top amplifier design (6SN7s, 6L6s) £4.14.0 carr. paid

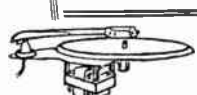

**COLLARO RADIOGRAM**  
unit, magnetic P.U., auto stop, latest type, £5.15.6 inc. P.T., post free.

**P.A. SPEAKERS**

U.S.A. make, re-entrant horn, built-in O.P. transformer 0-250-500-1000-2500 Ω. Complete with universal tripod extending to 8 ft. Carr. paid £8.8.0.

All supplied in sets of 4 speakers in fitted transit case. Carr. paid £30.

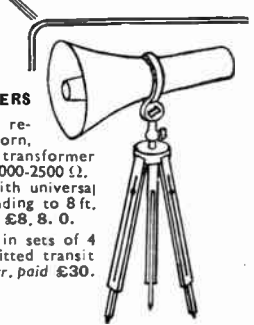

Stockists for EDDYSTONE, DENCO,

RAYMART, WODEN.

Latest Lists free on request

**Frith**  
**RADIOCRAFT Ltd.**  
69-71 CHURCH GATE · LEICESTER

PHONE 58927

**AIRMEC** the most advanced  
**Electronic Heat Generator yet produced**

The Airmec Heat Generator embodies latest electronic practice and is available in 5 kW and 2 kW models for both dielectric and induction heating. They are the most compact units of their power rating.

Specification includes latest type air-blast cooled oscillator valve, electrical and mechanical interlocks, efficient protection of electrical circuits against overloads. Repetition work by unskilled workers is facilitated by an automatic control with locked settings.

Both models are clean and attractive in appearance, finished in cream enamel. List GA157 explains fully the high standards reached in our equipment—we will gladly send you a copy and follow it with advice on any production problems you may care to raise. Please do not hesitate to ask.

**AIRMEC LABORATORIES LTD.**  
 19 CHARTERHOUSE STREET, LONDON, E.C.1

Telephone: Chancery 7843

Manufacturers of all types of industrial electronic equipment and test gear.



Works: High Wycombe, Bucks.

*Difficult Problems?*

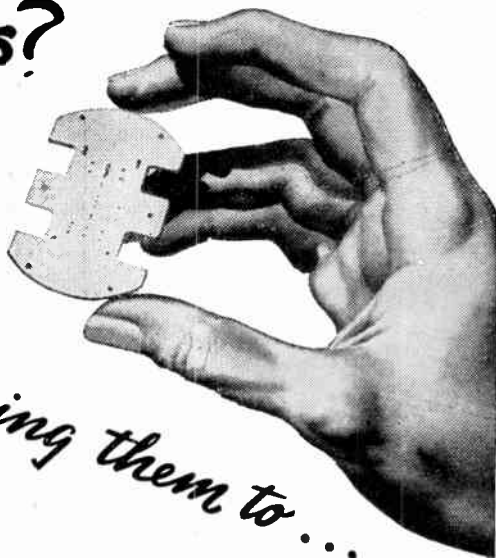
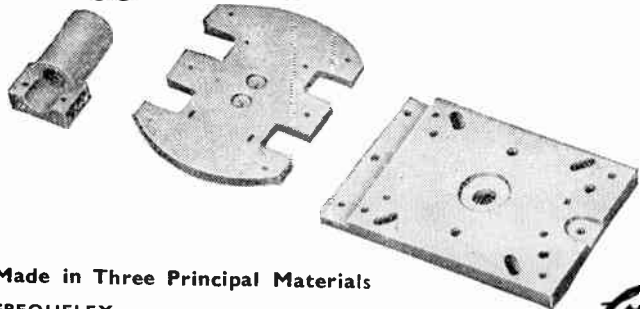

**Made in Three Principal Materials**

**FREQUELEX**

An insulating material of Low Di-electric Loss, for Coil Formers, Aerial Insulators, Valve Holders, etc.

**PERMALEX**

A High Permittivity Material. For the construction of Condensers of the smallest possible dimensions.

**TEMPLEX**

A Condenser material of medium permittivity. For the construction of Condensers having a constant capacity at all temperatures.



**Bullers**

**BULLERS LOW LOSS CERAMICS**

**BULLERS LTD., 6, LAURENCE POUNTNEY HILL, LONDON, E.C.4**

Telephone: Mansion House 9971 (3 lines)

Telegrams: "Bullers, Cannon, London"

# VALUES FROM VALLANCE'S

**EXCELLENT OFFER OF U.S. BUG KEYS.**  
Made by famous American Radio Manufacturers. Exceptionally well designed and constructed being built on a heavy cast black crackle base with all other parts chromium plated. Complete with switch. A key that makes sending a real pleasure. Unused U.S. Army Surplus, £2/11/6, post free.

**CATHODE RAY TUBES. 3½in. SCREEN.**  
Made by E.M.I. Electrostatic Deflection. Green Screen. Max. H.T. 800 volts. Complete with base, 18/- post free.

**ELSTONE OUTPUT TRANSFORMERS.**  
MR/18. Rated at 15 watts, max. 18 watts.  
13, 16, 18, 20, 22, 27, 33, 40, 52, 66 and 80 to ONE  
(Either Push-pull or Single Fed.)  
Primary Loading 2,000, 16,000 ohms.  
Secondary Impedance 1 to 30 ohms.  
Max. D.C. Current 100 m.a. Complete with Chart. Price 43/-, inc. post and packing.

MR/30. Specification as MR/15 but will handle 30 watts.  
Max. Primary Current 170 m.a. Price 51/-, inc. post and packing.

**BC-347-L INTERPHONE AMPLIFIERS.** Complete with 6F8Q valve. Terminal Panel, resistors and capacitors. Metal case 5½in. x 3½in. x 2½in. with circuit diagram in lid. Unused, 8/6, post free.

**BC-456-B. Modulator Units.** 12J5GT valve, transformer coupled to 1625 valve (807 with 12 volt heater), VR150 voltage stabiliser, three relays and many useful components. Price 22/-, including packing and carriage.

**DENCO LITERATURE.**  
Technical Bulletin D.T.B.1. (All information on Denco Coils.)  
Technical Bulletin D.T.B.2. (Information on Denco Coil Turrets CT6 and CT7.)  
Technical Bulletin D.T.B.3. (Details on building a Communication Receiver using the C.T.4 Coil Turret.) D.T.B.1, D.T.B.2, D.T.B.3, 3/6 each, post free.

**BRIMAR VALVE MANUAL.**  
(Gives details and operating conditions of all types of American and International valves (including localities). Price 3/-, post free.

**GREAT CIRCLE ZONE MAPS OF THE WORLD.** Printed on cloth in four colours with zones marked and index to zone areas. Price 6/8, post free.

Speedy Postal Service C.W.O. or C.O.D.

**BENDIX RADIO COMPASS UNIT BC433G.** 15 valves, 4 6K7, 2 6B8, 2 2051, 6N7, 6SC7, 6L7, 6J5, 5Z4, 200 to 1750 k/w. Brand new. Makes a fine long wave broadcast receiver. Price £4/17/6, carriage paid.

**VCR97 CATHODE RAY TUBES.** New in maker's crate. Short persistence. Ideal for television. Six inch screen. Price 35/6, plus 5/- extra for crate and carriage (not returnable).

**INDICATOR UNITS TYPE 62. EX-A.M.**  
Containing twenty valves. 16 5P61, 2 EB34, 2 EA50. One crystal and VCR97 tube. Many other components including potentiometers, large assortment of resistors and capacitors. Ideal for conversion into television receiving equipment, or building a super C.R.O. A first-class bargain at £3/7/6, carriage paid.

**MORSE KEYS.** Sound construction. Heavy brass fittings on heavy polished wood base. Price 3/6 post free.

**CELESTION TYPE P44 12in. LOUD SPEAKER.**  
Latest design. Special high flux density magnet with no external field, making it highly suitable for television receivers. Exceptional quality of reproduction, comparing favourably with speakers at twice the price. Transients are well defined, and a special convex high note cone gives good reproduction and diffusion of the upper register. Very light in weight. Size of baffle opening 11½in. Price £3/17/6, post free.

**AMC DIAL AND DRIVE ASSEMBLY.**  
An exceptionally fine dial for the home constructed superhet. The scale is finished in brown with chrome calibrations. Calibrated in frequency, wavelengths and station names. SW 16-50 metres. MW 200-550 metres. LW 800-2000 metres. Size of opening required 10½ in. x 4in. Complete with rigid brackets, tuning spindle, drive cone, pointer, drive drum and flexible coupler to drive condensers. Assembled ready for use. Price 23/6, post free.

**MIDGET MAINS TRANSFORMER MT/ML.** We are still able to offer this excellent transformer which has achieved great popularity. This is a small drop-through transformer, suitable for signal generators, V.F.O.'s, and any other application where size is the limiting factor.

**PRIMARY.** 200/230/250 volts with internally connected electrostatic screen.

**SECONDARIES.** 250/0/250 volts at 50 m.a.  
0/4/5 volts at 2 amps.  
0/6/3 volts at 1.5 amps.

**DIMENSIONS.** 2½in. x 2½in. x 3in. with four mounting feet. New and improved design. Price 24/-, post free.

When sending C.W.O. please include sufficient extra for post and packing.

## VALLANCE & DAVISON LTD.

Staff call signs: G2HHV,  
G8SX, G3ABD, G3CML.

144 BRIGGATE, LEEDS, 1.

Phone  
29428/9

**HIVAC**  
THE SCIENTIFIC  
VALVE  
BRITISH MADE

*Pioneers & Specialists in Small Valves*



Messrs. Hivac Ltd.  
Greenhill Crescent,  
Harrow-on-the-Hill,  
Middx.

**THE address for:-**  
*Subminiatures - Midgets - Miniatures*  
*and Cathode Tubes*

### For precision alignment of Tuned Circuits and visual observation of Electrical Phenomena.



Illustrated are the latest models of the 1200B Oscilloscope and the 1400B Visual Alignment Signal Generator.

Special features of the Oscilloscope are:  
High gain D.C. amplifiers on both axes, linear time base with perfect synchronisation at any frequency. Complete independence of all controls from each other.

The 1400B Unit will show the shape and characteristics of a tuned circuit response curve on the Oscillograph screen. Thus perfect alignment of an I.F. or R.F. amplifier is easily accomplished. Overall size of combined instruments: 7" wide, 11" high, 9" long.

● We also make electronic equipment for special purposes. If you have a problem in this field we will be pleased to co-operate.

Early Deliveries.

● Model 1200B Oscilloscope, £32 0 0 ● Model 1400B Unit, £8 10 0  
Write for Specifications to:-

## INDUSTRIAL ELECTRONICS

99, Grays Inn Road, London, W.C.1. Tel.: HOLborn 9873/4/5.  
Makers of Industrial Controls and Precision Instruments.





# “Taylor Valve Testers”

These instruments measure the mutual conductance of practically every type of British, American and Continental valve. In addition checks are provided for the emission of rectifiers and diodes, heater to cathode insulation, filament continuity and element shorts. In Model 47A, the indicating instrument forms the basis for a 20 range universal meter with a sensitivity of 1,000 ohms per volt and covering D.C. volts and current, A.C. volts and resistance.

**TAYLOR VALVE TESTER  
MODEL 47A**

**PRICE £27 - 0 - 0**

H.P. TERMS:  
£2 11s. 9d. Deposit  
and 11 monthly payments of £2 11s. 9d.

TAYLOR PRODUCTS INCLUDE: MULTIRANGE A.C. D.C. TEST METERS ● SIGNAL GENERATORS ● VALVE TESTERS ● A.C. BRIDGES ● CIRCUIT ANALYSERS ● CATHODE RAY OSCILLOGRAPHS ● HIGH AND LOW RANGE OHMMETERS ● OUTPUT METERS ● INSULATION TESTERS ● MOVING COIL INSTRUMENTS

**TAYLOR ELECTRICAL INSTRUMENTS LTD**  
419 - 424 MONTROSE AVENUE. SLOUGH. BUCKS ENGLAND



**IMMEDIATE  
DELIVERY**

**TAYLOR VALVE TESTER  
MODEL 45A**

**PRICE £22 - 0 - 0**

H.P. TERMS:  
£2 2s. 2d. Deposit  
and 11 monthly payments of £2 2s. 2d.



Telephone SLOUGH 21381 (\* lines)  
Grams & Cables "TAYLINS" SLOUGH

## Stabilised Insulation BY MODERN IMPREGNATION METHODS

# HYMEG

**HIGH-SPEED PRODUCTION**

Now, special methods of continuous conveyor impregnation and baking developed with the use of HYMEG have still further reduced processing times to a fraction of those previously believed necessary.

Often faster than infra-red baking with none of the defects, reduced handling, absence of special jigs, with complete freedom from blistering, bubbling and porosity, are some of the advantages claimed and substantiated for HYMEG High Speed Production methods.

HYMEG Synthetic Insulating Varnishes are recognised and widely used for their mechanical rigidity, improvement of electrical properties of windings: heat, moisture, oil, acid and alkali resistance as well as for the considerably reduced stoving time necessary.

# HYMEGLAS

**GLASS FIBRE INSULATION SYSTEM**

This integrated system of development is successful in enabling machines to be designed and operated without weak links in the chain of insulation below 200°C. Thus the fullest advantage is taken of modern glass fibre insulation by providing a degree of bonding and insulation at every point in which the uniting of Hymeg impregnation with the Hymeg as used for subsidiary insulations gives a solid homogeneous winding of equally efficient characteristics and heat resistance throughout.

Hymeglas therefore virtually eliminates any risk of insulation failure and enables motors and the like to operate under abnormal conditions for long periods without risk of electrical breakdown.

Due to the excellent space factor of glass fibre as compared with the more usual asbestos and mica Class B insulations, it is often possible in redesigning with the Hymeglas system to employ larger copper sections with well-known advantages.

The Berger Technical Service—the research work of which produced “HYMEG” and “HYMEGLAS” is available to advise manufacturers on all problems of insulation. Get in touch now with—

**LEWIS BERGER & SONS LTD. (Est. 1760)**  
35, BERKELEY SQUARE, LONDON. W.1.

Telephone: M.4Yfair 9171.

**MANUFACTURERS OF HIGH - PERFORMANCE INSULATING VARNISHES AND ENAMELS**

# COILS & PACKS

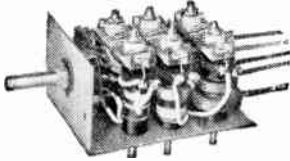

A LARGE variety of Adjustable Iron Dust Core Coils and Packs ranging from 5 to 2,000 metres, in suitable combinations and including high frequency stages together with all necessary padding and trimmer condensers, are available for most needs. Write for descriptive literature stating your particular problem.

LABORATORY



TESTED

H. C. ATKINS Laboratories, 32, Cumberland Road, Kew, Surrey  
Richmond 2950

A109

## LET'S EXPLORE

the possibilities of using one of our **Mine Detectors!** If you are a geologist, archeologist, plumber, surveyor, saw-miller, builder, municipal engineer or veterinary surgeon you will definitely need one.

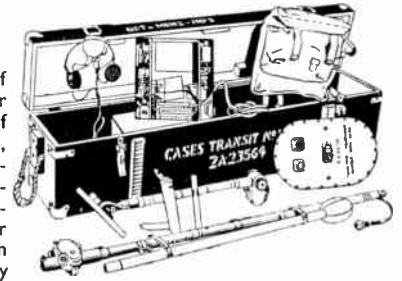

Designed for the location of metallic objects under ground or water, they will also detect the presence of metals in any place where it has no business to be—even the proverbial needle in the haystack! Supplied complete with amplifier, control box phones, search coils, poles, pack, spare valves, full operating instruction and circuit diagram, as illustrated, and despatched in solid transit case. Brand new—Only £6-15-0 A fraction of the manufacturing cost!

## CQ 2400 MEGACYCLES TUNING UNIT 207A

10 cm. KLYSTRON equipment comprising CV67 Klystron with tuning plugs, 5Z4G rectifier, 3 neon stabilisers, and power supply. BRAND NEW equipment may be adapted for use with a Super-regen receiver for the new 13 cm ham-band. The cavity, with extra capacity loading, will be suitable for 13 cms. R.S.G.B. Bulletin July gives details on use of the Klystron as foundation for the oscillator.

20/- ONLY (carr. & pkg. 5/-)

Terms: C.W.O. Remittances payable to E. & G. Distributing Corporation Ltd.

**M.O.S.** MAIL ORDER SUPPLY CO., Dept., W.W.,  
3 Robert St., Hampstead Rd., London, N.W.1.  
CALLERS TO: 24 New Rd., London, E.1. (Stepney Green 2760-3906)

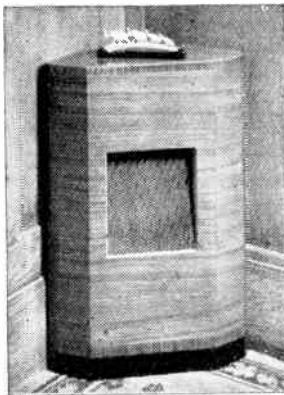

*"To say I am delighted is not enough—"*

*"I am extremely satisfied with the performance and tone, and feel proud to have such a very efficient and beautiful Extension Speaker in my home."*

From one of many letters sent us by enthusiastic users of the

**"BAFFLETTE" CONSOLE EXTENSION SPEAKER**

by

**Richard Allan**

Precision-built, with independent volume control; stands in corner or flat to wall; walnut veneer cabinet. **£6. 15. 0**  
mahogany £7 10.

Transformer 8/6 extra.

OTHER BAFFLETTE MODELS INCLUDE: De Luxe - £4.15.0  
Standard - - - £4.4.0 } Mahogany at small extra cost.  
Junior - - - - - 59/6 }

AT ALL GOOD RADIO SHOPS

Made and Guaranteed by

**RICHARD ALLAN RADIO LTD.,**  
Caledonia Road, Batley, Yorks.

Tel. Batley 1123

\*Grams: Acoustics, Batley

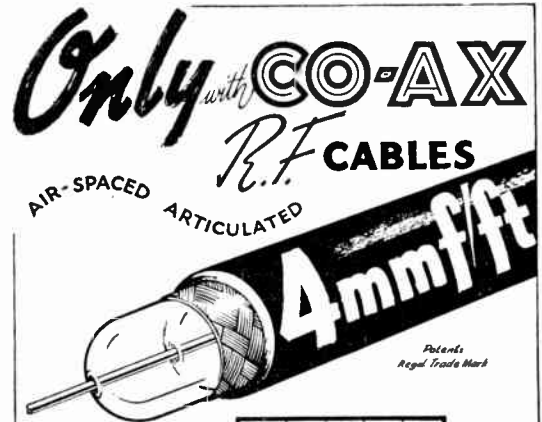

**THE LOWEST EVER CAPACITANCE OR ATTENUATION**

**IMMEDIATE DELIVERIES FOR HOME & EXPORT**

Write or cable for data sheets or deliveries to the originators of Bafflette or special Rf Cables

**TRANSRADIO LTD.**  
CONTRACTORS TO THE GOVERNMENT  
1305 CROMWELL ROAD LONDON SW7  
Cables: TRANSRAD, LONDON

LOW ATTN TYPES	IMPED OHMS	ATTEN db/1000 ft at 100 Mc/s	LEADING INDUCTIVE REACTANCE OHMS/1000 ft	Q.D.*
A 1	74	1.7	0.11	0.36
A 2	74	1.3	0.24	0.44
A34	7.3	0.6	1.5	0.88
LOW CAPAC TYPES	CAPAC nF/ft	IMPED OHMS	ATTEN db/1000 ft at 100 Mc/s	Q.D.*
C 1	7.3	150	2.5	0.36
P.C.1	10.2	132	3.1	0.36
C.H	6.3	173	3.2	0.36
C 2	6.3	171	2.15	0.44
C22	5.5	184	2.8	0.44
C 3	5.4	197	1.9	0.64
C33	4.8	220	2.4	0.64
C44	4.1	252	2.1	1.03

Patents  
Regd. Trade Mark

HIGH POWER FLEXIBLE

PHOTOCELL CABLE

VERY LOW CAPACITANCE

## Eliminate Positive Feedback

(Mechanical) "EQUIFLEX" PATENT MOUNTINGS will eliminate Mechanical and acoustic Vibration from being amplified and a Black Spot on Quality Reproduction. Call at your Dealers to see a complete set of special "EQUIFLEX." Damped units with all fittings and assembly chart suitable for the GARRARD R C 60 Turntable.

**GARRARD RC 60 UNIT** Price 21/6 Per Complete Boxed set of 4 Mountings and all fittings.

"EQUIFLEX" special Damped Mountings as illustrated for Chassis Suspension can be obtained from your Radio Dealer. Loadings of these units are from 2 lb. to 12 lbs. Giving a choice of distributed loading of from 8 lbs. to 50 lbs. where a four Point-Suspension is used.

Ask to see these special Units at your Dealers.

### TYPICAL RADIO CHASSIS

Wholesale Distributors and Dealers write for Terms and Particulars. Export Enquiries Welcomed. Illustrated Brochure upon request.

Sole Manufacturers:

**A. WELLS & CO. LTD.,**  
**PROGRESS WORKS, STIRLING RD., LONDON, E.17**  
 PHONE: LARKSWOOD 2691-4

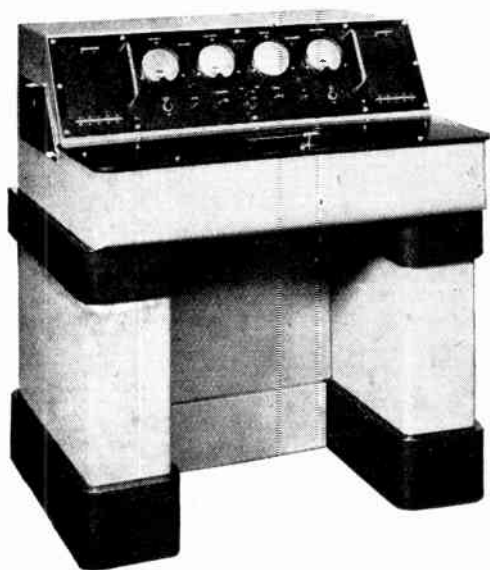
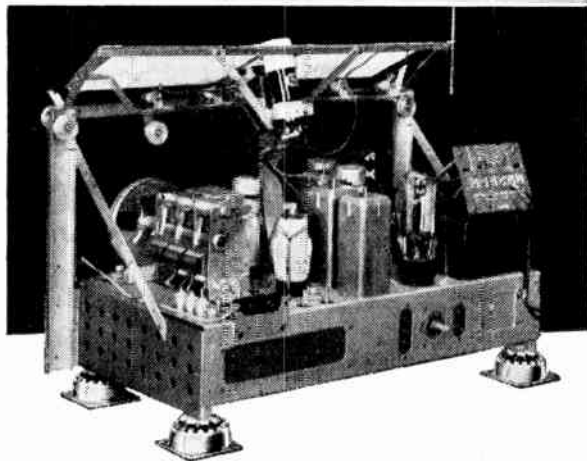
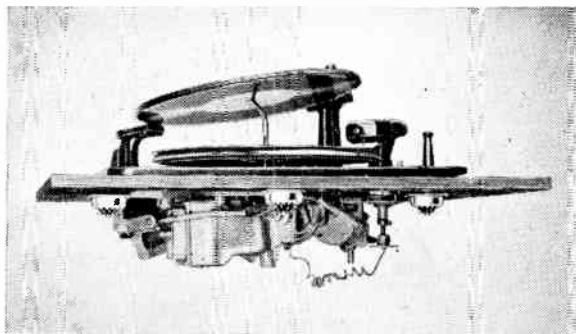

# RESISTOR NOISE METER

Manufactured to an approved Ministry of Supply specification for the measurement of inherent noise above one microvolt in fixed and variable resistors.

PLEASE WRITE FOR FULL DETAILS TO

**ERSKINE LABORATORIES LTD—SCALBY, SCARBOROUGH, YORKS.**



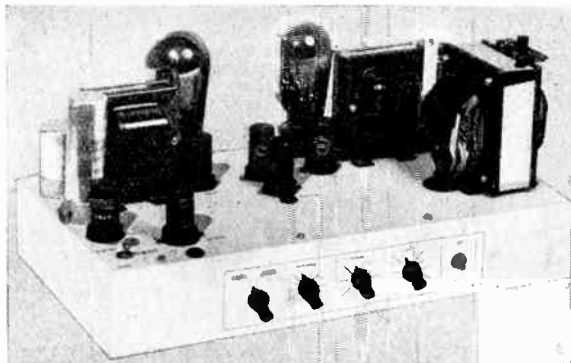

The famous high fidelity amplifier for home or music society. Distortion level below 0.5 per cent. ensures fidelity, whilst the two channels of bass boost give surprising depth to the reproduction, particularly at low volume levels. Designed for moving coil or miniature moving iron pick-ups, and incorporating a radio socket, the CONCERTO is the ideal reproducer.

Price **£27 10 0**

Dust cover with bottom plate and rubber feet 37/6 extra. Delivery by passenger train carriage paid; a deposit (returnable) of 10/- is charged for the crate

CHARLES AMPLIFIERS LTD., proudly present "LIVING MUSIC" their new 16 pp. catalogue, fully illustrated, showing their range of amplifiers and tuning units. No music lover should be without a copy. Kindly enclose 5d. in stamps. DEFERRED TERMS NOW AVAILABLE.

*Charles*  
**AMPLIFIERS**  
LTD

1m PALACE GATE · KENSINGTON · LONDON · W8  
Telephone: WEStern 3350

**TECHNICAL EXCELLENCE**

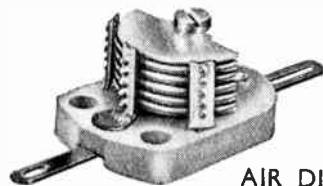

—combines with beauty and soundness of DESIGN in the

**OXLEY**

AIR DIELECTRIC TRIMMER

Type Approved Cat. A No. 464.

Width: 16.5 m/m. Length: 22 m/m. Height: 1.5 to 8pF—7.5 m/m. 1.8 to 20pF—10 m/m. 2 to 26pF—11 m/m. 2 to 32pF—12 m/m. Low: Straight line capacity. Power Factor: Less than .001. Insulation: Over 2,000 megohms. Voltage: 500 D.C.

OXLEY DEVELOPMENTS CO. LTD.  
ULVERSTON, NORTH LANCs. TELEPHONE: ULVERSTON 3306

*A New Constant Impedance*

**MICROPHONE MIXER UNIT**

by LUSTRAPHONE

Permits the controlled mixing and fading of microphone and/or gramophone inputs. Is valveless, and requires no power supply. Elegantly finished in matt gold and black. Silent in action, and long lasting.



Standard Model—3 Input Channels. 4 and 5 Channel models available. Details on request from the makers.

LUSTRAPHONE LTD. 34, BELSIZE LANE, LONDON, N.W.3.

**"You're CERTAIN to get it at ARTHURS!"**

★ **VALVES:** We have probably the largest Stock of valves in the Country. Send your enquiries. We will reply by return.

**PICK-UPS.** Decca £6 14 6. Decca head for Garrard £4 11 0. Adaptors 5/-. Connoisseur £4 11 0.

**PERSONAL RADIO SETS IN STOCK**  
New Olympic Romac, Long and Medium Wave £17 16 11  
Ever Ready ..... £12 18 10  
Marconi ..... £15 19 5  
New Marconi ..... £14 14 9

**REMINGTON FOURSOME SHAVERS**  
210-250 v. AC/DC ..... £7 17 6

**ALL AVO AND TAYLORS METERS.** List on request.

**PHILIPS CYCLE DYNAMO SET.....** £2 1 6

ALSO STOCKISTS OF ALL DOMESTIC APPLIANCES.  
**London's Oldest Leading Radio Dealers.**

*Arthur*  
EST. 1919  
PROPS: ARTHUR GRAY. LTD. Terms C.O.D. or cash with order.

Our Only Address: **Gray House, 150, Charing Cross Rd., London, W.C.2** TEMple Bar 5833/4.  
**ELECTRICAL, TELEVISION & RADIO ENGINEERS.**

**Cathode Ray Receiver Indicator Unit No. R-31 APS-2E. Brand New! Ex-U.S. Navy**

Employing 40 useful valves, 2 Cathode Ray tubes, power pack, motor blower, Milliammeters, etc. The following are the valves: 13 6SN7GT, 8 6AC7, 2 6U8, 6 6L6G, 3 VR150-30, 1 2X2, 3 6U4G, 2 6X5G, 2 6HG. SPECIAL PRICE £16/10

**MUIRHEAD SLOW MOTION DRIVES, 7/6 EACH.**

**VOLTMETERS, 0-300 volts A.C., moving iron, 2 1/2 in. dial, flush type, 17/6 EACH.**

**ABK1 SPARES KIT, including 92 valves individually boxed, 18 6BH7, 6 6H6, 8 7193, also many useful Relays, Resistors, Condensers, and a Dynamotor with extended Spindle which will work as a powerful motor on 200/250 A.C. mains without alteration. 145 items in all, brand new, properly packed. 70/- complete.**

**CRYSTAL MULTIPLIER UNIT, 2 to 6.87 Mc/s in 3-switch steps, 807 Oscillator and tuning control. Brand new with spare 807 valve, instruction books, etc. 55/- EACH.**

**RF AMPLIFIER, 100/124 Mc/s for 2V762 Triodes in push, pull, standard 19in. rack mounting, easily modified for 144 Mc/s. Brand new 75/-.**

**L. WILKINSON, 204, Lower Addiscombe Road, CROYDON.**

**Television**

FROM ANY **D.C. Mains**

Valradio Convertors will provide adequate A.C. for Television, Radiograms and the like from as low as 12v. D.C. input. We give two examples from the VALRADIO Range. Models for special inputs or outputs may be ordered.

- **MODEL 230/300** D.C. 200-250v. A.C. 200-250v., 300 watts, 50 or 75 c.p.s. **£16**
- **MODEL 230/200/110** D.C. 100-110v. A.C. 230v., 200 watts, 50 or 75 c.p.s. **£14**

**VALRADIO VIBRATOR CONVERTORS**

Leaflet detailing all models from:—

**VALRADIO LTD., 57, FORTRESS RD., LONDON, N.W.5**  
Telephone: Gulliver 5165

Rate 6/- for 2 lines or less and 3/- for every additional line or part thereof, average lines 6 words. Box Numbers, 2 words plus 1/-... Press Day: February 1949 issue, first post Thursday, January 6th. No responsibility accepted for errors.

WARNING

Readers are warned that Government surplus components which may be offered for sale through our columns carry no manufacturer's guarantee. Many of these components will have been designed for special purposes making them unsuitable for civilian use, or may have deteriorated as a result of the conditions under which they have been stored. We cannot undertake to deal with any complaints regarding any such components purchased.

NEW RECEIVERS AND AMPLIFIERS

R.A.F. 1155 receivers, new, £8/10; carriage and packing, etc.—Broadcast & Acoustic Equipment Co., Ltd., Tomland, Row, Ch. WAKE the easy way with the Heveille clock-radio; £12/12 retail plus tax; stamp for leaflet.—Inames Valley Products, 28, Camden Ave., Feltham. [1947] 1949 bandspread feeder unit with R.F. stage, time wavebands, 13.5-2,000 metres, 2-1/2 stamp for illustrated brochure.—Coulphoie Radio, Ormskirk, Lancs. [2528]

QUALITY ENTERTAINMENT!—Are you contemplating a new set this winter?—BCM/HF/DEL, London, W.C.2, is the address to remember for all types of radio and electronic apparatus built to specification. [1791]

SPENCER-WEST television pre-amplifier will effect a considerable improvement in signal/noise ratio for long distance reception.—Full particulars from Spencer-West, Quay Works, Gu. Yarmouth. [2488]

TELEVISION sound or vision units, 2HF stages, 1 detector and 1 video amplifier employing 3 EF50, 1 EA50, and adjustable iron cored coils, brand new, only 45/- each, carriage paid.—L. Wilkinson, 204, Lower Addiscombe Rd., Croydon. [2317]

JUNIOR version of Williamson's quality amplifier with specified output transformer, 12 watts, 7 valves, £16/16; 5-valve a.c. mains, 8-watt push-pull amplifiers, with output transformers, £9; Celestion 12in P.M. speakers, 3-ohm voice coil 75/-.—R. T., 64, St. Leonard's Rd., London, S.W.14. [2400]

MELICITY amplifiers now substantially reduced in price: Junior 5-watt, now £14/19/9; "Extended Range" 8-watt, £27/10 complete; response 20-20,000 cps, distortion 0.1% ensured by laboratory test of every 8-watt amplifier; matched for either coil or moving iron pick-ups.—Details from: F.S.R., Ltd., 87a, Upper Richmond Rd., Putney, S.W.15.

STOUNDING year end offer, to clear stocks. A Complete mains receiver kit, everything, including valves, beautiful cabinet, all components, assembly drawing, etc., right down to the last nut and bolt; not an odd kit set, but a first-class commercial 2-waveband receiver. Ideally suitable for resale, offered for one month only at £9/10, carr. paid; never again.—Radio Constructors, 28, Spital Hill, Sheffield, 4.

C.J.R. ELECTRICAL & ELECTRONIC DEVELOPMENT, Ltd., Hubert St., Birmingham, 6 (Aston Cross 2440), the Midlands specialist manufacturers of high fidelity equipment, for W. Philips, Philips, Philips, and other quality amplifiers built strictly to specification with finest components available; also tone control stages, loudspeaker cross over units, contrast expanders and radio feeders; send 2-1/2d stamp for full details and prices. [2233]

A.F. 1 F.F. response, complete with R. 4 mains H.F. pentode valves, 3 Mazda television diodes, 2 twin triode mains valves and 1 EF50 Mullard; also includes 24v motor generator, suitable for modification to universal motor, 2 magnetic relays, several mechanical multi-contact relays; includes resistances, condensers, variable and fixed, and other useful components; 25/- each, carriage paid.—Uncle Tom's Radio Cabin, 5, Seven Stars Court, Manchester, 4. [9623]

MASON'S (W.W.), Wivenhoe, nr. Colchester. —5 and 10-waveband gram chassis, covering 3-60mc/s and 150-1,500kc/s, feeder units with r.f. stage and flywheel tuning, radio kits auto-stop and 8 mixed changer units, amplifiers 5-500watts, Edgystone and Denco equipment and components, complete television chassis for London or Birmingham transmission and constructors' kits for London area from £45; s.a.e. for details or send 9d. now for our illustrated 54-page catalogue. [2020]

THE now famous Williamson amplifier as manufactured by Radio Trades Manufacturing Co. (Ealing), Ltd., is definitely acknowledged as the world's finest amplifier at a reasonable price (vide numerous testimonials from famous critics), built to specification from real quality components on extra heavy gauge chassis with cover, this amplifier constitutes the finest product in the trade to-day; if you are genuinely searching for quality reproduction your search is ended as we can supply what you want; price complete with cover £27/10; gram, motors, tuners, pre-amplifiers, speakers and pick-ups supplied; trade enquiries invited.—Write or call, R.T.M.C. (Ealing), Ltd., Laurel House, 141, Little Lalline Lane, W.5. Eal. 6962. [2025]

Partridge News

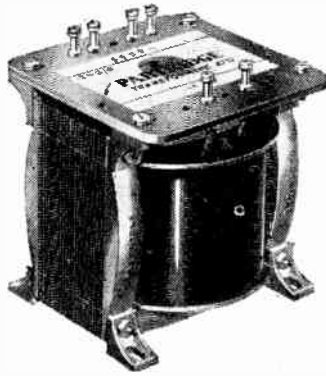

TOLWORTH FACTORY

Our new modern transformer factory and laboratory are now in operation and equipped with up-to-date machinery for the manufacture and testing of quality components. Increased facilities have enabled us to improve our service. As well as having 100 different types of transformers and chokes available from stock, we can wind to specification within 14-28 days depending on the quantity and types involved. Our range has been increased to cover power transformers up to 25 K.V.A. and we shall be pleased to send our catalogue and stock list upon request.



LONDON SALES OFFICE

For the benefit of our many friends we have made arrangements for the immediate supply from stock of small quantities of our standard components. These can be collected from our address at King's Buildings, Dean Stanley Street, Millbank, Westminster, S.W.1. Tel.: Abbey 2244. (250 yards from Big Ben). Hours: 10 a.m.-1.0 p.m. and 2.5-3.30 p.m. (Mondays to Fridays only). Kindly note this address is for stock sales only.



NEW ADDRESS

We should like to draw attention to our new address at Tolworth (situated just off the Kingston By-pass). This is now our sole factory. Callers and all correspondence should go to this address:—



PARTRIDGE TRANSFORMERS LTD

Roebuck Road, Tolworth, Surrey

B.C.348 American communication receivers, new, £18/10; R.28 American 10 valve receivers, new, 45/-; BC.453 American 6 valve receivers, 35/-; all carriage paid.—G. Lawrence & Co., 3, Slater Place, Liverpool 3. [2489]

UPLIFTERS, ELECTRONIC PRODUCTIONS, 36, Marylebone High St., W.1, Welbeck 4058. Specialists in the design and manufacture of high grade fidelity gramophone reproducers and radio units. If you are interested in obtaining the finest possible reproduction from recorded music we invite you to hear our equipment demonstrated in conjunction with the Wilkins and Wright coil pick-up and the Wharfedale corner cabinet speaker. We will gladly give you a quotation for the conversion of your existing radio gramophone into a first-class reproducing instrument, or for the design and construction of equipment to your own special requirements. Write for descriptive leaflets of our range of fidelity amplifiers and radio tuning units.

GOODSELL, Ltd., 40, Gardner St., Brighton, 1. J. SUSSELL.—The finest range of amplifiers available to Williamson specification, K.T.26 at £22; P.X.4 version at £17/17/6; and without a doubt the finest of all, the P.X.25 amplifier with two chassis and two power packs for 500 and 275 volts h.t. at £28/7, carriage extra; all on black crackle steel chassis, K.T.66 and P.X.4, £14/10/3; P.X.25 two chassis, £12/4/8; 4 paper condensers fitted on h.t. except in P.X.4, which has paper for reservoir Partridge transformers as standard, all valves B.V.A., beautifully finished with enclosed double fuse holder and recessed mains input; for use with above or any good amplifier of one tone control unit, separate 6-way treble and bass control, boost and cut available by turning a switch, 2 valves, L.63s at £6, or high gain with E.F.37s at £6/6; also quality feeders, including a specially designed superhet (2-band) for fidelity reception, variable sensitivity, distortion free detector, etc. Components for Williamson: Partridge mains transformer, 57/-; chokes, 2/6 and 3/6; output transformer, £5; R.T.S. output, tropical finish, to specification, £3/7/6. [2573]

RECEIVERS, AMPLIFIERS—SECOND-HAND

HALLICRAFT Skyrider, perfect condition, 12 valve speakers.—Box 2610. [2302] R. 18 8v battery set, £7; MCR.1 8/2. [2332] Both as new.—Box 2634. [2332]

G. W. SMITH & Co. (RADIO), Ltd., offers the following, sound and perfect:—

TELEVISION.—Ex-R.A.F. R. 585 receivers, brand new in sealed boxes, a complete 45mc T.V. strip, using 5 t.r.f. stages (E.F.50), diode stage (E.A.50) and video stage (E.F.50). In addition to the above there are some 17 other valves, including E.F.50, VR.54, 55, 56, 65, together with dozens of condensers and resistors all of useful values, supplied complete with circuit, £5/10; ex-R.A.F. type 1355 receivers, for use with types 24, 25, 26 and 27 U.H.F. units, complete with valves also suitable for T/V construction, 32/6; ex-Admiralty responder units, type W 4790B, brand new in sealed boxes complete with valves, very little modification needed for a complete vision and sound pack, £2/6 each; television Polystyrene 1/2in slugged coil formers with dust cores, 6d each, 4/9 dozen; wave-meters, ex-R.A.F. type W. 1191, brand new in sealed boxes, complete with crystal and spare set of valves, coverage 100kc-20mc, can be used as signal generator, £5/10 each; crystal multipliers, brand new in sealed boxes with 807 valves, 39/6 each; meters, 0-20v a.c., 7/6; 0-20 amp a.c., 7/6; 0-0.5amp thermo, 3/6; 0-1.5amp thermo, 7/6; 0-3amp thermo, 4/-; 0-6amp thermo, 4/-; 0-5amp d.c., 7/6; 0-20v d.c., 4/3; 0-5ma, 4/6 each; 2-speed s/v dials, as fitted to the 27 U.H.F. units, £1 each; Ex-R.A.F. type 39 aerial coupling units, complete with 0-3amp and 0-6amp thermo meters, also 100-watt dummy aerial, brand new, 7/6 each; Westectors type W.6, 6d each; 12-volt starter relays, 3/6 each; constant voltage transformers, 190-260-volt input, 230-volt output at 100-watt, 60-watt auto transformers, 17/6 each; 4mf Mansbridge condensers, 1,000-volt, 2/9 each; diode valve holders, 2/9 dozen; 200ma 5 Henry I.F. chokes, 4/6 each.

G. W. SMITH & Co. (RADIO), Ltd., 3, Lisle St., London, W.C.2. Tel. Gerrard 8204. Open all day Saturday. [2576]

RCA, AR77, in perfect condition; £28/10.—R.S.S., Ltd., 68a, Park Rd., N.8, Mou. 5533. FOR sale "Hallicrafters" S20R Sky Chameleon communications receiver; what offers?—Box 2922. [2398]

R88, 54-32mc, rack mounting, perfect condition.—Aing order, £40; buyer collects.—Burchill, 75, Green St., London, E.7. [2449]

INVICTA televisor, model TL5, completely overhauled by makers, condition as new, £35 or nearest offer.—Box 2915. [2308]

HAMMARLUND Super Pro. 17-tube H meter, crystal gate, excellent condition; requires separate pack.—Box 2931. [2440]

WIRELESS World 2 R.F. 3 valve quality tuner for use with quality amplifier; £6/10, including valves; new and unused.—Box 1384. [2308]

24" H.C. television (not Radar conversion) uses 6V6, 6X4, 6X5, 6X6, 6X7, 6X8, 6X9, 6X10, 6X11, 6X12, 6X13, 6X14, 6X15, 6X16, 6X17, 6X18, 6X19, 6X20, 6X21, 6X22, 6X23, 6X24, 6X25, 6X26, 6X27, 6X28, 6X29, 6X30, 6X31, 6X32, 6X33, 6X34, 6X35, 6X36, 6X37, 6X38, 6X39, 6X40, 6X41, 6X42, 6X43, 6X44, 6X45, 6X46, 6X47, 6X48, 6X49, 6X50, 6X51, 6X52, 6X53, 6X54, 6X55, 6X56, 6X57, 6X58, 6X59, 6X60, 6X61, 6X62, 6X63, 6X64, 6X65, 6X66, 6X67, 6X68, 6X69, 6X70, 6X71, 6X72, 6X73, 6X74, 6X75, 6X76, 6X77, 6X78, 6X79, 6X80, 6X81, 6X82, 6X83, 6X84, 6X85, 6X86, 6X87, 6X88, 6X89, 6X90, 6X91, 6X92, 6X93, 6X94, 6X95, 6X96, 6X97, 6X98, 6X99, 6X100. [2472]

HALLICRAFTER S27 V.H.F. receiver, overhauled, 144 meg band, Sky Champ/10 S20; first reasonable offer; wanted, ARRA, cash, or exchange; for holder above GW3KY.—"Brighton Mount", Holyhead. [2352]



## REALISATION OF PERFORMANCE

Last month we stressed the importance of good service relations with our customers. Now a word as to the equipment itself. We used to joke that we were the only firm that did not advertise perfect reproduction, but the fact remains that we have always been precisely accurate as to what we say in our advertisements about our products. We make no claim to "perfect reproduction" because such a claim is pure nonsense. Neither we nor any one else will ever be able to give perfect reproduction of musical sounds, so we content ourselves with providing the maximum possible musical enjoyment from radio and records.

The knowledge of designing non-distorting radios and amplifiers is widespread because the theory and practice of the science admits of exact scientific treatment. But the number of people who can design a non-distorting speaker is very small because more than science is involved. There has to be added a something which is really a fine art, and the practice of that art must not be hampered by having to design acceptable speakers for equipment which, through economic considerations, introduces distortion. It requires a great deal of knowledge to design a very good speaker and a great deal of courage to refuse to supply them to makers of equipment with an inferior performance. But this is how the Hartley-Turner 215 has made its name, as did its pre-war brothers.

We have accumulated enough evidence from all over the world to satisfy us that in the Model 215 we have produced a more musically satisfying speaker than any other at any price, and your first step towards realisation of performance is to buy it. The few that have appeared in the small advertisements of this journal have been eagerly snapped up and give unalloyed satisfaction. That these advertisements appeared at all is merely evidence that no man can please everyone. But we do please those who do want freedom from distortion. Send for our free literature to-day, and above all read "New Notes in Radio," a half-crown guide to the whole subject of high-fidelity which will clear up most of the problems that are worrying you. Like our speaker it gives, we are told, the truth without distortion.

**The HARTLEY-TURNER SPEAKER** £9 plus 1/6d. post and insurance. 5/- deposit on returnable carton.

### NOW READY.

**The Hartley-Turner Selected Record Catalogue.**

The first catalogue in the world based on hyper-critical examination of the world's records. No gramophone, especially a Hartley-Turner, is complete without it. In a loose-leaf binder with forthcoming supplements. Price 25/- post paid.

**H. A. HARTLEY CO. LTD.**  
152, HAMMERSMITH RD., LONDON, W

Riverside 7387

**TELEVISOR** for sale, comprising modified 3132 Rx. A6 indicator. 50 cycle power pack, all working order.—Offers to Box 3103, or Tel. Eltham 7381.

**NATIONAL HRO.** 50 k/c-30 m/c, in 9 bands. 230v power pack, all in very good condition; £32.—Callow, Ridgeway House, A.E.R.E., nr. Didcot, Berks. [2351]

**CHALLENGER** 19 5-2,000 metres, 30 watts. Magnavox 66, baffle, pick-up and motor separate box; £35.—Allen, 9, Ebury Place, S.W.1. Sl. 4401. [2343]

**FOR** sale, 7-valve 8 waveband radio unit as used in the Decola, perfect condition, very little used; bought August, 1948; £35.—Millard, 44 London Rd., Baldock, Herts. [2482]

**PYE** D1GT television receiver, £45; Murphy television receiver, Model V114, £50; both in excellent condition.—R. W. Clitheroe, 42, South Rd., Saffron Walden, Essex. [2420]

**HALLICRAFTER** SX28, 7-550m, 15 valves, excellent condition, £40; spare set new valves, £7; matched speaker £4, or nearest offer.—53, Aston Lane, Birmingham, 20. [2348]

**PORTABLE** amplifiers, 12watt a.c. gram mike inputs, separate bass, treble controls, £10; 3watt a.c./d.c. speaker included same cabinet, high fidelity, £5/10; London area.—Box 2393.

**GOING** abroad, no reasonable offer for lot of individual items refused. RX1155 and BC348 mod. mains and pen. output, 5 0-1 m/ammeters, 5in m/e and 8in p/m speakers with former, 200 various resistors and condensers.—Box 5190. [2525]

**M.R.C.I.** miniature communications 25-cw receiver, 5-valve superhet, covering 2,000-10 metres, with headphones and power pack, for any a.c. or d.c. mains; just overhauled; £8 or nearest offer.—Horsfield, Malt House, Willersey Broadway, Worcestershire. [2423]

**R.88** receivers, offers invited: 1155 receivers, new delivery, £8, carr. paid; 1124D receivers, with 6 universal valves, diagram and gen for television adaptability, to clear 18/6, carr. paid; 1224A receivers, new, £4/10.—J. Rae, 39, Penn Rd., Wolverhampton. [2547]

**BRAND** new, 230v a.c. operation, magnificent ventilated steel case, finished grey wrinkle enamel, valve line up: 6J7-6J7-6J7-6L6-6L6-5U4G, a fine quality product; price, carr. paid, with circuits, £16/5, or less valves, £13/15.—Lawrences, 61, Byron Str., Liverpool, Gen. 4430. [2366]

**H.R.O.** Senior, 9 coils, bandspreads, 2366 Bendix p.p., H.R.O. rack fitted coil container, excellent condition, only 5-meter missing (obtainable), nearest £35; 8 H.R.O. coils, set 100kc-30mc, 3.5, 14, 28mc bandspread, nearest £20 or individual offers; 7-4mc coil, 50/-.—The Amateurs Den, 181, Lake Rd., Poole, Dorset. [2551]

**BARTONS** high gain 25-watt amplifiers, output impedance 2-15 ohms with two high gain mike inputs with transformer to match M.C. mike, etc., also two low gain inputs, complete with meter, switched to check all valves, mains input 200-250v 50cy, price £12; also large power amplifiers up to 460 watts.—Please send for list to: Barton, 41, Bedminster Down Rd., Bristol, 3.

**RELIABLE** quality P.A. ampl. 56 watts, sep. P.U. and mike valves, 5 stages A.F. treble, and bass lifts, 4 DA20s, in class A, twin L.S. transis., mult. taps meter and jacks, exceptional smoothing, hum inaudible, adeg. gain, Xtal mikes, sep. power unit, 620v at 300 ma, in trolley, usable separately, sep. pot., with motor board, Xtal, P.U., B.T.H. motor and radio unit, adj. whis. filter; used only 50 hrs.; worth £85; what offers?—Archway 1016. [2322]

**FOR** sale, due to move, carefully concealed in genuine antique pieces, McMurdo-Silver Masterpiece record and single-disc player with "Coil" pick-up, receiver and changer built into 18th century commode, with doors to tuning unit and drawer for changer; single disc player in 18th century workbox; cinema type speaker in Regency cupboard with two doors, 5 wavebands, variable selectivity, B.F.O. treble and bass controls, 30watt P.P. output stages, two-stage pre-amplifier for coil P.U., with variable scratch filter, £175.—Flat 5, Green-cass, Groby Rd., Aitricham, Alt. 3596.

**TELEVISION** Ex-Govt. radar receivers, as a brand new in market, no alterations required, for use as vision receiver section in television set, contains 4 EF50 R.F. stages, 1 EA50 detector, 1 807, meter jack and selector switch, 70ohm co-axial input, supplied tuned to 45 mc/s, bandwidth 4 mc/s, and is equivalent to corresponding section in many commercial sets; 75/- inc. post. and pkg. circuit diagram and instructions for use as vision receiver; and for obtaining sound from same chassis; post orders only, satisfaction guaranteed.—Hanstead Radio, 38, Elsham Rd., London, W.14. [2490]

**R** 1585 Western Electric U.H.F. miniature receivers, 234-258mc/s, 12 valves, 3-6AK5, 7-9001, EBC33, 12A6, 3 R.F. stages with ganged tuner and 12 switched osc. coils giving 6-spot frequencies, 2 I.F. BFO amplified A.V.C. det. and power output, equipment offered comprises 3 units, receiver with 1 valve, rack mounting for receiver with A.V.C. unit and valve, and a remote control unit; power unit and connecting cables are not available; receiver size, 11in x 6in x 5in; condition unused and as new in manufacturer's cartons; the 3 units complete with valves as above, £4/10, plus 5/- carr. and 10/- dep. on crate (returnable); circuit diagrams, 2/6 ea; a s.a.e. will bring you a 10-page list of other surplus bargains.—H. English, Rayleigh Rd., Hutton, Brentwood, Essex. [2231]

**A.W.F. RADIO PRODUCTS LTD.**  
OFFER A MOST COMPREHENSIVE  
TRADE SERVICE TO ALL RADIO  
DEALERS AND ENGINEERS.

### Specialists in

**LOUDSPEAKER REPAIRS** to most types of commercial loudspeakers.

**A.W.F. L'S CONE ASSEMBLIES** for quick repairs in your own workshop. Cartons contain 3, 6, and 12 cone assemblies. Full instructions in each carton

**TRANSFORMER REWINDS**, interleaved and impregnated. 5 day service.

**INDIVIDUAL TRANSFORMERS** built to your own spec. (or we will advise) up to 1 kilowatt.

**TUNGSRAM VALVES**, good stocks available.

**EGEN VOLUME CONTROLS**, all values in stock, less switch, S.P.S., and D.P.S.T.

**T.G.C. CONDENSERS**, large range available.

**ERIE RESISTORS** in 1/2, 3/4, and 1 watt. AND HUNDREDS OF LINES TOO NUMEROUS TO LIST HERE.

SEND 1d. STAMP AND YOUR BILLHEAD FOR OUR LATEST LIST "THE FINEST VALUE IN THE TRADE."

ENJOY THE SPEEDY "SPECIALIST" SERVICE  
GIVEN BY

**A.W.F. Radio Products Ltd.**  
Bought Mills, Bradford, Yorks.

## CONDENSERS SURPLUS

**SPECIAL OFFER. FOUR GANG 300 pf.**  
3/6 each.

### ELECTROLYTIC.

All good makes. Recent manufacture. Tubular. Wire ends. 8 mfd. 500 v. 3/9. 50 mfd. 12 v. 1/3.

Metal tubular. Tag ends. 25 mfd. 25 v. 1/6.

Vertical can. 8-4 mfd. 450 v. 4/9. 8-16 mfd. 450 v. 5/3. 16 mfd. 350 v. 2/9. 32 mfd. 350 v. 3/-. 32 mfd. 275 v. 2/9.

All vertical can types supplied with clip.

### METAL CASED TUBULAR (American).

.01 mfd. 1000 v. .25 mfd. 350 v. 6d. 5/6 doz. .02 mfd. 750 v. 4d. 3/6 doz. .1 mfd. 350 v. 4d. 3/6 doz.

### CARDBOARD TUBULAR.

.1 mfd. 350 v. 4d. 3/3 doz. Midget .1 mfd. 150 v. .05 mfd. 350 v. 6d. 5/6 doz.

### MICA.

Midget. 20, 80 and 300 pf., 3d., 2/9 doz. .001 mfd. American, 4d., 3/6 doz. 200 and 250 pf., 4000 pf., 4d., 3/6 doz.

### PAPER.

American, 1 mfd., 600 v., 1/2, 12/- doz. British, 1 mfd. 600 v., 10d., 9/- doz. 4 mfd. 350 v., 2/-.

Cash with order. Post extra under 20/-.  
List of many other bargains available.

Trade Supplied.

**M. WATTS & Co.**  
8 Baker Street  
Weybridge, Surrey

Telephone: Weybridge 2542.



**P**ORTABLE mains transmitter-receiver, 4in x 8in x 10 1/2 in. 2 wavebands, 2 to 6 mc, with valves 6L6, 5Z4, 6SC7, 6K8, 6J7, £5 only.—B. E. R., 39, Brighton Rd., Birmingham. [2416]

**L**OCAL station radio feeder unit; £5/5; 6-watt high fidelity push-pull amplifier. £12/12; 12-watt model £18/18; all complete with valves; technical data sheets on request.—E.A.D., 13, Bence Lane, Darton, Barnsley. [2455]

**NEW LOUSPEAKERS**

**W**RITE for details of the new Flexicon conversion which considerably improves reproduction of speech and music to existing speakers.—Looker's Quality Radio, 106, Davidson Rd., East Croydon. [1923]

**H**IGH quality, precision-built speakers. Ticonal magnets, detachable diaphragms, die-cast chassis, twin cone.—Broadcast & Acoustic Equipment Co., Ltd., Broadcast House, Tombland, Norwich 26970. [6435]

**T**RIDEM 12 corner cabinet loudspeaker set a new listening standard, special 12in unit gives response 40-15,000 cps hand-made cabinet.—F.S.R., Ltd., 47A, Upper Richmond Rd., East Putney, S.W.15. [2354]

**LOUDSPEAKERS, SECOND-HAND**

**B**AKER 18in p.m. 15ohm, as new; 5gns.—Tel. Chiswick 5975, after 7 p.m. [2305]

**V**OICET light coil twin, field rectifier, C.P.T., £27/5, Balwyns Park, Bexley. [2305]

**V**ITAVOX K12/20, £6; Magnavox 66 230v, a.c., £5.—113, Hazel Rd., Huyton, Lancs. [2305]

**L**OWTHER-VOICET p.m. light coil twin unit, as brand new, £24.—Hewson, 28, Signhills Ave., Cleethorpes. [2305]

**E**.A.C. infinite baffle with HI-fi speaker, £12.—Bartley-Turner 215, £7, or offers.—Haskell, 8, Ash Grove, Guildford. [2330]

**B**AKER 18in p.m., 15ohm, in closed lin thick elmwood cabinet, 26in x 26in x 18in; £11.—111, Rupert Rd., Roby, Liverpool. [2360]

**F**ORNER sale, Voigt reflector corner horn with twin diaphragm unit and a.c. power unit for same.—Offers by letter to 34, Florence Rd., Sutton Coldfield. [2456]

**B**AKER super quality 12in triple cone speaker with Ticonal magnet, complete with infinite baffle cabinet, in veneered walnut, 15ohms speech coil, £7/10; new and unused, half original price.—Box 1383. [1764]

**E**X-U.S. Govt. P.A. reflex horn pressure loudspeakers, with built-in transformer tapped 250, 500, 1000, 2500ohms, £5/10 each; four in transit case, £20.—M. A. Weston, Harman's Cross, Corfe Castle, Dorset. [2505]

**V**OICET corner horn, special model, in natural light oak veneer, with horn mouth cover, twin light-coil diaphragm, perfect, £55 or offers; another, in dark walnut, French polished, £40.—Brewer, Bethcar, Ebbw Vale. [2098]

**H**ARTLEY-TURNER 215, £7; ditto, Duode de luxe, £6/10; Goodman 12in p.m., £5/10; Connoisseur p.u., 70/-; Telefunken 1001 p.u. and motor £10; a.c./d.c. meter, £4; or nearest; all as new.—Gardner, 41, Miller Ave., Grimsby. [2305]

**T**WO P.A. 12/2, inf. baffle expon. corner horns with bass chamber; each uniform top distrib. over 90 deg. arc, suitable halls or open air; high qual. Vitavox K12/20 units, 15ohm perm max flux lens, 17,000acoust. eff. 35%; 22x16 1/4 in high, 16-watt cables, etc., complete, cost £23 each, sold singly, also two L.S.s. similar above, but IBCD; HI-FI "PM 15 units, 30 watts each, 25% eff.; suit home and halls, or open air (slight addition), 26x20x16in, 18-watt cables, exc. cond.; cost £15/5 each; what offers?—Archway 117. [2323]

**VALVES**

**VALVES!** Valves! Valves!—Almost every type of valve in stock; why wait for valves? All of our stocks are brand new at makers' list prices, no ex-Government stock; send no money, we will send c.o.d. return of post.—Hansard, Market Place, Spalding. [2249]

**DYNAMOS, MOTORS, ETC.**

**G**ENUINE plug-on dynamotors for BC453, etc. 14v in, 230v out, 12/6.—Lawrences, 61, Byrom St., Liverpool. Cen. 4430. [2387]

**E**.D.C.C. rotary converter, 110 d.c./230 a.c. £180w with filter and silencing cabinet; perfect mechanically electrically; also Gamond universal a.c. motor and turntable, little use.—Box 2925. [2418]

**B**BATTERY chargers, 4 models, 2-6-12v, 1-2-4 amps D.C.; any mains voltage; also larger types, special transformers, chokes, test rear, interior car heaters, etc.—The Banner Electric Co., Ltd., Huddersfield. [2212]

**E**LECTRIC motors.—Our famous range of E motors again available from stock; example, 1/4hp single-phase, 200-250v, 1,400 rpm, from £6/16/6; send for lists.—John Steel, Bingley, Yorks. Tel. 1066 (4 lines). [1923]

**N**EW Onan pet. generators, 12/15v 600watt self-starter, air-cooled 4-stroke, voltage reg. auto cut-out, ammeter, complete with tools, spares and instruction book, £24, plus carriage; chargers: H.D. 50v, 50a, 3-ct. m/c meter, control panel, switches, and fuses, input 200/250 1ph or 440/3/0, £20, plus carr. pet. gens., 12/15v, 360watt Alco Lyons 4-stroke, new or hardy use, ammeter, etc., £16/10, carr. free; others, 200/250 in 24v, 25a, in steel case with control panel m.c. meters, rheos, fuses, etc., £12, plus carr.; 6/24 at 12a, with Gamond fuses, etc., see case, £10, plus carr.; rectifying units, input 230/1/50, output 220v, 3a, d.c., metal rects., £8/10, plus carr.—Pearce, 66, Gt. Percy St., London, W.C.1. (near Angel). See also under components. [2554]

**ARMSTRONG**

**Model RF103, Type 2  
10-VALVE ALL-WAVE CHASSIS  
WITH VARIABLE SELECTIVITY**

- High Performance ●
- Outstanding Selectivity ●

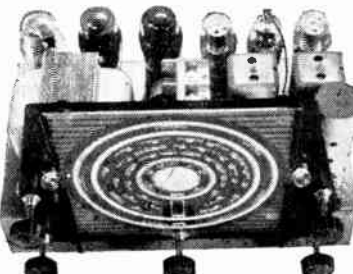

The ever-increasing difficulty in separating stations after dark is apparent to all. Our redesigned Model largely removes this serious obstacle to good listening. The two stages of I.F. amplification with variable selectivity permits of a maximum selectivity better than 6 K.c.s. On the short wavebands the actual sensitivity is 8 micro volts. It will be appreciated that this chassis has a performance of an extremely high order, and coupled with the 10 watt output makes, in our opinion, one of the most desirable musical instruments offered to the public. For 200-250 v. A.C. mains. Price 19 Gns. Plus Tax.

**SPECIAL NOTICE**

MODELS EXP83 and UNI83 briefly described hereunder now incorporate a remodeled coil pack with permeability iron cored coils giving increased selectivity and sensitivity and a new tone compensating circuit to still further increase quality of reproduction.

**Model EXP83. 8-VALVE ALL-WAVE RADIO CHASSIS** incorporating waveband expansion. Large glass scale. Treble boost control. High quality push-pull output gives 10 watts audio. For 200-250 v. A.C. mains. Price £15. 8. 8. Plus Tax.

**Model UNI-83. 8-VALVE ALL-WAVE RADIO CHASSIS** incorporating waveband expansion, e.g. the 16-50 m. band covers just over 20 inches on the large glass scale, treble boost control, high quality push-pull output giving 6 watts audio. For 200-250 v. D.C. or A.C. mains. Price £15. 8. 8. Plus Tax.

**Model EXP125. 14-VALVE ALL-WAVE RADIO CHASSIS** giving continuous waveband coverage from 11.9 m. upwards. Waveband expansion, R.F. Pre-amplifier. Two I.F. stages with variable selectivity. Electronic bass and treble lift controls. 15 watt push-pull output. For 200-250 v. A.C. mains.

Kindly write for Illustrated Catalogue Demonstrations at our Showrooms,

**ARMSTRONG WIRELESS & TELEVISION CO. LTD.**  
WALTERS ROAD, HOLLOWAY, LONDON, N.7  
Phone: NORTH 3213

**D**.C. to A.C. motor alternators, 200-250 volts D.C. input, 200-250 v. output, 50 cyc. 1 ph. 6.0 output at 200 watts, ball bearings, new, £12/10 each; also new rotary converters with special smoothing equipment up to 500 watts output for television, radiograms, etc.; prices on application.—Johnson Engineering, 519, Kennington Rd., London, S.E.1. Tel. Bodge 1412-3. [2191]

**TEST EQUIPMENT**

**C**OSSOR D.B. Osc'pe with instructions, new; £35.—Box 2640. [2366]

**R**.C. coupled audio osc., 5 steps, 20c/s-40kc/s; £15.—Box 2642. [2368]

**A**VINO MTR, universal, as new; £6.—16, Banbury Dr., W. Timperley, Cheshire. [2489]

**D**UMONT scope, 241, as new 5in tube, £20 or offer; also Wee Megger, £5.—Box 3241. [2489]

**C**OSSOR 339 oscillograph, reconditioned as new, at present fitted single beam tube 3 1/2 in. £27; (Hants).—Box 3106. [2468]

**F**OR sale as new, G.E.C. Miniscope, £17. Taylor signal tracer, £12.—Surtees, 78, High St., Felling, Gateshead, 10. [2427]

**M**ICROAMPMETERS, 0-100, FSD, blank scale, plug-in, 1/2 in. style, 2 1/2 in. 17d.—A. Stansfeld, 62, Aireworth Terrace, Keighley. [2489]

**S**ALE, test equipment, Avometers, Avometers, testers, signal generators, big reductions; list s.a.e.—Young, 134, Old Shoreham Rd., Southwick, Sussex. [1931]

**A**UDIO signal generator, model 205AG, by Hewlett Packard, Dumont oscilloscope, type 168, Corros and ultra oscilloscopes; cheap Write, B. E. R., 39, Brighton Rd., Birmingham. [2489]

**U**NBESD Partridge oscilloscope transformers combined E.H.T., H.T. & L.T. double screened, suitable for W.V. Oscilloscope, snip 45/-; Douglas power driven wave winder, sacrifice. £35.—Box 3108. [2424]

**T**AYLOR 45A valve tester, £18; E. Edgecombe all-purpose tester, £11, both as new; Shaftesbury model SC portable amplifier, complete outfit, nearest £1.—Bartley, 64, Stour Rd., Christchurch, Hants. [2462]

**M**ARCONI TF144G standard sig. gen. £29; Cossor 339A d.b. oscilloscope, £29; Cossor 343 ganging oscillator, £25; near offers considered, all ex. cond.—The Amateurs Den, 181, Lake Rd., Portsmouth. [2552]

**M**IDGET battery audio modulated signal generators, directly calibrated frequency metres, 6 ranges, 100kc-30mc, 3,000-10m new, ideal radio servicing; £5/10 (plus 2/6).—B.M. AMSP, London, W.C.1. [2333]

**O**NE Avo valve tester, complete with latest panel and instruction booklet; one Mullard test bridge; one 18in Beter audiotrium P.M. speaker, triple cone, as new and unused; best offer secure.—Box 2930. [2431]

**H**ICKOK multi-range test set a.c./d.c., 1,000-ohm d.v. inc. inf-resist V.M. Avo valve tester with 2 panels, cond/resist bridge, Weston and Philco oscillators, etc.; all for immediate sale; best offers secure.—Box 2612. [2304]

**S**ERVICE equipment.—Cossor frequency modulated ganging oscillator, model 3343; Cossor double beam oscillograph, model 3339; Cossor a.c. impedance bridge, model 3389, and equipment rack; £55.—Superb Radio Co., 42, Bedford Rd., Edmonton, N.9. Tel. How. 2059. [2337]

**I**OR sale, Western Electric TS-34/AP oscillograph, 2in tube (6AK5, 6AG7, 6S7-GT, 6AC7, 6AS6, 6SN7-GT, 573-GT-G, 6x5-GT-G valves), instruction book, fibre carrying case, 29in x 9 1/2 in x 10in, included, total weight 46lb; 40 or offer.—Indoe, 2, Lime Grove Gardens, Putney Rd., Bath. [2421]

**F**IND the fault with our high efficiency signal tracer; measure up with our multimeter; retim with our signal generator, oscilloscope and wobulator; whilst the big set's out of action, listen on our personal portable; Nuplans—each plan 2/6 from E.N.B., Whinnie Knowe, Sennen, Cornwall. S.a.e. list. [2487]

**S**IGNAL generators by Marconi Instruments, S type 144g, as new, £75 each; audio frequency oscillators by B.S.R., type L050a, new and in makers' carton, £22 each; all unused ex-Govt surplus; also voltmeters, ammeters, etc.; send for lists.—Oak Instruments, 195, Coppermill Lane, London, E.17. Larkwood 6122. [2569]

**O**SCILLOSCOPE and amplifier complete for £20. T.B. 10 c/s to 350,000 c/s. 16in Y plate amplifiers, easy to handle and has outstanding performance, brand new and fully guaranteed, immediate delivery complete with set of leads and booklet on oscilloscope technique.—Write for further details to Erskine Laboratories, Ltd., Scalby, Scarborough. [1648]

**T**EST meters, complete with leads in leather case with strap, surplus but absolutely new and unused, made by Avo, ranges volts 0-2-20-100-1,000-2,000 d.c.; amps, 0-20ma, 100ma, 200ma, 2amps, 20amps, 300amps, new and resistance 0-10,000ohms; an excellent present; only £3/10 ea.; cash with order to.—W. Tombs, Long Acre, Pendoylan, Glam. [2296]

**C**OMBINATION portable valve tester and multi-range meters by famous U.S.A. makers; ranges d.c. volts 0-10, 50, 250, 1,000 at 10,000 Ω; v. a.c. volts ditto at 2,000 Ω; v. d.c. ma 0-1, 10, 50, 250; 4 resistance ranges reading 0.1 Ω to 15 meg Ω; capacity 0.01 to 100F tests over 1,000 U.S.A. valves, black crackle case with carrying handle, each instrument tested and guaranteed, £17/10, carr. paid; U.S.A. make output meters, 5 ranges, 0-150v a.c., in small bakelite case, £4/17/6, post free. FRITH RADIOGRAPH, Ltd., 69-71, Churchgate, Leicester. [2550]

# 3 AMPLIFIERS

that meet all needs

## 3 WATT . . . 11 Gns.

P.14.—A highly portable amplifier—it weighs only 10 lbs. and is suitable for outdoor use. Works from a low power supply of 2 amps. at 6 volts. Built into case 13in. x 6½in. x 4in. with controls and sockets at one end.

## 15 WATT . . . 66 Gns.

P.10.—A quality amplifier in which the HT supply is carefully filtered and all components conservatively rated. No electrolytic condensers are used in any part of the circuit. Switch correction is provided for Decca and HMV recordings. Mounted on polished chromium plated chassis.

## 20 WATT . . . 26 Gns.

P.16.—Designed for universal mains supply, its output of 20 watts is exceptionally high. Total harmonic distortion at full output is only 4 per cent. and hum level is unusually low. Weight, 17 lbs. Overall size 15½in. x 7½in. x 8½in.

Write for leaflets giving full details.

# M c M U R D O

INSTRUMENT CO. LTD.  
Victoria Works, Ashtead, Surrey

# YOU can become a first-class RADIO ENGINEER

We are specialists in Home-Study Tuition in Radio, Television and Mathematics. Post coupon now for free booklet and learn how you can qualify for well-paid employment or profitable spare-time work.

## T. & C. RADIO COLLEGE

King Edward Ave., Aylesbury, Bucks.

(Post in unsealed envelope, 1d. stamp)

Please send me free details of your Home-Study Mathematics and Radio courses.

NAME .....  
ADDRESS .....  
W.W.79.

**M**ETERS.—0-1ma, 2½in, m/c, 13/6; 3.5 amp, 2in T.C., 5/-; 30ma, 2in, m/c, 6/-; 4 amp 2½in, thermo-coupled, 7/6; double reading, 40-120ma, 2in, m/c, 6/-; 300v, 2½in, m.m., 9/6; 15 to 2½in, m/c, 9/6; 300v, 2½in, m.l., 12/6; 300v, 2½in, 30 amp, 6in, m.l.; Ironcad, 35/-; 6,000v, 3½in, m/c, 5/6; 3,500v, 3in, m/c, 20/-; 150-volt, 2½in, m/c, 10/-; 15v/60v, double reading, 2in, m/c, 8/-; 2in meter movements with magnet (550 microamp), 2½in, post extra; ex-R.A.F. 2-valve (2-volt) microphone amplifiers, as used in plane inter-com., in self-contained metal case, can be used to make up a deaf aid outfit, intercommunication system, or with crystal set, complete with valves (also unused), 20/-, post 1/6; wooden box to hold amplifier, 2/- extra; letters only; new illustrated list sent on request with 1d stamp and s.a.e.

**HIGHSTONE UTILITIES, 58, New Wanstead, London, E.11.** [2221]  
**C**HARLES BRITAIN (RADIO), Ltd., 11, Copper Saint Martin's Lane, London, W.C.2. Tel. Temple Bar 0545.—Test set type 204, an audio frequency oscillator covering from 20 cys. to 40kc/s in four ranges, a precision instrument with a beautifully calibrated dial, ready for use on 230v 50 cycle a.c. mains, price £10, plus 10/- carr.; American indicator unit type P.N.4—By connecting a suitable power pack this can be converted into a 5in scope, with electronic switching for observing two signals simultaneously, contains 1.5in C.R.T. 5CP1, and 28 valves; 5, 6SL7, 14, 6SN7; 6, 6H6, 1, 6SH7; also 100ccx laboratory type crystal, a working model will be demonstrated to callers, price £3/19/6, plus 10/- carr.; Mains operated industrial oscilloscopes with 12in non-persistent tube in metal console cabinet, £15, or overhauled ready to operate £20, delivered free in London area; this is one of the finest bargains we have ever offered; full range of components available; send for list "W.W." of other bargains; also see display advert in this issue on page 62.—Charles Britain (Radio), Ltd. [2496]

**W**ALTON'S WIRELESS STORES, 203, Staveley Rd., Wolverhampton.—An assumed name offer in aircraft meters and instruments; in order to reduce our colossal stock of meters and instruments we are making the following special offer for a limited period only: Selection of aircraft electrical recording instruments, consisting of (1) course indicator which is a very sensitive centre reading microamp meter; (2) a fuel or oil temperature gauge which is a sensitive millamp meter, and (3) a fuel tank gauge which is a Desyn Follower meter with many uses; all these instruments are brand new and are in original wrappings; offered at the special bargain price of 8/11 carriage paid. New tank transmitting unit can be supplied to suit item 3 for 5/11 post paid. This selection consists of six different aircraft flying and other instruments, in practically all cases they are brand new and are taken from the following range: Compasses, gyroscopes, direction indicators, altimeters, fuel indicators, fuel transmitters, air speed indicators, artificial horizons, thermometers, oil gauges, etc., etc.; these are put up to our selection, and we do not guarantee any particular instrument to be included, but they are despatched on the understanding that they are to your satisfaction, and money will be refunded in full if returned within three days; original cost of this selection usually over £100; our special price is 21/-, carriage paid; send s.a.e. to-day for our full list of radio, electrical, photographic and miscellaneous components; you will be surprised at the value we offer.

**T**RANSMITTING EQUIPMENT  
**S**OUTHAMPTON County Borough Police.—The Watch Committee have for disposal one medium frequency Marconi transmitting and receiving equipment type 7P8/RF-42/1 for a.c. mains; also, one medium frequency Marconi receiving equipment type RP-42/1 for a.c. mains; both installations are complete with power pack, microphone, speaker, switch box and leads; offers to the under-signed should arrive not later than Monday, 13th December, 1948.—Charles G. Box, Chief Constable, Chief Constable's Office, Southampton, 29th November, 1948. [2448]

**G**RAMOPHONE AND SOUND EQUIPMENT  
**S**IMON SOUND SERVICE have recorders in stock. [8713]

**R**OTHERMEL ER2S sound-cell microphone. Lead, £4.—Selbit, 207, Blackfriars Rd., S.E.1.

**D**UO-TRAC Cellophone, original walnut cabinet, as new; 14 half-hour reels; first reasonable offer.—Box 2636. [2349]

**P**RECISION tracker, under and over motor board drive optional, 3 traverse speeds, 10rpm, plus cassette, Box 2639. [2365]

**M**EMOVQX RD-6/ANG-2 recorder, 1 hour speech, etc., on 7in disc using Micro-Groove technique; best offer.—Box 2638. [2364]

**C**.D.P. recorder.—The C.D.P. recorder at £32 is still the best value for money.—Bourne Instruments, Bourne, Lincs. Tel. 224. [2531]

**B**RIFERLEY ribbon P.F. with trans, as new, unused, £7; Connoisseur £3. Collaro head, £1.—2, Caeglas Ave., Rumney, Cardiff. [2358]

**C**OLLARO a.c. auto changer, £18; Lexington lead and trans, for same, £2; both new.—Tucker, 133, Mill Lane, N.W.6. Ham. 5264.

**L**EXINGTON Senr. pick-up with sapphire, 2-valve PRE amplifier, as new; £5/10.—Walls, Springfield View, Tlverton, Bath.

**S**OUND recording by the Direct Disk Method, by D. O'C. Roe, copies available, 5/-, post paid, from Birmingham Sound Reproducers, Ltd., Old Hill, Staffs. [2334]

## MOVING COIL

# AMMETERS & VOLTMETERS

EXGOVT., NEW, UNUSED & BOXED  
Offered at a fraction of original cost



## FINEST QUALITY PRECISION INSTRUMENTS

by famous makers such as Ferranti, Pullin, Metropolitan Vickers, Sangamo Weston, G.E.C.

### AMMETERS

2in. Flush, 50-0-50 amp

### VOLTMETERS

2in. Flush, 0-40 volt 2in. Flush, 0-20 volt

All at 3/11 each. Carriage paid.

Cash with order only.

Secure yours now—limited quantity.

# H. H. LINTON & CO., LTD.

34 Osnaurgh St., London, N.W.1

Telephone: EUSon 8406



WATTS	VOLTAGES	
65 watts Fitted with oval tapered bit or round pencil bit	100/110 120/130 230,250	110/120 200,220
125 watts Fitted with oval tapered bit or round pencil bit	100/110 200,220	110/120 230/250
240 watts Fitted with oval tapered bit	100/110 200,220	110/120 230,250



Write TODAY for folder Y. 10.

W. T. Henley's Telegraph Works Co. Ltd.,

Engineering Department,

51-53, Hatton Garden, London E.C.1.



**SIMON SOUND SERVICE** can supply your needs. (8712)

**C.D.P.** recorder, with extras, in good order; £25.—Hobbs, Chadlington, Oxford. (2559)

**TRANSFORMERS**, tone control and other chokes for "W.W." circuits.—R. Clark, 30, Langland Cres., Stanmore, Mdx W5 5321

**WILL** sell, or exchange for Magnetophone Tons. B., 2 disc recording machines, with amplifier, microphone, etc., also 2 Ward converters, 24v a.c. to 230 a.c. 250v.—B. 2645

**SCOTT** Philharmonic 30-valve Autogram, latest S violin model, burr walnut half-round cabinet, overhauled recently by experts, performance as new; any offers around £150, to.—41, Fearnville Place, Leeds. (2546)

**P.A. equip. comp.** Garrard autochanger, in case, 12watt amp, 2 inputs, sep. controls. R.C.A. circuit, 2 spers, 60ft cable, all in case; 200/250v a.c.; offers.—N. Guy, 117, Westbourne Terrace, W.2. (2311)

**INFINITE** Baffle corner deflectors, scientifically designed acoustic chambers as reviewed "Wireless World," June; send for catalogue.—Broadcast & Acoustic Equipment Co., Ltd., Broadcast House, Tombland, Norwich 26970.

**PARMEKO** 30watt recording amplifier, cost £85 new; MSS. recorder, offers; spectro sales 16m; tone control; also tone control unit, both guaranteed; dual-speed transcription motor playdesk with Wilkins-Wright p.u. for 17in discs.—Marsh, 2b, Riding St., Southampton. (2357)

**PROFESSIONAL** recording equipment to be traded; M.S.S. recording machines, recording amplifiers, ribbon and M/C microphones, blank discs, etc.; gramophone motors and lightweight pick-ups, radio pre-stare units and quality speakers, all from stock on full trade terms; Victor 16m tone projector, for immediate delivery.—Sound Discs (Supplies), Ltd., 37, Houghton St., Southampton. (1199)

**MEMBERSHIP** of the British Sound Recording Association ensures the professional and amateur recording engineer, and quality reproduction entirely at the latest information in the form of monthly lectures, publications, demonstrations and the official journal, "Sound Recording," published quarterly, Vol. 3, Nos. 1, 2, 3, 4 available at 2/6 each. Details of membership and application forms from Membership Secretary, Mr. A. King, 48 Mount View Rd., N. Chingford, London. (2)

**A.C. gram. motors** with 9in t.t., 200-240v, 75/-; Collaro ditto, 110/250v, variable speed with 12in t.t., £5; Collaro ditto but with universal autostop, £1/5/3; Collaro R.3 units motor/pick-up/autostop, var. speed, 12in t.t., £9; a.c./d.c. £12/18/9; Collaro a.t.o. (a.c.) out with rim-drive and 10in t.t., £5/14/8; Garrard model S, motor/pick-up/autostop unit, £5/18/4; Plessey new super-quiet record player units with pick-up £18; our dwarf audio amplifier with pick-up and tuner inputs, volume, tone and feedback controls, £5/19/6; bargain list 2/4d.—N.R.S., 102, Parkhill Rd., London, N.W.3

**COMPONENTS FOR THE MANUFACTURE OF SOUTHERN RADIO'S** wireless bargains—

**AMERICAN I.F.F.** receivers, BC966A type, in black crackle case, 3X VR136, 3X 6H6, 7X 6SH7, generator 18-480volt, easily connected to mains motor, relays and condensers, etc., 22/6 each, carriage 5/- extra; Marconi 600m headphones, leather headbands, 5/6 each, post 6d.; American crystals (2-pin fitting), 2.100, 2.115, 2.040, and 2.055kc/s, 5/- each, post 4d.; Dewrance pressure gauge, 0-2,000lb per sq in, £1, plus 1/6 post; telephone units with relays, push buttons, jack sockets and indicator lamps, in polished wooden cases, 5/6 each, post 4d.; Naval signalling lamps, in wooden transit case, 10/-, post 9d.; fractional hp motors, 200-250volts 50cps, size 4 1/2 x 2 1/2 in dia., black crackle finish, 15/-, post 1/6. Radio publications: "Radio" books, "Unusual Patented Circuits, 1944-1946," 3/6; "Radio Test Instruments," 3/6; "Elementary Radio Servicing," 3/6; "Advanced Service Technique," 3/6. British publications: "Radio Valve Equivalents," 2/6; "Radio Repairs Manual," 2/6; "The Walkie-Talkie Construction Manual," 2/6; "Radio Designs Manual," 2/6; "Frequency Modulation Receivers Manual," 2/6; "Modern Battery Receivers Manual," 2/6; "Television Constructors' Manual," 3/6; "Communications Receivers Manual," 2/6; "Amateur Transmitters' Construction Manual," 2/6; "Radio Test Equipment Manual," 2/6; "Ultra Short-wave Handbook," 2/6; "Radio Calculations Manual," 3/6; "Radio Constructors' Manual," 3/6; "Shortwave Radio Handbook," 2/6. Radio Inductance Manual, 2/6. Midgett condensers, 76pf, single gang, 2/6, post 4d.; twin gang, 5/-, post 4d.; Meters: 0-5ma thermo couple, 7/6, post 9d.; 0-5amps thermo couple, 7/6, post 9d.; 0-20volts moving coil, 7/6, post 9d.; 0-1ma moving coil, 12/6, post 9d.; 0-750ma moving coil, 12/6, post 9d.; Oscilloscope transformers, ratio 0.1 to 1, 6volts 50cps, 3/-, post 9d.

**SOUTHERN RADIO SUPPLY, Ltd.**, 46, Lisle St., London, W.C.2. Gerrard 6653. (2582)

**HIGH** quality I.F.s, 465 kc/s 7/6 pair; s.a.e. for similar component bargains.—Grayward Studio, Wells St., Rugby. (2437)

**FOR** sale, new emicose 15in c.r.t., with white mask deflector coils, focus coil, and line output trans., offers over £20.—Box 3138.

**SERVICEMAN** giving up business has for disposal complete stocks, including Western analyser, A.C. condensers, etc., offers single quantity; list.—Box 3137. (2513)

# ELECTRADIX RADIOS

BEST BRITISH BARGAINS

**THE ORIENTOR.** A positional aerial remote control. Adjust your beam from your chair; geared enclosed knob and 4in. dial with window, folding handle, position friction lock, first-grade job, 15/-.

**DYNAMOS.** D.C., 12 volts 10 amps., 1,400 r.p.m., £2; 30 volts 5 amps., 1,500 r.p.m., £4; 24 volts, 30 amps., 2,000 r.p.m., £2/10/-; 24 volts 40 amps., 800/1,000 r.p.m., £12/10/-; 50/70 volts 10 amps., 1,000 r.p.m., £18. Special 12 volts 10 amps. dynamo, 600/1,000 r.p.m. for Windmill work, C.A.V., weight 24 lbs., 10 1/2 in. x 5 in., with double-ended shaft, £5.

**SMALL MOTORS.** Sewing machine type, square construction with pulley belt and bracket easily connected to ordinary domestic sewing machine, 1/25 h.p., 230 volts A.C. new, £4/10/-.

Foot control, 55/-; 50 volts A.C. series motors, 1/12 h.p., with double-ended shaft, governor fitted on one end, £3.

**MOTOR COMPRESSOR.** 230 volts 1/2 amp. D.C. Higgs' motor, belt-driving Curtis compressor, 2 1/2 in. x 2 1/2 in. 60 lbs. pressure, 400 r.p.m., on channel iron base, £18.

**CRYPTO CONVERTER.** A.C./D.C. 230 volts, 50 cycles, 5 P. input, 240 volts D.C., 400 watts, 1,420 r.p.m., £8/10/-, carriage extra. Converters, A.C./D.C., 210 volts D.C. input, 23/29 volts, 13/8 amps. D.C. output, by Woods, £3/10/-, carriage extra.

**RESISTANCES.** Variable, panel mounting wire wound on porcelain former, 10 ohms 1 amp., 2/6. Slider resistances, 6 ohms 6 amps., 17/6. 3 ohms 10 amps., 17/6. 1.2 ohm 15 amps., 12/6. 11 ohms 4 1/2 amps., 12/6.

**DIMMERS.** Panel dimmers totally enclosed for valves, small light controls, or safety switches on test circuit, 100 ohms 1/2 amp., 50 ohms 1/2 amp., 2/6 each.

**RELAYS.** G.P.O. model 10 relays, 1 make contact and 10 with 2 break contact, on strip and in metal case, 20/- for 2 relays.

**SOLDERING IRONS.** New 230 volts or 110 volts, with flex and plug, 15/-.

**CIRCUIT TESTER.** Self-contained Govt. model, unused, 6/- 3/4 x 2 1/2 in., almost pocket size, useful for all electrical circuits, totally enclosed in polished wood box with carrying strap and contact switch, 12/6, with battery.

**METER MOVEMENTS.** D.C., highly sensitive, 100 micro-amps movement only, with pointer, 6/6, two in case, 10/6.

**MICROPHONES.** The New Lesdix table mike, high-grade carbon inset, in bakelite case and mounted on bakelite base with transformer. A charming table model, 12/6. G.P.O. mike buttons, 3/6. Insets, 2/6. Tannoy hand mike, multi-carbon inset in metal case, with switch in handle, 10/-.

**TRANSFORMER, 10/6 extra.**

**BATTERY CHARGER KIT.** Keep your accumulator in good condition from 230 volts A.C. mains, double wound transformer, metal rectifier, ballast resistance, terminals and base plate, 2 volts 1/2 amp., 21/-; 6 volts 1/2 amp., 35/-, with connection diagram.

**TELEPHONES** for House or Office. Constructors' Parts for your own set-up. Ex-G.P.O. stocks wall type, comprising Bracket Mike, Transformer and Condenser, Magneto Bell in walnut cabinet, 8in. x 6in. x 3in., fitted terminals and connections, Switch Hook and Contacts, Hand Magneto Generator and G.P.O. Receiver, 35/- per pair, with wiring diagram.

**ELECTRO MAGNETS.** Powerful 1/C electro-magnet 6/25 volts D.C. with screw-in solenoid core, weight 1 lb. 10 ozs., 2 1/2 x 1 1/2 in., will lift 7-28 lbs., type No. 1, 4/-; small 2/6 volts D.C. electro-magnet, weight 10 ozs., lift 1 1/2 to 4 lbs., 7/6.

**PARCELS.** 10 lb. useful oddments for the junk box. All clean, dismantled from Government and other surplus apparatus, 7/7 post free. (Not for Overseas buyers.)



Please include postage for mail orders.

# ELECTRADIX RADIOS

214, Queenstown Road, London, S.W.8

Telephone: MACaulay 2159.

**DOUGLAS** wave winders, in excellent condition, with all attachments and spares; £30 each; (Herts).—Box 3240. (2559)

**DOUGLAS** No. 2 automatic coil winder, for Douglas wave winders, in excellent condition, with attachments and spares; £35 each, or £110 the lot; (Herts).—Box 2030. (2064a)

**U.S.A.** rotary transformers, 18v to 450v, 60ma; may be made into a.c. motor by making two connections; 15/6; post 1/-.—M. A. Weston, Hartman's Cross, Corfe Castle, Dorset. (250c)

**H.T. trans.** 5kv U33 rect. cathode ray E. 0.1mf 6kv, as new, unused, £4 lot; unused rewinding 180ma 6.3v 3a, 2x4v 4a, £1/10.—46, Station Rd., Orpington, Kent. (2363)

**IR-COLDMM** (tuned labyrinth) chambers, individually designed and built for optimum results from any speaker, infinite baffles, bass chambers; details, Prices.—Box 2618. (2314)

**TELEVISION** magnifying lenses of famous make, to fit any and every make of receiver, just in; our price from £5/19/6.—Duke & Co., 219, Ilford Lane, Ilford, Essex. (2473)

**SUPPRESSORS:** 5c/1002 (containing 8 1mf 5c/850 condensers), 1/- each; 17/6 for 20; 5c/170, 2/6 each; 5 for 10/-; postage paid.—Smith, Highworth Rd., Farnlington, Berks. (2435)

**TELEVISION** scanning coils, 3U frame output transformer, 7/6; £10; also 1U transformers, 25/-; also mains transformers, chokes, etc.—The Banner Electric Co., Ltd., Hoddesdon. (Herts.)

**H.T. transformers,** mains transformers and chokes for electronic engineering home-bait televisor; delivery ex-stock.—Metropolitan Radio Service Co., 1021, Finchley Rd., N.W.11. Tel. Speedwell 3000. (11678A)

**TELEVISION** chassis and components of the highest quality, ready for assembly to "Electronic Engineering" specification; s.a.e. for list.—Osmon Radio Products, Ltd., Borough Hill, Weybridge, Surrey. (2459)

**H.T. transformers,** mains transformers and chokes for general purpose oscilloscope, as per W.W. May, 1948, delivery ex stock.—Metropolitan Radio Service Co., 1021, Finchley Rd., N.W.11. Tel. Speedwell 3000. (11265)

**YOU** will probably find at Smith's, Edgware Rd., 1/- Everything for the constructor from a 1/10watt resistor to a radiogram cabinet; lowest prices, biggest variety.—Near Metropolitan Music Hall, Pad 5801 (8005)

**H.T. transformers,** mains transformers and chokes for cathode-ray oscilloscope as per "W. World," Dec., 1948; delivery ex-stock.—Metropolitan Radio Service Company, 1021, Finchley Rd., N.W.11. Tel. Speedwell 3000. (2494)

**BATTERY** eliminators, manufacturer's surplus, input 200-250v a.c., output 120v 20ma, smoothed (no tapping), 1/6; universal motor accumulator, brand new, guaranteed 6 months, post free, 39/6.—C. Brinkman & Co., Chitty St., London, W.1. (2494)

**LITTLEWOODS.**—Electronic Engineering televisor, all components in stock, 3rd edition book printed Oct., 1948, containing latest revisions and modifications, 2/8 post free.—Henson Littlewood & Co., 27, Ballards Lane, Finchley, N.3. Fin. 3060. (2563)

**THE** pioneer manufacturers of the Williamson amplifier offer finest quality set of transformer and chokes at £2/15 inc. cr. totally shrouded, beautifully made and guaranteed. R.T.M.C. Ltd., 141, Little Ealing Lane, W.5. (See advert. under Amplifiers.) (2370)

**PANEL** indicator lamps, blue or red, 9d; toggle switches, 3amp 250v, 1/7/-; unsippable accumulators, 2v, 9/6; rotary universal motor accumulator, brand new, guaranteed 6 months, post free, 39/6.—C. Brinkman & Co., Chitty St., London, W.1. (2494)

**AMAZING** bargain, 9.6, complete kit parts for 3 W.B. superhet coil pack, including Yaxley type coils, trimmer, 100,000 ohm I.F.T.s 465, 7/6 pr.; amphenol octal 4/d; send for cheapest list in England.—Sussex Electronics, Ltd., (G) Bevendean, Brighton, Tel. 4446.

**OSMON RADIO PRODUCTS, Ltd.**—All components for the Osmon superhet available at attractive prices, including the famous Q coilpack, etc.; designed for easy assembling and perfect matching; send s.a.e. for free literature to Bridge View Works, Borough Hill, Croydon 1220. (2458)

**MANUFACTURERS**—Enamel, copper, wires, all gauges, laminations, all types, all stocks radio components, s/m, m/m, p/t and block condensers, close tolerance and high stability resistors to 1%; all goods guaranteed.—L. E. Simmonds, 10, Valencia Rd., Stanmore, Middlesex 698. (2515)

**TELEVISION** combined E.H.T., L.H.T. transformers for the electronic and home-made televisors; PRI. 200-250, SEC. 350-350, 250ma/6.3, 8 amps/4v 2 amp/5v tapped 4v 5 amps; 6.3v tapped, 2v 2 amp/4v tapped 2v E.H.T. rec. 2 amp E.H.T., 4k 3ma; 100.—R.S.S., Ltd., 68a, Park Rd., N.8. Mou. 5533. (2435)

**PAYMAX** are your suppliers for radio television and gramophone equipment, components kits and chassis; all at prices you can afford; all necessary items, including cabinets, for player or auto table radiograms; stamp for general list of state your requirements.—Paymax Elec. Co., Ltd., 126, Norwood Rd., S.E.24. (2435)

**"IT'S** foolish but it's fun" condensers, 1" moulded, tubular, silver mica, 50 assorted valves, 5/-; 1/2 meg vol. controls, 1/9 transformers, 250 a.c. output, 1 and 20 volts at 5amps, 28/6; M.E.S. 1/2 holders, 1/6 dozen; 7-core multi-colour circular flex, 12yds 5/6c.—Passingham (Dept. W.W.), North St., Kelghley.



## SOUTHERN RADIO'S WIRELESS BARGAINS

**BENDIX COMMAND RECEIVERS.** BC454, 3-6 meg. (1/1's 1415 kc.) and BC465 6-9.1 meg. (1/1's 2830 kc.). 6 valves: 128K7 (3), 128R7 (1) 1246 (1), 12K8 (1). Ideal for conversion to AC/DC receivers or car radio. Either set, new and boxed, 35/- each, postage 1/6.

**RECEIVERS TYPE 7E.** 150-505 kc. in two bands, 26 volt operation. Valves: VR92, VR57 and ARTH2. Flexible geared drive, Densyun control and other high quality components. New, 35/- each, post 1/6 extra.

**TRANSMITTER TUNING UNITS.** T.U.9B, 7,700-10,000 kc. T.U.10B, 10,000-25,000 kc. T.U.20, 200-500 kc. Any Unit £1 plus 2/6 carriage.

**CONTROL BOXES FOR BC455, BC454 AND BC455.** Comprising three slow motion drives and dials, three volume controls and six rotary switches. In sealed boxes, 12/6 each, plus 1/- post.

**CONTACTOR TIME SWITCHES.** By Smiths or Venuers. 10 hour movement giving two impulses per second. Ideal for darkroom work. Brand New in Soundproof box with thermostatic control. 10/-, post 1/4.

**DELCO HAND GENERATORS.** 6 volt 4 amp. output. BRAND NEW, with spare brushes, 17/6 post free.

**SCREENED VALVE CANS** with cell-on base and spring loaded valve retainer. 1/6 each.

**FIFTEEN FOOT COPPER AERIALS** in seven interlocking sections. 3/6, post 4d.

**24 VOLT MOTORS** with slow motion gearing and smoothing circuit. In maker's sealed cartons. 10/-, post 9d.

**BATTERIES.** M.C.R.1 type, 90 volts H.T. and 7i volts L.T., 6/6 each, post 9d.

**EVER-READY MINIMAX.** 67i volts, 5/8 each, post 4d.

**V.C.R.97 TUBES.** Brand new, 42/6, carriage and special packing 5/- extra.

**V.C.R. 97 BASES, 2/6.**

**INSPECTION LAMPS** with 2ft. lead and Lucas plug, 2/6, post 4d.

**THEROAT MICROPHONES.** Low impedance, with three foot lead and back plug. 3/6, post 6d.

**WESTECTORS W.X.6 and W.112.** 6/- per dozen, post 4d.

**Southern Radio Supply Ltd.**

46, LISLE STREET, LONDON, W.C.2.  
GERrard 6653

## THE HEART OF A FIRST-CLASS RADIO-GRAM

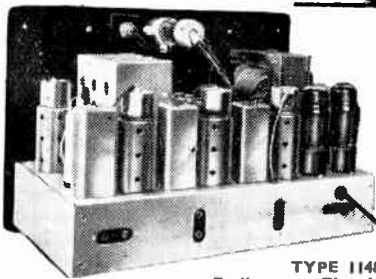

TYPE 1148

Radio-gram Chassis

Developed from the popular type 1047, this receiver will form the basis for a Radio-gram of unsurpassed performance, and at great saving in cost. Principal features include: 12 stage superhet circuit • 11 valves with magic eye indicator • 4 wavebands (11-2,000 metres) • R.F. Amplifier • 2 I.F. stages • 4 stages AVC • 10 watts push-pull output • Separate treble and bass controls • Tropicalised components.

Other Peerless equipment of interest to the enthusiast includes: 16-valve Communications Receiver Type 1546 • R/F Feeder Unit (comprising R/F portion of Type 1148 Receiver) • A/F Unit and Power Pack Type 1. All details on request.

**PEERLESS RADIO LIMITED**

374 KENSINGTON HIGH STREET, LONDON W.14

Telephone: WEStern 1221

**MAINS transformers, output transformers** and chokes for d.t.n. Williamson amplifier 9s per W. World, May, 1947, and for the economical 50-watt amplifier, "W. World," Dec. 1948; delivery ex-stock.—Metropolitan Radio Service Company, 1021, Finchley Rd., N.W.11 Tel. Speedwell 3000.

**UNUSED Sound Sales mains transformer,** model 500.250, primary 10-0-200-220-240 at 40/100 cycles; H.T. secondary 500-0-500V 250 mA; L.T. windings, 2-0-2 at 3.75 amps; 2-0-2 at 3.0 amps; 2-0-2 at 3.0 amps; 2-0-2 at 2.0 amps; 2-0-2 at 2.0 amps; price £6 or near offer.—Standard, Peene House Cottages, Newington, Folkestone.

**LOUDSPEAKER** bass and treble separator parts consisting of choke 6/-, and 15mf condenser, 15/-; cross over at 1,000 c.p.s.; suitable 2 to 15ohm speakers; circuit diagram of variable selectivity 5 with constructional hints, 3/-; variable selectivity I.F. transformers, 12/-; scratch filter, 15/-; trade enquiries invited.

**BATTERY** chargers: Car. 6 or 12-volt. Ior. B 200-250v a.c., 49/-; battery gram amplifiers in 14in x 8in x 6in cabinet with speaker, push-pull output 120v h.t., 2v l.t., 48/-, less batteries; electric motors, 200-250v a.c. with 3in grindstone fitted, 29/-; huge bumper parcel of assorted components, 10/-; all c.w.o., postage free.—Hughes Radio, 194, Mill St., Liverpool, 8.

**KITS** of radio receivers from £7/8; 4- and 5-valve new materials, table models, semi-midget; our latest kit.—Wylwyn Star 1948 has connections for gramophone pick-up, extensions to loudspeakers, A.V.C., 6 hours average time for constructing; full details, diagrams with each kit c.w.o. or c.o.d.—Isherwoods, Reme House, 81, Plungington Rd., Preston. Tel. 3338 Estd. 1936. [6788]

**TRANSFORMERS,** special quality, tropicalised, 6in x 6in x 7in, 230v primaries, secondary 350-0-350v at 300ma, 20-0-20v, 2 x 6.3v, 5v, 37/6; secondary 2 x 350-0-350v at 200ma, 2 x 6.3v C.T., 2 x 5v, 6.3v, 55/-, carriage 5/-; primary tapped 200-250v, secondary 500-0-500v at 120ma, 3 x 4v C.T., 10v, 32/6; 350ma L.F. chokes, 20/-; many other items, s.a.e. list.—Cross, Skerries, Cross Lane, Granke, West Kirby, Cheshire.

**SET** of four coils, long, medium and short, 4-pole 4-wa switch, pair 465kc standard iron cored, 1fs, twin gang condenser and circuit, 13/6; Rola 5-inch energised 1,000ohm field with transformer, require recentering, 7/6; mains transformer, 280-0-280volts 80mills, 6.3volt amp, 5volt 2amp screened pri, drop thru chassis type, primary input 220 and 240 volts, 13/6; write for lists.—Cohen, 67, Raleigh Ave., Hiss, Middx. [2478]

**45mc/s** television strip (5VR91) with 20 other valves, R3553 £3/10, R3515 new and boxed 2 valves, etc., 13.5mc/s IF strip, £4; R1124 6 Brimar valves, 20/-, 2-35/-; all with circuits; modulators (5 KT44-2-U17 or VU111, 1-MH4, etc.), 30/-, 2-50/-; all carriage paid; C.R.T., 1 1/2-inch screen VLS 492AG new and boxed, suitable for small oscilloscope with data, 17/6 post paid; s.a.e. particulars.—G. R. Adcock, Norwich Rd., Watton, Norfolk, 12451

**STRANGE** but true; brand new ex-Govt. and manufacturers' surplus equipment at prices lowest ever, offered to the public; example: moving coil microphone with recessed switch, 5/6; 60-ohm headphones, 3/6; long range signal lamps, 7/6; motor generators, easily converted to approx. 1/2hp motors, 20/-; smaller type, approx. 1/4hp, 17/6; 5-, 8-, 10-, 12-inch P.M. speakers, 10/6, 12/6, 22/6 and 85/- respectively; many other lines, s.a.e.—Radio Unlimited, 16, Carnarvon Rd., Leyton, E.10. [2252]

**TELRAD ELECTRONICS,** 70, Church Rd., Upper Norwood, London, S.E.19.—Write, call or 'phone Livingstone 4879 for television components to W.W. or E.E. design, E.E. chassis fitted with v/holders, coil formers, sockets and screens, vision 22/6 sound 18/3; 1/base, 17/6; power, 25/-; deflector coil ass. line o.p. track and focus coil ass, 32/6 each; gantries, straps and control panel, 10/-; 9in tube masks, cream 11/-, black 10/-; everything for television, radio and amp constructor. [2572]

**TELEVISION**—Focus coils and shrouds, frame and line deflector coils, line output transformers, blocking oscillator transformers; complete focus and deflector assemblies also available, supplied correct to designer's specification for "Wireless World" television receivers. Television components of all types, valves, condensers, resistors, tube masks, mains transformers and chokes, etc., etc., in stock at current prices.—For particulars write or 'phone, Handy Parts., 226, 228, Merton Rd., Wimbledon, S.W.19. Liberty [1420] 7461. Trade enquiries invited.

**SUPPRESSORS** which really work, positively best h.f. stoppers available, 4-section cast case, dust cores, 16 s.w.g., 4 0.1mf doms, 5/9; new vitreous resistors, 1 1/2 to 75K ohms, 30 and 75v, 1/6; 100 and 200v, 2 1/2 x 2 1/2in, all 5/6 doz; rectifiers, 2d per watt, viz., 24v 1a 4/4, 5a £1; 1/4a 300v 12/6, 1.500v 62/6; chargers, 24v 6a, met. rect., 2 meters 3 switches, etc., £4; bakelite t.r.f. midgets, 135/-; 750v wkg oil conds, 10-8 mid 3/9, 8mid 3/-, 0.1 bake tube, 0.5 1,000v, 1inid 250v, 2mid 250v, 2 1/2 x 2 1/2in, all 5/6 doz; 250v 5a sp. switches, panel lamps, 100ohm preset pots, all 5/6 doz; enclosed holders, 2 5a fuses, 1/-; 4-way ditto, 1/3; 20-32a overload releases, 1/-; block connectors, 2-way 7d, 4-way 9d; 6oz 35 s.w.g. en. wire, 1/3; screened inst. cases, 1 1/2 x 7/8 x 6 1/4, all post free, no c.o.d.—69, Allerton Grange Way, Leeds, 7. Tel. 56146.

## Specialists in

## HIGH-POWER AMPLIFIERS

from  
250W to 1kW

**W. Bryan Savage Ltd**

WESTMORELAND ROAD, LONDON, N.W.9

Telephone: Colindale 7131

## ETA

### FOUR-STATION PRESET TUNER TYPE TS41

A complete preset tuning unit for use in superhet circuits to select any three MW and one LW station. Exceptional sensitivity and stability are achieved by the use of new type inductors which enable each coil to be tuned over the whole of its band by adjustment of the dust iron core. Supplied with full instructions and a complete receiver circuit.

**Price 33/- plus 7/2 Pur. Tax.**

### I.F. TRANSFORMERS SERIES IT1

A midget IF transformer for 465kc/s which sets a new standard of efficiency. Permeability trimmers for both sections are brought out at the side of the can. "Q" in can-110; Size-1 1/2" dia, by 2 1/2" high. IT11 is critically coupled and has top grid lead, IT12 is overcoupled for diode circuits and has all connections at base.

**Price 7/- each**

ETA Components are obtainable from your local dealer or direct from

**ELECTRO TECHNICAL  
ASSEMBLIES**  
West Hill, St. Leonards-on-Sea,  
Sussex.





**CHARLES BRITAIN (RADIO) LTD.**  
11, UPPER SAINT MARTINS LANE,  
LONDON, W.G.2



Telephone: TEMple Bar 0545

**BEST BUY AT BRITAIN'S**

**VIDEO RECEIVER R1355.** Contains 10 valves 1 5U4G, 1 HVR2A, 8 8P61 and incorporates 7.7 Mc/s I.F. strip. Used in conjunction with the type 25 R.F. unit which plugs straight into this receiver, it forms an ideal vision receiver. Simple modification instructions supplied with each unit. May be seen working at our premises. Amazing bargain at only 30/- plus 5/- carr.

**TYPE 25 R.F. UNIT, 10/6 each.** Post Free.

**TELEVISION MAGNIFYING LENSES** for 6in. tubes, lup-oves viewing by increasing size of picture. Easily fixed. The latest plastic development in oil filled lenses. Yours for 39/6. Post paid.

**E.H.T. TRANSFORMER.** 1750 v. R.M.S. at 5 m/A 4 v. at 2 amps tapped at 2 v. For 230 v. Input. Especially suitable for VCR97 tubes. Brand new and guaranteed at 29/6 each. Post free.

**INDICATOR 62A.** The best Indicator of them all. Contains 21 valves, 12 EF50, 2 EB34, 4 8P61, 3 EA50, 6in. C.R.T. VCR97, 15 wirewound pots, etc. Price £4/10/- plus 15/- carr. **NOTE.—All tubes tested before despatch and demonstrated to callers.**

**SUPPRESSOR UNIT.** This is the simplest thing we have seen for easy conversion into a push-pull audio frequency amplifier. It contains Heavy duty mains power pack for 230 v. 50 cps. A.C. mains operation. 1 5U4G rectifier, 2 6V6, 1 6J7, 3 EB34, input and output sockets. Contained in heavy gauge metal cabinet size 14in. x 10in. x 9in. of handsome appearance. Exceptional value even for Britain's. All brand new in wooden crates. £3/10/- plus 10/- carr.

**THIS MONTH'S SPECIAL BARGAIN RECEIVER UNITS TYPES 25 OR 73.** These are actually the receiver portion of the TR1196. They contain 6 valves 2 EF39, 1 EK32, 1 EBC33, 2 EF36, one pair of 460 Kc/s I.F. Transformers, resistors, condensers, etc. Super value at 19/6 plus 5/- post and packing.

We have a few Super Quality communication receivers (AR88, etc.) for callers only.

**Shop hours 9 a.m. to 6 p.m.  
Open all day Saturday.**

**OPPORTUNITIES IN RADIO**



**Get this FREE Book!**  
**"ENGINEERING OPPORTUNITIES"** reveals how you can become technically-qualified at home for a highly-paid key-appointment in the vast Radio and Television Industry. In 108 pages of intensely interesting matter, it includes full details of our up-to-the-minute home study courses in all branches of **TELEVISION and RADIO, A.M. Brit. I.R.E., A.M.I.E.E., City & Guilds, Special Television, Servicing, Sound Film Projection, Short Wave, High Frequency, and General Wireless Courses.**  
**We definitely Guarantee**

**"NO PASS—NO FEE"**

If you're earning less than £10 a week, this enlightening book is for you. Write for your copy today. It will be sent FREE and without obligation.

**BRITISH INSTITUTE OF ENGINEERING TECHNOLOGY**  
388b, Shakespeare House,  
17 19, Stratford Place, London, W.1.

**G. A. RYALL, "Utopia,"** Mayfield Rd., Herne Bay Kent; mail order only, postage or carriage extra; c.o.d. £1 or over; full list, large s.a.e. please; U.S.A. tubular metal cased wire ended 0.1m.f. 500v 7/6 doz. 350v 5/6 doz; U.S.A. tubular metal cased wire ended 0.5m.f. 350 7/6 doz.; Mansbridge Im.f. 500v wkg. 3-2/-; Mansbridge Im.f. 400v wkg. 2/3 each; silver mica 10p.; 40p.f. 200p.f. 300p.f. 400p.f. 500p.f 3/6 doz.; mica 0.01m.f. 3-1/2; all condensers guaranteed; Amphenol type British 5-pin chassis valve holders 3/6 doz.; international octal chassis valve holders, bakolin, 4/- doz.; bar type 3-valve gangs 5/-; bar type 4-gangs 5/-; regulators 5/-; 1/2 watt assorted 100 ohms to 2 meg. level assortment 40-5/-; switches, SB. 2P 6w miniature 1/6, 3B, 2P 6w five poles total 2/3 each, SB. 3w 2/-, 2B SP 6w 1/6, SB. SP. 3w 1/-, 2B. 3P. 3w 2/-, SB. 2P. 4w 1/3; twelve-way group boards with 9-1w and 1/2w resistances, etc., 2/- all new; twenty other types in stock; octal plugs, cap and chassis socket, 3-3/-, with tags 3-3/6; high resistances, phones with sponge earcaps, with good class microphone, all wired into plug type 10H/10991, 10/9 pair; metal boxes, black finish with quarter inch pax. lin. panel, fixing lugs and corner sockets, size 8 1/2 x 7 1/2 x 3 1/2, 6/9 each new; 10,000 ohm bakelite cased volume controls medium spindle 1/6; metal cased minimum depth 1/4 meg valve., short spindle 1/6 each; special list for trade. [1613]

**COMPONENTS** for West Country amateurs: full range Eddystone components and receivers; Eddystone crystal calibrator, £12; tuner unit 145mc/s. 17/6; 77; Pyrex aerial insul. 1/3; 8X8pf. butterfly. 7/-; Denco CT4 6-band h.g. lead-in insul. 3/-; Denco CT4 6-band h.g. comm. rec. turret. £12/14/11; CT6 5-band. £10/9; CT7 5-band with r.f. £8/15; BFO units 12/6; DR21 constructors kits. £15/5/10; W1191 ex-R.A.F. sig. gen. and wmeter. £10/0/-; 100kc-20mc modulated, unused, complete with valves, crystal, cal. book and spares, £8. plus 10/- c. and p.; c.w.o. only; orders under 30/- add post s.a.e. for lists—G. N. Pill & Partners, 49, Colbour St., Plymouth. [2510]

**TELEVISION** branded components exact to E.E. designers specifications, vision chassis fitted valveholders, coil formers, 22/6; sound ditto chassis, 18/6; time base ditto, 18/6; power ditto chassis, 25/-; set Gantrys, clips, control panel, 10/-; complete chassis assembly with gantrys, etc., £4/14/6; Aden deflector coil assembly, 32/6; line transformer, 32/6; focus coil, 32/6; set 8 coils, fully wound, 15/-; Hunts 0.1 mfd tubular condenser with clip, 7,000 v.w. 14,000v test, 19/6; rubber mask for 9in tube, 11/-; Magnavista screen enlarger, 6gns; coaxial cable 1/3 per yard; Ultra midget 2-gang variable condenser for personal portables, 10/-; glass, s.m.l. dial, 6x8in 4/6, pan 4/6, escutcheon 5/6; 8in P.M., less trans, 17/6; 6in P.M. with trans, 22/6; P.P. output heavy duty trans. for 6L6 valves, tapped output 15 and 7.5 and ditto for 6V6 valves at 21/- each; American throat microphones, boxed, 3/- each; condensers 8 mfd 450v at 2/6, 8 mfd 350v 2/-, 8 plus 16 mfd 450v 5/6; trimmer kit in smart case, 17/- coils Quadrad, 45/-, rotary trans. in 6-12v, out. 200-480v 50 Ma. or motor d.c. mains, 15/-; Collaro a.c./d.c. motor, and P.U. on plate, £12/17/6; 4-pin vibrators, 6v, 6/-; switches, Yaxley type 3-pole 2-way 2/-, 4-pole 3-way 3/-, 4-pole 4-way 3/6, 6-pole 4-way 4/6; 10-pole 3-way 7/6; midget switches 4-pole 3-way 3/-; 4-pole 2-way 3/-; enamelled copper wire, various gauges in 1/2lb rees; tinned copper wire, 18, 20, 22 at 1/6 per 1/2lb reel; full list at 2/4d postage all orders.—O. Greenlick, Ltd., 265, Whitechapel Rd., London, E.1. Bis. 5079. [2377]

**SELENIUM** rectifiers, charger kits, etc., new goods, not surplus; charger kits guaranteed one year, data sheet supplied; add postage 7d up to 15/-, 1/3 above; standard charger kit for motor.st or radio cells, 12v 3 amp S.T.C. selenium rectifier with 50-watt tapped transformer and ballast bulb for 2v to 12v charger, 45/-; ditto, 2-amp rectifier and 45-watt trans., 35/-; ditto, 1 amp rect. and 25-watt trans., 32/-; also 6v kits, 3-amp, 42/-, 4-amp 47/6, 2-amp 32/-; handsome steel case, 2a 15/6, 3a 18/6; medium duty charger kit, 12v 4 amp rectifier with 75-watt transformer and ballast bulb for 6v, 12v charger, 62/-; steel case special manufacture, 18/6; heavy duty transformer, 120 watts, with large 6 amp rectifier for 6v, 12v charger, £2/15; ditto, with 0 ohm slider and 0-6 amp ammeter, £5; ditto, but with ballast bulb in place of slider and ammeter, £4/5; transformer, 180-watt, with 24v 6 amp rectifier, giant finned type, £6/8/6, tapped for 6v, 12v, 18v, 24v; rectifier, 12v, 3 amp 9/7, 12v 2 amp 12/6, 6v 2 amp 9/7, 2v 3 amp 21/-, 12v 4 amp 24/-, 12v 5 amp 26/6, giant finned type, 12v 6 amp 33/-, 6v 10 amp 26/- ditto 24v 6 amp 62/-, 24v 2.5 amp 32/6, 36v 4 amp 55/-, also various rectifiers for garage charger conversions in stock; H.T. rectifiers, selenium small space type 250v 60 ma half-wave 7/-, ditto 110v 60 ma 6/-, ditto 120v 20 ma 7/-, 250v 100 ma bridge full wave 13/6; 350-0-350 80 ma. c. tap, 13/6; 450v ma, h/w, 7/-; crystal diodes, new, capsuled, 3/9; fluorescent chokes, 80 watt, 16/6; h.g.h-grade 0-6 ammeters, bakelite, flush type 12/6; Rola 8in P.M.s, less trans, 15/-; Aerovox 2mfd, 1,000v, oil filled cond., 3/6; motorists' chargers, 6v, 12v, 1.5 amp, heavy duty type, 55/-.  
**CHAMPION, 43, Uplands Way, London, N.21.**  
Tel. Lab. 4457. [2583]

**TELEVISION!**  
**Why not make your own?**

**"THE HOME BUILT TELEVISOR"**

Book of instructions, wiring diagram and full list of parts 6/6 post free.

Full scale blueprints shortly available.

Units supplied ready wired.

E.H.T. Trans., shrouded	£3 7 6
Focus Coils	£1 17 6
Line Transformers	£2 2 0
Scanning Coils	£1 12 6
9in. White Masks	12 0
12in. White Masks	£1 0 0

Send now to:—  
**TELERADIO Co.**  
157, Fore St.,  
Edmonton, N.18.  
(Phone TOT 3386)  
**The Leading Kit Suppliers.**

**COPPER WIRE, Enamelled, Silk, D.C.C., etc.,** all sizes. **TRANSFORMERS & CHOKES** made to your special requirements. **SMALL MOTORS** 1200 to 1 H.P. a speciality. **ALL COMPONENTS** for the Radio and Television constructor.

Send S.A.E. for list to:  
**STAN. HOLT,**  
349, HIGH ST., SMETHWICK, STAFFS.

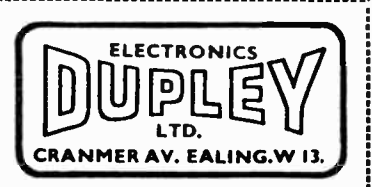

PHONE EALING 5688  
**WILLIAMSON AMPLIFIER COMPONENTS**

**OUTPUT TRANSFORMER £4 7 6**  
**TO DESIGNERS' SPECIFICATION**

**MAINS TRANSFORMER £4 2 6**  
**CHOKE, 15 HEN. 150 MA. £1 7 6**  
**CHOKE, 30 HEN. 30 MA. 9 6**

Send for details of above and full range of standard transformers and chokes.  
Manufacturers' enquiries invited



# GALPINS

ELECTRICAL STORES

408 HIGH STREET, LEWISHAM, LONDON, S.E.13

Telephone: Lee Green 0309. Near Lewisham Hospital.

TERMS: CASH WITH ORDER. NO C.O.D.

**RECEIVERS, R1155**, complete working order. £9/7/6; power units for above with output stage built in and moving coil speaker, mains operation, £5; buzz telephone sets, Canadian, with Morse key, fielder and ringing generator, 17/-; television or oscilloscope transformers, suitable for C.R.T.s, V.C.R. 517, 97, and 5 C.P1, etc., 0-2000v 500-0-500v, 6.3v 8amps, two 4v 2amps, two 4v lamp (H.V. insulated) for C.R.T. and H.V. rectifier, Pri. 0-200, 250, 250v, 50 cycles electrostatic screen, £4/0; e.h.t. transformers, 0-2000v, F.M.S. 5ma 0-2-4v heater winding, Pri. 0-250v, 50 cycles, vacuum impregnated, 24/- each; receivers, R1132, B.C. 348, P.C.R.2, all less valves, 70/-; heater transformer (H.V. insulated), 4v, 2amps, Pri. 250v 50 cycles, vacuum impregnated, 12/-; broadcast microphones G.P.O. pattern, complete, 7/8; rubber-covered wire 3mm 1/1, 029 30m/yds 13/6, 500yds 20/-; tubular neons, 4 1/2 in. 1/6; bulbs, blue internal coated, 110v, 35watts, S.B.C. and 12v 36watts M.B.C. 2 for 1/6; bulbs, clear, 100v, 25watts M.B.C., 6 for 2/-; The Trading Post, Ltd., 40, South Ealing Rd., South Ealing, W.5, Tel. EA. 5903. [2460

**NEW S.T.C.** selenium rectifiers; the largest range of l.t. metal rectifiers in the country; makers current products; not surplus; from stock H4/200 EHT for W.W. televisor 28/- ea., p.f. 6d.; 3a, 21/6; 4a, 21/6; 5a, 21/6; 6a, 22/6; 10a, 24/6; all p. 10d; 30v, 2a, 14/-; 5a, 35/-; 8a, 38/6; 45v, 5a, 48/-; 100v, 2a, 34/6; all p. 1/-; full-wave bridge-conn., 17v, 1.5a, 12/1; 2a, 15/1; 2.5a, 20/6; 3a, 21/6; 4a, 25/-; 5a, 27/-; 6a, p.f. 35v, 3a, 18/6; 1a, 21/6; 1.5a, 21/6; 2a, 29/6; 3a, 35/-; 4a, 42/-; 5a, 43/6; 100v, 1.5a, 72/-; all p. 10; heavy duty type 7in sq. fins, 16v, 10a, 43/8; 20a, 80/-; 17v, 6a, 34/-; 35v, 6a, 64/-; 10a, 71/-; 54v, 6a, 90/-; 65v, 10a, 130/-; all p. 1/4; industrial rectifiers, tunnel cooled, 17v, 12a, 7/6; 17v, 50a, 17/-; 10a, 100v, 10/-; 100v, 6a, 100v, 6a, 100v, 10a, 192/-; carr. 2/6; valve chargers, conversions to metal rect. from stock, Philips 328 and 367; Tungar 68504, 68530, U600, etc., fitted in 5 mins. without alteration to present charger; pse. state make, type, no. and max. d.c. output; complete ordering charts; trans. rect., rheo., 54v, 6a, £11/10, incl. tapping switch; 35v, 6a, £7/19/6; 16v, 10a, £6/12/6; 17v, 6a, £4/12/6; 16v, 5a, £3/10; vent steel case, 7/6 extra; 16v, 4a, £3, case 7/6; 16v, 2a, 38/6, case 7/6; transformers, 200/250, input 16v, 10a, 65/-; 17v, 6a, 47/6; 1/4, 16v, 5a, 18/6; p. 1/-; 16v, 4a, 35/6; p. 1/-; 16v, 2a, 23/6; p. 10/-; slider res., all values from 24/6, p. 1/-; ammeters 0-6a, M.I., 12/6; m/c, 0-5a, 15/-, both p. 6d.; 0-14a, m/c 5in dial, 32/6, p. 1/4; we stock the new S.T.C. portable charger as advertised in the 'Autocar', etc.; fully automatic and guaranteed 1 yr.; charges 6/12v batteries at 3/5a, from 200/250 a.c., £10, carr. free; send for illus. leaflet; another type to charge 6/12v at 5/6a, from 200/250 a.c. with rheo. and meter in steel case, £6/18/6, carr. free; see 12/6; under dynamos; terms c.o.d., post goods only; others c.w.o., or pro-forma invoice; wholesale and retail.—Pearce, 66, Gt. Percy St., London, W.C.1 (near Angel). Est. 17 yrs. [2533

**SUPREME RADIO, 746b, Romford Rd., Manor Park, London, E.160.** Est. 15 yrs.—Televison components as follows: E.H.T. 4k/v or 5k/v, 2v fil., tested at 20k/v, 55/- ea.; scanning coils, 25/6 ea.; line transformers, 21/- ea.; focus coils, 30/- ea.; H.T. transformer, 350-0-350v 6.3v 6amp, 4v 8amp, 4v 3amp, 0-2v 6.3v 2amp, 250 m/v, with screen, 70/- ea.; 5hy choke, 250 m/v, 100v, 100y, 80 m/v, 80y, 8/8 ea.; valve holders for EF50 valves, ceramic type, 6d ea.; retaining rings for E.F.50 valves, 8d ea.; valve holders for E.R.50 valves, bakelite, 1/- ea.; anti-Corona caps, 8d ea.; co-axial cable or 80ft balanced twin feeder, 1/- yd., 11/- doz, yds. only; co-ax plug and socket, 1/- complete. These components and also all values of resistances, variable controls and condensers for the E.E. television receiver in stock at the keenest prices. Just arrived, revised edition E.E. home built televisor handbook, 2/6 ea.; also buy out plan and wiring diagram for E.E. televisor, 3/6 ea.; tubular condensers: 25mfd 25v Midget T.C.C. tag end, 1/2 ea., 13/- doz.; 50mfd 12v, 1/- ea., 11/- doz.; 0.01mfd 1,000v, 0.02mfd 750v, 0.05mfd 500v, 5/6 doz.; 0.1mfd 500v, 6/6 doz.; 0.1mfd 350v, 5/6 doz.; 0.001mfd and 0.0005mfd Midget mica, 5/6 doz.; Metallimic condensers, 0.002mfd 500v, 6/- doz., and 0.01mfd 350v, 7/6 doz.; screw base 0.5 metal condensers, 350v, 6/- doz.; 8mfd 350v cardboard, 26/- doz.; 8mfd 350v tub metal tag end cond., 22/- doz.; 16-8mfd 350v can type, 46/- doz.; 16-8mfd 540v Midget tubular cond., 56/- doz.; 4mfd 350v screw base tubular condenser, 15/- doz.; 550v screw base tubular condenser, 22/- doz.; 16mfd 350v Midget Driflite can condenser, 22/- doz.; 32mfd 350v can type, 3/- ea., 33/- doz.; 1/2 watt resistances, 100, 220, 270, 470, 820, 1200, 1800, 3900, 8200, 2.2 KΩ, 11 KΩ, 39 KΩ, 470 KΩ, 10 MΩ, 1/9 doz., 18/6 gross only or assorted; 1/2 watt resistances, 1000, 1500, 2000, 4000, 5000, 6000, 8000, 10 KΩ, 16 KΩ, 20 KΩ, 150 KΩ, 200 KΩ, 500 KΩ, 1.5 MΩ and 5 MΩ, these in doz. or assorted, 2/- doz., 21/- gross only; also most other values at 3/- doz., 30/- gross only; 1 watt resistances, 470, 4700, 1 KΩ, 3.3 KΩ, 8.2 KΩ, 18 KΩ, 33 KΩ, 47 KΩ, 75 KΩ, 68 KΩ, 1 meg., 4/- doz., 45/- gross only; 2 watt resistances, 2 KΩ, 18 KΩ, 1 MΩ, 5/6 doz., 6/- gross only; trade enquiries invited; terms c.w.o., no c.o.d.; send 6d extra for postage orders under £5; 2½d s.a.e. all enquiries and list. [2495

**EX GOVT. MAINS TRANSFORMERS.** Input 230 volts 50 cys., output 450/0/450 volts 250 m/a, 6.3 v, 8 a., 6.3 v, 8 a., 6.3 v, 5 a., 6.3 v, 5 a., 5 volts 4 amps 45/- each, carriage 5/-. Another, same input, output 350/0/350 volts at 180 m/a, twice 5 volts at 4 amps, twice 6.3 volts at 5 amps three times 47/6 each, carriage 5/-. Another, same input 350/0/350 volts 250 m/a, 50/0/50 volts at 100 m/a, four 6.3 volts at 5 amps, also 5 volts at 4 amps, 42/6 each, carriage 5/-. (Size of these transformers is approx. 7 1/2 in. x 7 1/2 in. x 6 1/2 in., weight 20lbs.).

**CHARGING UNITS, Selenium Rectifiers.** Input 100/250 volts 50 cys. for charging 24 volts at 10 amps., complete with Meter, resistances, fuses, etc., complete in rack size 27in. x 24in. x 16in., to clear £10 each, carriage 10/-.

**MAINS TRANSFORMERS.** Input 230 volts 50 cys., Output 42 to 50 volts at 100 amps., £12/10 each, carriage 10/-, another 200/250 volts in steps of 10 volts, output tapped 6, 12, 18, and 24 volts, at 10/12 amps, 45/- each, carriage 2/-, another 230 volts input, output 12 volts at 8 1/2 amps, 25/- each, carriage 2/-, another 220 volts input, output tapped 12 1/2, 25, 37 1/2, 50, 60, 75, 87 1/2, 100 and 110 volts at 1,100 watts, £4/15/- each, carr. 7/6. (These transformers are all double wound).

**MAINS TRANSFORMERS, all 200/250 v 50 cys., 1 phase, input, output, 700/0/700 v., 70 m/a., 4 v., 2 1/2 a., 12 v., 1 a., 30/- each. Another 525/525 v. 150 m/a, 6.3 v, 5 a, 5 v, 3 a., 37/- each. 250/250 v. 100 m/a, 6.3 v, 5 a, 5 v, 3 a., 37/- each. Mains Smoothing Chokes, 10 Hy, 100 m/a, 6/-; 150 m/a, 8/6; 350 m/a, 25/-; 5 Hy, 250 m/a, 17/6.**

**EX-GOVERNMENT (G.E.C.) ELECTRIC FANS.** 12v., A.C. D.C. laminated field, complete with 5in. impellor. New, boxed, 20/- each, post 1/-.

**MAINS VARIABLE RESISTANCES** (slider type), new, ex-Govt., 14 ohms, carry 1 to 4 amps., graduated, useful as dimmers, etc., 17/6 each; another 0.4 ohms, carry 25 amps, 17/6 each, post 1/6. Ex-Govt. Moving-coil Cell Testers, 3-0-3 v. (new), 15/- each.

**MAINS TRANSFORMERS (Auto Wound).** Voltage Changers tapped 10, 20, 25, 90, 130, 150, 190, 210 and 230 v., all at 1,000 watts, a combination of 34 voltages can be obtained from this transformer, new ex-Government Stock, £5/10 each, carriage 5/-. Mains Booster Transformer, tapped 0, 6, 10, 19, 175, 200, 220, 225, 240 and 250 v. at 1,500 watts (new, ex-Government), £5/5/- each, carriage 5/-. Another Auto wound, tapped 0, 110, 150, 190, 210 and 230 v. at 1,500 watts, £6/10/- each, carriage 5/-. Ditto, 2,000 watts, £7/5/- each, carriage 5/-.

**EX-R.A.F. MICROPHONE TESTERS** (new). These consist of a Ferranti 0 to 450 m/amp, 2 1/2 in. scale meter shunted to 1 m/a, incorporated Westinghouse Rectifier, the whole encased in polished teak case, calibrated at present 0 to 10 v, 25/- each.

**EX-R.A.F. CRYSTAL CALIBRATORS UNITS.** Type 18, R.A.F. serial No. 10a/15237. These units contain 100 kcs. xstal, 2-EF 50 valves and numerous other items all new and unused, 35/- each.

**ELECTRIC LIGHT CHECK METERS** (Watt Hour). A.C. 50 cys., 200/250 v., 5 amp. load, 18/6, post 2/-, 10 amp, 21/-, post 2/-; 20 amps, 25/- post 2/-; also a few only Pre-Payment 1-l/2 slot type, 20 amp. load, less coin box, complete with synchronous motor, 35/- each, carriage 3/6.

**EX-NAVAL 1/2 IN. SPARK COILS**, approximately 3,000 v., from 6 v. supply, 8/6. G.P.O. Galvanometers, reading 300/30, vertical type, 8/6 each. Ex-R.A.F. Impulse Transformer (Mag-netron), output believed to be approximately 15,000 v. at 3 kw., for 1 m/a, 7/6 each. Variometers for No. 19 Mk. II Receivers, 6/4 each.

**EX-NAVAL CROMPTON PARKINSON TONG-TESTERS**, 0 to 100, and 0 to 400 amps., new, in leather carrying case, 90/- each. A.C. VMeters, 0 to 300 6in. scale, calibrated 50 cys., 37/6 each.

**SPECIAL OFFER METERS**, all new, boxed. Moving Coil, first grade instruments, 0 to 20 v., 10/- each, or 3 for 25/-; 0 to 40 v., 12/6 each; 0 to 100 amps. 15/- each, all 2in. scale. 0 to 20 v. A.C., calibrated 50 cycles, 25/- each; 0 to 40 amps., thermo-coupled 25/- each.

**MAINS TRANSFORMERS**, as new, input 230 v., 50 cycles, output 12 v. at 8 1/2 amps, A.R.P. shelter transformers, 25/- each, post 2/-.

**CHARGING SWITCHBOARDS**, size 17 1/2 in. x 16 1/2 in. x 8 in., containing 5 circuits, 5 moving coil 0 to 15, Ammeters, 10 to 50 V/meter, 4.1-ohm 12 amp. resistances 1 1/4-ohm 1-4 amp Resistance, all variable also Switches Fuses etc., condition as new, £4/10/- each, carriage 10/-.

**SWITCHBOARD METERS**, 6in. scale, 0 to 500 v. A.C., 50 cys., 42/6; 0 to 50 amps. A.C., 50 cys., 37/6 each.

**EX-R.A.F. CRYSTAL MONITORS**, type 2, complete in wooden carrying case, the frequency depending on crystal used, 5/- each. Short Wave Aerial Coupling Units (Wave-meters), 5/- each.

**LARGE TYPE RECTIFIERS**, Output 50 v. at 1 amp. 1/2 watt, input voltage 70/75 v., 17/6.

**MAINS TRANSFORMERS (Auto Wound)**, input 200/250 volts, output tapped 14 and 17 1/2 volts at 30 amps, 45/- each, carriage 5/-. Another same input with two 4 volt at 20 amps. output, 25/- each, carriage 3/-.

**FRACTIONAL H.P. MOTORS**, 230 volt series wound with laminated fields easily convertible to work off A.C. Mains, approx. 16ch h.p., 20/- each, post 1/6. Another of a larger type approx 1/2 h.p., 32/6 each, carriage 2/6.

**EX R.A.F. R.F. UNITS** (New) containing 6 valves including E.F.50s, 5U4Gs, Grounded Grid Triodes, also a 24 volt Miniature Motor with laminated field, and approx. 60/75 Resistances and Condensers, 32/6 each, carriage 3/6.

**EX NAVAL CATHODE RAY RECTIFIER UNITS**, New, containing High Voltage Condensers, Resistances, Chokes, Volume Controls, all mounted on brass chassis, 22in. x 11in., to clear 37/6 each, carriage 3/6.

**EX R.A.F. I.F.F. UNITS**, 10 Valve Short Wave complete with valves, E.F.50s., S.P.41s, E.A.50s, fitted with a motor generator, 12 volts input, 450 volts at 50 m/amps. output, these units are as new, 30/- each, carriage 3/6.

**EX R.A.F. AMPLIFIERS TYPE 6**, Containing Input and Output Transformers 0 to 150 M/amp. Output Meter, made to use with PX4s in push pull, these are complete less valves and power pack. New, 37/6 each, carriage 3/6. Tests Sets, Type 21I, (New) containing 4 E.F.50s, and other useful components, complete in metal box, 25/- each, carriage 2/-.

**LARGE CONDENSERS (NEW)**, 80 M.F.D. at 250 volt A.C. working, 10/- each, carriage 2/6. CONVERTERS, 24 volts D.C., input 230 volts 50 cycles 1 Phase at 100 watts output, 65/- each, carriage 3/6.

**EX NAVAL TELEPHONES**, with self energised headsets, complete with buzzer (24 volts), and calling device, 22/- per pair, carriage 2/6.

**LARGE VARIABLE RESISTANCES** (Stud Switch-arm type), 25 studs, 50 ohms to carry 1.4 to 9 amps., 30/- each. 10 ohms to carry 9 to 14 amps., 32/6 each.

**MAINS TRANSFORMERS**, 200/250 volts 50 cys. input, output 350/0/350 volts at 250 m/amps, 4 v. 8 a., 4 v. 4 a., 6 v. 6 a. 6 v. 2 a. tapped at 25 volts, 65/-, Ditto, 500/0/500 volts at 300 m/amps, 6.8 a., 4 v. 8 a., 5 v. 4 a., 62/6, Ditto, 350/0/350 volts at 180 m/amps, 4 v. 4 a., 6.3 v. 4 a., 5 v. 3 a., 38/6, post 1/6. Ditto, 500/0/500 volts at 150 m/amps, 4 v. 4 a., 6.3 v. 4 a., 5 v. 3 a., 45/-, post 1/6. Another 100/230 volts input, 12 volts at 15 amps. output, 32/6 each.

Notice to our Clients in both Northern and Southern IRELAND, when ordering please allow at least double the amount of carriage stated to allow for C.C.C. and part duty.

**L-R-S IN STOCK**  
CASH or EASY TERMS

- Goodman's "Axiom Twelve" Speaker Unit  
One of the finest quality speakers available  
to-day. Cash price **£8 8 0**
- Goodman's Standard 12" Speaker " **£15 15 0**
- Avo Model 7 Meter " " **£19 10 0**
- Avomitor AC/DC Meter " " **£8 10 0**
- Avomitor DC Meter " " **£4 4 0**
- Avo New Wide Angle Signal  
Generator. (Ready soon). " " **£20 0 0**
- Avo Valve Tester, Complete " " **£16 10 0**
- Collaro Radiogram Units—various models.
- Stuart Centrifugal Electric Pumps for all  
pumping purposes.

Specifications of all the above on request.

Please write for our **EASY TERMS.**

PERSONAL ATTENTION TO ALL ENQUIRIES

**The LONDON RADIO SUPPLY CO.**

Est. 1925

**BALCOMBE, SUSSEX**



**'Radiospares'**  
**Quality Parts**

The  
**Service Engineer's**  
**First Choice**



**CLYDESDALE**

For Ex-Service Electronic Bargains.

**T.1154 XMTR.** 4 W.B. MODEL, with valves plug/skts., and circuit (less Power pack) at £10/10/- each, also 3 W.B. Model as above £7/18/6 each, carr. paid.

**R.1155 RECEIVER,** 5 W.B. MODEL, 14-3 mc/s., 1500-500 kc/s., 500-75 kc/s., 10 valves communication and D.F. with valves, pl./skts. and circuit (less power pack) at £12/12/- each, carriage paid.

Brand New, in maker's cartons. **38 A.F.V. XMTR RCVR.,** frequency 7.3-9 mc/s., 6 valves, complete with 12 v. vibrator in two units, with spares, aerial and instruction book (less junction cable) at 79/6 per set carriage paid.

**A.1134A AMPLIFIER,** 2 valves, 2 stages, Intermcom. etc. (complete less batteries) at 110/6 each post paid.  
**A.1118 AMPLIFIER,** 2 valves, 2 stages relay controller pre-amp., complete (less batteries) at 12/6 each. Post paid.

**SILICON CRYSTAL DIODE C.V.102** at 5/- each.

**JOHNSON "JUMBO" VALVEHOLDER FOR C.V.57** etc. H.V. porcelain base, retaining clamp at 2/6 each or 25/- per doz.

Send now for 112 page list No. 5. Print name and address.

**CLYDESDALE SUPPLY CO., LTD.**

2, Bridge St., Glasgow, C.5. Phone SOUTH 2708 9  
Visit our Branches in Scotland, England and Northern Ireland.

**TRANSFORMERS,** output, standard pentode. 2/6 each, guaranteed; chokes, 2/6 each; Lee product, midget, 5 henry, 40ma; very large quantities of these available.—Duke & Co., 219 Ilford Lane, Ilford, Essex.

**R**ODING LABORATORIES (ELECTRONICS).—Owing to overwhelming demand, we are about a week behind on delivery of 30 and 40 coil packs, 50 coil pack, 3-wave s/het, 21/-; or with pushbuttons (inc. gram switching), 30/-; model 40 (with r.f. stage), 2-gangs; midget pack (1 1/4 in cube), 2-wave and gram, 21/-; i.f. trans (465 kcs), 5/- each; 0.0005 2-gangs, 9/-; 5-valve chassis, steel, sprayed cream. 13in x 8in x 2 1/2 in, 10/-; drum drives complete, 2/7; hor. glass dials and J.B. backing plates, 8/7; pointers, 1/3; 6 1/2 in Plessey p.m. spkrs with tr. 12/6; 2in Cossor M.E. with tr. (field 400 or 1,250 ohms), 15/-; 10in Plessey M.E. with tr. (field 1,250 ohms), 21/-; i.f. trans, 11/6 doz; a.c. or a.c./d.c. 4-valve plus s/hets (less cab. and spkr) £29/17/4; complete set coils and chokes for sound and vision units (television, £1; completely wired and tested units for same, vision £6, sound £4; panel signal lamps, 2/6 each; bakelite dielectric midget condensers, 0.0003 0.0005, 3/6; new books: Modern Battery Receivers, 2/8 post free; Experimental Circuits, 2/8 p.f.; Radio Equipment, 2/8 p.f.; Valve Application, 5/2 p.f.; Anti-Interference, 2/8 p.f.; Walkie Talkies, 2/8 p.f.; Radio Inside Out, 4/8 p.f.; Reference Handbook, 12/8 p.f.; Home Constructor's Handbook, 26 p.f.; all goods brand new; send stamp for latest lists; please include postage under 22; mail order only.—Roding Laboratories, Mail Order Dept., 70, Lord Av., Ilford. [2529]

**R**ADIO CLEARANCE, Ltd., 27, Tottenham Court Rd., London, W.1. Tel. Museum 9188.—Master osc. V.F.O. by Wilcox Gay, type M.1. 19467A, uses 807 electron coupled osc., very stable, employs 2 circuits, grid 1-5mc/s in 6 bands, plate 2-10mc/s in 3 bands; grid current meter (0-10ma), supplied in original cartons, brand new with accessories and instruction book, £5/15 carr. paid; Xtal multipliers, M1 19468, Xtal osc. using 807 freq., 2-7mc/s, 0-10ma meter, brand new, in cartons with inst. book, etc., 45/-; receivers, R.U.19, 6-valve straight set with 3 R.F. stages, using plug-in coils, H.R.O. type, valves 3-78s, 2-77s, 1-1642, black case, 15in x 8in x 8in, provision for remote or local control, dial 0-100 supplied new, complete with valves and 6-coil packs, covering O.187/305, P.281/455, Q.524/844, E.1285/2155, G.2960/4620, H.3865/6265, M.5075-7780, K.8750/13950kc/s; heaters wired for 26v operation, £4/10/- carr. paid; personal receivers, B.C. 728c, 7-valve rec. using 1,4v valves, super het, with 4 push-buttons, covering 2-6mc/s; operates from 2v acc. by 2v vib., with provision for charging from 12v by vib., carried slung on shoulder; supplied brand new, complete with valves, telescopic AE, access and inst. book, built-in loudspeaker, £9/9, carr. paid mains trans., 500-0-500v, 120ma, 4v 3.5a, 4v 3.5a, 4v 4a, all C.T., 10v 1a, primary 200/250v, 50c/s, 22/6, post 1/6; mains, trans., 460v 200ma, 210v 15ma, 6.3v 5a, primary, 230/250v, 50 c/s, 16/6, post 1/6; mains trans., 290-0-290, 80ma, 5v 2a, 6.3v 2.5a, primary 210/250v 50c/s, 17/6, post 1/-; mains trans., 290-0-290 80ma, 4v 1a, 6.3v 2.5a, primary 200/250v 50c/s, 12/6, post 9d.; smooth chokes, 20H 40ma, 220Ω, 3/11; smoo'h chokes, 80ma 150Ω 5/-; smoothing chokes, 5H, 200ma, 90Ω, 7/6; 20H 300ma, 150Ω, weight 13lb, 18/6, carr. 2/-; electrolytics, 100mf, 6v, 6d; 50mf, 12v, 1/-; 25mf, 25v, 1/6; 25mf, 50v, 1/9; 50mf, 50v, 2/-; 8mf, 150v, 1/6; 8mf, 170v, 1/9; 8mf, 500v, 2/6; 16mf, 350v, 3/-; 8+8mf, 450v, 4/-; 8+16mf, 450v, 5/-; 8+24mf, 350v, 4/-; 16+24, 350v, 4/6; 16+16mf, 350v, 4/6; 16+16, 450v, 5/-; 8+8, 350v, 3/6; 32mf, 450v, 5/-; meters, all moving coil, 2in round metal case, 500 microamp movements, 0-500 microamps, 7/6; 0-15,600v, 6/6; 0-20a and 0-40a, with shunts, 5/-; 2in square bakelite cases, 0-500 microamp, 9/6; 0-1ma, 7/6; 0-5ma, 6/-; 0-50ma, 7/-; 0-150ma, 6/-; 2 1/2 in circular bakelite cases, 0-500 microamps, 16/6; 0-15v, 7/-; 0-30ma, 7/-; 0-100ma, 9/6; 0-200ma, 9/6; 0-6ma, scaled 1.5v, 3v, 60ma, 5,000Ω, 12/6; 0-300v a.c. (moving coil with rect.), 12/6; 0-1ma, 2 1/2 in desk type, 15/-; 100-0-100v, 2 1/2 in (1ma movement), 7/-; 0-5,500v, 3 1/4 in, 17/6; 2 1/2 in circular, 100 microamp, scaled for use in insulation tester, 4m-inif, 18/6; metal rectifiers, 250v 60ma, H.W., 4/6; 350v 60ma, H.W., 5/-; 40v 120ma, H.W., 6/6; Mansbridge cond., 4mf, 600v, 3/6; 4mf, 1,000v, 4/-; 1mf, 1,000v, 1/-; wire-wound V.C., 200Ω, 400Ω, 500Ω, 1,500Ω, 2.5k, 5k, 10k, 25k, all 3W type, 2/6; throat mikes, American carbon, 1.6; British moving iron, 1/4 pr.; rotary trans. power units, input 12 or 24v (state which), output 250v 60ma, 6.5v, 2.5a, metal case 9in x 4in x 7in, 7/6, post 1/6; receivers, type 76, cover 150-505kc/s, size 6 1/2 in x 9 in, 10 in, 3 valves, VR53, ARTH2, EA50, spiral S.M. dial, 30/-; control units with 2 meters, 2 n square, 0-5ma and 0-40v, 8/6; auto trans., 200/250v to 110v, 50c/s, 60 watts, in metal case, 19/6; transmitter tuning units, in black crackle cases, with S.M. dials, type P, covers 6-9mc/s, 22/6; type C, covers 1.5-3mc/s, 17/6, both 2 1/2 in; telescope aerials, 15in closed, 7ft 6in extended, 3/11; E.H.T. trans., 4,000v, 1ma, 2v 2a, primary 230v 50c/s, 45/-.



**QUARTZ CRYSTAL UNITS**

For—  
**AIRCRAFT, MARINE AND COMMERCIAL USE** are available in the complete range from 35 kilocycles to 15 megacycles.

Alternative mountings in standard two-pin A.M. pattern 10X, International octal, and miniature type FT243, can be supplied for most frequencies.

Prices are fully competitive, and we specialise in prompt deliveries for urgent requirements.

WE WELCOME YOUR ENQUIRIES.

**THE QUARTZ CRYSTAL Co., Ltd.**  
63-71 Kingston Road,  
NEW MALDEN, SURREY  
Telephone: MALden 0374

**WARD ROTARY CONVERTERS**

For Radio, Neon Signs, Television, Fluorescent Lighting, X-ray, Cinema Equipment and numerable other applications.

We also manufacture :—

Petrol Electric Generating Plants, H.T. Generators, D.C. Motors, etc., up to 15 K.V.A.

**CHAS. F. WARD**  
LORDSGROFT WORKS, HAVERHILL, SUFFOLK

Telephone: Haverhill 253 & 4.

**"WEYRAD"**

CRESCENT WORKS, WEYMOUTH

**3-WAVE**

**MIDGET**

**COIL PACKS**

SIZE 3" x 2 1/2" x 1 1/2".

AVAILABLE IN 4 TYPES :—

★B5 { SHORT, MEDIUM & LONG  
B6 { WAVES.

★B7 { 12.5-37, 33-100, & 200-550  
B8 { metres.

★ Tuned with 365 pF.

PRICE **35/-** (+ 7/10 P.T.)

SPECIAL TUNING SCALES AND DRIVES CAN BE SUPPLIED.



# Commence the New Year with Electro-acoustic equipment designed and built by engineers who have made it a life study

The choice we offer you of Tuners, Amplifiers, Corrector Units, Filters and Loudspeakers leaves nothing to be desired in building an equipment of the highest fidelity

Daily demonstrations at

**THE LOWTHER MANUFACTURING CO.**  
Lowther House, St. Mark's Road,  
**BROMLEY, KENT.**  
Rav. 5225.

## THE BRITISH NATIONAL RADIO SCHOOL ESTD. 1940

With Good Wishes for a Prosperous New Year  
Join the B.N.R.S. and  
MAKE CERTAIN

★  
Radio, Radar, Maths., Physics.

**The B.N.R.S. FOUR YEAR PLAN**  
covers the full syllabus of :  
**A.M.I.E.E., A.M.Brit.I.R.E. and  
CITY and GUILDS Radio and  
Telecommunications Exams.**

Six months' trial period without obligation to continue.

Send for free booklet to :-

**STUDIES DIRECTOR  
BRITISH NATIONAL RADIO SCHOOL  
66, ADDISCOMBE ROAD, CROYDON**  
Phone : Addiscombe 3341

**ELECTROLYTICS**, brand new stock 8mf. 350v, tubulars, 1 10 ea., £1 per doz.; 8mf. 450v, 2/6 ea., 27/- doz.; 9-16mf. 450v, cans, 4/6 ea., 47/- doz.; 32mf, 350v, cans, 2/11 ea., 30/- doz.; 32mf, 275v, midjet cans, 3/3 ea., 33/- doz.; selenium rectifiers, 600v, 40ma, 3/6 ea., 30/9 per doz.; 50v, 80ma, 5/9 ea., 52/6 doz.; 250v, 100ma, 5/9 ea., 52/6 doz.; 50ma, 3/3 ea., 35/- doz.; 50ma, 3/2 ea., 31/- doz.; 40ma, 2/11 ea., 29/- doz.; 15v, 1a, H.W., C.T., 5/6 ea.; 6v, 5a, C.T., 2/3 ea., 18/- doz.; J.B. epicyclic drives, 1/9 ea., 18/- doz.; aluminium chassis 16 gauge, 10-51-2in, 3/3 ea., 30/- doz.; 11-6-2 1/2in, 3/3 ea.; 12-8-2 1/2in, 4/9 ea.; 16-8-2 1/2in, 5/9 ea.; 20-8-2 1/2in, 6/9 ea.; brand new dry batteries, 22.5v, 1/8 ea., 15/- doz.; ex-R.A.F. test buzzer and Morse key, complete with battery, 3/11; electrolytics, removed from vibrator units, 8mf, 450v, 1/9 ea., 18/- doz.; 200mf, 12v, 1/3 ea., 11/- doz.; c.w.o. or c.o.d. over £1; postage extra under £2; trade supplied; lists 21/d.—Radio Supply Co., 15, Queen Sq., Leeds, 2. [2554]

**WANTED, EXCHANGE, ETC.**

**R**EQUIRED, Deca Portrola portable radio-gram, Box 314. [2502]  
**T**ELETYPE and teletype apparatus urgently required.—Box 2633. [2331]  
**V**OIGT unit and Brierley pick-up wanted.—152, Wensley Drive, Leeds, 7. [2325]  
**W**ANTED, large quantities of 584 spares.—Mr. Jones, Burt House, Bushey, [2424]  
**S**ERVICE sheets urgently wanted, any quantity to replace lost collection.—Box 3245.  
**M**ARCONI output meter type T-340.—Ostle, 101, Senhouse St., Maryport, Cumb. [2546]  
**V**OIGT H.C. horn and bars chamber only, in good condition.—Robinson, 20, The Den, Wembley. [2348]  
**W**T.D., Magnetophone, Tons. B., or will exchange twin-channel disc recording apparatus.—Box 2644. [2375]  
**W**ANTED, Mark 19 TX/RX sets, also marine d.f. screening loops.—Matheson, Fishmarket, Aberdeen 5304. [2524]  
**W**ANTED, Multiplex telegraph perforated tape transmitters; any age or condition; write, giving details, to Box 2611. [2303]  
**W**ANTED, B.C.610 for cash, or would exchange American sound projector, 16mf, with cash adjustment.—Box 2232. [2148]  
**W**ILL exchange gear which includes K12/20 Vitavox (new), gram motor crg. PU, 250 mt. pack, etc., for comm. RX.—Box 2613. [2306]  
**W**ANTED, addition from 1935 onwards; good price given.—V. Conway, 10, Evelyn St., Leeds, 7. [2307]  
**30/-** per dozen paid for 12v l.t. rectifiers, 10 D 2003 or 280/LU 670A, and same for 2 or 4 amp "hot-wire" meters.—Box 2616.  
**W**E buy top prices for used test equipment, all types.—University Radio, Ltd., 22, Lisle St., London, W.C.2. Tel. Ger. 4447 and Ger. 8582. [19992]

**R**EDUNDANT radio components, materials and equipment of all kinds urgently required in large quantities; immediate cash available and fair prices paid.—Radio Agencies, Ltd., 157, Wardour St., W.1, Gerrard 2640. [2208]

**U**RGENTLY required, Auto-Memota direct starters for 4hp 400-440v, list No. 14 A.D., amp rating of trips 0.6 to 0.9 or other amperages would be suitable.—Full particulars, giving prices and quantities available, to Denfords Engineering Co., Ltd., Box Trees Mill, Wheatley, Halifax.

**W**E buy for cash, new, used, radio, electrical equipment, all types; especially wanted, radios, radiograms, test equipment, motors, chargers, recording.—If real price not wanted, to sell at the maximum price call, write or phone to University Radio, Ltd., 22, Lisle St., Leicester Sq., W.C.2. Ger. 4447.

**REPAIRS AND SERVICE**

**M**AINS transformers rewound, new transformers to any specification.  
**M**O.TOR rewinds and complete overhauls; first-class workmanship, fully guaranteed.  
**F.M. ELECTRIC Co., Ltd.,** Potters Bldgs., Warser Gate, Nottingham, Est. 1917. Tel. 3855.

**M**AINS transformer rewound and constructed to any specification; prompt delivery.—Brown, 3, Bede Burn Rd., Jarrow. [3460]

**L**OUDSPEAKER repairs, British, American, any make, moderate prices.—Sinclair Speakers, 12, Pembroke St., London, N.1. Terminus 4355.

**L**OUDSPEAKERS repaired; clock coils, L chokes rewound; prompt attention; prices quoted.—E. Mason, 5, Balham Grove, Balham, London, S.W. [7667]

**E**LECTRIC gram motors, auto-changers repaired, rewound.—Radio & Transformer Services, Manchester Rd., Hollinwood, Lancs. Tel. Pst. 2507. [2410]

**R**EWINDS and conversions to mains and output transformers, from 4/6; pp equipment a speciality.—N.L. Rewinds, 4, Brecknock Rd., N.7. Tel. Arnold 3390. [6283]

**A**REWIND service which duplicates or modifies as required; transformers, loudspeakers, etc.; prompt returns.—Raidel Services, 49, Lr. Addiscombe Rd., Croydon, Cro. 6537.

**S**ERVICE with a Smile.—Repairers of all types of British and American receivers; coil rewinds; American valves, spares, line cord.—F.R.I., Ltd., 22, Howland St., W.1. Museum 5675. [1575]

**R**EWINDS, mains transformers, speaker field coil, chokes, high-grade workmanship, 7day delivery; new transformers constructed to customers' specification, singly or in quantities.—Metropolitan Radio Service Co., 1021, Finchley Rd., N.W.11. Speedwell 3000. [3719]

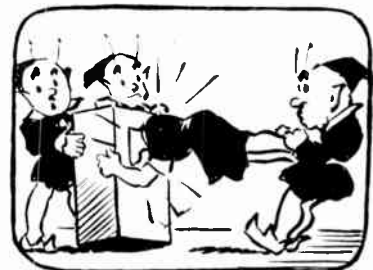

**THE "FLUXITE QUINS" AT WORK**

"Give us a hand. Wrench him clear.  
Steady now, boys. Mind his ear.  
And listen, young spiritie,  
Next time you FLUXITE  
just get at this set from the rear."

See that FLUXITE is always by you—in the house—garage—workshop—wherever speedy soldering is needed. Used for over 40 years in Government works and by leading engineers and manufacturers. Of all Ironmongers—in tins, 10d., 1/6 & 3/-

**TO CYCLISTS!** Your wheels will NOT keep round and true unless the spokes are tied with fine wire at the crossings AND SOLDERED. This makes a much stronger wheel. It's simple—with FLUXITE—but IMPORTANT.

The FLUXITE GUN puts FLUXITE where you want it by a simple pressure. Price 1/6, or filled, 2/6.



ALL MECHANICS WILL HAVE

# FLUXITE

**IT SIMPLIFIES ALL SOLDERING**

Write for Book on the ART OF "SOFT" SOLDERING and for Leaflets on CASE-HARDENING STEEL and TEMPERING TOOLS with FLUXITE. Price 1d. each.

**FLUXITE LTD.**  
(Dept. W.W.), Bermondsey Street, S.E.1





Type 2 units for 3.5 and 7.0 Mc. bands. Type 1CJ/200, 100 Kc. unit for use as a frequency substandard. Write for List QCA-1805A. A limited number of reprints of the paper entitled "Quartz Crystals" by Edward A. Fielding, B.Sc. Tech. (Rons), A.M.C.T., A.M.I.E.E. read to the Radio Society of Great Britain on November 14th, 1947, are available free on request.

**SALFORD ELECTRICAL INSTRUMENTS LTD.**  
 2, BEECHWOOD ROAD, Salford, LANCASHIRE.  
 Proprietors: THE GENERAL ELECTRIC CO. LTD. England

## MORSE CODE TRAINING



There are Candler Morse Code Courses for **BEGINNERS AND OPERATORS**. Send for this Free "BOOK OF FACTS" it gives full details concerning all Courses.

**THE CANDLER SYSTEM CO.**  
 (Room 55W), 121 Kingsway, London, W.C.7  
 Candler System Co., Denver, Colorado, U.S.A.

### THESE ARE IN STOCK

- Radio Laboratory Handbook. By M. G. Scroggie. 12s. 6d. Postage 5d.
  - Television Receiving Equipment. By W. T. Cocking. 12s. 6d. Postage 5d.
  - Amateur Radio Valve Technique. By D. N. Corfield and P. V. Cundy. 3s. 6d. Postage 2d.
  - The Mathematics of Wireless. By Ralph Stranger. 7s. 6d. Postage 5d.
  - Television Explained. By W. E. Miller. 3s. 6d. Postage 2d.
  - Fundamentals of Radar. By Stephen A. Knight. 10s. Postage 5d.
  - The Amplification and Distribution of Sound. By A. E. Greenlees. 16s. Postage 9d.
  - The Principles and Practice of Wave Guides. By L. G. H. Huxley. 21s. Postage 9d.
  - The Cathode Ray Oscillograph in Industry. By W. Wilson. 18s. Postage 9d.
- We have the finest selection of British and American radio books. Complete list on application.

**The Modern Book Co.**  
 (Dept. W.1)  
 19-23, PRAED STREET,  
 LONDON, W.2

**EVERY** make of electrical measuring instruments repaired and standardised.—The Electrical Instrument Repair Service, 329, Kilburn Lane, London, W.9. Tel. Lad. 4168. [2527]

**RADIO MAINTENANCE SERVICE** for guaranteed rewinds and repairs; armatures; F.H.P. motors vac. units, etc.; good deliveries.—139, Goldhurst Terrace, N.W.6. Mo. 6133

**"STURDY"** rewinds mains transformers, chokes and fields, first-class work, prompt deliveries and satisfaction guaranteed.—Sturdy Electric Co., Ltd., Dipton, Newcastle-on-Tyne. [2450]

**REWINDS**—Mains transformers, chokes, L.F. fields, O/P transformers, etc.; prompt deliveries and satisfaction guaranteed.—Thomas Bolton & Co., 20, Heath Terrace, Leamington Spa, Tel. 18. [2483]

**ACCURATE** coil winding; tuning coils, I.F., L.F. fields, and mains transformers rewound and wound to specifications; wave and progressive wave winding.—Rynford, Ltd., 17, Arwenack St., Falmouth. [2497]

**REPAIRS** to moving coil speakers, cones, C coils fitted, field rewound or altered; speaker transformers, clock coils rewound; guaranteed satisfaction, prompt service; we do not rewind mains trans.—Closed Sat. [2497]

**L.S. REPAIR SERVICE**, 49, Trinity Rd., Upper Tooting, London, S.W.17 Balham 2359.

**A SECOND** to none rewind service, reliable, clean, neat, return of post, new transformers, stances, or to specification, E.H.T., 270V, choke, stamp quotations.—R.E.F., 137A, Ashton Rd., Oldham. [2379]

**TRANSFORMERS** and chokes to specification, single or quantities; finest quality work and finish; all units fully tested and guaranteed.—Millett & Holden Ltd., Oxford Garage, Millets, Nelson St., Southend-on-Sea, Essex.

**C.D.P. recorder**—Any owner of an early model C.D.P. recorder can have this brought in line with the present day model at a cost of £3/10; please write for particulars.—Bourne Instruments, Bourne, Lincs, Tel. 224. [2580]

**24 HOUR** service, 6 months' guarantee, any transformer rewind, mains outputs and i.f.s., etc.; all types of new transf., etc., supplied to specification; business heading or service card for trade prices.—Majestic Winding Co., 180, Windham Rd., Bournemouth.

**REWINDING** of all types of transformers, R chokes, clockcoils, etc.; quick service; new transformers supplied to any spec. "Wireless World," transformers a speciality; bobbin replacements for all makes of trans.—Radio & Transformer Services, Manchester Rd., Hollinwood, Tel. Fai. 2507. [2409]

**REWINDS** and repairs, mains transformers, R O/P trans., clock coils, field coils, pick-ups; vacuum and gram. motors; new transformers to any specification; guaranteed work; competitive prices; delivery 2-3 days.—W. Groves, Manufacturing Electrical Engineer, 154, Ickneild Port Rd., B'ham, 16. [1482]

**A.W.F. TRADE SERVICE** offers you speedy loudspeaker repairs, loudspeaker cone assemblies, mains transformer rewinds from 15/-; new transformers at keenest trade prices; transformers built to your own specifications; lists 1d.—A.W.F. Radio Products, Ltd., Borough Mills, Bradford, Yorks. Tel. 22838. [1164]

**L. COTTENHAM**, the leading repair specialist of the North for your loud speaker repairs, all types repaired, fields rewound, any resistance transformers rewound; guaranteed first-class work at keen competitive prices; quick service; factors terms; send your next repair to—L. Cottenham, Loudspeaker Repair Factory, Whitley Lane, Bradford, Yorks. [2492]

**NATIONAL RADIO SERVICE & TELEVISION Co.**—Trade service engineers; immediate service any district; rewinds to all types transformers, armatures, motors, loudspeaker cones, speech coils fitted, British and American components and valves; inquiries invited for contract trade service; multiple transformer winding.—63, High St., St. John's Wood, N.W.8. Primrose 6725. [6752]

**AMPLIFIER** Testing; we have all facilities for testing and adjusting high-quality amplifiers, no push-pull feed-back amplifier will operate really properly unless rigorously tested and suitably adjusted—with its speaker system. We take a keen personal interest in this work, and gladly co-operate with you in obtaining absolutely optimum performance. We also have facilities for light assembly construction and production testing of note magnifiers and specialised electronic equipment.—Donald Dun, Ltd., 12, Hollywood Rd., S.W.10. Tel. Flaxman 5705.

**WORK WANTED**

**WE** make wireless and radiogram cabinets for home and export; immediate deliveries.—Radiac, Ltd., 26, Bronesbury Rd., London, N.W.6. Main Sale 8792. [18025]

**RADIO** mfrs. can undertake development and assembly of radio or electronic equipment; winding shop with vacuum impregnation plant; ample space and labour available.—Box 685.

**EXTRA** high grade receivers and amplifiers designed to any specification; we design to your own requirements, precision workmanship, write for quotation.—Dennis Bryan, 30, Windsor Drive, Timperley, Cheshire. [2180]

**DRAWING** and tracing work for radio and electrical engineering, jig and tool and light engineering, photomirring; full set of drawings undertaken to commercial or Ministry standards.—Drawing & Tracing, Ltd., 456a, Ewell Rd., Tolworth, Surbiton. Elbridge 7406

### Mr. A. C. BARKER'S NATURAL LOUDSPEAKER

is very close to truth not only because of its smooth and extended response, but self control which insists on transients being transient and complex sounds being themselves in detail without blur, each note clean and clear cut: that is, of course, subject to the use of an equally well behaved input. These factors are fundamental for natural, satisfying, living sound and they can only be achieved by a sound source critically damped throughout the full audio range. Mr. Barker's patent drive and cone are the nearest approach yet.

**BCM/AADU, LONDON, W.C.1**

### The "ADCOLA" Soldering Instrument



Designed for Wireless Assembly and Maintenance.  
 3/16" diam. Copper Bit, working temperature reached in 1/3 mins., consumption 25 watts, weight 23 ozs.  
 Supplied in voltage ranges from 6.7v. to 230/250v.  
 Price 22/6 each.  
 British and Foreign patents.  
 Sole Manufacturers:

**ADCOLA PRODUCTS LIMITED**  
 Alliance House, Caxton Street, London, S.W.1  
 Write or Phone: WH1, 0030.

### WESTERN GATEWAY HEADQUARTERS for Radio Equipment and Components

- MOTOR.** Blower motor, 24 v. input, 10/- each, plus postage.
- CONDENSERS.** Govt. Surplus. New. 0.15 plus 0.15 mfd., 7 kv., oil-filled, 15/-, 4 plus 4 mfd., 3 kv., 25/-, 4 mfd., 2 kv., 12/6, plus postage.
- CROKES.** 10H 100 ma 100 ohms, 7/6. 20 H 100 ma 350 ohms, 10/6. 32H 200 ma super potted job, 20/-, 15-20H 500 ma 80 ohms, 25/-. Carriage extra.
- H.T. UNIT.** Regulated 140-120 v. up to 60 ma/200/250 v. input. Ideal for bias supply or battery receiver. 35/-, plus 2/6 carriage.
- AMPLIFIER, 25 WATTS OUTPUT.** TG10, with valves: 2 6L6, 2 6X7, 2 6S7, 5/1/6, less motor and P.E. cell, 110 v. A.C. input. 47/13/6. Auto-transformer, 21/- extra, plus 10/- carriage.
- VIBRATOR UNIT.** Jefferson-Travis, 120-150 v. 50/30 ma in black crackle case with leads. 12 v. input, 19/6, plus 1/6 postage.
- INDICATOR DEVICES.** Type 73, Units with VCR 138A tube, 4 8P11's, 2 Siemens high-speed relays, considerable quantities of resistors, condensers, etc. 39/6, plus 6/- pass. carriage.
- TUBES.** VCR138A tube. This is a super tube for 'scope work, complete with base, 30/- each, plus 1/6 postage.

**ARTHUR H. RADFORD**  
 28, BEDMINSTER PARADE, BRISTOL, 3.  
 Tel.: 64314.  
 Open Saturdays: 9-5.30 p.m.





**HILL & CHURCHILL LTD.**

BOOKSELLERS

**SWANAGE, DORSET**

Available from stock

Markus & Zeluff—Electronics for Engineers	36/-
J. Atkinson—Telephony (British P.O.) Vol. 1	35/-
Sturley—Radio Receiver Design Volume 1	28/-
Sturley—ditto Volume 2	28/-
Brainerd—Ultra-High Frequency Techniques	28/-
Terman—Measurements in Radio Engineering	27/-
Terman—Fundamentals of Radio	24/-
Weller—Radio Technology	21/-

Postage Extra.

CATALOGUE ON APPLICATION

**THE "WILLIAMSON" AMPLIFIER**

This amplifier has now been seen and heard by a number of our customers and friends, the majority of whom agree that it surpasses all other versions in both construction and performance.

All specified components are in stock, including Partridge transformers and chokes, T.C.C. super tropical type capacitors, Welwyn high stability resistors, and matched valves.

Also now available separately, a completely drilled steel chassis, stove enamelled in maroon, and made to fine limits.

Dimensions: 17in. long, 11in. wide, 2½in. deep. Price 27/6 each.

Send for our illustrated leaflet dealing with this fine amplifier.

Trade enquiries invited

**ROGERS DEVELOPMENTS CO.**  
106, Heath Street, Hampstead, London,  
N.W.3. Telephone: HAMpstead 6901

## RECEIVERS for WEST COUNTRY AMATEURS. EDDYSTONE 640



Cash £27 10 0 or terms.

**G. N. PILL & PARTNERS**  
49, COBOURG STREET, PLYMOUTH  
Telephone: 2239

**T**ELEVISION service engineer required. Bedford Station of National Organisation; exceptional opportunity right man.—Box 3242.

**G**LASSBLOWER required for research laboratories; all round experience in hard and soft glasses, including lathe work essential.—Apply in person or write to Personnel Department, E.M.I. Ltd., Blyth Rd., Hayes, Middx.

**R**ADIO draughtsmen required by large light engineering company, North London; applicants with knowledge of electronics equipment design preferred, but practical shop and drawing office experience essential.—Write Box 2229.

**S**ENIOR mechanical designer with experience of electro-mechanisms for work on industrial electronic equipment in the Midlands; salary range £600-£1,000.—Details of age, qualifications and exp. quoting ref. D.O.23, to Box 2233.

**A**LARGE engineering group requires draughtsmen of senior and junior grades in several parts of the country.—Men with sound electrical or mechanical drawing office experience should apply to Box 1933. All replies are acknowledged. [1960]

**D**EVELOPMENT engineer wanted, with experience in radio test equipment, good pay and prospects.—Write giving full particulars of experience and salary required, to Taylor Electrical Instruments, Ltd., Montrose Avenue, Slough, Bucks. 2466

**S**ENIOR design draughtsman required for work in connection with commercial radio receivers and electronic equipment.—Write, giving full particulars of experience, salary, etc., to the Labour Manager, Bush Radio, Ltd., Power Rd., Chiswick, W.4. [2005]

**P**RODUCTION engineering research association requires instrument designer with wide electrical and mechanical experience.—Applications giving full details, including salary required, to Secretary, Staveley Lodge, Melton Mowbray, Leics. [2411]

**F**IRST-CLASS mechanical designers required; men with experience in the design of domestic radio receivers and components preferred.—Applications in writing to Personnel Department, Murphy Radio, Ltd., Welwyn Garden City, Herts. [2481]

**A**N engineer with considerable experience in pulse circuitry technique required immediately; please give full details of experience to date and state salary.—Application form from The Staff Manager, Ferranti, Ltd., Hollinwood, Lancs. [2406]

**S**ENIOR and junior, experienced development, research engineers and draughtsmen required for radio, television, electronics, radar, speakers; please refer to S.30, H.N.3, Herts. Inspectors, repairers, service engineers, etc.—Technical Employment Agency, 179, Clapham Rd., S.W.9. (Brixton 3487). [2556]

**P**HYSICIST required for research on the magnetic properties of powder metallurgy products; applicants must hold an Honours Degree and should possess special knowledge of magnetic measurements; the post is in Northamptonshire; salary according to qualifications and experience.—Please reply to Box 2924. [2403]

**F**ULLY qualified electronic engineer required by hearing aid manufacturers, 50 years from London; able to carry through development to production stage; sound technical background and practical experience essential.—Apply in writing, stating qualifications and salary required, to Box 3107. [2473]

**T**ECHNICAL assistant, required by S.W. Radio firm, aged approximately 25 with B.Sc. (Eng.), should have had some experience of electronic development work.—Write, giving full details of age, experience, qualifications and salary required, to Box 635, c/o J. G. King & Son, 50, Fleet St, London, E.C.4. [2445]

**I**NTERNATIONAL Company has two vacancies for radio/radar engineering instructors in Karachi; applicants preferably single should have recent teaching experience and knowledge of civil airline radio/radar equipment air and ground; salaries £200 and £500 p.a., plus ample allowances.—Particulars to Box 2925. [2408]

**C**ORRESPONDENCE clerk required by leading manufacturer of radio and electronic components; essential qualifications are ability to handle voluminous and varied correspondence rudimentary technical knowledge and similar recent experience.—Write, stating age, experience and salary required, to Box 3135.

**R**ADIO service engineer required for provincial firm of high standing, must be of first class technical standard and have had considerable practical experience, knowledge of television an advantage; wage according to ability and confirmed after one months' probation.—Apply to Barnes & Avis, Ltd., 140-1, Friar St., Reading.

**R**ADIO technicians required at Ongar W/T transmitting station, candidates should have had practical experience of operating high power transmitting apparatus; preference given residents North Weald and district.—Apply in writing to Manager, W/T Station, Cable & Wireless, Ltd., North Weald, Epping, Essex, giving qualifications and experience. [2436]

**A**PPLICATIONS are invited by a company situated within a 25 miles radius of London for the position of senior engineer to take charge of a laboratory engaged upon design, development and application of R.F. heating; applicants should have an Honours Degree in science and previous experience of the work upon which the laboratory is engaged; salary £700 to £1,000 p.a., according to qualifications.—Applications should be addressed to Box 2923.

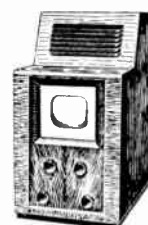
**£15  
TELEVISOR**

This is the title of our latest publication giving 26 pages of photographs, wiring diagrams and constructional notes of an excellent little T.V. receiver. You can make this from Government surplus equipment, and the total cost should not exceed £15. Send 7/6 and start right away.

A demonstration receiver can be seen at our address.

**MINE DETECTORS.** For the location of metal even under water—we can offer the famous American 481R 625—new in original packing complete with instructions and spares. Price is £10 10s. carriage paid. British made models £8 15s.

**INFRA RED IMAGE CONVERTER.** Complete with technical data. Price 14/6.

**E.H.T. TRANSFORMER.** 4000 v. 2 and 4 v. heater winding. 50/-  
Television Transformer, 360-0-350, 250 mA., 0.3 v. 7 amps., 6.3 v. 4 amps., 0-45 v. 3 amps., 0-2-6.3 v. 2 amps., 60/6.  
E.H.T. Rectifier Hivac 5000 v. 4 v., 11/-, 250 mA. Cho. 10 henries, 9/6.  
Electrolytics, 350 v. working, 32 mfd., 2/-; 8 mfd., 2/-; 8,000 volt tubulars for E.H.T. Smoothing, 2/- each.

**BULL'S EX-GOVERNMENT DEPOT**

ELECTRON HOUSE, WINDMILL HILL, RUISLIP MANOR, MIDDLESEX.

Open Saturdays until 5 p.m.

**AUDIO FILTERS**

Field-free, Hi-Q, Toroidal Windings. Permalloy Cores—Permanent Accuracy. Low, High, Band-pass or Cross-over. ADJUSTABLE Whistle and Scratch Extractors.

**LYNCAR LABORATORIES**

29, Camborne Road, Morden, Surrey. L1B 3247

**THE COIL PICK-UP**

Sapphire needles for this Pick-up are available at 10/- each, plus 4/5 tax.

**WILKINS & WRIGHT LTD.,**  
Holyhead Road, Birmingham 21.

**TELEVISION SCANNING  
COILS**

Technical Publication No. 29. Post FREE  
HAYNES RADIO Ltd., Queensway, Enfield.

**INDIVIDUAL TRANSFORMER  
REWINDS**

SEND YOUR "BURNT OUT" TRANSFORMER TO BE REWOUND. NO TECHNICAL DATA REQUIRED. OUR TRANSFORMER WINDINGS ARE DOUBLE WOUND AND BACKED BY A SPECIALISED SERVICE  
LOUDSPEAKER REPAIRS,  
FIELD COILS.

**SOUTHERN TRADE SERVICES LTD.,**  
297/299, HIGH STREET,  
Telephone: CROYDON 4870.



# POTENTIOMETERS

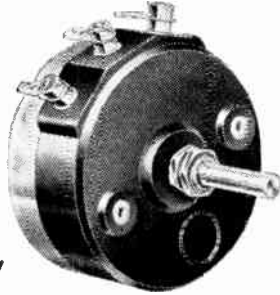

by

# RELIANCE

Type	P.I.W.	Power	Wire-Wound
Rating	RANGES		
20 W. Max. (linear)	10-500,000 Ω Max. (linear)	150-250,000 Ω Max. (graded)	100-50,000 Ω Max. (non-inductive)
15 W. Max. (graded)			

CHARACTERISTICS: linear, log., semi-log., inverse log., non-inductive, etc.

FULL DATA FROM:

## RELIANCE

Manufacturing Co. (Southwark) Ltd.  
Sutherland Rd., Higham Hill, London, E.17  
Telephone: Larkwood 3245

**VACANCIES** for draughtsman/designer (mechanical) and junior television development engineers.—Write, Personnel Manager, Sobell Industries, Ltd., Langley Park, Langley, Bucks, stating age, qualifications, experience, and salary required. [2426]

**YOUNG** man required, energetic, adaptable and imaginative salesman to give demonstrations of high fidelity amplifiers, to deal with correspondence and advertising, salary and commission basis giving ample scope, London area.—Box A.C. 35106, Samson Clarke, 57-61, Mortimer St., W. [2441]

**QUALIFIED** radio service engineer, fully experienced with domestic receivers; take charge of modern service dept. quick diagnosis essential, fully conversant with all types of valves and modern test gear, smart appearance and able to drive; good salary and commission on service work; fullest particulars.—Bernard Smith, 106, High St., Barnstaple, Devon. [2470]

**QUALIFIED** engineer, experienced in the technique required to participate in a development project of considerable interest; applications should give details of academic training and subsequent experience, together with salary required.—Application form from, The Staff Manager, Ferranti, Ltd., Hollinwood, Lancs.

**ELECTRONIC** engineer, required with a degree or equivalent technical qualification and design experience of centimetre wave transmitters, receivers and test equipment; a vacancy also exists for a general electronic circuit engineer.—Write indicating salary required, etc., to Personnel Manager, The Sperry Gyroscope Co., Ltd., Great West Rd., Brentford, Middlesex.

**DRAUGHTSMAN**, vacancy London for young draughtsman with general experience precision light mechanisms or instruments; electronic knowledge an advantage, but applicant with interest in design of electro-mechanical products preferred; good practical and technical training; state age and full details, experience and technical qualifications, also salary required.—Box 3197. [2550]

**SENIOR** development engineers required, must have good technical training, preferably with Hons. Degree in Physics or Engineering and radio laboratory experience; able to carry through development, with assistants, to production stage; salary up to £800 according to qualifications.—Apply in writing to Personnel Department, Murphy Radio, Ltd., Welwyn Garden City, Herts. [2105]

**DEVELOPMENT** engineer required to work on experimental types of cathode ray tubes; applicants should possess a physics degree and have had practical experience in the design, development and manufacture of cathode ray tubes; details of apply giving details of qualifications, experience and salary required, to Personnel Department C/F, E.M.I. Factories, Ltd., Blyth Rd., Hayes, Middx. [2438]

**DESIGN** draughtsmen are required by the English Electric Co., Ltd., Stafford, for research and development work on electronic equipment; applicants must have higher national certificate or equivalent, and shop experience; salary according to experience.—Send full details to Central Personnel Services, English Electric Co., Ltd., Queens House, Kingsway, W.C.2, quoting Ref. DO.25. [2192]

**RADIO** operator mechanic required for radio R.C. station situated fifteen miles north of London; applicant should be able to receive morse at 30/35 w.p.m. using typewriter, and possess good all-round technical knowledge particularly communication receivers, experience in teleprinter operation and maintenance an advantage, shift duties, salary according to qualifications.—Write, stating exp., qualifications.—Box 3102.

**APPLICATIONS** are invited from engineering and physics graduates and from designer-draughtsmen with a degree or equivalent qualifications, by the Research Laboratories of the General Electric Co., Ltd., East Lane, North Wembley, Middlesex, for work on telecommunications equipment; experience of pulse and wave form techniques an advantage.—Apply to the Director, stating age, academic record and exp.

**JUNIOR** engineer required for examination and analysis of cathode ray tubes; previous experience desirable but not essential, providing suitable technical background; vacancy offers good prospects for enthusiastic junior and facilities extended for furthering technical training.—Apply giving age, details of experience if any, together with technical qualifications, to Personnel Department, C/F, E.M.I. Factories Ltd., Blyth Rd., Hayes, Middx. [2199]

**MAINTENANCE** engineers, required by S.W. London firm, successful applicants should have higher National Certificate or equivalent and some experience in service and maintenance of electrical control equipment with particular reference to programme controllers and general electrical furnace control equipment, age 25-30.—Write, giving details of age, qualifications, experience and salary required, to Box 634, c/o J. G. King & Son, 150, Fleet St., London, E.C.4.

**ELECTRONIC** engineers with honours degree or equivalent are required for research and advanced development work by the Nelson Research Laboratories, English Electric Co., Ltd., Stafford; preference will be given to men with sound electrical engineering experience; salary according to qualifications.—Apply by letter to Chief, Administration, Nelson Research Laboratories, English Electric Co., Ltd., Stafford, stating age, experience and academic qualifications.

## HENRY'S

VALVES. We have over 10,000 new boxed B.V.A. valves in stock at current B.O.T. prices. Let us know your requirements.

**THE NEW GARRARD MODEL 5, GRAM MCNOR.** Latest rim driven motor, Popular Garrard magnetic pick-up, auto stop, 10in. turntable spring suspension. A.C. 200 250 v. only 25/18/4, including P.T.

**FILAMENT TRANSFORMER.** 6.3 v. tapped at 5 v., 4 v., and 2 v., at 3a., only 15/-.

**PUSH-PULL OUTPUT TRANSFORMERS.** For 6V's, matching to 3, 8 or 15 ohms, 10 watts, 17/6. For 6V's or PX 4's, 3, 8 or 15 ohms, 80 m/a D.C. each half 18/- only.

**TUFNOL SHEET.** First grade, polished finish, size 2 1/2in. x 1 1/2in. x 1/8in. thick. Weight 10 lbs. Drilled at intervals around the edge for 4BA counter-sunk nuts—only 15/- per sheet.

**VGR 97 CATHODE RAY TUBE.** This very useful tube, can now be supplied, brand new and individually boxed, to callers only at the very low price of 35/-.

**POCKET VOLTMETER.** Ex-Govt. Two range, 0-15 v., 0-250 v., 11/0. Brand new complete in Web carrying case, only 10/6.

**THE E.T.A. FOUR-STATION SUPERHET TUNER.** Completely self-contained tuner, may be set to select any three medium and one long wave stations. No tuning condenser required. Four-position switch. Tuning by high permeability dust cores. Litz wound coils. Once set requires no further adjustment. The station you want at a flick of a switch. Size 2 1/2in. high by 3in. x 3in. Complete with full-illustrated instructions and suitable A.C. and A.C./D.C. circuit. Only 33/-, plus 7/2 Purchase Tax.

**TELEPHONE HANDSETS.** G.P.O. type (self-energised) with presser switch. Complete lead and plug. Brand new, 10/6 each only.

**TELEVISION "SCANCO"** television components can now be supplied from stock as under. Scanning Coils, 25/6; Line Transformer, 25/6; Focus Coil, 30/-; 4KV E.H.T. Transformer 59/6; 5KV E.H.T. Transformer 65/-. These components are superb and guaranteed standard in every respect. **PORTHINTER Television Mains Transformer,** exactly to "Electronic Engineering" specification, 75/-. **HUNTS .1 mfd. 7000 v.w., 18/6. T.C.C. Micaoid Condensers, 500pF 2/6 each. ALADDIN coil formers,** complete with iron dust core, 9d. each only.

5in. C.B.T. CEM22, available from stock to callers only, and many other useful accessories, including drilled chassis, etc., etc., and all valves required for all T.V. circuits.

**"DENCO" COIL TURRET TYPE.—CT6V.** Improved version. Five wavebands, 150-300 kc/s, 510-1,500, 1.5-4 mc/s, 4-12 mc/s, 10-30 mc/s. Foolproof construction, eliminating water switches. Extra provision for "Gram." Iron-cored coils. Polystyrene formers and insulation throughout. Silver-plated contacts. Supplied complete with tuning condenser, drive assembly, and large vertical reading black glass dial. Also provision for magic eye. The dial is illuminated from the rear, and two M.E.3. bulb holders are provided for the purpose. Cabinet opening for dial should measure 6 1/2in. x 6 1/2in. The whole complete with full wiring diagram and instructions, 24/19 6. Pm-61/1/3 P. Tax.

**NEON INDICATOR LAMPS** to be directly connected to 200/250 volts. Complete in holder, for one hole fitting 1/2in. diameter, 3/9 each complete. Quotations for quantities.

All goods supplied by us are guaranteed 100%. Our reputation is your guarantee.

TRADE SUPPLIED

Send Stamp for Current Comprehensive list.

**HENRY'S**  
5, HARROW ROAD, W.2  
PADdington 1008 9

## ALLEN COMPONENTS LTD.

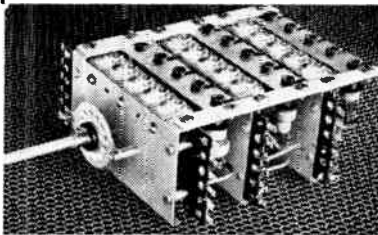

### Type 320 5-wave band coil unit.

A comprehensive pre-aligned assembly consisting of switch, complete set of aerial, H.F., and oscillator coils and all associated trimming and padding condensers for 5 wave band operation with tuned H.F. stage on all bands. All coils have dust iron cores for inductance adjustment. A six position switch is used with provision for pick up connections and H.F. muting on the sixth position. For use with any of the standard frequency changer valves (6K8, ECH35 etc.) and an I.F. frequency of 465 Kc.

Ranges: 1, 13—40. 2, 30—100. 3, 80—200. 4, 200—550. 5, 900—2000 metres.

PRICE £5 19 6

Send for latest catalogue of our full range of components for Radio and Television.

**ALLEN COMPONENTS LTD.**  
Tower Road, Willesden, N.W.10

Telephone Willesden 3675

## COVENTRY RADIO

COMPONENT SPECIALISTS SINCE 1925

We hold large stocks of Avo Model 7 and Minor Meters, Valve Testers, Collaro Gram Motors AC and AC/DC, Pick Ups, Wearite "P" Coils, Components by Bulgin, Belling-Lee, Colvern, Carr, Dubilier, Erie, Gardner's, T.C.C., Philips, Westinghouse, Weymouth, Witwyn. Every Well-known Quality Component.

SEND FOR OUR 1949 COMBINED LIST RESISTOR COLOUR CODE, COIL DATA SERVICE VALVE EQUIVALENT CHART —

Price Complete 9d. Post Paid

YOU CAN DEPEND ON

**COVENTRY RADIO**  
DUNSTABLE ROAD, LUTON, BEDS.

**WE OFFER**

A large range of used and new Test Equipment, Converters, Recorders, Amplifiers, Motors, Transformers, etc.

All guaranteed and at very attractive prices.

We buy good modern used equipment of all types for spot cash.

**UNIVERSITY RADIO LTD.**

22 LISLE STREET, LONDON, W.C.2.

Tel.: GER 4447 & 8582.

**PHOTO-ELECTRIC CELLS**

for  
Talking Picture Apparatus.

Catalogue now available

**RADIO-ELECTRONICS LTD.,**

St. George's Works, South Norwood,  
London, S.E. 25.

**NEW DUAL TESTSCOPE**

Ideal for  
high and low  
voltage testing; 1/3c,  
100/850 A.C. and D.C.

All wrench made on old models.  
Send for interesting leaflet (R.14) on Electrical and Radio Testing, from all Dealers or Direct.

**RUNBAKEN-MANCHESTER-1**

**TELEVISION**

an essential accessory for

**LONG DISTANCE VIEWING**

A type AC/2 pre-amplifier.

Full particulars from **SPENCER-WEST,**  
North Quay Works, Gt. Yarmouth.

**TRANSFORMERS & CHOKES**

High Quality Vacuum Impregnated

**AUSTIN MILLS LTD.**

LOWER CARRS  
STOCKPORT

Telephone: STO. 3791 Established 20 years.

**FEEDERS FOR E.R.5 AND E.R.10!**

**E.R.F.1:** For radio and records; treble control is on 11-way switch giving five "cut"—mid, straight line—five "lift" in steps of 3DB at 10K c.p.s. Bass control is a "pot." straight line at minimum to max. of 23DB at 50 c.p.s. VALVES: 3 x L63 (or 615). PRICE complete: 5 gns.

**E.R.F.2:** Exactly as above but with high gain stage for gram. VALVES: 4 x L63 (or 615). PRICE complete: £7/10/-.

**E.R.F.3:** For records only, a single L63 or 615 with V/C and "top cut" control. PRICE: £3/5/-.

Details shortly of Ian Bailey Concert Reproducer Series 2 at about £35.

**ELMSLEIGH RADIO CO.,**

1102 LONDON RD., LEIGH-ON-SEA, ESSEX  
Leigh-on-Sea 75168

APPLICATIONS are invited from physicists or engineers for work in a group engaged upon the manufacture of x-ray tubes in the N.W. London area; experience of vacuum work and high voltage useful; education to Higher National Certificate or Pass Degree standard preferred. Write giving age, qualifications and experience to Box 9 G.W., c/o Geo. J. Smith & Co., Ltd., 154, Fleet St., E.C.4.

LARGE electrical organisation requires an assistant engineer, capable of writing specifications, dealing with tenders and contracts for sound installations; design work on speaker amplifier and electronic circuits; successful applicant would be required to assist in special surveys of factories, etc.; some general experience of office routine; B.Sc. and/or A.M.I.E.E. qualifications preferred, but not essential.—Write, giving full details as to age, previous experience and salary required, to Box 2231.

RADIO and electronic senior engineer required by leading firm of manufacturers; applicants must have extensive practical experience in technical development of electronic equipment with special knowledge of circuit techniques; post is within 20 miles' radius of London and is progressive; recognised qualifications are desirable, but practical ability is the essential factor, age preferably not over 35 years; fares paid for interview; salary approx. £450 p.a., according to qualifications and experience.

—Written applications, giving date of birth, full details of qualifications and experience, etc., and quoting reference 439M, should be addressed to Regional Appointments Office, Ministry of Labour & Nat. Service, 25, Vaux St., Reading. THE Admiralty invite applications for appointment as temporary draughtsmen (mechanical, electrical, electronic, construction) at research and development establishments situated in various parts of England and Scotland (principally southern England); candidates must be British subjects and have served an engineering apprenticeship or had equivalent workshop experience; if 23 years of age or over, they must possess the Higher National Certificate (or equivalent); if under 23 they should possess the Ordinary National Certificate (or equivalent); drawing office experience in the preparation of designs of complete mechanical assemblies is desirable; experience connected with experimental and development work will be additional advantage; salary will be assessed on age and experience within the range of £283—£440 rising to £525 according to age, experience and location of employment; appointments will be on temporary basis but with an opportunity, which is expected will arise within 12 months, to compete for established appointment; successful applicants will be liable to appointment to any of the establishments concerned.—Applications should be sent to C.E.11 (Room 88), Empire Hotel, Admiralty, Bath; original testimonials should not be forwarded, only candidates for interview will be advised. [2432]

B.B.C. invites applications for a senior post in the Television Section of the Research Department at Kingswood, Surrey; candidates must possess 3 University Honours degrees in electrical engineering or physics, and must have a sound knowledge of telecommunications theory; they must also have a sound knowledge and practical experience of modern television; knowledge and experience of the optical and colour problems involved in television, and of the workshop techniques involved in the construction of electrical and optical apparatus are very desirable; experience of laboratory vacuum plant and a knowledge of photo-electricity are also desirable. The successful applicant will be expected to show initiative in taking a leading part in research work in television, especially that on high definition and colour; such work will include the development of experimental monochrome and colour television apparatus, and on ancillary equipment; it will also involve the devising and carrying out of subjective and objective appraisal tests; copies of any original papers should accompany applications for this post; the salary is in a grade rising by annual increments of £60 to a maximum of £1,360 per annum.—Applications, stating age, qualifications and experience, should reach the Engineering Establishment Officer, Broadcasting House, London, W.1, within 7 days of the appearance of this advertisement. [2443]

**SITUATIONS WANTED**

RADIO engineer (26), grad. Brit. I.R.E., City and Guilds final, seeks progressive post in industry; N.W. England preferred.—Box 3195.

DEVELOPMENT engineer, age 23, first class D.C. & G. IV radio, 5 yrs. lab. experience, seeks progressive position in North London area.—Box 3194. [2543]

RADIO engineer (28) requires progressive R post London or S. England; qualific. equiv. C. & G. IV, metric, exp. V.H.F. technique from installation to development.—Box 3193.

TECHNICIAN, age 27, married, three years as transmitter engineer in B.B.C., five years in R.A.F. as radio mechanic and operator/air crew, industrial experience, seeks post as technician in research or development laboratory; prospects more important than pay.—Box 3104.

**CONSULTANTS**

CONSULTING physical chemist, own laboratory, high academic qualifications, offers services for research and development on Physical and chemical problems, development of inventions, etc.—Box 3111. [2480]

**ENGINEERING OPPORTUNITIES**

This unique handbook shows the easiest way to secure A.M.I.E.E., A.M.Brit.I.R.E., A.M.I.E.E., City and Guilds, etc.

We Guarantee—

**"NO PASS—NO FEE."**

Details are given on over 150 Home-study Diploma courses in all branches of Civil, Mech., Elec., Motor, Aero, Radio, Television and Production Engineering, Training, Building, Govt. Employment, R.A.F. Maths, Matriculation, etc.

Safeguard your future; send for your copy at once—FREE.

B.I.E.T., 387, SHAKESPEARE HOUSE,  
17 TRATFORD LAGE LONDON W.1

**TRANSFORMERS & COILS TO SPECIFICATION.**

MANUFACTURED OR REWOUND

Filter Coils + 1% a Speciality.

**JOHN FACTOR LTD.**

9-11 EAST STREET TORQUAY DEVON

Phone: Torquay 2162



To those who own a

**Voigt Loudspeaker**

we wish a

**Merry Xmas.**

To those who do not yet own a Voigt speaker we wish the best Xmas possible in the circumstances.

**VOIGT PATENTS LTD.**  
LONDON, S.E.26

**A.B. OAK wafer switches**

The wave-change switch with silver-plated double contacts.

**A.B. METAL PRODUCTS LTD.,**  
Great South-West Road, Feltham, Middx.

**"PERIMET" ELECTRODE**

Soldering and Brazing Tool

Operates from 4 or 6 Volt Accumulator or Transformer



15s.  
Post free

MAINS TRANSFORMER, 3 Heats, 35s. Post free.

**HOLBOROW & CO.,**  
71, Weymouth Bay Avenue, Weymouth.

For correct pitch and tempo,  
your Turntable must be running  
at the correct speed.

The new "UNLIMITEX" Universal  
**STROBOSCOPE**

indicates both 78 and 33 1/3 r.p.m. when viewed by 25-, 50-, or 60-cycle light. A most useful accessory for recording and transcription.

Price 1/9 each, post paid.

(Trade enquiries for quantities invited.)

**WIRELESS SUPPLIES LIMITED**

(Props. Unlimitex Radio Ltd.)

264-266, Old Christchurch Road,  
**BOURNEMOUTH, Hants.**





## For CONSTRUCTORS and CONNOISSEURS only, please . . .

The ACOS G.P.12 Crystal Pick-up (with permanent sapphire stylus) is intended only for those who demand perfection in recorded music. Editorial reviews in the technical radio press have been unanimous in their endorsement of the superlative reproductive qualities of this remarkable pick-up. It can be obtained from leading radio dealers for 104/- inc. P.T.

**FREE ILLUSTRATED FOLDER** describing the G.P.12 (and also crystal and magnetic models for the less exacting) may be obtained by returning the coupon below.



TO COSMOCORD LTD., ENFIELD, MIDDIX.

Please send folder of ACOS Pick-ups.

NAME \_\_\_\_\_  
ADDRESS \_\_\_\_\_

W.W.

### AGENCIES

**ASSOC. Brit. I.E.E.** wishes to contact manufacturers of all electronic instruments desirous of being represented in West Africa.—Box 3181. [2535]

### AGENTS WANTED

**ENQUIRIES** invited from established service engineering shops with interest in high fidelity equipment to act as sole district representatives for London firm; demonstration equipment supplied free on loan, and orders dealt with from London.—Please Write, Box A.C. 35509, Samson C.arks, 57/61, Mortimer St., W.1.  
**LARGE** factors of radio equipment and spares (ex-Government) seek commission agents for the following cities: London and district; Bristol and Cardiff; Birmingham and district; Leicester and Nottingham; Leeds, Sheffield and district; Newcastle-on-Tyne and district; Ipswich and Norwich; Southampton and district; North Wales; Glasgow and district; Inverness and district.—Apply by letter in first instance to: Weston Products (Liverpool), Ltd., Sales Department, 71 Great George St., Liverpool, 1, Tel. Royal 8754. [2446]

### BUSINESS AND PROPERTY

**BELFAST**—Office-showroom; over 1,000 sq. ft.; main street centre; fine light; good access.—Write Box 3110. [2477]

**LIMITED** company for sale at Brighton, wholesaler and retail radio plus electrical contracting, modern d.i. shop with office and workshop on 14 years lease and separate stores, present turnover £80 per week, 1,500 postal customers, unlimited scope; £1,500 p.u.s. v. approx. £1,000; modern unfurnished flat available with garage 1 mile away; full particulars at interview only.—Box 3109. [2475]

### FINANCIAL PARTNERSHIP

**£750**—Working partner required, established radio business, technical, capable complete control; S. Lond. n.—Box 2501. [2476]

### TECHNICAL TRAINING

**A.M.I.E.E.**, City and Guilds, etc. on "No Pass All the Year" terms, over 95% successes; for full details of modern courses in all branches of electrical technology send for our 112-page handbook, free and post free.—B.I.E.T. (Dept. 388A), 17, Stratford Place, London, W.1. [6270]

**UNRIVALLED** opportunities for training in 2 and 3 year telecommunications engineering courses commencing early in 1949; in addition to considerable practical work at the Institutes the 3 year course includes 1 year's training in 2 and 3 year (H.N.V.) factories and laboratories at Hayes (H.N.V.), Columbus, Marconiphone, etc.—Full details, including information concerning postal courses, from Dept. W.W., E.M.I. Institutes, Ltd., 43, Grove Park Rd., London, W.4. Tel. Chiswick 4417-8. [2577]

### TUTOR

The British National Radio School

**OFFERS** you a career. WRITE to-day for free booklet describing our wide range of training courses in radio, Radar, telecommunications, principles, mathematics, physics, and mechanics; correspondence and day classes for the new series of C. & G. examinations; we specialise in turning "operator" into "engineers," and for this purpose our "Four Year Plan" (leading to A.M.I.E.E. and A.M.Brit.I.R.E., with 9 C. & G. Certificates as interim rewards) is unsurpassed; and provides anee has no strings attached.—Studies Director, B.Sc., A.M.I.E.E., M.Brit.I.R.E., 66, Addiscombe Rd., Croydon Surrey. [6811]

**ENGINEERING** careers and qualifications

**BOTH** Government and industry have announced and emphasised that young men with technical knowledge and qualifications must receive every chance to rise to the highest positions within their capacity, in post-war engineering and allied industry; write to-day for "The Engineer's Guide to Success"—200 copies free—which shows you how you can become A.M.I.E.E., A.M.I.Mech.E., A.P.R.Ac.S., etc., and covers all branches in radio, aeronautical, mechanical, electrical, production, aeronautical, etc.

**THE** Technological Institute of Great Britain, 82, Temple Bar House, London, E.C.4. [1776]

**RADIO** training.—P.M.G. exams, and I.E.E. Diploma; prospectus free.—Technical College, Hull. [0611]

**TELEVISION** postal course for radio trades Examination Board's diploma, also postal courses for P.M.G. 2nd and 1st class Certificates and Amateur Radio Transmitting licence. Apply: British School of Telegraphy, Ltd., 179, Clapham Rd., London, S.W.8. (40 years' experience in coaching students in wireless telegraphy and allied subjects.) [2486]

**RADIO ENGINEERING** SCHOOL, Air Service Training, Hamble, Southampton, provides the best full-time training for responsible positions in industry or aviation; students coached for C. & G. Inter. and Final Certs. in radio or tele-communications; Graduateship of Brit. I.R.E., M.C.A., radio engineer licence, and for air and marine radio officers' licences; full details from the Commandant. [2260]

**THE** Institute of Practical Radio Engineers have available Home Study Courses in every phase of radio and television engineering, specialising in the practical training of apprentices in the retail trade; enrolments limited, fees moderate.—The Syllabus of Instructional Text may be obtained post free from the Secretary, I.P.R.E., Fairfield House, 20, Fairfield Road, Crouch End, London, N.8. [1614]

## LASKY'S RADIO LEAD WITH THE BIGGEST NEW YEAR'S BARGAINS

**INDICATOR UNIT TYPE 62.** Containing 20 valves and 6in. cathode ray tube VCR97 (short persistence). Valve line up: 16 8P61, 2 EA50, 2 EB34. Dozens of components, resistances, condensers, 117 Mc/s crystal Muirhead slow motion drive with dial, etc., 16 pt/meters. Totally enclosed in metal case, size: 18in. x 8 1/2in. x 11in. Enamelled grey or black, with coloured control knobs. **LASKY'S PRICE 58/6**, carriage 7/6 extra.

**BRAND NEW AND UNUSED EX-GOVT. CATHODE RAY TUBES TYPE VCR97.** 6in. short persistence. Each tube is contained in spruing vacuum transit case. Fully guaranteed and tested. Heater 4 volts, 1 amp., H.T. 2,500 volts max. **LASKY'S PRICE 35/-**, carriage 7/6 extra.

We advise you to collect these tubes by hand if possible, owing to the great risk of breakage when transported by carrier.

### AT LAST IT'S HERE.

**THE MAGNIFYING LENS TO FIT A VCR97.** It makes your home-built television set almost equal to a 9in. commercial set. Fits directly to front of cabinet. Simple and easy. Requires 4 screws only. **LASKY'S PRICE 29/6**, postage and packing 1/6 extra.

**BIGGER, BETTER, CLEARER, AND SHARPER PICTURES FROM YOUR 6in. CATHODE RAY TUBE.**

**INDICATOR UNIT TYPE 62A (GEE SET).** Containing 21 valves, 117 Mc/s crystal and 6in. cathode ray tube type VCR97 (short persistence). Valve line up: 12 EF50, 2 EB34, 4 8P61, 3 EA50, also 16 pt/meters (wire wound), hundreds of various components, condensers, resistances, switchgear, Muirhead slow motion drive and dial, etc. Totally enclosed in metal cabinet, size: 18in. long, 8 1/2in. wide, 11in. deep. Black enamel finish, front panel black with coloured control knobs. Wgt. 40 lbs. **LASKY'S PRICE 99/6**, carriage 7/6 extra.

Send a 2d. stamp with your name and address in block letters, please for a full list of our Ex-Govt. bargains. It will pay you to pay us a visit.

## LASKY'S RADIO 370, HARROW RD., PADDINGTON LONDON, W.9. (Opp. Paddington Hospital)

Telephone: CUNNINGHAM 1979

Hours. Mon.—Sat. 9.30 a.m. to 6 p.m.  
Thurs. Half-day 1 p.m.

## TELEVISION FROM EX-GOVT GEAR

At the cost of only a few pounds it is possible to build a Television Receiver, utilising ex-Govt. Radar Units. The **FULL CONSTRUCTIONAL DETAILS** can be purchased for only 7/6, but if the under-mentioned Radar Units are ordered the data is supplied gratis. Alternatively, the cost will be allowed if the units are purchased within 14 days.

**UNIT 1** is a Vision Receiver IF Strip at 55/-.

**UNIT 2** is a Radar Indicator containing CR Tube, etc., at 75/-.

The combined H.T. and E.H.T. Mains Transformer is specially made, and costs 110/-. If this is ordered with the above two units the total cost is **ONLY £11 10/-** showing a saving of 10/-. Customers ordering by post are requested to add 12/6 carriage, plus 10/- deposit on returnable packing case.

An optional item as our specially made **MAGNIFYING LENS** which adds to the entertainment value by increasing the picture size. This costs **ONLY 29/6**, plus 1/6 postage.

For the convenience of callers we are 2 mins. from High Holborn (Chancery Lane Stn.), and 5 mins. from King's Cross (Buses 186, 613, etc.). We are open from 9-6, Saturdays 9-1.

C.W.O. please.

S.A.E. for lists

**E.U.I. THE RADIO CORNER**  
138 GRAY'S INN ROAD,  
LONDON, W.C.1.

## MIDLAND INSTRUMENT Co.

### BRAND NEW GOVT. SURPLUS STOCK

**ELECTRIC TIME CLOCK** runs for over 1 year from 3 volt cycle battery. 44-45 24-hour setting, also sex. hand, jewelled movement, 3 1/2in. dia. by 1 1/2in. brand hand, sections, 7/6 post 9d. **EX-G.P.O. TELEPHONE STANDS** (less handsets) consists of hand generator, bell, dial (numbers and letters) 6-way cord and terminal block, 15/- post 1/4, two post free. Ditto less dials, 12/6 post 1/4; dials only, 3/6 post 6d. **ELECTRIC PUMPS**, centrifugal type, self priming, must be used approx. 25ft., delivery 10-g.p.m., ideal for water supply, garden fountains, lilge pumps, etc., two models, 12 or 24 v. A.C./D.C., 25/- post 1/4. **TRANSFORMERS**, input 230 v. 50 cps., output 20 v. 50 cps., or with little alteration, 100 v. at 51 amp., 25/- carriage 5/-, ALTIMETERS, sensitive "Kullman" type 15/- post 9d. **ARTIFICIAL HORIZONS** contains Sperry gyroscope, cost 25s. 3/6, post 1/-, **DIRECTION INDICATORS**, gyroscope compasses 7/6 post 1/-. **MAGNETIC COMPASSES**, type P-8, alcohol fluxgate, engraved 300 deg., luminous cross-wires, in wood carrying cases, 10/- post 1/-. Also P-18 O-2A and O-6A magnetic compasses in box. **D.R. MASTER COMPASS SETS**, special offer, limited stock, all brand new, consists of one master compass, one pilot's repeater compass, one observer's repeater compass, one variation setting corrector, 25 carriage 10/-. **WALKIE-TALKIE AERIALS**, copper collapsible, sections, 7 1/2in. long, 1/2in. dia., tapers to 3/32in. Also aces good fishing rod, 2/6, post 6d. **RADIO SUPPRESSORS TYPE "D"**, 6-section metal cases, dust coated coils and condensers, suitable for most types of radio interference, size 6in. x 4 1/2in. x 2in., easily worth 25/- our price 2/8 post 1/-. **MICROPHONES**, all fitted switch, carbon differential, 1/6 post 4d., electromagnetic, 1/6 post 4d., moving coil, 5/-, post 6d. **REPEATER MOTORS** small repeater compass type, 2/6 post 7d. **TELEPHONE SETS**, consists of two combined microphones and telephones, 25ft. connecting flex, provides perfect two way communication, self-energised, no battery required. 7/6 post 9d. **MOTORS**, fitted overload clutch and 1/4ft. flexible drive, 24 v. A.C./D.C., 1 h.p., exceptional offer 20/- post 1/4. **MAINS MOTORS**, 300/250 v. A.C./D.C., takes approx. 1 amp., fitted gearbox, final drive approx. 25 F.p.m., another final drive with 1 step, intermittent maltice cross movement, also fitted enclosed fan blower, 25/-, post 1/4. Hundreds of other interesting items. Send for our current lists, 2d. with s.a.e. Orders over 30/- post-paid, carriage orders are extra in all cases, our C.O.D. service has been cancelled for the time being.

**MOORPOOL CIRCLE, BIRMINGHAM, 17**  
Tel. HARborne 1308 or 2644



**A.M.I.Mech.F., A.M.I.E.E., City and Guilds,** etc., on "No Pass—No Fee" terms, over 95% success; for details of exams, and courses in all branches of engineering, building, etc. Write for 108-page handbook—free.—B.I.E.T. (Dept. 387B), 17, Stratford Place, London, W.1.

**BOOKS, INSTRUCTIONS, ETC.**  
YOURS for the asking; grand new catalogue of over 100 new publications dealing with every aspect of radio, television and electrical engineering; also 6-page ditto of exceptional bargain lines in radio and gram equipment, and the pick of current Government releases; s.a.e. please. to: Radio Unlimited, 16, Carnarvon Rd., Leyton, E.10. [2251]

**THIS Does these**



**ACCURATELY and QUICKLY**  
Chassis, Brackets, Shrouds, Condensers and Transformer clips—**TREPPANING** Steel or Aluminium  
Five sizes—12" to 36"  
Full particulars from  
**A. A. TOOLS, (W),**  
197A, WHITEACRE ROAD  
ASHTON-UNDER-LYNE

**WEBB'S** 1948 radio map of world, new multi-colour printing, with up-to-date call signs and fresh information, on heavy art paper, 4/6, post 6d. on linen on rollers, 11/6, post 9d.—Webb's Radio, 1-4, Soho St., W.1, Gerrard 2089.

**BRANS'** "Radio Valve Vade-Mecum," 1948 Edition (two volumes), 18/6, post free, listing over 10,000 types; also Brans' "Radio-schema's," 5 volumes circuits and technical data on Continental and some British and American receivers, 24 postage 2/6; fuller details in November issue; only one copy may be sent to any one address.—Peter Armstrong, 136, Bickenhall Mansions, London, W.1. Wellbeck 4895. [2585]

**LOOK!**

**Mains Transformers, Screened, Fully Interleaved and Impregnated.**

<b>H.S.63.</b> Input 200/250, Output 250/0/250, 60 m/A, 6.3 v. at 3 amp., 5 v. at 2 amp.	15/6 Half Shrouded
<b>H.S.40.</b> Windings as above, 4 v. at 4 amp., 4 v. at 2 amp.	19/6 Fully Shrouded
<b>F.S.2.</b> Input 200/250, Output 250/0/250, 80 m/A.	19/6 Fully Shrouded
<b>F.S.3.</b> Input 200/250, Output 350/0/350, 6.3-4.0 v. at 4 amp., 5-4.0 v. at 2 amp.	17/6 Half Shrouded
<b>H.S.2.</b> Windings as F.S.2, 80 m/A.	17/6 Half Shrouded
<b>H.S.3.</b> Windings as F.S.3, 80 m/A.	17/6 Half Shrouded

C.W.O. (add 1/3 in the £ for Carriage. Over £2 Carriage Paid).

**H. ASHWORTH, 676 Great Horton Rd., Bradford, Yorks.**

**FORREST** (EST. 1922)

**FOR QUALITY**

- TRANSFORMERS
- CHOKES, ETC.
- REWINDS (all makes)

**SHIRLEY, BIRMINGHAM . . . . SHI. 2483**

**BRASS, COPPER, DURAL, ALUMINIUM, BRONZE**

ROD, BAR, SHEET TUBE, STRIP WIRE.

**3,000 STANDARD STOCK SIZES**

No Quantity too Small List on application

London: **H.ROLLET & Co., Ltd. Livers' 1:**  
6, Chesham Place, S.W.1. Kirkby Estate, SLOane 3463 SIMONSWOOD 3271/3

**EDDYSTONE**

'640' . . . . £27 10s. 9d.

H.P. Terms available.

Orders now being booked in strict rotation.

Full range of components.

All C.O.D. orders promptly executed.

Send for Catalogue, 1/- post free.

**SPECIAL OFFER**

P.M. Speakers  
Goodman's, Tru.ox, Rola (as available).  
5 inch 13/-; 6 inch 14/-; 8 inch 16/- including packing and postage.

**B.T.S.**

The Radio firm of the South.  
63, London Road, Brighton 1, Sussex.  
'Phone : Brighton 1555

**INDEX TO ADVERTISERS**

A.A. Tools . . . . .	PAGE 72	Eta Tool Co. (Leicester), Ltd. . . . .	PAGE 22	Premier Radio Co. . . . .	PAGE 31
A.B. Metal Products, Ltd. . . . .	70	Factor, J., Ltd. . . . .	70	Quartz Crystal Co., Ltd. . . . .	64
Acoustical Mfg. Co., Ltd. . . . .	40	Film Industries, Ltd. . . . .	Edit. 503	Radford, A. H. . . . .	66
Ad. Auriema Inc. . . . .	20	Fluxite, Ltd. . . . .	48	Radio-Electronics, Ltd. . . . .	70
Adqola Products, Ltd. . . . .	66	Forrest, H. W. . . . .	72	Radiomart (B'ham), Ltd. . . . .	26
Advance Components, Ltd. . . . .	10	Frith Radiocraft, Ltd. . . . .	48	Radiospares . . . . .	30
Aerialite, Ltd. . . . .	14	Furzehill Laboratories, Ltd. . . . .	20	Rediffusion, Ltd. . . . .	64
Airmec Laboratories, Ltd. . . . .	49	Galpins . . . . .	63	Reliance Mfg. Co. (Southwark), Ltd. . . . .	69
Allan, Richard, Radio, Ltd. . . . .	52	Gardners Radio, Ltd. . . . .	42	Reproducers & Amplifiers, Ltd. . . . .	6
Allen Components, Ltd. . . . .	69	General Electric Co., Ltd. . . . .	7, 32	R.M. Electric, Ltd. . . . .	6
Armstrong Wireless & Television Co., Ltd. . . . .	57	General Lamination Products, Ltd. . . . .	26	Rogers Developments Co. . . . .	68
Ashworth, H. . . . .	72	Goodmans Industries, Ltd. . . . .	2	Rollet, H., & Co., Ltd. . . . .	72
Atkins, H. C. Laboratories . . . . .	70	Gray, A., Ltd. . . . .	54	Runkken . . . . .	70
Austin Mills, Ltd. . . . .	72	Hadley Bros., Ltd. . . . .	5	Salford Electrical Instruments, Ltd. . . . .	66
Automatic Coil Winder & Electrical Equip't. Co., Ltd. . . . .	1	Hartley, H. A. Co., Ltd. . . . .	56	Sangamo Weston, Ltd. . . . .	35
A.W.F. Radio Products, Ltd. . . . .	56	Haynes Radio, Ltd. . . . .	68	Savage Transformer, Ltd. . . . .	18
Barker, A. C. . . . .	66	Henry's W. T., Telegraph Works Co., Ltd. . . . .	58	Savage, W. Bryan, Ltd. . . . .	60
Belling & Lee, Ltd. . . . .	41	Hill & Churchill, Ltd. . . . .	50	Simon Sound Service . . . . .	2
Berger, Lewis & Sons, Ltd. . . . .	51	Hivac, Ltd. . . . .	70	Sound Rentals, Ltd. . . . .	14
Bird, S. S., & Sons, Ltd. . . . .	41	Holborow & Co. . . . .	50	Sounds . . . . .	44
Birmingham Sound Reproducers, Ltd. . . . .	47	Holsun Batteries, Ltd. . . . .	12	Southern Radio Supply, Ltd. . . . .	67
Brierley, J. H. (Gramophones & Recordings), Ltd. . . . .	16	Holt, Stan . . . . .	62	Southern Trade Services, Ltd. . . . .	68
Brighton Tele-Services . . . . .	72	Hunt, A. H., Ltd. . . . .	35	Stability Radio Components, Ltd. . . . .	46
Britain, C. (Radio), Ltd. . . . .	62	Imhof, A., Ltd. . . . .	Edit. 505	Standard Electrical Eng. Co. . . . .	29
British Communications Corp'n., Ltd. . . . .	16	Industrial Electronics . . . . .	Edit. 505	Standard Telephones & Cables, Ltd. . . . .	39, 45
British Institute of Engineering Technology . . . . .	62, 67, 70	International Correspondence School, Ltd. . . . .	46	Stearite & Porcelain Products, Ltd. . . . .	21
British Insulated Callender's Cables, Ltd. . . . .	Cover 41	Jackson Bros. (London), Ltd. . . . .	24	Stern Radio, Ltd. . . . .	67
British National Radio School . . . . .	65	Johnson, Matthey & Co., Ltd. . . . .	27	Stewart Transformers, Ltd. . . . .	24
British Physical Laboratories . . . . .	24	Kerry's (Gt. Britain), Ltd. . . . .	22	Stratton & Co., Ltd. . . . .	26
Brown, S. G., Ltd. . . . .	20	Lasky's Radio . . . . .	71	Taylor Electrical Instruments, Ltd. . . . .	51
Bulgin, A. F., & Co., Ltd. . . . .	Edit. 509	Leak, H. J. & Co., Ltd. . . . .	13	Telegraph Condenser Co., Ltd. . . . .	15
Bull, J., & Sons . . . . .	61	Linton, H. H., & Co., Ltd. . . . .	54	Telephoto Co. . . . .	62
Bull's Ex-Govt. Depot . . . . .	68	London Central Radio Stores . . . . .	25	Te-e-Radio (1943) Ltd. . . . .	32
Bullers, Ltd. . . . .	49	London Radio Supply Co. . . . .	64	Thompson, W. & J. R. (Woodturners), Ltd. . . . .	30
Burgoyne Eng. Co., Ltd. . . . .	66	Lowther Mfg. Co. . . . .	65	Transradio, Ltd. . . . .	52
Candler System Co. . . . .	6	Lustraphone, Ltd. . . . .	54	Trix Electrical Co., Ltd. . . . .	Edit. 501
Charles Amplifiers, Ltd. . . . .	54	Lyncar Laboratories . . . . .	68	Truvox Eng. Co., Ltd. . . . .	17
Chloride Electrical Storage Co., Ltd. . . . .	4	Mail Order Supply Co. . . . .	52	T. & C. Radio College . . . . .	58
Cinema-Television, Ltd. . . . .	34	Marconi Instruments, Ltd. . . . .	28	United Insulator Co., Ltd. . . . .	3
Clydesdale Supply Co., Ltd. . . . .	64	Marconi Wireless Telegraphy Co., Ltd. . . . .	12	Universal Electrical Instruments Corp'n. . . . .	71
Colcaro, Ltd. . . . .	25	Masteradio, Ltd. . . . .	23	University Radio, Ltd. . . . .	70
Cosmocond, Ltd. . . . .	71	McMichael Radio, Ltd. . . . .	48	Vallance & Davison, Ltd. . . . .	50
Couplphone Radio . . . . .	46	McMurdo Instrument Co., Ltd. . . . .	8	Vitavox, Ltd. . . . .	54
Coventry Radio . . . . .	49	Metro Pex, Ltd. . . . .	5	Vitvoxt Patents, Ltd. . . . .	42
Davis, Alec . . . . .	69	Midland Instrument Co. . . . .	71	Vortexion, Ltd. . . . .	43
Denco (Clacton), Ltd. . . . .	32	Modern Book Co. . . . .	66	Ward, Chas. F. . . . .	64
Desoutter Bros., Ltd. . . . .	36	Motherwell Machinery & Scrap Co., Ltd. . . . .	67	Watts, M., & Co. . . . .	56
Drayton Regulator & Instrument Co., Ltd. . . . .	30	M.R. Supplies, Ltd. . . . .	28	Wayne Kerr Labs., Ltd., The . . . . .	47
Dubiler Condenser Co. (1925), Ltd. . . . .	71	Mullard Electronic Products, Ltd. . . . .	8, 39	Webb's Radio . . . . .	19
Dupley Electronics, Ltd. . . . .	62	Multicore Solders, Ltd. . . . .	Cover iv	Wells & Co., Ltd. . . . .	53
Edison Swan Electric Co., Ltd. . . . .	11, 33	Oxley Developments Co., Ltd. . . . .	54	Westinghouse Brake & Signal Co., Ltd. . . . .	4
Electradix Radios . . . . .	59	Parmeko . . . . .	40	West, Spencer . . . . .	70
Electric & Musical Industries, Ltd. . . . .	14, 44	Partridge Transformers, Ltd. . . . .	40	Weymouth Radio Mfg. Co., Ltd., The . . . . .	64
Electro Technical Assemblies . . . . .	60	Peerless Radio, Ltd. . . . .	60	Wharfedale Wiresles, Works . . . . .	34
Electronic Instruments, Ltd. . . . .	18	Pennine Amplifiers . . . . .	67	Whiteley Electrical Radio Co., Ltd. . . . .	18
Elmsfield Radio Co. . . . .	71	Phillips Electrical, Ltd. . . . .	60	Wilkins & Wright, Ltd. . . . .	68
Erie Resistor, Ltd. . . . .	Cover iii	Pill, G. N., & Partners . . . . .	44	Wilson, M., Ltd. . . . .	54
Erskine Laboratories, Ltd. . . . .	53			Wireless Supplies Unltd. . . . .	Edit. 507
				Wright & Wearle, Ltd. . . . .	37

Printed in Great Britain for the Publishers, LEFFER AND SONS LTD., Dorset House, Stamford Street, London, N.E.1, by THE CORNWALL PRESS LTD., Paris Garden, Stamford Street, London, S.E.1. "Wireless World" can be obtained abroad from the following—AUSTRALIA AND NEW ZEALAND: Gordon & Gotch, Ltd. IRELAND: A. H. Wheeler & Co. CANADA: Imperial News Co., Gordon & Gotch, Ltd. SOUTH AFRICA: Central News Agency, Ltd.; William Dawson & Sons (S.A.), Ltd. UNITED STATES: The International News Co.

1993

*Quality*

**ACKNOWLEDGED  
THROUGHOUT  
THE WORLD**



**ERIE**

*Radio & Electronic Components*

**RESISTORS · CERAMICONS · Hi-K CERAMICONS · POTENTIOMETERS  
SUPPRESSORS : VITREOUS ENAMELLED WIRE-WOUND RESISTORS**

Erie Resistor Ltd., The Hyde, London, N.W.9, England

Telephone: COLindale 8011-4.

Cables: RESISTOR, LONDON.

Factories: London & Gt. Yarmouth, England · Toronto, Canada · Erie, Pa., U.S.A.

THERE ARE MANY BRANDS OF SOLDER MADE IN U.S.A. — YET

**American manufacturers of radio and electrical equipment prefer British made**

## ERSIN MULTICORE SOLDER

**GENERAL ELECTRIC COMPANY**  
 GENERAL OFFICE SCHENECTADY, N. Y.  
 May 8, 1947

"The girls on our wiring line are loud in their praises of Ersin Multicore Solder. I find it superior to that which we are now using and the flux is non-corrosive. I have instructed our factory to switch over to Ersin Multicore Solder."

**STROMBERG-CARLSON COMPANY**  
 ESTABLISHED 1894  
 ROCHESTER 3, NEW YORK  
 August 15, 1947

"We are using this on radio production lines with very good results. I believe this is being used with greater success than other solder previously used. We have proved to our own satisfaction that Ersin Solder is not corrosive."

**Emerson**  
 RADIO AND PHONOGRAPH CORPORATION  
 111 EIGHTH AVENUE NEW YORK CITY, N. Y.  
 Oct. 16, 1947

"After testing your Multicore Solder on our production lines, we found it to be the fastest solder we ever used. One of its salient advantages is its extraordinary effectiveness in the soldering of tarnished metals."

**OREGON STATE COLLEGE**  
 SCHOOL OF SCIENCE  
 CORVALLIS, OREGON  
 May 15, 1947

"I have found Ersin Multicore Solder excellent for electrical instrument work as the fluxing action is such that a minimum of solder is used in producing a neat job. I also use Ersin Solder in instrument construction where there is danger of distortion when heating with a flame. Joints made in this manner with Ersin Solder have less solder on the outside of the work due to the excellent penetration of Ersin flux."

Despite the fact that there are freight charges and duties to be paid on the importation into U.S.A. of Ersin Multicore Solder and its higher initial cost, many American radio concerns prefer to import this British made solder for use in the manufacture of their equipment. They find that the use of Ersin Multicore—which alone has 3 cores of extra-active non-corrosive Ersin flux—effects great savings in material and labour costs, giving high speed precision soldering without waste. It will pay you to use only Ersin Multicore Solder.

*The Finest Cored Solder in the World*

Ersin Multicore Solder is supplied on nominal 7 lb. reels for use by manufacturers. Prices on application. The prices for the size I Carton illustrated, are detailed below:



Catalogue Ref. No.	Alloy Tin-Lead	S.W.G.	Approx. length per carton	List price per carton (subject)
C 16014	60/40	14	34 feet	6 0
C 16018	60/40	18	88 feet	6 9
C 14013	40/60	13	21 feet	4 10
C 14016	40/60	16	46 feet	5 3

**MULTICORE SOLDERS LTD.**  
 MELLIER HOUSE, ALBEMARLE STREET, LONDON, W.1. REGent 1411